

# ZOOM Super PLAYER

# 8080

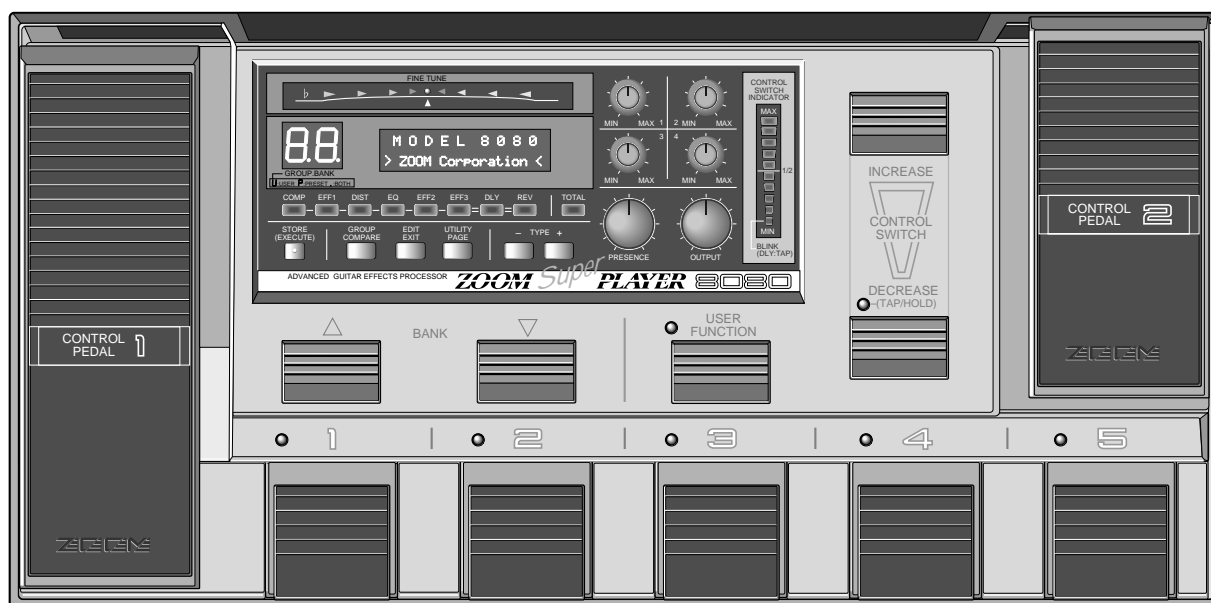

## Operation Manual

# ZOOM®

Thank you for selecting the **ZOOM SUPER PLAYER 8080** (hereafter simply called the "8080"). The 8080 is a sophisticated multi-effect device with the following features and functions:

- 47 types of high-quality single effects produced by two new-generation Zoom DSP ZFx-2 chips. Up to 10 effects can be combined for simultaneous use, with flexible patching arrangements. Virtually unlimited possibilities let you create your ultimate guitar sound.
- Large internal memory holds 150 superb preset patches programmed by top-notch professionals, plus 50 user- definable patches.
- Many effects simulate the sound of famous vintage effects that are hard to find nowadays. Faithful recreation even includes the operation 'feel'.
- Seamless patch change lets you activate a new patch while the old patch still reverberates, ensuring smooth transitions.
- Dedicated analog circuitry for various distortion effects. Built-in amp simulator maintains dynamic guitar sound also during line recording and headphone monitoring.
- Patches can include external effect on/off setting and external amp channel selection.
- Four data entry knobs and an array of large foot switches allow easy control and adjustment with an analog touch. Even musicians who have so far only used compact effects will instantly feel at home.
- Integrated auto-chromatic guitar tuning function with tuning meter allows quick and precise tuning of instruments on stage.
- Three real-time control circuits and two control pedals can be used for pedal wah, pedal pitch shifter and any other effect parameter or level setting. Separate control switches allow step-by-step adjustment.

Please take the time to read this manual carefully, in order to get the most out of your 8080 and to ensure optimum performance and reliability.

# Organization of This Manual

The pages explaining operation steps are organized as follows.

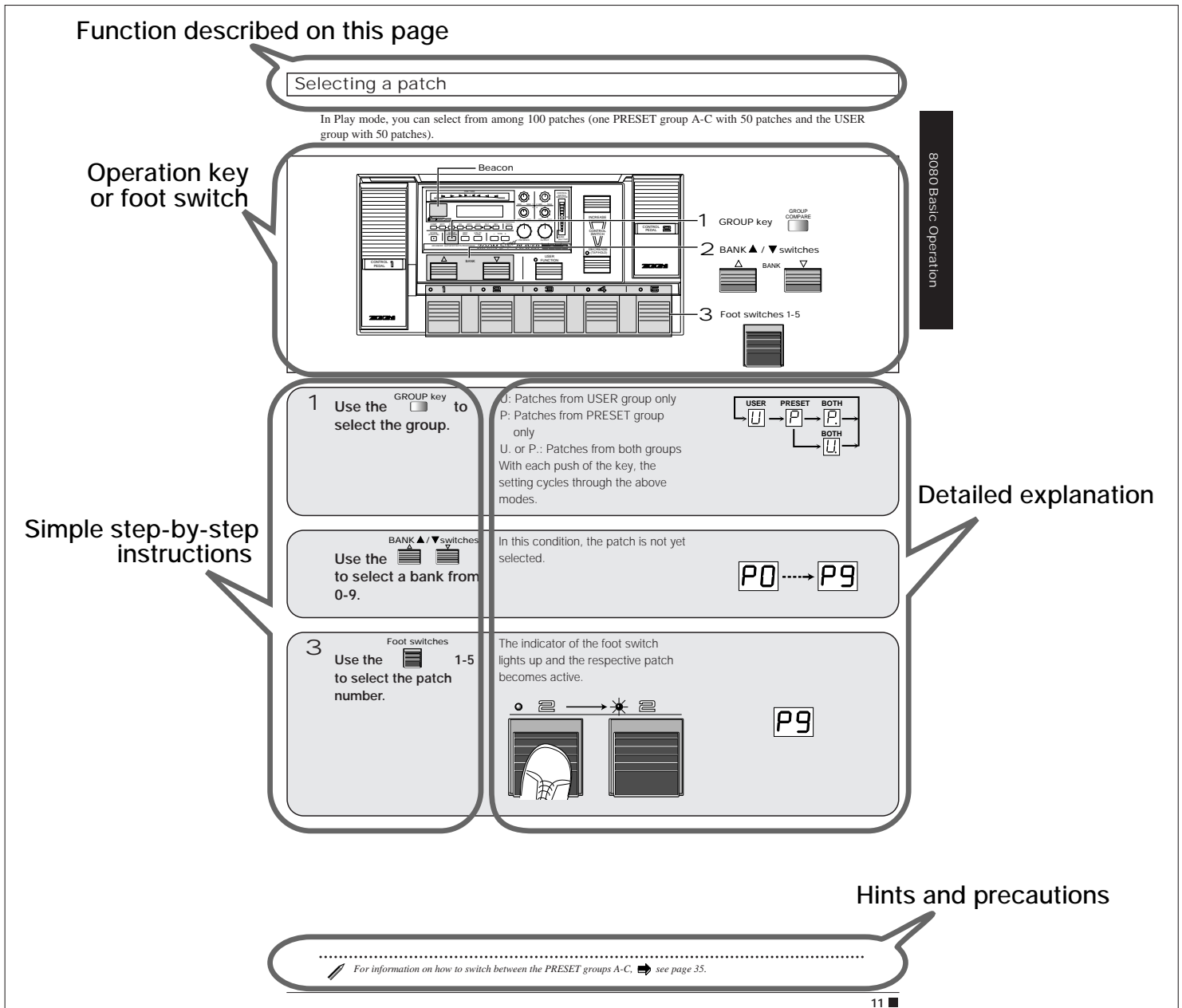

8080 Basic Operation

## Graphical Symbols Used in This Manual

The following symbols are used in this manual.



[Note]

Important warnings and information about points to consider and possible problems



[Hint]

Additional information regarding useful and convenient functions and usage steps



[Refer to p. ] Indicates a page where related information can be found.

# USAGE AND SAFETY PRECAUTIONS

## Safety Precautions

In this manual, symbols are used to highlight warnings and cautions for you to read so that accidents can be prevented. The meanings of these symbols are as follows:



Warning

This symbol indicates explanations about extremely dangerous matters. If users ignore this symbol and handle the device the wrong way, serious injury or death could result.



Caution

This symbol indicates explanations about dangerous matters. If users ignore this symbol and handle the device the wrong way, bodily injury and damage to the equipment could result.

**Please observe the following safety tips and precautions to ensure hazard-free use of the 8080.**



Warning

### • Power requirements

The 8080 is powered by the supplied AC adapter. To prevent malfunction and safety hazards, Do not use any other kind of AC adapter.

When using the 8080 in an area with a different line voltage, please consult your local ZOOM distributor about acquiring a proper AC adapter.



Caution

### • Environment

Avoid using your 8080 in environments where it will be exposed to:

- Extreme temperature
- High humidity or moisture
- Excessive dust or sand
- Excessive vibration or shock



Caution

### • Handling

Since the 8080 is a precision electronic device, avoid applying excessive force to the switches and buttons. Also take care not to drop the unit, and do not subject it to shock or excessive pressure.



Caution

### • Alterations

Never open the case of the 8080 or attempt to modify the product in any way since this can result in damage to the unit.



Caution

### • Connecting cables and input and output jacks

You should always turn off the power to the 8080 and all other equipment before connecting or disconnecting any cables. Also make sure to disconnect all cables and the AC adapter before moving the 8080.

## Usage Precautions

### • Electrical interference

For safety considerations, the 8080 has been designed to provide maximum protection against the emission of electromagnetic radiation from inside the device, and from external interference. However, equipment that is very susceptible to interference or that emits powerful electromagnetic waves should not be placed near the 8080, as the possibility of interference cannot be ruled out entirely.

Whatever the type of digital control device, the 8080 included, electromagnetic damage can cause malfunctioning, and can corrupt or destroy data. Since this is an ever-present danger, thorough care should be taken to minimize the risk of damage.

### • Cleaning

Use a soft, dry cloth to clean the 8080. If necessary, slightly moisten the cloth. Do not use abrasive cleanser, wax, or solvents (such as paint thinner or cleaning alcohol), since these may dull the finish or damage the surface.

**Please keep this manual in a convenient place for future reference.**

# Contents

## Basic Operation

Names of Parts .....	6
Top Panel View .....	6
Rear Panel View .....	6

Connection Examples .....	7
---------------------------	---

Outline of the 8080 .....	8
Effect module configuration .....	8
Patches .....	8
Modes .....	9
Preparations .....	9

Trying Out a Patch (Play Mode Operation) .....	10
Indications in Play mode .....	10
Selecting a patch .....	11
Effect Module On/Off Switching .....	12
Using the bypass/mute function .....	13
Using the Auto tuner function .....	14
Calibrating the tuner reference pitch .....	15
Adjusting the patch level .....	16

## Advanced Operation

Editing a Patch (Edit Mode Operation) .....	18
Activating the Edit mode .....	18
Indications in Edit mode .....	19
Switching modules on and off .....	20
Changing the parameter settings .....	21
Comparing an edited patch with its original condition .....	22
Storing an edited patch .....	23

Using the RTM Function .....	24
Using the CONTROL pedals for RTM .....	24
Using the CONTROL switches for RTM .....	26
Tapping input of delay time .....	28
Delay hold .....	30

Utility Mode .....	32
Switching between Utility mode and Play mode .....	32
Amp simulator settings: pages 1, 2 .....	33
USER FUNCTION switch settings: page 3 .....	33
MIDI settings: pages 4 - 6 .....	34
Foot switch settings: pages 7, 8 .....	35
Switching PRESET groups A/B/C: page 9 .....	35

Using the USER FUNCTION Switch .....	36
To switch between Play mode and Manual mode with the USER FUNCTION switch .....	36
Using the USER FUNCTION switch to call up a bank or patch .....	38
Using the USER FUNCTION switch to select PRESET A/B/C .....	40

Other Functions .....	41
Controlling an external effect device .....	41
Controlling an external amplifier .....	42
Returning the 8080 to the factory default condition .....	44

## Effect Types and Parameters

Effect Modules of the 8080 .....	46
CMP (Compressor) Module .....	47
EFF1 Module .....	48
DIST (Distortion) Module .....	50
EQ Module .....	54
EFF2 Module .....	55
EFF3 Module .....	58
DLY (Delay) Module .....	60
REV (Reverb) Module .....	62
TOTAL Module .....	63

## APPENDIX

MIDI Implementation .....	66
Specifications .....	67
Troubleshooting .....	68

### MIDI Implementation Chart

ZOOM *Super* PLAYER



---

# Basic Operation

---

<b>Names of Parts</b> .....	<b>6</b>
Top Panel View.....	6
Rear Panel View.....	6
<b>Connection Examples</b> .....	<b>7</b>
<b>Outline of the 8080</b> .....	<b>8</b>
Effect module configuration.....	8
Patches.....	8
Modes.....	9
Preparations.....	9
<b>Trying Out a Patch (Play Mode Operation)</b> .....	<b>10</b>
Indications in Play mode.....	10
Selecting a patch.....	11
Effect Module On/Off Switching.....	12
Using the bypass/mute function.....	13
Using the Auto tuner function.....	14
Calibrating the tuner reference pitch.....	15
Adjusting the patch level.....	16

# Names of Parts

## Top Panel View

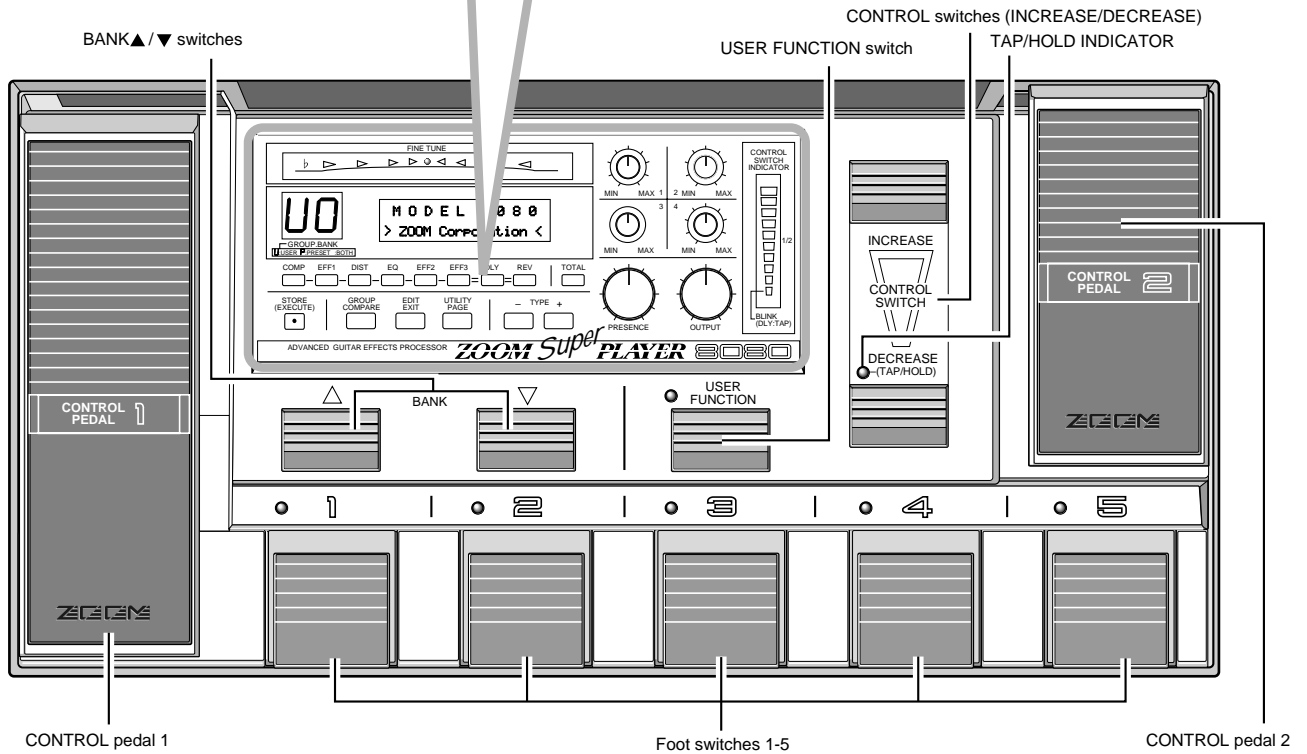
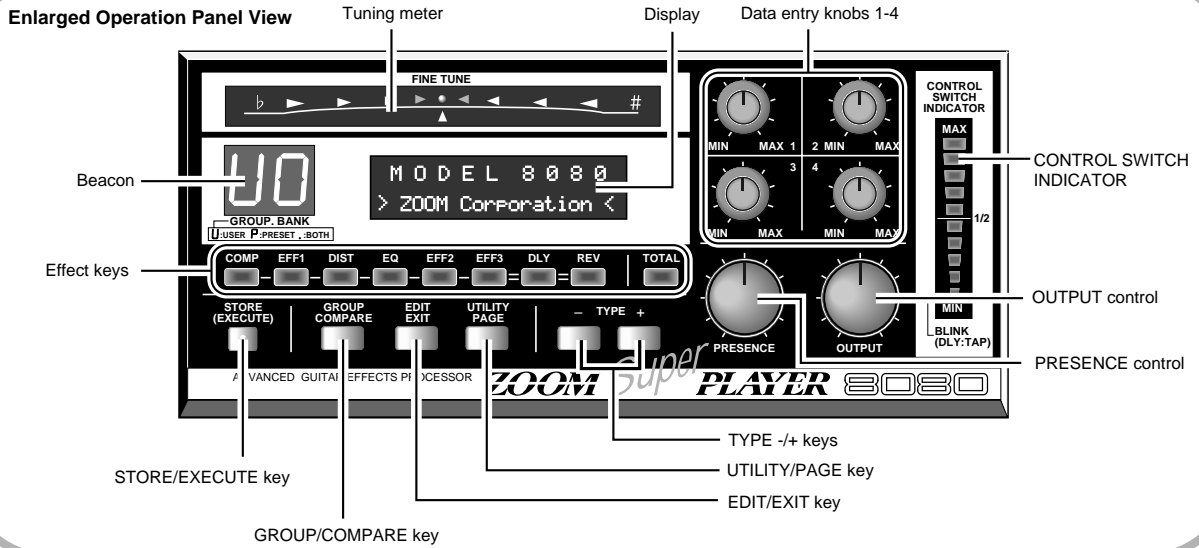

## Rear Panel View

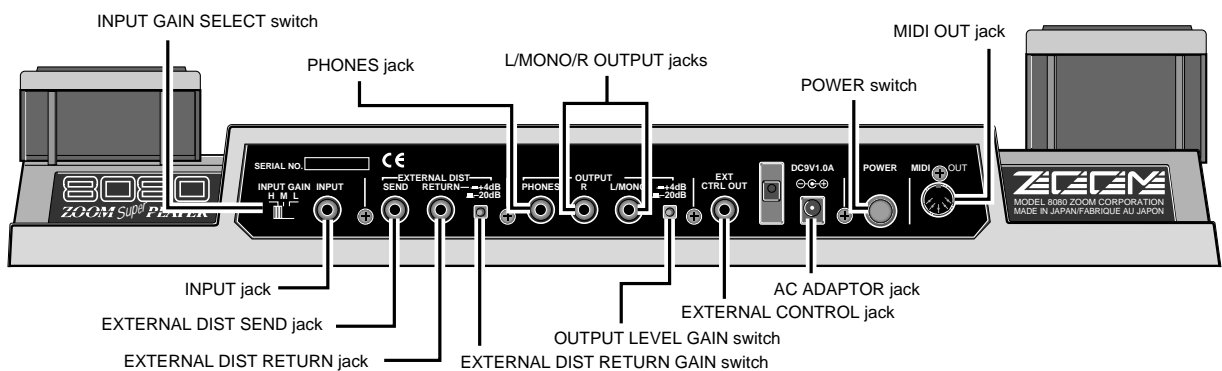

# Connection Examples

## Connection example 1: instrument/guitar amplifier connection

When using only one guitar amplifier, connect the L/MONO OUTPUT jack of the 8080 to the input of the guitar amplifier. In this case, the L and R signals of stereo effects will be combined in the output.

When using two guitar amplifiers, connect the L and R OUTPUT jacks of the 8080 to the inputs of the guitar amplifiers.

 Set the **OUTPUT LEVEL GAIN** switch to the position which matches the input sensitivity of the connected equipment. For connection to a guitar amplifier, the "-20 dB" position will normally be best, whereas professional effect devices and mixing consoles will work better with the "+4 dB" setting.

## Connection example 3: external guitar amplifier connection

When wishing to control channel switching of a guitar amplifier using the foot switches of the 8080, connect the **EXTERNAL CONTROL** jack of the 8080 with the foot switch jack of the guitar amplifier, using either a stereo or mono cable ( ➡ p. 42).

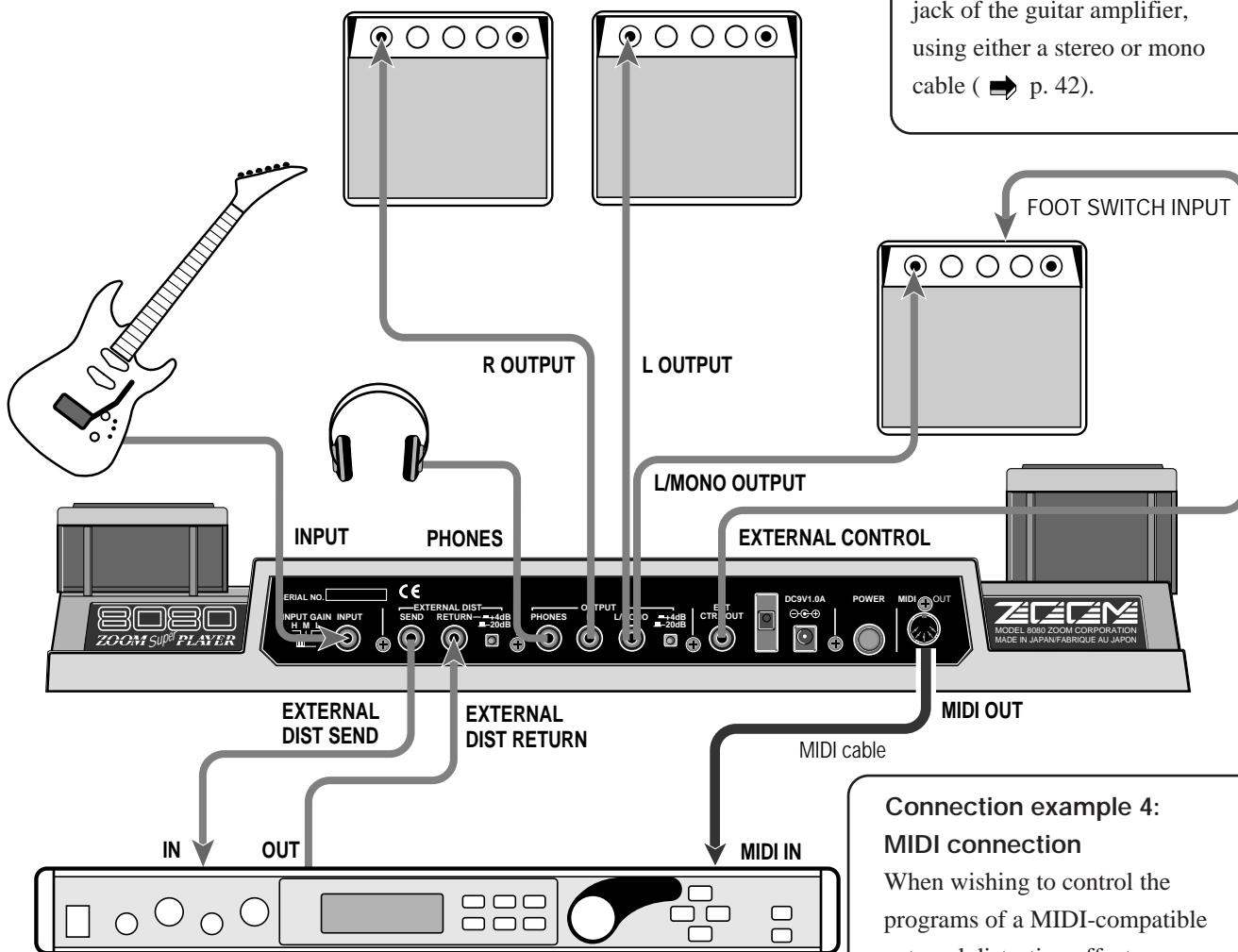

## Connection example 2: external effect/preamplifier connection

When wishing to control the on/off condition of an external distortion effect or preamplifier or similar, connect the effect device in the **EXTERNAL DIST SEND** and **EXTERNAL DIST RETURN** loop ( ➡ p. 41).

 Set the **EXTERNAL DIST RETURN GAIN** switch to the position which matches the output level of the connected equipment. For use with a compact effect device, the "-20 dB" position will normally be best, whereas professional effect devices and guitar preamplifiers will work better with the "+4 dB" setting.

## Connection example 4: MIDI connection

When wishing to control the programs of a MIDI-compatible external distortion effect or preamplifier or similar, connect the MIDI jack of the device to the **MIDI OUT** jack of the 8080, using a MIDI cable ( ➡ p.34).



# Outline of the 8080

This section explains what the 8080 is and what it can do. You will also find explanations of some important terms here.

## Effect module configuration

The 8080 is a multi-effect device made up of eight different effect modules (effect blocks). Each effect module acts like a single compact effect. The following modules are available:

- **COMP** ..... Compressor effects for processing the sound level
- **EFF1** ..... Equalizer effects and wah/modulation effects with strong characteristics.  
Can be inserted before or after the DIST module.
- **DIST** ..... Analog distortion effects
- **EQ** ..... Basic equalizer effects
- **EFF2** ..... Modulation-type effects for changing pitch and creating special effects
- **EFF3** ..... Standard modulation-type effects such as flanger and chorus
- **DLY** ..... Stereo delay effects
- **REV** ..... Reverberation effects

Almost all effect modules contain several variations of an effect (effect types), out of which the user can select the most suitable one. The illustration below shows the signal flow in the 8080 and the effect types for the various effect modules.

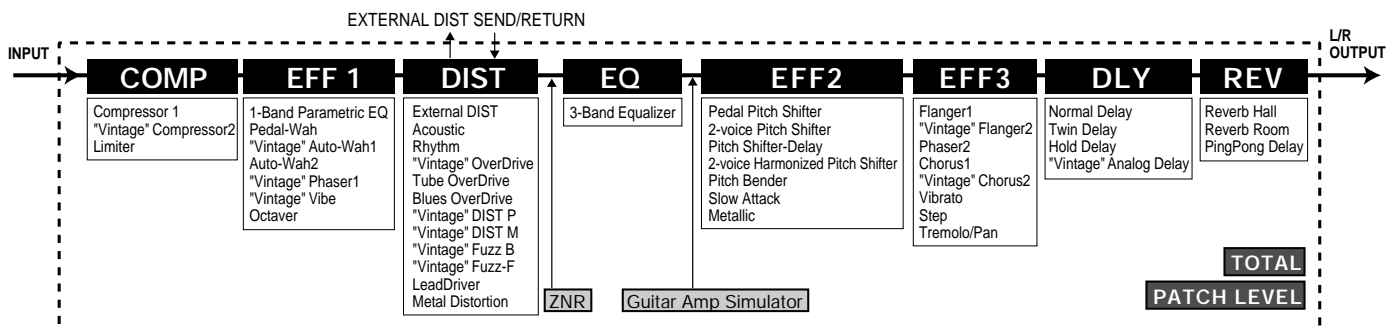

*The EFF1 module can be inserted before or after the DIST module.  
The EFF2 and EFF3 modules can be connected in series or parallel.*

## Patches

Internal settings of the 8080 are called patches which can be stored in memory and called up at any time. A patch consists of the parameter settings for the various effect modules, plus information about the patch level, control pedal and control switch settings, EFF1 routing, EFF2/EFF3 connection type, etc. The section enclosed in a dotted line in the above illustration is a patch.

The 8080 divides patches into four groups: one USER group for patches that can be changed by the user and three PRESET groups (A-C) for patches that have been programmed at the factory. Each group contains 50 patches, resulting in a total of 200 patches. The 8080 allows simultaneous use of one group from the PRESET A-C groups and one patch from the USER group.

Within a group, patches are divided into "banks" of five patches each. Every group has ten such banks (numbered 0-9).

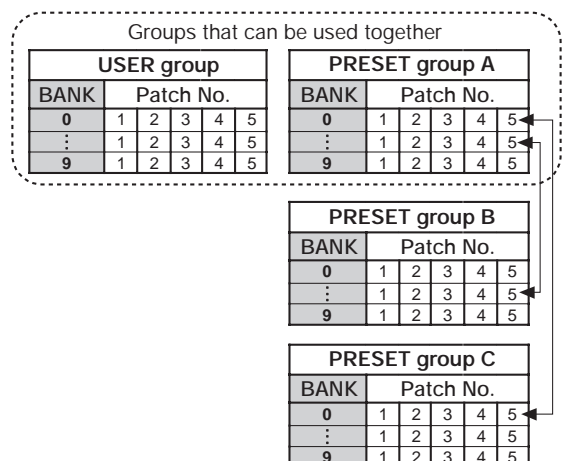

**HINT** You can use the USER FUNCTION switch on the top panel to select PRESET groups A-C ( ➡ p. 40).

## Modes

The 8080 has the following three main operation modes:

- **Play mode** ..... In this mode, you select patches and use them for playing. You can also temporarily turn effects off, tune your instrument, and perform some other functions.
- **Edit mode** ..... In this mode, you can edit (change) the parameters of the effect modules in the currently selected patch.
- **Utility mode** ..... In this mode, you can make amp simulator, MIDI, and other settings which affect all patches.



Besides the above mentioned main operation modes, the 8080 also has a manual mode for turning effect modules off and on with the foot switches during a performance, and the so-called initialize mode for resetting the unit to the factory defaults.

## Preparations

**1** Turn power to the amplifier(s) off and set the volume to minimum.

**2** Connect the 8080 to the instrument, amplifier(s) etc.

**3** Plug the AC adapter of the 8080 into an AC outlet.



**4** Set the INPUT GAIN SELECT switch on the rear panel of the 8080 to a position which matches the output level of the guitar.



Recommended switch settings are as follows. Guitars with single-coil pickups: "H", guitars with hum-bucking type pickups: "M", guitars with active type pickups: "L".

**5** Turn the 8080 on.

POWER



**6** Turn the amplifier(s) on.

**7** Adjust the OUTPUT control of the 8080 to a suitable position and adjust the level controls on the instrument and the amplifier(s).



**8** Use the PRESENCE control on the 8080 to adjust the timbre.



The settings of the OUTPUT and PRESENCE controls are not memorized.

# Trying Out a Patch

(Play Mode Operation)

The Play mode is the basic operation mode of the 8080, in which you select patches and use them while playing your instrument. When the 8080 is turned on, the Play mode is automatically activated and patch number 1 of the USER group/bank 0 is selected.

## Indications in Play mode

In Play mode, the beacon, display, and effect keys show the following information.

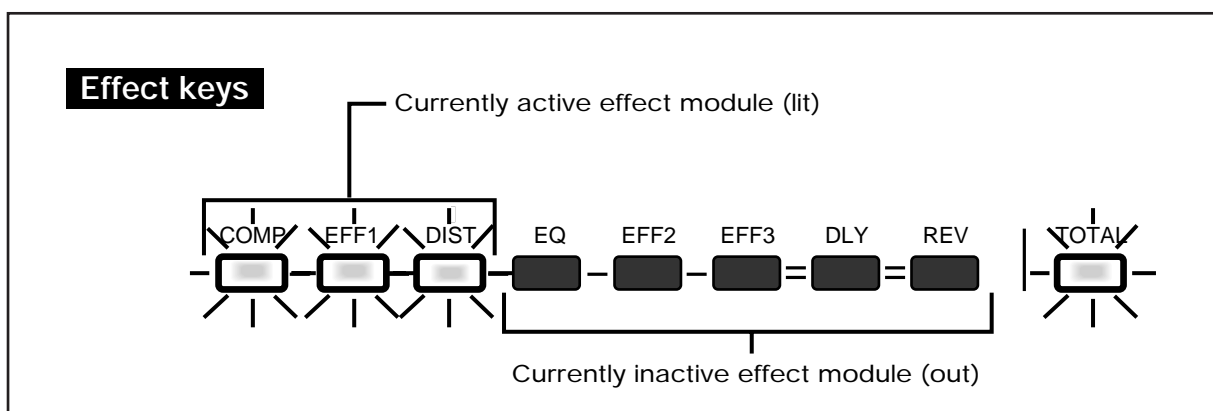
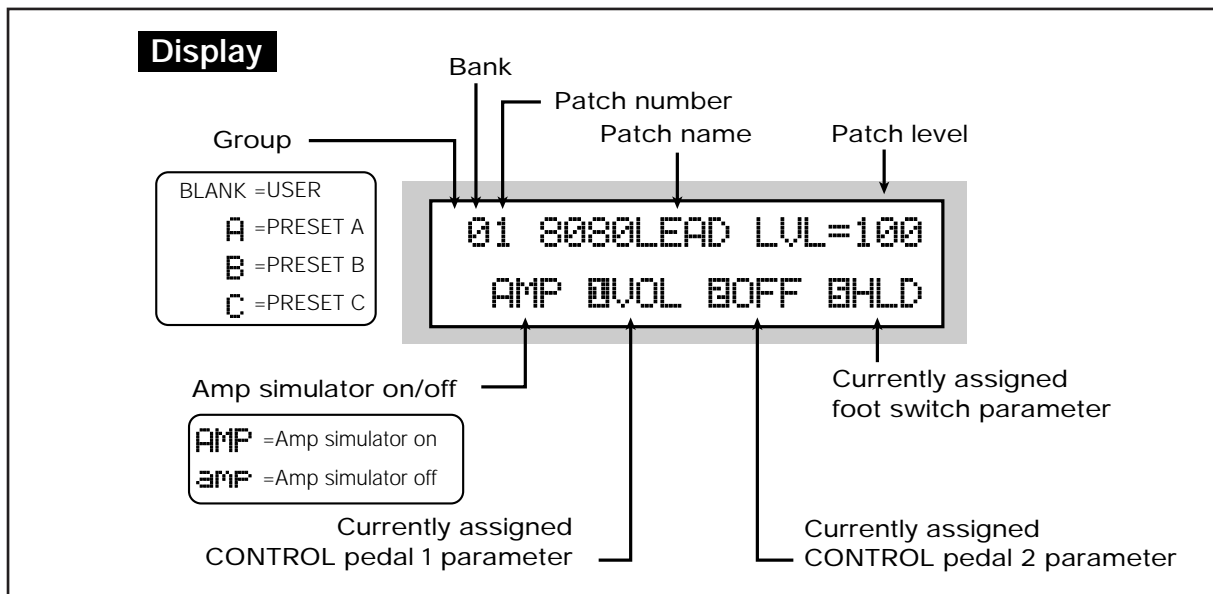
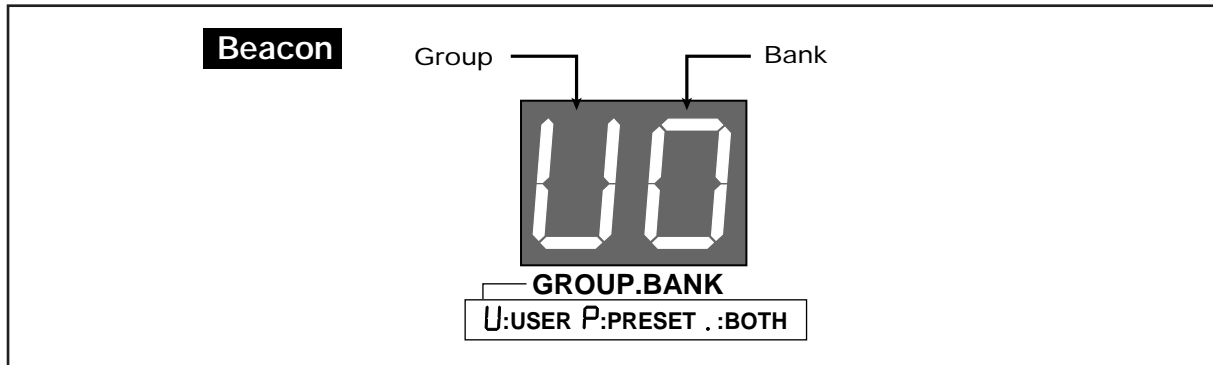

*The patch names and values shown in the illustration are an example. The actual display may differ.*

## Selecting a patch

In Play mode, you can select from among 100 patches (one PRESET group A-C with 50 patches and the USER group with 50 patches).

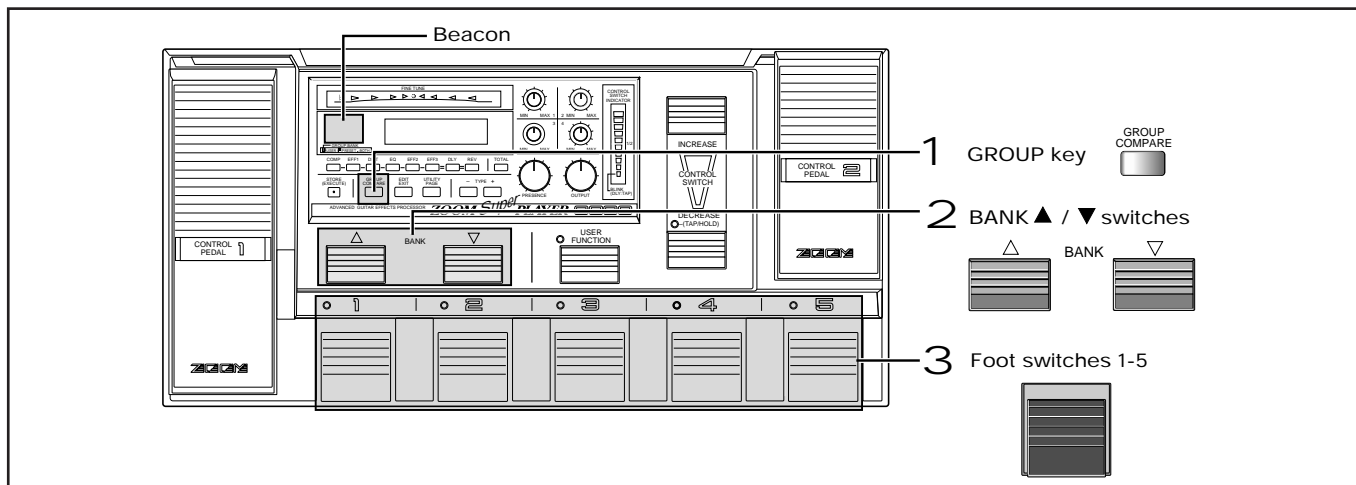

**1** Use the  to select the group.

U: Patches from USER group only  
 P: Patches from PRESET group only  
 U. or P.: Patches from both groups  
 With each push of the key, the setting cycles through the above modes.

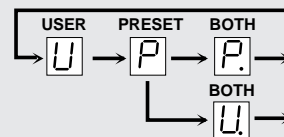

**2** Use the  to select a bank from 0-9.

In this condition, the patch is not yet selected.

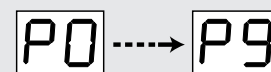

**3** Use the  1-5 to select the patch number.

The indicator of the foot switch lights up and the respective patch becomes active.

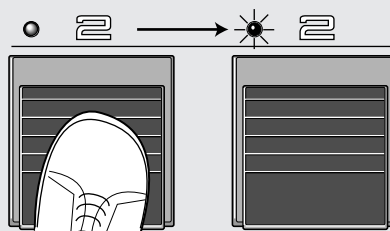

P9



For information on how to switch between the PRESET groups A-C, ➡ see page 35.

# Effect Module On/Off Switching

Each patch of the 8080 is made up of several effect modules. Use the effect keys to switch the desired modules on and off.

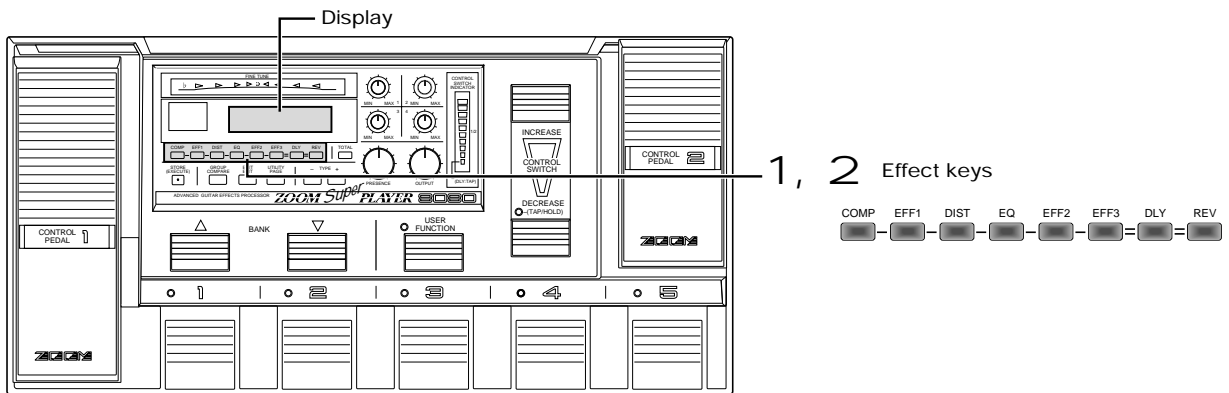

- 1 Press any <sup>Effect key</sup> that is lit (except the TOTAL key).

In Play mode, the keys of effect modules that are currently active are lit, and the keys of modules that are currently inactive are out. Pressing a lit effect key turns that module off.

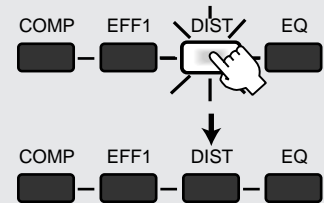

```
01 8080LEAD LVL=100
AMP 0VOL 0OFF 0HLD
```

- 2 Press the <sup>Effect key</sup> once more.

The key lights up and the module becomes active again.

Other effect modules can be switched off and on in the same way.

```
01 8080LEAD LVL=100
0 AMP 0VOL 0OFF 0HLD
```

When an effect module is switched off or on, the indication "E" appears on the display. This indicates that the currently selected patch has been changed (edited).

The TOTAL module contains settings that are active for the entire patch. This module can therefore not be switched off.

**HINT** Unless you store the new setting ( ➔ p. 23), any changes that you have made in the effect module on/off setting of a patch will be lost when you select a different patch.

## Using the bypass/mute function

In the bypass condition, all effects of the 8080 are temporarily disabled, so that only the original sound is heard. This is useful for example to check the overall sonic character of a patch.  
 In the mute condition, the effects of the 8080 as well as the original sound are disabled, so that the output is muted. This is convenient for using the auto tuner function ( ➡ p. 14) without letting others hear the sound.

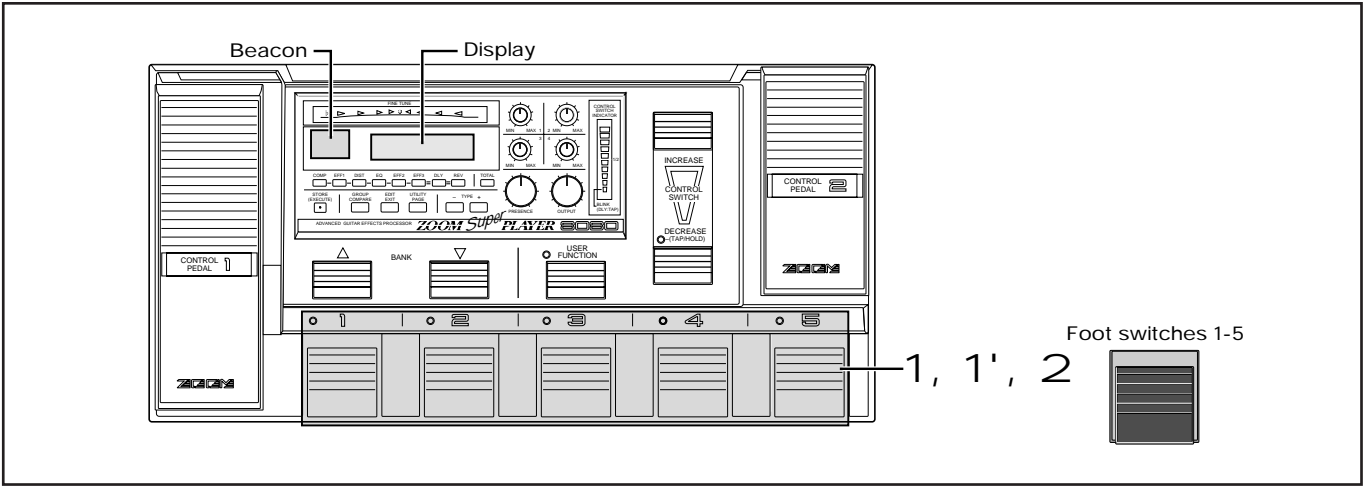

**1 To set the 8080 to the bypass condition, briefly press** the  **1-5** whose LED is lit (i.e. the pedal switch that was used to choose the current patch).

All effects in the patch are now bypassed and the original instrument sound is heard. The indicator of the foot switch flashes.

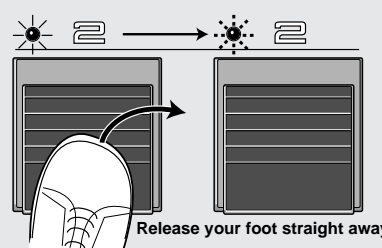

01 8080LEAD BYPASS  
TUNER CALIB=440Hz

**1' To set the 8080 to the mute condition, press** the  **1-5** whose LED is lit (i.e. the pedal switch that was used to choose the current patch) for one second or more.

The output of the 8080 is cut off and the indicator of the foot switch flashes.

**Keep your foot more than one second**

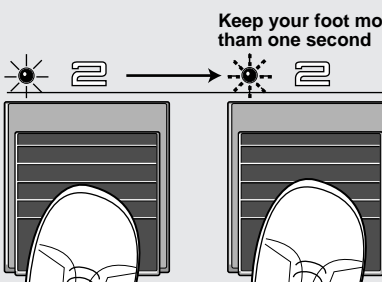

01 8080LEAD MUTE  
TUNER CALIB=440Hz

**2 Press the**  **once more to turn the patch back on again.**

Normal Play mode can also be restored by selecting a different patch.

00

01 8080LEAD LVL=100  
AMP EVOL BOFF BHLD

# Using the Auto tuner function

The 8080 incorporates an auto-chromatic tuner which makes it easy to tune your guitar. This function can be used when the 8080 is in the bypass/mute condition.

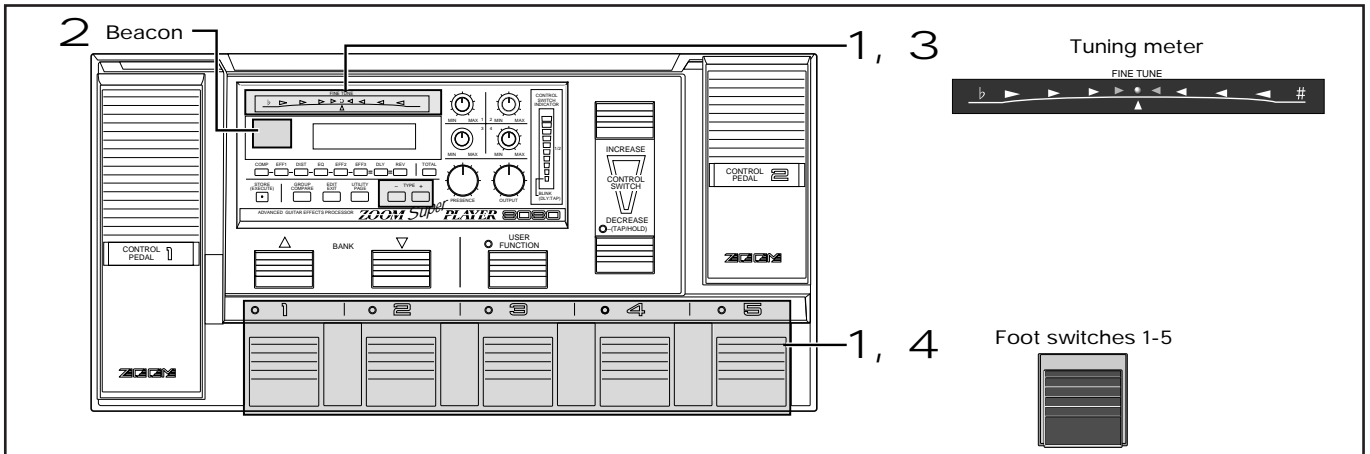

1 Press the  Foot switches The auto tuner can now be used.

1-5 whose LED is lit (i.e. the pedal switch that was used to choose the current patch) to set the 8080 to the bypass or mute condition.



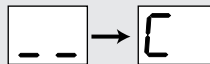

2 Pick the open string on the guitar you want to tune. The beacon shows the note which is closest to the current pitch. Tune the guitar to the desired pitch.

C =		F =		A =	
C# =		F# =		A# =	
D =		G =		B =	
D# =		G# =			
E =					

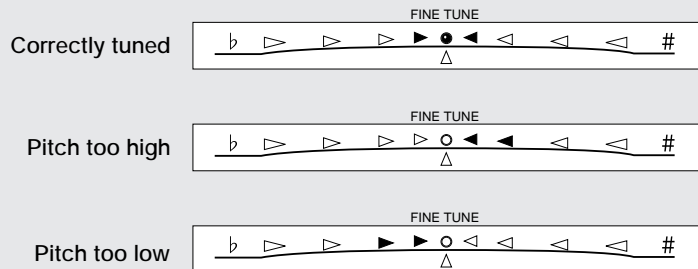

3 When the beacon shows the desired note, continue the tuning process until the FINE TUNE LED of the tuning meter lights up.



4 Press the  Foot switches once more or select a different patch to revert to normal Play mode.



 For tuning on stage or other situations where the sound should not be heard, use the mute function.

# Calibrating the tuner reference pitch

The reference pitch of the auto tuner in the 8080 can be adjusted as follows.

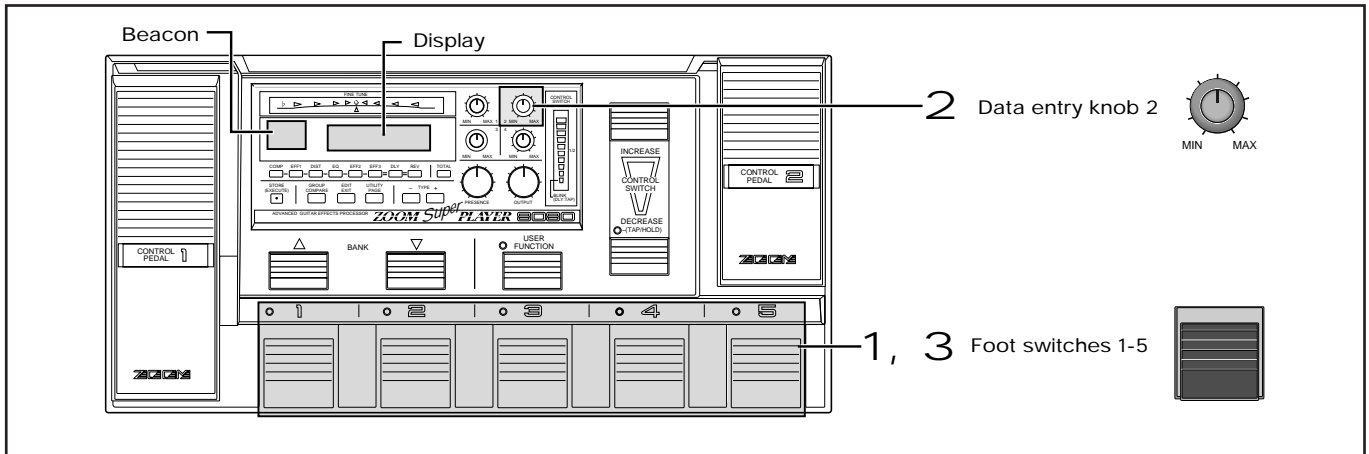

## 1 Press the Foot switches

1-5 whose LED is lit (i.e. the pedal switch that was used to choose the current patch) to set the 8080 to the bypass or mute condition.

```
01 8080LEAD BYPASS
TUNER CALIB=440Hz
```

## 2 Select the pitch with

Data entry knob



4.

The indication "TUNER CALIB" appears on the display, along with the current value. Calibration is possible within the range from 435 to 445 Hz.

```
01 8080LEAD BYPASS
TUNER CALIB=440Hz
```

↑ Calibration

## 3 Press the Foot switches

once more or select a different patch to revert to normal Play mode.

```
01 8080LEAD LVL=100
AMP BVOL BOFF BHLD
```



*The new reference pitch is stored automatically.*



## Adjusting the patch level

You can set the level independently for each patch. This is useful for example to differentiate between lead sound and rhythm sound.

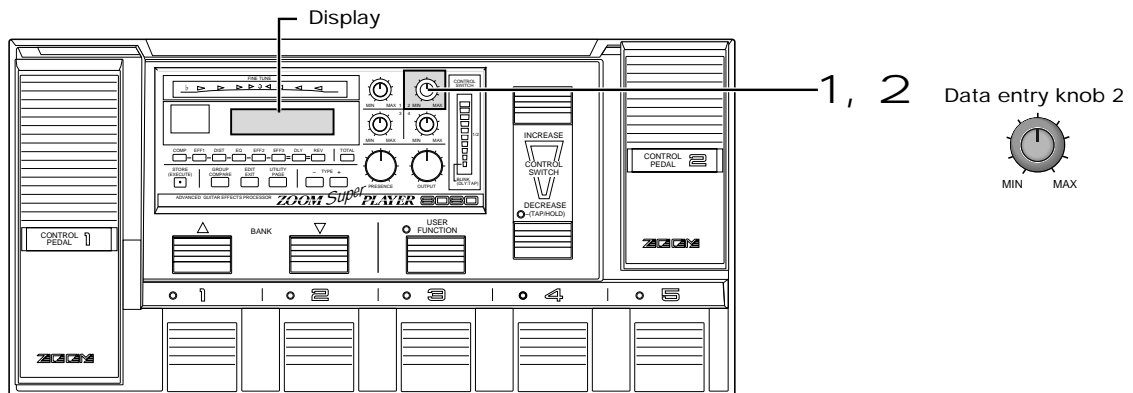

- 1** In Play mode, move the Data entry knob 2. The value of "LVL" changes.

```
01 8080LEAD LVL= 90
E AMP EVOL BOFF BHL0
```

- 2** Adjust data Data entry knob 2 to a suitable level while playing your instrument.

```
01 8080LEAD LVL= 80
E AMP EVOL BOFF BHL0
```

*When the data entry knob 2 is moved, the indication "E" appears on the display. This indicates that the currently selected patch has been changed (edited).*

*The patch level determines the level for each individual patch and can be stored as a parameter ( ➔ p. 23).*



---

# Advanced Operation

---

<b>Editing a Patch (Edit Mode Operation)</b> .....	<b>18</b>
Activating the Edit mode .....	18
Indications in Edit mode .....	19
Switching modules on and off .....	20
Changing the parameter settings .....	21
Comparing an edited patch with its original condition .....	22
Storing an edited patch .....	23
<b>Using the RTM Function</b> .....	<b>24</b>
Using the CONTROL pedals for RTM .....	24
Using the CONTROL switches for RTM .....	26
Tapping input of delay time .....	28
Delay hold .....	30
<b>Utility Mode</b> .....	<b>32</b>
Switching between Utility mode and Play mode .....	32
Amp simulator settings: pages 1, 2 .....	33
USER FUNCTION switch settings: page 3 .....	33
MIDI settings: pages 4 - 6 .....	34
Foot switch settings: pages 7, 8 .....	35
Switching PRESET groups A/B/C: page 9 .....	35
<b>Using the USER FUNCTION Switch</b> .....	<b>36</b>
To switch between Play mode and Manual mode with the USER FUNCTION switch .....	36
Using the USER FUNCTION switch to call up a bank or patch .....	38
Using the USER FUNCTION switch to select PRESET A/B/C .....	40
<b>Other Functions</b> .....	<b>41</b>
Controlling an external effect device .....	41
Controlling an external amplifier .....	42
Returning the 8080 to the factory default condition .....	44

# Editing a Patch

(Edit Mode Operation)

In the Edit mode, you can change the parameters of the various effects, to create your own sound effects.

## Activating the Edit mode

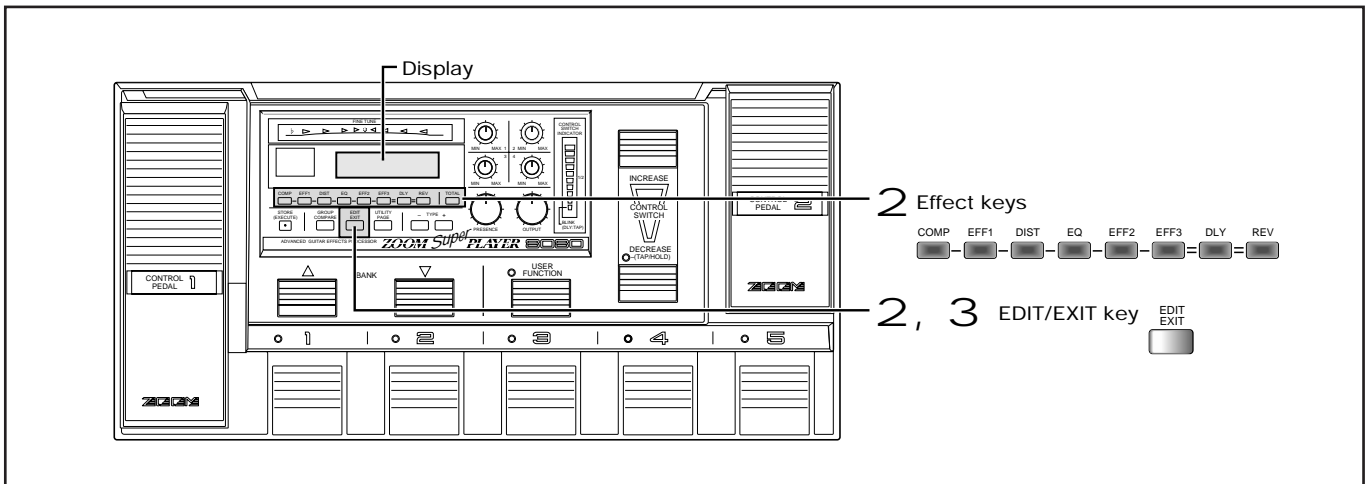

- 1 In Play mode, select the patch you want to edit. ("Selecting a patch" ➔ p. 11).

```
01 8080LEAD LVL=100
AMP VOL BOFF BHL
```

- 2 Press the  .

The 8080 enters the Edit mode. Pressing any effect key will cause the key indicator to flash. This shows that effect module on/off settings and parameters of this effect can now be edited.

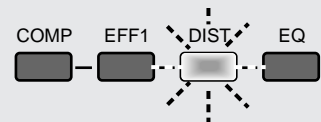

```
Tb0D OD= 16 EQ=+10
LVL= 5 ZNR=off
```

For a detailed explanation of editing procedures, ➔ see p. 21.

- 3 When editing is terminated, press the  again.

The 8080 returns to the Play mode.

```
01 8080LEAD LVL=100
AMP VOL BOFF BHL
```

*You can select a patch from the USER or PRESET groups for editing. But because PRESET group patches are read-only, you cannot store an edited patch from a PRESET group in the same location. If you have edited a patch from a PRESET group, a number in the USER group will be selected automatically as store destination.*

# Indications in Edit mode

In Edit mode, display, and effect keys show the following information.

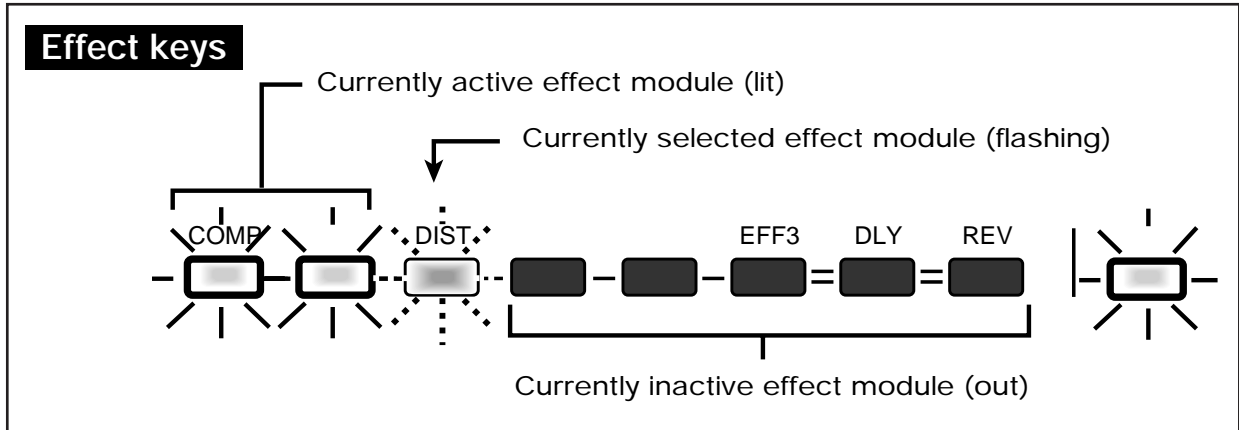
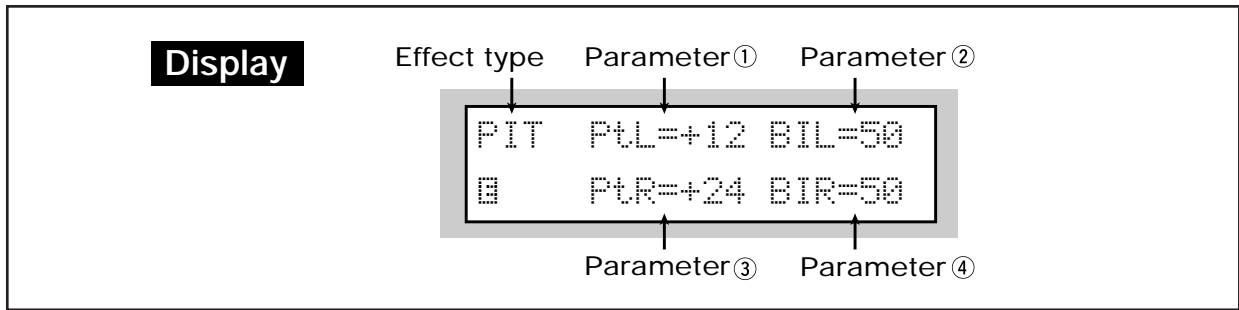

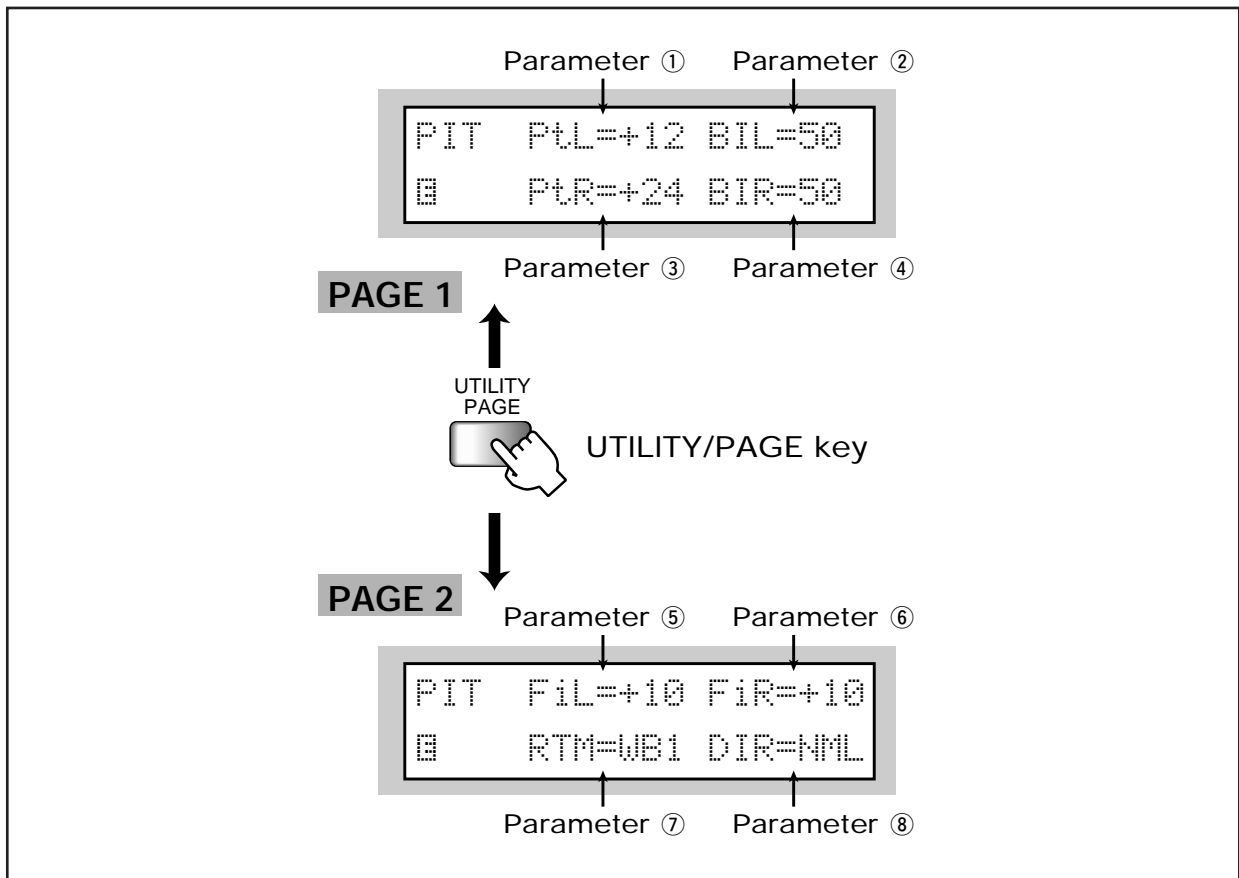

In Edit mode, each effect module except for the TOTAL module has two pages of parameter indications. Use the UTILITY/PAGE key to switch between these pages.

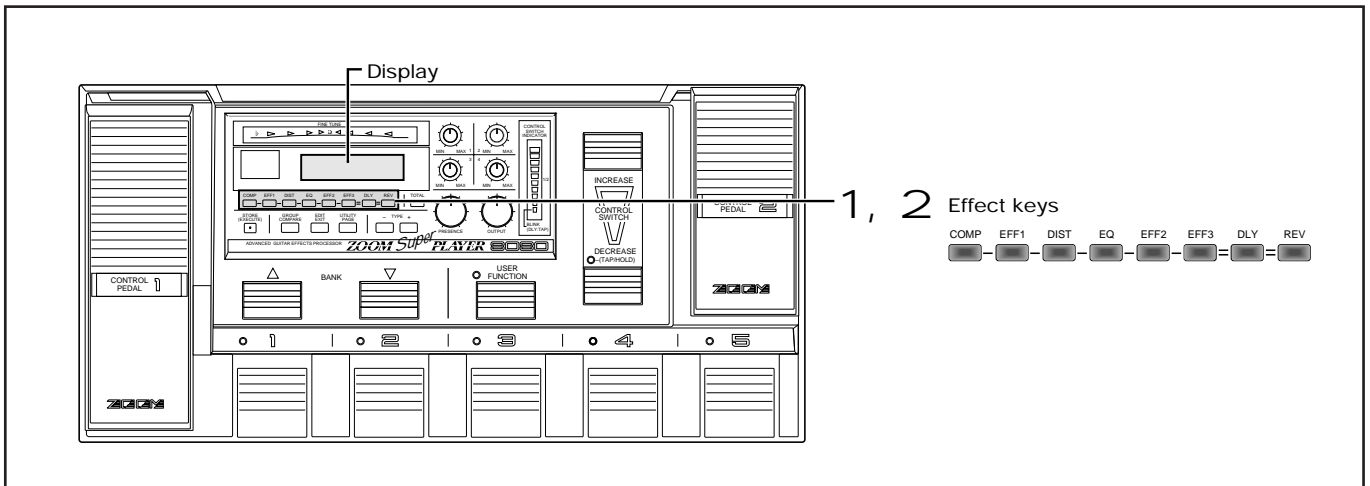

## Switching modules on and off

The most simple form of editing is switching effect modules on and off. This is performed with the effect keys.



- 1 Use the  to select the effect module to be switched on or off.

The effect key flashes. If the selected effect module is on, the parameters of that module are shown on the display. If the module is off, "MODULE OFF" appears on the display.

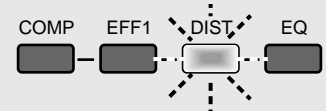

```
Tb0D  OD= 16  EQ=+10
      LVL=  5  ZNR=off
```

- 2 Press the same  again.

```
Tb0D  MODULE OFF
      E          ZNR=off
```

 When an effect module is switched off or on, the indication "E" appears on the display. This indicates that the currently selected patch has been changed (edited).

# Changing the parameter settings

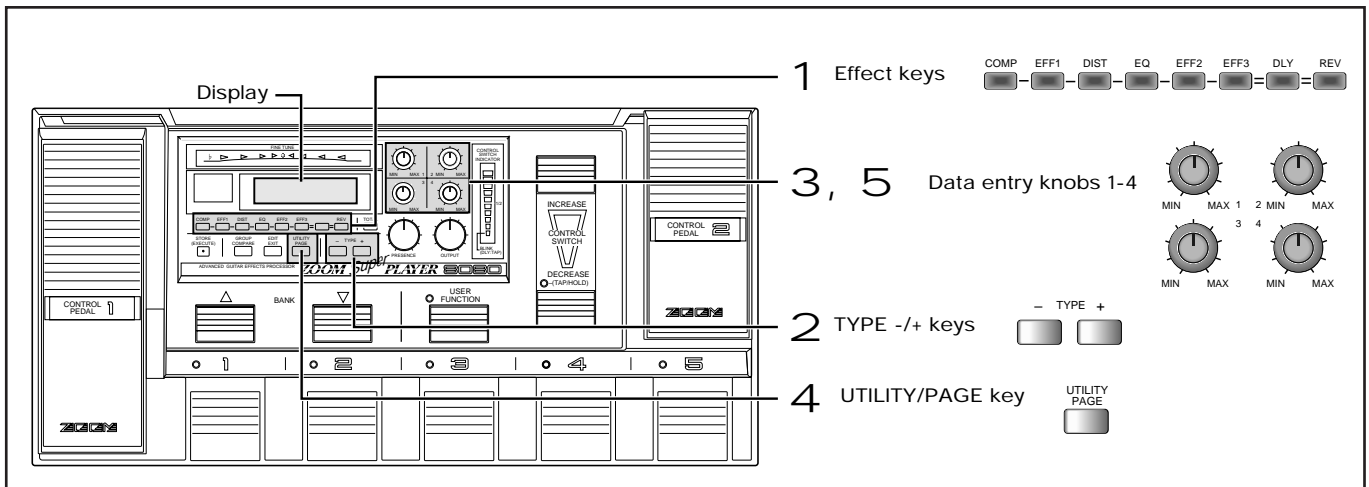

**1** Use the **Effect keys** to select the effect module to be edited.

PitD PIT=+12 TIM=10  
 FB= 0 BAL=50

**2** Use the **TYPE +/- keys** to switch the effect type.

When effect modules are switched, the corresponding parameter on the display also changes.

PIT PtL=+12 BIL=50  
 B PtR=+24 BIR=50

**3** Use the **Data entry knobs 1-4** to change the parameter settings.

The parameters shown on the display are allocated to the data entry knobs 1-4, so that turning a certain knob alters the corresponding parameter.

PIT PtL=+12 BIL=50  
 B PtR=+24 BIR=30

**4** Use the **UTILITY/PAGE key** to call up page 2 with more parameters.

PIT FiL=+10 FiR=+10  
 B RTM=UB1 DIR=NML

**5** The parameters on page 2 again can be adjusted with the **Data entry knobs 1-4**.

PIT FiL=+10 FiR=+10  
 B RTM=UB1 DIR=INV

**6** Other effect modules can be edited in the same way.

**HINT** For details on effect types and parameters, see the section "Effect Types and Parameters" starting on **p. 45**.

## Comparing an edited patch with its original condition

During editing, you can temporarily revert to the original condition of the patch, to quickly evaluate the changes you have made. This is called the Compare function.

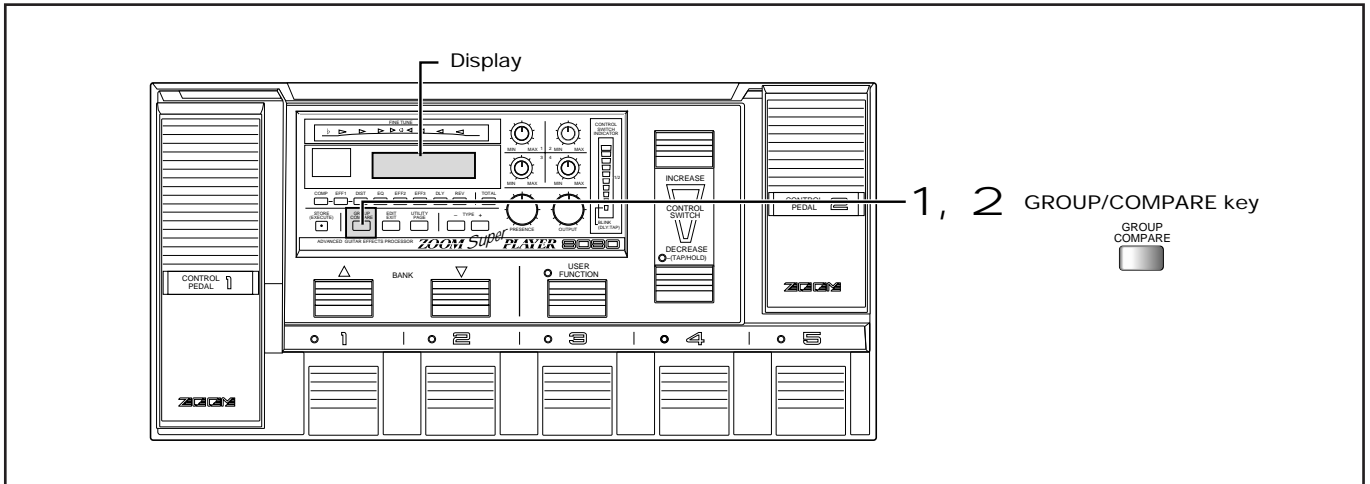

- 1** In Edit mode, press the **GROUP/COMPARE** key.

The indication "CMPR" appears on the display and the edited parameters revert to their original settings.

```
VDSP DST=16
CMPR LVL=15 ZNR=off
```

- 2** Press the **GROUP/COMPARE** key **again**.

The parameters change to the edited status.

```
VDSP DST=15
LVL=15 ZNR=off
```



When an effect module is switched off or on, the indication "E" appears on the display. This indicates that the currently selected patch has been changed (edited).

## Storing an edited patch

If an edited patch is not stored in the USER group, all changes will be lost when you select a different patch. If you like the changes you have made, do not forget to store the patch.

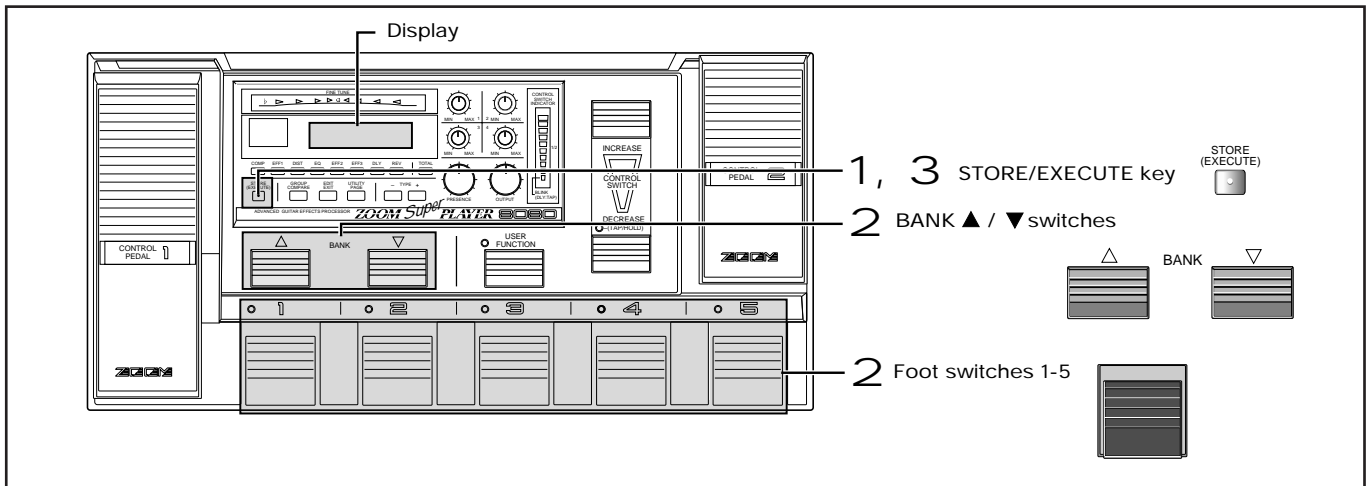

- 1** Press the STORE/EXECUTE key

```
01 8080LEAD
[ ] STORE?   U0-1
```

- 2** Use the BANK ▲/▼ switches and the Foot switches to select the store destination.

If no selection is made, the current bank and patch number will be used.

- 3** Press the STORE/EXECUTE key **once more.**

The display briefly changes as shown below and the store process is carried out. The 8080 then reverts to Play mode.

```
01 8080LEAD
[ ] Completed
```

**HINT** Before storing the patch, you can also change the patch name ( ➡ p. 64).

**HINT** By pressing the EDIT/EXIT key before pressing the STORE/EXECUTE key the second time, you can cancel the process without storing. The unit reverts to the Play mode.

**TIP** If the STORE/EXECUTE key is pressed after editing a patch from one of the PRESET groups, "USER group, bank 0, patch number 1" will automatically be selected as store destination.

**TIP** When a patch is stored, any patch that is already present in the selected location will be erased (overwritten).



# Using the RTM Function

The 8080 incorporates a so-called RTM (real-time modulation) function which lets the user change effect parameters in real time. During a performance, the CONTROL pedals 1 and 2 and the CONTROL switches can be used to change previously determined effect module parameters.

**HINT** In the factory default condition, CONTROL pedal 1 is set to adjust the volume of each patch and CONTROL pedal 2 can be assigned to various parameters with the CONTROL switches. Before you make any changes, we suggest to try this out for yourself.

## Using the CONTROL pedals for RTM

Using CONTROL pedals 1 and 2 to continuously adjust parameters such as volume or wah can be very effective during a performance. To do this, the following steps are required.

- In the TOTAL module, select the effect module to be assigned to CONTROL pedal 1 and 2.
- Within the selected effect module, select the parameter to be controlled and the change direction.

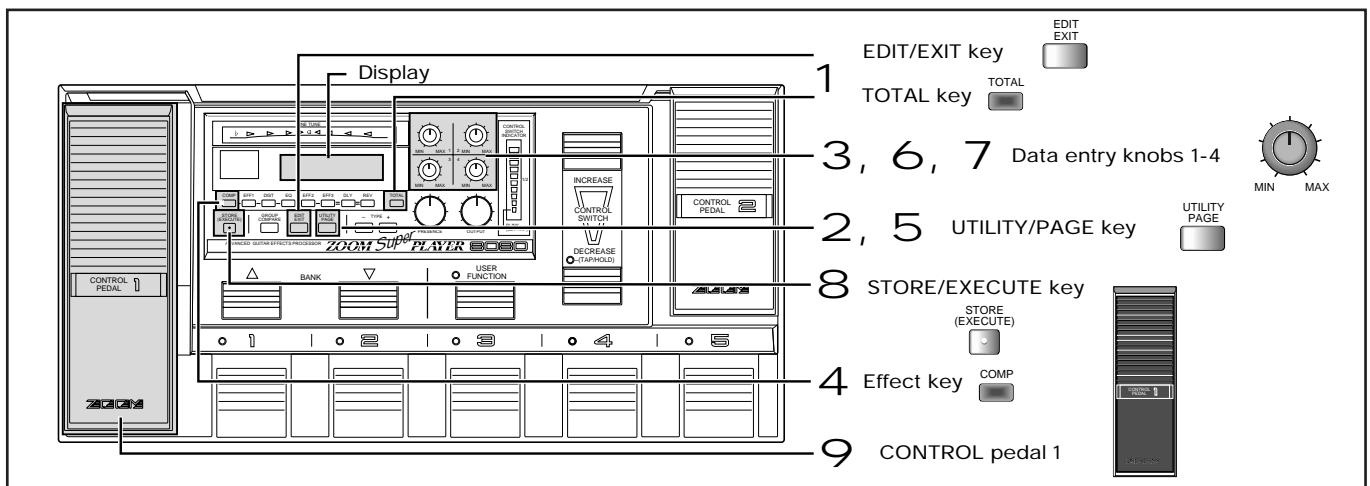

- 1** In Play mode, press the .

The 8080 enters the Edit mode. If the TOTAL key is not flashing, press the TOTAL key to select the TOTAL parameters.

```
SERIAL/PARALLEL:
1 EF2 EF3
```

- 2** Press the **once.**

```
CONTROL SET: CSW=DLY
2 CP1=VOL CP2=OFF
```

- 3** Use **3** to select the effect module to assign to CONTROL pedal 1 .

This page serves to assign effect modules to the CONTROL switches (data entry knob 2), CONTROL pedal 1 (data entry knob 3) and CONTROL pedal 2 (data entry knob 4).

The illustration below shows an example for assigning the EF3 effect module to CONTROL pedal 1.

```
CONTROL SET: CSW=DLY
2 CP1=EF3 CP2=OFF
```

- 4** Press the for the effect module assigned to the CONTROL pedal to display the parameters of that module.

```
FLG DPT=50 SPD= 50
2 FB= 0 MAN= 0
```

**5** Press the **UTILITY/PAGE** key  once to display the **RTM** parameter.

Except for the **TOTAL** and **EQ** modules, page 2 of every effect module includes the **RTM** parameter.



"**RTM**" (**RTM destination**) stands for the parameter to be controlled by **RTM**. "**DIR**" (**RTM direction**) stands for the direction in which the parameter is to be controlled.

**6** Use  **3** to select the parameter (only for effect types where the **RTM** destination can be selected).

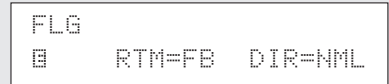

**7** Use  **4** to select the direction for the "**RTD=**" item.

You can select either "**NML**" (normal) or "**INV**" (inverted).

The meaning of "**NML**" and "**INV**" depends on the effect type controlled by the pedal.

Controlling <b>VIB</b> (Vintage Vibe) and <b>PPIT</b> (Pedal Pitch Shifter) with the pedals		
	Pedal released	Pedal depressed
<b>NML</b>	Minimum	Maximum
<b>INV</b>	Maximum	Minimum
Controlling effect types of <b>DIST</b> effect module with the pedals		
	Pedal released	Pedal depressed
<b>NML</b> ( Minimum value for setting)	Preset parameter value	Preset parameter value
<b>INV</b>	Minimum value for setting	Minimum value for setting
Controlling other effect types with the pedal		
	Pedal released	Pedal depressed
<b>NML</b>	Minimum	Preset parameter value
<b>INV</b>	Preset parameter value	Maximum

**8** If desired, store the patch.

("Storing an edited patch"  p. 23).

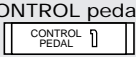
**9** Operate  while playing the instrument.

The selected effect module parameter changes according to the pedal movement. In this example, the compression depth can be adjusted with the pedal. **CONTROL** pedal 2 can be assigned in the same way.

 For effect types where the **RTM** destination can be changed (some effect types in effect modules **EFF2** and **EFF3**), the indication "**RTM=**" is shown on the display, and data entry knob 3 can be used to select the parameter. For effect types where the **RTM** destination is fixed, "**RTM →**" is shown on the display.

 The "Minimum" value of the **DIST** module depends on the distortion type and the parameter setting value.

 In **Play** mode, the lower line of the display shows the modules assigned to **CONTROL** pedals 1 and 2.

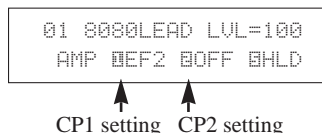

 In principle, **CONTROL** pedal 1, **CONTROL** pedal 2, and the **CONTROL** switches cannot be used to control the

same effect module. If an attempt is made to assign several controllers to the same module in step 3 (**TOTAL** module setting), priority will automatically be set in the order **CP1**, **CP2**, **CSW**.

**TOTAL** module setting

**Play** mode display

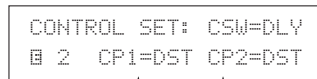

If the same module was assigned to **CP1** and **CP2** ...

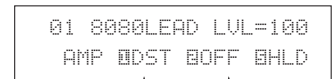

**CP1** is selected and **CP2** becomes "**OFF**".

 The minimum value of the distortion gain control varies according to the type of distortion and the parameter settings. The minimum value achieved by these changes may be smaller than **Gain 1**, depending on the settings.

# Using the CONTROL switches for RTM

The CONTROL switches can be used with the RTM function to alter parameters in discrete steps. This lets you easily and quickly adjust distortion or overdrive intensity, flanger speed etc. during a performance.

To use the CONTROL switches for adjusting effect parameters, the following steps are required.

- In the TOTAL module, select the effect module to be assigned to the CONTROL switches.
- If desired, within the selected effect module, select the parameter to be controlled.

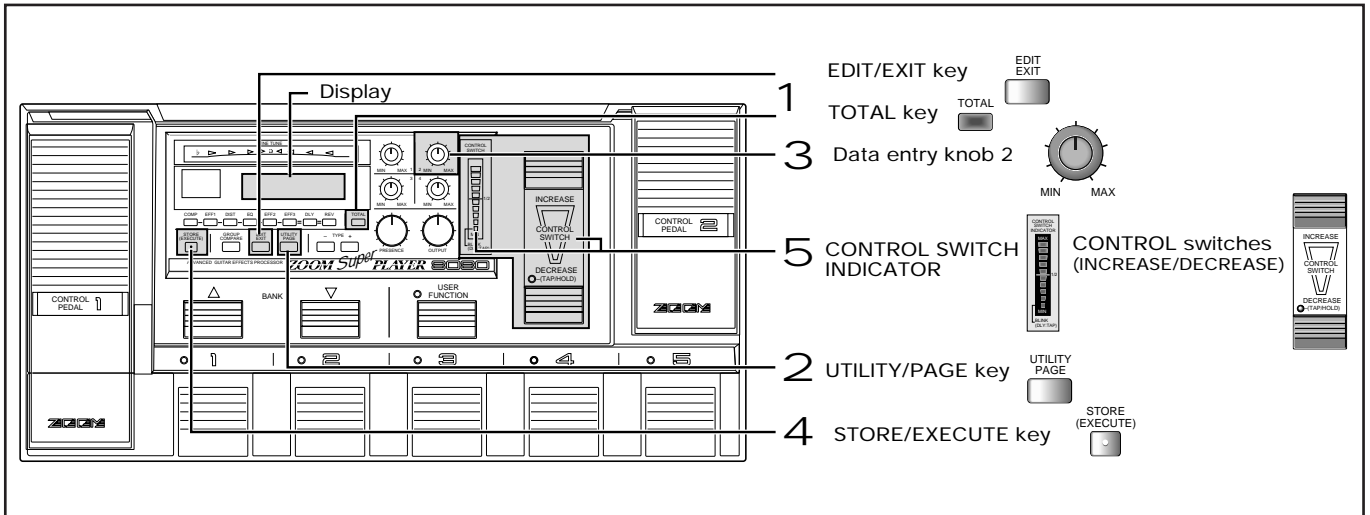

**1** In Play mode, press the **EDIT/EXIT** key.

The 8080 enters the Edit mode. If the TOTAL key is not flashing, press the TOTAL key to select the TOTAL parameters.

```
SERIAL/PARALLEL:
1 EF2 + EF3
```

**2** Press the **UTILITY/PAGE** key once.

```
CONTROL SET: CSW=DST
2 CP1=VOL CP2=OFF
```

**3** Use the **Data entry knob** to select the effect module to be assigned to the **CONTROL switches**.

CSW is the parameter for selecting the item to be adjusted by the CONTROL switches.

```
CONTROL SET: CSW=EF1
2 CP1=VOL CP2=OFF
```

*For effect types where the RTM destination can be changed (some effect types in effect modules EFF2 and EFF3), the parameter to be controlled can be selected at the RTM page for that module ( p. 55).*

Among the effect types of the DLY module, the RTM page has a dedicated parameter for the CONTROL switches called "CSW" (CSW mode select). This allows use of the CONTROL switches separately from the "RTM" (RTM destination) item ( p. 60).

**RTM page of DLY module**

```
DLY HiD= 0 TYP= MN
RTM Mix CSW=Tap
```

Parameters adjusted by CONTROL switches

**4** If desired, store the patch.

("Storing an edited patch" ➔ p. 23).

**5** Operate the  while playing the instrument.

Pressing the INCREASE switch increases the parameter value in discrete steps, and pressing the DECREASE switch decreases it. The current setting can be verified with the CONTROL SWITCH INDICATOR.

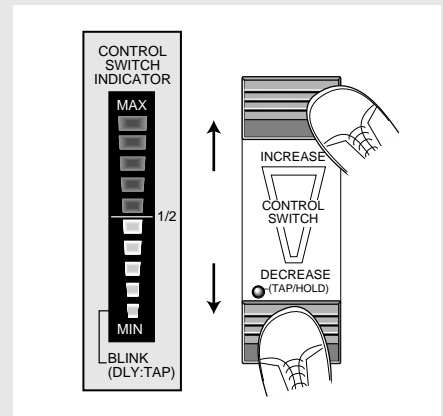

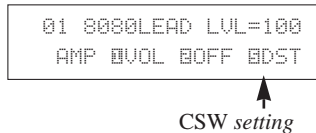

 Unlike when using the CONTROL pedal 1 and 2, there is no need to set "DIR" (control direction) for the assigned effect module. The INCREASE switch always increases the parameter and the DECREASE switch always decreases it.

 **HINT** In Play mode, the lower line of the display shows the module assigned to the CONTROL switches.

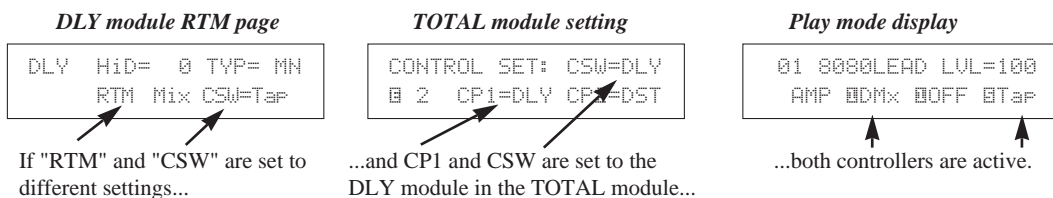

 **HINT** In principle, CONTROL pedal 1, CONTROL pedal 2, and the CONTROL switches cannot be used to control the same effect module. However, if the "CSW" parameter in the DLY module is set to a different item than the "RTM" parameter, the DLY module can be assigned to CONTROL pedal 1 or 2 and the CONTROL switches at the same time.



 **HINT** Briefly tapping a CONTROL switch changes the value by 1/10 of the total adjustment range. Keeping a CONTROL switch depressed causes the value to change continuously in steps of 1 unit (but the CONTROL SWITCH INDICATOR shows changes in 10-unit steps). For example, if the total adjustment range is 100, tapping a CONTROL switch will change the value by 10, and holding a CONTROL switch depressed will change the value consecutively in steps of 1.

## Tapping input of delay time

The DECREASE CONTROL switch can be used to set the delay time of the delay module by tapping. To do this, the following steps are required.

- In the TOTAL module, select the DLY effect module to be assigned to the CONTROL switches.
- Within the DLY effect module, set the CSW parameter to "Tap".

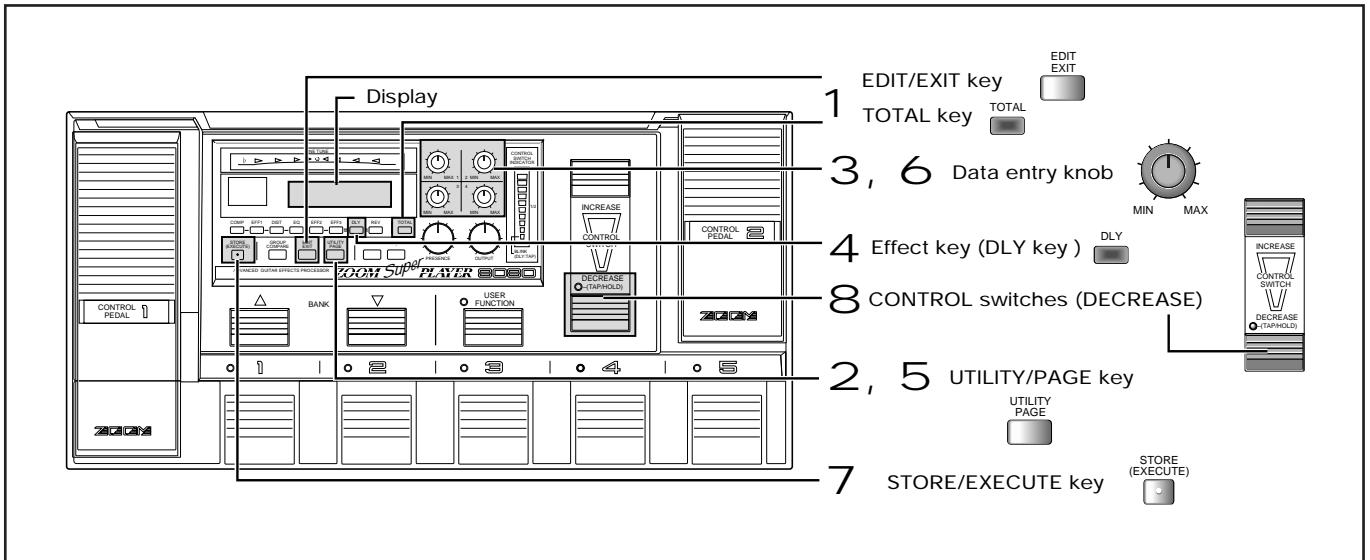

- 1** In Play mode, press the **EDIT/EXIT** key.

The 8080 enters the Edit mode. If the TOTAL key is not flashing, press the TOTAL key to select the TOTAL parameters.

```
SERIAL/PARALLEL:
1 EF2 EF3
```

- 2** Press the **UTILITY/PAGE** key once.

```
CONTROL SET: CSW=DST
2 CP1=UOL CP2=OFF
```

- 3** Use the **Data entry knob** to set the CSW parameter to "DLY".

```
CONTROL SET: CSW=DLY
2 CP1=UOL CP2=OFF
```

- 4** Press the **DLY** Effect key to select the delay module.

```
DLY TIM=1000(mS)
2 FB= 3 Mix= 30
```

- 5** Press the **UTILITY/PAGE** key once to display the RTM parameter on page 2.

```
DLY HiD= 0 SEL=MN
2 RTM=Mix CSW=Mix
```

6

Data entry knob

Use  4 to set the CSW parameter to "Tap".

```
DLY HiD= 0 SEL=MN
@ RTM=Mix CSW=Tap
```

7

If desired, store the patch.

In Play mode, if a patch for which tap input is possible is selected, the panel indicators flash as follows.

("Storing an edited patch"  p. 23).

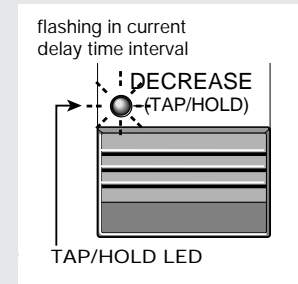
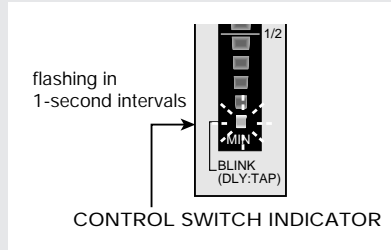

8

While playing your instrument, tap the DECREASE  twice in the desired tempo.

CONTROL switches

The 8080 detects the interval between taps of the switch and sets the delay time accordingly.

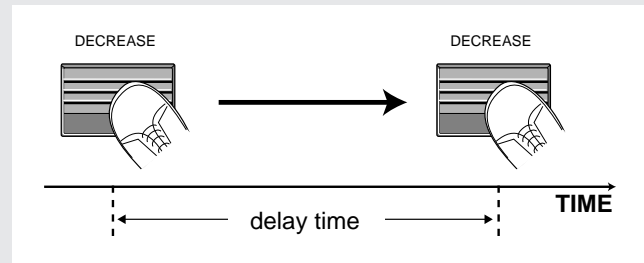

If the tapping interval is more than 4 seconds, the CONTROL SWITCH INDICATOR flashes more rapidly and the delay time will not be set. In this case, press the DECREASE CONTROL switch once more to start the tap input again.

# Delay hold

Using the CONTROL switches, you can cause the 8080 to sample and hold a guitar phrase. To do this, the following steps are required.

- In the TOTAL module, select the DLY effect module to be assigned to the CONTROL switches.
- Within the DLY effect module, set the effect type to "HLD".

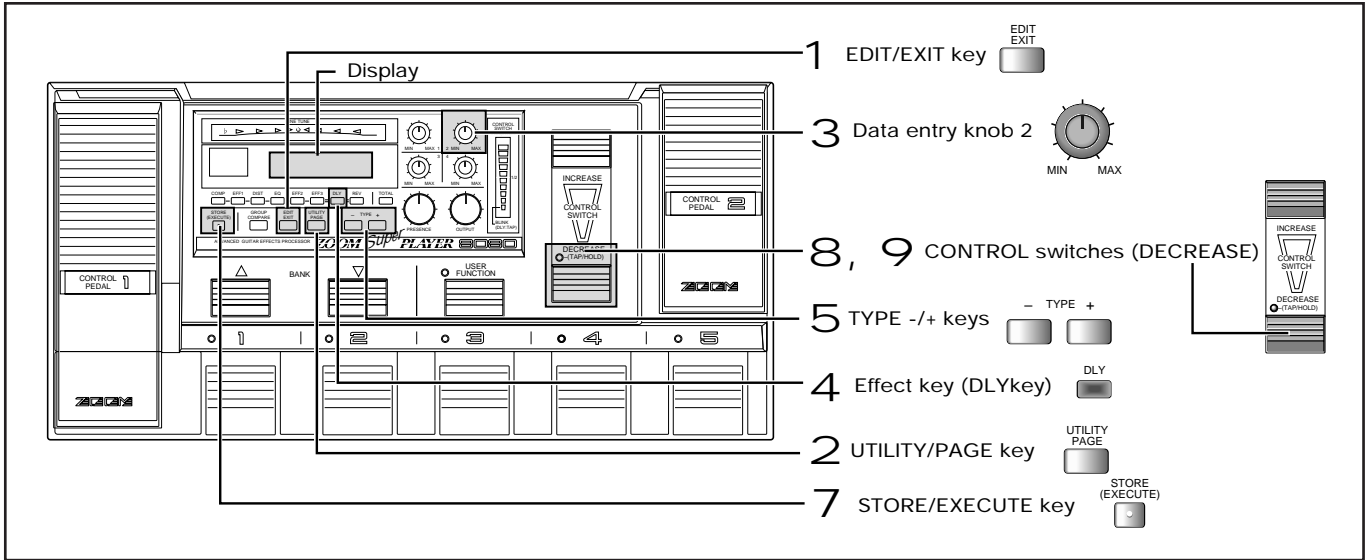

1 In Play mode, press the EDIT/EXIT key.

```
SERIAL/PARALLEL:
1 EF2 EF3
```

2 Press the UTILITY/PAGE key once.

```
CONTROL SET: CSW=DST
2 CP1=VOL CP2=OFF
```

3 Use the Data entry knob 2 to set the CSW parameter to "DLY".

```
CONTROL SET: CSW=DLY
B 2 CP1=VOL CP2=OFF
```

4 Press the DLY Effect key to select the delay module.

```
DLY TIM=1000(MS)
B FB= 3 Mix= 30
```

5 Use the TYPE +/- keys to set the effect type to "HDL" (Hold Delay).

```
HLD TIM=1000(MS)
B FB= 3 Mix= 30
```

*If the DLY module is off, press the DLY key once more to turn it on.*

6 Adjust other delay parameters as required.

7 If desired, store the patch.

The TAP indicator of the DECREASE CONTROL switch will go out.

("Storing an edited patch" → p. 23).

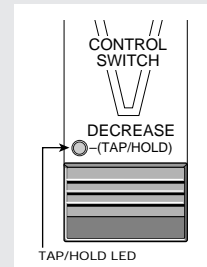

8 While playing your instrument, press the DECREASE CONTROL switches at the start of the phrase to be sampled.

The phrase is sampled for the length of the preset delay time and then repeated.

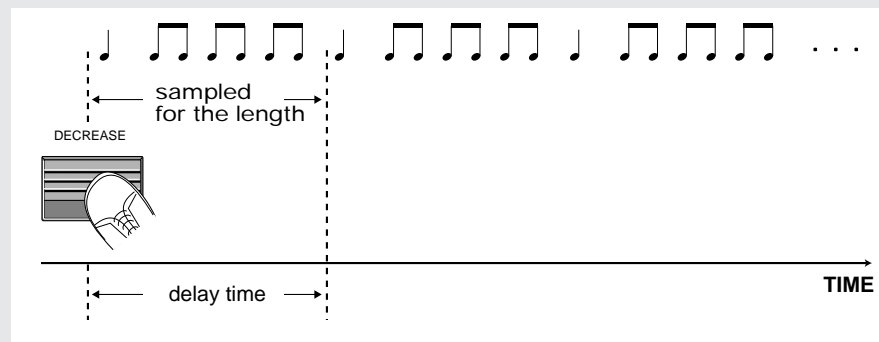
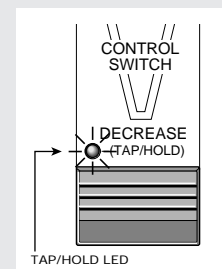

9 To stop the delay sound, press the DECREASE CONTROL switches again.

The delay sound ceases.

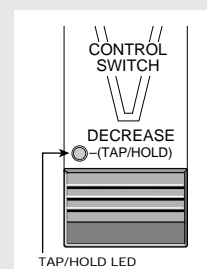

The delay time setting determines for which interval the delay hold will be active. Set the delay time to 2 or 4 beats, according to the song tempo.



If the CUV parameter of the seamless function setting in the TOTAL module is set to "HLD" (→ p. 63), the delay sound continues also if the patch is changed at this point. To stop it, change the patch again or use the bypass/mute function.



# Utility Mode

In Utility mode, you can set parameters which apply to all patches.

## Switching between Utility mode and Play mode

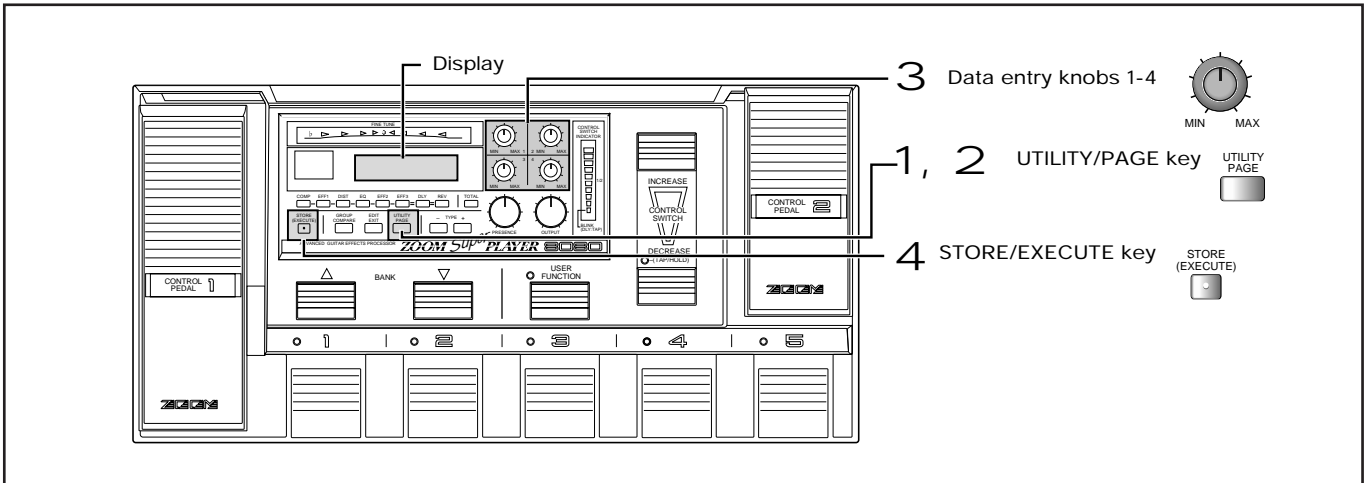

- 1 In Play mode, press the UTILITY/PAGE key.

The 8080 enters the Utility mode.

```
AMP COL=1 LVL=100
1 LoG=0 HiG=0
```

- 2 Keep pressing the UTILITY/PAGE key until the desired page is displayed.

The Utility mode has nine pages.

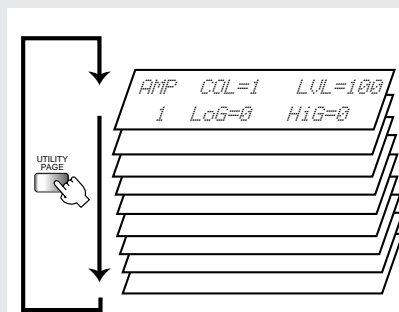

### Utility mode pages

- Pages 1, 2: Amp simulator settings
- Page 3: USER FUNCTION switch settings
- Pages 4 - 6: MIDI settings: pages
- Pages 7, 8: Foot switch settings
- Page 9: Switching PRESET groups A/B/C

- 3 Use the Data entry knobs 1-4 to change settings.

As in Edit mode, the knobs are assigned to various parameters.

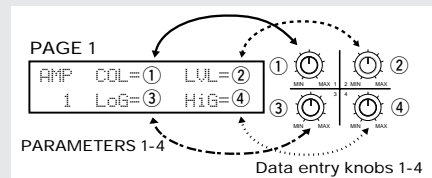

- 4 Press the STORE/EXECUTE key twice in succession.

The changed settings are stored, and the unit returns to the Play mode. When wishing to return to the Play mode without storing, press the EDIT/EXIT key.

*If Utility mode settings are not stored, they will remain active only until the unit is next turned off. When turned on again, the unit reverts to the previous settings. If you wish to keep changes you have made, do not forget to press the STORE/EXECUTE key twice to perform the store process. Note that any edited patch will also be stored at this time.*

## Amp simulator settings: pages 1, 2

The 8080 incorporates an amp simulator that is separate from the effect modules in the patches. Using the amp simulator yields realistic guitar amp sound also when listening through headphones or audio speakers.

Pages 1 and 2 of the Utility mode serve for setting amp simulator parameters.

**PAGE 1**

AMP COL=① LVL=②  
 1 LoG=③ HiG=④

UTILITY PAGE

**PAGE 2**

AMP CAB=⑤ DPT=⑥  
 2

Parameters	Comment	Values
① <b>COL(Color)</b>	Sets the amplifier type.	OFF, 1 - 3
② <b>LVL(Level)</b>	Sets the output level.	0 - 100
③ <b>LoG(Low EQ Gain)</b>	Adjusts the low-range equalizer.	-10 - +10
④ <b>HiG(High EQ Gain)</b>	Adjusts the high-range equalizer.	-10 - +10
⑤ <b>CAB(Cabinet)</b>	Selects the speaker cabinet type.	COM, CMB, STK
⑥ <b>DPT(Depth)</b>	Adjusts the depth of the cabinet effect.	0 - 100



The following settings are available for the COL parameter.

**OFF:** Amp simulator disabled

**1:** Amplifier with flat frequency response

**2:** Vintage amplifier with pronounced midrange

**3:** Modern amplifier with prominent high end and low end

The following settings are available for the CAB parameter.

**COM:** Compact

**CMB:** Combo

**STK:** Stack

## USER FUNCTION switch settings: page 3

The USER FUNCTION switch can be programmed to perform any of the four functions listed below.

- **PATCH** ..... Select the patch set with the PAT parameter.
- **BANK** ..... Select the bank set with the BNK parameter.
- **MANUAL** ..... Switch between Play mode and Manual mode.
- **PRESET** ..... Switch between PRESET groups A/B/C.

Page 3 of the Utility mode serves to select the USER FUNCTION switch function.

**PAGE 3**

USER FUNCTION= ①  
 3 BNK=② PAT=③

Parameters	Comment	Values
① <b>USER FUNCTION=</b>	Function to be activated by USER FUNCTION switch.	PATCH, BANK, MANUAL, PRESET (Factory default: PRESET)
② <b>BNK(Bank Number)</b>	Sets the bank to be called up by the USER FUNCTION switch.	U0 - P9
③ <b>PAT(Patch Number)</b>	Sets the patch to be called up by the USER FUNCTION switch.	U01 - P95

## MIDI settings: pages 4 - 6

The pedals and foot switches of the 8080 can be used to send MIDI control change messages from the MIDI OUT jack. Pages 4 through 6 of the Utility mode serve to make MIDI settings, such as selecting the MIDI channel and control change numbers.

### PAGE 4

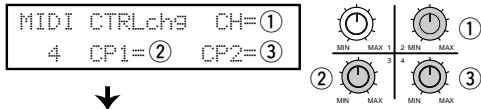

### PAGE 5

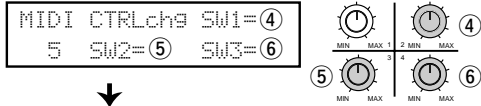

### PAGE 6

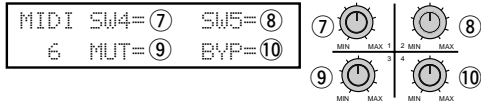

Parameters	Comment	Values
① <b>CH (Channel)</b>	Selects the MIDI OUT channel of the 8080.	1 - 16
② <b>CP1 (Control Pedal 1)</b>	Sets the control change number for CONTROL pedal 1.	1 - 31 (Default: 7)
③ <b>CP2 (Control Pedal 2)</b>	Sets the control change number for CONTROL pedal 2.	1 - 31 (Default: 1)
④ <b>SW1 (Switch 1)</b>	Sets the control change number for foot switch 1.	64 - 95 (Default: 70)
⑤ <b>SW2 (Switch 2)</b>	Sets the control change number for foot switch 2.	64 - 95 (Default: 71)
⑥ <b>SW3 (Switch 3)</b>	Sets the control change number for foot switch 3.	64 - 95 (Default: 72)
⑦ <b>SW4 (Switch 4)</b>	Sets the control change number for foot switch 4.	64 - 95 (Default: 73)
⑧ <b>SW5 (Switch 5)</b>	Sets the control change number for foot switch 5.	64 - 95 (Default: 74)
⑨ <b>MUT (Mute)</b>	Sets the control change number for mute on/off.	64 - 95 (Default: 80)
⑩ <b>BYP (Bypass)</b>	Sets the control change number for bypass on/off.	64 - 95 (Default: 91)

Items ② and ③ produce continuous output corresponding to the pedal action. Items ④ through ⑩ cause the output to be either 127 or 0, depending on the foot switch on or off condition.

**HINT** When switching patches in Play mode, a program change message ranging from 0 (U01) to 99 (P95) is always output from the MIDI OUT jack.

The control change messages set by items ④ - ⑧ for the foot switches are output only in manual mode and edit mode. In play mode, operating the foot switches causes program change messages to be output.

## Foot switch settings: pages 7, 8

When the 8080 is in Manual mode or Edit mode, foot switches 1-5 can be used to switch effect modules on and off. Pages 7 and 8 of the Utility mode serve to assign modules to the various switches.

### PAGE 7

Fsw ASSIGN: SW1=①  
7 SW2=② SW3=③

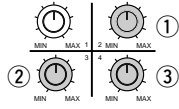

UTILITY PAGE

### PAGE 8

Fsw ASSIGN: SW4=④ SW5=⑤  
8

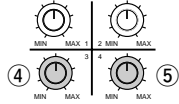

Parameters	Comment	Values
① SW1 (Switch 1)	Sets the effect module to be controlled by foot switch 1.	CMP, EF1, DST, EQ EF2, EF3, DLY, REV
② SW1 (Switch 2)	Sets the effect module to be controlled by foot switch 2.	CMP, EF1, DST, EQ EF2, EF3, DLY, REV
③ SW1 (Switch 3)	Sets the effect module to be controlled by foot switch 3.	CMP, EF1, DST, EQ EF2, EF3, DLY, REV
④ SW1 (Switch 4)	Sets the effect module to be controlled by foot switch 4.	CMP, EF1, DST, EQ EF2, EF3, DLY, REV
⑤ SW1 (Switch 5)	Sets the effect module to be controlled by foot switch 5.	CMP, EF1, DST, EQ EF2, EF3, DLY, REV

It is not possible to assign the same effect module to several foot switches. If this is attempted, the foot switch with the lowest number only is active. For example, if the DST module was already assigned to SW1 and then SW3 is also set to "DST", the indication changes to lower case ("SW3=dst") and the setting will not be active until the setting of SW1 is changed.

## Switching PRESET groups A/B/C: page 9

The patches of the 8080 are divided into the USER group and the PRESET groups A, B and C. Only two groups can be active at any one time: the USER group and one PRESET group. Page 9 of the Utility mode serves to select the PRESET group A/B/C (called Folder A/B/C here).

### PAGE 9

PRESET FOLDER SELECT  
9 FOLDER = A

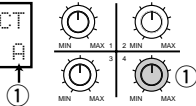

Parameters	Comment
① FOLDER	Selects the PRESET group (A, B, C) to be used in Play mode.

It is also possible to use the USER FUNCTION switch to select PRESET groups A/B/C during a performance ( ➡ p. 40).

# Using the USER FUNCTION Switch

The USER FUNCTION switch can be programmed by the user to perform a desired function. The following four functions are available: switch between Play mode and Manual mode, call up a predefined bank number, call up a predefined patch number, switch between PRESET groups A/B/C.

In the factory default condition, the switch is set to select PRESET groups.

## To switch between Play mode and Manual mode with the USER FUNCTION switch

In Manual mode, the foot switches 1-5 can be used to turn predefined effect modules on and off. To do this, the following steps are required.

- In Utility mode, set the USER FUNCTION switch parameter to "MANUAL".
- In Utility mode, assign the desired effect modules to foot switches 1-5.

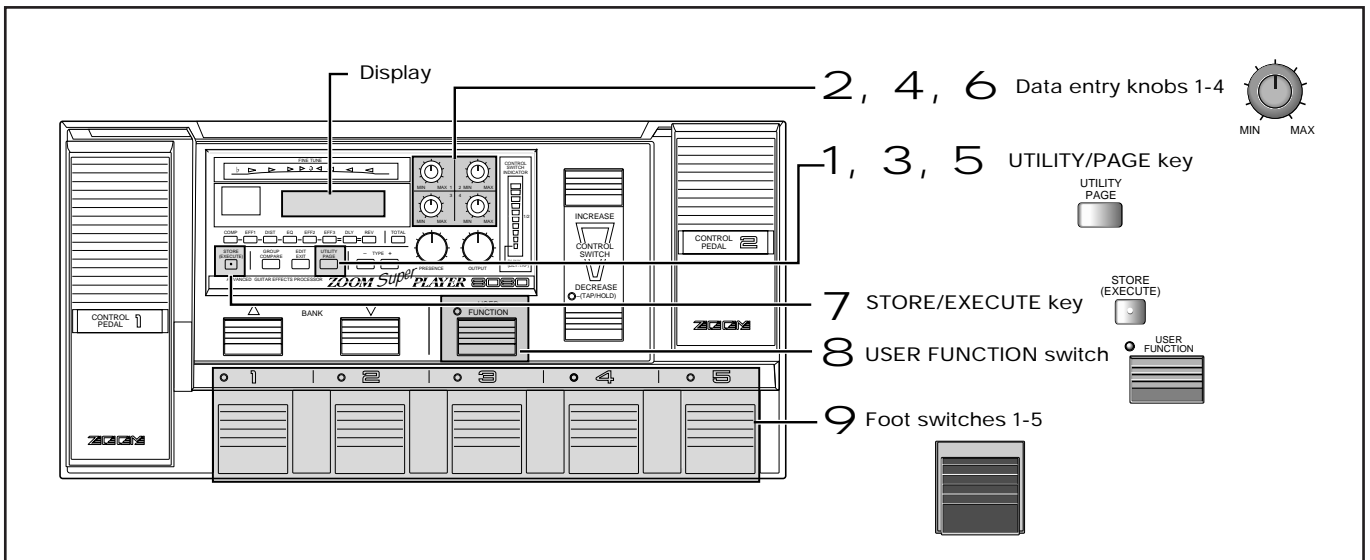

- 1** In Play mode, press the **UTILITY/PAGE** key **three** times to call up the page shown below.

This is the page for selecting the function of the USER FUNCTION switch.

```
USER FUNCTION=MANUAL
3
```



- 2** Verify that the "USER FUNCTION=" item is set to "MANUAL".

If not, use Data entry knob 2 to select the setting.

- 3** Press the **UTILITY/PAGE** key **four** times to call up the page shown below.

This is the page for selecting the effect modules to be assigned to foot switches 1-3.

```
Fsw ASSIGN: SW1=EF1
7 SW2=DST SW3=EF2
```

**4** Use  **2-4** to select effect modules for  **1-3**.

Data entry knobs

Foot switches



```
Fsw ASSIGN: SW1=CMP
              7 SW2=EF1 SW3=DST
```

**5** Press the  **once more to call up the page shown below.**

UTILITY/PAGE key

This is the page for selecting the effect modules to be assigned to foot switches 4 and 5.

```
Fsw ASSIGN:
              8 SW4=EF3 SW5=DLY
```

**6** Use  **3 and 4** to select effect modules for  **4 and 5**.

Data entry knobs

Foot switches

```
Fsw ASSIGN: SW1=CMP
              8 SW4=DLY SW5=REV
```

**7** Press the  **two times.**

STORE/EXECUTE key

two

The Utility mode settings are stored and the unit returns to the Play mode.

```
01 8080LEAD LVL=100
AMP EQVL BOFF BHL
```

**8** Press the  **while playing the instrument in Play mode.**

USER FUNCTION switch

while

This will activate Manual mode, and the effect modules that can be switched by foot switches 1-5 are shown on the display.

```
01 8080LEAD MANUAL
CMP EP1 DST DLY REV
↑   ↑   ↑   ↑   ↑
SW1 SW2 SW3 SW4 SW5
```

**9** Use the  **1-5** to turn the effect modules on and off, as desired.

Foot switches

.....

 You cannot assign the same effect module to several foot switches. ➡ Page 35.

 If Utility mode settings are not stored, they will remain active only until the unit is next turned off. When turned on again, the unit reverts to the previous settings. If you wish to keep changes you have made, do not forget to press the STORE/EXECUTE key twice to perform the store process. Note that any edited patch will also be stored at this time.

## Using the USER FUNCTION switch to call up a bank or patch

The USER FUNCTION switch can be used to call up a predefined bank or patch during a performance. This is convenient for example for frequently needed patches in a song. To do this, the following steps are required.

- In Utility mode, set the USER FUNCTION switch parameter to "BANK" (bank number) or "PATCH" (patch number).
- In Utility mode, set the predefined bank number or patch number.

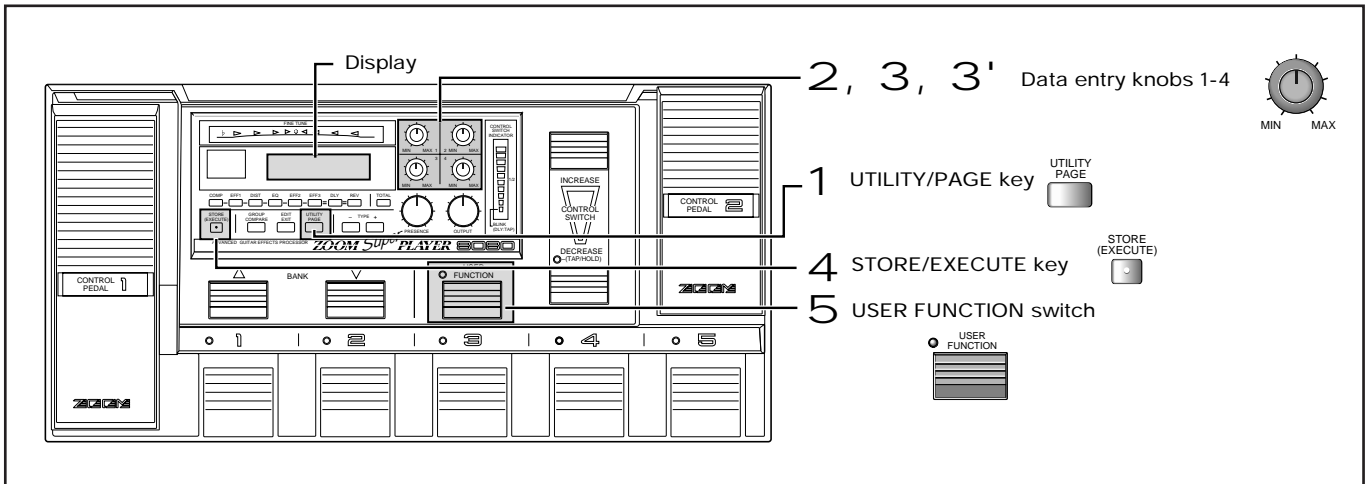

- 1** In Play mode, press the  three times to call up the page shown below.

```
USER FUNCTION=PRESET
3
```

- 2** Use  2 to set the "USER FUNCTION=" item to "BANK" or "PATCH".

"BANK"

```
USER FUNCTION= BANK
3 BNK=U0
```

"PATCH"

```
USER FUNCTION= PATCH
3 PAT=U01
```

- 3** If "BANK" was selected, use  3 to set the desired bank number in the "BNK=" item.

```
USER FUNCTION= BANK
3 BNK=U9
```

3 ' If "PATCH" was

selected, use

Data entry knob



3 to set

the desired patch  
number in the "PAT="  
item.

```
USER FUNCTION= PATCH
3                PAT=U09
```

4 Press the  
STORE/EXECUTE key  two  
times.

The Utility mode settings are stored  
and the unit returns to the Play  
mode.

```
01 8080LEAD LVL=100
AMP BVOL BOFF BHL
```

5 Press the  
USER FUNCTION switch  while

The preset bank number or patch  
number will be called up.

playing the instrument  
in Play mode.

 *If Utility mode settings are not stored, they will remain active only until the unit is next turned off. When turned on again, the unit reverts to the previous settings. If you wish to keep changes you have made, do not forget to press the STORE/EXECUTE key twice to perform the store process. Note that any edited patch will also be stored at this time.*



# Using the USER FUNCTION switch to select PRESET A/B/C

The USER FUNCTION switch can be used to select a group among PRESET groups A, B, C. To do this, the function of the USER FUNCTION switch must be set to "PRESET" in Utility mode.

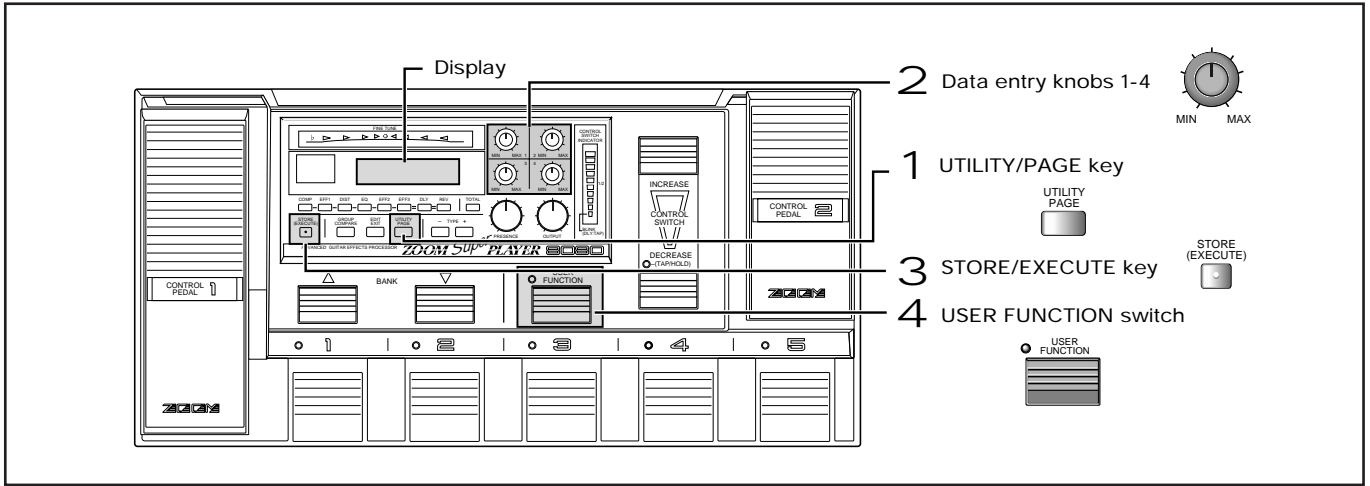

- 1 In Play mode, press the UTILITY/PAGE key three times to call up the page shown below.**

This is the page for selecting the function of the USER FUNCTION switch.



- 2 Use Data entry knob 2 to set the "USER FUNCTION=" item to "PRESET".**

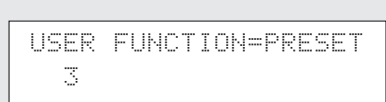

- 3 Press the STORE/EXECUTE key two times.**

The Utility mode settings are stored and the unit returns to the Play mode.

- 4 Press the USER FUNCTION switch while playing the instrument in Play mode.**

The new PRESET group (folder) will be briefly shown on the display, such as "Pfold=B", and the group is switched.

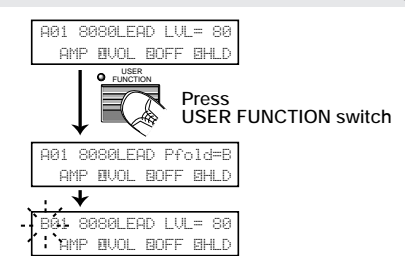

- 5 Select a patch from the new PRESET group.**

The new patch becomes active. ("Selecting a patch" ➔ p. 11).

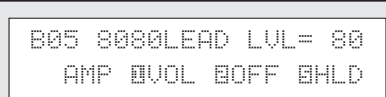

*If Utility mode settings are not stored, they will remain active only until the unit is next turned off. When turned on again, the unit reverts to the previous settings. If you wish to keep changes you have made, do not forget to press the STORE/EXECUTE key twice to perform the store process. Note that any edited patch will also be stored at this time.*

*Simply pressing the USER FUNCTION switch does not yet change the currently selected patch.*

# Other Functions

This section explains how to use the 8080 for controlling an external effect device or amplifier, and how to use the Initialize mode to reset the 8080 to the factory default condition.

## Controlling an external effect device

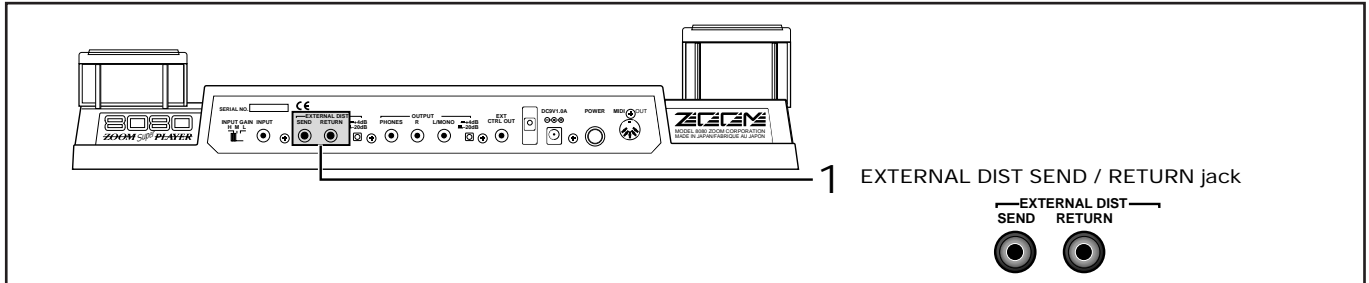

- 1 Connect the device in the **EXTERNAL DIST SEND / RETURN** jack loop of the 8080 (➡ p. 7).

- 2 Activate the Edit mode and select "EXT" (external distortion) as the effect type of the DIST module.

```
EXT  BST=OFF  SND=off  
LVL= 1  ZNR=off
```

- 3 If required, set the "BST" (booster type), "SND" (send level), and "LVL" (signal level for next module) parameters.

- 4 Store the patch as required.

When this patch is selected, the external effect device in the EXTERNAL DIST SEND/RETURN loop of the 8080 can be used.

Leave the external effect device always turned on and perform simulated on/off switching at the 8080.

When an external effect is selected, but nothing is connected to the RETURN jack, the sound will not be interrupted, because the 8080 internally sends the signal to the next module. However, the EXT module parameters settings will be active, so that the sound may be different from the sound with the SND parameter set to "off".

# Controlling an external amplifier

Some guitar amplifiers allow channel switching or on/off switching of built-in effects by an external foot switch. By connecting the foot switch jack of such an amplifier with the EXTERNAL CONTROL jack on the 8080, the amplifier can be controlled within a patch of the 8080.

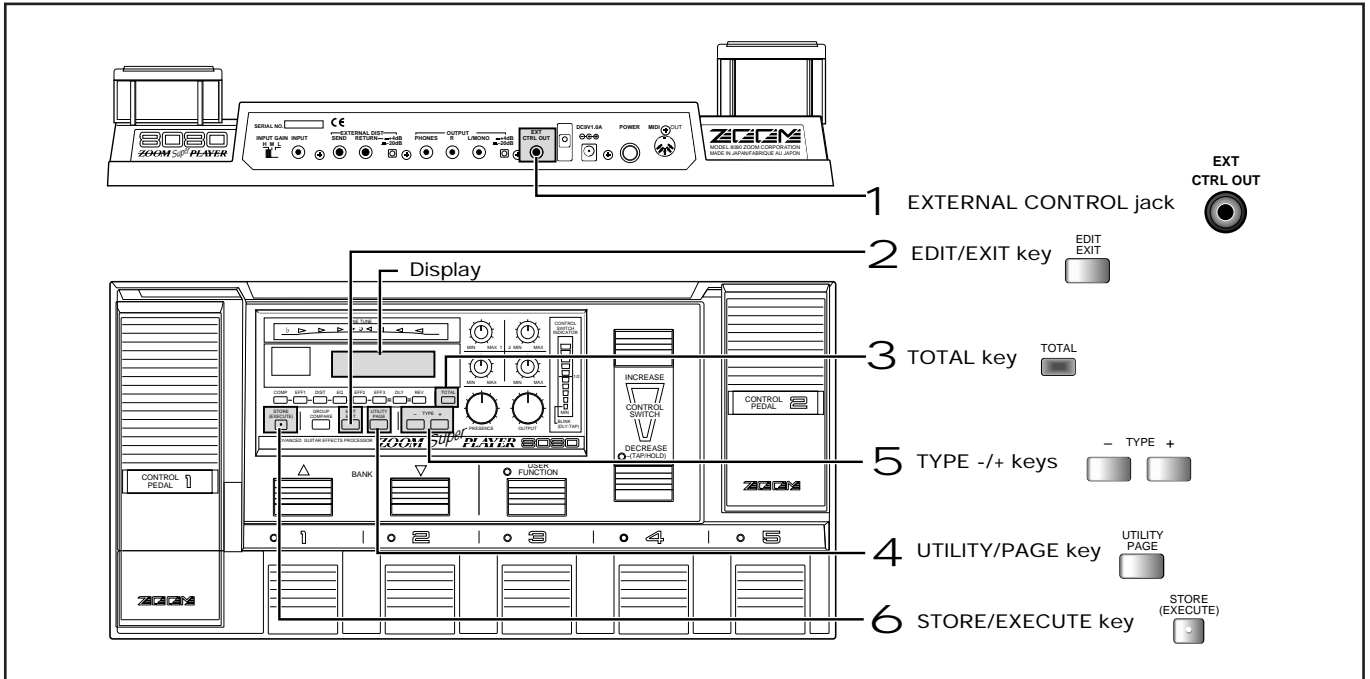

- 1 **Connect the foot switch jack of such an amplifier with the EXTERNAL CONTROL jack**  
  
**on the 8080 (➔ p. 7).**

Use a stereo cable or mono cable to connect the jack to the foot switch jack on the amplifier. Normally, the on/off state of two circuits is achieved by shorting the tip or ring to ground. Amplifier operation will change accordingly.

- 2 **In Play mode, press the EDIT/EXIT key**  
  
**to activate the Edit mode.**

```
SERIAL/PARALLEL:
1 EF2 EF3
```

- 3 **Press the TOTAL key**  
  
**to select the TOTAL module.**

- 4 **Press the UTILITY/PAGE key**  
  
**three times.**

```
EXT CONTROL OUT:
4 TYPE=R(s) T(s)
```



The EXTERNAL CONTROL jack is configured for a stereo cable and can be used to control two on/off circuits.

Stereo phone plug

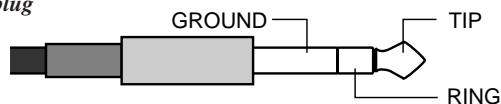

5 Use the <sup>TYPE -/+ keys</sup>  to select one of the four combinations shown below.

Display	Ring	Tip
R(s) T(s)	Short	Short
R(o) T(o)	Open	Open
R(o) T(s)	Open	Short

R(s) T(o)    Short    Open

6 Store the patch as required.

("Storing an edited patch"  p. 23).

When this patch is selected, channel selection or effect on/off switching can be performed for the external amplifier.



Foot switch specifications may differ for various amplifiers. Normally, the same cable as used for the foot switch supplied with the amplifier (mono or stereo) should be used. For details, please refer to the manual of the amplifier. Be sure to turn the equipment off before making any connections.



Some amplifiers may not be suitable for control from the 8080, even if a foot switch jack is provided.

## Returning the 8080 to the factory default condition

You can return all settings of the 8080 including all USER group patches to the factory default condition. This is useful for example if you have inadvertently erased the contents of a USER group patch.

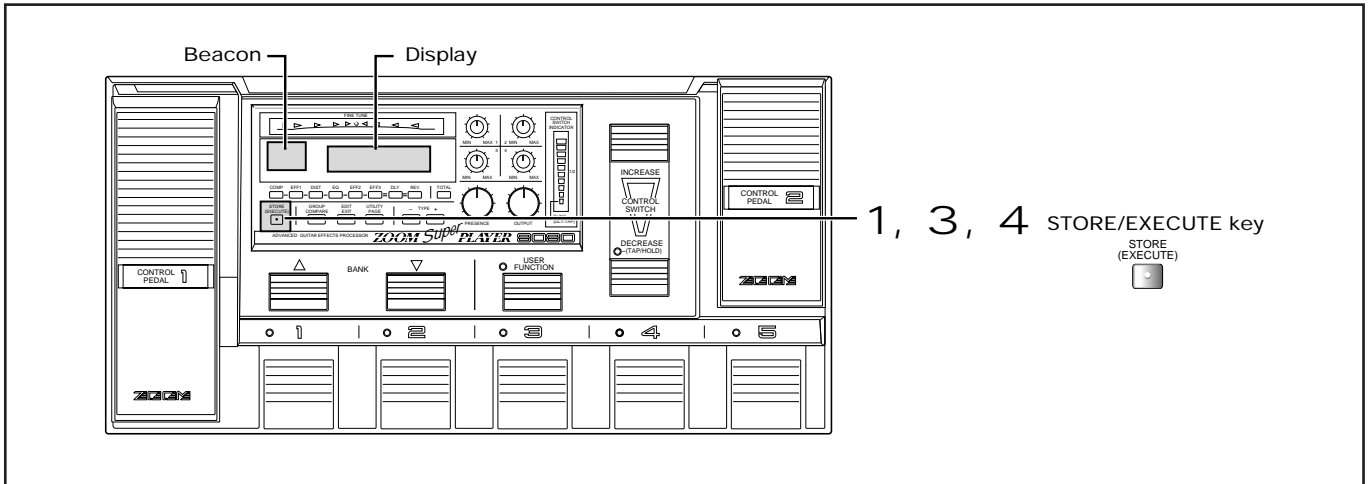

- 1 Turn the 8080 off.  
(Turn the amplifier volume to minimum.)



- 2 Turn the 8080 on while holding the STORE/EXECUTE key depressed.

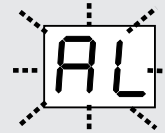
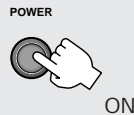

- 3 Press the STORE/EXECUTE key **once** more.

The 8080 goes into standby for "ALL-INITIALIZE".

```
ALL INITIALIZE
PLEASE EXECUTE Key
```

- 4 To carry out "ALL-INITIALIZE", press the STORE/EXECUTE key

All settings of the 8080 are reset to the factory default condition.

```
01 8080LEAD LVL=100
AMP 0V0L 0OFF 0HLD
```



If you wish to cancel the initialize process, press the EDIT/EXIT key instead of pressing the STORE/EXECUTE key a second time.



---

# Effect Types and Parameters

---

Effect Modules of the 8080 .....	46
CMP (Compressor) Module .....	47
EFF1 Module .....	48
DIST (Distortion) Module .....	50
EQ Module .....	54
EFF2 Module .....	55
EFF3 Module .....	58
DLY (Delay) Module .....	60
REV (Reverb) Module .....	62
TOTAL Module .....	63

# Effect Modules of the 8080

This section describes all effect types and parameters contained in the various effect modules.

The 8080 has eight effect modules, comprising the effect types shown in the table below.

COMP	EFF 1	DIST	EQ	EFF2	EFF3	DLY	REV
Compressor 1 "Vintage" Compressor2 Limiter	1-Band Parametric EQ Pedal-Wah "Vintage" Auto-Wah1 Auto-Wah2 "Vintage" Phaser1 "Vintage" Vibe Octaver	External DIST Acoustic Rhythm "Vintage" OverDrive Tube OverDrive Blues OverDrive "Vintage" DIST P "Vintage" DIST M "Vintage" Fuzz B "Vintage" Fuzz-F LeadDriver Metal Distortion	3-Band Equalizer	Pedal Pitch Shifter 2-voice Pitch Shifter Pitch Shifter-Delay 2-voice Harmonized Pitch Shifter Pitch Bender Slow Attack Metallic	Flanger1 "Vintage" Flanger2 Phaser2 Chorus1 "Vintage" Chorus2 Vibrato Step Tremolo/Pan	Normal Delay Twin Delay Hold Delay "Vintage" Analog Delay	Reverb Hall Reverb Room PingPong Delay

Effect modules and Effect types

The signal flow among the effect modules is as follows.

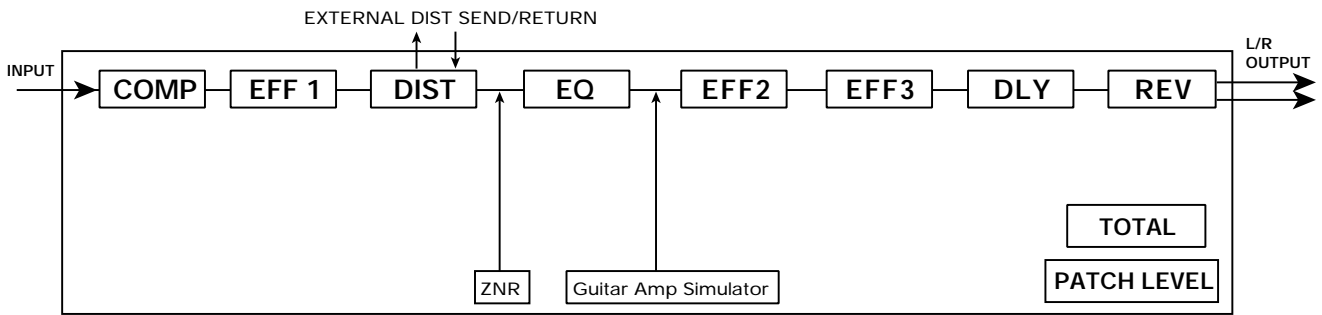

*The EFF1 module can be inserted before or after the DIST module. The insertion point is set as a parameter of EFF1 ( ➡ p. 48).*

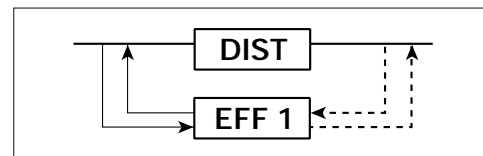

EFF1 module insertion point

*For the connection between the EFF2 module and EFF3 module, you can select serial or parallel connection. This is set as a parameter of the TOTAL module ( ➡ p. 63).*

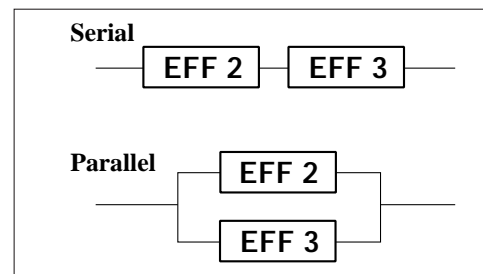

EFF2 and EFF3 module connection

# CMP (Compressor) Module

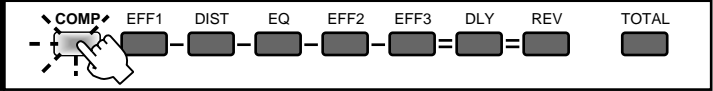

This module provides compression of the input signal to allow sustain effects without overload and to make the sound more uniform.

## CMP: Compressor 1

A standard compressor with natural-sounding sustain.

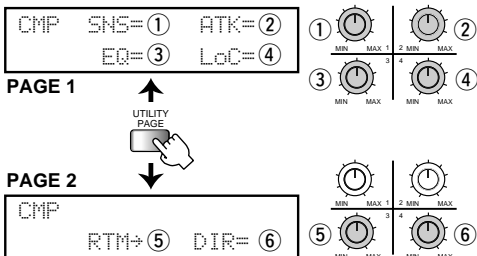

Parameters	Comment	Values
① SNS (Sensitivity)	Sets the depth of the compression effect.	1 – 50
② ATK (Attack)	Sets the speed with which compression responds to picking.	0 – 10
③ EQ (EQ)	Sets the compressor tone control.	-7 – +7
④ LoC (Low-Cut)	Controls the low-cut filter.	off, on
⑤ RTM (RTM Destination)	Shows which RTM parameter is being controlled.	SNS
⑥ DIR (RTM Direction)	Sets the RTM direction.	NML, INV

*For modules where "RTM → " is being shown, the RTM parameter cannot be changed.*

## VCMP: Vintage Compressor 2

Recreates a compressor type highly popular among fusion guitarists in the seventies and eighties.

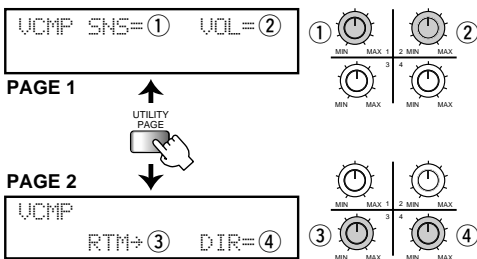

Parameters	Comment	Values
① SNS (Sensitivity)	Sets the depth of the compression effect.	1 – 50
② VOL (Volume)	Sets the output level.	1 – 10
③ RTM (RTM Destination)	Shows which RTM parameter is being controlled.	SNS
④ DIR (RTM Direction)	Sets the RTM direction.	NML, INV

## LIM: Limiter

The limiter serves to keep the level below a certain threshold, creating a more uniform sound.

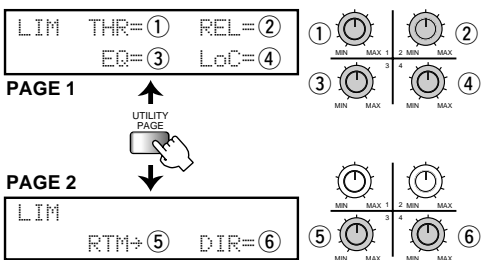

Parameters	Comment	Values
① THR (Threshold)	Sets the point where the limiter takes effect.	1 – 50
② REL (Release)	Sets the time required for the level to return to the original value after falling below the threshold.	0 – 10
③ EQ (EQ)	Sets the limiter tone control.	-7 – +7
④ LoC (Low-Cut)	Controls the low-cut filter.	off, on
⑤ RTM (RTM Destination)	Shows which RTM parameter is being controlled.	THR
⑥ DIR (RTM Direction)	Sets the RTM direction.	NML, INV



# EFF1 Module

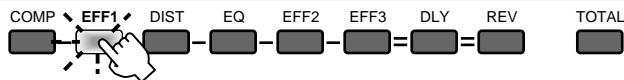

This module contains equalizer effects and wah/modulation effects with strong characteristics. It can be inserted before or after the DIST module.

## PEQ: 1-Band Parametric EQ

Parametric equalizer with high-range enhancer.

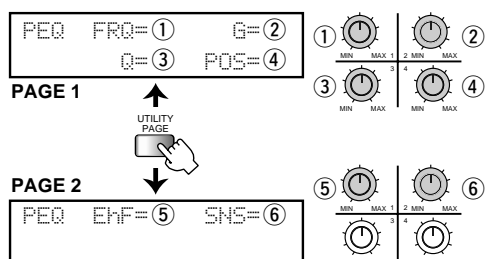

Parameters	Comment	Values
① <b>FRQ (Frequency)</b>	Sets the boost/cut frequency.	63, 160, 400, 1.0, 2.5
② <b>G (Gain)</b>	Sets the boost/cut amount.	-18, -16, ..., +5, +6
③ <b>Q (Q)</b>	Sets the width of the boost/cut frequency range.	78, 2.1
④ <b>POS (Insert Position)</b>	Sets the module insertion point. "BFR" means before the DIST module and "AFT" after the DIST module.	BFR, AFT
⑤ <b>EhF (Enhance Frequency)</b>	Sets the enhancer frequency.	1 - 4
⑥ <b>SNS (Enhance Sensitivity)</b>	Sets the enhancer sensitivity.	off, 1 - 10

## PWAH: Pedal-Wah

Recreation of an ever-popular vintage-type pedal wah.

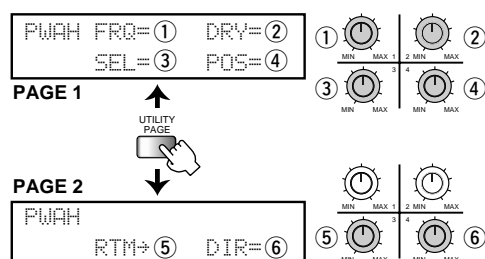

Parameters	Comment	Values
① <b>FRQ (Frequency)</b>	Sets the center frequency that is active when the patch is called.	1 - 50
② <b>DRY (Dry Mix)</b>	Sets the balance between effect sound and dry sound (original sound). When set to 0, no original sound is output.	0 - 10
③ <b>SEL (Type Select)</b>	Lets you select one of two wah types.	1, 2
④ <b>POS (Insert Position)</b>	Sets the module insertion point. "BFR" means before the DIST module and "AFT" after the DIST module.	BFR, AFT
⑤ <b>RTM (RTM Destination)</b>	Shows which RTM parameter is being controlled.	FRQ
⑥ <b>DIR (RTM Direction)</b>	Sets the RTM direction.	NML, INV

## VAWA: Vintage Auto-Wah 1

Recreates a vintage auto-wah sound cherished by fusion and funk musicians in the seventies and eighties.

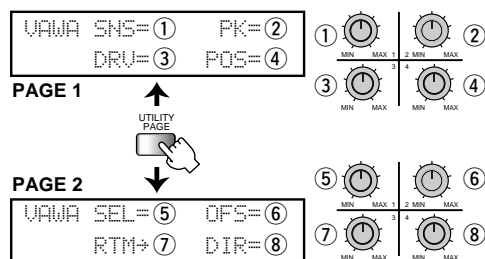

Parameters	Comment	Values
① <b>SNS (Sensitivity)</b>	Sets the wah effect sensitivity. With higher values, the wah effect starts already when strings are picked softly.	1 - 50
② <b>PK (Peak)</b>	Higher values give a stronger wah effect.	1 - 10
③ <b>DRV (Drive)</b>	Sets the wah effect direction. When set to "up", the center frequency is shifted upwards, and when set to "dwn" downwards.	dwn, up
④ <b>POS (Insert Position)</b>	Sets the module insertion point. "BFR" means before the DIST module and "AFT" after the DIST module.	BFR, AFT
⑤ <b>SEL (Type Select)</b>	Three filter types can be selected for the wah effect: Low (low-pass filter), Mid (band-pass filter), HiP (high-pass filter).	Low, Mid, HiP
⑥ <b>OFS (Offset)</b>	Sets the center frequency where the wah effect becomes active.	Low, Hi
⑦ <b>RTM (RTM Destination)</b>	Shows which RTM parameter is being controlled.	SNS
⑧ <b>DIR (RTM Direction)</b>	Sets the RTM direction.	NML, INV

## AWA: Auto-Wah 2

Standard auto-wah effect where wah depends on picking intensity.

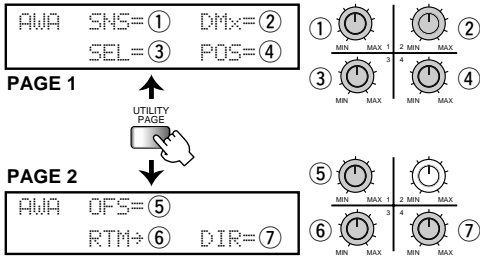

Parameters	Comment	Values
① SNS (Sensitivity)	Sets the wah effect sensitivity.	1 – 50
② DRY (Dry Mix)	Sets the balance between effect sound and dry sound (original sound). When set to 0, no original sound is output.	0 – 10
③ SEL (Type Select)	Sets the wah effect direction. When set to "up", the center frequency is shifted upwards, and when set to "dwn" downwards.	dwn, up
④ POS (Insert Position)	Sets the module insertion point. "BFR" means before the DIST module and "AFT" after the DIST module.	BFR, AFT
⑤ OFS (Offset)	Sets the center frequency where the wah effect becomes active.	Low, Hi
⑥ RTM (RTM Destination)	Shows which RTM parameter is being controlled.	SNS
⑦ DIR (RTM Direction)	Sets the RTM direction.	NML, INV

## VPHA: Vintage Phaser 1

Sound effect with a distinct undulation. Recreates a phaser type made popular by fusion guitarists in the seventies and eighties.

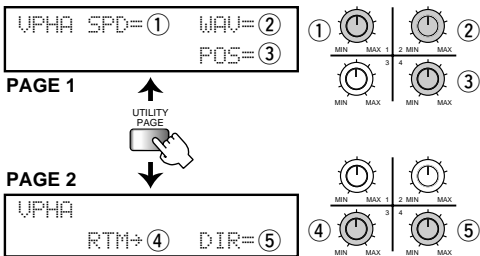

Parameters	Comment	Values
① SPD (Speed)	Sets the undulation speed of the phaser effect.	1 – 50
② WAV (Wave Type)	Alters the undulation curve.	1 – 4
③ POS (Insert Position)	Sets the module insertion point. "BFR" means before the DIST module and "AFT" after the DIST module.	BFR, AFT
④ RTM (RTM Destination)	Shows which RTM parameter is being controlled.	SPD
⑤ DIR (RTM Direction)	Sets the RTM direction.	NML, INV

## VIB: Vintage Vibe

Recreates a vintage-type vibe effect where the intensity and speed depends on the pedal action.

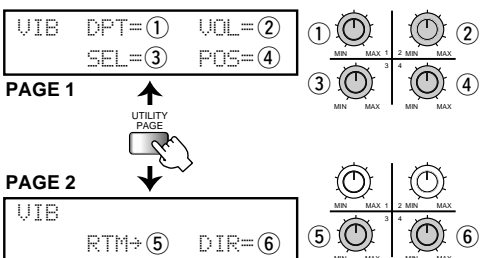

Parameters	Comment	Values
① DPT (Depth)	Sets the depth of the vibe effect.	1 – 50
② VOL (Volume)	Sets the output level.	1 – 10
③ SEL (Type Select)	"CHO" causes original sound to be mixed to the effect sound to achieve a chorus effect. "VIB" is the vibe sound only.	CHO, VIB
④ POS (Insert Position)	Sets the module insertion point. "BFR" means before the DIST module and "AFT" after the DIST module.	BFR, AFT
⑤ RTM (RTM Destination)	Shows which RTM parameter is being controlled.	SPD
⑥ DIR (RTM Direction)	Sets the RTM direction.	NML, INV

## OCT: Octaver

Adds a 1-octave or 2-octave lower component to the original sound.

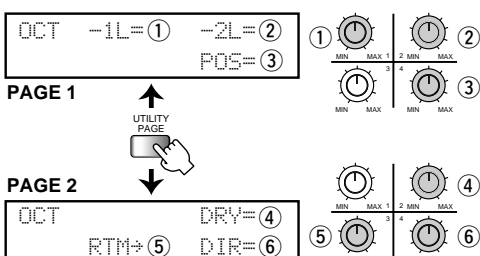

Parameters	Comment	Values
① -1L (-1 Octave Level)	Sets the output level of the 1-octave lower component.	0 – 10
② -2L (-2 Octave Level)	Sets the output level of the 2-octave lower component.	0 – 10
③ POS (Insert Position)	Sets the module insertion point. "BFR" means before the DIST module and "AFT" after the DIST module.	BFR, AFT
④ DRY (Dry Level)	Sets the original sound output level.	0 – 10
⑤ RTM (RTM Destination)	Shows the parameter that is being controlled by RTM. The control range extends from "WLv" (Wet Level) zero to the preset value set with "-1L" and "-2L".	WLv
⑥ DIR (RTM Direction)	Sets the RTM direction.	NML, INV

# DIST (Distortion) Module



This module contains ten different distortion and overdrive effects, including one for control of external distortion devices and a unique "Acoustic" effect that turns the sound of an electric guitar into that of an acoustic guitar. ZNR (Zoom Noise Reduction) is also available in this module.

**HINT** ZNR can be used also when the DIST module is off.

## EXT: External DIST (Distortion)

This effect type serves for control of a device connected in the EXTERNAL DIST SEND/RETURN loop of the 8080. It also allows boosting the output.

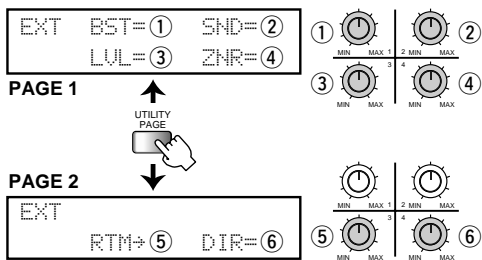

Parameters	Comment	Values
① <b>BST (Booster Type)</b>	The boost frequency range can be set to "Low" (bass), "Mid" (midrange) or "Tre" (treble). When set to "off", the boost function is disabled.	off, Low, Mid, Tre
② <b>SND (Send Level)</b>	Sets the send level for the external device.	off, 1 – 10
③ <b>LVL (Level)</b>	Sets the output level for the next module.	1 – 16
④ <b>ZNR (ZNR)</b>	Sets the activation threshold for Zoom Noise Reduction which suppresses noise during no-signal passages. The key to effective use of ZNR is setting the value as high as possible without causing the noise cutoff to sound unnatural. ZNR can be used also when the DIST module is off.	Off, 1 – 10
⑤ <b>RTM (RTM Destination)</b>	Shows which RTM parameter is being controlled.	SND
⑥ <b>DIR (RTM Direction)</b>	Sets the RTM direction.	NML, INV

**HINT** Even if nothing is connected to the RETURN jack, the signal will be sent to the next module. However, since parameters settings such as BST and SND are active, the sound may be altered.

When this effect type is selected, internal distortion effects of the 8080 cannot be used.

In the DIST module, when the setting is "DIR=NML", pushing the pedal from the up position all the way down causes the parameter to be altered from the minimum value to the preset value (programmed value for the patch). When the setting is "DIR=INV", pushing the pedal from the up position all the way down causes the parameter to be altered from the current value to the minimum value. The minimum value depends on the distortion type and the parameter setting.

## Acou: Acoustic

This effect changes the sound of an electric guitar to a sound resembling that of an acoustic guitar.

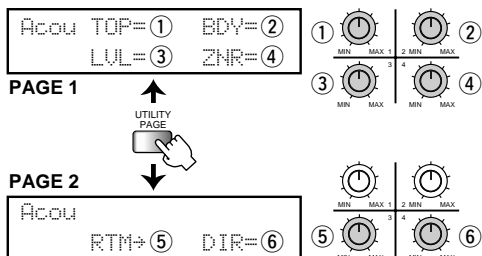

Parameters	Comment	Values
① <b>TOP (Top)</b>	Adjusts the high-frequency range.	1 – 10
② <b>BDY (Body)</b>	Sets the body size.	1 – 10
③ <b>LVL (Level)</b>	Sets the output level.	1 – 16
④ <b>ZNR (ZNR)</b>	Sets the activation threshold for Zoom Noise Reduction which suppresses noise during no-signal passages. The key to effective use of ZNR is setting the value as high as possible without causing the noise cutoff to sound unnatural. ZNR can be used also when the DIST module is off.	Off, 1 – 10
⑤ <b>RTM (RTM Destination)</b>	Shows which RTM parameter is being controlled.	LVL
⑥ <b>DIR (RTM Direction)</b>	Sets the RTM direction.	NML, INV

## RHY: Rhythm

Effect with a crunch type sound that is well suited to rhythm guitar.

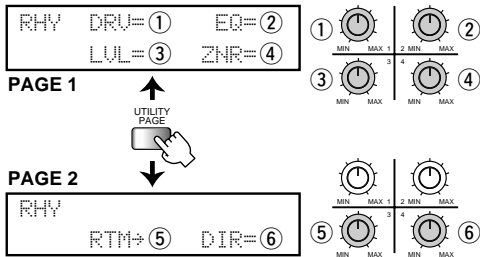

Parameters	Comment	Values
① DRV (Drive)	Sets the distortion type.	1 – 30
② EQ (EQ)	Sets the tonal quality. Higher values emphasize the treble range.	-10 – +10
③ LVL (Level)	Sets the output level.	1 – 16
④ ZNR (ZNR)	Sets the activation threshold for Zoom Noise Reduction which suppresses noise during no-signal passages. The key to effective use of ZNR is setting the value as high as possible without causing the noise cutoff to sound unnatural. ZNR can be used also when the DIST module is off.	Off, 1 – 10
⑤ RTM (RTM Destination)	Shows which RTM parameter is being controlled.	DRV
⑥ DIR (RTM Direction)	Sets the RTM direction.	NML, INV

## V-OD: Vintage Overdrive

Recreates the kind of effect that first introduced the concept of overdrive.

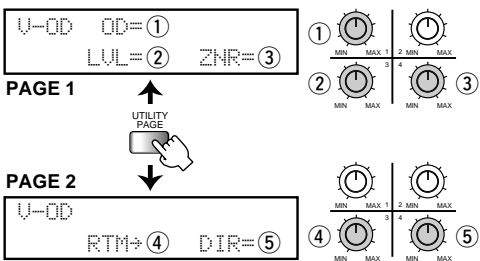

Parameters	Comment	Values
① OD (Overdrive)	Sets the distortion type.	1 – 30
② LVL (Level)	Sets the output level.	1 – 16
③ ZNR (ZNR)	Sets the activation threshold for Zoom Noise Reduction which suppresses noise during no-signal passages. The key to effective use of ZNR is setting the value as high as possible without causing the noise cutoff to sound unnatural. ZNR can be used also when the DIST module is off.	Off, 1 – 10
④ RTM (RTM Destination)	Shows which RTM parameter is being controlled.	OD
⑤ DIR (RTM Direction)	Sets the RTM direction.	NML, INV

## TbOD: Tube Overdrive

Characteristic tube amplifier type overdrive.

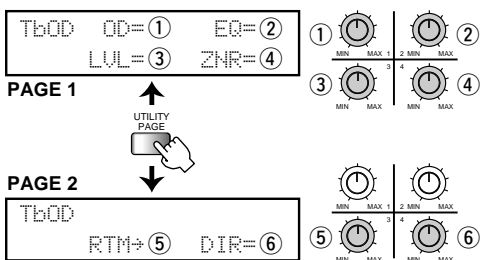

Parameters	Comment	Values
① OD (Overdrive)	Sets the distortion type	1 – 30
② EQ (EQ)	Sets the tonal quality. Higher values emphasize the treble range.	-10 – +10
③ LVL (Level)	Sets the output level.	1 – 16
④ ZNR (ZNR)	Sets the activation threshold for Zoom Noise Reduction which suppresses noise during no-signal passages. The key to effective use of ZNR is setting the value as high as possible without causing the noise cutoff to sound unnatural. ZNR can be used also when the DIST module is off.	Off, 1 – 10
⑤ RTM (RTM Destination)	Shows which RTM parameter is being controlled.	OD
⑥ DIR (RTM Direction)	Sets the RTM direction.	NML, INV

## BsOD: Blues Overdrive

Overdrive with a solid body.

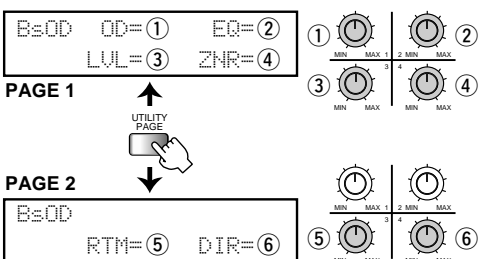

Parameters	Comment	Values
① OD (Overdrive)	Sets the distortion type.	1 – 30
② EQ (EQ)	Sets the tonal quality. Higher values emphasize the treble range.	-10 – +10
③ LVL (Level)	Sets the output level.	0 – 15
④ ZNR (ZNR)	Sets the activation threshold for Zoom Noise Reduction which suppresses noise during no-signal passages. The key to effective use of ZNR is setting the value as high as possible without causing the noise cutoff to sound unnatural. ZNR can be used also when the DIST module is off.	Off, 1 – 10
⑤ RTM (RTM Destination)	Shows which RTM parameter is being controlled.	OD
⑥ DIR (RTM Direction)	Sets the RTM direction.	NML, INV

## VDSP: Vintage Distortion P

Recreates a popular vintage distortion effect with wild character.

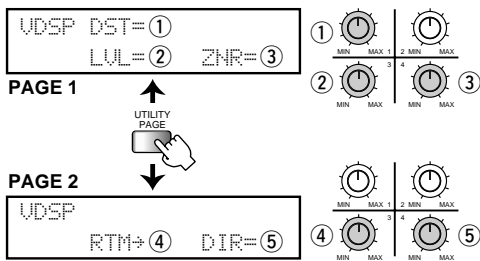

Parameters	Comment	Values
① <b>DST (Distortion)</b>	Sets the distortion type.	1 – 30
② <b>LVL (Level)</b>	Sets the output level.	1 – 16
③ <b>ZNR (ZNR)</b>	Sets the activation threshold for Zoom Noise Reduction which suppresses noise during no-signal passages. The key to effective use of ZNR is setting the value as high as possible without causing the noise cutoff to sound unnatural. ZNR can be used also when the DIST module is off.	Off, 1 – 10
④ <b>RTM (RTM Destination)</b>	Shows which RTM parameter is being controlled.	DST
⑤ <b>DIR (RTM Direction)</b>	Sets the RTM direction.	NML, INV

## VDSM: Vintage Distortion M

Recreates a vintage distortion effect that took the world by storm: hard stacked-amp type distortion.

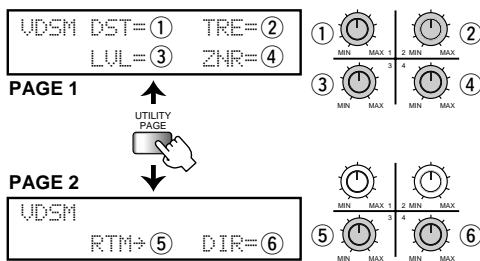

Parameters	Comment	Values
① <b>DST (Distortion)</b>	Sets the distortion type.	1 – 30
② <b>TRE (Treble)</b>	Adjusts the treble range. Higher values emphasize the range and lower values cut the range.	-10 – +10
③ <b>LVL (Level)</b>	Sets the output level.	1 – 16
④ <b>ZNR (ZNR)</b>	Sets the activation threshold for Zoom Noise Reduction which suppresses noise during no-signal passages. The key to effective use of ZNR is setting the value as high as possible without causing the noise cutoff to sound unnatural. ZNR can be used also when the DIST module is off.	Off, 1 – 10
⑤ <b>RTM (RTM Destination)</b>	Shows which RTM parameter is being controlled.	DST
⑥ <b>DIR (RTM Direction)</b>	Sets the RTM direction.	NML, INV

## VFzB: Vintage Fuzz B

Recreates the archetypical fuzz sound.

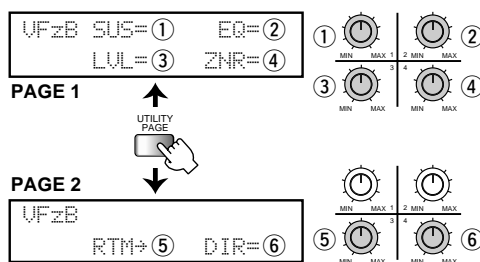

Parameters	Comment	Values
① <b>SUS (Sustain)</b>	Sets the distortion type.	1 – 30
② <b>EQ (EQ)</b>	Sets the tonal quality. Higher values emphasize the treble range.	-10 – +10
③ <b>LVL (Level)</b>	Sets the output level.	1 – 16
④ <b>ZNR (ZNR)</b>	Sets the activation threshold for Zoom Noise Reduction which suppresses noise during no-signal passages. The key to effective use of ZNR is setting the value as high as possible without causing the noise cutoff to sound unnatural. ZNR can be used also when the DIST module is off.	Off, 1 – 10
⑤ <b>RTM (RTM Destination)</b>	Shows which RTM parameter is being controlled.	SUS
⑥ <b>DIR (RTM Direction)</b>	Sets the RTM direction.	NML, INV



## VFzF: Vintage Fuzz F

Recreates a popular, solid-sounding fuzz effect.

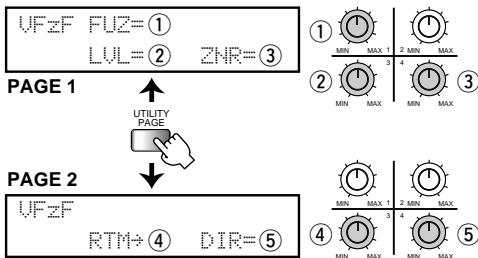

Parameters	Comment	Values
① <b>FUZ (Fuzz)</b>	Sets the distortion type.	1 – 30
② <b>LVL (Level)</b>	Sets the output level.	1 – 16
③ <b>ZNR (ZNR)</b>	Sets the activation threshold for Zoom Noise Reduction which suppresses noise during no-signal passages. The key to effective use of ZNR is setting the value as high as possible without causing the noise cutoff to sound unnatural. ZNR can be used also when the DIST module is off.	Off, 1 – 10
④ <b>RTM (RTM Destination)</b>	Shows which RTM parameter is being controlled.	FUZ
⑤ <b>DIR (RTM Direction)</b>	Sets the RTM direction.	NML, INV

## LEAD: Lead Driver

Distortion with prominent midrange, ideal for lead guitar.

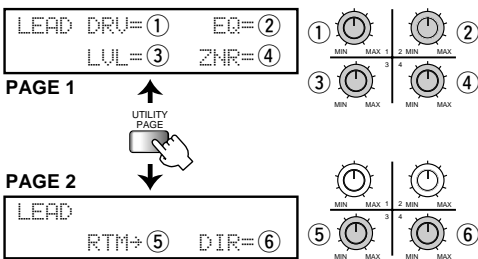

Parameters	Comment	Values
① <b>DRV (Drive)</b>	Sets the distortion type.	1 – 30
② <b>EQ (EQ)</b>	Sets the tonal quality. Higher values emphasize the treble range and lower values cut the treble range.	-10 – +10
③ <b>LVL (Level)</b>	Sets the output level.	1 – 16
④ <b>ZNR (ZNR)</b>	Sets the activation threshold for Zoom Noise Reduction which suppresses noise during no-signal passages. The key to effective use of ZNR is setting the value as high as possible without causing the noise cutoff to sound unnatural. ZNR can be used also when the DIST module is off.	Off, 1 – 10
⑤ <b>RTM (RTM Destination)</b>	Shows which RTM parameter is being controlled.	DRV
⑥ <b>DIR (RTM Direction)</b>	Sets the RTM direction.	NML, INV

## MTL: Metal Distortion

Distortion effect most suitable for heavy metal, with strong emphasis on bass and treble.

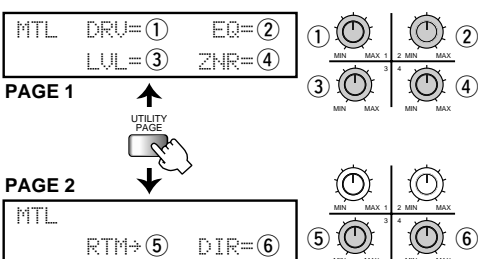

Parameters	Comment	Values
① <b>DRV (Drive)</b>	Sets the distortion type.	1 – 30
② <b>EQ (EQ)</b>	Sets the tonal quality. Higher values emphasize the treble range.	-10 – +10
③ <b>LVL (Level)</b>	Sets the output level.	1 – 16
④ <b>ZNR (ZNR)</b>	Sets the activation threshold for Zoom Noise Reduction which suppresses noise during no-signal passages. The key to effective use of ZNR is setting the value as high as possible without causing the noise cutoff to sound unnatural. ZNR can be used also when the DIST module is off.	Off, 1 – 10
⑤ <b>RTM (RTM Destination)</b>	Shows which RTM parameter is being controlled.	DRV
⑥ <b>DIR (RTM Direction)</b>	Sets the RTM direction.	NML, INV

# EQ Module

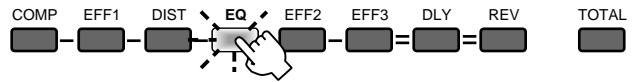

This is an equalizer module for providing tonal compensation.

## 3-EQ: 3-Band Equalizer

This parametric equalizer allows boost and cut in three bands (high, mid, low). Q is fixed for each band.

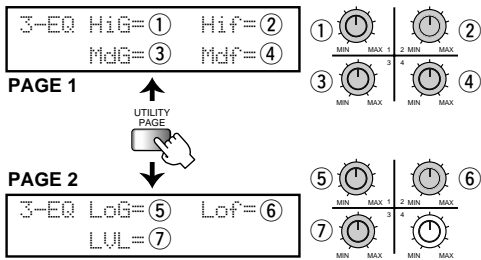

Parameters	Comment	Values
① <b>HiG (High Gain)</b>	Provides boost/cut for the high frequency range.	-12 – +12
② <b>Hif (High Frequency)</b>	Sets the boost/cut frequency for the high frequency range.	5.0, 6.3
③ <b>MdG (Middle Gain)</b>	Provides boost/cut for the mid frequency range.	-12 – +12
④ <b>Mdf (Middle Frequency)</b>	Sets the boost/cut frequency for the mid frequency range.	200, 315, 500, 630, 800, 1.2, 2.0, 3.1
⑤ <b>LoG (Low Gain)</b>	Provides boost/cut for the low frequency range.	-12 – +12
⑥ <b>Lof (Low Frequency)</b>	Sets the boost/cut frequency for the low frequency range.	80, 125
⑦ <b>LVL (Level)</b>	Sets the output level.	-18, -16. ... – +5, +6

# EFF2 Module

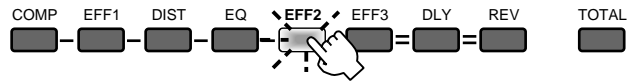

This module contains modulation-type effects for changing the pitch and creating special effects.

## PPIT: Pedal Pitch Shifter

Allows changing the pitch in real time with a pedal. There are 16 pitch change patterns.

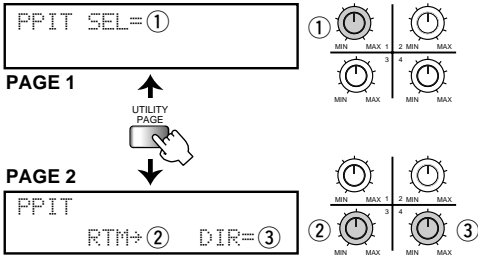

Parameters	Comment	Values
① SEL (Type Select)	Allows selection of pitch change pattern from 16 possibilities.	1 – 16
② RTM (RTM Destination)	Shows which RTM parameter is being controlled.	PIT
③ DIR (RTM Direction)	Sets the RTM direction.	NML, INV

When "DIR" (RTM Direction) is set to "NML", the 16 pitch change patterns work as shown below.

Pattern	Display (Name)	Pedal up (min. value)	Pedal down (max. value)
1	DTYBend (Dirty bend)	-100cent	DRY
2	HrmCho (Harmonized choking)	-200cent+DRY	-10cent+DRY
3	Detune (Detune)	0cent	+50cent+DRY
4	Bend Down (Bend down)	0cent	-200cent
5	Bend Up (Bend up)	0cent	+1oct
6	Arm Dw-1 (Arm down 1)	0cent	-1oct
7	Arm Dw-2 (Arm down 2)	0cent	-2oct
8	Infinity (Infinity bend down)	0cent	-∞
9	min/Maj (Minor/major)	+300cent+DRY	+400cent+DRY
10	OctHrm (Octave harmony)	-1oct+DRY	+1oct+DRY
11	-5th/4th (Perfect -5th/perfect 4th)	-700cent+DRY	+500cent+DRY
12	5th/6th (Perfect 5th/6th)	+700cent+DRY	+900cent+DRY
13	4Oct-SFT (4-octave shift)	-2oct	+2oct
14	MANU-FN (Manual flanger)	+1oct+DRY	+2oct+DRY
15	CRS-fade (X-fade)	-∞+DRY	+1oct
16	Stop (Stop)	-∞+DRY	+1oct+DRY

*For this effect type, when the setting is "DIR=NML", pushing the pedal from the up position all the way down causes the parameter to be altered from the minimum value to the maximum value. When the setting is "DIR=INV", the change is from the maximum value to the minimum value.*

## PIT: 2-Voice Pitch Shifter

This effect divides the original sound into two components (L and R) for which the pitch shifter can be set individually. By mixing these two sounds with the original sound, a 3-tone harmony is created.

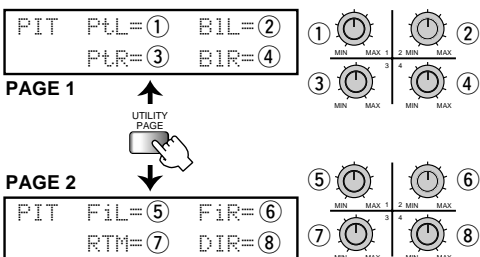

Parameters	Comment	Values
① PtL (Pitch L)	Controls the pitch shift amount for the L side within ± 2 octaves, in 1-semitone steps.	-24 – +24
② BIL (Balance L)	Sets the balance between effect sound and original sound for the L side. Higher values result in more pronounced effect sound.	0 – 100
③ PtR (Pitch R)	Controls the pitch shift amount for the R side within ± 2 octaves, in 1-semitone steps.	-24 – +24
④ BIR (Balance R)	Sets the balance between effect sound and original sound for the R side. Higher values result in more pronounced effect sound.	0 – 100
⑤ FiL (Fine L)	Fine adjusts the pitch shift amount for the L side.	-10 – +10
⑥ FiR (Fine R)	Fine adjusts the pitch shift amount for the R side.	-10 – +10
⑦ RTM (RTM Destination)	Sets the parameter to be controlled by RTM. When "WBI" (Wet Balance) is selected, the L/R balance can be controlled simultaneously.	BIL, BIR, WBI
⑧ DIR (RTM Direction)	Sets the RTM direction.	NML, INV



## PitD: Pitch Shifter-Delay

This special effect adds a predelay to the pitch shifter, with the repeated sound being gradually shifted in pitch.

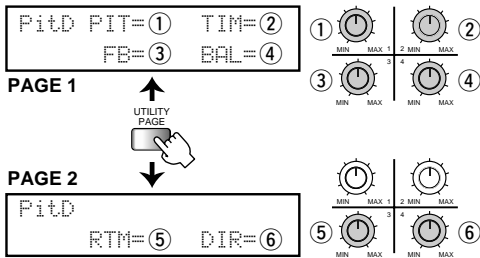

Parameters	Comment	Values
① PIT (Pitch)	Controls the pitch shift within $\pm 1$ octaves.	-12 – +12
② TIM (Time x10ms)	Sets the predelay time in 10-ms steps.	0 – 100
③ FB (Feedback)	Sets the predelay repeat amount.	0 – 10
④ BAL (Balance)	Sets the balance between original sound and effect sound. Higher values result in more pronounced effect sound.	0 – 100
⑤ RTM (RTM Destination)	Sets the parameter to be controlled by RTM.	PIT, FB, BAL
⑥ DIR (RTM Direction)	Sets the RTM direction.	NML, INV

## HPS: 2-voice Harmonized Pitch Shifter

This is an intelligent pitch shifter which divides the original sound into two components (L and R) and creates diatonic harmonies with different scales for the two sides.

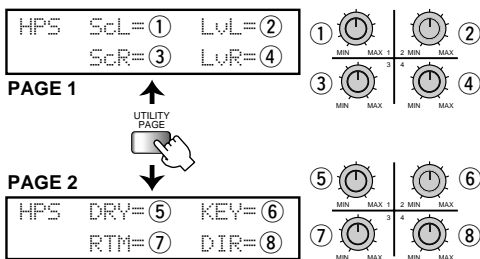

Parameters	Comment	Values
① ScL (Scale L)	Sets the harmony interval on the L side. The following settings are available:	-6t (perfect sixth down), -5t (perfect fifth down), -4t (major fourth down), -m3 (minor third down), -M3 (major third down), +M3 (major third up), +m3 (minor third up), +4t (perfect fourth up), +5t (perfect fifth up), +6t (perfect sixth up),
② LvL (Level L)	Sets the effect sound level on the L side.	0 – 100
③ ScR (Scale R)	Sets the harmony interval on the R side. The following settings are available:	-6t (perfect sixth down), -5t (perfect fifth down), -4t (major fourth down), -m3 (minor third down), -M3 (major third down), +M3 (major third up), +m3 (minor third up), +4t (perfect fourth up), +5t (perfect fifth up), +6t (perfect sixth up),
④ LvR (Level R)	Sets the effect sound level on the R side.	0 – 100
⑤ DRY (Dry Level)	Sets the original sound output level.	0 – 100
⑥ KEY (Key)	Sets the tonic key of the scale. The following settings are available:	C, C#, D, D#, E, F, F#, G, G#, A, A#, B
⑦ RTM (RTM Destination)	Displays the parameter that is being controlled by RTM. When "WLv" (Wet Level) is selected, "LvA" and "LvB" are controlled simultaneously.	LvL, LvR, WLv
⑧ DIR (RTM Direction)	Sets the RTM direction.	NML, INV

### Examples

KEY=C  
Direct

Scale L  
= + M3

Scale R  
= - 4t

## PBND: Pitch Bender

This effect detects the picking intensity and accordingly bends the pitch up or down.

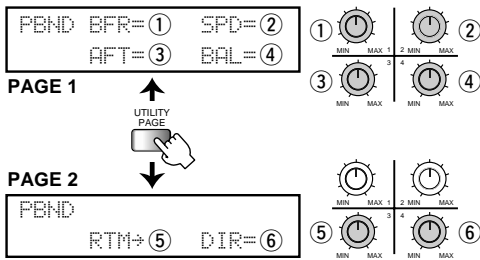

Parameters	Comment	Values
① BFR (Before Pitch)	Sets the pitch at the start of the effect. Setting range is $\pm 1$ or $\pm 2$ octaves, in 1-semitone steps.	-24, -12, -11, ..., 0, ..., +11, +12, +24
② SPD (Speed)	Sets the pitch bend rate.	1 - 100
③ AFT (After Pitch)	Sets the pitch at the end of the effect. Setting range is $\pm 1$ or $\pm 2$ octaves, in 1-semitone steps.	-24, -12, -11, ..., 0, ..., +11, +12, +24
④ BAL (Balance)	Sets the balance between original sound and effect sound.	0 - 100
⑤ RTM (RTM Destination)	Shows which RTM parameter is being controlled.	SPD
⑥ DIR (RTM Direction)	Sets the RTM direction.	NML, INV

## SLOW: Slow Attack

This effect has two selectable types: slow attack for automatically creating a "violin" playing style, and dynamic filter which opens up according to picking intensity and emphasizes the low or high frequencies.

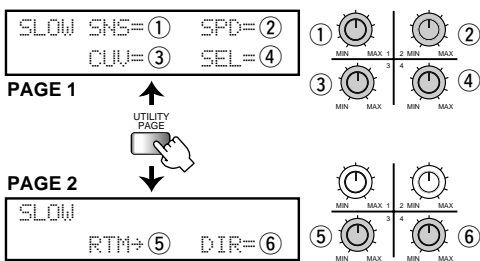

Parameters	Comment	Values
① SNS (Sensitivity)	Sets the volume attenuation depth and filter alteration width.	0 - 50
② SPD (Speed)	Sets the time until the volume level rises or the filter effect becomes audible. Lower values result in slower action.	1 - 100
③ CUV (Curve)	Sets the curve for volume change and filter action.	0 - 3
④ SEL (Type Select)	"SLO" selects the slow attack affect and "DYN" the dynamic filter.	SLO, DYN
⑤ RTM (RTM Destination)	Shows which RTM parameter is being controlled.	SPD
⑥ DIR (RTM Direction)	Sets the RTM direction.	NML, INV

*In this effect, the action of parameters 1-3 depends on parameter 4.*

## MET: Metallic

This is a ring modulator effect which produces a metallic sound. The modulation frequency changes with time.

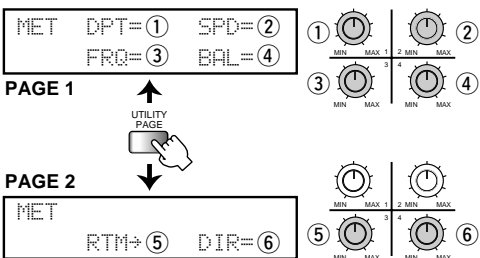

Parameters	Comment	Values
① DPT (Depth)	Sets the modulation frequency for picking.	0 - 10
② SPD (Speed)	Sets the rate at which the modulation frequency changes.	1 - 100
③ FRQ (Frequency)	Sets the end frequency for the modulation.	0 - 10
④ BAL (Balance)	Sets the balance between original sound and effect sound.	0 - 100
⑤ RTM (RTM Destination)	Shows which RTM parameter is being controlled.	BAL
⑥ DIR (RTM Direction)	Sets the RTM direction.	NML, INV

# EFF3 Module

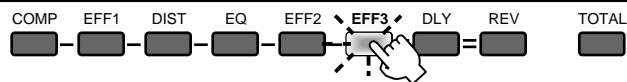

This module contains conventional modulation-type effects such as flanger and chorus.

## FLG: Flanger 1

Characteristic flanger effect indispensable for jet sound.

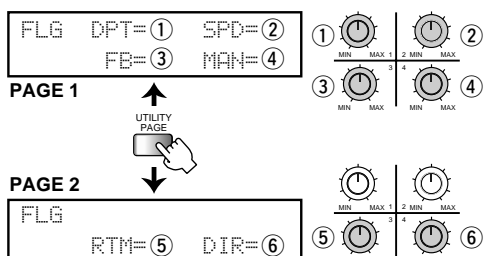

Parameters	Comment	Values
① DPT (Depth)	Sets the depth of the flanging effect	0 – 10
② SPD (Speed)	Sets the speed of the flanging effect.	1 – 100
③ FB (Feedback)	Increasing this parameter emphasizes modulation, resulting in a more pronounced flanging effect.	0 – 10
④ MAN (Manual)	Sets the predelay time.	0 – 10
⑤ RTM (RTM Destination)	Sets the parameter to be controlled by RTM.	SPD, FB
⑥ DIR (RTM Direction)	Sets the RTM direction.	NML, INV

## VFLG: Vintage Flanger 2

Recreates a vintage flanger effect that has been extensively used by hard rock musicians.

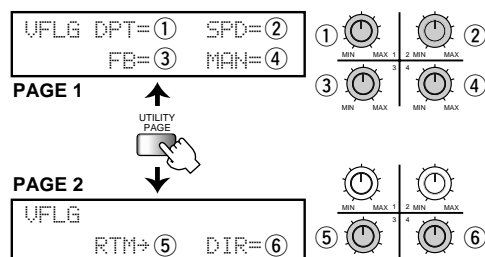

Parameters	Comment	Values
① DPT (Depth)	Sets the depth of the flanging effect.	0 – 50
② SPD (Speed)	Sets the speed of the flanging effect.	1 – 100
③ FB (Feedback)	Increasing this parameter emphasizes modulation, resulting in a more pronounced flanging effect.	0 – 10
④ MAN (Manual)	Sets the predelay time.	0 – 10
⑤ RTM (RTM Destination)	Shows which RTM parameter is being controlled.	SPD
⑥ DIR (RTM Direction)	Sets the RTM direction.	NML, INV

## PHA: Phaser 2

Phaser effect which allows detailed manual settings.

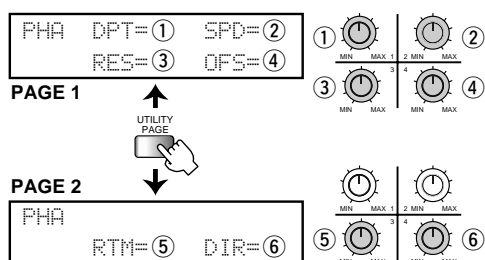

Parameters	Comment	Values
① DPT (Depth)	Sets the depth of the phaser effect.	0 – 50
② SPD (Speed)	Sets the speed of the phaser effect.	1 – 100
③ RES (Resonance)	Emphasizes the phaser effect.	0 – 10
④ OFS (Offset)	Sets the center frequency when no modulation is applied.	0 – 10
⑤ RTM (RTM Destination)	Sets the parameter to be controlled by RTM.	SPD, RES
⑥ DIR (RTM Direction)	Sets the RTM direction.	NML, INV

## CHO: Chorus 1

This chorus effect lends body and ambience to the sound. The tonal quality of the effect can also be adjusted, to achieve a warm chorus sound.

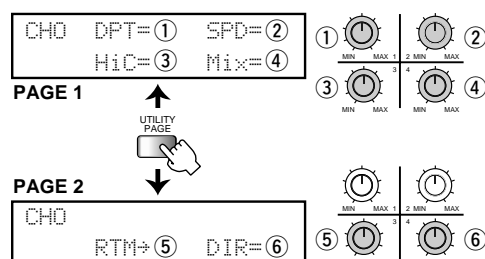

Parameters	Comment	Values
① DPT (Depth)	Sets the depth of the phaser effect.	0 – 50
② SPD (Speed)	Sets the speed of the phaser effect.	1 – 100
③ HiC (High Cut)	Causes a treble cut in the effect sound.	0 – 10
④ Mix (Mix)	Adjusts the balance between original sound and effect sound.	0 – 100
⑤ RTM (RTM Destination)	Shows which RTM parameter is being controlled.	Mix
⑥ DIR (RTM Direction)	Sets the RTM direction.	NML, INV

## VCHO: Vintage Chorus 2

Recreates a traditional guitar chorus effect.

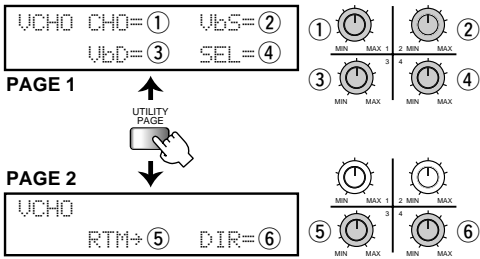

Parameters	Comment	Values
① CHO (Chorus Intensity)	Sets the chorus depth when the SEL parameter is set to "CHO".	0 – 50
② VbS (Vibrato Speed)	Sets the vibrato speed when the SEL parameter is set to "VIB".	1 – 100
③ VbD (Vibrato Depth)	Sets the vibrato depth when the SEL parameter is set to "VIB".	0 – 10
④ SEL (Type Select)	Serves to select the chorus or vibrato effect.	CHO, VIB
⑤ RTM (RTM Destination)	Displays the parameter that is being controlled by RTM. When the SEL parameter is set to "CHO", "Mix" (balance between original sound and effect sound) is controlled. When the SEL parameter is set to "VIB", "SPD" is controlled.	Mix, SPD
⑥ DIR (RTM Direction)	Sets the RTM direction.	NML, INV

## VBRT: Vibrato

Vibrato effect with periodically altered pitch.

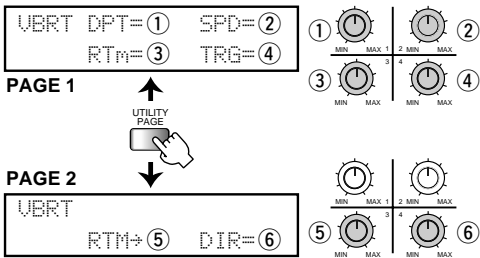

Parameters	Comment	Values
① DPT (Depth)	Sets the depth of the vibrato effect.	0 – 50
② SPD (Speed)	Sets the speed of the vibrato effect.	1 – 100
③ RTM (Rise Time)	Sets the time interval between picking and the start of vibrato.	0 – 10
④ TRG (Trigger)	When this parameter is set to "On", vibrato is triggered by the picking action.	off, on
⑤ RTM (RTM Destination)	Shows which RTM parameter is being controlled.	SPD
⑥ DIR (RTM Direction)	Sets the RTM direction.	NML, INV

## STEP: Step

This effect creates an auto-arpeggio sound by randomly changing the filter action.

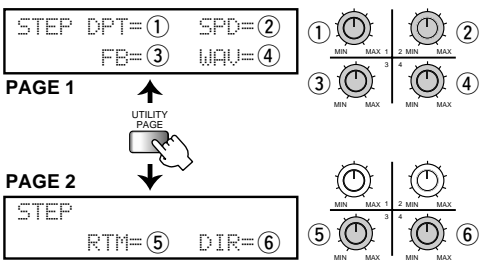

Parameters	Comment	Values
① DPT (Depth)	Sets the range of the filter action change.	0 – 50
② SPD (Speed)	Sets the speed of the effect.	1 – 100
③ FB (Feedback)	Sets the effect sound feedback amount.	0 – 10
④ WAV (Wave Type)	The modulation curve (waveform) can be selected from three types.	1 – 3
⑤ RTM (RTM Destination)	Sets the parameter to be controlled by RTM.	SPD, FB
⑥ DIR (RTM Direction)	Sets the RTM direction.	NML, INV

## PAN: Tremolo/Pan

This effect can be used as tremolo effect or as an automatic stereo panpot.

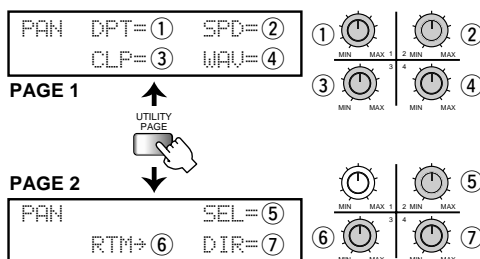

Parameters	Comment	Values
① DPT (Depth)	Sets the depth of the tremolo/auto-pan effect.	0 – 50
② SPD (Speed)	Sets the speed of the tremolo/auto-pan effect.	1 – 100
③ CLP (Clip)	Increasing this value causes the tremolo waveform to be flattened, for an even more pronounced tremolo/auto-pan effect.	0 – 10
④ WAV (Wave Type)	The modulation waveform can be selected from fore types. "TRI" is a triangular wave and "SIN" a sine wave.	TRI, SIN, up, down
⑤ SEL (Type Select)	"TRM" selects the tremolo effect and "PAN" the auto-pan effect.	TRM, PAN
⑥ RTM (RTM Destination)	Shows which RTM parameter is being controlled.	SPD
⑦ DIR (RTM Direction)	Sets the RTM direction.	NML, INV

# DLY (Delay) Module



This module provides four types of delay effects including ultra-long delay of up to 4 seconds and an analog-type delay.

## DLY: Normal Delay

This is a traditional delay effect with delay times up to 4 seconds. You can select monaural delay or ping-pong delay. Using one of the CONTROL switches, tapping input of delay time is possible.

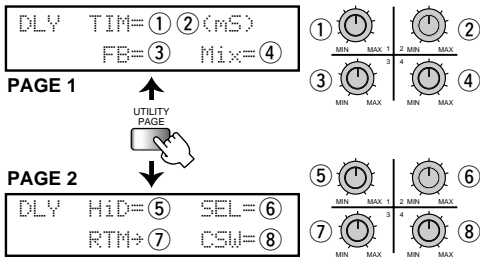

Parameters	Comment	Values
① TIM (Time x 100ms)	Sets the delay time in 100-ms steps.	0 - 40 (x100)
② (mS) (Time Fine)	Fine adjusts the delay time in 1-ms steps.	0 - 99
③ FB (Feedback)	Sets the feedback amount.	0 - 10
④ Mix (Mix)	Adjusts the mix between original sound and effect sound.	0 - 100
⑤ HiD (High Damp)	Sets the degree of high-range attenuation during feedback.	0 - 10
⑥ SEL (Type Select)	Can be set to "MN" (mono delay) or "PPD" (ping-pong delay).	MN, PPD
⑦ RTM (RTM Destination)	Displays the parameter that is being controlled by RTM.	Mix
⑧ CSW (CSWselect)	Sets the CONTROL switch function to "Mix" (balance between original sound and effect sound) or "Tap" (tapping input of delay time).	Mix, Tap

## TWIN: Twin Delay

This delay effect uses two delay times. Time1 is selected by the user and Time2 is the double of Time1. This allows one player to sound like three.

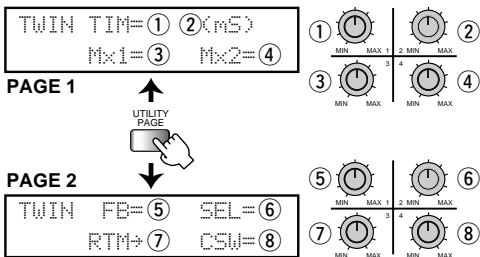

Parameters	Comment	Values
① TIM (Time1)	Set the Time1 delay time in 100-ms steps.	0 - 20 (x100)
② (mS) (Time Fine)	Fine adjusts the Time1 delay time in 1-ms steps.	0 - 99
③ Mx1 (Time1 Mix)	Adjusts the mixing amount of the Time1 effect sound.	0 - 100
④ Mx2 (Time2 Mix)	Adjusts the mixing amount of the Time2 (double of Time1) effect sound.	0 - 100
⑤ FB (Feedback)	Sets the feedback amount.	0 - 10
⑥ SEL (Type Select)	Determines the connection type within the module (see illustration below).	L-R, R-L, MN, SPC
⑦ RTM (RTM Destination)	Displays the parameter that is being controlled by RTM.	Mix
⑧ CSW (CSWselect)	Sets the CONTROL switch function to "Mix" (balance between original sound and effect sound) or "Tap" (tapping input of delay time).	Mix, Tap

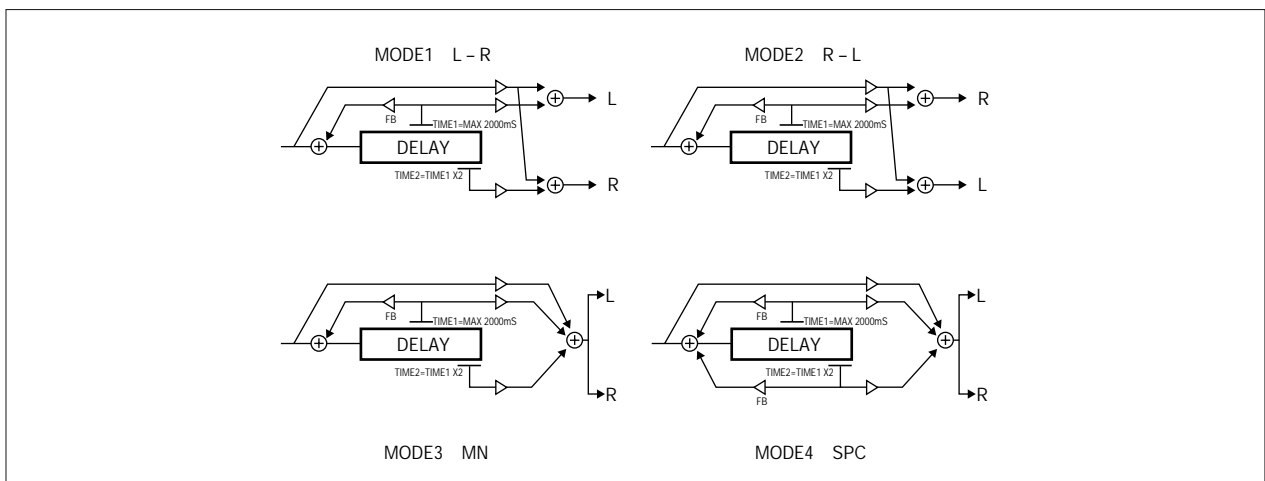

## HOLD: Hold Delay

This delay effect samples a phrase and repeats it. When the CONTROL switch is pressed once, the sound is sampled for the preset delay time. Pressing the CONTROL switch again causes the phrase to be repeated.

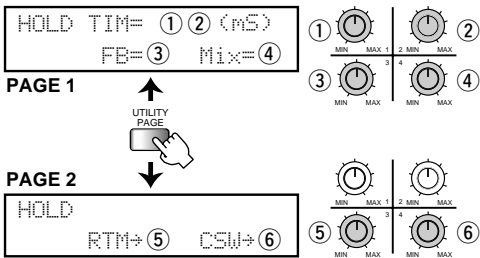

Parameters	Comment	Values
① TIM (Time)	Set the delay time in 100-ms steps.	0 – 40 (x100)
② (mS) (Time Fine)	Fine adjusts the delay time in 1-ms steps.	0 – 99
③ FB (Feedback)	Sets the feedback amount.	0 – 10
④ Mix (Mix)	Adjusts the mix between original sound and effect sound.	0 – 100
⑤ RTM (RTM Destination)	Shows which RTM parameter is being controlled.	Mix
⑥ CSW (CSWselect)	Shows the parameter that is being controlled by the CONTROL switches.	HLD

## VANA: Vintage Analog Delay

Vintage analog delay type sound with depth and body.

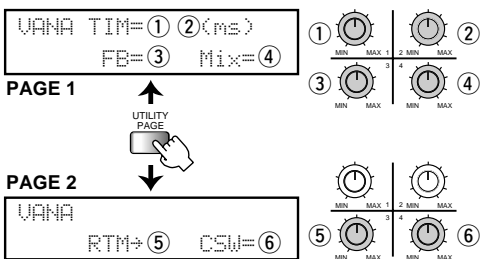

Parameters	Comment	Values
① TIM (Time)	Set the delay time in 100-ms steps.	0 – 10 (x100)
② (mS) (Time Fine)	Fine adjusts the delay time in 1-ms steps.	0 – 99
③ FB (Feedback)	Sets the feedback amount.	0 – 10
④ Mix (Mix)	Adjusts the mix between original sound and effect sound.	0 – 100
⑤ RTM (RTM Destination)	Shows which RTM parameter is being controlled.	Mix
⑥ CSW (CSWselect)	Sets the CONTROL switch function to "Mix" (balance between original sound and effect sound) or "Tap" (tapping input of delay time).	Mix, Tap



# REV (Reverb) Module



This effect module contains three types of stereo reverberation effects.

## HALL: Reverb Hall

This effect recreates the reverberation of a concert hall.

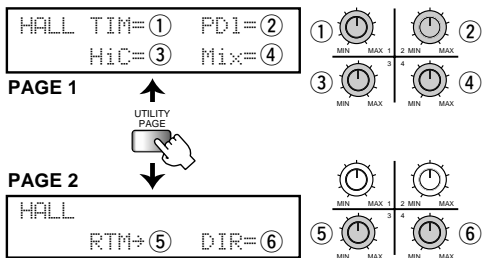

Parameters	Comment	Values
① TIM (Time)	Sets the reverb duration.	0 – 10
② PDI (Pre Delay)	Sets the time interval until the early reflections. Higher values result in a larger simulated space.	0 – 100
③ HiC (High Cut)	Controls high-frequency attenuation in the effect sound.	0 – 30
④ Mix (Mix)	Adjusts the mix between original sound and effect sound.	0 – 100
⑤ RTM (RTM Destination)	Shows which RTM parameter is being controlled.	Mix
⑥ DIR (RTM Direction)	Sets the RTM direction.	NML, INV

## ROOM: Reverb Room

This effect recreates the reverberation of a room (in a studio).

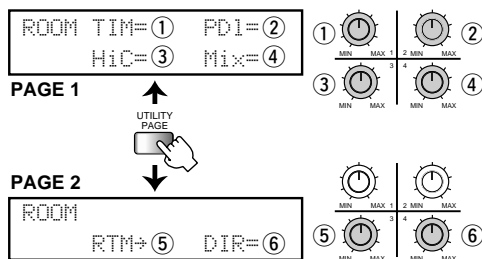

Parameters	Comment	Values
① TIM (Time)	Sets the reverb duration.	0 – 10
② PDI (Pre Delay)	Sets the time interval until the early reflections. Higher values result in a larger simulated space.	0 – 100
③ HiC (High Cut)	Controls high-frequency attenuation in the effect sound.	0 – 30
④ Mix (Mix)	Adjusts the mix between original sound and effect sound.	0 – 100
⑤ RTM (RTM Destination)	Shows which RTM parameter is being controlled.	Mix
⑥ DIR (RTM Direction)	Sets the RTM direction.	NML, INV

## PPD: Ping-Pong Delay

This is a stereo delay effect where the delay sound alternates between right and left. It can also be switched to mono.

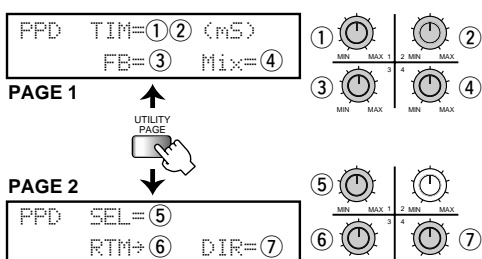

Parameters	Comment	Values
① TIM (Time)	Set the delay time in 100-ms steps.	0 – 20 (X100)
② (mS) (Time Fine)	Fine adjusts the delay time in 1-ms steps.	0 – 99
③ FB (Feedback)	Sets the feedback amount.	0 – 30
④ Mix (Mix)	Adjusts the mix between original sound and effect sound.	0 – 100
⑤ SEL (Type Select)	"MN" selects monaural delay and "PPD" selects ping-pong delay.	MN, PPD
⑥ RTM (RTM Destination)	Shows which RTM parameter is being controlled.	Mix
⑦ DIR (RTM Direction)	Sets the RTM direction.	NML, INV

# TOTAL Module



Strictly speaking, this module is not an effect module, but it serves for setting various parameters for the CONTROL pedals and CONTROL switches. It also contains settings for the seamless function, for editing patch names and for other parameters that affect all patches. The module has five pages which are switched with the UTILITY/PAGE key.

## Page 1: Serial connection/parallel connection

Determines whether the EFF2 and EFF3 modules are connected in series or parallel.

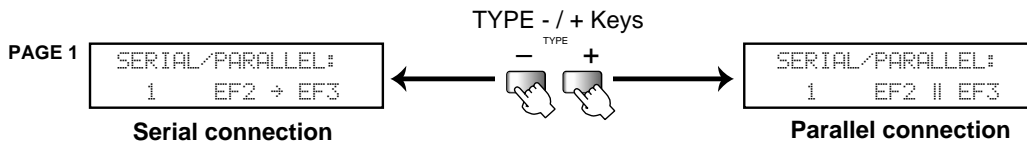

Pressing the TYPE - key selects serial connection. "→" appears on the display.  
Pressing the TYPE + key selects parallel connection. "||" appears on the display.

## Page 2: CONTROL pedal and CONTROL switch settings

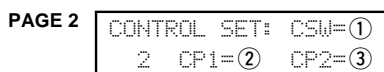

Parameters	Comment	Values
① CSW (Control Switch)	Sets the CONTROL switch module function.	OFF, CMP, EF1, DST, VOL, EF2, EF3, DLY, REV
② CP1 (Control Pedal 1)	Sets the CONTROL pedal 1 module function.	OFF, CMP, EF1, DST, VOL, EF2, EF3, DLY, REV
③ CP2 (Control Pedal 2)	Sets the CONTROL pedal 2 module function.	OFF, CMP, EF1, DST, VOL, EF2, EF3, DLY, REV

*"VOL" is not the volume of a specific patch but the overall volume.*

*In principle, the CONTROL switches cannot be used to control the same effect module as CONTROL pedal 1 or CONTROL pedal 2. If several controllers are set to the same module on this page, priority will be assigned in the order CP1, CP2, CSW when returning to the Play mode. Only the controller with the highest priority is active and the others are set to "OFF" (➡ p. 27). However, if the "CSW" parameter in the RTM page of the DLY module is set to a different item than the "RTM" parameter, the DLY module can be assigned to CONTROL pedal 1 or 2 and the CONTROL switches at the same time. (➡ p. 27).*

## Page 3: Seamless function settings

The seamless function lets the reverb or delay sound from the previous effect linger on when you switch effects, creating a smooth transition without audible breaks.



Parameters	Comment	Values
① TIM (SEAM Time)	Sets the time until the reverberation subsides, in 100-ms steps.	OFF, 0.1 – 99
② CUV (SEAM Curve)	The reverberation attenuation pattern can be set to "LNR" (reverberation is cut when the time interval set with the "TIM" parameter has elapsed) or "HLD" (reverberation continues for the programmed duration).	LNR, HLD

*For reverb, the seamless function operates only if reverb in the newly selected module is off. If the programmed reverb time of the patch is shorter than the time set with the "TIM" parameter, the programmed reverb time has priority.*



## Page 4: External control output settings

The control output can be used to switch channels at a guitar amplifier.

Use the TYPE +/- keys to switch the settings, as shown below.

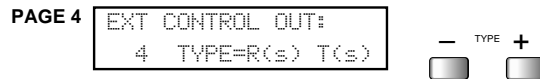

Display	Ring	Tip
R(s) T(s)	Short	Short
R(o) T(o)	Open	Open
R(o) T(s)	Open	Short
R(s) T(o)	Short	Open

The selected ring and tip configuration is shown on the display.

## Page 4: External control output settings

Use the data entry knobs and the TYPE +/- keys to add or edit a patch name of up to 8 characters.

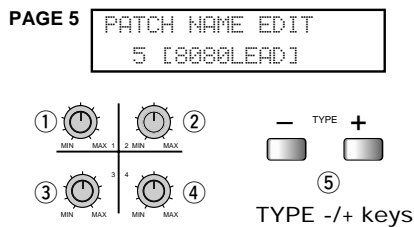

- ① Selects numerals from 0-9.
- ② Selects alphabet characters from A-Z and a-z.
- ③ Selects special characters and symbols.
- ④ Moves the cursor to the point to be edited.
- ⑤ The TYPE +/- keys can be used to select the character before or after the current one.

ZOOM *Super* PLAYER



---

# APPENDIX

---

MIDI Implementation .....	66
Specifications .....	67
Troubleshooting .....	68
MIDI Implementation Chart	

---

# MIDI Implementation

## 8080 MIDI IMPLEMENTATION

### 1. TRANSMITTED DATA

#### 1) CHANNEL VOICE MESSAGES

STATUS	SECOND	THIRD	DESCRIPTION
1011 nnnn	0ccc cccc	0vvv vvvv	<u>CONTROL CHANGE</u>
	0ccc cccc	0vvv vvvv	<u>CONTROL PEDAL 1</u> ccc cccc : Control No. 1-31 (Selectable, memorized. Default 7) vvv vvvv : Control Value (0-127)
	0ccc cccc	0vvv vvvv	<u>CONTROL PEDAL 2</u> ccc cccc : Control No. 1-31 (Selectable, memorized. Default 1) vvv vvvv : Control Value (0-127)
	0ccc cccc	0vvv vvvv	<u>Signal Mute</u> ccc cccc : MUTE (64-95 selectable, memorized. Default 80) vvv vvvv : MUTE on / off (When vvv vvvv is 0, MUTE is turned off.) (When vvv vvvv is 127, MUTE is turned on.)
	0ccc cccc	0vvv vvvv	<u>Bypass</u> ccc cccc : Bypass (64-95 selectable, memorized. Default 91) vvv vvvv : Bypass on / off (When vvv vvvv is 0, Bypass is turned off.) (When vvv vvvv is 127, Bypass is turned on.)
	0ccc cccc	0vvv vvvv	<u>Foot Switch (Effect Module) On / Off</u> ccc cccc : Module on / off (64-95 selectable, memorized.) vvv vvvv : on / off (When vvv vvvv is 0, module is turned off.) (When vvv vvvv is 127, module is turned on.) defaults Foot Switch1 70, Foot Switch2 71, Foot Switch3 72, Foot Switch4 73, Foot Switch5 74
1100 nnnn	0ppp pppp	---- ----	<u>PROGRAM CHANGE</u> ppp pppp : Program Number (When ppp pppp is 00-49, group is USER.) (When ppp pppp is 50-99, group is PRESET.)

NOTES :

\* nnnn = MIDI Channel Number (0000 - 1111)

### 2. RECOGNIZED DATA

NONE.

# Specifications

- Effect programs 47 (45 effect types + amp simulator + ZNR)
- Effect modules 8 + AMP + ZNR
- Patch memory capacity USER: 0 banks x 5 = 50 (read and write)  
PRESET: 3 groups (A,B,C) x 10 banks x 5 = 150 (read only)  
Total 200 patches
- Sampling frequency 44.1 kHz
- A/D converter 18 bit, 128 times oversampling, bitstream type
- D/A converter 20 bit, 128 times oversampling, bitstream type
- DSP ZFx-2 (developed by ZOOM) x 2
- Inputs
  - Guitar input
    - Monaural phone jack x 1
    - Rated input level: Input gain switch H = Guitars with single-coil pick ups  
M = hum-bucking type  
L = active type
    - Input impedance: 480 kilohms
  - External return
    - Monaural phone jack x 1
    - Rated input level: Input gain switch +4 dB = +4 dBm  
-20 dB = -20 dBm
    - Input impedance: 45 kohms
- Outputs
  - Line output
    - Monaural phone jack x 2 (Stereo)
    - Rated output level: Output level switch +4 dB = +4 dBm  
-20 dB = -20 dBm
    - Output impedance: 610 ohms (Output volume MAX/Level switch+4dB)
  - Headphone output
    - Stereo phone jack x 1
    - Power consumption: 50 mW into 32-ohm load
  - External send
    - Monaural phone jack x 1
    - Rated output level: -10 dBm
    - Output impedance: 1.5 kilohms
- Control connectors MIDI OUT, EXTERNAL CONTROL OUT
- Displays
  - 2-digit 7-segment LED beacon
  - Tuning meter
  - Control indicator
  - 2-line, 20-digit FL display
- Power requirements 9 V DC, 1.0 A (from supplied AC adapter AD-0002 or AD-0007)
- Dimensions 510 (W) x 250 (D) x 83 (H) mm
- Weight 3 kg

\* 0 dBm = 0.775 Vrms

\* Design and specifications subject to change without notice.

# Troubleshooting

Symptom	Check	Remedy
No sound or very low volume	• Are shielded cables connected properly?	Make connections as described in "Connections" and then turn the unit on.
	• Is the guitar connected properly to the INPUT jack of the 8080 and the amplifier to the OUTPUT jack of the 8080?	Make connections as described in "Connections" and then turn the unit on.
	• Is a shielded cable defective?	Try replacing the cable.
	• Is the connected guitar amplifier turned on?	Turn amplifier on.
	• Are level controls on guitar and amplifier set properly?	Adjust controls to achieve suitable volume.
	• Are level controls and parameters of 8080 set properly (OUTPUT control, patch level, VOL/LEVEL parameters)?	Activate Edit mode and adjust parameters.
	• Gain parameter of EQ effect set too low?	Activate Edit mode and adjust parameters. (➡ p.54)
	• Are CONTROL pedals and CONTROL switches set too low?	Operate CONTROL pedals and CONTROL switches.
	• Is the mute condition active?	Press foot switch with flashing indicator to turn muting off.
Patches cannot be switched	• Is Edit mode activated?	Press EDIT/EXIT key to return to Play mode.
	• Is unit in standby condition for store or all- initialize?	Press the STORE/EXECUTE key to carry out the function, or press the EDIT/EXIT key to cancel.
CONTROL pedals or CONTROL switches have no effect	• Is effect module selected in CONTROL SET (TOTAL module) turned on?	Activate Edit mode and adjust parameters. (➡ p. 63)
	• Are DIR (direction) parameter and control parameters set properly?  For example, if PWA module is assigned to a CONTROL pedal and the DIR parameter of the PWA module is set to "NML", the controlled FRQ parameter changes only from the minimum value to the current setting. If the minimum value is set to "1", pressing the pedal will have no effect.	Activate Edit mode and adjust parameters.

# MIDI Implementation Chart

[ MULTI EFFECTOR ]  
[ Model 8080 ]

## MIDI Implementation Chart

Date : 1. August. 1996  
Version : 1.00

Function ...	Transmitted	Recognized	Remarks
<b>Basic Channel</b>   Default Change	1 - 16 1 - 16	X X	Memorized
<b>Mode</b>   Default Messages Altered	3 X *****	X X	
<b>Note Number</b>   True voice	X *****	X	
<b>Velocity</b>   Note ON Note OFF	X X	X X	
<b>After Touch</b>   Key's Ch's	X X	X X	
<b>Pitch Bend</b>	X	X	
<b>Control Change</b>	○ 1 - 31 1 - 31 64 - 95 64 - 95 64 - 95 64 - 95 64 - 95 64 - 95 64 - 95	X	CONTROL PEDAL 1 CONTROL PEDAL 2 Foot Switch1 ON/OFF Foot Switch2 ON/OFF Foot Switch3 ON/OFF Foot Switch4 ON/OFF Foot Switch5 ON/OFF Signal Mute All Bypass
<b>Prog Change</b>   True #	○ ( 0 - 99 ) *****	X	USER PATCH 0 - 49 PRESET PATCH 50 - 99
<b>System Exclusive</b>	X	X	X
<b>Common</b>   Song Pos Song Sel Tune	X X X	X X X	
<b>System Real Time</b>   Clock Commands	X X	X X	
<b>Aux Messages</b>   Local ON/OFF All Notes OFF Active Sens Reset	X X X X	X X X X	
<b>Notes</b>			

Mode 1 : OMNI ON, POLY  
Mode 3 : OMNI OFF, POLY

Mode 2 : OMNI ON, MONO  
Mode 4 : OMNI OFF, MONO

○ : YES  
X : NO

**ZOOM<sup>®</sup>**

**CATCH US IF YOU CAN**

**ZOOM CORPORATION**

NOAH Bldg., 2-10-2, Miyanishi-cho, Fuchu-shi, Tokyo 183, Japan  
PHONE: 81-423-69-7116 FAX: 81-423-69-7115

Printed in Japan 8080-5000