

# YAMAHA

# TG55

tone generator  
GENERATEUR DE SON  
TONE GENERATOR

A decorative graphic consisting of a series of horizontal lines of varying thicknesses, some solid black and some white, creating a striped effect.

OPERATING MANUAL  
MANUEL D'UTILISATION  
BEDIENUNGSANLEITUNG

# SUPPLEMENTAL MARKING INFORMATION

This information on safety is provided to comply with U.S.A. laws, but should be observed by users in all countries.

YAMAHA Digital Musical Instrument Products will have either a label similar to the graphic shown below or a molded/stamped facsimile of the graphic on its enclosure. The explanation of these graphics appears on this page. Please observe all cautions indicated.

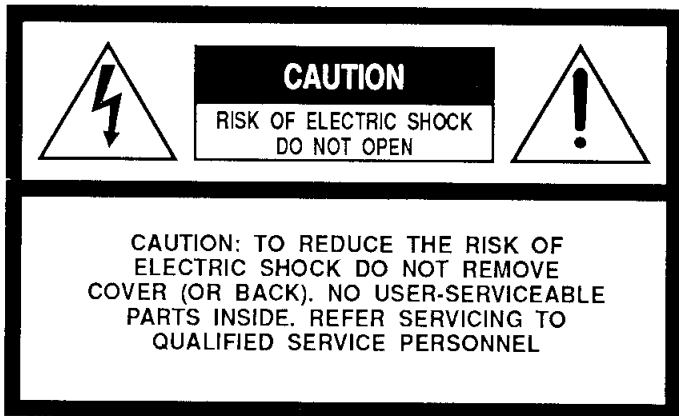

The exclamation point within an equilateral triangle is intended to alert the users to the presence of important operating and maintenance (servicing) instructions in the literature accompanying the product.

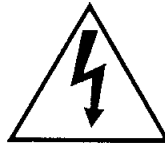

The lightning flash with arrowhead symbol within an equilateral triangle is intended to alert the user of the presence of uninsulated "dangerous voltage" within the product's enclosure that may be of sufficient magnitude to constitute a risk of electric shock to persons.

## FCC INFORMATION (USA)

While the following statements are provided to comply with FCC Regulations in the United States, the corrective measures listed below are applicable worldwide.

This series of YAMAHA professional music equipment uses frequencies that appear in the radio frequency range and if installed in the immediate proximity of some types of audio or video devices (within three meters), interference may occur. This series of YAMAHA professional music equipment has been type tested and found to comply with the specifications set for a class B computing device in accordance with those specifications listed in subpart J of part 15 of the FCC rules. These rules are designed to provide a reasonable measure of protection against such interference. However, this does not guarantee that interference will not occur. If your professional music equipment should be suspected of causing interference with other electronic devices, verification can be made by turning your professional music equipment off and on. If the interference continues when your equipment is off, the equipment is not the source of interference. If your equipment does appear to be the source of the interference, you should try to correct the situation by using one or more of the following measures:

Relocate either the equipment or the electronic device that is being affected by the interference. Utilize power outlets for the professional music equipment and the device being affected that are on different branch (circuit breaker or fuse) circuits, or install AC line filters.

In the case of radio or TV interference, relocate the antenna or, if the antenna lead-in is 300 ohm ribbon lead, change the lead-in to a co-axial type cable.

If these corrective measures do not produce satisfactory results, please contact your authorized YAMAHA professional products dealer for suggestions and/or corrective measures.

If you cannot locate a franchised YAMAHA professional products dealer in your general area contact the Electronic Service Division, YAMAHA Corporation of America, 6600 Orangethorpe Ave., Buena Park, CA 90620, U.S.A.

If for any reason, you should need additional information relating to radio or TV interference, you may find a booklet prepared by the Federal Communications Commission helpful:

"How to identify and Resolve Radio - TV Interference Problems". This booklet is available from the U.S. Government Printing Office, Washington D.C. 20402 - Stock No. 004-000-00345-4.

\* This applies only to products distributed by YAMAHA CORPORATION OF AMERICA.

## IMPORTANT NOTICE FOR THE UNITED KINGDOM

### Connecting the Plug and Cord

IMPORTANT. The wires in this mains lead are coloured in accordance with the following code:

BLUE : NEUTRAL

BROWN : LIVE

As the colours of the wires in the mains lead of this apparatus may not correspond with the coloured markings identifying the terminals in your plug proceed as follows:

The wire which is coloured BLUE must be connected to the terminal which is marked with the letter N or coloured BLACK.

The wire which is coloured BROWN must be connected to the terminal which is marked with the letter L or coloured RED.

\* This applies only to products distributed by YAMAHA-KEMBLE MUSIC (U.K.) LTD.

## CANADA

THIS APPARATUS COMPLIES WITH THE "CLASS B" LIMITS FOR RADIO NOISE EMISSIONS SET OUT IN RADIO INTERFERENCE REGULATIONS.

CET APPAREIL EST CONFORME AUX NORMES "CLASS B", POUR BRUITS RADIOELECTRIQUES. TEL QUE SPECIFIE DANS LE REGLEMENT SUR LE BROUILLAGE RADIOELECTRIQUE.

\* This applies only to products distributed by YAMAHA CANADA MUSIC LTD.

# TG55 EDIT REFERENCE

## ● PRESET VOICE LIST

No.	EL*	Name	No.	EL	Name	No.	EL	Name
1	1	Piano	23	4	Big Band	45	2	VCO Lead
2	2	Voyager	24	2	Orch Brass	46	2	Spirit VCF
3	2	Pro55Brass	25	2	SynthBrass	47	2	OZ Lead
4	2	Elektrodes	26	1	Flute	48	4	Get Lucky
5	4	Zuratustra	27	1	Saxophone	49	4	Gamma Band
6	2	DawnChorus	28	2	FolkGuitar	50	2	Metal Reed
7	2	GX Dream	29	2	12 String	51	4	Modomatic
8	2	GrooveKing	30	2	MuteGuitar	52	2	DataStream
9	4	DistGuitar	31	2	SingleCoil	53	2	Mystichoir
10	4	ZenAirBell	32	1	Pick Bass	54	2	St.Michael
11	2	FullString	33	2	Thumb Bass	55	2	Scatter
12	4	Jazz Man	34	2	SynBadBass	56	2	Triton
13	2	ClassPiano	35	2	VCO Bass	57	4	Amazon
14	2	Rock Piano	36	2	Violin	58	2	StatinGlass
15	1	DX E.Piano	37	1	ChamberStr	59	4	BrassChime
16	2	Hard EP	38	2	VCF String	60	2	Piano Mist
17	2	Cry Clav	39	2	Nova Quire	61	4	Xanadu
18	2	Funky Clav	40	2	Vibraphone	62	2	WdBass Duo
19	2	Deep Organ	41	2	Takerimba	63	(61)	Drum Set 1
20	2	Warm Organ	42	1	Gloken	64	(61)	Drum Set 2
21	1	Trumpet	43	2	DigiBell			
22	4	Stab Brass	44	2	Oriental			

\* EL=Number of elements.

## ● PRESET WAVE LIST

No.	Name	No.	Name	No.	Name	No.	Name
1	Piano	21	GtrSteel	41	Digital2	61	BD 3
2	E.Piano1	22	Gtr Gut	42	Digital3	62	SD 1
3	E.Piano2	23	12string	43	Pulse 10	63	SD 2
4	E.Piano3	24	E.Guitar	44	Pulse 25	64	SD 3
5	E.Piano4	25	E.Bass	45	Pulse 50	65	Rim
6	E.Piano5	26	Popping	46	Tri	66	Tom 1
7	E.Piano6	27	WoodBass	47	Voice	67	Tom 2
8	E.Piano7	28	Syn Bass	48	Piano Np	68	HHclosed
9	Harpsi	29	Violin	49	EPianoNp	69	HH open
10	Organ 1	30	Strings	50	Vibe Np	70	Crash
11	Organ 2	31	Chorus	51	Bottle	71	Ride
12	Pipe	32	Itopia	52	Tuba	72	Claps
13	Trumpet	33	Vibe	53	Vocal Ga	73	Cowbell
14	Mute Tp	34	Marimba	54	Bamboo	74	Shaker
15	Trombone	35	Glocken	55	Noise		
16	Flugel	36	Shamisen	56	Styroll		
17	Sax	37	Harp	57	Bulb		
18	Flute	38	Mtl Reed	58	Bell Mix		
19	Brass	39	Saw	59	BD 1		
20	SynBrass	40	Digital1	60	BD 2		

# YAMAHA

YAMAHA CORPORATION  
PO Box 1, Hamamatsu, Japan  
Printed in Japan

# ● TG55 Voice Edit Parameters

VOICE Mode  
Wave Assign  
Volume  
Note Shift  
Detune  
Note Limit/L  
Note Limit/H  
Vel. Limit/L  
Vel. Limit/H  
Pan  
Output Asgn  
EF Balance  
OSC Frq.Mode  
OSC Frq.Note  
OSC Frq.Tune  
AEG Mode  
AEG R1/HT  
AEG R2  
AEG L2  
AEG R3  
AEG L3  
AEG R4  
AEG L4  
AEG RR  
AEG R Scale  
AEG LS BP1  
AEG LS BP2  
AEG LS BP3  
AEG LS BP4

AEG LS OFS1  
AEG LS OFS2  
AEG LS OFS3  
AEG LS OFS4  
Sens. Vel.  
Sens. V.Rate  
Sens. AMS  
Sens. PMS  
LFO Wave  
LFO Speed  
LFO Delay  
LFO Phase  
LFO AMOD  
LFO PMOD  
LFO CutoffMOD  
PEG L0  
PEG R1  
PEG L1  
PEG R2  
PEG L2  
PEG R3  
PEG L3  
PEG RR  
PEG RL  
PEG Range  
PEG R.Scale  
PEG Vel.SW

**F I L T E R**  
FLType  
FL\Cutoff  
FLMode  
FL\CEG L0  
FL\CEG R1  
FL\CEG L1  
FL\CEG R2  
FL\CEG L2  
FL\CEG R3  
FL\CEG L3  
FL\CEG R4  
FL\CEG L4  
FL\CEG RR1  
FL\CEG RL1  
FL\CEG RR2  
FL\CEG RL2  
FL\R.Scale  
FL\LS BP1  
FL\LS BP2  
FL\LS BP3  
FL\LS BP4  
FL\LS OFS1  
FL\LS OFS2  
FL\LS OFS3  
FL\LS OFS4  
FL\Resonance  
FL\Vel.Sens  
FL\Mod.Sens

**C O N T R O L L E R**  
Element Initialize  
CNTL\Pitch Bend  
CNTL\AT P.Bias  
CNTL\RandomPitch  
CNTL\AMOD CTL#  
CNTL\AMOD RNG  
CNTL\PMOD CTL#  
CNTL\PMOD RNG  
CNTL\CoffMOD CTL#  
CNTL\CoffMOD RNG  
CNTL\Cutoff CTL#  
CNTL\Cutoff RNG  
CNTL\EG Bias CTL#  
CNTL\EG Bias RNG  
CNTL\Volume CTL#  
CNTL\Volume MIN  
**E F**  
EFType  
EFOutput Level  
EF \*\* Others \*\*  
VOICE Name  
VOICE Edit Recall  
VOICE Initialize

Shaded blocks represent parameters available within a single function display.

## Basic AWMII Element

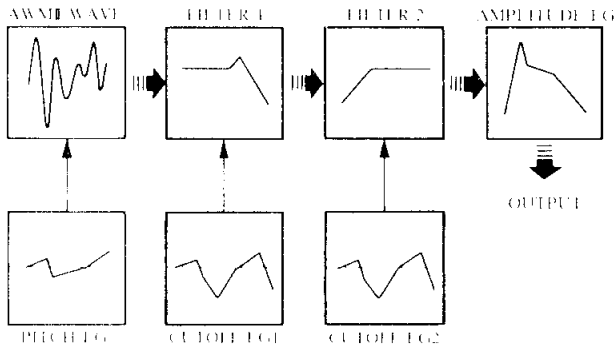

## Amplitude EG Parameters

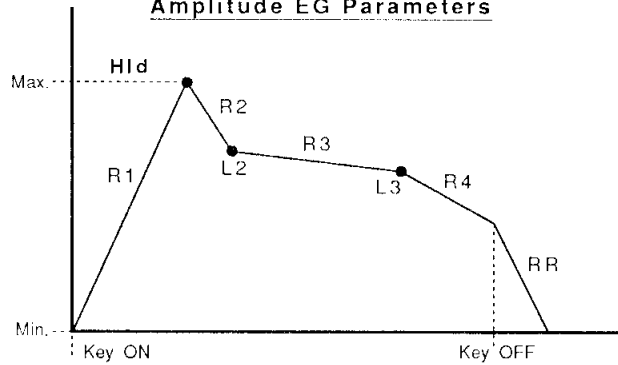

## Pitch EG Parameters

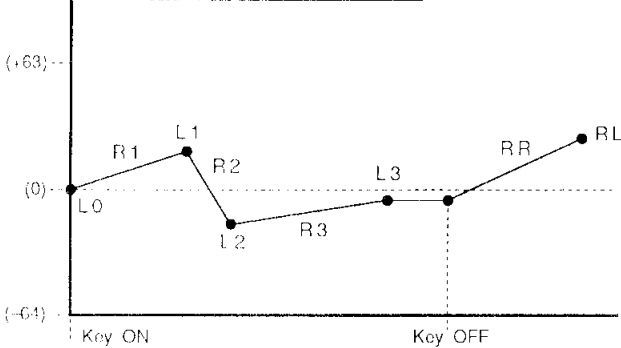

## Cutoff EG Parameters

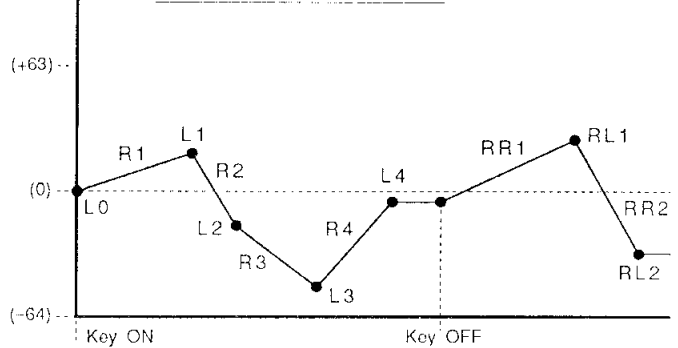

# **TG55 Tone Generator**

**Operating Manual**

# Congratulations!

Your TG55 Tone Generator represents the state-of-the-art in digital tone generation technology. In addition to superior sound, the TG55 revives the fine arts of musical control and creativity with a voice architecture that allows extensive sample layering and programmable dynamic timbre variation. With the TG55, individual sampled "waves" are building blocks that you arrange and process with a sophisticated dynamic filter system to create sound that's a perfect match for your music. You also have pitch envelope generators, amplitude envelope generators, a range of 34 programmable effects, and a wealth of other ways to customize your sound.

## MAIN FEATURES

---

- Second-generation 16-bit AWM2 (Advanced Wave Memory) technology for superior sound.
- Versatile 1, 2, or 4-element voice architecture and complex envelope generators for extensive sample layering capability.
- Sophisticated dynamic filter system offers unlimited real-time timbre variation.
- 74 waveform samples in ROM.
- 64 preset voices in ROM.
- 64-voice internal RAM memory.
- External waveform and voice card slots.
- Multi-timbre capability with 16 memory locations for multi-timbre setups.
- Drum voices allow 61 different drum and other waveforms to be assigned to different keys.
- Velocity switching for expressive power.
- Extensive voice editing functions.
- 34 high-quality programmable digital effects built in.
- Pannable stereo output.

# TG55 Tone Generator

## Contents

---

<b>PRECAUTIONS</b> .....	2
<b>HOW TO USE THIS OPERATION MANUAL</b> .....	3
<b>THE CONTROLS &amp; CONNECTORS</b> .....	4
<b>■ TUTORIALS</b> .....	8 *
1. SETTING UP YOUR SYSTEM .....	9
2. SELECTING AND PLAYING VOICES .....	11
3. THE MULTI PLAY MODE .....	17
4. EDITING VOICES .....	25
<b>■ REFERENCE</b>	
VOICE EDIT MODE .....	40 *
DRUM EDIT MODE .....	80 *
MULTI EDIT MODE .....	92 *
UTILITY MODE .....	104 *
<b>■ ERROR MESSAGES</b> .....	114
<b>■ SPECIFICATIONS</b> .....	116
<b>■ INDEX</b> .....	117
<b>■ MIDI DATA FORMAT</b> .....	Add-1
<b>■ MIDI IMPLEMENTATION CHART</b> .....	Add-20

\* See these pages for local tables of contents.

# PRECAUTIONS (PLEASE READ THIS BEFORE PROCEEDING!!)

---

## 1. Avoid Excessive Heat, Humidity, Dust and Vibration

Keep the unit away from locations where it is likely to be exposed to high temperatures or humidity — such as near radiators, stoves, etc. Also avoid locations which are subject to excessive dust accumulation or vibration which could cause mechanical damage.

## 2. Avoid Physical Shocks

Strong physical shocks to the unit can cause damage. Handle it with care.

## 3. Do Not Open The Case Or Attempt Repairs Or Modifications Yourself

This product contains no user-serviceable parts. Refer all maintenance to qualified YAMAHA service personnel. Opening the case and/or tampering with the internal circuitry will void the warranty.

## 4. Make Sure Power Is Off Before Making Or Removing Connections

Always turn the power OFF prior to connecting or disconnecting cables.

## 5. Handle Cables Carefully

Always plug and unplug cables — including the AC cord — by gripping the connector, not the cord.

## 6. Clean With a Soft Dry Cloth

Never use solvents such as benzine or thinner to clean the unit. Wipe clean with a soft, dry cloth.

## 7. Always Use the Correct Power Supply

The power requirements for the TG55 are clearly marked on the rear panel. Make sure the specified mains voltage matches the voltage in your area before using the unit!

## 8. Electrical Interference

Since the TG55 contains digital circuitry, it may cause interference and noise if placed too close to TV sets, radios or similar equipment. If such a problem does occur, move the TG55 further away from the affected equipment.

## 9. Memory Backup

The TG55 contains a special long-life battery that retains the contents of its internal RAM memory even when the power is turned OFF. The backup battery should last for approximately 5 years. When the battery voltage drops to a level that is too low to maintain the memory contents, the following message will appear on the TG55 display when the power is turned ON:

```
ERROR! HIT "EXIT"  
Internal Bat.Lo
```

If this display appears, have the backup battery replaced by qualified YAMAHA service personnel. DO NOT ATTEMPT TO REPLACE THE BACKUP BATTERY YOURSELF!



# HOW TO USE THIS OPERATIONAL MANUAL

---

This operation manual is broadly divided into two main sections — TUTORIALS and REFERENCE.

## What's In the TUTORIALS Section

The TUTORIALS section contains four separate tutorials that take you step-by-step through the main procedures you will need to know to become familiar with your TG55:

1. SETTING UP YOUR SYSTEM [Page 9]  
Basic system connections and MIDI channel matching.
2. SELECTING AND PLAYING VOICES [Page 11]  
Selecting and playing voices from the PRESET, INTERNAL, and CARD voice banks.
3. THE MULTI PLAY MODE [Page 17]  
Creating multi-voice setups for use with an external sequencer.
4. EDITING VOICES [Page 25]  
The basic information you need to know about the AWM2 tone generation system in order to edit voices quickly and efficiently, and general procedure for editing and creating new voices.

We recommend that you go through the tutorials in sequence while actually carrying out the procedures on your TG55. Once you've gone through the entire TUTORIALS section in this way, you should be familiar enough with the TG55 to need only the REFERENCE section in future.

## What's In the REFERENCE Section

The REFERENCE section is the “nuts and bolts” section of the manual, individually describing each of the TG55's many functions in detail. The REFERENCE section is divided into four sub-sections, each describing the various functions within a particular TG55 mode.

1. VOICE EDIT MODE [Page 40]
2. DRUM EDIT MODE [Page 80]
3. MULTI EDIT MODE [Page 92]
4. UTILITY MODE [Page 104]

Once you have become completely familiar with the way the TG55 works by going through the TUTORIALS section, you should only need to refer to the REFERENCE section from time to time to get details on functions you've never used before, or refresh your memory about functions that you don't use very often.

Each sub-section of the REFERENCE section has its own table of contents, so you should be able to locate any particular function quickly and easily. Functions and references can also be located by referring to the INDEX at the back of the manual.

# THE CONTROLS & CONNECTORS

## ■ FRONT PANEL

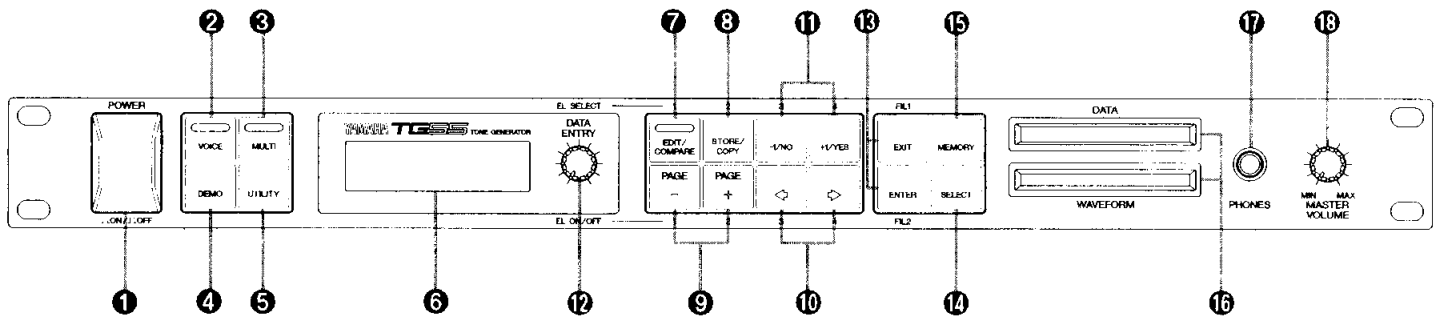

- 1** [POWER] Switch. Press to turn power ON or OFF.
- 2** [VOICE] Key & Indicator Selects the normal voice play mode in which any of the TG55's preset, internal or card voices can be played via a MIDI keyboard or other controller connected to the MIDI IN connector.
- 3** [MULTI] Key & Indicator Selects the multi-play mode in which up to 16 voices can be controlled on 16 different MIDI channels via an external MIDI sequencer.
- 4** [DEMO] Key Activates the built-in demonstration pieces — a great way to hear what the TG55 can do after you set up your system.
- 5** [UTILITY] Key Accesses the TG55 utility functions including MIDI parameters, master tuning, transposition, overall velocity curve selection, effect on/off switching, memory card formatting and save/load operations.
- 6** Liquid Crystal Display Panel This 16-character x 2-line backlit liquid crystal display panel shows the selected voice or multi-play setup name in the voice or multi-play modes, as well as function names and parameters in the utility and edit modes.
- 7** [EDIT/COMPARE] Key & Indicator Activates the voice edit mode when a voice between 1 and 62 is selected, the drum edit mode when voice number 63 or 64 is selected, or the multi-play edit mode if the multi-play mode is selected. Also activates the compare function when in any edit mode, allowing quick comparison of the original and edited voice or multi-play setup.
- 8** [STORE/COPY] Key Used to store edited data to an internal or card memory location. Also selects several handy data copy functions in the TG55 edit modes.
- 9** [PAGE -] and [PAGE +] Keys These keys are used primarily to select the various function screens in the TG55 voice, multi-play and drum editing modes, as well as in the utility mode.

- ⑩ ◀ and ▶ **Cursor Keys**      Move the screen cursor from parameter to parameter in many of the TG55 editing functions.
- ⑪ [-1/NO] and [+1/YES] **Keys**      Select voices and multi-play setups, and are used to edit parameter values in any of the TG55 edit modes. Either key can be pressed briefly for single stepping in the specified direction, or held for continuous scrolling. These keys are also used to answer the “Sure?” confirmation prompt when saving or initializing data.
- ⑫ [DATA ENTRY] **Control**      The [DATA ENTRY] control is the fastest way to select a value or item from a large range when editing. It can also be used to select voices in the voice play mode while the [ENTER] key is held.
- ⑬ [ENTER] and [EXIT] **Keys**      The [ENTER] key is used to enter function subsets while editing, initiate data save and initialize operations, start demo playback, etc. The [EXIT] allows you to immediately exit from editing function subsets, exit from any editing or utility mode, stop demo playback, etc.
- ⑭ [SELECT] **Key**      Allows selection of voice elements and filters during voice editing.
- ⑮ [MEMORY] **Key**      Selects the data bank — preset, internal or card — from which voices or multi-play setups will be selected.
- ⑯ **DATA and WAVE Card Slots**      The DATA card slot accepts Yamaha MCD64 or MCD32 Memory Cards for storage and retrieval of TG55 voices, multi-play setups and system data. The WAVE card slot accepts pre-programmed wave cards — i.e. cards containing sets of sampled waves for use in TG55 voices.
- ⑰ **PHONES Jack**      Accepts a standard pair of stereo headphones (1/4" stereo phone plug) for headphone monitoring of the TG55 sound without the need for external amplification equipment.
- ⑱ **MASTER VOLUME Control**      Adjusts the volume of the sound delivered via the rear-panel OUTPUT jacks and the front-panel PHONES jack.

## ■ REAR PANEL

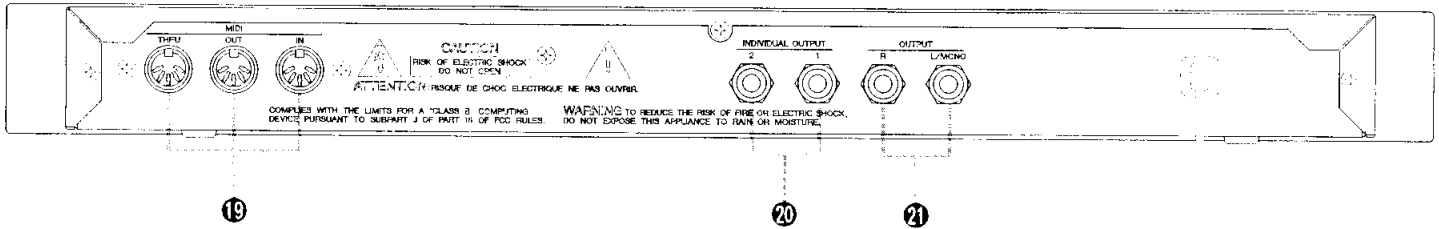

### 19 MIDI IN, OUT and THRU Connectors

The MIDI IN connector receives the data from a keyboard, sequencer or other MIDI controller which is to control the TG55. The MIDI THRU connector simply re-transmits the data received at the MIDI IN connector, allowing convenient chaining of MIDI devices. The MIDI OUT connector transmits bulk data from the TG55 when one of the MIDI bulk dump functions are activated.

### 20 INDIVIDUAL OUTPUT 1 and 2 Jacks

These are most ideally used as "additional outputs" for multi-play setups in which each voice can be individually assigned to the normal stereo outputs described below, or either or both INDIVIDUAL OUTPUTS. The multi-play voices can thus be distributed to four outputs and sent to a mixing console.

### 21 OUTPUT R and L/MONO Jacks

These are the main stereo outputs from the TG55. If a plug is inserted only into the L/MONO jack, the left and right-channel signals are combined and delivered via this jack (for connection to a monaural sound system).

# TUTORIALS SECTION

---

# TUTORIALS

## Contents

---

<b>1. SETTING UP YOUR SYSTEM</b> .....	9
Connections .....	9
Power-on Procedure .....	9
MIDI Channel Matching .....	10
Enjoy the Demos .....	10
<b>2. SELECTING AND PLAYING VOICES</b> .....	11
The PRESET, INTERNAL and CARD Voice Banks .....	11
Selecting the VOICE PLAY Mode, a Voice Bank, and Voice .....	14
Selecting Voices From Your Keyboard/Controller .....	15
Voice Numbers 63 and 64 are Drum-set Voices .....	16
<b>3. THE MULTI PLAY MODE</b> .....	17
A Basic MULTI PLAY System .....	17
MULTI PLAY Mode, Bank and Setup Selection .....	18
MULTI PLAY Polyphony and Dynamic Note Allocation .....	18
Checking and Modifying MULTI PLAY Voice Assignments .....	18
Creating an Original MULTI PLAY Setup .....	20
Storing an Edited MULTI PLAY Setup .....	23
Conclusion .....	24
<b>4. EDITING VOICES</b> .....	25
TG55 Voicing Basics .....	25
The TG55 Voice Parameter Chart .....	28
Programming the “VeloChorus” Voice .....	31
Storing an Edited Voice .....	36

# 1. SETTING UP YOUR SYSTEM

## Connections

Assuming that you will use a MIDI keyboard or similar MIDI controller to control the TG55, your system should be set up as shown below.

**CAUTION!!:** Make sure that both the TG55 and your sound system are turned OFF when making connections.

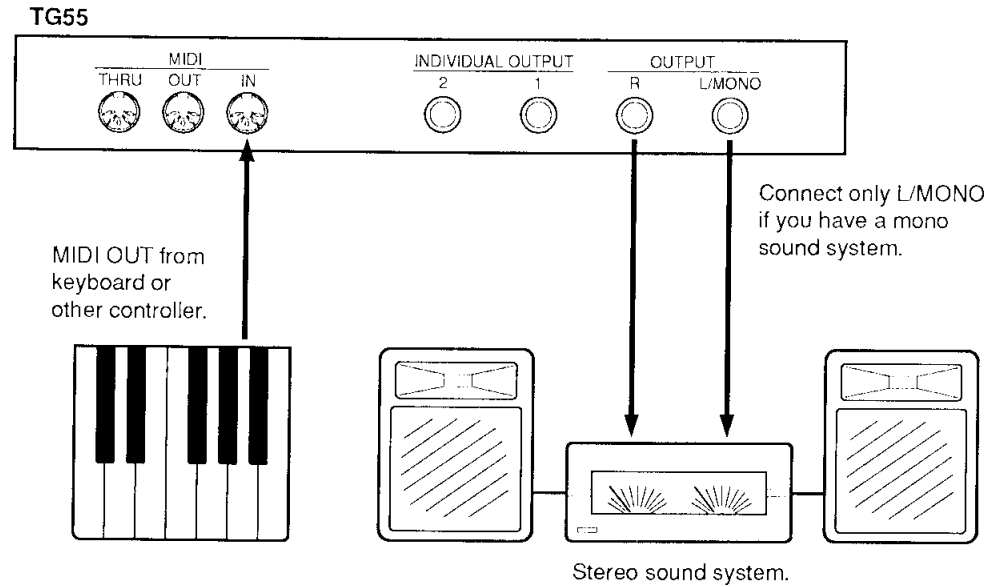

Be sure to use a high-quality MIDI cable of not longer than about 15 meters to connect your keyboard or controller to the TG55 MIDI IN connector.

## Power-on Procedure

1. Make sure your sound system's volume is turned almost all the way down prior to turning power on.
2. Turn on the MIDI keyboard or controller.
3. Turn on the TG55.
4. Turn on the sound system.

## MIDI Channel Matching

Depending on your particular system setup and keyboard or controller, you may have to match the TG55 MIDI receive channel to that of the keyboard/controller before the system will function properly. If you don't already know what MIDI channel your keyboard/controller is set to transmit on, refer to its operation manual.

The TG55 can be set to receive on any of the 16 available MIDI channels, or in the "omni" mode which means that it will accept data on any or all channels. If the only MIDI components in your system are a keyboard/controller and the TG55, it might be simpler to just set the TG55 to the omni mode so that it doesn't matter what channel the keyboard/controller is transmitting on. If other MIDI devices receiving or transmitting on specific channels are present, however, then the TG55 will have to be set to receive on the appropriate channel.

1. Press the [UTILITY] key.
2. Press the [PAGE +] or [PAGE -] key a few times until the following display appears:

```
UT MIDI
  Press "ENTER"
```

If you can't locate the above display after pressing the [UTILITY] key, press the [EXIT] key and then repeat step 2.

3. Press [ENTER]
4. Press the [PAGE +] or [PAGE -] key a few times until the following display appears:

```
UT MIDI\Receive
Ch=omni Note=all
```

("REFERENCE" section, page 108)

5. Use the [DATA ENTRY] control or [-1/NO] and [+1/YES] keys to select a channel between 1 and 16, or the "omni" mode.
6. Press the [VOICE] key to return to the VOICE PLAY mode.

## Enjoy the Demos

The TG55 is programmed with several demo tunes that you might enjoy listening to after setting up your system. Take a short break and enjoy the demos:

1. Press the [DEMO] key.
2. Press the [ENTER] key to start demo playback.
3. Press the [EXIT] key when you want to stop demo playback.



## 2. SELECTING AND PLAYING VOICES

### The PRESET, INTERNAL and CARD Voice Banks

Here's a global view of the TG55 system:

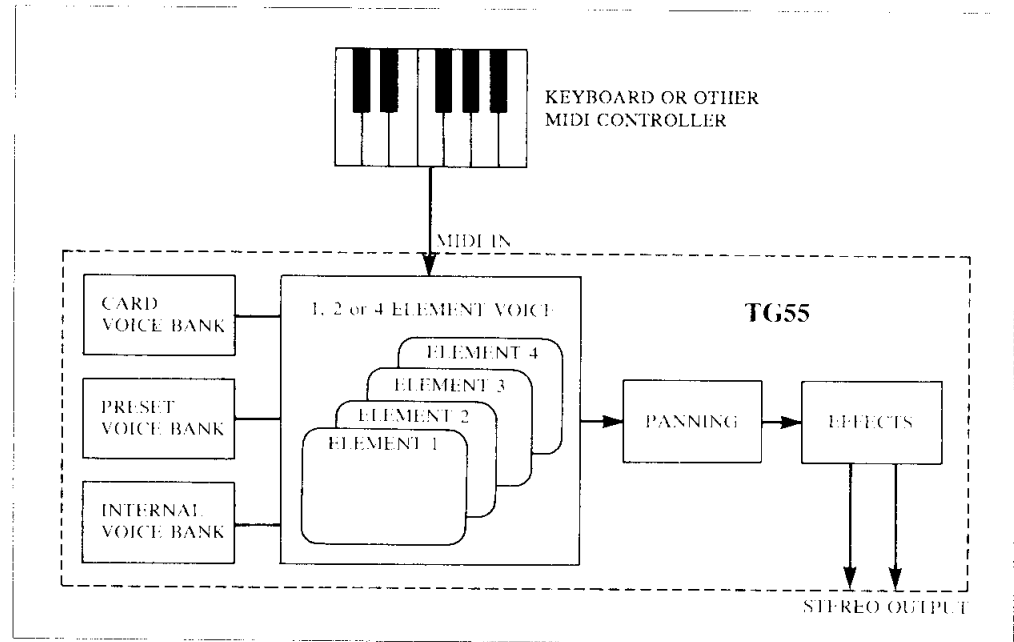

Please note that the voices played by the TG55 can come from three different sources: the PRESET voice bank, the INTERNAL voice bank, or a CARD voice bank:

#### PRESET

The PRESET voice bank contains 64 pre-programmed voices in ROM (Read Only Memory) that cannot be overwritten or changed in any way. The PRESET voice bank is represented on the display by the letter "P".

#### INTERNAL

The INTERNAL voice bank is a RAM (Random Access Memory) area into which you can store up to 64 voices that you create or load from an external memory card. The INTERNAL voice bank is represented on the display by the letter "I".

#### CARD

The CARD memory bank is a YAMAHA MCD64 or MCD32 Memory Card (or pre-programmed voice card) plugged into the TG55 DATA card slot on the front panel. Memory cards are convenient for external storage and transportation of voices that you or others create. You can also store sets of related voices on different memory cards. An MCD32 Memory Card allows storage of up to 64 voices. An MCD64 Memory Card holds two banks of 64 voices each — a total of 128 voices per card. The CARD voice bank is represented on the display by the letter "C" (the second bank of MCD64 cards is represented by a reversed "C").

Any voice in any of these voice banks can be selected and played while the TG55 is in the VOICE PLAY mode.

● PRESET VOICE LIST

No.	EL*	Name	No.	EL	Name	No.	EL	Name
1	1	Piano	23	4	Big Band	45	2	VCO Lead
2	2	Voyager	24	2	Orch Brass	46	2	Spirit VCF
3	2	Pro55Brass	25	2	SynthBrass	47	2	OZ Lead
4	2	Elektrodes	26	1	Flute	48	4	Get Lucky
5	4	Zuratustra	27	1	Saxophone	49	4	Gamma Band
6	2	DawnChorus	28	2	FolkGuitar	50	2	Metal Reed
7	2	GX Dream	29	2	12 String	51	4	Modomatic
8	2	GrooveKing	30	2	MuteGuitar	52	2	DataStream
9	4	DistGuitar	31	2	SingleCoil	53	2	Mystichoir
10	4	ZenAirBell	32	1	Pick Bass	54	2	St.Michael
11	2	FullString	33	2	Thumb Bass	55	2	Scatter
12	4	Jazz Man	34	2	SynBadBass	56	2	Triton
13	2	ClassPiano	35	2	VCO Bass	57	4	Amazon
14	2	Rock Piano	36	2	Violin	58	2	SatinGlass
15	1	DX E.Piano	37	1	ChamberStr	59	4	BrassChime
16	2	Hard EP	38	2	VCF String	60	2	Piano Mist
17	2	Cry Clav	39	2	Nova Quire	61	4	Xanadu
18	2	Funky Clav	40	2	Vibraphone	62	2	WdBass Duo
19	2	Deep Organ	41	2	Takerimba	63	(61)	Drum Set 1
20	2	Warm Organ	42	1	Gloken	64	(61)	Drum Set 2
21	1	Trumpet	43	2	DigiBell			
22	4	Stab Brass	44	2	Oriental			

\* EL=Number of elements' see page 25.

No.	Name	Comments
P01	Piano	Orthodox acoustic piano.
P02	Voyager	Choir with "sizzle." Play long chords.
P03	Pro55Brass	Fat analog brass pad.
P04	Elektrodes	Mellow electric piano.
P05	Zaratustra	Big orchestra. Brass volume on MW.
P06	DawnChorus	Breathy choir. MW fades out breath.
P07	GX Dream	A punchy voice reminiscent of the YAMAHA GX1.
P08	GrooveKing	Classic funky, resonant synth voice.
P09	DistGuitar	Heavy guitar. Slow fade to feedback.
P10	ZenAirBell	Percussive bell/gong combination.
P11	FullString	Light touch for small, heavy for large string section.
P12	JazzMan	Split wood bass and trumpet. MW swaps horns.
P13	ClassPiano	Classical Grand Piano
P14	RockPiano	Fat piano. Perfect for chord work.
P15	DX E.Piano	Electronic piano.
P16	Hard EP	Electric piano with sharp attack and hard tone.
P17	Cry Clav	Automatic "wah" clav with resonant attack.
P18	Funky Clav	Fat, funky clav.
P19	Deep Organ	Rock Organ
P20	Warm Organ	Full, rich organ with rotating speaker effect.
P21	Trumpet	Solo trumpet.
P22	Stab Brass	Thin pop brass section.
P23	Big Band	Big unison horn section. Play in octaves. MW fades to solo trumpet.
P24	Orch Brass	Big classical brass section with pan.

No.	Name	Comments
P25	SynthBrass	Powerful synth brass pad.
P26	Flute	Breathy when played hard.
P27	Saxophone	Solo sax with lots of presence.
P28	FolkGuitar	Steel-string acoustic folk guitar.
P29	12 String	Full 12-string guitar.
P30	MuteGuitar	Muted electric guitar.
P31	SingleCoil	Single-coil electric guitar pickup.
P32	Pick Bass	Punchy picked bass.
P33	Thumb Bass	Play hard for slap bass sound.
P34	SynBadBass	Funky synth bass.
P35	VCO Bass	Fat analog bass.
P36	Violin	Solo violin with after-touch vibrato.
P37	ChamberStr	Small violin section.
P38	VCF String	Analog synth strings. Brightness on MW.
P39	Nova Quire	Choir with a unique attack.
P40	Vibraphone	Traditional vibraphone with tremolo on MW.
P41	Takerimba	Bamboo marimba. Brightness on MW.
P42	Glocken	Glockenspiel. Brightness on MW.
P43	DigiBell	Spacious synth bell.
P44	Oriental	Oriental orchestra. Light touch for string section only.
P45	VCO Lead	Analog sawtooth lead voice.
P46	Spirit VCF	Analog synth with big, slow filter sweep.
P47	OZ Lead	Soft synth lead.
P48	Get Lucky	Fat square-wave synth sound with detune on MW.
P49	Gamma Band	Oriental percussion ensemble. MW fades in metal drums and bells.
P50	Metal Reed	Harmonica or accordion with after-touch pitch bend.
P51	Modomatic	Choir with big MW filter sweep.
P52	DataStream	Best with long notes.
P53	Mystichoir	Play long chords for shifting notes.
P54	St.Michael	Choir with bells on release.
P55	Scatter	Voice on staccato notes, filtered synth on long tones.
P56	Triton	Best with long chords.
P57	Amazon	Wide touch range.
P58	SatinGlass	Metallic, spacious synth voice.
P59	BrassChime	Filtered brass with chimes.
P60	Piano Mist	Piano bell. MW fades to staccato filtered voice.
P61	Xanadu	Solo multi-tuned flute.
P62	WdBass Duo	Split wood bass and piano.
P63	Drum Set 1	Drum set including bass and sound effects.
P64	Drum Set 2	Drum set including bass and sound effects.

## Selecting the VOICE PLAY Mode, a Voice Bank, and Voice

1. If the VOICE PLAY mode is not already selected — as indicated by a lit [VOICE] key LED and “VOICE PLAY” across the top of the LCD — press the [VOICE] key to select it.

```
VOICE PLAY
P01 Piano
```

2. The [MEMORY] key is used to select the desired voice bank. If no memory card is inserted in the DATA slot, the [MEMORY] key alternately selects the PRESET and INTERNAL voice banks — indicated by the first letter of the voice number on the bottom line of the LCD.

```
VOICE PLAY
P01 Piano
```



```
VOICE PLAY
I01 Grand
```



```
VOICE PLAY
P01 Piano
```

If a memory card which contains voice data is inserted in the CARD slot, the card voice bank (or banks in the case of an MCD64) will also be selected in sequence by the [MEMORY] key.

```
VOICE PLAY
P01 Piano
```



```
VOICE PLAY
I01 Grand
```



```
VOICE PLAY
C01 Voice Name
```



```
VOICE PLAY
001 Voice Name
```



```
VOICE PLAY
P01 Piano
```

3. Use the [-1/NO] and [+1/YES] keys to select the desired voice within the current bank. Holding the [-1/NO] and [+1/YES] causes continuous scrolling in the specified direction.

**Special Technique:** Voices can also be selected rapidly by rotating the [DATA ENTRY] control while holding the [ENTER] key.

4. Play the selected voice via your keyboard/controller. If you don't get any sound at this point:
  - Make sure your sound system is turned ON and the volume is turned up to a reasonable level.
  - Make sure that the TG55 MASTER VOLUME control is turned up to a reasonable level.
  - Check all connections — MIDI and audio.
  - Make sure the TG55 is set to receive on the appropriate MIDI channel (see "1. SETTING UP YOUR SYSTEM" on page 9)

### Selecting Voices From Your Keyboard/Controller

The voice selectors or increment/decrement keys on your keyboard/controller can also be used to remotely select the corresponding TG55 voices. A TG55 utility function allows you to turn this capability on or off as required.

1. Press the [UTILITY] key.
2. Press the [PAGE +] or [PAGE -] key a few times until the following display appears:

```
UT MIDI
  Press "ENTER"
```

If you can't locate the above display after pressing the [UTILITY] key, press the [EXIT] key and then repeat step 2.

3. Press [ENTER]
4. Press the [PAGE +] or [PAGE -] key a few times until the "UT MIDI/Program" display appears:

```

UT MIDI\Program
= off

```

(“REFERENCE” section, page 108)

- Use the [DATA ENTRY] control or [-1/NO] and [+1/YES] keys to select “off” if you do not want your keyboard/controller voice selectors to select the TG55 voices, or “normal” if you do.
- Press the [VOICE] key to return to the VOICE PLAY mode.

## Voice Numbers 63 and 64 are Drum-set Voices

Although most TG55 voices have a 1, 2 or 4-element configuration (we’ll learn more about elements in the “EDITING VOICES” section, beginning on page 25), voices 63 and 64 in any voice bank are special drum-set voices that essentially have a 61-element configuration. Each element, in this case, corresponds to a different key on a keyboard. A range of high-quality drum and percussion waveforms can be assigned to the different elements/keys and handled as a single voice — i.e. each key plays a different instrument within that “drum set.”

The drum-set voices are particularly useful with the TG55’s MULTI PLAY mode, described in the next tutorial, and an external sequencer.

### ● Voice 63: Drum Set 1



Key	Wave Name	No.	Key	Wave Name	No.
			C6	Syn Bass	P28
			B5	Syn Bass	P28
A#5	Syn Bass	P28	A5	Syn Bass	P28
G#5	Syn Bass	P28	G5	Syn Bass	P28
F#5	Syn Bass	P28	F5	Syn Bass	P28
			E5	Syn Bass	P28
D#5	Syn Bass	P28	D5	Syn Bass	P28
C#5	Syn Bass	P28	C5	Syn Bass	P28
			B4	Bulb	P57
A#4	Vocal Ga	P53	A4	Vocal Ga	P53
G#4	Bell Mix	P58	G4	Bottle	P51
F#4	Bottle	P51	F4	Bottle	P51
			E4	Styroll	P56
D#4	Shaker	P74	D4	Ride	P71
C#4	Bamboo	P54	C4	Vibe Np	P50
			B3	Vibe Np	P50
A#3	Claps	P72	A3	Claps	P72
G#3	Popping	P26	G3	Popping	P26
F#3	Tube	P52	F3	Tube	P52
			E3	Tube	P52
D#3	Ride	P71	D3	Ride	P71
C#3	Crash	P70	C3	Crash	P70
			B2	HH open	P69
A#2	Crash	P70	A2	HH closed	P68
G#2	Shaker	P74	G2	Cowbell	P73
F#2	Claps	P72	F2	Tom 1	P66
			E2	SD 1	P62
D#2	Rim	P65	D2	Tom 1	P66
C#2	SD 2	P63	C2	Tom 1	P66
			B1	Tom 1	P66
A#1	SD 3	P64	A1	BD 1	P59
G#1	BD 2	P60	G1	Tom 2	P67
F#1	Tom 2	P67	F1	Tom 2	P67
			E1	Tom 2	P67
D#1	BD 3	P61	D1	BD 3	P61
C#1	BD 2	P60	C1	BD 2	P60

### ● Voice 64: Drum Set 2

Key	Wave Name	No.	Key	Wave Name	No.
			C6	Syn Bass	P28
			B5	Syn Bass	P28
A#5	Syn Bass	P28	A5	Syn Bass	P28
G#5	Syn Bass	P28	G5	Syn Bass	P28
F#5	Syn Bass	P28	F5	Syn Bass	P28
			E5	Syn Bass	P28
D#5	Syn Bass	P28	D5	Syn Bass	P28
C#5	Syn Bass	P28	C5	Syn Bass	P28
			B4	Bulb	P57
A#4	Vocal Ga	P53	A4	Vocal Ga	P53
G#4	Bell Mix	P58	G4	Bottle	P51
F#4	Bottle	P51	F4	Bottle	P51
			E4	Styroll	P56
D#4	Shaker	P74	D4	Ride	P71
C#4	Bamboo	P54	C4	Vibe Np	P50
			B3	Vibe Np	P50
A#3	Claps	P72	A3	Claps	P72
G#3	Popping	P26	G3	Popping	P26
F#3	Tube	P52	F3	Tube	P52
			E3	Tube	P52
D#3	Ride	P71	D3	Ride	P71
C#3	Crash	P70	C3	Crash	P70
			B2	HH open	P69
A#2	Crash	P70	A2	HH closed	P68
G#2	Shaker	P74	G2	Cowbell	P73
F#2	Claps	P72	F2	Tom 2	P67
			E2	SD 2	P63
D#2	Rim	P65	D2	Tom 2	P67
C#2	SD 1	P62	C2	Tom 2	P67
			B1	Tom 2	P67
A#1	SD 3	P64	A1	BD 2	P60
G#1	BD 1	P59	G1	Tom 1	P66
F#1	Tom 1	P66	F1	Tom 1	P66
			E1	Tom 1	P66
D#1	BD 3	P61	D1	BD 3	P61
C#1	BD 1	P59	C1	BD 1	P59

### 3. THE MULTI PLAY MODE

**Note:** If you do not intend to use the TG55 with a sequencer (or if you intend to do so at a later date) and have no need for the MULTI PLAY mode at the moment, skip ahead to “4. EDITING VOICES” beginning on page 25.

#### A Basic MULTI PLAY System

The TG55 MULTI PLAY (multi-timbre) mode allows different voices to be assigned to up to 16 different MIDI channels. This allows you to record multi-voice compositions on a MIDI sequencer recorder such as the YAMAHA QX3, and play them back using only the sequencer and TG55.

Here’s an example of a sequencer recording and playback setup:

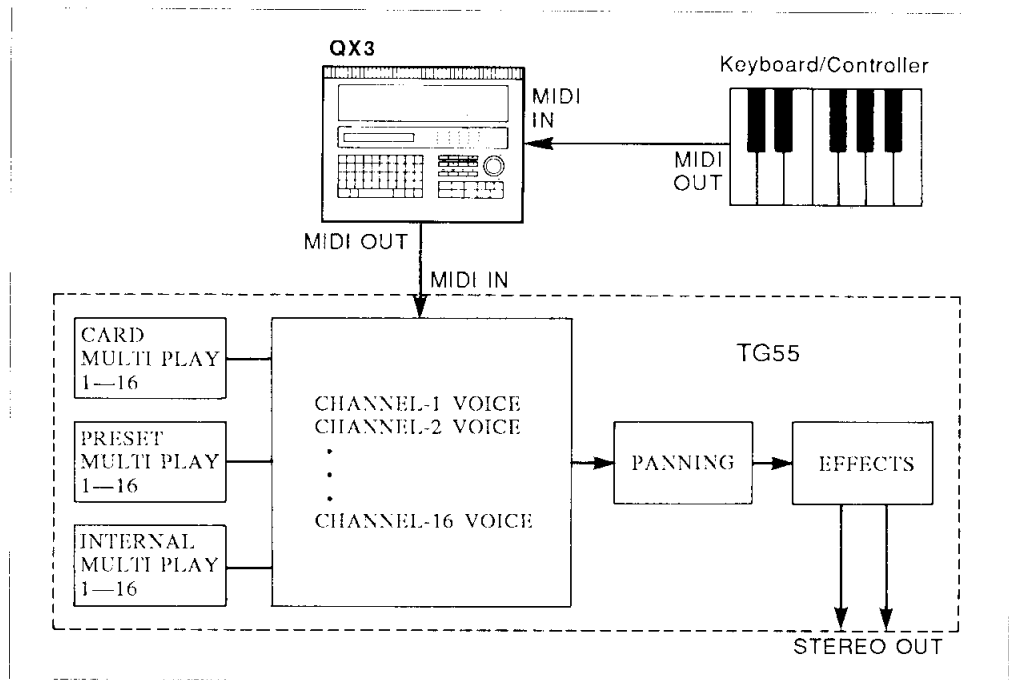

**A Note About the QX3:** The QX3 can be set up so that when you record on any track, the data being recorded is transmitted via the QX3 MIDI OUT on the appropriate MIDI channel, while at the same time all previously recorded tracks are transmitted on their particular channels, so you hear all the parts — including the part being recorded — played by the appropriate voices.

In addition to 16 PRESET MULTI PLAY setups, 16 INTERNAL memory locations are provided for complete “MULTI PLAY” setups including voice-to-channel assignments, individual voice volume, note shift, tuning, panning, and effects. This allows you to create up to 16 original “orchestras” with different combinations of voices that can be recalled whenever needed. MULTI PLAY setups can also be stored on external memory cards in the same way as ordinary voices.

## MULTI PLAY Mode, Bank and Setup Selection

The MULTI PLAY mode, memory banks and individual MULTI PLAY setups are selected in the same way as the TG55 voices:

- [MULTI] to select the MULTI PLAY mode.
- [MEMORY] to select the desired memory bank.
- [-1/NO] and [+1/YES] to select the desired MULTI PLAY setup ([ENTER] + [DATA ENTRY] also works).

## MULTI PLAY Polyphony and Dynamic Note Allocation

Since the TG55 can produce a maximum of 16 notes at the same time (16-note polyphony), the number of simultaneous notes that each voice in a MULTI PLAY setup can produce depends on the number of voices being played at the time. If all 16 voices are played at once, each can only produce a single note. On the other hand, if only one voice is being played the TG55's "Dynamic Note Allocation" feature allows 16 notes to be played simultaneously by that one voice even if 16 voices are assigned.

The TG55 also has a RESERVED NOTE function that allows you to specify a minimum number of notes for each voice ("REFERENCE" section, page 98).

## Checking and Modifying MULTI PLAY Voice Assignments

Here's how you can see what voices are assigned to the various channels in any MULTI PLAY setup, and change the voice assignments temporarily to try out alternative voices.

1. When you first select the MULTI PLAY mode by pressing the [MULTI] key, a display similar to the following will appear:

```
MULTI PLAY
PG1 POP
```

At this point you can use the [-1/NO] and [+1/YES] keys to select any of the 16 MULTI PLAY setups within the current bank.

2. If you press either the [PAGE -] or [PAGE +] key after selecting the desired MULTI PLAY setup, a display similar to the following will appear:

```
<Pick Bass >
CH 1=P32
```

This display allows you to see and change the voices assigned to each channel. In the above display, "CH 1=P32" on the bottom line indicates that voice P32 is assigned to channel 1 (CH 1). Voice P32 is "Pick Bass," as indicated on the top display line. Note the underline cursor under the "1" of "CH 1."

3. While the underline cursor is positioned below the channel (CH) parameter, the [-1/NO] and [+1/YES] keys can be used to select any of the 16 MIDI channels and see which voices are assigned to each.



4. When you're done checking the voice assignments you can return to the normal MULTI PLAY mode display by pressing either the [PAGE -] or [PAGE +] key ... or you could continue and temporarily change one or more voices assignments as described in the following steps.
5. To change a voice assignment, first select the channel to which the new voice will be assigned, as described in the preceding steps.
6. Move the cursor to the voice parameter by pressing the > key. The underline cursor should now be located under the voice number.
7. Use the [-1/NO] and [+1/YES] keys to select the new voice for that channel, or turn the channel "off" (decrementing below voice number 01 selects "off"). Different memory banks can be selected by using the [MEMORY] key.

```

<*****>
      CH 1=off
    
```

If you have set the UTILITY mode "UT MIDI/Program" function to "normal" as described in "Selecting Voices From Your Keyboard/Controller" on page 15, you can also select voices remotely via your keyboard's voice selectors.

8. To assign a new voice to a different channel, simply move the cursor back to the channel parameter by pressing the < key and repeat the above procedure.

**Note:** This function is primarily intended for checking voice assignments and making temporary changes to try out different voices in a MULTI PLAY setup. Voice assignment changes are only temporary and the original voice assignments will be restored as soon as a different MULTI PLAY setup or mode is selected. Permanent changes can be made in the MULTI PLAY EDIT mode, described next.

## Creating an Original MULTI PLAY Setup

In this section we'll go through the steps to create a simple "Jazz Quartet" MULTI PLAY setup consisting of the following voices:

Channel 1 .....P01 Piano  
Channel 2 .....P62 WdBass Duo  
Channel 3 .....P40 Vibraphone  
Channel 4 .....P63 Drum Set 1  
Channels 5 ... 16 ...off

**Note:** P62 WdBass Duo is actually a split voice with wood bass ranging from C-2 to E3 and piano on all higher keys up to G8.

1. If it is not already selected, press [MULTI] to select the MULTI PLAY mode.
2. Use the [MEMORY], [-1/NO] and [+1/YES] keys to select MULTI PLAY setup I01.

```
MULTI PLAY
I01 P0P
```

3. Press [EDIT/COMPARE] to enter the MULTI PLAY EDIT mode.
4. If a display similar to the following is not showing, press the [PAGE +] key a few times until it appears (the [PAGE -] and [PAGE +] keys are used to locate the various functions within the TG55's edit modes).

```
<Pick Bass >CH 1
P32 P19 P21 P27
```

This is the display for the MULTI PLAY EDIT mode voice assignment function ("REFERENCE" section, page 96).

5. The ◀ and ▶ cursor keys are used to move the cursor (▄) to the desired channel (a channel number between CH1 and CH16 will appear in the upper right-hand corner of the display), and the [DATA ENTRY] control or [+1/YES] and [-1/NO] keys are used to assign the desired voice to the selected channel.
  - With the cursor at the channel-1 position, make sure the P01 (Piano) voice is selected.
  - Move the cursor to the channel-2 position by pressing ▶, then select voice P62 (WdBass Duo).
  - Move the cursor to the channel-3 position by pressing ▶, then select voice P40 (Vibraphone).
  - Move the cursor to the channel-4 position by pressing ▶, then select voice P63 (Drum Set 1).

- Move the cursor to all the remaining channel positions (5 ... 16) and turn each “off” by holding the [-1/NO] key until the “off” display appears. Note that the cursor can be moved past the end of the display screen to access the remaining channels in groups of four.

```

<Piano      >CH 1
#P01 P62 P40 P63
    
```

6. Press the [PAGE +] key to move to the next MULTI PLAY EDIT mode function: Volume (“REFERENCE” section, page 96).

```

Volume      CH 1
#127 127 127 127
    
```

7. The volume function operates in basically the same way as the voice assignment function described above. The ◀ and ▶ cursor keys are used to select the channel/voice for which the volume is to be adjusted, then the [DATA ENTRY] control or [+1/YES] and [-1/NO] keys are used to set the desired volume. A setting of “0” produces no sound while a setting of “127” produces maximum volume.

With the Jazz Quartet setup, the relatively gentle wood bass sound tends to become “buried” under the other instruments, so leave its volume setting at the maximum of 127, and lower the other three voices to about 110.

```

Volume      CH 1
#110 127 110 110
    
```

**Volume**

Piano .....	110
WdBass Duo .....	127
Vibraphone .....	110
Drum Set 1 .....	110

8. Press the [PAGE +] key three times to move to the Reserved Note function (“REFERENCE” section, page 98). We’ll skip the Note Shift and Tune (“REFERENCE” section, page 97) functions for this setup, since we don’t need to tune or transpose the pitch of any of the voices in the Jazz Quartet setup.

```

ReserveNote CH 1
# 0  0  0  0
    
```

9. The main use for Reserved Note function is to ensure that a minimum number of notes are available to specific instruments even under circumstances in which less would normally be available. In this case we'll set channel 1 (Piano) to 8 since jazz piano tends to involve a lot of "thick" chord work, and channel 3 (Vibraphone) to 4, which is enough for two-handed phrases. This simply means that there will always be at least 8 notes available for piano and 2 notes available for vibraphone (Vibraphone uses 2-elements: 2 elements x 2 notes = 4), no matter how many notes are played at the same time by bass and drums. If the total number of notes played exceeds 16 at any instant, the bass or drum voice notes will be truncated rather than the piano or vibes notes.

**Reserved Note**

```
Piano .....8
WdBass Duo .....0
Vibraphone .....4
Drum Set 1 .....0
```

The ◀ and ▶ cursor keys are used to select the voice/channel, then the [DATA ENTRY] control or [+1/YES] and [-1/NO] keys are used to set the number of reserved notes.

10. Press the [PAGE +] key to move to the next MULTI PLAY EDIT mode function: Pan ("REFERENCE" section, page 98).

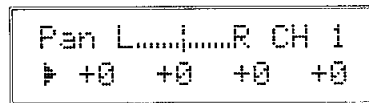

11. This function allows each individual voice in the setup to be panned to a different position in the stereo sound field (you'll only hear this if you're using a stereo sound system fed by the TG55 OUTPUT R and L/MONO jacks).

As always, the ◀ and ▶ cursor keys are used to select the voice/channel for which the pan position is to be set, then the [DATA ENTRY] control or [+1/YES] and [-1/NO] keys are used to set the pan position.

The upper line of the display also shows a graphic representation of the stereo sound field with "L" representing "left" and "R" representing "right." As you change the pan value the vertical bar will appear at the corresponding position on the graphic display.

Set the pan positions of the Jazz Quartet voices as follows:

**Pan**

```
Piano .....-17 (half way to the left)
WdBass Duo .....-9 (slightly to the left)
Vibraphone .....+17 (half way to the right)
Drum Set 1 .....+5 (slightly to the right)
```

12. Press the [PAGE +] key twice to move on to the Effect Level function ("REFERENCE" section, page 99). We'll skip the Output Assign function because the default settings are acceptable for this application.

```
EF Level   CH 1
#100 100 100 100
```

- The Effect Level function individually sets the effect level for each voice in the setup. You know how to move the cursor around and change settings by now.

Set the Effect Level for all four voices to 100 (this is equivalent to the individual voice effect level settings).

**Effect Level**

```
Piano .....100
WdBass Duo .....100
Vibraphone .....100
Drum Set 1 .....100
```

A hall reverb effect is already selected for the I01 MULTI PLAY setup, so we won't bother with the many possible effect settings for now ("REFERENCE" section, page 74).

- Press the [PAGE +] key twice to move on to the MULTI Name function ("REFERENCE" section, page 101).

```
MULTI Name
"POP"
```

- Here's where we actually name our MULTI PLAY setup: "Jazz Quart". The MULTI Name function allows a name of up to 10 characters to be assigned to the current setup. Use the ◀ and ▶ cursor keys to place the underline cursor under the character to be changed, then use the [DATA ENTRY] control or [+1/YES] and [-1/NO] keys to select the desired character. Continue until the entire voice name has been programmed.
- Press [MULTI] to exit from the edit mode and return to the MULTI PLAY mode. The reversed letter "E" that appears to the right of the voice number indicates that the MULTI PLAY setup has been edited.

**Caution!!:** If you select a different MULTI PLAY setup or mode at this point, the edited MULTI PLAY setup will be erased. To keep an edited setup, it must be stored to an INTERNAL or CARD memory location, as described in the following section. For a special method of recalling a multi-play setup lost in this way, see "MULTI RECALL" on page 101.

**Storing an Edited MULTI PLAY Setup**

Now that you've created your first MULTI PLAY setup — "Jazz Quart" — you'll want to store it to one of the TG55's 16 internal MULTI PLAY memory locations or a memory card location.

- After exiting the edit mode by pressing the [MULTI] key, press the [STORE/COPY] key. The following display will appear:

```
STORE I01  
→I01:POP
```

The MULTI PLAY memory number on the top line indicates the source setup — i.e. “Jazz Quart,” the setup we just created. The MULTI PLAY number after the arrow on the bottom line is the target setup — i.e. the memory location to which we will store the edited setup.

2. The target memory location can be changed by using the [-1/NO] and [+1/YES] keys. The [MEMORY] key can be used to change banks, if necessary (obviously you can't store to the read-only PRESET bank, or to a card if no card is loaded).
3. When you're satisfied with the target memory location selection, press [ENTER].

```
STORE I01 Sure?  
→I01:POP
```

“Sure?” appears on the top line of the display, asking you to confirm your intention to store to the selected target location. This confirmation step is important because once you store, all previous data in the target location is erased and completely replaced by the new data.

4. Press [+1/YES] to confirm and actually execute the store operation, or [-1/NO] to cancel. “Executing!” will appear on the display during store, and “Completed!” will appear briefly when the store operation is finished.

```
Executing!
```

```
Completed!
```

Your “Jazz Quart” MULTI PLAY setup has now been stored and can be recalled whenever needed!

**Note:** See the ERROR MESSAGES section on page 114 for information on memory-card related error messages.

## Conclusion

If you've gone all the way through this section and followed all the instructions, you've actually done much more than program your first MULTI PLAY setup. You've learnt about many of the most important TG55 programming procedures and, as a result, should find the next tutorial easy to handle.

There are a few functions and features of the MULTI PLAY mode that we haven't looked at in this tutorial. Refer to the “REFERENCE” section for details.

## 4. EDITING VOICES

### TG55 Voicing Basics

#### AWM2 Waveforms

“AWM2” is an acronym for YAMAHA’s second-generation 16-bit Advanced Wave Memory. This is a digital waveform storage and reproduction system that rivals the quality of the finest compact disc players, providing unprecedented clarity and realism in the reproduction of acoustic instruments and other natural timbres. Technically speaking, AWM2 deals with 16-bit wave data sampled at 32 or 48 kilohertz, 24-bit internal signal processing, and high-resolution 22-bit digital-to-analog converters.

The TG55 contains 2 megabytes of of sampled waveform ROM, so you have a choice of 74 built-in waveforms from which to construct voices.

#### ● PRESET WAVE LIST

No.	Name	No.	Name	No.	Name	No.	Name
1	Piano	21	GtrSteel	41	Digital2	61	BD 3
2	E.Piano1	22	Gtr Gut	42	Digital3	62	SD 1
3	E.Piano2	23	12string	43	Pulse 10	63	SD 2
4	E.Piano3	24	E.Guitar	44	Pulse 25	64	SD 3
5	E.Piano4	25	E.Bass	45	Pulse 50	65	Rim
6	E.Piano5	26	Popping	46	Tri	66	Tom 1
7	E.Piano6	27	WoodBass	47	Voice	67	Tom 2
8	E.Piano7	28	Syn Bass	48	Piano Np	68	HH closed
9	Harpsi	29	Violin	49	EPianoNp	69	HH open
10	Organ 1	30	Strings	50	Vibe Np	70	Crash
11	Organ 2	31	Chorus	51	Bottle	71	Ride
12	Pipe	32	Itopia	52	Tuba	72	Claps
13	Trumpet	33	Vibe	53	Vocal Ga	73	Cowbell
14	Mute Tp	34	Marimba	54	Bamboo	74	Shaker
15	Trombone	35	Glocken	55	Noise		
16	Flugel	36	Shamisen	56	Styroll		
17	Sax	37	Harp	57	Bulb		
18	Flute	38	Mtl Reed	58	Bell Mix		
19	Brass	39	Saw	59	BD 1		
20	SynBrass	40	Digital1	60	BD 2		

#### Elements and Voice Architecture

Each TG55 voice is composed of one, two or four “elements.” The only limitation is that the maximum polyphony of the TG55 is 16 (i.e. the maximum number of notes that can be played simultaneously is 16). This means that a 1-element voice can produce the full 16 notes, while a “layered” 2-element voice can produce 8, and a layered 4-element voice can produce 4.

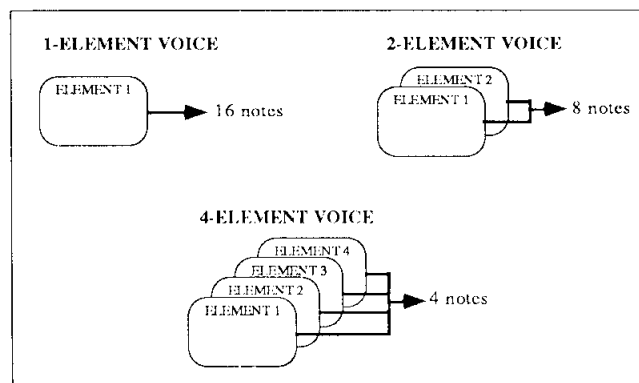

Each element can be assigned an AWM2 waveform from the 74 provided in internal ROM, or others available on plug-in waveform cards. You can have a single element voice that uses only a single waveform, or multi-element voices that combine two or four different waveforms in a number of ways. Each element has its own programmable 5-segment amplitude envelope generator so you can “layer” waveforms enveloped in different ways to create any number of unique sonic hybrids. See page 53 of the “REFERENCE” section for a full description of the amplitude envelope generator parameters.

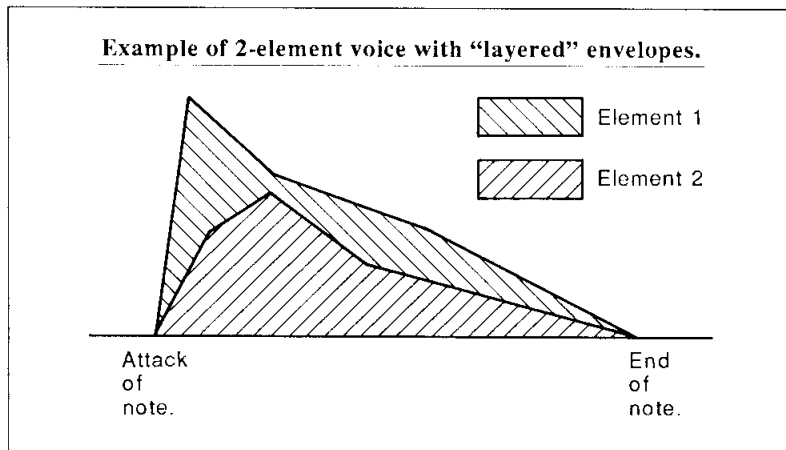

As an alternative to layering elements, each element can be assigned to a different section of the keyboard for exotic split keyboard setups using the low and high-note limit functions described on page 48 of the “REFERENCE” section.

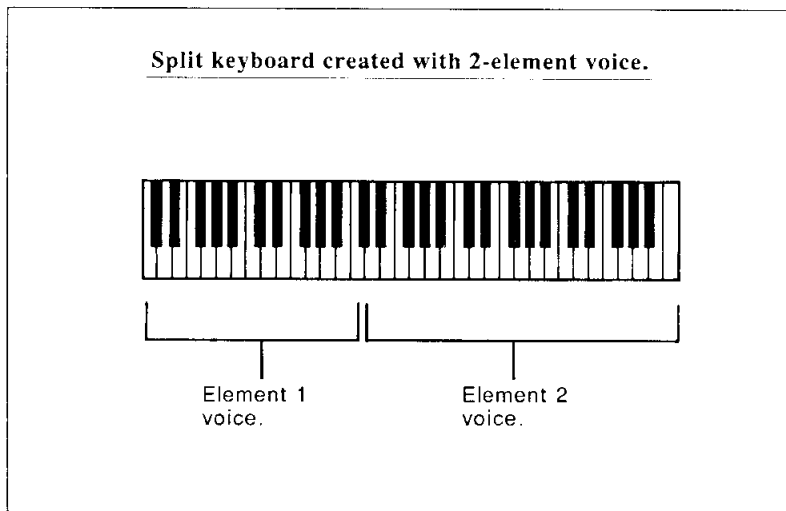



Each element also has a pitch envelope generator and two filter cutoff envelope generators that control the TG55's innovative digital filter system. The block diagram below shows how the various operational blocks within each element are interconnected.

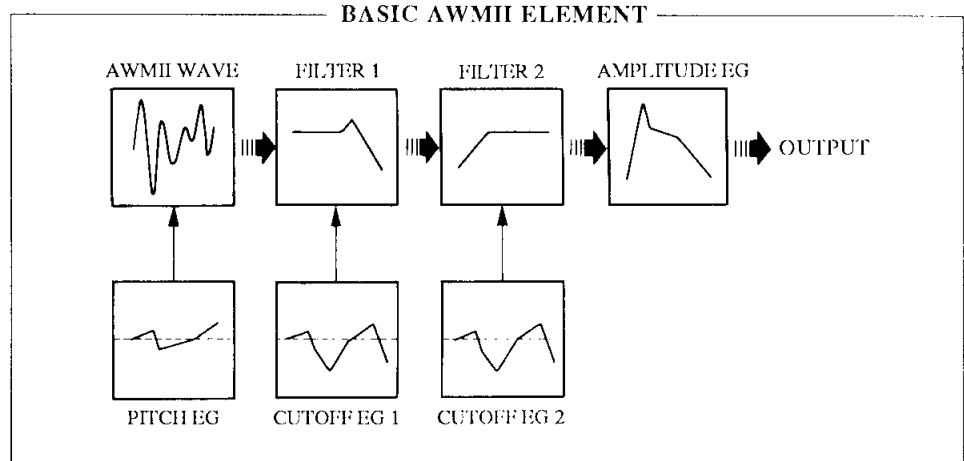

### Digital Filters

Each element has two digital filters. Filter 1 (FL1) is switchable for either low-pass or high-pass response, while Filter 2 (FL2) is a low-pass type. Each filter has its own 6-segment envelope generator so that a virtually unlimited range of dynamic filtering patterns can be produced. See page 63 of the "REFERENCE" section for details on the filter cutoff envelope generators. Filter cutoff can also be controlled by the element's LFO (low-frequency oscillator).

Low-pass and high-pass filters can be combined to create a bandpass response, or both filters can be set for low-pass operation — each with a rolloff slope of 12-dB/octave — to produce a steep 24-dB/octave low-pass curve. The filters also have a resonance parameter in the low-pass mode that allows you to boost their cutoff-frequency peak — all the way into oscillation if you like. The following graphs show the types of filter response that can be achieved.

### Filter Response Examples

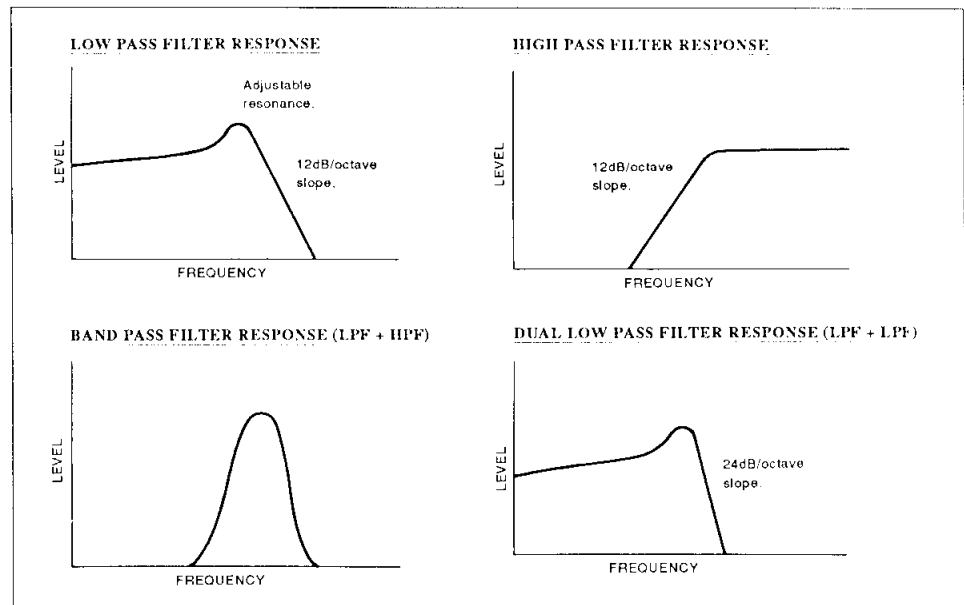

## Other Programmable Parameters & Effects

For each element in any voice you can also control volume, note shift, detuning, high and low note limits, high and low velocity limits for velocity-switched keyboard dynamics, pan position, LFO modulation, controller assignments and more. Of course, the standard pitch and modulation wheels perform their familiar functions, but you can also assign any MIDI controller to amplitude modulation, pitch modulation, filter cutoff modulation, direct filter cutoff control, envelope generator bias and volume ... not to mention after-touch pitch bias (“REFERENCE” section, pages 69 through 72).

You also have direct access to 34 digital effect programs including reverb, delay, early reflection, tone control and distortion — each with several programmable parameters. See page 74 of the “REFERENCE” section for details on the effects and their various parameters.

### TG55 Effects

1: Rev.Hall	(Reverb Hall)
2: Rev.Room	(Reverb Room)
3: RevPlate	(Reverb Plate)
4: RevChrch	(Reverb Church)
5: Rev.Club	(Reverb Club)
6: RevStage	(Reverb Stage)
7: BathRoom	(Reverb Bath Room)
8: RevMetal	(Reverb Metal)
9: Delay	(Single Delay)
10: DelayL/R	(Stereo Delay)
11: St.Echo	(Stereo Echo)
12: Doubler1	(Single Doubler)
13: Doubler2	(Stereo Doubler)
14: PingPong	(Ping Pong Delay)
15: Pan Ref.	(Pan Reflections)
16: EarlyRef	(Early Reflections)
17: Gate Rev	(Gate Reverb)
18: Rvs Gate	(Reverse Gate)
19: FB E/R	(Feedback Early Reflections)
20: FB Gate	(Feedback Gate)
21: FB Rvs	(Feedback Reverse)
22: Dly1&Rev	(Delay 1 & Reverb)
23: Dly2&Rev	(Delay 2 & Reverb)
24: Tunnel	(Tunnel Reverb)
25: Tone 1	(Tone Control 1)
26: Dly1&T1	(Delay 1 & Tone Control 1)
27: Dly2&T1	(Delay 2 & Tone Control 1)
28: Tone 2	(Tone Control 2)
29: Dly1&T2	(Delay 1 & Tone Control 2)
30: Dly2&T2	(Delay 2 & Tone Control 2)
31: Dist&Rev	(Distortion & Reverb)
32: Dst&Dly1	(Distortion & Delay 1)
33: Dst&Dly2	(Distortion & Delay 2)
34: Dist.	(Distortion)

### TG55 Voice Parameter Chart

The voice parameter chart on the following page lists all of the programmable voice parameters — titled as they appear on the TG55 editing screen. You might want to make copies of this chart in order to jot down parameters as you program your own voices.

TG55 Voice Parameter Chart.

Voice Name:

	EL1	EL2	EL3	EL4		EL1	EL2	EL3	EL4
VOICE Mode					FL1\CEG R3				
Wave Select					FL1\CEG L3				
Volume					FL1\CEG R4				
Note Shift					FL1\CEG L4				
Detune					FL1\CEG RR1				
Note Limit/L					FL1\CEG RL1				
Note Limit/H					FL1\CEG RR2				
Vel. Limit/L					FL1\CEG RL2				
Vel. Limit/H					FL1\R.Scale				
Pan					FL1\LS BP1				
Output Asgn					FL1\LS BP2				
EF Balance					FL1\LS BP3				
OSC Frq.Mode					FL1\LS BP4				
OSC Frq.Note					FL1\LS OFS1				
OSC Frq.Tune					FL1\LS OFS2				
AEG Mode					FL1\LS OFS3				
AEG R1/HT					FL1\LS OFS4				
AEG R2					FL2\Type				
AEG L2					FL2\Cutoff				
AEG R3					FL2\Mode				
AEG L3					FL2\CEG L0				
AEG R4					FL2\CEG R1				
AEG RR					FL2\CEG L1				
AEG R.Scale					FL2\CEG R2				
AEG LS BP1					FL2\CEG L2				
AEG LS BP2					FL2\CEG R3				
AEG LS BP3					FL2\CEG L3				
AEG LS BP4					FL2\CEG R4				
AEG LS OFS1					FL2\CEG L4				
AEG LS OFS2					FL2\CEG RR1				
AEG LS OFS3					FL2\CEG RL1				
AEG LS OFS4					FL2\CEG RR2				
Sens. Vel.					FL2\CEG RL2				
Sens. V.Rate					FL2\R.Scale				
Sens. AMS					FL2\LS BP1				
Sens. PMS					FL2\LS BP2				
LFO Wave					FL2\LS BP3				
LFO Speed					FL2\LS BP4				
LFO Delay					FL2\LS OFS1				
LFO Phase					FL2\LS OFS2				
LFO AMOD					FL2\LS OFS3				
LFO PMOD					FL2\LS OFS4				
LFO CutoffMOD					FL\Resonance				
PEG L0					FL\Vel.Sens				
PEG R1					FL\Mod.Sens				
PEG L1					CNTL\Pitch Bend				
PEG R2					CNTL\AT P.Bias				
PEG L2					CNTL\RandomPitch				
PEG R3					CNTL\AMOD CTL#				
PEG L3					CNTL\AMOD RNG				
PEG RR					CNTL\PMOD CTL#				
PEG RL					CNTL\PMOD RNG				
PEG Range					CNTL\CoffMOD CTL#				
PEG R.Scale					CNTL\CoffMOD RNG				
PEG Vel.SW					CNTL\Cutoff CTL#				
FL1\Type					CNTL\Cutoff RNG				
FL1\Cutoff					CNTL\EG Bias CTL#				
FL1\Mode					CNTL\EG Bias RNG				
FL1\CEG L0					CNTL\Volume CTL#				
FL1\CEG R1					CNTL\Volume MIN				
FL1\CEG L1					EF\Type				
FL1\CEG R2					EF\Output Level				
FL1\CEG L2					EF\ ** Others **				

# TG55 Voice Parameter Chart.

Voice Name: VeloChorus

	EL1	EL2	EL3	EL4		EL1	EL2	EL3	EL4
VOICE Mode	2 Element				FL1\CEG R3	0	0		
Wave Select	P31	P56			FL1\CEG L3	0	0		
Volume	127	100			FL1\CEG R4	0	0		
Note Shift	0	0			FL1\CEG L4	0	0		
Detune	0	0			FL1\CEG RR1	0	0		
Note Limit/L	C-2	C-2			FL1\CEG RL1	0	0		
Note Limit/H	G8	G8			FL1\CEG RR2	0	0		
Vel. Limit/L	1	55			FL1\CEG RL2	0	0		
Vel. Limit/H	127	127			FL1\R.Scale	0	0		
Pan	0	0			FL1\LS BP1	C1	C1		
Output Asgn	str	str			FL1\LS BP2	G2	G2		
EF Balance	50	60			FL1\LS BP3	E4	E4		
OSC Frq.Mode	norm	norm			FL1\LS BP4	C6	C6		
OSC Frq.Note	—	—			FL1\LS OFS1	0	0		
OSC Frq.Tune	0	0			FL1\LS OFS2	0	0		
AEG Mode	nrm	nrm			FL1\LS OFS3	0	0		
AEG R1/HT	30	63			FL1\LS OFS4	0	0		
AEG R2	37	12			FL2\Type	THU	THU		
AEG L2	59	50			FL2\Cutoff	127	127		
AEG R3	28	30			FL2\Mode	LFO	LFO		
AEG L3	54	47			FL2\CEG L0	—	—		
AEG R4	0	0			FL2\CEG R1	—	—		
AEG RR	30	30			FL2\CEG L1	—	—		
AEG R.Scale	0	0			FL2\CEG R2	—	—		
AEG LS BP1	C1	C1			FL2\CEG L2	—	—		
AEG LS BP2	G2	G2			FL2\CEG R3	—	—		
AEG LS BP3	E4	E4			FL2\CEG L3	—	—		
AEG LS BP4	C6	C6			FL2\CEG R4	—	—		
AEG LS OFS1	0	0			FL2\CEG L4	—	—		
AEG LS OFS2	0	0			FL2\CEG RR1	—	—		
AEG LS OFS3	0	0			FL2\CEG RL1	—	—		
AEG LS OFS4	0	0			FL2\CEG RR2	—	—		
Sens. Vel.	0	0			FL2\CEG RL2	—	—		
Sens. V.Rate	off	off			FL2\R.Scale	—	—		
Sens. AMS	0	0			FL2\LS BP1	C1	C1		
Sens. PMS	2	0			FL2\LS BP2	G2	G2		
LFO Wave	tri	tri			FL2\LS BP3	E4	E4		
LFO Speed	57	65			FL2\LS BP4	C6	C6		
LFO Delay	70	0			FL2\LS OFS1	0	0		
LFO Phase	0	0			FL2\LS OFS2	0	0		
LFO AMOD	0	0			FL2\LS OFS3	0	0		
LFO PMOD	0	0			FL2\LS OFS4	0	0		
LFO CutoffMOD	0	0			FL\Resonance	3	0		
PEG L0	-15	-22			FL\Vel.Sens	0	0		
PEG R1	60	40			FL\Mod.Sens	0	0		
PEG L1	0	0			CNTL\Pitch Bend	2			
PEG R2	63	63			CNTL\AT P.Bias	0			
PEG L2	0	0			CNTL\RandomPitch	0			
PEG R3	63	63			CNTL\AMOD CTL#	12			
PEG L3	0	0			CNTL\AMOD RNG	64			
PEG RR	63	63			CNTL\PMOD CTL#	1			
PEG RL	0	0			CNTL\PMOD RNG	64			
PEG Range	2 oct	2 oct			CNTL\CoffMOD CTL#	1			
PEG R.Scale	0	0			CNTL\CoffMOD RNG	0			
PEG Vel.SW	off	off			CNTL\Cutoff CTL#	12			
FL1\Type	LPF	LPF			CNTL\Cutoff RNG	0			
FL1\Cutoff	114	127			CNTL\EG Bias CTL#	2			
FL1\Mode	EG	EG			CNTL\EG Bias RNG	0			
FL1\CEG L0	-20	0			CNTL\Volume CTL#	14			
FL1\CEG R1	27	16			CNTL\Volume MIN	0			
FL1\CEG L1	0	-18			EF\Type	1: Rev.Hall			
FL1\CEG R2	0	0			EF\Output Level	100%			
FL1\CEG L2	0	0			EF\** Others **	Time 2.6 / LPF 8.0 / Delay 29			

## Programming the "VeloChorus" Voice

Now that you've got the basic idea, try programming the VeloChorus voice described below. VeloChorus is a 2-element voice in which the "Chorus" waveform is assigned to element 1 and the "Styroll" waveform is assigned to element 2. Both waveforms are enveloped and filtered, and the Styroll waveform is "velocity switched" so it only appears — layered onto the chorus sound — when you play the keys on your keyboard quite hard.

Here's the Voice Parameter Chart for the VeloChorus voice.

The changes are made in "real time" as you program. So don't be afraid to play the voice via your keyboard/controller as you program, to hear the sound as it gradually takes shape.

1. If it is not already selected, press [VOICE] to select the VOICE PLAY mode.
2. Use the [MEMORY], [-1/NO] and [+1/YES] keys to select VOICE I01.

```
VOICE PLAY
I01 Piano
```

3. Press [EDIT/COMPARE] to enter the VOICE EDIT mode.
4. Press the [PAGE -] key a few times until the following display appears (the [PAGE -] and [PAGE +] keys are used to locate the various functions within the TG55's edit modes).

```
VOICE
Initialize
```

5. The voice initialize function allows us to create an "initialized" voice in which all parameters are set to their "standard" values. This is useful because the controller parameters — i.e. pitch wheel and modulation wheel — are also set to function normally, so we won't have to go to the trouble to program these particular parameters for this example ("REFERENCE" section, page 78).

Press the [ENTER] key.

```
VOICE      Sure?
Initialize
```

"Sure?" appears on the top line of the display, asking you to confirm your intention to initialize the voice. Press [+1/YES] to confirm and actually execute the initialize operation. "Completed!" will appear briefly when the initialization is finished.

```
Completed!
```

6. Press the [PAGE +] key once to move ahead to the VOICE Mode function (“REFERENCE” section, page 46).

```
VOICE Mode
  =1 Element
```

7. Press the [+1/YES] key to change “=1 Element” to “=2 Element”. This selects the 2-element voice configuration (the [-1/NO] and [+1/YES] keys are used to change the value of a selected parameter in the edit modes).

```
VOICE Mode
  =2 Element
```

8. Press the [PAGE +] key once to move ahead the AWM Wave Selection function (“REFERENCE” section, page 46).

```
<T+1    >  EL1
#P46 P46 *** ***
```

9. When the 2-element mode is selected (as it should be after the last step), element 1 (EL1) and element 2 (EL2) are available and a different waveform from among the TG55’s 74 preset waveforms can be assigned to each. The unavailable elements are represented by “\*\*\*” on the display.

The ◀ and ▶ cursor keys are used to move the cursor to the desired element (EL1 or EL2 will appear in the upper right-hand corner of the display), and the [DATA ENTRY] control or [+1/YES] and [-1/NO] keys are used to assign the desired wave to the selected element. The selected wave number is shown at the current cursor location, and the full name of the assigned wave is shown in the upper left-hand corner of the display.

- With the cursor at the EL1 position, select the P31 (Chorus) waveform.
- Move the cursor to the EL2 position by pressing ▶, then select the P56 (Styroll) waveform.

```
<Chorus  >  EL1
#P31 P56 *** ***
```

10. Press the [PAGE +] key to move to the Volume function (“REFERENCE” section, page 47).

```
Volume 127  EL1
#127 127 *** ***
```

- The volume function operates in basically the same way as the voice assignment function described above. The ◀ and ▶ cursor keys are used to select the element for which the volume is to be adjusted, then the [DATA ENTRY] control or [+1/YES] and [-1/NO] keys are used to set the desired volume. A setting of “0” produces no sound while a setting of “127” produces maximum volume.

For the VeloChorus voice, leave the Chorus volume setting at the maximum of 127, and lower the Styroll setting to about 100.

```

Volume 127  EL1
▶127 100 *** **
    
```

- Press the [PAGE +] key five times to move to the Vel. Limit/L function (“REFERENCE” section, page 49). We’ll skip the Note Shift (“REFERENCE” section, page 47), Detune, and Note Limit (“REFERENCE” section, page 48) functions for this voice, since we don’t need to detune or transpose the pitch of either of the waveforms in the VeloChorus voice, or set note limits to create a split keyboard setup.

```

Vel. Limit/L EL1
▶ 1 1 *** **
    
```

- The Velocity Limit function is where we setup the VeloChorus voice’s interesting velocity switching feature. This function lets us set the lowest velocity value for a range of velocity values over which the element will produce output. A little more explanation is in order:

Every MIDI “note on message” (the MIDI message that is transmitted every time a note is played on a keyboard or other MIDI controller) contains a “velocity” value that tells the tone generator how hard the note has been played. The range of MIDI velocity values is from 1 to 127 — thus the 1 ... 127 range of this function. By setting the low velocity limit of the Styroll element to about “55”, the Styroll portion of the voice will only sound when a key is played hard enough to transmit a velocity value greater than 55. The low velocity limit of the Chorus waveform is left at “1” so that the Chorus element sounds no matter how hard or soft you play the keys.

You should be getting quite familiar with the basic procedure by now: the ◀ and ▶ cursor keys are used to select the element for which the low velocity limit is to be set, and the [DATA ENTRY] control or [+1/YES] and [-1/NO] keys are used to set the low velocity limit.

- Press the [PAGE +] key four times to move to the EF Balance function (“REFERENCE” section, page 51), skipping the Vel. Limit/H (“REFERENCE” section, page 49), Pan (“REFERENCE” section, page 50), and Output Asgn (“REFERENCE” section, page 51) functions on the way.

```

EF Balance  EL1
▶ 0 0 *** **
    
```

15. Set the EF Balance (Effect Balance) for EL1 and EL2 as follows:

```
EL1 (Chorus) .....50
EL2 (Styroll) .....60
```

16. Press the [PAGE +] key twice to move on to the AEG (Amplitude Envelope Generator) functions (“REFERENCE” section, page 53), skipping the OSC Frq.Mode (“REFERENCE” section, page 52) display.

```
AEG Mode      EL1
nrq  63  63  63+
```

17. Here we program the amplitude envelope generators for EL1 and EL2 — and learn a new element selection technique.

Element Selection: If you press and hold the [SELECT] key the element selection and switching display will appear.

```
SELECT  FL1  EL1
        1   2  *  *
```

On the upper display line “FL1” indicates that Filter 1 is selected and “EL1” indicates that Element 1 is selected. The lower display line indicates that the 2-element mode has been selected (elements 1 and 2 are active). The asterisks ( \* ) indicate elements that are not available (3 and 4 in this case).

While the [SELECT] key is held, any of the available elements can be selected by pressing the corresponding [EL SELECT] key (note the green markings above the [EDIT/COMPARE], [STORE/COPY], [-1/NO] and [+1/YES] keys).

Also while the [SELECT] key is pressed, any of the available elements can also be turned ON or OFF (usually to hear how a single element in a multiple-element voice sounds) by pressing the corresponding [EL ON/OFF] key (note the green markings below the [PAGE -], [PAGE +], ◀ and ▶ keys). An available element that has been turned OFF in this manner appears as a “-” on the display.

Releasing the [SELECT] key returns the display to the current function.

You know how to select elements, select parameters using the ◀ and ▶ keys, and change values using the [DATA ENTRY] control or [-1/NO] and [+1/YES] keys, so go ahead and program the various amplitude envelope generator parameters for each element as follows:



Parameter	E1 (Chorus)	E2 (Styroll)
AEG Mode	nrm	nrm
AEG R1 (Rate 1)	30	63
AEG R2 (Rate 2)	37	12
AEG L2 (Level 2)	59	50
AEG R3 (Rate 3)	28	30
AEG L3 (Level 3)	54	47
AEG R4 (Rate 4)	0	10
AEG RR (Release Rate)	30	30

**Hint:** The arrow symbols (↔ and ⇆) that appear at either end of the display mean that more parameters can be accessed by moving the cursor in the indicated direction using the ◀ and ▶ keys.

18. Go through the next eight display screens yourself while referring to the VeloChorus Voice Chart on the previous page, checking all parameters and making adjustments when necessary.

19. When you get to this display:



It's time to learn a new technique.

The filter functions are accessed by pressing the [ENTER] key from the above display — just like it says on the screen. Once you're "in" the filter function subset, you can move around using the [PAGE -] and [PAGE +] keys just as you can anywhere else. When you're finished with the filter function subset, return to the main function set by pressing the [EXIT] key.

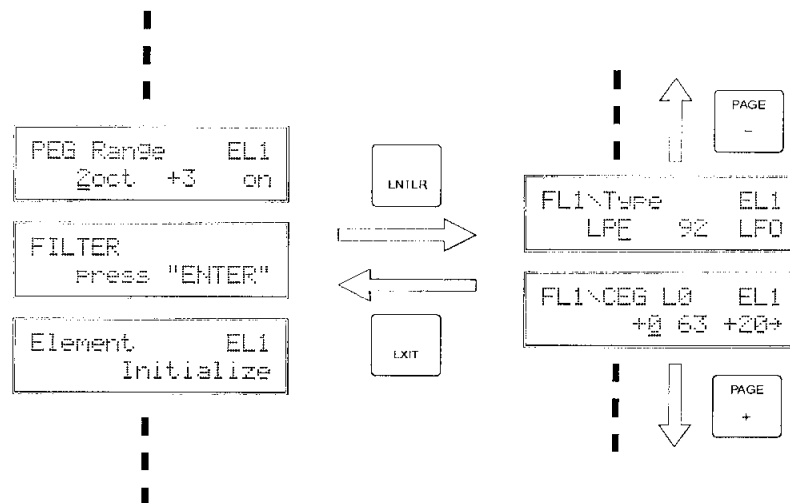

The filter 1 or filter 2 envelope generator can be selected by holding the [SELECT] key and pressing the [EXIT/FIL1] or [ENTER/FIL2] key, respectively (this operation will also take you directly to the filter functions from anywhere within the voice edit mode).

Now that you're in the filter function subset, go ahead and program the filter parameters, referring to the VeloChorus voice parameter chart on page 30.

20. After pressing [EXIT] to exit from the filter function subset, skip through the next three screens — Element Initialize (“REFERENCE” section, page 67), Controller (“REFERENCE” section, page 69), and Effect (“REFERENCE” section, page 73) — using the [PAGE +] key. That brings us to the Voice Name (“REFERENCE” section, page 77) function, where we actually name our original voice: “VeloChorus”.

```
VOICE Name  
"INIT VOICE"
```

21. The VOICE Name function allows a name of up to 10 characters to be assigned to the current voice. Use the ◀ and ▶ cursor keys to place the underline cursor under the character to be changed, then use the [DATA ENTRY] control or [+1/YES] and [-1/NO] keys to select the desired character. Continue until the entire voice name has been programmed.
22. Press [VOICE] to exit from the edit mode and return to the VOICE mode. The reversed letter “E” that appears to the right of the voice number indicates that the voice has been edited.

**Caution!!:** If you select a different voice or mode at this point, the edited voice will be erased. To keep an edited voice, it must be stored to an INTERNAL or CARD memory location, as described in the following section. For a special method of recalling a voice lost in this way, see “VOICE RECALL” on page 77.

## Storing an Edited Voice

Now that you’ve created your first original voice — “VeloChorus” — you’ll want to store it to one of the TG55’s 64 internal voice memory locations or a memory card location.

1. After exiting the edit mode by pressing the [VOICE] key, press the [STORE/COPY] key. The following display will appear:

```
STORE I01  
→I01:Piano
```

The voice number on the top line indicates the source setup — i.e. the “VeloChorus” voice we just created in the TG55’s edit buffer memory. The voice number after the arrow on the bottom line is the target voice — i.e. the memory location to which we will store the edited voice.

2. The target memory location can be changed by using the [-1/NO] and [+1/YES] keys. The [MEMORY] key can be used to change banks, if necessary (obviously you can’t store to the read-only PRESET bank, or to a card if no card is loaded).

**Note:** If you intend to store the voice to a memory card, make sure that the card has been properly formatted (“REFERENCE” section, page 111), and that the card’s WRITE PROTECT switch is turned OFF (refer to the MCD64 or MCD32 Memory Card instructions for details).

3. When you're satisfied with the target memory location selection, press [ENTER].

```
STORE I01  Sure?
→I01:Piano
```

“Sure?” appears on the top line of the display, asking you to confirm your intention to store to the selected target location. This confirmation step is important because once you store, all previous data in the target location is erased and completely replaced by the new data.

4. Press [+1/YES] to confirm and actually execute the store operation, or [-1/NO] to cancel. “Executing!” will appear on the display during store, and “Completed!” will appear briefly when the store operation is finished.

```
Completed!
```

Your “VeloChorus” voice has now been stored and can be recalled whenever needed!

**Note:** Refer to the “ERROR MESSAGES” section on page 114 for information on memory-card related error messages.

## Conclusion

Well that's about it. You've learned the basics of getting around in the TG55's play and edit modes. Be sure to read the “General Operation” sections in the reference section for more important operating techniques. The voice edit mode, for example, offers element, AEG and effect copy functions that can make the job of programming voices much faster and more efficient.

If you've carefully gone through all four tutorials, you should now be able to handle just about any TG55 job simply by referring to the reference section.



# REFERENCE SECTION

---

# VOICE EDIT MODE

## Contents

---

<b>GENERAL OPERATION</b> .....	42
Selecting the Voice Edit Mode .....	42
Selecting the Various Voice Edit Mode Functions .....	42
Selecting an Element to Edit/Element ON-OFF Switching .....	43
Edit/Compare Operation .....	43
The Element, AEG and Filter Copy Functions .....	44
The Effect Copy Function .....	45
<b>FUNCTIONS &amp; PARAMETERS</b> .....	46
VOICE MODE .....	46
AWM WAVE SELECTION .....	46
VOLUME .....	47
NOTE SHIFT .....	47
DETUNE .....	48
LOW NOTE LIMIT .....	48
HIGH NOTE LIMIT .....	49
LOW VELOCITY LIMIT .....	49
HIGH VELOCITY LIMIT .....	50
PANNING .....	50
OUTPUT ASSIGN .....	51
EFFECT BALANCE .....	51
OSCILLATOR MODE/NOTE/TUNE .....	52
AMPLITUDE ENVELOPE GENERATOR (AEG) MODE/LEVEL/RATE .....	53
AMPLITUDE ENVELOPE GENERATOR (AEG) RATE SCALING .....	54
AMPLITUDE ENVELOPE GENERATOR (AEG) LEVEL SCALE BREAKPOINT .....	54
AMPLITUDE ENVELOPE GENERATOR (AEG) LEVEL SCALE OFFSET .....	54
SENSITIVITY (VELOCITY, AMPLITUDE & PITCH MODULATION) .....	55
LOW FREQUENCY OSCILLATOR (LFO) WAVEFORM/SPEED/DELAY/PHASE .....	57
LOW FREQUENCY OSCILLATOR (LFO) MODULATION DEPTH, AMPLITUDE/PITCH/CUTOFF .....	58

---

PITCH ENVELOPE GENERATOR (PEG) LEVEL/RATE .....	59
PITCH ENVELOPE GENERATOR (PEG) SENSITIVITY, RANGE/RATE SCALING/VELOCITY SWITCH.....	60
FILTER: TYPE/CUTOFF/MODE .....	61
FILTER: CUTOFF ENVELOPE GENERATOR .....	63
FILTER: RATE SCALING .....	64
FILTER: LEVEL SCALING BREAKPOINT .....	64
FILTER: LEVEL SCALING OFFSET .....	65
FILTER: RESONANCE/VELOCITY SENSITIVITY/ MODULATION SENSITIVITY .....	65
ELEMENT INITIALIZE .....	67
CONTROLLER: PITCH BEND RANGE .....	69
CONTROLLER: AFTER TOUCH PITCH BIAS .....	69
CONTROLLER: RANDOM PITCH RANGE .....	69
CONTROLLER: AMPLITUDE MODULATION .....	70
CONTROLLER: PITCH MODULATION .....	70
CONTROLLER: CUTOFF MODULATION .....	71
CONTROLLER: CUTOFF FREQUENCY CONTROL .....	71
CONTROLLER: EG BIAS CONTROL .....	72
CONTROLLER: VOLUME CONTROL .....	72
EFFECT: TYPE/OUTPUT LEVEL .....	73
EFFECT: EFFECT PARAMETERS .....	74
VOICE NAME .....	77
VOICE RECALL .....	77
VOICE INITIALIZE .....	78

# GENERAL OPERATION

## Selecting the Voice Edit Mode

Press the [VOICE] key followed by the [EDIT/COMPARE] key. Both the [VOICE] and [EDIT/COMPARE] key indicators should be lit.



If the VOICE PLAY mode is already selected (i.e. the [VOICE] key indicator is lit), it is only necessary to press the [EDIT/COMPARE] key.



You can exit the voice edit mode and return to the voice play mode at any time by pressing either the [VOICE] key or the [EXIT] key.

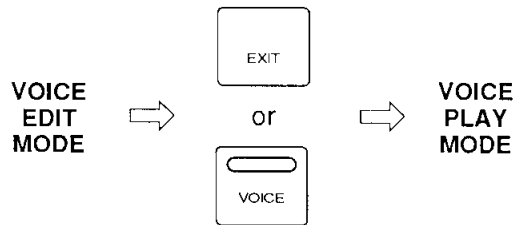

## Selecting the Various Voice Edit Mode Functions

Once the voice edit mode has been selected, the various voice editing functions can be selected by using the [PAGE -] and [PAGE +] keys.

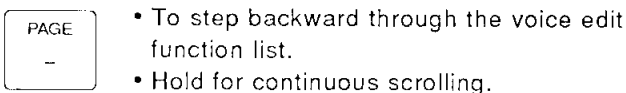
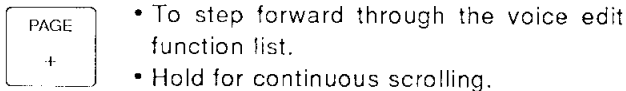

Some functions only have a single parameter, while others contain several that must be selected using the ◀ and ▶ cursor keys. In many cases the ◀ and ▶ keys are used to select one of the available elements in a multi-element voice. The value of a selected parameter is adjusted using the [-1/NO] and [+1/YES] keys or the [DATA ENTRY] control.

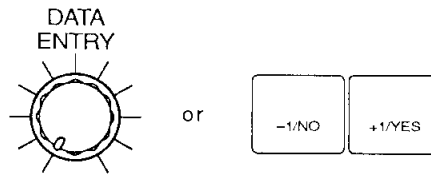
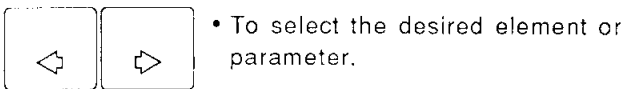

- To edit value of selected element/parameter.

In still other cases a “function” accessed by the [PAGE -] and [PAGE +] keys will actually be a “doorway” to a separate list of jobs relating to that function. In the voice edit mode, the FILTER, CONTROLLER and EFFECT functions are of this type. When “Filter” is selected, for example, “press ENTER” will appear on the bottom line of the display.



When you press “[ENTER],” the [PAGE -] and [PAGE +] keys can be used to access a whole subset of FILTER functions. When you’re finished editing filter functions, press the “[EXIT]” key to return to the primary function list.



## Selecting an Element to Edit/Element ON-OFF Switching

Although the ◀ and ▶ cursor keys are used to select a particular element in many functions, some functions that can be individually programmed for each element contain several different parameters which must be selected using the ◀ and ▶ keys, so an alternative means of element selection has been provided.

If you press and hold the [SELECT] key the element selection and switching display will appear.



On the upper display line "FL1" indicates that Filter 1 is selected and "EL1" indicates that Element 1 is selected. The lower display line indicates that the 2-element mode has been selected (elements 1 and 2 are active). The asterisks (\*) indicate elements that are not available (3 and 4 in this case).

While the [SELECT] key is held, any of the available elements can be selected by pressing the corresponding [EL SELECT] key (note the green markings above the [EDIT/COMPARE], [STORE/COPY], [-1/NO] and [+1/YES] keys).

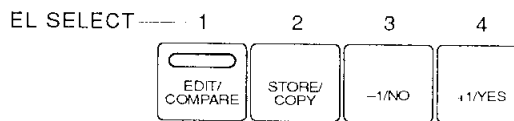

Also while the [SELECT] key is pressed, any of the available elements can also be turned ON or OFF (usually to hear how a single element in a multiple-element voice sounds) by pressing the corresponding [EL ON/OFF] key (note the green markings below the [PAGE -], [PAGE +], ◀ and ▶ keys). An available element that has been turned OFF in this manner appears as a "-" on the display.

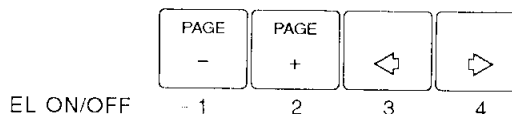

Releasing the [SELECT] key returns the display to the current function.

## Edit/Compare Operation

Normally, when you play a voice that is being edited in the voice edit mode you hear the sound of the edited voice. This can be compared with the original (pre-edit) sound by pressing the [EDIT/COMPARE] key to activate the COMPARE mode. The [EDIT/COMPARE] key indicator will flash while the COMPARE mode is active. Press the [EDIT/COMPARE] key again to return to the VOICE EDIT mode.

**NOTE:** While the COMPARE mode is active it is not possible to select any other functions. The [EXIT] key can be used, however, to return to the voice play mode.

**NOTE:** When the compare function is used, the contents of the TG55 "recall buffer" are replaced with the current contents of the edit buffer (i.e. the current status of the voice being edited). This can affect the outcome of a VOICE RECALL operation — see "VOICE RECALL" on page 77.

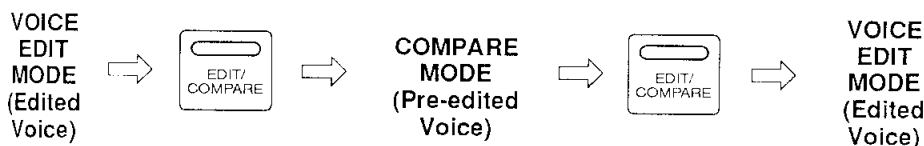

## The Element, AEG and Filter Copy Functions

The Element, AEG and Filter Copy functions make it possible to copy all parameter assignments, just the AEG parameter assignments, or just the filter parameter assignments from any other element to the element currently being edited. This is useful if, for example, you want to create an AEG curve that is the same as, or varies only slightly from, one that already exists.

1. Make sure the voice edit mode is engaged and that any function other than one of the EFFECT, AEG or FILTER functions is selected if you want to copy all element parameters, that one of the AEG functions is selected if you want to copy the AEG parameters, or that one of the FILTER functions is selected if you want to copy the filter parameters.
2. Select the element to which the new parameter data will be copied using the standard element selection procedure described above.
3. Press the [STORE/COPY] key. One of the following displays will appear, depending on the currently selected function.

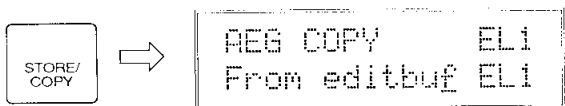
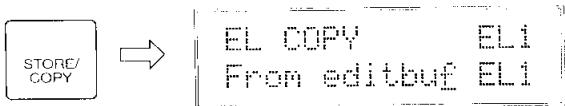

4. Next, select the voice from which the parameter data is to be copied by using the [DATA ENTRY] control, or using the [+1/YES] and [-1/NO] keys. "editbuf" refers to the voice that is currently being edited, and other voices can be selected by using standard procedure — [MEMORY] key to select voice bank; [DATA ENTRY] control or [+1/YES] and [-1/NO] keys to select the voice.

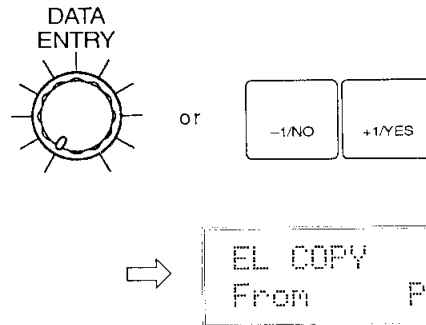

5. Move the underline cursor to the element parameter to the right by pressing the  $\triangleright$  key, then choose the particular element of the selected voice you want to copy the data from using the [DATA ENTRY] control or [+1/YES] and [-1/NO] keys.\* If the element number appears in reverse, the voice does not use that element and no data is available.

\* For Filter Copy, the "editbuf" setting allows copying parameters from filter 1 to filter 2, or vice versa, when copying within the same element (e.g. EL1 → EL1). In this case, the filter to be copied to must be selected prior to pressing [STORE/COPY] key by holding the [SELECT] key and pressing either the [EXIT/FIL1] or [ENTER/FIL2] key. "F2→F1" or "F1→F2" will appear on the upper line of the display to show the selected copy direction.

6. When the elements to and from which the data is to be copied have been properly selected, press the [ENTER] key. "Sure?" will appear on the top line of the LCD.



7. Press the [+1/YES] key to confirm and actually execute the copy operation, or [-1/NO] to cancel. "Executing!" will appear briefly on the display while the data is being copied, then "Completed!" will appear for a few seconds when the copy operation has been successfully completed.

- When the copy operation has finished, the TG55 will return automatically to the display that was showing immediately prior to activation of the element copy function.

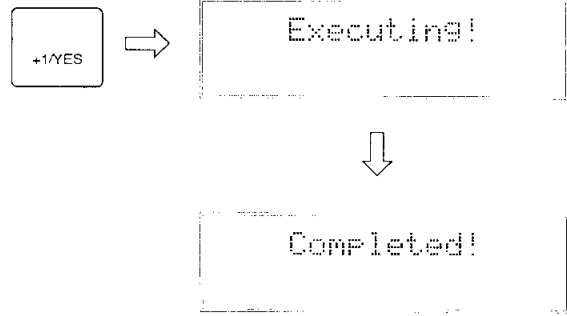

## The Effect Copy Function

The Effect Copy function makes it possible to copy the effect parameter assignments from any other voice or multi-timbral setup to the voice currently being edited.

- Make sure the voice edit mode is engaged and that one of the EFFECT functions is selected.
- Press the [STORE/COPY] key. The following display will appear.



- Use the ◀ and ▶ cursor keys to move to the Multi/Voice parameter and select "Multi" if you want to copy the effect parameters from a multi-timbral setup, or "Voice" if you want to copy the effect parameters from a preset or internal voice.
- Next, move the cursor to the multi or voice number parameter by pressing the ▷ key, and select the multi-timbral setup or voice from which the parameter data is to be copied by using the [DATA ENTRY] control or the [+1/YES] and [-1/NO] keys. The [MEMORY] key can be used to select the "P" (preset) or "I" voice bank if necessary.

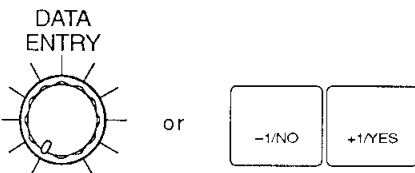

- Press the [ENTER] key. "Sure?" will appear on the top line of the LCD.



- Press the [+1/YES] key to confirm and actually execute the copy operation, or [-1/NO] to cancel. "Executing!" will appear briefly on the display while the data is being copied, then "Completed!" will appear for a few seconds when the copy operation has been successfully completed.

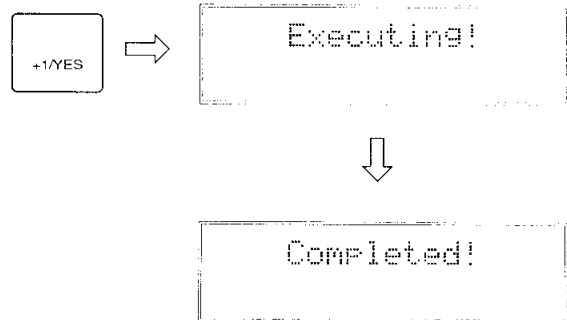

- When the copy operation has finished, the TG55 will return automatically to the display that was showing immediately prior to activation of the effect copy function.

# FUNCTIONS & PARAMETERS

## VOICE MODE

```
VOICE Mode
=1 Element
```

**Summary:** Determines whether the voice will be a 1-element (max. 16-note polyphony), 2-element (max. 8-note polyphony) or 4-element (max. 4-note polyphony) type.

**Settings:** 1 Element, 2 Element, 4 Element.

**Procedure:** The [DATA ENTRY] control or [+1/YES] and [-1/NO] keys are used to select the desired number of elements.

**Details:** The number of elements used in a voice basically determines the number of different waveforms that can be played simultaneously: one waveform in the 1-element mode, two waveforms in the 2-element mode, and four waveforms in the 4-element mode. Since each individual element has its own waveform, filters, envelope generator, etc., the waveforms in a multi-element voice can be combined in several

different ways. They can simply be played simultaneously, limited to specific regions of the keyboard to create a "split keyboard" voice, one waveform could be used only for the attack portion of the voice while another is used for the sustain, and so on.

When selecting the 2- or 4-element mode, always keep in mind the fact that these modes reduce the number of notes you can play at the same time:

Mode	Polyphony
1-element mode:	16 notes
2-element mode:	8 notes
4-element mode:	4 notes

The tutorial goes into further detail concerning the use of the multi-element modes.

**Refer to:** Tutorial, page 25...27, 32.

## AWM WAVE SELECTION

```
<Piano > EL1
#P01 *** *** ***
```

**Summary:** Assigns a preset or card wave to each active voice element.

**Settings:**

P01 ... P58 (preset voices)  
P59 ... P74 (preset drums)  
C01 ... max. C99 (card voices)

**Procedure:** When the 1-element mode is selected (as in the example LCD display, above), only a single wave may be assigned. The unavailable elements are each represented by " \*\*\* " on the display.

If the 2- or 4-element mode is selected, different waves may be assigned to each available element. The ◀ and ▶ cursor keys are used to move the cursor to the desired element (EL1, EL2, EL3 or EL4 will appear in the upper right-hand corner of the display), and the [DATA ENTRY] control or [+1/YES] and [-1/NO] keys are used to assign the desired wave to the selected element. The wave number (P01 ... P74, C01 ... C99) is shown at the current cursor location, and the full name of the assigned wave is shown in the upper left-hand corner of the display.

**Details:** Completely different waves can be assigned to each element, but it is also possible to assign the same wave to different elements. In this case

the waves can be filtered differently and/or have different envelopes to create an endless range of interesting effects.

Refer to: Tutorial, page 25, 32.

## VOLUME

```
Volume 127  EL1
▶127 *** *** ***
```

**Summary:** Allows individual adjustment of element volume as well as overall (total) volume adjustment.

**Settings:** 0 ... 127

**Procedure:** The ◀ and ▶ cursor keys are used to select the element for which the volume is to be adjusted, or overall "Total" volume control (EL1, EL2, EL3, EL4 or Total will appear in the upper right-hand corner of the display). Unavailable elements are represented by " \*\*\* " on the display. The [DATA ENTRY] control or [+1/YES]

and [-1/NO] keys are used to set the desired volume.

**Details:** A setting of "0" produces no sound while a setting of "127" produces maximum volume.

The ability to independently adjust the volume of each element makes it simple to set up the optimum balance or "mix" between elements. Overall volume adjustment can be used to match the the overall level of different voices.

Refer to: Tutorial, page 32.

## NOTE SHIFT

```
Note Shift  EL1
▶ +0 *** *** ***
```

**Summary:** Individually shifts the pitch of each active element up or down in semitone steps.

**Settings:** -64 ... +63.

**Procedure:** The ◀ and ▶ cursor keys are used to select the element to be note-shifted (EL1, EL2, EL3 or EL4 will appear in the upper right-hand corner of the display). Unavailable elements are represented by " \*\*\* " on the display. The [DATA ENTRY] control or [+1/YES] and [-1/NO] keys are used to set the desired degree of note shift.

**Details:** A setting of "-12," for example, shifts the pitch of the selected element down by one octave; a setting of "+4" shifts the pitch up by a major third.

The Note Shift function can be used to transpose a voice to its most useful range, or to create harmony (intervals) between different elements in a multi-element voice.

Refer to: Utility mode "TRANSPPOSE," page 106.

## DETUNE

```
Detune      EL1  
# +0 *** *** ***
```

**Summary:** Allows slight upward or downward pitch adjustment of each active element.

**Settings:** -7 ... +7

**Procedure:** The ◀ and ▶ cursor keys are used to select the element to be detuned (EL1, EL2, EL3 or EL4 will appear in the upper right-hand corner of the display). Unavailable elements are represented by “\*\*\*” on the display. The [DATA ENTRY] control or [+1/YES] and [-1/NO] keys are used to set the desired degree of detuning.

**Details:** The maximum minus setting of “-7” produces a downward pitch shift of approximately a quarter of a semitone, and the maximum plus setting of “+7” produces an upward pitch shift of approximately the same amount. A setting of “0” produces no pitch change.

The Detune function allows different elements in a multi-element voice to be slightly detuned in relation to each other, thereby “thickening” the overall sound.

**Refer to:** “OSCILLATOR MODE/NOTE/TUNE,” page 52.

## LOW NOTE LIMIT

```
Note Limit/L EL1  
# C2 *** *** ***
```

**Summary:** Individually sets the low note limit for each active element (the lowest note that each element will produce).

**Settings:** C 2 ... G8

**Procedure:** The ◀ and ▶ cursor keys are used to select the element for which the low note limit is to be set (EL1, EL2, EL3 or EL4 will appear in the upper right-hand corner of the display). Unavailable elements are represented by “\*\*\*” on the display. The [DATA ENTRY] control or [+1/YES] and [-1/NO] keys are used to set the low note limit.

The low note limit can also be set by pressing the [ENTER] key — “KBD” will flash on the display — and then the key on your keyboard corresponding to the desired low note.

**Details:** The C-2 to G8 range of this function covers a full 10-1/2 octaves. “C3” corresponds to “middle C” on a keyboard.

This function, in conjunction with the High

Note Limit function described below, allows the sound from an element to be limited to a specific region of the keyboard (or scale of other types of MIDI controllers). If the Low Note Limit is set to C3 and the High Note Limit for the same element is set to C4, for example, the sound from that element will only be produced between C3 and C4 — the octave immediately above middle C. This makes it simple to produce split voices.

If the High Note Limit is set to a note that is **lower** than the Low Note Limit for the same element, the full range of notes (C-2 ... G8) will be produced.

**Refer to:** Tutorial, page 26. “HIGH NOTE LIMIT” on page 49.

```
Note Limit/L EL1  
#KBD *** *** ***
```

## HIGH NOTE LIMIT

```
Note Limit/H EL1
  G8 *** *** ***
```

**Summary:** Individually sets the high note limit for each active element (the highest note that each element will produce).

**Settings:** C-2 ... G8

**Procedure:** The ◀ and ▶ cursor keys are used to select the element for which the high note limit is to be set (EL1, EL2, EL3 or EL4 will appear in the upper right-hand corner of the display). Unavailable elements are represented by "\*\*\*" on the display. The [DATA ENTRY] control or [+1/YES] and [-1/NO] keys are used to set the high note limit.

The high note limit can also be set by pressing the [ENTER] key — "KBD" will flash on the display — and then the key on your keyboard corresponding to the desired high note.

**Details:** See "LOW NOTE LIMIT," above.

**Refer to:** Tutorial, page 26. "LOW NOTE LIMIT" on page 48.

## LOW VELOCITY LIMIT

```
Vel. Limit/L EL1
  1 *** *** ***
```

**Summary:** Sets the lowest velocity value for a range of velocity values over which each active element will produce output.

**Settings:** 1 ... 127

**Procedure:** The ◀ and ▶ cursor keys are used to select the element for which the low velocity limit is to be set (EL1, EL2, EL3 or EL4 will appear in the upper right-hand corner of the display). Unavailable elements are represented by "\*\*\*" on the display. The [DATA ENTRY] control or [+1/YES] and [-1/NO] keys are used to set the low velocity limit.

The low velocity limit can also be set by pressing the [ENTER] key — "KBD" will flash on the display — and then a key on your keyboard at approximately the desired velocity.

**Details:** Every MIDI "NOTE ON MESSAGE" (the MIDI message that is transmitted every time a note is played on a keyboard or other MIDI controller) contains a "velocity" value that tells the

tone generator how hard the note has been played. The range of MIDI velocity values is from 1 to 127 — thus the 1 ... 127 range of this function.

The Low Velocity Limit function, in conjunction with the High Velocity Limit function described below, makes it possible to specify a range of velocity values over which the selected element will produce sound. You could, for example, set Low Velocity Limit to "60" and High Velocity Limit to "127." This would cause that element to produce output **only** when a velocity value between 60 and 127 was received — i.e. when a fairly loud note is played. A second element could then be set to produce output only when velocity values below 60 are received, so that completely different sounds are produced on soft and loud notes.

**Refer to:** Tutorial, page 33. "HIGH VELOCITY LIMIT" on page 50.

## HIGH VELOCITY LIMIT

```
Vel. Limit/H EL1  
#127 *** *** ***
```

**Summary:** Sets the highest velocity value for a range of velocity values over which each active element will produce output.

**Settings:** 1 ... 127

**Procedure:** The ◀ and ▶ cursor keys are used to select the element for which the high velocity limit is to be set (EL1, EL2, EL3 or EL4 will appear in the upper right-hand corner of the display). Unavailable elements are represented by "\*\*\*" on the display. The [DATA ENTRY] control or [+1/YES] and [-1/NO] keys are used to set the high velocity limit.

The high velocity limit can also be set by pressing the [ENTER] key — "KBD" will flash on the display — and then a key on your keyboard at approximately the desired velocity.

**Details:** See "LOW VELOCITY LIMIT," above.

**Refer to:** Tutorial, page 33. "LOW VELOCITY LIMIT" on page 49.

## PANNING

```
Pan L.....R EL1  
# +0 *** *** ***
```

**Summary:** Determines the position in the stereo sound field in which the sound from each active element will be heard (left to right).

**Settings:** -31 ... +31

**Procedure:** The ◀ and ▶ cursor keys are used to select the element for which the pan position is to be set (EL1, EL2, EL3 or EL4 will appear in the upper right-hand corner of the display). Unavailable elements are represented by "\*\*\*" on the display. The [DATA ENTRY] control or [+1/YES] and [-1/NO] keys are used to set the pan position.

The upper line of the display also shows a graphic representation of the stereo sound field with "L" representing "left" and "R" representing "right." As you change the pan value the vertical bar will appear at the corresponding position on the graphic display.

**Details:** Minus values represent panning to the left, and positive values represent panning to the right. "0" positions the sound of the selected element in the center of the stereo sound field.

For a single-element voice the Pan position should generally be set to center ("0") unless you have some specific reason why you want the sound to appear only at the L/MONO or R output jack. In multi-element voices interesting stereo effects can be produced by placing the output from different elements at different locations in the stereo sound field.

**Refer to:** "OUTPUT ASSIGN," on page 51. "THE CONTROLS AND CONNECTORS," page 6.



## OUTPUT ASSIGN

```

Output Assign
          =str
  
```

**Summary:** Determines whether the current voice is delivered via the L/MONO and R OUTPUT jacks, or the INDIVIDUAL 1 and/or 2.

**Settings:** str, -:-, 1:-, -:2, 1:2

**Procedure:** The [DATA ENTRY] control or [+1/YES] and [-1/NO] keys are used to select "str," "-:-," "1:-," "-:2," or "1:2."

**Details:** When the "str" (STEREO) setting is selected, the L/MONO and R OUTPUT jacks are active and the INDIVIDUAL 1 and 2 jacks are off. This is the "normal mode" of operation which allows the output from individual elements to be positioned from left to right in the stereo sound field (See "PANNING," above). When any setting **other** than "str" is selected, the INDIVIDUAL 1 and 2 outputs are active and the L/MONO and R OUTPUT jacks are off.

Setting	Result
str	Outputs L/MONO and R ON. 1 and 2 OFF.
-:-	Outputs 1 and 2 both OFF. L/MONO and R OFF.
1:-	Output 1 ON, 2 OFF. L/MONO and R OFF.
-:2	Output 1 OFF, 2 ON. L/MONO and R OFF.
1:2	Outputs 1 and 2 both ON. L/MONO and R OFF.

Also please note that the TG55 effects are not applied to the sound at the INDIVIDUAL outputs.

**Refer to:** "PANNING" on page 50. "THE CONTROLS AND CONNECTORS," page 6.

## EFFECT BALANCE

```

EF Balance  EL1
  50 *** *** ***
  
```

**Summary:** Determines the balance between the direct and effect sound for each active element.

**Settings:** 0 ... 100

**Procedure:** The ◀ and ▶ cursor keys are used to select the element for which the effect balance is to be set (EL1, EL2, EL3 or EL4 will appear in the upper right-hand corner of the display). Unavailable elements are represented by "\*\*\*" on the display. The [DATA ENTRY] control or [+1/YES] and [-1/NO] keys are used to set the effect balance.

**Details:** A setting of "0" produces only the direct sound of the selected element, while a setting of "100" produces only the effect sound. A setting of "50" delivers both the direct and effect sound in approximately equal proportions.

The effect (reverb, delay, etc.) applied to the voice is selected and edited using the EFFECT functions described on page 74.

**Refer to:** Tutorial, page 33. "EFFECT: TYPE/OUTPUT LEVEL" on page 73. "EFFECT: EFFECT PARAMETERS" on page 74. Utility mode "EFFECT" on page 107.

## OSCILLATOR MODE/NOTE/TUNE

### ● Frequency Mode

```
OSC Frq.Mode EL1
norm +0
```

**Summary:** Determines whether the AWM wave for the selected element is reproduced in the normal (variable pitch) or fixed-pitch mode.

**Settings:** norm, fix

**Procedure:** If the Frequency Mode ("Frq.Mode" on upper LCD line) parameter is not already selected, use the ◀ and ▶ cursor keys to select it. Use the [DATA ENTRY] control or [+1/YES] and

[-1/NO] keys to select the "fix" or "norm" setting.

**Details:** Normally you want the pitch of the AWM wave (or waves) used in a voice to be controllable from a keyboard or other type of controller, so this parameter will be set to "norm" for most applications.

In some cases — sound effects in particular — you might want the same pitch to be produced no matter what note you play on the keyboard or other controller. In this case, the "fix" mode is appropriate. The Frequency Note parameter described below can be used to set the note produced when the "fix" mode is selected.

### ● Frequency Note

```
OSC Frq.Note EL1
fix A3 +0
```

**Summary:** Sets the frequency (note) of the AWM wave for the selected element when the "fix" mode (above) is selected.

**Settings:** C-2 ... G8

**Procedure:** The "Frq.Note" parameter **only** appears when the "Frq.Mode" parameter described above has been set to "fix."

Use the ◀ and ▶ cursor keys to select the Frequency Note ("Frq.Note") parameter. Use the [DATA ENTRY] control or [+1/YES] and [-1/NO] keys to select the desired note.

The frequency note can also be set by pressing the [ENTER] key — "KBD" will flash on the display — and then the key on your keyboard corresponding to the desired note.

**Details:** The C-2 to G8 range of this parameter covers a full 10-1/2 octaves. "C3" corresponds to "middle C" on a keyboard.

**Refer to:** "NOTE SHIFT," page 47.

### ● Frequency Tune

```
OSC Frq.Tune EL1
fix A3 +0
```

**Summary:** Allows tuning of the AWM wave assigned to the selected element.

**Settings:** -64 ... +63

**Procedure:** Use the ◀ and ▶ cursor keys to select the Frequency Tune ("Frq.Tune") parameter. Use the [DATA ENTRY] control or [+1/YES] and [-1/NO] keys to set the tuning as required.

**Details:** Each tuning increment corresponds to a 75/64-cent change in pitch. The entire tuning range is therefore  $75/64 \times 127$  (i.e. 64 + 63 increments) — almost 150 cents. Since 100 cents equals one semitone, the tuning range is approximately one and a half semitones. A setting of "0" produces normal pitch (A3 = 440 Hertz).

Please note that this parameter is used to individually tune different elements within a voice. Overall tuning control is provided by the MASTER tune function in the UTILITY mode.

**Refer to:** "MASTER TUNE" on page 106. "DETUNE" on page 48.

# AMPLITUDE ENVELOPE GENERATOR (AEG) MODE/LEVEL/RATE

AEG Mode	EL1
nrm 53	5 58+

**Summary:** All the parameters within this function determine the “shape” of the amplitude envelope of the selected element.

**Settings:**

Mode parameter: nrm, hld

R1/HT, R2, L2, R3, L3, R4 and RR parameters: 0 ... 63

**Procedure:** If the Mode (“Mode” on upper LCD line) parameter is not already selected, use the  $\leftarrow$  and  $\rightarrow$  cursor keys to select it, then use the [DATA ENTRY] control or [+1/YES] and [-1/NO] keys to select the “nrm” (normal) or “hld” (hold) setting. Once the desired mode has been selected, use the  $\leftarrow$  and  $\rightarrow$  cursor keys to select the various rate and level parameters in turn (R1/HT, R2, L2, R3, L3, R4 and RR), using the [DATA ENTRY] control or [+1/YES] and [-1/NO] keys to set the value of each. “R1” (Rate 1) will appear when the “nrm” mode has been selected, but “HT (Hold Time)” will appear instead when the “hld” mode is selected.

The arrow symbols ( $\leftarrow$  and  $\rightarrow$ ) that appear at either end of the display mean that more parameters can be accessed by moving the cursor in the indicated direction using the  $\leftarrow$  and  $\rightarrow$  keys.

**Details:**

The “nrm” and “hld” mode settings affect the initial attack of the sound, determining how the amplitude envelope begins. In the “nrm” mode, the envelope begins from zero level, reaching the maximum AWM level at a rate determined by the R1 (Rate 1) parameter. In this mode there will always be a slight delay between the initiation of a note and maximum level. The following two diagrams show the kind of envelopes that can be produced in the “nrm” mode.

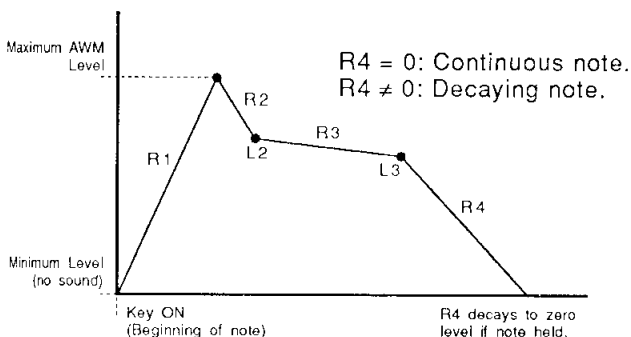

The envelop begins at zero level, reaches maximum level at the rate determined by the R1 parameter, moves to L2 (Level 2) at R2 (Rate 2), moves on to L3 (Level 3) at R3 (Rate 3), and finally decays to zero level at R4 (Rate 4) if the note is held the entire time.

If the note is released before the end of the envelope described above, then the sound decays to zero level from the point at which the note is released at the rate determined by the RR (Release Rate) parameter.

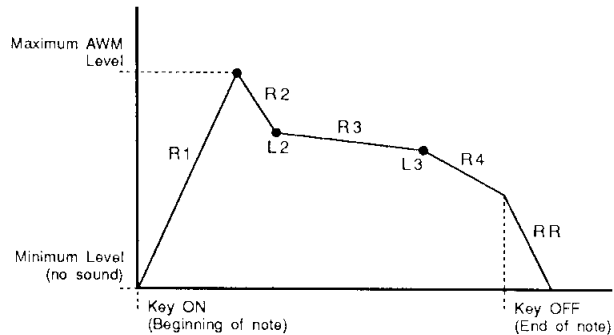

If the “hld” mode is selected, the envelope begins immediately from maximum AWM level, allowing the fast attack transients of waveforms to pass unaffected. In this case the R1 parameter is replaced by the HT (Hold Time) parameter. The HT parameter determines the length of time between the beginning of the envelope and the point at which the envelope begins to move towards L2 (Level 2) at R2 (Rate 2), as shown below.

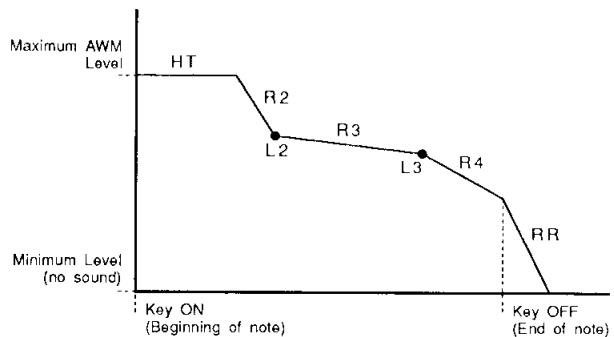

For the level parameters, a setting of “0” corresponds to the lowest possible level (no sound) while a setting of “63” produces the highest output level. A “0” rate parameter setting produces the slowest rate between levels, while the maximum setting of “63” produces the fastest (almost instantaneous) change.

Refer to: Tutorial, page 26, 34.

## AMPLITUDE ENVELOPE GENERATOR (AEG) RATE SCALING

```
AEG R.Scale  EL1  
              =+7
```

**Summary:** Allows the overall amplitude envelope generator decay rate for the selected element to be varied across the entire pitch range.

**Settings:** -7 ... +7

**Procedure:** Use the [DATA ENTRY] control or [+1/YES] and [-1/NO] keys to set the desired degree of rate scaling.

**Details:** Plus (“+”) settings produce a longer overall envelope time for the low notes and a shorter en-

velope time for the high notes. This is useful for simulating instruments such as piano, in which the low notes take much longer to decay than the high notes. The maximum “+7” setting produces the greatest envelope length variation across the pitch range. Minus (“-”) settings produce the opposite effect — short low notes and long high notes. A setting of “+0” results in no envelope length variation.

**Refer to:** “AMPLITUDE ENVELOPE GENERATOR (AEG) MODE/LEVEL/RATE,” page 53.

## AMPLITUDE ENVELOPE GENERATOR (AEG) LEVEL SCALE BREAKPOINT

```
AEG LS BP1  EL1  
  C1  G2  E4  C6
```

**Summary:** Allows four separate amplitude envelope generator level-scaling breakpoints to be set at any notes between C-2 and G8 for the selected element.

**Settings:** C-2 ... G8

**Procedure:** Use the ◀ and ▶ cursor keys to select the desired breakpoint (BP1, BP2, BP3 and BP4, from left to right), then use the [DATA ENTRY] control or [+1/YES] and [-1/NO] keys to set the breakpoint note.

The breakpoint can also be set by pressing the [ENTER] key — “KBD” will flash on the display — and then the key on your keyboard corresponding to the desired breakpoint.

**Details:** Level scale offset values are applied to each of the breakpoints using the LEVEL SCALE OFFSET function described below. Natural level variations can thereby be produced across the range of the controlling keyboard. No breakpoint can be set to a key lower than the breakpoint to its left.

**Refer to:** “AMPLITUDE ENVELOPE GENERATOR (AEG) LEVEL SCALE OFFSET” below.

## AMPLITUDE ENVELOPE GENERATOR (AEG) LEVEL SCALE OFFSET

```
AEG LS OFS1  EL1  
  +0  +0  +0  +0
```

**Summary:** Sets the amount of level offset for each of the four level-scaling breakpoints set in the “AMPLITUDE ENVELOPE GENERATOR

(AEG) LEVEL SCALE BREAKPOINT” function described above.

**Settings:** -127 ... +127

**Procedure:** Use the ◀ and ▶ cursor keys to select the desired offset parameter (OFS1, OFS2, OFS3 and OFS4, from left to right), then use the [DATA

ENTRY] control or [+1/YES] and [-1/NO] keys to set the level-scaling offset for the corresponding breakpoint.

**Details:** Negative values reduce the level, and positive values increase the level at the corresponding breakpoint. No matter what value is chosen, the EG level will never exceed its maximum of 63.

When different offsets are set for adjacent breakpoints, the level varies accordingly and smoothly between the breakpoints.

**Refer to:** "AMPLITUDE ENVELOPE GENERATOR (AEG) LEVEL SCALE BREAKPOINT" on page 54.

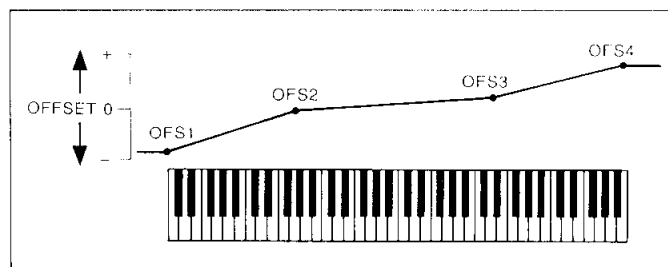

## SENSITIVITY (VELOCITY, AMPLITUDE & PITCH MODULATION)

### ● Velocity Sensitivity

```
Sens. Vel.  E11
+4  on  +3  3
```

**Summary:** Determines how the output level of the selected element changes in response to velocity changes (e.g. keyboard dynamics).

**Settings:** -7 ... +7

**Procedure:** If the Velocity Sensitivity ("Vel." on upper LCD line) parameter is not already selected, use the ◀ and ▶ cursor keys to select it. Use the [DATA ENTRY] control or [+1/YES] and

[-1/NO] keys to select the required degree of velocity sensitivity.

**Details:** Plus "+" settings produce higher output level in response to higher velocity values — i.e. the harder a key is played, the louder the sound. The maximum setting of "+7" produces the maximum level variation in response to velocity changes. Minus "-" settings produce the opposite effect: lower level in response to higher velocity. A setting of "+0" results in no level variation. Make sure that the volume is turned down when making "-" settings, or you may not be able to hear the full effect.

### ● Velocity Rate Sensitivity ON/OFF

```
Sens. V.Rate E11
+4  on  +3  3
```

**Summary:** Determines whether overall envelope length of the amplitude envelope generator for the selected element will or will not be controlled by velocity information.

**Settings:** on, off

**Procedure:** Use the ◀ and ▶ cursor keys to select the Velocity Rate Sensitivity parameter

("V.Rate"). Use the [DATA ENTRY] control or [+1/YES] and [-1/NO] keys to select "on" or "off."

**Details:** When this parameter is turned "on," higher velocity values produce a faster attack rate. When "off" no envelope rate variation is produced.

**Refer to:** "AMPLITUDE ENVELOPE GENERATOR (AEG) MODE/LEVEL/RATE," page 53.

---

## ● Amplitude Modulation Sensitivity

```
Sens. AMS    E11
+4   on   +3  3
```

**Summary:** Determines the sensitivity of the selected element to amplitude modulation (tremolo effect) applied via the low-frequency oscillator (LFO) and appropriate controllers.

**Settings:** -7 ... +7

**Procedure:** Use the ◀ and ▶ cursor keys to select the Amplitude Modulation Sensitivity parameter ("AMS"). Use the [DATA ENTRY] control or [+1/YES] and [-1/NO] keys to set the required degree of amplitude modulation sensitivity.

**Details:** A setting of "0" allows no amplitude modulation by any means, while a setting of "+7" results in maximum sensitivity to amplitude modulation. Minus settings produce reverse EG bias — i.e. a higher modulation value produces lower level.

When setting up the low-frequency oscillator or a controller to apply amplitude modulation, this parameter must be set to a value other than "0" for amplitude modulation to take place.

**Refer to:** "LOW FREQUENCY OSCILLATOR (LFO) WAVEFORM/SPEED/DELAY/PHASE" on page 57. "LOW FREQUENCY OSCILLATOR MODULATION DEPTH, AMPLITUDE/PITCH/CUTOFF" on page 58. "CONTROLLER" functions from page 69 to page 72.

---

## ● Pitch Modulation Sensitivity

```
Sens. PMS    E11
+4   on   +3  3
```

**Summary:** Determines the sensitivity of the selected element to pitch modulation (vibrato effects) applied via appropriate controllers.

**Settings:** 0 ... 7

**Procedure:** Use the ◀ and ▶ cursor keys to select the Pitch Modulation Sensitivity parameter ("PMS"). Use the [DATA ENTRY] control or [+1/YES] and [-1/NO] keys to set the required degree of pitch modulation sensitivity.

**Details:** A setting of "0" allows no pitch modulation by any means, while a setting of 7 results in maximum sensitivity to amplitude modulation.

When setting up the low-frequency oscillator or a controller to apply pitch modulation, this parameter must be set to a value other than "0" for pitch modulation to take place.

**Refer to:** "LOW FREQUENCY OSCILLATOR (LFO) WAVEFORM/SPEED/DELAY/PHASE" on page 57. "LOW FREQUENCY OSCILLATOR MODULATION DEPTH, AMPLITUDE/PITCH/CUTOFF" on page 58. "CONTROLLER" functions from page 69 to page 72.

## LOW FREQUENCY OSCILLATOR (LFO) WAVEFORM/SPEED/DELAY/PHASE

### ● Wave

```
LFO Wave  ~  EL1
sin 37 20 0
```

**Summary:** Determines the waveform of the LFO for the selected element.

**Settings:** tri, dwn, up, squ, sin, S/H

**Procedure:** If the Wave parameter is not already selected, use the ◀ and ▶ cursor keys to select it. Use the [DATA ENTRY] control or [+1/YES] and [-1/NO] keys to select the desired LFO waveform.

#### Details:

“tri” = Triangle.  
 “dwn” = Downward sawtooth.  
 “up” = Upward sawtooth.  
 “squ” = Square.  
 “sin” = Sinc.  
 “S/H” = Sample and hold.

**Refer to:** “SENSITIVITY (VELOCITY, AMPLITUDE & PITCH MODULATION,” page 55.

### ● Speed

```
LFO Speed  ~  EL1
sin 32 20 0
```

**Summary:** Sets the speed of the LFO for the selected element.

**Settings:** 0 ... 99

**Procedure:** Use the ◀ and ▶ cursor keys to select the Speed parameter. Use the [DATA ENTRY]

control or [+1/YES] and [-1/NO] keys to set the desired LFO speed.

**Details:** “0” produces the slowest LFO speed, and “99” produces the fastest LFO speed.

**Refer to:** “SENSITIVITY (VELOCITY, AMPLITUDE & PITCH MODULATION,” page 55.

### ● Delay

```
LFO Delay  ~  EL1
sin 37 20 0
```

**Summary:** Sets the delay time between the beginning of a note and the beginning of LFO operation for the selected element.

**Settings:** 0 ... 99

**Procedure:** Use the ◀ and ▶ cursor keys to select the Delay parameter. Use the [DATA ENTRY]

control or [+1/YES] and [-1/NO] keys to set the desired LFO delay.

**Details:** The minimum setting of “0” results in no delay, while the maximum setting of “99” produces the longest possible delay before the LFO begins operation.

**Refer to:** “SENSITIVITY (VELOCITY, AMPLITUDE & PITCH MODULATION,” page 55.

## ● Phase

```
LFO Phase  EL1
sin 37 20 0
```

**Summary:** Determines at which point in the LFO waveform the LFO will begin operation for the selected element.

**Settings:** 0 ... 99

**Procedure:** Use the ◀ and ▶ cursor keys to select the Phase parameter. Use the [DATA ENTRY]

control or [+1/YES] and [-1/NO] keys to set the desired LFO phase.

**Details:** If the LFO is used for pitch modulation, for example, a phase setting of "0" would cause the vibrato effect to begin with an upward pitch sweep, while a setting of "55" would cause the vibrato to begin with a downward pitch sweep. The change can be subtle, and experimentation is the best way to find the best setting.

**Refer to:** "SENSITIVITY (VELOCITY, AMPLITUDE & PITCH MODULATION," page 55.

## LOW FREQUENCY OSCILLATOR MODULATION DEPTH, AMPLITUDE/PITCH/CUTOFF

## ● Amplitude Modulation Depth

```
LFO AMOD  EL1
0 0 0
```

**Summary:** Determines the amount of amplitude modulation applied to the selected element.

**Settings:** 0 ... 127

**Procedure:** If the Amplitude Modulation ("AMOD") parameter is not already selected, use the ◀ and ▶ cursor keys to select it. Use the [DATA ENTRY] control or [+1/YES] and [-1/NO] keys to set the desired degree of amplitude modulation.

**Details:** A "0" setting produces no modulation while a setting of "127" produces maximum modulation. Amplitude modulation produces a periodic variation in the volume of the sound, thus creating a tremolo effect.

Please note that the amplitude modulation sensitivity parameter (see page 56) must also be set to an appropriate value before amplitude modulation can be applied.

**Refer to:** "Amplitude Modulation Sensitivity" on page 56.

## ● Pitch Modulation Depth

```
LFO PMOD  EL1
0 0 0
```

**Summary:** Determines the amount of pitch modulation applied to the selected element.

**Settings:** 0 ... 127

**Procedure:** Use the ◀ and ▶ cursor keys to select the Pitch Modulation ("PMOD") parameter. Use the [DATA ENTRY] control or [+1/YES] and [-1/NO] keys to set the desired degree of pitch modulation.

**Details:** A "0" setting produces no modulation while a setting of "127" produces maximum modulation. Pitch modulation produces a periodic pitch variation, thereby creating a vibrato effect.



Please note that the pitch modulation sensitivity parameter (see page 56) must also be set to an appropriate value before pitch modulation can be applied.

**Refer to:** "Pitch Modulation Sensitivity" on page 56.

## ● Filter Cutoff Modulation Depth

```

LFO CutoffMOD EL1
      0  0  0
  
```

**Summary:** Determines the amount of modulation applied to the cutoff frequency of the filter of the selected element.

**Settings:** 0 ... 127

**Procedure:** Use the ◀ and ▶ cursor keys to select the Filter Cutoff Modulation ("CutoffMOD") parameter. Use the [DATA ENTRY] control or [+1/YES] and [-1/NO] keys to set the desired degree of cutoff modulation.

**Details:** A "0" setting produces no modulation while a setting of "127" produces maximum modulation. Filter cutoff modulation produces wah-wah type effects.

Please note that the filter cutoff modulation sensitivity parameter (see page 66) must also be set to an appropriate value before cutoff frequency modulation can be applied.

**Refer to:** Tutorial, page 27. "FILTER: RESONANCE/VELOCITY SENSITIVITY/MODULATION SENSITIVITY" on page 65.

## PITCH ENVELOPE GENERATOR (PEG) LEVEL/RATE

```

PEG L0          EL1
      +0  0  +0+
  
```

**Summary:** All parameters within this function determine the "shape" of the pitch envelope generator for the selected element.

**Settings:**

L0, L1, L2, L3, and RL parameters: -64 ... +63

R1, R2, R3 and RR parameters: 0 ... 63

**Procedure:** Use the ◀ and ▶ cursor keys to select the various rate and level parameters in turn (L0, R1, L1, R2, L2, R3, L3, RR and RL), using the [DATA ENTRY] control or [+1/YES] and [-1/NO] keys to set the value of each.

The arrow symbols ( ← and → ) that appear at either end of the display mean that more parameters can be accessed by moving the cursor in the indicated direction using the ◀ and ▶ keys.

**Details:** Unlike the amplitude envelope generator, the "Level" parameters of which actually correspond to volume levels, the pitch envelope generator level parameters correspond to pitch. Plus "+" values produce higher pitch while minus "-" values produce lower pitch. "0" level values produce normal pitch.

The "Rate" parameters work in the same way as the amplitude envelope generator rate parameters: a setting of "0" produces the slowest rate between levels, while the maximum setting of "63" produces the fastest (almost instantaneous) change.

The pitch envelope begins at L0 (Level 0), moves to L1 (Level 1) at a rate determined by the setting of R1, then to L2 (Level 2) at R2 (Rate 2), and then to L3 (Level 3) at R3 (Rate 3). The pitch stays at L3 until the key is released, and then moves to RL (Release Level) at the rate determined by RR (Release Rate).

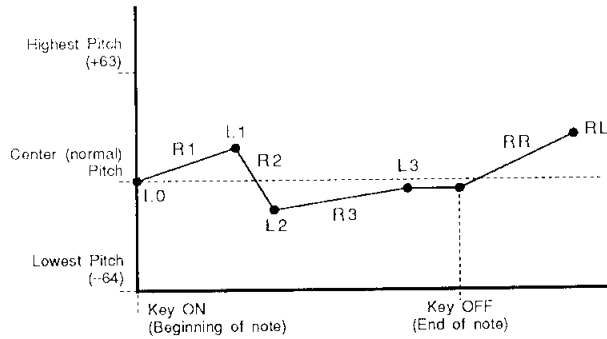

## PITCH ENVELOPE GENERATOR SENSITIVITY, RANGE/RATE SCALING/VELOCITY SWITCH

### ● PEG Range

```

PEG Range      EL1
 2oct +3      on
  
```

**Summary:** Sets the maximum range of pitch envelope generator pitch variation.

**Settings:** 2oct, 1oct, 1/2oct

**Procedure:** If the Range parameter is not already selected, use the ◀ and ▶ cursor keys to select it. Use the [DATA ENTRY] control or [+1/YES] and [-1/NO] keys to select the desired range.

**Details:** This parameter determines the **total maximum** range of the pitch envelope generator, so a setting of "2oct" means that the maximum range is  $\pm 1$  octave. That is, if a level parameter is set to +63, for example, the pitch at that point will be one octave above normal pitch.

**Refer to:** "PITCH ENVELOPE GENERATOR (PEG) LEVEL/RATE," page 59.

### ● PEG Rate Scaling

```

PEG R.Scale    EL1
 2oct +3      on
  
```

**Summary:** Allows the overall pitch envelope generator rate for the selected element to be varied across the entire pitch range.

**Settings:** -7 ... +7

**Procedure:** Use the ◀ and ▶ cursor keys to select the Rate Scaling ("R.Scale") parameter. Use the [DATA ENTRY] control or [+1/YES] and [-1/NO] keys to set the desired degree of rate scaling.

**Details:** Plus ("+") settings produce a longer overall envelope time for the low notes and a shorter envelope time for the high notes. The maximum "+7" setting produces the greatest envelope length variation across the pitch range. Minus ("-") settings produce the opposite effect — a shorter low-note envelope and longer high-note envelope. A setting of "+0" results in no envelope length variation.

**Refer to:** "PITCH ENVELOPE GENERATOR (PEG) LEVEL/RATE," page 59.

● PEG Velocity Switch

```
PEG Vel.SW  EL1
  Zoct +3   ON
```

**Summary:** Determines whether overall envelope length of the pitch envelope generator for the selected element will or will not be controlled by velocity information.

**Settings:** on, off

**Procedure:** Use the ◀ and ▶ cursor keys to select the Velocity Switch (“Vel.SW”) parameter. Use the [DATA ENTRY] control or [+1/YES] and [-1/NO] keys to turn the velocity switch “on” or “off.”.

**Details:** When this parameter is turned “on,” higher velocity values produce a longer pitch envelope — i.e. the harder a key is played the longer the pitch variation. When “off” no envelope rate variation is produced.

**Refer to:** “PITCH ENVELOPE GENERATOR (PEG) LEVEL/RATE,” page 59.

**FILTER: TYPE/CUTOFF/MODE**

● Type

```
FL1Type  EL1
  LPE 92  LFO
```

**Summary:** Determines the response of the selected filter.

**Settings:**

- Filter 1 (FL1): THU, LPF, HPF
- Filter 2 (FL2): THU, LPF

**Procedure:** If the Type parameter is not already selected, use the ◀ and ▶ cursor keys to select it. Use the [DATA ENTRY] control or [+1/YES] and [-1/NO] keys to select the desired filter response.

Filter 1 or Filter 2 can be selected by holding the [SELECT] key and pressing the [EXIT/FIL1] or [ENTER/FIL2] key, respectively.

**Details:** The “THU” (THROUGH) setting turns the filter OFF.

The “LPF” (Low Pass Filter) setting produces a filter response that allows only frequencies **below** the cutoff frequency (See “Cutoff” below) to pass.

LPF Filter Response

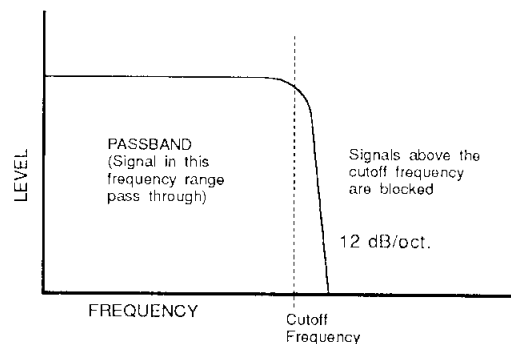

The “HPF” (High Pass Filter — available only on filter 1) setting produces a filter response that allows only frequencies above the cutoff frequency (See “Cutoff” below) to pass.

HPF Filter Response

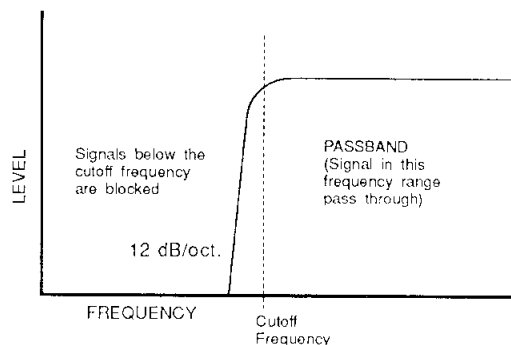

By combine the HPF setting of filter 1 with the LPF setting of filter 2, it is possible to create a BPF (Band Pass Filter) response that allows only frequencies that fall between the cutoff of the HPF and LPF to pass. In this case the cutoff of the LPF must be set at a higher frequency than that of the HPF. It is also possible to set both filters to "LPF" and the same cutoff frequency, resulting in a steep 24-dB per octave filter slope.

Refer to: Tutorial, page 27, 35. "FILTER: CUTOFF ENVELOPE GENERATOR," page 63.

### Bandpass Filter (HPF + LPF) Response

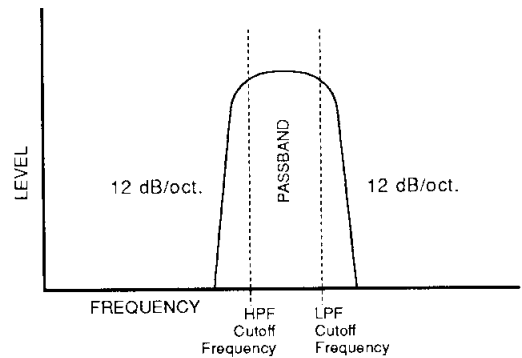

### ● Cutoff

```

FL1\Cutoff  EL1
LPF  92  LFO
  
```

**Summary:** Sets the cutoff frequency of the selected filter.

**Settings:**

- 0 ... 127 (LPF)
- 0 ... 114 (HPF)

**Procedure:** Use the  $\leftarrow$  and  $\rightarrow$  cursor keys to select the Cutoff parameter. Use the [DATA ENTRY] control or [+1/YES] and [-1/NO] keys to select the desired cutoff frequency.

Filter 1 or Filter 2 can be selected by holding the [SELECT] key and pressing the [EXIT/FIL1] or [ENTER/FIL2] key, respectively.

**Details:** Lower cutoff values produce a lower cutoff frequency and higher values produce a higher cutoff frequency.

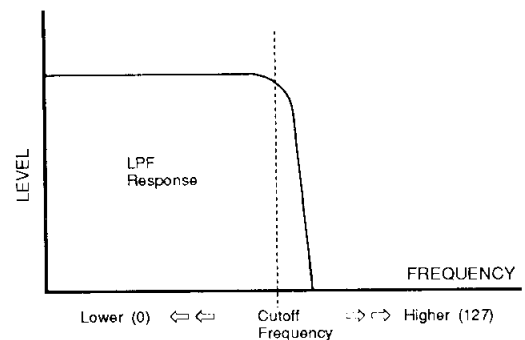

With an LPF response, a lower cutoff frequency reduces the range of high frequencies passed, making the sound "darker" or "rounder."

With a HPF response, a higher cutoff frequency reduces the range of low frequencies passed, making the sound "thinner" or "sharper."

Refer to: Tutorial, page 27, 35. "FILTER: CUTOFF ENVELOPE GENERATOR," page 63.

## ● Mode

```

FL1 Mode      EL1
  LPF      92  LFO
  
```

**Summary:** Determines whether the cutoff frequency of the selected filter will be controlled by the LFO or by the filter envelope generator (EG).

**Settings:** EG, LFO, EGVA

**Procedure:** Use the ◀ and ▶ cursor keys to select the Mode parameter. Use the [DATA ENTRY] control or [+1/YES] and [-1/NO] keys to select the “EG” or “LFO” setting.

Filter 1 or Filter 2 can be selected by holding the [SELECT] key and pressing the [EXIT/FIL1] or [ENTER/FIL2] key, respectively.

**Details:** Varying the filter cutoff frequency can create “sweep” or “wah-wah” type effects. If the cutoff is controlled via the LFO a cyclic variation based on the “shape” of the selected LFO

waveform is produced. If EG control is selected, the filter envelope generator (a separate EG is provided for each filter — see “FILTER: CUTOFF ENVELOPE GENERATOR” below) can be set up to produce a wide range of time-based variations.

Please note that if “LFO” is selected, the filter cutoff envelope generator parameters have no effect on the sound and will not appear on the display: Cutoff EG levels and rates, rate scaling, and level scaling. The filter can only be controlled from controllers (modulation wheel, etc.) if the LFO mode is selected.

If the “EGVA” setting is selected, the R1 and L1 envelope parameters are controlled by note velocity (i.e. the harder a key is played the higher the R1 speed and L1 level). All EG parameters are controlled by note velocity when “EG” is selected.

**Refer to:** Tutorial, page 27, 35. “FILTER: CUTOFF ENVELOPE GENERATOR,” below.

## FILTER: CUTOFF ENVELOPE GENERATOR

```

FL1 CEG L0  EL1
  +0 63 +20+
  
```

**Summary:** All parameters within this function determine the “shape” of the cutoff envelope generator for the selected filter. This function is only available if the “Mode” parameter (page 63) is set to “EG” or “EGVA.”

**Settings:**

L0, L1, L2, L3, L4, RL1 and RL2 parameters:

-64 ... +63

R1, R2, R3, R4, RR1 and RR2 parameters:

0 ... 63

**Procedure:** Use the ◀ and ▶ cursor keys to select the various rate and level parameters in turn (L0, R1, L1, R2, L2, R3, L3, R4, L4, RR1, RL1, RR and RL2), using the [DATA ENTRY] control or [+1/YES] and [-1/NO] keys to set the value of each.

The arrow symbols (↔ and ↔) that appear at either end of the display mean that more para-

eters can be accessed by moving the cursor in the indicated direction using the ◀ and ▶ keys.

The filter 1 or filter 2 envelope generator can be selected by holding the [SELECT] key and pressing the [EXIT/FIL1] or [ENTER/FIL2] key, respectively.

**Details:** The cutoff envelope generator level parameters correspond to cutoff frequency. Plus “+” values produce higher cutoff frequencies while minus “-” values produce lower cutoff frequencies. “0” level values produce the normal cutoff frequency as determined by the cutoff parameter (See “Cutoff” on page 62).

The “Rate” parameters work in the same way as the amplitude and pitch envelope generator rate parameters: a setting of “0” produces the slowest rate between levels, while the maximum setting of “63” produces the fastest (almost instantaneous) change.

The pitch envelope begins at L0 (Level 0), moves to L1 (Level 1) at a rate determined by the setting of R1, then to L2 (Level 2) at R2 (Rate 2), then to L3 (Level 3) at R3 (Rate 3), and

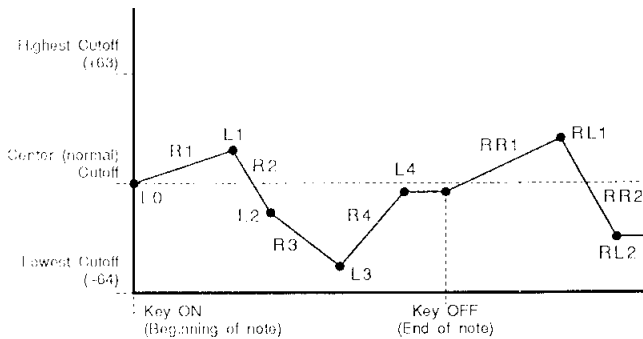

then to L4 (Level 4) at R4 (Rate 4). The cutoff stays at L4 until the key is released, and then moves to RL1 (Release Level 1) at the rate determined by RR1 (Release Rate 1), and finally to RL2 (Release Level 2) at RR2 (Release Rate 2).

**Refer to:** Tutorial, page 27, 35. "FILTER: RATE SCALING," below. "FILTER: LEVEL SCALING BREAKPOINT," below. "FILTER: LEVEL SCALING OFFSET," page 65.

## FILTER: RATE SCALING

```

| FL1\R.Scale  EL1
|              =+Z
|

```

**Summary:** Allows the overall cutoff envelope generator rate for the selected filter to be varied across the entire pitch range (i.e. keyboard range). This function is only available if the "Mode" parameter (page 63) is set to "EG" or "EGVA."

**Settings:** 7 ... +7

**Procedure:** Use the [DATA ENTRY] control or [+1/YES] and [-1/NO] keys to set the desired degree of rate scaling.

The filter 1 or filter 2 envelope generator can be selected by holding the [SELECT] key and pressing the [EXIT/FIL1] or [ENTER/FIL2] key, respectively.

**Details:** Plus ("+") settings produce a longer overall envelope time for the low notes and a shorter envelope time for the high notes. The maximum "+7" setting produces the greatest envelope length variation across the pitch range. Minus ("-") settings produce the opposite effect --- a shorter low-note envelope and longer high-note envelope. A setting of "+0" results in no envelope length variation.

**Refer to:** "FILTER: CUTOFF ENVELOPE GENERATOR," page 63.

## FILTER: LEVEL SCALING BREAKPOINT

```

| FL1\LS BP1  EL1
|  C1  G2  E4  G6
|

```

**Summary:** Allows four separate cutoff envelope generator level-scaling breakpoints to be set at any notes between C-2 and G8 for the selected filter.

**Settings:** C-2 ... G8

**Procedure:** Use the < and > cursor keys to select the desired breakpoint (BP1, BP2, BP3 and BP4, from left to right), then use the [DATA ENTRY] control or [+1/YES] and [-1/NO] keys to set the breakpoint note.

The filter 1 or filter 2 envelope generator can be selected by holding the [SELECT] key

and pressing the [EXIT/FIL1] or [ENTER/FIL2] key, respectively.

The breakpoint can also be set by pressing the [ENTER] key --- "KBD" will flash on the display --- and then the key on your keyboard corresponding to the desired breakpoint.

**Details:** Level scale offset values are applied to each of the breakpoints using the LEVEL SCALE OFFSET function described below. Natural filter level variations can thereby be produced across the range of the controlling keyboard.

**Refer to:** "FILTER: LEVEL SCALING OFFSET" on page 65. "FILTER: CUTOFF ENVELOPE GENERATOR," page 63.

## FILTER: LEVEL SCALING OFFSET

```

FL1\N5 OFS1 EL1
  +0  +0  +0  +0
  
```

**Summary:** Sets the amount of level offset for each of the four level-scaling breakpoints set in the "FILTER: LEVEL SCALING BREAKPOINT" function described above.

**Settings:** -127 ... +127

**Procedure:** Use the  $\leftarrow$  and  $\rightarrow$  cursor keys to select the desired offset parameter (OFS1, OFS2, OFS3 and OFS4, from left to right), then use the [DATA ENTRY] control or [+1/YES] and [-1/NO] keys to set the level-scaling offset for the corresponding breakpoint.

The filter 1 or filter 2 envelope generator can be selected by holding the [SELECT] key and pressing the [EXIT/FIL1] or [ENTER/FIL2] key, respectively.

**Details:** Negative values reduce the level, and positive values increase the level at the corresponding breakpoint. No matter what value is chosen, the EG level will never exceed its maximum of 63.

When different offsets are set for adjacent breakpoints, the level varies accordingly and smoothly between the breakpoints.

**Refer to:** "FILTER: LEVEL SCALING BREAKPOINT" on page 64. "FILTER: CUTOFF ENVELOPE GENERATOR," page 63.

## FILTER: RESONANCE/VELOCITY SENSITIVITY/MODULATION SENSITIVITY

### ● Resonance

```

FL\Resonance EL1
  @  +6  +3
  
```

**Summary:** Determines the degree of resonance of filter 1 and filter 2.

**Settings:** 0 ... 99

**Procedure:** If the Resonance parameter is not already selected, use the  $\leftarrow$  and  $\rightarrow$  cursor keys to select it. Use the [DATA ENTRY] control or [+1/YES] and [-1/NO] keys to select the desired degree of resonance.

**Details:** This parameter has a similar effect to the "resonance" settings on traditional analog synthesizer filters -- i.e. it determines the height of a peak in the filter response at the cutoff frequency.

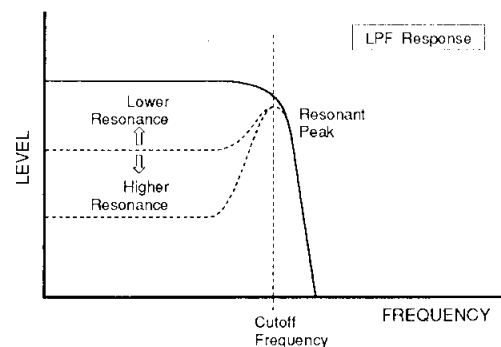

Higher resonance values produce a higher resonant peak and reduce the overall passband level.

**Refer to:** Tutorial, page 27, 35. "FILTER: TYPE/CUTOFF/MODE," page 61.

---

## ● Velocity Sensitivity

```
FL\Vel.Sens  EL1
           0  +6  +3
```

**Summary:** Determines how the filter 1 and filter 2 cutoff frequencies change in response to velocity changes (e.g. keyboard dynamics).

**Settings:** -7 ... +7

**Procedure:** Use the ◀ and ▶ cursor keys to select the Velocity Sensitivity (“Vel.Sens” on upper LCD line) parameter. Use the [DATA ENTRY] control or [+1/YES] and [-1/NO] keys to select the required degree of velocity sensitivity.

**Details:** Plus “+” settings produce higher cutoff frequencies in response to higher velocity values — i.e. the harder a key is played, the higher the cutoff frequency. The maximum setting of “+7” produces the maximum level variation in response to velocity changes. Minus “-” settings produce the opposite effect: lower cutoff in response to higher velocity. A setting of “+0” results in no cutoff variation.

**Refer to:** “FILTER: TYPE/CUTOFF/MODE,” page 61.

---

## ● Modulation Sensitivity

```
FL\Mod.Sens  EL1
           0  +6  +3
```

**Summary:** Determines the sensitivity of the filter 1 and filter 2 cutoff frequency to modulation applied via the LFO and appropriate controllers.

**Settings:** -7 ... +7

**Procedure:** Use the ◀ and ▶ cursor keys to select the Modulation Sensitivity parameter (“Mod.Sens”). Use the [DATA ENTRY] control or [+1/YES] and [-1/NO] keys to set the required degree of modulation sensitivity.

**Details:**

Plus “+” settings produce higher cutoff frequencies in response to modulation — i.e. the greater the modulation, the higher the cutoff frequency.

The maximum setting of “+7” produces the maximum cutoff variation in response to modulation. Minus “-” settings produce the opposite effect: lower cutoff in response to modulation. A setting of “+0” results in no cutoff modulation.

When setting up the low-frequency oscillator or a controller to apply cutoff modulation, this parameter must be set to a value **other than “0”** for pitch modulation to take place.

**Refer to:** “LOW FREQUENCY OSCILLATOR (LFO) WAVEFORM/SPEED/DELAY/PHASE” on page 57. “LOW FREQUENCY OSCILLATOR MODULATION DEPTH, AMPLITUDE/PITCH/CUTOFF” on page 58. “CONTROLLER” functions from page 69 to page 72.



ELEMENT INITIALIZE



**Summary:** Initializes all parameters of the active element.

**Settings:** None

**Procedure:** After selecting the "ELEMENT Initialize" display, press the [ENTER] key. "Sure?" will appear on the upper line of the display. Press the [+1/YES] to initialize or [-1/NO] to cancel the initialize operation.

"Completed!" will appear briefly when the initialization is finished.

**Details:** When Element Initialize is executed, the element parameters are initialized to the following values:

The element initialize function is useful if you want to begin programming an element "from scratch."

**Refer to:** "VOICE INITIALIZE," page 78.

Functions	Initialized Values			
AWM wave selection	P46 (Tri)			
Volume	127			
Note shift	+0			
Detune	+0			
Low note limit	C-2			
High note limit	G8			
Low velocity limit	1			
High velocity limit	127			
Panning	+0			
Effect balance	0			
Oscillator mode/note/tune	Mode norm	Note —	Tune +0	
AEG mode/level/rate	Mode nrm	R1 63	R2 63	L2 63
	R3 63	L3 63	R4 0	RR 63
AEG rate scaling	+0			
AEG level scale breakpoint	BP1 C1	BP2 G2	BP3 E4	BP4 C6
AEG level scale offset	OFS1 +0	OFS2 +0	OFS3 +0	OFS4 +0
Sensitivity	Velocity +0	V. rate off	AMS +0	PMS 3
LFO waveform/speed/delay/phase	Wave tri	Speed 65	Delay 0	Phase 0
LFO modulation depth, amplitude/ pitch/cutoff	AMOD 0	PMOD 0	CutoffMOD 0	

Functions	Initialized Values				
PEG level/rate	L0	R1	L1		
	+0	63	+0		
	R2	L2	R3	L3	
	63	+0	63	+0	
	RR	RL			
	63	+0			
PEG sensitivity, range/rate scaling/ velocity	Range	R. scale	Vel. SW		
	2oct	+0	off		
Filter: type/cutoff/mode	Type	Cutoff	Mode		
	THU	127	LFO		
Filter: cutoff envelope generator	L0	R1	L1		
	+0	0	+0		
	R2	L2	R3	L3	
	0	+0	0	+0	
	R4	L4	RR1	RL1	
	0	+0	0	+0	
	RR2	RL2			
	0	+0			
Filter: rate scaling	+0				
Filter: level scaling breakpoint	BP1	BP2	BP3	BP4	
	C1	G2	E4	C6	
Filter: level scaling offset	OFS1	OFS2	OFS3	OFS4	
	+0	+0	+0	+0	
Filter: resonance/velocity sensitivity/ modulation sensitivity	Resonance	Vel. sens	Mod.sens		
	0	+0	+0		

## CONTROLLER: PITCH BEND RANGE

```
CNTL\Pitch Bend
Range = 2
```

**Summary:** Sets the maximum pitch bend range.

**Settings:** 0 ... 12

**Procedure:** Use the [DATA ENTRY] control or [+1/YES] and [-1/NO] keys to set the required pitch bend range.

**Details:** Each increment from “0” to “12” represents a semitone. A setting of “0” produces no pitch

bend. A setting of “12” allows a maximum pitch bend of plus or minus one octave, while a setting of “4” allows a maximum pitch bend of plus or minus a major third.

If the MIDI controller used is a keyboard, pitch bend is normally controlled via its pitch bend wheel.

## CONTROLLER: AFTER TOUCH PITCH BIAS

```
CNTL\AT P.Bias
Range = +0
```

**Summary:** Sets the maximum pitch variation range achievable via after-touch control.

**Settings:** -12 ... +12

**Procedure:** Use the [DATA ENTRY] control or [+1/YES] and [-1/NO] keys to set the required after touch pitch bias range.

**Details:** Each increment represents a semitone. A setting of “0” produces no pitch variation. A setting of “+12” allows a maximum pitch variation of one octave up, while a setting of “-12” allows a maximum pitch variation of one octave down corresponding to after-touch key pressure.

## CONTROLLER: RANDOM PITCH RANGE

```
CNTL\RandomPitch
Range = 0
```

**Summary:** Sets the amount of random pitch variation produced each time a note is played.

**Settings:** 0 ... 7

**Procedure:** Use the [DATA ENTRY] control or [+1/YES] and [-1/NO] keys to set the required random pitch range.

**Details:** When this function is set to a value other than “0,” the pitch changes randomly each time

a note is played. The random pitch change is applied independently to each note in a chord. A setting of “7” produces the greatest amount of random pitch change.

This function is ideal for simulating the sound of instruments like the clavichord, string sections or other ensembles in which the pitch of each note is rarely in perfect tune with the others.

## CONTROLLER: AMPLITUDE MODULATION

```
CNTL\AMOD : ---  
CTL#= 0 RNG= 0
```

**Summary:** Assigns a controller to, and sets the maximum depth of amplitude modulation applied by the LFO.

**Settings:**

CTL# (Control Number) Parameter: 0 ... 120,  
AT

RNG (Range) Parameter: 0 ... 127

**Procedure:** Use the ◀ and ▶ keys to select the “CTL#” or “RNG” parameter, then use the [DATA ENTRY] control or [+1/YES] and [-1/NO] keys to set the selected parameter as required.

**Details:** The “CTL#” parameter corresponds to MIDI control numbers. Standard controller assignments are noted in the upper right-hand corner of the display:

Set the CTL# parameter to the number of the controller with which you intend to control this function.

The RNG parameter can be set to a value between 0 and 127. A setting of “0” produces no change when the assigned controller is operated, while a setting of “127” produces the maximum possible change.

If you assign a breath controller (CTL# 2) to amplitude modulation, for example, the harder you blow into the breath controller, the greater will be the depth of the amplitude modulation produced. Please note that the amplitude modulation sensitivity parameter described on page ?? must be set to an appropriate value before amplitude modulation will function.

**Refer to:** “SENSITIVITY (VELOCITY, AMPLITUDE & PITCH MODULATION),” page 55.

## CONTROLLER: PITCH MODULATION

```
CNTL\PMOD : MOD  
CTL#= 1 RNG= 43
```

**Summary:** Assigns a controller to, and sets the maximum depth of pitch modulation applied by the LFO.

**Settings:**

CTL# (Control Number) Parameter: 0 ... 120,  
AT

RNG (Range) Parameter: 0 ... 127

**Procedure:** Use the ◀ and ▶ keys to select the “CTL#” or “RNG” parameter, then use the [DATA ENTRY] control or [+1/YES] and [-1/NO] keys to set the selected parameter as required.

**Details:** The “CTL#” parameter corresponds to MIDI control numbers. Standard controller assignments are noted in abbreviations shown in the upper right-hand corner of the display:

Set the CTL# parameter to the number of the controller with which you intend to control this function.

The RNG parameter can be set to a value between 0 and 127. A setting of “0” produces no change when the assigned controller is operated, while a setting of “127” produces the maximum possible change.

If you assign the modulation wheel (CTL# 1) to pitch modulation, for example, rolling the modulation wheel away from you will produce deeper pitch modulation. Please note that the pitch modulation sensitivity parameter described on page ?? must be set to an appropriate value before pitch modulation will function.

**Refer to:** “SENSITIVITY (VELOCITY, AMPLITUDE & PITCH MODULATION),” page 55.

## CONTROLLER: CUTOFF MODULATION

```

CNTL\CoffMOD: ---
CTL#= 0 RNG= 0
  
```

**Summary:** Assigns a controller to, and sets the maximum depth of filter cutoff modulation applied by the LFO.

**Settings:**

CTL# (Control Number) Parameter: 0 ... 120, AT

RNG (Range) Parameter: 0 ... 127

**Procedure:** Use the ◀ and ▶ keys to select the "CTL#" or "RNG" parameter, then use the [DATA ENTRY] control or [+1/YES] and [-1/NO] keys to set the selected parameter as required.

**Details:** The "CTL#" parameter corresponds to MIDI control numbers. Standard controller assignments are noted in the upper right-hand corner of the display:

Set the CTL# parameter to the number of the controller with which you intend to control this function.

The RNG parameter can be set to a value between 0 and 127. A setting of "0" produces no change when the assigned controller is operated, while a setting of "127" produces the maximum possible change.

If you assign a foot controller (CTL# 4) to cutoff modulation, for example, pressing forward on the foot controller pedal increases the depth of the cutoff modulation. Please note that the cutoff modulation sensitivity parameter described on page 65 must be set to an appropriate value before cutoff modulation will function.

**Refer to:** "FILTER: RESONANCE/VELOCITY SENSITIVITY/MODULATION SENSITIVITY," page 65.

## CONTROLLER: CUTOFF FREQUENCY CONTROL

```

CNTL\Cutoff : DE
CTL#= 6 RNG=127
  
```

**Summary:** Assigns a controller to, and sets the range of cutoff frequency control.

**Settings:**

CTL# (Control Number) Parameter: 0 ... 120, AT

RNG (Range) Parameter: 0 ... 127

**Procedure:** Use the ◀ and ▶ keys to select the "CTL#" or "RNG" parameter, then use the [DATA ENTRY] control or [+1/YES] and [-1/NO] keys to set the selected parameter as required.

**Details:** The "CTL#" parameter corresponds to MIDI control numbers. Standard controller assignments are noted in the upper right-hand corner of the display:

Set the CTL# parameter to the number of the controller with which you intend to control this function.

The RNG parameter can be set to a value between 0 and 127. A setting of "0" produces no change when the assigned controller is operated, while a setting of "127" produces the maximum possible change.

If you assign a [DATA ENTRY] controller (CTL# 6) to cutoff frequency control, for example, higher [DATA ENTRY] controller settings will result in higher cutoff frequencies. You could assign a foot controller to cutoff frequency control to create wah-wah pedal type effects.

**Refer to:** "FILTER: RESONANCE/VELOCITY SENSITIVITY/MODULATION SENSITIVITY," page 65.

## CONTROLLER: EG BIAS CONTROL

```
CNTL\EG Bias: ---  
CTL#= 0 RNG= 0
```

**Summary:** Assigns a controller to, and sets the range of envelope generator bias control.

**Settings:**

CTL# (Control Number) Parameter: 0 ... 120,  
AT

RNG (Range) Parameter: 0 ... 127

**Procedure:** Use the ◀ and ▶ keys to select the “CTL#” or “RNG” parameter, then use the [DATA ENTRY] control or [+1/YES] and [-1/NO] keys to set the selected parameter as required.

**Details:** The “CTL#” parameter corresponds to MIDI control numbers. Standard controller assignments are noted in the upper right-hand corner of the display:

Set the CTL# parameter to the number of the controller with which you intend to control this function.

The RNG parameter can be set to a value between 0 and 127: A setting of “0” produces no change when the assigned controller is operated, while a setting of “127” produces the maximum possible change.

If you assign a [DATA ENTRY] controller (CTL# 6) to EG bias control, for example, higher [DATA ENTRY] controller settings will result in higher EG levels. You could assign a breath controller to EG bias control to create tonguing and breath effects.

**Refer to:** “AMPLITUDE ENVELOPE GENERATOR (AEG) MODE/LEVEL/RATE,” page 53.

## CONTROLLER: VOLUME CONTROL

```
CNTL\Volume : ---  
CTL#= 0 MIN= 0
```

**Summary:** Assigns a controller to, and sets the range of volume control.

**Settings:**

CTL# (Control Number) Parameter: 0 ... 120,  
AT

MIN (Minimum) Parameter: 0 ... 127

**Procedure:** Use the ◀ and ▶ keys to select the “CTL#” or “MIN” parameter, then use the [DATA ENTRY] control or [+1/YES] and [-1/NO] keys to set the selected parameter as required.

**Details:**

The “CTL#” parameter corresponds to MIDI control numbers. Standard controller assignments are noted in the upper right-hand corner of the display:

Set the CTL# parameter to the number of the controller with which you intend to control this function.

The MIN parameter determines the minimum volume level that can be set using the assigned controller.

Normally the volume control (CTL# 7) will be assigned to this function, but you could assign a foot controller (CTL# 4) instead to allow foot-controlled swells and other expressive dynamics.

## EFFECT: TYPE/OUTPUT LEVEL

## ● Type

```
EF>Type
1:Rev.Hall 100%
```

**Summary:** Selects one of 34 digital effects for the current voice.

**Settings:**

- 1: Rev.Hall (Reverb Hall)
- 2: Rev.Room (Reverb Room)
- 3: RevPlate (Reverb Plate)
- 4: RevChrch (Reverb Church)
- 5: Rev.Club (Reverb Club)
- 6: RevStage (Reverb Stage)
- 7: BathRoom (Reverb Bath Room)
- 8: RevMetal (Reverb Metal)
- 9: Delay (Single Delay)
- 10: DelayL/R (Stereo Delay)
- 11: St.Echo (Stereo Echo)
- 12: Doubler1 (Single Doubler)
- 13: Doubler2 (Stereo Doubler)
- 14: PingPong (Ping Pong Delay)
- 15: Pan Ref. (Pan Reflections)
- 16: EarlyRef (Early Reflections)
- 17: Gate Rev (Gate Reverb)
- 18: Rvs Gate (Reverse Gate)

- 19: FB E/R (Feedback Early Reflections)
- 20: FB Gate (Feedback Gate)
- 21: FB Rvs (Feedback Reverse)
- 22: Dly1&Rev (Delay 1 & Reverb)
- 23: Dly2&Rev (Delay 2 & Reverb)
- 24: Tunnel (Tunnel Reverb)
- 25: Tone 1 (Tone Control 1)
- 26: Dly1&T1 (Delay 1 & Tone Control 1)
- 27: Dly2&T1 (Delay 2 & Tone Control 1)
- 28: Tone 2 (Tone Control 2)
- 29: Dly1&T2 (Delay 1 & Tone Control 2)
- 30: Dly2&T2 (Delay 2 & Tone Control 2)
- 31: Dist&Rev (Distortion & Reverb)
- 32: Dst&Dly1 (Distortion & Delay 1)
- 33: Dst&Dly2 (Distortion & Delay 2)
- 34: Dist. (Distortion)

**Procedure:** If the Type parameter is not already selected, use the < and > cursor keys to select it. Use the [DATA ENTRY] control or [+1/YES] and [-1/NO] keys to select the desired effect.

**Details:** Each effect has three different editable parameters that allow the effect to be "customized" to suit you individual needs.

**Refer to:** "EFFECT: EFFECT PARAMETERS," page 74. Utility mode "EFFECT," page 107.

## ● Output Level

```
EF\Output Level
1:Rev.Hall 100%
```

**Summary:** Sets the level of the selected effect in relation to the direct (no effect) sound.

**Settings:** 0% ... 100%

**Procedure:** Use the < and > cursor keys to select the Output Level parameter. Use the [DATA ENTRY] control or [+1/YES] and [-1/NO] keys to set the desired output level.

**Details:** A setting of "0%" results in no effect, leaving only the "dry" sound of the voice. The maximum setting of "100%" applies the maximum amount of effect.

**Refer to:** Tutorial, page 23.

## EFFECT: EFFECT PARAMETERS

```
EF\Time      :sec  
1.2 thru    50
```

**Summary:** Accesses the individual programmable parameters for the selected effect.

**Settings:** The parameters and settings for each type of effect are different. See “Details” below.

**Procedure:** Use the ◀ and ▶ keys to select the desired parameter, then use the [DATA ENTRY] control or [+1/YES] and [-1/NO] keys to set its value.

**Details:** Brief descriptions of the parameters provided for each effect type are provided below:

### 1 ... 8: Reverb Effects

- **Time:** 0.3 ... 10 seconds  
Sets the amount of time it takes for the reverb sound to decay to an inaudible level.
- **LPF:** 1.25 ... 12 kHz, Thru  
Rolls off (attenuates) the high-frequency content of the reverb signal above the selected frequency. The LPF is OFF when set to THRU.
- **Delay:** 0.1 ... 50 milliseconds  
Sets the delay time before the reverb sound begins.

### 9: Delay

- **Time:** 0.1 ... 300 milliseconds  
Sets the delay time.
- **FB Delay:** 0.1 ... 300 milliseconds  
Determines the amount of time before feedback is applied, and therefore the length of the initial delay before subsequent repeats begin.
- **FB Gain:** 0% ... 99%  
Determines the amount of feedback returned to the input of the effect processor. Higher values produce a greater number of repeats.

### 10: Delay L/R

- **Lch Delay:** 0.1 ... 300 milliseconds  
Sets the delay time of the left channel.
- **Rch Delay:** 0.1 ... 300 milliseconds  
Sets the delay time of the right channel.

- **FB Gain:** 0% ... 99%

Determines the amount of feedback returned to the input of the effect processor. Higher values produce a greater number of repeats.

### 11: Stereo Echo

- **Lch Delay:** 0.1 ... 152 milliseconds  
Sets the delay time of the left channel.
- **Rch Delay:** 0.1 ... 152 milliseconds  
Sets the delay time of the right channel.
- **FB Gain:** 0% ... 99%  
Determines the amount of feedback returned to the input of the effect processor. Higher values produce a greater number of repeats.

### 12: Doubler 1

- **Delay:** 0.1 ... 50 milliseconds  
Sets the doubling delay.
- **HPF:** Thru, 160 ... 1000 Hertz  
Rolls off (attenuates) the low-frequency content of the signal above the set frequency. The HPF is OFF when set to THRU.
- **LPF:** 1.25 ... 12 kilohertz, Thru  
Rolls off (attenuates) the high-frequency content of the signal above the set frequency. The LPF is OFF when set to THRU.

### 13: Doubler 2

- **Lch Delay:** 0.1 ... 50 milliseconds  
Sets the delay time of the left channel.
- **Rch Delay:** 0.1 ... 50 milliseconds  
Sets the delay time of the right channel.
- **LPF:** 1.25 ... 12 kilohertz, Thru  
Rolls off (attenuates) the high-frequency content of the signal above the set frequency. The LPF is OFF when set to THRU.

### 14: Ping Pong Delay

- **Time:** 0.1 ... 152 milliseconds  
Sets the delay time.
- **Pre-delay:** 0.1 ... 152 milliseconds  
Sets an initial delay time before the subsequent repeats begin.
- **FB Gain:** 0% ... 99%  
Determines the amount of feedback returned to the input of the effect processor. Higher values produce a greater number of repeats.



**15: Panned Reflections**

- Room Size: 0.5 ... 3.2  
Sets the separation between reflections. Higher values produce greater separation between reflections, and therefore the effect of a bigger room.
- FB Gain: 0% ... 99%  
Determines the amount of feedback returned to the input of the effect processor. Higher values produce a greater number of reflections.
- Direction: L → R, R → L  
Determines the direction of the pan sweep.

**16: Early Reflections****17: Gate Reverb****18: Reverse Gate**

- Room Size: 0.5 ... 3.2  
Sets the separation between reflections. Higher values produce greater separation between reflections, and therefore the effect of a bigger room.
- LPF: 1.25 ... 12 kilohertz, Thru  
Rolls off (attenuates) the high-frequency content of the signal above the set frequency. The LPF is OFF when set to THRU.
- Delay: 0.1 ... 50 milliseconds  
Sets the delay time before the early reflection sound begins.

**19: Feedback Early Reflections****20: Feedback Gate****21: Feedback Reverse Gate**

- Room Size: 0.5 ... 3.2  
Sets the separation between reflections. Higher values produce greater separation between reflections, and therefore the effect of a bigger room.
- LPF: 1.25 ... 12 kilohertz, Thru  
Rolls off (attenuates) the high-frequency content of the signal above the set frequency. The LPF is OFF when set to THRU.
- FB Gain: 0% ... 99%  
Determines the amount of feedback returned to the input of the effect processor. Higher values produce a greater number of rereflections.

**22: Delay 1 & Reverb****24: Tunnel**

- Time: 0.3 ... 10 seconds  
Sets the amount of time it takes for the reverb sound to decay to an inaudible level.
- Delay: 0.1 ... 152 milliseconds  
Sets the delay time.
- FB Gain: 0% ... 99%  
Determines the amount of feedback returned to the input of the effect processor. Higher values produce a a greater number of delay repeats.

**23: Delay 2 & Reverb**

- Time: 0.3 ... 10 seconds  
Sets the amount of time it takes for the reverb sound to decay to an inaudible level.
- Lch Delay: 0.1 ... 152 milliseconds  
Sets the delay of the left channel.
- Rch Delay: 0.1 ... 152 milliseconds  
Sets the delay of the right channel.

**25: Tone Controls**

- Low: -12 ... +12 dB  
Sets the amount of boost or cut applied to the low frequencies. A setting of "0" produces no boost or cut. Minus values produce cut and plus values produce boost.
- Mid: -12 ... +12 dB  
Sets the amount of boost or cut applied to mid-band frequencies. A setting of "0" produces no boost or cut. Minus values produce cut and plus values produce boost.
- High: -12 ... +12 dB  
Sets the amount of boost or cut applied to the high frequencies. A setting of "0" produces no boost or cut. Minus values produce cut and plus values produce boost.

**26: Delay 1 & Tone 1****27: Delay 2 & Tone 1****29: Delay 1 & Tone 2****30: Delay 2 & Tone 2**

- Brilliance: 0 ... 12  
Determines the brilliance of the sound. Higher values produces a more brilliant, "sharper" sound.
- Delay: 0.1 ... 300 milliseconds  
Sets the delay time.

- **FB Gain:** 0% ... 99%

Determines the amount of feedback returned to the input of the effect processor. Higher values produce a greater number of repeats.

### **28: Tone Controls 2**

- **HPF:** Thru, 160 ... 1000 Hz

Rolls off (attenuates) the low-frequency content of the signal above the set frequency. The HPF is OFF when set to THRU.

- **Mid:** -12 ... +12 dB

Sets the amount of boost or cut applied to mid-band frequencies. A setting of "0" produces no boost or cut. Minus values produce cut and plus values produce boost.

- **LPF:** 1.25 ... 12.0 kilohertz, Thru

Rolls off (attenuates) the high-frequency content of the signal above the set frequency. The LPF is OFF when set to THRU.

### **31: Distortion & Reverb**

- **Time:** 0.3 ... 10 seconds

Sets the amount of time it takes for the reverb sound to decay to an inaudible level.

- **Depth:** 0% ... 100%

Sets the degree of distortion produced. Higher values produce more distortion.

- **Balance:** 0% ... 100%

Sets the amount of reverb in relation to distortion. A setting of "0" produces distortion only, while a setting of "100" produces distortion plus maximum reverb. "50" produces an approximately even balance between the distortion and reverb sound.

### **32: Distortion & Delay 1**

### **33: Distortion & Delay 2**

- **Time:** 0.1 ... 300 milliseconds

Sets the delay time.

- **FB Gain:** 0% ... 99%

Determines the amount of feedback returned to the input of the effect processor. Higher values produce a greater number of repeats.

- **Depth:** 0% ... 100%

Sets the degree of distortion produced. Higher values produce more distortion.

### **34: Distortion**

- **Level:** 0% ... 100%

Sets the degree of distortion produced. Higher values produce more distortion.

- **HPF:** Thru, 160 ... 1000 Hz

Rolls off (attenuates) the low-frequency content of the signal above the set frequency. The HPF is OFF when set to THRU.

- **LPF:** 1.25 ... 12.0 kilohertz, Thru

Rolls off (attenuates) the high-frequency content of the signal above the set frequency. The LPF is OFF when set to THRU.

**Refer to:** "EFFECT: TYPE/OUTPUT LEVEL," page 73. Utility mode "EFFECT," page 107.

## VOICE NAME

```

VOICE Name
  "Grand"

```

**Summary:** Assigns a name of up to 10 characters to the current voice.

**Settings:** The following characters are available for use in voice names:

```

[Space] ! " # $ % & ' ( ) * + , - . / 0 1 2 3 4 5 6 7 8 9 : ; < = > ? @
A B C D E F G H I J K L M N O P Q R S T U V W X Y Z [ \ ] ^ _ `
a b c d e f g h i j k l m n o p q r s t u v w x y z { | } ~ +

```

**Procedure:** Use the < and > cursor keys to place the underline cursor under the character to be changed. Use the [DATA ENTRY] control or [+1/YES] and [-1/NO] keys to select the desired char-

acter. Continue until the entire voice name has been programmed.

**Details:** It's a good idea to give your voices names that make the voice easily identifiable. If you've created a new voice that combines piano and organ waves, for example, you could call it something like "PianOrgan".

**Refer to:** Tutorial, page 36.

## VOICE RECALL

```

VOICE Edit
  Recall

```

**Summary:** Recalls the last voice edited from the TG55 edit buffer.

**Settings:** None

**Procedure:** After selecting the "VOICE Edit Recall" display, press the [ENTER] key. "Sure?" will appear on the upper line of the display. Press the [+1/YES] to initialize or [-1/NO] to cancel the initialize operation.

"Completed!" will appear briefly when the recall operation is finished.

**Details:** Even if you've exited the voice edit mode and called a different voice, this function will recall the last voice edited with all parameters as they were at the time the voice edit mode was exited.

Please note, however, that a compare operation overwrites the recall buffer with the contents of the edit buffer at that time. A recall operation following a compare operation will therefore recall the contents of the edit buffer at the time of the compare operation.

**Refer to:** Tutorial, page 37.

## VOICE INITIALIZE



“Completed!” will appear briefly when the initialization is finished.

**Summary:** Initializes all parameters of the current voice.

**Settings:** None.

**Procedure:** After selecting the “VOICE Initialize” display, press the [ENTER] key. “Sure?” will appear on the upper line of the display. Press the [+1/YES] to initialize or [-1/NO] to cancel the initialize operation.

**Details:** When Voice Initialize is executed, the voice parameters are initialized to the following values:

The voice initialize function is useful if you want to begin programming a voice “from scratch.”

**Refer to:** Tutorial, page 31. “ELEMENT INITIALIZE,” page 67.

Functions	Initialized Values			
Voice mode	1 element			
AWM wave selection	P46 (Tri)			
Total volume	127			
Note shift	+0			
Detune	+0			
Low note limit	C-2			
High note limit	G8			
Low velocity limit	1			
High velocity limit	127			
Panning	+0			
Output assign	str			
Effect balance	0			
Oscillator mode/note/tune	Mode norm	Note —	Tune +0	
AEG mode/level/rate	Mode nrm	R1 63	R2 63	L2 63
		R3 63	R4 0	RR 63
AEG rate scaling	+0			
AEG level scale breakpoint	BP1 C1	BP2 G2	BP3 E4	BP4 C6
AEG level scale offset	OFS1 +0	OFS2 +0	OFS3 +0	OFS4 +0
Sensitivity	Velocity +0	V. rate off	AMS +0	PMS 3
LFO waveform/speed/delay/phase	Wave tri	Speed 65	Delay 0	Phase 0
LFO modulation depth, amplitude/ pitch/cutoff	AMOD 0	PMOD 0	CutoffMOD 0	

Functions	Initialized Values			
PEG level/rate	L0	R1	L1	
	+0	63	+0	
	R2	L2	R3	L3
	63	+0	63	+0
	RR	RL		
	63	+0		
PEG sensitivity, range/rate scaling/ velocity	Range	R. scale	Vel. SW	
	2oct	+0	off	
Filter: type/cutoff/mode	Type	Cutoff	Mode	
	THU	127	LFO	
Filter: cutoff envelope generator	L0	R1	L1	
	+0	0	+0	
	R2	L2	R3	L3
	0	+0	0	+0
	R4	L4	RR1	RL1
	0	+0	0	+0
	RR2	RL2		
	0	+0		
Filter: rate scaling	+0			
Filter: level scaling breakpoint	BP1	BP2	BP3	BP4
	C1	G2	E4	C6
Filter: level scaling offset	OFS1	OFS2	OFS3	OFS4
	+0	+0	+0	+0
Filter: resonance/velocity sensitivity/ modulation sensitivity	Resonance	Vel. sens	Mod.sens	
	0	+0	+0	
Controller: pitch bend range	2			
Controller: after touch pitch bias	+0			
Controller: random pitch range	0			
Controller: amplitude modulation	CTL#	RNG		
	12	64		
Controller: pitch modulation	CTL#	RNG		
	1	64		
Controller: cutoff modulation	CTL#	RNG		
	1	0		
Controller: cutoff frequency control	CTL#	RNG		
	12	0		
Controller: EG bias control	CTL#	RNG		
	2	0		
Controller: volume control	CTL#	MIN		
	14	0		
Effect: type/output level	Type	Output level		
	1	100%		
Effect: time/LPF/delay	Time	LPF	Delay	
	2.6 sec	8.0 kHz	29 ms	
Voice name	INIT VOICE			