

**PORTATONE**  
**PSR-S5000**



***Owner's Manual***

# SPECIAL MESSAGE SECTION

This product utilizes batteries or an external power supply (adapter). DO NOT connect this product to any power supply or adapter other than one described in the manual, on the name plate, or specifically recommended by Yamaha.

This product should be used only with the components supplied or; a cart, rack, or stand that is recommended by Yamaha. If a cart, etc., is used, please observe all safety markings and instructions that accompany the accessory product.

## **SPECIFICATIONS SUBJECT TO CHANGE:**

The information contained in this manual is believed to be correct at the time of printing. However, Yamaha reserves the right to change or modify any of the specifications without notice or obligation to update existing units.

This product, either alone or in combination with an amplifier and headphones or speaker/s, may be capable of producing sound levels that could cause permanent hearing loss. DO NOT operate for long periods of time at a high volume level or at a level that is uncomfortable. If you experience any hearing loss or ringing in the ears, you should consult an audiologist.

**IMPORTANT:** The louder the sound, the shorter the time period before damage occurs.

## **NOTICE:**

Service charges incurred due to a lack of knowledge relating to how a function or effect works (when the unit is operating as designed) are not covered by the manufacturer's warranty, and are therefore the owners responsibility. Please study this manual carefully and consult your dealer before requesting service.

## **ENVIRONMENTAL ISSUES:**

Yamaha strives to produce products that are both user safe and environmentally friendly. We sincerely believe that our products and the production methods used to produce them, meet these goals. In keeping with both the letter and the spirit of the law, we want you to be aware of the following:

## **Battery Notice:**

This product MAY contain a small non-rechargeable battery which (if applicable) is soldered in place. The average life span of this type of battery is approximately five years. When replacement becomes necessary, contact a qualified service representative to perform the replacement.

This product may also use "household" type batteries. Some of these may be rechargeable. Make sure that the battery being charged is a rechargeable type and that the charger is intended for the battery being charged.

When installing batteries, do not mix batteries with new, or with batteries of a different type. Batteries MUST be installed correctly. Mismatches or incorrect installation may result in overheating and battery case rupture.

## **Warning:**

Do not attempt to disassemble, or incinerate any battery. Keep all batteries away from children. Dispose of used batteries promptly and as regulated by the laws in your area. Note: Check with any retailer of household type batteries in your area for battery disposal information.

## **Disposal Notice:**

Should this product become damaged beyond repair, or for some reason its useful life is considered to be at an end, please observe all local, state, and federal regulations that relate to the disposal of products that contain lead, batteries, plastics, etc. If your dealer is unable to assist you, please contact Yamaha directly.

## **NAME PLATE LOCATION:**

The name plate is located on the bottom of the product. The model number, serial number, power requirements, etc., are located on this plate. You should record the model number, serial number, and the date of purchase in the spaces provided below and retain this manual as a permanent record of your purchase.

**Model**

---

**Serial No.**

---

**Purchase Date**

---

# PLEASE KEEP THIS MANUAL

92-BP (bottom)

# FCC INFORMATION (U.S.A.)

## 1. IMPORTANT NOTICE: DO NOT MODIFY THIS UNIT!

This product, when installed as indicated in the instructions contained in this manual, meets FCC requirements. Modifications not expressly approved by Yamaha may void your authority, granted by the FCC, to use the product.

**2. IMPORTANT:** When connecting this product to accessories and/or another product use only high quality shielded cables. Cable/s supplied with this product **MUST** be used. Follow all installation instructions. Failure to follow instructions could void your FCC authorization to use this product in the USA.

**3. NOTE:** This product has been tested and found to comply with the requirements listed in FCC Regulations, Part 15 for Class "B" digital devices. Compliance with these requirements provides a reasonable level of assurance that your use of this product in a residential environment will not result in harmful interference with other electronic devices. This equipment generates/uses radio frequencies and, if not installed and used according to the instructions found in the users manual, may cause interference harmful to the operation of other electronic devices. Compliance with FCC regulations does

not guarantee that interference will not occur in all installations. If this product is found to be the source of interference, which can be determined by turning the unit "OFF" and "ON", please try to eliminate the problem by using one of the following measures:

Relocate either this product or the device that is being affected by the interference.

Utilize power outlets that are on different branch (circuit breaker or fuse) circuits or install AC line filter/s.

In the case of radio or TV interference, relocate/reorient the antenna. If the antenna lead-in is 300 ohm ribbon lead, change the lead-in to co-axial type cable.

If these corrective measures do not produce satisfactory results, please contact the local retailer authorized to distribute this type of product. If you can not locate the appropriate retailer, please contact Yamaha Corporation of America, Electronic Service Division, 6600 Orangethorpe Ave, Buena Park, CA90620

The above statements apply **ONLY** to those products distributed by Yamaha Corporation of America or its subsidiaries.

\* This applies only to products distributed by YAMAHA CORPORATION OF AMERICA.

(class B)

## OBSERVERA!

Apparaten kopplas inte ur växelströmskällan (nätet) så länge som den är ansluten till vägguttaget, även om själva apparaten har stängts av.

**ADVARSEL:** Netspændingen til dette apparat er IKKE afbrudt, så længe netledningen sidder i en stikkontakt, som er t endt — også selvom der er slukket på apparatets afbryder.

**VAROITUS:** Laitteen toisiopiiriin kytketty käyttökytkin ei irroita koko laitetta verkosta.

(standby)

This product contains a high intensity lamp that contains a small amount of mercury. Disposal of this material may be regulated due to environmental considerations. For disposal information in the United States, refer to the Electronic Industries Alliance web site: [www.eiae.org](http://www.eiae.org)

\* This applies only to products distributed by YAMAHA CORPORATION OF AMERICA.

(mercury)

## COMPLIANCE INFORMATION STATEMENT (DECLARATION OF CONFORMITY PROCEDURE)

Responsible Party : Yamaha Corporation of America

Address : 6600 Orangethorpe Ave., Buena Park, Calif.  
90620

Telephone : 714-522-9011

Type of Equipment : Electronic Keyboard

Model Name : PSR-S500

This device complies with Part 15 of the FCC Rules.

Operation is subject to the following conditions:

- 1) this device may not cause harmful interference, and
- 2) this device must accept any interference received including interference that may cause undesired operation.

See user manual instructions if interference to radio reception is suspected.

\* This applies only to products distributed by YAMAHA CORPORATION OF AMERICA.

(FCC DoC)

## IMPORTANT NOTICE FOR THE UNITED KINGDOM Connecting the Plug and Cord

**IMPORTANT.** The wires in this mains lead are coloured in accordance with the following code:

BLUE : NEUTRAL

BROWN : LIVE

As the colours of the wires in the mains lead of this apparatus may not correspond with the coloured markings identifying the terminals in your plug proceed as follows:

The wire which is coloured BLUE must be connected to the terminal which is marked with the letter N or coloured BLACK.

The wire which is coloured BROWN must be connected to the terminal which is marked with the letter L or coloured RED.

Making sure that neither core is connected to the earth terminal of the three pin plug.

\* This applies only to products distributed by Yamaha-Kemble Music (U.K.) Ltd.

(2 wires)

# PRECAUTIONS

## PLEASE READ CAREFULLY BEFORE PROCEEDING

\* Please keep this manual in a safe place for future reference.



### WARNING

Always follow the basic precautions listed below to avoid the possibility of serious injury or even death from electrical shock, short-circuiting, damages, fire or other hazards. These precautions include, but are not limited to, the following:

#### Power supply/AC power adaptor

- Only use the voltage specified as correct for the instrument. The required voltage is printed on the name plate of the instrument.
- Use the specified adaptor (PA-300, PA-301 or an equivalent recommended by Yamaha) only. Using the wrong adaptor can result in damage to the instrument or overheating.
- Check the electric plug periodically and remove any dirt or dust which may have accumulated on it.
- Do not place the AC adaptor cord near heat sources such as heaters or radiators, and do not excessively bend or otherwise damage the cord, place heavy objects on it, or place it in a position where anyone could walk on, trip over, or roll anything over it.

#### Do not open

- Do not open the instrument or attempt to disassemble the internal parts or modify them in any way. The instrument contains no user-serviceable parts. If it should appear to be malfunctioning, discontinue use immediately and have it inspected by qualified Yamaha service personnel.

#### Water warning

- Do not expose the instrument to rain, use it near water or in damp or wet conditions, or place containers on it containing liquids which might spill into any openings.
- Never insert or remove an electric plug with wet hands.

#### Fire warning

- Do not put burning items, such as candles, on the unit. A burning item may fall over and cause a fire.

#### If you notice any abnormality

- If the AC adaptor cord or plug becomes frayed or damaged, or if there is a sudden loss of sound during use of the instrument, or if any unusual smells or smoke should appear to be caused by it, immediately turn off the power switch, disconnect the adaptor plug from the outlet, and have the instrument inspected by qualified Yamaha service personnel.



### CAUTION

Always follow the basic precautions listed below to avoid the possibility of physical injury to you or others, or damage to the instrument or other property. These precautions include, but are not limited to, the following:

#### Power supply/AC power adaptor

- When removing the electric plug from the instrument or an outlet, always hold the plug itself and not the cord.
- Unplug the AC power adaptor when not using the instrument, or during electrical storms.
- Do not connect the instrument to an electrical outlet using a multiple-connector. Doing so can result in lower sound quality, or possibly cause overheating in the outlet.

#### Location

- Do not expose the instrument to excessive dust or vibrations, or extreme cold or heat (such as in direct sunlight, near a heater, or in a car during the day) to prevent the possibility of panel discoloration or damage to the internal components.
- Do not use the instrument in the vicinity of a TV, radio, stereo equipment, mobile phone, or other electric devices. Otherwise, the instrument, TV, or radio may generate noise.

- Do not place the instrument in an unstable position where it might accidentally fall over.
- Before moving the instrument, remove all connected adaptor and other cables.
- When setting up the product, make sure that the AC outlet you are using is easily accessible. If some trouble or malfunction occurs, immediately turn off the power switch and disconnect the plug from the outlet. Even when the power switch is turned off, electricity is still flowing to the product at the minimum level. When you are not using the product for a long time, make sure to unplug the power cord from the wall AC outlet.
- Use only the stand specified for the instrument. When attaching the stand or rack, use the provided screws only. Failure to do so could cause damage to the internal components or result in the instrument falling over.

## Connections

- Before connecting the instrument to other electronic components, turn off the power for all components. Before turning the power on or off for all components, set all volume levels to minimum. Also, be sure to set the volumes of all components at their minimum levels and gradually raise the volume controls while playing the instrument to set the desired listening level.

## Maintenance

- When cleaning the instrument, use a soft, dry cloth. Do not use paint thinners, solvents, cleaning fluids, or chemical-impregnated wiping cloths.

## Handling caution

- Never insert or drop paper, metallic, or other objects into the gaps on the panel or keyboard. If this happens, turn off the power immediately and unplug the power cord from the AC outlet. Then have the instrument inspected by qualified Yamaha service personnel.
- Do not place vinyl, plastic or rubber objects on the instrument, since this might discolor the panel or keyboard.
- Do not rest your weight on, or place heavy objects on the instrument, and do not use excessive force on the buttons, switches or connectors.

- Do not use the instrument/device or headphones for a long period of time at a high or uncomfortable volume level, since this can cause permanent hearing loss. If you experience any hearing loss or ringing in the ears, consult a physician.

## Saving data

### Saving and backing up your data

- The panel settings and some other types of data are not retained in memory when you turn off the power to the instrument. Save data you want to keep to the Registration Memory (page 67.)  
Saved data may be lost due to malfunction or incorrect operation.  
Save important data to a USB storage device/or other external device such as a computer. (pages 76, 87)

### Backing up the USB storage device/external media

- To protect against data loss through media damage, we recommend that you save your important data onto two USB storage devices/external media.

Yamaha cannot be held responsible for damage caused by improper use or modifications to the instrument, or data that is lost or destroyed.

Always turn the power off when the instrument is not in use.

Even when the power switch is in the "STANDBY" position, electricity is still flowing to the instrument at the minimum level. When you are not using the instrument for a long time, make sure you unplug the AC power adaptor from the wall AC outlet.

The illustrations and LCD screens as shown in this owner's manual are for instructional purposes only, and may appear somewhat different from those on your instrument.

## ● Trademarks

- The bitmap fonts used in this instrument have been provided by and are the property of Ricoh Co., Ltd.
- Windows is the registered trademarks of Microsoft® Corporation.
- The company names and product names in this Owner's Manual are the trademarks or registered trademarks of their respective companies.

This product incorporates and bundles computer programs and contents in which Yamaha owns copyrights or with respect to which it has license to use others' copyrights. Such copyrighted materials include, without limitation, all computer software, style files, MIDI files, WAVE data, musical scores and sound recordings. Any unauthorized use of such programs and contents outside of personal use is not permitted under relevant laws. Any violation of copyright has legal consequences. **DON'T MAKE, DISTRIBUTE OR USE ILLEGAL COPIES.**

Copying of the commercially available musical data including but not limited to MIDI data and/or audio data is strictly prohibited except for your personal use.

## Logos



### GM System Level 1

“GM System Level 1” is an addition to the MIDI standard which ensures that any GM-compatible music data can be accurately played by any GM-compatible tone generator, regardless of manufacturer. The GM mark is affixed to all software and hardware products that support GM System Level.



### XGlite

As its name implies, “XGlite” is a simplified version of Yamaha’s high-quality XG tone generation format. Naturally, you can play back any XG song data using an XGlite tone generator. However, keep in mind that some songs may play back differently compared to the original data, due to the reduced set of control parameters and effects.



### XF

The Yamaha XF format enhances the SMF (Standard MIDI File) standard with greater functionality and open-ended expandability for the future. The instrument is capable of displaying lyrics when an XF file containing lyric data is played.



### STYLE FILE

The Style File Format is Yamaha’s original style file format which uses a unique conversion system to provide high-quality automatic accompaniment based on a wide range of chord types.



### USB

USB is an abbreviation for Universal Serial Bus. It is a serial interface for connecting a computer with peripheral Devices. It allows “hot swapping” (connecting peripheral devices while the power to the computer is on).

***Congratulations and thank you for purchasing the Yamaha PSR-S500 PortaTone!***

***Please read this owner's manual carefully before using the instrument in order to take full advantage of its various features.***

***Make sure to keep this manual in a safe and handy place even after you finish reading, and refer to it often when you need to better understand an operation or function.***

## **Accessories**

The instrument package includes the following items. Please check that you have them all.

- Music rest
- Accessory CD-ROM
- Owner's manual (this book)
- AC Power Adaptor (May not be included depending on your particular area. Please check with your Yamaha dealer.)

# Special Features of the PSR-S500

## ■ Play a Variety of Instrument Voices ▶ Page 17

The instrument voice that sounds when you play the keyboard can be changed to violin, flute, harp, or any of an extensive range of voices. You can change the mood of a song written for piano, for example, by using violin to play it instead. Experience a whole new world of musical variety.



## ■ Save and Recall Panel Settings to Registration Memory ▶ Page 67

This convenient function lets you save a 'snapshot' of your custom panel settings—up to 64 complete “Registrations.” These can be called up instantly any time you need them—perfect for making broad sound/effect changes when playing live!

8 banks x 8 presets = 64 Registrations

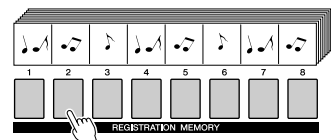

## ■ Play Along with Styles ▶ Page 23

Want to play with full accompaniment? Try the auto-accompaniment Styles. The accompaniment styles provide the equivalent of a full backing band covering wide variety of styles from waltzes to 8-beat to samba ... and much more. Select a style that matches the music you want to play, or experiment with new styles to expand your musical horizons.

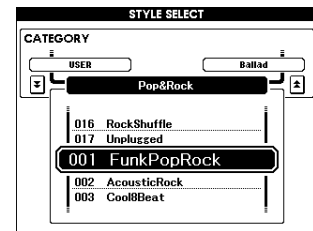

## ■ Easy Performance with Music Notation Display ▶ Page 30

When you play back a song, the corresponding score will be shown on the display as the song plays. This is a great way to learn how to read music. If the song contains lyric and chord data\*, the lyrics and chords will also appear on the score display.

\* No lyrics or chords will appear on the display if the song you are using with the score display function does not contain the appropriate lyric and chord data.

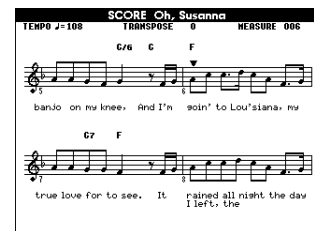

## ■ Save and Load Data to USB Flash Memory or Computer ▶ Pages 73 and 83

These data organization tools let you store your original User songs or custom panel settings (Registration Memory) to a USB Flash Memory device or a computer, then load the data back to the instrument as needed.

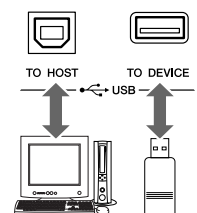



# Contents

Logos.....	6
Accessories .....	7
Special Features of the PSR-S500 .....	8
<b>Setting Up</b> .....	<b>10</b>
Power Requirements.....	10
Connecting Headphones (PHONES/OUTPUT Jack) .....	10
Connecting a Footswitch (SUSTAIN Jack).....	10
Connecting to a Computer (USB Terminal).....	11
Turning the Power On .....	11
Changing the Display language .....	12
Adjusting the LCD CONTRAST control.....	12
<b>Panel Controls and Terminals</b> .....	<b>14</b>
Front Panel.....	14
Rear Panel .....	15
<b>Quick Guide</b>	
<b>Playing Songs</b> .....	<b>16</b>
<b>Try playing a variety of Instrument Voices</b> .....	<b>17</b>
Select and Play a Voice .....	17
Playing Two Voices Simultaneously—DUAL.....	18
Playing Different Voices with the Left and Right Hands —LEFT .....	19
Playing Drum Kits.....	21
<b>Playing Styles</b> .....	<b>22</b>
Select a Styles Rhythm .....	22
Playing Along with a Style .....	23
Playing Auto-accompaniment Chords .....	25
<b>Playing with the Music Database</b> .....	<b>26</b>
<b>Using Songs</b> .....	<b>27</b>
Selecting and Listening to a Song.....	27
Song Fast Forward, Fast Reverse, and Pause .....	28
Types of Songs .....	29
Displaying the Song Score .....	30
Displaying the Lyrics.....	31
<b>Recording Your Own Performance</b> .....	<b>32</b>
Track Configuration .....	32
Quick Recording Procedure .....	33
Multi-track Recording Procedure.....	34
Song Clear—Deleting User Songs.....	37
Track Clear—Deleting a Specified Track From a User Song.....	38
<b>Backup and Initialization</b> .....	<b>39</b>
Backup .....	39
Initialization.....	39
<b>Basic Operation and Displays</b> .....	<b>40</b>
Basic Operation.....	40
The Displays.....	42
MAIN Display Items.....	43
<b>Reference</b>	
<b>Playing with the Effects</b> .....	<b>44</b>
Adding Harmony.....	44
Changing the Reverb Type .....	45
Changing the Chorus Type .....	46
Panel Sustain .....	47
Adding DSP .....	47
Pitch Bend .....	48

<b>Using Various Functions</b> .....	<b>49</b>
Playing with the metronome .....	49
Using Tap Start.....	51
Touch Response .....	51
EQ settings .....	52
Pitch Controls .....	53
Changing the pitch of the instrument in octaves.....	54
<b>Style (Auto Accompaniment) Functions</b> .....	<b>55</b>
Pattern Variation (sections) .....	55
One Touch Setting.....	58
Variation Change and OTS (OTS LINK).....	58
Setting the Split Point .....	59
Playing a Style with Chords but without Rhythm (Stop Accompaniment) .....	60
Adjusting the Style Volume.....	60
Chord Basics .....	61
User Style .....	63
Playing Styles Using the Entire Keyboard .....	63
<b>Song Settings</b> .....	<b>64</b>
Song Volumes .....	64
Changing the Tempo .....	64
A-B Repeat .....	65
Muting Independent Song Parts .....	66
<b>Memorize Your Favorite Panel Settings</b> .....	<b>67</b>
Saving to the Registration Memory .....	67
Recalling a Registration Memory.....	68
Registration Clear—Deleting a Specified Registration Memory.....	69
<b>The Functions</b> .....	<b>70</b>
Selecting and Setting Functions .....	70
<b>Using USB Flash Memory</b> .....	<b>73</b>
USB Flash Memory .....	73
Using USB Flash Memory .....	74
Formatting USB Flash Memory .....	75
Saving Data .....	76
Convert a User Song to SMF Format and Save.....	77
Loading User Files and Style Files .....	78
Deleting Data from USB Flash Memory .....	79
Playing Songs Saved to USB Flash Memory .....	79
<b>Connections</b> .....	<b>80</b>
Connectors .....	80
Connection to a USB Storage Device .....	80
Connecting a Personal Computer .....	82
Transferring Performance Data to and from a Computer .....	83
Initial Send.....	84
Transferring Data Between the Computer and Instrument.....	85
<b>Accessory CD-ROM Installation Guide</b> .....	<b>88</b>
Important Notices about the CD-ROM.....	88
CD-ROM Contents .....	89
System Requirements .....	90
Software Installation .....	90
<b>Appendix</b>	
Troubleshooting.....	95
Messages .....	96
Voice List.....	98
Drum Kit List.....	104
Style List.....	107
Music Database List .....	108
Effect Type List.....	110
MIDI Implementation Chart.....	114
MIDI Data Format .....	116
Specifications .....	117
Index.....	118



# Setting Up

Be sure to do the following operations **BEFORE** turning on the power.

## Power Requirements

- 1 Make sure that the [STANDBY/ON] switch of the instrument is set to STANDBY.

### ⚠ WARNING

- Use **ONLY** a Yamaha PA-300 or PA-301 AC Power Adaptor (or other adaptor specifically recommended by Yamaha) to power your instrument from the AC mains. The use of other adaptors may result in irreparable damage to both the adaptor and the instrument.

- 2 Connect the AC adaptor (PA-300, PA-301 or other adaptor specifically recommended by Yamaha) to the power supply jack.

- 3 Plug the AC adaptor into an AC outlet.

### ⚠ CAUTION

- Unplug the AC Power Adaptor when not using the instrument, or during electrical storms.

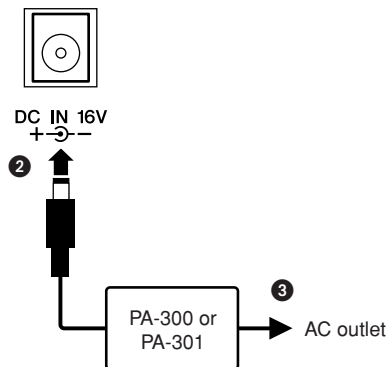

Make all necessary connections below **BEFORE** turning the power on.

## Connecting Headphones (PHONES/OUTPUT Jack)

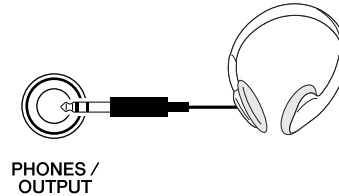

The instrument speakers are automatically shut off when a plug is inserted into this jack. The PHONES/OUTPUT jack also functions as an external output. You can connect the PHONES/OUTPUT jack to a keyboard amplifier, stereo system, mixer, tape recorder, or other line-level audio device to send the instrument's output signal to that device.

### ⚠ WARNING

- Avoid listening with the headphones at high volume for long periods of time; doing so may not only result in ear fatigue, it may be damaging to your hearing.

### ⚠ CAUTION

- To prevent damage to the speakers, set the volume of the external devices at the minimum setting before connecting them. Failure to observe these cautions may result in electric shock or equipment damage. Also, be sure to set the volumes of all devices at their minimum levels and gradually raise the volume controls while playing the instrument to set the desired listening level.

## Connecting a Footswitch (SUSTAIN Jack)

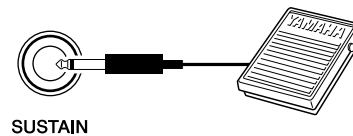

The sustain function lets you produce a natural sustain as you play by pressing a footswitch. Plug the Yamaha FC4 or FC5 footswitch into this jack and use it to switch sustain on and off.

### NOTE

- Make sure that the footswitch plug is properly connected to the SUSTAIN jack before turning on the power.
- Do not press the footswitch while turning the power on. Doing this changes the recognized polarity of the footswitch, resulting in reversed footswitch operation.

## Connecting to a Computer (USB Terminal)

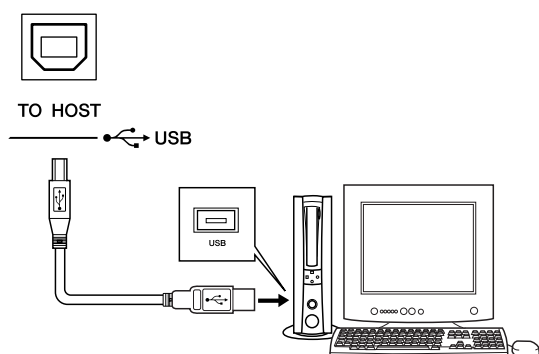

Connect the instrument's USB terminal to the USB terminal of a computer, and you can transfer performance data and song files between the two (page 85). To use the USB data-transfer features you'll need to do the following:

- First, make sure the POWER switch on the instrument is set to OFF, then use a USB cable to connect the instrument to the computer. After making the connections, turn the instrument's power on.
- Install the USB MIDI driver on your computer.

Installation of the USB-MIDI driver is described on page 90.

## Turning the Power On

Turn down the volume by turning the [MASTER VOLUME] control to the left and press the [STANDBY/ON] switch to turn on the power. Press the [STANDBY/ON] switch again to turn the power OFF.

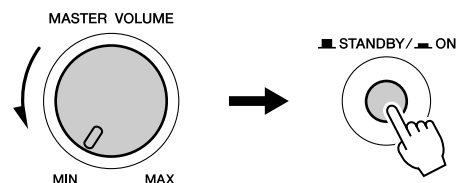

Backup data in the flash memory is loaded to the instrument when the power is turned on. If no backup data exists on flash memory, all instrument settings are restored to the initial factory defaults when the power is turned on.

### **CAUTION**

- Even when the switch is in the "STANDBY" position, electricity is still flowing to the instrument at the minimum level. When you are not using the instrument for a long time, make sure you unplug the AC power adaptor from the wall AC outlet.

### **CAUTION**

- Never attempt to turn the power off when a "Writing.." message is shown in the display. Doing so can damage the flash memory and result in a loss of data.

### Changing the Display language

This instrument allows you to select English or Japanese as the display language. The default display language is English, but if you switch to Japanese the lyrics, file names and some messages will be displayed in Japanese where appropriate.

- 1 Press the [FUNCTION] button.

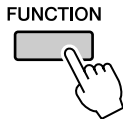

- 2 Press the CATEGORY [▲] and [▼] buttons a number of times until the “Language” item appears. The currently selected display language will appear below the “Language” item.

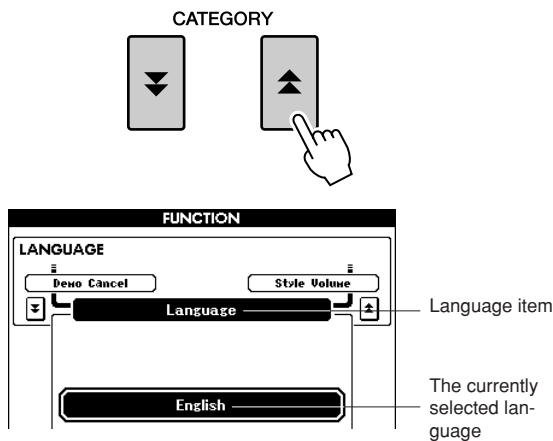

- 3 Select a display language. The [+] button selects English and the [-] button selects Japanese. The language selection will be stored in the internal flash memory so that it is retained even when the power is turned off.



- 4 Press the [EXIT] button to return to the MAIN display.

### Adjusting the LCD CONTRAST control

Adjust the LCD CONTRAST control on the rear panel of the instrument for optimum display legibility.

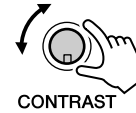

● Music Rest

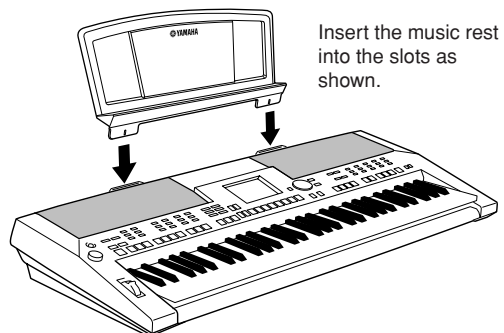



# Panel Controls and Terminals

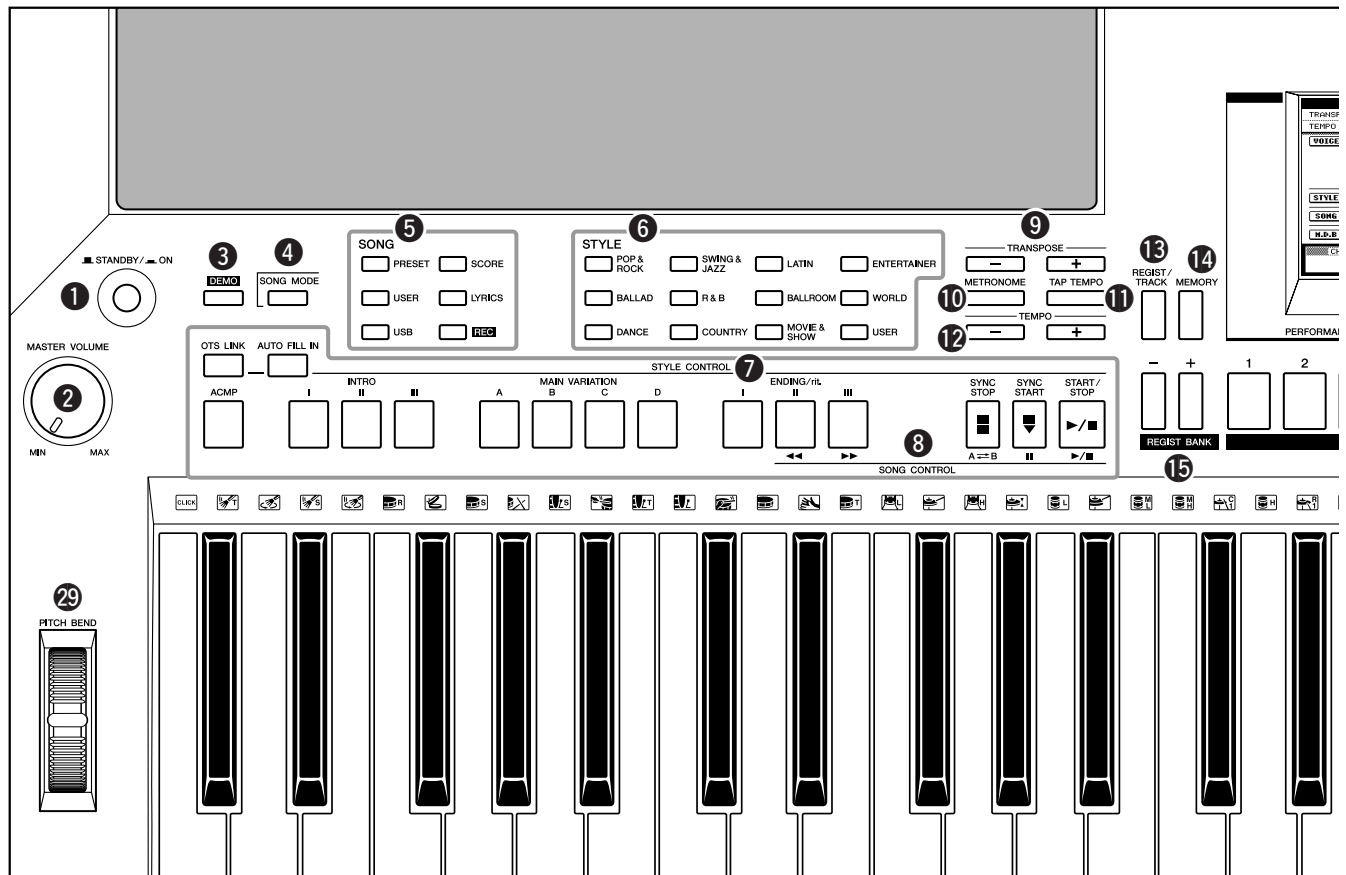

## Front Panel

- ① [STANDBY/ON] switch ..... page 16
- ② [MASTER VOLUME] control.... pages 16, 40
- ③ [DEMO] button ..... page 16
- ④ [SONG MODE] button ..... page 27
- ⑤ SONG
  - [PRESET], [USER], [USB] buttons ..... page 27
  - [SCORE] button ..... page 30
  - [LYRICS] button ..... page 31
  - [REC] button ..... page 33
- ⑥ STYLE ..... page 22
- ⑦ STYLE CONTROL
  - [OTS LINK] button ..... page 58
  - [AUTO FILL IN] button ..... page 55
  - [ACMP] button ..... page 23
  - INTRO [I]–[III] buttons ..... page 55
  - MAIN VARIATION [A]–[D] buttons ..... page 55
  - ENDING/rit. [I]–[III] buttons ..... page 55
  - [SYNC STOP] button ..... page 57
  - [SYNC START] button ..... pages 23, 56
  - [START/STOP] button ..... pages 22, 41

- ⑧ SONG CONTROL
  - [◀◀] button ..... page 28
  - [▶▶] button ..... page 28
  - [A ↔ B] button ..... page 65
  - [||] button ..... page 28
  - [▶/■] button ..... pages 28, 41
- ⑨ TRANSPOSE [+] and [-] buttons .... page 53
- ⑩ [METRONOME] button ..... page 49
- ⑪ [TAP TEMPO] button ..... page 51
- ⑫ TEMPO [+] and [-] buttons ..... page 49
- ⑬ [REGIST/TRACK] button ..... page 66
- ⑭ [MEMORY] button ..... page 67
- ⑮ REGIST BANK [+] and [-] buttons .. page 67
- ⑯ REGISTRATION MEMORY [1]–[8] buttons ..... page 67
- ⑰ Display ..... pages 12, 42
- ⑱ [EXIT] button ..... page 42

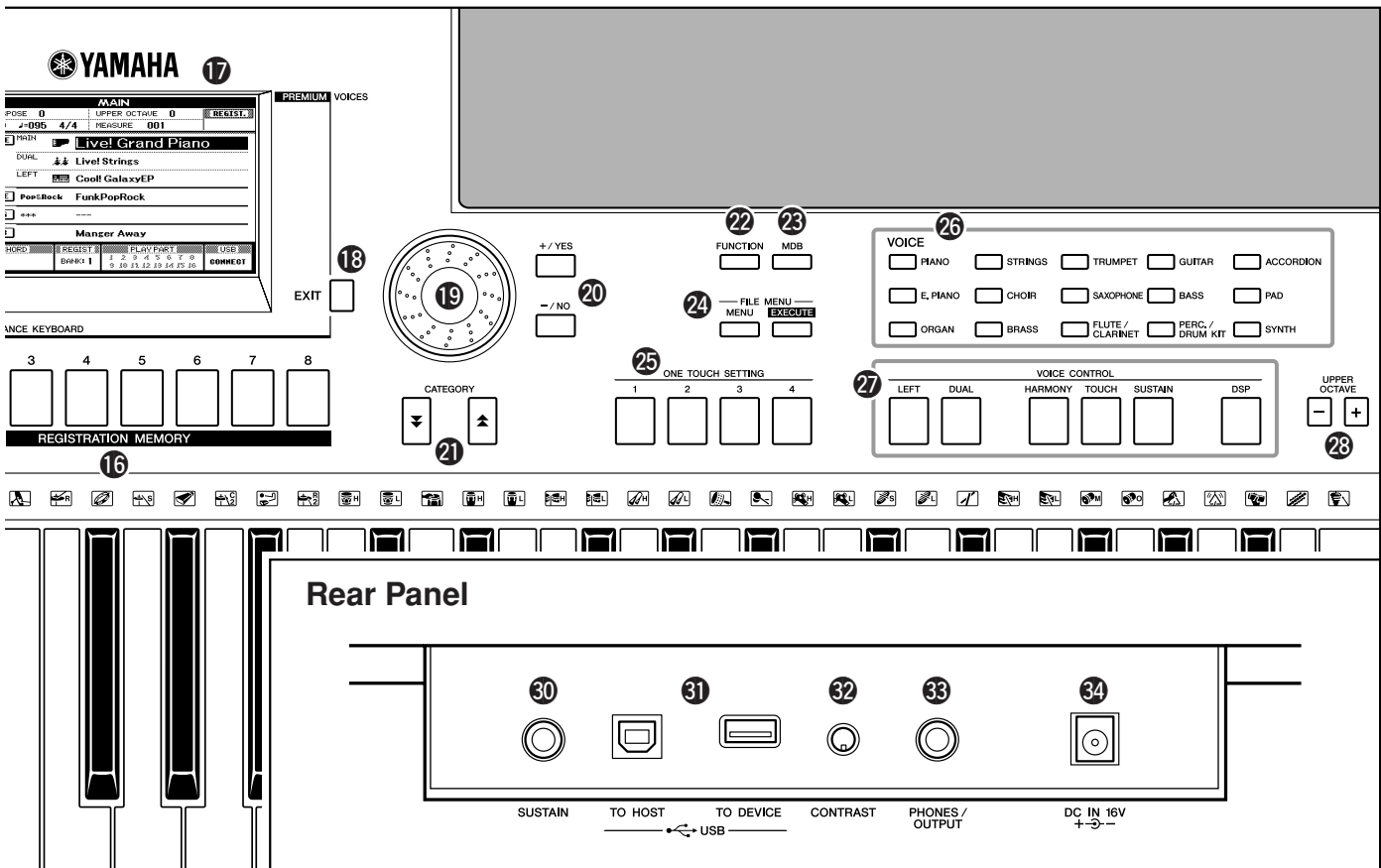

- 19 Dial ..... page 41
- 20 [+ / YES] and [- / NO] buttons ..... page 41
- 21 CATEGORY [▲] and [▼] buttons ... page 41
- 22 [FUNCTION] button ..... page 70
- 23 [MDB] button ..... page 26
- 24 FILE MENU [MENU] and [EXECUTE] buttons ..... pages 74, 75
- 25 ONE TOUCH SETTING [1]–[4] buttons ..... page 58
- 26 VOICE ..... page 17
- 27 VOICE CONTROL
  - [LEFT] button ..... page 19
  - [DUAL] button ..... page 18
  - [HARMONY] button ..... page 44
  - [TOUCH] button ..... page 51
  - [SUSTAIN] button ..... page 47
  - [DSP] button ..... page 47
- 28 UPPER OCTAVE [+] and [-] buttons ..... page 54
- 29 [PITCH BEND] wheel ..... page 48

**Rear Panel**

- 30 SUSTAIN jack ..... page 10
- 31 USB TO HOST and TO DEVICE terminals ..... page 80
- 32 CONTRAST knob ..... page 12
- 33 PHONES/OUTPUT jack ..... page 10
- 34 DC IN 16V jack ..... page 10



# Playing Songs

This instrument include a Demonstration Song. Let's start by playing the Demonstration Song.

## 1 Press the [STANDBY/ON] button until it locks in the ON position.

The Main display appears in the LCD.

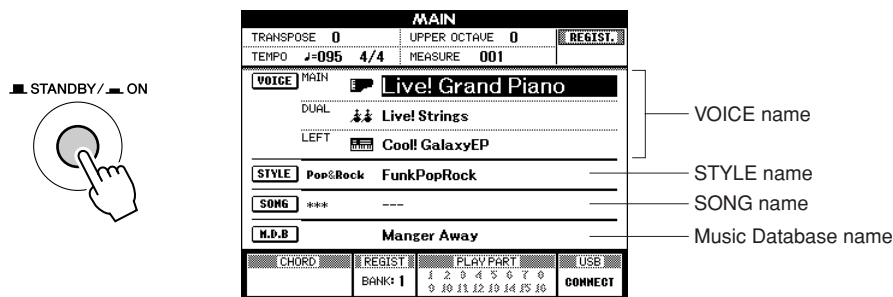

## 2 Press the [DEMO] button to start the Demo.

The Demo display appears in the LCD.

Gradually raise the [MASTER VOLUME] control while playing the instrument to set the desired listening level.

The Demo Song will restart when playback reaches the end.



## 3 Press the [▶/■] button to stop Demo.

Operation automatically returns to the Main display.

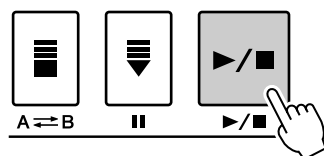

### NOTE

- The [DEMO] button doesn't function when the Demo Cancel function is set to enable. (See page 72.)





# Try playing a variety of Instrument Voices

In addition to piano, organ, and other “standard” keyboard instruments, this instrument has a large range of realistic Voices—including guitar, bass, strings, sax, trumpet, drums and percussion, sound effects, and a wide variety of other musical sounds.

## Select and Play a Voice

In this operation, you’ll select a Main Voice and play it on the keyboard.

### 1 Select and press the desired Voice category button in the Voice section.

The Main Voice selection display will appear.

The currently selected category name, Voice number and name will be highlighted.

For this example, select the “Flute&Clarinet” category.

#### NOTE

- To change the Voice category, press another category button.

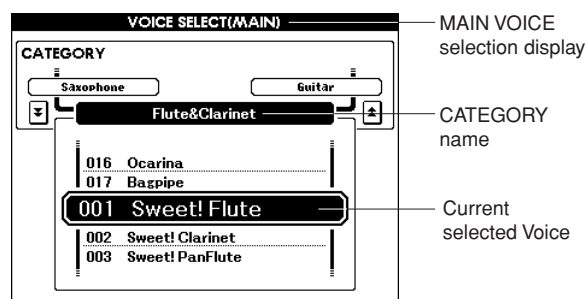
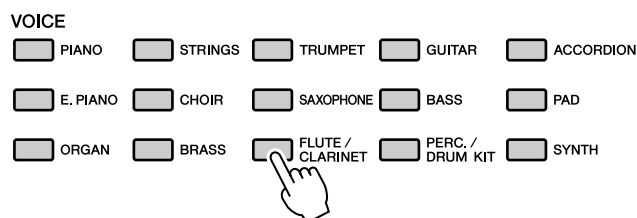

### 2 Select the Voice you want to play.

Look at the highlighted Voice name and rotate the dial. The available Voices will be selected and displayed in sequence. The Voice selected here becomes the Main Voice.

For this example, select the “010 Flute” Voice.

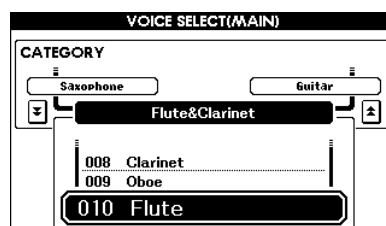
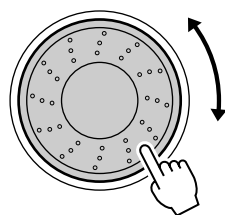

### 3 Play the keyboard.

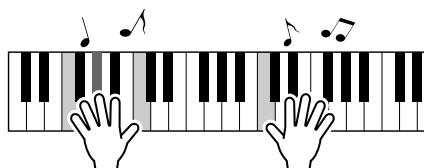

Try selecting and playing a variety of Voices.  
Press the [EXIT] button to return to the MAIN display.

## Playing Two Voices Simultaneously—DUAL

This lets you select a second Voice which you can play in addition to the Main Voice. The second Voice is known as the “Dual” Voice.

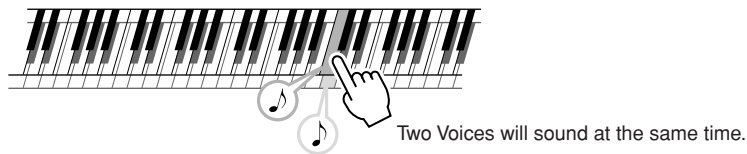

### 1 Press the [DUAL] button.

The [DUAL] button turns the Dual Voice on or off. When Dual Voice is turned on, the [DUAL] button is lit. The currently selected Dual Voice will sound in addition to the Main Voice when you play the keyboard.

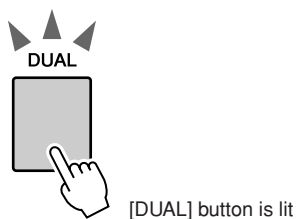

### 2 Press and hold the [DUAL] button for longer than a second.

The Dual Voice selection display appears. The currently selected category name, Voice number and name will be highlighted.

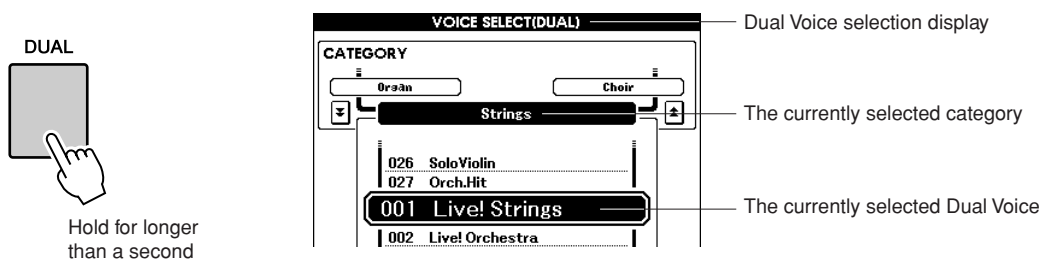

### 3 Select and press the desired Voice category button in the Voice section.

For this example, select the “PERCUSSION/DRUM” category.

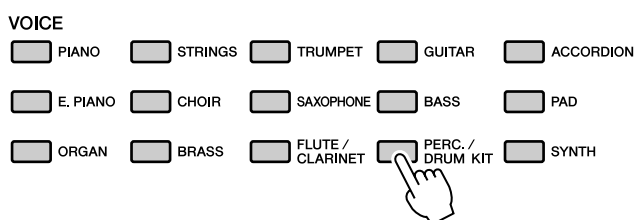

#### NOTE

- To change the Voice category, press another category button.

## 4 Select the Voice you want to play.

Look at the highlighted Voice name and rotate the dial. The available Voices will be selected and displayed in sequence. The Voice selected here becomes the Dual Voice.

For this example, select the “003 Marimba” Voice.



## 5 Play the keyboard.

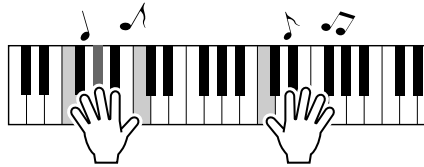

Try selecting and playing a range of Dual Voices.

Press the [EXIT] button to return to the MAIN display.

## Playing Different Voices with the Left and Right Hands—LEFT

In the Left mode you can play different Voices from the keys to the left and right of the keyboard “split point.” The Main and Dual Voices can be played to the right of the split point, while the Voice played to the left of the split point is the Left Voice. The split point setting can be changed as required (page 59).

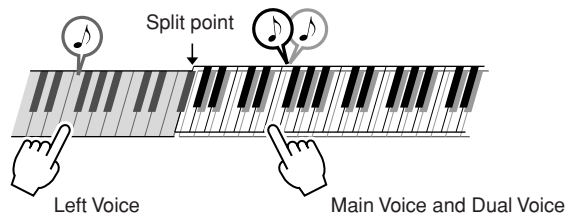

## 1 Press the [LEFT] button.

The [LEFT] button turns the left Voice on or off. The currently selected Left Voice will sound when you play keys to the left of the keyboard split point.

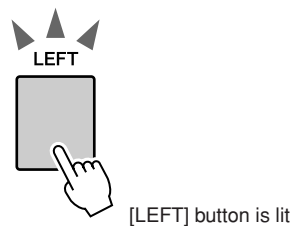

## 2 Press and hold the [LEFT] button for longer than a second.

The LEFT Voice selection display will appear.  
The currently selected category name, Voice number and name will be highlighted.

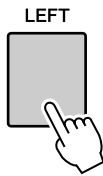

Hold for longer than a second

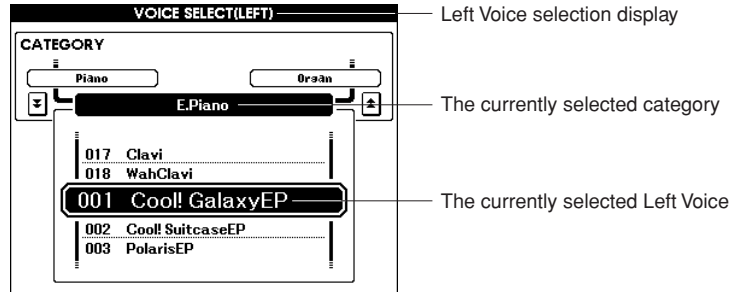

## 3 Select and press the desired Voice category button in the VOICE section.

For this example, select the “GUITAR” category.

**NOTE**

• To change the Voice category, press another category button.

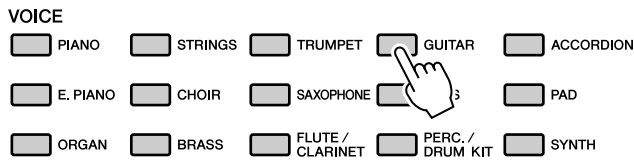

## 4 Select the Voice you want to play.

Look at the highlighted Voice name and rotate the dial. The available Voices will be selected and displayed in sequence. The Voice selected here becomes the Left Voice.

For this example, select the “041 FolkGuitar” Voice.

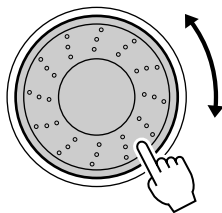

## 5 Play the keyboard.

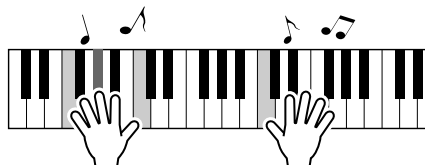

Try playing the selected Left Voice.

Press the [EXIT] button to return to the MAIN display.

# Playing Drum Kits

Drum Kits are collections of drum and percussion instruments. When you select a violin or other normal instrument—as a Main Voice, for example—all keys produce the sound of the same violin, only at different pitches. If you select a Drum Kit as the Main Voice, however, each key produces the sound of a different drum or percussion instrument.

**1** Press the [PERC./DRUM KIT] button.  
The “PERC./DRUM KIT” category appears.

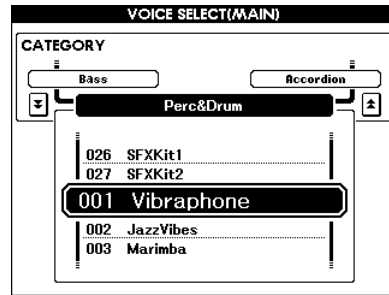
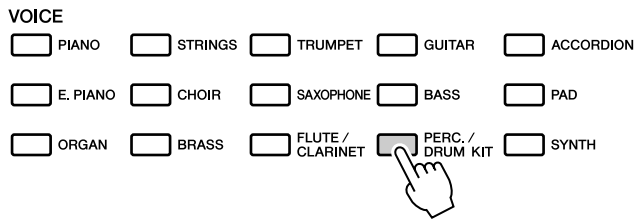

**2** Rotate the dial and select the Drum Kit you want to play (013–027).

Voice numbers 001–012 are percussion numbers.

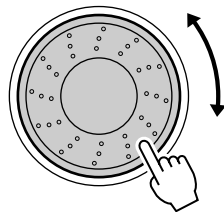

### Drum Kits List

Voice No.	Drum Kit name	Voice No.	Drum Kit name	Voice No.	Drum Kit name
013	Standard Kit 1	018	Rock Kit	023	Cuban Kit
014	Standard Kit 2	019	Electronic Kit	024	Pop Latin Kit
015	Jazz Kit	020	Analog Kit	025	Arabic Kit
016	Brush Kit	021	Dance Kit	026	SFX Kit 1
017	Room Kit	022	Symphony Kit	027	SFX Kit 2

**3** Play each key and enjoy the Drum Kit.  
A good Drum Kit to start out with is 013, Standard Kit 1.

**NOTE**  
• See the Drum Kit List on page 104.

**Example: 013 Standard Kit 1**

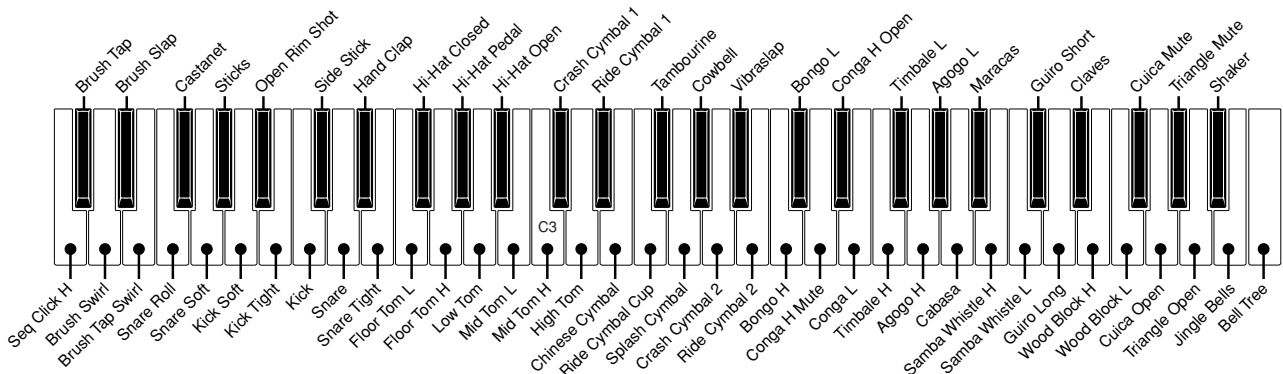



# Playing Styles

This instrument includes an auto-accompaniment feature that plays appropriate “Styles” (rhythm + bass + chord accompaniment) when you play left-hand chords.

You can select from 150 different Styles covering a range of musical genres and time signatures (see page 107 for a complete list of the available Styles). Here’s how you can use the auto-accompaniment feature.

## Select a Styles Rhythm

Most Styles include a rhythm part. You can select from a wide variety of rhythmic types—rock, blues, samba, and many, many more. Let’s begin by listening to just the basic rhythm. The rhythm part is played using percussion instruments only.

### 1 Select and press the desired Style category button in the Style section.

The Style selection display appears.

The currently selected category name, Voice number and name will be highlighted.

#### NOTE

- To change the Style category, press another category button.

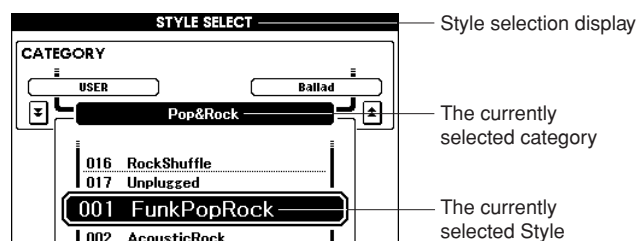
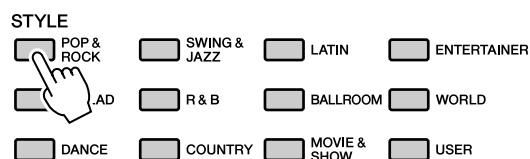

### 2 Select the Style you want to play.

Look at the highlighted Voice name and rotate the dial. The available Styles will be selected and displayed in sequence.

See the Style list on page 107.

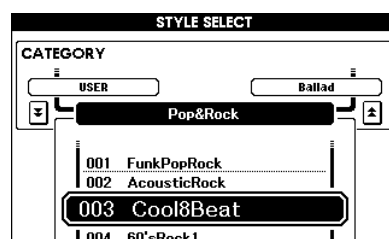
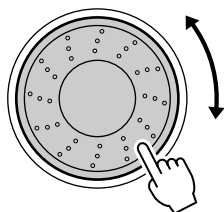

### 3 Press the [START/STOP] button.

The Style rhythm will start playing.

To stop playback, press the [START/STOP] button again.

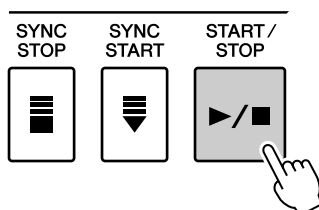

## Playing Along with a Style

You learned how to select a Style rhythm on the preceding page.

Here we'll see how to add bass and chord accompaniment to the basic rhythm to produce a full, rich accompaniment that you can play along with.

### 1 Select and press the desired Style category button in the Style section.

Press the [EXIT] button to return to the Main display.

### 2 Turn automatic accompaniment on.

Press the [ACMP] button.

Pressing this button a second time will turn automatic accompaniment off.

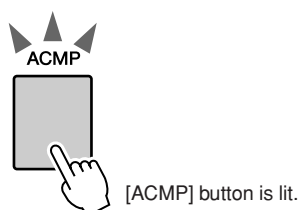

#### ● When automatic accompaniment is on ...

The area of the keyboard to the left of the split point (54: F#2) becomes the "auto accompaniment region" and is used only for specifying the accompaniment chords.

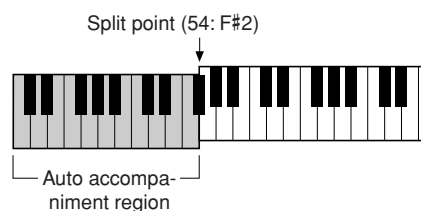

#### NOTE

- The Split point can be changed as required; refer to page 59.

### 3 Turn Sync Start on.

Press the [SYNC START] button to turn the Sync Start function on.

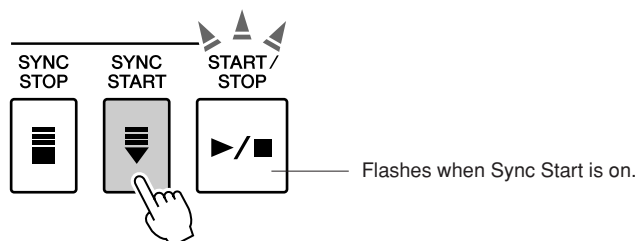

When Sync Start is on, the bass and chord accompaniment included in a Style will start playing as soon as you play a note to left of the keyboard split point. To cancel or disable Sync Start, press the button a second time to turn the Sync Start function off.

## 4 Play a left-hand chord to start the Style.

You can still “play” chords even if you don’t actually know any chords. This instrument will recognize even a single note as a chord. Try playing from one to three notes at the same time to the left of the split point. The chord will change according to the left-hand notes you play.

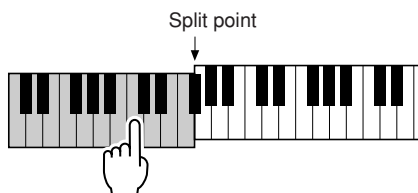

## 5 Play a variety of left-hand chords while playing a melody with your right hand.

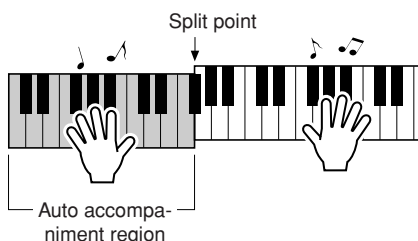

## 6 Press the [START/STOP] button to stop Style playback when you’re done.

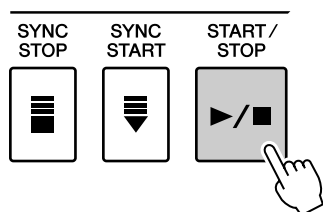

You can switch Style “sections” to add variety to the accompaniment. Refer to “Pattern Variation (sections)” on page 55.



# Playing Auto-accompaniment Chords

There are two ways of playing auto-accompaniment chords:

- **Easy Chords**
- **Standard Chords**

The instrument will automatically recognize the different chord types.

The keyboard to the left of the split point (default: 54/F#2) becomes the “accompaniment range.” Play the accompaniment chords in this area of the keyboard.

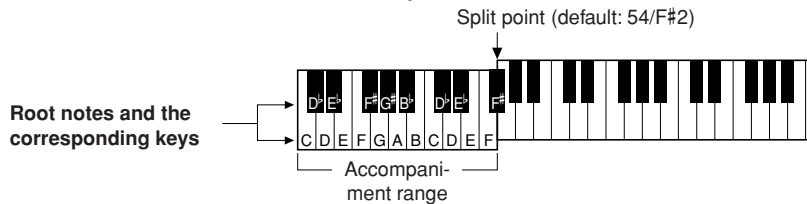

## ■ Easy Chords .....

This method lets you easily play chords in the accompaniment range of the keyboard using only one, two, or three fingers.

	<ul style="list-style-type: none"> <li>• <b>To play a major chord</b> Press the root note of the chord.</li> </ul>
	<ul style="list-style-type: none"> <li>• <b>To play a minor chord</b> Press the root note together with the nearest black key to the left of it.</li> </ul>
	<ul style="list-style-type: none"> <li>• <b>To play a seventh chord</b> Press the root note together with the nearest white key to the left of it.</li> </ul>
	<ul style="list-style-type: none"> <li>• <b>To play a minor seventh chord</b> Press the root note together with the nearest white and black keys to the left of it (three keys altogether).</li> </ul>

## ■ Standard Chords .....

This method lets you produce accompaniment by playing chords using normal fingerings in the accompaniment range of the keyboard.

● **How to play Standard Chords [Example for “C” chords]**

\* Notes enclosed in parentheses ( ) are optional; the chords will be recognized without them.

● **Multi Fingering and Full Keyboard**

These let you select the accompaniment section of the keyboard for chord playing. (See the “Chord Fingering” section in the Function Setting List on page 71.)

**Multi Fingering:** As explained above, the keys to the left of the split point (default: 54, F#2) become the accompaniment range. This method lets you play the accompaniment chords in the specified area of the keyboard, and is set as the default for the instrument.

**Full Keyboard:** This lets you play the accompaniment chords freely from anywhere on the keyboard.



# Playing with the Music Database

You want to play music in your favorite Style, but you're not sure how to select the best Voice and Style for the type of music you want to play, simply select the appropriate Style from the Music Database. The panel settings will automatically be adjusted for the ideal combination of sounds and Style!

## 1 Press the [MDB] button.

The music database selection display will appear. The currently selected category name, MDB number and name will be highlighted.

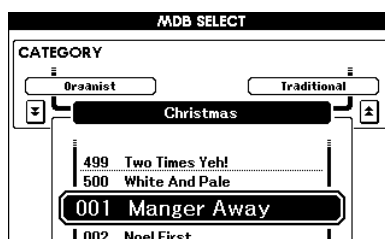
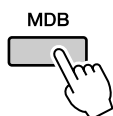

## 2 Select the desired Music Database which matches the music style or type you want to play.

Press [▲], [▼] category button when changing the MDB category. Referring to the Music Database List on page 108 of the manual, use the dial to select a music database. Select one that matches the music style of the Song you intend to play. For this example select "090 Alex's Band" in the Swing category.

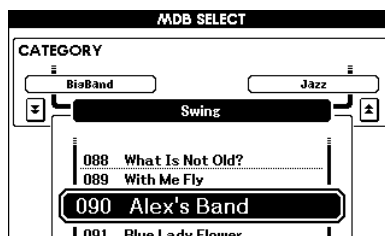
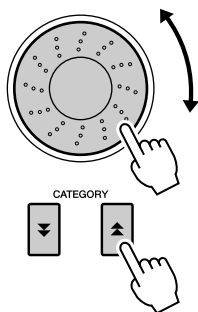

## 3 Play the chords with your left hand and the melody with your right.

The swing Style will start playing when you play a left-hand chord to the left of the split point (page 23). Refer to page 25 for information about playing chords.

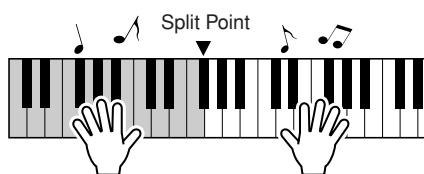

You can check the assigned Voice and Style at this point by pressing the [EXIT] button to return to the MAIN display.

## 4 Press the [▶/■] button to stop playback.



# Using Songs

With this instrument the term “Song” refers the data that makes up a piece of music.

In this section we’ll learn how to select and play Songs.

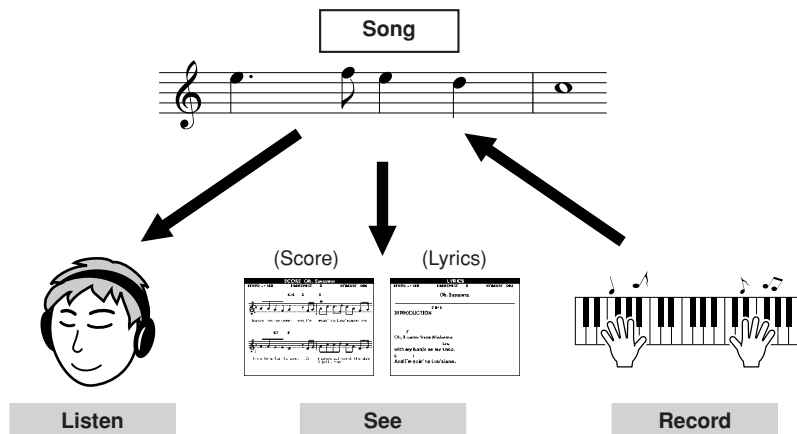

## Selecting and Listening to a Song

### 1 Select and press one of the Song category buttons, which corresponds to the type of Song you want to listen to.

[PRESET]: Five preset Songs are available here.

[USER] : This contains your recorded Songs and Songs loaded from computer.

[USB] : This contains USB Songs when a USB flash memory device is connected to the DEVICE terminal.

The Song selection display will appear.

The currently selected Song number and name will be highlighted.

#### NOTE

- When the instrument is in the Song mode, the [SONG MODE] button is lit. When Style mode is enabled, the button is not lit.

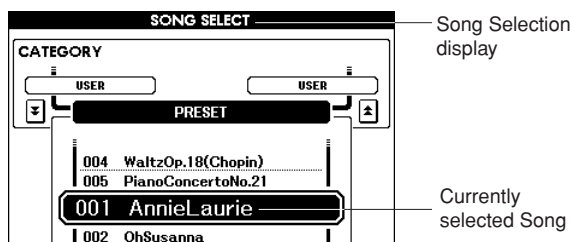
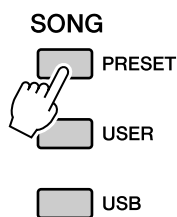
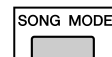

### 2 Select a Song.

Use the dial to select the Song you want to listen to.

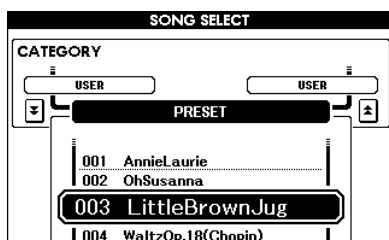
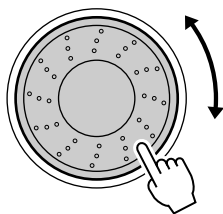

PRESET	Built-in Songs 1 Annie Laurie (Traditional) 2 Oh, Susanna (Sunny Skylar, S. Foster) 3 Little Brown Jug (Traditional) 4 Waltz Op.18 (F. Chopin) 5 Piano Concerto No.21 2nd Mov. (W.A. Mozart)
USER	User Songs (Songs you record yourself) or Songs transferred from a computer (pages 85–87)
USB	Songs in a USB flash memory connected to the instrument (page 74)

### 3 Listen to the Song.

Press the [▶/■] button to begin playback of the selected Song.  
 You can stop playback at any time by pressing the [▶/■] button again.

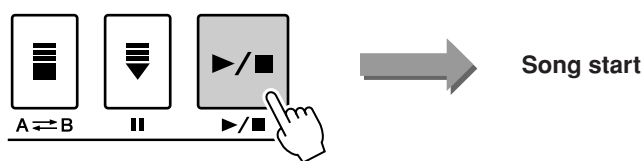

**NOTE**

• Some of the preset songs have been edited for length or arrangement, and may not be exactly the same as the original.

## Song Fast Forward, Fast Reverse, and Pause

These are just like the transport controls on a cassette deck or CD player, letting you fast forward [▶▶], rewind [◀◀], and pause [||] playback of the Song.

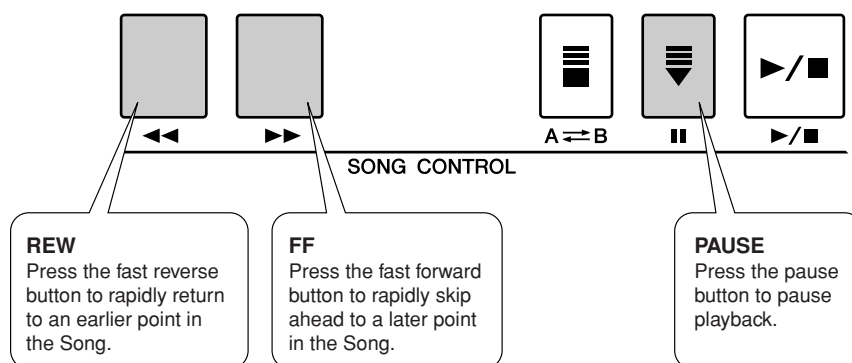

**NOTE**

• When an A-B repeat range is specified, the fast reverse and forward function will only work within that range.

## Types of Songs

The following four types of Songs can be used by this instrument.

- **Preset Songs** (the five Songs built into the instrument)..... **Preset Song numbers 001–005.**
- **User Songs** (recordings of your own performances) ..... **USER Song numbers 001–005.**
- **Loaded Songs** (Song data loaded from computer) ..... **USER Song numbers 006–**
- **USB Songs** (Song data in the USB flash memory) ..... **Song numbers 001–.**

The chart below shows the basic operation flow for using the preset Songs, user Songs, loaded Songs and USB Song from storage to playback.

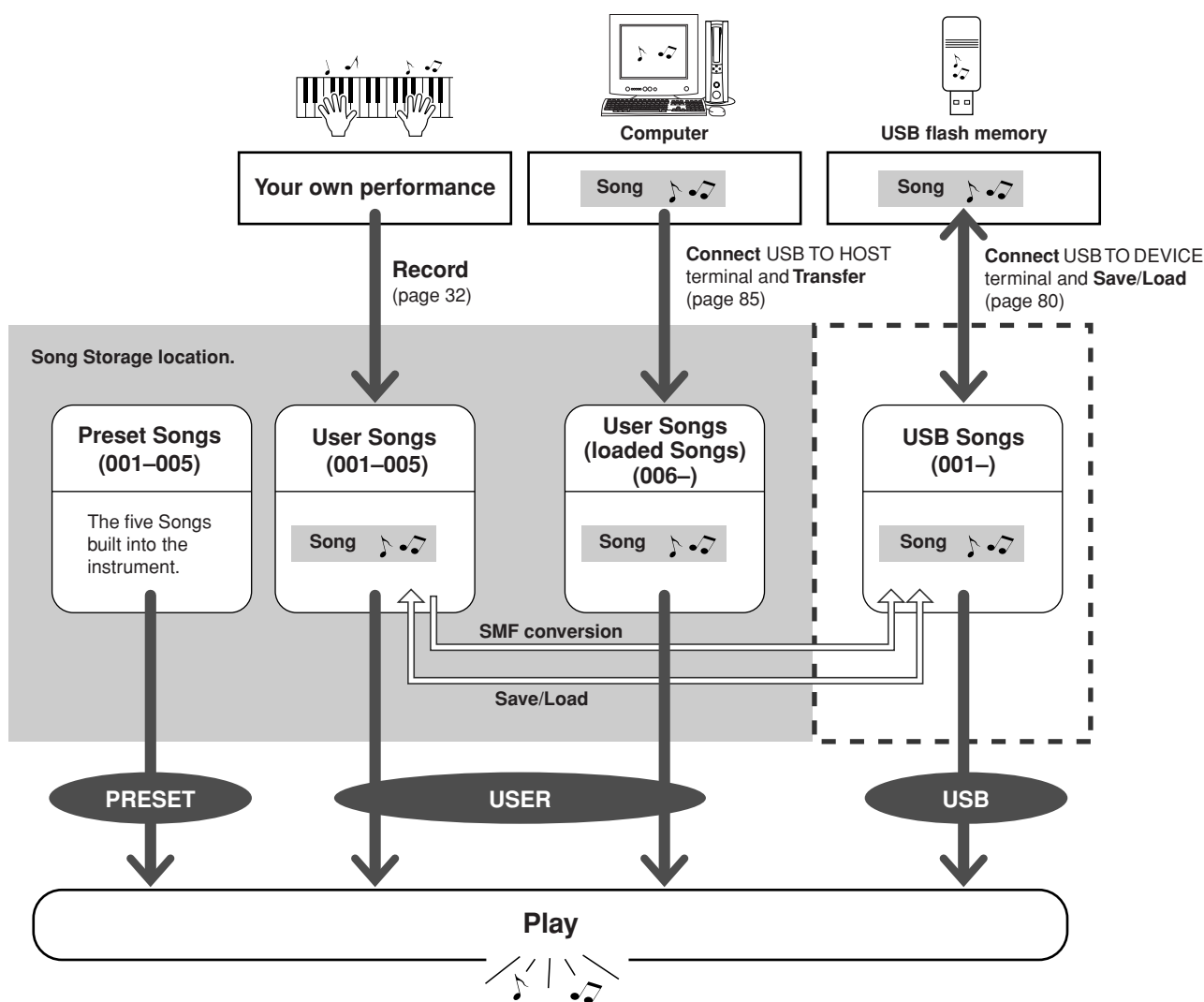

**NOTE**

• Different internal memory areas are used to store user Songs and loaded Song files transferred from a computer. User Songs cannot be directly transferred to the loaded Song area of the internal memory, and vice versa.

## Displaying the Song Score

This instrument is capable of displaying the scores (notation) of Songs.

Scores are displayed for the preset Songs. Scores can also be displayed for Songs loaded from computer as well as Songs played back from USB flash memory.

Although User Songs you record yourself cannot display a score as is, they can be converted to SMF (Standard MIDI File) format and stored to USB flash memory, from where they can be played with score display. (Refer to “Convert a User Song to SMF Format and Save” on page 77.)

### 1 Select a Song.

Follow steps 1 and 2 of the procedure described on page 27.

### 2 Press the [SCORE] button and a single-staff score will appear.

There are two types of score display: single-staff and double-staff. These are alternately selected each time the [SCORE] button is pressed.

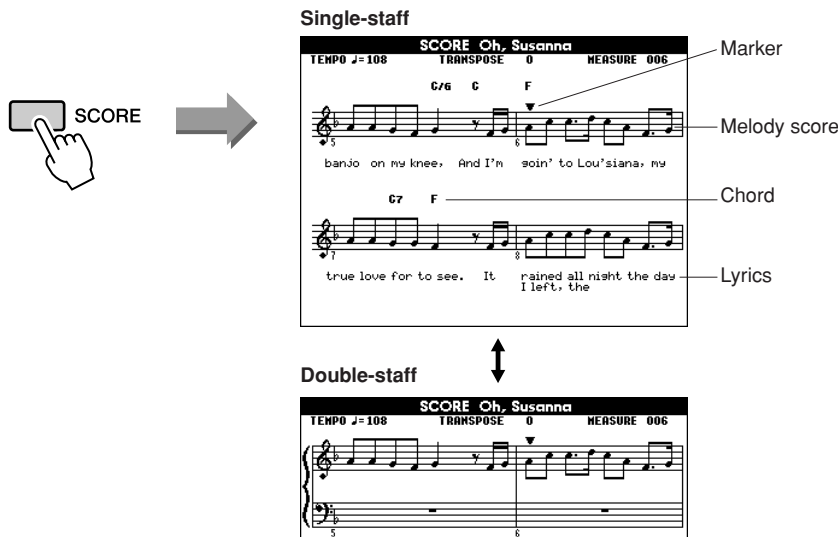

**NOTE**

- Both chords and lyrics will be shown in single-staff score display of a Song that includes chord and lyric data.
- When there are many lyrics in a Song, they may be displayed in two rows a measure.
- Some lyrics or chords may be abbreviated if the selected Song has a lot of lyrics.
- Small notes that are hard to read may be easier to read after you use the quantize function (page 72).

**NOTE**

- No lyrics are shown in double-staff display.

### 3 Press the [▶/■] button.

The Song will begin playing. The triangular cursor will move across the top of the score to indicate the current location.

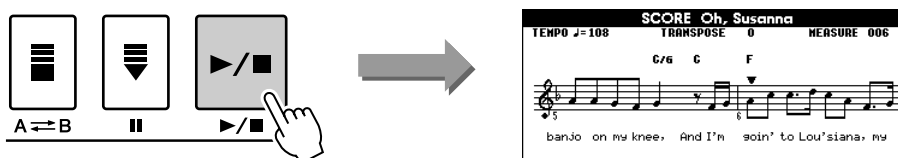

### 4 To return to the MAIN display, press the [EXIT] button.

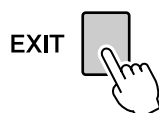

## Displaying the Lyrics

If a Song contains lyric data, the lyrics can be made to appear on the display. No lyrics will be displayed for a Song that contains no lyric data, even if the [LYRICS] button is pressed.

### 1 Select a Song.

Follow steps 1 and 2 of the procedure described on page 27. Try to select the Preset SONG 001–002.

### 2 Press the [LYRICS] button.

The title, lyricist, and composer of the Song will appear on the display.

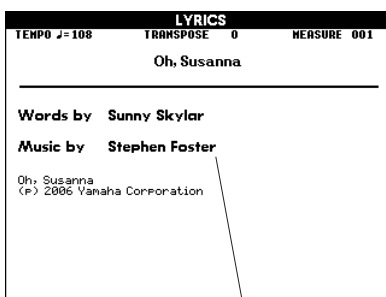

Song title, Lyricist, Composer

#### NOTE

- Songs downloaded from the Internet or commercially available Song files, including XF format files (page 6), are compatible with the lyrics display features as long as they are standard MIDI file format files containing lyric data. Lyrics display may not be possible with some files.

#### NOTE

- If the lyrics display shows garbled characters, try changing the display language (page 12).

### 3 Press the [▶/■] button.

The Song will play back while the lyrics and chords are shown on the display. The lyrics will be highlighted to show the current location in the Song.

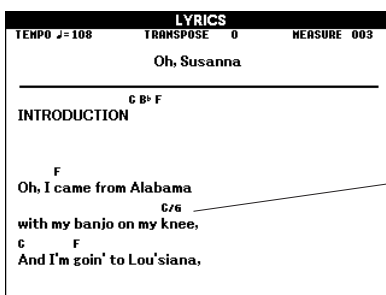
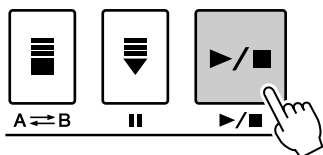

Lyrics and Chord

### ■ Preset Songs That Can be Used For Lyrics Display

Song No.	Song Name
001	Annie Laurie
002	Oh, Susanna



# Recording Your Own Performance

You can record up to five of your own performances and save them as user Songs 001 through 005.

These Songs can be played in the same manner as the preset Songs. Once your performances have been saved as user Songs, they can be converted to SMF (Standard MIDI File) format files and saved to USB flash memory (page 77) and used with the score display function. This means that when inspiration strikes and you create a great melody, you can save it in both listenable and written score form.

## ■ Recordable data

You can record to a total of 9 tracks: 8 melody tracks and 1 Style (chord) track. Each track can be recorded individually.

- **Melody Track [1]–[8].....** Record the melody or other parts, such as bass.
- **Style Track [ACMP] .....** Record the Rhythm and Chord.

## ■ Recording methods

- **Quick Recording.....** Immediately start recording by pressing the [REC] button. (see page 33)
- **Multi Recording.....** Specify the Song or Part number and then start recording. (see page 34)

### NOTE

- Up to approximately 10,000 notes can be recorded, if you record only to the melody tracks.
- Up to approximately 5,400 chord changes can be recorded, if you record only to the accompaniment track.
- User Songs as such cannot produce score display, but they can be converted to SMF (Standard MIDI File) format and stored to USB flash memory (page 77), from which they can be played with score display.
- Even if you change the Voice during recording, the DSP type will not be changed and the original DSP type will still be applied.

## Track Configuration

Generally, Song data consists of 16 tracks. On this instrument, you can record your performance step-by-step to each of tracks 1–8. For example, you can select the Main Voice for recording to Track 1, then set the Dual Voice to Track 2, and so on. (When the Quick Recording mode is selected, the playing parts and their corresponding tracks are set automatically.)

## ■ Recording track

When Multi track recording is selected, you can specify the recording track [1]–[8] and accompaniment track.

In this instrument, data cannot be recorded to tracks [9]–[16]. However, in the case of Songs loaded from computer, if the Song has data in tracks [9]–[16], you can playback and mute these tracks as desired. (See page 66.)



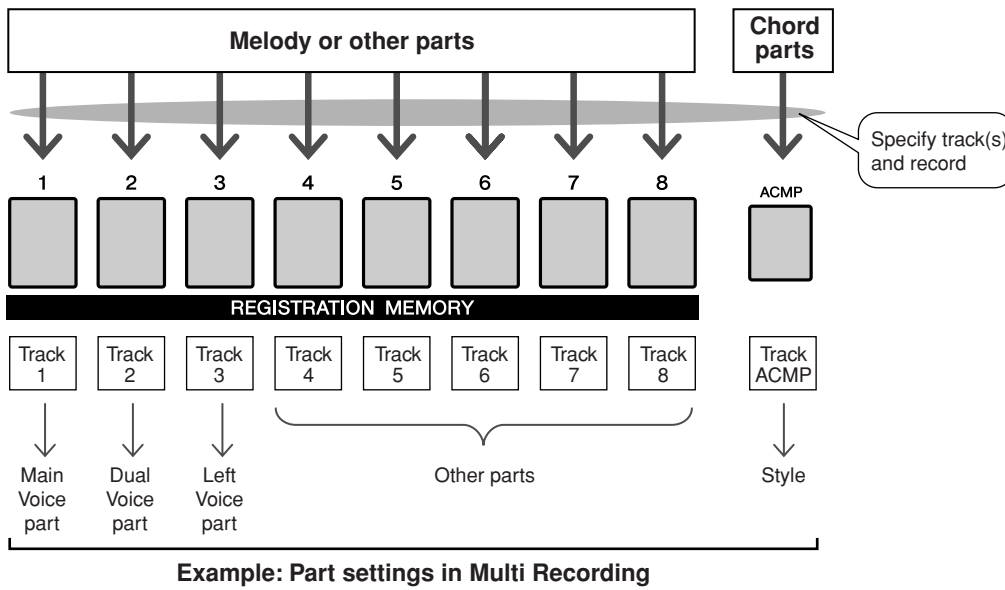

## Quick Recording Procedure

You can easily start recording your performance by simply pressing the [REC] button. In this case, the track number and part number of tracks are set automatically.

### 1 Press the [REC] button.

The User Song number for recording will be selected automatically and tracks [1]–[3] will be set to recording ready mode. Performance parts are as follow:

If accompaniment is set to ON before pressing [REC] button, accompaniment track will be also set to recording ready mode automatically.

**NOTE**

- You can manually select the recorded user Song number if you select it before pressing the [REC] button.

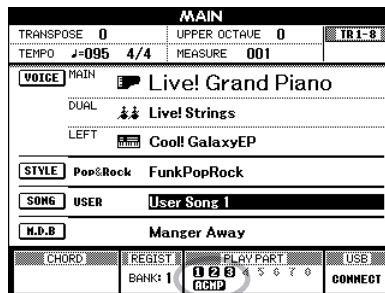

REC ready

Track 1	Main Voice part
Track 2	Dual Voice part
Track 3	Left Voice part
Track ACMP	Accompaniment part

Make sure to turn the Dual Voice or Left Voice on when recording the Dual Voice or Left Voice.

## 2 Recording will start when you play the keyboard.

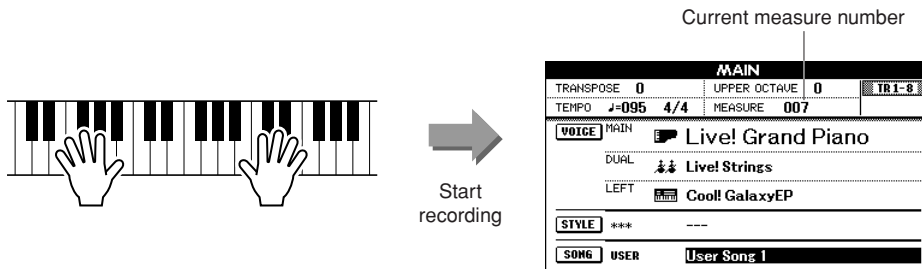

## 3 Stop recording by pressing the [▶/■] or [REC] button.

Track numbers containing recorded data are indicated with framed rectangles.

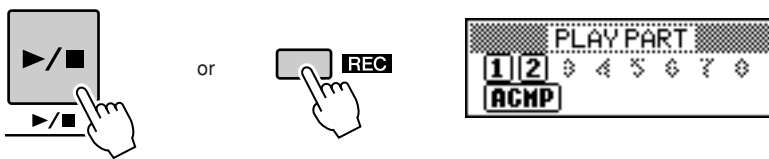

## 4 Press the [▶/■] button to play back the recording.

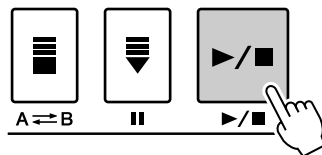

### Multi-track Recording Procedure

You can set the recorded user Song number and the parts for tracks individually.

## 1 From the MAIN display press the [USER] button, then use the dial to select the user Song number (001–005) you want to record to.

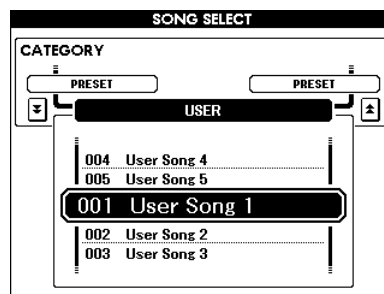
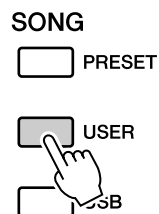

## 2 Select the recording part for each track (Part Assign).

### ◆ Selecting the part for the Melody track (tracks 1–8)

While holding down the [REC] button, press one of the track buttons [1]–[8] until the desired part is shown at the track button. Each time you press the button, the part is changed in order (such as MAIN, DUAL, LEFT) in the Main display.

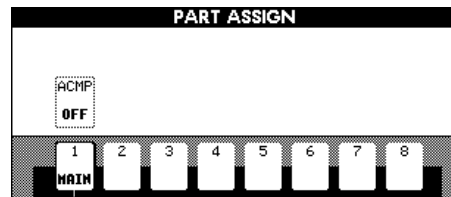
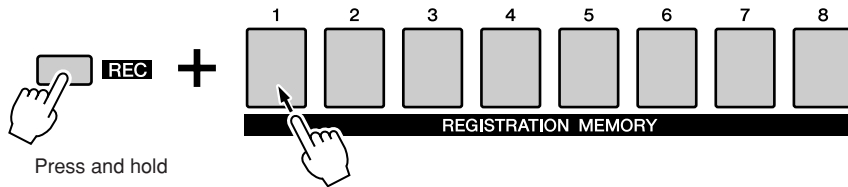

Track 1 is MAIN part.

### ◆ Selecting the part for the Accompaniment track

While holding down the [REC] button, press the [ACMP] button. The REC indication will be highlighted in the display and operation will be set to record ready mode.

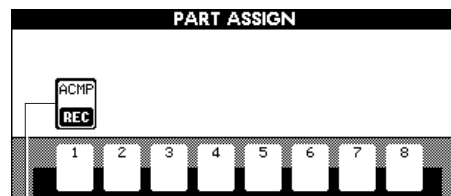
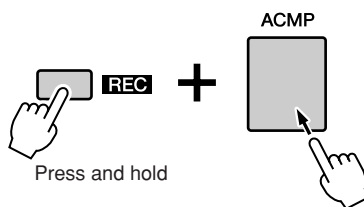

ACMP is set to record ready mode.

#### ⚠ CAUTION

- If you record your performance to a track that contains previous data, the previous data will be overwritten by the new data.

#### NOTE

- When ACMP track is set to REC ON, the accompaniment will be automatically set to ON.
- When press the [REC] button during accompaniment on, the ACMP track will be automatically set to REC ON.
- ACMP ON/OFF does not change while recording is in progress.
- An assigned part cannot be specified to another track.
- A maximum of three melody tracks can be recorded simultaneously.

#### NOTE

- If you want to cancel the record ready mode of a track, simultaneously hold down the [REC] button and press again the track button you want to cancel.

### 3 Recording will start when you play the keyboard.

You can also start recording by pressing the [▶/■] button. Press the [EXIT] button, and the measure number is shown in the Main display. When recording is started, the display automatically returns to the Main display.

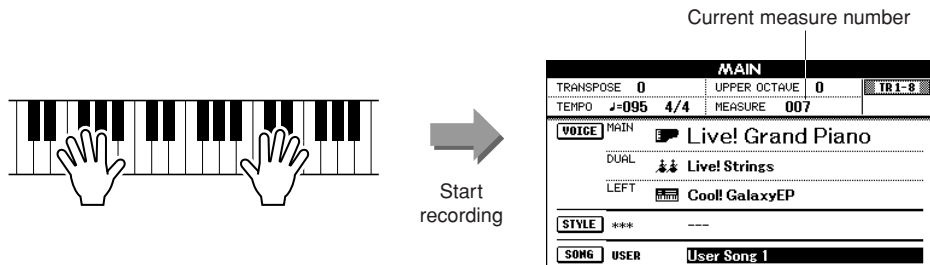

#### NOTE

- When Song memory is full, a corresponding message is shown in the display and recording will be stopped. In this case, delete any unnecessary Song data by using Song clear or track clear then start recording again. (See page 37.)

### 4 Stop recording by pressing the [▶/■] or [REC] button.

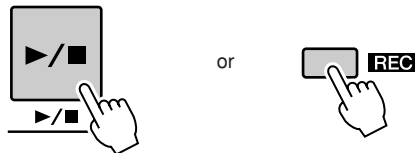

Alternately, if you press one of the ENDING/rit. [I]–[III] buttons while recording the ACMP track, an appropriate ending pattern will play and then recording will stop. When recording stops, the current measure number will return to 001 and the recorded track numbers in the display will be shown in a box border.

#### ■ To Record Other Tracks.

Repeat steps 2 through 4 to record any of the remaining tracks.

You can listen to the previously recorded tracks by pressing the appropriate [1]–[8] buttons while recording. Previously recorded track numbers are shown in a box border.

You can also mute previously recorded tracks (the muted tracks will not appear in the display) while recording new tracks (page 66).

#### ■ Redo the Recording

Simply select the track you want to re-record for recording in the normal way. The newly recorded material will overwrite the previous data.

#### NOTE

- Press the [REGIST/TRACK] button a number of times until the "TR 1–8" item appears on the display.

### 5 After the recording is completed:

#### ◆ Play the User Song

The operation is the same as that for Preset Songs (see page 27).

**1** Press the [USER] button.

**2** The current Song number/name will be highlighted—use the dial to select the user Song (001 to 005) you want to play.

**3** Press the [▶/■] button.

#### ◆ Save the User Song to USB flash Memory (see page 76)

#### ◆ Convert the Song data to SMF format and then save to USB flash Memory (see page 77)

● **Not recorded data**

The following data is recorded before the beginning of the Song. Even if you change the data while recording is in progress, the data is not recorded.

Reverb type, Chorus type, DSP type, DSP send level, Dry level, Style number, Style volume, Time signature

## Song Clear—Deleting User Songs

This function clears an entire user Song (all tracks).

- 1** From the MAIN display, select the user Song (001 to 005) you want to clear.
- 2** Press the [REGIST/TRACK] button a number of times until the “TR 1–8” item appears on the display.
- 3** Press and hold the REGISTRATION MEMORY [1] button for longer than a second while holding the REGISTRATION MEMORY [8] button.

A confirmation message will appear on the display.

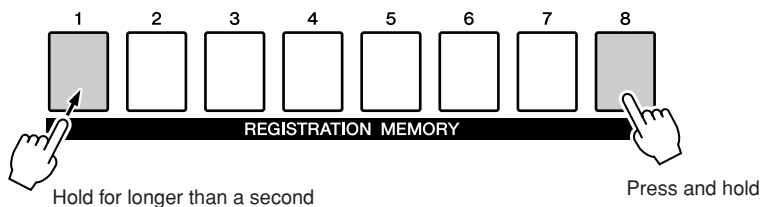

- 4** Press the [+ / YES] button.  
A confirmation message will appear again on the display.  
You can cancel the clear operation by pressing the [- / NO] button.
- 5** Press the [+ / YES] button again to clear the Song.  
The clear-in-progress message will appear briefly on the display while the Song is being cleared.

**NOTE**

- If you want to clear a single, specified track, refer to the Track Clear operation on page 38.

**NOTE**

- To execute the Song Clear function press the [+ / YES] button. Press [- / NO] to cancel the Song Clear operation.

## Track Clear—Deleting a Specified Track From a User Song

This function lets you delete a specified track from a User Song.

**1** From the MAIN display select the User Song (001 to 005) you want to clear.

**2** Press the [REGIST/TRACK] button a number of times until the item you want to clear appears.

The item changes in order from “REGIST.” to “TR 1–8” to “ACMP. TR”. Select the desired track: “TR 1–8” or “ACMP. TR”.

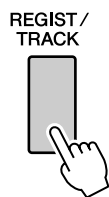

**3** Press and hold the REGISTRATION MEMORY track button ([1] to [8]) corresponding to the track you want to clear for longer than a second.

A confirmation message will appear on the display.

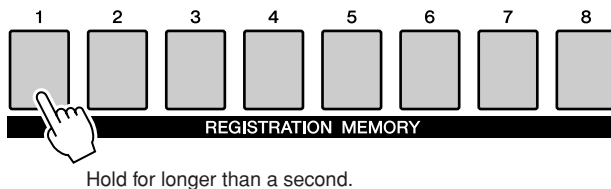

**4** Press the [+ / YES] button.

A confirmation message will appear again on the display. You can cancel the clear operation by pressing the [- / NO] button.

**5** Press the [+ / YES] button again to clear the Song.

The clear-in-progress message will appear briefly on the display while the track is being cleared.

### NOTE

- To execute the Track Clear function press the [+ / YES] button. Press [- / NO] to cancel the Track Clear operation.



# Backup and Initialization

## Backup

The following data items are automatically saved as backup data in the internal memory even if you turn the power off. To recall the default settings and data, use the Initialization operation.

### ● Backup parameters

- USER Song
- Style file
- Registration memory
- Auto Fill In On/Off
- Each parameters in the function display:  
Tuning, Split point, Touch sensitivity, Style volume, Song volume, Metronome volume,  
Demo cancel, Language, Master EQ type, Chord fingering

## Initialization

This function erases all backup data in the instrument's internal memory and restores the initial default settings and data.

The following initialization procedures are provided.

### ■ Backup Clear .....

To clear data backed up to the internal memory, simultaneously hold the highest white key on the keyboard and turn the power on by pressing the [STANDBY/ON] switch. The backed up data will be erased and the default values restored.

#### NOTE

- Language settings for the instrument cannot be changed in this operation. If you want to change the language, use the Function settings.

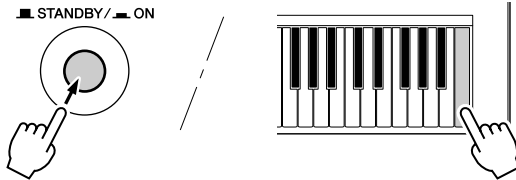

### ■ MEMORY Clear .....

To clear the Song data or Style file that has been transferred to the internal memory from a computer, simultaneously hold the highest white key on the keyboard and the three highest black keys and then turn the power on by pressing the [STANDBY/ON] switch.

#### CAUTION

- When you execute the Clear operation, Song data you have purchased will also be cleared. Be sure to save any important data to a computer.

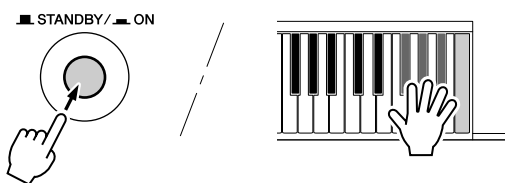



# Basic Operation and Displays

## Basic Operation

Overall PSR-S500 control is based on the following simple operations.

- 1** Use the category buttons to select a CATEGORY.
- 2** Use the dial to select an item or value.
- 3** Starting/stopping a Song or Style.

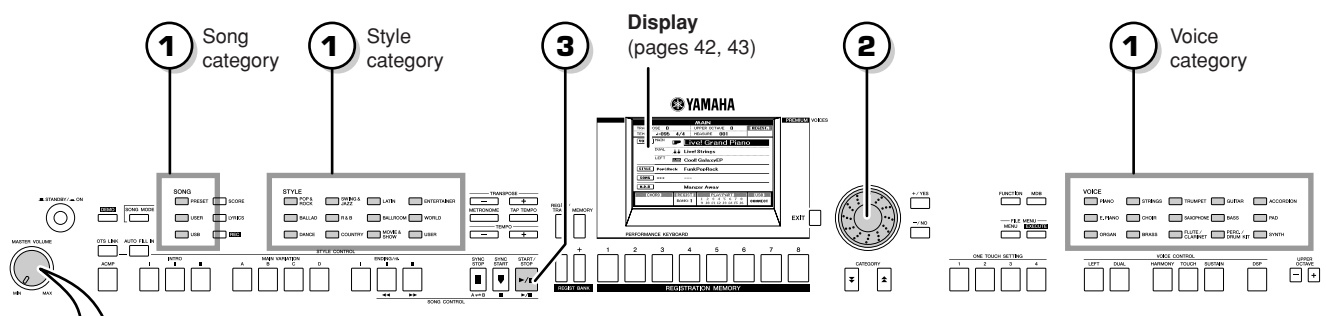

**● Volume Adjustment**  
Adjusts the volume of the sound heard via the instrument's speakers or a pair of headphones plugged into the PHONES jack.

Rotate counterclockwise to lower the volume.

Rotate clockwise to increase the volume.

## 1 Use category buttons to select a CATEGORY.

**SONG**

- PRESET
- USER
- USB

**● Song category**  
Select the Song category you want to play

**STYLE**

- POP & ROCK
- SWING & JAZZ
- LATIN
- ENTERTAINER
- BALLAD
- R & B
- BALLROOM
- WORLD
- DANCE
- COUNTRY
- MOVIE & SHOW
- USER

**● Style category**  
Select the Style category you want to play

**VOICE**

- PIANO
- STRINGS
- TRUMPET
- GUITAR
- ACCORDION
- E. PIANO
- CHOIR
- SAXOPHONE
- BASS
- PAD
- ORGAN
- BRASS
- FLUTE / CLARINET
- PERC. / DRUM KIT
- SYNTH

**● Voice category**  
Select the Voice category you want to play

\* If you want to change the category, press another category button or use the Category [ $\blacktriangle$ ], [ $\blacktriangledown$ ] button.



● **Category buttons [▲], [▼]**

You can change the category after you've selected a Song, Style or Voice category.

Pressing these buttons allow you to step in sequence through the categories.

Example: Voice selection display

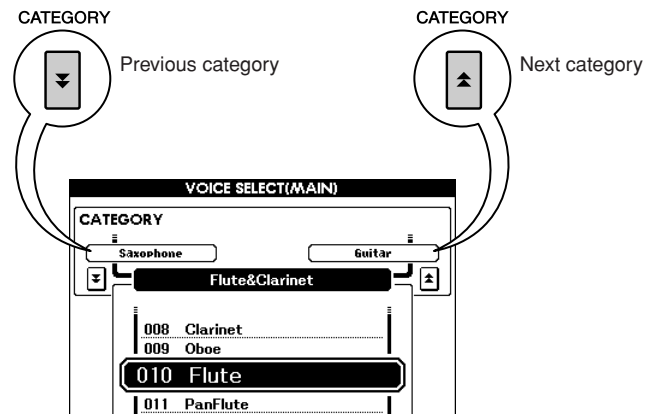

## 2 Use the dial to select an item or value.

When you select the category such as Song, Style or Voice, the selected category name and item is shown on the display. The item can be changed by using the dial or the [+ / YES], [- / NO] buttons.

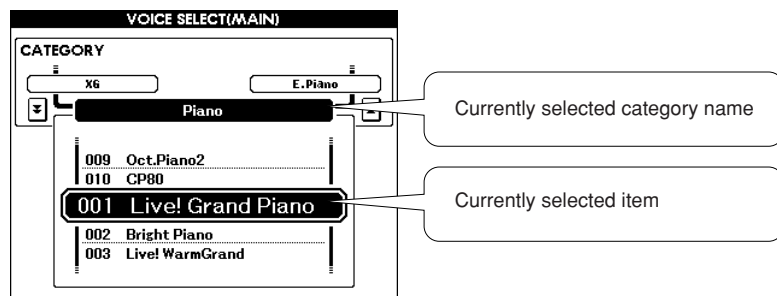

● **Dial**

Rotate the dial clockwise to increase the value of the selected item, or counter-clockwise to decrease its value. Rotate the dial to continuously increase or decrease the value.

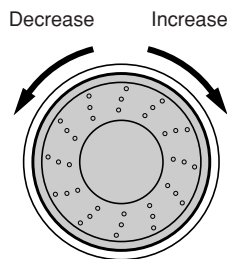

● **[+ / YES], [- / NO] buttons**

Press the [+ / YES] button briefly to increment the value by 1, or press the [- / NO] button briefly to decrement the value by 1. Press and hold either button to continuously increment or decrement the value in the corresponding direction.

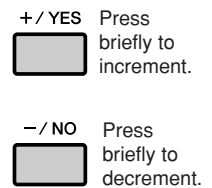

In most procedures described throughout this owner's manual, the dial is recommended for selection simply because it is the easiest and most intuitive selection method. Please note however, that most items or values that can be selected using the dial can also be selected using the [+ / YES] and [- / NO] buttons.

## 3 Starting/stopping a Song or Style.



Press the [START/STOP] button after selecting the Song category or Style category to start playback of the selected Song or Style (rhythm).

# The Displays

## ● Display names

The display provides important, easy-to-understand indications for performing all operations. The name of the current display appears at the top of the display. You can see the “MAIN” indication at the top on the display.

## ● MAIN Display

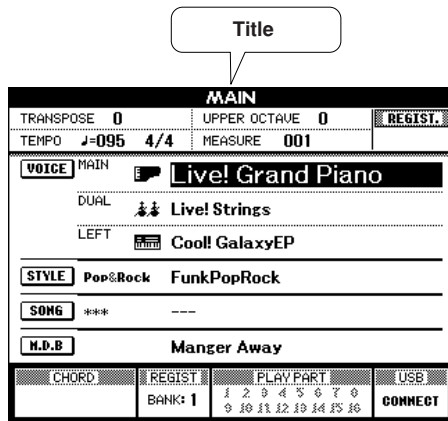

### Call up the Main display

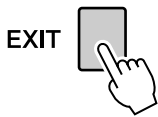

Most basic operations are carried out from the instrument's MAIN display. You can return to the MAIN display from any other display by pressing the [EXIT] button near the lower right corner of the display panel.

## ● FUNCTION display (page 70)

The FUNCTION display provides access to 49 utility functions. The FUNCTION display appears when the [FUNCTION] button is pressed. In the FUNCTION display you can use the CATEGORY [▲] and [▼] buttons (page 41) to select 49 different function items. Press the CATEGORY button(s) as many times as necessary until the required function appears. You can then use the dial or the [+ / YES] and [- / NO] buttons to adjust the value of the function as required.

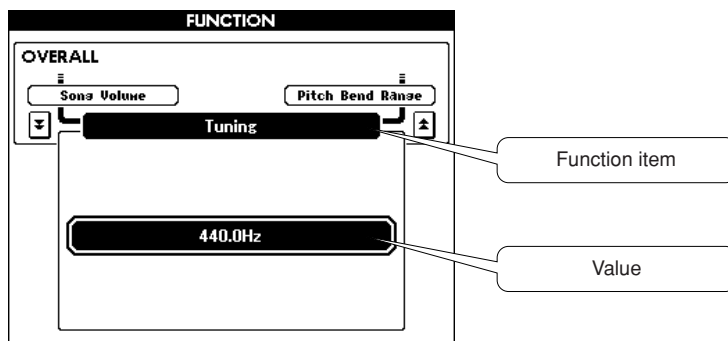

# MAIN Display Items

The MAIN display shows all of the current basic settings: Song, Style, Voice. It also includes a range of indicators that show the on/off status of a range of functions.

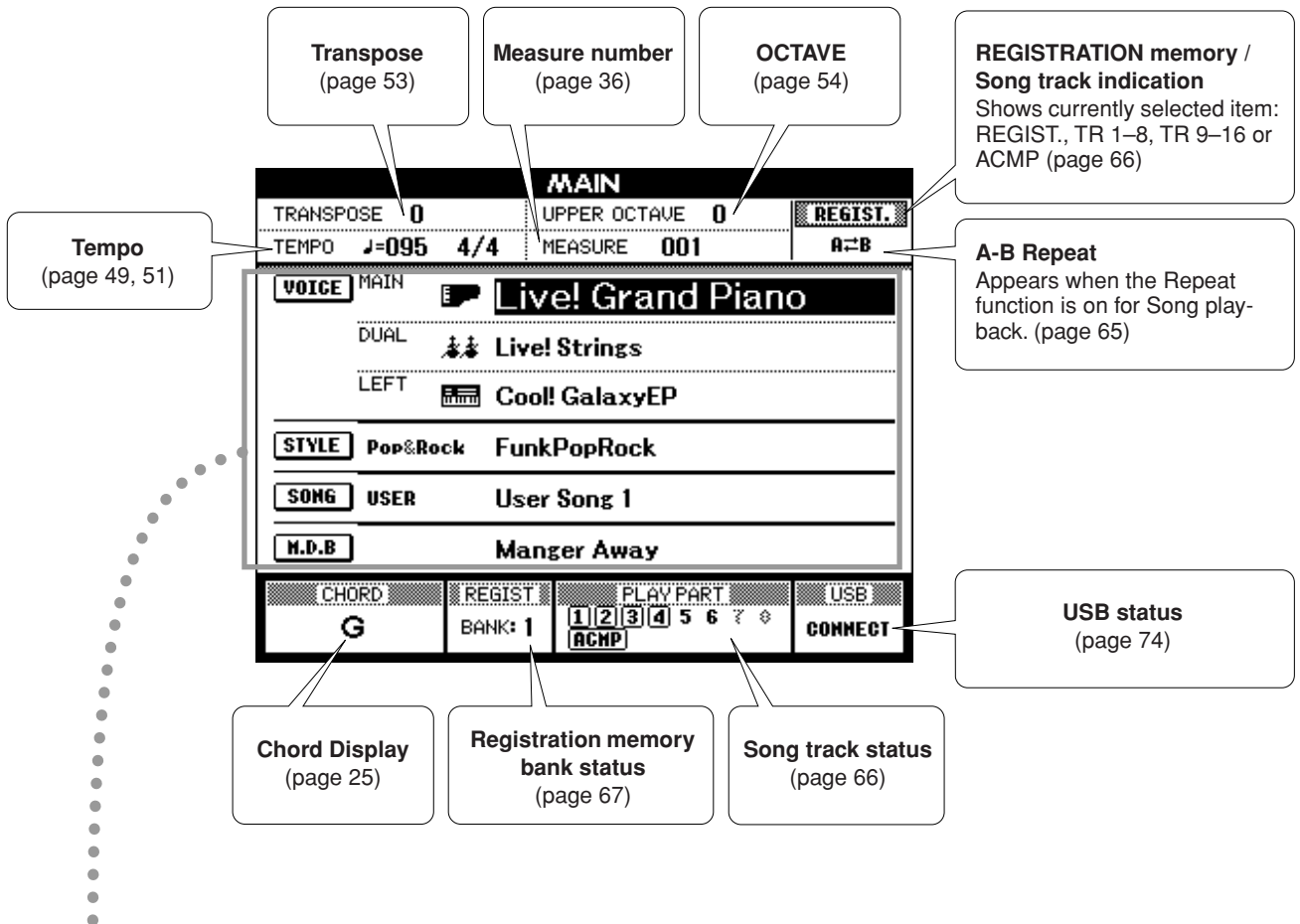

<b>VOICE</b> MAIN	<b>Live! Grand Piano</b>	Main Voice (page 17)
DUAL	<b>Live! Strings</b>	Dual Voice (page 18)
LEFT	<b>Cool! GalaxyEP</b>	Left Voice (page 19)
<b>STYLE</b> Pop&Rock	<b>FunkPopRock</b>	Style (page 22)
<b>SONG</b> USER	<b>User Song 1</b>	Song (page 27)
<b>M.D.B</b>	<b>Manger Away</b>	Music Database (page 26)

# Playing with the Effects

## Adding Harmony

This feature adds Harmony, Tremolo or Echo effects to the Main Voice.

### 1 Press the [HARMONY] button to turn the Harmony function on.

The [HARMONY] button lights indicating that Harmony is on.

To turn Harmony off, press the [HARMONY] button again.



**NOTE**

• When you press the [HARMONY] button to turn this feature on, the appropriate Harmony type for the currently selected Main Voice is automatically selected.

### 2 Press and hold the [HARMONY] button for longer than a second.

The currently selected Harmony type will be displayed.

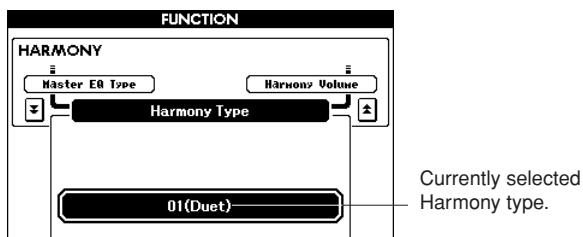
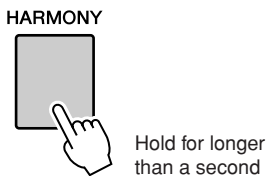

### 3 Use the dial to select a Harmony type.

Refer to the Effect Type List on page 110 for information about the available Harmony types.

Try playing the keyboard with the Harmony function. The effect and operation of each Harmony type is different—for details, refer to the section below “How to sound each Harmony Type” as well as the Effect Type List.

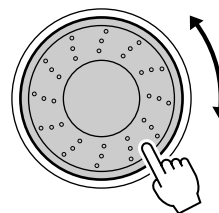

**NOTE**

- The Harmony notes can be added only to the Main Voice, not to Dual or Left Voices.
- The keys left of the Split Point of the keyboard produce no Harmony notes when the Auto Accompaniment is on (ACMP ON lights).
- When chord fingering is set to Full Keyboard, the Harmony function is turned off automatically.

#### ● How to sound each Harmony Type

- Harmony types 01 to 05

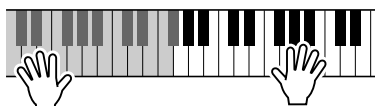

Press the right-hand keys while playing chords in the Auto Accompaniment range of the keyboard when the Auto Accompaniment is on (page 23).

- Harmony types 06 to 12 (Trill)

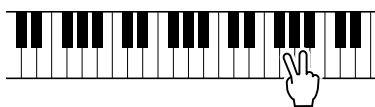

Hold down two keys.

- Harmony types 13 to 19 (Tremolo)



Keep holding down the keys.

- Harmony types 20 to 26 (Echo)



Keep holding down the keys.

You can adjust the Harmony Volume in the Function Settings (page 72).

## Changing the Reverb Type

Reverb enhances the sound of the Voices with the rich ambience of a concert hall.

When you select a Style or Song the optimum reverb type for the Voice used is automatically selected. If you want to select a different reverb type, use the operation described below.

- 1 Press the [FUNCTION] button to call up the FUNCTION display.

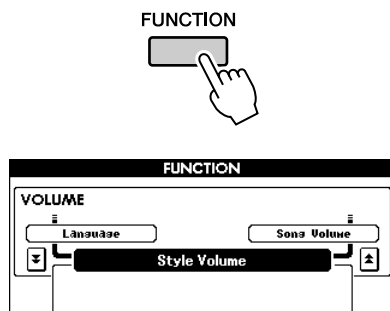

- 2 Press the CATEGORY [▲] and [▼] buttons as many times as necessary to call up Reverb Type.

The currently selected Reverb Type will be displayed.

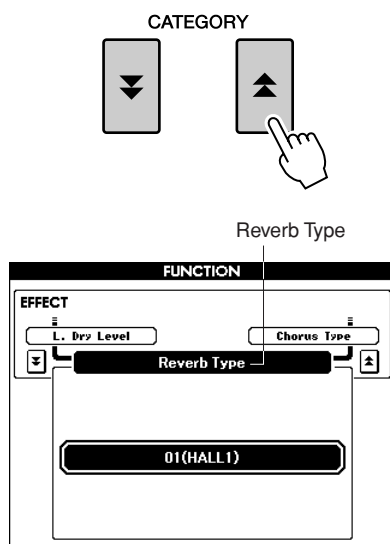

- 3 Use the dial to select a Reverb Type.

You can check the sound of the selected Reverb Type by playing the keyboard.

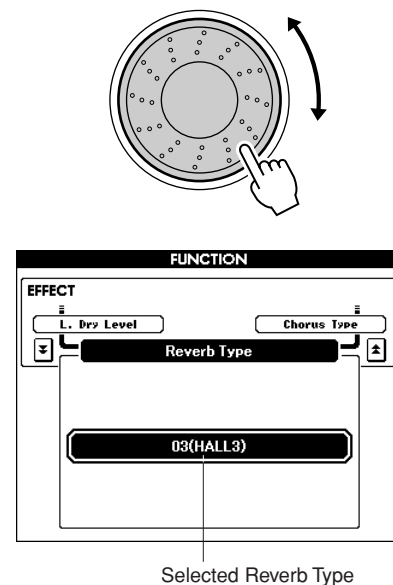

Refer to the Effect Type List on page 110 for information about the available Reverb Types.

### ● Adjusting the Reverb Level

You can individually adjust the amount of reverb that is applied to the Main, Dual, and Left Voices. (See page 71).

## Changing the Chorus Type

The Chorus effect creates a thick sound that is similar to many of the same Voices being played in unison. When you select a Style or Song the optimum chorus type for the Voice used is automatically selected. If you want to select a different Chorus Type, use the procedure described below.

- 1 Press the [FUNCTION] button to call up the FUNCTION display.

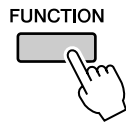

- 2 Press the CATEGORY [▲] and [▼] buttons as many times as necessary to call up Chorus Type.

The currently selected Chorus Type will be displayed.

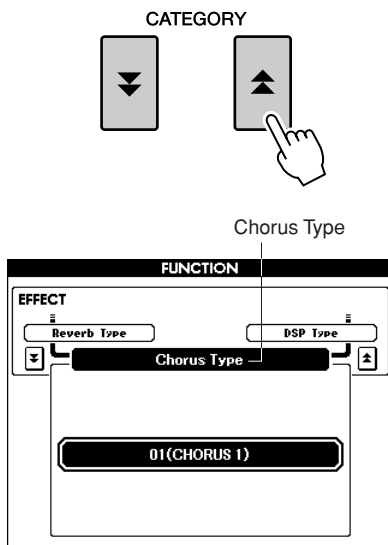

- 3 Use the dial to select a Chorus Type.

You can check the sound of the selected Chorus Type by playing the keyboard.

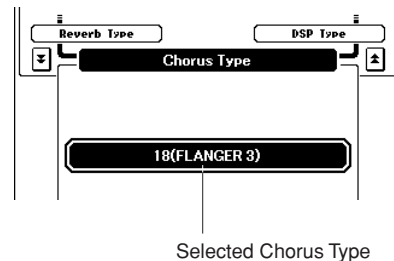
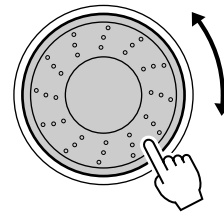

Refer to the Effect Type List on page 111 for information about the available Chorus Types.

### ● Adjusting the Chorus Level

You can individually adjust the amount of Chorus that is applied to the Main, Dual, and Left Voices. (See page 71).

## Panel Sustain

This function adds sustain to the keyboard Voices. Use it when you want to add sustain to the Voices at all times, regardless of footswitch operation. The sustain function does not affect the Left Voice.

**Press the [SUSTAIN] button to turn the sustain function on.**

The [SUSTAIN] button lights indicating that Sustain is on.

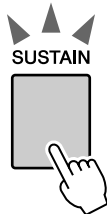

**NOTE**

• For certain Voices, the sustain effect may not be obvious or audible, even when the panel sustain function is turned on.

## Adding DSP

A total of 178 DSP effects can be added to the Main, Dual and Left Voices. These range from reverb-like ambience effects to distortion and other dynamic processing tools that let you enhance the sound, or completely transform it.

**NOTE**

• DSP is term of abbreviated form of Digital Signal Processor and it uses a micro processor to change the audio in various ways.

**1 Use the [DSP] button to turn the DSP function on.**

The [DSP] button lights indicating that DSP is on. To turn DSP off, press the [DSP] button again.

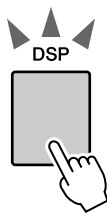

[DSP] button lights when DSP is on.

**NOTE**

- When DSP is turned on, the optimum DSP type for the current Voice is automatically selected.
- The volume of the currently playing Voice changes when turning DSP on or off. This is not a malfunction. The amount of change differs depending on the selected Voice.
- The DSP type is an overall setting—only one type can be selected. For this reason, when you play a newly loaded Song or Style, for example, the currently playing Voices may not sound as expected. This is normal, since the Song or Style has its own DSP type which replaces any selection you've made before loading. A similar phenomenon occurs when you use the [▶▶], [◀◀] buttons or A-B Repeat function during song playback.

**2 Press and hold the [DSP] button for longer than a second.**

The currently selected DSP type will be displayed.

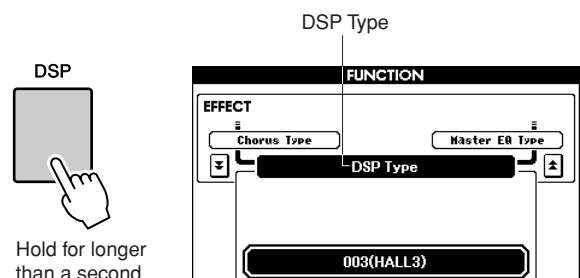

**3 Use the dial to select a DSP type.**

Refer to the DSP Type List on page 111 for information about the available DSP types.

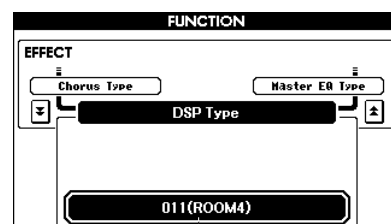
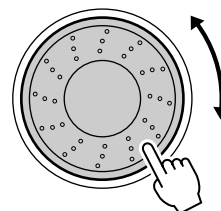

Currently selected DSP type.

## Pitch Bend

The pitch bend wheel can be used to add smooth pitch variations to notes you play on the keyboard. Roll the wheel upward to raise the pitch, or downward to lower the pitch. If you use this feature with a Voice such as the “042 Overdriven” guitar Voice (page 17), you can produce remarkably realistic string-bending effects.

You can change the amount of pitch bend produced by the wheel, as described on page 71.

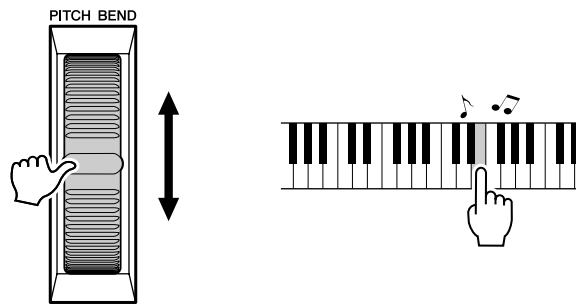

**NOTE**

- Pitch Bend is not applied to the Left Voice when accompaniment is turned on.



# Using Various Functions

## Playing with the metronome

This instrument includes a metronome with adjustable tempo and time signature. Play and set the tempo that is most comfortable for you.

### ■ Turn the metronome on.....

Press the [METRONOME] button to start the metronome.

To stop the metronome, press the [METRONOME] button again.

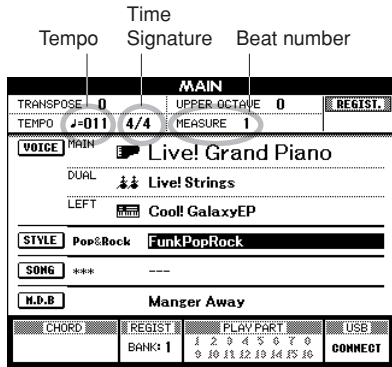
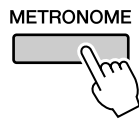

### ■ Set the metronome tempo.....

1 Press the TEMPO [+] / [-] button to call up the tempo setting and use the buttons to raise or lower the tempo.

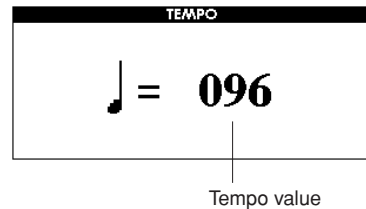
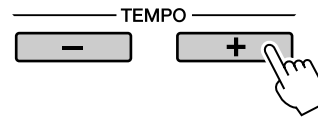

2 Use the dial to select a tempo from 11 to 280.

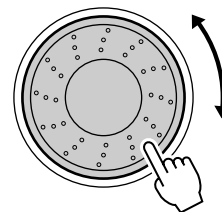

Press the [EXIT] button to return to the Main display.

**NOTE**

- The tempo can be changed by either pressing the TEMPO [+] / [-] buttons repeatedly or holding them down.

## ■ Changing the Time Signature . . .

In this example we'll set up a 3/8 time signature.

### 1 Press and hold the [METRONOME] button for longer than a second.

The currently selected time signature is displayed.

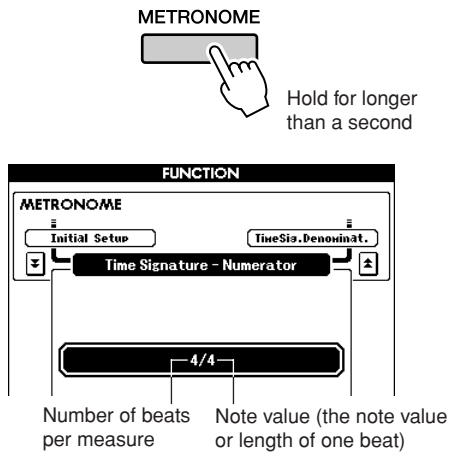

### 2 Use the dial to select the number of beats per measure.

A chime will sound on the first beat of each measure, while a metronome “click” will sound on all others. You can also set the time signature to “00,” in which case the chime will not sound and the “click” sound will be heard on all beats. Up to 60 can be set. Select 3 for this example.

**NOTE**

• When playing the Song or Style the beat value cannot be changed, since the beat is synchronized to the selected Song or Style.

### 3 Press the CATEGORY [▲] button once to call up the Time Signature Denominator display.

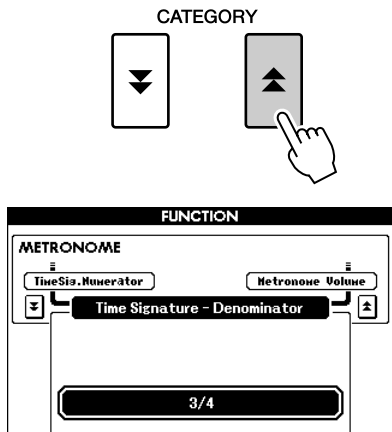

### 4 Use the dial to select a beat length.

Select the required length for each beat: 2, 4, 8, or 16 (half note, quarter note, eighth note, or 16th note). For this example, select 8. The time signature should now be set to 3/8.

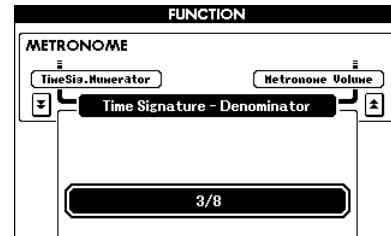

Press the [METRONOME] button to confirm the settings.

## ■ Adjusting the Metronome Volume

### 1 Press the [FUNCTION] button.

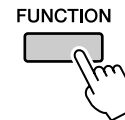

### 2 Press the CATEGORY [▲] and [▼] buttons as many times as necessary to call up Metronome Volume.

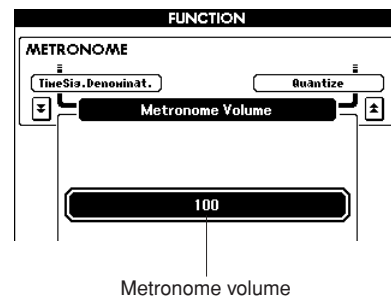
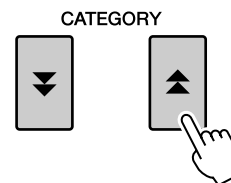

### 3 Use the dial to set the metronome volume.

## Using Tap Start

You can also set the tempo by simply tapping the [TAP TEMPO] button at the required tempo—four times for time signatures in 4, and three times for time signatures in 3.

You can change the tempo during Song or Style playback by pressing the button just twice.

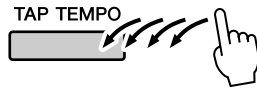

## Touch Response

### ■ Turning Touch Response on/off. .

Keyboard Touch Response can be turned on by pressing the [TOUCH] button.

When Touch Response is on you can control the volume of notes according to how hard you play the keys.

The [TOUCH] button lights indicating Touch Response is turned on.

To turn Touch Response off, press the [TOUCH] button again.

When Touch Response is off, the same volume will be produced no matter how hard or soft you play the keys.

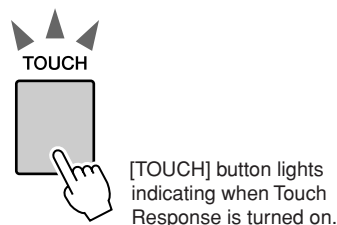

### ■ Adjusting the Touch Response Sensitivity . . . . .

The sensitivity of the keyboard's Touch Response can be adjusted in three steps (1–3). The higher the number, the greater the volume variation produced by the variation in how hard you play the keys—i.e., the keyboard becomes more “sensitive.”

#### 1 Press the [FUNCTION] button to call up the FUNCTION display.

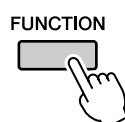

#### 2 Press the CATEGORY [▲] and [▼] buttons as many times as necessary to call up Touch Sensitivity.

The name of the currently selected sensitivity number is displayed.

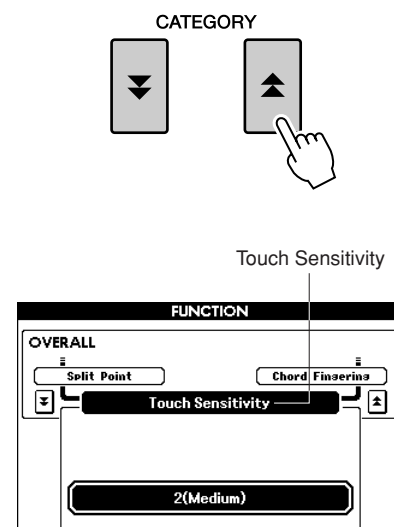

#### 3 Use the dial to select a Touch Sensitivity setting between 1 and 3. Higher values produce greater (easier) volume variation in response to keyboard dynamics—i.e., greater sensitivity.

##### NOTE

• The initial default setting is 2.

## EQ settings

Five pre-programmed EQ settings are available. Settings 1 and 2 are best for listening via the instrument's built-in speakers, setting 3 is for headphones, and settings 4 and 5 are ideal for listening via external speakers or when connecting to an external mixer.

### 1 Press the [FUNCTION] button.

The currently selected function will appear in the display.

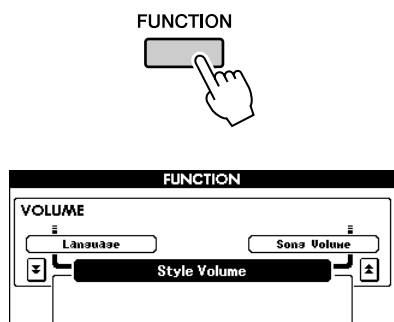

### 2 Press the CATEGORY [▲] and [▼] buttons as many times as necessary to call up Master EQ Type.

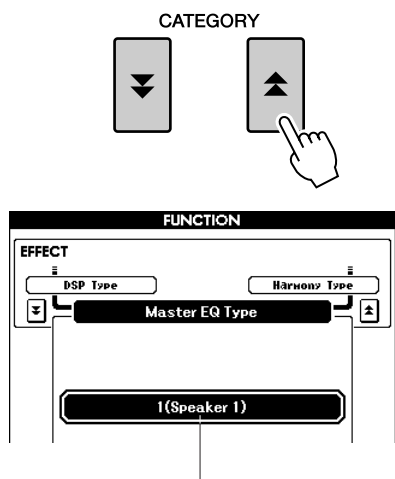

The currently selected EQ type will appear.

### 3 Use the dial to select an EQ Setting for the best sound.

## Pitch Controls

### ◆ Large Pitch Changes (Transpose)

The overall pitch of the instrument can be shifted up or down by a maximum of one octave in semitone increments.

#### 1 Press one of the TRANSPOSE [+] / [-] buttons.

The value is shown in the display, indicating the amount of transposition over or below the normal value.

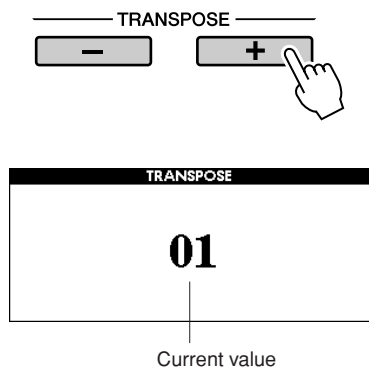

#### 2 Use the dial to set the transpose value between -12 and +12 as required.

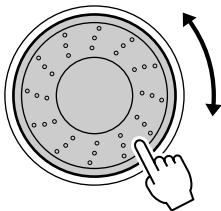

#### NOTE

• This setting does not affect Drum Kit Voices.

Press the [EXIT] button to return to the Main display.

Pressing the TRANSPOSE [+] / [-] buttons allows single-step changes. Pressing and holding either TRANSPOSE [+] / [-] button continuously increases or decreases the value.

### ◆ Small Pitch Changes (Tuning)

The overall tuning of the instrument can be shifted up or down by a maximum of 1 semitone in approximately 0.2-Hz steps. The default setting is 440 Hz.

#### 1 Press the [FUNCTION] button.

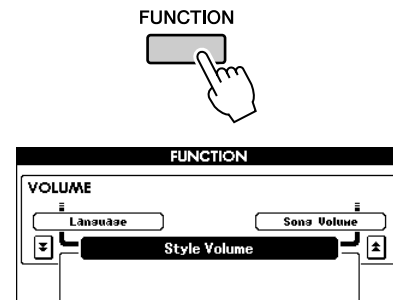

#### 2 Press the CATEGORY [▲] and [▼] buttons as many times as necessary to call up Tuning.

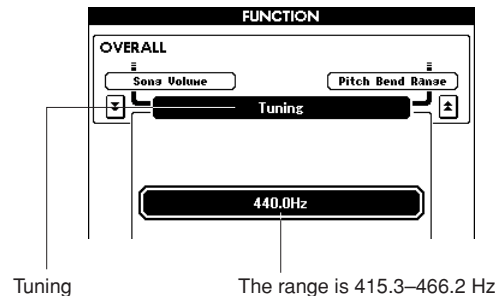

#### 3 Use the dial to set the tuning value between 415.3–466.2Hz as required.

#### NOTE

• This setting does not affect Drum Kit Voices.

## Changing the pitch of the instrument in octaves

You can change the playing pitch of the Main and Dual Voices in octave intervals.

### 1 Press the UPPER OCTAVE [+] button to raise the pitch by one octave.

The newly changed value is shown in the LCD. Press the [EXIT] button to return to the Main display.

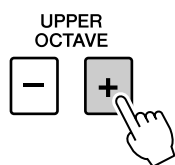

● In the case of UPPER OCTAVE +1 One octave up

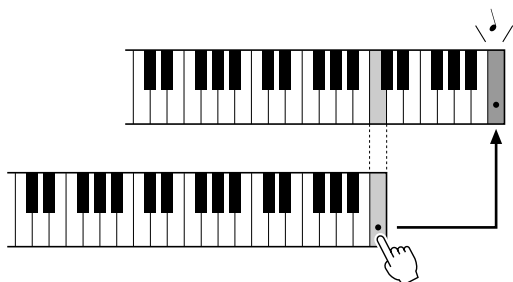

**NOTE**

• When a Drum Kit is selected, each percussion Voice assigned to the keyboard are shifted in location but not pitch.

### 2 Press the UPPER OCTAVE [-] button to lower the pitch by one octave.

The newly changed value—now one octave lower—is shown in the LCD.

Press the UPPER OCTAVE [-] button again to lower the pitch one more octave.

Press the [EXIT] button to return to the Main display.



● In the case of UPPER OCTAVE -1

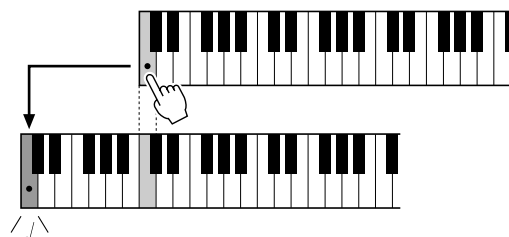

One octave down

# Style (Auto Accompaniment) Functions

Basic operation of the Style (Auto Accompaniment) feature is described on page 22 of the Quick Guide.

Included here is information on how you can play the Styles in various ways, how to adjust the Style volume, how you can play chords using the Styles, and more.

## Pattern Variation (sections)

The instrument features a wide variety of Style “sections” that allow you to vary the arrangement of the accompaniment to match the Song you are playing.

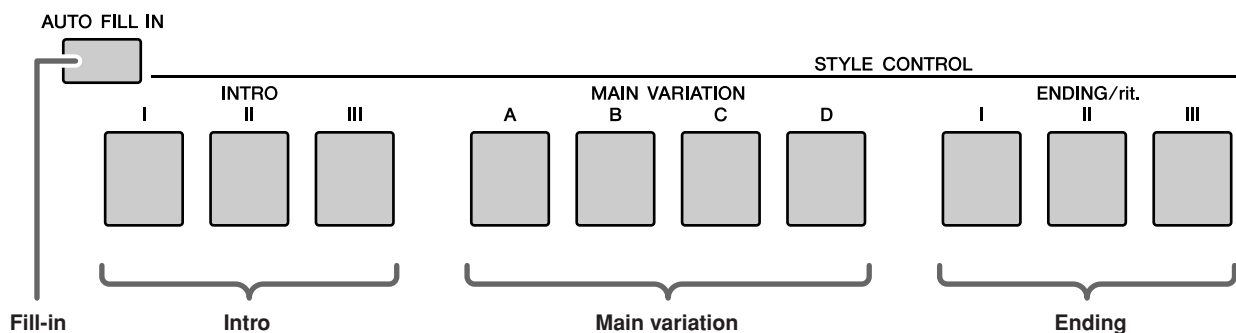

### ●INTRO section

This is used for the beginning of the Song. When the intro finishes playing, accompaniment shifts to the main section. The length of the intro (in measures) differs depending on the selected Style.

### ●MAIN VARIATION section

This is used for playing the main part of the Song. It plays a main accompaniment pattern, and repeats indefinitely until another section’s button is pressed. There are four variations on the basic pattern (A–D), and the Style playback sound changes harmonically based on the chords you play with your left hand.

### ●ENDING section

This is used for the ending of the Song. When the ending is finished, the Auto Accompaniment stops automatically. The length of the ending (in measures) differs depending on the selected Style.

### ●AUTO Fill-in section

This is automatically added before the current section changes to a newly selected section.

**1** Select the desired Style. (See page 22.)

**2** Press the [ACMP] button to turn Auto Accompaniment on.

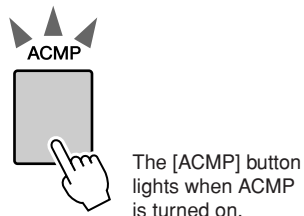

**3** Press the [AUTO FILL IN] button to turn the Auto Fill In function on.

The initial default setting for Auto Fill In is “on.”



**4** Press the [SYNC START] button to turn Synchro Start on.

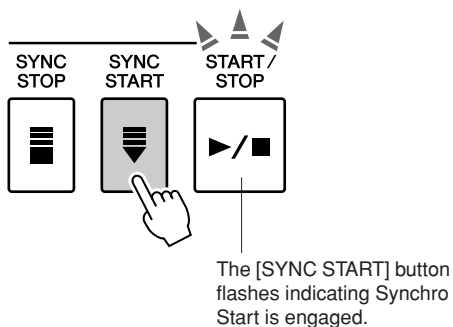

### ● Synchro Start

When Synchro Start is on you, can start the Style by playing any key in the accompaniment range of the keyboard.

**5** Press one of the MAIN VARIATION [A]–[D] buttons.

The selected Main Variation button flashes.

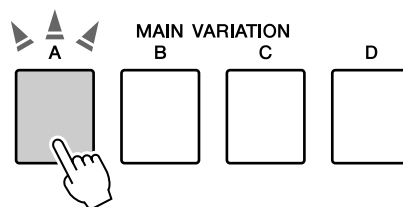

**6** Press one of the INTRO [I]–[III] buttons.

The selected Intro button lights.

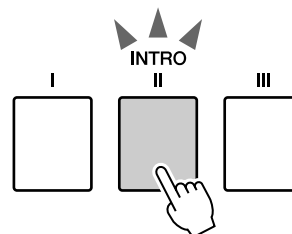

**7** Play a chord in the accompaniment range and start the Intro section.

Try playing a C major chord. (See “Playing Auto-accompaniment Chords” on page 25.)

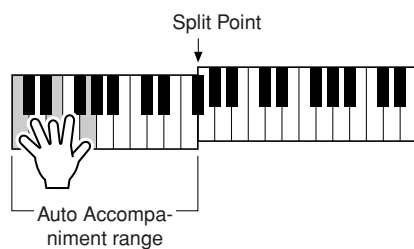

**NOTE**

- The Baroque Air Style in the MOVIE & SHOW category does not have a Rhythm part, so there is no rhythm sound for this Style. Also, this Style does not have a Fill-In section.



- 8** Press one of the **MAIN VARIATION [A]–[D]** buttons.

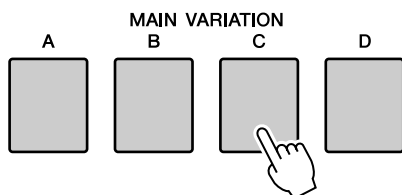

When the fill-in is finished, it leads smoothly into the selected Main section A–D.

- 9** Press one of the **ENDING/rit. [I]–[III]** buttons.

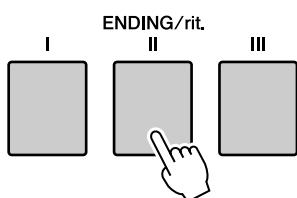

This switches to the Ending section. When the Ending is finished, the Auto Accompaniment stops automatically. You can have the Ending gradually slow down (ritardando) by pressing one of the ENDING/rit. [I]–[III] buttons again while the Ending is playing back.

### ● Synchro Stop

When this function is selected, the accompaniment Style will only play while you are playing chords in the accompaniment range of the keyboard.

Style playback will stop when you release the keys. To turn the function on, press the [SYNC STOP] button.

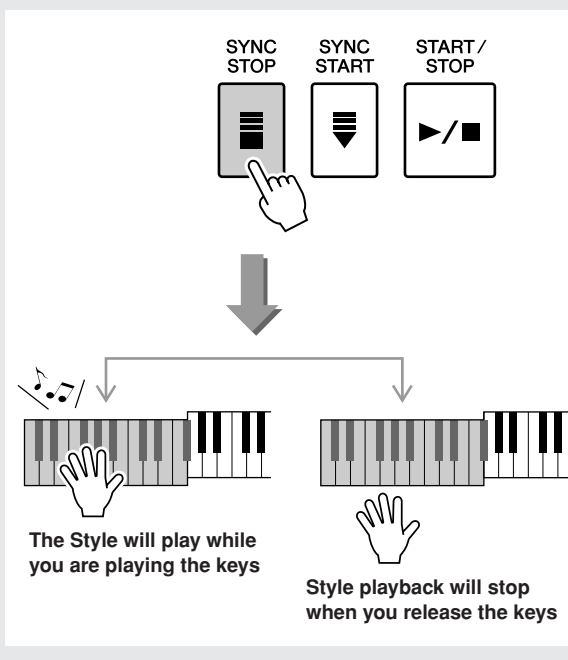

## One Touch Setting

Sometimes selecting the ideal Voice to play with a Song or Style can be confusing. The One Touch Setting feature automatically selects four ideally matched Voices for the Style you've selected.

**1** Select the desired Style. (See page 22.)

**2** Press one of the ONE TOUCH SETTING [1]–[4] buttons.

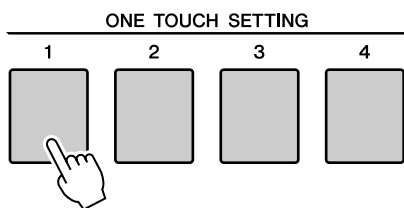

**3** Play the chord in the accompaniment range and start the Style.

Try selecting other ONE TOUCH SETTING [1]–[4] buttons and listen to the results.

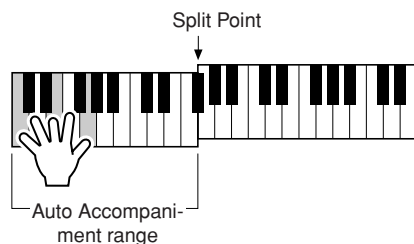

## Variation Change and OTS (OTS LINK)

When change the MAIN VARIATION [A]–[D] to other MAIN VARIATION [A]–[D] during OTS LINK is on, OTS 1–4 automatically change the number according to the selected variation number. (see below)

Press the [OTS LINK] button to turn on the OTS link.

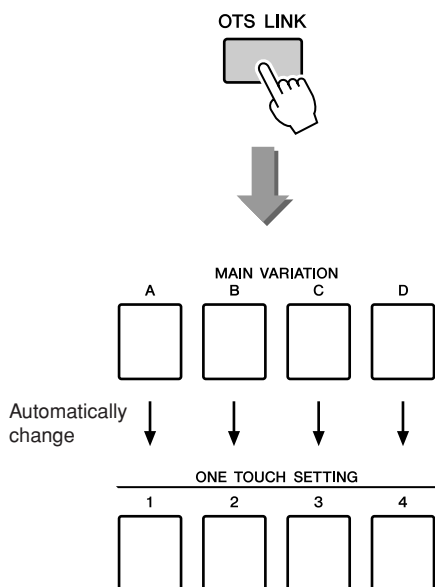

## Setting the Split Point

The initial default Split Point is key number 54 (the F#2 key), but you can change it to another key using the procedure described below.

### 1 Press the [FUNCTION] button.

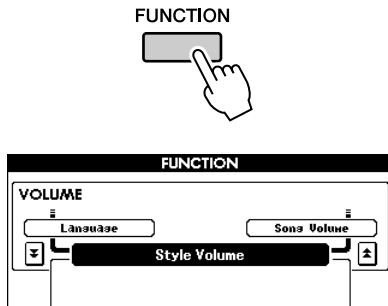

### 2 Use the CATEGORY [▲] and [▼] buttons as many times as necessary to call up Split Point.

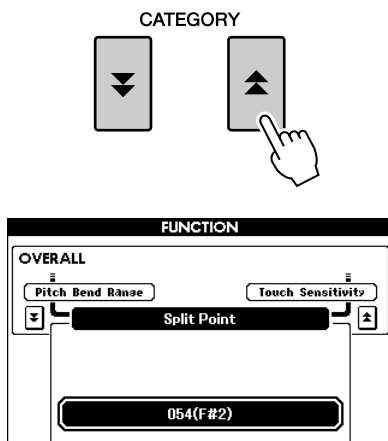

### 3 Use the dial to set the Split Point to any key from 000 (C-2) through 127 (G8).

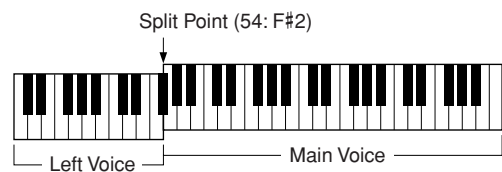

#### NOTE

- Changing the Split Point here also changes the Auto Accompaniment Split Point.
- The Left Voice sounds when the split-point key is played.

## Playing a Style with Chords but without Rhythm (Stop Accompaniment)

When Auto Accompaniment is on (ACMP button lights) and Synchro Start is off, you can play chords in the left-hand accompaniment range of the keyboard while the Style is stopped and still hear the accompaniment chords. This is called “Stop Accompaniment,” and any of the chord fingerings recognized by the instrument can be used (page 25).

Select a Style, then press the [ACMP] button to turn Auto Accompaniment on.

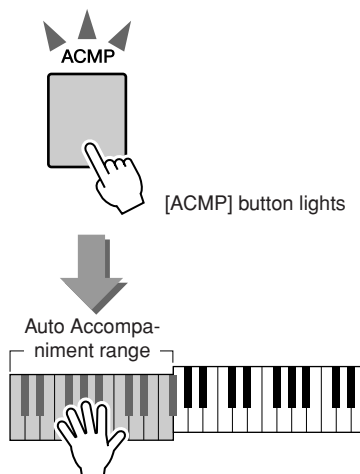

## Adjusting the Style Volume

If the instrument is in the Song mode, press one of the Style category buttons to enter the Style mode. (page 22)

**1** Press the [FUNCTION] button.

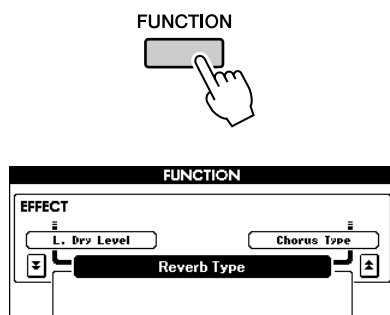

**2** Use the CATEGORY [▲] and [▼] buttons as many times as necessary to call up Style Volume.

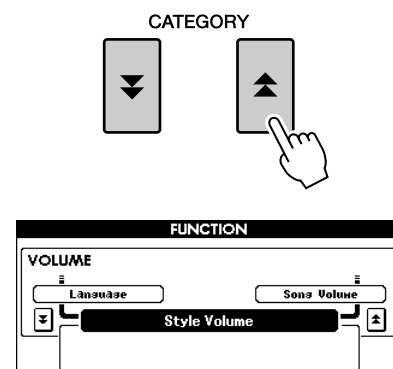

**3** Use the dial to set the Style Volume between 000 and 127.

## Chord Basics

Two or more notes played together constitute a “chord”.

The most basic chord type is the “triad” consisting of three notes: the root, third, and fifth degrees of the corresponding scale. A C major triad, for example, is made up of the notes C (the root), E (the third note of the C major scale), and G (the fifth note of the C major scale).

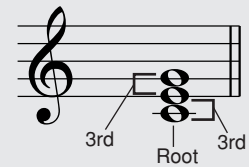

In the C major triad shown above, the lowest note is the “root” of the chord (this is the chord’s “root position” ... using other chord notes for the lowest note results in “inversions”). The root is the central sound of the chord, which supports and anchors the other chord notes. The distance (interval) between adjacent notes of a triad in root position is either a major or minor third.

Major third—four half steps (semitones)

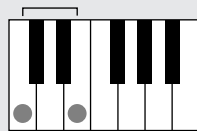

Minor third—three half steps (semitones)

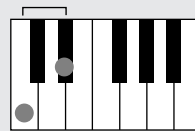

The lowest interval in our root-position triad (between the root and the third) determines whether the triad is a major or minor chord, and we can shift the highest note up or down by a semitone to produce two additional chords, as shown below.

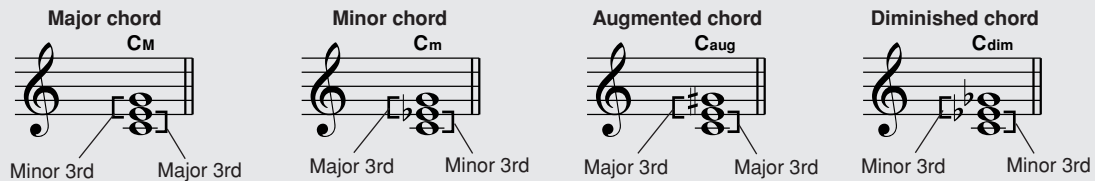

The basic characteristics of the chord sound remain intact even if we change the order of the notes to create different inversions. Successive chords in a chord progression can be smoothly connected, for example, by choosing the appropriate inversions (or chord “voicings”).

### ● Reading Chord Names

Chord names tell you just about everything you need to know about a chord (other than the inversion/voicing). The chord name tells you what the root of the chord is, whether it is a major, minor, or diminished chord, whether it requires a major or flatted seventh, what alterations or tensions it uses ... all at a glance.

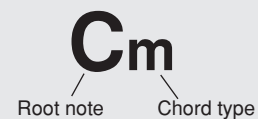

### ● Some Chord Types (These are just some of the “Standard” chord types recognized by the PSR-S500.)

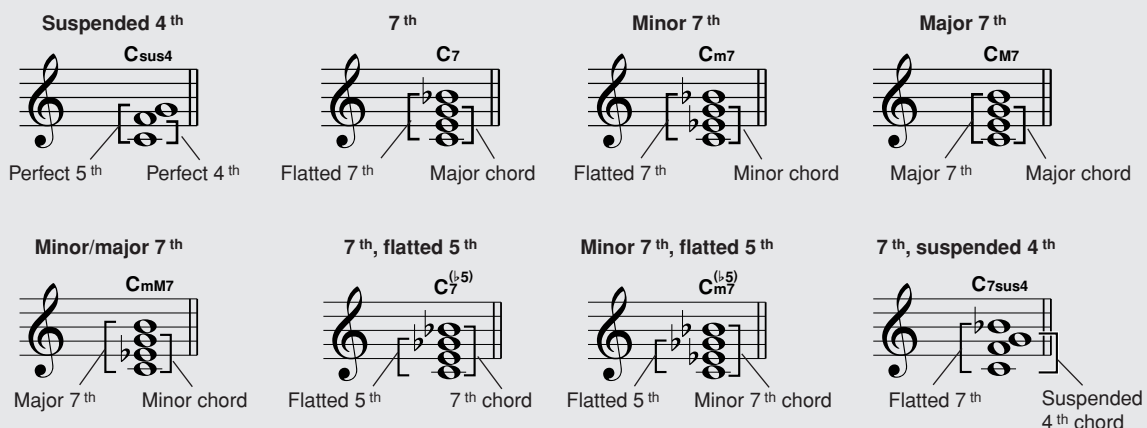

## ■ Recognized Standard Chords.....

All chords in the chart are “C-root” chords.

Chord Name/[Abbreviation]	Normal Voicing	Chord (C)	Display
Major [M]	1 - 3 - 5	C	C
Add ninth [(9)]	1 - 2 - 3 - 5	C <sup>(9)</sup>	Cadd9
Sixth [6]	1 - (3) - 5 - 6	C <sub>6</sub>	C6
Sixth ninth [6(9)]	1 - 2 - 3 - (5) - 6	C <sub>6</sub> <sup>(9)</sup>	C6 <sup>9</sup>
Major seventh [M7]	1 - 3 - (5) - 7	CM7	CM7
Major seventh ninth [M7(9)]	1 - 2 - 3 - (5) - 7	CM <sub>7</sub> <sup>(9)</sup>	CM7 <sup>9</sup>
Major seventh add sharp eleventh [M7(#11)]	1 - (2) - 3 - #4 - 5 - 7 or 1 - 2 - 3 - #4 - (5) - 7	CM <sub>7</sub> <sup>(#11)</sup>	CM7#11
Flatted fifth [(b5)]	1 - 3 - b5	C <sup>(b5)</sup>	C <sup>b5</sup>
Major seventh flatted fifth [M7b5]	1 - 3 - b5 - 7	CM <sub>7</sub> <sup>(b5)</sup>	CM7 <sup>b5</sup>
Suspended fourth [sus4]	1 - 4 - 5	C <sub>sus4</sub>	Csus4
Augmented [aug]	1 - 3 - #5	C <sub>aug</sub>	Caug
Major seventh augmented [M7aug]	1 - (3) - #5 - 7	CM <sub>7aug</sub>	CM7aug
Minor [m]	1 - b3 - 5	C <sub>m</sub>	Cm
Minor add ninth [m(9)]	1 - 2 - b3 - 5	C <sub>m</sub> <sup>(9)</sup>	Cm add9
Minor sixth [m6]	1 - b3 - 5 - 6	C <sub>m6</sub>	Cm6
Minor seventh [m7]	1 - b3 - (5) - b7	C <sub>m7</sub>	Cm7
Minor seventh ninth [m7(9)]	1 - 2 - b3 - (5) - b7	C <sub>m7</sub> <sup>(9)</sup>	Cm7 <sup>9</sup>
Minor seventh add eleventh [m7(11)]	1 - (2) - b3 - 4 - 5 - (b7)	C <sub>m7</sub> <sup>(11)</sup>	Cm7 <sup>11</sup>
Minor major seventh [mM7]	1 - b3 - (5) - 7	C <sub>mM7</sub>	CmM7
Minor major seventh ninth [mM7(9)]	1 - 2 - b3 - (5) - 7	C <sub>mM7</sub> <sup>(9)</sup>	CmM7 <sup>9</sup>
Minor seventh flatted fifth [m7b5]	1 - b3 - b5 - b7	C <sub>m7</sub> <sup>(b5)</sup>	Cm7 <sup>b5</sup>
Minor major seventh flatted fifth [mM7b5]	1 - b3 - b5 - 7	C <sub>mM7</sub> <sup>(b5)</sup>	CmM7 <sup>b5</sup>
Diminished [dim]	1 - b3 - b5	C <sub>dim</sub>	Cdim
Diminished seventh [dim7]	1 - b3 - b5 - 6	C <sub>dim7</sub>	Cdim7
Seventh [7]	1 - 3 - (5) - b7 or 1 - (3) - 5 - b7	C <sub>7</sub>	C7
Seventh flatted ninth [7(b9)]	1 - b2 - 3 - (5) - b7	C <sub>7</sub> <sup>(b9)</sup>	C7 <sup>b9</sup>
Seventh add flatted thirteenth [7(b13)]	1 - 3 - 5 - b6 - b7	C <sub>7</sub> <sup>(b13)</sup>	C7 <sup>b13</sup>
Seventh ninth [7(9)]	1 - 2 - 3 - (5) - b7	C <sub>7</sub> <sup>(9)</sup>	C7 <sup>9</sup>
Seventh add sharp eleventh [7(#11)]	1 - (2) - 3 - #4 - 5 - b7 or 1 - 2 - 3 - #4 - (5) - b7	C <sub>7</sub> <sup>(#11)</sup>	C7#11
Seventh add thirteenth [7(13)]	1 - 3 - (5) - 6 - b7	C <sub>7</sub> <sup>(13)</sup>	C7 <sup>13</sup>
Seventh sharp ninth [7(#9)]	1 - #2 - 3 - (5) - b7	C <sub>7</sub> <sup>(#9)</sup>	C7#9
Seventh flatted fifth [7b5]	1 - 3 - b5 - b7	C <sub>7b5</sub>	C7 <sup>b5</sup>
Seventh augmented [7aug]	1 - 3 - #5 - b7	C <sub>7aug</sub>	C7aug
Seventh suspended fourth [7sus4]	1 - 4 - (5) - b7	C <sub>7sus4</sub>	C7sus4
Suspended second [sus2]	1 - 2 - 5	C <sub>sus2</sub>	Csus2

**NOTE** ¶

- Notes in parentheses can be omitted.
- Playing two same root keys in the adjacent octaves produces accompaniment based only on the root.
- A perfect fifth (1 + 5) produces accompaniment based only on the root and fifth which can be used with both major and minor chords.
- The chord fingerings listed are all in “root” position, but other inversions can be used—with the following exceptions: m7, m7b5, 6, m6, sus4, aug, dim7, 7b5, 6(9), sus2.

**NOTE** ¶

- Inversion of the 7sus4 and m7(11) chords are not recognized if the notes shown in parentheses are omitted.
- The auto accompaniment will sometimes not change when related chords are played in sequence (e.g. some minor chords followed by the minor seventh).
- Two-note fingerings will produce a chord based on the previously played chord.

## User Style

This instrument features 11 internal Style categories, but it also allows you to import additional Styles (only those with an “.sty” extension) that you’ve downloaded from the Internet or gotten from other sources, and load them into a User Style and use them in the same way as the internal Styles. For details on loading a Style file, see “Loading User Files and Style Files” on page 78.

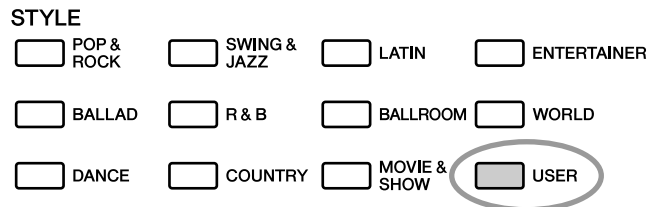

In order to load a Style file it is necessary to first either transfer the Style file to the instrument from a computer, or connect a USB flash memory containing the Style file to the USB TO DEVICE connector. Refer to “Transferring Performance Data to and from a Computer” on page 83 for details on the file transfer procedure.

If you are using a USB flash memory device, refer to “Loading User Files and Style Files” on page 78.

## Playing Styles Using the Entire Keyboard

In “Playing Along with a Style” on page 23 we described two methods of playing Styles (Multi, Full Keyboard) in which chords were either detected only to the left of the keyboard Split Point or over the entire keyboard. By making the settings described below, chord detection for Style accompaniment occurs over the entire range of the keyboard, allowing for even more dynamic Style performance. In this mode only chords played in the normal way (page 25) can be detected.

**1** Press the [ACMP] button for longer than a second.

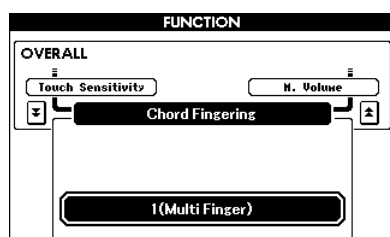
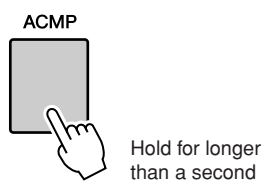

**2** Use the dial to select 2 “FullKeyboard”.

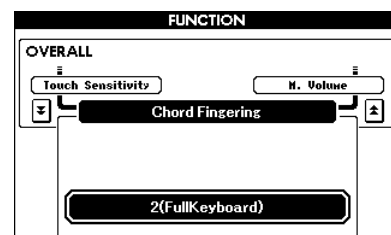
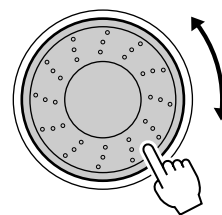

## Song Volumes

**1** Press the [FUNCTION] button.

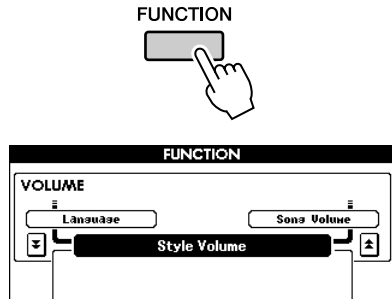

**2** Use the CATEGORY [ $\blacktriangle$ ] and [ $\blacktriangledown$ ] buttons as many times as necessary to call up Song Volume.

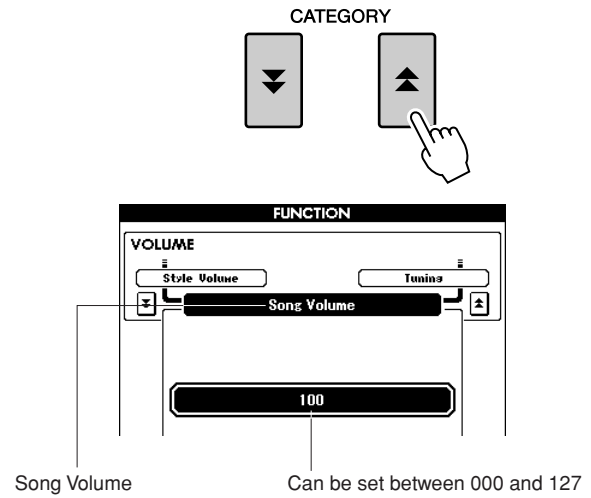

**3** Use the dial to set the Song volume between 000 and 127.

**NOTE**

• Song volume can be adjusted while a Song is selected.

## Changing the Tempo

When playing the Song you can change the tempo as required. Press the TEMPO [+]/[-] buttons. The tempo display will appear and you can use the dial or the TEMPO [+]/[-] buttons to set to tempo to anywhere from 011 and 280 quarter-note beats per minute.

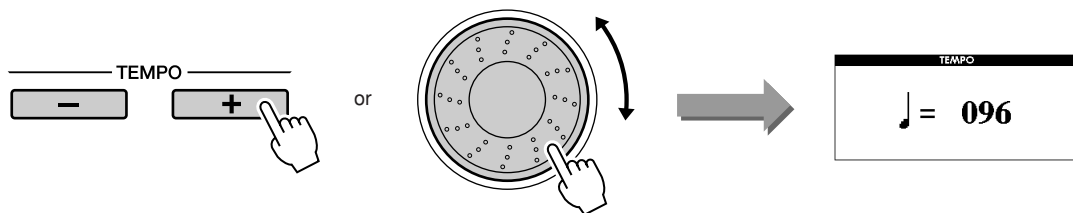

You can return to the original tempo by simultaneously pressing both the TEMPO [+] and [-] buttons. Press the [EXIT] button to return to the Main display. Pressing the TEMPO [+]/[-] buttons allows single-step changes. Pressing and holding either button continuously increases or decreases the value.



## A-B Repeat

You can specify a section of a Song—"A" is the start point and "B" is the end point—for repeat playback. The A-B Repeat function is also very convenient for practicing when used along with the score display features of the instrument (page 30).



- 1 Play the Song (page 27) and press the [A ⇌ B] button at the beginning of the section you want to repeat (the "A" point).

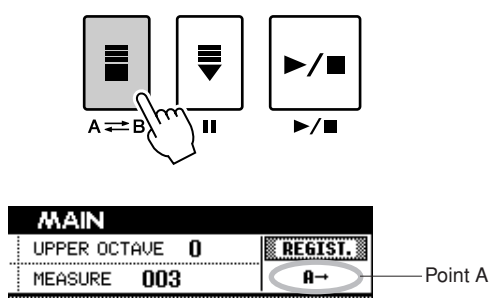

- 2 Press the [A ⇌ B] button a second time at the end of the section you want to repeat (the "B" point).

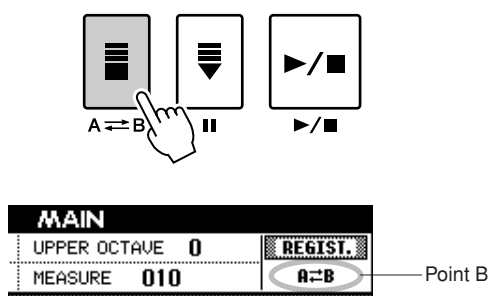

- 3 The specified A-B section of the Song will now play repeatedly.

You can cancel A-B repeat playback at any time by pressing the [A ⇌ B] button.

### NOTE

- The repeat start and end points can be specified in one-measure increments.
- The current measure number is shown in the display during playback.
- If you want to set the start point "A" at the very beginning of the Song press the [A ⇌ B] button before starting playback of the Song.

## Muting Independent Song Parts

Each “track” of a Song plays a different part of the Song—melody, percussion, accompaniment, etc. You can mute individual tracks and play the muted part on the keyboard yourself, or simply mute tracks other than the ones you want to listen to.

Use the [REGIST/TRACK] button to select the TR 1–8, TR 9–16 or ACMP.TR and use the REGISTRATION MEMORY [1]–[8] buttons to mute or un-mute the corresponding tracks ([1]–[8], [9]–[16] or ACMP). The border around the track number in the display disappears when that track is muted. Refer to page 32 for information about the Song track configuration.

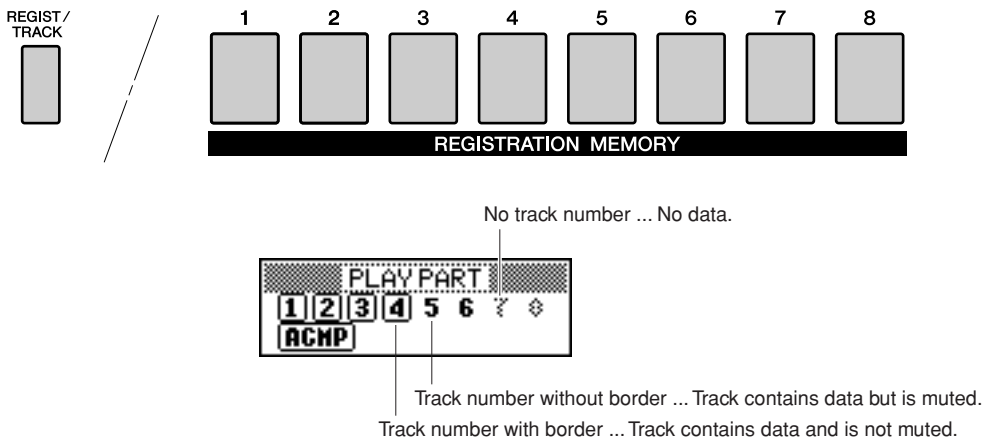

### 1 Press the [REGIST/TRACK] button until the desired track is shown on the display, and then select the track.

The following items appear on the display when you press the [REGIST/TRACK] button. “REGIST” → “TR 1–8” → “TR 9–16” or “ACMP.TR”

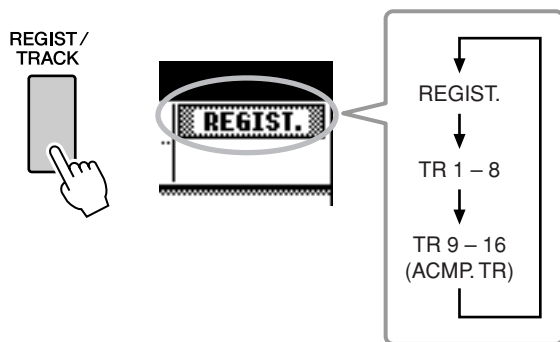

### 2 Press the desired REGISTRATION MEMORY [1]–[8] buttons to set the mute track.

To cancel the mute, press the appropriate REGISTRATION MEMORY [1]–[8] buttons again.

Display	Setting
TR 1–8	Specify the mute tracks of 1–8 by pressing the [1]–[8] buttons.
TR 9–16	Specify the mute tracks of 9–16 by pressing the [1]–[8] buttons.
ACMP.TR	Specify the mute track of ACMP by pressing the [1] button.

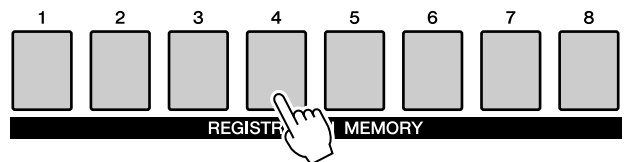

# Memorize Your Favorite Panel Settings

This instrument has a Registration Memory feature that lets you save your favorite settings for easy recall whenever they're needed. Up to 64 complete setups can be saved (8 banks of 8 setups each).

Up to 64 presets (eight banks of eight each) can be memorized.

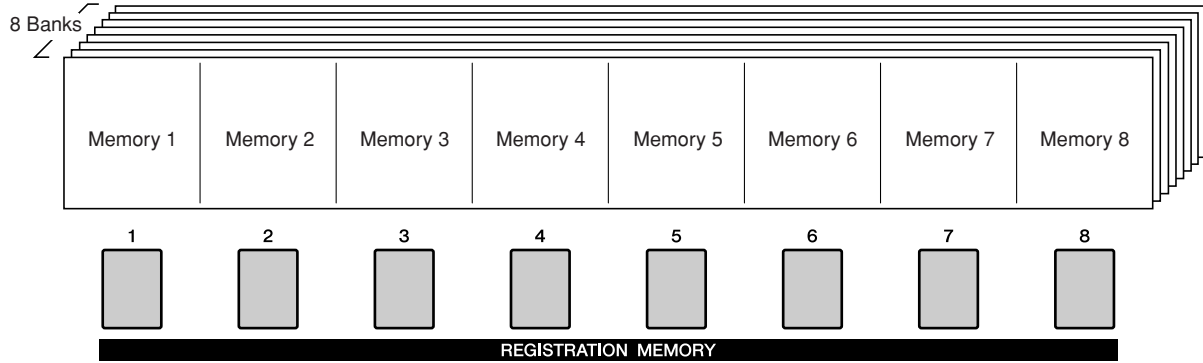

## Saving to the Registration Memory

- 1 Set the panel controls as required—select a Voice, accompaniment Style, etc.
- 2 Press the REGIST BANK [+] / [-] buttons until the desired bank number is shown on the display.  
You can also use the dial in the Bank Select display.

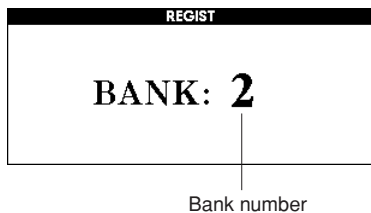
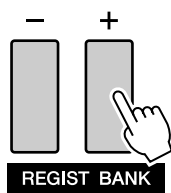

**NOTE**

• Data cannot be saved to the registration memory during Song playback.

- 3 To store the current panel settings, simultaneously hold down the [MEMORY] button and press one of the REGISTRATION MEMORY [1]–[8] buttons.

The button corresponding to the stored Registration lights.

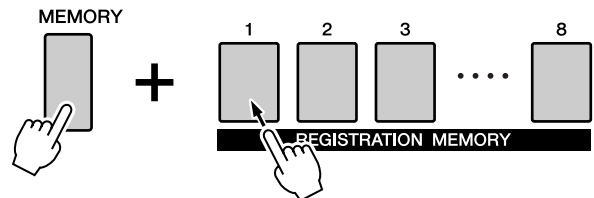

**NOTE**

• You can also save your panel settings memorized to registration memory button into USB flash memory as a user file (see page 76).

**CAUTION**

• If you select a Registration Memory number that already contains data, the previous data is deleted and overwritten by the new data.

**CAUTION**

• Do not turn off the power while saving settings to the registration memory, otherwise the data may be damaged or lost.

## Recalling a Registration Memory

Make sure that “REGIST” appears in the display (press the [REGIST/TRACK] button until it is shown).

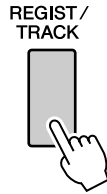

### 1 Press the REGIST BANK [+]/[-] button to select the desired bank.

You can also use the dial to select the bank number.

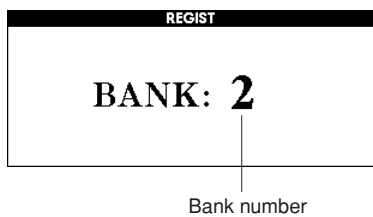
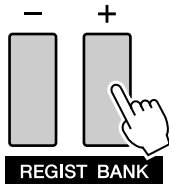

### 2 Press the REGISTRATION MEMORY button, [1]–[8], containing the settings you want to recall. The panel controls will be instantly set accordingly.

The button to which the data is stored lights in green and the currently set button is in red.

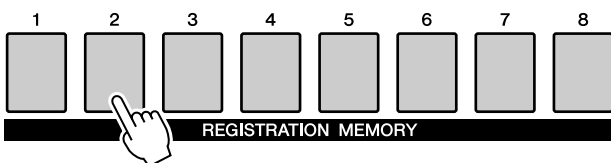

### ● Settings that can be saved to the Registration Memory

#### • Style settings\*

Style number, Auto Accompaniment ON/OFF, Split Point, Style settings (Main A/B), Style Volume, Tempo, Chord Fingering, Upper Octave

#### • Voice settings

Main Voice setting (Voice number, Volume, Octave, Pan, Reverb Level, Chorus Level), Dual Voice settings (Dual ON/OFF, Voice number, Volume, Octave, Pan, Reverb Level, Chorus Level), Left Voice settings (Left ON/OFF, Voice number, Volume, Octave, Pan, Reverb Level, Chorus Level)

#### • Effect settings

Reverb Type, Chorus Type, Panel Sustain ON/OFF

#### • Harmony settings

Harmony ON/OFF, Harmony Type, Harmony Volume

#### • Other settings

Transpose, Pitch Bend Range, Upper Octave

\*Style settings are not available for Registration Memory when using the Song features.

## Registration Clear—Deleting a Specified Registration Memory

Keep in mind that groups of data cannot be deleted or cleared from the instrument at a single time.

- 1 Press the [REGIST/TRACK] button a number of times until the “REGIST.” item appears.**

The item changes in order from “REGIST.” to “TR 1–8” to “ACMP.TR”.

This step is not necessary if the instrument is in the Style mode.

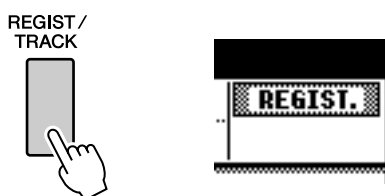

- 2 Press the [REGIST/BANK] button a number of times until the desired bank number appears.**

The Registration Memory button is lit in green if Registration data is stored to the memory.

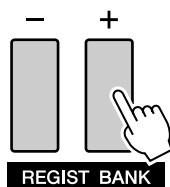

- 3 Press and hold the REGISTRATION MEMORY button corresponding to the Registration you want to clear for longer than a second.**

A confirmation message will appear on the display.

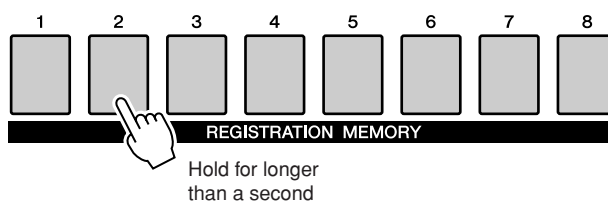

- 4 Press the [+ / YES] button.**

A confirmation message will appear again on the display.

You can cancel the clear operation by pressing the [- / NO] button.

- 5 Press the [+ / YES] button again to clear a Registration Memory.**

The clear-in-progress message will appear briefly on the display while the Song is being cleared.

# The Functions

The “Functions” provide a wide range of both detailed and overall instrument parameters, such as adjusting the tuning, setting the split point, and editing the voices and effects.

## Selecting and Setting Functions

There are 49 function parameters in all.

**1** Find the function you want to set in the list that begins on page 71.

**2** Press the [FUNCTION] button.

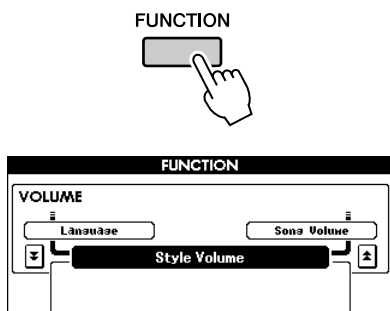

**3** Select a function. Press the CATEGORY [ $\blacktriangle$ ] and [ $\blacktriangledown$ ] buttons as many times as necessary until the function’s display name appears in the display.

Take a look at the function list starting on page 71.

The name of the previous item in the list appears to the upper left, and the name of the next item in the list appears to the upper right of the currently selected item.

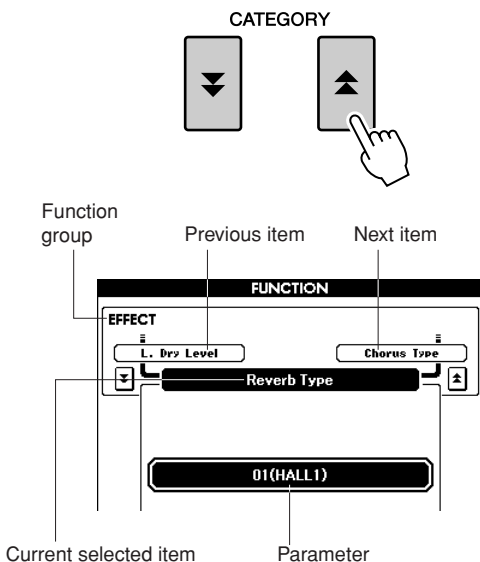

**4** Use the dial or the [+ / YES] and [- / NO] buttons, to set the parameters.

The [+ / YES] and [- / NO] buttons are used to make ON / OFF type settings: [+ / YES] = ON, [- / NO] = OFF.

In some cases, pressing the [+ / YES] button will execute the selected function, and pressing [- / NO] will cancel the selection. Press the [+ / YES] and [- / NO] buttons simultaneously to recall the default setting (excepting the initial setup of MIDI).

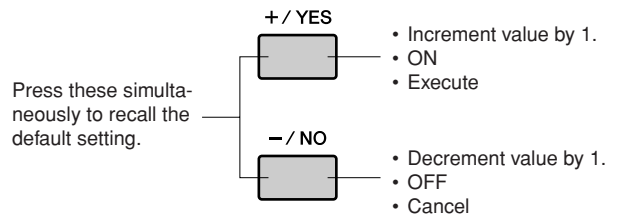

## ■ Function Setting List

Group	Function Item	Display Indication	Range/Settings	Description
VOLUME	Style Volume	Style Volume	000–127	Determines the volume of the Style.
	Song Volume	Song Volume	000–127	Determines the volume of the Song.
OVERALL	Tuning	Tuning	415.3–466.2	Sets the pitch of the instrument's sound in approximately 0.2Hz increments.
	Pitch Bend Range	Pitch Bend Range	01–12	Sets the pitch bend range in semitone increments.
	Split Point	Split Point	000–127 (C-2–G8)	Determines the highest key for the Split voice and sets the Split "point"—in other words, the key that separates the Split (lower) and Main (upper) voices. The Split Point setting and Accompaniment Split Point setting are automatically set to the same value.
	Touch Sensitivity	Touch Sensitivity	1 (Soft), 2 (Medium), 3 (Hard)	Determines the sensitivity of the feature.
	Chord Fingering	Chord Fingering	1 (Multi Finger), 2 (FullKeyboard)	Sets the chord detection mode. In the Multi Finger mode both normal chords and simple chords played to the left of the split point are detected. In the Full Keyboard mode normal chords played anywhere on the keyboard will be detected, and the notes played will sound as well.
MAIN VOICE	Volume	Main Volume	000–127	Determines the volume of the Main voice.
	Octave	Main Octave	-2→+2	Determines the octave range for the Main voice.
	Pan	Main Pan	000 (left)– 64 (center)– 127 (right)	Determines the pan position of the Main voice in the stereo image. The value "0" results in the sound being panned full left; the value "127" results in the sound being panned full right.
	Reverb Level	Main Reverb Level	000–127	Determines how much of the Main voice's signal is sent to the Reverb effect.
	Chorus Level	Main Chorus Level	000–127	Determines how much of the Main voice's signal is sent to the Chorus effect.
	DSP Level	Main DSP Level	000–127	Determines how much of the Main voice's signal is sent to the DSP effect.
	Dry Level	Main Dry Level	000–127	Determines how much of the Main Voice's unprocessed signal sounds (no Reverb, Chorus or DSP effect processing).
DUAL VOICE	Volume	Dual Volume	000–127	Determines the volume of the Dual voice.
	Octave	Dual Octave	-2→+2	Determines the octave range for the Dual voice.
	Pan	Dual Pan	000 (left)– 64 (center)– 127 (right)	Determines the pan position of the Dual voice in the stereo image. The value "0" results in the sound being panned full left; the value "127" results in the sound being panned full right.
	Reverb Level	Dual Reverb Level	000–127	Determines how much of the Dual voice's signal is sent to the Reverb effect.
	Chorus Level	Dual Chorus Level	000–127	Determines how much of the Dual voice's signal is sent to the Chorus effect.
	DSP Level	Dual DSP Level	000–127	Determines how much of the Dual voice's signal is sent to the DSP effect.
	Dry Level	Dual Dry Level	000–127	Determines how much of the Dual Voice's unprocessed signal sounds (no Reverb, Chorus or DSP effect processing).
LEFT VOICE	Volume	Left Volume	000–127	Determines the volume of the Left voice.
	Octave	Left Octave	-2→+2	Determines the octave range for the Left voice.
	Pan	Left Pan	000 (left)– 64 (center)– 127 (right)	Determines the pan position of the Left voice in the stereo image. The value "0" results in the sound being panned full left; the value "127" results in the sound being panned full right.
	Reverb Level	Left Reverb Level	000–127	Determines how much of the Left voice's signal is sent to the Reverb effect.
	Chorus Level	Left Chorus Level	000–127	Determines how much of the Left voice's signal is sent to the Chorus effect.
	DSP Level	Left DSP Level	000–127	Determines how much of the Left voice's signal is sent to the DSP effect.
	Dry Level	Left Dry Level	000–127	Determines how much of the Left Voice's unprocessed signal sounds (no Reverb, Chorus or DSP effect processing).

Group	Function Item	Display Indication	Range/Settings	Description
EFFECT	Reverb Type	Reverb Type	01–26	Determines the Reverb type, including off (26). (See the list on page 110)
	Chorus Type	Chorus Type	1–31	Determines the Chorus type, including off (31). (See the list on page 111)
	DSP Type	DSP Type	001–179	Determines the DSP type, including off (179). (See the list on page 111)
	Master EQ Type	Master EQ Type	1 (Speaker 1), 2 (Speaker 2), 3 (Headphones), 4 (Line Out 1), 5 (Line Out 2)	Sets the equalizer applied to the instrument output (including speakers, headphones or other output) for optimum sound in different listening situations.
HARMONY	Harmony Type	Harmony Type	01–26	Determines the Harmony type. (See the list on page 110)
	Harmony Volume	Harmony Volume	000–127	Determines the volume of the Harmony effect.
PC MODE	PC Mode	PC Mode	PC1/PC2/OFF	Optimizes the MIDI settings for connecting to a computer (page 84).
MIDI	Local ON/OFF	Local	ON/OFF	Determines whether the instrument's keyboard controls the internal tone generator (ON) or not (OFF). (page 83)
	External Clock ON/OFF	External Clock	ON/OFF	Determines whether the instrument synchronizes to the internal clock (OFF) or an external clock (ON). (page 83)
	Keyboard Out	Keyboard Out	ON/OFF	Determines whether keyboard performance data of the instrument is transmitted (ON) or not (OFF).
	Style Out	Style Out	ON/OFF	Determines whether Style data is transmitted (ON) via USB TO HOST or not (OFF) during Style playback.
	Song Out	Song Out	ON/OFF	Determines whether Song data is transmitted (ON) via USB TO HOST or not (OFF) during Song playback.
	Initial Setup	Initial Setup	YES/NO	Allows you to instantly send a data 'snapshot' of all panel settings to a computer or sequencer. Press [+ / YES] to send, or press [- / NO] to cancel.
METRO-NOME	Time Signature Numerator	Time Signature Numerator	00–60	Determines the time signature of the Metronome.
	Time Signature Denominator	Time Signature Denominator	2, 4, 8, 16	Sets the length of each metronome beat.
	Volume	Metronome Volume	000–127	Determines the volume of the Metronome.
SCORE	Quantize	Quantize	1 (1/4 note), 2 (1/4 note triplet), 3 (1/8 note), 4 (1/8 note triplet), 5 (1/16 note), 6 (1/16 note triplet), 7 (1/32 note), 8 (1/32 note triplet)	Depending on the song data, you can make the score more readable by adjusting the timing of the notes. This determines the minimum timing resolution used in the song. For example, if there are both quarter notes and eighth notes in the song, you should set this value to "eighth note." Any notes or rests shorter than this value will not be shown in the score.
	Right-Part	Right-Part	GuideTrack 1–16	Determines the guide track number for your right hand lesson. The setting is only effective for songs in SMF format 0 transferred from USB flash memory.
	Left-Part	Left-Part	GuideTrack 1–16	Determines the guide track number for your left hand lesson. The setting is only effective for songs in SMF format 0 transferred from USB flash memory.
UTILITY	Demo Cancel	Demo Cancel	ON/OFF	Determines whether Demo cancel is enabled or not. When this is set to ON, the Demo Song will not play, even if the [DEMO] button is pressed.
LANGUAGE	Language	Language	English/Japanese	Determines the display language for the demo displays, song file names, lyrics and certain display messages. All other messages and names are displayed in English. When this is set to Japanese, the file names are displayed in the Japanese font. The lyrics display follows the language setting originally made in the song data; however, when no such setting exists, the setting here is used.

\* All these settings can be conveniently reset to their initial default values by pressing the [+ / YES] and [- / NO] buttons simultaneously. (The exception to this is Initial Send, which is an operation, not a setting.)





# Using USB Flash Memory

USB flash memory is a memory medium used for storing data.

When a USB flash memory device is inserted in this instrument's USB TO DEVICE terminal, user songs created on the instrument and the registered settings can be saved to or loaded from the device. USB flash memory can also be used to transfer song data downloaded from the Internet to the instrument. Furthermore, user songs saved to USB flash memory in MIDI file format can also be used with these features.

In this section we'll look at the procedures for setting up and formatting USB flash memory devices, as well as for saving and loading data to and from them.

If you don't have a USB flash memory device, you will need to purchase one (or more, as needed).

The instrument does not necessarily support all commercially available USB storage devices. Yamaha cannot guarantee operation of USB storage devices that you purchase.

Before purchasing a USB storage device, please consult your Yamaha dealer, or an authorized Yamaha distributor (see list at end of the Owner's Manual) for advice.

## USB Flash Memory

Before using a USB device, read through the "Precautions when using the USB TO DEVICE terminal" section on page 82. For information about USB devices compatible with the instrument, see "Connection to a USB Storage Device" on page 80.

### ● To protect your data (write-protect switch)

Some USB flash memory devices are equipped with a write-protect switch. To prevent accidental erasure of important data saved in USB flash memory, slide the write-protect switch on the device to the "protect" position. When saving data, make sure that the write-protect switch is set to the "overwrite" position.

## Using USB Flash Memory

**1** Connect a USB flash memory to the USB TO DEVICE terminal, being careful to insert it in the proper direction. (Do not try to force an improper connection.)

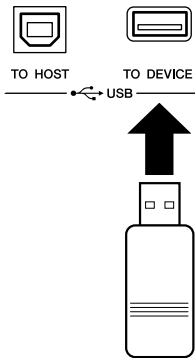

**IMPORTANT**

In order to play songs copied to a USB flash memory from a computer or other device, the songs must be stored either in the USB flash memory's root directory or a first-level/second-level folder in the root directory. Songs stored in these location can be selected and played as USB song (page 28). Songs stored in third-level-folders created inside a second-level folder cannot be selected and played by this instrument.

USB flash memory (Root)

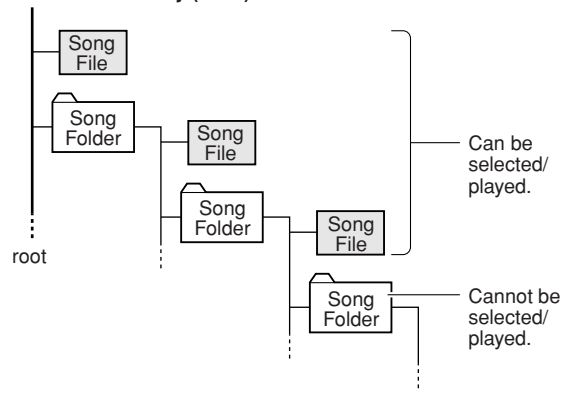

**2** Check that the “CONNECT” message is shown in the MAIN display.

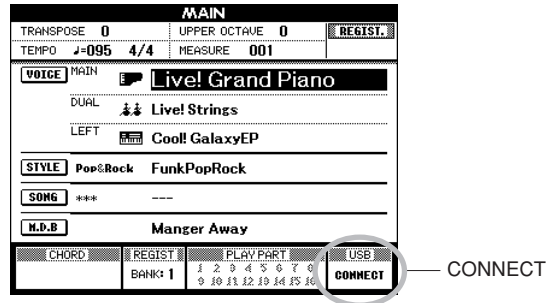

You can go to the FILE CONTROL display from which you can access USB flash memory operations by pressing the [MENU] button from this display. (Do not press this button now, but only when instructed to in the sections below.)

Menu	Reference Page
Format	75
Save	76
SMF Save	77
Load	78
Delete	79

A message (information or confirmation dialog) sometimes appears in the display to facilitate operation. Refer to the “Messages” section on page 96 for an explanation of each message.

**NOTE**

No sound will be produced if you play the keyboard while the FILE CONTROL display is showing. Also, in this state only buttons related to file functions will be active.

**NOTE**

The FILE CONTROL display will not appear in any of the following cases:

- During style or song playback.
- While data is being loaded from a USB flash memory.

## Formatting USB Flash Memory

A new USB flash memory device must be formatted before it can be used by this instrument.

### **CAUTION**

- If you format a USB flash memory that already contains data, all of the data will be erased. Be careful not to erase important data when using the format function.

**1** After connecting the USB flash memory to be formatted to the instrument's USB TO DEVICE terminal, check that the "CONNECT" message is shown in the MAIN display.

**2** Press the FILE MENU [MENU] button.

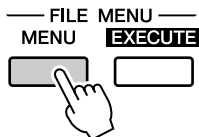

**3** Use the CATEGORY [▲] and [▼] buttons to select the Format item.

The display prompts you for confirmation.

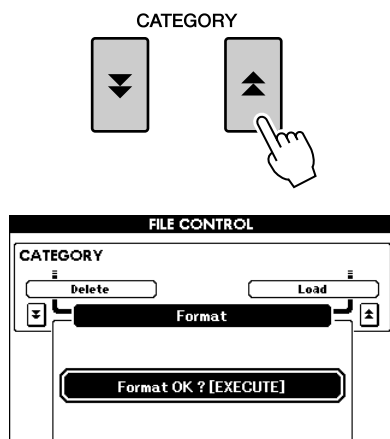

**4** Press the [EXECUTE] button and the display prompts you for confirmation.

You can press the [-/NO] button at this point to cancel the operation.

**5** Press the [EXECUTE] button again, or the [+ /YES] button, and the format operation will begin.

### **CAUTION**

- Once the format-in-progress message appears in the display, the format operation cannot be canceled. Never turn off the power or remove the USB flash memory device during this operation.

**6** A message appears in the display indicating that the operation is complete.

Press the [EXIT] button to return to the MAIN display.

### **NOTE**

- If the USB flash memory device has been write-protected, an appropriate message will appear in the display and you will not be able to execute the operation.

## Saving Data

Three types of data are saved to one “User File” by this operation: user song, style file, and registration memory data. When you save a “User File” the style file and registration memory are also saved automatically.

**1** Make sure that a appropriately formatted USB flash memory device has been properly connected to the instrument’s USB TO DEVICE terminal, and that a “CONNECT” message is shown in the MAIN display.

**2** Press the FILE MENU [MENU] button.

**3** Use the CATEGORY [▲] and [▼] buttons to locate the User File Save item.

A default file name will automatically be created.

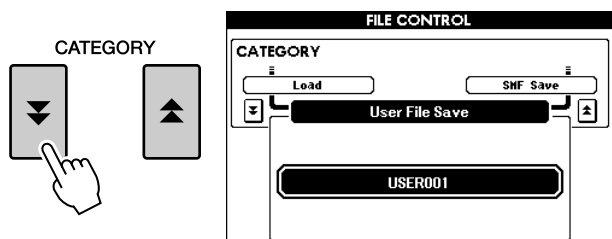

### ● To Overwrite an Existing File

If you want to overwrite a file that already exists on the USB flash memory device, use the dial or the [+ / YES] and [- / NO] buttons to select the file, then skip ahead to step 6.

#### NOTE

- If the USB flash memory has been write-protected, an appropriate message will appear in the display and you will not be able to execute the operation.
- If there is not enough capacity left on the USB flash memory device to save the data, an appropriate message will appear in the display and you will not be able to save the data. Erase unwanted files from the USB flash memory device to make more memory available (page 79), or use a different USB device.
- Refer to the “Messages” list on page 96 for other possible errors that might prevent you from completing the operation.

**4** Press the [EXECUTE] button. A cursor will appear below the first character in the file name.

**5** Change the file name as necessary.

- The [1] button moves the cursor to the left, and the [2] button moves it to the right.
- Use the dial to select a character for the current cursor location.
- The [8] button deletes the character at the cursor location.

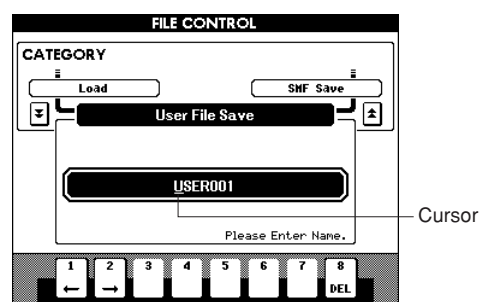
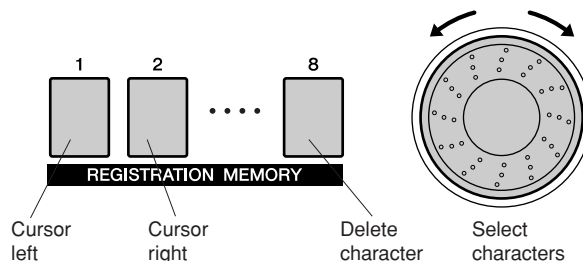

**6** Press the [EXECUTE] button. The display prompts you for confirmation.

You can cancel the save operation at this point by pressing the [- / NO] button.

**7** Press the [EXECUTE] button again, or the [+ / YES] button, and the save operation will begin.

The user song will be stored to the USER FILE folder in the USB flash memory device.

#### CAUTION

- Once the save-in-progress message appears in the display, the operation cannot be canceled. Never turn off the power or remove the USB flash memory device during this operation.

**8** Press the [EXIT] button to return to the MAIN display.

#### NOTE

- If an existing filename is specified the display prompts you for confirmation. Press [EXECUTE] or [+ / YES] if it is OK to overwrite the file, or [- / NO] to cancel.
- The amount of time it will take to perform the save operation depends on the particular USB flash memory device you are using.

## Convert a User Song to SMF Format and Save

This operation converts a user song (song numbers 001–005) to SMF Format 0 and saves the file to USB flash memory.

### ● What is SMF (Standard MIDI File)?

The SMF (Standard MIDI File) format is one of the most common and widely compatible sequence formats used for storing sequence data. There are two variations: Format 0 and Format 1. A large number of MIDI devices are compatible with SMF Format 0, and most commercially available MIDI sequence data is provided in SMF Format 0.

**1** Make sure that a properly formatted USB flash memory device has been properly connected to the instrument's USB TO DEVICE terminal, and that the "CONNECT" message is shown in the MAIN display.

**2** Press the FILE MENU [MENU] button.

**3** Use the CATEGORY [▲] and [▼] buttons to locate the SMF Save item.

The SOURCE FILE—a user song name—will be highlighted.

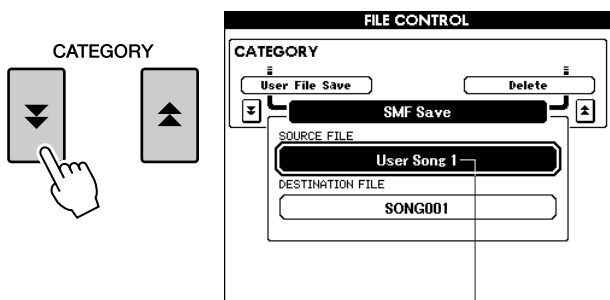

The source user song name.

**4** Use the dial to select the source user song.

You can press the [+ / YES] and [- / NO] buttons simultaneously to select the first user song.

**5** Press the [EXECUTE] button.

The DESTINATION SONG will be highlighted, and a default name will appear for the converted song file.

### ● To Overwrite an Existing File

If you want to overwrite a file that already exists on the USB flash memory device, use the dial or the [+ / YES] and [- / NO] buttons to select the file, then skip ahead to step 7.

**6** Press the [EXECUTE] button. A cursor will appear below the first character in the file name.

**7** Change the file name as necessary.

Refer to "Saving Data" on page 76 for filename entry.

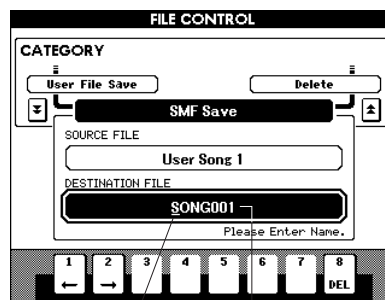

Cursor The name of the file to be saved

**8** Press the [EXECUTE] button. The display prompts you for confirmation.

You can cancel the save operation at this point by pressing the [- / NO] button.

**9** Press the [EXECUTE] button again, or the [+ / YES] button, and the save operation will begin.

The user song will be stored to the USER FILE folder in the USB flash memory device.

### ⚠ CAUTION

- Once the save-in-progress message appears in the display, the operation cannot be canceled. Never turn off the power or remove the USB flash memory during this operation.

**10** A message appears in the display indicating that the operation is complete.

Press the [EXIT] button to return to the MAIN display.

### NOTE

- If an existing filename is specified, the display prompts you for confirmation. Press [EXECUTE] or [+ / YES] if it is OK to overwrite the file, or [- / NO] to cancel.
- The amount of time it will take to perform the save operation depends on the particular USB flash memory device you are using.

## Loading User Files and Style Files

User files and style file residing on a USB flash memory can be loaded to the instrument.

### **CAUTION**

- Save important data to a USB flash memory before loading data that will overwrite it.

- 1 With the USB flash memory device containing the file you want to load connected to the USB TO DEVICE connector, check that the “CONNECT” message is shown in the MAIN display.
- 2 Press the FILE MENU [MENU] button.
- 3 Use the CATEGORY [▲] and [▼] buttons to locate the Load item.

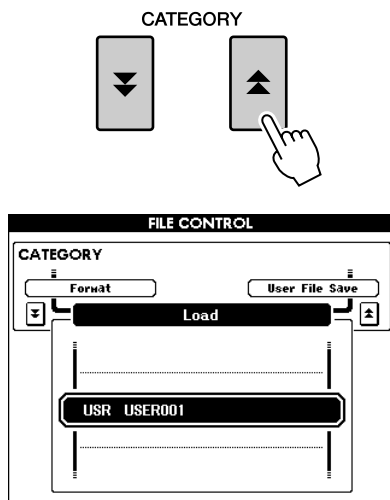

- 4 Use the dial to select the user file or style file you want to load.

All user files in the USB flash memory device will be displayed first, followed by the style files.

### **NOTE**

- Style files must be located in the root directory. Style files located within folders will not be recognized.

- 5 Press the [EXECUTE] button. The display prompts you for confirmation.

You can cancel the load operation at this point by pressing the [-/NO] button.

- 6 Press the [EXECUTE] button again, or the [+ /YES] button, and the load operation will begin.

### **CAUTION**

- Once the load-in-progress message appears in the display, the operation cannot be canceled. Never turn off the power or remove the USB flash memory during this operation.

- 7 A message appears in the display indicating that the operation is complete.

Press the [EXIT] button to return to the MAIN display.

## Deleting Data from USB Flash Memory

This procedure deletes selected user files and SMF files from a USB flash memory device.

- 1 Make sure that the USB flash memory device containing the file(s) you want to delete has been properly connected to the instrument's USB TO DEVICE terminal, and that the "CONNECT" is shown in the MAIN display.
- 2 Press the FILE MENU [MENU] button.
- 3 Use the CATEGORY [▲] and [▼] buttons to locate the Delete item.

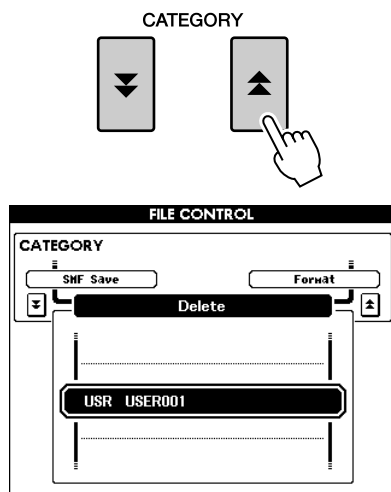

- 4 Select the file you want to delete.

You can press the [+ / YES] and [- / NO] buttons simultaneously to select the first song or user file on the USB flash memory.

- 5 Press the [EXECUTE] button. The display prompts you for confirmation.

You can cancel the delete operation at this point by pressing the [- / NO] button.

- 6 Press the [EXECUTE] button again, or the [+ / YES] button, and the delete operation will begin.

### CAUTION

- Once the delete-in-progress message appears in the display, the operation cannot be canceled. Never turn off the power or remove the USB flash memory during this operation.

- 7 A message appears in the display indicating that the operation is complete.

Press the [EXIT] button to return to the MAIN display.

### NOTE

- If the USB flash memory has been write-protected, an appropriate message will appear in the display and you will not be able to execute the operation.

## Playing Songs Saved to USB Flash Memory

- 1 Make sure that the USB flash memory device containing the song you want to play has been properly connected to the instrument's USB TO DEVICE terminal, and that the "CONNECT" is shown in the MAIN display.
- 2 Press the [USB] button.

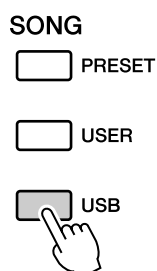

- 3 Use the dial to select the song you want to play.

- 4 Press the [▶/■] button.

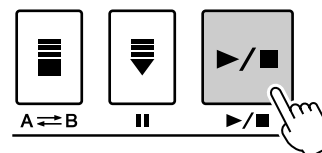

## Connectors

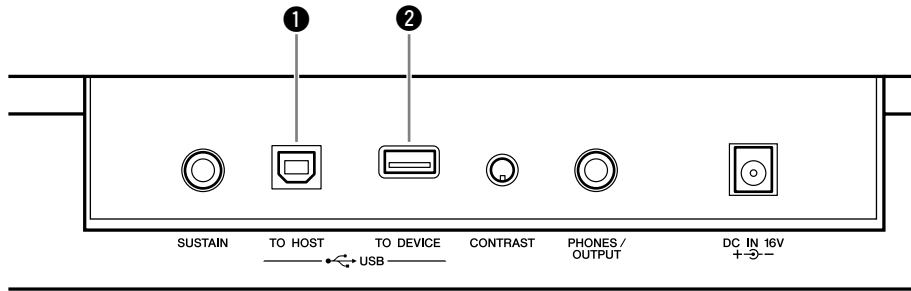

### 1 USB TO HOST terminal

This terminal allows direct connection to a personal computer. Refer to “Connecting a Personal Computer” on page 82 for more information.

### 2 USB TO DEVICE terminal

This terminal allows connection to USB storage devices. Refer to “Connection to a USB Storage Device” below.

## Connection to a USB Storage Device

By connecting the instrument to a USB storage device, you can save data you’ve created, as well as read or play the data from the connected device.

### Compatible USB storage devices .....

A USB storage device, such as a floppy disk drive and flash memory can be connected to the USB TO DEVICE terminal. Other USB devices such as a computer keyboard or mouse cannot be used.

Before purchasing USB storage devices, please consult your Yamaha dealer, or an authorized Yamaha distributor (see list at end of the Owner’s Manual) for advice.

**CAUTION**

- Avoid frequently turning the power on/off to the USB storage device, or connecting/disconnecting the cable too often. Doing so may result in the operation of the instrument “freezing” or hanging up. While the instrument is accessing data (such as in the Save and Delete operations), do NOT unplug the USB cable, do NOT remove the media from the device, and do NOT turn the power off to either device. Doing so may corrupt the data on either or both devices.

### Connection to a USB storage device .....

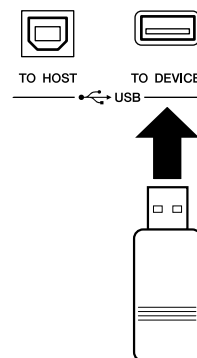

**CAUTION**

- Some USB memory devices may require more current than the instrument can supply, causing the instrument’s over-current protection function to be activated and making it impossible to use the device. If this occurs “OverCurrent” will appear in the lower-right area of the MAIN display. To restore normal operation remove the USB device from the USB TO DEVICE connector and turn the instrument’s power off and then back on again.



### Backing up the instrument data to a computer

Once you've saved data to a USB flash memory device, you can copy the data to the hard disk of your computer, then archive and organize the files as desired. Simply reconnect the device as shown below.

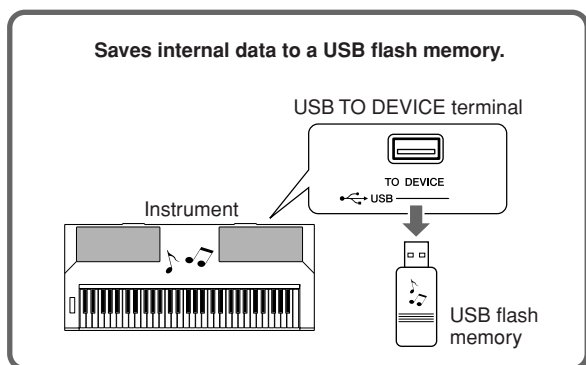

Disconnect the USB flash memory device from the computer and connect it to the instrument.

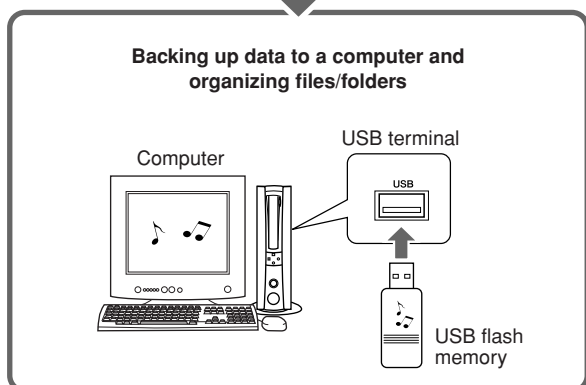

### Copying files from a computer hard disk to USB flash memory and then playing back the songs on the instrument

Files on a computer's hard disk can be transferred to the instrument by first copying them to a USB flash memory device, then connecting/inserting the media to the instrument. User files, style files and MIDI songs can be copied to a USB flash memory device from the hard disk of the computer. Once you've copied the data, connect the device to the USB TO DEVICE terminal of the instrument and play back the MIDI songs, or load the user file or style file on the instrument.

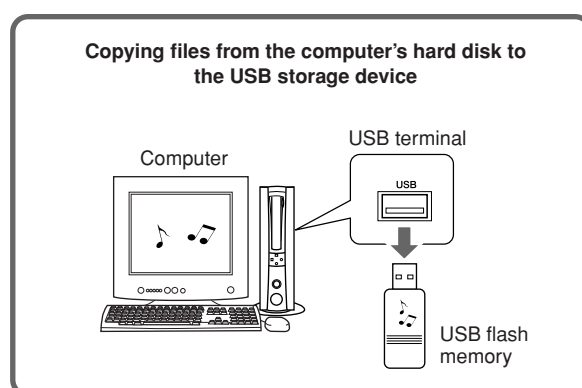

Disconnect the USB storage device from the computer and connect it to the instrument.

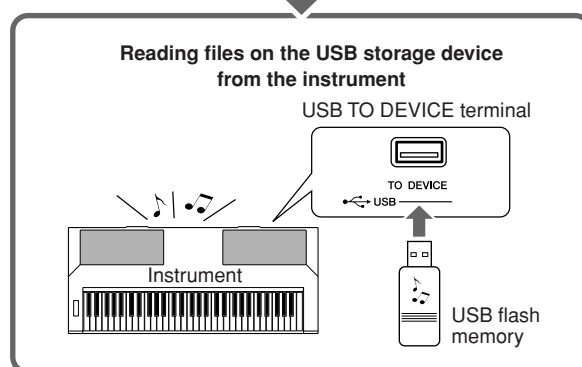

## Connecting a Personal Computer

The following functions become available when this instrument is connected to a computer.

- Performance data can be transferred between the instrument and the computer (page 83).
- Files can be transferred between the instrument and the computer (page 85).

The connection procedure is as follows:

### 1 Install the USB-MIDI driver on your computer.

The USB-MIDI driver is included on the CD-ROM.

Installation of the USB MIDI driver is described on pages 91–92.

### 2 Connect the USB terminal of the computer to the USB terminal on the instrument using a standard USB cable (USB cable sold separately).

The supplied CD-ROM also includes a Musicsoft Downloader application that allows you to transfer song files from your computer to the instrument's flash memory. For instructions about how to install Musicsoft Downloader and how to transfer song files, see pages 85, 92.

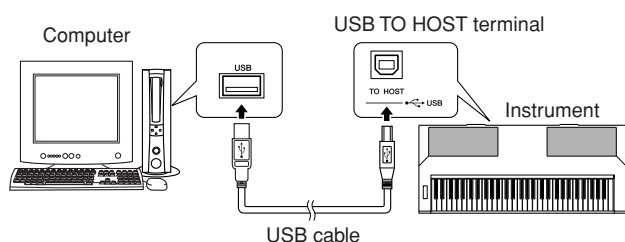

### ■ USB Precautions

Please observe the following precautions when connecting the instrument to a computer via a USB cable.

Failure to do so can cause the instrument and/or the computer to hang up (freeze), possibly causing corruption or loss of data.

If the instrument or computer does hang up, turn the power to both devices off and then on again, and restart the computer.

#### ⚠ CAUTION

- Wake the computer from a sleep/suspended/standby mode before connecting the USB cable.
- Connect the USB cable to the instrument and computer before turning power to the instrument on.
- Check the following points before turning the instrument's power on or off, and before plugging or unplugging the USB cable.
  - Quit all applications.
  - Make sure that no data transfer is in progress. (Data is transferred whenever you play the keyboard or play a song.)
- Allow at least 6 seconds between turning the instrument's power on and off, and between plugging and unplugging the USB cable.
- Directly connect the instrument to the computer using a single USB cable. Do not use a USB hub.

#### NOTE

- The Musicsoft Downloader application may not be able to access the instrument in the following cases:
  - During style playback.
  - During song playback.
  - During a file control operation (while the FILE CONTROL display is showing).

## Transferring Performance Data to and from a Computer

By connecting the instrument to a computer, the instrument's performance data can be used on the computer, and performance data from the computer can be played on the instrument.

- When the instrument is connected with computer, it transmits/receives performance data.

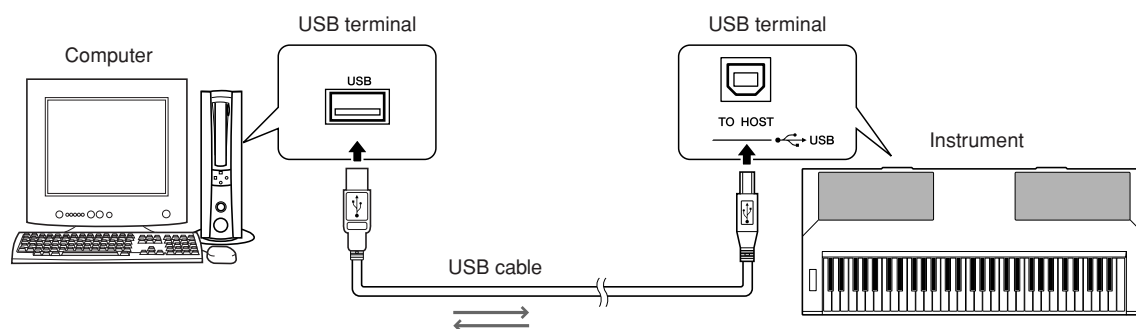

## ■ MIDI settings .....

These settings pertain to performance data transmission and reception.

Item	Range/Settings	Description
Local	ON/OFF	Local control determines whether or not notes played on the instrument are sounded by its internal tone generator system: the internal tone generator is active when local control is on, and inactive when local control is off.
External Clock	ON/OFF	These settings determine whether the instrument is synchronized to its own internal clock (OFF), or to a clock signal from an external device (ON).
Keyboard Out	ON/OFF	These settings determine whether keyboard performance data of the instrument is transmitted (ON) or not (OFF).
Style Out	ON/OFF	These settings determine whether Style data is transmitted (ON) or not (OFF) during Style playback.
Song Out	ON/OFF	These settings determine whether Song data is transmitted (ON) or not (OFF) during Song playback.

### **CAUTION**

- If you can't get any sound out of the instrument, this may be the most likely cause.

### **CAUTION**

- If External Clock is ON and no clock signal is being received from an external device, the song, style, and metronome functions will not start.

- 1 Press the [FUNCTION] button.

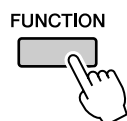

- 2 Use the CATEGORY [▲] and [▼] buttons to select the item you want to change its value.

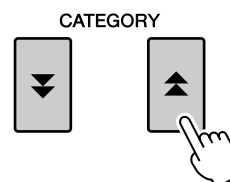

- 3 Use the dial to select ON or OFF.

## ■ PC Mode .....

A number of MIDI settings need to be made when you want to transfer performance data between the computer and the instrument. The PC Mode item can conveniently make multiple settings for you in one operation. Three settings are available: PC1, PC2, and OFF.

This setting is not necessary when transferring song or backup files between the computer and the instrument.

\* Set the PC mode to PC2 when using Digital Music Notebook.

	PC1	PC2*	OFF
Local	OFF	OFF	ON
External Clock	ON	OFF	OFF
Song Out	OFF	OFF	OFF
Style Out	OFF	OFF	OFF
Keyboard Out	OFF	ON	ON

**1** Press and hold the [DEMO] button for longer than a second so that the PC Mode item appears.

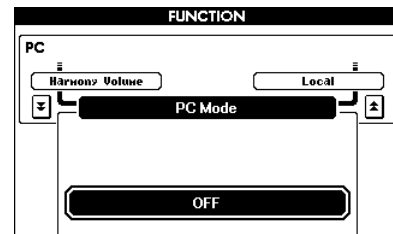
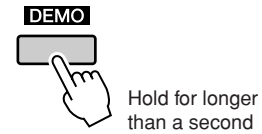

**2** Use the dial to select PC1, PC2, or OFF.

**NOTE**

- When the PC2 setting is selected the instrument's style, song, demo, song recording, and lesson features cannot be used.

**NOTE**

- You can also access the PC Mode item by first pressing the [FUNCTION] button and then using the CATEGORY [▲] and [▼] buttons to locate it (page 70).

## Initial Send

This function lets you send the panel setup data to a computer. Before you record performance data to a sequencer application running on your computer, it is a good idea to first send and record the panel setup data before the actual performance data.

**1** Press the [FUNCTION] button.

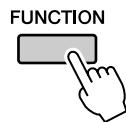

**2** Use the CATEGORY [▲] and [▼] buttons to select the Initial Setup item.

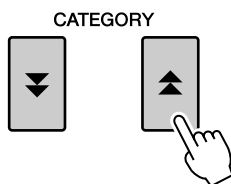

**3** Press [+ / YES] to send, or press [- / NO] to cancel.

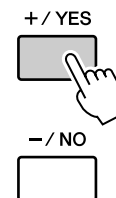

## Transferring Data Between the Computer and Instrument

MIDI songs and Style files stored to a computer can be transferred to the instrument. Backup files can also be transferred from the instrument to the computer and back. In order to transfer songs between your computer and the instrument you will need to install the Musicsoft Downloader application and the USB MIDI Driver included on the Accessory CD-ROM on your computer. Refer to the Accessory CD-ROM Installation Guide on page 88 for installation details.

### ● Data that can be transferred from a computer

- Song Capacity (max.): 512 songs total
- Data Capacity: Internal memory 811 KB
- Data Format: SMF format 0, SMF format 1, style file (extension: .sty), Backup File

#### NOTE

- Even if the number of songs transferred is less than 512, if the amount of data exceeds 811 KB, the song data cannot be transferred to the instrument.

### ■ With the Musicsoft Downloader You Can .....

- Transfer MIDI songs you have downloaded from the Internet or created on your computer from the computer to the instrument's flash memory.

⇒ Refer to the procedure described below.

- Backup files can be transferred from the instrument to a computer and back.

⇒ Refer to the procedure described on page 87.

Use the Musicsoft Downloader application with Internet Explorer 5.5 or higher.

### ■ Use Musicsoft Downloader to Transfer Songs from the Computer to the Instrument's Flash Memory .....

#### NOTE

- If a Song or Style is being played, stop playback before proceeding.

- 1 Install the Musicsoft Downloader and USB MIDI driver to your computer, then connect the computer and the instrument (page 90).

- 2 After selecting the language, double-click the Musicsoft Downloader shortcut icon that is created on the desktop. This will launch the Musicsoft Downloader application and the main window will appear.

#### NOTE

- The instrument cannot be operated while the Musicsoft Downloader is running.

- 3 Click the "Add File" button and the Add File window will appear.

- 4 Click the button to the right of "Look in" and select the folder from the drop-down menu that appears. Double-click the "SongData" Folder on the window. Select the file you want to transfer to the instrument, and click "Open".

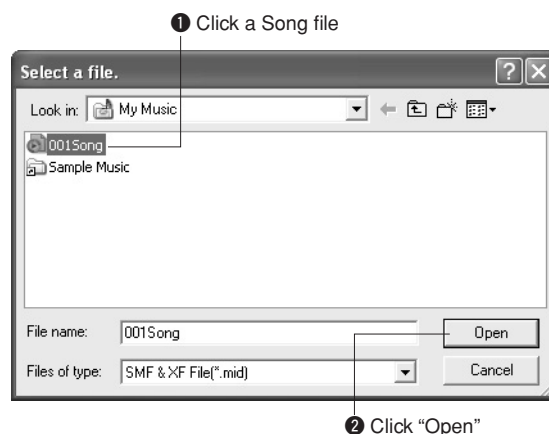

- 5** A copy of the selected MIDI song file will appear in the “List of files stored temporarily” at the top of the window. The memory medium will also be displayed at the bottom of the window to specify the destination for the transfer. Click “Instrument,” and then “Flash memory.”

“Flash memory” here refers to the internal memory of the instrument.

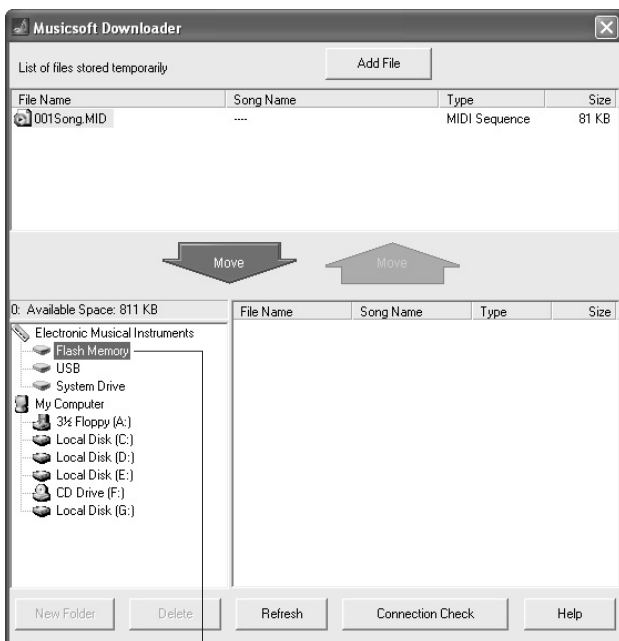

① Click “Electronic Musical Instruments”, and then “Flash Memory”

- 6** After selecting the file in the “List of files stored temporarily,” click the downward [Move] button and a confirmation message will appear. Click [OK] and the song will be transferred from the “List of files stored temporarily” to the instrument’s memory.

- 7** Close the window to close the Musicsoft Downloader.

**NOTE**

- Before playing back the song transferred from your computer, make sure to close the Musicsoft Downloader program.

- 8** To playback a song stored in the memory of the instrument, press the [USER] button. Use the dial to select the song you want to play, then press the [▶/■] button to start playback.

**CAUTION**

- Do not unplug the USB cable during a data transfer. Not only will the data not be transferred and saved, but operation of the memory media may become unstable and its contents may disappear.

**CAUTION**

- Stored data can be lost due to equipment malfunction or improper operation. For safety we recommend that you keep a copy of all important data stored on your computer.

## ■ Transferring Backup files from the Instrument to a Computer ●●

You can use the Musicsoft Downloader to transfer Backup files containing backup data (page 39), including the five User Songs stored on the instrument, to a computer. If you click “Electronic Musical Instruments” in the Musicsoft Downloader display, and then “System Drive,” a file named “PSR-S500.BUP” will appear in the lower right corner of the Musicsoft Downloader display. This is the backup file. For details about how to transfer backup files using the Musicsoft Downloader application, refer to the Online help in the application.

### NOTE

- Preset Song data cannot be transmitted from the instrument.

### ⚠ CAUTION

- The backup data, including the five User Songs, is transmitted/received as a single file. As a result, all backup data will be overwritten every time you transmit or receive. Keep this in mind when transferring data.

### ⚠ CAUTION

- Do not rename the backup file on the computer. If you do so it will not be recognized when transferred to the instrument.

### ● Using Songs with Notation

In order to use songs with notation (SMF format 0 only) transferred from a computer for lessons and practice, you’ll need to specify which channels are to be played back as the right-hand and left-hand parts.

- 1 Press the [USER] button and select the song residing in internal memory for which you want to set the guide track.
- 2 Press the [FUNCTION] button.
- 3 Use the CATEGORY [▲] and [▼] buttons to select the R-Part or L-Part item.
- 4 Use the dial to select the channel you want to play back as the specified right- or left-hand part.

We recommend that you select channel 1 for the right-hand part and channel 2 for the left-hand part.



# Accessory CD-ROM Installation Guide

## SPECIAL NOTICES

- ⚠ This CD-ROM is copy-protected. Yamaha makes no representations or warranties with regard to any problems while attempting to copy the CD-ROM or software and cannot be held responsible for the results of attempts to copy the data.
- The software and this owner's manual are the exclusive copyrights of Yamaha Corporation.
  - Use of the software and this manual is governed by the license agreement which the purchaser fully agrees to upon breaking the seal of the software packaging. (Please read carefully the Software Licensing Agreement on page 94 of this manual before installing the application.)
  - Copying of the software or reproduction of this manual in whole or in part by any means is expressly forbidden without the written consent of the manufacturer.
  - Yamaha makes no representations or warranties with regard to the use of the software and documentation and cannot be held responsible for the results of the use of this manual and the software.
  - This disk is a CD-ROM. Do not attempt to play the disk on an audio CD player. Doing so may result in irreparable damage to your audio CD player.
  - Future upgrades of application and system software and any changes in specifications and functions will be announced separately.
  - The screen displays as illustrated in this owner's manual are for instructional purposes, and may appear somewhat different from the screens which appear on your computer.

## Important Notices about the CD-ROM

### ● Data Types

This CD-ROM includes application software. Please refer to page 90 for software installation instructions.

#### **⚠ CAUTION**

- *Do not attempt to play this CD-ROM on an audio CD player. The result high-volume noise can potentially cause hearing damage or damage your CD player and speakers.*

### ● Operating System (OS)

The applications in this CD-ROM are provided in versions for Windows operating systems.



## CD-ROM Contents



Folder Name	Application / Data Name	Contents
① MSD_	Musicsoft Downloader	This application can be used to transfer data between computer and instrument's memory.
② DMN_FlashDemo	Flash Demo	Digital Music Notebook is an educational content that lets you enjoy music while learning. Full motion demo software which introduces all features of the Digital Music Notebook.
③	USB-MIDI Driver (Windows 98/Me)	This driver software is necessary to connect MIDI devices to your computer via USB.
	USBdrv2k	

### ■ Using the CD-ROM .....

Please read the Software License Agreement on page 94 before opening the CD-ROM package.

**1 Check the system requirements to make sure that the software will run on your computer.**

**2 Insert the included CD-ROM into the CD-ROM drive.**

After you set the language, the start window will appear on the display.

**3 Install the USB MIDI driver to the computer.**

Refer to “Installing the USB-MIDI Driver” on page 90 for installation and setup instructions.

**4 Connect the instrument to the computer. The connection procedure is described on page 82.**

**5 Install the software.**

Musicsoft Downloader:  
See page 92.

**6 Launch the software.**

For further software operation refer to the online help supplied with the software.

Refer to the “Troubleshooting” on page 93 when you have trouble with installing the driver.

## System Requirements

Application/Data	OS	CPU	Memory	Hard Disk	Display
Musicsoft Downloader	Windows 98SE/Me/2000/XP Home Edition/XP Professional	233 MHz or higher; Intel® Pentium®/Celeron® processor family	64 MB or more (256 MB or more is recommended)	at least 128 MB of free space (at least 512 MB of free space is recommended)	800 x 600 HighColor (16-bit)
USB Driver for Windows 98/Me	Windows 98/Me	166 MHz or higher; Intel® Pentium®/Celeron® processor family	32 MB or more (64 MB or more is recommended)	at least 3 MB of free space	—
USB Driver for Windows 2000/XP	Windows 2000/XP Home Edition/XP Professional				
Digital Music Notebook	Windows® XP Professional Edition, SP1a more	400MHz or higher; Intel® Pentium®/Celeron® Processor family (1GHz or more is recommended)	128 MB or more (256 MB or more is recommended)	at least 50 MB of free space	1024 x 768 HighColor (16-bit)
Digital Music Notebook (Requirements for playing content with video included.)	Windows® XP Home Edition, SP1a more Windows 2000 Professional, SP4 more	1GHz or higher; Intel® Pentium®/Celeron® Processor family (1.4GHz or more is recommended)	256 MB or more		

## Software Installation

### ● Uninstall (Removing the Software)

Installed software can be removed from your computer as follows:  
 From the Windows Start menu select Start → Settings → Control panel → Add or Remove Applications → Install and Uninstall. Select the item you want to remove and click [Add or Remove]. Follow the on-screen instructions to remove the selected software.

**NOTE**

• The actual names of the menu items and buttons will depend on the OS version you are using.

### ■ Installing the USB-MIDI Driver....

In order to be able to communicate with and use MIDI devices connected to your computer, the appropriate driver software must be properly installed on your computer.  
 The USB-MIDI driver allows sequence software and similar applications on your computer to transmit and receive MIDI data to and from MIDI devices via a USB cable.

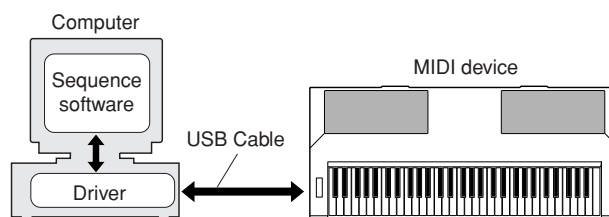

- Windows 98/Me installation → page 91.
- Windows 2000 installation → page 91.
- Windows XP installation → page 92.

Check the drive name of the CD-ROM drive you will be using (D:, E:, Q: etc.) The drive name is displayed beside the CD-ROM icon in your “My Computer” folder. The root directory of the CD-ROM drive will be D:\, E:\, or Q:\, respectively.

## Installing the driver on Windows 98/Me

- 1** Start the computer.
- 2** Insert the supplied CD-ROM into the CD-ROM drive. A start window will appear automatically.
- 3** First, make sure the POWER switch on the instrument is set to OFF, then use a USB cable to connect the USB terminal of the computer to the USB connector of the instrument. When the instrument is turned on, the computer automatically displays the “Add New Hardware Wizard. Otherwise, refer to “Troubleshooting” in the “Accessory CD-ROM Installation Guide” section of the Owner’s Manual.

For Windows Me users, check the radio button to the left of “Automatic search for a better driver (Recommended)” and click [Next]. The system automatically starts searching and installing the driver. Proceed to Step 8. If the system does not detect the driver, select “Specify the location of the driver (Advanced)” and specify the CD-ROM drive’s root directory to install the driver and click [Next]. Execute the installation by following the onscreen instructions and proceed to Step 8.

### NOTE

• If you are using Windows Me, skip Step 4–7.

- 4** Click [Next].  
The window enables you to select the search method.
- 5** Check the radio button to the left of “Search for the best driver for your device. (Recommended)”. Click [Next].  
The window enables you to select a location in which to install the driver.
- 6** Check the “Specify a location” box, click “Browse..”, then specify the root directory of the CD-ROM drive and continue the installation. The CD-ROM drive letter may vary depending on your computer’s configuration.
- 7** When the system detects the driver on the CD-ROM and is ready for installation, it is shown as a message on the screen. Make sure that the “YAMAHA USB MIDI Driver” is listed, and click [Next]. The system starts the installation.
- 8** When installation is complete, a message indicating so appears. Click [Finish].  
The driver has been installed.

### NOTE

• Some computers may take about ten seconds to show this screen after the installation is complete.

## Installing the driver on Windows 2000

- 1** Start the computer and use the “Administrator” account to log into Windows 2000.
- 2** Select [My Computer] → [Control Panel] → [System] → [Hardware] → [Driver Signing] → [File Signature Verification], and check the radio button to the left of “Ignore—Install all files, regardless of file signature” and click [OK].
- 3** Insert the supplied CD-ROM into the CD-ROM drive. A start window will appear automatically.
- 4** First, make sure the POWER switch on the MIDI device is set to OFF, then use a USB cable to connect the MIDI device to the computer. After making the connections, turn on the power of the MIDI device. The system automatically launches the Found New Hardware Wizard.

Otherwise, refer to “Troubleshooting” in the “Accessory CD-ROM Installation Guide” section of the Owner’s Manual. Click [Next]. (Some computers may take a while to display the Wizard window.)

- 5** Select the radio button for “Search for a suitable driver for my device [recommended]”, then click [Next].

### NOTE

• If the Wizard panel informs you that “The software you are about to install does not contain a Microsoft digital signature”, click [Yes].

- 6** Check the “CD-ROM drives” check box, deselect all other check boxes, then click [Next].

### NOTE

• If the system prompts you to insert the Windows CD-ROM during detection of the drivers, point to the “USBdrv2k\_” folder (e.g., D:\USBdrv2k\_) and continue the installation.

- 7** Deselect the “Install one of the other drivers”, then click [Next].
- 8** When the installation is complete, the Wizard displays “Completing the Found New Hardware Wizard”.  
Click [Finish]. (Some computers may take a while to display the Wizard window.)
- 9** Restart the computer.  
The USB-MIDI driver installation is complete.

### Installing the driver on Windows XP

- 1** Start the computer and use the “Administrator” account to log into Windows.
- 2** Select [Start] → [Control Panel]. If the control panel appears as “Pick a category”, click “Switch to Classic View” in the upper left of the window. All control panels and icons will be displayed.
- 3** Go to [System] → [Hardware] → [Driver Signing Options] and check the radio button to the left of “Ignore” and click [OK].
- 4** Click the [OK] button to close System Properties, and then click “X” in the upper right of the window to close the Control Panel.
- 5** Insert the supplied CD-ROM into the CD-ROM drive. A start window will appear automatically.
- 6** First, make sure the POWER switch on the MIDI device is set to OFF, then use a USB cable to connect the MIDI device to the computer. After making the connections, turn on the power of the MIDI device.  
The system launches the Found New Hardware Wizard automatically. Otherwise, refer to “Troubleshooting” in the “Accessory CD-ROM Installation Guide” section of the Owner’s Manual. If the system displays “Found New Hardware” in the lower right corner, wait until Wizard windows is displayed. (Some computers may take a while to display the window.)

If the Wizard window prompts you to specify whether or not to connect to Windows Update, select the radio button for “No, not this time”, then click [Next].

- 7** Select the radio button for “Install the software automatically (recommended)”, then click [Next].

**NOTE**

• If during the installation the system displays “...has not passed Windows Logo testing to verify its compatibility with Windows XP”, click [Continue Anyway].

- 8** When the installation is complete, the Wizard displays “Completing the Found New Hardware Wizard”.

Click [Finish]. (Some computers may take a while to display the Wizard window.)

- 9** Restart the computer.

If the system displays “Found New Hardware” in the lower right corner, wait until the Wizard window is displayed. (Some computers may take a while to display the Wizard window.)

The USB-MIDI driver installation is complete.

### ■ Installing the Musicsoft Downloader and Digital Music Notebook Applications...

**IMPORTANT**

- You will need to log in with administrator (root) privileges in order to install Musicsoft Downloader on a computer running Windows 2000 or XP.
- You will need to log in with administrator (root) privileges in order to install Digital Music Notebook on a computer running Windows 2000 or XP.

**IMPORTANT**

- When installing the Digital Music Notebook, make sure that Internet Explorer 6.0 (with SP1) or higher is installed to your computer.

**IMPORTANT**

- Credit card settlement is required to purchase Digital Music Notebook content. Credit card processing may not be possible for some areas, so please check with your local authorities to make sure that your credit card can be used.

- 1** Insert the Accessory CD-ROM into your computer’s CD-ROM drive. The start window will appear automatically showing software applications.

**NOTE**

- If the start window does not appear automatically, double click your “My Computer” folder to open it. Right-click the CD-ROM icon and select “Open” from the pop-up menu. Double click “Start.exe” and proceed to step 2, below.

- 2** Click [Musicsoft Downloader] or [Digital Music Notebook].

- 3** Click the [install] button or [Digital Music Notebook Download] button, and follow the onscreen instructions to install the software.

For Digital Music Notebook operating instructions see the help menu: launch the Digital Music Notebook application and click “Help”.

For Musicsoft Downloader operating instructions see the Help menu: launch the Musicsoft Downloader application and click “Help”.

- \* You can obtain the latest version of the Musicsoft Downloader at the following Internet URL.

<http://music.yamaha.com/download/>

**IMPORTANT**

- Only Musicsoft Downloader can be used to transfer files between this instrument and a computer. No other file transfer application can be used.

## ■ Troubleshooting

### The driver cannot be installed.

- **Is the USB cable connected correctly?**  
Check the USB cable connection. Disconnect the USB cable, then connect it again.

- **Is the USB function enabled on your computer?**

When you connect the instrument to the computer for the first time, if the “Add New Hardware Wizard” does not appear, the USB function on the computer may be disabled. Perform the following steps.

- 1** Select [Control Panel] → [System] → [Device Manager] (for Windows 98/Me), or select [Control Panel]\* → [System] → [Hardware] → [Device Manager] (for Windows 2000/XP).

\* Classic View only in Windows XP.

- 2** Make sure that no “!” or “x” marks appear at “Universal serial bus controller” or “USB Root Hub”. If you see an “!” or “x” mark, the USB controller is disabled.

- **Is any unknown device registered?**  
If driver installation fails, the instrument will be marked as an “Unknown device”, and you will not be able to install the driver. Delete the “Unknown device” by following the steps below.

- 1** Select [Control Panel] → [System] → [Device Manager] (for Windows 98/Me), or select [Control Panel]\* → [System] → [Hardware] → [Device Manager] (for Windows 2000/XP).

\* Classic View only in Windows XP.

- 2** Look for “Other devices” in the menu “View devices by type”.
- 3** If you find “Other devices”, double-click it to extend the tree to look for “Unknown device”. If one appears, select it and click the [Remove] button.
- 4** Remove the USB cable from the instrument, and make the connection again.
- 5** Install the driver again.
  - Windows 98/Me users... see page 91
  - Windows 2000 users..... see page 91
  - Windows XP users..... see page 92

### When controlling the instrument from your computer via USB, the instrument does not operate correctly or no sound is heard.

- Did you install the driver? (page 90)
- Is the USB cable connected correctly?
- Are the volume settings of the instrument, playback device, and application program set to the appropriate levels?
- Have you selected an appropriate port in the sequence software?
- Are you using the latest USB MIDI driver?  
The latest driver can be downloaded from the following web site.

<http://music.yamaha.com/download/>

### Playback response is delayed.

- Does your computer satisfy the system requirements?
- Is any other application or device driver running?

### Cannot suspend or resume the computer correctly.

- Do not suspend the computer while the MIDI application is running.  
If you are using Windows 2000, you may not be able to suspend/resume normally, depending on the particular environment (USB Host Controller, etc.). Even so, simply disconnecting and connecting the USB cable will allow you to use the instrument functions again.

### How can I delete or re-install the driver?

#### [Windows Me/98]

- 1** When the instrument is recognized correctly, double-click “System” in the Control Panel to open the System window.
- 2** Double-click the “Device Manager” tab, select “YAMAHA USB MIDI Driver” and delete it.
- 3** Use the MS-DOS prompt or Explorer to delete the following three files.

**NOTE**

- To delete these files using Explorer, select "Folder Options" from the Tool (View) menu, and select "Show all files (and folders)."
  - \WINDOWS\INF\OTHER\1039.INF
  - \WINDOWS\SYSTEM\Xgusb.driv
  - \WINDOWS\SYSTEM\Ymidusb.sys

- 4** Disconnect the USB cable.
- 5** Restart the computer.
- 6** Re-install the driver.

## ATTENTION SOFTWARE LICENSE AGREEMENT

PLEASE READ THIS SOFTWARE LICENSE AGREEMENT ("AGREEMENT") CAREFULLY BEFORE USING THIS SOFTWARE. YOU ARE ONLY PERMITTED TO USE THIS SOFTWARE PURSUANT TO THE TERMS AND CONDITIONS OF THIS AGREEMENT. THIS AGREEMENT IS BETWEEN YOU (AS AN INDIVIDUAL OR LEGAL ENTITY) AND YAMAHA CORPORATION ("YAMAHA").  
BY BREAKING THE SEAL OF THIS PACKAGE YOU ARE AGREEING TO BE BOUND BY THE TERMS OF THIS LICENSE. IF YOU DO NOT AGREE WITH THE TERMS, DO NOT INSTALL, COPY, OR OTHERWISE USE THIS SOFTWARE.

### 1. GRANT OF LICENSE AND COPYRIGHT

Yamaha hereby grants you the right to use one copy of the software program(s) and data ("SOFTWARE") accompanying this Agreement. The SOFTWARE shall encompass any updates to the accompanying software and data. The SOFTWARE is owned by Yamaha and/or Yamaha's licensor(s), and is protected by relevant copyright laws and all applicable treaty provisions. While you are entitled to claim ownership of the data created with the use of SOFTWARE, the SOFTWARE will continue to be protected under relevant copyrights.

- **You may** use the SOFTWARE on a **single computer**.
- **You may** make one copy of the SOFTWARE in machine-readable form for backup purposes only, if the SOFTWARE is on media where such backup copy is permitted. On the backup copy, you must reproduce Yamaha's copyright notice and any other proprietary legends that were on the original copy of the SOFTWARE.
- **You may** permanently transfer to a third party all your rights in the SOFTWARE, provided that you do not retain any copies and the recipient reads and agrees to the terms of this Agreement.

### 2. RESTRICTIONS

- **You may not** engage in reverse engineering, disassembly, decompilation or otherwise deriving a source code form of the SOFTWARE by any method whatsoever.
- **You may not** reproduce, modify, change, rent, lease, or distribute the SOFTWARE in whole or in part, or create derivative works of the SOFTWARE.
- **You may not** electronically transmit the SOFTWARE from one computer to another or share the SOFTWARE in a network with other computers.
- **You may not** use the SOFTWARE to distribute illegal data or data that violates public policy.
- **You may not** initiate services based on the use of the SOFTWARE without permission by Yamaha Corporation

Copyrighted data, including but not limited to MIDI data for songs, obtained by means of the SOFTWARE, are subject to the following restrictions which you must observe.

- Data received by means of the SOFTWARE may not be used for any commercial purposes without permission of the copyright owner.
- Data received by means of the SOFTWARE may not be duplicated, transferred, or distributed, or played back or performed for listeners in public without permission of the copyright owner.
- The encryption of data received by means of the SOFTWARE may not be removed nor may the electronic watermark be modified without permission of the copyright owner.

### 3. TERMINATION

This Agreement becomes effective on the day that you receive the SOFTWARE and remains effective until terminated. If any copyright law or provisions of this Agreement is violated, the Agreement shall terminate automatically and immediately without notice from Yamaha. Upon such termination, you must immediately destroy the licensed SOFTWARE, any accompanying written documents and all copies thereof.

### 4. LIMITED WARRANTY ON MEDIA

As to SOFTWARE sold on tangible media, Yamaha warrants that the tangible media on which the SOFTWARE is recorded will be free from defects in materials and workmanship under normal use for a period of fourteen (14) days from the date of receipt, as evidenced by a copy of the receipt. Yamaha's entire liability and your exclusive remedy will be replacement of the defective media if it is returned to Yamaha or an authorized Yamaha dealer within fourteen days with a copy of the receipt. Yamaha is not responsible for replacing media damaged by accident, abuse or misapplication. TO THE FULLEST EXTENT PERMITTED BY LAW, YAMAHA EXPRESSLY DISCLAIMS ANY IMPLIED WARRANTIES ON THE TANGIBLE MEDIA, INCLUDING THE IMPLIED WARRANTIES OF MERCHANTABILITY AND FITNESS FOR A PARTICULAR PURPOSE.

### 5. DISCLAIMER OF WARRANTY ON SOFTWARE

You expressly acknowledge and agree that use of the SOFTWARE is at your sole risk. The SOFTWARE and related documentation are provided "AS IS" and without warranty of any kind. NOTWITHSTANDING ANY OTHER PROVISION OF THIS AGREEMENT, YAMAHA EXPRESSLY DISCLAIMS ALL WARRANTIES AS TO THE SOFTWARE, EXPRESS, AND IMPLIED, INCLUDING BUT NOT LIMITED TO THE IMPLIED WARRANTIES OF MERCHANTABILITY, FITNESS FOR A PARTICULAR PURPOSE AND NON-INFRINGEMENT OF THIRD PARTY RIGHTS. SPECIFICALLY, BUT WITHOUT LIMITING THE FOREGOING, YAMAHA DOES NOT WARRANT THAT THE SOFTWARE WILL MEET YOUR REQUIREMENTS, THAT THE OPERATION OF THE SOFTWARE WILL BE UNINTERRUPTED OR ERROR-FREE, OR THAT DEFECTS IN THE SOFTWARE WILL BE CORRECTED.

### 6. LIMITATION OF LIABILITY

YAMAHA'S ENTIRE OBLIGATION HEREUNDER SHALL BE TO PERMIT USE OF THE SOFTWARE UNDER THE TERMS HEREOF. IN NO EVENT SHALL YAMAHA BE LIABLE TO YOU OR ANY OTHER PERSON FOR ANY DAMAGES, INCLUDING, WITHOUT LIMITATION, ANY DIRECT, INDIRECT, INCIDENTAL OR CONSEQUENTIAL DAMAGES, EXPENSES, LOST PROFITS, LOST DATA OR OTHER DAMAGES ARISING OUT OF THE USE, MISUSE OR INABILITY TO USE THE SOFTWARE, EVEN IF YAMAHA OR AN AUTHORIZED DEALER HAS BEEN ADVISED OF THE POSSIBILITY OF SUCH DAMAGES. In no event shall Yamaha's total liability to you for all damages, losses and causes of action (whether in contract, tort or otherwise) exceed the amount paid for the SOFTWARE.

### 7. THIRD PARTY SOFTWARE

Third party software and data ("THIRD PARTY SOFTWARE") may be attached to the SOFTWARE. If, in the written materials or the electronic data accompanying the Software, Yamaha identifies any software and data as THIRD PARTY SOFTWARE, you acknowledge and agree that you must abide by the provisions of any Agreement provided with the THIRD PARTY SOFTWARE and that the party providing the THIRD PARTY SOFTWARE is responsible for any warranty or liability related to or arising from the THIRD PARTY SOFTWARE. Yamaha is not responsible in any way for the THIRD PARTY SOFTWARE or your use thereof.

- Yamaha provides no express warranties as to the THIRD PARTY SOFTWARE. IN ADDITION, YAMAHA EXPRESSLY DISCLAIMS ALL IMPLIED WARRANTIES, INCLUDING BUT NOT LIMITED TO THE IMPLIED WARRANTIES OF MERCHANTABILITY AND FITNESS FOR A PARTICULAR PURPOSE, as to the THIRD PARTY SOFTWARE.
- Yamaha shall not provide you with any service or maintenance as to the THIRD PARTY SOFTWARE.
- Yamaha is not liable to you or any other person for any damages, including, without limitation, any direct, indirect, incidental or consequential damages, expenses, lost profits, lost data or other damages arising out of the use, misuse or inability to use the THIRD PARTY SOFTWARE.

### 8. GENERAL

This Agreement shall be interpreted according to and governed by Japanese law without reference to principles of conflict of laws. Any dispute or procedure shall be heard before the Tokyo District Court in Japan. If for any reason a court of competent jurisdiction finds any portion of this Agreement to be unenforceable, the remainder of this Agreement shall continue in full force and effect.

### 9. COMPLETE AGREEMENT

This Agreement constitutes the entire agreement between the parties with respect to use of the SOFTWARE and any accompanying written materials and supersedes all prior or contemporaneous understandings or agreements, written or oral, regarding the subject matter of this Agreement. No amendment or revision of this Agreement will be binding unless in writing and signed by a fully authorized representative of Yamaha.



# Troubleshooting

Problem	Possible Cause and Solution
When the instrument is turned on or off, a popping sound is temporarily produced.	This is normal and indicates that the instrument is receiving electrical power.
When using a mobile phone, noise is produced.	Using a mobile phone in close proximity to the instrument may produce interference. To prevent this, turn off the mobile phone or use it further away from the instrument.
There is no sound even when the keyboard is played or when a song or style is being played back.	Check that nothing is connected to the PHONES/OUTPUT jack on the rear panel. When a set of headphones is plugged into this jack, no sound is output.
	Check the Local Control on/off. (See page 83.)
	Is the FILE CONTROL display showing? The instrument's keyboard, etc., will not produce any sound while the FILE CONTROL display is showing. Press the [EXIT] button to return to the MAIN display.
The style or song does not play back when the [START/STOP] button is pressed.	Is External Clock set to ON? Make sure External Clock is set to OFF; refer to "External Clock" on page 83.
The style does not sound properly.	Make sure that the Style Volume (page 71) is set to an appropriate level.
	Is the split point set at an appropriate key for the chords you are playing? Set the split point at an appropriate key (page 59).
	Is the [ACMP] button lit? If it is not lit, press the [ACMP] button so it lights.
No rhythm accompaniment plays when the [START/STOP] button is pressed after selecting the BaroqueAir Style in the MOVIE & SHOW category.	This is not a malfunction. Style BaroqueAir Style does not have a Rhythm part, so there is no rhythm sound for this Style. Also, this Style does not have a Fill-In section. The other parts will begin playing when you play a chord in the accompaniment.
Not all of the voices seem to sound, or the sound seems to be cut off.	The instrument is polyphonic up to a maximum of 32 notes. If the Dual voice or Split voice is being used and a style or song is playing back at the same time, some notes/sounds may be omitted (or "stolen") from the accompaniment or song.
The footswitch (for sustain) seems to produce the opposite effect. For example, pressing the footswitch cuts off the sound and releasing it sustains the sounds.	The polarity of the footswitch is reversed. Make sure that the footswitch plug is properly connected to the SUSTAIN jack before turning on the power.
The sound of the voice changes from note to note.	This is normal. The AWM tone generation method uses multiple recordings (samples) of an instrument across the range of the keyboard; thus, the actual sound of the voice may be slightly different from note to note.
The Demo display is shown in Japanese, and/or there are Japanese characters in the display messages.	Make sure the Language setting in the FUNCTION display is set to English. (See page 12)
The ACMP indicator does not appear when the [ACMP] button is pressed.	Always press desired style category button first when you are going to use any style-related function.
There is no harmony sound.	The harmony effects (01–26) behave differently according to their type. Types 01–05 function when style playback is on, chords are played in the accompaniment range of the keyboard, and a melody is played in the right-hand range. Types 06–26 will function whether style playback is on or off. For types 06–12 you need to play two notes at the same time.



# Messages

LCD Message	Comment
Access error!	Indicates the failure in reading or writing from/to the media or the flash memory.
All Memory Clearing...	Displayed while erasing all data in the flash memory. Never turn the power off during data transmission.
Are you sure?	Confirms whether Song Clear or Track Clear is executed or not.
Backup Clearing...	Displayed while clearing the back-up data in the flash memory.
Cancel	Displayed when the transmission of Initial Send is cancelled.
Clearing...	Displayed while executing Song Clear or Track Clear of the user songs.
Com Mode	Displayed when the Musicsoft Downloader is started on the PC connected to the keyboard. This will not be displayed while the instrument is played back.
Completed	Indicates the specified job completion such as data saving and transmission.
Copy File	Displayed while copying a file in the Musicsoft Downloader.
Create Directory	Displayed while creating a folder in the Musicsoft Downloader application.
Data Error!	Displayed when the user song contains illegal data.
Delete File	Displayed while deleting a file in the Musicsoft Downloader.
Delete OK ?	Confirms whether the Delete job is executed or not.
Delete Directory	Displayed while deleting a folder in the Musicsoft Downloader.
Deleting...	Displayed while the delete function is engaged.
End	Displayed when the transmission of Initial Send has been completed.
Error!	Displayed when writing has failed.
File information area is not large enough.	Indicates that saving data in the media cannot be executed since the total number of files have become too many.
File is not found.	Indicates there is no file.
File too large. Loading is impossible.	Indicates that loading data cannot be executed since the file data is too large.
Flash Clearing...	Displayed while clearing the song or style data transmitted to the internal flash memory.
Format OK ? [EXECUTE]	Confirms whether formatting the media is executed or not.
Formatting...	Displayed while formatting.
Load OK ?	Confirms whether loading is executed or not.
Loading...	Displayed while loading data.
Media capacity is full.	Displayed when saving data cannot be executed since the media memory becomes full.
Memory Full	Displayed when the internal memory becomes full during song recording.
Move File	Displayed while moving a file in the Musicsoft Downloader.
Now Writing... (Don't turn off the power now, otherwise the data may be damaged.)	Displayed while writing data in the memory. Never turn the power off while writing. Doing so may result in data loss.
Overwrite ?	Confirms whether overwriting is executed or not.
Please Wait...	Displayed when executing the jobs that take some time, such as displaying scores and lyrics.
Rename File	Displayed while rewriting the file name in the Musicsoft Downloader.
Save OK ?	Confirms whether saving is executed or not.
Saved data is not found.	Displayed when the data to be saved doesn't exist.



LCD Message	Comment
Saving...	Displayed while saving data in the memory. Never turn the power off while saving. Doing so may result in data loss.
Send OK?	Confirms whether the data transmission is executed or not.
Sending...	Displayed while transmitting data.
Since the media is in use now, this function is not available.	Indicates that the file control function is currently unavailable since the media is being accessed.
Sure ? [YES/NO]	Reconfirms whether each operation is executed or not.
The limit of the media has been reached.	Indicates that saving data cannot be executed since the folder/directory structure has become too complicated.
The media is not formatted.	Indicates the inserted media has not been formatted.
The media is write-protected.	Indicates that the inserted media cannot be written since it is write-protected. Set to the write-protect switch to the "overwrite" position before use.
The song data is too large to be converted to notation.	Indicates that the score cannot be displayed since the song data is too large.
There are too many files.	Indicates that saving data cannot be executed since the total number of files exceeds the capacity.
This function is not available now.	Indicates the designated function is not available since the instrument is executing another job.
[nnn] file name	Indicates the file name of the currently transmitting. "nnn" indicates the receiving block.

**NOTE**

- Not all the messages are listed in the table: the messages necessary to be explained only.



Voice No.	Bank Select		MIDI Program Change# (1-128)	Voice Name
	MSB (0-127)	LSB (0-127)		
14	0	114	62	FullHorns
15	0	118	58	SmoothTromb
16	0	115	62	HighBrass
17	0	113	64	OberBrass
18	0	122	62	TrumpetEns
19	0	119	62	MellowHorns
20	0	113	62	BigBandBrS
21	0	118	62	PopBrass
22	0	112	64	AnalogBrS
23	0	113	58	Trb.Section
24	0	117	62	SmallBrass
25	0	114	64	SoftAnalog
26	0	115	63	FunkyAnalog
27	0	114	63	TechnoBrass
28	0	112	63	SynthBrass
<b>Trumpet</b>				
1	0	115	57	Sweet! Trumpet
2	0	117	58	Sweet! Trombone
3	0	116	57	JazzTrumpet
4	0	112	57	SoloTrumpet
5	0	113	57	FlugelHorn
6	0	116	58	Trombone
7	0	115	58	SoftTromb
8	0	112	58	SoloTromb
9	0	114	58	MellowTromb
10	0	112	60	MutedTrump
11	0	113	59	BaritonHorn
12	0	114	59	BaritonHit
13	0	112	59	Tuba
14	0	113	34	AlpBass
<b>Saxophone</b>				
1	0	117	67	Sweet! TenorSax
2	0	114	66	Sweet! AltoSax
3	0	113	65	Sweet! SopranoSax
4	0	118	67	GrowlSax
5	0	112	68	BaritoneSax
6	0	112	65	SopranoSax
7	0	112	67	TenorSax
8	0	112	66	AltoSax
9	0	113	67	WoodwindEns
<b>Flute&amp;Clarinet</b>				
1	0	114	74	Sweet! Flute
2	0	114	72	Sweet! Clarinet
3	0	113	76	Sweet! PanFlute
4	0	112	70	EnglishHorn
5	0	112	71	Bassoon
6	0	115	74	Class.Flute
7	0	112	73	Piccolo
8	0	112	72	Clarinet
9	0	112	69	Oboe
10	0	112	74	Flute
11	0	113	74	PanFlute
12	0	112	79	Whistle
13	0	112	76	EthnicFlute
14	0	112	78	Shakuhachi
15	0	112	75	Recorder
16	0	112	80	Ocarina
17	0	112	110	Bagpipe
<b>Guitar</b>				
1	0	116	25	Dynamic Nylon
2	0	117	26	Steel Guitar
3	0	115	27	Cool! JazzGuitar
4	0	114	29	Cool! Elec.Gtr
5	0	114	26	Sweet! Mandolin
6	0	118	26	Dyno Steel
7	0	117	29	Cool! Stratsphere
8	0	125	28	Cool! VintageLead
9	0	113	26	12Strings Guitar
10	0	115	31	Cool! PowerLead
11	0	116	26	Dynamic Steel

Voice No.	Bank Select		MIDI Program Change# (1-128)	Voice Name
	MSB (0-127)	LSB (0-127)		
12	0	117	30	Cool! BluesGuitar
13	0	112	28	Cool! CleanGuitar
14	0	115	25	Classic Guitar
15	0	115	28	PedalSteel
16	0	116	30	RockGuitar
17	0	126	28	VintageStrum
18	0	117	31	PowerChord
19	0	117	28	60'sClean
20	0	119	27	SmoothLead
21	0	115	30	VintageAmp
22	0	113	31	CrunchGtr
23	0	115	26	CampfireGtr
24	0	118	28	SolidGuitar
25	0	123	28	VintageOpen
26	0	115	29	VintageMute
27	0	114	30	LeadGuitar
28	0	124	28	ChorusGtr
29	0	120	28	VintageTrem
30	0	113	27	OctaveGtr
31	0	114	28	DeepChorus
32	0	113	28	TremoloGtr
33	0	114	31	HeavyStack
34	0	122	28	WahGuitar
35	0	112	31	Distortion
36	0	119	28	Elec.12Str
37	0	113	30	FeedbackGtr
38	0	112	29	MutedGuitar
39	0	113	29	FunkGuitar
40	0	116	31	VoodooLead
41	0	112	26	FolkGuitar
42	0	112	30	Overdrive
<b>Bass</b>				
1	0	114	34	Cool! FingerBass
2	0	112	33	Aco.Bass
3	0	112	35	PickBass
4	0	112	36	Cool! Fretless
5	0	112	37	SlapBass
6	0	114	40	SubBass
7	0	114	39	HardBass
8	0	112	39	ResoBass
9	0	113	36	SuperFretles
10	0	113	37	FusionBass
11	0	114	33	Bass&Cymbal
12	0	112	40	AnalogBass
13	0	116	40	DrySynBass
14	0	115	40	80'sSynBass
15	0	113	39	HiQBass
16	0	112	38	FunkBass
17	0	115	39	ClickBass
18	0	112	34	MellowFinger
<b>Perc&amp;Drum</b>				
1	0	112	12	Vibraphone
2	0	113	12	JazzVibes
3	0	112	13	Marimba
4	0	112	14	Xylophone
5	0	112	115	SteelDrums
6	0	112	9	Celesta
7	0	112	10	Glocken
8	0	112	11	MusicBox
9	0	112	15	TubularBell
10	0	112	109	Kalimba
11	0	112	16	Dulcimer
12	0	112	48	Timpani
13	127	0	1	StandardKit1
14	127	0	2	StandardKit2
15	127	0	33	JazzKit
16	127	0	41	BrushKit
17	127	0	9	RoomKit
18	127	0	17	RockKit
19	127	0	25	ElectroKit

## Voice List

Voice No.	Bank Select		MIDI Program Change# (1-128)	Voice Name
	MSB (0-127)	LSB (0-127)		
20	127	0	26	AnalogKit
21	127	0	28	DanceKit
22	127	0	49	SymphonyKit
23	126	0	41	CubanKit
24	126	0	44	PopLatinKit
25	126	0	36	ArabicKit
26	126	0	1	SFXKit1
27	126	0	2	SFXKit2
<b>Accordion</b>				
1	0	112	22	Musette
2	0	117	22	Steirisch
3	0	113	22	TuttiAccrd
4	0	115	22	SmallAccrd
5	0	116	22	Accordion
6	0	112	24	TangoAccrd
7	0	113	24	Bandoneon
8	0	114	22	SoftAccrd
9	0	113	23	ModernHarp
10	0	114	23	BluesHarp
<b>Pad</b>				
1	0	113	95	Insomnia
2	0	115	90	NeoWarmPad
3	0	113	100	CyberPad
4	0	112	96	Wave2001
5	0	112	100	Atmosphere
6	0	112	92	XenonPad
7	0	112	95	Equinox
8	0	112	89	Fantasia
9	0	112	93	DX Pad
10	0	113	89	Symbiont
11	0	114	89	Stargate
12	0	112	90	Area51
13	0	113	90	DarkMoon
14	0	115	95	Ionosphere
15	0	115	89	GoldenAge
16	0	114	95	Solaris
17	0	117	89	Millennium
18	0	114	90	Dunes
<b>Synth</b>				
1	0	122	82	Oxygen
2	0	123	82	Matrix
3	0	120	82	WireLead
4	0	113	81	HipLead
5	0	117	81	HopLead
6	0	116	82	FireWire
7	0	115	82	Analogon
8	0	114	82	Blaster
9	0	115	85	Skyline
10	0	112	81	SquareLead
11	0	112	82	Saw.Lead
12	0	118	81	TinyLead
13	0	121	82	FunkyLead
14	0	114	85	Paraglide
15	0	112	85	Portatone
16	0	113	82	BigLead
17	0	117	82	Warp
18	0	119	82	Fargo
19	0	113	85	Adrenaline
20	0	112	99	Stardust
21	0	112	84	AeroLead
22	0	114	81	MiniLead
23	0	113	88	Impact
24	0	113	99	SunBell
25	0	112	88	UnderHeim
26	0	116	81	HiBias
27	0	115	81	Vinylead

## ● XGlite Voice/XGlite Optional Voice\* List

Voice No.	Bank Select		MIDI Program Change# (1-128)	Voice Name
	MSB (0-127)	LSB (0-127)		
<b>XG</b>				
1	0	0	1	Grand Piano
2	0	1	1	Grand Piano KSP
3	0	40	1	Piano Strings
4	0	41	1	Dream
5	0	0	2	Bright Piano
6	0	1	2	Bright Piano KSP
7	0	0	3	Electric Grand Piano
8	0	1	3	Electric Grand Piano KSP
9	0	32	3	Detuned CP80
10	0	0	4	Honky-tonk Piano
11	0	1	4	Honky-tonk Piano KSP
12	0	0	5	Electric Piano 1
13	0	1	5	Electric Piano 1 KSP
14	0	32	5	Chorus Electric Piano 1
15	0	0	6	Electric Piano 2
16	0	1	6	Electric Piano 2 KSP
17	0	32	6	Chorus Electric Piano 2
18	0	41	6	DX + Analog Electric Piano
19	0	0	7	Harpsichord
20	0	1	7	Harpsichord KSP
21	0	35	7	Harpsichord 2
22	0	0	8	Clavi
23	0	1	8	Clavi KSP
24	0	0	9	Celesta
25	0	0	10	Glockenspiel
26	0	0	11	Music Box
27	0	64	11	Orgel
28	0	0	12	Vibraphone
29	0	1	12	Vibraphone KSP
30	0	0	13	Marimba
31	0	1	13	Marimba KSP
32	0	64	13	Sine Marimba
33	0	97	13	Balimba
34	0	98	13	Log Drums
35	0	0	14	Xylophone
36	0	0	15	Tubular Bells
37	0	96	15	Church Bells
38	0	97	15	Carillon
39	0	0	16	Dulcimer
40	0	35	16	Dulcimer 2
41	0	96	16	Cimbalom
42	0	97	16	Santur
43	0	0	17	Drawbar Organ
44	0	32	17	Detuned Drawbar Organ
45	0	33	17	60's Drawbar Organ 1
46	0	34	17	60's Drawbar Organ 2
47	0	35	17	70's Drawbar Organ 1
48	0	37	17	60's Drawbar Organ 3
49	0	40	17	16+2'2/3
50	0	64	17	Organ Bass
51	0	65	17	70's Drawbar Organ 2
52	0	66	17	Cheezy Organ
53	0	67	17	Drawbar Organ 2
54	0	0	18	Percussive Organ
55	0	24	18	70's Percussive Organ
56	0	32	18	Detuned Percussive Organ
57	0	33	18	Light Organ
58	0	37	18	Percussive Organ 2
59	0	0	19	Rock Organ
60	0	64	19	Rotary Organ
61	0	65	19	Slow Rotary
62	0	66	19	Fast Rotary
63	0	0	20	Church Organ
64	0	32	20	Church Organ 3
65	0	35	20	Church Organ 2
66	0	40	20	Notre Dame
67	0	64	20	Organ Flute
68	0	65	20	Tremolo Organ Flute

Voice No.	Bank Select		MIDI Program Change# (1-128)	Voice Name
	MSB (0-127)	LSB (0-127)		
69	0	0	21	Reed Organ
70	0	40	21	Puff Organ
71	0	0	22	Accordion
72	0	0	23	Harmonica
73	0	32	23	Harmonica 2
74	0	0	24	Tango Accordion
75	0	64	24	Tango Accordion 2
76	0	0	25	Nylon Guitar
77	0	43	25	Velocity Guitar Harmonics
78	0	96	25	Ukulele
79	0	0	26	Steel Guitar
80	0	35	26	12-string Guitar
81	0	40	26	Nylon & Steel Guitar
82	0	41	26	Steel Guitar with Body Sound
83	0	96	26	Mandolin
84	0	0	27	Jazz Guitar
85	0	32	27	Jazz Amp
86	0	0	28	Clean Guitar
87	0	32	28	Chorus Guitar
88	0	0	29	Muted Guitar
89	0	40	29	Funk Guitar
90	0	41	29	Muted Steel Guitar
91	0	45	29	Jazz Man
92	0	0	30	Overdriven Guitar
93	0	43	30	Guitar Pinch
94	0	0	31	Distortion Guitar
95	0	40	31	Feedback Guitar
96	0	41	31	Feedback Guitar 2
97	0	0	32	Guitar Harmonics
98	0	65	32	Guitar Feedback
99	0	66	32	Guitar Harmonics 2
100	0	0	33	Acoustic Bass
101	0	40	33	Jazz Rhythm
102	0	45	33	Velocity Crossfade Upright Bass
103	0	0	34	Finger Bass
104	0	18	34	Finger Dark
105	0	40	34	Bass & Distorted Electric Guitar
106	0	43	34	Finger Slap Bass
107	0	45	34	Finger Bass 2
108	0	65	34	Modulated Bass
109	0	0	35	Pick Bass
110	0	28	35	Muted Pick Bass
111	0	0	36	Fretless Bass
112	0	32	36	Fretless Bass 2
113	0	33	36	Fretless Bass 3
114	0	34	36	Fretless Bass 4
115	0	0	37	Slap Bass 1
116	0	32	37	Punch Thumb Bass
117	0	0	38	Slap Bass 2
118	0	43	38	Velocity Switch Slap
119	0	0	39	Synth Bass 1
120	0	40	39	Techno Synth Bass
121	0	0	40	Synth Bass 2
122	0	6	40	Mellow Synth Bass
123	0	12	40	Sequenced Bass
124	0	18	40	Click Synth Bass
125	0	19	40	Synth Bass 2 Dark
*126	0	40	40	Modular Synth Bass
127	0	41	40	DX Bass
128	0	0	41	Violin
129	0	8	41	Slow Violin
130	0	0	42	Viola
131	0	0	43	Cello
132	0	0	44	Contrabass
133	0	0	45	Tremolo Strings
134	0	8	45	Slow Tremolo Strings
135	0	40	45	Suspense Strings
136	0	0	46	Pizzicato Strings
137	0	0	47	Orchestral Harp
138	0	40	47	Yang Chin

## Voice List

Voice No.	Bank Select		MIDI Program Change# (1-128)	Voice Name
	MSB (0-127)	LSB (0-127)		
139	0	0	48	Timpani
140	0	0	49	Strings 1
141	0	3	49	Stereo Strings
142	0	8	49	Slow Strings
143	0	35	49	60's Strings
144	0	40	49	Orchestra
145	0	41	49	Orchestra 2
146	0	42	49	Tremolo Orchestra
147	0	45	49	Velocity Strings
148	0	0	50	Strings 2
149	0	3	50	Stereo Slow Strings
150	0	8	50	Legato Strings
151	0	40	50	Warm Strings
152	0	41	50	Kingdom
153	0	0	51	Synth Strings 1
154	0	0	52	Synth Strings 2
155	0	0	53	Choir Aahs
156	0	3	53	Stereo Choir
157	0	32	53	Mellow Choir
158	0	40	53	Choir Strings
159	0	0	54	Voice Oohs
160	0	0	55	Synth Voice
161	0	40	55	Synth Voice 2
162	0	41	55	Choral
163	0	64	55	Analog Voice
164	0	0	56	Orchestra Hit
165	0	35	56	Orchestra Hit 2
166	0	64	56	Impact
167	0	0	57	Trumpet
168	0	32	57	Warm Trumpet
169	0	0	58	Trombone
170	0	18	58	Trombone 2
171	0	0	59	Tuba
172	0	0	60	Muted Trumpet
173	0	0	61	French Horn
174	0	6	61	French Horn Solo
175	0	32	61	French Horn 2
176	0	37	61	Horn Orchestra
177	0	0	62	Brass Section
178	0	35	62	Trumpet & Trombone Section
179	0	0	63	Synth Brass 1
180	0	20	63	Resonant Synth Brass
181	0	0	64	Synth Brass 2
182	0	18	64	Soft Brass
183	0	41	64	Choir Brass
184	0	0	65	Soprano Sax
185	0	0	66	Alto Sax
186	0	40	66	Sax Section
187	0	0	67	Tenor Sax
188	0	40	67	Breathy Tenor Sax
189	0	0	68	Baritone Sax
190	0	0	69	Oboe
191	0	0	70	English Horn
192	0	0	71	Bassoon
193	0	0	72	Clarinet
194	0	0	73	Piccolo
195	0	0	74	Flute
196	0	0	75	Recorder
197	0	0	76	Pan Flute
198	0	0	77	Blown Bottle
199	0	0	78	Shakuhachi
200	0	0	79	Whistle
201	0	0	80	Ocarina
202	0	0	81	Square Lead
203	0	6	81	Square Lead 2
204	0	8	81	LM Square
205	0	18	81	Hollow
206	0	19	81	Shroud
207	0	64	81	Mellow
208	0	65	81	Solo Sine

Voice No.	Bank Select		MIDI Program Change# (1-128)	Voice Name
	MSB (0-127)	LSB (0-127)		
209	0	66	81	Sine Lead
210	0	0	82	Sawtooth Lead
211	0	6	82	Sawtooth Lead 2
212	0	8	82	Thick Sawtooth
213	0	18	82	Dynamic Sawtooth
214	0	19	82	Digital Sawtooth
215	0	20	82	Big Lead
216	0	96	82	Sequenced Analog
217	0	0	83	Calliope Lead
218	0	65	83	Pure Lead
219	0	0	84	Chiff Lead
220	0	0	85	Charang Lead
221	0	64	85	Distorted Lead
222	0	0	86	Voice Lead
223	0	0	87	Fifths Lead
224	0	35	87	Big Five
225	0	0	88	Bass & Lead
226	0	16	88	Big & Low
227	0	64	88	Fat & Perky
228	0	65	88	Soft Whirl
229	0	0	89	New Age Pad
230	0	64	89	Fantasy
231	0	0	90	Warm Pad
232	0	0	91	Poly Synth Pad
233	0	0	92	Choir Pad
234	0	66	92	Utopia
235	0	0	93	Bowed Pad
236	0	0	94	Metallic Pad
237	0	0	95	Halo Pad
238	0	0	96	Sweep Pad
239	0	0	97	Rain
240	0	65	97	African Wind
241	0	66	97	Carib
242	0	0	98	Sound Track
243	0	27	98	Prologue
244	0	0	99	Crystal
245	0	12	99	Synth Drum Comp
246	0	14	99	Popcorn
247	0	18	99	Tiny Bells
248	0	35	99	Round Glockenspiel
249	0	40	99	Glockenspiel Chimes
250	0	41	99	Clear Bells
251	0	42	99	Chorus Bells
252	0	65	99	Soft Crystal
253	0	70	99	Air Bells
254	0	71	99	Bell Harp
255	0	72	99	Gamelimba
256	0	0	100	Atmosphere
257	0	18	100	Warm Atmosphere
258	0	19	100	Hollow Release
259	0	40	100	Nylon Electric Piano
260	0	64	100	Nylon Harp
261	0	65	100	Harp Vox
262	0	66	100	Atmosphere Pad
263	0	0	101	Brightness
264	0	0	102	Goblins
265	0	64	102	Goblins Synth
266	0	65	102	Creeper
267	0	67	102	Ritual
268	0	68	102	To Heaven
269	0	70	102	Night
270	0	71	102	Glisten
271	0	96	102	Bell Choir
272	0	0	103	Echoes
273	0	0	104	Sci-Fi
274	0	0	105	Sitar
275	0	32	105	Detuned Sitar
276	0	35	105	Sitar 2
277	0	97	105	Tamboura
278	0	0	106	Banjo

Voice No.	Bank Select		MIDI Program Change# (1-128)	Voice Name
	MSB (0-127)	LSB (0-127)		
279	0	28	106	Muted Banjo
280	0	96	106	Rabab
281	0	97	106	Gopichant
282	0	98	106	Oud
283	0	0	107	Shamisen
284	0	0	108	Koto
285	0	96	108	Taisho-kin
286	0	97	108	Kanoon
287	0	0	109	Kalimba
288	0	0	110	Bagpipe
289	0	0	111	Fiddle
290	0	0	112	Shanai
291	0	0	113	Tinkle Bell
292	0	96	113	Bonang
293	0	97	113	Altair
294	0	98	113	Gamelan Gongs
295	0	99	113	Stereo Gamelan Gongs
296	0	100	113	Rama Cymbal
297	0	0	114	Agogo
298	0	0	115	Steel Drums
299	0	97	115	Glass Percussion
300	0	98	115	Thai Bells
301	0	0	116	Woodblock
302	0	96	116	Castanets
303	0	0	117	Taiko Drum
304	0	96	117	Gran Cassa
305	0	0	118	Melodic Tom
306	0	64	118	Melodic Tom 2
307	0	65	118	Real Tom
308	0	66	118	Rock Tom
309	0	0	119	Synth Drum
310	0	64	119	Analog Tom
311	0	65	119	Electronic Percussion
312	0	0	120	Reverse Cymbal
313	0	0	121	Fret Noise
314	0	0	122	Breath Noise
315	0	0	123	Seashore
316	0	0	124	Bird Tweet
317	0	0	125	Telephone Ring
318	0	0	126	Helicopter
319	0	0	127	Applause
320	0	0	128	Gunshot
321	64	0	1	Cutting Noise
322	64	0	2	Cutting Noise 2
323	64	0	4	String Slap
324	64	0	17	Flute Key Click
325	64	0	33	Shower
326	64	0	34	Thunder
327	64	0	35	Wind
328	64	0	36	Stream
329	64	0	37	Bubble
330	64	0	38	Feed
331	64	0	49	Dog
332	64	0	50	Horse
333	64	0	51	Bird Tweet 2
334	64	0	56	Maou
335	64	0	65	Phone Call
336	64	0	66	Door Squeak
337	64	0	67	Door Slam
338	64	0	68	Scratch Cut
339	64	0	69	Scratch Split
340	64	0	70	Wind Chime
341	64	0	71	Telephone Ring 2
342	64	0	81	Car Engine Ignition
343	64	0	82	Car Tires Squeal
344	64	0	83	Car Passing
345	64	0	84	Car Crash
346	64	0	85	Siren
347	64	0	86	Train
348	64	0	87	Jet Plane

Voice No.	Bank Select		MIDI Program Change# (1-128)	Voice Name
	MSB (0-127)	LSB (0-127)		
349	64	0	88	Starship
350	64	0	89	Burst
351	64	0	90	Roller Coaster
352	64	0	91	Submarine
353	64	0	97	Laugh
354	64	0	98	Scream
355	64	0	99	Punch
356	64	0	100	Heartbeat
357	64	0	101	Footsteps
358	64	0	113	Machine Gun
359	64	0	114	Laser Gun
360	64	0	115	Explosion
361	64	0	116	Firework

The voice number with an asterisk (\*) is XGlite optional voice.



# Drum Kit List

- “ ” indicates that the drum sound is the same as “Standard Kit 1”.
- Each percussion voice uses one note.
- The MIDI Note # and Note are actually one octave lower than keyboard Note # and Note. For example, in “128: Standard Kit 1”, the “Seq Click H” (Note# 36/Note C1) corresponds to (Note# 24/Note C0).
- Key Off: Keys marked “O” stop sounding the instant they are released.
- Voices with the same Alternate Note Number (\*1 ... 4) cannot be played simultaneously. (They are designed to be played alternately with each other.)
- \*: XGlite optional kit.

		Voice No.				13		14	17	18	19	20	
		MSB (0-127) / LSB (0-127) / PC (1-128)				127/000/001		127/000/002	127/000/009	127/000/017	127/000/025	127/000/026	
		Keyboard		MIDI		Key Off	Alternate Note	Standard Kit 1	Standard Kit 2	Room Kit	Rock Kit	Electronic Kit	Analog Kit
		Note#	Note	Note#	Note								
		25	C# 0	13	C# -1		3	Surdo Mute					
		26	D 0	14	D -1		3	Surdo Open					
		27	D# 0	15	D# -1			Hi Q					
		28	E 0	16	E -1			Whip Slap					
		29	F 0	17	F -1		4	Scratch H					
		30	F# 0	18	F# -1		4	Scratch L					
		31	G 0	19	G -1			Finger Snap					
		32	G# 0	20	G# -1			Click Noise					
		33	A 0	21	A -1			Metronome Click					
		34	A# 0	22	A# -1			Metronome Bell					
		35	B 0	23	B -1			Seq Click L					
		36	C 1	24	C 0			Seq Click H					
C1	C#1	37	C# 1	25	C# 0			Brush Tap					
D1	D#1	38	D 1	26	D 0	O		Brush Swirl					
E1	E#1	39	D# 1	27	D# 0			Brush Slap					
F1	F#1	40	E 1	28	E 0	O		Brush Tap Swirl			Reverse Cymbal	Reverse Cymbal	
G1	G#1	41	F 1	29	F 0	O		Snare Roll	Snare Roll 2				
A1	A#1	42	F# 1	30	F# 0			Caanet			Hi Q 2	Hi Q 2	
B1	B#1	43	G 1	31	G 0			Snare Soft	Snare Soft 2	Snare Noisy	Snare Snappy Electro	Snare Noisy 4	
C2	C#2	44	G# 1	32	G# 0			Sticks					
D2	D#2	45	A 1	33	A 0			Kick Soft		Kick Tight 2	Kick 3	Kick Tight 2	
E2	E#2	46	A# 1	34	A# 0			Open Rim Shot	Open Rim Shot H Short				
F2	F#2	47	B 1	35	B 0			Kick Tight	Kick Tight Short	Kick 2	Kick Gate	Kick Analog Short	
G2	G#2	48	C 2	36	C 1			Kick	Kick Short	Kick Gate	Kick Gate Heavy	Kick Analog	
A2	A#2	49	C# 2	37	C# 1			Side Stick					Side Stick Analog
B2	B#2	50	D 2	38	D 1			Snare	Snare Short	Snare Snappy	Snare Rock	Snare Noisy 2	Snare Analog
C3	C#3	51	D# 2	39	D# 1			Hand Clap					
D3	D#3	52	E 2	40	E 1			Snare Tight	Snare Tight H	Snare Tight Snappy	Snare Rock Rim	Snare Noisy 3	Snare Analog 2
E3	E#3	53	F 2	41	F 1			Floor Tom L	Floor Tom 1	Tom Room 1	Tom Rock 1	Tom Electro 1	Tom Analog 1
F3	F#3	54	F# 2	42	F# 1	1		Hi-Hat Closed					Hi-Hat Closed Analog
G3	G#3	55	G 2	43	G 1			Floor Tom H	Tom Room 2	Tom Room 2	Tom Rock 2	Tom Electro 2	Tom Analog 2
A3	A#3	56	G# 2	44	G# 1	1		Hi-Hat Pedal					Hi-Hat Closed Analog 2
B3	B#3	57	A 2	45	A 1			Low Tom	Tom Room 3	Tom Room 3	Tom Rock 3	Tom Electro 3	Tom Analog 3
C4	C#4	58	A# 2	46	A# 1	1		Hi-Hat Open					Hi-Hat Open Analog
D4	D#4	59	B 2	47	B 1			Mid Tom L	Tom Room 4	Tom Room 4	Tom Rock 4	Tom Electro 4	Tom Analog 4
E4	E#4	60	C 3	48	C 2			Mid Tom H	Tom Room 5	Tom Room 5	Tom Rock 5	Tom Electro 5	Tom Analog 5
F4	F#4	61	C# 3	49	C# 2			Crash Cymbal 1					Crash Analog
G4	G#4	62	D 3	50	D 2			High Tom	Tom Room 6	Tom Room 6	Tom Rock 6	Tom Electro 6	Tom Analog 6
A4	A#4	63	D# 3	51	D# 2			Ride Cymbal 1					
B4	B#4	64	E 3	52	E 2			Chinese Cymbal					
C5	C#5	65	F 3	53	F 2			Ride Cymbal Cup					
D5	D#5	66	F# 3	54	F# 2			Tambourine					
E5	E#5	67	G 3	55	G 2			Splash Cymbal					
F5	F#5	68	G# 3	56	G# 2			Cowbell					Cowbell Analog
G5	G#5	69	A 3	57	A 2			Crash Cymbal 2					
A5	A#5	70	A# 3	58	A# 2			Vibraslap					
B5	B#5	71	B 3	59	B 2			Ride Cymbal 2					
C6	C#6	72	C 4	60	C 3			Bongo H					
D6	D#6	73	C# 4	61	C# 3			Bongo L					
E6	E#6	74	D 4	62	D 3			Conga H Mute					Conga Analog H
F6	F#6	75	D# 4	63	D# 3			Conga H Open					Conga Analog M
G6	G#6	76	E 4	64	E 3			Conga L					Conga Analog L
A6	A#6	77	F 4	65	F 3			Timbale H					
B6	B#6	78	F# 4	66	F# 3			Timbale L					
C7	C#7	79	G 4	67	G 3			Agogo H					
D7	D#7	80	G# 4	68	G# 3			Agogo L					
E7	E#7	81	A 4	69	A 3			Cabasa					
F7	F#7	82	A# 4	70	A# 3			Maracas					Maracas 2
G7	G#7	83	B 4	71	B 3	O		Samba While H					
A7	A#7	84	C 5	72	C 4	O		Samba While L					
B7	B#7	85	C# 5	73	C# 4			Guiro Short					
C8	C#8	86	D 5	74	D 4	O		Guiro Long					
D8	D#8	87	D# 5	75	D# 4			Claves					Claves 2
E8	E#8	88	E 5	76	E 4			Wood Block H					
F8	F#8	89	F 5	77	F 4			Wood Block L					
G8	G#8	90	F# 5	78	F# 4			Cuica Mute			Scratch H 2	Scratch H 2	
A8	A#8	91	G 5	79	G 4			Cuica Open			Scratch L 2	Scratch L 3	
B8	B#8	92	G# 5	80	G# 4	2		Triangle Mute					
C9	C#9	93	A 5	81	A 4	2		Triangle Open					
D9	D#9	94	A# 5	82	A# 4			Shaker					
E9	E#9	95	B 5	83	B 4			Jingle Bells					
F9	F#9	96	C 6	84	C 5			Bell Tree					
G9	G#9	97	C# 6	85	C# 5								
A9	A#9	98	D 6	86	D 5								
B9	B#9	99	D# 6	87	D# 5								
C10	C#10	100	E 6	88	E 5								
D10	D#10	101	F 6	89	F 5								
E10	E#10	102	F# 6	90	F# 5								
F10	F#10	103	G 6	91	G 5								



Voice No.						13	21	15	16	22
MSB (0-127) / LSB (0-127) / PC (1-128)						127/000/001	127/000/28	127/000/033	127/000/041	127/000/049
Keyboard		MIDI		Key Off	Alternate Note	Standard Kit 1	Dance Kit*	Jazz Kit	Brush Kit	Symphony Kit
Note#	Note	Note#	Note							
	25	C#	0	13	C#	-1	3	Surdo Mute	Kick Dance 1	
	26	D	0	14	D	-1	3	Surdo Open	Kick Dance 2	
	27	D#	0	15	D#	-1		Hi Q		
	28	E	0	16	E	-1		Whip Slap		
	29	F	0	17	F	-1	4	Scratch H	Scratch Dance 1	
	30	F#	0	18	F#	-1	4	Scratch L	Scratch Dance 2	
	31	G	0	19	G	-1		Finger Snap		
	32	G#	0	20	G#	-1		Click Noise		
	33	A	0	21	A	-1		Metronome Click	Dance Percussion 1	
	34	A#	0	22	A#	-1		Metronome Bell	Reverse Dance 1	
	35	B	0	23	B	-1		Seq Click L	Dance Percussion 2	
	36	C	1	24	C	0		Seq Click H	Hi Q Dance 1	
C1	37	C#	1	25	C#	0		Brush Tap	Snare Analog 3	
D1	38	D	1	26	D	0	O	Brush Swirl	Vinyl Noise	
E1	39	D#	1	27	D#	0		Brush Slap	Snare Analog 4	
F1	40	E	1	28	E	0	O	Brush Tap Swirl	Reverse Cymbal	
G1	41	F	1	29	F	0	O	Snare Roll	Reverse Dance 2	
A1	42	F#	1	30	F#	0		Caanet	Hi Q 2	
B1	43	G	1	31	G	0		Snare Soft	Snare Techno	Snare Jazz H
C2	44	G#	1	32	G#	0		Sticks	Snare Dance 1	
D2	45	A	1	33	A	0		Kick Soft	Kick Techno Q	
E2	46	A#	1	34	A#	0		Open Rim Shot	Rim Gate	Kick Soft 2
F2	47	B	1	35	B	0		Kick Tight	Kick Techno L	Gran Cassa
G2	48	C	2	36	C	1		Kick	Kick Techno	Kick Jazz
A2	49	C#	2	37	C#	1		Side Stick	Side Stick Analog	Kick Small
B2	50	D	2	38	D	1		Snare	Snare Clap	Brush Slap 2
C3	51	D#	2	39	D#	1		Hand Clap	Dance Clap	Brush Slap 3
D3	52	E	2	40	E	1		Snare Tight	Snare Dry	Snare Jazz L
E3	53	F	2	41	F	1		Floor Tom L	Tom Analog 1	Brush Tap 2
F3	54	F#	2	42	F#	1		Hi-Hat Closed	Hi-Hat Closed Analog3	Tom Jazz 1
G3	55	G	2	43	G	1	1	Floor Tom H	Tom Analog 2	Tom Brush 1
A3	56	G#	2	44	G#	1	1	Hi-Hat Pedal	Hi-Hat Closed Analog 4	Tom Brush 2
B3	57	A	2	45	A	1		Low Tom	Tom Analog 3	Tom Jazz 2
C4	58	A#	2	46	A#	1	1	Hi-Hat Open	Hi-Hat Open Analog 2	Tom Brush 3
D4	59	B	2	47	B	1		Mid Tom L	Tom Analog 4	Tom Jazz 3
E4	60	C	3	48	C	2		Mid Tom H	Tom Analog 5	Tom Brush 4
F4	61	C#	3	49	C#	2		Crash Cymbal 1	Crash Analog	Tom Jazz 4
G4	62	D	3	50	D	2		High Tom	Tom Analog 6	Tom Jazz 5
A4	63	D#	3	51	D#	2		Ride Cymbal 1		Tom Jazz 6
B4	64	E	3	52	E	2		Chinese Cymbal		Tom Brush 6
C5	65	F	3	53	F	2		Ride Cymbal Cup		Tom Jazz 6
D5	66	F#	3	54	F#	2		Tambourine	Tambourine Analog	Hand Cymbal Short
E5	67	G	3	55	G	2		Splash Cymbal		
F5	68	G#	3	56	G#	2		Cowbell	Cowbell Analog	
G5	69	A	3	57	A	2		Crash Cymbal 2		Hand Cymbal 2
A5	70	A#	3	58	A#	2		Vibraslap	Vibraslap Analog	
B5	71	B	3	59	B	2		Ride Cymbal 2	Ride Analog	Hand Cymbal 2 Short
C6	72	C	4	60	C	3		Bongo H	Bongo Analog H	
D6	73	C#	4	61	C#	3		Bongo L	Bongo Analog L	
E6	74	D	4	62	D	3		Conga H Mute	Conga Analog H	
F6	75	D#	4	63	D#	3		Conga H Open	Conga Analog M	
G6	76	E	4	64	E	3		Conga L	Conga Analog L	
A6	77	F	4	65	F	3		Timbale H		
B6	78	F#	4	66	F#	3		Timbale L		
C7	79	G	4	67	G	3		Agogo H		
D7	80	G#	4	68	G#	3		Agogo L		
E7	81	A	4	69	A	3		Cabasa		
F7	82	A#	4	70	A#	3		Maracas	Maracas 2	
G7	83	B	4	71	B	3	O	Samba While H		
A7	84	C	5	72	C	4	O	Samba While L		
B7	85	C#	5	73	C#	4		Guiro Short		
C8	86	D	5	74	D	4	O	Guiro Long		
D8	87	D#	5	75	D#	4		Claves	Claves 2	
E8	88	E	5	76	E	4		Wood Block H	Dance Percussion 3	
F8	89	F	5	77	F	4		Wood Block L	Dance Percussion 4	
G8	90	F#	5	78	F#	4		Cuica Mute	Dance Breath 1	
A8	91	G	5	79	G	4		Cuica Open	Dance Breath 2	
B8	92	G#	5	80	G#	4		Triangle Mute		
C9	93	A	5	81	A	4	2	Triangle Open		
D9	94	A#	5	82	A#	4		Shaker		
E9	95	B	5	83	B	4		Jingle Bells		
F9	96	C	6	84	C	5		Bell Tree		
G9	97	C#	6	85	C#	5				
A9	98	D	6	86	D	5				
B9	99	D#	6	87	D#	5				
C10	100	E	6	88	E	5				
D10	101	F	6	89	F	5				
E10	102	F#	6	90	F#	5				
F10	103	G	6	91	G	5				

# Drum Kit List

		Voice No.					13	26	27	25	23	24	
		MSB (0-127) / LSB (0-127) / PC (1-128)					127/000/001	126/000/001	126/000/002	126/000/36	126/000/41	126/000/44	
		Keyboard		MIDI		Key Off	Alternate Note	Standard Kit 1	SFX Kit 1	SFX Kit 2	ArabicKit*	CubanKit*	PopLatinKit*
		Note#	Note	Note#	Note								
		25	C# 0	13	C# -1		3	Surdo Mute					
		26	D 0	14	D -1		3	Surdo Open					
		27	D# 0	15	D# -1			Hi Q					
		28	E 0	16	E -1			Whip Slap					
		29	F 0	17	F -1		4	Scratch H					
		30	F# 0	18	F# -1		4	Scratch L					
		31	G 0	19	G -1			Finger Snap					Hand Clap
		32	G# 0	20	G# -1			Click Noise					
		33	A 0	21	A -1			Metronome Click					
		34	A# 0	22	A# -1			Metronome Bell				Conga H Tip	Conga H Tip
		35	B 0	23	B -1			Seq Click L				Conga H Heel	Conga H Heel
		36	C 1	24	C 0			Seq Click H			Nakarazan Dom	Conga H Open	Conga H Open
C1	C#1	37	C# 1	25	C# 0			Brush Tap			Cabasa	Conga H Mute	Conga H Mute
D1	D#1	38	D 1	26	D 0	O		Brush Swirl			Nakarazan Edge	Conga H Slap Open	Conga H Slap Open
E1	E#1	39	D# 1	27	D# 0			Brush Slap			Hager Dom	Conga H Slap	Conga H Slap
F1	F#1	40	E 1	28	E 0	O		Brush Tap Swirl			Hager Edge	Conga H Slap Mute	Conga H Slap Mute
G1	G#1	41	F 1	29	F 0	O		Snare Roll			Bongo H	Conga L Slap	Conga L Slap
A1	A#1	42	F# 1	30	F# 0			Caanet			Bongo L	Conga L Heel	Conga L Heel
B1	B#1	43	G 1	31	G 0			Snare Soft			Conga H Mute	Conga L Open	Conga L Open
C2	C#2	44	G# 1	32	G# 0			Sticks			Conga H Open	Conga L Mute	Conga L Mute
D2	D#2	45	A 1	33	A 0			Kick Soft			Conga L	Conga L Slap Open	Conga L Slap Open
E2	E#2	46	A# 1	34	A# 0			Open Rim Shot			Zagrouda H	Conga L Slap	Conga L Slap
F2	F#2	47	B 1	35	B 0			Kick Tight			Zagrouda L	Conga L Slide	Conga L Slide
G2	G#2	48	C 2	36	C 1			Kick	Cutting Noise	Phone Call	Kick Soft	Bongo H Open 1 finger	Bongo H Open 1 finger
A2	A#2	49	C# 2	37	C# 1			Side Stick	Cutting Noise 2	Door Squeak		Bongo H Open 3 finger	Bongo H Open 3 finger
B2	B#2	50	D 2	38	D 1			Snare		Door Slam	Snare Soft	Bongo H Rim	Bongo H Rim
C3	C#3	51	D# 2	39	D# 1			Hand Clap	ring Slap	Scratch Cut	Arabic Hand Clap	Bongo H Tip	Bongo H Tip
D3	D#3	52	E 2	40	E 1			Snare Tight		Scratch H 3	Snare	Bongo H Heel	Bongo H Heel
E3	E#3	53	F 2	41	F 1			Floor Tom L		Wind Chime		Bongo H Slap	Bongo H Slap
F3	F#3	54	F# 2	42	F# 1	1		Hi-Hat Closed		Telephone Ring 2		Bongo L Open 1 finger	Bongo L Open 1 finger
G3	G#3	55	G 2	43	G 1			Floor Tom H				Bongo L Open 3 finger	Bongo L Open 3 finger
A3	A#3	56	G# 2	44	G# 1	1		Hi-Hat Pedal				Bongo L Rim	Bongo L Rim
B3	B#3	57	A 2	45	A 1			Low Tom				Bongo L Tip	Bongo L Tip
C4	C#4	58	A# 2	46	A# 1	1		Hi-Hat Open				Bongo L Heel	Bongo L Heel
D4	D#4	59	B 2	47	B 1			Mid Tom L				Bongo L Slap	Bongo L Slap
E4	E#4	60	C 3	48	C 2			Mid Tom H				Timbale L Open	Timbale L Open
F4	F#4	61	C# 3	49	C# 2			Crash Cymbal 1					
G4	G#4	62	D 3	50	D 2			High Tom					
A4	A#4	63	D# 3	51	D# 2			Ride Cymbal 1					
B4	B#4	64	E 3	52	E 2			Chinese Cymbal	Flute Key Click	Car Engine Ignition	Crash Cymbal 2		
C5	C#5	65	F 3	53	F 2			Ride Cymbal Cup		Car Tires Squeal	Duhulla Dom	Paila L	Paila L
D5	D#5	66	F# 3	54	F# 2			Tambourine		Car Passing		Timbale H Open	Timbale H Open
E5	E#5	67	G 3	55	G 2			Splash Cymbal		Car Crash	Duhulla Tak		
F5	F#5	68	G# 3	56	G# 2			Cowbell		Siren			
G5	G#5	69	A 3	57	A 2			Crash Cymbal 2		Train	Duhulla Sak		
A5	A#5	70	A# 3	58	A# 2			Vibraslap		Jet Plane	Claves		
B5	B#5	71	B 3	59	B 2			Ride Cymbal 2		arship	Doff Dom	Paila H	Paila H
C6	C#6	72	C 4	60	C 3			Bongo H		Bur	Katem Dom	Cowbell Top	Cowbell Top
D6	D#6	73	C# 4	61	C# 3			Bongo L		Roller Coaster	Katem Tak		
E6	E#6	74	D 4	62	D 3			Conga H Mute		Submarine	Katem Sak		
F6	F#6	75	D# 4	63	D# 3			Conga H Open			Katem Tak		
G6	G#6	76	E 4	64	E 3			Conga L			Doff Tak	Guiro Short	Guiro Short
A6	A#6	77	F 4	65	F 3			Timbale H			Tabla Dom	Guiro Long	Guiro Long
B6	B#6	78	F# 4	66	F# 3			Timbale L			Tabla Tak1		
C7	C#7	79	G 4	67	G 3			Agogo H			Tabla Tik		
D7	D#7	80	G# 4	68	G# 3			Agogo L	Shower	Laugh	Tabla Tak2	Tambourine	Tambourine
E7	E#7	81	A 4	69	A 3			Cabasa	Thunder	Scream	Tabla Sak		
F7	F#7	82	A# 4	70	A# 3			Maracas	Wind	Punch	Tabla Roll of Edge		
G7	G#7	83	B 4	71	B 3	O		Samba While H	ream	Heartbeat	Tabla Flam		
A7	A#7	84	C 5	72	C 4	O		Samba While L	Bubble	Footeps	Sagat 1	Maracas	Maracas
B7	B#7	85	C# 5	73	C# 4			Guiro Short	Feed		Tabel Dom	Shaker	Shaker
C8	C#8	86	D 5	74	D 4	O		Guiro Long			Sagat 3	Cabasa	Cabasa
D8	D#8	87	D# 5	75	D# 4			Claves			Tabel Tak		Cuica Mute
E8	E#8	88	E 5	76	E 4			Wood Block H			Sagat 2		Cuica Open
F8	F#8	89	F 5	77	F 4			Wood Block L			Rik Dom		
G8	G#8	90	F# 5	78	F# 4			Cuica Mute			Rik Tak 2		
A8	A#8	91	G 5	79	G 4			Cuica Open			Rik Finger 1		
B8	B#8	92	G# 5	80	G# 4		2	Triangle Mute			Rik Tak 1		
C9	C#9	93	A 5	81	A 4		2	Triangle Open			Rik Finger 2		Triangle Mute
D9	D#9	94	A# 5	82	A# 4			Shaker			Rik Brass Tremolo		Triangle Open
E9	E#9	95	B 5	83	B 4			Jingle Bells			Rik Sak		
F9	F#9	96	C 6	84	C 5			Bell Tree	Dog	Machine Gun	Rik Tik		Bell Tree
G9	G#9	97	C# 6	85	C# 5				Horse	Laser Gun			
A9	A#9	98	D 6	86	D 5				Bird Tweet 2	Explosion			
B9	B#9	99	D# 6	87	D# 5					Firework			
C10	C#10	100	E 6	88	E 5								
D10	D#10	101	F 6	89	F 5								
E10	E#10	102	F# 6	90	F# 5								
F10	F#10	103	G 6	91	G 5				Maou				



# Style List

Style No.	Style Name
<b>Pop&amp;Rock</b>	
1	FunkPopRock
2	AcousticRock
3	Cool8Beat
4	60'sRock1
5	60'sRock2
6	VintageGtrPop
7	60'sGuitarPop
8	70's8Beat
9	90'sGuitarPop
10	KoolShuffle
11	BubblegumPop
12	BritPopSwing
13	JazzPop
14	HardRock
15	RootRock
16	RockShuffle
17	Unplugged
<b>Ballad</b>	
1	8BeatAdria
2	OrganBallad
3	PianoBallad
4	8BeatBallad
5	EPBallad
6	6-8Modern
7	Chillout
8	NewR&BBallad
9	16BeatBallad
10	PowerBallad
11	EasyBallad
<b>Dance</b>	
1	Ibiza
2	TechnoParty
3	DiscoHouse
4	DiscoPhilly
5	70'sDisco
6	80'sDisco
7	DreamDance
8	House
9	FrenchHouse
10	Garage
11	ClassicHipHop
12	NewHipHop
13	HipHopGroove
14	LatinDJ's
<b>Swing&amp;Jazz</b>	
1	OrchBigBand
2	OrchestraSwing1
3	OrchestraSwing2
4	BigBandFast
5	BigBandShuffle
6	MidnightSwing
7	JumpJive
8	OrganGroove
9	JazzClub
10	Five-Four

Style No.	Style Name
11	JazzWaltzFast
12	Dixieland
13	Ragtime
14	Charleston
<b>R&amp;B</b>	
1	BluesRock
2	BluesBallad
3	Soul
4	FranklySoul
5	6-8Soul
6	SoulBrothers
7	OldiesR&R
8	60'sRock&Roll
9	Rock&Roll
10	Twist
11	GospelSisters
12	WorshipMed
13	DetroitPop
14	ModernR&B
15	ComboBoogie
<b>Country</b>	
1	NewCountry
2	CountryHits
3	CountryBallad
4	CountryPop
5	CountryShuffle
6	Country2-4
7	FingerPickin
8	Bluegrass
9	Hoedown
10	CountryWaltz
<b>Latin</b>	
1	BrazilianSamba
2	FastBossa
3	Beguine
4	Mambo
5	Salsa
6	Calypso
7	Merengue
8	Bachata
9	CubanSon
10	RumbalIsland
11	RumbaFlamenca
12	HappyReggae
13	LatinDisco
<b>Ballroom</b>	
1	VienneseWaltz
2	EnglishWaltz
3	Slowfox
4	Foxtrot
5	Quickstep
6	Tango
7	Swingfox
8	Pasodoble
9	Samba
10	ChaChaCha

Style No.	Style Name
11	Rumba
12	Jive
13	OrganSwing
14	OrganSamba
15	OrganQuickstep
16	9-8Waltz
17	TraditionalWaltz
<b>Movie&amp;Show</b>	
1	70'sTVTheme
2	Sci-fiMarch
3	WildWest
4	SaturdayNight
5	Showtune
6	Moonlight6-8
7	ClassicPianoBld
8	BaroqueAir
9	OrchestralBolero
10	OrchestralMarch
11	ChristmasSwing
12	ChristmasWaltz
<b>Entertainer</b>	
1	DiscoFox
2	DiscoHands
3	AlpBallad
4	ScandSlowRock
5	ScandShuffle
6	70'sFrenchHit
7	SchlagerPop
8	SchlagerBeat
9	SchlagerPolka
10	PolkaPop
11	Tijuana
12	Carnival
13	PubPiano
<b>World</b>	
1	IrishDance
2	SpanishPaso
3	FrenchMusette
4	OrientalPop
5	Sirtaki
6	PopFlamenco
7	Reel
8	Jig
9	Tarantella
10	OberPolka
11	OberWaltzer
12	GermanMarch
13	USMarch
14	6-8March



# Music Database List

No.	MDB Name
<b>Christmas</b>	
1	Manger Away
2	Noel First
3	Rednosed Rudolph
4	Silent Christmas
5	Wonderful Time
<b>Traditional</b>	
6	Abide This Hymn
7	Ave Maria NoMore
8	Can Can Orpheus
9	Moulin Heart
10	Texas YellowRose
<b>Showtime</b>	
11	Dance Lord
12	For Cabaret!
13	Night Time
14	NoBusiness Like!
15	The Cat's Memory
16	The Great Times
<b>World</b>	
17	Beautiful Sun
18	Close Your Face
19	Goodbye Roma
20	I Land In Sun
21	La Cucarumba
22	La Maison Viens
23	Latin Cuccuru
24	Musette De Reine
25	PopulaireChanson
26	Ya Salama
<b>Screen Theme</b>	
27	Ark Raider March
28	Be A Muppet!
29	Bills Barnacles
30	Does It Better
31	Escape Great!
32	Fighting Stars
33	Large Country
34	Mind Read?
35	Mi-Re-Do
36	My Favorites!
37	ParadiseConquest
38	SevenMagnificent
39	Some Day Prince
40	Starsky Cops
41	Tie, Hat, Tails
42	Under Sea
<b>Pop Classics</b>	
43	24 Hour Tulsa
44	Afternoon Sun
45	All On My Own
46	At Broadway
47	Bend And Shape
48	Boxing Song
49	Broken Heart
50	Can Help Yourself
51	Chance Take
52	Complete Eclipse
53	Day Is Perfect
54	Dont Break Heart
55	Easier To Say It
56	Friends Help
57	Girl Wants Bobby
58	Girl, Brown Eyes
59	Heartache Beat
60	Holiday Summer
61	I'm Your Venus

No.	MDB Name
62	John B's Sloop
63	Lane Of Pennies
64	Lost Religion
65	Love Somebody
66	Loves YouSheDoes
67	Need Somebody
68	Nice Paradise
69	Not Usual
70	Raindrop Walk
71	Ride Ticket
72	Sally Mustang
73	Sky Spirits
74	Spin The Wheel
75	Still Standing
76	Suzie Wake Up
77	Sweet Lord Song
78	Thanks For Music
79	This Is My Party
80	Together n Happy
<b>BigBand</b>	
81	Big Band Patrol
82	Bugle Boy Boogie
83	L For Love
84	Savoy Stompin'
85	Tasty Honey
86	Tramp Lady
87	Wail, Jump, Jive
88	What Is Not Old?
89	With Me Fly
<b>Swing</b>	
90	Alex's Band
91	Blue Lady Flower
92	Bye Blues, Bye
93	Charles On
94	Coffee Cream
95	Get Out Of Bed
96	Hopes High
97	Just Chickens!
98	My Shadow And Me
99	Not Forgettable
100	Not Misbehaving
101	Out Of Your Kick
102	Ragtime Tiger
103	Safari Swing
104	Smiling Swing
105	Tap Dancing Bo
106	Two Foot Five
107	Whole Thing Off
<b>Jazz</b>	
108	Not Decided
109	Wild Cat Dixie
110	Winners Easy
<b>Oldies</b>	
111	Baby Be Mine
112	Breathe Air
113	Diana's Twist
114	Doll's Alive!
115	Don't Want Milk
116	Down Town
117	Final Waltz
118	Girl From Uptown
119	Golden Silence
120	Guitar Apache
121	Hard Breakup
122	Have I Got It?
123	He Kiss Crystal
124	Heaven Steps

No.	MDB Name
125	I'm A Pola!
126	Land Wonderful!
127	Lips Are Lucky
128	Lonely Night
129	Magic Puff
130	Marina's Song
131	Me Please
132	Mend A Chino
133	Motion Of Poetry
134	No Love Feeling
135	Pete Retite
136	Pillow Tears
137	Saw Her Standing
138	Star Of Movie
139	Teenie Bikini
140	The Ghetto
141	Tomorrow Love Me
142	Tonight, Hey
143	Twisting Again
144	Walk Right To
145	Woman's Pretty!
146	WordsAren't Easy
147	You & You Alone
148	You Sorry Now?
<b>Disco</b>	
149	Babylon Rivers
150	Born Alive Disco
151	Brown Girl Ring
152	Celebrate
153	Cool Daddy Disco
154	Day Difference
155	Dee Eye S C Oh!
156	Disco Hustle
157	Fever At Night
158	Fire Relight
159	Good Feel
160	I Love That Boat
161	It's A Tragedy!
162	Keepin' Alive
163	Navy Disco
164	Never Give Up
165	Philadelphia
166	Swedish Queen
167	Theme Of Love
168	Train Of Love
169	Why Am See A?
170	Youre Everything
<b>Party Time</b>	
171	Aga Doo
172	Big Samba Bamboo
173	Blankenesenolop
174	Dancing Bird
175	Drink Cider
176	Hands Up Party
177	Kreuzberg
178	Louie My Brother
179	Mexican Trumpet
180	The Bucklehuck
<b>Rock&amp;Roll</b>	
181	All Shaken Up
182	Beethoven Rock
183	Blue Shoes
184	Clock Rock
185	Don't Hurry Love
186	Great Fire Balls
187	I'm A Wanderer
188	Let's Sue Peggy

No.	MDB Name
189	Music Rock&Roll
190	Rock & Roll Jail
191	Shouting Twist
192	Twist Play
<b>R&amp;B/Gospel</b>	
193	Admire
194	Baby Groove
195	Dont Get Excited
196	It's Soul, Man!
197	Man Love Woman
198	Road End
199	See You Again
200	Soul Thought
201	The Rivers Side
<b>Classical</b>	
202	Classical Maria
203	Danube Blue
204	Dream Of Love
205	Dreams Forgotten
206	G String Air
207	Gladiators Entry
208	In The Key Of F
209	March Radetzky
210	Skaters Dance
211	Sonata Moonlight
212	Third Etude
<b>Dance Floor</b>	
213	Back Singer
214	Catch 22
215	First Sight
216	Ibiza Adagio
217	It's So Horny
218	Janeiro Samba
219	Kids
220	Life Is High
221	London, Ready
222	Move Up
223	Once More
224	Rose Desert
225	She Believes
<b>Country</b>	
226	Back On The Road
227	Blue Bonanza
228	Boy Country
229	Country Road
230	Forever On Mind
231	Hi, Mary
232	I'm Lonesome
233	Lucille Left Me
234	Nuts
235	Only Need You
236	Road Of The King
237	Special Orange
238	Waltz Tennessee
<b>Ballroom</b>	
239	A Band Ah!
240	All Goes
241	Balls Of Fire
242	Band Strike
243	Besame
244	Bird Is Yellow
245	Brazil
246	Cherry And Apple
247	Cope Cabana
248	Crazy LittleLove
249	Cumban El
250	Cumparsita Tango

No.	MDB Name
251	Espana Viva
252	Eyes Of Green
253	Face Dance Music
254	Free Best Things
255	Green Mountain
256	Hear Music
257	Heaven Blue
258	He's Got To Go
259	High Moon
260	Holiday Home
261	I Won't Be Cruel
262	Jealous Tango
263	Jeeps Creepers
264	Knife, Mack
265	Lift Yourself Up
266	Moon Waltz
267	Not On Sunday
268	Nothing But Love
269	Nuts Rhythm
270	Old House
271	Old St. Bernards
272	On Your Street
273	Partner Change
274	Perfidious One
275	Portugal April
276	Quando Samba
277	Sandman
278	Say Magnifique!
279	Spanish Dance
280	Tango Blue
281	Teddy Is A Bear
282	Tied Ribbon
283	Tiny Hotel
284	Walk In Love
285	When Smiling
286	ZingHeart String
<b>Latin</b>	
287	A More
288	Bananaboat Comes
289	Corazon un Tengo
290	Don't Worry!
291	Eyes From Spain
292	Flea From Spain
293	Frenetic Beguine
294	GuitarFor Volare
295	Guntanamea
296	Italian Mambo
297	Jamaica Goodbye
298	Luminous
299	Mambo Jamming
300	Mentiroso Es
301	More Than
302	Nada Mas Que
303	Phone Me
304	Samba One Note
305	Start TheBeguine
306	Taxi In Tijuana
<b>Ballad</b>	
307	A Hero
308	At Once Ballad
309	Back Forever
310	Ballad For Woman
311	Beneath My Wings
312	Change My Love
313	Eyes Of Blue
314	Fly Away One Day
315	Friends Are For

No.	MDB Name
316	Hard To SaySorry
317	Hi, Greetings
318	I T'Aime
319	I'm Saving Love
320	Know Me Now
321	Leave Me Now
322	Live Without You
323	London Streets
324	Love's Glory
325	Make Love To You
326	San Francisco
327	Up We Belong
328	When We Touch
329	Wind On Candle
330	You Inspire
331	You'll Be Here
332	Your True Color
<b>Sing-alongs</b>	
333	Brown Knees
334	Danny's Boy
335	Espana Viva
336	Iron Is Old!
337	My Clementine
338	My Dads ADustman
339	My Man Is Old
340	Old Smokey
341	Silver Lining
342	Smile Irish Eyes
343	Song For Susanna
344	Song Sideboard
345	Tipperary Way
<b>Schlager</b>	
346	Autobahnpolka
347	Blind Passenger
348	Capri Beat
349	Deep Love
350	Glaube An Wunder
351	Goodbye Amor
352	I Have Sad Love
353	In Ewigkeit
354	Italian Guy
355	Mexican Fiesta
356	Moscow City
357	No Tears
358	Oh Maria
359	Paloma Pop
360	Spanish Island
361	The Little House
362	Where Is Love?
363	Wonderful Blonde
<b>Family</b>	
364	Necessary Bear
365	Noisy Old Car?
<b>Easy Listening</b>	
366	Balloon Bossa
367	Beyond Ocean
368	Farewell
369	MakeThrough Rain
370	Mother!
371	New World
372	Portugal InApril
373	Raindrop Head
374	Something Silly!
375	The Wind And Me
376	Town Durham
<b>March &amp; Polka</b>	
377	Bogey March

No.	MDB Name
378	Double Eagle
379	Polka Is Happy!
380	Post Washington
381	Rosa
382	Stripes andStars
383	Teddy Picnic
384	Trombones Parade
385	Vienna Forever
<b>All Time Hits</b>	
386	All Of My Loving
387	At Heart Young
388	Away And Up
389	Born Smiling
390	Don't Be Bad
391	Game Makes Tears
392	Guitar Wheels
393	Hard Day AtNight
394	Heaven, Too Much
395	I Hold Your Hand
396	Letters Of Love
397	Lover's A Dream
398	Make Thru Night
399	Mrs. Robin's Son
400	My Shell Swing
401	My Tears Go By
402	Ones Are Young
403	Please Do Love
404	Simple Heart
405	Tender Love
406	Throw Love Away
407	Troubled Water
408	Two Times Yeh!
409	Un-Till
410	Walking Boots
411	Wind Blowing
412	Woods Of Norway
413	Yellow Sub
<b>Rock</b>	
414	Alabama's Home
415	Born To Be Mild
416	Dave On The Road
417	Get Satisfied
418	Jumping Rock
419	Keep Thinking
420	Last Countdown
421	Need To Be Free
422	Tiger's Eye
423	Velvet Is Black
424	Whatever YouRock
<b>Waltz</b>	
425	Ani Waltz
426	Charmaine Waltz
427	Daisy's Bicycle
428	Dutch Tulip
429	Dutch Windmill
430	FascinationWaltz
431	Fledermaus
432	Is It True Love?
433	Lover Waltz
434	Raggy Three Four
435	Remember?
436	Samson's Girl
437	Snow Waltz
438	Somewhere Love
439	Spring Voices
440	The Little Pub
441	Waltz Cuckoo

No.	MDB Name
442	Waltz Emperor
443	Waltz Of Amore
444	Waltz To Skate
445	Whatever Will Be
<b>Instrumentals</b>	
446	Birds At Night
447	Black AndWhite
448	Four Plus One
449	Invites
450	Lonely Piper
451	Maple Ragtime
452	Piece Of Funk
453	Round The World
454	String Holiday
455	Yak This Sax
<b>Modern Pop</b>	
456	All Change
457	Always Rain OnMe
458	Angle of Charlie
459	Flame Eternal
460	Girl BelongsToMe
461	Go Love Way
462	I'm Torn
463	In The Family
464	It's Only Words
465	Life Groove
466	Life's Walk
467	Light For Love
468	Love Part Time
469	Maroon Love
470	Only Need Love
471	Perhaps Emma
472	Rollercoaster
473	Sorry To Say
474	Sure Of That?
475	Swinging Sultan
476	Tell Her All
477	Thing Called Lve
478	Time Riding
479	Took So Long
480	Why Marry Her?
<b>Latin Pop</b>	
481	Dance Morning
<b>Pop Ballads</b>	
482	Crazy MissingYou
483	Dont Let The Sun
484	No Matter What
485	One More Year?
486	World Heal
487	World We Are
<b>Worship</b>	
488	God Is Mighty
<b>Organist</b>	
489	Bamba Party
490	Cat Groove
491	El Ranchero
492	Face Of A Child
493	Guide Me Home
494	Hi Dolly
495	Samba Cavaquinho
496	Side To Side
497	Steam TrainSamba
498	Tico Samba
499	Two Times Yeh!
500	White And Pale



# Effect Type List

## ● Harmony Types

No.	Type	Description	
01	Duet	Harmony types 01–05 are pitch-based and add one-, two- or three-note harmonies to the single-note melody played in the right hand. These types sound when chords are played in the auto accompaniment range of the keyboard. These Harmony types will also work when playing songs that contain chord data.	
02	Trio		
03	Block		
04	Country		
05	Octave		
06	Trill 1/4 note		<p>Types 6–26 are rhythm-based effects and add embellishments or delayed repeats in time with the auto accompaniment. These types sound whether the auto accompaniment is on or not; however, the actual speed of the effect depends on the Tempo setting (page 64). The individual note values in each type let you synchronize the effect precisely to the rhythm. Triplet settings are also available: 1/6 = quarter-note triplets, 1/12 = eighth-note triplets, 1/24 = sixteenth-note triplets.</p> <ul style="list-style-type: none"> <li>• The Trill effect Types (06–12) create two-note trills (alternating notes) when two notes are held.</li> <li>• The Tremolo effect Types (13–19) repeat all held notes (up to four).</li> <li>• The Echo effect Types (20–26) create delayed repeats of each note played.</li> </ul>
07	Trill 1/6 note		
08	Trill 1/8 note		
09	Trill 1/12 note		
10	Trill 1/16 note		
11	Trill 1/24 note		
12	Trill 1/32 note		
13	Tremolo 1/4 note		
14	Tremolo 1/6 note		
15	Tremolo 1/8 note		
16	Tremolo 1/12 note		
17	Tremolo 1/16 note		
18	Tremolo 1/24 note		
19	Tremolo 1/32 note		
20	Echo 1/4 note		
21	Echo 1/6 note		
22	Echo 1/8 note		
23	Echo 1/12 note		
24	Echo 1/16 note		
25	Echo 1/24 note		
26	Echo 1/32 note		

## ● Reverb Types

No.	Type	Description	MSB	LSB
1	HALL1	Reverb simulating the acoustics of a hall.	1	0
2	HALL2		1	16
3	HALL3		1	17
4	HALL4		1	18
5	HALL5		1	1
6	HALL M		1	6
7	HALL L		1	7
8	ROOM1	Reverb simulating the acoustics of a room	2	16
9	ROOM2		2	17
10	ROOM3		2	18
11	ROOM4		2	19
12	ROOM5		2	0
13	ROOM6		2	1
14	ROOM7		2	2
15	ROOM S		2	5
16	ROOM M		2	6
17	ROOM L		2	7
18	STAGE1	Reverb suitable for a solo instrument.	3	16
19	STAGE2		3	17
20	STAGE3		3	0
21	STAGE4		3	1
22	PLATE1	Reverb simulating a plate reverb unit.	4	16
23	PLATE2		4	17
24	PLATE3		4	0
25	GM PLATE		4	7
26	NO EFFECT	No effect.	0	0

## ● Chorus Types

No.	Type	Description	MSB	LSB
1	CHORUS1	Conventional chorus program with rich, warm chorusing.	66	17
2	CHORUS2		66	8
3	CHORUS3		66	16
4	CHORUS4		66	1
5	CHORUS5		65	2
6	CHORUS6		65	0
7	CHORUS7		65	1
8	CHORUS8		65	8
9	GM CHORUS1		65	3
10	GM CHORUS2		65	4
11	GM CHORUS3		65	5
12	GM CHORUS4		65	6
13	FB CHORUS		65	7
14	CELESTE1	A 3-phase LFO adds modulation and spaciousness to the sound.	66	0
15	CELESTE2		66	2
16	FLANGER1	Creates a sound reminiscent of a jet airplane.	67	8
17	FLANGER2		67	16
18	FLANGER3		67	17
19	FLANGER4		67	1
20	FLANGER5		67	0
21	GM FLANGER		67	7
22	SYMPHONIC1	Adds more stages to the modulation of Celeste.	68	16
23	SYMPHONIC2		68	0
24	PHASER1	Cyclically modulates the phase to add modulation to the sound.	72	0
25	PHASER2		72	8
26	EP PHASER1		72	17
27	EP PHASER2		72	18
28	EP PHASER3		72	16
29	ENS DETUNE		87	0
30	ROTARY SP5	Simulates a rotary speaker.	66	18
31	NO EFFECT	No effect.	0	0

## ● DSP Types

No.	Type	Description	MSB	LSB
1	HALL1	Reverb simulating the acoustics of a hall.	1	0
2	HALL2		1	16
3	HALL3		1	17
4	HALL4		1	18
5	HALL5		1	1
6	HALL M		1	6
7	HALL L		1	7
8	ROOM1	Reverb simulating the acoustics of a room.	2	16
9	ROOM2		2	17
10	ROOM3		2	18
11	ROOM4		2	19
12	ROOM5		2	0
13	ROOM6		2	1
14	ROOM7		2	2
15	ROOM S		2	5
16	ROOM M		2	6
17	ROOM L		2	7
18	STAGE1	Reverb suitable for a solo instrument.	3	16
19	STAGE2		3	17
20	STAGE3		3	0
21	STAGE4		3	1
22	PLATE1	Reverb simulating a plate reverb unit.	4	16
23	PLATE2		4	17
24	PLATE3		4	0
25	GM PLATE		4	7
26	CHORUS1	Conventional chorus program with rich, warm chorusing.	66	17
27	CHORUS2		66	8
28	CHORUS3		66	16
29	CHORUS4		66	1
30	CHORUS5		65	2
31	CHORUS6		65	0
32	CHORUS7		65	1
33	CHORUS8		65	8
34	GM CHORUS1		65	3
35	GM CHORUS2		65	4
36	GM CHORUS3		65	5
37	GM CHORUS4		65	6
38	FB CHORUS		65	7
39	CELESTE1	A 3-phase LFO adds modulation and spaciousness to the sound.	66	0
40	CELESTE2		66	2

## Effect Type List

No.	Type	Description	MSB	LSB
41	SYMPHONIC1		68	16
42	SYMPHONIC2	Adds more stages to the modulation of Celeste.	68	0
43	ENS DETUNE	Chorus effect without modulation, created by adding a slightly pitch-shifted sound.	87	0
44	KARAOKE1		20	0
45	KARAOKE2	Echo for karaoke.	20	1
46	KARAOKE3		20	2
47	ER1		9	0
48	ER2	This effect isolates only the early reflection components of the reverb.	9	1
49	GATE REVERB	Simulation of gated reverb.	10	0
50	REVERS GATE	Simulation of gated reverb played back in reverse.	11	0
51	EQ DISCO	Equalizer effect that boosts both high and low frequencies, as is typical in most disco music.	76	16
52	EQ TEL	Equalizer effect that cuts both high and low frequencies, to simulate the sound heard through a telephone receiver.	76	17
53	2BAND EQ	A stereo EQ with adjustable LOW and HIGH. Ideal for drum Parts.	77	0
54	3BAND EQ	A mono EQ with adjustable LOW, MID, and HIGH equalizing.	76	0
55	HM ENHANCE1		81	16
56	HM ENHANCE2	Adds new harmonics to the input signal to make the sound stand out.	81	0
57	ST 3BAND EQ	An EQ which allows equalization of low, mid and high bands.	76	18
58	FLANGER1		67	8
59	FLANGER2		67	16
60	FLANGER3	Creates a sound reminiscent of a jet airplane.	67	17
61	FLANGER4		67	1
62	FLANGER5		67	0
63	GM FLANGER		67	7
64	DYN FLANGER	Dynamically controlled flanger.	110	0
65	DELAY LCR1	Produces three delayed sounds: L, R and C (center).	5	16
66	DELAY LCR2		5	0
67	DELAY LR	Produces two delayed sounds: L and R. Two feedback delays are provided.	6	0
68	ECHO	Two delayed sounds (L and R), and independent feedback delays for L and R.	7	0
69	CROSS DELAY	The feedback of the two delayed sounds is crossed.	8	0
70	DIST HEAVY	Heavy distortion.	73	0
71	ST DIST	Stereo distortion.	73	8
72	COMP+DIST1	Since a Compressor is included in the first stage, steady distortion can be produced regardless of changes in input level.	73	16
73	COMP+DIST2		73	1
74	OVERDRIVE		74	0
75	OVERDRIVE2	Adds mild distortion to the sound.	74	9
76	ST OD	Stereo Overdrive.	74	8
77	DIST HARD		75	16
78	DIST HARD2	Hard-edge distortion.	75	22
79	DIST HARD3		75	25
80	DIST SOFT		75	17
81	DIST SOFT2	Soft, warm distortion.	75	23
82	DIST SOFT3		75	26
83	ST DIST HARD	Hard-edge stereo distortion.	75	18
84	ST DIST SOFT	Soft, warm soft distortion.	75	19
85	V_DIST HARD		98	0
86	V_DIST SOFT	Distortion which simulates vintage tube and fuzz sounds.	98	2
87	AMP SIM1		75	0
88	AMP SIM2	A simulation of a guitar amp.	75	1
89	ST AMP1		75	20
90	ST AMP2		75	21
91	ST AMP3	Stereo amp simulator.	75	8
92	ST AMP4		75	24
93	ST AMP5		75	27
94	DST+DELAY1	Distortion and Delay are connected in series.	95	16
95	DST+DELAY2		95	0
96	OD+DELAY1	Overdrive and Delay are connected in series.	95	17
97	OD+DELAY2		95	1
98	CMP+DST+DLY1	Compressor, Distortion and Delay are connected in series.	96	16
99	CMP+DST+DLY2		96	0
100	CMP+OD+DLY1	Compressor, Overdrive and Delay are connected in series.	96	17
101	CMP+OD+DLY2		96	1
102	V_DIST H+DLY		98	1
103	V_DIST S+DLY	V Distortion and Delay are connected in series.	98	3
104	MBAND COMP	Multi-band compressor that allows you to adjust the compression effect for individual frequency bands.	105	0
105	COMPRESSOR	Holds down the output level when a specified input level is exceeded. A sense of attack can also be added to the sound.	83	0
106	NOISE GATE	Gates the input when the input signal falls below a specified level.	84	0
107	VCE CANCEL	Attenuates the vocal part of a CD or other source.	85	0
108	AMBIENCE	Blurs the stereo positioning of the sound to add spatial width.	88	0
109	TALKING MOD	Adds a vowel sound to the input signal.	93	0
110	LO-FI	Degrades the audio quality of the input signal.	94	0
111	DYN FILTER	Dynamically controlled filter.	109	0
112	ISOLATOR	Controls the level of a specified frequency band of the input signal.	115	0



## Effect Type List

No.	Type	Description	MSB	LSB
113	PHASER1	Cyclically modulates the phase to add modulation to the sound.	72	0
114	PHASER2		72	8
115	EP PHASER1		72	17
116	EP PHASER2		72	18
117	EP PHASER3		72	16
118	DYN PHASER		111	0
119	PITCH CHG1	Changes the pitch of the input signal.	80	16
120	PITCH CHG2		80	0
121	PITCH CHG3		80	1
122	ROTARY SP1	Simulates a rotary speaker.	69	16
123	ROTARY SP2		71	17
124	ROTARY SP3		71	18
125	ROTARY SP4		70	17
126	ROTARY SP5		66	18
127	ROTARY SP6		69	0
128	ROTARY SP7		71	22
129	ROTARY SP8		69	17
130	ROTARY SP9		69	18
131	ROTARY SP10		71	23
132	ROTARY SP11		71	24
133	ROTARY SP12		70	20
134	ROTARY SP13		66	19
135	ROTARY SP14		69	19
136	ROTARY SP15		69	20
137	ROTARY SP16		71	25
138	2WAY ROT SP		86	0
139	DST+ROT SP	Distortion and rotary speaker connected in series.	69	1
140	DST+2ROT SP	Distortion and 2-way rotary speaker connected in series.	86	1
141	OD+ROT SP	Overdrive and rotary speaker connected in series.	69	2
142	OD+2ROT SP	Overdrive and 2-way rotary speaker connected in series.	86	2
143	AMP+ROT SP	Amp simulator and rotary speaker connected in series.	69	3
144	AMP+2ROT SP	Amp simulator and 2-way rotary speaker connected in series.	86	3
145	DUAL ROT SP1	Rotary speaker simulation with speed switching.	99	0
146	DUAL ROT SP2		99	1
147	AUTO PAN1	Several panning effects that automatically shift the sound position (left, right, front, back).	71	16
148	AUTO PAN2		71	0
149	EP AUTOPAN		71	21
150	AUTO PAN3		71	1
151	TREMOLO1	Rich Tremolo effect with both volume and pitch modulation.	70	16
152	TREMOLO2		71	19
153	TREMOLO3		70	0
154	EP TREMOLO		70	18
155	GT TREMOLO1		71	20
156	GT TREMOLO2		70	19
157	VIBE VIBRATE	Vibraphone effect.	119	0
158	AUTO WAH1	Cyclically modulates the center frequency of a wah filter.	78	16
159	AUTO WAH2		78	0
160	AT WAH+DST1	The output of an Auto Wah can be distorted by Distortion.	78	17
161	AT WAH+DST2		78	1
162	AT WAH+OD1	The output of an Auto Wah can be distorted by Overdrive.	78	18
163	AT WAH+OD2		78	2
164	TOUCH WAH1	Changes the center frequency of a wah filter according to the input level.	82	0
165	TOUCH WAH2		82	8
166	TOUCH WAH3		82	20
167	TC WAH+DST1	The output of an Touch Wah can be distorted by Distortion.	82	16
168	TC WAH+DST2		82	1
169	TC WAH+OD1	The output of an Touch Wah can be distorted by Overdrive.	82	17
170	TC WAH+OD2		82	2
171	CLAVI TC WAH	Clavinet Touch Wah.	82	18
172	CLAVI TC WAH2		82	21
173	EP TC WAH	EP Touch Wah	82	19
174	EP TC WAH2		82	22
175	WH+DST+DLY1	Wah, Distortion and Delay are connected in series.	97	16
176	WH+DST+DLY2		97	0
177	WH+OD+DLY1	Wah, Overdrive and Delay are connected in series.	97	17
178	WH+OD+DLY2		97	1
179	NO EFFECT	No effect.	0	0



Prog Change : True #	o 0 - 127 *****	o 0 - 127	
System Exclusive	o	o	
: Song Pos.	x	x	
: Song Sel.	x	x	
: Tune	x	x	
System : Clock	o	o	
Real Time: Commands	o	o	
Aux : All Sound OFF	x	o (120, 126, 127)	
: Reset All Cntrls	x	o (121)	
: Local ON/OFF	x	o (122)	
: All Notes OFF	x	o (123-125)	
Mes- : Active Sense	o	o	
sages: Reset	x	x	

\*1 Refer to #2 on page 116.

Mode 1 : OMNI ON , POLY                      Mode 2 : OMNI ON , MONO                      o : Yes  
 Mode 3 : OMNI OFF, POLY                      Mode 4 : OMNI OFF, MONO                      x : No



# MIDI Data Format

## NOTE:

- 1 By default (factory settings) the instrument ordinarily functions as a 16-channel multi-timbral tone generator, and incoming data does not affect the panel voices or panel settings. However, the MIDI messages listed below do affect the panel voices, auto accompaniment, and songs.
  - MIDI Master Tuning
  - System exclusive messages for changing the Reverb Type and Chorus Type.
  
- 2 Messages for these control change numbers cannot be transmitted from the instrument itself. However, they may be transmitted when playing the accompaniment, song or using the Harmony effect.
  
- 3 Exclusive
  - <GM System ON> F0H, 7EH, 7FH, 09H, 01H, F7H
    - This message automatically restores all default settings for the instrument, with the exception of MIDI Master Tuning.
  
  - <MIDI Master Volume> F0H, 7FH, 7FH, 04H, 01H, II, mm, F7H
    - This message allows the volume of all channels to be changed simultaneously (Universal System Exclusive).
    - The values of "mm" is used for MIDI Master Volume. (Values for "II" are ignored.)
  
  - <MIDI Master Tuning> F0H, 43H, 1nH, 27H, 30H, 00H, 00H, mm, II, cc, F7H
    - This message simultaneously changes the tuning value of all channels.
    - The values of "mm" and "II" are used for MIDI Master Tuning.
    - The default value of "mm" and "II" are 08H and 00H, respectively. Any values can be used for "n" and "cc".
  
  - <Reverb Type> F0H, 43H, 1nH, 4CH, 02H, 01H, 00H, mmH, IIH, F7H
    - mm : Reverb Type MSB
    - II : Reverb Type LSBRefer to the Effect Type List (page 110) for details.
  
  - <Chorus Type> F0H, 43H, 1nH, 4CH, 02H, 01H, 20H, mmH, IIH, F7H
    - mm : Chorus Type MSB
    - II : Chorus Type LSBRefer to the Effect Type List (page 111) for details.
  
  - <DSP Type> F0H, 43H, 1nH, 4CH, 02H, 01H, 40H, mmH, IIH, F7H
    - mm : DSP Type MSB
    - II : DSP Type LSBRefer to the Effect Type List (page 111) for details.
  
- 4 When the accompaniment is started, an FAH message is transmitted. When accompaniment is stopped, an FCH message is transmitted. When the clock is set to External, both FAH (accompaniment start) and FCH (accompaniment stop) are recognized.
  
- 5 Local ON/OFF
  - <Local ON> Bn, 7A, 7F
  - <Local OFF> Bn, 7A, 00Value for "n" is ignored.



# Specifications

## Keyboards

- 61 Standard-size keys (C1–C6), with Touch Response.

## Display

- 320 x 240 dots LCD display (backlit)

## Setup

- STANDBY/ON
- MASTER VOLUME: MIN–MAX
- LCD CONTRAST

## Panel Controls

- DEMO, SONG MODE
- SONG-PRESET, SONG-USER, SONG-USB, SONG-SCORE, SONG-LYRICS, SONG-REC
- STYLE CATEGORY, VOICE CATEGORY
- TRANSPOSE [-] [+], METRONOME, TAP TEMPO, TEMPO [-] [+]
- OTS LINK, AUTO FILL IN, ACMP, INTRO [1]–[3], MAIN VARIATION [A]–[D], ENDING/rit. [1]–[3] (REW) (FF), A-B REPEAT (SYNC STOP), PAUSE (SYNC START), START/STOP
- REGIST/TRACK, MEMORY, REGIST BANK [-] [+], REGISTRATION MEMORY [1]–[8], EXIT, CATEGORY [▲] [▼], Dial, [+ / YES] [- / NO]
- FUNCTION, MDB, FILE MENE-MENU, FILE MENE-EXECUTE, ONE TOUCH SETTING [1]–[4], LEFT, DUAL, HARMONY, TOUCH, SUSTAIN, DSP, UPPER OCTAVE [-] [+]

## Realtime Control

- Pitch Bend Wheel

## Voice

- 283 Panel Voices + 361 XGlite voices + 15 Drum/SFX Kits
- Polyphony: 32
- LEFT
- DUAL

## Style

- 150 Preset Styles + 1 User Style File
- Style Control: ACMP ON/OFF, SYNC STOP, SYNC START, START/STOP, INTRO [1]–[3], MAIN VARIATION [A]–[D], ENDING/rit. [1]–[3], AUTO FILL IN
- Fingering: Multi Finger, Full Keyboard
- Style Volume

## Music Database

- 500

## Registration Memory

- 8 banks x 8 memories
- Regist Clear

## Function

- VOLUME: Style Volume, Song Volume
- OVERALL: Tuning, Pitch Bend Range, Split Point, Touch Sensitivity, Chord Fingering
- MAIN VOICE: Volume, Octave, Pan, Reverb Level, Chorus Level, DSP Level, Dry Level
- DUAL VOICE: Volume, Octave, Pan, Reverb Level, Chorus Level, DSP Level, Dry Level
- LEFT VOICE: Volume, Octave, Pan, Reverb Level, Chorus Level, DSP Level, Dry Level
- EFFECT: Reverb Type, Chorus Type, DSP Type, Master EQ Type
- HARMONY: Harmony Type, Harmony Volume
- PC: PC Mode
- MIDI: Local On/Off, External Clock, Keyboard Out, Style Out, Song Out, Initial Setup
- METRONOME: Time Signature Numerator, Time Signature Denominator, Metronome Volume
- SCORE: Quantize, Right-Part, Left-Part
- UTILITY: Demo Cancel
- LANGUAGE: Language

## Effects

- Harmony: 26 types
- Reverb: 25 types
- Chorus: 30 types
- DSP: 178 types

## Song

- 5 Preset Songs + 5 User Songs + USB Memory
- Song Clear, Track Clear
- Song Volume
- Song Control: A-B REPEAT, PAUSE, REW, FF, START/STOP

## Recording

- Song
  - User Song: 5 Songs
  - Recording Tracks: 1, 2, 3, 4, 5, 6, 7, 8, STYLE

## MIDI

- Local On/Off
- Initial Setup
- External Clock
- Keyboard Out
- Style Out
- Song Out

## Auxiliary jacks

- PHONES/OUTPUT, DC IN 16V, USB TO HOST, USB TO DEVICE, SUSTAIN

## Amplifier

- 12W + 12W

## Speakers

- 12cm x 2 + 3cm x 2

## Power Consumption

- 25W

## Power Supply

- Adaptor: Yamaha PA-301 or PA-300 AC power adaptor

## Dimensions (W x D x H)

- 946 x 402 x 130 mm (37-1/4" x 15-7/8" x 5-1/8")

## Weight

- 7.5kg (16 lbs., 9 oz.)

## Supplied Accessories

- Music Rest
- Accessory CD-ROM
- Owner's Manual
- AC Power adaptor (May not be included depending on your particular area.)

## Optional Accessories

- Headphones: HPE-150
- Keyboard Stand: L6
- Footswitch: FC4/FC5

\* Specifications and descriptions in this owner's manual are for information purposes only. Yamaha Corp. reserves the right to change or modify products or specifications at any time without prior notice. Since specifications, equipment or options may not be the same in every locale, please check with your Yamaha dealer.



# Index

- + / YES, - / NO button ..... 15, 41
- ▶ / ■ button ..... 14, 28, 41
- ■ button ..... 14, 28
- A ⇌ B button ..... 14, 65
- ▶▶ button ..... 14, 28
- ◀◀ button ..... 14, 28

**A**

- A-B Repeat ..... 65
- Accessories ..... 7
- ACMP button ..... 14, 23
- Auto Accompaniment Region ..... 23
- AUTO FILL IN button ..... 14
- Auto Fill-in ..... 55

**B**

- Backup ..... 39
- Backup Clear ..... 39
- Backup File (Transfer) ..... 87
- Bank ..... 67
- Beat ..... 50

**C**

- Category ..... 17, 22, 27, 40
- Category ▲ and ▼ buttons ..... 15, 41
- CD-ROM ..... 7, 88
- Chord ..... 23, 25, 61–62
- Chord Fingering ..... 25, 63
- Chorus ..... 46
- Chorus Type ..... 111
- Clear (Song Track) ..... 38
- Clear (User Song) ..... 37
- Computer ..... 81–83, 85
- Contrast ..... 12
- CONTRAST knob ..... 12, 15

**D**

- DC IN 16V jack ..... 10, 15
- Delete (File Menu) ..... 79
- DEMO button ..... 14, 16
- Demo Cancel ..... 72
- Demo Song ..... 16
- Dial ..... 15, 41
- Display ..... 42
- Drum Kit ..... 21
- Drum Kit List ..... 104
- DSP ..... 47
- DSP button ..... 15, 47
- DSP Type ..... 111
- DUAL button ..... 15, 18
- Dual Voice ..... 18
- Dual Voice Chorus level ..... 71
- Dual Voice Dry Level ..... 71

- Dual Voice DSP Level ..... 71
- Dual Voice Octave ..... 71
- Dual Voice Pan ..... 71
- Dual Voice Reverb Level ..... 71
- Dual Voice Volume ..... 71

**E**

- Effect Type List ..... 110
- Ending ..... 55
- ENDING/rit. I–III buttons ..... 14, 55
- EXECUTE button (File Menu) ..... 15, 75
- EXIT button ..... 14, 42
- External Clock ..... 83
- External Song ..... 29

**F**

- FF ..... 28
- File Control ..... 74
- FILE MENU, EXECUTE button ..... 15, 75
- FILE MENU, MENU button ..... 15, 74–75
- File Save (File Menu) ..... 76
- Flash Clear ..... 39
- Flash Memory ..... 29
- Footswitch ..... 10
- Format (File Menu) ..... 75
- Fullkeyboard ..... 63
- FUNCTION button ..... 15, 70
- FUNCTION display ..... 42
- Function Settings ..... 70–72

**H**

- Harmony ..... 44
- HARMONY button ..... 15, 44
- Harmony Type ..... 44, 110
- Harmony Volume ..... 72
- Headphones ..... 10

**I**

- Initial Send ..... 84
- Initial Setup ..... 84
- Initialization ..... 39
- INTRO I–III buttons ..... 14, 55

**K**

- Keyboard Out ..... 83

**L**

- Language ..... 12
- LEFT button ..... 15, 19
- Left Part ..... 87
- Left Voice ..... 19
- Left Voice Chorus Level ..... 71

- Left Voice Dry Level ..... 71
- Left Voice DSP Level ..... 71
- Left Voice Octave ..... 71
- Left Voice Pan ..... 71
- Left Voice Reverb Level ..... 71
- Left Voice Volume ..... 71
- Load (File Menu) ..... 78
- Loaded Song ..... 29
- Local ..... 83
- Lyrics ..... 31
- LYRICS button ..... 14, 31

**M**

- Main ..... 55
- MAIN A–D buttons ..... 14, 55
- MAIN Display ..... 42
- MAIN VARIATION (Style) ..... 55
- Main Voice ..... 17
- Main Voice Chorus Level ..... 71
- Main Voice Dry Level ..... 71
- Main Voice DSP Level ..... 71
- Main Voice Octave ..... 71
- Main Voice Pan ..... 71
- Main Voice Reverb level ..... 71
- Main Voice Volume ..... 71
- Master EQ Type ..... 52
- MASTER VOLUME control .. 11, 14, 40
- MDB button ..... 15, 26
- Measure ..... 36
- MEMORY button ..... 14, 67
- MENU button (File Menu) ..... 15, 74–75
- Message (LCD) ..... 96
- Metronome ..... 49
- METRONOME button ..... 14, 49–50
- Metronome Volume ..... 50
- MIDI ..... 83
- MIDI Data Format ..... 116
- MIDI Implementation Chart ..... 114
- Multi Recording ..... 34
- Music Database ..... 26
- Music Database List ..... 108
- Music Rest ..... 13
- Mute ..... 66

**O**

- Octave ..... 54
- One Touch Setting (OTS) ..... 58
- ONE TOUCH SETTING 1–4 buttons ..... 15, 58
- Options ..... 117
- OTS LINK button ..... 14, 58

**P**

- Part Assign ..... 35

- PAUSE ..... 28  
 PC ..... 84  
 PHONES/OUTPUT jack ..... 10, 15  
 Pitch Bend ..... 48  
 Pitch Bend Range ..... 71  
 PITCH BEND wheel ..... 15, 48  
 Power Adaptor ..... 10  
 PRESET button ..... 14, 27  
 Preset Song ..... 29
- Q**
- Quantize ..... 72  
 Quick Recording ..... 33
- R**
- REC button ..... 14, 33  
 Record ..... 32  
 REGIST BANK +, - buttons ..... 14, 67  
 REGIST/TRACK button ..... 14, 66  
 Registration Memory ..... 67  
 REGISTRATION MEMORY  
   1–8 buttons ..... 14, 67  
 Repeat (A-B Repeat) ..... 65  
 Reverb ..... 45  
 Reverb Type ..... 110  
 REW ..... 28  
 Right Part ..... 87
- S**
- Score ..... 30  
 SCORE button ..... 14, 30  
 Section ..... 55  
 SMF (Standard MIDI File) ..... 77  
 SMF Save ..... 77  
 SOFTWARE LICENSE AGREEMENT  
   ..... 94  
 Song ..... 27–29  
 SONG category buttons ..... 14, 27  
 Song Clear ..... 37  
 Song Memory ..... 32, 35  
 SONG MODE button ..... 14, 27  
 Song Out ..... 83  
 Song Volume ..... 64  
 Specifications ..... 117  
 Split Point ..... 19, 59  
 STANDBY/ON switch ..... 11, 14  
 START/STOP button ..... 14, 22, 41  
 Stop Accompaniment ..... 60  
 Store (Registration) ..... 67  
 Style ..... 22, 55  
 STYLE category buttons ..... 14, 22  
 Style File ..... 63  
 Style List ..... 107  
 Style Out ..... 83
- Style Volume ..... 60  
 SUSTAIN (Footswitch) ..... 10  
 Sustain (Panel) ..... 47  
 SUSTAIN button ..... 15, 47  
 SUSTAIN jack ..... 10, 15  
 SYNC START button ..... 14, 23, 56  
 SYNC STOP button ..... 14, 57  
 Synchro Start ..... 56  
 Synchro Stop ..... 57
- T**
- Tap Start ..... 51  
 TAP TEMPO button ..... 14, 51  
 Tempo ..... 64  
 TEMPO +, - buttons ..... 14, 49, 64  
 Time Signature ..... 50  
 TOUCH button ..... 15, 51  
 Touch Sensitivity ..... 51  
 Track ..... 32, 66  
 Track Clear ..... 38  
 Transfer ..... 85, 87  
 Transpose ..... 53  
 TRANSPOSE +, - buttons ..... 14, 53  
 Troubleshooting (Installation Guide) ..... 93  
 Troubleshooting (Instrument) ..... 95  
 Tuning ..... 53
- U**
- UPPER OCTAVE +, - buttons ..... 15, 54  
 USB ..... 80  
 USB button ..... 14, 27  
 USB MIDI Driver ..... 91–92  
 USB Song ..... 29  
 USB TO DEVICE terminal ..... 15, 74, 80  
 USB TO HOST terminal ..... 15, 80, 82  
 USER (Song) button ..... 14, 27  
 USER (Style) button ..... 63  
 User File ..... 76, 78  
 User Song ..... 29, 32  
 User Style ..... 63
- V**
- Voice ..... 17  
 VOICE category buttons ..... 15, 17  
 Voice List ..... 98  
 Volume ..... 40
- X**
- XGlite ..... 6

# Limited Warranty

**90 DAYS LABOR**

**1 YEAR PARTS**

Yamaha Corporation of America, hereafter referred to as Yamaha, warrants to the original consumer of a product included in the categories listed below, that the product will be free of defects in materials and/or workmanship for the periods indicated. This warranty is applicable to all models included in the following series of products:

## **PSR SERIES OF PORTATONE ELECTRONIC KEYBOARDS**

If during the first 90 days that immediately follows the purchase date, your new Yamaha product covered by this warranty is found to have a defect in material and/or workmanship, Yamaha and/or its authorized representative will repair such defect without charge for parts or labor.

If parts should be required after this 90 day period but within the one year period that immediately follows the purchase date, Yamaha will, subject to the terms of this warranty, supply these parts without charge. However, charges for labor, and/or any miscellaneous expenses incurred are the consumers responsibility. Yamaha reserves the right to utilize reconditioned parts in repairing these products and/or to use reconditioned units as warranty replacements.

**THIS WARRANTY IS THE ONLY EXPRESS WARRANTY WHICH YAMAHA MAKES IN CONNECTION WITH THESE PRODUCTS. ANY IMPLIED WARRANTY APPLICABLE TO THE PRODUCT, INCLUDING THE WARRANTY OF MERCHANT ABILITY IS LIMITED TO THE DURATION OF THE EXPRESS WARRANTY. YAMAHA EXCLUDES AND SHALL NOT BE LIABLE IN ANY EVENT FOR INCIDENTAL OR CONSEQUENTIAL DAMAGES.**

Some states do not allow limitations that relate to implied warranties and/or the exclusion of incidental or consequential damages. Therefore, these limitations and exclusions may not apply to you.

This warranty gives you specific legal rights. You may also have other rights which vary from state to state.

## **CONSUMERS RESPONSIBILITIES**

If warranty service should be required, it is necessary that the consumer assume certain responsibilities:

1. Contact the Customer Service Department of the retailer selling the product, or any retail outlet authorized by Yamaha to sell the product for assistance. You may also contact Yamaha directly at the address provided below.
2. Deliver the unit to be serviced under warranty to: the retailer selling the product, an authorized service center, or to Yamaha with an explanation of the problem. Please be prepared to provide proof purchase date (sales receipt, credit card copy, etc.) when requesting service and/or parts under warranty.
3. Shipping and/or insurance costs are the consumers responsibility.\* Units shipped for service should be packed securely.

\*Repaired units will be returned PREPAID if warranty service is required within the first 90 days.

**IMPORTANT:** Do NOT ship anything to ANY location without prior authorization. A Return Authorization (RA) will be issued that has a tracking number assigned that will expedite the servicing of your unit and provide a tracking system if needed.

4. Your owners manual contains important safety and operating instructions. It is your responsibility to be aware of the contents of this manual and to follow all safety precautions.

## **EXCLUSIONS**

This warranty does not apply to units whose trade name, trademark, and/or ID numbers have been altered, defaced, exchanged removed, or to failures and/or damages that may occur as a result of:

1. Neglect, abuse, abnormal strain, modification or exposure to extremes in temperature or humidity.
2. Improper repair or maintenance by any person who is not a service representative of a retail outlet authorized by Yamaha to sell the product, an authorized service center, or an authorized service representative of Yamaha.
3. This warranty is applicable only to units sold by retailers authorized by Yamaha to sell these products in the U.S.A., the District of Columbia, and Puerto Rico. This warranty is not applicable in other possessions or territories of the U.S.A. or in any other country.

Please record the model and serial number of the product you have purchased in the spaces provided below.

Model \_\_\_\_\_ Serial # \_\_\_\_\_ Sales Slip # \_\_\_\_\_

Purchased from \_\_\_\_\_ Date \_\_\_\_\_  
(Retailer)

**YAMAHA CORPORATION OF AMERICA**  
**Electronic Service Division**  
**6600 Orangethorpe Avenue**  
**Buena Park, CA 90620**

**KEEP THIS DOCUMENT FOR YOUR RECORDS. DO NOT MAIL!**



For details of products, please contact your nearest Yamaha representative or the authorized distributor listed below.

Pour plus de détails sur les produits, veuillez-vous adresser à Yamaha ou au distributeur le plus proche de vous figurant dans la liste suivante.

Die Einzelheiten zu Produkten sind bei Ihrer unten aufgeführten Niederlassung und bei Yamaha Vertragshändlern in den jeweiligen Bestimmungsländern erhältlich.

Para detalles sobre productos, contacte su tienda Yamaha más cercana o el distribuidor autorizado que se lista debajo.

## NORTH AMERICA

### CANADA

**Yamaha Canada Music Ltd.**  
135 Milner Avenue, Scarborough, Ontario,  
M1S 3R1, Canada  
Tel: 416-298-1311

### U.S.A.

**Yamaha Corporation of America**  
6600 Orangethorpe Ave., Buena Park, Calif. 90620,  
U.S.A.  
Tel: 714-522-9011

## CENTRAL & SOUTH AMERICA

### MEXICO

**Yamaha de México S.A. de C.V.**  
Calz. Javier Rojo Gómez #1149,  
Col. Guadalupe del Moral  
C.P. 09300, México, D.F., México  
Tel: 55-5804-0600

### BRAZIL

**Yamaha Musical do Brasil Ltda.**  
Rua Joaquim Floriano, 913 - 4º andar, Itaim Bibi,  
CEP 04534-013 Sao Paulo, SP. BRAZIL  
Tel: 011-3704-1377

### ARGENTINA

**Yamaha Music Latin America, S.A.**  
**Sucursal de Argentina**  
Viamonte 1145 Piso2-B 1053,  
Buenos Aires, Argentina  
Tel: 1-4371-7021

### PANAMA AND OTHER LATIN AMERICAN COUNTRIES/ CARIBBEAN COUNTRIES

**Yamaha Music Latin America, S.A.**  
Torre Banco General, Piso 7, Urbanización Marbella,  
Calle 47 y Aquilino de la Guardia,  
Ciudad de Panamá, Panamá  
Tel: +507-269-5311

## EUROPE

### THE UNITED KINGDOM

**Yamaha-Kemble Music (U.K.) Ltd.**  
Sherbourne Drive, Tilbrook, Milton Keynes,  
MK7 8BL, England  
Tel: 01908-366700

### IRELAND

**Danfay Ltd.**  
61D, Sallynoggin Road, Dun Laoghaire, Co. Dublin  
Tel: 01-2859177

### GERMANY

**Yamaha Music Central Europe GmbH**  
Siemensstraße 22-34, 25462 Rellingen, Germany  
Tel: 04101-3030

### SWITZERLAND/LIECHTENSTEIN

**Yamaha Music Central Europe GmbH,  
Branch Switzerland**  
Seefeldstrasse 94, 8008 Zürich, Switzerland  
Tel: 01-383 3990

### AUSTRIA

**Yamaha Music Central Europe GmbH,  
Branch Austria**  
Schleiergasse 20, A-1100 Wien, Austria  
Tel: 01-60203900

### CZECH REPUBLIC/SLOVAKIA/ HUNGARY/SLOVENIA

**Yamaha Music Central Europe GmbH,  
Branch Austria, CEE Department**  
Schleiergasse 20, A-1100 Wien, Austria  
Tel: 01-602039025

### POLAND

**Yamaha Music Central Europe GmbH  
Sp.z o.o. Oddział w Polsce**  
ul. 17 Stycznia 56, PL-02-146 Warszawa, Poland  
Tel: 022-868-07-57

### THE NETHERLANDS/ BELGIUM/LUXEMBOURG

**Yamaha Music Central Europe GmbH,  
Branch Benelux**  
Clarissenhof 5-b, 4133 AB Vianen, The Netherlands  
Tel: 0347-358 040

### FRANCE

**Yamaha Musique France**  
BP 70-77312 Marne-la-Vallée Cedex 2, France  
Tel: 01-64-61-4000

### ITALY

**Yamaha Musica Italia S.P.A.**  
Viale Italia 88, 20020 Lainate (Milano), Italy  
Tel: 02-935-771

### SPAIN/PORTUGAL

**Yamaha-Hazen Música, S.A.**  
Ctra. de la Corona km. 17, 200, 28230  
Las Rozas (Madrid), Spain  
Tel: 91-639-8888

### GREECE

**Philippos Nakas S.A. The Music House**  
147 Skiathou Street, 112-55 Athens, Greece  
Tel: 01-228 2160

### SWEDEN

**Yamaha Scandinavia AB**  
J. A. Wettergrens Gata 1  
Box 30053  
S-400 43 Göteborg, Sweden  
Tel: 031 89 34 00

### DENMARK

**YS Copenhagen Liaison Office**  
Generatorvej 6A  
DK-2730 Herlev, Denmark  
Tel: 44 92 49 00

### FINLAND

**F-Musiikki Oy**  
Kluuvikatu 6, P.O. Box 260,  
SF-00101 Helsinki, Finland  
Tel: 09 618511

### NORWAY

**Norsk filial av Yamaha Scandinavia AB**  
Grini Næringspark 1  
N-1345 Østerås, Norway  
Tel: 67 16 77 70

### ICELAND

**Skifan HF**  
Skeifan 17 P.O. Box 8120  
IS-128 Reykjavik, Iceland  
Tel: 525 5000

### OTHER EUROPEAN COUNTRIES

**Yamaha Music Central Europe GmbH**  
Siemensstraße 22-34, 25462 Rellingen, Germany  
Tel: +49-4101-3030

## AFRICA

**Yamaha Corporation,  
Asia-Pacific Music Marketing Group**  
Nakazawa-cho 10-1, Hamamatsu, Japan 430-8650  
Tel: +81-53-460-2312

## MIDDLE EAST

### TURKEY/CYPRUS

**Yamaha Music Central Europe GmbH**  
Siemensstraße 22-34, 25462 Rellingen, Germany  
Tel: 04101-3030

### OTHER COUNTRIES

**Yamaha Music Gulf FZE**  
LB21-128 Jebel Ali Freezone  
P.O.Box 17328, Dubai, U.A.E.  
Tel: +971-4-881-5868

## ASIA

### THE PEOPLE'S REPUBLIC OF CHINA

**Yamaha Music & Electronics (China) Co.,Ltd.**  
25/F., United Plaza, 1468 Nanjing Road (West),  
Jingan, Shanghai, China  
Tel: 021-6247-2211

### HONG KONG

**Tom Lee Music Co., Ltd.**  
11/F., Silvercord Tower 1, 30 Canton Road,  
Tsimshatsui, Kowloon, Hong Kong  
Tel: 2737-7688

### INDONESIA

**PT. Yamaha Music Indonesia (Distributor)  
PT. Nusantik**  
Gedung Yamaha Music Center, Jalan Jend. Gatot  
Subroto Kav. 4, Jakarta 12930, Indonesia  
Tel: 21-520-2577

### KOREA

**Yamaha Music Korea Ltd.**  
Tong-Yang Securities Bldg. 16F 23-8 Yoido-dong,  
Youngdungpo-ku, Seoul, Korea  
Tel: 02-3770-0660

### MALAYSIA

**Yamaha Music Malaysia, Sdn., Bhd.**  
Lot 8, Jalan Perbandaran, 47301 Kelana Jaya,  
Petaling Jaya, Selangor, Malaysia  
Tel: 3-78030900

### PHILIPPINES

**Yupangco Music Corporation**  
339 Gil J. Puyat Avenue, P.O. Box 885 MCPO,  
Makati, Metro Manila, Philippines  
Tel: 819-7551

### SINGAPORE

**Yamaha Music Asia Pte., Ltd.**  
#03-11 A-Z Building  
140 Paya Lebar Road, Singapore 409015  
Tel: 747-4374

### TAIWAN

**Yamaha KHS Music Co., Ltd.**  
3F, #6, Sec.2, Nan Jing E. Rd. Taipei.  
Taiwan 104, R.O.C.  
Tel: 02-2511-8688

### THAILAND

**Siam Music Yamaha Co., Ltd.**  
891/1 Siam Motors Building, 15-16 floor  
Rama 1 road, Wangmai, Pathumwan  
Bangkok 10330, Thailand  
Tel: 02-215-2626

### OTHER ASIAN COUNTRIES

**Yamaha Corporation,  
Asia-Pacific Music Marketing Group**  
Nakazawa-cho 10-1, Hamamatsu, Japan 430-8650  
Tel: +81-53-460-2317

## OCEANIA

### AUSTRALIA

**Yamaha Music Australia Pty. Ltd.**  
Level 1, 99 Queensbridge Street, Southbank,  
Victoria 3006, Australia  
Tel: 3-9693-5111

### NEW ZEALAND

**Music Houses of N.Z. Ltd.**  
146/148 Captain Springs Road, Te Papapa,  
Auckland, New Zealand  
Tel: 9-634-0099

### COUNTRIES AND TRUST TERRITORIES IN PACIFIC OCEAN

**Yamaha Corporation,  
Asia-Pacific Music Marketing Group**  
Nakazawa-cho 10-1, Hamamatsu, Japan 430-8650  
Tel: +81-53-460-2312

**HEAD OFFICE** Yamaha Corporation, Pro Audio & Digital Musical Instrument Division  
Nakazawa-cho 10-1, Hamamatsu, Japan 430-8650  
Tel: +81-53-460-3273



Yamaha Home Keyboards Home Page (English Only)  
<http://music.yamaha.com/homekeyboard>  
Yamaha Manual Library  
<http://www.yamaha.co.jp/manual/>

U.R.G., Pro Audio & Digital Musical Instrument Division, Yamaha Corporation  
© 2006 Yamaha Corporation

WH27920 XXXPOXXX.X-01A0  
Printed in China