

**YAMAHA**

Clavinova®

CVP-98
CVP-96
CVP-600

Owner's Manual Bedienungsanleitung Mode d'emploi Manual de instrucciones

IMPORTANT**Check Your Power Supply**

Make sure that your local AC mains voltage matches the voltage specified on the name plate on the bottom panel. In some areas a voltage selector may be provided on the bottom panel of the main keyboard unit near the power cord. Make sure that the voltage selector is set for the voltage in your area. The voltage selector is set at 240V when the unit is initially shipped. To change the setting use a "minus" screwdriver to rotate the selector dial so that the correct voltage appears next to the pointer on the panel.

WICHTIG**Netzspannung überprüfen**

Vergewissern Sie sich vor dem Anschließen an das Stromnetz, daß die örtliche Netzspannung den Betriebs-Spannungswerten auf dem Typenschild an der Unterseite des Instruments entspricht. In bestimmten Verkaufsgebieten ist das Instrument mit einem Spannungswähler an der Unterseite neben der Netzkabeldurchführung ausgestattet. Falls vorhanden, muß der Spannungswähler auf die örtliche Netzspannung eingestellt werden. Der Spannungswähler wurde werkseitig auf 240 V voreingestellt. Zum Verstellen drehen Sie den Spannungsregler mit einem Schlitzschraubendreher, bis der Zeiger auf den korrekten Spannungswert weist.

IMPORTANT**Vérifiez la source d'alimentation**

Vérifiez que la tension spécifiée sur le panneau inférieur correspond à la tension du secteur. Dans certaines régions, l'instrument peut être équipé d'un sélecteur de tension situé sur le panneau inférieur du clavier à proximité du cordon d'alimentation. Vérifiez que ce sélecteur est bien réglé en fonction de la tension secteur de votre région. Le sélecteur de tension est réglé sur 240 V au départ d'usine. Pour modifier ce réglage, utilisez un tournevis à lame plate pour tourner le sélecteur afin de mettre l'indication correspondant à la tension de votre région vis à vis du repère triangulaire situé sur le panneau.

IMPORTANTE**Compruebe la alimentación de su área**

Asegúrese de que tensión de alimentación de CA de su área corresponde con la tensión especificada en la placa de características del panel inferior. En algunas zonas puede haberse incorporado un selector de tensión en el panel inferior de la unidad del teclado principal, cerca del cable de alimentación. Asegúrese de que el selector de tensión esté ajustado a la tensión de su área. El selector de tensión se ajusta a 240V cuando la unidad sale de fábrica. Para cambiar el ajuste, emplee un destornillador de cabeza "recta" para girar el selector de modo que aparezca la tensión correcta al lado del indicador del panel.

SPECIAL MESSAGE SECTION

PRODUCT SAFETY MARKINGS: Yamaha electronic products may have either labels similar to the graphics shown below or molded/stamped facsimiles of these graphics on the enclosure. The explanation of these graphics appears on this page. Please observe all cautions indicated on this page and those indicated in the safety instruction section.

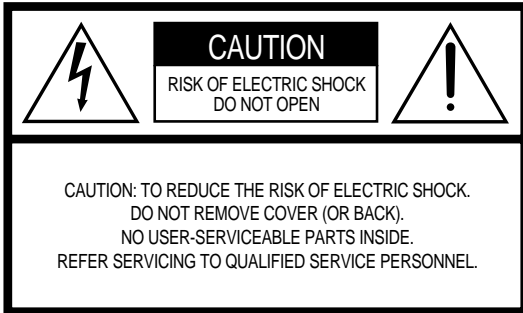

See bottom of Keyboard enclosure for graphic symbol markings



The exclamation point with the equilateral triangle is intended to alert the user to the presence of important operating and maintenance (servicing) instructions in the literature accompanying the product.



The lightning flash with arrowhead symbol within the equilateral triangle is intended to alert the user to the presence of uninsulated “dangerous voltage” within the product’s enclosure that may be of sufficient magnitude to constitute a risk of electrical shock.

IMPORTANT NOTICE: All Yamaha electronic products are tested and approved by an independent safety testing laboratory in order that you may be sure that when it is properly installed and used in its normal and customary manner, all foreseeable risks have been eliminated. **DO NOT** modify this unit or commission others to do so unless specifically authorized by Yamaha. Product performance and/or safety standards may be diminished. Claims filed under the expressed warranty may be denied if the unit is/has been modified. Implied warranties may also be affected.

SPECIFICATIONS SUBJECT TO CHANGE: The information contained in this manual is believed to be correct at the time of printing. However, Yamaha reserves the right to change or modify any of the specifications without notice or obligation to update existing units.

ENVIRONMENTAL ISSUES: Yamaha strives to produce products that are both user safe and environmentally friendly. We sincerely believe that our products and the production methods used to produce them, meet these goals. In keeping with both the letter and the spirit of the law, we want you to be aware of the following:

Battery Notice: This product MAY contain a small non-rechargeable battery which (if applicable) is soldered in place. The average life span of this type of battery is approximately five years. When replacement becomes necessary, contact a qualified service representative to perform the replacement.

Warning: Do not attempt to recharge, disassemble, or incinerate this type of battery. Keep all batteries away from children. Dispose of used batteries promptly and as regulated by applicable laws. Note: In some areas, the servicer is required by law to return the defective parts. However, you do have the option of having the servicer dispose of these parts for you.

Disposal Notice: Should this product become damaged beyond repair, or for some reason its useful life is considered to be at an end, please observe all local, state, and federal regulations that relate to the disposal of products that contain lead, batteries, plastics, etc.

NOTICE: Service charges incurred due to lack of knowledge relating to how a function or effect works (when the unit is operating as designed) are not covered by the manufacturer’s warranty, and are therefore the owners responsibility. Please study this manual carefully and consult your dealer before requesting service.

NAME PLATE LOCATION: The graphic below indicates the location of the name plate. The model number, serial number, power requirements, etc., are located on this plate. You should record the model number, serial number, and the date of purchase in the spaces provided below and retain this manual as a permanent record of your purchase.

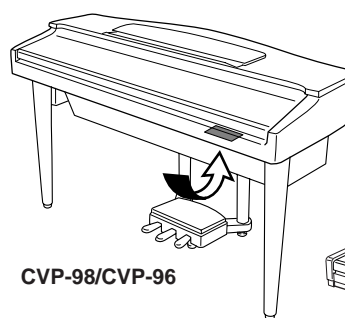

CVP-98/CVP-96

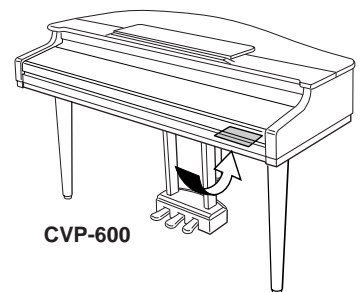

CVP-600

Model _____

Serial No. _____

Purchase Date _____

PRECAUTIONS

PLEASE READ CAREFULLY BEFORE PROCEEDING

* Please keep these precautions in a safe place for future reference.



WARNING

Always follow the basic precautions listed below to avoid the possibility of serious injury or even death from electrical shock, short-circuiting, damages, fire or other hazards. These precautions include, but are not limited to, the following:

- Do not open the instrument or attempt to disassemble the internal parts or modify them in any way. The instrument contains no user-serviceable parts. If it should appear to be malfunctioning, discontinue use immediately and have it inspected by qualified Yamaha service personnel.
- Do not expose the instrument to rain, use it near water or in damp or wet conditions, or place containers on it containing liquids which might spill into any openings.
- If the power cord or plug becomes frayed or damaged, or if there is a sudden loss of sound during use of the instrument, or if any unusual smells or smoke should appear to be caused by it, immediately turn off the power switch, disconnect the electric plug from the outlet, and have the instrument inspected by qualified Yamaha service personnel.
- Only use the voltage specified as correct for the instrument. The required voltage is printed on the name plate of the instrument.
- Before cleaning the instrument, always remove the electric plug from the outlet. Never insert or remove an electric plug with wet hands.
- Check the electric plug periodically and remove any dirt or dust which may have accumulated on it.



CAUTION

Always follow the basic precautions listed below to avoid the possibility of physical injury to you or others, or damage to the instrument or other property. These precautions include, but are not limited to, the following:

- Do not place the power cord near heat sources such as heaters or radiators, and do not excessively bend or otherwise damage the cord, place heavy objects on it, or place it in a position where anyone could walk on, trip over, or roll anything over it.
 - When removing the electric plug from the instrument or an outlet, always hold the plug itself and not the cord. Pulling by the cord can damage it.
 - Do not connect the instrument to an electrical outlet using a multiple-connector. Doing so can result in lower sound quality, or possibly cause overheating in the outlet.
 - Remove the electric plug from the outlet when the instrument is not to be used for extended periods of time, or during electrical storms.
 - Before connecting the instrument to other electronic components, turn off the power for all components. Before turning the power on or off for all components, set all volume levels to minimum.
 - Do not expose the instrument to excessive dust or vibrations, or extreme cold or heat (such as in direct sunlight, near a heater, or in a car during the day) to prevent the possibility of panel disfiguration or damage to the internal components.
 - Do not use the instrument near other electrical products such as televisions, radios, or speakers, since this might cause interference which can affect proper operation of the other products.
 - Do not place the instrument in an unstable position where it might accidentally fall over.
 - Before moving the instrument, remove all connected cables.
 - When cleaning the instrument, use a soft, dry cloth. Do not use paint thinners, solvents, cleaning fluids, or chemical-impregnated wiping cloths. Also, do not place vinyl, plastic or rubber objects on the instrument, since this might discolor the panel or keyboard.
 - On the CVP-600, gently remove dust and dirt with a soft cloth. Do not wipe too hard since small particles of dirt can scratch the instrument's finish.
 - On the CVP-600, bumping the surface of the instrument with metal, porcelain, or other hard objects can cause the finish to crack or peel. Use caution.
 - Do not rest your weight on, or place heavy objects on the instrument, and do not use excessive force on the buttons, switches or connectors.
 - Take care that the key cover does not pinch your fingers, and do not insert a finger or hand in the key cover gap.
 - Never insert or drop paper or metallic or other objects between the slits of the key cover and the keyboard. If this happens, immediately turn off the power and remove the electric plug from the outlet and have the instrument inspected by qualified Yamaha service personnel.
 - Do not place the instrument against a wall (allow at least 3 cm/one-inch from the wall), since this can cause inadequate air circulation, and possibly result in the instrument overheating.
 - Read carefully the attached documentation explaining the assembly process. Failure to assemble the instrument in the proper sequence might result in damage to the instrument or even injury.
 - Do not operate the instrument for a long period of time at a high or uncomfortable volume level, since this can cause permanent hearing loss. If you experience any hearing loss or ringing in the ears, consult a physician.
- USING THE BENCH (if included)**
- Do not play carelessly with or stand on the bench. Using it as a tool or step-ladder or for any other purpose might result in accident or injury.
 - Only one person should sit on the bench at a time, in order to prevent the possibility of accident or injury.
 - If the bench screws become loose due to extensive long-term use, tighten them periodically using the included tool.
- SAVING USER DATA**
- Always save data to a floppy disk frequently, in order to help prevent the loss of important data due to a malfunction or user operating error.

Yamaha cannot be held responsible for damage caused by improper use or modifications to the instrument, or data that is lost or destroyed.

Always turn the power off when the instrument is not in use.

Thank you for purchasing the Yamaha Clavinova! We recommend that you read this manual carefully so that you can fully take advantage of the advanced and convenient functions of the Clavinova. We also recommend that you keep this manual in a safe and handy place for future reference.

Included Accessories

- **Music Software Collection Disk (+ Music Book)**

This disk features various recorded song samples for playing on the Clavinova, and MIDI driver software for computers (page 157).

- **Floppy Disk**

Blank disk for recording your performances.

- **Owner's Manual and Reference Manual (Assembly Instructions and Lists)**

- **Bench (included or optional depending on locale)**

Table of Contents

<p style="text-align: center;">CHAPTER 1: Getting Ready</p> <p>Features of the Clavinova 4</p> <p>About This Manual 5 Conventions Used in This Manual 5</p> <p>Handling Floppy Disks 7</p> <p>Setting Up the Clavinova 8 Music Stand 8 Key Cover 8 Lid (CVP-600 only) 9 Turning on the Power 9 Headphones 9</p> <p>Panel Controls and Terminals 10</p> <p>Basic Operation 12 LCD Display and LCD Buttons 12 PAGE [◀] [▶] Buttons 14 [EXIT] Button 15 [DISPLAY HOLD] Button 15 Adjusting the Contrast of the LCD Display 15 Memory Backup 16 Display Messages 16</p>	<p>Adjusting the Volume 17 [MASTER VOLUME] 17 [ACMP/SONG VOLUME] 17 [MIXER] 17 [EXP.PEDAL] 18</p> <p>Adjusting the Timbre of the Sound 19 [MASTER EQUALIZER] 19 Power Bass (CVP-98 only) 21</p> <p style="text-align: center;">CHAPTER 2: Help Mode and Demo Play</p> <p>Using the Help Mode 22</p> <p>Demo Play 24</p> <p style="text-align: center;">CHAPTER 3: Voices</p> <p>Selecting Voices 27 Selecting a Voice from the VOICE SELECT Display 27 Selecting Voices from the Main Display 28 Organ Combination (Organ Combi.) 29 Keyboard Percussion 32</p>	<p>Playing Two Voices Simultaneously — Dual Mode 33 Selecting the Dual Voice 33 Setting the Volume Balance of the Two Voices 34 Detuning the Pitches of the Two Voices 35 Changing the Octave Setting of the Two Voices 35</p> <p>Playing Two Voices from Different Sides of the Keyboard — Split Mode 36 Selecting the Split Voice 36 Changing the Split Point 37 Setting the Volume Balance of the Two Voices 38 Changing the Octave Setting of the Two Voices 38 Using the Dual and Split Functions Simultaneously 39</p> <p>Using the Pedals 40 Damper Pedal (Right) 40 Sostenuto Pedal (Center) 40 Soft Pedal (Left) 40</p>
---	--	---

Reverb	41
Reverb ON/OFF	41
Selecting the Reverb Type	41
Setting the Total Depth	42
Setting the Depth for Each Part — Reverb Part Depth	43

Voice Effects	44
Effect ON/OFF	44
Selecting the Effect Type	45
Setting the Effect Depth	46
Restoring the Basic Settings	46

CHAPTER 4:
**Accompaniment Styles
(Rhythm and Auto Accompaniment)**

Selecting Accompaniment Styles	47
Selecting a style from the STYLE SELECT Display	47
Selecting styles from the Main Display	48
Tempo Control and Volume Adjustment	49

Starting/Stopping the Accompaniment Style	50
Starting the Accompaniment Style	50
Break	53
Stopping the accompaniment style	53

Using the Metronome	54
----------------------------	----

Playing with the Auto Accompaniment	56
Types of Auto Accompaniment	56
Stopping the Auto Accompaniment	59
Adjusting the Overall Auto Accompaniment Volume	60
Individual Part Volume Control	60
Changing the Split Point	61

Other Auto Accompaniment Functions	62
Harmony	62
One Touch Setting	63
Virtual Arranger	64
Synchronized Stop Function	64
Small Accompaniment (SMALL ACMP) ...	65
Chord Assist	66

Custom Style	68
Other Custom Style Functions	74
Playing Back Your Custom Styles	77
Custom Style Alert & Error Displays	78

Style File Load	80
Loading Disk Styles	80
Using Loaded Style Files	82

CHAPTER 5:
Registrations

Registrations (Registering/ Recalling Panel Setups)	83
Recalling the Registered Panel Settings	84
Naming the Registration	85
Freeze Function	86

CHAPTER 6:
Song Control

Song Playback	87
Playback	87
Part Cancel	91
Assignment of Tracks to 1/RIGHT and 2/LEFT, and Voice Assignment	92
Overall Song Playback Volume Control ..	93
Individual Part Volume Control	94
Changing Settings in the TRACK MIXER Display	96
Repeat Functions	97
Other Playback Controls	99
Playing Other Types of Music Data	99

Guide Control	100
Guide Methods and Piano Roll	100
Using the Guide Function	101
Other Guide-related Functions	103

Song Recording	105
Recording Setup: Disk Format	106
Quick Recording	107
Track Recording (Multi-track Recording)	110
Adding New Tracks	113
Punch-in/out Recording	113
Chord Sequence	116
Other Chord Sequence Functions	119
Record Edit Function	120
Song Name	121
Track Edit	122
Initial Edit (Changing the Initial Data) .	124
Making Settings in the INITIAL EDIT Display	125
Recording Without a Disk	127

CHAPTER 7:
The Utility Functions

Keyboard	130
Keyboard 1 (KEYBOARD 1) Display — PAGE 1	130
Keyboard 2 (KEYBOARD 2) Display — PAGE 2	131

Pedal	133
Pedal (PEDAL) Display — PAGE 3	133

Disk	135
Format (FORMAT) Display — PAGE 4 ...	135
Song Copy (SONG COPY) Display — PAGE 5	136
Song Delete (SONG DELETE) Display — PAGE 6	138
Registration (REGISTRATION) Display — PAGE 7	139
Transform (TRANSFORM) Display — PAGE 8	142

MIDI	143
MIDI 1 Display — PAGE 9	143
MIDI 2 Display — PAGE 10	144
MIDI 3 Display — PAGE 11	146

Backup	147
Backup (BACKUP) Display — PAGE 12	147
Recall (RECALL) Display — PAGE 13 ...	148

Utility	149
Micro Tuning (MICRO TUNING) Display — PAGE 14	149
Scale Tuning (SCALE TUNING) Display — PAGE 15	150
Pop-up Time (POPUPTIME) Display — PAGE 16	153
Alert Sound (ALERT) Display — PAGE 17	153

CHAPTER 8:
Others

The Connectors	154
-----------------------	-----

Connecting to a Personal Computer	156
--	-----

Index	158
--------------------	-----

CHAPTER 1: Getting Ready

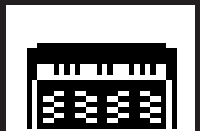

Features of the Clavinova

● Large, Easy-to-use LCD Display

The large LCD (along with the dedicated buttons) provides comprehensive and easy-to-understand control of the Clavinova's operations (page 12).

● Wealth of Rich, Realistic Voices

The Clavinova has a wide variety of authentic and dynamic voices (133 Clavinova voices + 480 XG voices + 12 Drum Kits). These include exceptionally natural-sounding piano, strings and brass voices. Moreover, you can play realistic drum and percussion sounds directly from the keyboard. (See page 32.)

● Playback of Song Disks

The Clavinova can play back various commercially available song disks. With the appropriate disk software, you can play the piano part of the song yourself along with playback of a full orchestra or backing band.

● Special Guide Functions for Easy Learning

With the appropriate disk software, the LCD display and guide lamps help you learn songs by showing you when and where to play the proper notes. The three-step system helps you to easily and quickly master each song. (See page 100.)

● Fun, Dynamic Automatic Accompaniment

The Automatic Accompaniment of the Clavinova gives you full and exciting instrumental backing in your favorite music styles, according to the chords you play. There are 100 accompaniment styles (page 47), plus an additional 40 "Pianist" styles that allow you to enjoy solo piano accompaniment (page 57).

● Easy-to-use Recording Features

Depending on your keyboard expertise and preference, you use a variety of different recording methods: Quick Recording, Track Recording, and Step Recording of Automatic Accompaniment (Chord Sequence Function) (page 105).

● Convenient TO HOST Terminals for Direct Connection to Computers

The Clavinova can be used as a high-quality sound source for playback of music software for computers. It can also be used as a master keyboard for inputting performance data and creating music with a computer. (See page 156.)

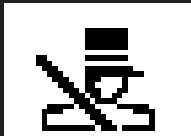

About This Manual

Conventions Used in This Manual

■ Indications of Buttons and LCD Display

[]: This indicates actual panel buttons.

When this mark is used, words such as button, slider, jack (terminal) sometimes may not be used. For example, the slider for the master volume is expressed as [MASTER VOLUME] in this manual.

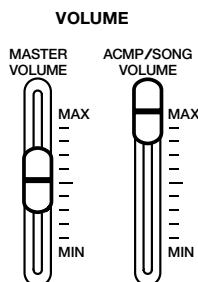

NOTE

- The illustrations and LCD displays shown here are for explanation purposes only, and may be different than those that actually appear on the Clavinova.

Bold characters:

Items in the LCD display and the LCD buttons corresponding to these items (directly below, or to the left or right) are indicated in bold characters in this manual. For example, the term “VOICE” shown in the LCD display is written as **VOICE**. Also the LCD buttons corresponding to “VOICE ▼ ▲” in the display are indicated as **VOICE ▼ ▲** in the manual.

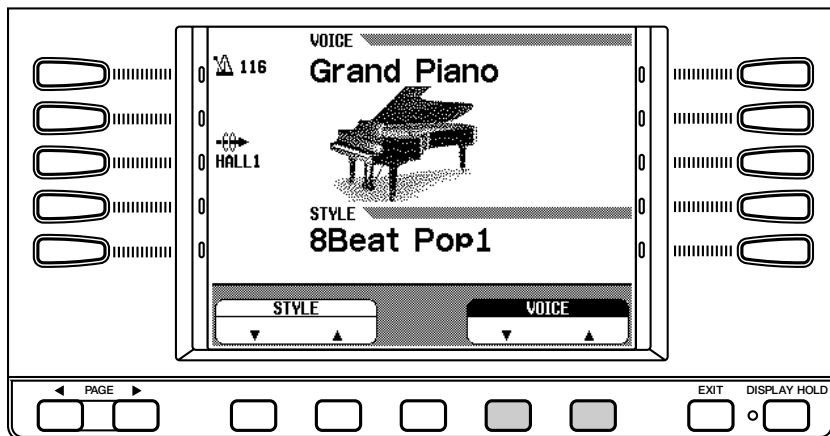

■ Indications of Operation Explanations

The arrows shown below are used in this manual in order to distinguish the results of the operation from the operation steps.

Operation results

♥ → ♠ This mark indicates that executing ♥ results in ♠.

Operation steps

♥ > ♣ This mark indicates that after executing ♥, then execute ♣.

■ Basic Settings:

The functions of the Clavinova are set to certain standard values or standard conditions when the instrument is shipped. These settings and conditions are called the basic settings. The basic settings of each function can be changed according to your preferences. Depending on the settings of the Backup function (page 147), you can have the Clavinova maintain your own edited settings or return to the basic settings after turning off the power. The Recall function (page 148) lets you restore the basic settings at anytime.

■ Main display:

This refers to the LCD display shown below, which appears first when turning on the power.

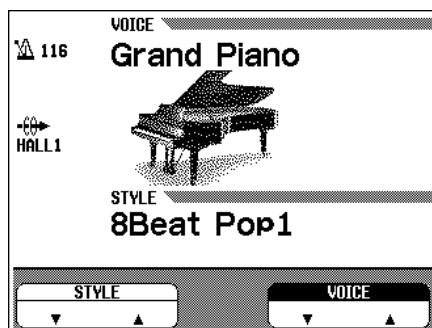

● Pop-up:

When certain panel buttons are pressed, the relevant display appears. Some of these displays are shown temporarily before returning to the previous display. These are called “pop-up” displays.

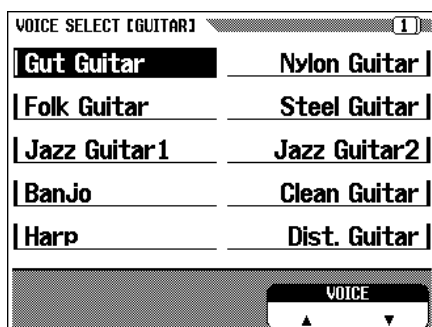

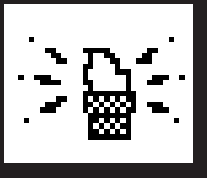

Handling Floppy Disks

The “Music Software Collection” disk and one blank disk are supplied with the Clavinova.

■ Taking Care of Your Floppy Disks

- Do NOT eject the disk during recording or playback, or at any time when the DISK IN USE lamp is lit. Doing so may damage both the disk and the FDD.
- Do NOT turn the Clavinova on or off while the disk is in the drive.
- Always eject the disk before turning the Clavinova off.
- When ejecting a floppy disk from the disk drive:

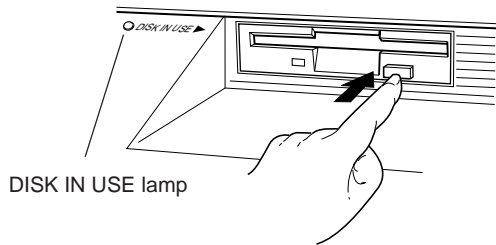

NOTES

- To eject a floppy disk, press the eject button slowly as far as it will go. Then when the disk is fully ejected, remove it by hand.
- The disk may not be ejected properly if the eject button is pressed too quickly or if it is not pressed in far enough. (The eject button may become stuck halfway with the disk extending from the slot by only a few millimeters). If this is the case, do not attempt to pull out the partially ejected disk. Doing so may damage the disk drive mechanism and/or the floppy disk. To remove a partially ejected disk, try pressing the eject button once again or push the disk back into the slot, then repeat the eject procedure carefully.

- Never open or close the key cover while a disk is extending from the drive (i.e. in the ejected position). The key cover may contact the disk, possibly damaging the disk or even the disk drive.
- Do not insert anything but floppy disks into the disk drive. Other objects may cause damage to the disk drive or floppy disk.
- Use the 3.5-inch 2DD or 2HD floppy disks with the Clavinova.

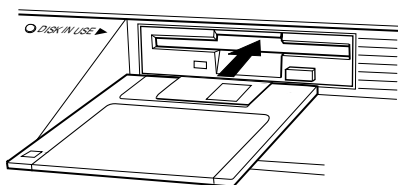

■ Precautions Regarding Floppy Disk Use

- Never open the disk’s shutter. Dirt or dust on the Internal magnetic surface will cause data errors.
- Never leave disks near a speaker, TV, or other device that emits a strong magnetic field.
- Do not store disks in places exposed to direct sunlight or sources of high temperature.
- Do not place heavy objects such as books on top of a disk.
- Avoid getting the disks wet.
- Be sure to store the disks in environmental conditions as specified below:
 - Storage temperature: 4° to 53°C (39° to 127°F).
 - Storage humidity: 8 to 90% relative humidity.
 - Store in an area free from dust, sand, smoke, etc.
- Be sure to apply the disk label at the proper position. When changing the label never cover the old label with a new label; always remove the old label first.

■ Head Cleaning

The head of the disk drive unit will get dirty as you use it eventually causing data errors. If this occurs, clean the head with a 3.5 inch head cleaning disk (available from most computer supply stores).

■ Data Backup

It is recommended that you copy your recorded songs to another disk for backup (see page 136). If the original disk is damaged or your song is deleted, the backup disk can be used instead of the original.

■ Protecting Your Data (Write Protect Tab)

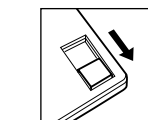
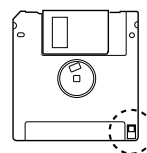

Write protect tab open (locked — write protected)

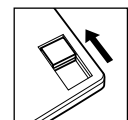

Write protect tab closed (unlocked — write enabled)

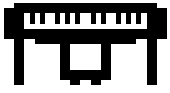

Setting Up the Clavinova

Music Stand

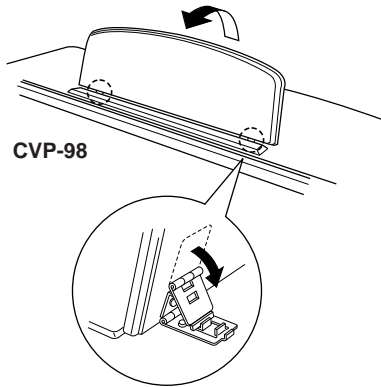

■ To raise the music stand:

- 1 Pull the stand up and toward yourself as far as it will go.
- 2 Flip down the two metal supports at the left and the right on the rear of the music stand.
- 3 Lower the music stand so that it rests on the metal supports.

On the CVP-98/96, the illustration shows that the angle of the music stand can be set in one of three positions, according to the position of the metal supports. Set the left and right metal supports to the same position.

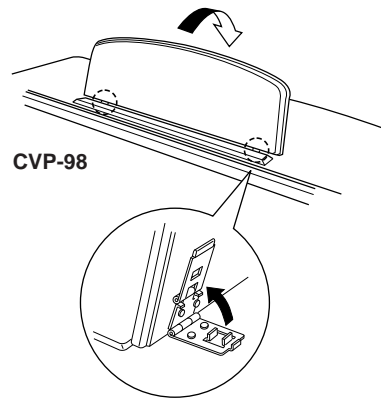

■ To lower the music stand:

- 1 Pull the music stand toward yourself as far as it will go.
- 2 Raise the two metal supports (at the rear of the stand).
- 3 Gently lower the music stand backward until it is all the way down.



- Do not try to use the music stand in a half-raised position. Also, when lowering the stand, make sure to press it until it is all the way down.

Key Cover

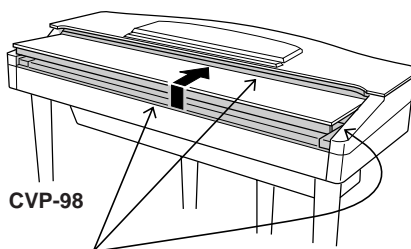

Be careful to avoid catching your fingers when opening or closing the cover.

■ To open the key cover:

- 1 Lift the cover slightly (not too much).
- 2 Slide the cover open.

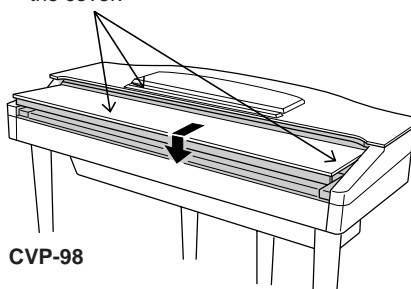

■ To close the key cover:

- 1 Slide the cover toward you.
- 2 Gently lower the cover over the keys.



- Hold the cover with both hands when moving it, and do not release it until it is fully opened or closed. Be careful to avoid catching fingers (yours or others) between the cover and main unit.
- Do not place objects on top of the key cover. Small objects placed on the key cover may fall inside the main unit when the cover is opened and may not be able to be removed. This could cause electric shock, short circuit, fire or other serious damage to the instrument.

Lid (CVP-600 only)

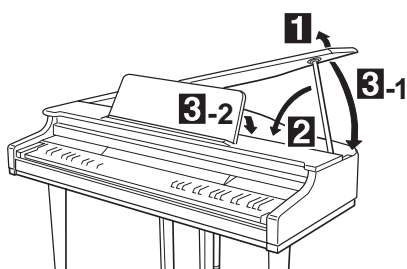
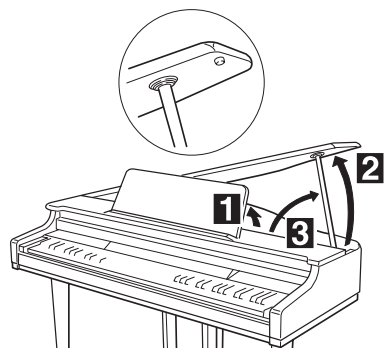

To open the lid:

- 1** Raise the music stand as described in “Music Stand” on page 8.
- 2** Raise and hold the right side of the lid (viewed from the keyboard end of the instrument).
- 3** Raise the lid stay and carefully lower the lid so that the end of the stay fits into the recess in the lid.

To close the lid:

- 1** Hold the lid stay and carefully raise the lid.
- 2** Hold the lid in its raised position and lower the lid stay.
- 3** Carefully lower the lid, then lower the music stand as described in “Music Stand” on page 8.



- Make sure that the end of the stay fits securely in the lid recess. If the stay is not properly seated in the recess the lid may fall causing damage or injury.
- Be careful that you or others do not bump the stay while the lid is raised. The stay may be bumped out of the lid recess causing the lid to fall.
- Be careful not to catch your fingers when raising or lowering the lid.

Turning on the Power

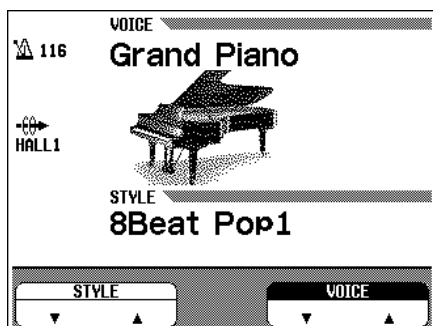
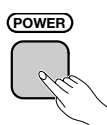

- 1** Connect the power cord.
Insert the plugs at the ends of the cord, one into the AC INLET on the bottom panel of the Clavinova, and the other into a standard AC outlet.
- 2** Press the **[POWER]** switch. The power is turned on and the main display appears in the LCD display. The voice of Grand Piano 1 and the accompaniment style of 8Beat Pop1 are selected automatically at first. The power lamp which is located at the left front of the main unit is lit up.
 - * If the LCD is difficult to read, adjust the contrast with the **[CONTRAST]** button at the left of the LCD.
 - * Adjust the volume by using **[MASTER VOLUME]**.

Press **[POWER]** again when turning off the power. Both the display and the power lamp at the left of the panel will turn off.

Headphones

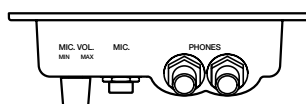

Standard stereo phone jack

Connect a set of stereo headphones (optional) to the **[PHONES]** jack. When headphones are connected, the internal speaker system is automatically shut off. Since the Clavinova has two PHONES jacks, two sets of headphones can be used simultaneously, allowing two people to enjoy listening to the performance.

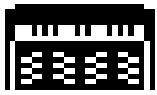

Panel Controls and Terminals

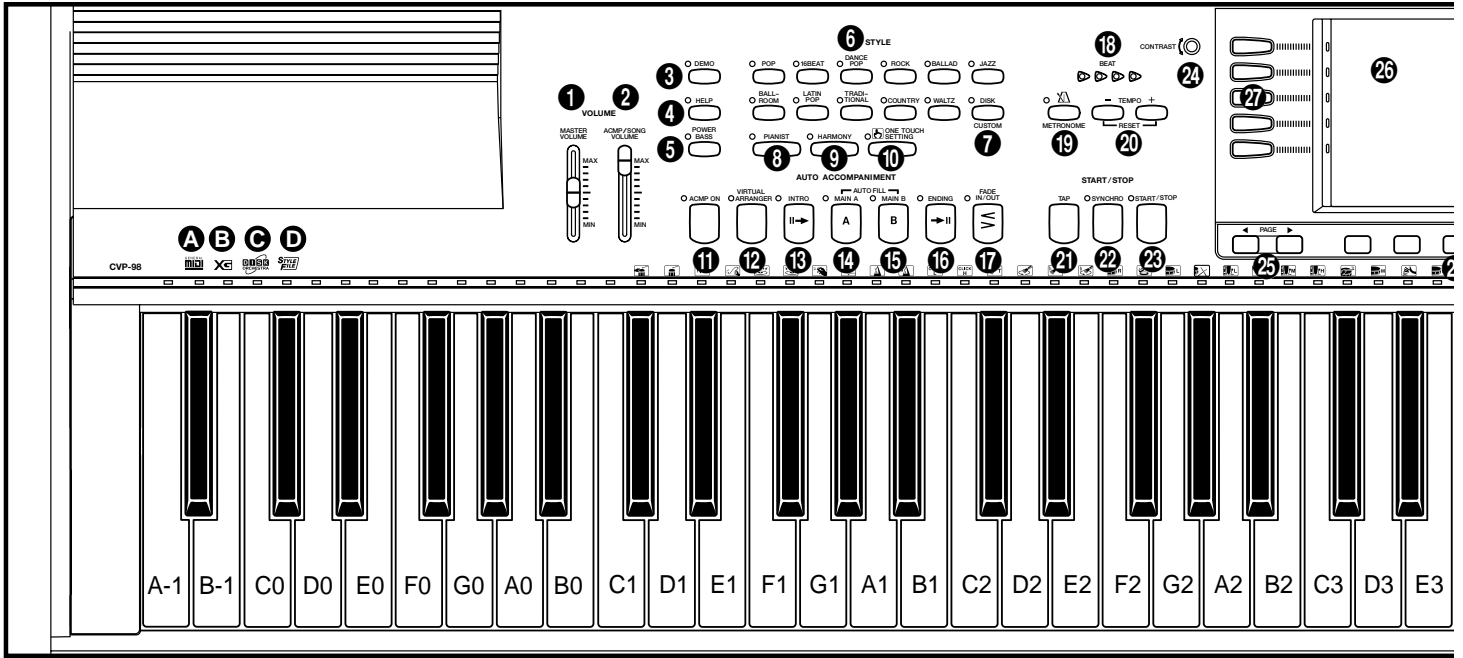
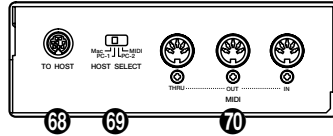
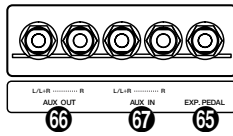

CVP-98

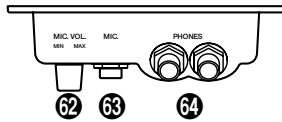

- A** This is the GM (General MIDI) logo. This indicates that the CVP-98/96/600 can playback GM-compatible disk software. See page 8 in the Reference Manual for more information on GM.
- B** This is the XG format logo. This indicates that the CVP-98/96/600 can playback XG-compatible disk software. See page 8 in the Reference Manual for more information on the XG format.
- C** This is the Disk Orchestra Collection (DOC) format logo. This indicates that the CVP-98/96/600 can playback DOC format disks. See page 8 in the Reference Manual for more information on the DOC format.
- D** This is the Style File logo. This indicates that the CVP-98/96/600 can use optional Yamaha Style File disks. See page 80 for more information on Style File data.

Volume Section

- 1** [MASTER VOLUME] page 17
- 2** [ACMP/SONG VOLUME] page 17
- 3** [DEMO] page 24
- 4** [HELP] page 22
- 5** [POWER BASS] (CVP-98) page 21

Accompaniment Style Section

- 6** STYLE buttons page 47
- 7** [DISK/CUSTOM] page 68
- 8** [PIANIST] page 57
- 9** [HARMONY] page 62
- 10** [ONE TOUCH SETTING] page 63
- 11** [ACMP ON] page 57
- 12** [VIRTUAL ARRANGER] page 64
- 13** [INTRO] page 51
- 14** [MAIN A] page 50
- 15** [MAIN B] page 50
- 16** [ENDING] page 53
- 17** [FADE IN/OUT] page 52
- 18** [BEAT] page 52
- 19** [METRONOME] page 54
- 20** TEMPO [-/+] page 49

Start/Stop Section

- 21** [TAP] page 51
- 22** [SYNCHRO] page 51
- 23** [START/STOP] pages 50, 53

Display Control Section

- 24** [CONTRAST] page 15
- 25** PAGE [◀, ▶] page 14
- 26** LCD display page 12

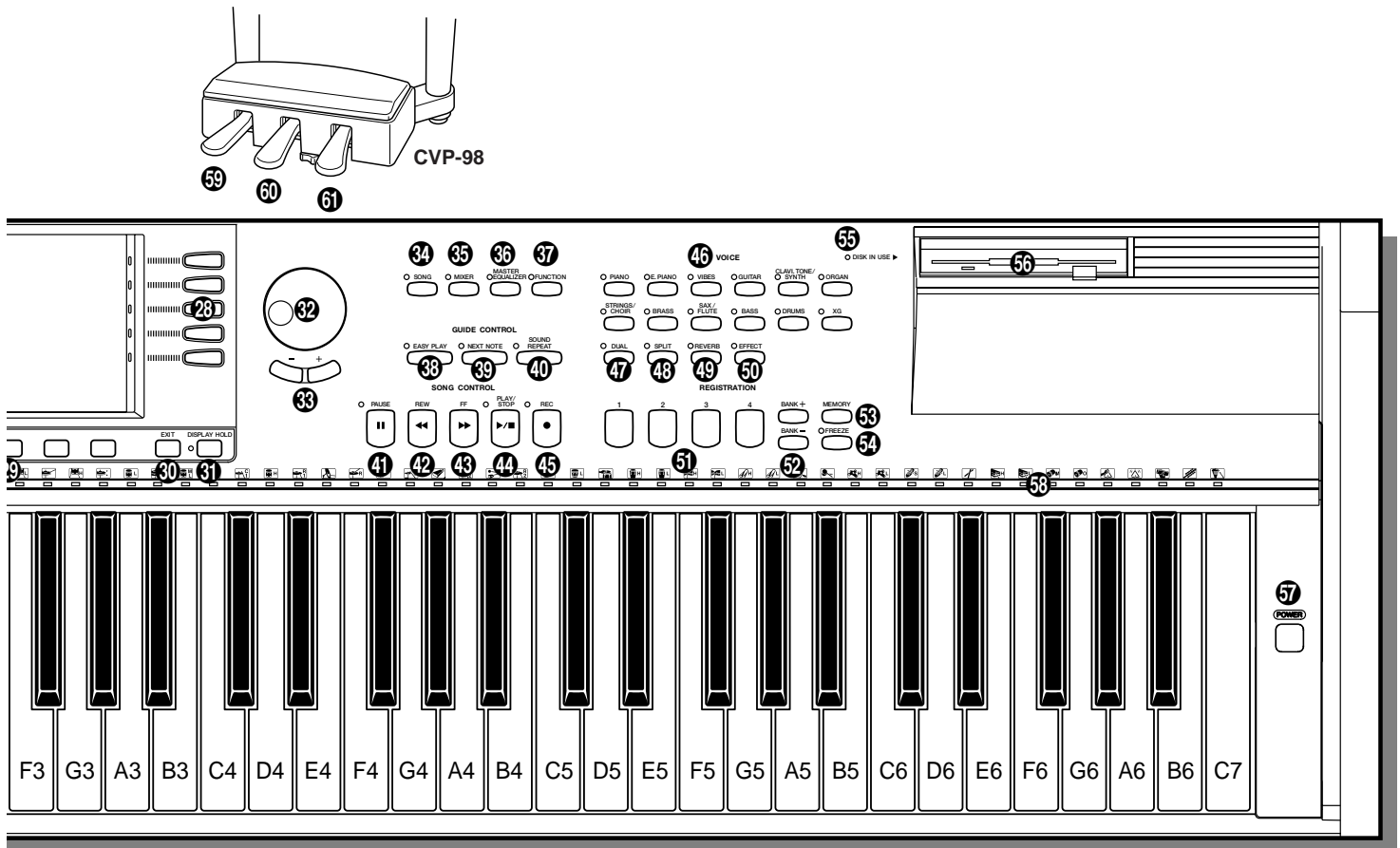

- 27 Left LCD buttons page 12
 - 28 Right LCD buttons page 12
 - 29 LCD buttons page 12
 - 30 [EXIT] page 15
 - 31 [DISPLAY HOLD] page 15
 - 32 Data dial page 13
 - 33 [-/+] page 13
 - 34 [SONG] page 88
 - 35 [MIXER] page 17
 - 36 [MASTER EQUALIZER] page 19
 - 37 [FUNCTION] page 128
- Guide Control Section**
- 38 [EASY PLAY] page 100
 - 39 [NEXT NOTE] page 100
 - 40 [SOUND REPEAT] page 101
- Song Control Section**
- 41 [PAUSE] page 99
 - 42 [REW] page 99
 - 43 [FF] page 99
 - 44 [PLAY/STOP] page 89
 - 45 [REC] page 108
- Voice Section**
- 46 VOICE buttons page 27
 - 47 [DUAL] page 33
 - 48 [SPLIT] page 36
 - 49 [REVERB] page 41
 - 50 [EFFECT] page 44
- Registration Section**
- 51 REGISTRATION [1] - [4] page 84
 - 52 BANK [-] [+] page 83
 - 53 [MEMORY] page 84
 - 54 [FREEZE] page 86
 - 55 DISK IN USE lamp page 7
 - 56 Floppy disk drive (3.5") page 7
 - 57 [POWER] page 9
 - 58 Keyboard guide lamps page 104
 - 59 Soft pedal page 40
 - 60 Sostenuto pedal page 40
 - 61 Damper pedal page 40
 - 62 [MIC.VOL.] page 154
 - 63 [MIC.] page 154
 - 64 [PHONES] page 154
 - 65 [EXP.PEDAL] page 18
 - 66 AUX OUT [R], [L/L+R] page 155
 - 67 AUX IN [R], [L/L+R] page 154
 - 68 [TO HOST] page 155
 - 69 [HOST SELECT] page 155
 - 70 MIDI [IN], [OUT], [THRU] page 155

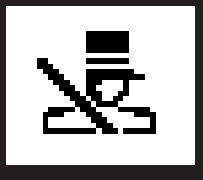

Basic Operation

Virtually all of the Clavinova's operations are done from the LCD display. When you press a button on the panel once, the relevant function's display appears. Depending on the display that appears, you can conveniently perform various functions and change values/settings by using the buttons located directly below, or to the left or right of the LCD, and the data dial and [-/+] buttons at the right of the LCD. Once you're familiar with these operations, you can easily use other functions in the same way.

LCD Display and LCD Buttons

The five buttons located under the LCD display are referred to as the LCD buttons. These buttons are used either to select the corresponding items displayed in the LCD or to change the values. The five buttons located to the left and right of the LCD display are referred to as the left/right LCD buttons. These buttons are used to directly select parameters and settings in the LCD display.

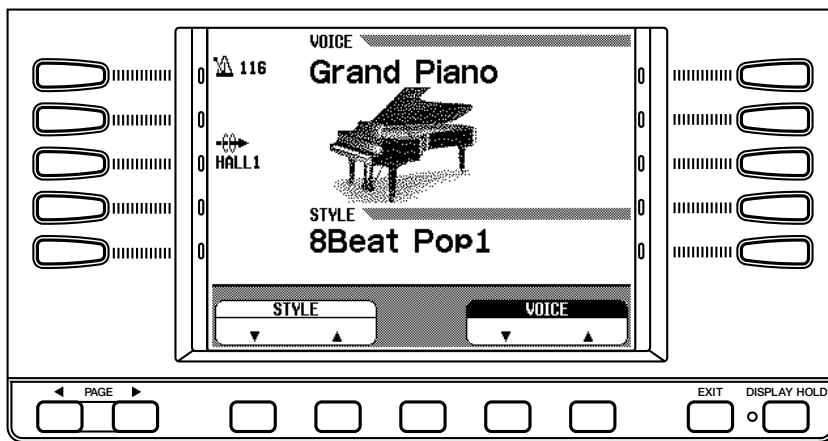

The functions of the LCD buttons differ depending on the selected LCD. Keep in mind that functions are enclosed in two types of rectangles, one a "soft" rectangle with rounded corners, the other a "hard" rectangle with 90-degree corners.

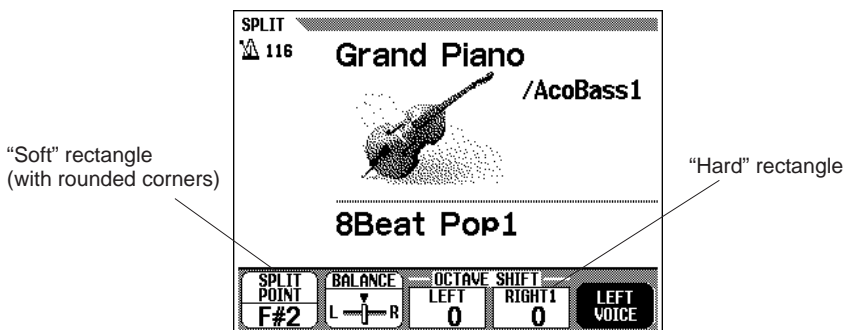

■ When function is within “soft” rectangle:.....

First press the appropriate LCD button under the display (the selected item is highlighted), and use the data dial or [-/+] to set the items which are in “soft” rectangles with rounded corners.

Alternately, after selecting the item, press the LCD button again. For example, when selecting a voice from the display shown below, press the LCD button below **VOICE ▼▲** at the lower right. **VOICE** then is highlighted, and you can select the desired voice by using the data dial or the [-/+] buttons.

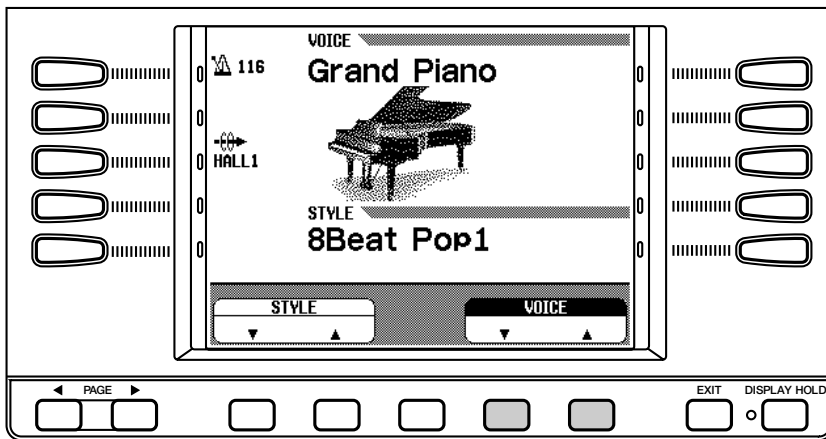

For functions or parameters that have ▼ and ▲ or ◀ and ▶ indications, you can reset the value to its basic value by simultaneously pressing both LCD buttons (or both [-/+] buttons).

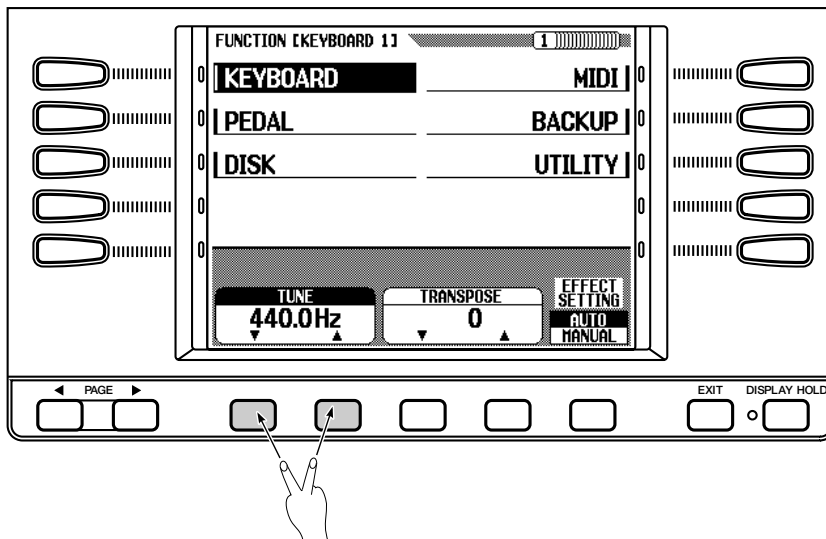

NOTE

Display Highlight

- When selecting an item or parameter in the display, the indication of the selected item is highlighted (appears in reverse display).

When holding down a button...

- In some cases, when one of the LCD buttons or [-/+] buttons is held down, the value or setting changes continuously.

NOTE

- There are some functions and parameters whose settings cannot be returned to the basic value even by pressing the ▼ and ▲ buttons, or the ◀ and ▶ buttons simultaneously.

Basic Operation

■ When function is within “hard” rectangle:.....

Items within a “hard” rectangle can be directly selected or switched ON/OFF by simply pressing the corresponding LCD button located directly below the desired item.

For example, when selecting the first Demo song in the display shown below, you can immediately begin playback of the first song by pressing the LCD button under **1**.

Settings which can be selected by using the left and right LCD buttons are surrounded by “hard” rectangles. Select these settings directly by pressing the left or right LCD buttons.

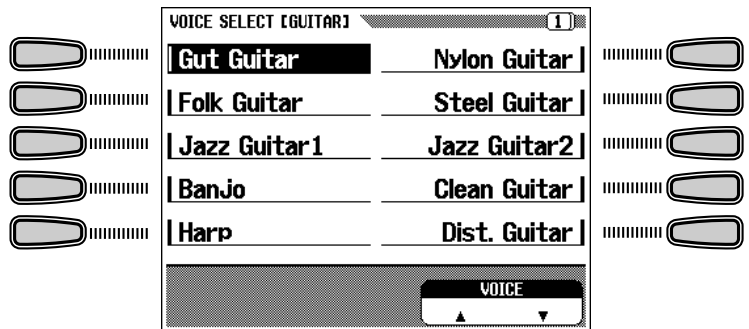
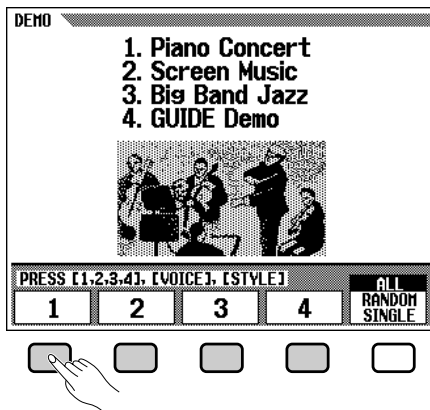

PAGE [◀] [▶] Buttons

Some of the Clavinova’s functions are contained on successive display pages. To select the next page or previous page, press the appropriate PAGE [◀] [▶] button. The current page and the entire number of pages for the function are indicated at the top right of the display.

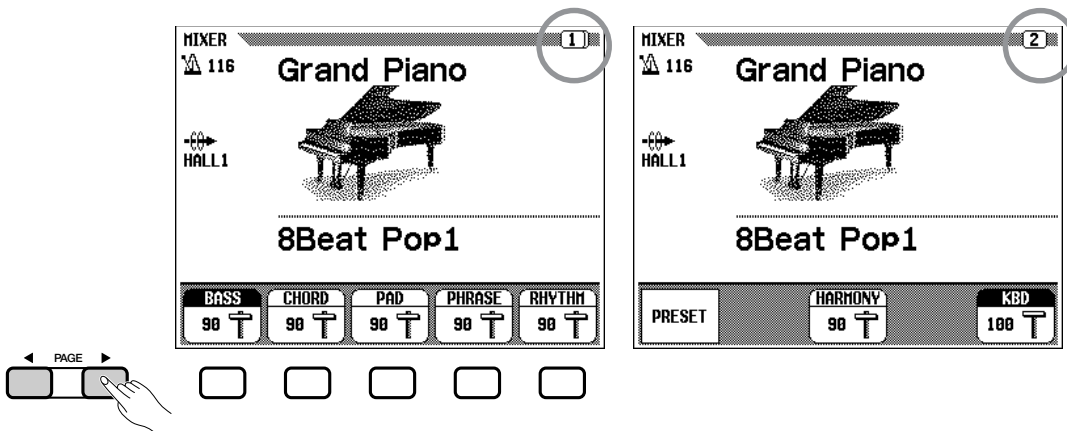

[EXIT] Button

Press [EXIT] in order to leave the current mode or return to the previous display.

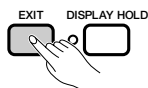

[DISPLAY HOLD] Button

The [DISPLAY HOLD] button lets you keep the display from changing. For example, voices and accompaniment styles can be selected by pressing the VOICE button or STYLE button. The display of the selected voice/style appears for a few seconds, then changes to the previous display. Displays such as this that appear briefly are called pop-up displays. The [DISPLAY HOLD] lamp flashes to indicate that it is the pop-up display, and that the previous display will appear after a few seconds. By pressing the [DISPLAY HOLD] at this point, the lamp stays lit continuously and the selected display stays. Pressing [DISPLAY HOLD] again turns the lamp off and the display returns to the previous one.

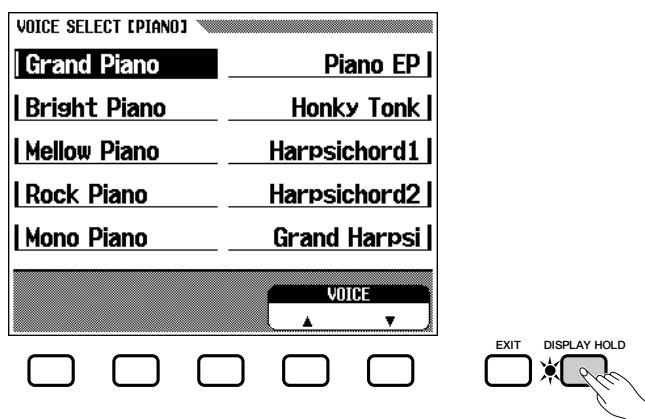

NOTE

- If [DISPLAY HOLD] is pressed for any non pop-up display, and the lamp is lit up, the pop-up display cannot be opened.

NOTE

- The duration of pop-up displays can be set with the Pop-up Time parameter (page 153).

Adjusting the Contrast of the LCD Display

Turn the [CONTRAST] button in order to adjust the contrast or brightness of the display.

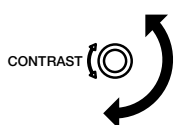

Memory Backup

The Backup function (page 147) can be used to maintain various values and settings, even after the power has been turned off. In the Backup function display, each parameter group to be backed up can be selected individually. Values and settings which are not backed up revert to the basic settings when the power is turned off.

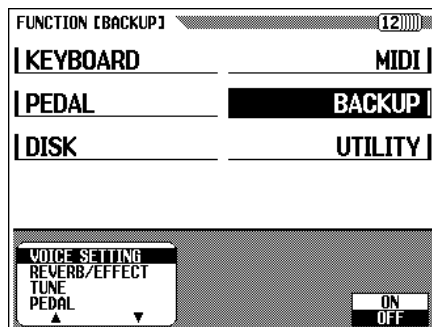

When set to ON, the last setting of these parameters are retained in memory even after the power is turned off. For a list of the backup parameters, see page 147.

If the Clavinova is left unused without the power being turned on for approximately a week, the backed up data is deleted and all the settings return to the basic settings. For this reason, you should turn on the power at least once a week and keep it on for a few minutes.

NOTE

Backup of the Last Settings

- For parameters which can be set to Backup ON/OFF, the basic setting is indicated as "Backup of last settings: ON (or OFF)" in the explanation of each parameter.
- Items set to Backup ON can be returned to the basic setting anytime by using the Recall function (page 148).

Display Messages

For ease of operation, the Clavinova shows various messages that either prompt you to the next operation, ask for confirmation, or inform you that the last operation is not effective, valid or appropriate. When such messages appear, follow the instructions as shown. For details about each message, please refer to the "Messages" section on page 2 in the Reference Manual.

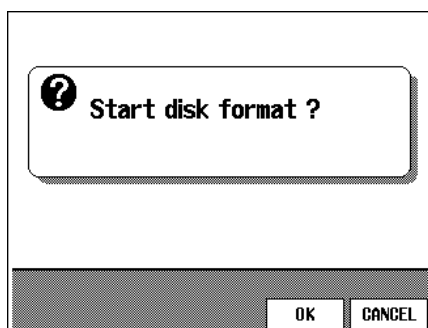

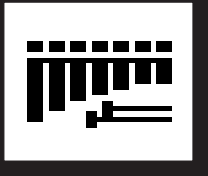

Adjusting the Volume

The Clavinova has two sliders on the panel for adjusting the volume. It also allows you to adjust the volume of each part of the Automatic Accompaniment or song.

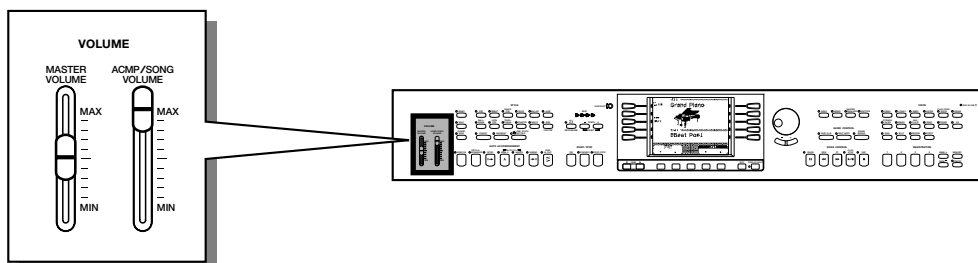

[MASTER VOLUME]

This determines the entire volume of the Clavinova.

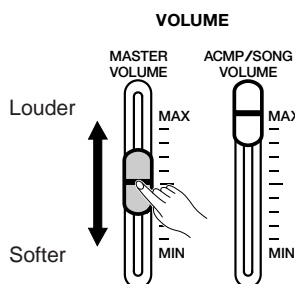

NOTE

- This also determines the output level of the signal at the [PHONES] and [AUX OUT] jacks.

[ACMP/SONG VOLUME]

This determines the playback volume of the Automatic Accompaniment and Songs.

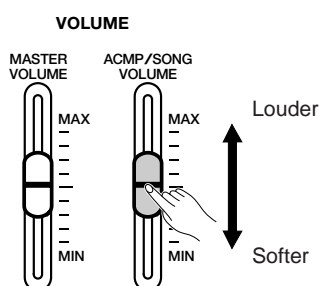

NOTE

- This control has no effect on the volume of your keyboard performance.

[MIXER]

Call up the Mixer display by pressing [MIXER]. In the Mixer display, the volume of Automatic Accompaniment and individual parts of a song can be adjusted. Press [MIXER] again (or [EXIT]) to return to the previous display.

There are three types of mixer display, as shown below.

Adjusting the Volume

● Automatic Accompaniment Volume

See Automatic Accompaniment volume (page 60) for details.

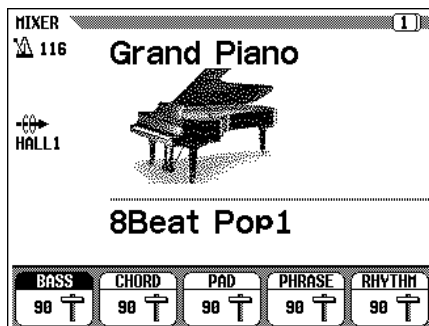

● Page 1, when using disk

See Song volume (page 94) for details.

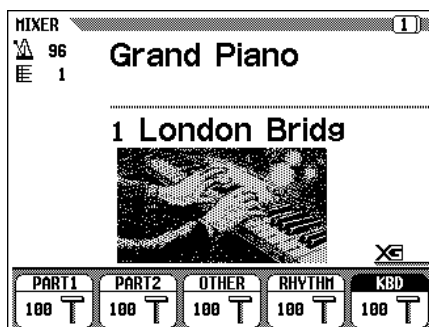

● Page 2, when using disk

See Song volume (page 95) for details.

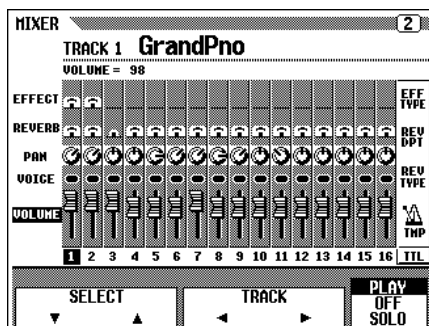

[EXP.PEDAL]

You can control the volume of your keyboard performance with your foot, by connecting the optional Yamaha FC7 foot controller to the [EXP.PEDAL] jack of the Clavinova.

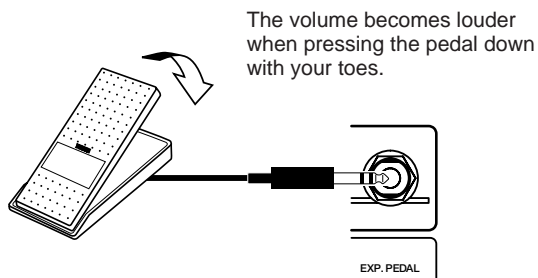



Adjusting the Timbre of the Sound

The sound timbre can be adjusted by using the [MASTER EQUALIZER] and [POWER BASS] (CVP-98 only) controls.

NOTE

- Distortion could result if these effects are set to higher levels. If this is the case, reduce the overall volume with the [MASTER VOLUME] control.

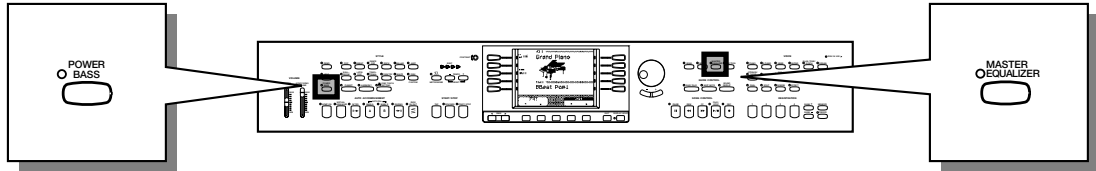

[MASTER EQUALIZER]

The lamp lights when the [MASTER EQUALIZER] button is pressed. The MASTER EQUALIZER display appears, allowing you to finely adjust the timbre of the sound with a five-band equalizer. Five preset settings are provided; use these as a basis for making your own settings. The set values affect all the parts.

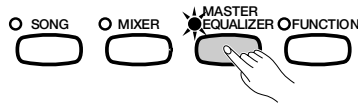

■ Changing the Master Equalizer Settings

1 Select the type of equalization.

Use the left and right LCD buttons in the MASTER EQUALIZER display. Six different types are available: **FLAT**, **JAZZ**, **POPS**, **ROCK**, **CLASSIC**, and **USER**.

- ➔ The central frequency and the gain of the selected type will appear in the LCD display.

The gain becomes 0 for all frequencies when **FLAT** is selected.

NOTE

MASTER EQUALIZER type

- Basic setting: **FLAT**
- Backup of last settings: **OFF**

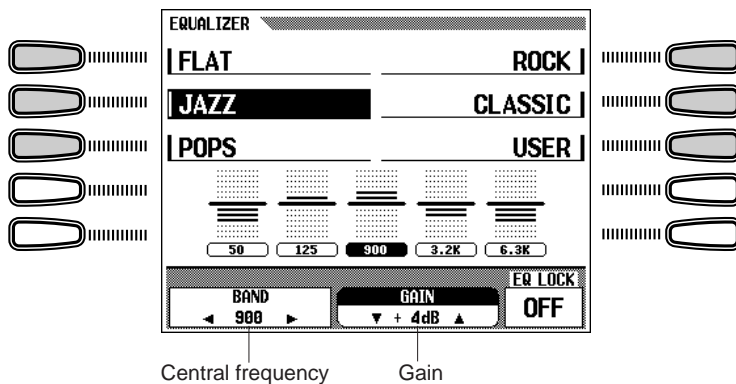

Adjusting the Timbre of the Sound

2 Select the band (frequency range) to be adjusted.

Select the band you wish to adjust by pressing the **BAND** ◀ or ▶ button.

- The central frequency of the selected band (expressed in Hz) is shown in the **BAND** ◀ ▶ section of the display.

3 Change the value.

Change the value of the gain either by pressing the **GAIN** ▼ ▲ buttons, or by using the data dial or [-/+] buttons.

Since the value can be changed during playback, you can adjust the settings while listening to the changes in the sound.

- The value is shown in the **GAIN** section of the display.

If you change the value (even slightly) when any type except **USER** is selected, **USER** will be highlighted and the newly set value will overwrite the original **USER** setting.

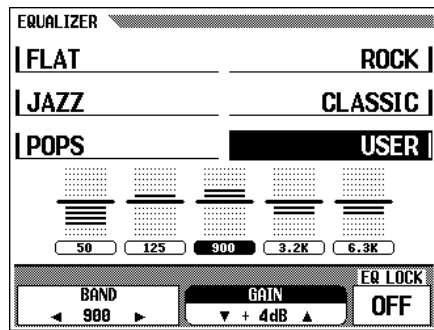

■ EQ LOCK ON/OFF

When equalizer setting values are contained in the song data or when the equalizer setting data is received via MIDI, the current settings in the MASTER EQUALIZER display will be overridden by the settings of the song data or MIDI data. Set the **EQ LOCK** to **ON** to prevent reception of this data, or set to **OFF** to enable reception.

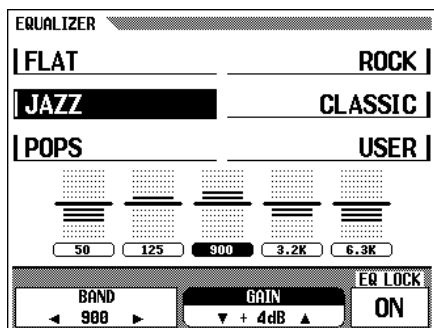

NOTE

Gain

- Range: -12 — 0 — +12 (dB)

NOTE

EQ LOCK ON/OFF

- Settings: ON/OFF
- Basic setting: OFF

Power Bass (CVP-98 only)

Press the **[POWER BASS]** button (the lamp lights) to emphasize the sounds of the lower range.

The amount of the emphasis can be changed by the **VOLUME** ▼ ▲ buttons in the POWER BASS display.

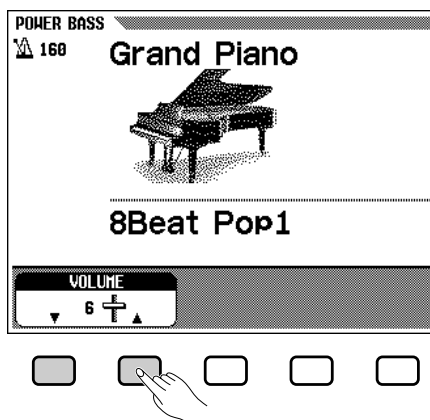
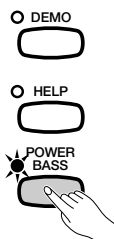

To turn off the Power Bass function and return the sound to normal, press the **[POWER BASS]** button again so that the lamp goes out.

NOTE

POWER BASS ON/OFF...

- Settings: ON/OFF
- Basic setting: OFF
- Backup of last settings: OFF

NOTE

VOLUME of POWER BASS

- Range: 1 — 10
- Basic value: 6
- Backup of last settings: OFF

CHAPTER 2: Help Mode and Demo

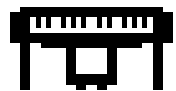

Using the Help Mode

The Help mode provides convenient explanations of the main functions of the Clavinova. As the explanations shown in the display automatically progress, the Clavinova actually operates itself in demonstration — the Clavinova sounds various voices and styles.

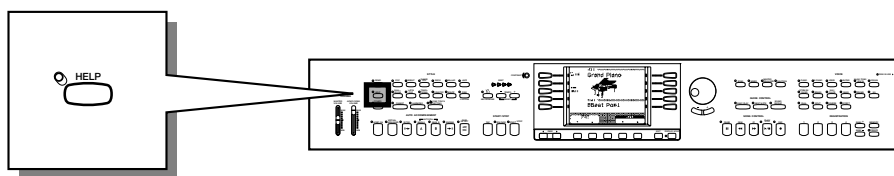

1 Call up the Help mode.

Press the [HELP] button. The Help menu display appears.

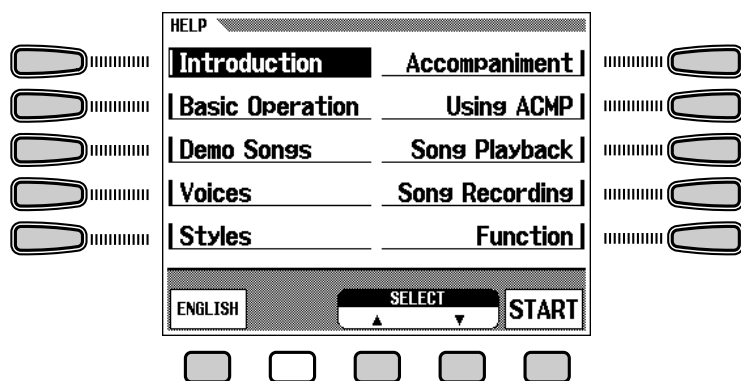
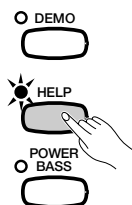

2 Select the language if necessary.

Select the desired language for help (ENGLISH, GERMAN, FRENCH, SPANISH or JAPANESE) by pressing the first LCD button at the bottom.

NOTE

- While the Help mode is active, no other operations can be used.

NOTE

- The selected language is always backed up even after the power is turned off.

3 Select the desired menu.....

Use the left/right LCD buttons to select the desired menu.

You can also select the menu by pressing the **SELECT ▼ ▲** buttons.

The selected menu is highlighted. Ten menus (listed below) are available.

Help Menus

- | | |
|--------------------|-------------------|
| 1. Introduction | 6. Accompaniment |
| 2. Basic Operation | 7. Using ACMP |
| 3. Demo Songs | 8. Song Playback |
| 4. Voices | 9. Song Recording |
| 5. Styles | 10. Function |

4 Start the explanation.....

Press **START** to begin the explanation of the selected menu.

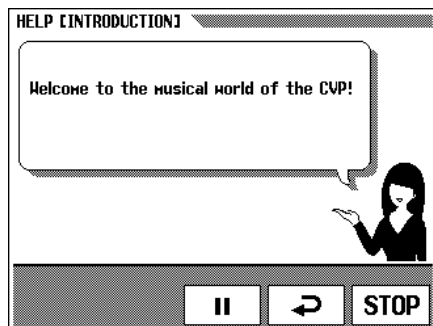

The display pages are advanced automatically. To pause the explanation, press **II**. Then, by pressing **↶**, you can return to the previous page and read the explanations.

➤ To resume the explanation, press **II** again.

5 Stop the explanation.....

When the explanation is finished, the display automatically returns to the Help menu display. If you wish to stop the explanation while it is playing and return to the Help menu display, press the **STOP** button.

You can select another menu and read through other explanations, or you can exit from the Help mode and to go back to the main display by pressing **[HELP]** (or by pressing **[EXIT]**).



Demo Play

The Clavinova features a total of 27 demo pieces: 4 entire Demo songs, 12 special pieces showcasing the voices, and 11 showcasing the styles. Listen to them all and hear what the Clavinova can do.

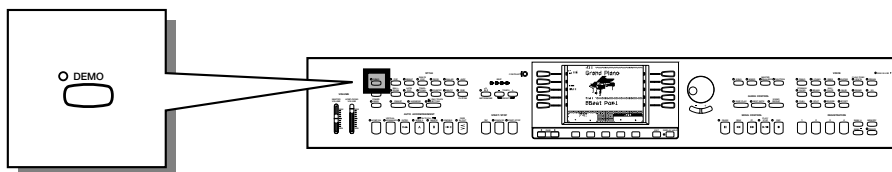

1 Call up the Demo Play mode.

Press [DEMO]. The lamps of the STYLE button and VOICE button flash continuously, and the DEMO display appears.

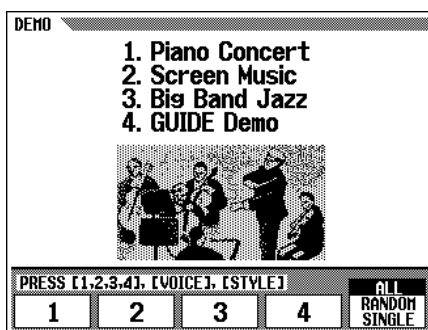
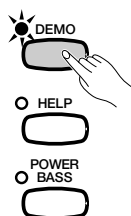

2 Select the desired Play mode.

Select the desired play mode by pressing the LCD button at the right. The following three modes are available:

ALL	All the songs play back continuously in order, starting from the selected song. Playback continues repeatedly until stopped.
RANDOM	All the songs play back randomly, starting from the selected song. Playback continues repeatedly until stopped.
SINGLE	Only the selected song plays back. When the song is finished, playback stops automatically.

3 Select the song and start playback.

When the song is selected, the Demo automatically plays back in the currently selected Play mode. There are three ways to play back the song(s), as described below:

(A) To listen to a Demo song for voices, press the VOICE button corresponding to the desired voice.

→ Playback starts from the Demo song of the selected voice. The lamp of the corresponding VOICE button flashes.

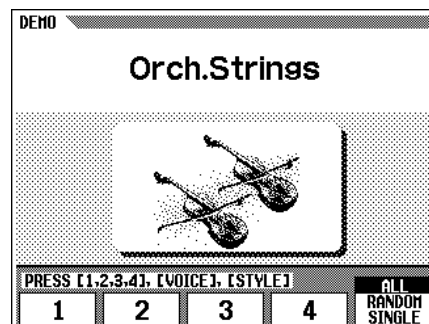
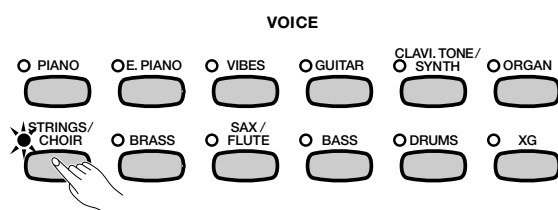

(B) To listen to a Demo song for styles, press the STYLE button corresponding to the desired style.

→ Playback starts from the Demo song of the selected style. The lamp of the corresponding STYLE button flashes.

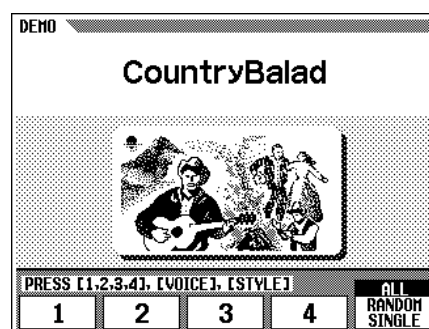
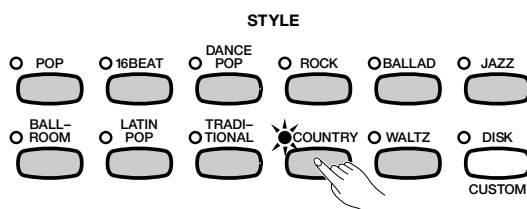

(C) To listen to one of the entire Demo songs, press one of the LCD buttons corresponding to 1 - 4 in the display.

→ The currently selected song number is highlighted during playback.

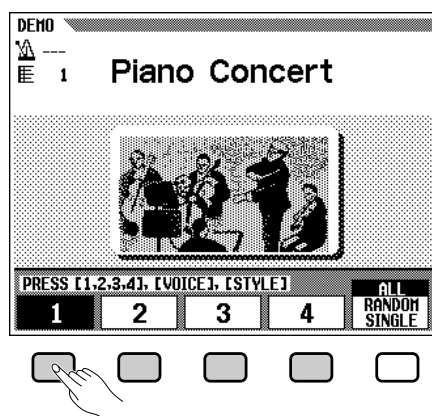

Demo playback can also be started by pressing [START/STOP] or [PLAY/STOP].

● Playing the keyboard with Demo playback

You can play the keyboard while the demo song is playing back. You can also change the tempo (page 49) and use the [REW], [FF] and [PAUSE] buttons. The Guide function (page 100) can also be used when playing back the “4. GUIDE Demo” song. However, the voice cannot be changed.

NOTE

- Demo song data is not output through the [MIDI OUT] terminal; however, your keyboard performance data is output.

CHAPTER 3: Voices



Selecting Voices

The Clavinova features a wealth of rich, authentic voices, including piano, strings and brass instruments. It also features a Keyboard Percussion function that lets you play the realistic drum and percussion sounds directly from the keyboard.

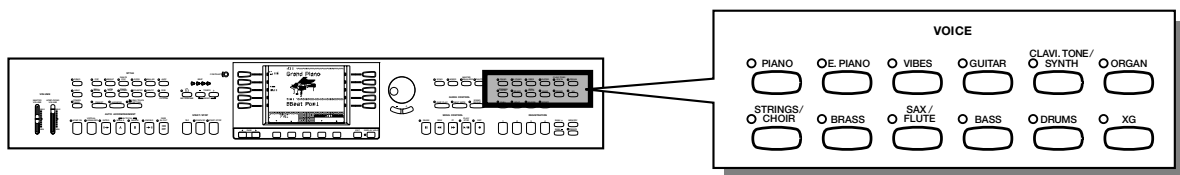

● Voice Types

- Clavinova Voices: 133
- XG Voices: 480
- Drum Kit: 12 kits

* For a list of the voices, see page 26 in the Reference Manual.

* The voices of the Clavinova are divided into twelve groups, and each voice group is assigned to the corresponding VOICE button on the panel.

Selecting a Voice from the VOICE SELECT Display

1 Select the voice group.

Select the desired voice group by pressing the appropriate VOICE button.

→ The pop-up display of the VOICE SELECT display appears.

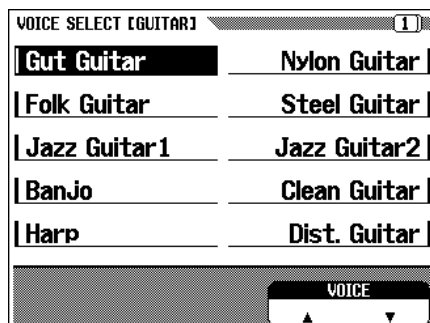
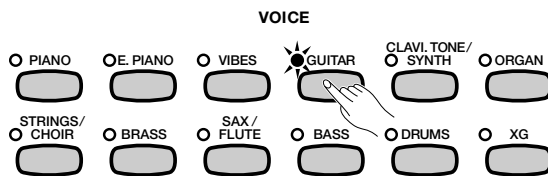

NOTE

Pop-up Display

- The pop-up display returns to the previous display after a few seconds. You can keep the pop-up display from changing by using the Display Hold function (page 15).

NOTE

Backing Up the Selected Voice

- The last selected voice in each group can be retained in memory, even after turning off the power, when the Backup function (page 147) is set to ON.
- When the power is turned ON, the GRAND PIANO voice is selected automatically. However, if the Backup function (page 147) is set to ON, the last selected voice will automatically be selected.

Selecting Voices

2 Select the voice.....

Select the desired voice by pressing the appropriate left/right LCD button.. The data dial and [-/+] buttons can be also used.

You can also select the voice by pressing the **VOICE ▼ ▲** buttons.

Some of the VOICE SELECT displays have several successive pages. Use the PAGE [◀] [▶] buttons to call up the various pages.

3 Play the selected voice.....

Adjust the volume by using the [MASTER VOLUME] slider.



NOTE

Automatic Effect Settings

- Selecting a voice automatically selects the best-suited effects for that particular voice. You can disable this so that effects are not automatically selected by using the Effect Setting parameter (page 131).

Selecting Voices from the Main Display

You can also select a voice by using **VOICE ▼ ▲**, even after the VOICE SELECT display has changed back to the main display.

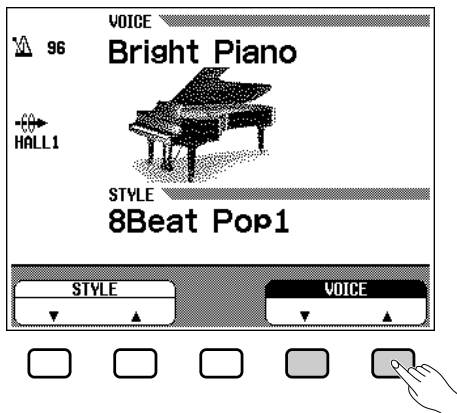

1 Press either **VOICE ▼** or **▲**.....

→ **VOICE** is highlighted.

2 Select the voice.....

Select the voice by using the data dial or [-/+] buttons. You can also select voices by pressing **VOICE ▼ ▲**. (When selecting a voice in this way, the voice can be selected not only from a certain voice group but from all voices.)

3 Play the voice.....

Adjust the volume by using the [MASTER VOLUME] slider.



NOTE

About XG Voices

- Yamaha's XG format is a major new enhancement to the GM (General MIDI) System Level 1 format. It provides for more instrument sounds and variations, as well as greater expressive control over voices and effects. XG also ensures compatibility with future instruments and software.

Organ Combination (Organ Combi.)

To call up the ORGAN COMBINATION display, press the [ORGAN] button and select **Organ Combi.** in the pop-up display. With the Organ Combination function in this display, you can select from six different kinds of organ sounds, and even create your own organ sounds by editing these voices.

Selecting Organ Combination Voices

Select the desired voice by pressing the left/right LCD buttons in the pop-up ORGAN COMBINATION display.

→ The settings of the selected voice are shown in the display.

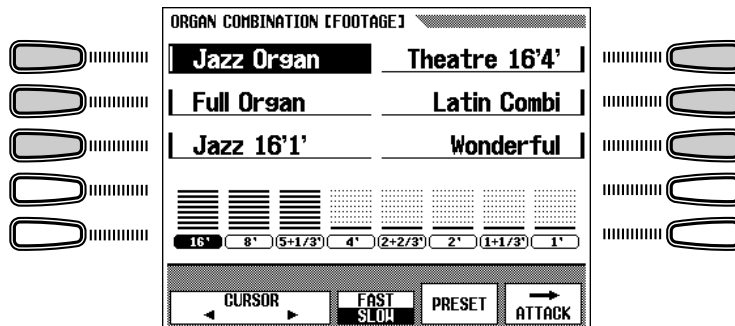

Editing Organ Combination Voices

The editing features in this function let you recreate organ voices by adjusting several footage settings, just as on conventional organs. Various organ voices can be created by the setting combinations shown below.

FOOTAGE display

- Footage volume setting (eight continuous voices corresponding to conventional organ footages)
- Setting the speed of the rotary speaker effect (FAST/SLOW)

ATTACK display

- Attack Footage volume setting (three decay voices used as percussive attack sounds)
- Length setting (length of attack sound for decaying voices)
- Response setting (speed of sound starting for continuous voices)
- Attack Mode setting (EACH/FIRST)

To create a percussive organ sound, adjust the volume of the decay sound and the attack length of attack sound to appropriate settings, then add them to the continuous voice. To recreate the sound of a pipe organ with a slow attack, set the Response to a large value.

NOTE

- The edited voices can be backed up in sets of six by setting VOICE SETTING to ON (in the Function section's Backup parameter, page 147).

NOTE

- An asterisk (*) appears next to the voice name when the selected voice has been already edited.

NOTE

- **Rotary speed effect:** A rich, swirling chorus effect, created by actual rotation of a speaker.
- **Attack sound:** A sharp, percussive sound at the beginning of a note.
- **Attack Mode:** The manner in which the attack sound is output.

Selecting Voices

■ Editing the Voice

Select the desired voice for editing, then set each parameter.

The ORGAN COMBINATION has two display pages: [FOOTAGE] and [ATTACK]. Press the right-most LCD button to change between the displays. Press the **PRESET** button in each display to instantly return to the pre-edited voice.

● Making settings in the ORGAN COMBINATION [FOOTAGE] display

Footage volume setting

Select the footage “bar” to be adjusted by using the **CURSOR** buttons, then set the volume by using the data dial or [-/+] buttons.

Setting the speed of the rotary speaker effect

Press the middle LCD button to change between **FAST/SLOW**.

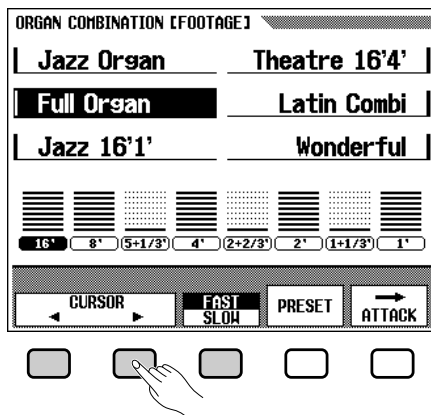

NOTE

- To call up the ATTACK display, press the **CURSOR** button when the cursor is at “1.”

● Voice Type and Volume Image (About Organ Footages)

The standard pitch is 8 feet. A setting of 4 feet is one octave higher than 8 feet, 2 feet is two octaves higher, and 1 foot is three octaves higher; 16 feet is one octave lower.

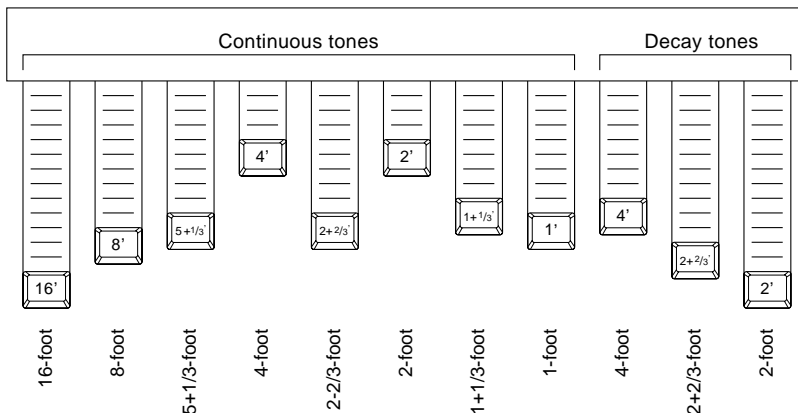

● Making Settings in the ORGAN COMBINATION [ATTACK] Display

Attack Footage Volume, Length, and Response settings

Select the appropriate bar in the display by pressing the **CURSOR** buttons, then set the Volume, Length or Response by using the data dial or [-/+] buttons.

Setting the Attack Mode

Press the middle LCD button to change between the **EACH/FIRST** settings. When set to **EACH**, the attack sound is applied to all played notes.

When set to **FIRST**, the attack sound is applied only to the first played note in a legato sequence, and is not applied to subsequent notes played in legato.



- To call up the FOOTAGE display, press the **CURSOR** ◀ button when the cursor is at "4."

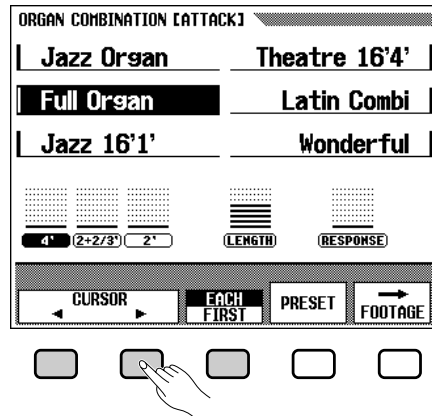

● Image of Attack Length and Response

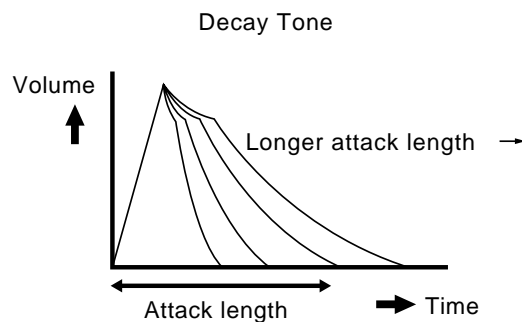
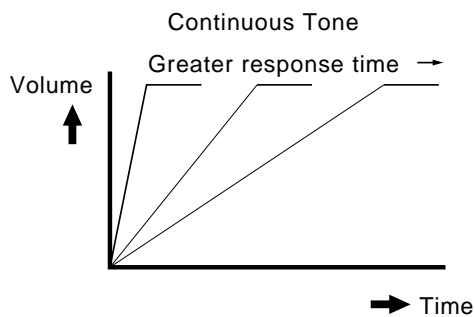

Keyboard Percussion

The Clavinova has twelve Drum Kits in the [DRUMS] voice group. When one of the Drum Kits is selected, various drum and percussion sounds are assigned individually to the keys, letting you play the sounds from the keyboard.

The various drum/percussion instruments of the Standard Kit are marked by symbols above the assigned keys.

See the Drum Kit list on page 32 in the Reference Manual for the types of percussion sounds in each Drum Kit.

NOTE

- When a Drum Kit is selected, only the keys with drum or percussion symbols printed above them will sound.
- The Transpose (page 130), Tune (page 130) and Octave Shift (page 35, 38) functions do not affect the Drum Kits.

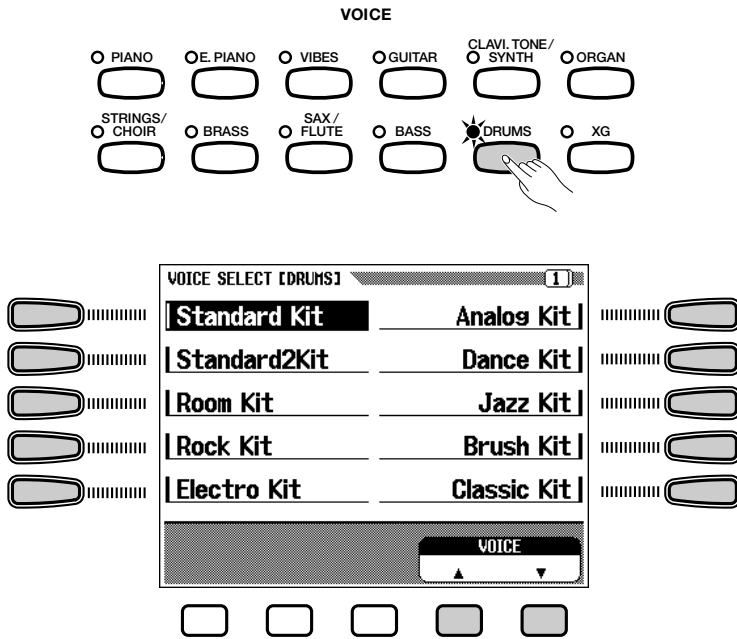

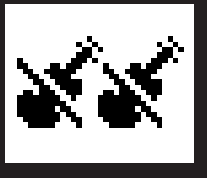

Playing Two Voices Simultaneously — Dual Mode

The Dual mode of the Clavinova allows you to select and play two different voices simultaneously in a layer. This makes it easy to create exceptionally rich and thick tonal textures. The volume balance and the depth of detune* can also be set for the two voices.

**Detune: This lets you finely change the pitch of the two different voices, creating a "thicker" sound.*

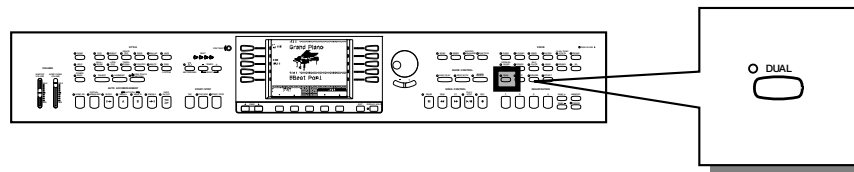

Selecting the Dual Voice

1 Select the first voice.

Select a voice in the normal way. (See page 27.)

2 Call up the Dual mode.

To call up the Dual mode, press the [DUAL] button.

→ The DUAL pop-up display appears.

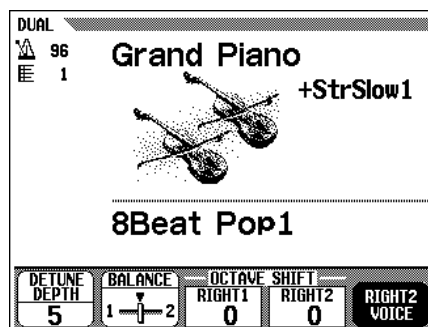
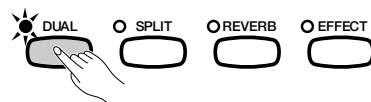

3 Select the second voice.

The second voice can be selected from the DUAL pop-up display. Select the second voice by using the VOICE buttons, and/or the data dial or [-/+] buttons after pressing **RIGHT2 VOICE** (it is highlighted). Pressing **RIGHT2 VOICE** also advances through the available voices; holding it down advances continuously.

NOTE

Second Voice

- Range: All voices
- Basic setting: Strings Slow 1
- Backup of last settings: OFF

Playing Two Voices Simultaneously — Dual Mode

The second voice can be selected from all available voices, including the same voice as the first one.

You can also select a voice by using **RIGHT1 VOICE** or **RIGHT2 VOICE**, even after the pop-up DUAL display has changed back to the main DUAL display.

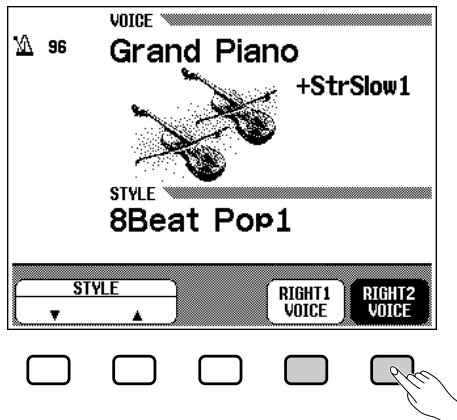

After pressing **RIGHT1 VOICE** or **RIGHT2 VOICE** (it is highlighted), select the voice in the normal way.

4 Exit the Dual mode.

Press **[DUAL]** again; the lamp turns off and the Dual mode is no longer active.

NOTE

- If you select a voice with the **VOICE** buttons when **STYLE** \blacktriangledown \blacktriangle is highlighted, selection of the **RIGHT1 VOICE** is automatically called up.

Setting the Volume Balance of the Two Voices

1 Press **BALANCE** from the DUAL pop-up display.

→ It is highlighted.

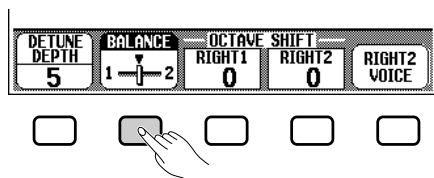

2 Adjust the volume balance of the two voices by using the data dial or **[-/+]** buttons.

Pressing **BALANCE** lets you increase the level of the second voice only. Equal balance can be instantly reset by simultaneously pressing the **[-/+]** buttons.

NOTE

Volume Balance

- Basic setting: Equal volume
- Backup of last settings: OFF

NOTE

- The Volume Balance setting globally affects all voice combinations. Different settings cannot be made for each voice.

Detuning the Pitches of the Two Voices

The Detune Depth setting lets you produce an even richer sound by finely detuning the pitch of the two voices.

1 Press DETUNE DEPTH from the DUAL pop-up display.

→ It is highlighted.

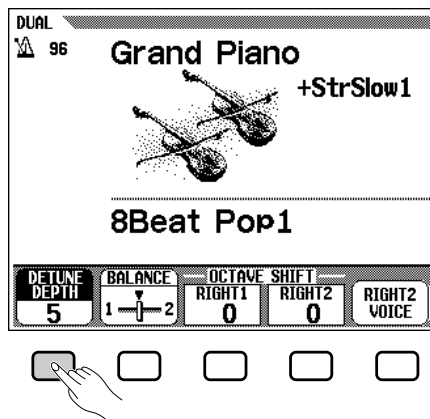

2 Adjust the Detune Depth by using the data dial or [-/+] buttons.

You can also press **DETUNE DEPTH** to increase the value. The higher the value, the greater the Detune Depth.

NOTE

Detune Depth

- Range: 0 - 10
- Basic setting: 5
- Backup of last settings: OFF

NOTE

- The Detune Depth setting globally affects all voice combinations. Different settings cannot be made for each voice.

Changing the Octave Setting of the Two Voices

The Octave Shift setting lets you adjust the pitch of the two voices up or down an octave.

Press either **RIGHT 1** or **RIGHT 2** of the **OCTAVE SHIFT** parameter in the DUAL pop-up display.

→ The values change each time the LCD button is pressed. Available settings are -1, 0, and +1.

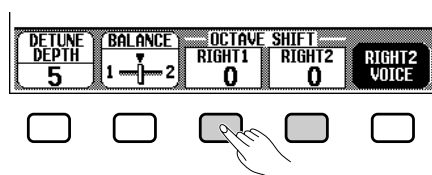

NOTE

Octave Shift

- Settings: -1 (1 octave lower)
0 (no octave shift)
+1 (1 octave higher)
- Basic setting: 0 (no octave shift)
- Backup of last settings: OFF

NOTE

About the Sounding Range for Octave Shift

- Notes below and above the original 88-key range (A-1 to C7) sound one octave higher and lower, respectively.
- The **RIGHT1** setting is effective for normal playing with one voice, and also affects the **RIGHT1** setting in the **SPLIT** mode (page 36).

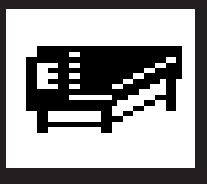

Playing Two Voices from Different Sides of the Keyboard — Split Mode

The Split mode of the Clavinova allows you to select and play two different voices with your left and right hands — for example, play bass with the left and piano with the right.

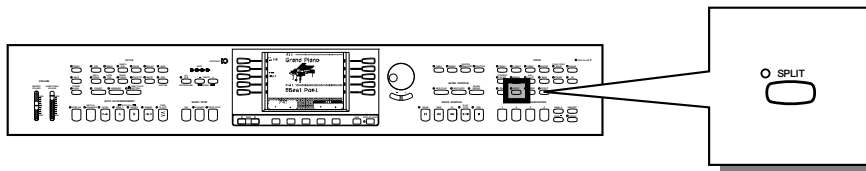

Selecting the Split Voice

1 Select the voice for the right keyboard range.

Select the desired voice in the normal way.

2 Call up the Split mode.

To call up the Split mode, press the [SPLIT] button.

→ The SPLIT pop-up display appears.

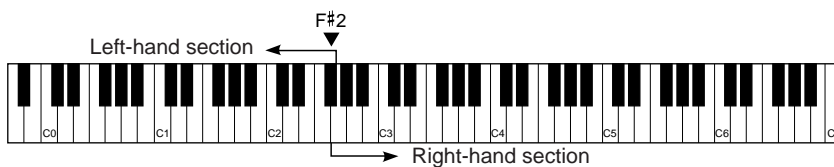
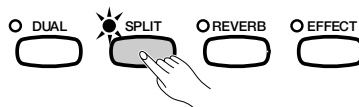
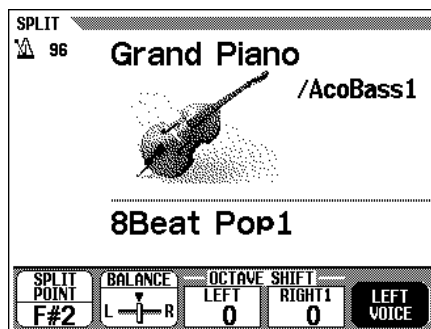

3 Select the voice for the left keyboard range.

The second voice can be selected from the SPLIT pop-up display. Select the second voice by using the VOICE buttons, and/or the data dial or [-/+] buttons after pressing **LEFT VOICE** (it is highlighted). Pressing **LEFT VOICE** also advances through the available voices; holding it down advances continuously.

The second voice can be selected from all available voices.

NOTE

Left range voices

- Range: All voices
- Basic setting: Acoustic Bass 1
- Backup of last settings: OFF

Playing Two Voices from Different Sides of the Keyboard — Split Mode

You can also select a voice by using **LEFT VOICE** or **RIGHT1 VOICE**, even after the pop-up SPLIT display has changed back to the main SPLIT display.



NOTE

- If you select a voice with the VOICE buttons when **STYLE** ▼▲ is highlighted, selection of **RIGHT1 VOICE** is automatically called up.

After pressing **LEFT VOICE** or **RIGHT1 VOICE** (it is highlighted), select the voice in the normal way.

4 Exit the Split mode.

Press [**SPLIT**] again; the lamp turns off and the Split mode is no longer active.

Changing the Split Point

You can set the point dividing the right and left keyboard ranges at any desired key position.

The basic setting of the Split Point is F#2.

To set the Split Point, press the desired key while holding down the [**SPLIT**] button. (The Split Point key is included in the left range.)

- ➔ The keyboard guide lamp corresponding to the selected Split Point lights, and the key name is displayed at **SPLIT POINT** in the display.

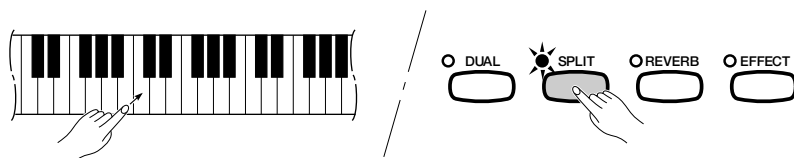

NOTE

Split Point

- Range: All keys
- Basic setting: F#2
- Backup of last settings: OFF

NOTE

- The Split Point setting globally affects all voice combinations. Different settings cannot be made for each voice.

Playing Two Voices from Different Sides of the Keyboard — Split Mode

You can also set the Split Point by using the data dial or [-/+] buttons, after pressing **SPLIT POINT** in the pop-up SPLIT display. Pressing **SPLIT POINT** also advances the value. To reset the value to the basic setting of F#2, simultaneously press the [-/+] buttons.

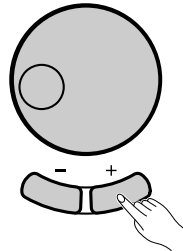
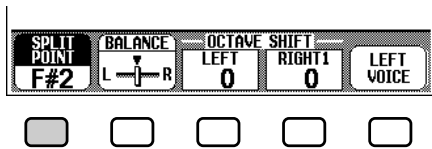

NOTE

- You can use the Damper Range function (page 134) to set the damper pedal to affect one or both sides of the Split. Available settings are:
 - Only right range
 - Only left range
 - Both ranges
- In the basic setting, the damper pedal affects only the right range.

Setting the Volume Balance of the Two Voices

1 Press **BALANCE** from the SPLIT pop-up display.

→ It is highlighted.

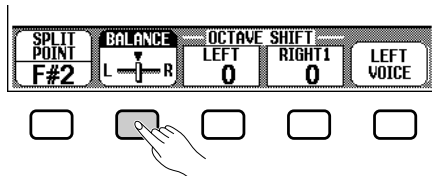

NOTE

Volume Balance

- Basic setting: Equal volume
- Backup of last settings: OFF

NOTE

- The Volume Balance setting globally affects all voice combinations. Different settings cannot be made for each voice.

2 Adjust the volume balance of the two voices by using the data dial or [-/+] buttons.

Pressing **BALANCE** lets you increase the level of the right voice only. Equal balance can be instantly reset by simultaneously pressing the [-/+] buttons.

Changing the Octave Setting of the Two Voices

The Octave Shift setting lets you adjust the pitch of the two voices up or down an octave.

Press either **LEFT** or **RIGHT1** of the **OCTAVE SHIFT** parameter in the SPLIT pop-up display.

→ The values change each time the LCD button is pressed. Available settings are -1, 0, and +1.

NOTE

Octave Shift

- Settings: - 1 (1 octave lower)
0 (no octave shift)
+ 1 (1 octave higher)
- Basic setting: 0 (no octave shift)
- Backup of last settings: OFF

..... Playing Two Voices from Different Sides of the Keyboard — Split Mode

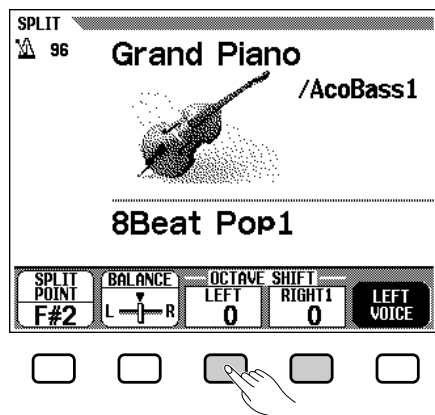

NOTE

About the Sounding Range for Octave Shift

- Notes below and above the original 88-key range (A-1 to C7) sound one octave higher and lower, respectively.
- The **RIGHT1** setting is effective for normal playing with one voice. This setting also affects the **RIGHT1** setting in the DUAL mode (page 33).

NOTE

- You can use the Single Finger, Multi Finger, or Fingered modes (page 56) of the Automatic Accompaniment function with the Split mode. In this case, pressing the keys in the left range will sound the Automatic Accompaniment voices as well as the left range voice.

Using the Dual and Split Functions Simultaneously

The [DUAL] and [SPLIT] buttons can be turned on simultaneously. The right range set for the Split mode can be used with two voices (Dual) when using the Dual and Split modes simultaneously.

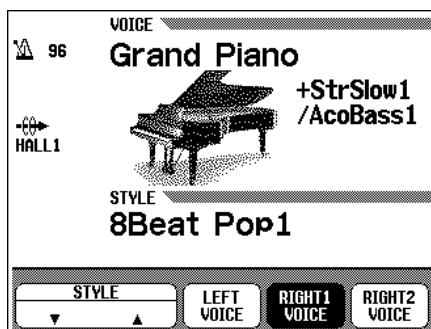

NOTE

- The volume balance of Dual and Split can be set individually.
- The Octave Shift **RIGHT1** parameter is set the same for both Dual and Split.

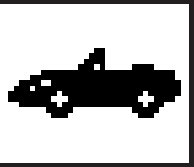

Using the Pedals

The Clavinova has three pedals.

Damper Pedal (Right)

The damper pedal performs the same function as the damper pedal on an actual acoustic piano, letting you sustain the sound of the voices even after releasing your fingers from the keys.

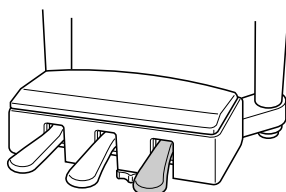

NOTE

- Certain voices in the [DRUMS] or [XG] groups may not be affected by use of the damper pedal.
- Some voices may sound continuously or have a long decay after the notes have been released while the damper pedal is held.

Sostenuto Pedal (Center)

If you play a note or chord on the keyboard and press the sostenuto pedal while the note(s) are held, those notes will be sustained as long as the pedal is held, but all subsequently played notes will not be sustained. This makes it possible to sustain a chord, for example, while other notes are played staccato.

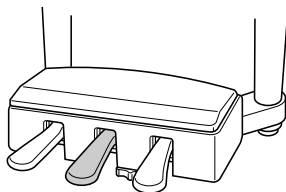

NOTE

- Certain voices in the [DRUMS] or [XG] groups may not be affected by use of the sostenuto pedal.
- Certain voices, such as [STRINGS] or [BRASS], sustain continuously when the sostenuto pedal is pressed.

Soft Pedal (Left)

Pressing this pedal reduces the volume and slightly changes the timbre of the notes you play.

You can also assign one of many other functions to this pedal; for example, you can use it to start/stop the Automatic Accompaniment, or use it to play Fill Ins. See page 133 for details.

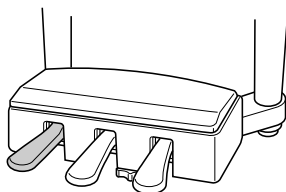

NOTE

- The effect of the soft pedal may differ slightly depending on the selected voice.

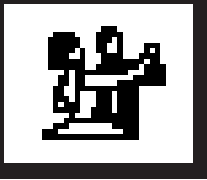

Reverb

Reverb is an effect that recreates the decaying reflections of a sound in a performance space, and reproduces the special ambience of a concert hall. The Clavinova has various Reverb effects and allows you to set the Reverb Depth to your preference. The Reverb effect here is also applied to the microphone input signal received via the [MIC.] jack.

NOTE

- The same Reverb Type is applied to both the sound of the Clavinova and the microphone input.

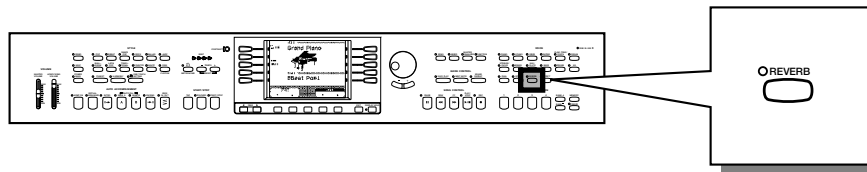

Reverb ON/OFF

To turn on reverb, press the [REVERB] button. The lamp lights and Reverb is set to ON.

- ➔ The REVERB pop-up display appears, indicating the current Reverb Type and Depth settings.

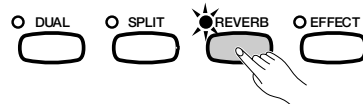

To turn Reverb off, press [REVERB] again. The lamp turns off and Reverb is no longer active.

NOTE

Reverb ON/OFF

- Basic setting: Differs depending on the voice.
- Backup of last settings: OFF

NOTE

- The REVERB ON/OFF panel button has no effect on the Song, Accompaniment playback and microphone sound.
- The Reverb applied to the microphone signal is always on. To turn it off, set the Reverb Depth to "0".
- When Reverb is on, the Reverb icon "☞" and the Reverb Type are indicated in the main display.

Selecting the Reverb Type

Select the Reverb Type by pressing the left/right LCD buttons in the REVERB pop-up display.

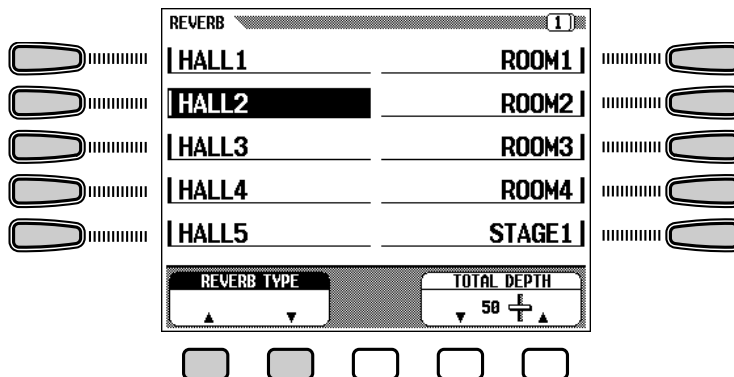

NOTE

Reverb Type

- Range: (Refer to the Reverb Type list.)
- Basic setting: Differs depending on the accompaniment style. (The assigned type for the selected style will automatically be selected. In other words, when you select a different style, the reverb type corresponding to the new style will automatically be selected.)
- Backup of last settings: OFF

You can also select the Reverb Type by using the **REVERB TYPE** ▼ ▲ buttons, or by pressing **REVERB TYPE** (to highlight the parameter) and using the data dial or [–/+] buttons.

● Reverb Type List

HALL1	Concert hall reverb.
HALL2	
HALL3	
HALL4	
HALL5	
ROOM1	Small room reverb.
ROOM2	
ROOM3	
ROOM4	
STAGE1	Reverb for solo instruments.
STAGE2	
STAGE3	
PLATE	Simulated steel plate reverb.
WHITE ROOM	Distinctive short reverb with initial delay.
TUNNEL	Simulation of long tunnel-like space.
BASEMENT	Small, highly reflective room reverb.

NOTE

- The Reverb Type setting globally affects all voices. Different settings cannot be made for each voice.
- The indication “XG REVERB” is displayed when receiving via MIDI a reverb type which is not on the panel.

NOTE

Keep in mind...

- Depending on the selected voice, the depth of the effect may sound stronger or weaker, even though the same Reverb Type is selected.
- The effect cannot be applied to the sounds input through the AUX IN [R] [L/L+R] jacks.

NOTE

- If the Reverb Type in Effect (page 45) is selected and both [REVERB] and [EFFECT] are set to on, both reverb effects will be applied.

Setting the Total Depth

The overall depth of the selected Reverb Type can be set with the Total Depth parameter (**TOTAL DEPTH** ▼ ▲).

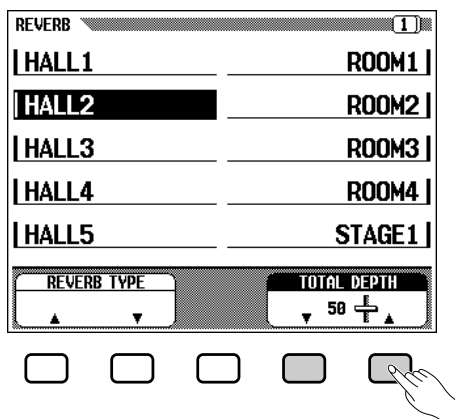

You can also set it by pressing **TOTAL DEPTH** ▼ ▲ (it is highlighted) and using the data dial or [–/+] buttons.

The values can be changed in 5-unit steps. To reset the value to the basic setting of 50, simultaneously press **REVERB TYPE** ▼ ▲ or simultaneously press the [–/+] buttons.

NOTE

Total Depth

- Range: 0 (no effect) — 100 (maximum)
- Basic setting: 50
- Backup of last settings: OFF

NOTE

- The Total Depth setting globally affects all voices. Different settings cannot be made for each voice.
- Different Reverb Depth settings can be made for each part. (Refer to the next section.)

Setting the Depth for Each Part — Reverb Part Depth

The Reverb Part Depth parameter lets you make different Reverb Depth settings for the microphone input connected to the [MIC.] jack, the rhythm, bass, and chord parts of the Automatic Accompaniment (page 47), as well as the parts you play from the keyboard.

To use this, call up the REVERB PART DEPTH display in the second page of the REVERB pop-up display by using the PAGE [◀] [▶] buttons.

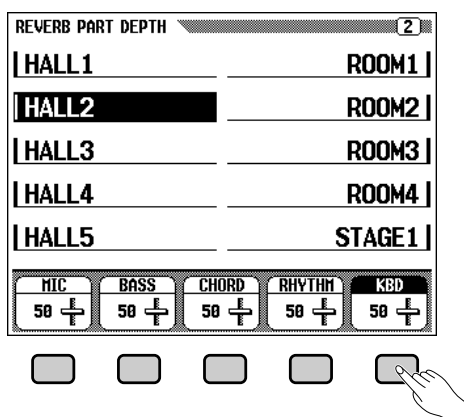

Select the desired part by using the **MIC.**, **BASS**, **CHORD**, **RHYTHM** and **KBD** (keyboard) in the REVERB PART DEPTH display. You can also select several parts and adjust their settings simultaneously.

- Set the Reverb Depth of the highlighted part by using the data dial or [−/+] buttons. The values can be changed in 5-unit steps.

You can also advance the Depth value by pressing **MIC.**, **BASS**, **CHORD**, **RHYTHM** or **KBD** (keyboard). To reset the value to the basic setting of 50, simultaneously press the [−/+] buttons.

NOTE

Reverb Part Depth

- Range: 0 (no effect) — 100 (maximum) for each part
- Basic setting: 50 for each part
- Backup of last settings: OFF

NOTE

- The actual Reverb Depth is dependent on both the Part Depth and Total Depth settings. In other words, if one of the settings is “0” (no effect), no Reverb will be produced even if the other setting is “100.”

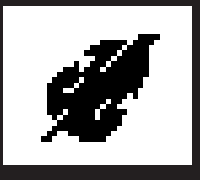

Voice Effects

The Clavinova has various types of effects besides Reverb that enhance the sound of the voices or create wild, special effects. You can also adjust the depth of the effect as desired. The Effect here is also applied to the microphone input signal received via the [MIC.] jack.



Automatic Effect Settings

- Selecting a voice automatically selects the best-suited effects for that particular voice. You can disable this so that effects are not automatically selected by using the Effect Setting parameter in the Function section (page 131).



- The same Effect Type is applied to both the sound of the Clavinova and the microphone input.

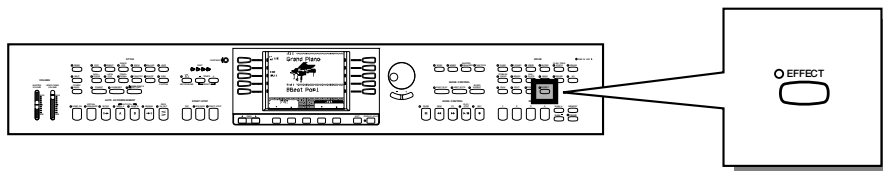

Effect ON/OFF

To turn Effect on, press [EFFECT]. (The lamp lights.)

- ➔ The EFFECT pop-up display appears and the current Effect Type and Depth are shown.

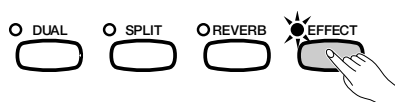

EFFECT	
HALL1	ROOM3
HALL2	STAGE1
HALL3	STAGE2
ROOM1	STAGE3
ROOM2	CHORUS1
EFFECT TYPE	RESET
▲ ▼	R1 DPT 50
	MIC DPT 0

To turn Effect off, press [EFFECT] again. (The lamp turns off.)



- If the Effect Depth is set to 0, the [EFFECT] lamp will not light.



Effect ON/OFF

- Basic setting: Differs depending on the voice.
- Backup of last settings: OFF



- When Effect is on, the Effect icon "⊕" and the Effect Type are indicated in the main display.

Selecting the Effect Type

Select the Effect Type by pressing the left/right LCD buttons in the EFFECT pop-up display.

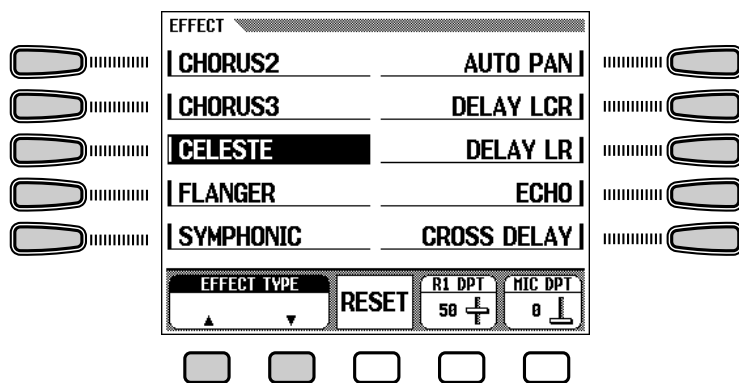

You can also select the Effect Type by using the **EFFECT TYPE** ▼ ▲ buttons, or by pressing **EFFECT TYPE** (to highlight the parameter) and using the data dial or [-/+] buttons.

To reset the value to the basic setting, simultaneously press **EFFECT TYPE** ▼ ▲ or simultaneously press the [-/+] buttons.

The Reverb Types in the list below can also be selected from the effect display.

● Effect Type List

Reverb Types (selectable from the Effect display)

HALL1	Concert hall reverb.	STAGE1	Reverb for solo instruments.
HALL2		STAGE2	
HALL3		STAGE3	
ROOM1	Small room reverb.		
ROOM2			
ROOM3			

Effect Types

CHORUS1	Conventional chorus program with rich, warm chorusing.	DELAY L,R	Initial delay for each stereo channel, and two separate feedback delays.
CHORUS2		ECHO	Stereo delay.
CHORUS3		CROSS DELAY	Complex effect that sends the delayed repeats "bouncing" between the left and right channels.
CELESTE	Three-phase LFO for richer, more pronounced chorusing.	TREMOLO	Rich Tremolo effect with both volume and pitch modulation.
FLANGER	Pronounced three-phase modulation with slight metallic sound.	ROTARY FAST	Rotary speaker simulation.
SYMPHONIC	Exceptionally rich & deep chorusing.	ROTARY SLOW	Rotary speaker simulation.
AUTO PAN	Several panning effects that automatically shift the sound position (left, right).	PHASER	Pronounced, metallic modulation with periodic phase change.
DELAY L,C,R	Three independent delays, for the left, right and center stereo positions.	WAH	Repeating filter sweep "wah" effect.

NOTE

- Range: (Refer to the Effect Type list.)
- Basic setting: Differs depending on the voice.
- Backup of last settings: OFF

NOTE

- When other effect type or OFF messages are received via MIDI, **HG EFFECT** is indicated in the display.
- The word "delay" refers to the echo-like effect of delayed repeats of the sound.

NOTE

When Using the DUAL or SPLIT Function:

- When the effects of both voices are set to ON, and the types are different, the effect for the second voice of the Dual mode or the left voice of the Split mode may be temporarily cancelled in some cases. After this point, if you subsequently increase the Effect Depth value of the second voice of Dual mode or of the left range voice of SPLIT mode, the effects will be applied to both voices.

NOTE

- If the Reverb Type in Effect is selected and both [REVERB] and [EFFECT] are set to on, both reverb effects will be applied.

Setting the Effect Depth

The Effect Depth parameter lets you adjust the degree or depth of the currently selected effect type. To set this, press **R1 DPT** or **MIC DPT** (to highlight the corresponding parameter), and use the data dial or [-/+] buttons.

Depending on the currently selected voice, the **R1 DPT** indication may automatically change to the **R2 DPT**, or **L DPT**. Use **MIC DPT** to set the Effect Depth applied to the microphone input connected to the [MIC.] jack.

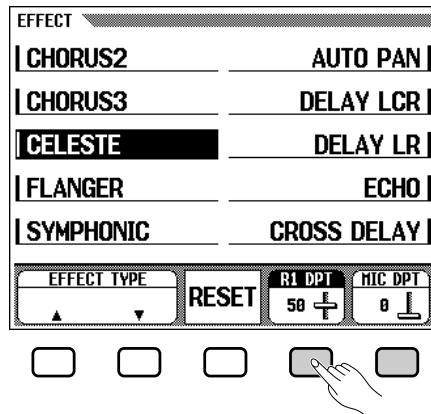

The following parameters can be selected by first selecting the corresponding voice from the main display of the Dual or Split modes.

R1 DPT	First voice of Dual mode or right voice of Split mode
R2 DPT	Second voice of Dual mode
L DPT	Left voice of Split mode

Pressing **R1 DPT** or **MIC DPT** also advances the value. To reset the value to the basic setting, simultaneously press the [-/+] buttons.

NOTE

Effect Depth

- Range: 0 (no effect) — 100 (maximum)
- Basic setting: Differs depending on the voice. (microphone = 0)
- Backup of last settings: OFF

NOTE

- If the Effect Depth is set to 0, the [EFFECT] lamp will not light.

Restoring the Basic Settings

You can easily restore the basic settings of the selected voice's **EFFECT TYPE** and **R1 DPT** parameters by pressing **RESET** in the display.

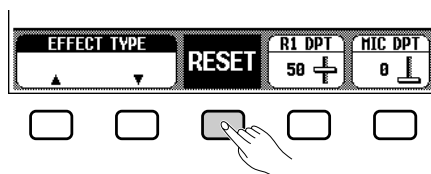

CHAPTER 4: Accompaniment Styles

(Rhythm and Auto Accompaniment)



Selecting Accompaniment Styles...

The Clavinova has 100 musical “Styles” that can be used as a basis for rhythm accompaniment, or fully orchestrated rhythm, bass, and chord accompaniment (Auto Accompaniment; page 56).



- The Clavinova also features forty special [PIANIST] styles consisting of only piano voices, which you can use with the Auto Accompaniment feature. (These styles will not sound if Auto Accompaniment is not in use.) (See page 57.)

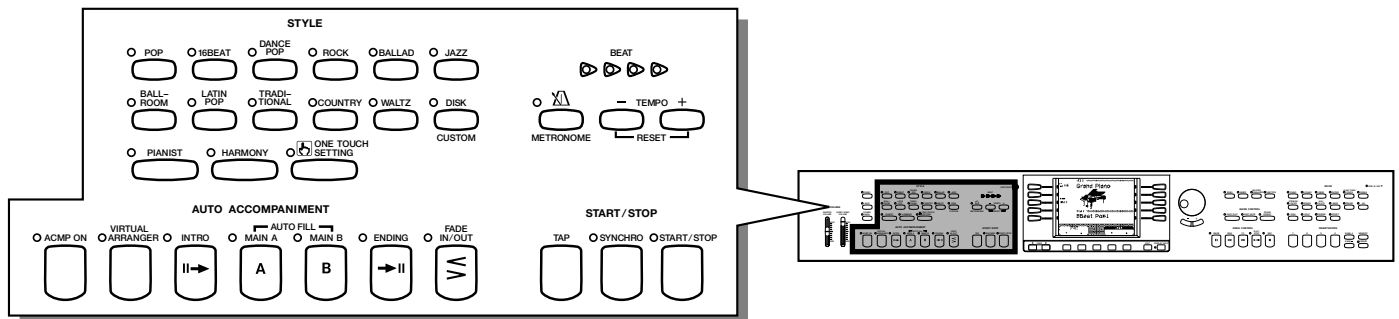

● Auto Accompaniment

Auto Accompaniment provides full instrumental backing, using all the parts included with the style. When not using Auto Accompaniment, only the rhythm part sounds. (For details on Auto Accompaniment, see page 50.)

The 100 preset Styles of the Clavinova are divided into eleven groups, and each style group is assigned to the corresponding STYLE button on the panel.



- For information on the styles, see the Style List on page 34 in the Reference manual.

Selecting a style from the STYLE SELECT Display

1 Select the accompaniment style group.....

Select the desired style group by pressing the appropriate STYLE button.

- The STYLE SELECT pop-up display appears.



Pop-up Display

- The pop-up display returns to the previous display after a few seconds. You can keep the pop-up display from changing by using the Display Hold function (page 15).

Selecting Accompaniment Styles

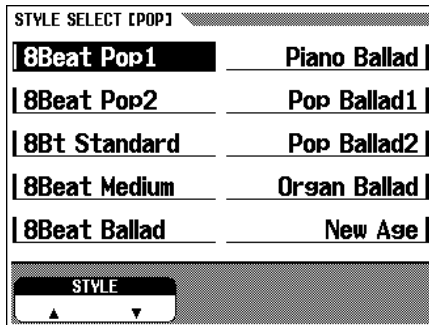
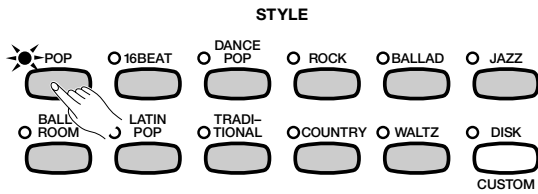

NOTE

- The last selected style in each group can be retained in memory, even after turning off the power, when the Backup function (page 147) is set to ON.
- When the power is turned ON, the 8Beat Pop1 style is selected automatically. However, if the Backup function (page 147) is set to ON, the last selected style will automatically be selected.

2 Select the Style.....

Select the desired style by pressing the appropriate left/right LCD button.

The data dial and [-/+] buttons also can be used.

You can also select the style by pressing the **STYLE ▼ ▲** buttons.

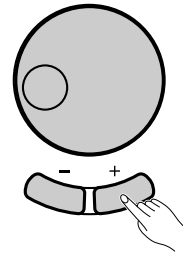
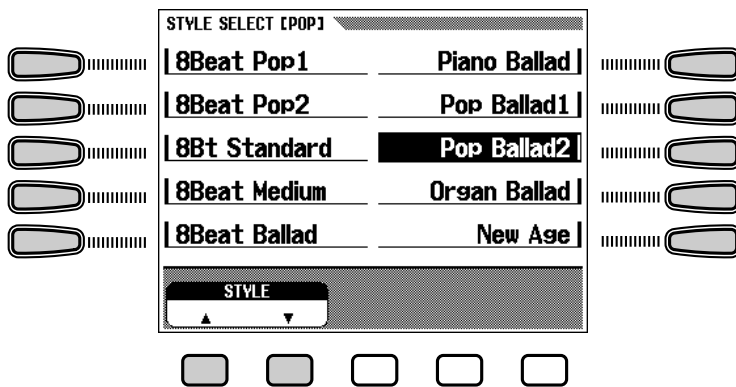

Selecting styles from the Main Display

You can also select a style by using **STYLE ▼ ▲**, even after the STYLE SELECT display has changed back to the main display.

NOTE

- When Style Buttons are Inactive**
- Accompaniment style cannot be selected in the Song Play mode.

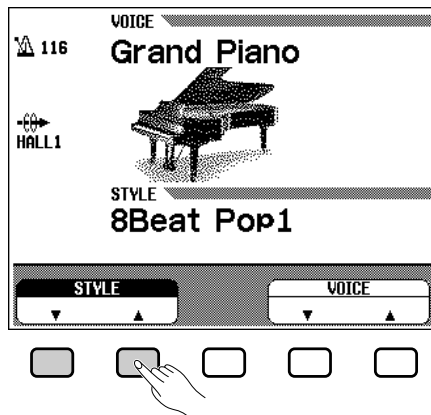

NOTE

[DISK/CUSTOM]

- The Clavinova features a [DISK/CUSTOM] button that allows you to use styles on optional Style File Disks (page 80) or your original styles (page 68).

1 Press either STYLE ▼ or ▲.

→ STYLE is highlighted.

2 Select the style.

Select the style by using the data dial or [-/+] buttons. You can also select styles by pressing **STYLE ▼ ▲**. (When selecting a style in this way, the style can be selected not only from a certain style group but from all styles.)

Tempo Control and Volume Adjustment

Whenever you select a different style, the preset tempo for that style is also selected, and the tempo is shown at the left side in the main display. (Unless you try changing the style during playback, in which case the same tempo is maintained.)

Press the **TEMPO [-/+]** buttons. (The tempo indication in the main display is highlighted.)

- ➔ Use the data dial or [-/+] buttons to set the tempo. You can also press either TEMPO [-/+] button briefly to decrement or increment the tempo value by one, or hold the button for continuous decrementing or incrementing. (In the STYLE SELECT pop-up display, only the TEMPO [-/+] buttons can be used.)

NOTE

Tempo

- Range: 32 — 280
- Basic setting: Differs depending on the style.
- Backup of last settings: OFF

NOTE

Restoring the Basic Style Tempo

- You can restore the preset tempo for the selected Style at any time by simultaneously pressing both TEMPO [-/+] buttons.

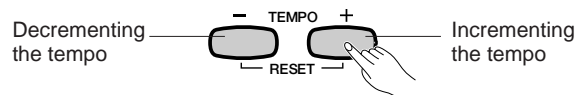
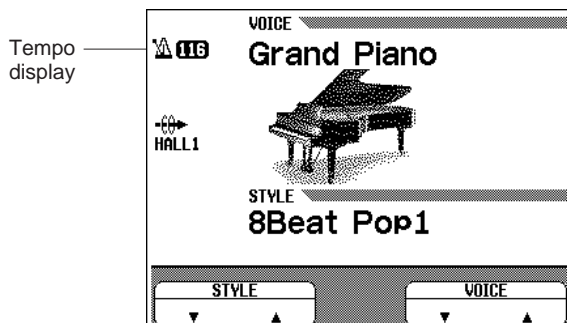

Use [ACMP/SONG VOLUME] to control the volume of the style.

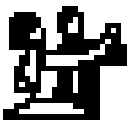

Starting/Stopping the Accompaniment Style

Starting the Accompaniment Style

There are several ways to start the accompaniment style, as described below:

■ Straight Start

Press the [START/STOP] button.

→ The lamp lights up and the style starts.

Each of the styles also has two main variations that can be selected by pressing the [MAIN A] or [MAIN B] buttons. The lamp of the currently selected pattern lights. Main A is the basic pattern of the style and Main B is a variation or rearrangement of the Main A. Judicious switching between Main A and Main B patterns within a song can add variety and make the overall rhythm more interesting. Switching during playback automatically plays a fill in (Auto Fill) before changing to the new pattern.

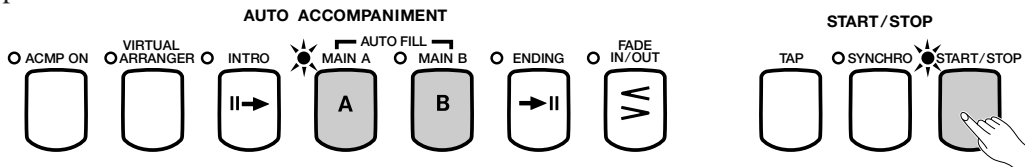

● Auto Fill

Press the [MAIN A] or [MAIN B] button during playback of the style. The lamp of the button flashes and the Fill-in pattern plays automatically.

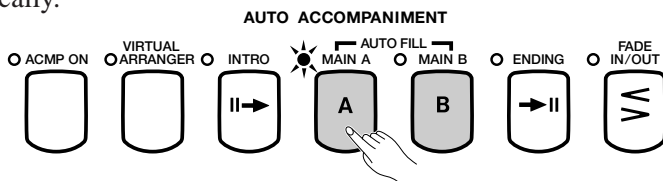

■ After automatic playback of the Fill-in, the rhythm pattern will change as described:

- When Main A is playing back and [MAIN A] is pressed → Changes to [MAIN A].
- When Main A is playing back and [MAIN B] is pressed → Changes to [MAIN B].
- When Main B is playing back and [MAIN A] is pressed → Changes to [MAIN A].
- When Main B is playing back and [MAIN B] is pressed → Changes to [MAIN B].

The Fill-in pattern keeps repeating when [MAIN A] or [MAIN B] is held down.

If you press the flashing button earlier than the last eighth note of the measure while the Fill-in is playing back, the Auto Fill function will be released.

If you press [MAIN A] or [MAIN B] after the last eighth note of the measure during style playback, the pattern changes to the Fill-in pattern from the next measure.

■ Synchronized Start.....

This method lets you start the style by simply playing a note or chord on the keyboard.

To use this, press the [SYNCHRO] button. (The lamp lights.) The [BEAT] lamp flashes in time with the selected tempo, indicating that Synchronized Start is in stand-by. (To cancel Synchronized Start, press the [SYNCHRO] button again so the lamp turns off.)

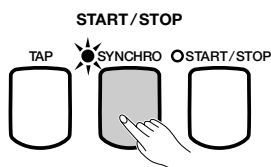

Press one of the [INTRO], [MAIN A], or [MAIN B] buttons to select the starting pattern, then play the keyboard to start the Style.

■ Tap Start.....

This function lets you set the tempo and start the style in one operation.

Simply tap the [TAP] button at the desired tempo — four times for 2- and 4-beat styles, three times for 3-beat styles, and five times for 5-beat styles.

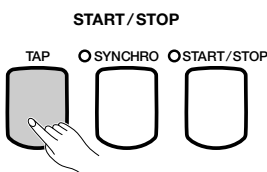

When playing a 4-beat song... → ...tap 4 times.

The [TAP] button can also be used to change the tempo during style playback (by tapping the button twice). In this case the tap “click” will not sound.

■ Start With an Introduction.....

First press the [MAIN A] button, then the [INTRO] button. (The [INTRO] lamp lights and the [MAIN A] lamp flashes.) This indicates that the style will start with the Intro A pattern and be followed automatically by the Main A pattern.

To cancel starting with an introduction, press the [INTRO] button so that the lamp turns off.

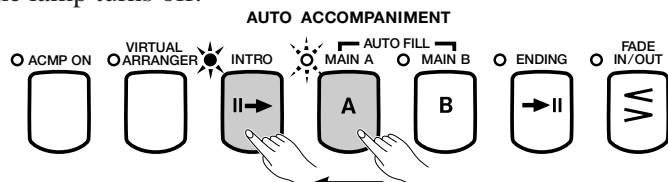

To start the style, press the [START/STOP] button, or press the [SYNCHRO] button and play a note or chord on the keyboard.

- ➔ The [INTRO] lamp turns off and the [MAIN A] lamp lights when the pattern changes from Intro A to Main A.

NOTE

- If the [SYNCHRO] is pressed during style playback, style playback stops and Synchronized Start is automatically set to stand-by.
- When the Split mode is used or when a split point is set for Auto Accompaniment, only the left-hand section of the keyboard can be used for Synchronized Start. (See page 36.)

NOTE

- If you do not tap the [TAP] button the required number of times (i.e., 3 times for a 3-beat style), the Tap Start function will be canceled after a few seconds.

Starting/Stopping the Accompaniment Style

There are two introduction patterns: Intro A and Intro B.

If you press **[INTRO]** after pressing **[MAIN B]**, the style starts with the Intro B pattern, followed by Main B.

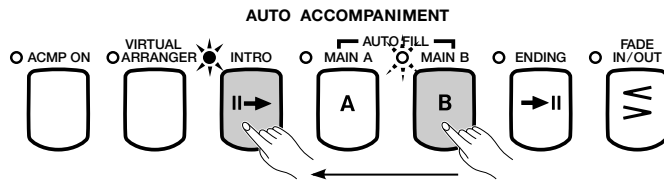

NOTE

- If you press the **[MAIN A]** button before pressing **[INTRO]** and then press **[MAIN B]**, playback starts with Intro A and continues automatically with the Main B pattern. (The reverse is also true: i.e., selecting Intro B with **[MAIN B]** before pressing **[INTRO]**, then pressing **[MAIN A]** to continue with Main A.)

Start with Fade In

This function lets you gradually fade in the volume of the Style with any of the start methods above.

Press the **[FADE IN/OUT]** button (the lamp lights) and fade in start is set to stand-by.

Press the **[FADE IN/OUT]** button again to turn the lamp off and cancel the fade in start.

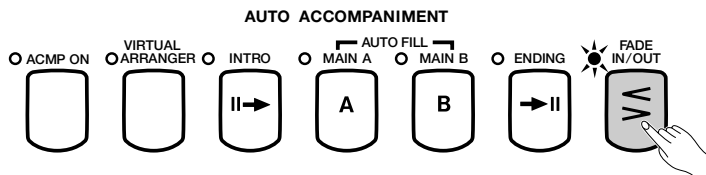

To start the style, press the **[START/STOP]** button, or press the **[SYNCHRO]** button and play a note or chord on the keyboard.

- The lamp flashes during the fade in, and the lamp turns off when the fade in is completed.

[FADE IN/OUT] can be set to on no matter which pattern (**[INTRO]**, **[MAIN A]**, **[MAIN B]**, **[ENDING]**) is selected.

Starting styles with the Left Pedal

You can also use the left pedal to start the style by setting the the Left Pedal function (page 133) to Start/Stop. The pedal can also be set to control Break, Fade-in/out, Fill-in, or Ending. This setting is exceptionally convenient, since it lets you control the style with your foot while leaving both hands free to play.

[BEAT]

During style playback, the left-most beat lamp (red) flashes on the first beat of each measure, and the other lamps (green) flash for each successive beat. The current tempo and measure number are shown at the left side of the LCD display.

Starting/Stopping the Accompaniment Style

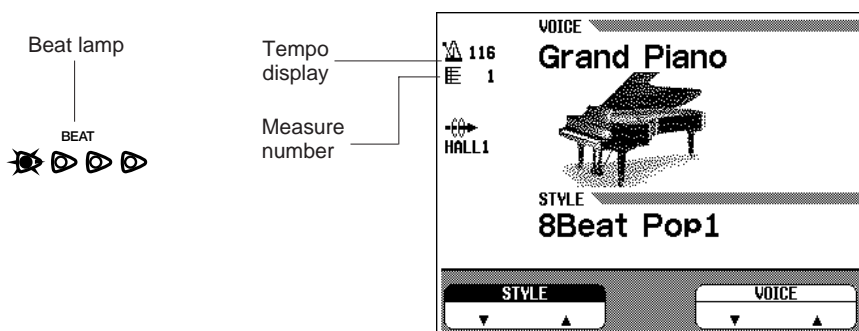

Break

When the Left Pedal function (page 133) is set to **BREAK**, you can use the left pedal to trigger a break (silence) in the accompaniment for dynamic effect.

Holding down the left pedal creates the break, and playback resumes from the top of the next measure after the pedal is released.

To cancel the break, press the left pedal again during the break.

Stopping the accompaniment style

To stop style playback, press the [START/STOP] button.

To playback an ending pattern before stopping, press the [ENDING] button.

Press [ENDING] a second time during playback to produce a ritardando (gradually slowing) ending.

Different ending patterns are provided for the MAIN A and MAIN B variations. (The [ENDING] lamp lights during ending playback). The [MAIN A] lamp also lights when changing from the Main A pattern, and the [MAIN B] lamp lights when entering from Main B.) The ending begins from the top of the next measure if the [ENDING] button is pressed on or after the second beat of a measure.

You can have the accompaniment fade out (gradually decrease in volume to silence) and automatically stop by pressing the [FADE IN/OUT] button. Then, it automatically sets to fade in stand-by (the lamp lights) and stays in this condition for a few seconds before releasing.

[FADE IN/OUT] can be set to on no matter which pattern ([INTRO], [MAIN A], [MAIN B], [ENDING]) is selected.

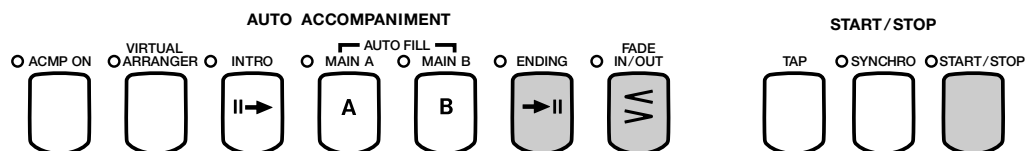

When the Left Pedal function (page 133) is set to START/STOP, you can stop the style by using the left pedal.



Using the Metronome

The Clavinova features a convenient metronome that is ideal for practicing.

■ [START/STOP] of Metronome

To start the metronome, simply press the [METRONOME] button so that its lamp lights.

- ➔ The metronome pop-up display appears and the currently selected beat and volume are indicated.



The metronome can be used also during playback. Press the [METRONOME] button again to stop the metronome sound. (The METRONOME lamp turns off.)

■ Adjusting the Tempo and Volume of the Metronome

As with the same parameter for the style, you can set the tempo over a range of 32 — 280 by using the TEMPO [-/+] buttons. Press the TEMPO [-/+] buttons. (The tempo indication in the Main Display is highlighted.)

- ➔ Use the data dial or [-/+] buttons to set the tempo. You can also press either TEMPO [-/+] button briefly to decrement or increment the tempo value by one, or hold the button for continuous decrementing or incrementing.

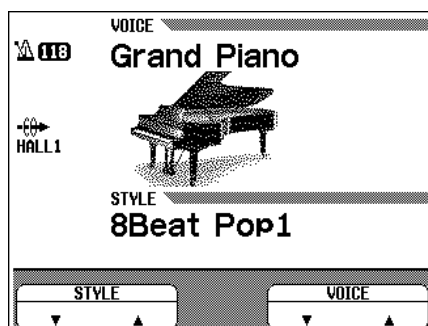
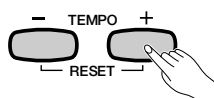

NOTE

Metronome Volume

- Range: 0 — 100
- Basic setting: 50
- Backup of last settings: OFF

The metronome volume can also be set from the METRONOME pop-up display.

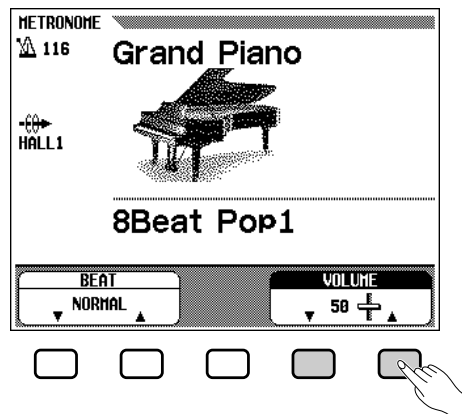

Adjust the volume by selecting **VOLUME** ▼ ▲ (it is highlighted) and using the data dial or [-/+] buttons. You can also adjust it by continuously pressing **VOLUME** ▼ or ▲. As with the volume parameter of the style, it can also be adjusted by using [ACMP/SONG VOLUME].

■ Selecting the Beat (Time Signature).....

The pop-up display that appears when the [METRONOME] button is pressed also lets you select the beat or time signature.

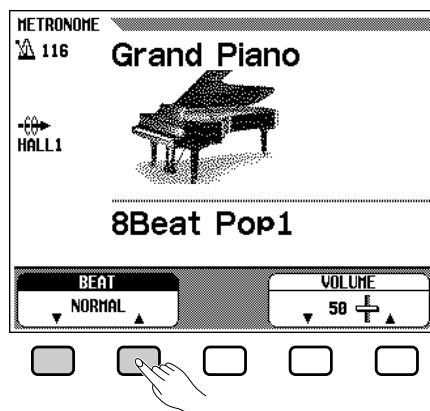

Select the Beat parameter with **BEAT** ▼ or ▲ (it is highlighted), then change the value with the data dial or [-/+] buttons. You can also select the value by holding down **BEAT** ▼ or ▲.

When **NORMAL** is selected, the metronome click sounds continuously at the current tempo with no accented beats. The **2**, **3**, **4** and **5** selections produce a bell accent on the first beat of each measure.

NOTE

Using Style and Metronome Together

- If a style is started by pressing the [START/STOP] button while the metronome is playing, the metronome will continue to sound along with the style.
- Pressing the [START/STOP] button simultaneously stops both the metronome and the Style, when both the metronome and style are playing.

NOTE

When Playing Back Free-tempo Disk Software

- The metronome cannot be used when playing disk software that is in free-tempo (see page 90).



Playing with the Auto Accompaniment...

The Clavinova includes a sophisticated Auto Accompaniment system that can provide automated rhythm, bass and chord backing for your performance in 100 different styles.



- The playback data of the Auto Accompaniment is normally not output through the MIDI [OUT]. However it can be output via MIDI by using the Auto Accompaniment/Harmony Send parameter (page 146) in the Function MIDI 3 page.

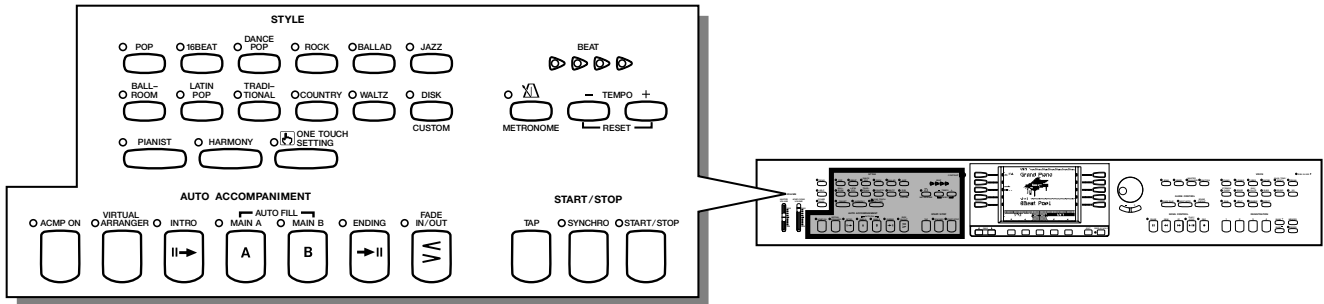

Types of Auto Accompaniment

The Auto Accompaniment function lets you produce automatic accompaniment in the selected style simply by indicating chords on the keyboard.

● Single Finger

The Single Finger method makes it easy to produce accompaniment using major, seventh, minor and minor-seventh chords by pressing certain keys (according to simple rules) in the left range of the keyboard (lower than the split point indicated by the keyboard guide lamp). (See page 58.)

● Fingered

The Fingered method lets you produce automatic accompaniment by playing full chords in the left range of the keyboard (lower than the split point). (See page 59.)

● Multi Finger

With Multi Finger, you can use either the Single Finger or Fingered method to indicate chords for the accompaniment. (See page 59.)

● Full Keyboard

Full Keyboard automatically produces appropriate automatic accompaniment for virtually anything you play on the keyboard, in any range. (See page 59.)



- Detailed explanations of the use of Single Finger, Multi Finger, Fingered, and Full Keyboard are given on pages 58 and 59.

1 Select a style.....

Select the desired style. (See page 47.)



When Style Buttons are Inactive

- Accompaniment style cannot be selected in the Song Play mode.

● Pianist

Press the [PIANIST] button to select the piano-only accompaniment styles. Forty different Pianist styles are available.

When the [PIANIST] button is pressed, the STYLE SELECT [PIANO] pop-up display appears.

→ The [PIANIST] lamp lights.

Select the desired Pianist style by pressing the appropriate left/right LCD button. The data dial and [-/+] can be also used.

You can also select the Pianist style by pressing the STYLE ▼ ▲ buttons.

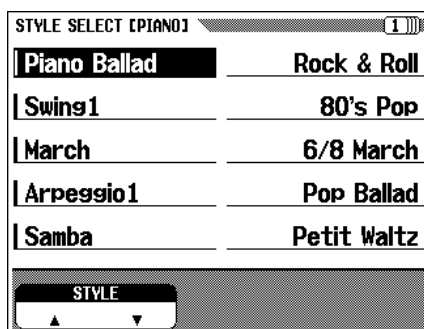
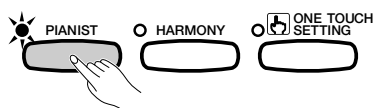

The STYLE SELECT [PIANO] display has several successive pages. Use the PAGE [◀] [▶] buttons to call up the various pages.

2 Set the tempo.

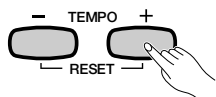

3 Set the Auto Accompaniment function to ON.

To do this, press the [ACMP ON] button. (The lamp lights.)

→ The Accompaniment Mode pop-up display appears.

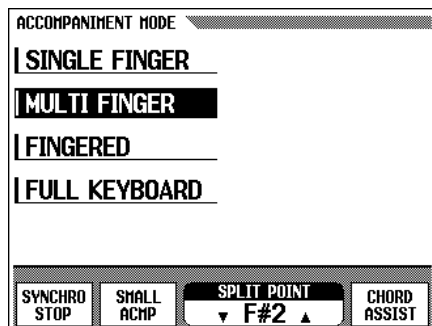
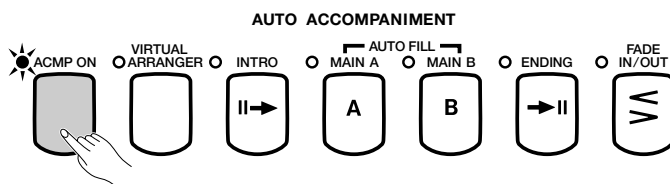

Press the [ACMP ON] button again to turn off the lamp and set Auto Accompaniment to OFF.

NOTE

- When the Auto Accompaniment function is set to ON, Synchro Start is automatically set to stand-by.

NOTE

When the [ACMP ON] Button is Inactive

- The [ACMP ON] button cannot be turned on during playback of commercially available disk software. When playing back songs recorded with the recording function of the Clavinova, it cannot be turned on if Auto Accompaniment has been recorded to the song; however, it can be turned on if Auto Accompaniment is not used for the song. Also, it cannot be turned on if the song data was converted by use of the Transform function.

Playing with the Auto Accompaniment

4 Select the chord indication method.

To do this, press one of the left LCD buttons — **SINGLE FINGER**, **MULTI FINGER**, **FINGERED** or **FULL KEYBOARD** — while the **ACCOMPANIMENT MODE** pop-up display is active.

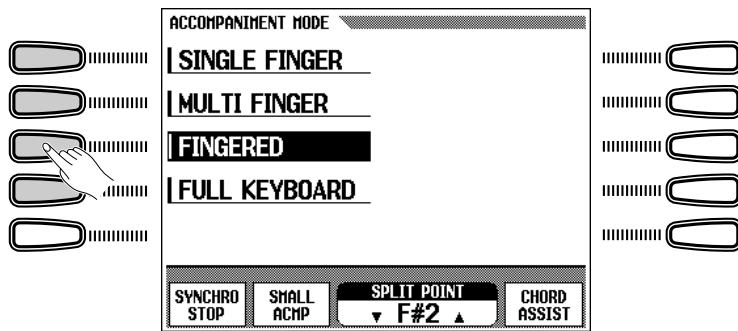

NOTE

- Chord Indication Method**
- Basic setting: Multi Finger
 - Backup of last settings: OFF

NOTE

- The **SYNCHRO STOP** (page 64), **SMALL ACHP** (page 65), **SPLIT POINT** (page 61), and **CHORD ASSIST** (page 66) functions shown in the **ACCOMPANIMENT MODE** display are explained later (see corresponding page references).

5 Start the Auto Accompaniment.

To start Auto Accompaniment, press **[START/STOP]**. Alternately, press **[SYNCHRO]**, then play the keyboard. Auto Accompaniment can also be started by using the left pedal (see page 133).

● Single Finger

To play Auto Accompaniment appropriate to the selected style, press one, two, or three keys in the left range (below and including the split point), following the rules described below.

- Chord names appear at the left side of the LCD display.

Play the melody with the keys in the right range along with the Auto Accompaniment.

■ Single Finger Chords

The following four chord types can be played with Single Finger:



- **Major**
Press the root note of the chord.

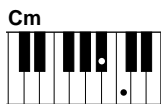

- **Minor**
Simultaneously press the root note of the chord and any black key to the left of it.



- **Seventh [7]**
Simultaneously press the root note of the chord and any white key to the left of it.

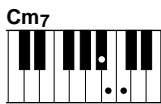

- **Minor Seventh [m7]**
Simultaneously press the root note of the chord any white and black key to the left of it (three keys altogether).

Chord name

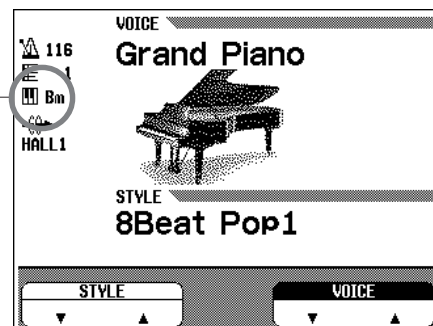

NOTE

- The illustration below shows the corresponding keys for each root note.



● Fingered

To play Auto Accompaniment, play any chord in the left range (below and including the split point). Play the melody in the right range along with the Auto Accompaniment.

If the Clavinova cannot recognize the played chord, “*” will appear instead of the chord name in the display.

■ Fingered Chords

The chord types below can be played with the Fingered method. For a fingering chart showing all chords in the example key of C, see page 36 in the Reference Manual.

- Major
- Sixth [6]
- Major seventh [M7]
- Major seventh flatted fifth [M7 (b5)]
- Major seventh sharp eleventh [M7 (#11)]
- Added ninth [add 9]
- Major seventh ninth [M7 (9)]
- Six ninth [6 (9)]
- Flatted fifth [(b5)]
- Augmented [aug]
- Seventh augmented [7 (#5)]
- Major seventh augmented [M7 (#5)]
- Minor [m]
- Minor sixth [m6]
- Minor seventh [m7]
- Minor seventh flatted fifth [m7 (b5)]
- Minor added ninth [m add 9]
- Minor seventh ninth [m7 (9)]
- Minor seventh eleventh [m7 (11)]
- Minor major seventh flatted fifth [mM7 (b5)]
- Minor major seventh [mM7]
- Minor major seventh ninth [mM7 (9)]
- Minor flatted fifth [m (b5)]
- Diminished seventh [dim7]
- Seventh [7]
- Seventh suspended fourth [7sus4]
- Seventh ninth [7 (9)]
- Seventh sharp eleventh [7 (#11)]
- Seventh added thirteenth [7 (13)]
- Seventh flatted fifth [7 (b5)]
- Seventh flatted ninth [7 (b9)]
- Seventh added flatted thirteenth [7 (b13)]
- Seventh sharp ninth [7 (#9)]
- Suspended fourth [sus4]

● Multi Finger

This method allows you to produce accompaniment using either Single Finger or Fingered. However, when indicating minor, seventh or minor seventh chords, it is necessary to play the white key and/or black key nearest the root note of the chord.

● Full Keyboard

When the Full Keyboard mode is selected, the Clavinova will automatically create appropriate accompaniment while you play just about anything using both hands, anywhere on the keyboard. You don't have to worry about specifying the accompaniment chords. The name of the detected chord will appear in the display. (Although Full Keyboard is designed to work with many songs, some arrangements may not be suitable for use with this feature.)

NOTE

- The automatic accompaniment will sometimes not change when related chords are played in sequence (e.g. some minor chords followed by the minor seventh).
- The same accompaniment continues even after releasing the chord in the left range until the next chord is played.

NOTE

On-bass Chords

- To play “on-bass” chords, press the desired bass note one octave lower than the chord. For example, in order to play F on C (F chord with a C bass), play an F chord (F, A and C) and press C +C (octave notes) in the lower range of the keyboard. (Use this function for chord sequence recording.)

NOTE

- Two-note fingerings will produce a chord based on the previously played chord.
- “No chord” (i.e., rhythm-only accompaniment) can be produced by pressing any three consecutive keys (e.g., C, C#, D) simultaneously. This lets you create dynamic rhythm “breaks in the accompaniment. A “- -” indication will appear instead of a chord name in the display.

NOTE

- Chord detection occurs at approximately 8th-note intervals. Extremely short chords — less than an 8th note in length — may not be detected.

NOTE

Keep in mind...

- The DUAL or SPLIT mode can be used with the Auto Accompaniment.

Stopping the Auto Accompaniment

Press [START/STOP], [ENDING] or [FADE IN/OUT] to stop the Auto Accompaniment.

You can also turn off the Auto Accompaniment by pressing the [ACMP ON] button (the lamp turns off).

NOTE

- The [INTRO], [MAIN A], [MAIN B], [ENDING], and [FADE IN/OUT] buttons can be used to play different style sections, as explained on page 50.

Playing with the Auto Accompaniment

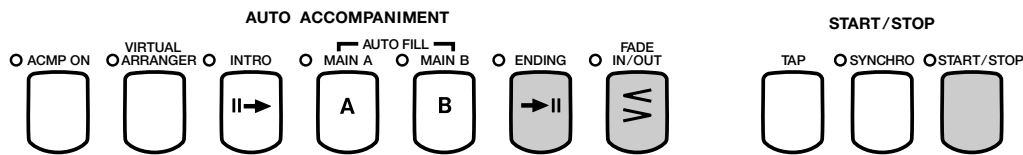

The [MAIN A], [MAIN B], [ENDING] and [FADE IN/OUT] operation can be done by using the left pedal (see page 133), conveniently allowing you to change sections without taking your hands from the keyboard.

Adjusting the Overall Auto Accompaniment Volume

Use the [ACMP/SONG VOLUME] control to adjust the overall volume of the Auto Accompaniment. (This does not affect the volume of parts played from the keyboard.) This control lets you adjust the level balance of the accompaniment and the voices played from the keyboard.

Use the [MASTER VOLUME] to control the entire volume of the Clavinova.

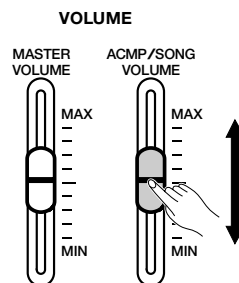

Individual Part Volume Control

The Clavinova has five accompaniment parts: Bass, Chord, Pad, Phrase, and Rhythm.

BASS	The Bass part uses voices appropriate to each style, including acoustic bass and synth bass.
CHORD	The Chord part provides appropriate rhythmic chordal accompaniment for each style. You'll find guitar, piano, and other chordal instruments here.
PAD	The Pad part plays long chords where necessary, using sustained instruments such as strings, organ, and choir.
PHRASE	The Phrase part is used for embellishments such as punchy brass stabs, arpeggiated chords, and other extras that make the accompaniment more interesting.
RHYTHM	This is the main rhythm part. The Rhythm part usually plays one of the drum kits.

Each volume setting of the five accompaniment parts can be adjusted individually by using the mixer function. Press the [MIXER] button (the lamp lights) and the MIXER display appears.

NOTE

- By adjusting the volume balance of the various parts and setting some parts' volume to 0, you can create different types of accompaniment and make changes to the basic style accompaniment.
- Some styles may not use all five accompaniment parts.

Volume of Each Part

- Range: 0 — 100 (maximum)
- Basic setting: KBD (keyboard volume): 100; other parts: 90
- Backup of last settings: OFF

NOTE

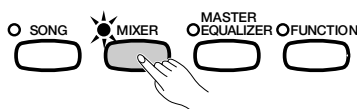
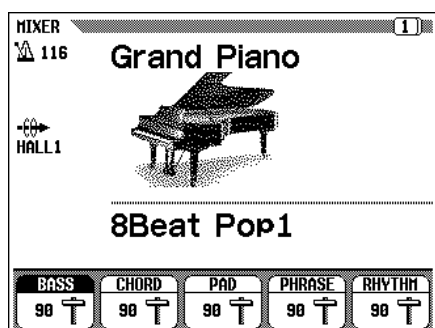

Select the desired part by pressing **BASS**, **CHORD**, **PAD**, **PHRASE**, or **RHYTHM** and set the value by using the data dial or [-/+] buttons. The value changes in units of two. You can also select several parts and adjust their volume settings simultaneously. To reset the value to the basic setting of 90, simultaneously press the [-/+] buttons.

To exit the function, press the [**MIXER**] button again (the lamp turns off) and the previous display appears.

You can also press the [**EXIT**] button to return to the previous display.

Use the PAGE [◀] [▶] buttons to call up the second page of the MIXER display. On this page you can adjust the volumes of your own keyboard performance and the Harmony sound (see page 62).

Press **KBD** (keyboard volume) or **HARMONY** to select the part and use the data dial or [-/+] buttons to set the value.

Press **PRESET** to return the volume values of all parts to the basic settings.

NOTE

Part Volume Relation

- [ACMP/SONG VOLUME] is relative to the [MASTER VOLUME].
- Each part volume of the Auto Accompaniment is relative to the [ACMP/SONG VOLUME].
- KBD (keyboard volume) is relative to the [MASTER VOLUME].
- The Harmony part volume is relative to the KBD part volume.

NOTE

Reverb Depth of Each Part

- For details on setting the Reverb Depth for each part, see page 43.

Changing the

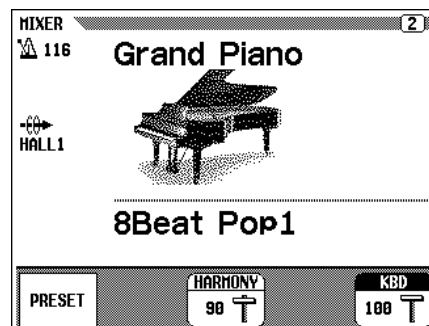

Split Point

The right range and left range for Auto Accompaniment can be divided at any key. Press the desired key while holding the [**ACMP ON**] to set the split point. (The split point key is included in the left range.)

➔ The keyboard guide lamp of the set split point lights.

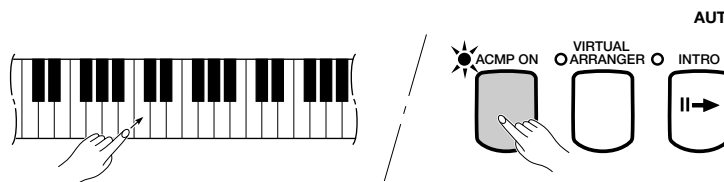

The split point also can be set by pressing the **SPLIT POINT** ▼ or ▲ button, or by using the data dial or [-/+] buttons.

To reset the value to the basic setting of “F#2,” simultaneously press both **SPLIT POINT** ▼ ▲ buttons or the [-/+] buttons.

NOTE

- The split point set here for the Auto Accompaniment is the same parameter as set in the Split function (page 37).

NOTE

Split Point

- Range: All keys
- Basic setting: F#2
- Backup of last settings: OFF

NOTE

- The split point cannot be set when **FULL KEYBOARD** is selected.

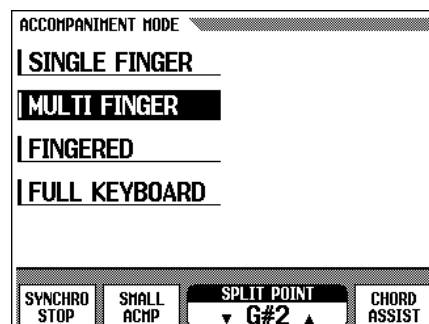



Other Auto Accompaniment Functions

The Clavinova has many other features and functions that make the use of the Auto Accompaniment even more convenient and enjoyable.

Harmony

This feature adds harmony or embellishment notes to the melody you play in the right range of the keyboard. The harmony notes are produced automatically to match chords played with Auto Accompaniment.

1 Set the Harmony function to ON.

To do this, press the [HARMONY] button (the lamp lights).

➔ The ACCOMPANIMENT HARMONY pop-up display appears.

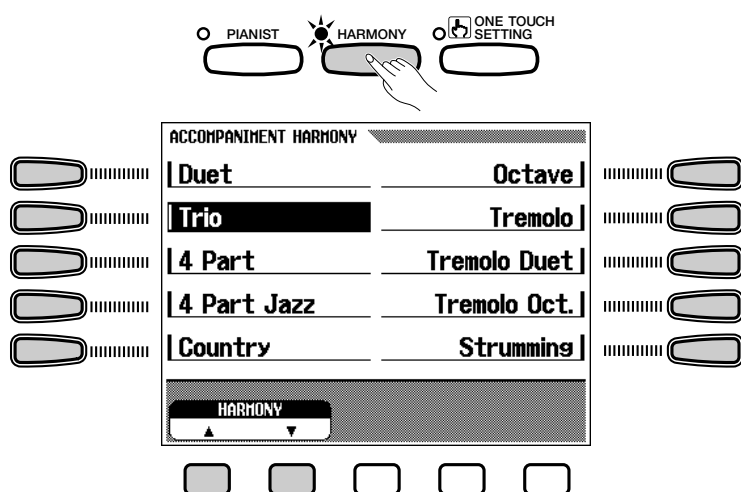

➤ Use the the left/right LCD buttons to select the Harmony types in the ACCOMPANIMENT HARMONY pop-up display. The data dial and the [-/+] buttons can also be used.

You can also select the Harmony type by using the **HARMONY ▼ ▲** buttons.

2 Play the keyboard.

Play the keyboard along with the Auto Accompaniment.

3 Turn Harmony off.

To turn Harmony off, press the [HARMONY] button again (the lamp turns off).

Since the Harmony function can be turned on and off while playing, you can add “spice” and professional polish to your performance by applying harmony to selected phrases as you play.

NOTE

- The Harmony feature cannot be turned on when Full Keyboard is selected for the Auto Accompaniment.

NOTE

- With some Harmony types the voice used for the Harmony will be different from the currently selected voice.
- The Harmony feature can be used while playing back the intro or ending or while the Auto Accompaniment is off, but only octaves (no intermediate harmonies) will be produced.
- When chords are played in the right-hand section of the keyboard, the harmony will be applied to the last note played.

● Left Pedal and Harmony

If the Left Pedal Function is set to HARMONY ON/OFF (see page 133), harmonization of notes played on the right-hand section of the keyboard only occurs while the left pedal is pressed. This allows you to add harmony only to certain phrases in the middle of the song as you play, without having to take your hands from the keyboard.

NOTE

- The Left Pedal HARMONY ON/OFF function is not effective when the Harmony feature is off (i.e. the [HARMONY] lamp is not lit).

One Touch Setting

Each style has programmed panel setups of voices and effects that can be recalled easily and instantly via the One Touch Setting function. Each style has four different One Touch Settings.

For a list of the One Touch Setting parameters, refer to page 35 of the Reference Manual.

NOTE

- There are no One Touch Settings for the accompaniment styles of the [PIANIST] or [DISK/CUSTOM] groups.

■ Using the One Touch Setting Function

1 Select the desired style in the normal way, then press the [ONE TOUCH SETTING] button.

→ The lamp lights and the One Touch Setting pop-up display appears.

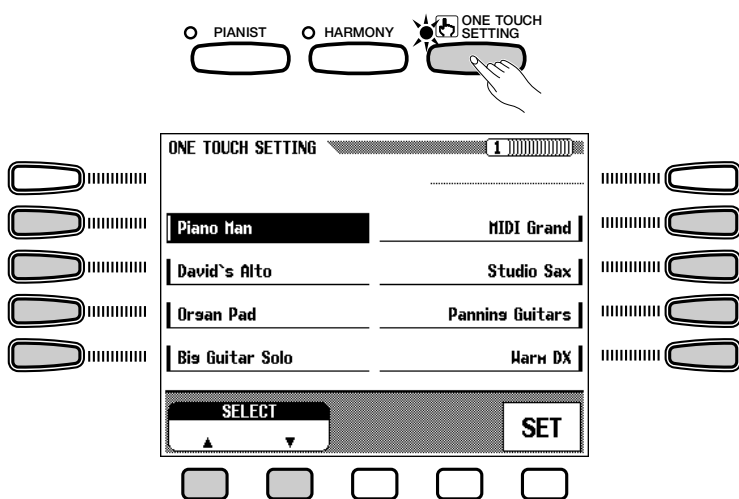

NOTE

- When using the ONE TOUCH SETTING function, the Auto Accompaniment turns on automatically. If the [ONE TOUCH SETTING] button is turned on before starting the style, Synchronized Start is set to stand-by.
- If you change the One Touch Setting during style playback, the tempo setting remains the same.
- Harmony will not be turned on if the Full Keyboard mode is selected, even if the selected One Touch Setting setup includes "Harmony On."

2 Select the desired setting by using the left/right LCD buttons. The data dial, [-/+] buttons, and PAGE [◀/▶] buttons can also be used. You can also select the setting by using the **SELECT** ▼ ▲ buttons. Press the **SET** button to actually change the panel setup to that of the selected setting.

The menu for the selected style is shown at first in the display; however, the menus for all other styles can be selected in this display.

Other Auto Accompaniment Functions

The panel setup called up here can be freely changed according to your preferences. You can also save it to memory by using the Registraton function (page 83).

To exit One Touch Setting, press the [ONE TOUCH SETTING] button again (the lamp turns off), and the previous panel setup before using One Touch Setting is recalled.

Virtual Arranger

To use this, press the [VIRTUAL ARRANGER] button (the lamp lights). The lamp automatically lights when the power is turned on. With Virtual Arranger, you can play simple chords, and the Clavinova automatically embellishes them and provides melodic Auto Accompaniment.

Virtual Arranger is effective only when Auto Accompaniment is set to ON and the Full Keyboard mode is not selected.

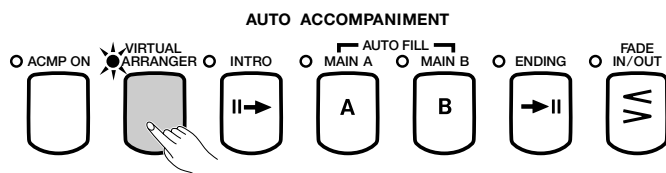

NOTE

- The melodic Auto Accompaniment may sometimes not match with the melody or chord progression of the song being played.
- When a [DISK/CUSTOM] style is selected, the Virtual Arranger function has no effect, even if set to on.

Synchronized Stop Function

This function lets you have the Auto Accompaniment sound only when you hold down keys in the left-hand range (below and including the split point). Auto Accompaniment automatically stops when you release your left hand from the keyboard, and starts again when you play the keys again. This is useful for beginning players who have difficulty playing in precise time. It is also effective for creating accompaniment “breaks” during the performance.

This function can only be used when Auto Accompaniment is set to on. However, it cannot be used when Full Keyboard is selected.

Press the [ACMP ON] button to call up the ACCOMPANIMENT MODE pop-up display.

- Press **SYNCHRO STOP** so that it is highlighted.
- ➔ The [SYNCHRO START] lamp lights.

To turn Synchronized Stop off, press **SYNCHRO STOP** again.

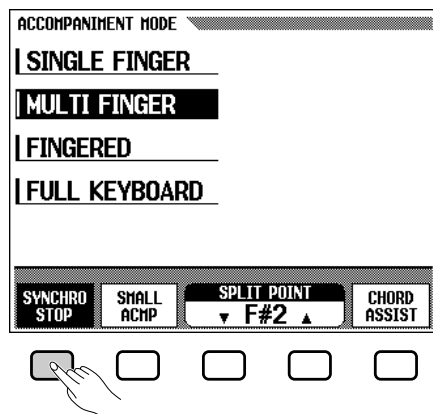

Small Accompaniment (SMALL ACMP)

The Small Accompaniment function lets you mute some of the selected Auto Accompaniment parts, creating a simpler and smaller orchestration and accompaniment.

Press [ACMP ON] to call up the ACCOMPANIMENT MODE pop-up display.

- To turn Small Accompaniment on, press the **SMALL ACMP** button so that it is highlighted.

To turn Small Accompaniment off, press the **SMALL ACMP** button again.

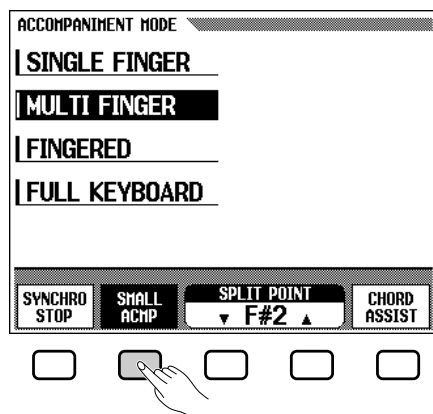

NOTE

- **SMALL ACMP** can be set to ON when a [PIANIST] style is selected; however, the Auto Accompaniment sounds are not changed.

Chord Assist

This function uses the keyboard guide lamps to show you appropriate fingerings for chords. (See page 104.)

The Chord Assist feature is essentially an electronic “chord book” that shows you appropriate fingerings for chords, and is ideal when you want to quickly learn how to play certain chords. Simply specify the desired chord via the display, and the fingerings of the Fingered method are indicated by the keyboard guide lamps.

1 Set the Chord Assist function to ON.

To do this, first press the [ACMP ON] button to call up the ACCOMPANIMENT MODE pop-up display.

- Press **CHORD ASSIST** to set the Chord Assist function to on. The CHORD ASSIST display appears and the chord indication automatically changes to Fingered.

2 Start the Auto Accompaniment.

Press [START/STOP] or use Synchronized Start (see page 50) to start the Auto Accompaniment.

3 Enter the chord root.

Press **ROOT** (it is highlighted), then use the data dial or [-/+] buttons to select the desired root note of the chord.

You can also select the root note by pressing **ROOT**.

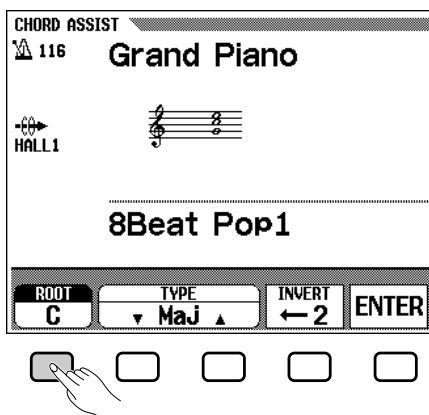

4 Enter the chord type.....

Press **TYPE** ▼ or ▲ (it is highlighted), then use the data dial or [-/+]
buttons to select the desired chord type.

You can also select the chord type by pressing **TYPE**.

5 Enter the chord.....

The fingering for the selected chord appears on the keyboard guide lamps. And the selected chord is also indicated in notation form in the center of the LCD display. At this point you can either play the indicated chord on the keyboard or press **ENTER** to actually enter the specified chord, at which the specified chord accompaniment will sound.

The following chord types can be specified from the LCD display.

Major [Maj]	Augmented [aug]
Minor [m]	Minor flatted fifth [m (♭5)]
Seventh [7]	Seventh suspended fourth [7sus4]
Minor seventh [m7]	Seventh augmented [7 (#5)]
Minor seventh flatted fifth [m7 (♭5)]	Diminished seventh [dim7]
Sixth [6]	Flatted fifth [(♭5)]
Minor sixth [m6]	Seventh flatted fifth [7 (♭5)]
Major seventh [M7]	Minor major seventh [mM7]
Suspended fourth [sus4]	

6 Rotate the fingering as desired.....

Press **INVERT** in the LCD to shift the fingering down the keyboard. Each time the **INVERT** button is pressed the next viable fingering for the chord appears. The inversion number appears in the **INVERT** section of the display.

7 Stop the Auto Accompaniment.....

Use [START/STOP] or [ENDING] to stop the accompaniment.

8 Turn Chord Assist off.....

To turn Chord Assist off, press the [ACMP ON] button (the lamp turns off). Auto Accompaniment also is turned off at the same time.

NOTE

- All the Fingered chords can be entered from the keyboard.
- The root and type of the chord name entered from the LCD appears in the **ROOT** and **TYPE** parameter locations, while the chord name recognized from the keyboard (or entered by the **ENTER** button) appears at the side of the keyboard icon located at the left of the LCD.
- A flashing keyboard guide lamp indicates a note which may be omitted.

NOTE

- The split point is not shown on the guide lamps when the Chord Assist function is engaged.
- If the split point is set below F#2 it will automatically be reset to F#2.



Custom Style

The Clavinova Custom Style feature allows you to create original accompaniment styles that can be later recalled and played at any time, just like the presets. Up to 12 custom styles can be maintained in internal memory at the same time, and any number can be saved to disk for later reloading and use.

The basic custom style recording procedure is outlined below.

NOTE

- Custom style data is not retained in memory when the power is turned off, so be sure to save your custom styles to disk before turning the power off.
- One pre-programmed temporary style is automatically loaded into the [DISK/CUSTOM] memory whenever the power is turned on. (Memory is common to the Custom Styles and the loaded styles from the optional Style File disks — page 80.)

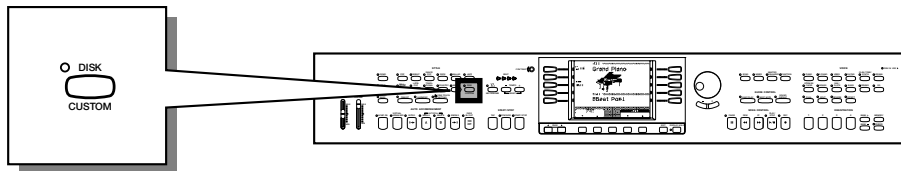

1 Engage the Custom Style feature.

Press the [DISK/CUSTOM] style selector so that its indicator lights, then press the **CUSTOM STYLE** LCD button. The “**Please select a source style.**” message will appear on the display for a few seconds before going to the CUSTOM STYLE display page 1 and the current [DISK/ CUSTOM] style will begin playing.

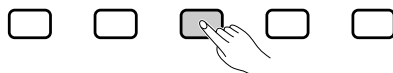
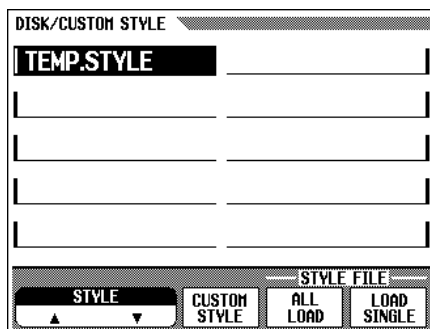
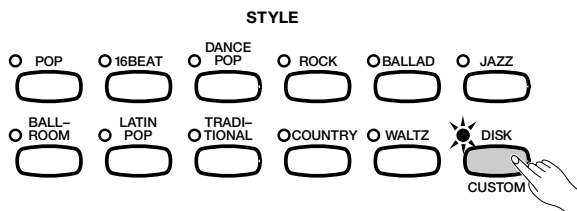

2 Select a source style.

Select a preset style that is close to the style you want to create. Preset style selection is carried out in the normal way (page 47).

If you want to select a [DISK/CUSTOM] style, press the [DISK/CUSTOM] style button once again and use the **STYLE ▲** and **▼** buttons, or the data dial or [-/+] buttons to select a [DISK/CUSTOM] style.

3 Select the section you want to record.

In the CUSTOM STYLE display page 1, press the first LCD button as many times as necessary to select the section you want to program first: MAIN A, MAIN B, INTRO, FILL IN, or ENDING. The MAIN A section is initially selected.

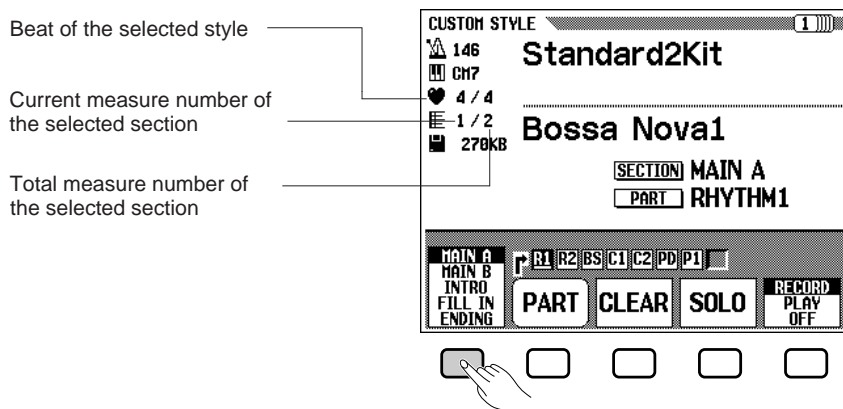

NOTE

- In the CUSTOM STYLE, MAIN A, MAIN B, INTRO, FILL IN or ENDING are referred to as "section", and RHYTHM 1/2, BASS, CHORD 1/2, PAD or PHRASE 1/2 are referred to as "part".
- Only one pattern can be created for each INTRO, FILL IN and ENDING section.
- Whether the "A" or "B" variations of the INTRO, FILL IN and ENDING sections are used as the source pattern depends on whether the MAIN A or MAIN B section was selected when the Custom Style function was engaged. (As for FILL IN, "FILL IN from A to A", or "FILL IN from B to B" is used.)

4 Change the time signature and number of measures, if required.

If you want to create a style in a different time signature than the current style, or change the number of measures in the selected section, Press the PAGE [▶] button to go to CUSTOM STYLE display page 2.

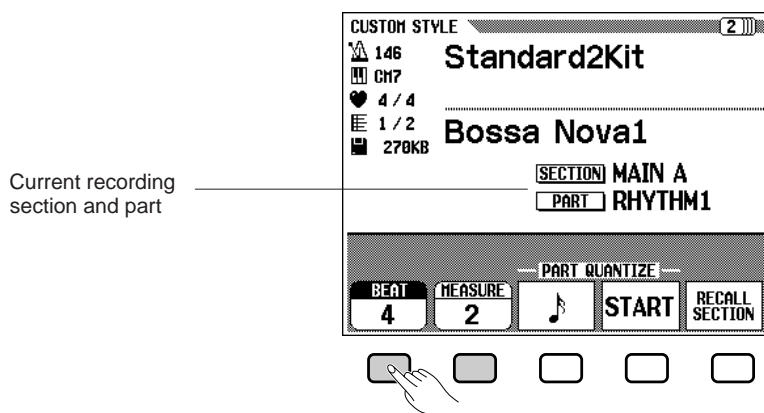

Use the **BEAT** LCD button to select a different time signature, or the data dial or [-/+] buttons once the **BEAT** parameter has been selected. As soon as you choose to change the beat value, the “**Clear style ?**” prompt will appear, since you will have to completely clear all sections and parts of the style and start recording from scratch if you change the time signature. Press **OK** to clear the style, or **CANCEL** to abort. Once the style has been cleared you can select a new time signature as required: 2, 3, 4, or 5.

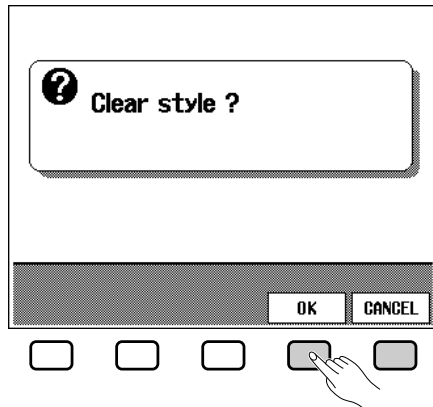

Use the **MEASURE** LCD button to select a different number of measures for the selected section, or the data dial or [-/+] buttons once the **MEASURE** parameter has been selected. As soon as you choose to change the number of measures in the section, the “**Clear section ?**” prompt will appear, since you will have to clear all parts of the currently selected section and start recording from scratch if you change the number of measures. Press **OK** to clear the section, or **CANCEL** to abort. Once the section has been cleared you can select a new number of measures as required: 1 through 8. The **FILL IN** section has only 1 measure and the number of measures cannot be changed although the **FILL IN** section can be cleared using this operation.

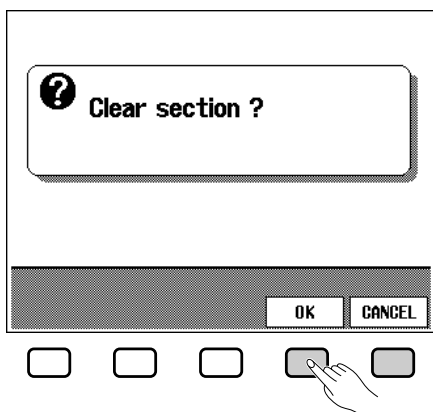

Once the **BEAT** and/or **MEASURE** parameters have been set as required, press the **PAGE** [◀] button to go back to the first Custom Style page.

5 Select the part and voice you want to record.

Use the **PART** LCD button, the data dial, or [-/+] buttons to select the part you want to record:

R1	Rhythm 1
R2	Rhythm 2
Bs	Bass
C1	Chord 1
C2	Chord 2
Pd	Pad
P1	Phrase 1
P2	Phrase 2

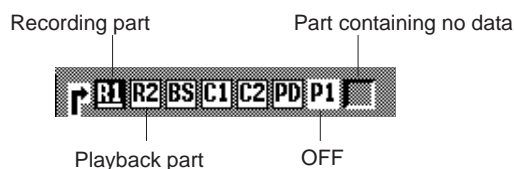
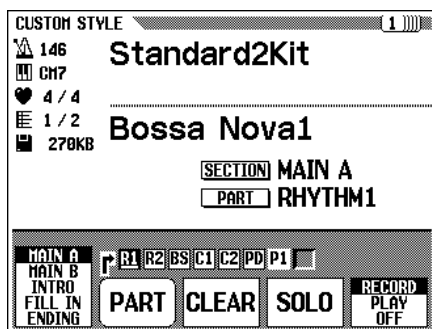

The R1 part is initially selected and set to the record mode. Any part you select can be set to the record mode by using the rightmost LCD button to select “**RECORD**” after selecting the part (the part number will be highlighted). Since parts other than R1 and R2 must be cleared before they can be recorded (if the source style is a preset style or a style loaded from the optional Style File disk) the “**Clear part ?**” confirmation will appear if you select a part that contains data: press **OK** to clear the part and continue, or **CANCEL** to abort. Only one part can be set to the record mode. All other parts will be set to “**PLAY**” (part number surrounded by box) or turned “**OFF**” (part number only — no box). No indication appears for the parts that contain no data.

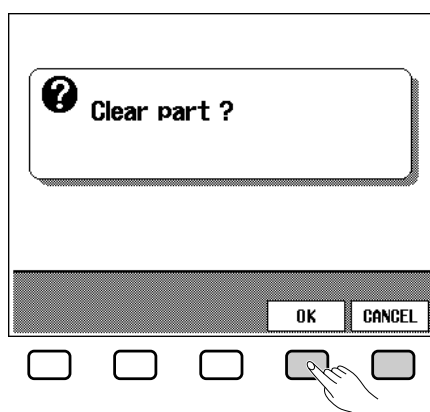

At this point you can also select the voice you want to record with (the preset voice for that part will initially be selected). For the R1 part, only **[DRUMS]** voices can be used. For the R2 part, all voices except Organ Combi. voice can be used. For the remaining parts, all voices except **[DRUMS]** and Organ Combi. voice can be used.

6 Record the selected part.....

You can now add new parts to the selected part by playing the keyboard at the appropriate timing (play in C Major seventh since the Custom Style is recorded as a C Major seventh pattern). If you want to create a totally new part from scratch, press the **CLEAR** LCD button to clear the selected part before beginning to record. If both the R1 and R2 parts are cleared the metronome will sound to provide a timing guide (the metronome sound is not recorded). When a drum kit voice is used, a single drum instrument sound can be cleared from the R1 or R2 part by pressing the key corresponding to the instrument to be cleared while holding the keyboard “C1” key. The metronome timing guide can also be cleared in this way.

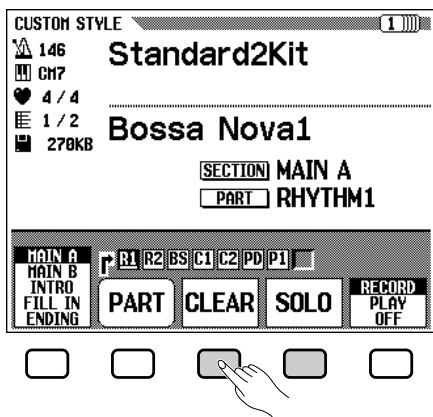

Another useful recording aid is the **SOLO** LCD button: when this button is pressed and highlighted, only the selected part will sound. Press the **SOLO** button again to turn the solo function off and hear the entire style.

7 Quantize the recorded part, if necessary.....

You can “tighten up” the timing of a recorded part by aligning all notes to specified beats via the PART QUANTIZE function in CUSTOM STYLE display page 2 (press the PAGE [▶] button). Press the LCD button below the note symbol to select “quantize size” — i.e. the beats to which the notes in the current part will be aligned:

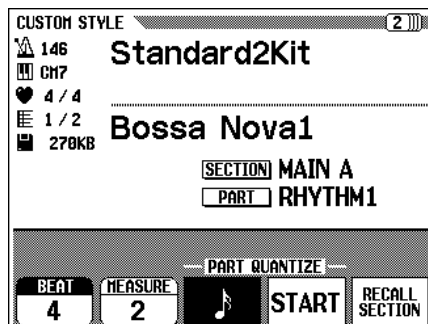
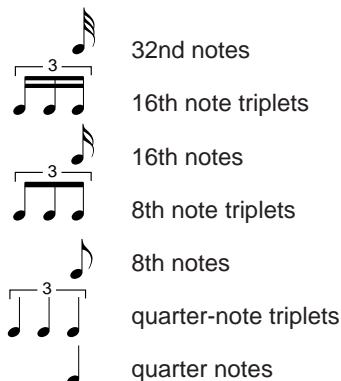

NOTE

- Playback can be started and stopped via the [START/STOP] button as required while in the Custom Style mode — data cannot be recorded while playback is stopped.

NOTE

- The timing guide will stop as soon as the Custom Style is stored.
- The sound of all parts is automatically stopped at the end of the style — i.e. at the point between repeats when recording. It is therefore not advisable to record over this point.

NOTE

- Quantization can also be applied to the already recorded part.

Once the required quantize size has been selected press the **START** LCD button to actually quantize the current part. Playback will stop for an instant while the data is being quantized, then the **START** LCD button will change to **UNDO**, allowing you to undo the quantize operation and return to the pre-quantized data if the results are not as you expected. You will not be able to UNDO once another button has been pressed.

8 Repeat until the custom style is complete.....

Repeat steps 3 through 7 until all parts or all sections have been recorded as required.

9 Name the custom style.....

When your custom style is complete, use the PAGE buttons to select CUSTOM STYLE display page 3, and press the **STYLE NAME** LCD button to go to the style naming page.

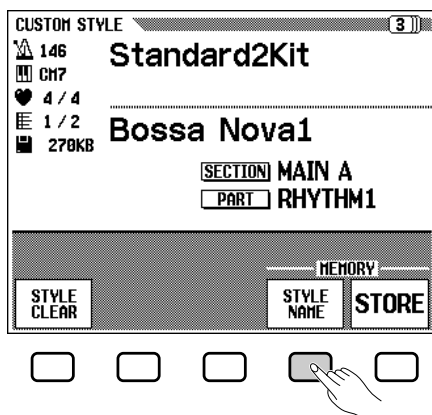

The current style name appears in the upper right corner of the display. Use the **CHAR** LCD button to position the underline cursor at the character you want to change (style names can be up to 12 characters in length). Use the data dial and/or the [-/+] buttons to select the character you want to enter from the list in the center of the display, then press the **CHAR SET** LCD button to enter the character at the current cursor position. Repeat this procedure until your name is complete. The **BACK SPACE** LCD button can be used to back up one space and delete a character.



When the name is complete press the **OK** LCD button to register the name for the current custom style, or **CANCEL** to abort.

NOTE

- During Custom Style recording, no MIXER display is available.

10 Store the custom style.

Press the **STORE** LCD button in CUSTOM STYLE display page 3 to store the current custom style in the internal memory. The “**Store XXXXXXXX?**” confirmation prompt and **MEMORY No.** parameter will appear (“XXXXXXXX” is the style name). Use the **MEMORY No.** ▲ and ▼ LCD buttons to select the memory number — 1 through 12 — to which you want to store the custom style, then press **OK** to store or **CANCEL** to abort.



NOTE

- The tempo setting at the time the Custom Style is stored becomes the preset tempo for that style.
- If the selected memory number already contains a style, the style name will appear next to the memory number. The existing style will be overwritten when a new style is stored.

11 Exit when done.

Press the **[EXIT]** button to exit from the Custom Style mode and return to the normal play mode.

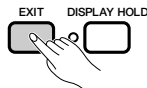

NOTE

- Custom style data is not retained in memory when the power is turned off, so be sure to save your custom style before turning the power off — see “Save to disk” on page 76.

Other Custom Style Functions

In addition to the various functions described in the basic custom style recording procedure, above, the CUSTOM STYLE display pages include several other functions that you may find useful when creating custom styles.

Recall Section

This function makes it possible to recall the last-stored version of the currently selected section (all parts of the section are recalled). Simply press the **RECALL SECTION** LCD button in CUSTOM STYLE display page 2. If the recall operation can't be carried out (i.e. The time signature has been changed), the “**Can't recall!**” alert display will appear. If this happens press **OK** to return to the previous display.

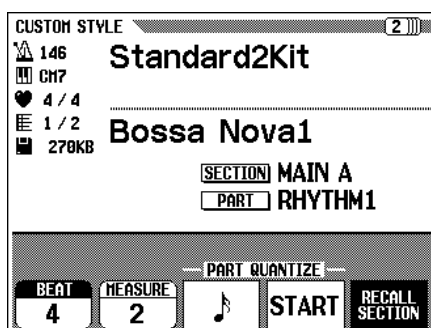

■ Style Clear

Press the **STYLE CLEAR** LCD button in CUSTOM STYLE display page 3 to entirely clear the current custom style. The “**Are you sure?**” confirmation prompt will appear. Press **YES** to clear the style or **NO** to abort.

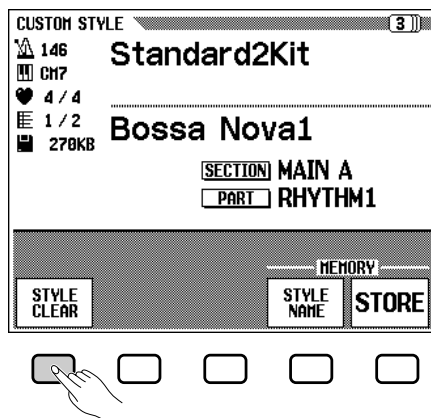

■ Volume & Effects

CUSTOM STYLE display page 4 includes a range of parameters that let you individually set the volume, reverb, effect, and pan for each part of each custom style section. Use the **SECTION** parameter to select the section (or “ALL” sections), and the **PART** parameter to select the part (or “ALL” parts). The third LCD button selects VOLUME, REVERB, EFFECT or PAN, and the **VALUE** (or **DEPTH**) parameter sets the amount or depth. When VOLUME is selected the **SECTION** parameter is fixed at “ALL” and the **VALUE** range is from -50 to +50, relative to the preset volume of the source style. The REVERB and EFFECT **DEPTH** ranges are from 0 to 100. The PAN **VALUE** settings are L10 (full left) ... C (center) ... R10 (full right). When EFFECT is selected the **TYPE** parameter appears and you can also select the effect type via the **TYPE** LCD button. The available effect types are listed below.

Effect Type List

- CHORUS 1
- CHORUS 2
- CHORUS 3
- CELESTE 1
- CELESTE 2
- CELESTE 3
- FLANGER 1
- FLANGER 2
- OFF

NOTE

- Normally the preset **VALUE** and **EFFECT TYPE** are initially selected. If **PART** is set to “ALL”, the R1 part preset values are displayed. If **SECTION** is set to “ALL”, the MAIN A preset values are displayed.
- Effect type “OTHERS” may appear if the preset effect type is other than that of what is in the list. The “OTHERS” selection cannot be re-selected once you change to a different type.

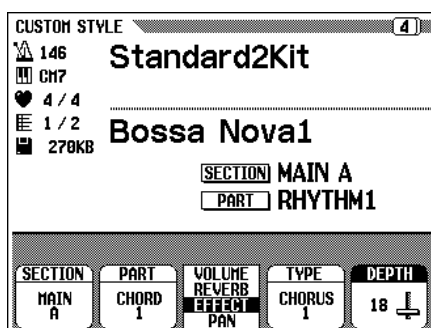

Save to Disk

A complete set of 12 custom styles or individual custom styles can be saved to disk via CUSTOM STYLE page 5.

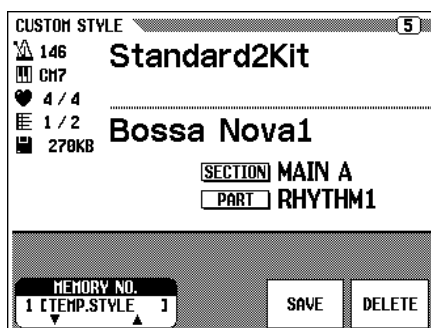

After making sure that a properly formatted disk is inserted in the Clavinova disk drive (page 7), use the **MEMORY No.** ▲ and ▼ buttons to select the memory number of the custom style you want to save to disk, or “ALL” if you want to save a complete set of 12 custom styles. When this is done, press the **SAVE** LCD button to start saving the data to disk. At this point the name entry display will appear and you can enter a name for the Custom Style disk file in the same way as you entered a name for the Custom Style itself (page 73). Press **SAVE** when the name has been entered. If a file with the same name already exists the “**Same name! Overwrite?**” confirmation prompt will appear. Press **OK** to overwrite the existing file or **CANCEL** to abort.

NOTE

- Saved Custom Style files can be loaded via the “STYLE FILE LOAD” function described in the “Style File Load” section (page 80).



Your custom styles must be stored to internal memory before they can be saved to disk (see step 10 of the basic custom style recording procedure). If a custom style has not been stored and you attempt to save it to

disk, the “**Please store to memory before saving to disk**” alert display will appear. If this happens press **OK** to return to the previous display (CUSTOM STYLE display page 3), store the custom style, then try saving again.

■ Delete from Disk

Saved custom styles can also be deleted from disk via CUSTOM STYLE page 5.



After making sure that the disk containing the custom style files is inserted in the Clavinova disk drive, press the **DELETE** LCD button. Use the **FILE** **▲** **▼** LCD buttons to select the custom style file you want to delete from disk. The “Are you sure?” confirmation prompt will appear. Press **YES** to delete the custom style file or **NO** to abort.

Press the **[EXIT]** button to exit from the Custom Style mode and return to the normal play mode.

Playing Back Your Custom Styles

Once created, your original custom styles can be selected for playback by pressing the **[DISK/CUSTOM]** button (its LED will light), and then using the **STYLE** **▲** and **▼** LCD buttons — or the data dial or **[-/+]** buttons — to select the custom style you want to play. The selected style can then be played and used with ABC auto accompaniment in exactly the same way as the preset styles (page 47).

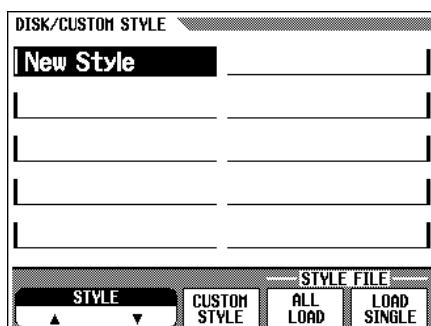

NOTE

- Since only one type of **INTRO**, **FILL IN**, and **ENDING** section can be recorded for each Custom Style, no “A/B” variations are produced during playback.

Custom Style Alert & Error Displays

The following alert and error displays may appear in the corresponding situations.

■ Insufficient Memory To Store

This alert message will appear if there is not enough memory to perform a store operation.

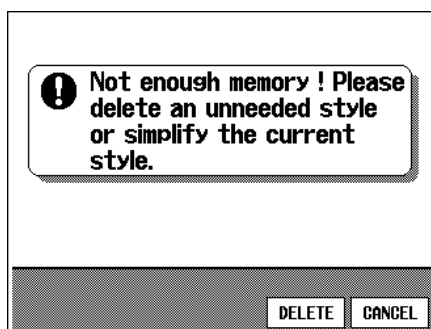

In this case it will be necessary to either delete a style you don't need or simplify the style you are currently recording. Press **CANCEL** to return to CUSTOM STYLE display page 1, at which point you can simplify the current style (by clearing a part, etc.), or **DELETE** to go to the "Delete style ?" display:

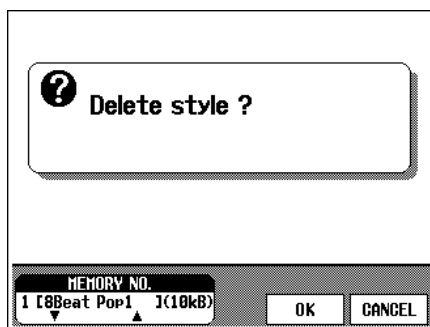

Use the **MEMORY No.** ▲ and ▼ buttons to select the number of the style you want to delete, then press **OK** to delete the style, or **CANCEL** to abort.

■ Memory Full During Recording

This alert message will appear if the memory becomes full during recording or editing.

NOTE

- The amount of memory being used for the selected style is also shown on the display (in approximate kilobytes) so as to set up the approximate standard which style to delete in relation to the total 300 KB memory space.

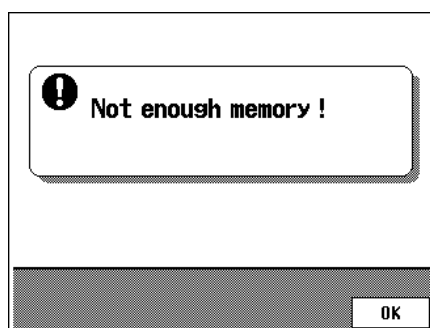

Press **OK** to return to CUSTOM STYLE display page 1 and simplify the style by clearing a part, etc.

■ Exit Before Store

If you press **[EXIT]** button to exit from the Custom Style function before storing the style the following display will appear.

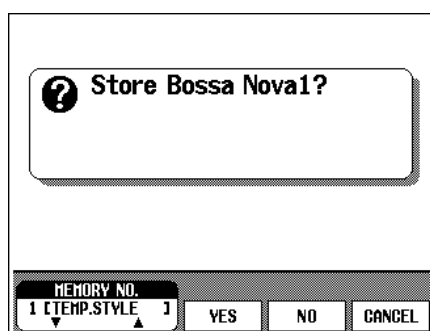

Select a memory number and press **YES** to store the style and then exit, press **NO** to exit without storing the style, or press **CANCEL** to return to the Custom Style mode.

■ Style Change Before Store.....

If you attempt to select a different source style before storing the current style you recorded, the following display will appear.

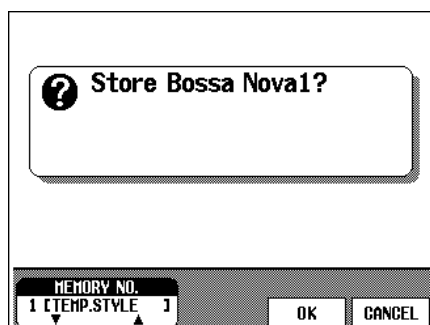

Select a memory number and press **OK** to store the style and then select the new source style, or press **CANCEL** to return to the Custom Style mode.

NOTE

- If you want to select a different source style without storing the current style, exit from the CUSTOM STYLE mode without storing the style (see "Exit Before Store" above), and then re-enter the CUSTOM STYLE mode.

Style files from optional Yamaha “Style File” disks, or disks containing custom style files you’ve created yourself, can be loaded into the Clavinova and played as required.

NOTE

About the Yamaha Style File Format

• The Style File Format is Yamaha’s original auto-accompaniment format which has evolved through years of development and refinement. Style File Format allows you to use exceptionally high quality accompaniments with a variety of chord types through its unique conversion system. In addition to the internal styles, the optional style disks let you use different sophisticated styles created with the Style File Format.

NOTE

- Loaded disk styles will be retained in memory only until the power is turned off.
- One pre-programmed temporary style is automatically loaded into the [DISK/CUSTOM] memory whenever the power is turned on.

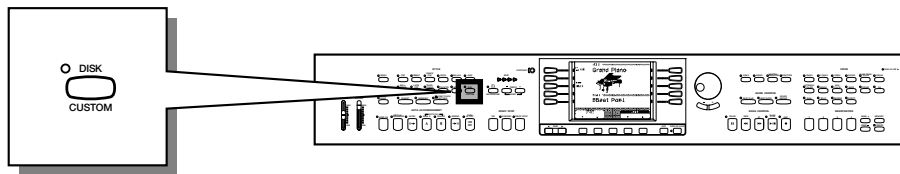

Loading Disk Styles

1 Insert the Style Disk.....

Insert the Style File Disk into the disk drive with the sliding door on the disk facing the drive slot and the label side facing upward. The disk should click into place and the DISK IN USE lamp will light briefly while the Clavinova reads and identifies the disk. When an appropriate Style File disk is inserted, the STYLE FILE LOAD display (see step 2 below) will appear automatically. If the disk is already inserted and the STYLE FILE LOAD display is not showing, press the [DISK/CUSTOM] selector to call the DISK/CUSTOM STYLE display and press the **LOAD SINGLE** button.

NOTE

- If a disk containing both song and style files is loaded, the SONG PLAY mode will automatically be selected. In this case press the SONG [PLAY] button so that its indicator goes out to exit from the SONG PLAY mode, then press the [DISK/CUSTOM] button.

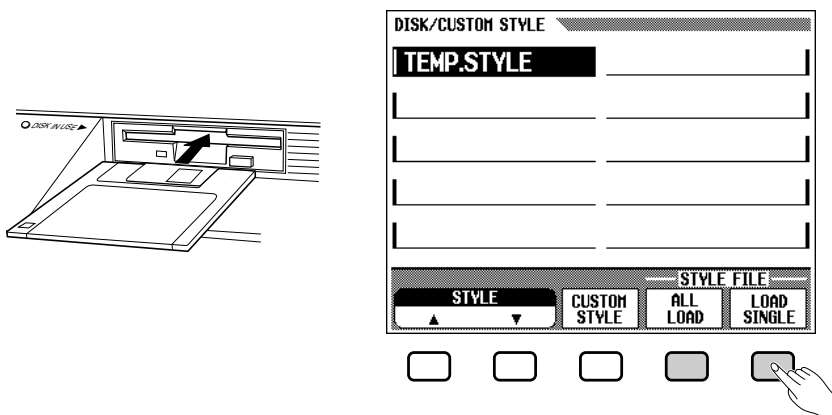

A set of 12 files saved by using the Custom Style save “ALL” function (page 76) can be loaded by pressing the **ALL LOAD** LCD button rather than the **LOAD SINGLE** button. The rest of the ALL LOAD procedure is essentially the same as the LOAD SINGLE procedure, as follows.

2 Select a Style File

To select the desired style, use the left/right LCD buttons. You can also use the **STYLE ▲ ▼** buttons, data dial, or [-/+] buttons.

You can “preview” the selected style by pressing the **LISTEN** LCD button (the “LISTEN” function is not available in the ALL LOAD display).

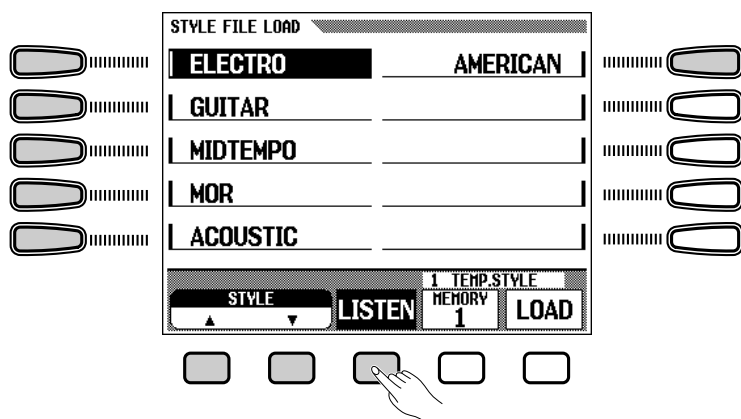

Press the **LISTEN** LCD button again or the [START/STOP] button to stop listening.

3 Select a Memory Number & Load the Style

Use the **MEMORY** LCD button to select the memory number to which the selected style file is to be loaded (1 through 12), then press the **LOAD** LCD button to load the style file.

Repeat Step 2 and 3 to select and load more style files as you like.

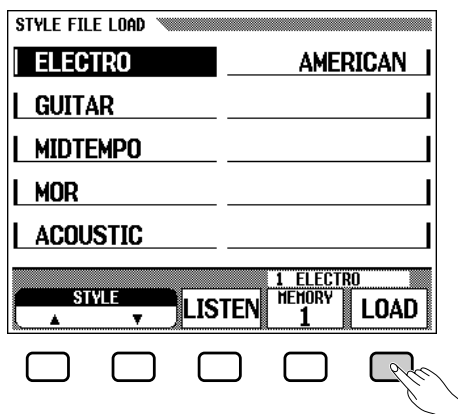

NOTE

- If a tempo is set prior to loading the style, that tempo becomes the default for the loaded style.
- Some styles are too large for the LISTEN function. In this case the “Too much data for LISTEN function! Please load data.” alert display will appear. In this case load the style directly as in step 3.
- ABC is automatically turned on when the LOAD SINGLE button is pressed and the style is played back automatically with the ABC accompaniment in C Major when the LISTEN LCD button is pressed. You can also change the chord or try playing on the keyboard if you like.

NOTE

- If the selected memory number already contains a style, the style name will appear at the lower right in the display. The existing style will be overwritten when a new style is loaded.

Style File Load

It is not necessary to select a memory number when ALL LOAD is selected in step 1. Simply press **OK** to load or **CANCEL** to abort.

If there is not enough memory to load the specified file the “**Not enough memory! Delete an unneeded style ?**” alert display will appear. In this case it will be necessary to delete a style you don’t need before loading the new style. Use the **MEMORY No.** ▲ and ▼ buttons to select the number of the style you want to delete, then press **DELETE** to delete the style, or **CANCEL** to abort.

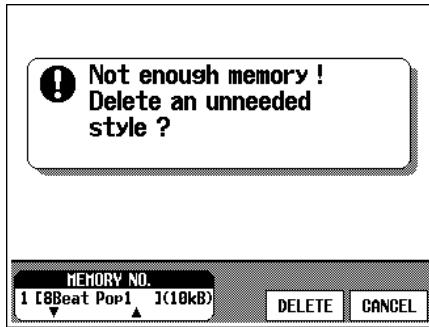

4 Eject the Disk When Done

When you’ve finished with the Style File disk, press the disk drive **EJECT** button to remove it and return to the normal play mode display. You can return to the normal play mode without removing the disk by pressing the **[EXIT]** button or a **STYLE** selector.

NOTE

- The ALL LOAD display is as follows:

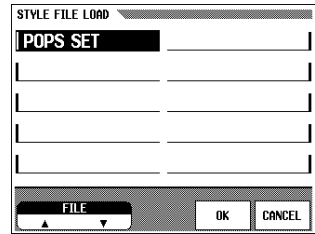

When ALL LOAD is executed, all data in the 12 memories will be replaced by new data.

NOTE

- The amount of memory being used for the selected style is also shown on the display (in approximate kilobytes) so as to set up the approximate standard which style to delete in relation to the total 300 KB memory space.

NOTE

- The **DISK IN USE** lamp will light while the style is being loaded. NEVER attempt to remove a disk while the **DISK IN USE** lamp is lit.
- The **LISTEN**, **LOAD**, **[EXIT]** and style buttons will not function while the style data is being loaded (i.e. while the **DISK IN USE** lamp is lit).

Using Loaded Style Files

Once loaded, style files can be selected for playback by pressing the **[DISK/CUSTOM]** button (its LED will light), and then using the **STYLE** ▲ and ▼ LCD buttons — or the data dial or **[-/+]** buttons — to select the style you want to play. The selected style can then be played and used with ABC auto accompaniment in exactly the same way as the preset styles (page 47).

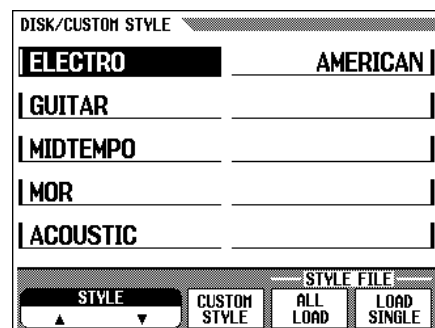
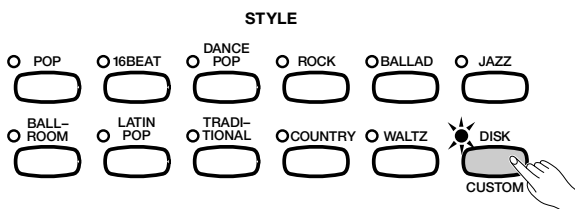

CHAPTER 5: Registrations



Registrations (Registering/Recalling Panel Setups)

The Registration feature can be used to memorize a number of complete panel setups that you can recall whenever needed. A total of 20 setups (5 banks x 4 memories) can be registered.

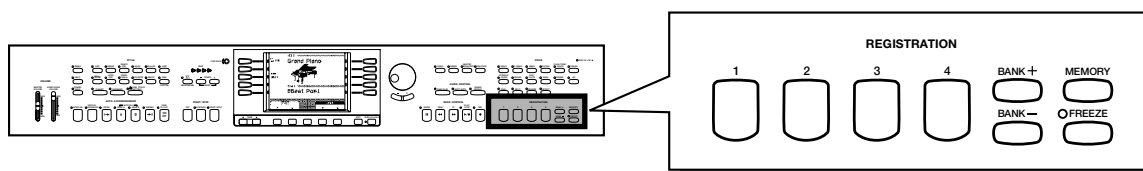

1 Set up the controls as required.....

For a list of the parameter settings memorized by the Registration function, refer to page 35 of the Reference Manual.

2 Select a Registration bank.....

Press the BANK [-] [+] buttons to display the banks below and to the right of the style name in the main display.

Select one of the five banks: **A** — **E**.

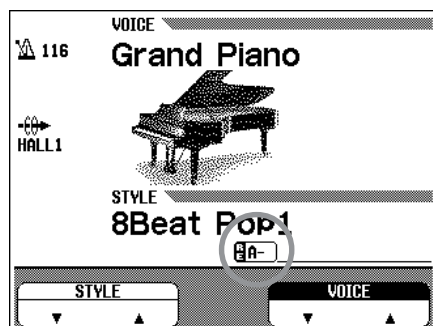
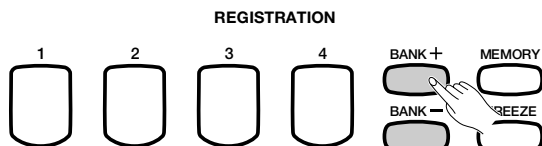

3 Register the panel setup.

While holding the [MEMORY] button, simultaneously press one of the REGISTRATION [1] — [4] buttons. Any data that was previously in the selected location is erased and replaced by the new settings. The corresponding Registration number (bank/button number) and the Registration name will appear below and to the right of the style name in the main display. “A-1 (number 1 of bank A)” and “REGIST A-1” (temporary Registration name) will appear next to the RE mark.

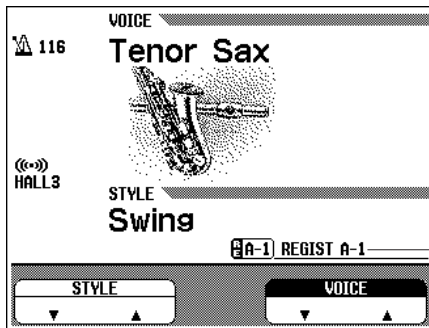
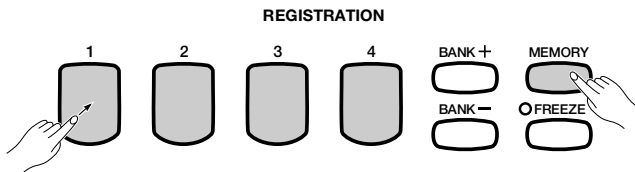

Registered Registration number and name

NOTE

Registration

- Range: Bank: A— E, Button: 1 — 4
- Basic setting: Pre-programmed settings are registered in all Registration numbers.
- Backup of last settings: ON

NOTE

- The REGISTRATION [NAME] pop-up display appears when pressing the [MEMORY] button; however, this display is not necessary in registering the panel setup.
- The data for each Registration or a group of 20 Registrations can be saved to floppy disk, for future recall. (See page 139.)

Recalling the Registered Panel Settings

Press the BANK [-] [+] buttons as described above (in step #2) to select the bank corresponding to the desired Registration. Then, simply press the corresponding REGISTRATION [1] — [4] button to recall the desired Registration. The recalled Registration number (bank/button number) and the Registration name will appear below and to the right of the style name in the LCD display. A pencil icon appears at the right of the Registration name in the display as soon as any change is made to the panel buttons or settings. In other words, if the pencil icon is displayed, the current panel settings are different from those stored in memory.

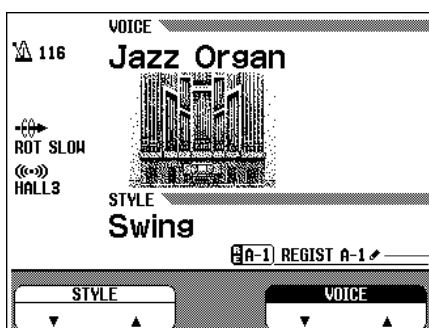

Edit Symbol

NOTE

- Only selecting a different bank will not change the Registration settings.
- The Registration settings are recalled only when one of the REGISTRATION [1] — [4] buttons is pressed.
- If the Left Pedal function is set to “Registration” (see page 133), the left pedal can be used to step through the Registrations, letting you recall a different Registration each time the pedal is pressed. However, other left pedal settings assigned to each Registration cannot be recalled in this case.

Naming the Registration

A temporary name is given to the Registration setup when you register the panel settings; however, you can change this name freely with this function.

1 Press the [MEMORY] button to call up the REGISTRATION [NAME] pop-up display.

- Select the number of the Registration whose name you wish to change by using the left/right LCD buttons. The data dial and [-/+] buttons also can be used.

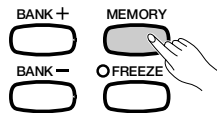

You can also select the Registration number by using the **BANK ▼ ▲** or **REGIST ▼ ▲** buttons.

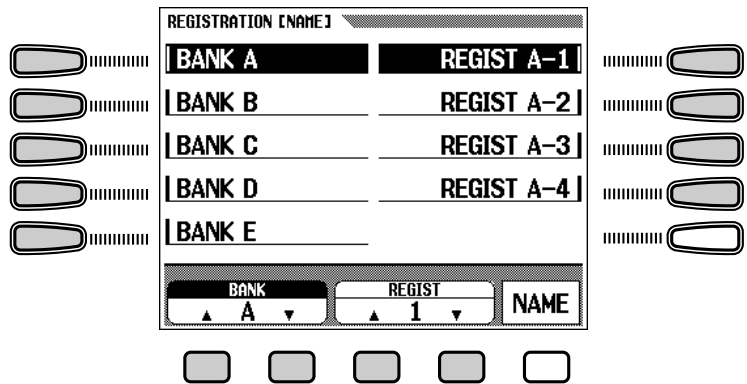

2 Press the NAME button to call up the display for entering the name.

Use the **CHAR ▶** button to move the underline cursor to the desired character position in the file name display. (File names can be up to 12 characters in length).

- Use the data dial or [-/+] buttons to select and highlight the character or mark you wish to enter. Press the **CHAR SET** button to enter the selected character to the current cursor position in the file name. Continue entering other characters or marks in this way until you complete the name.



To delete the character at the previous position, press the **BACK SPACE** button. The character before the underline cursor is deleted and the cursor moves back to the deleted position.

To abort the Registration naming operation and return to the main display, press the **CANCEL** button.

When the Registration name is complete, press the **OK** button to register it. The display will return to the main display and the Registration name is indicated below and to the right of the style name.

CHAPTER 6: Song Control

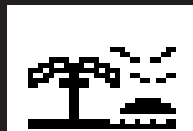

Song Playback

In this manual, the recorded music data of your performance, and the song data of various disk software are all referred to as “songs.”

The Clavinova can play back songs you’ve recorded yourself using the Song Record function (page 105), and other songs of various musical styles. You can also play along on the keyboard with the songs as they play back. Moreover, with song data software that includes lyrics, you can view the lyrics in the display during playback.

NOTE • Consult your Yamaha dealer for information on song data that is compatible with the Lyric Display function of the Clavinova.

NOTE • See the section “Handling Floppy Disks” (page 7) for information on using floppy disks.
• Playback data cannot be output via MIDI.

NOTE **Playback of Different Disks**
• In addition to songs you’ve recorded yourself, the CVP-98/96/600 can play back commercially available disks of Yamaha DOC software, XG software, and Disklavier PianoSoft as well as GM software. See the section “Playing Other Types of Music Data” on page 99.

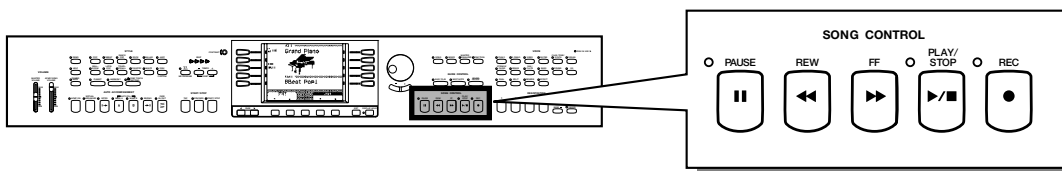

Playback

1 Enter the Song Play mode.

Gently insert the included “Music Software Collection” disk or a disk containing songs you’ve recorded yourself into the disk drive. Make sure to insert the disk face up in correct direction, as shown in the illustration, until it clicks into place. The Song Play mode is automatically called up when a song disk is inserted in the disk drive.

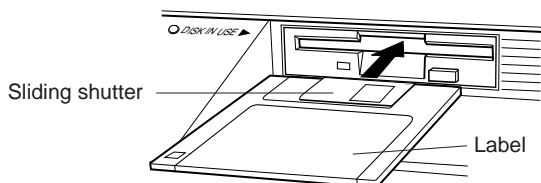

NOTE
• The Song Play mode is not automatically engaged from the disk-related FUNCTION displays, or the CUSTOM STYLE display — even when inserting the disk.

- The DISK IN USE lamp lights while the Clavinova reads and identifies the disk. Once the disk has been identified, the SONG PLAY [MAIN] display (display page 1) appears in the display and the [SONG] lamp lights.

If a song disk is already inserted but the Song Play mode is not engaged, press the [SONG] button.

- The [SONG] lamp lights. Press the PAGE [◀] [▶] buttons to select the first page, if the SONG PLAY [MAIN] display is not shown.

2 Select a song number.

Select the desired song number for playback by using the **SONG ▼** or **▲** buttons, data dial or [-/+] buttons.

- The selected song number, name, current tempo and the file icon which indicates the type of the file are displayed.

Select “ALL” if you want all songs on the disk to be played in order. Select “RANDOM” if you want all songs on the disk to be played at random. For either selection “ALL” or “RANDOM” the songs will be repeated until playback is stopped.

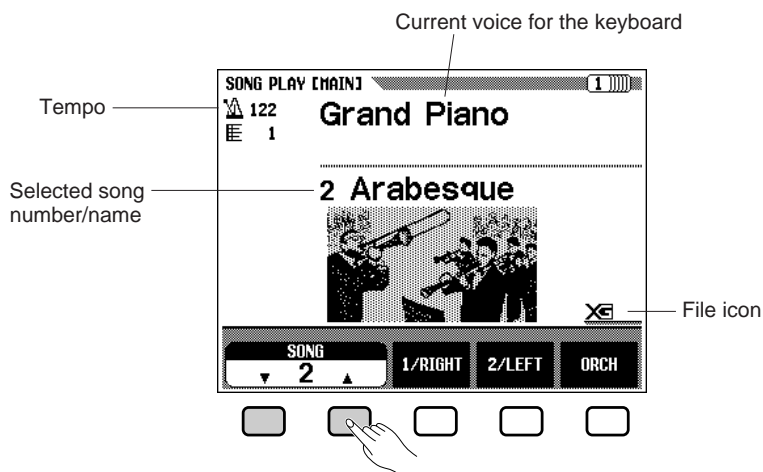

NOTE

- Song numbers 1 - 60 are displayed, including song numbers that contain no song data. However, no song names are displayed for song numbers that contain no data.

● File Icons

There are four icons (shown below) that indicate the type of the file.

	XG/SMF format file
	DOC/ESEQ format file
	Yamaha Disklavier PianoSoft or XG/ESEQ file
	Song data recorded with the CVP-98/96/600

NOTE

- Refer to the section “MIDI and Data Compatibility” (page 8 in the Reference Manual) for information on file formats.
- Icons are not shown for song data file recorded with other CVP models, excepting the CVP-98/96/600 and CVP-94/92.

Use the PAGE [◀] [▶] buttons to call up the SONG PLAY [LIST] display (display page 3), to view the entire list of the song names in the disk. The desired song can be selected easily by using the left/right LCD buttons, data dial, or [-/+] buttons. You can also select the song by pressing the **SONG** ▼ ▲ buttons. Up to ten song titles are shown in the display at a time. If more songs are on the disk, the next ten titles will appear when you scroll past the last title shown in the display.



3 Start and stop playback.

Start playback of the selected song by pressing the panel [PLAY/STOP] button.

- Playback of the selected song starts. Unless **ALL** or **RANDOM** is selected, the selected song will play through to the end and playback will stop automatically. The current measure number and tempo will be shown in the display during playback.

You can also start playback of the selected song by pressing the [START/STOP] button.

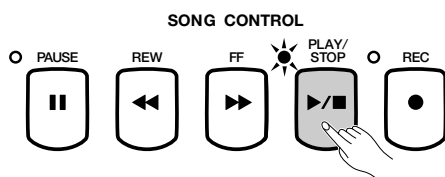

Press the panel [PLAY/STOP] button to stop playback.

- Song playback stops.

You can also stop playback by pressing the [START/STOP] button.

You can exit from the song play mode by pressing the [SONG] button. The lamp turns off and the previous display appears.

NOTE

When nothing appears in the song name location...

- This indicates that there is no song data for this song number.

NOTE

Repeat Playback from Specific Songs

- If you first select **ALL** in the SONG PLAY [MAIN] display, and then select a song in the SONG PLAY [LIST] display (display page 3), all songs will be repeatedly played back starting from the selected song.

NOTE

Repeat Playback of a Single Song

- If you select a song in the SONG PLAY [MAIN] display or in the SONG PLAY [LIST] display (display page 3), and then select the **1 SONG** in the SONG PLAY **REPEAT** display (display page 4), only the selected song will be played back repeatedly until stopped.

NOTE

Voice Selection During Playback

- The voice you play from the keyboard can be changed during song playback by selecting a voice in the normal way (page 27). The voices of the 1/RIGHT & 2/LEFT part being played back can be changed in the SONG PLAY [PART] display (page 92).

NOTE

- Please note that the song may not start immediately after pressing [PLAY/STOP].

NOTE

Turning off the Keyboard Guide Lamp

- The keyboard guide lamps corresponding to the keys being played by the 1/RIGHT and 2/LEFT part will light in real time. These guide lamps can be turned off in the SONG PLAY [GUIDE MODE] display (display page 5). (See page 103.)

NOTE

Turning Off the Lyric Display

- The lyrics are shown in the display when playing back software which contains lyric data. If you want to stop the lyrics from appearing, you can disable the function from display page 5 of the SONG PLAY [GUIDE MODE] display.

NOTE

Using the Pedal to Start/Stop Playback

- By setting the Left Pedal Function to **START/STOP** in the FUNCTION [PEDAL] display (display page 3), the left pedal can function the same as the [START/STOP] button. (See page 133.)

● Adjusting the Tempo

The playback tempo of the song can be changed freely as desired. (See page 49.) The preset tempo for the selected song can be restored at any time by simultaneously pressing the TEMPO [-/+] buttons.

Usually the tempo is indicated by numbers. However in case of the free tempo software, “- - -” will appear in place of the tempo on the display, and the measure numbers shown on the display will not correspond to the actual measure; this only serves as a reference as to much of the song has been played back. The increase or decrease of the tempo based on the basic tempo is indicated by a percentage figure in the display when the tempo is changed (from -99 to +99 at maximum; the range differs depending on the software).

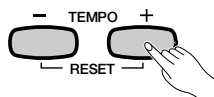

NOTE

- The beat lamp may not flash for songs not having rhythm.
- With some songs, the displayed measure numbers may not match those marked on the score.

4 Eject the disk

When you've finished with the currently loaded disk, simply press the disk drive's EJECT button to remove it.

➔ The LCD display returns to the main display.

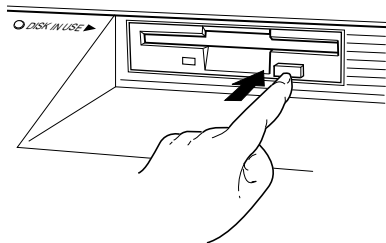

CAUTION

- Make sure not to take out the disk while the DISK IN USE lamp is lit or while a song is being played back.

NOTE

Volume Adjustment for Each Part

- The volume of each Part can be adjusted in the MIXER display.

NOTE

Adjusting the Level Balance of Song Playback and the Keyboard Voices

- Use the [ACMP/SONG VOLUME] control (page 17) to adjust the volume.

NOTE

- When playing back a song recorded with the Auto Accompaniment function, Auto Accompaniment cannot be turned on by pressing the [ACMP ON] button.

Part Cancel

The **1/RIGHT** (right hand), **2/LEFT** (left hand) and **ORCH** (accompaniment) buttons in the SONG PLAY [MAIN] display can be used to turn playback of the corresponding parts on or off. The buttons are highlighted when the parts are turned on. For example, you can turn off the right- and/or left-hand parts so you can practice them on the keyboard.



In this example, 1/RIGHT is cancelled.

The track assignment for each button can be changed in display page 6 of the SONG PLAY [PART] display (page 92).

Turning Individual Accompaniment Parts On or Off

Normally, pressing the **ORCH** (accompaniment) LCD button turns all orchestra parts (tracks 3 — 16) — or all parts other than 1/RIGHT and 2/LEFT — on or off at once. You can, however, turn these parts on or off individually from the SONG PLAY [TRACK PLAY] display (display page 2).

1 Select the SONG PLAY TRACK PLAY page.

Use the PAGE [◀] [▶] buttons to select the SONG PLAY [TRACK PLAY] display (display page 2).

- Tracks which contain data are indicated above **TRACK** ◀ / ▶.
- Tracks enabled for playback are indicated by a box surrounding the track number. Tracks which do not contain data are not displayed.



NOTE

- Part ON/OFF can be switched during playback.
- Parts not having any data cannot be turned on. [This applies when there is actually no data in the assigned track (page 92), or when the assigned track is set to "TRK - - (OFF)."]

NOTE

- In the case of Yamaha Disklavier PianoSoft files, DOC files and XG/ESEQ files, the part indication does not appear for the parts without data.

NOTE

- All track numbers appear whether the tracks contain data or not when a Standard MIDI file song is selected (excepting songs recorded on the CVP-98/96/600/94/92).

2 Select the desired track for playback (PLAY/OFF, SOLO).

Select the track by using **TRACK** ◀ or ▶, or the data dial, or the [-/+] buttons.

→ The selected track is indicated by an underline mark.

Select playback or off for the selected track by pressing one of the far right LCD buttons **PLAY** (playback) or **OFF**.

When a track is muted, the track number is “ghosted” (shown in lighter indication) in the display. The voice used by the currently selected track is shown above **PLAY/OFF**.

Select a track, then press and highlight the **SOLO** LCD button to hear only the selected track. Press the **SOLO** LCD button again to cancel the Solo function.

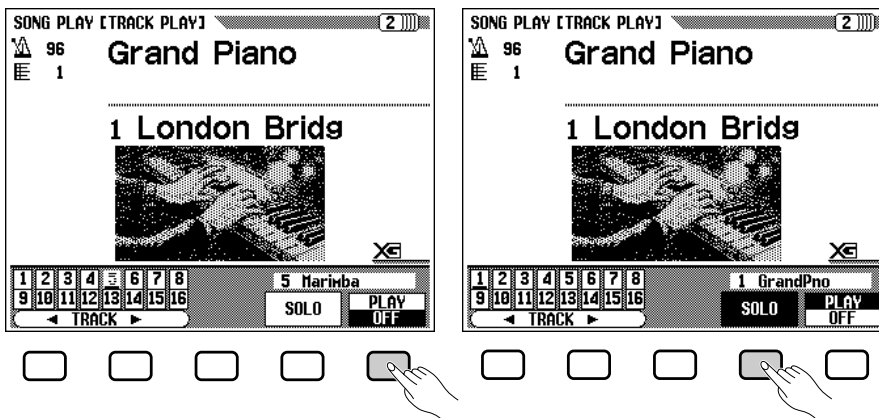

Assignment of Tracks to 1 /RIGHT and 2 /LEFT, and Voice Assignment

■ Assigning Tracks to 1 /RIGHT and 2 /LEFT

Specific tracks can be assigned to the **1 /RIGHT** and **2 /LEFT** in the SONG PLAY [MAIN] display, allowing you to selectively turn playback of assigned tracks on or off. TRACK - - (OFF) can be assigned to **2 /LEFT**. The same track cannot be assigned to both parts.

Select the SONG PLAY [PART] display (display page 6) by using the PAGE [◀] [▶] buttons.

➤ Press the **1 /RIGHT** or **2 /LEFT** button to highlight the section in the display, then use the data dial or [-/+] buttons to assign the desired track.

You can also select the track by pressing the **1 /RIGHT** or **2 /LEFT** button.

NOTE

- The track assignments of DOC files and Yamaha Disklavier PianoSoft files are fixed, and therefore cannot be changed.

NOTE

- Tracks cannot be assigned during playback.



NOTE

About Track Assignments

- Basic setting: Differs depending on the file type (The [2/LEFT] parameter may sometimes be set to "TRK - - (OFF).")

NOTE

- The playback voice cannot be assigned during playback.

■ Selecting Voices for 1/RIGHT and 2/LEFT Parts

The playback voices for the 1/RIGHT and 2/LEFT parts can be selected in the SONG PLAY [PART] display.

Press **PART1,2 VOICE** ▼ or ▲ to highlight the corresponding section of the display, then select the playback voice for 1/RIGHT and 2/LEFT parts by using the data dial or [-/+] buttons.

Or you can also select it by using the **PART1,2 VOICE** ▼ or ▲.

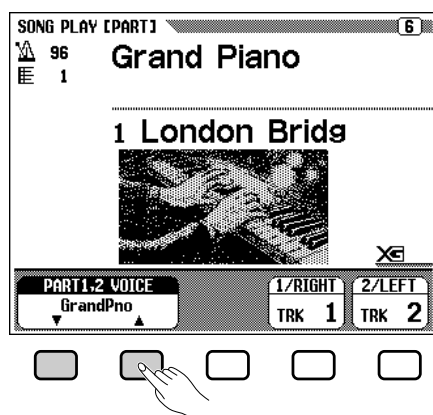

Overall Song Playback Volume Control

The [ACMP/SONG VOLUME] button can be used to control the overall volume of song playback.

When the power is turned on, the [ACMP/SONG VOLUME] level is automatically set to its MAX volume regardless of the slider's position. After that, moving the slider will set the volume to the corresponding level.

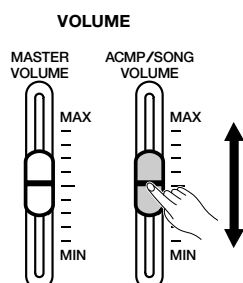

NOTE

- If Auto Accompaniment is turned on during the playback of an original song that was recorded without Auto Accompaniment, the [ACMP/SONG VOLUME] control will affect the level of the Auto Accompaniment rather than that of song playback. However, Auto Accompaniment cannot be turned on when playing back data transformed with the Transform function (page 142).
- The Auto Accompaniment function cannot be used when playing back commercially available disk software or songs recorded with Auto Accompaniment.

Individual Part Volume Control

To adjust the playback volume of individual parts, press the [MIXER] button while in the Song Play mode to call up the MIXER display. The display corresponding to the software being played back appears in display page 1, and you can control the volume balance of the keyboard sound and the orchestra accompaniment. Each track can be adjusted in display page 2.

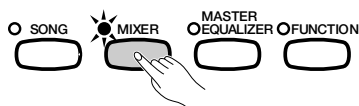

■ Page 1.....

Press one of the LCD buttons to highlight the desired parameter, then use the data dial or [-/+] buttons to adjust the volume of each part.

Several parts can be selected at once by simultaneously pressing the corresponding LCD buttons. The volume of all selected parts can then be adjusted together. Values can be adjusted in two-unit steps.

● When Playing Back XG/SMF Files or Original Song Data

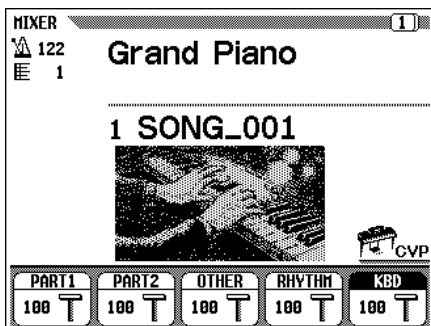

PART1	Part 1
PART2	Part 2
OTHER	Parts 3 — 8, 11 — 16
RHYTHM	Parts 9 and 10
KBD	Volume of your keyboard performance

● When Playing Back DOC Files

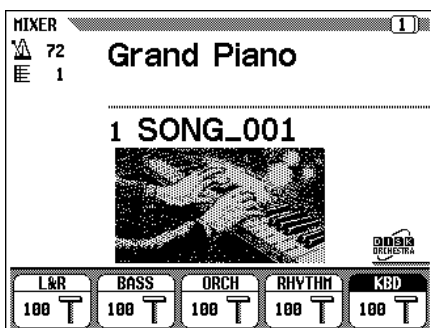

L&R	Right- and left-hand parts (piano part)
BASS	Bass part
ORCH	Orchestra part
RHYTHM	Rhythm part
KBD	Volume of your keyboard performance

● When Playing Back XG/ESEQ Files

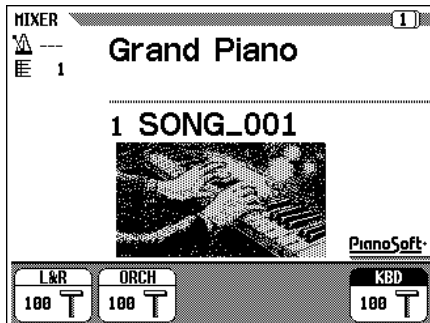

L&R	Right- and left-hand parts (piano part)
ORCH	Accompaniment part
KBD	Volume of your keyboard performance

● When Playing Back Yamaha Disklavier PianoSoft Files

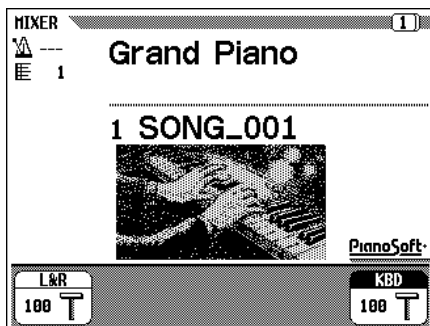

L&R	Right- and left-hand parts (piano part)
KBD	Volume of your keyboard performance

■ Page 2.....

Use the PAGE [◀] [▶] buttons to call up display page 2 of the TRACK MIXER display so that all sixteen tracks appear. From this page you can change the volume, voice, Reverb Depth, etc.

The parameters below can be changed. See the indicated reference pages for each parameter.

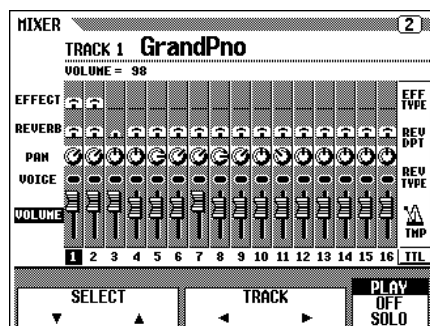

Available parameters in the TRACK MIXER display

● When track 1 — 16 is selected:

- VOLUME (See page 94.)
- VOICE (See page 27.)
- PAN (See page 132.)
- REVERB DEPTH (See page 43.)
- EFFECT DEPTH (See page 46.)

● When TTL (Total) is selected:

- TEMPO (See page 49.)
- REVERB TYPE (See page 41.)
- REVERB DEPTH (See page 42.)
- EFFECT TYPE (See page 46.)

NOTE

- The parameters Program Change Number (**PRG#**), Bank LSB (**BNK LSB**), and Bank MSB (**BNK MSB**), which are used to select voices via MIDI, are displayed when VOICE is selected.

NOTE

- Depending on the file type, some parameters cannot be changed. For such parameters, a "Fixed" indication is shown.

Changing Settings in the TRACK MIXER Display

1 Select the track to be changed.

Select the desired track by pressing **TRACK** ◀ or ▶. Selecting **TTL** (Total) will change the overall settings of the song rather than the settings of individual tracks.

Press the far right LCD button to select **PLAY** (playback), **OFF**, or **SOLO** for the selected track. Select **SOLO** if you want to play only the selected track.

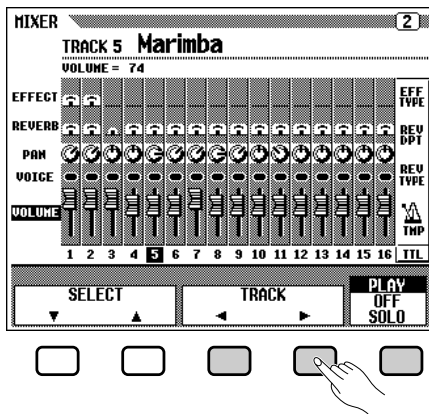

2 Select the parameter to be edited.

Press **SELECT** ▼ or ▲ to select the desired parameter.

Current value of the selected track

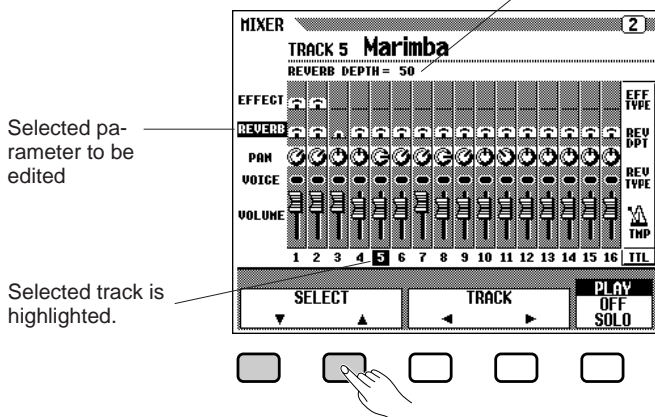

3 Edit the value or setting.

Use the data dial or [-/+] buttons to change the value or setting. You can make changes to the parameters while the song is playing back, letting you immediately hear the results of your edits.

NOTE

- Depending on the file type, voice changes may only be possible for tracks 1 and 2.

NOTE

- Selecting **TTL** and changing the **REVERB DEPTH** value will also affect the sound of your keyboard performance.
- The voices of tracks to which data of Auto Accompaniment, rhythm and/or harmony have been recorded can also be changed.
- Volume range: 0 — 100
- One **EFFECT TYPE** can be set to a single song. If another song is selected, all settings will return to the basic settings for the song (or the settings used for recording the song).
- If Auto Accompaniment is turned on during playback of an original song that was recorded without the Auto Accompaniment function, the **MIXER** display will function as Auto Accompaniment Part Volume Control instead of Song Track Volume Control.

Repeat Functions

The Clavinova has convenient repeat functions that let you repeated play back the same song or sections within the song. This function is useful if you want to practice a difficult phrase repeatedly.

Select the desired mode from the available four Repeat modes from the SONG PLAY [REPEAT] display (display page 4).

Four Repeat modes

- OFF (Repeat function is turned off)
- PHRASE (Phrase Repeat)
- 1 SONG (1 Song Repeat)
- AB mode (AB Repeat)



NOTE

- The **ALL** or **RANDOM** playback mode (in the SONG PLAY [MAIN] display) will be disengaged when any of the Repeat modes are selected.
- Any previously set Repeat mode will be reset to OFF when a different song is selected.

■ Phrase Repeat (DOC files only)

For commercially available DOC files, you can select specific phrase numbers (as indicated on the accompanying sheet music) and repeatedly practice only the selected phrase. (Phrase Repeat can be used for the four songs for which notation is provided in the included Music Book.)

If you select **PHRASE** by using the **REPEAT MODE** ▼ or ▲ buttons, the **PHRASE** display for selection of the phrase number will appear at the right of the button. Press **PHRASE** ▼ or ▲ to highlight the corresponding section of the display, then select the phrase number by using the data dial or [-/+] buttons.

You can also select the phrase number by pressing **PHRASE** ▼ or ▲.

Once song playback is started, the selected phrase will be played back repeatedly until playback is stopped.



NOTE

- Parts can be turned on/off even during the performance.
- The Guide function can also be used simultaneously with Phrase Repeat.
- When Phrase Repeat is started, a lead-in count automatically plays before the phrase. However, for free-tempo songs, a lead-in count is not available.

■ 1 Song Repeat

When **1 SONG** is selected by pressing the **REPEAT MODE** ▼ or ▲ button, any song selected and played as described above will play repeatedly until stopped.



■ AB Repeat

This function allows you to specify any section (between point A and point B) of a song, letting you repeatedly play back the selected section for practice.

When **AB mode** is selected by the **REPEAT MODE** ▼ or ▲ buttons, **A →** and **B** will appear at the right of the buttons in the display to specify points A and B.



While the song is playing back, press the **A →** button once at the beginning of the section to be repeated.

- Then, press the **B** button at the end of the section to be repeated. Repeat playback of the specified section (from point A to point B) will begin automatically.

The programmed A and B points are retained until a different song or a different Repeat mode is selected. The same section can be played back repeatedly as many times as you desire by using the **[PLAY/STOP]** button.

NOTE

- Lead-in count is not played.

NOTE

- The specified A — B points will be erased when a new song number or another Repeat mode is selected.
- A lead-in count automatically plays before the specified section A — B Repeat playback is started. However, for free-tempo songs, a lead-in count is not available.
- To specify the A point as the beginning of the song, press **A →** before playback starts. In this case a lead-in count is not available.
- When both the A and B points are specified, pressing the **B** button clears only the B point, resulting in repeat playback between the A point and the end of the song.
- When both the A and B points are specified, pressing the **A →** button clears both A and B points, allowing you to specify other A and B points within the song.
- The B point cannot be selected unless an A point is selected.

Other Playback Controls

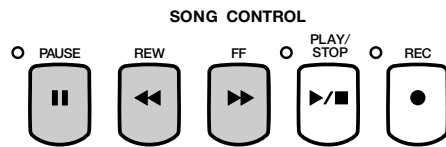

Pause

Press the **[PAUSE]** button during song playback to temporarily stop song playback. Press **[PAUSE]** again or the **[PLAY/STOP]** button to resume playback from the same point.

Rewind and Fast Forward

Use the **[REW]** and **[FF]** buttons to rewind or fast forward to the playback point of the song.

- While playback is stopped or paused, the **[REW]** and **[FF]** buttons can be used to step backward or forward through the song a measure at a time. Holding down either button continuously moves through the song in the corresponding direction.
- During playback, the **[REW]** and **[FF]** buttons allow you to move the playback point of the song rapidly as long as the button is held. No sound is produced during **[REW]** operation.

NOTE

- Using the **[REW]** button may cause the voice, tempo, and/or volume to change.

Playing Other Types of Music Data

About Compatible Software

The CVP-98/96/600 can playback the following types of software.

- **Sequence formats: SMF (format 0 and 1), ESEQ**
- **Voice allocation formats: GM System Level 1, XG, DOC**

Refer to the section “MIDI and Data Compatibility” (page 8 in the Reference Manual) for information on the voice allocation formats and sequence formats.

The internal tone generator of the CVP-98/96/600 automatically resets for compatibility with song data of the Yamaha XG format (including GM System Level 1) (page 8 in the Reference Manual) or of Yamaha DOC voice allocation (page 8 in the Reference Manual), depending on the playback data. (However, the selected voice allocation on the panel will not change.)

Song Data Recorded on Other Instruments

Song data recorded on other Clavinovas (CVP-50/70/55/65/75/83S/85A/87A/59S/69A/69/79A/89/92/94 and CLP-705) will normally be played back with the correct voices even though the volume balance may be slightly different. However, data recorded using the Auto Accompaniment function of the CVP-50/70 cannot be played back properly.

Song data recorded on the Yamaha Disklavier can also be played back.

NOTE

- Regardless of the type of software, only the following disk formats can be used: 3.5" 2DD 720 kilobyte format and 3.5" 2HD 1.44 megabyte format.



Guide Control

The Clavinova has a special Guide function which allows you to practice by using the appropriate disk software. The “piano roll” display and the keyboard guide lamp indicate which keys you should play, and when you should play them. You can even practice at your own pace since the Clavinova pauses playback of the accompaniment until you play the correct keys.

The Guide function can also be used during playback of the “4. GUIDE Demo” song in the Demo mode. Press one of the GUIDE CONTROL buttons during playback of the “4. GUIDE Demo” song in the Demo mode, and use the Guide function to play the melody part.

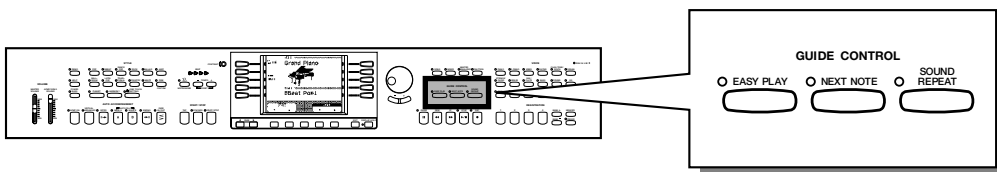

Guide Methods and Piano Roll

The Clavinova has three different Guide methods that can be selected depending on your playing experience or preferences. Beginning players should practice first with Easy Play, then go on to Next Note, then Sound Repeat.

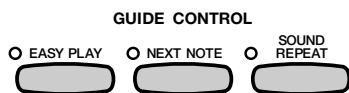

■ Practicing the Timing: Easy Play

Since the Easy Play method lets you practice only the timing of the notes, you can play anywhere on the keyboard. The melody will play back smoothly when you play with the correct timing. (The accompaniment plays back normally in tempo.)

■ Practicing the Notes: Next Note

The Next Note method lets you check which notes to play by looking at the piano roll display and the keyboard guide lamps. Since the Clavinova waits to play the accompaniment until you play the correct note, you can practice at your own pace.

The keyboard guide lamps indicate the timing in which to play, by changing from lit-up to flashing.

NOTE

When the keyboard guide lamps do not flash...

- The guide lamps may not flash in the case of a few songs because of a special guide system. In case of such songs, however, you can switch to the Next Note method so that the lamps flash, if you like. See the “Other Guide-related Functions” on page 103.

■ Practicing Phrase-by-phrase with the Playback: Sound Repeat

In the Sound Repeat method, the Clavinova plays back a short phrase. Listen to the phrase and practice.

Playback of one phrase repeats three times, then is followed automatically by the next phrase.

NOTE

Number of Repeats

- You can set the number of times the phrase will be repeated from the SONG PLAY [GUIDE MODE] display (display page 5). (See page 104.)
- The keyboard guide lamps can be turned on or off as desired.

● Piano Roll

To show the piano roll in the display, press any GUIDE CONTROL button, then press the [PLAY/STOP] button to start playback. A bar of the same length as the note to be played scrolls down from the top of the display toward the bottom. You should play the note at the time the bar reaches the bottom of the display. In order to play the note with the correct duration, hold the note for as long as the bar remains in the display.

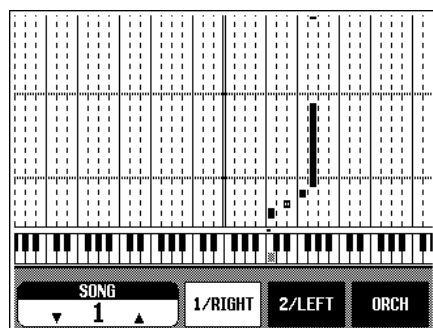

NOTE

Piano Roll On/Off

- The piano roll display can be turned on or off from the SONG PLAY [GUIDE MODE] display (display page 5). (See page 104.)

Using the Guide Function

1 Set up the desired song for practicing.....

Check that the disk is properly inserted in the disk drive before calling up the Guide function.

- > Select the song and cancel the part that you wish to practice yourself from the SONG PLAY [MAIN] display (display page 1).

NOTE

Before Practicing

- Before starting to practice, playback the entire song without cancelling the part to be practiced and listen to it carefully. This will give you a clear idea of how the song should be played, and will make your practice sessions progress more smoothly.

NOTE

Auto Part Cancel

- If you turn on the Guide function without cancelling playback of the part to be practiced, 1/RIGHT part is guided (or the 2/LEFT part is guided when the 1/RIGHT part contains no data). However, when you cancel the part before turning on Guide, the setting will be kept until the song is changed.

2 Select the Guide method.

Press one of the GUIDE CONTROL buttons: [EASY PLAY], [NEXT NOTE] or [SOUND REPEAT].

→ The lamp of the corresponding button lights.

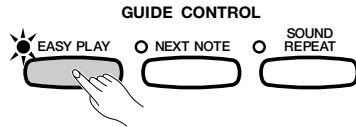

3 Practice the part.

Press the [PLAY/STOP] button to start playback.

→ The piano roll will appear. Practice along with the accompaniment.

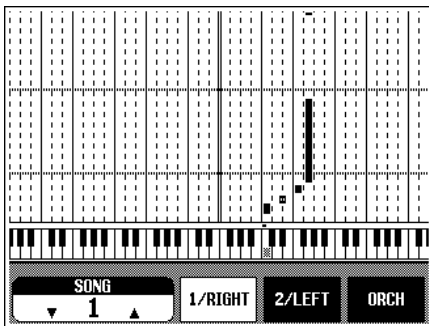

4 Stop your practice session.

The Guide function stops automatically when playback reaches the end of the song. You can also stop song playback by pressing the [PLAY/STOP] button.

To turn off the Guide function, press the appropriate button — [EASY PLAY], [NEXT NOTE] or [SOUND REPEAT] — so that the lamp turns off.

NOTE

Turning Off the Keyboard Guide Lamps

- The keyboard guide lamp can be turned on and off in the SONG PLAY [GUIDE MODE] display. (See page 104.)

NOTE

When the GUIDE CONTROL buttons cannot be turned on...

- The GUIDE CONTROL buttons can be used only in the Song Play mode or when the "4. GUIDE Demo" song is selected in the Demo mode. Only one Guide mode can be selected at a time.

NOTE

Piano Roll On/Off

- The piano roll display can be turned on or off from the SONG PLAY [GUIDE MODE] display (display page 5). (See page 104.)

NOTE

- The correct melody plays back no matter which note you play in the EASY PLAY mode.

NOTE

The Guide method can be changed during playback.

- (However, the Guide mode cannot be changed for songs in which **SPECIAL** is indicated in the GUIDE MODE location in SONG PLAY [GUIDE MODE] display page 5.)

NOTE

- The [PAUSE] button cannot be used in the Next Note or Sound Repeat methods.

NOTE

- The keyboard guide lamps light corresponding to the notes played by the 1/RIGHT and 2/LEFT parts during song playback, even when Guide is set to off — unless the **LAMP** button is turned off in the SONG PLAY [GUIDE MODE] display. The guide lamps indicate the notes to be played by both the 1/RIGHT and 2/LEFT parts when both are turned on or off; when only one of the parts is turned off, the lamps indicate the notes to be played by the part that is turned off.
- The guide part can be selected, the guide lamps can be turned on and off, and the Guide function itself can be turned on or off during playback.

NOTE

- Playback tempo can be set to any desired value after a song has been selected by using the TEMPO [–/+] buttons.
- The positions of the guide lamps will not change, even if the Transpose function (page 130) is used to transpose the pitch of the keyboard.
- The Guide function may not work properly with software which was not produced for independent left- and right-hand playback.
- Since the Guide phrases used in the Sound Repeat method are automatically determined by the Clavinova, they may not precisely match the actual musical phrases. Also, the phrases may become shorter when the Guide function is used for both the left- and right-hand parts.

Other Guide-related Functions

Various settings related to the Guide functions can be made in the SONG PLAY [GUIDE MODE] display (display page 5).

NOTE

- The settings made in this display will also be effective in the Guide function during playback of the “4. GUIDE Demo” song in the Demo mode.

GUIDE MODE

NORMAL is usually displayed in the location of the **GUIDE MODE**. Change the indication to **ENSEMBLE** by pressing the **GUIDE MODE** button; the part which was set to Part Cancel in the SONG PLAY [MAIN] display (display page 1) can then be played with the regular Part Cancel function and the other part (not set to Part Cancel) can be played with the Easy Play function.

NOTE

- The **ENSEMBLE** mode is effective only for songs which have data in both the [1/RIGHT] and [2/LEFT] parts.
- The **ENSEMBLE** mode cannot be used when Next Note or Sound Repeat is selected.

When Next Note is selected and **SPECIAL** is indicated in the **GUIDE MODE** display, a special Guide method is engaged for the selected song. To return the normal Next Note mode, press the **GUIDE MODE** button so that the indication changes to **NORMAL**.

NOTE

- The **SPECIAL** indication appears automatically depending on the song being played back. The **SPECIAL** indication will not appear, even when pressing the **GUIDE MODE** button, when playing back songs that do not feature the special method.
- When using the Easy Play or Sound Repeat method, the respective method is still active, even if the **SPECIAL** indication is shown.



NOTE

Guide Modes

- Settings: NORMAL/ENSEMBLE/(SPECIAL)
- Basic setting: Auto indication of NORMAL/(SPECIAL)
- Backup of last settings: OFF

■ Setting the Sound Repeat Number

To set the number of times the phrase is repeated in the Sound Repeat mode, press the **SOUND REPEAT** button. When **AUTO** is selected, only the notes which have not been played correctly are repeated; the Guide function will automatically go on to the next phrase once the previous one has been played properly.

NOTE

- Sound Repeat Number**
- Settings: *AUTO, 2 - 10*
 - Basic setting: *3*
 - Backup of last settings: *OFF*

■ Lyric Display ON/OFF

To turn lyric display off, press the **LYRICS** button to set the function to OFF.

NOTE

- Lyric Display**
- Setting: *ON/OFF*
 - Basic setting: *ON*
 - Backup of last settings: *OFF*



■ Setting the Piano Roll Indication

The piano roll settings **AUTO/ON/OFF** can be changed by pressing the **PIANO ROLL** button. When **AUTO** is selected, the piano roll will appear by turning on one of the **GUIDE CONTROL** buttons. When this is set to **ON**, the piano roll is always shown during playback; when set to **OFF**, the piano roll is not displayed.

NOTE

- Piano Roll**
- Settings: *AUTO/ON/OFF*
 - Basic setting: *AUTO*
 - Backup of last settings: *OFF*



■ Keyboard Guide Lamp ON/OFF

To turn off the keyboard guide lamps, press the **LAMP** button to set the function to OFF.

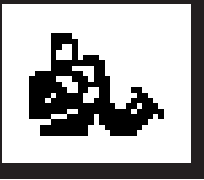

Song Recording

The Clavinova features comprehensive song recording functions that allow you to record your own performances to floppy disks. Three recording methods are available: Quick Recording (page 107), which lets you record quickly and easily; Track Recording (page 110), with which you can record multiple instrumental parts; and Chord Sequence (page 116), which lets you step-record Auto Accompaniment chords.

The music you create by recording is called a song. Up to approximately 60 songs can be recorded on a single disk, depending on the amount of data contained in each song. Before you can record, however, you must “format” a new disk. (See page 106).

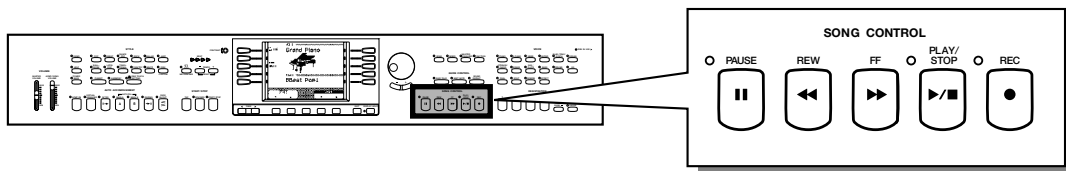

● Structure of a Song

A song can be made up of several instrumental parts, each assigned to a different track, as shown in the example below.

Song Recording track chart

Track 1	Piano Part (right-hand)
Track 2	Piano Part (left-hand)
Track 3	Bass Part
Track 4	Strings Part
:	:
Track 9	Rhythm Part
Track 10	Rhythm Part
:	:
Track 16	Organ Part

(Up to a maximum of 16 tracks.)

Various confirmation, alert, and error messages may appear in the display during operation. Refer to the “Messages” section (page 2 in the Reference Manual) for information on the messages.

NOTE

- Refer to “Handling Floppy Disks” (page 7) for information on using floppy disks.
- Songs recorded by the CVP-98/96/600 are saved as XG/SMF (format 0) files. See page 8 in the Reference Manual for information on the XG/SMF (format 0) format.
- Recorded song data is not output through the MIDI OUT terminal when played back.

Recording Setup: Disk Format

Before you can record to the included blank disk, you will have to format it. Commercially available blank disks must also be formatted before using. Refer to Format in the Function section (page 135) to re-format floppy disks that have already been used for recording.

1 Insert a disk.

Gently insert the included blank disk for recording into the disk drive face up as shown in the illustration until it clicks into place.

- ➔ A few seconds after inserting the disk into the disk drive, a “Start disk format?” message appears in the display. To start formatting, press the **OK** button. To cancel the format operation, press **CANCEL**.

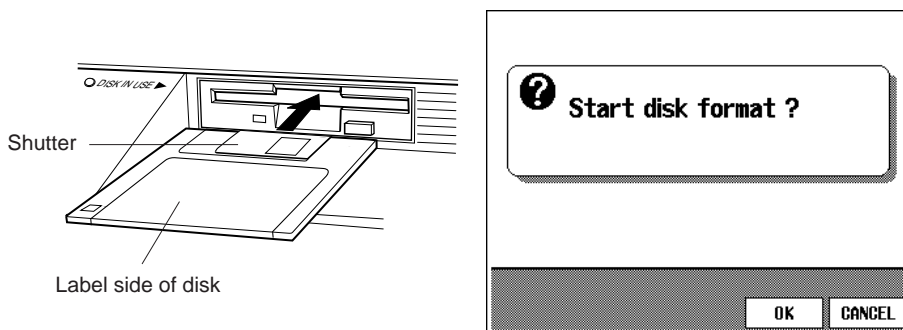

NOTE

- The same display appears when inserting blank unformatted disks, or disks of different formats.

NOTE

Format Types

- 2DD disks are formatted to 720 KB, while 2HD disks are formatted to 1.44 MB.

2 Execute the format operation.

An “Are you sure?” message appears in the LCD display; press **YES** to execute the operation, or **NO** button to cancel it.

A bar graph appears in the LCD display during formatting to indicate progress of the operation. The display automatically returns to the previous display when formatting is completed.

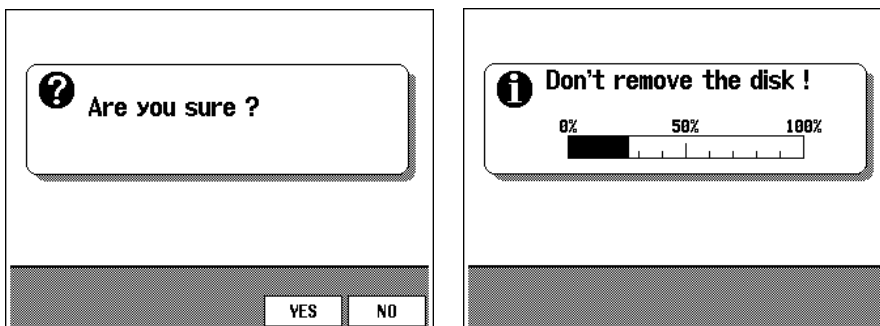

Quick Recording

1 Insert a formatted disk.

Make sure that the disk's write protect tab is set to the "write" position, then insert the disk face up with the shutter forward until it clicks into place.

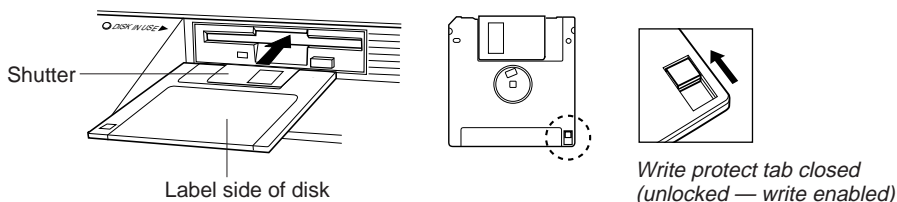

- ➔ The DISK IN USE lamp stays lit until the Clavinova reads and recognizes the disk. If the Song Play mode is not automatically called up, press the [SONG] button.
- ➔ The lamp lights and the SONG PLAY MAIN display appears. If the SONG PLAY MAIN display is not shown, use the PAGE [◀] [▶] buttons to select display page 1.

2 Select the song number to be recorded.

Select the desired song number for recording by using the **SONG ▼** or **▲** buttons, data dial or [-/+] buttons. The song number can be selected from between 1 and 60. The selected number becomes the location that the song will be recorded. If a song name appears beside the song number, the selected song already contains data, and another song number must be selected.

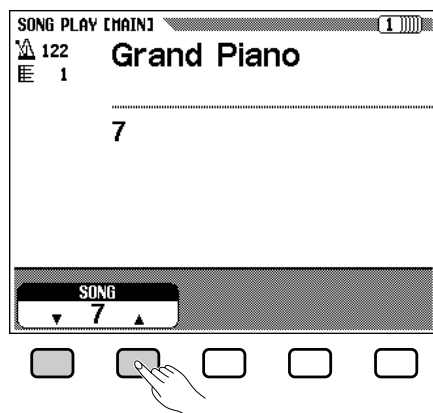

NOTE

- The SONG PLAY mode will not automatically be called up, even after inserting the disk, in disk-related Function operations and the CUSTOM STYLE display.

NOTE

Using Style File Disks

- When using Style File disks, first load the desired data from the Style File disk (page 80), then insert the recording disk.

3 Select the record mode.

Press the [REC] button.

- ➔ The [REC] lamp lights and the QUICK RECORD display of record mode page 1 appears.

Call up page 1 by using the PAGE [◀] [▶] buttons if the lamp is lit but the QUICK RECORD display is not shown.

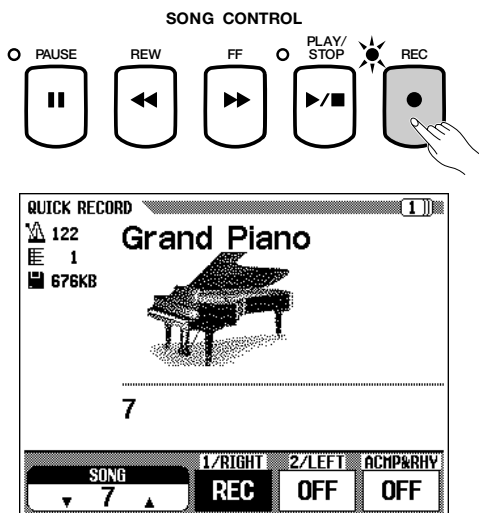

4 Select the part for recording.

In Quick Recording, three parts can be recorded: the right hand part (1/RIGHT), the left hand part (2/LEFT) and the Auto Accompaniment & rhythm part (ACMP & RHY). Press the appropriate button — 1/RIGHT, 2/LEFT or ACMP&RHY — to set the part to **REC** (record enable) or **OFF** (record/playback disabled). The **PLAY** (playback) setting can be selected only for parts which already contain data.

The **ACMP&RHY** part can automatically be set to **REC** by pressing the panel [ACMP ON] button. To record only the rhythm, leave **ACMP&RHY** set to **REC**, then press the [ACMP ON] button so that the lamp goes out.

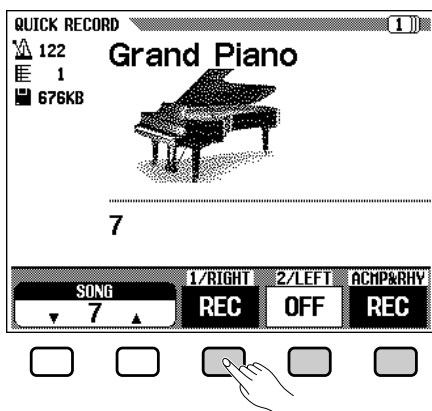

When a part is set to **REC** (record enable), recording is set to stand-by and automatically starts when you play the keyboard.

NOTE

- The song number for recording can be changed in the QUICK RECORD display.
- If Auto Accompaniment is turned on when entering the record mode, the **ACMP&RHY** track will automatically change to the **REC** display.

NOTE

- Both **1/RIGHT** and **2/LEFT** cannot be set to **REC** at the same time.

NOTE

Tracks Recorded with Harmony, Dual or Split Functions

- You can record your performance with harmony parts using the Harmony function, or record two different parts by using the Dual or Split functions. Harmony is recorded to tracks 6, 7 and 8. When using Dual with recording of the 1/RIGHT part, data is recorded to tracks 1 and 3; when using Split with recording of the 1/RIGHT part, data is recorded to tracks 1 and 5. When using Dual with the 2/LEFT part, data is recorded to tracks 2 and 4; when using Split with the 2/LEFT part, data is recorded to tracks 2 and 5.

NOTE

Tracks Recorded Using Auto Accompaniment

- When recording Auto Accompaniment, the rhythm is recorded to tracks 9 - 10, bass to track 11, and chordal backing to tracks 12 - 16.

NOTE

- When any part is displayed in **REC**, the remaining memory capacity of the disk (in kilobytes) will appear directly below the measure indication in the display. Empty 2DD and 2HD disks should have about 690KB and 1400KB, respectively. This is room enough for about 50,000/100,000 notes if no other data is recorded.

NOTE

- When the **ACMP&RHY** part is set to **REC**, the metronome will sound to provide a timing guide in the Synchronized Start mode before recording is started. (The metronome doesn't sound when Synchronized Start is released.)
- The Chord Sequence recording method (page 116) lets you record Auto Accompaniment without having to play chord parts in tempo.

5 Select the desired voices and accompaniment style, etc.

Select the voices and accompaniment style and set the tempo in the normal way, and other settings needed. (If you want to try out the selected voices, style and tempo, etc., make sure to do so before entering the SONG PLAY mode, since the recording will start as soon as you play the keyboard or press the [START/STOP] button.)

6 Start recording.

There are several ways to start recording, as described below.

- **Recording your keyboard performance (1 / RIGHT or 2 / LEFT)**

Start playing the keyboard or press the [PLAY/STOP] button.

- **Recording the Auto Accompaniment or rhythm (ACMP&RHY)**

Start playing the keyboard (in the left range when the keyboard is split) with the Synchronized Start function or press the [START/STOP] button.

- **Recording your keyboard performance together with the Auto Accompaniment or rhythm**

Start recording in the same way as described in “Recording the Auto Accompaniment or rhythm (ACMP&RHY)” above to start recording your keyboard performance together with the Auto Accompaniment or rhythm.

- **Recording the Auto Accompaniment or rhythm in the middle of recording your keyboard performance**

Start recording your keyboard performance as in “Recording your keyboard performance (1 / RIGHT or 2 / LEFT)” above, then start recording the Auto Accompaniment or rhythm while you play as described in “Recording the Auto Accompaniment or rhythm (ACMP&RHY)” above.

NOTE

When Using Style File Disks

- When using Style File disks, make sure to load the data from the Style File disk (page 80) before inserting the disk for recording.

NOTE

- The Auto Accompaniment functions — INTRO, AUTO FILL, ENDING, and FADE IN/OUT — can be also recorded. Press the INTRO button before starting to record, press the AUTO FILL button during recording, press the ENDING button at the end of recording, and press the FADE IN/OUT button at the beginning or ending of the recording. When the ENDING button or the FADE IN/OUT button is pressed at the ending, recording stops automatically after playing the ending pattern or fade out.

NOTE

Recording Along with the Metronome

1. After selecting the voice, press the [METRONOME] button, and set the Beat parameter in the METRONOME display. → The metronome will start sounding.
2. The recording starts as soon as you play the keyboard. The metronome sound is not recorded.

When a disk is not inserted...

- A song can be recorded to internal memory if it is short enough. A maximum of approximately 2500 notes 25KB can be recorded; however, this amount may be less if other functions are used. The internally recorded song will be deleted when the power is turned off or when another song is loaded. See “Recording Without a Disk” (page 127) for more information.

NOTE

Adjusting the Volume During Recording

- During recording, you can adjust the volume of the recorded Auto Accompaniment and/or keyboard part from the [ACMP/SONG VOLUME] control and the MIXER display. When entering the record mode, [ACMP/SONG VOLUME] is automatically reset to the default value (MAX), regardless of the current slider position.

Turning Harmony or Split On/Off During Recording

- When recording the 1/RIGHT part, [HARMONY] or [SPLIT] can be set to on and recorded for only this part. When the 2/LEFT part is selected, the Harmony sound and the left range of the split cannot be recorded. When the recording part is changed, [HARMONY] and [SPLIT] are automatically turned off.

NOTE

- The keyboard guide lamps do not light up during recording.

7 Stop recording.

Press the [PLAY/STOP] button.

- ➔ Recording stops. When the recorded data has been written to disk, the [REC] lamp goes out and the song play display appears. You can also stop recording by pressing the [REC] button.

When pressing the [START/STOP] button, only the recording of the Auto Accompaniment or rhythm will stop. You can continue recording your keyboard performance, without the Auto Accompaniment and rhythm. Press either the [PLAY/STOP] or [REC] button in order to actually stop recording.

8 Play back the recording.

Press the [PLAY/STOP] button.

- ➔ The recorded data will be played back. During playback you can use the [REW], [FF] and [PAUSE] buttons to control the playback, and use the TEMPO [-/+] buttons to change the tempo. You can also play along on the keyboard.

Playback will stop automatically when the end of the recording is reached, or you can press the [PLAY/STOP] button again to stop it at anytime.

NOTE

- The Clavinova may continue to write data to the disk for a short time after you stop recording. DO NOT eject the disk while the DISK IN USE lamp of the disk drive is lit.
- When a song has been recorded, a temporary name **SONG ***** (***) is the number) will automatically be given to the song. You can change the name as desired. (See page 120.)
- The [ACMP ON] and/or [HARMONY] lamp(s) automatically go out when recording of these parts has finished.
- When recording is finished, [ACMP/SONG VOLUME] is automatically reset to the default setting (MAX), regardless of the current slider position.

Track Recording (Multi-track Recording)

1 Set up the instrument for recording.

The first three steps in the Track Recording process are exactly the same as those for Quick Recording. (See page 107.)

2 Select the TRACK RECORD Page

Use the PAGE [◀] [▶] buttons to select the TRACK RECORD page (RECORD display page 2). Each track will be displayed in the TRACK ◀▶ section. Tracks which are enabled for playback are indicated by a box surrounding the track number, and tracks which are record-enabled are indicated by highlighted number. Tracks which do not contain data are not displayed.

NOTE

- When the Rhythm track(s) contain data, an "■" indication appears at the right below "RHYTHM" in the display.



3 Select the desired track for recording.

Press the **TRACK** ◀ or ▶ buttons or use the data dial or [-/+] buttons to select the track.

→ The selected track is indicated by an underline mark.

Use the LCD button at the far right to set the selected tracks to **RECORD** (record enable) or **OFF** (record/playback disable). **PLAY** can only be selected for tracks which contain data. When a track is muted, the track number is “ghosted” (shown in lighter indication) in the display.

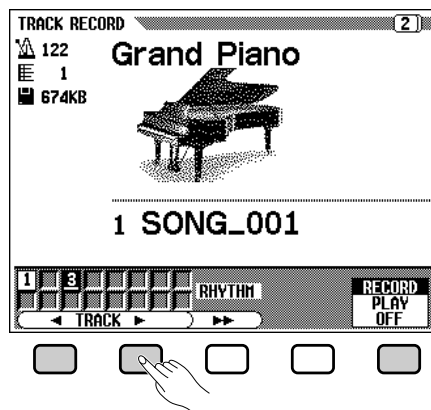

Three separate tracks can be set to record simultaneously when recording keyboard parts.

If you intend to record using the Dual or Split functions, two tracks must be record-enabled.

If you intend to use both the Dual and Split functions simultaneously, three tracks must be selected.

If Auto Accompaniment and/or Harmony are turned on, the recording track numbers are automatically fixed, as described below.

- * If Auto Accompaniment is turned on, tracks 9 through 16 are automatically record-enabled for recording the Auto Accompaniment data. If the Harmony function is turned on, tracks 6 through 8 are automatically record-enabled for recording the Harmony data.

When the **RHYTHM** button is pressed, tracks 9 and 10 are automatically selected for the rhythm data. Set tracks 9 and 10 to **RECORD**, **PLAY**, or **OFF** by using the LCD button at the far right.



NOTE

- Track 10 (and 9, in some cases) can only be used to record the rhythm sound of the accompaniment style and cannot be used to record keyboard part. Also, the keyboard part should be recorded on a track other than those used for Harmony or Auto Accompaniment.
- When Auto Accompaniment is turned on, Synchronized Start recording is automatically set to stand-by.
- When the RHYTHM tracks (9 and 10) are set to **RECORD**, the metronome will sound to provide a timing guide in the Synchronized Start mode.

4 Set all performance features as required.

After setting the tracks to be recorded, set up all necessary performance features as required: voice, accompaniment style, tempo, reverb, etc.

5 Start recording.

There are several ways to start recording, as described below.

• Recording your keyboard performance

Start playing the keyboard or press the [PLAY/STOP] button.

• Recording the Auto Accompaniment or rhythm

Start playing the keyboard (in the left range when the keyboard is split) with the Synchronized Start function or press the [START/STOP] button.

• Recording your keyboard performance together with the Auto Accompaniment or rhythm

Start recording in the same way as described in “Recording the Auto Accompaniment or rhythm“ above to start recording your keyboard performance together with the Auto Accompaniment or rhythm.

• Recording the Auto Accompaniment or rhythm in the middle of recording your keyboard performance

Start recording your keyboard performance as in “Recording your keyboard performance” above, then start recording the Auto Accompaniment or rhythm while you play as described in “Recording the Auto Accompaniment or rhythm” above.

The current measure number is shown in the display as you record. The parameters listed below will be recorded in addition to notes you play. (Recorded parameters differ depending on the play styles and settings.)

Parameters Recorded for Each Track

- Notes
- Voice
- Volume (initially maximum)
- Pan
- Damper pedal
- Soft pedal
- Sostenuato pedal
- Reverb depth
- Effect depth
- Individual part volume
- Fade-in/out (converted into volume data)

Other Recorded Parameters

Accompaniment style data which is recorded but not listed above includes:

- Individual part volume

Parameters Recorded for the Entire Song

- Tempo
- Reverb type
- Reverb depth
- Effect type*
- Accompaniment style
- Intro
- Main A/B
- Fill-in
- Ending

* The last recorded track effect takes priority.

NOTE

- If Auto Accompaniment and/or Harmony are already on when the Track Recording page is selected, the corresponding tracks are automatically record-enabled and the Synchronized Start mode is automatically turned on.
- If you want to re-record part of the song (for example, if you've made a mistake in the recording), you can easily do so with the Punch-in /out Recording function (page 113).

NOTE

Backing Up Your Data

- Any time you have recorded some amount of data, you should copy the data to another song number for backup purposes (see page 136 for information on the Copy operation). Doing this prevents accidental loss of important data, should you inadvertently delete the data during recording.

6 Stop recording.

Press the [PLAY/STOP] button.

- ➔ Recording stops. The [REC] lamp goes out when the data has been written to the disk, and the song play display appears.

You can also stop recording by pressing the [REC] button.

When pressing the [START/STOP] button, only the recording of the Auto Accompaniment or rhythm will stop. You can continue recording your keyboard performance without the Auto Accompaniment or rhythm. Press either the [PLAY/STOP] or [REC] button in order to actually stop recording.

NOTE

- When recording is finished, [ACMP/ SONG VOLUME] is automatically reset to the default setting (MAX), regardless of the current slider position.

Adding New Tracks

You can add a new track to your song by selecting a new record track(s) and voice(s) for recording as described above. You can record while playing back and monitoring the previously recorded tracks, letting you assemble a complete song by repeating this process.

NOTE

- If you record on a track that has already been recorded, the previous material will be erased and the new material will be recorded in its place.

Punch-in/out Recording

With the Punch-in/out Recording function, you can selectively re-record specified sections of the song. Punch-in/out recording allows you to start recording from any “Punch-in” point within a previously recorded track and stop recording at any “Punch-out” point, leaving intact all recorded material up to the Punch-in point and following the Punch-out point.

NOTE

- Punch-in/out recording cannot be used on tracks to which Auto Accompaniment, rhythm and/or Harmony are recorded.

1 Play back the song.

Play back the song in order to locate the point you want to Punch-in (re-record) from .

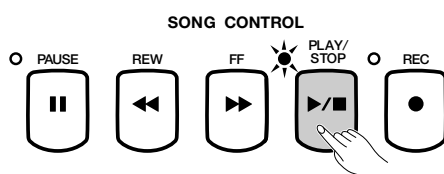

2 Pause before the Punch-in point.

Press the [PAUSE] button to pause play back a bit before the point at which you want to start recording. Leave a measure or more before the Punch-in point so you'll be able to grasp the timing for the Punch in.

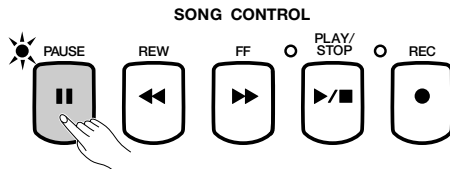

3 Turn on the Punch-in/out function.

Press the [REC] button.

→ The PUNCH IN/OUT display appears.

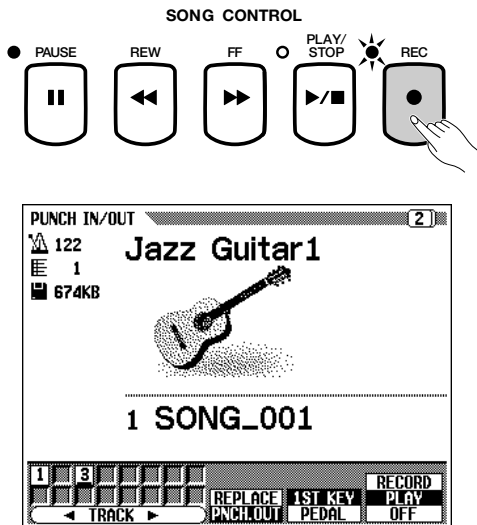

4 Select a track.

Press the **TRACK** ◀ or ▶ buttons or use the data dial or [-/+] buttons to select the track.

→ The selected track is indicated by an underline mark.

Use the LCD button at the far right to set the selected track to **RECORD** (record enable) or **OFF** (record/playback disable). **PLAY** can only be selected for tracks which contain data. When a track is muted, the track number is “ghosted” (shown in lighter indication) in the display.

NOTE

- Only tracks which allow Punch-in/out Recording will appear and can be selected. The rhythm, Auto Accompaniment and Harmony tracks cannot be selected.

NOTE

Auto Setting of Punch-in/out

- If no other track is selected, the last recorded track is automatically selected for Punch-in/out.

5 Select the Punch-in mode.

Select the desired Punch-in mode by using the LCD button located second from the right. Two modes are available, as described below.

1ST KEY	Recording begins as soon as the first key is played, after Punch-in playback is started in step 7 (below).
PEDAL	Recording begins as soon as the left pedal is pressed, after Punch-in playback is started in step 7 (below).

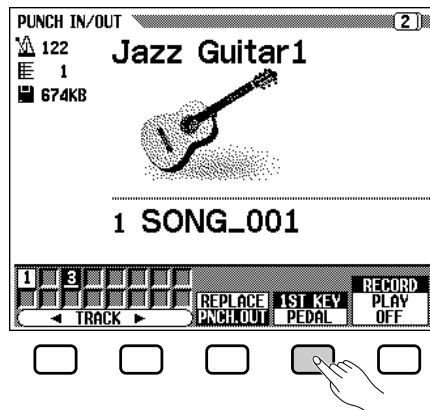

NOTE

- When the PEDAL Punch-in mode is selected, the left pedal is automatically assigned for this function only (the normal pedal function is canceled).

6 Select the Punch-out mode.

Select the desired Punch-out mode by using the center LCD button. Two modes are available, as described below.

REPLACE	When recording is stopped, all data following the stopped point will be erased.
PNCH.OUT	When recording is stopped, all data following the stopped point will remain intact.

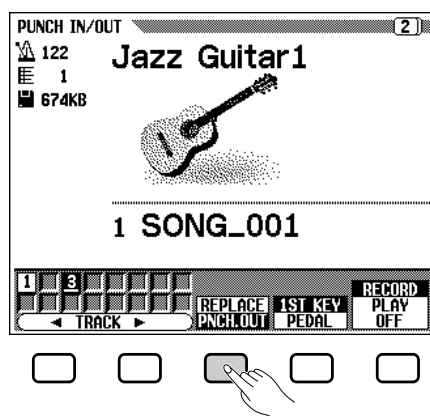

7 Start playback and recording.

Press the [PLAY/STOP] or [PAUSE] button to start playback from the current paused location.

To start Punch-in record when the 1ST KEY mode is selected, simply begin playing at the point from which you want to record.

To start Punch-in record when the PEDAL mode is selected, press the left pedal at the point from which you want to record.

NOTE

- When the PEDAL Punch-in mode is selected, recording can be started directly by pressing the left pedal, without having to start playback by pressing the [PLAY/STOP] or [PAUSE] button.

8 Stop recording.

Press the [PLAY/STOP] button.

- ➔ Recording stops. When the data has been written to disk, the [REC] lamp goes out and the SONG PLAY [MAIN] display appears.

You can also stop recording by pressing the [REC] button.

NOTE

- When the PEDAL mode is selected, recording can also be stopped by pressing the left pedal.

Chord Sequence

The Chord Sequence function allows you to enter Auto Accompaniment data step-by-step according to chord names, and lets you record the accompaniment part without having to play the song in time with the rhythm or at a certain tempo.

1 Set up the instrument for recording.

Just as you did in steps 1 through 3 of Quick Recording, insert a formatted disk, select a song number, then press the [REC] button to enter the Record mode.

- Select the RECORD [EDIT] display, page 3 of the Record mode, by using the PAGE [◀] [▶] buttons.

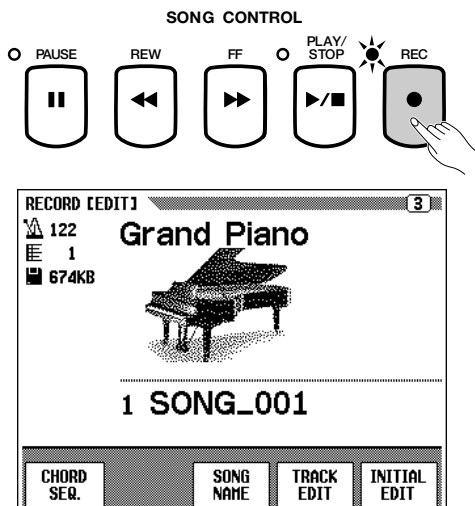

● Set Up for Step Recording of the Data

You can enter the chords with the **SINGLE FINGER**, **MULTI FINGER**, or **FINGERED** Auto Accompaniment modes, or by specifying the chord name manually from the LCD display. If you wish to enter chords with one of the Auto Accompaniment modes, select the desired mode at this point.

2 Turn on the Chord Sequence function.

Press the **CHORD SEQ.** button in the RECORD [EDIT] display.

- ➔ The CHORD SEQUENCE display appears and Auto Accompaniment is turned on. If the Full Keyboard mode is currently active, the Fingered Chord mode will be selected instead.

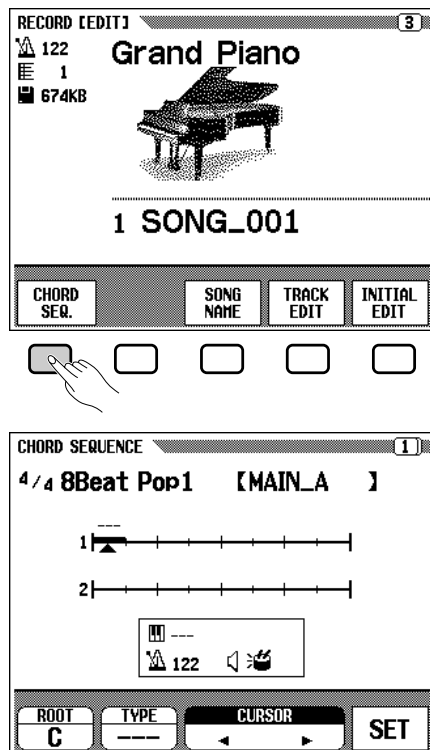

3 Move the cursor to the entry point.

The display shows measures as a horizontal line with 8th-note divisions.

To move the triangular cursor along the measure indication to the point at which you want to enter a chord or style change, press one of the **CURSOR** ◀ ▶ buttons (the section is highlighted), then use the data dial or [-/+] buttons.

You can also move the triangular cursor by pressing the **CURSOR** ◀ ▶ buttons.

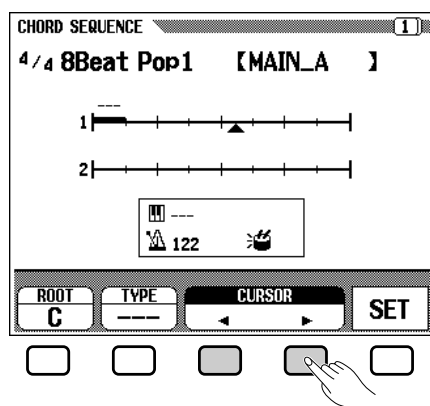

NOTE

Changing the Auto Accompaniment Mode

- Auto Accompaniment cannot be turned off while the Chord Sequence function is active. However, you can select from among the Multi Finger, Fingered, and Single Finger Auto Accompaniment modes from the pop-up display by pressing the [ACMP ON] button. The split point can also be changed.

NOTE

When Chord Sequence cannot be turned on...

- The chord sequence function cannot be used when no disk has been inserted in the disk drive.

NOTE

- The Chord Sequence data will automatically replace any previous data in the Auto Accompaniment and rhythm tracks that was recorded in the Quick Record or Track Record modes.
- Up to 999 measures can be recorded using the Chord Sequence function.
- The chord input resolution will be automatically selected according to the current style. For styles of 2/4, 3/4, 4/4, 5/4, 6/8, 9/8 and 12/8 time signatures, one chord can be entered on every 8th note or 8th-note triplet. For other time signatures, one chord can be entered for each measure.

NOTE

Entering Accompaniment Style and Section Changes

- One style change or section change (page 118) can be made at the beginning of each measure (The Intro pattern can only be entered at the beginning of a song.). However, Auto Fill data can be entered anywhere you desire.

NOTE

Adjusting the Volume of Auto Accompaniment

- You can also enter volume changes for the Auto Accompaniment. Used judiciously, these can help you create professional-sounding dynamic changes in the Auto Accompaniment of your song. To do this, first enter the Auto Accompaniment part volume data from the MIXER display; the volume event symbol (V) will appear in the box in the middle of the display. To actually record the volume data at the current position, press the **SET** button in the CHORD SEQUENCE display. (An initial volume event is automatically entered at the beginning of a song.)

4 Enter and set the chords and/or style changes.

To enter a chord, either play the chord with appropriate fingering on the left range of the Auto Accompaniment section of the keyboard (lower than the split point), or highlight **ROOT** or **TYPE** in the LCD display and use the data dial or [-/+] buttons.

You can also select the chord by pressing the **ROOT** or **TYPE** button.

- To enter a style change (style, section and tempo) simply make the appropriate selections in the normal way.
- Once the chord and/or style has been selected, press the **SET** button. The data is recorded to the current location, and a black box and the recorded chord name appear in the measure indication. The cursor automatically moves to the next position.

The entered data of the recorded style will be shown in the display: the time signature, the style name and section appear at the top of the display, and the chord name and tempo in the box at the middle of the display.

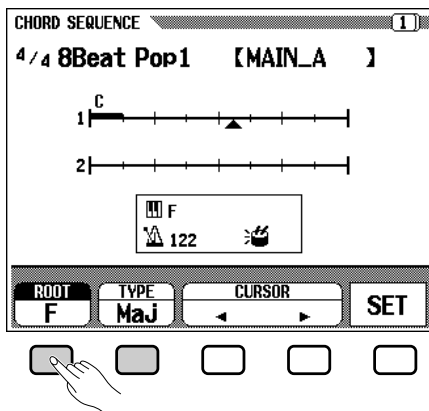

Continue moving the cursor to other positions and enter chords and style changes in this manner. You can always check the entered data during the operation by playing back the sequence using the **[PLAY/STOP]** button.

The data recorded by the Chord Sequence function is listed below.

Data Recorded By the Chord Sequence Function

- Accompaniment style
- Section (MAIN A/B, Intro, Ending, Auto-fill, Fade-in/out, Break)
- Chord name
- Auto accompaniment part volume (MIXER settings)
- Tempo
- Rhythm on/off
- ACMP/SONG volume (as an initial setting only)
- SMALL ACMP
- VIRTUAL ARRANGER (one ON/OFF setting for an entire song only)

NOTE

- The input chord name also appears in the **ROOT** and **TYPE** sections of the display when a chord is entered via the keyboard.

NOTE

- The chord name is indicated only at the first beat of the measure line, with the exception of 4/4 and 12/8 time signatures, for which indications appear at the first and third beats.

NOTE

- Fade-out cannot be entered during Fade-in.

NOTE

Entering Rhythm-only Sections

- You can also record the rhythm alone (without accompaniment) to your song. To do this, record a blank chord in the desired measure by leaving the **TYPE** parameter set to " - - -".

NOTE

Entering a Break

- A complete break can be created by setting the chord type to " - - -" and setting rhythm sound to "OFF" (see "RHYTHM ON/OFF" below).

NOTE

- The types of chords that can be entered are the same as those listed for the fingered mode (page 59). On-bass chords can be entered via the keyboard.
- The measure number is indicated at the left of the measure indication.
- For information on other useful editing features, see the section "Chord Sequence Page 2 Functions" below.
- The same chord, as set previously (i.e., the same chord shown in the box at the middle of the display), cannot be entered even if the **SET** button is pressed.

5 Stop recording.

When all recording has been finished, select page 2 of the CHORD SEQUENCE display, then press the **END MARK** and **SET** buttons and input an “end mark” which determines the location of the ending. The end mark will be displayed in the box at the middle of the display.

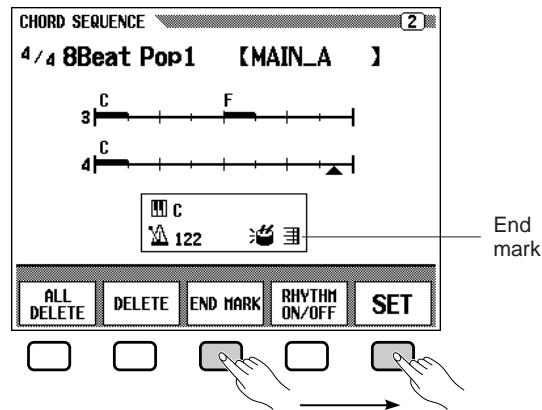

Finally, press the **[REC]** button and a “Save recorded data?” message will appear. Press **YES** to store the recorded data and automatically leave the Chord Sequence function; the display returns to the SONG PLAY display. To leave without saving the data, press **NO**. To continue editing the sequence without saving the data, press **CANCEL**.

NOTE

- The chord sequence data now resides in tracks 9 through 16, and can be played back in the normal way. Add other tracks as desired by using the standard track selection and recording procedure. You can also record over the Auto Accompaniment parts and replace them with original material if you like by using the standard track selection and record procedure.
- The song recorded via the Chord Sequence function can be modified later by re-entering the Chord Sequence mode and making the desired changes. However, keep in mind that any data recorded over the Auto Accompaniment parts (with normal track recording) will be replaced by the preset accompaniment style data. (For example, even if you’ve recorded your own bass part, it will be erased and replaced by the original bass pattern if you correct the data in the Chord Sequence display.)

Other Chord Sequence Functions

Page 2 of the CHORD SEQUENCE display contains a number of versatile functions that help you enter chords more efficiently.

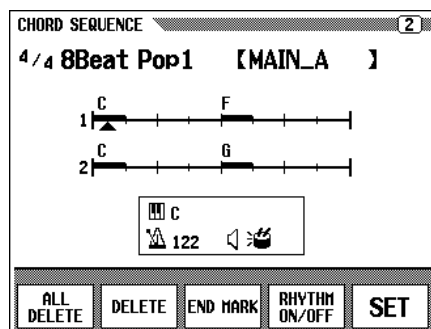

ALL DELETE

To delete all sequence data, press the **ALL DELETE** button. An “Are you sure?” confirmation prompt appears. Press **YES** to execute the operation, or **NO** to cancel.

DELETE

To delete the data at the current cursor location, press the **DELETE** button. An “Are you sure?” confirmation prompt appears. Press **YES** to execute the operation, or **NO** to cancel.

END MARK

To enter an “end mark” at the current cursor location, press the **END MARK** button followed by the **SET** button. An end mark signifies the end of the song, and should always be entered to properly end each song. (An end mark is unnecessary when ending with an Ending pattern or Fade-out.) The cursor cannot be moved past an end mark. You can delete an end mark by using the **DELETE** button, just as with other normal data.

RHYTHM ON/OFF

To turn the rhythm sound on or off, press the **RHYTHM ON/OFF** button followed by the **SET** button. No rhythm sound is produced following the location to which a “rhythm off” event is entered; the rhythm starts sounding again from the location to which a “rhythm on” event is entered.



End Mark

- Unless an end mark is entered, the song will end one measure after the last entered data. If an Ending pattern or Fade-out is input, the song will end at the last measure of the Ending or Fade-out.



- The rhythm on/off status can be checked by mark in the box at the middle of the display.

Record Edit Function

The Record mode also features a number of convenient edit functions that provide even greater control over the song data. The Record Edit functions include: Song Name, which lets you name a recorded song file; Track Edit, which gives you a variety of track-related editing controls, such as Track Mix and Track Delete; and Initial Edit, which lets you change the data at the beginning of a song, such as voice, reverb, and effect settings.

To select the Record Edit function, call up the RECORD [EDIT] display (Record display page 3) after selecting the song you wish to edit.



- The Record Edit functions can only be used for song data recorded with the CVP-98/96/600 (or 94/92).



Song Name

This function is used to name song files recorded with the Clavinova or to change existing names. To call up the Song Name function, press the **SONG NAME** button in the RECORD [EDIT] display.

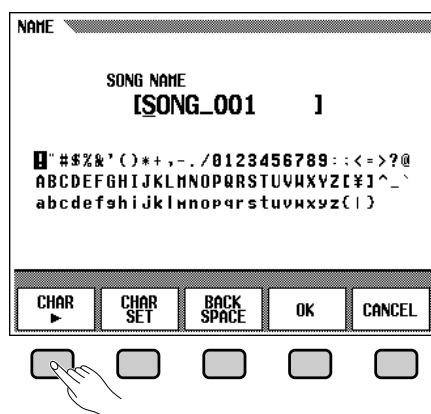

NOTE

- The Song Name function cannot be used when a disk has not been inserted in the disk drive.

1 Enter the desired name.

Use the **CHAR ►** button to move the underline cursor to the desired character position in the file name display. (File names can be up to 12 characters in length).

- Use the data dial or [-/+] buttons to select and highlight the character or mark you wish to enter.

Press the **CHAR SET** button to enter the selected character to the current cursor position and move to the next position. Continue entering other characters or marks in this way.

To delete the character at the previous position, press the **BACK SPACE** button. The character before the underline cursor is deleted and the cursor moves back to the deleted position.

To abort the Song Name operation and return to the RECORD EDIT display, press the **CANCEL** button.

2 Register the name.

When the song file name is complete, press the **OK** button to register it. The new name is registered as the current song file name. To cancel the operation, press the **CANCEL** button.

To exit from the Song Name function, press the [REC] button (the lamp goes out).

Track Edit

Press the **TRACK EDIT** button in the RECORD [EDIT] display to call up the TRACK EDIT display. There are three pages in the TRACK EDIT display: TRACK EDIT [MIX], TRACK EDIT [DELETE], and TRACK EDIT [QUANTIZE].

■ Track Mix — Track Edit Page 1

The Track Mix function combines the data from two specified tracks and copies the result to a third specified track.

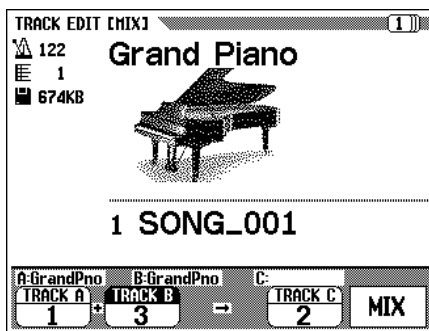

1 Specify the two tracks to be mixed.

Press the **TRACK A** and **TRACK B** buttons to highlight the parameters, and use the data dial or [-/+] buttons to select the two track numbers to be mixed. The voices which are used for the selected tracks are indicated at the side of A:/B:, located at the left of the LCD display.

2 Specify the destination track.

Use the **TRACK C** parameter to specify the track to which you want to record the mixed data. You can also specify the track for the mixed data by highlighting the appropriate section using the **TRACK C** button, then using the data dial or [-/+] buttons.

Any previous data in the destination track will be erased.

3 Execute the Track Mix operation.

Press the **MIX** button to begin execution of the Track Mix operation. An "Are you sure?" confirmation prompt will appear. Press **YES** to execute the Track Mix operation or press **NO** to cancel.

When this is completed, the **MIX** button will change to **UNDO**, allowing you to undo the Track Mix operation and restore the previous data (before mixing).

Press the **[REC]** button (the lamp goes out) to exit the Track Mix function.

You can also exit the Track Mix function by pressing the **[EXIT]** button.

NOTE

Track Copy

- Only tracks containing data will appear and can be selected for **TRACK A** and **TRACK B**. In addition, "--" (no track) can also be selected for **TRACK B**. In this case, the data of **TRACK A** will simply be copied to **TRACK C**.

NOTE

- For the Track Mix function, the selected track voice and volume data, etc. (i.e., all data except note data) of **TRACK A** will be effective for the track after the mix operation.

NOTE

- The previous data of the mixed track will remain even after executing Track Mix. If the old data is not needed, you should delete it. (See "Track Delete" below.)
- A bar graph indicating the progress of the Track Mix operation will appear while the data is being processed.
- You can check if the results are as you expected or not, by starting and stopping playback with the **[PLAY/STOP]** button before performing the **UNDO** operation.
- The Undo function cannot be used if you've selected another track or exited from this mode.
- The Undo feature cannot be used for data recorded to internal RAM (see page 127).

Track Delete — Track Edit, Page 2

The Track Delete function can be used to delete the data from any specified track.



1 Specify the track to be deleted.

Use the **TRACK** ▼ or ▲ button to highlight the Track parameter, then use the data dial or [-/+] buttons to select the track to be deleted.

2 Execute the Delete operation.

Press the **DELETE** button. At the “Are You Sure?” confirmation prompt, press **YES** to execute the Delete operation or **NO** to cancel.

The **DELETE** display will change to the **UNDO** display after the Delete operation is executed. If the result is not what you expected, press the **UNDO** button to restore the data of the deleted track to what it was before performing the Delete operation.

To exit the Track Delete function, press the **[REC]** button (the lamp goes out).

You can also press the **[EXIT]** button to exit the Track Delete function.

Track Quantize

You can “tighten up” the timing of a recorded part by aligning all notes to specified beats with the Track Quantize function. For example, you can accurately align the recorded notes to 8th- or 16th-note resolution.



NOTE

- Only tracks containing data will appear and can be selected.

NOTE

- A bar graph indicating the progress of the Track Delete operation will appear while the data is being processed.
- You can check if the results are as you expected or not, by starting and stopping playback with the **[PLAY/STOP]** button before performing the **UNDO** operation.
- The Undo function cannot be used if you've selected another track or exited from this mode.
- The Undo feature cannot be used for data recorded to internal RAM (see page 127).

1 Specify the track to be quantized.

Use the **TRACK** ▼ or ▲ button to highlight the Track parameter, then use the data dial or [-/+] buttons to select the track to be quantized.

2 Specify the quantize “size.”

Press the LCD button below the note symbol to select the desired quantize “size” as shown below.

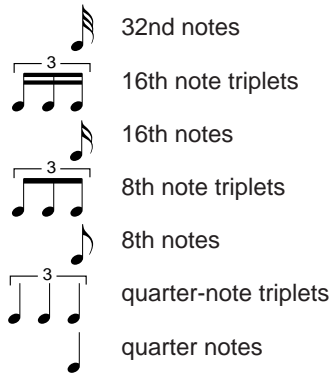

3 Execute the Quantize operation.

Press the **QUANTIZE** button. At the “Are you sure?” confirmation prompt, press the **YES** button to execute the Quantize operation or **NO** button to cancel.

The **QUANTIZE** display will be changed to the **UNDO** display after the Quantize operation is executed. If the result is not what you expected, press the **UNDO** button to restore the data of the quantized track to what it was before performing the Quantize operation.

To exit the Track Quantize function, press the **[REC]** button (the lamp goes out).

You can also press the **[EXIT]** button to exit the Track Quantize function.

NOTE

- Only tracks containing data will appear and can be selected.

NOTE

- Only the note data and voice data are quantized.
- A bar graph indicating the progress of the Quantize operation will appear while the data is being processed.
- You can check if the results are as you expected or not, by starting and stopping playback with the **[PLAY/STOP]** button before performing the **UNDO** operation.
- The Undo function cannot be used if you've changed the quantize “size,” selected another track, or exited from this mode.
- The Undo feature cannot be used for data recorded to internal RAM (see page 127).

Initial Edit (Changing the Initial Data)

The Initial Edit function allows you to change the volume level of each track or the initial data set for the entire song after you've finished recording. The INITIAL EDIT display appears when you press the **INITIAL EDIT** button in the RECORD [EDIT] display. All sixteen tracks are displayed simultaneously in this display and the settings such as volume, voices and reverb depth can be changed.

NOTE

- Any voice changes entered in the middle of the original song will be erased when the voice parameter is changed in the Initial Edit mode.
- Depending on the data type, some parameters cannot be changed. For such parameters, a “Fixed” indication is shown.
- For songs recorded to 1/RIGHT or 2/LEFT of the copied DOC files, voice changes can only be made to track 1 or 2.

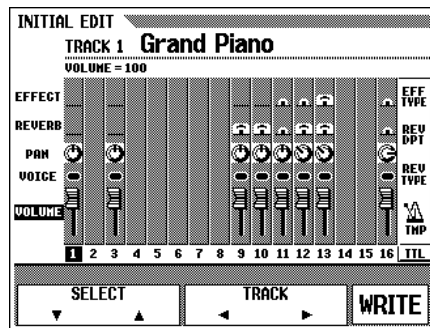

The following parameters can be changed in the Initial Edit display. Refer to the indicated page for details on each parameter.

Parameters which can be changed with Initial Edit:

- When one of tracks 1 - 16 is selected
 - Volume (page 94)
 - Voice (page 27)
 - Pan (page 132)
 - Reverb Depth (page 43)
 - Effect Depth (page 46)
- When [TTL] (Total) is selected
 - Tempo (page 49)
 - Reverb Type (page 41)
 - Reverb Depth (page 42)
 - Effect Type (page 46)

NOTE

- The parameters Program Change Number (**PRG#**), Bank LSB (**BNK LSB**), and Bank MSB (**BNK MSB**), which are used to select voices via MIDI, are also displayed when VOICE is selected.

Making Settings in the INITIAL EDIT Display

1 Select the track to be edited.

Select the track whose parameters you wish to change by pressing the **TRACK** ◀ or ▶ button. If **TTL** (Total) is selected, the setting change will be made not for each track but for the entire song.

2 Select the parameters to be changed.

Select the parameters to be changed by pressing the **SELECT** ▼ or ▲ button.

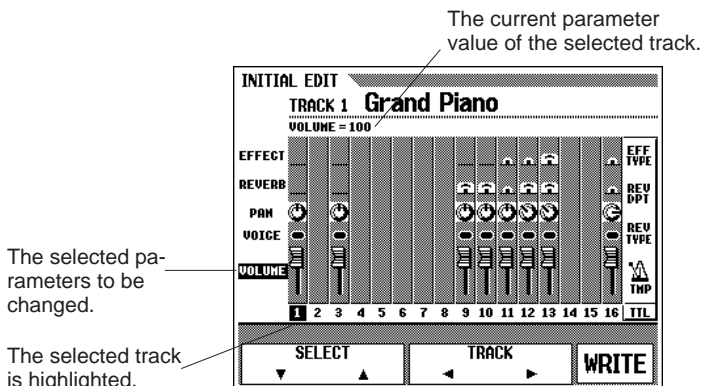

3 Change the settings.

Use the data dial or [-/+] buttons to change the settings. You can instantly check the effect of the changes, since the settings can be changed during playback.

4 Write the changes.

When all the Initial Data changes have been made as desired, press the **WRITE** button. At the “Are you sure?” confirmation prompt, press the **YES** button to actually make the specified changes, or **NO** to cancel.

When this is completed, the **WRITE** button will change to **UNDO**, allowing you to undo the Write operation and restore the data of the edited track to what it was before you made any edits.

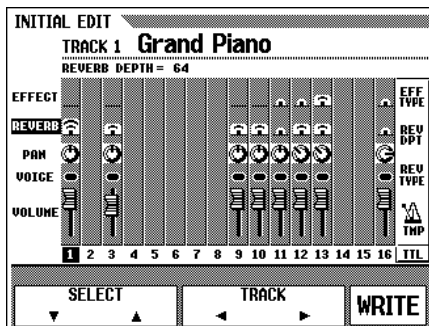

5 Exit the Initial Edit function.

To do this, press the **[REC]** button.

- ➔ The **[REC]** lamp goes out and the Initial Edit operation is completed.

You can also exit the Initial Edit function by pressing the **[EXIT]** button.

If you do this after making any edits that you have not yet written to disk, a “Write edited data?” confirmation prompt will appear. Press **YES** to write the edited data and exit from the Initial Edit mode, **NO** to exit without writing the data, or **CANCEL** to return to the Initial Edit mode and continue editing.

NOTE

- If **[TTL]** is selected and the value of the reverb depth is changed, the new setting will also affect the keyboard sound.
- The voices of the tracks to which Auto Accompaniment, rhythm and/or Harmony data have been recorded, can also be changed.
- The volume parameter's initial default value is 100 for each track. The value can only be decreased.
- Only one effect type can be set for each song.
- The data may not be played back accurately if you use the **[REW]** button while editing the data.

NOTE

- All edited data for any number of tracks within a single song can be written in a one-time Write operation, by pressing the **WRITE** button.
- You can check if the results of the Initial Edit are as you expected or not, by starting and stopping playback with the **[PLAY/STOP]** button before performing the **UNDO** operation.
- The Undo function cannot be used if you've selected another track or exited from the Initial Edit mode.
- The Undo feature cannot be used for data recorded to internal RAM (see page 127).

Recording Without a Disk

The Clavinova has internal RAM memory (about 25KB) that allows a limited amount of recording — even if a disk is not loaded — up to approximately 2,500 notes, if no other data is recorded. If you enter the Song Record mode without inserting a disk, **CVP MEMORY** will be indicated in the **SONG** display as shown below, and the Quick Recording, Track Recording and Punch-in/out Recording functions will become available.

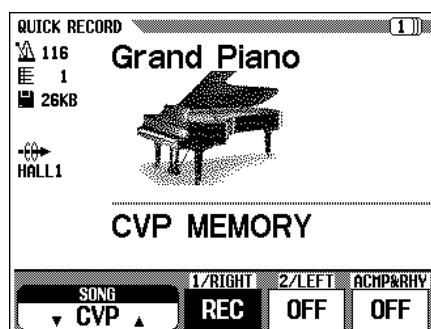

Quick Record display when using the internal RAM.

When entering the Song Play mode after recording the song to internal RAM, the **CVP** indication is shown in the **SONG** section of the display, allowing you to playback normally.

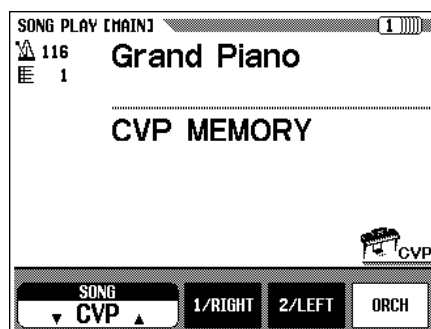

Song PLAY MAIN display when playing back the internal RAM song.

If you insert a song disk (and select a song number) when the internal RAM contains recorded song data, a “Delete CVP MEMORY?” confirmation prompt will appear. Press **YES** to delete the song data recorded to the internal RAM. The song data recorded to internal RAM also can be erased by turning the power off. If you wish to keep the recorded data, use the Song Copy function (page 136) to copy the recorded data to disk.

■ Playback.....

The recorded song can be played back in the normal way.

NOTE

- Chord Sequence data cannot be recorded to internal RAM memory.
- The Song Name function cannot be engaged for data recorded to internal RAM. However, the Track Edit function (page 122) and the Initial Edit function (page 124) can be engaged for data recorded to internal RAM.

NOTE

- Song data recorded to internal RAM is deleted when entering the Demo mode or Custom Style mode, or when loading Style Files. In such cases, a confirmation prompt does not appear.

CHAPTER 7: The Utility Functions

The Function mode provides various advanced functions that, for example, let you make various MIDI settings, or give you greater, more convenient control over disk-related operations. These sophisticated functions let you customize the Clavinova to your own musical needs and preferences.

The following functions are available:

Keyboard Group	Tune	Page 130
	Transpose	Page 130
	Effect Setting	Page 131
	Key Touch	Page 131
	Pan	Page 132
Pedal Group	Left Pedal	Page 133
	Damper Range	Page 134
	Damper Mode	Page 134
	Soundboard (CVP-98 only)	Page 134
Disk Group	Format	Page 135
	Song Copy	Page 136
	Song Delete	Page 138
	Registration	Page 139
	Transform	Page 142
MIDI Group	Send Channel	Page 143
	Local Control	Page 144
	Sync	Page 144
	MIDI Filter	Page 144
	MIDI Transpose	Page 146
	Auto Accompaniment & Harmony Transmission	Page 146
	Remote Keyboard	Page 146
Backup Group	Backup	Page 147
	Recall	Page 148
Utility Group	Micro Tuning	Page 149
	Scale Tuning	Page 150
	Pop-up Time	Page 153
	Alert Sound	Page 153

■ Selecting and Operating the Functions

All functions in this mode can be selected and set by using the following procedure.

1 Press the [FUNCTION] button.

→ The lamp lights and the Function mode display appears.

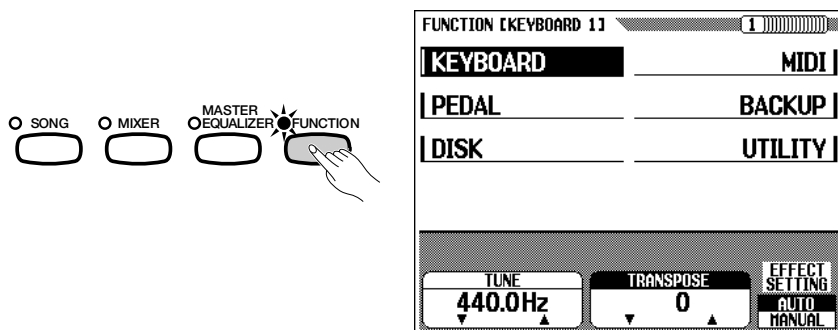

2 Select the group by using the left/right LCD buttons, and call up the page of the desired function by using the PAGE [◀] [▶] buttons. You can also select the page from all the display pages by using the PAGE [◀] [▶].

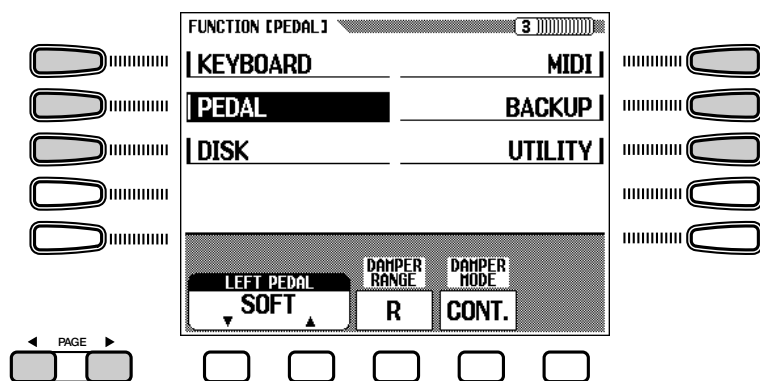

3 For the round-edged parameter box, press the appropriate LCD button to highlight the desired section of the display, then use the data dial or [-/+] button to change the settings.

For the sharp-edged parameter box, you can use the appropriate LCD button to select and execute the functions.

4 Press the [FUNCTION] button when finished.

→ The [FUNCTION] lamp will go out.

You can also exit by pressing the [EXIT] button.

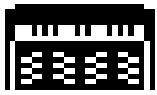

Keyboard

Keyboard 1 (KEYBOARD 1) Display — PAGE 1

■ Tune

The Tune function lets you make fine adjustments to the pitch, allowing you to accurately match the tuning with that of other instruments. The frequency (in Hz) of A3 is displayed in the **TUNE** section. It can be set in approximately 0.2-Hz steps over a range of +/- approximately 26 Hz (+/- approximately 100 cents).

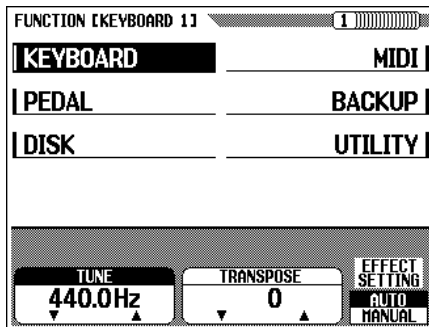

■ Transpose

The Transpose function makes it possible to shift the pitch of the keyboard in semitone units, allowing you to match the pitch of the keyboard to the range of other instruments or singers, or letting you easily play in a different key without having to change your fingering. For example, if the Transpose amount is set to “+5” semitones, playing C results in a pitch of F, or in other words, you can play in the key of C major on the keyboard and automatically have the pitch transposed to F major.

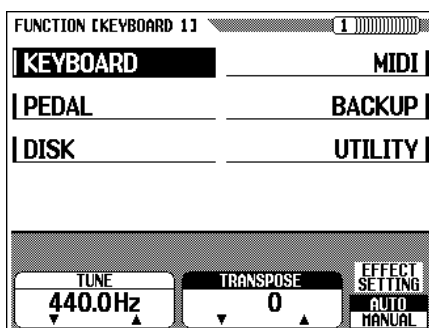

NOTE

Tune

- Range: 414.8 Hz (-102.1 cent) — 466.6Hz (+101.62 cents)
- Initial value : 440 Hz
- Backup of last settings: OFF

Restoring the Basic Setting

- To restore the basic setting, simultaneously press both the **TUNE** ▼▲ buttons or both the [-/+] buttons.

Hz (Hertz)

- Pitch is measured in units of Hertz (abbreviated Hz), which represents the number of times the sound wave vibrates in a second.

Cent

- Cent is a unit of pitch, equal to 1/100 of a semitone. (100 cents = 1 semitone)

NOTE

- Tune has no effect on the Drum Kit voices.
- The XG Master Tune setting is effective when playing back songs containing XG Master Tune data. The corresponding value is indicated in the Keyboard 1 display (Function display page 1).

NOTE

Transpose

- Range: -24 semitone (-2 octaves) — + 24 semitone (+ 2 octaves)
- Initial Value: 0
- Backup of last settings: OFF

Restoring the Basic Setting

- To restore the basic setting, simultaneously press both the **TRANSPOSE** ▼▲ buttons or both the [-/+] buttons.

Soundable Range of Transpose

- Notes below and above the original 88-key range (A-1 to C7) sound one or two octave(s) higher and lower, respectively.

NOTE

- The Transpose function does not affect the Drum Kit voices.
- When playing back songs containing XG Transpose data, the XG Transpose data is effective only for the data playback sound. The value set on the panel affects the keyboard sound.
- The value set here affects the play data transmitted via MIDI.

■ Effect Setting

This feature determines whether the basic effect setting (page 44) for each voice is automatically selected or not, when the voice is selected.

To change the setting, press the **EFFECT SETTING** button. When set to **AUTO**, the basic effect setting for each voice is automatically selected when the voice is selected; when set to **MANUAL**, effect settings are not changed when voices are selected.

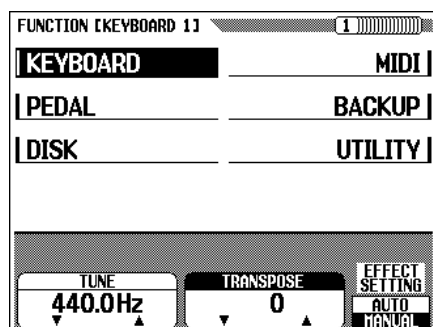

NOTE

Effect Setting

- Settings: *AUTO, MANUAL*
- Basic Setting: *AUTO*
- Backup of last setting: *OFF*

Effect Setting

- The effect type, effect depth and effect ON/OFF parameters are set for each voice.

Keyboard 2 (KEYBOARD 2) Display — PAGE 2

■ Key Touch

Key Touch determines how your playing strength (velocity) affects the volume of the voices. Four types are available for tailoring the keyboard response to the selected voice, type of song, or your own playing preferences. Select the type by pressing the **KEY TOUCH** button. The data dial and [-/+] buttons cannot be used.

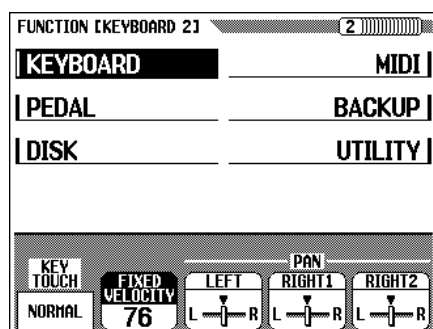

Settings

HARD	This setting requires you to play the keys quite strongly to produce maximum loudness.
NORMAL	This is the standard keyboard response and is used as the basic setting.
SOFT	This setting lets you produce a relatively loud sound even when playing the keys softly.
FIXED	This setting produces the same degree of loudness, no matter how strongly or softly you play the keys. You can set the fixed loudness by pressing the FIXED VELOCITY button to highlight the parameter, then using the data dial or [-/+] buttons to set the level (range: 1 — 127, basic setting: 76).

NOTE

- This function does not affect the actual weight of the keys.

NOTE

Key Touch

- Basic setting: *NORMAL*
- Basic setting (of *FIXED VELOCITY*): *76*
- Backup of last settings: *OFF*

■ Pan

Pan determines the stereo image of the voices, or in other words, where the sound of the voice appears to come from — left, center, or right. The Pan position can be set individually for the following three voice assignments:

LEFT	Left voice in the Split mode
RIGHT1	Right voice in the Split mode/1st voice in the Dual mode/voice for normal keyboard performance
RIGHT2	2nd voice in the Dual mode

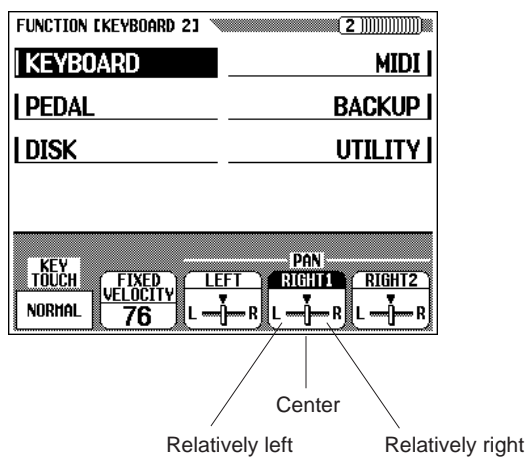

The default Pan position for some voices features keyboard scaling. This shifts the Pan position depending on what keys you play. The lower you play on the keyboard, the more the sound shifts to the left; the higher you play, the more the sound shifts to the right.

The Drum Kit voices have special pan settings for each individual instrument. The Pan setting in this function moves the sound relatively left or right of the special pan setting for each sound.

NOTE

Pan

- Settings: **L** (left) — Center — **R** (right) (21 steps)
- Basic setting: Settings for each voice (center, key scale pan, drum kit pan)
 - * However, the basic settings of each voice is displayed in the center position in the LCD display.
- Backup of last settings: OFF

Restoring the Basic Setting

- To restore the basic setting, simultaneously press both [-/+] buttons.

NOTE

- The Pan setting affects all voices globally.
- The Pan setting affects the keyboard-played voices only.
- In the normal play mode (single voice mode) only the **RIGHT1** (right range/1st voice) setting is effective.

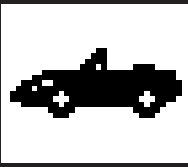

Pedal

Pedal (PEDAL) Display — PAGE 3

■ Left Pedal

This function conveniently lets you set the left pedal to control one of various functions.

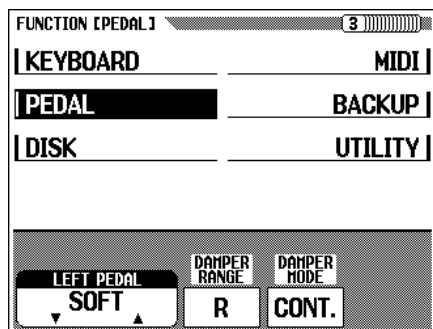

CVP-96

Controllable Functions and Data

SOFT	The left pedal functions as the soft pedal (basic setting). (See page 40.)
START/STOP	The left pedal functions the same as the [START/STOP] button. (See page 89.)
HARMONY	When the Harmony function is set to on, Harmony is applied only while the left pedal is held down. (See page 62.)
REGISTRATION	The panel settings registered to the next Registration number are recalled each time the left pedal is pressed. (See page 84.)
MAIN A	The left pedal performs the same function as the [MAIN A] button. (See page 50.)
MAIN B	The left pedal performs the same function as the [MAIN B] button. (See page 50.)
ENDING/RIT.	The left pedal performs the function same as the ENDING button. You can have the song end ritardando (slow down gradually) by pressing the left pedal twice in succession. (See page 53.)
BREAK	Pressing the left pedal during the style playback produces a break in the accompaniment and rhythm for as long as the pedal is held. When the pedal is released, normal playback resumes from the next measure. (See page 53.) If you press the left pedal a second time within one measure, normal playback resumes immediately.
FADE IN/OUT	The left pedal performs the function same as the [FADE IN/OUT] button. (See pages 52 and 53.)

NOTE

Left Pedal

- Basic setting: *SOFT*
- Backup of the last settings: *OFF*

NOTE

- If the left pedal is set to *REGISTRATION*, the setting of the left pedal function in Registration memory is not recalled.

■ Damper Range

This determines whether the damper pedal affects the right-hand, left-hand, or both voices in a Split setup. Press the **DAMPER RANGE** button to set. The data dial and the [-/+] buttons cannot be used.

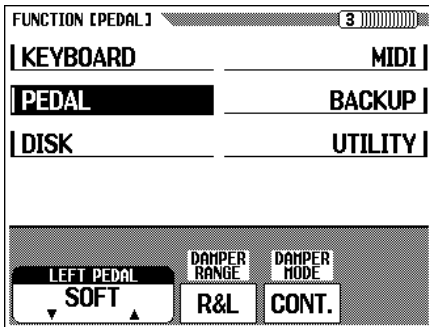

CVP-96

■ Damper Mode

This function lets you set how the damper pedal affects the sustain sound. Pedal-controlled sustain can be done as a simple on/off switch, or as a continuously changing sustain (in eight-step gradations) in which the further down you press the pedal the longer the sound sustains. To set the function, press the **DAMPER MODE** button. In this case, the data dial and the [-/+] buttons cannot be used.

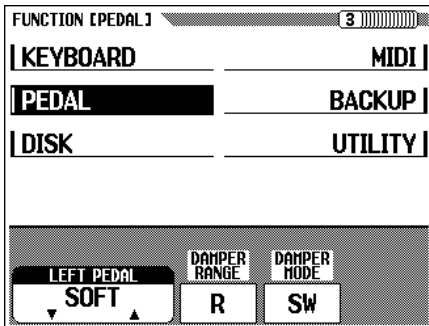

CVP-96

■ Soundboard Depth (CVP-98 only)

Certain piano voices (Grand Piano, Bright Piano, Mellow Piano, and Mono Piano) feature a special effect which recreates the soundboard resonance of an actual acoustic piano. A string resonance effect can also be applied when pressing the damper pedal. This function lets you adjust the depth of these effects.

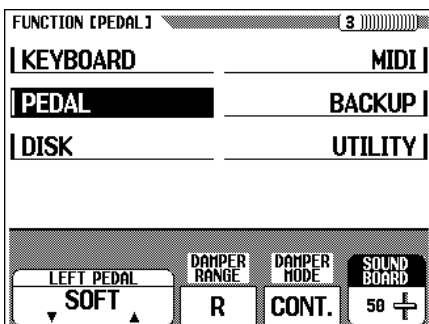

NOTE

Damper Range

- Settings: R (the damper pedal affects only the right-hand voice), L (the damper pedal affects only the left-hand voice), R&L (the damper affects both the left-and right-hand voices)
- Basic setting: R
- Backup of last settings: OFF

NOTE

Damper Mode

- Settings: CONT. (continous changing system)/SW (ON/OFF switch system)
- Basic Setting: CONT.
- Backup of the last settings: OFF

NOTE

Soundboard Depth

- Value: 0 — 100
- Basic value: 50
- Backup of last settings: OFF



Disk

When using the disk-related function, make sure to first set the [FUNCTION] button to on and call up the appropriate page before inserting the floppy disk. Disk functions cannot be used — even when pressing the [FUNCTION] button — if a floppy disk has been inserted and the [SONG] button is set to on. In this case, press the [SONG] button again so that the lamp goes out, then use the Disk functions.

Format (FORMAT) Display — PAGE 4

Format the floppy disk for the use with the Clavinova. Refer to page 106 for information on formatting a new, blank disk or disks of different formats.

The operation explained here is for re-formatting a disk that has already been used with the Clavinova and deleting all data on the disk.

1 Insert the disk to be formatted.....

Make sure that the disk's write protect tab is set to the "write" position, and insert the disk into the disk drive face up with the shutter forward until it clicks into place.

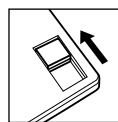
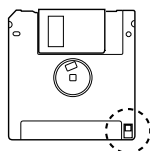
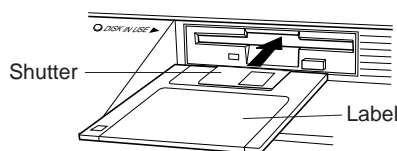

Write protect tab closed (unlocked — write enabled)

2 Execute the format operation.....

Press the **START** button.

- ➔ An "Are you sure" confirmation prompt will appear. Press **YES** to execute the format or **NO** to cancel.

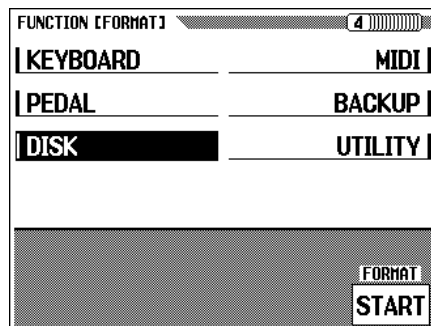

A bar graph appears in the LCD display during format to indicate the process of format. Once a disk has been formatted, song data and other data can be recorded, saved, or copied to it.

CAUTION

- **Formatting a disk erases all the data on the disk.**

NOTE

Types of Format

- 2DD disks are formatted into 720 KB, while 2HD disks are formatted into 1.44 MB.

Song Copy (SONG COPY) Display — PAGE 5

This function allows you to copy song data (data files on disk) recorded by the Clavinova to a different song number on the same disk, or to a different disk.

1 Set up the disk(s).....

Insert the disk containing the source song.

➤ Press either of the left-most two LCD buttons to select the copy type. Two copy types are available.

DISK 1 - 1	This function allows you to copy the song to a different song number on the same disk.
DISK 1 - 2	This function allows you to copy the song to a different disk.

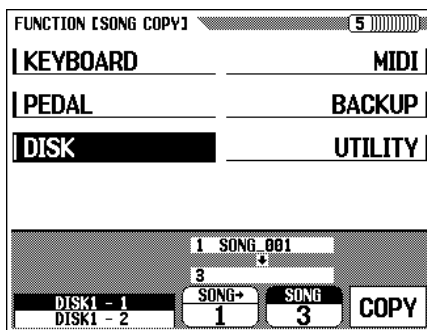

2 Select the source song.....

Press the **SONG** ➔ button to highlight the parameter, then use the data dial or [-/+] buttons to select the source song.

➔ The selected song name will appear in the upper section of the LCD display.

3 Select the destination song number (DISK1 - 1 only).....

This step is only for the **DISK1 - 1** copy type. If you have selected the **DISK1 - 2** type copy, go on to step 4.

Press the **SONG** button to highlight the parameter, then use the data dial or [-/+] buttons to select the destination song number.

➔ If the destination song number already contains data, the name of the song file will appear in the middle section of the LCD display. In this case, the original data of the destination song number will be erased and overwritten by the source song data when executing the copy operation.

NOTE

- If the Clavinova's internal memory contains song data recorded without a disk, the **CUP** mode will be automatically selected for copying the internal memory data to disk (see page 138), and the **DISK1 - 1** or **DISK1 - 2** copy mode cannot be selected. In this case if you want to keep the data of internal memory, copy it to disk first, and delete the internal memory data by using the Song Delete function (page 138). Then, attempt the **DISK1 - 1** or **DISK1 - 2** copy operation again.
- When using the Copy function within the same disk, the operation cannot be performed if the destination song is set to the same number as the source song. In this case, a "Select a different number!" message appears.

4 Execute the Copy operation.....

Press the **COPY** button.

- ➔ The Copy operation begins. If you are copying to the same disk, an “Are you sure?” confirmation prompt will appear. Press the **YES** button to continue or the **NO** button to cancel.

If you are copying the data to a different disk, a “Number of disk exchange (**)” message appears to indicate the number of times the disk will have to be changed. Press the **OK** button to continue, or the **CANCEL** button to abort the operation.

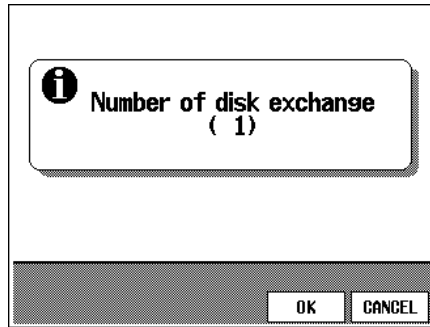

When copying to a different disk, follow the instructions in the LCD display, changing the source and destination disks as necessary.

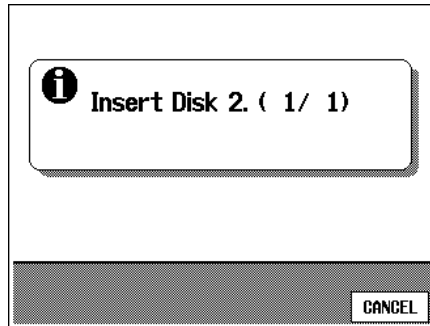

The first time the destination disk is inserted, the following LCD display will appear. Use the data dial or [-/+] buttons to select the destination song number.

- If the destination song number already contains data, the song name will appear in the LCD display. In this case, the original data of the destination song number will be erased and overwritten by the source song data when executing the copy operation. Press the **OK** button to continue, or **CANCEL** to abort.

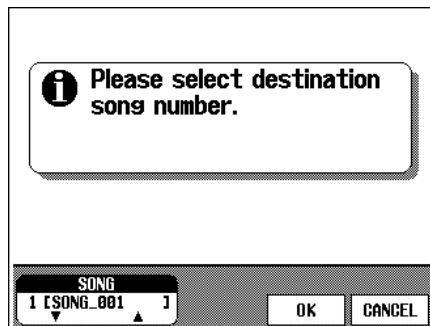

NOTE

- The copy operation is not effective if the same song numbers are selected as the source song and the destination song in the **DISK 1 - 1** type copy. In this case, a “Select a different number!” message will appear.

NOTE

Caution on Copying Commercial Software

- Copying of commercially available software is strictly prohibited, except for your personal use.

NOTE

- Data files (other than those made with the CVP-98/96/600/94/92) that have been copied once cannot be copied a second time to another disk. Also, additional data can be recorded only to the right-hand/left-hand parts of the copied DOC files.
- Song data of the CVP-94/92/79A/69/69A/59S can be copied by the CVP-98/96/600.

● Copying Data Recorded Without a Disk

If you've recorded a song without inserting a disk, the song data is automatically recorded to the Clavinova's internal RAM. To copy the data to the disk, first select the Song Copy display and insert a formatted disk.

- Select the destination song number, then copy to disk in the normal way.

The **CUP - DISK** parameter is automatically selected, with the internal RAM data as the source data for copying.

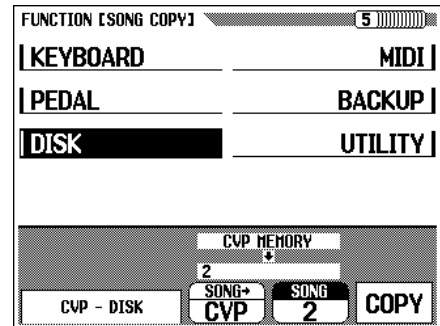

Song Delete (SONG DELETE) Display — PAGE 6

You can delete unneeded song data from the disk in this display. Be careful not to delete any important data on the disk; once the Delete operation is performed, it cannot be undone.

1 Set up the disk.

Insert the disk containing the song data to be deleted into the disk drive.

2 Select the song to be deleted.

Use the data dial or [-/+] buttons to select the song to be deleted. The song data in the Clavinova's internal RAM can be also deleted with this operation. To do this, select the **CUP MEMORY** parameter instead of the song number (**CUP MEMORY** appears only when the internal RAM contains song data).

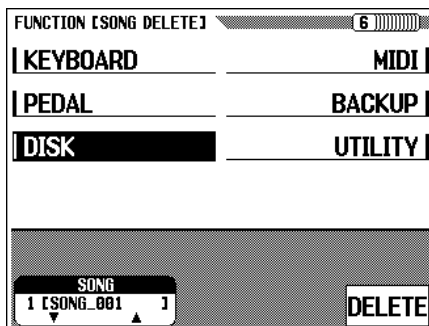

3 Execute the Delete operation.

Press the **DELETE** button.

- ➔ An "Are you sure?" confirmation prompt will appear. Press the **YES** button to delete the selected song, or press the **NO** button to cancel the operation.

Registration (REGISTRATION) Display — PAGE 7

This function allows you to save the panel settings registered using the Registration function to disk, load Registration data from disk, delete Registration data from a disk, or name Registration files.

Before executing the Registration function, make sure that the disk you want to use for this operation is inserted in the disk drive.

Refer to page 35 in the Reference Manual for a list of settings registered by the Registration function.

1 Select the file type.

Press either of the two left-most LCD buttons to select the file type to be loaded, saved, deleted or named.

REGISTRATION	Contains each or all Registration file(s) in 20 Registration memory locations.
ALL SETUP	An All Setup file contains all panel setting data in the list on page 35 in the Reference Manual.

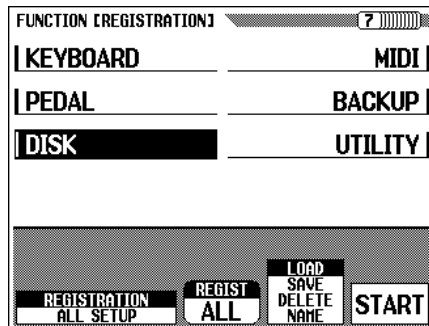

To save or load the data of **REGISTRATION**, first set the **REGIST** (Registration number) parameter. When saving, press the **REGIST** button to select the desired Registration file number from **ALL** or **A-1 – E-4** to save to disk. When loading, select the internal destination location from **ALL** or **A-1 – E-4**.

2 Select the file operation.

Use the second LCD button from the right to select the desired file operation: **LOAD**, **SAVE**, **DELETE** or **NAME**.

3 Press the **START** button.

→ Operation begins.

The subsequent steps for each file operation depend on the operation you've selected. Refer to the corresponding instructions for each operation below.

■ **SAVE**

When you select **SAVE**, the name entry function display for the file to be saved will appear.



Press the **CHAR ►** button to move the underline cursor, and select the character position of the file name. (File names can contain up to twelve characters.)

- Use the data dial or [-/+] buttons to highlight the characters to be input.

Press the **CHAR SET** button to input the selected characters at the current underline position of the file name. Continue moving the cursor to other characters or marks and entering them in this way.

To delete the character at the previous position, press the **BACK SPACE** button. The character before the underline cursor is deleted and the cursor moves back to the deleted position.

To abort the name entry operation and return to the FUNCTION [REGISTRATION] display, press the **CANCEL** button.

When the file name has been completely entered, press the **SAVE** button to execute the Save operation.

If you enter a name that already exists on the disk, a “Same name! Overwrite?” message will appear. Press the **OK** button to overwrite the original file with the new file, or **CANCEL** to abort the Save operation.

■ **NAME**

When you select **NAME**, the Name function display will appear.

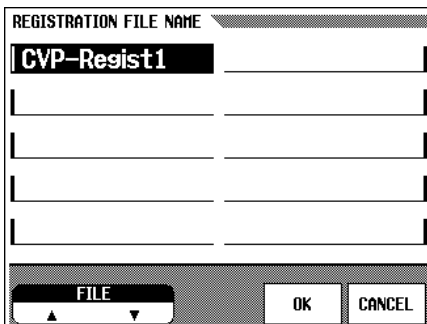

First, select the desired file to be named. Press either of the two left-most LCD buttons to select the file, then press the **OK** button.

- The name entry display will appear. Enter a new file name in the same way as described above for the Save function.
- Pressing the **OK** button changes the current name to the newly entered name. Press the **CANCEL** button to abort. If you enter a name that already exists on the disk, a “Same name! Overwrite?” message will appear. In this case, press the **OK** button to overwrite the original file with the renamed file, or **CANCEL** to abort the Name operation.

■ **LOAD**

When you select **LOAD**, the Load function display will appear. The original internal data will be erased and overwritten when executing the Load operation. Make sure to save all important data to disk (see page 140) before using the Load operation.

First, select the desired file to be loaded. Press either of the two left-most LCD buttons to select the file, then press the **OK** button.

- ➔ An “Are you sure?” confirmation prompt will appear. Press the **YES** button to load the selected file, or the **NO** button to abort the Load operation.

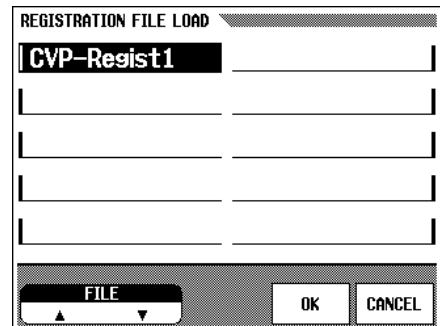

■ **DELETE**

When you select **DELETE**, the Delete function display will appear.

First, select the desired file to be deleted. Press either of the two left-most LCD buttons to select the file, then press the **OK** button.

- ➔ An “Are you sure?” confirmation prompt will appear. Press the **YES** button to delete the selected file, or the **NO** button to abort the Delete operation.

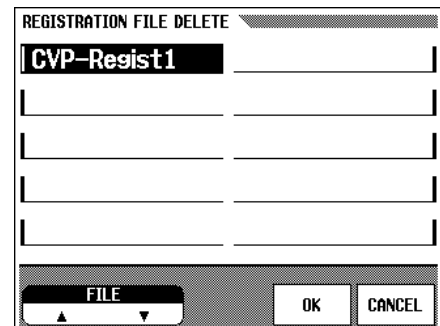

Transform (TRANSFORM) Display — PAGE 8

This function allows you to convert song data recorded on the CVP-98/96/600 so that the data can be played back on other Clavinova models or a Disklavier.

Make sure to insert a proper disk (2DD disk containing the data to be converted) in the disk drive.

1 Select the conversion type.

Use either of the two left-most LCD buttons to select the target format of the file (the instrument for which the converted data is to be used). The following three types are available.

CVP PERFORMANCE	This type converts the selected data for playback on the CVP-50/70/55/65/75/83S/85A/87A/89, CLP-705, DOM-30, and DOU-10.
PIANO FORMAT 1	This type converts the data for playback on the Disklavier, excepting the MX100A and MX100B.
PIANO FORMAT 2	This type converts the data for playback on the Disklavier MX100A or MX100B.

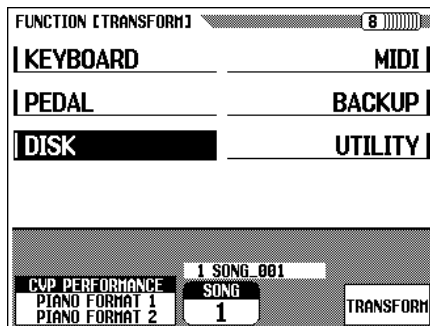

2 Select the song to be converted by using the data dial or [-/+] buttons.

3 Press the TRANSFORM button.

An “Are you sure?” confirmation prompt will appear. Press the **YES** button to start data conversion of the selected song, or the **NO** button to cancel the operation. When the conversion process is finished, a “Completed! SONG No.**” message appears to indicate the song number to which the data was saved.

If the conversion was executed by using CVP PERFORMANCE, “C)” is added to the beginning of the original name, and if the conversion was executed by the PIANO FORMAT 1/2, “P)” is added to the beginning of the original name.

NOTE

Compatible Disk Types for Data Conversion

- Only 2DD type disks can be used for this operation. If a 2HD disk is used a “2HD disk is not valid! Please copy to 2DD disk.” message will appear. In this case, first copy the song you wish to convert to a 2DD disk by using the Song Copy function (page 136), then attempt the conversion again.
- Data in the Clavinova’s internal memory cannot be converted until it is saved to disk.

NOTE

About the CVP-94/92/59S/69A/69/79A Clavinovas

- The CVP-94/92/59S/69A/69/79A Clavinovas can play back the song data recorded on the CVP-98/96/600 without conversion.
- The original pre-converted data remains intact even after the conversion has been executed.

NOTE

- If data converted to PIANO FORMAT 1/2 is played back on the CVP series, DOM-30 or DOU-10 instruments, tracks 1 and 2 will not sound.

NOTE

- Recording or editing cannot be performed on the converted songs.



MIDI

Functions related to MIDI (Musical Instrument Digital Interface) can be called up from pages 9 through 11.

NOTE

- If you are using the MIDI terminals, set the HOST SELECT switch to "MIDI".

MIDI 1 Display — PAGE 9

■ Set the Send Channel SEND CH

In any MIDI control setup, the MIDI channels of the transmitting and receiving equipment must be matched for proper data transfer (channels 1 through 16). This function sets the MIDI transmit channels of the Clavinova .

Independent MIDI channels can be set for the following three different types of play data.

LEFT	Left voice in the Split mode
RIGHT1	Right voice in the Split mode/1st voice in the Dual mode/voice for normal keyboard performance
RIGHT2	2nd voice in the Dual mode

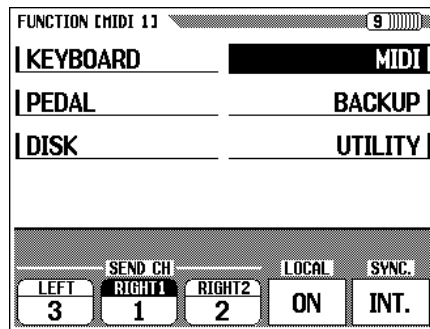

NOTE

Transmission Channel

- **LEFT** setting: OFF (no transmission), channels 1 — 16
- Basic setting: 3
- Backup of last settings: OFF
- **RIGHT 1** setting: OFF (no transmission), channels 1 — 16
- Basic setting: 1
- Backup of last settings: OFF
- **RIGHT 2** setting: OFF (no transmission), channels 1 — 16
- Basic setting: 2
- Backup of last settings: OFF

● MIDI Reception

The Clavinova always receives MIDI data in the “Multi Timbre” mode. This is a mode in which the Clavinova voices can be independently controlled on different MIDI channel numbers (1 through 16) by an external MIDI device. This means that you can produce the sound of a full band or ensemble on the Clavinova by using a computer or MIDI sequencer.

■ Local Control ON/OFF LOCAL

“Local Control” refers to the fact that, normally, the Clavinova keyboard controls its internal tone generator, allowing the internal voices to be played directly from the keyboard. This situation is called “Local Control ON”. When the local control is set to off, the “keyboard” and “sound source” are separated and no sound is output through the Clavinova when playing the keyboard. However, the data of the keyboard performance is output through MIDI. By setting Local Control to off, you can play an external MIDI tone generator from the keyboard of the Clavinova without sounding the internal voices.

To set this, press the **LOCAL** button. The data dial and [-/+] buttons cannot be used.

■ Sync

Playback of songs and Auto Accompaniment is normally controlled by the internal clock (INT.) of the Clavinova at a specific tempo. By setting this clock to “EXT.”, the Clavinova’s tempo can be controlled by an external sequencer or rhythm machine. For example, this lets you play the Auto Accompaniment of the Clavinova in perfect synchronization with an external sequencer.

To set this, press the **SYNC.** button. The data dial and the [-/+] buttons cannot be used.

NOTE

Local Control

- Settings: ON/OFF
- Basic setting: ON
- Backup of last settings: OFF

NOTE

Sync

- Settings: INT. (internal clock)/EXT. (external clock)
- Basic setting: INT.
- Backup of last settings: OFF

NOTE

- If the clock mode is set to EXT. and a MIDI clock signal is not being received from an external source, features related to the Auto Accompaniment and the accompaniment styles cannot be used.

MIDI 2 Display — PAGE 10

The MIDI 2 function display contains the MIDI filter settings which can be used to turn transmission and reception of certain types of MIDI data on or off.

■ Program ON/OFF

Normally the Clavinova will respond to MIDI program change numbers received from an external keyboard or another MIDI device. For example, the Clavinova can change voices in response to MIDI program change messages received from a connected MIDI sequencer. (These messages do not affect the keyboard-played voices.) The voices of connected external MIDI devices can also be changed by program change messages transmitted from the Clavinova. (Program change messages are transmitted when changing voices on the panel of the Clavinova.)

Depending on your particular MIDI setup, you may find that this feature is convenient in some cases and not in others. Set **PROGRAM** to off if you wish to disable the program change transmission/reception. Set **PROGRAM** to “Tx&Rx” to turn on transmission/reception of program change messages.

NOTE

Program

- Settings: Tx&Rx (transmitted/received), OFF (not transmitted/received)
- Basic setting: Tx&Rx
- Backup of last settings: OFF

NOTE

- Bank MSB and LSB messages can be transmitted and received even when Program is set to off.

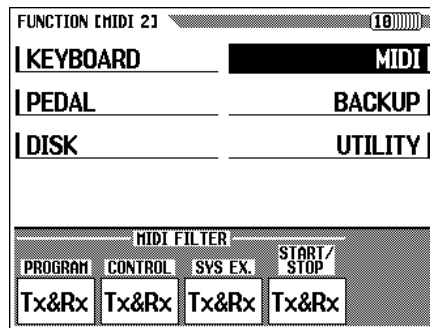

The program numbers of the Clavinova’s voices are standardized according to the XG voice allocation. See the Voice List on page 26 in the Reference Manual for details.

■ **Control ON/OFF**

Control change messages are used for various non-keyboard performance controls, such as the damper pedal, or for expressive control of the sound of a connected MIDI device, such as effects and volume. For example, the Clavinova can respond to control change messages transmitted from an external MIDI sequencer. (These messages do not affect the keyboard-played voices.) Similarly, an external MIDI device can be controlled by sending control change messages from the Clavinova to that device. (Control change messages are transmitted when operating the damper pedal, etc. on the Clavinova.) Set **CONTROL** to off if you want control change messages not to be transmitted or received.

Control change data recognized by the Clavinova is listed in detail on page 10 in the Reference Manual.

■ **System Exclusive ON/OFF**

System exclusive messages are used for more advanced or detailed MIDI control, or for controls related to specific manufacturer’s devices. Set **SYS EX.** to off if you desire not to transmit/receive the system exclusive messages. Set **SYS EX.** to “Tx&Rx” enable transmission and reception of these messages.

System exclusive data recognized by the Clavinova is listed in detail on page 12 in the Reference Manual.

■ **Start/Stop ON/OFF**

By using the Start/Stop command, the rhythm and performance of the receiving device can be started/stopped from the sending device via MIDI. For example, you can transmit the start/stop command from an external MIDI sequencer to start and stop the Auto Accompaniment or song playback on the Clavinova. Also, the playback of an external MIDI sequencer or rhythm machine can be started/stopped by starting/stopping the Auto Accompaniment on the Clavinova. Set **START/STOP** to off if you want to disable transmission/reception of start/stop. Set it to on to enable transmission/reception.

NOTE

Control

- Settings: Tx&Rx (transmitted/received), OFF (not transmitted/received)
- Basic setting: Tx&Rx
- Backup of last settings: OFF

NOTE

System Exclusive

- Settings: Tx&Rx (transmitted/received), OFF (not transmitted/received)
- Basic setting: Tx&Rx
- Backup of last settings: OFF

NOTE

Start/Stop

- Settings: Tx&Rx (transmitted/received), OFF (not transmitted/received)
- Basic setting: Tx&Rx
- Backup of last settings: OFF

MIDI 3 Display — PAGE 11

From the MIDI 3 display you can set whether or not MIDI data received from an external device is affected by the Transpose setting (page 130) or not, whether or not the Auto Accompaniment, rhythm and Harmony data is transmitted, and whether or not the MIDI data received from an external device affects the keyboard-played voices.

■ MIDI Transpose Receive

When **MIDI TRANSPOSE** is set to on, the Transpose setting (page 130) will affect the MIDI data received by the Clavinova.

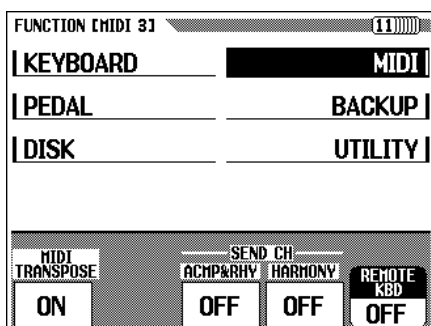

■ Transmitting Auto Accompaniment /Harmony Data

When the **ACMP&RHY** parameter is set to on, accompaniment data is transmitted via the MIDI [OUT] terminal when playing back the Auto Accompaniment. The data is transmitted over MIDI channels 9 - 16.

If the **HARMONY** parameter is set to on, Harmony data is transmitted via the MIDI [OUT] terminal when using the Harmony function. The data is transmitted over MIDI channels 6 - 8.

The Auto Accompaniment or Harmony can be recorded to a computer or external sequencer by using these functions.

■ Remote Keyboard

MIDI data received over the channel set in the **REMOTE KBD** parameter will affect your keyboard performance. The received data also can be recorded. Select OFF to prevent external MIDI data from affecting your keyboard performance. The following four data types can be received.

- Key ON/OFF
- Control Change (performance expression data; only those listed below)

#1 Modulation	#66 Soft Pedal
#7 Volume	#123 All notes off
#11 Expression	BANK Select MSB
#64 Sustain Pedal	BANK Select LSB
#65 Sostenuto Pedal	
- Program Change (voice change data)
- Pitch Bend

NOTE

Transpose Receive

- Settings: ON (enabled), OFF (disabled)
- Basic setting: ON
- Backup of last settings: OFF

NOTE

- The Transpose setting made in the KEYBOARD 1 Page 1 in the Function section is effective for data transmitted via MIDI.

NOTE

Auto Accompaniment/ Harmony Transmission

- Setting of **ACMP&RHY**: OFF (not transmitted), 9 - 16 ch (transmitted)
- Basic setting: OFF (not transmitted)
- Backup of last settings: OFF
- Setting of **HARMONY**: OFF (not transmit), 6 - 8 ch (transmit)
- Basic setting: OFF (not transmit)
- Backup of last settings: OFF

NOTE

- When transmitting the Auto Accompaniment or Harmony data via MIDI, do not select the Auto Accompaniment/ Harmony MIDI channels 6 - 8 or 9 - 16 for transmitting the data of your keyboard performance. Doing so may result in your keyboard performance data being mixed with the Auto Accompaniment or Harmony data.
- If either the **ACMP&RHY** or **HARMONY** is turned on, the Auto Accompaniment or Harmony playback data is transmitted via MIDI, even if the **RIGHT 1** transmission channel (page 143) is turned off.

NOTE

Remote Keyboard

- Settings: OFF (not received), 1 - 16 (received over the specified channel)
- Basic setting: OFF
- Backup of last settings: OFF

NOTE

- MIDI data received by the remote keyboard function cannot be output via the MIDI [OUT] terminal.

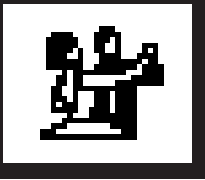

Backup

Backup (BACKUP) Display — PAGE 12

This function allows you to set the backup of various parameter groups on or off. When set to on, the corresponding settings will not be reset to the basic settings (default settings) when power is turned off.

Press the ▼ or ▲ button or use the data dial or [-/+] buttons to select the desired group, then use the right-most LCD button to set the selected group to backup on/off. The (“*”) mark at the beginning of the group name indicates that the backup setting of the group is turned on. The settings of groups whose backup settings are set to off will return to the basic settings (default settings) when the power is turned off.

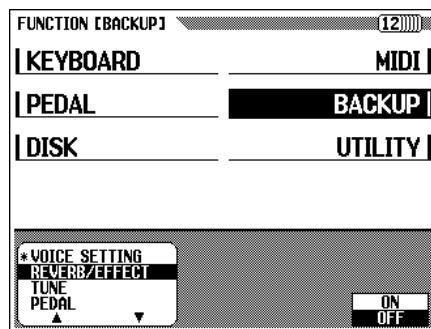

Backup is used for the following groups on the Clavinova.

- VOICE SETTING
- REVERB/EFFECT
- TUNE (master tuning, micro tuning, scale tuning)
- PEDAL
- ACMP SETTING (Auto Accompaniment-related settings)
- SONG SETTING
- REGISTRATION
- MIDI SETTING
- UTILITY (pop-up time, alert sound)

Refer to the list on page 35 in the Reference Manual for the specific parameters of each group.

Parameters that are backed up will be retained in memory for about a week if the Clavinova is not turned on during this time. All parameters will be reset to their default values if the power remains off for longer than about a week. To ensure that your backed-up settings are maintained, turn the power on for a few minutes at least once a week.

NOTE

- The basic settings (default settings) for the BACKUP function are as follows: REGISTRATION and UTILITY are set to ON, all other parameter groups are set to OFF.
- The Help language and backup on/off setting itself are always backed up.

Recall (RECALL) Display — PAGE 13

This function can be used to recall the initial factory settings (basic settings) for a range of parameters — individually or all at once.

Press the ▼ or ▲ buttons or use the data dial or [–/+] buttons to select the group you want to recall, then press the **START** button.

- ➔ An “Are you sure?” confirmation prompt will appear. Press the **YES** button to recall or **NO** to cancel.

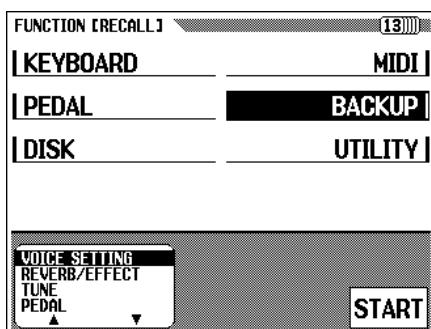

The following parameter groups of the Clavinova can be recalled.

- VOICE SETTING
- REVERB/EFFECT
- TUNE (master tuning, micro tuning, scale tuning)
- PEDAL
- ACMP SETTING (Auto Accompaniment-related settings)
- SONG SETTING
- REGISTRATION
- MIDI SETTING
- UTILITY (pop-up time, alert sound)
- ALL (all the above settings)

Refer to the list on page 35 in the Reference Manual for the specific parameters of each group.

NOTE

- The initial settings (basic settings) for the Help language and the above backup on/off settings are not recalled by this function.

However, these and all other settings can be reset to the initial factory values by turning the power on while holding the right-most key on the keyboard (C7). When this is done, a “Back up data erased and replaced by Factory data” message appears to indicate that all backed up data is erased and all factory settings are recalled. After this message, the main display will appear.

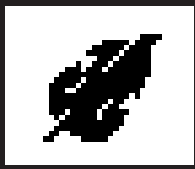

Micro Tuning (MICRO TUNING) Display — PAGE 14

The Micro Tuning Feature makes it possible to individually tune each key of the keyboard. The created tuning can be saved to a disk and loaded whenever necessary. The set tuning can be turned on or off at anytime by using the left-most LCD button in this display.

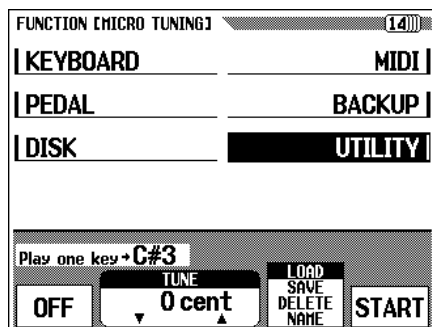

1 Select the desired key.....

Press any desired key to be tuned.

- ➔ The note name and the current tuning value of the pressed key will appear in the display.

2 Set the tuning.....

Press the **TUNE** ▼ or ▲ buttons or use the data dial or [-/+] to tune the pitch of the selected key. If you set the parameter at the left-most LCD button to ON, you can play the key being tuned in order to check the sound during this operation. The normal tuning of ±0 cents for the selected key can be instantly recalled by simultaneously pressing both the **TUNE** ▼ or ▲ buttons.

NOTE

- Range: -100 cents (- 1 semitone) — +100 cents (+ 1 semitone)
- Basic Value: 0 (for all keys)
- Backup of last settings: OFF

3 Repeat steps 1 and 2.....

Repeat steps 1 and 2 until all the required keys have been tuned.

The completed tuning can be named as a tuning file and saved to disk. It can also be loaded whenever necessary or deleted if not needed.

Make sure that a proper disk (either containing the micro tuning data or set up for saving) is inserted in the disk drive before executing these file operations.

1 Select the desired file operation.

Use the LCD button located second from right to select the desired file operation: **LOAD**, **SAVE**, **DELETE** or **NAME**.

2 Press the START button.

After the **START** button is pressed, the display corresponding to the selected file operation appears.

The subsequent steps are the same as those explained on pages 140 and 141. Refer to the pages below, depending on the selected file operation.

SAVE	See page 140.
NAME	See page 140.
LOAD	See page 141.
DELETE	See page 141.

Scale Tuning (SCALE TUNING) Display — PAGE 15

This feature allows you to select from various tuning (temperament) configurations, when selecting **PRESET** in this display. By selecting **USER**, you can create your own user scale, in which the tuning you set for a single octave takes effect for the entire keyboard. The created tuning can be saved to disk for future recall.

■ Preset Scale

This function lets you select from various pre-programmed tunings or temperaments.

Until equal temperament — the most commonly used tuning at present — was accepted, various tunings have been created over the years for use with the particular music and instruments of the era. This feature lets you play in historically authentic tunings, and get a better feeling for the music of the corresponding eras.

The Clavinova contains the following seven temperaments.

- EQUAL
- PURE(MAJOR)
- PURE(MINOR)
- MEANTONE
- PYTHAGOREAN
- WERCKMEISTER
- KIRNBERGER

- 1 Select **PRESET** with the left-most LCD button, and the following display appears.

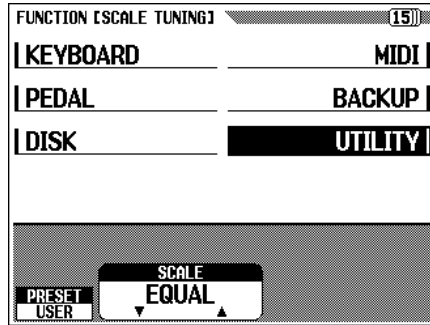

- 2 Press the **SCALE** ▼ or ▲ to highlight the parameter, then use the data dial or [-/+] buttons to select the temperament type.
When selecting temperaments other than equal (**EQUAL**) temperament, the central key (reference pitch for the temperament) must be set. This allows you to produce the proper temperament in the desired key.
- 3 Press the **KEY** button to highlight the parameter, then use the data dial or [-/+] buttons to select the central key.

NOTE

Central Key

- Settings: C, C#, D, D#, E, F, F#, G, G#, A, A#, B
- Basic setting: C

User Scale

This function allows you to individually tune each key within an octave.

The setting made for one key is automatically assigned to the same key in all other octaves.

- 1 Select **USER** with the left-most LCD button left; the following display will appear.

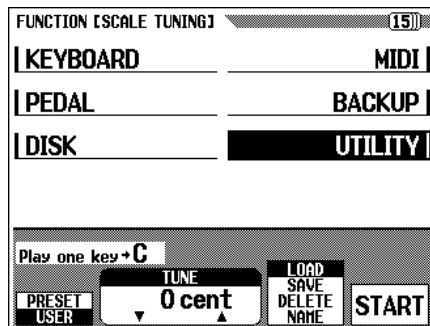

- 2 Press the desired key to be tuned.
 - The note name and the current tuning value of the pressed key appears.
- 3 Set the pitch by pressing the **TUNE ▼** or **▲** buttons, or by using the data dial or **[-/+]** buttons. You can play the key being tuned to check the sound during this operation. The default tuning of ± 0 cents can be instantly recalled for the selected key by simultaneously pressing the **TUNE ▼** and **▲** buttons.
- 4 Repeat steps 2 and 3 until all the required keys have been tuned.

The completed tuning can be named as a tuning file and saved to disk. It can also be loaded whenever necessary or deleted if not needed.

Make sure that a proper disk (either containing the scale tuning data or set up for saving) is inserted in the disk drive before executing these file operations.

- 1 Select the desired file operation.

Use the LCD button located second from right to select the desired file operation: **LOAD**, **SAVE**, **DELETE** or **NAME**.
- 2 Press the **START** button.

After the **START** button is pressed, the display corresponding to the selected file operation appears.

The subsequent steps are the same as those explained on pages 140 and 141. Refer to the pages below, depending on the selected file operation.

SAVE	See page 140.
NAME	See page 140.
LOAD	See page 141.
DELETE	See page 141.

NOTE

Scale Tuning — User

- Range: -64 cents — +63 cents
- Basic Value: 0 (for all keys)
- Backup of last settings: OFF

Pop-up Time (POPUP TIME) Display — PAGE 16

This determines the amount of time the pop-up displays remain on the display screen before disappearing. The pop-up time of the voice/accompaniment style displays can be set independently from all other pop-up displays.

To set the pop-up time of voice/accompaniment style, first press the **VOICE/STYLE** button to highlight the parameter, then use the data dial or [-/+] buttons. To set the pop-up time for the other displays, use the same method as above, pressing the **OTHERS** button instead of the **VOICE/STYLE** button. The default pop-up time can be recalled by pressing the corresponding ▼ and ▲ buttons simultaneously.

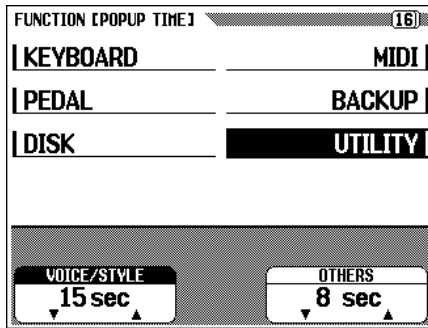

NOTE

Pop-up Time

- Range: 0sec (0 second) — 30sec (30 seconds), ∞sec (remains indefinitely)
- Basic settings: 15 seconds for voice/accompaniment style, 8 seconds for others
- Backup of last settings: ON

NOTES

- When 0sec (0 seconds) is selected, the the popup display will be displayed only while the operating button is held. If ∞sec is selected, the [DISPLAY HOLD] lamp will not flash and the pop-up display will not close automatically. In this case, press the [EXIT] button to close the display.

Alert Sound (ALERT) Display — PAGE 17

This function allows you to select one of six “Alert Voices” which will sound when an error is encountered, and set the alert volume.

Press the **VOICE** ▼ or ▲ button to highlight the parameter, then use the data dial or [-/+] buttons to select the desired alert sound. The alert sound automatically plays when it is selected, allowing you to check the sound during the operation. The default alert sound can be recalled instantly by pressing the [-/+] buttons simultaneously.

To set the alert volume, press the **VOLUME** button to highlight the parameter, then use the data dial or [-/+] buttons. The default volume level of 50 can be recalled instantly by pressing the [-/+] buttons simultaneously.

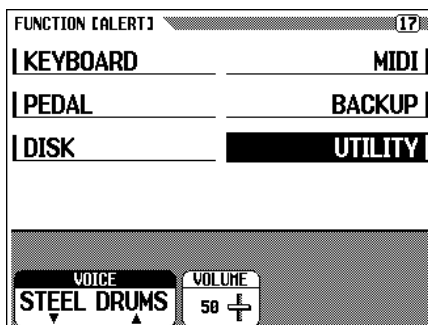

NOTE

Alert Sound

- Settings: STEEL DRUMS, AGOGO, WOOD BLOCK, TIMPANI, CELESTA 4FT, KALIMBA
- Basic setting: STEEL DRUMS
- Backup of last settings: ON
- Volume range: 0 — 100
- Basic setting: 50
- Backup of last setting: ON

CHAPTER 8: Others

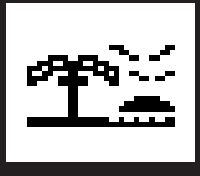

The Connectors

■ [MIC.VOL.] Dial and [MIC.] Jack

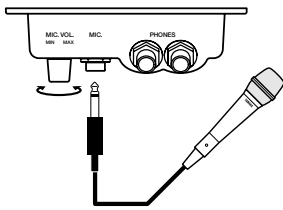

By connecting a microphone to the [MIC.] jack (standard 1/4" phone), you can enjoy singing along with your own performance or with song playback. The sound input from the microphone is output through the Clavinova's speakers. The microphone volume can be adjusted with the [MIC.VOL.] dial.

■ [PHONES] Jacks

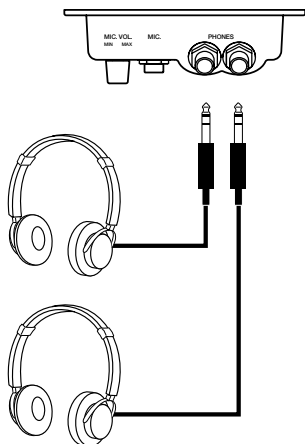

To use headphones, connect them to one of the [PHONES] jacks (standard 1/4" phone jacks). The internal speaker system of the Clavinova is automatically shut off when a pair of headphones are connected. Two people can enjoy the sound together by connecting two pairs of headphones to the two available terminals.

■ AUX IN [L/L+R] Jacks

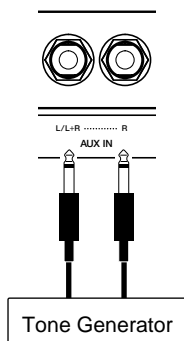

The sounds of other instruments or tone generator modules can be output through the speaker system of the Clavinova by connecting audio cables to the jacks as shown below.

NOTE

Recommended Headphones:
• Yamaha HPE-160 headphones

CAUTION

- Do not return the sound output through AUX OUT [L/L+R] [R] jacks to the AUX IN [L/L+R] [R] jacks. Also, when connecting the AUX OUT [L/L+R] [R] jacks to external audio equipment, do not connect these devices back into the Clavinova's AUX IN [L/L+R] [R] jacks. Since the input sound from the Clavinova's AUX IN [L/L+R] [R] is output through the Clavinova's AUX OUT [L/L+R] [R] as is, connecting as described above may result in feedback, making normal playback impossible and even resulting in damage to the instrument.

NOTE

- Internal [MASTER VOLUME] and [REVERB] settings cannot be applied to the input sound received at the AUX IN [L/L+R] [R] jacks.
- Use the AUX IN [L/L+R] and AUX OUT [L/L+R] jacks for mono input and mono output, respectively.

■ AUX OUT [L/L+R] [R] Jacks

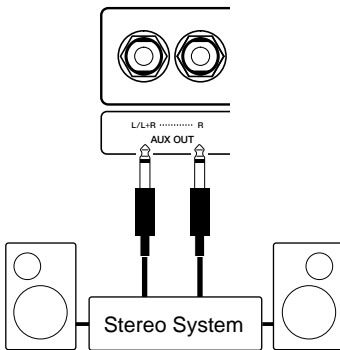

By connecting audio cables to the jacks as shown below, output the sound of the Clavinova to a stereo system, amplifier, mixing console, or recording equipment. Set the [MASTER VOLUME] of the Clavinova to around the middle position and adjust the volume level from the connected equipment.

■ [EXP.PEDAL] Terminal

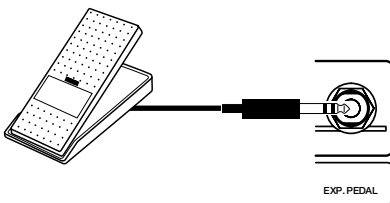

An optional Yamaha FC7 Foot Controller can be connected to this terminal for controlling the volume of your keyboard performance with your foot.

■ MIDI [IN] [OUT] [THRU] Terminals

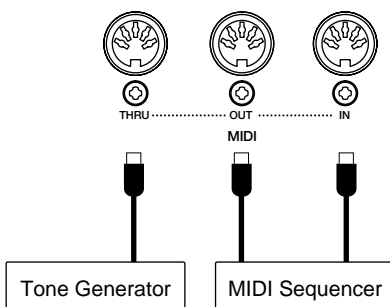

Connect the Clavinova to external MIDI devices by using MIDI connecting cables. Set the HOST SELECT switch below to “MIDI” when using the MIDI terminals.

■ HOST SELECT switch and [TO HOST] terminals

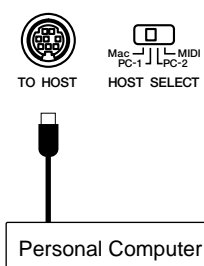

[TO HOST] terminal is connected directly to the personal computer.

Set the HOST SELECT switch to match the corresponding computer or connected MIDI device.

See the section “Connecting to a Personal Computer” for details.

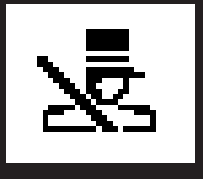

Connecting to a Personal Computer ...

Although the Clavinova can be connected to a personal computer via the MIDI IN/OUT connectors and a MIDI interface, the TO HOST connector and HOST SELECT switch allow direct connection to Apple Macintosh or IBM-PC/AT personal computers for sequencing and other music applications without the need for a separate MIDI interface.

■ Connecting to an Apple Macintosh Series Computer

Connect the TO HOST connector of the Clavinova to the modem or printer port on your Macintosh, depending on which port your MIDI software is using for MIDI data communication, using a standard Macintosh 8-pin system peripheral cable. Set the HOST SELECT switch to the "Mac" position.

You may also have to make other MIDI interface settings on the computer side, depending on the type of software you use (refer to your software owner's manual). In any case the clock speed should be set to 1 MHz.

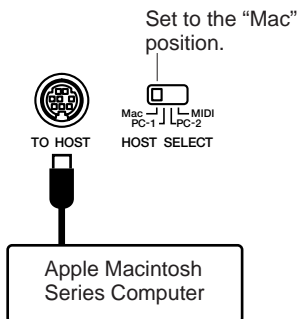

● "Mac" Cable Connections

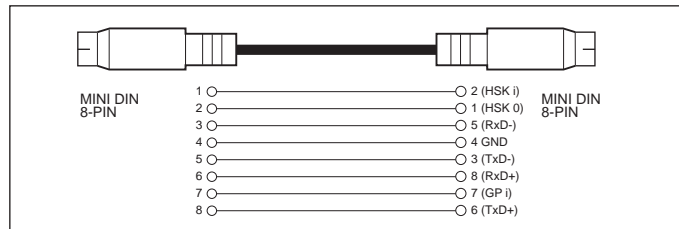

- 8-pin system peripheral cable.
- Data transfer rate: 31,250 bps.

■ Connecting to an IBM-PC/AT Series Computer

Connect the TO HOST connector of the Clavinova to the RS-232C port on your IBM computer, using a standard 8-pin MINI DIN → 9-pin D-SUB cross cable. Set the HOST SELECT switch to the "PC-2" position.

Refer to your software owner's manual for information on any settings you might have to make on the computer side.

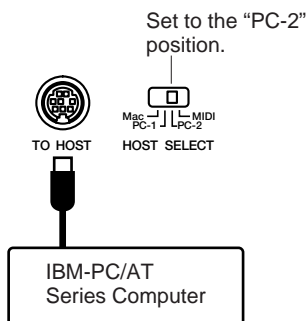

● "PC-2" Cable Connections

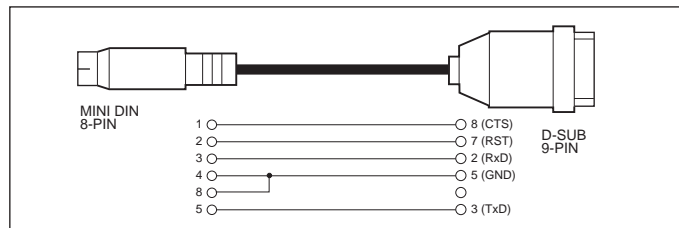

- 8-pin mini DIN → 9-pin D-SUB cable.
- Data transfer rate: 38,400 bps.

NOTE

- When using the [TO HOST] terminal of the Clavinova, first turn the power off on both the Clavinova and the computer before connecting the cable. After connecting the cable, turn the power of the computer on first, then the Clavinova.
- When not using the [TO HOST] terminal of the Clavinova, make sure the cable is disconnected from the [TO HOST] terminal. If the cable is left connected, the Clavinova may not function properly.
- When the HOST SELECT switch is set to "Mac", "PC-1", or "PC-2, no data transfer occurs via the MIDI connectors. To use the MIDI connectors for connection via a standard MIDI interface, set the HOST SELECT switch to "MIDI".
- If your system doesn't work properly with the connections and settings listed above, your software may require different settings. Check your software operation manual and if it requires a 31,250 bps. data transfer rate, set the HOST SELECT switch to "PC-1".

● Connector Pin Numbers

MINI DIN 8-PIN



D-SUB 9-PIN

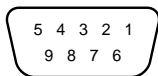

● MIDI Driver

The included Music Software Collection disk also contains special MIDI Driver software, which may be necessary when using computer software with the Clavinova. Install the MIDI driver from the disk to your computer if necessary. Refer to the text files on the disks listed below for installation instructions.

Windows 95:

A:\driver\win95\readme.txt

A:\driver\win95\license.txt

Windows 3.1 (IBM PC Series):

A:\driver\win31\ibmpc\cbxt3.txt

"A:" is the disk directory.

Trademarks

- *Apple and Macintosh are trademarks of Apple Computer, Inc.*
- *IBM-PC/AT is a trademark of International Business Machines Corporation.*
- *Windows is the registered trademark of Microsoft® Corporation.*
- *All other trademarks are the property of their respective holders.*

Index

A

Accompaniment style 47
Alert Sound 153
Auto Accompaniment 47, 56
Auto Accompaniment/Song Volume 17

B

Backup 16, 147
Break 53

C

Chord Assist 66
Chord Sequence 116
computer, connecting to a 156
contrast 15
Custom Style 68

D

Damper Range 134
Damper Mode 134
Demo play 24
Demo Song List 26
Dual 33

E

Easy Play 100
Effect Setting 131
Effect Type List 45
Effects 44
English Help 22
Expression Pedal 18, 155

F

File Icons 88
Fingered 56, 59
floppy disks 7
Format 106, 135
free tempo software 90
Freeze 86
Full Keyboard (FULL KEYBOARD) .. 56, 59
Function mode 128

G

Guide 100

H

Harmony 62
headphones 9, 154
Help 22

I

Initial Edit 124

K

key cover 8
Key Touch 131
Keyboard 1 130
Keyboard 2 131
keyboard guide lamps 104
Keyboard Percussion 32

L

LCD buttons 12
LCD display 12
left pedal 133
Lid (CVP-600) 9
Local Control 144
Lyrics 104

M

Master Equalizer 19
messages .. 16, 78; 2 (Reference Manual)
metronome 54
Microphone 154
Micro Tuning 149
MIDI 1 143
MIDI 2 144
MIDI 3 146
MIDI filter settings 144
Mixer 17, 60, 94
Multi Finger 56, 59
music stand 8

N

Next Note 100

O

One Touch Setting 63
Organ Combination 29

P

Pan 132
Part Cancel 91
Part 71
pedals 40, 133
Pianist 57
Piano Roll 101
Pop-up Time 153
power 9
Power Bass (CVP-98) 21
Punch In/Out recording 113

Q

Quantize 72, 123
Quick Recording 107

R

Recall 148
Record Edit functions 120
Registration 83, 139
Reverb Type List 42
Reverb 41

S

Scale Tuning 150
sections 69
Send Channel 143
setting up 8
Single Finger 56, 58
Small Accompaniment
(SMALL ACMP) 65
Song Copy 136
Song Delete 138
Song Name 121
Song Number 88
Song Play (Guide mode) 103
Song Play (Main) 87
Song Play (Part) 92
Song Play (Repeat) 97
Song Play (Track Play) 91
Song playback 87
Song recording 105
Soundboard Depth (CVP-98) 134
Sound Repeat 101
Split Point 37, 61
Split 36
Start 50, 112, 115
Start/Stop 89
Stop 53, 113, 116
Style File disk 80
Style File 80
Style Name 73
Styles, selecting 47
Sync 144
Synchro Stop 64

T

Tempo 49, 54, 90
terminals/jacks 154
Track Delete 123
Track Edit 122
Track Mix 122
Track Recording 110
Transform 142
Transpose 130
Tune 130

V

Virtual Arranger 64
Voices, selecting 27
Volume 17, 49, 54, 60, 93, 94

FCC INFORMATION (U.S.A.)

1. IMPORTANT NOTICE: DO NOT MODIFY THIS UNIT!

This product, when installed as indicated in the instructions contained in this manual, meets FCC requirements. Modifications not expressly approved by Yamaha may void your authority, granted by the FCC, to use the product.

2. IMPORTANT: When connecting this product to accessories and/or another product use only high quality shielded cables. Cable/s supplied with this product **MUST** be used. Follow all installation instructions. Failure to follow instructions could void your FCC authorization to use this product in the USA.

3. NOTE: This product has been tested and found to comply with the requirements listed in FCC Regulations, Part 15 for Class "B" digital devices. Compliance with these requirements provides a reasonable level of assurance that your use of this product in a residential environment will not result in harmful interference with other electronic devices. This equipment generates/uses radio frequencies and, if not installed and used according to the instructions found in the users manual, may cause interference harmful to the operation of other electronic devices.

Compliance with FCC regulations does not guarantee that interference will not occur in all installations. If this product is found to be the source of interference, which can be determined by turning the unit "OFF" and "ON", please try to eliminate the problem by using one of the following measures: Relocate either this product or the device that is being affected by the interference.

Utilize power outlets that are on different branch (circuit breaker or fuse) circuits or install AC line filter/s.

In the case of radio or TV interference, relocate/reorient the antenna. If the antenna lead-in is 300 ohm ribbon lead, change the lead-in to co-axial type cable.

If these corrective measures do not produce satisfactory results, please contact the local retailer authorized to distribute this type of product. If you can not locate the appropriate retailer, please contact Yamaha Corporation of America, Electronic Service Division, 6600 Orangethorpe Ave, Buena Park, CA90620

The above statements apply **ONLY** to those products distributed by Yamaha Corporation of America or its subsidiaries.

* This applies only to products distributed by YAMAHA CORPORATION OF AMERICA.

IMPORTANT NOTICE FOR THE UNITED KINGDOM

Connecting the Plug and Cord

IMPORTANT. The wires in this mains lead are coloured in accordance with the following code:

BLUE : NEUTRAL
BROWN : LIVE

As the colours of the wires in the mains lead of this apparatus may not correspond with the coloured markings identifying the terminals in your plug proceed as follows:

The wire which is coloured BLUE must be connected to the terminal which is marked with the letter N or coloured BLACK.

The wire which is coloured BROWN must be connected to the terminal which is marked with the letter L or coloured RED.

Making sure that neither core is connected to the earth terminal of the three pin plug.

CAUTION: TO PREVENT ELECTRIC SHOCK, MATCH WIDE BLADE OF PLUG TO WIDE SLOT, FULLY INSERT.

ATTENTION: POUR ÉVITER LES CHOCS ÉLECTRIQUES, INTRODUIRE LA LAME LA PLUS LARGE DE LA FICHE DANS LA BORNE CORRESPONDANTE DE LA PRISE ET POUSSER JUSQU'AU FOND.

- This applies only to products distributed by Yamaha Canada Music Ltd.
- Ceci ne s'applique qu'aux produits distribués par Yamaha Canada Musique Ltée.

IMPORTANT SAFETY INSTRUCTIONS

INFORMATION RELATING TO PERSONAL INJURY, ELECTRICAL SHOCK, AND FIRE HAZARD POSSIBILITIES HAS BEEN INCLUDED IN THIS LIST.

WARNING- When using any electrical or electronic product, basic precautions should always be followed. These precautions include, but are not limited to, the following:

- 1.** Read all Safety Instructions, Installation Instructions, Special Message Section items, and any Assembly Instructions found in this manual **BEFORE** making any connections, including connection to the main supply.
- 2.** Main Power Supply Verification: Yamaha products are manufactured specifically for the supply voltage in the area where they are to be sold. If you should move, or if any doubt exists about the supply voltage in your area, please contact your dealer for supply voltage verification and (if applicable) instructions. The required supply voltage is printed on the name plate. For name plate location, please refer to the graphic found in the Special Message Section of this manual.
- 3.** This product may be equipped with a polarized plug (one blade wider than the other). If you are unable to insert the plug into the outlet, turn the plug over and try again. If the problem persists, contact an electrician to have the obsolete outlet replaced. Do **NOT** defeat the safety purpose of the plug.
- 4.** Some electronic products utilize external power supplies or adapters. Do **NOT** connect this type of product to any power supply or adapter other than one described in the owner's manual, on the name plate, or specifically recommended by Yamaha.
- 5.** **WARNING:** Do not place this product or any other objects on the power cord or place it in a position where anyone could walk on, trip over, or roll anything over power or connecting cords of any kind. The use of an extension cord is not recommended! If you must use an extension cord, the minimum wire size for a 25' cord (or less) is 18 AWG. **NOTE:** The smaller the AWG number, the larger the current handling capacity. For longer extension cords, consult a local electrician.
- 6.** Ventilation: Electronic products, unless specifically designed for enclosed installations, should be placed in locations that do not interfere with proper ventilation. If instructions for enclosed installations are not provided, it must be assumed that unobstructed ventilation is required.
- 7.** Temperature considerations: Electronic products should be installed in locations that do not significantly contribute to their operating temperature. Placement of this product close to heat sources such as; radiators, heat registers and other devices that produce heat should be avoided.
- 8.** This product was **NOT** designed for use in wet/damp locations and should not be used near water or exposed to rain. Examples of wet/damp locations are; near a swimming pool, spa, tub, sink, or wet basement.
- 9.** This product should be used only with the components supplied or; a cart, rack, or stand that is recommended by the manufacturer. If a cart, rack, or stand is used, please observe all safety markings and instructions that accompany the accessory product.
- 10.** The power supply cord (plug) should be disconnected from the outlet when electronic products are to be left unused for extended periods of time. Cords should also be disconnected when there is a high probability of lightning and/or electrical storm activity.
- 11.** Care should be taken that objects do not fall and liquids are not spilled into the enclosure through any openings that may exist.
- 12.** Electrical/electronic products should be serviced by a qualified service person when:
 - a. The power supply cord has been damaged; or
 - b. Objects have fallen, been inserted, or liquids have been spilled into the enclosure through openings; or
 - c. The product has been exposed to rain; or
 - d. The product does not operate, exhibits a marked change in performance; or
 - e. The product has been dropped, or the enclosure of the product has been damaged.
- 13.** Do not attempt to service this product beyond that described in the user-maintenance instructions. All other servicing should be referred to qualified service personnel.
- 14.** This product, either alone or in combination with an amplifier and headphones or speaker/s, may be capable of producing sound levels that could cause permanent hearing loss. **DO NOT** operate for a long period of time at a high volume level or at a level that is uncomfortable. If you experience any hearing loss or ringing in the ears, you should consult an audiologist. **IMPORTANT:** The louder the sound, the shorter the time period before damage occurs.
- 15.** Some Yamaha products may have benches and/or accessory mounting fixtures that are either supplied as a part of the product or as optional accessories. Some of these items are designed to be dealer assembled or installed. Please make sure that benches are stable and any optional fixtures (where applicable) are well secured **BEFORE** using. Benches supplied by Yamaha are designed for seating only. No other uses are recommended.

PLEASE KEEP THIS MANUAL

For details of products, please contact your nearest Yamaha or the authorized distributor listed below.

Pour plus de détails sur les produits, veuillez-vous adresser à Yamaha ou au distributeur le plus proche de vous figurant dans la liste suivante.

Die Einzelheiten zu Produkten sind bei Ihrer unten aufgeführten Niederlassung und bei Yamaha Vertragshändlern in den jeweiligen Bestimmungsländern erhältlich.

Para detalles sobre productos, contacte su tienda Yamaha más cercana o el distribuidor autorizado que se lista debajo.

NORTH AMERICA

CANADA

Yamaha Canada Music Ltd.
135 Milner Avenue, Scarborough, Ontario,
M1S 3R1, Canada
Tel: 416-298-1311

U.S.A.

**Yamaha Corporation of America,
Keyboard Division**
6600 Orangethorpe Ave., Buena Park, Calif. 90620,
U.S.A.
Tel: 714-522-9011

CENTRAL & SOUTH AMERICA

MEXICO

**Yamaha de Mexico S.A. De C.V.,
Departamento de ventas**
Javier Rojo Gomez No.1149, Col. Gpe Del
Moral, Deleg. Iztapalapa, 09300 Mexico, D.F.
Tel: 686-00-33

BRAZIL

Yamaha Musical do Brasil LTDA.
Av. Rebouças 2636, São Paulo, Brasil
Tel: 011-853-1377

ARGENTINA

Yamaha Music Argentina S.A.
Viamonte 1145 Piso2-B 1053,
Buenos Aires, Argentina
Tel: 1-371-7021

PANAMA AND OTHER LATIN AMERICAN COUNTRIES/ CARIBBEAN COUNTRIES

Yamaha de Panama S.A.
Torre Banco General, Piso 7, Urbanización Marbella,
Calle 47 y Aquilino de la Guardia,
Ciudad de Panamá, Panamá
Tel: 507-269-5311

EUROPE

THE UNITED KINGDOM

Yamaha-Kemble Music (U.K.) Ltd.
Sherbourne Drive, Tilbrook, Milton Keynes,
MK7 8BL, England
Tel: 01908-366700

IRELAND

Danfay Ltd.
61D, Sallynoggin Road, Dun Laoghaire, Co. Dublin
Tel: 01-2859177

GERMANY/SWITZERLAND

Yamaha Europa GmbH.
Siemensstraße 22-34, 25462 Rellingen,
F.R. of Germany
Tel: 04101-3030

AUSTRIA

Yamaha Music Austria
Schleiergasse 20, A-1100 Wien Austria
Tel: 01-60203900

THE NETHERLANDS

Yamaha Music Nederland
Kanaalweg 18G, 3526KL, Utrecht, The Netherlands
Tel: 030-2828411

BELGIUM

Yamaha Music Belgium
Keiberg Imperiastraat 8, 1930 Zaventem, Belgium
Tel: 02-7258220

FRANCE

**Yamaha Musique France,
Division Claviers**
BP 70-77312 Marne-la-Vallée Cedex 2, France
Tel: 01-64-61-4000

ITALY

**Yamaha Musica Italia S.P.A.,
Home Keyboard Division**
Viale Italia 88, 20020 Lainate (Milano), Italy
Tel: 02-935-771

SPAIN

Yamaha-Hazen Electronica Musical, S.A.
Jorge Juan 30, 28001, Madrid, Spain
Tel: 91-577-7270

PORTUGAL

Valentim de Carvalho CI SA
Estrada de Porto Salvo, Paço de Arcos 2780 Oeiras,
Portugal
Tel: 01-443-3398/4030/1823

GREECE

Philippe Nakas S.A.
Navarinou Street 13, P.Code 10680, Athens, Greece
Tel: 01-364-7111

SWEDEN

Yamaha Scandinavia AB
J. A. Wettergrens Gata 1
Box 30053
S-400 43 Göteborg, Sweden
Tel: 031 89 34 00

DENMARK

YS Copenhagen Liaison Office
Generatorvej 8B
DK-2730 Herlev, Denmark
Tel: 44 92 49 00

FINLAND

Warner Music Finland OY/Fazer Music
Aleksanterinkatu 11, P.O. Box 260
SF-00101 Helsinki, Finland
Tel: 0435 011

NORWAY

Norsk filial av Yamaha Scandinavia AB
Grini Næringspark 1
N-1345 Østerås, Norway
Tel: 67 16 77 70

ICELAND

Skifan HF
Skeifan 17 P.O. Box 8120
IS-128 Reykjavik, Iceland
Tel: 525 5000

OTHER EUROPEAN COUNTRIES

Yamaha Europa GmbH.
Siemensstraße 22-34, 25462 Rellingen, F.R. of
Germany
Tel: 04101-3030

AFRICA

**Yamaha Corporation,
International Marketing Division**
Nakazawa-cho 10-1, Hamamatsu, Japan 430-8650
Tel: 053-460-2312

MIDDLE EAST

TURKEY/CYPRUS

Yamaha Europa GmbH.
Siemensstraße 22-34, 25462 Rellingen,
F.R. of Germany
Tel: 04101-3030

OTHER COUNTRIES

**Yamaha Corporation,
International Marketing Division**
Nakazawa-cho 10-1, Hamamatsu, Japan 430-8650
Tel: 053-460-2312

ASIA

HONG KONG

Tom Lee Music Co., Ltd.
11/F., Silvercord Tower 1, 30 Canton Road,
Tsimshatsui, Kowloon, Hong Kong
Tel: 2737-7688

INDONESIA

**PT. Yamaha Music Indonesia (Distributor)
PT. Nusantik**
Gedung Yamaha Music Center, Jalan Jend. Gatot
Subroto Kav. 4, Jakarta 12930, Indonesia
Tel: 21-520-2577

KOREA

Cosmos Corporation
#131-31, Neung-Dong, Sungdong-Ku, Seoul
Korea
Tel: 02-466-0021~5

MALAYSIA

Yamaha Music Malaysia, Sdn., Bhd.
Lot 8, Jalan Perbandaran, 47301 Kelana Jaya,
Petaling Jaya, Selangor, Malaysia
Tel: 3-703-0900

PHILIPPINES

Yupango Music Corporation
339 Gil J. Puyat Avenue, P.O. Box 885 MCPO,
Makati, Metro Manila, Philippines
Tel: 819-7551

SINGAPORE

Yamaha Music Asia Pte., Ltd.
Blk 202 Hougang, Street 21 #02-01,
Singapore 530202
Tel: 747-4374

TAIWAN

Yamaha KHS Music Co., Ltd.
10F, 150, Tun-Hwa Northroad,
Taipei, Taiwan, R.O.C.
Tel: 02-2713-8999

THAILAND

Siam Music Yamaha Co., Ltd.
121/60-61 RS Tower 17th Floor,
Ratchadaphisek RD., Dindaeng,
Bangkok 10320, Thailand
Tel: 02-641-2951

THE PEOPLE'S REPUBLIC OF CHINA AND OTHER ASIAN COUNTRIES

**Yamaha Corporation,
International Marketing Division**
Nakazawa-cho 10-1, Hamamatsu, Japan 430-8650
Tel: 053-460-2317

OCEANIA

AUSTRALIA

Yamaha Music Australia Pty. Ltd.
17-33 Market Street, South Melbourne, Vic. 3205,
Australia
Tel: 3-699-2388

NEW ZEALAND

Music Houses of N.Z. Ltd.
146/148 Captain Springs Road, Te Papapa,
Auckland, New Zealand
Tel: 9-634-0099

COUNTRIES AND TRUST TERRITORIES IN PACIFIC OCEAN

**Yamaha Corporation,
International Marketing Division**
Nakazawa-cho 10-1, Hamamatsu, Japan 430-8650
Tel: 053-460-2317

HEAD OFFICE Yamaha Corporation, Electronic Musical Instrument Division
Nakazawa-cho 10-1, Hamamatsu, Japan 430-8650
Tel: 053-460-3273

