

YAMAHA

Synthesizer

CS-5

● OWNER'S MANUAL

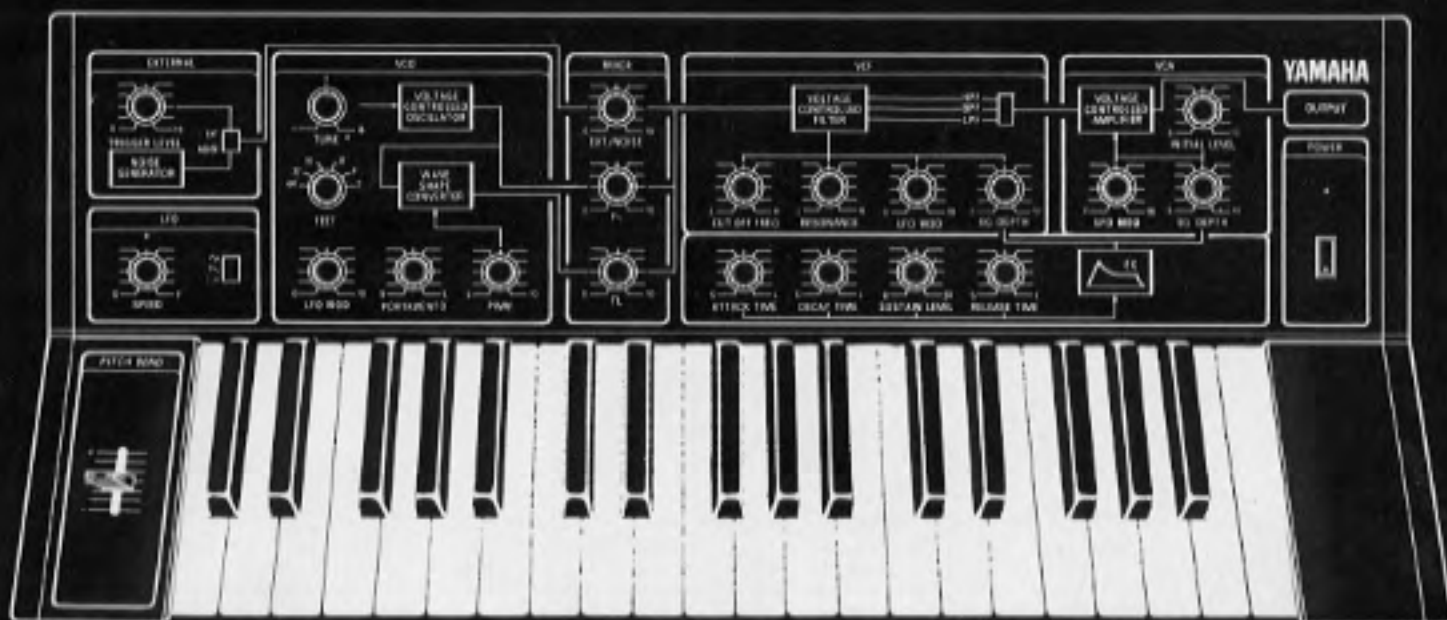

PROFILE

The CS-5 synthesizer is ideal for a wide variety of applications. It can serve as a beginner's instrument, and it can equally well be used as a versatile solo keyboard.

Points of Attention

Installation

Avoid places subjected to direct sunshine, high humidity, or extremely dusty locations. Never use the synthesizer near fire or heat-producing objects, such as on top of a power amplifier.

Cleaning

When cleaning the set, do not wipe the panel or keyboard with thinner or other cleaning liquids, as this may leave stains or cause discoloration. Always use only a soft and dry piece of cloth.

Connections

Connections to an amplifier or other equipment must be made appropriately and with due care, as wrong connections may lead to damage in the synthesizer or amplifier.

Volume

The volume level should always be set with care, as the application of excessive input to the amplifier may cause damage to the amplifier or speakers.

EXTERNAL

This block controls the external input signal.

page **10** **14**

VCO

Voltage controlled oscillator block to control the pitch and generate square waves and sawtooth waves as sound sources.

page **8**

LFO

This block consists of a very low frequency oscillator to modulate the VCO, VCF, and VCA blocks.

page **9**

PITCH BEND

Sliding control to change the pitch manually during performance.

page **8**

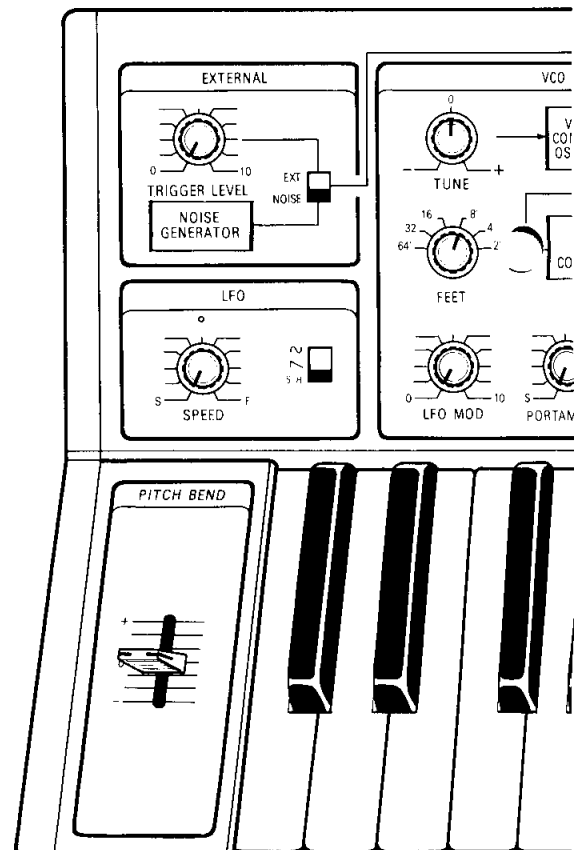

MIXER

This section selects the sound sources sent to the VCF and serves to adjust the levels.

page 10

VCF

Voltage controlled filter block. This block produces the tone color by controlling the harmonic structure of the sound source which in turn is governed by the cut-off frequency of the filter. Control voltages are given by the CUT OFF FREQ knob, by the envelope set in the EG block, etc.

page 11

VCA

Voltage controlled amplifier block. This block controls the volume according to the envelope set by the EG block and other factors.

page 12

OUTPUT

POWER

Power switch

Envelope generator to produce the curve of temporal change in the sound ('envelope'), by means of trigger signals representing the ON/OFF timing of the keyboard.

page 12 13

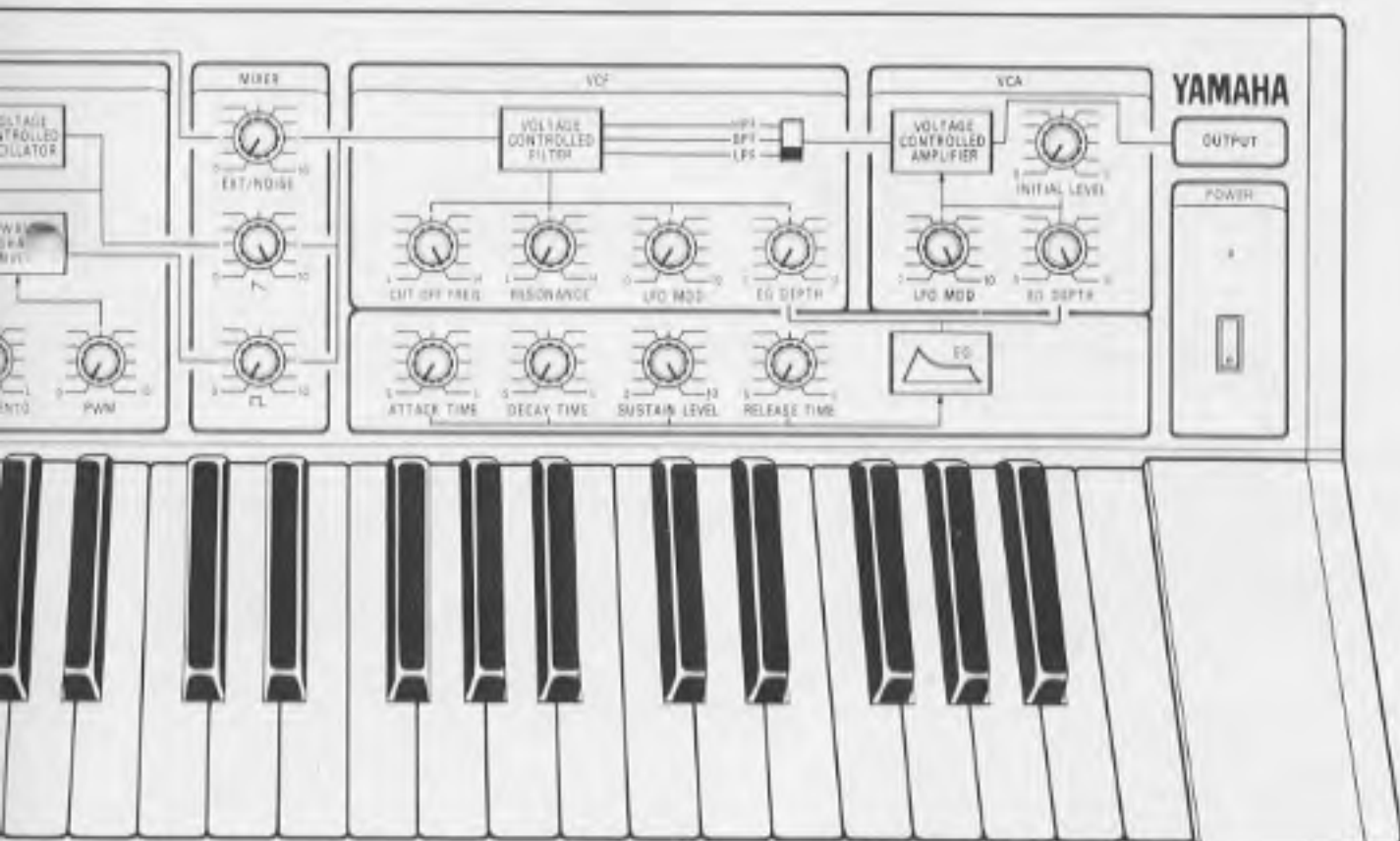

WHAT IS A SYNTHESIZER

Unlike other musical instruments, the synthesizer has no fixed sound of its own. Thus, before playing it, it is necessary to shape the sounds. But with the synthesizer you will be able to create, with your own hands and by synthesizing sounds, a new type of sound that can never be made by any other musical instrument.

• THE THREE ELEMENTS OF SOUND

How does a synthesizer make sounds? Before explaining the principle of the synthesizer, let us consider what kind of properties sound has.

Sound produced by musical instruments such as the piano or the guitar has a certain pitch, according to the key or string used. It is possible to change the pitch by changing the length of the vibrating portion of the string. In this case, the string's number of vibrations per second also changes. The slower the string vibrates, the lower the pitch becomes. In this way, it is possible to express the difference in pitch by the number of vibrations (frequency).

PITCHES

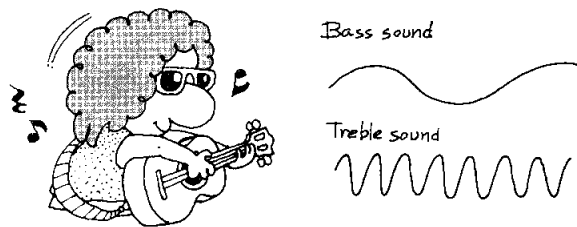

However, between the sound of a piano and that of a guitar there is a difference in tone even when both sounds are of the same pitch: no one will mistake the sound of the piano for that of the guitar. This is because there is a difference in the way the strings vibrate (the vibration waveform), due to the difference in the arrangement by which the sounds are generated, and because of the difference in the shape and size of the musical instruments.

TONES

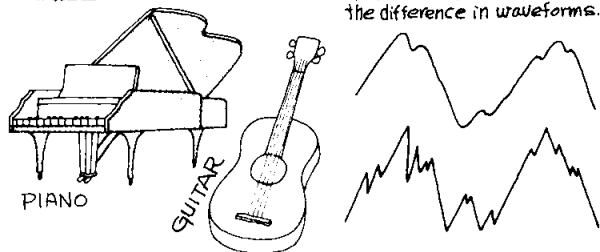

Furthermore, even when both the pitch and tone quality are the same there can be a difference in sound, such as when the same key of the piano is hit in a forcible or a gentle manner. It is easy to discern the two sounds from each other because of the

magnitude (volume) of the sound. This is because a difference will be produced in the size and amplitude of the string's vibrations, due to the intensity with which it has been struck.

In this way, sounds produced by musical instruments have such elements as pitch, tone and volume, whose differences add to the sound's characteristics. These elements are referred to as "the three elements of sound", which may also be considered as the difference in frequency, waveform and amplitude.

• TEMPORAL CHANGE IN SOUNDS

However, the elements which render sounds with certain characteristics are not confined to these three. Taking the piano for example, the volume will reach maximum the instant the key is hit, then will decrease gradually. When the finger is released from the keyboard, the sound will fade out. In the case of the organ, the action of depressing the key will cause the volume to rise to a certain level, which will be retained for the duration the keyboard is depressed. The sound will fade away when the finger is released from the key.

ENVELOPE

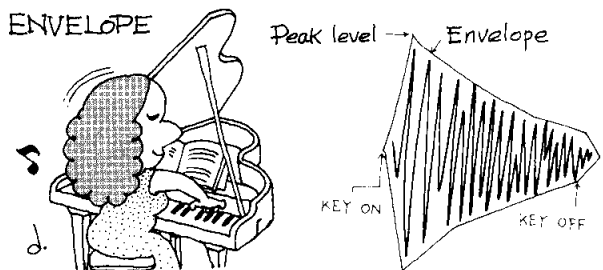

In such musical instruments as the trumpet, for example, the harmonic spectrum changes together with the change in volume. The tone changes too, along with the passage of time.

Thus, the sounds of musical instruments undergo delicate changes from the time the sound is generated to the time it fades away. These temporal changes are known as an "envelope."

• HARMONICS

What must we do in order to produce electrical sounds that have the above mentioned three elements of sound, these are pitch, tone and volume, and which vary with time (have an envelope)? Before going into the matter, let us view sound again from a different angle.

As regards the vibration waveforms by which the tone is determined, it is known that any given waveform can be considered as consisting of a certain number of sine waves. In other words, all waveforms can be produced by combining a large number of sine waves. For example, let us overlap over a single sine wave waveforms having an integral multiple

number of vibrations, such as 2-fold, 3-fold, and so on. It is seen that the waveform will gradually come to resemble a sawtooth waveform. In addition to this, it is apparent that this sawtooth waveform has a cycle similar to that of the sine wave that has been used as the basis. The sine wave with the basic cycle is referred to as the fundamental and the sine waves of harmonic overtones as the harmonics. In the case of musical instruments, the way in which harmonics are contained in sounds will depend on the arrangement by which sounds are generated. When we discuss the difference in tones (waveforms), it is the same as discussing what kind of harmonics the sounds contain.

Accordingly, one can express the three elements of sound in another manner, that is, as 1) pitch, 2) the manner in which harmonics are contained (harmonic structure) and 3) volume.

SAWTOOTH WAVE

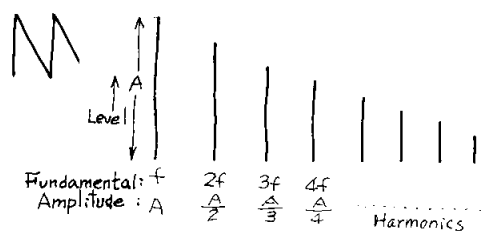

• STRUCTURE OF THE SYNTHESIZER

In the synthesizer, sounds are synthesized by electronically effecting control on the four properties of sound (the three elements of sound plus the envelope), dividing it into 4 blocks.

Control of pitch is effected by the VCO, that of harmonic spectrum by the VCF, that of volume by the VCA and that of envelope by the EG (envelope generator). The following describes the functions of each block.

• VCO

The VCO block produces sound sources of frequencies corresponding to the intervals of the keyboard. The sound source waveforms produced by the VCO are sawtooth waves and square waves that include many harmonics in a regular manner. These waves are oscillated, using an electronic circuit.

• VCF

The VCF block determines the tone, changing the harmonic spectrum of the sound sources by cutting, or emphasizing, certain parts of the harmonics by passing the sound sources through filters. The boundary between the portion that passes through the filter and the portion that is cut off is known as the cut-off frequency. The VCF creates the characteristic harmonic spectrum, by varying the cut-off frequency.

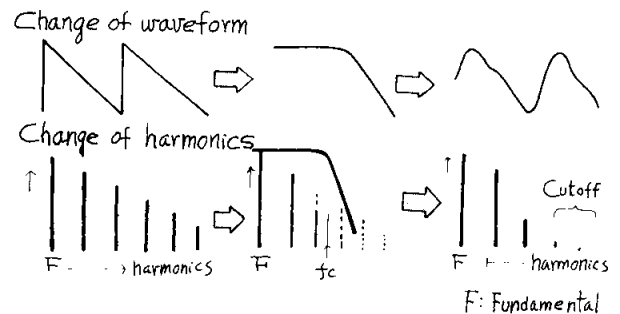

In addition to adjusting the cut-off frequency by means of a knob, the tone is caused to undergo a temporal change (from the time the sound is generated to the time it ceases) to give it an “envelope”. This is accomplished by effecting control on the filter’s cut-off frequencies by means of the envelope generator.

• VCA

The VCA block adds an “envelope” to the volume. The process starting from the generation of the sound up to the point the sound gradually fades away is governed by the envelope generator’s ATTACK TIME, DECAY TIME, SUSTAIN LEVEL, RELEASE TIME (A.D.S.R.), changing the amplification degree of the VCA amplifier.

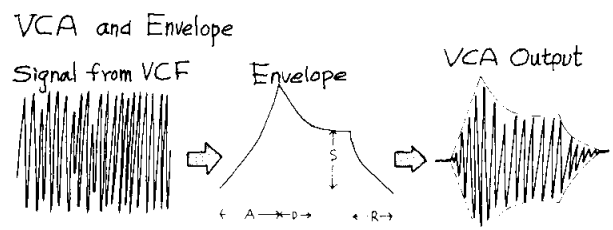

The signals from the VCO reach the VCF where they undergo a change with regard to their harmonic spectrum by being passed through a filter. The signals, now containing certain tone characteristics, are given a volume “envelope” at the VCA and then fed out. In this way, all elements of the properties of sound are controlled electronically, by utilizing the three elements of sound and the “envelope.” The synthesizer has, in addition to the blocks described above, other blocks such as the LFO which permit further changes in the sounds. But in this case too, the job is performed by controlling the three elements of sound and the envelope.

We hope that the points described in this section may be helpful to understand the immense possibilities and great pleasure awaiting you on a path that will lead you into a new world of music using a totally new musical instrument, the synthesizer.

CONNECTIONS

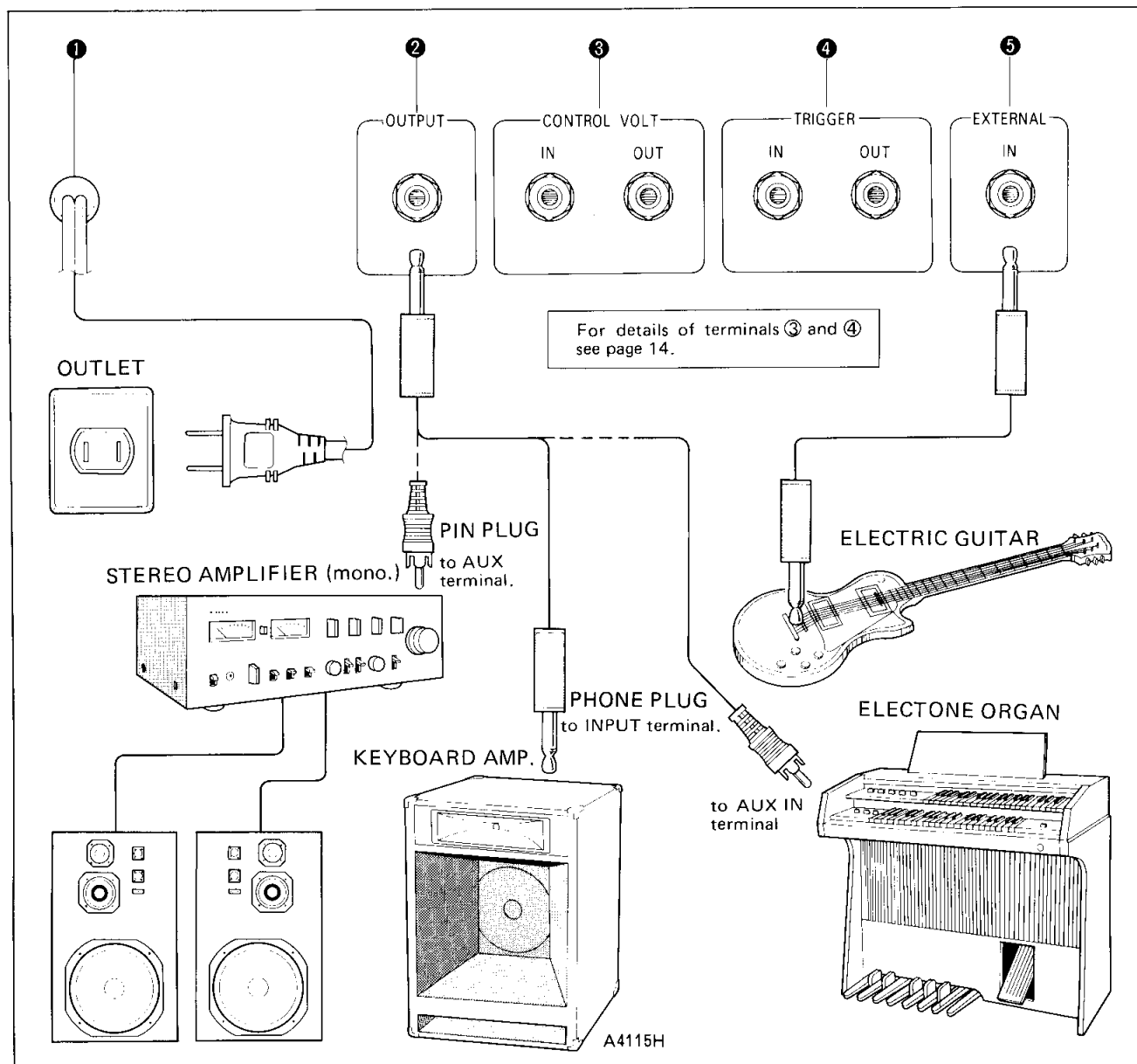

1 POWER CORD

Connect the power cord plug to an AC outlet.

2 OUTPUT

The CS-5 can be connected to all kinds of amplifiers. Use connection cords with plugs matching the shape of the input terminal of the amplifier to be used. The following input terminals are to be used:

KEYBOARD AMPLIFIER	INPUT TERMINAL
GUITAR AMPLIFIER	LOW INPUT
STEREO AMPLIFIER	AUX TERMINAL
ELECTRONIC ORGAN	EXT IN, AUX IN, EXP IN, etc.

3 CONTROL VOLT 4 TRIGGER

By connecting the set with other synthesizers, such as CS-5, CS-10, CS-15, CS-30 etc., having CONTROL VOLT (or KEY VOLT), and TRIGGER terminals, this set can be used as a multi-system synthesizer. See page 14 for further details.

5 EXTERNAL

If an electric guitar or the like is connected as sound source, it is possible to give its sound a synthesizer effect by the control blocks. For details see page 14.

HOW TO PRODUCE SOUND

Each section will be explained according to the signal flow. Please operate the knobs and switches in each item to understand their function while listening to the changes in sound.

To immediately obtain sound when the keys are depressed, it is necessary to set the synthesizer (hereafter referred to as basic setting).

BASIC SETTING

1. Connect the synthesizer properly by referring to CONNECTIONS on the previous page.
2. Set the synthesizer as shown in the illustration according to the following steps.

① POWER SWITCH

When pushed down, the synthesizer is switched on and the indicator illuminates.

- Set the MIXER block as follows:
 ▷ (sawtooth wave) knob → 10 (fully right)
 - Set the VCF block as follows:
 HPF/BPF/LPF switch → LPF
 CUT OFF FREQ knob → H (fully right)
 - Set the VCA BLOCK as follows:
 EG DEPTH knob → 10 (fully right)
 - Set the EG block as follows:
 SUSTAIN LEVEL knob → 10 (fully right)
- Set the other knobs and switches as illustrated below. Under this condition sound is produced when the keys are depressed.

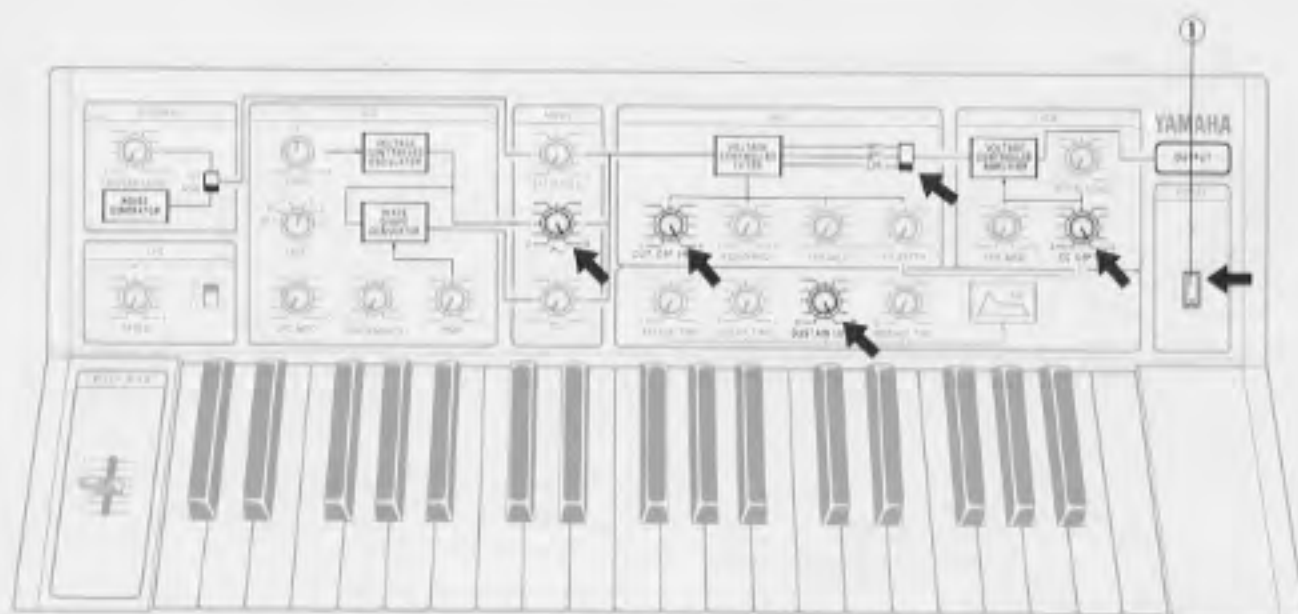

3. This complete the basic setting.

The CS-5 panel layout follows the block diagram (circuit diagram), showing actual operation of the synthesizer and flow of signals. Signals flowing from left to right are controlled in each block and thus the sound is created.

FUNCTIONS KEYBOARD/VCO

The keyboard block consists of the keyboard, the voltage (CONTROL VOLT) corresponding to the pitch and the TRIGGER control signal representing the KEY-ON and KEY-OFF timing.

② KEYBOARD

The CS-5 is a monophonic synthesizer covering three octaves with 37 keys.

- When two or more keys are simultaneously depressed, priority is given to the key of the higher pitch.
- The sound range to be covered can be changed by the FEET switch in the VCO block.

③ PITCH BEND

The pitch can be varied up and down within the range of 1 octave manually by shifting the PITCH BEND sliding control.

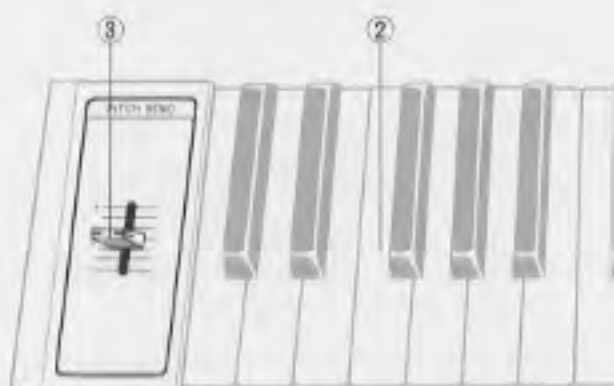

The VCO block is a voltage controlled oscillator generating sawtooth and square waves which become the sound sources according to the control signals from the keyboard block.

④ TUNE

This knob adjusts the pitch. Turning it towards "plus" increases pitch and turning it towards "minus" decreases pitch. This is used to tune the synthesizer with other instruments.

- It will take about 15 minutes after the synthesizer is switched ON until the pitch becomes stabilized. Thus, the synthesizer should be turned on 15 minutes before tuning.

⑤ FEET

The keyboard covers 3 octaves with 37 keys. The sound range to be covered can be shifted by the FEET switch as illustrated below.

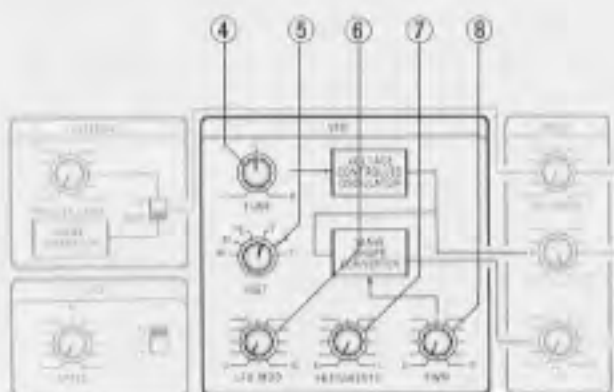

⑥ LFO MOD

The frequencies of oscillation generated in the VCO can be further modulated within a certain range by the LFO block. The further the LFO MOD knob is turned towards 10, the deeper the modulation becomes.

⑦ PORTAMENTO

PORTAMENTO is an effect by which the sound of one key smoothly changes into the pitch of the next one depressed. The shifting speed is adjusted by this knob. The further it is turned towards L, the longer the transition time becomes.

FUNCTIONS VCO/LFO

⑧ PWM (Pulse Width Modulation)

Modulates the pulse width of the VCO's (square) waves at a period set with the SPEED knob in the LFO. When the knob is turned to 0, symmetrical square waves are produced. The further it is turned towards 10, the larger becomes the change in pulse width.

- To confirm the effect of the PWM, it is necessary to turn the ∇ (sawtooth wave) knob ⑫ and the EXT/NOISE knob ⑪ in the MIXER block fully left, and turn the \square (square wave) knob towards 10.
- The PWM follows a \sim (sine wave), regardless of the waveform switch position in the LFO.

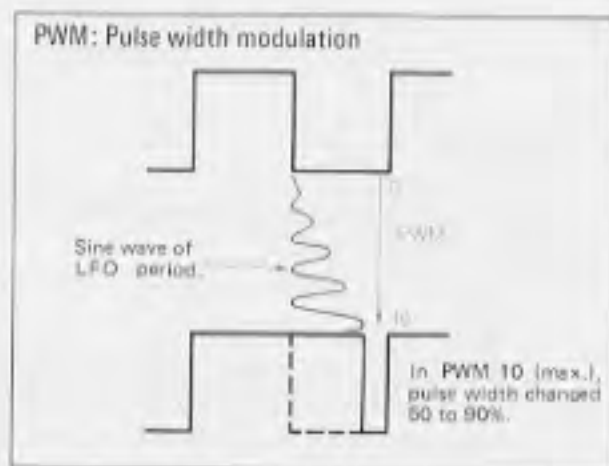

The LFO is a very low frequency oscillator block to produce periodical changes in pitch, tone, and volume as created by the VCO, VCF, and VCA blocks.

- To confirm the effect of the LFO, it is necessary to turn up the LFO MOD knobs in each block.

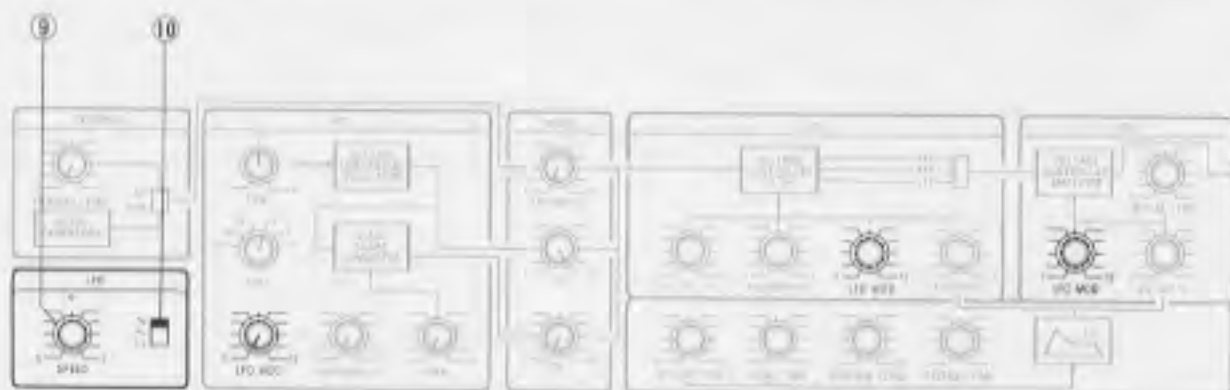

⑨ SPEED

This knob adjusts the modulation period. The speed becomes faster the further the knob is turned towards F. The adjustable range is 0.3 to 100 Hz. By changing the speed different sound effects can be produced.

⑩ LFO

\sim : SINE WAVE

Gently changing sound effects can be obtained.

Vibrato effect to VCO.

"Wah Wah" and "Growl" effects to VCF.

Tremolo effect to VCA.

∇ : SAWTOOTH WAVE

Intermittent sudden change and slow change.

S/H : SAMPLE AND HOLD

Causes irregular changes. S/H samples an instant value of the irregularly changing noise waves, and sustains that value until another sampling is made, thus producing irregularly changing modulation signals. The sampling period is determined by the SPEED knob ⑨.

S/H Principle

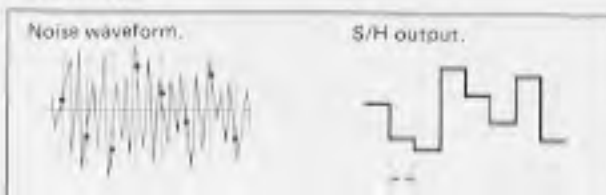

FUNCTIONS MIXER/EXTERNAL

The MIXER block selects the waveforms to be used as sound sources and adjusts the input level to the VCF block.

11 EXT/NOISE

When external signals or noise selected by the EXT/NOISE switch of the EXTERNAL block are used as the sound source, adjust their volume with this knob.

12 : Sawtooth wave

Adjusts the sawtooth wave levels. Sawtooth waves have harmonics of doubled integers, which suits them to be used as pseudo sound sources for imitating instruments and the like.

13 : Square wave

Adjusts the square wave levels. The pulse width modulation of these waves can be controlled by the PWM knob (8) in the VCO block. Square waves have harmonics of the next odd number, but if they are modulated, an effect peculiar to the synthesizer can be obtained.

- In the MIXER the volumes of the respective waveforms can be adjusted independently and the different sound sources can be freely mixed.

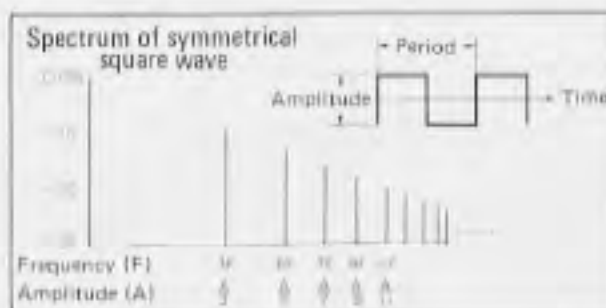
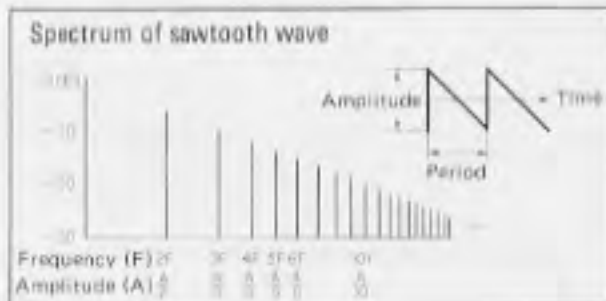
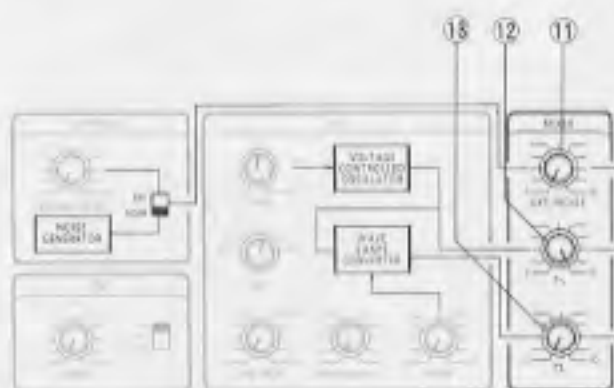

The EXTERNAL block is an input controlling section which permits using external signals such as from an electric guitar connected to the EXTERNAL terminal on the rear panel, as the sound sources of the synthesizer.

- For the EXTERNAL signals and TRIGGER LEVEL knob see page 14.

14 NOISE

With the EXT/NOISE switch set to NOISE, NOISE can be chosen as the sound source by the EXT/NOISE knob in the MIXER block. The noise is white noise including widely dispersed frequencies ranging from very low to very high. It is well suited as sound source to imitate such natural sounds as wind, waves, train sounds, etc.

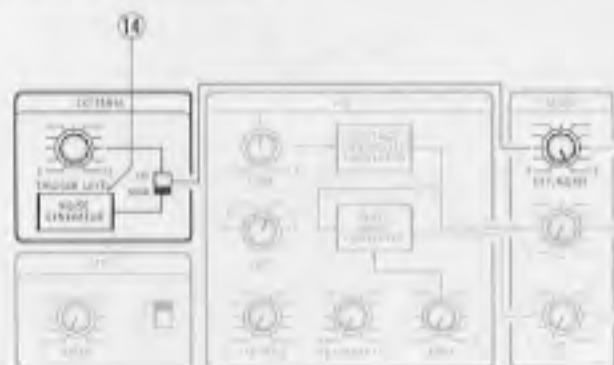

FUNCTIONS VCF

The VCF (voltage controlled filter) block changes the harmonic structure and creates the tone coloration by filtering the sound source signals selected in the MIXER block.

15 HPF/BPF/LPF

HPF : High-pass filter

Frequencies higher than the cut-off frequency set by the CUT OFF FREQ knob (16) pass.

BPF : Band-pass filter

Frequencies lying between the cut-off frequency set by the CUT OFF FREQ knob pass. The CUT OFF FREQ knob is used to vary the width of the band of frequencies being passed, from narrow to wide.

LPF : Low-pass filter

Frequencies lower than the cut-off frequency set by the CUT OFF FREQ knob pass. This is the type of filter generally used in synthesizers.

- When the CUT OFF FREQ knob is turned fully to L in the LPF position, all frequencies are cut off with no sound being produced.
- When the CUT OFF FREQ knob is turned fully to H in the HPF or BPF position, the volume will become small since only harmonics in the high range are passed through.

16 CUT OFF FREQ

The boundary frequency between the range being passed by the filter and the range to be cut is called the cut-off frequency. The harmonics of the sound source signals are partially cut by adjusting the cut-off frequency to influence the tone coloration. Turning the knob towards H will cause the cut-off frequency to become higher.

17 RESONANCE

If the RESONANCE knob is turned towards H, the harmonics in the neighborhood of the cut-off frequency are emphasized, and the tones are more accentuated.

18 LFO MOD

Permits the change of the tones periodically by modulating the cut-off frequency of the VCF at a period given by the LFO. The modulation will become deeper the more the knob is towards 10.

19 EG DEPTH

Controls the depth of the envelope that is to be applied to the VCF by the EG (Envelope Generator) block. Depth increases when the knob is turned towards 10.

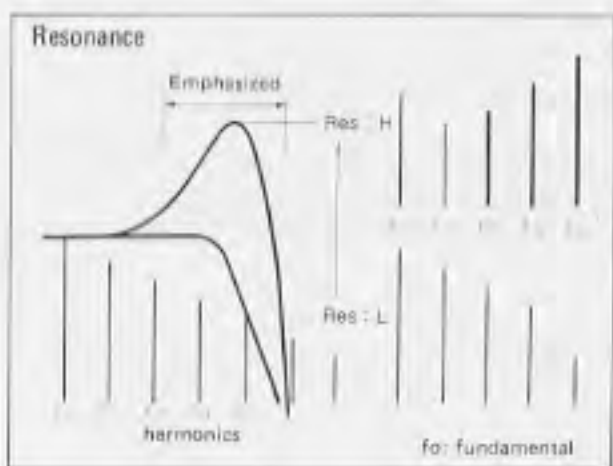
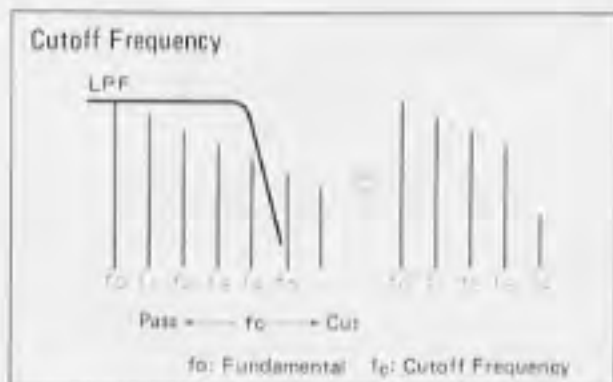
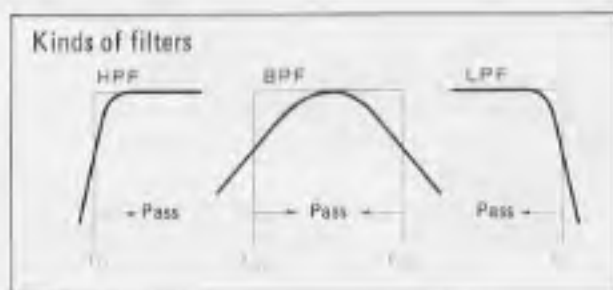
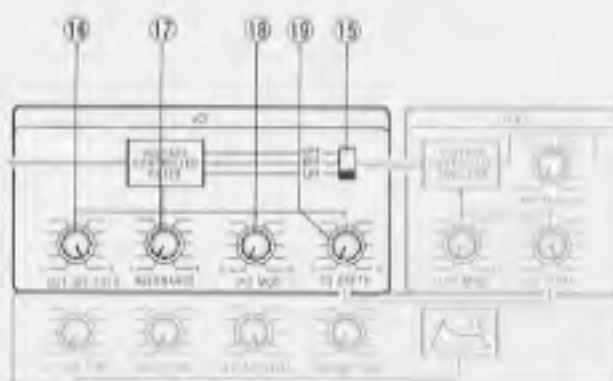

FUNCTIONS VCA/EG

The VCA (voltage controlled amplifier) block effects changes in volume of the signals coming from the VCF.

20 INITIAL LEVEL

Adjusts the volume level (initial level) of the VCA output when keys are not depressed. When the knob is set to 0, the volume is determined only by the values of the EG DEPTH and EG block knobs.

21 EG DEPTH

Adjusts the depth of the envelope set by the EG block applied to the VCA block. Adjustments of EG DEPTH control the amplitude of the VCA output.

- The VCA output volume is the sum of the levels set by the INITIAL LEVEL knob 20 and the EG DEPTH knob 21.

22 LFO MOD

Modulates the VCA at a period set by the LFO and produces a tremolo-like effect (LFO wave: sine wave). Modulation becomes deeper as the knob is turned towards 10.

The EG block creates an envelope curve which submits the sound to temporal change in the four modes of ATTACK TIME, DECAY TIME, SUSTAIN LEVEL, and RELEASE TIME.

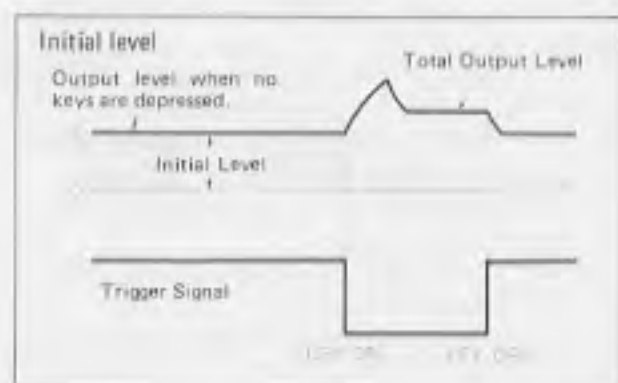
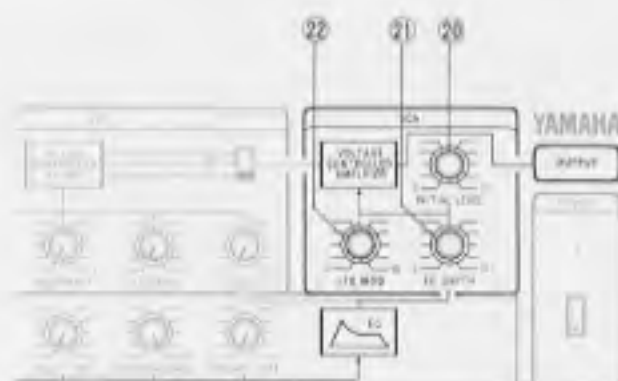

The EG is controlled by the KEY-ON/KEY-OFF signals from the keyboard and louds temporal change to the tone produced in the VCF and the volume in the VCA.

- This block can be triggered by the external signals connected to the EXTERNAL terminal on the rear panel. For details see page 14.
- To confirm the operations of the EG block, it is necessary to use the EG DEPTH knobs in the VCF and VCA blocks. Turn the INITIAL LEVEL knob 20 in the VCA block completely to 0.

23 ATTACK TIME

Adjusts the time from the moment when keys are depressed until maximum change. It controls the attack characteristics at the beginning of sound production. Turning the knob towards L causes slower attack.

24 DECAY TIME

Adjusts the time from the maximum change until the stable condition set with the SUSTAIN LEVEL knob 25 is reached. Turning the knob towards L causes slower decay.

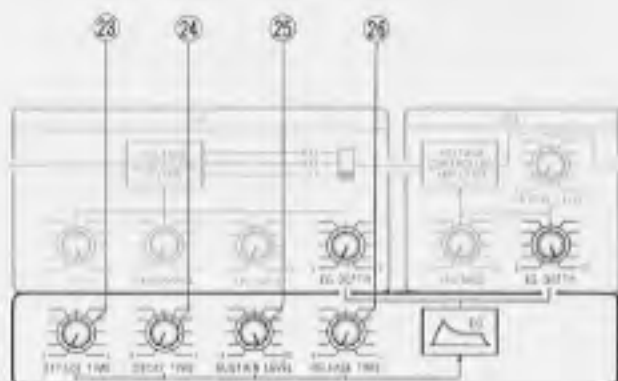

FUNCTIONS EG

25 SUSTAIN LEVEL

Adjusts the stable sound level that will persist until keys are released after changes by ATTACK TIME and DECAY TIME have been completed. Turning the knob towards 10 causes the SUSTAIN LEVEL to become higher.

26 RELEASE TIME

Adjusts the time from the release of keys until the sound completely fades away. Turning the knob towards L causes the time to become longer.

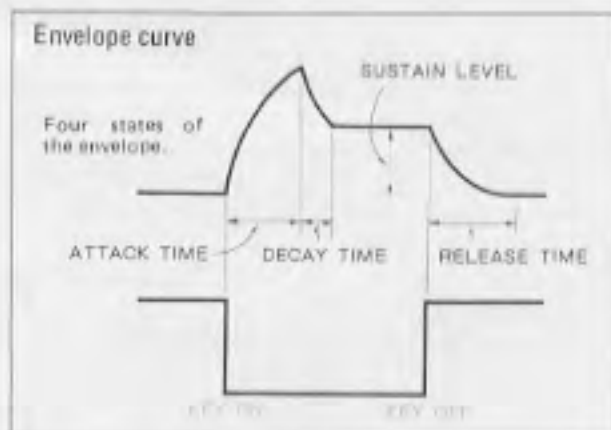

• When EG is applied to VCF

The envelope applied to the VCF controls the VCF's cut-off frequency and changes the harmonic structure of the sound source from the VCO.

The cut-off frequency is determined by the CUT OFF FREQ knob in the VCF block, the KEY VOLTAGE from the keyboard, etc., but if a waveform (control voltage) like an envelope from the EG block is applied, the cut-off frequency will also change like the envelope curve. For example, in the case of LPF (low-pass filter), it becomes the highest at the peak of the envelope curve and passes more harmonics of a higher range.

In this way, the envelope curve can change the waveform (tone) passing the VCF.

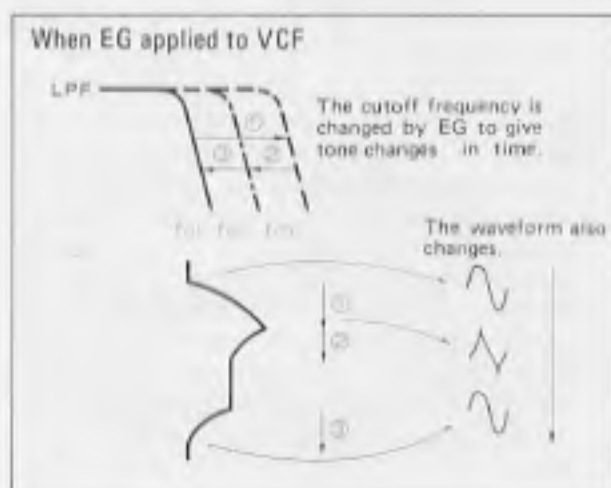

• When EG is applied to VCA

As shown in the illustration on the right, the volume can be controlled according to the envelope curve.

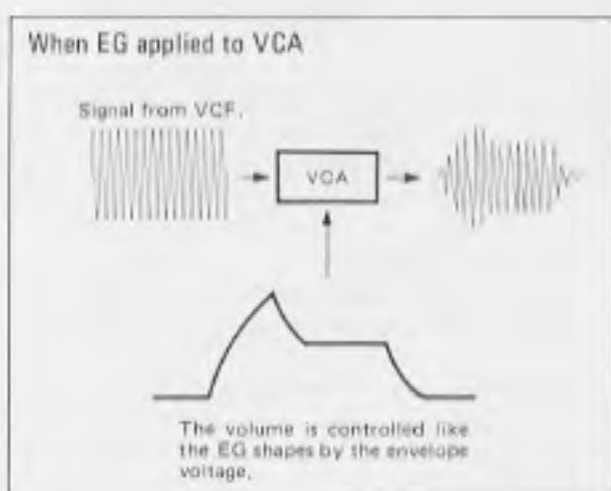

HOW TO USE EXTERNAL TERMINALS

Sound sources such as an electric guitar, electric piano etc. can be connected to the EXTERNAL terminals on the rear panel. The signals can then be fed through the synthesizer from the VCF block on, and they can also be used as trigger signals controlling the start of the EG (corresponding to KEY-ON, KEY-OFF from the keyboard). Thus, operation of the synthesizer by external sound sources is possible.

① EXTERNAL

Terminal to connect external signals, such as from an electric guitar or electric piano.

② EXT/NOISE

When external signals are used as the sound source, this switch must be set to EXT.

③ TRIGGER LEVEL

Adjusts the level of the external signal to generate trigger signals for the EG (equivalent to KEY-ON, KEY-OFF from the keyboard). Sensitivity becomes higher when the knob is turned towards 10.

- The trigger is always controlled by this knob, regardless of the position of the EXT/NOISE switch (2).
- External signals can be used as the sound source alone without any trigger function. This knob must be set to 0 and adjustment is made only by the EXT/NOISE switch (2) and the EXT/NOISE knob in the MIXER block.

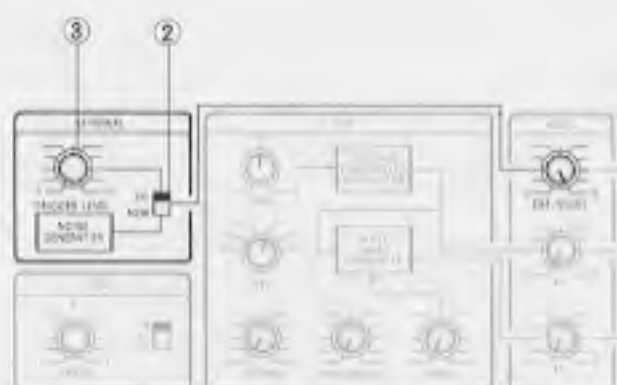

Using Two Synthesizers

The keyboard data of the CS-5 can be sent to the control block of another CS-5 synthesizer (or another synthesizer having similar terminals) by using the CONTROL VOLT and TRIGGER terminals on the rear panel. This permits the building up of a double synthesizer system.

① CONTROL VOLT

Keyboard data signal controlling the pitch, etc. being generated by the VCO.

② TRIGGER

Keyboard data representing the KEY-ON and KEY-OFF timing, for control of the EG (envelope generator).

- The illustration on the right shows an example in which the keyboard of SYNTHESIZER 1 is being played and SYNTHESIZER 2 is being controlled.
- Be careful not to make wrong connections (such as OUT to OUT), as this may cause damage to the units.

SYNTHESIZER 1

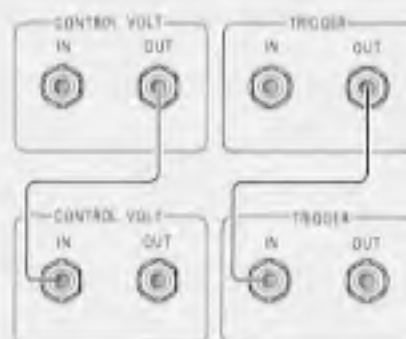

SYNTHESIZER 2



OPERATING SEQUENCES

BASIC SETTING



Setting

- 1 Set the synthesizer up according to CONNECTIONS page 6.
- 2 Turn on the switches of the synthesizer and amplifier and set the volume of the amplifier to a suitable position.

SOUND CREATING

- 1 With the synthesizer you can determine your own original sound even before starting actual performance.
- 2 Signals are flowing from left to right and can be controlled by the respective knobs on the panel.
- 3 Sound signals corresponding to the intervals of the keys are generated by the VCO block when keys are depressed. Set the knobs of the VCF and VCA blocks as shown above so that the oscillating signals of basic sounds can be produced (without being influenced by the VCF and VCA blocks).
- 4 **VCO block/MIXER block**
 - Selects the sound sources for the basic sound with the MIXER volume.
 - Depressing the keys will produce sound.
 - Range of the keyboard is determined by the FEET switch.
- 5 **VCF block**
 - Produces the basic harmonic structure (tone). You select the filter characteristics with the HPF, BPF, LPF switch, and determine the harmonic structure further with the CUT OFF FREQ and RESONANCE knobs.
- 6 **EG block**
 - Produces temporal changes from the start of the sound being generated to its fading away. There are ATTACK TIME, DECAY TIME, SUSTAIN LEVEL, and RELEASE TIME.
- 7 **VCA block**
 - Controls temporal changes in volume with the EG DEPTH and INITIAL LEVEL knobs.
- 8 **VCF block**
 - Produces temporal change in tone coloration with the EG DEPTH knob.
- 9 **LFO/EFFECT**
 - Selects the SPEED and waveforms of the LFO block. Also serves to adjust the LFO MOD of the VCO, VCF, and VCA, if needed.
 - Permits variations during performance with the PORTAMENTO knob and PITCH BEND slide control.
- 10 The steps from [5] to [9] are the basic procedure to create sound. To achieve your ideal sound, it is necessary to operate the respective knobs repeatedly while confirming the results by ear. The original sounds thus created can be reproduced at any time if the position of each knob is registered in the SOUND MEMO.

SOUND MEMO.

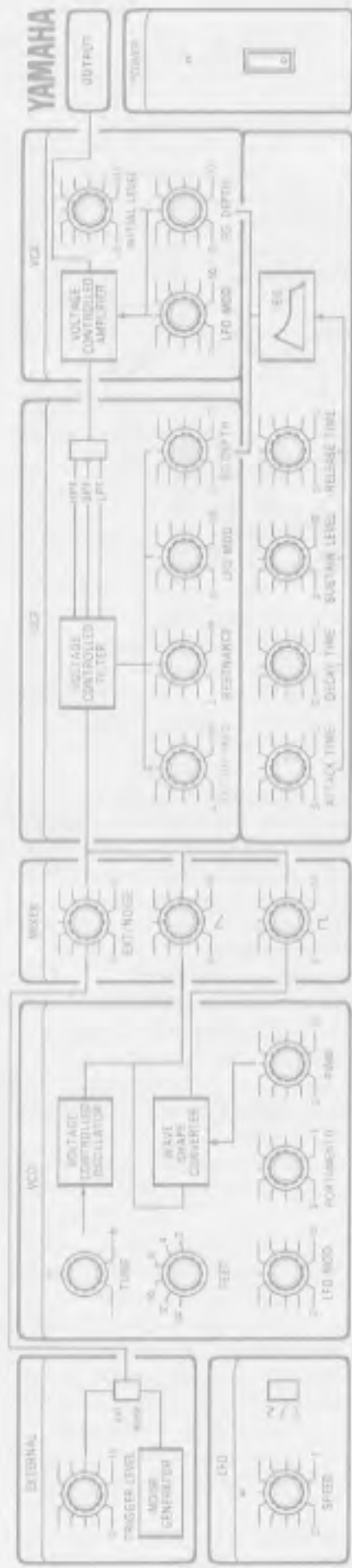

DATE: / /

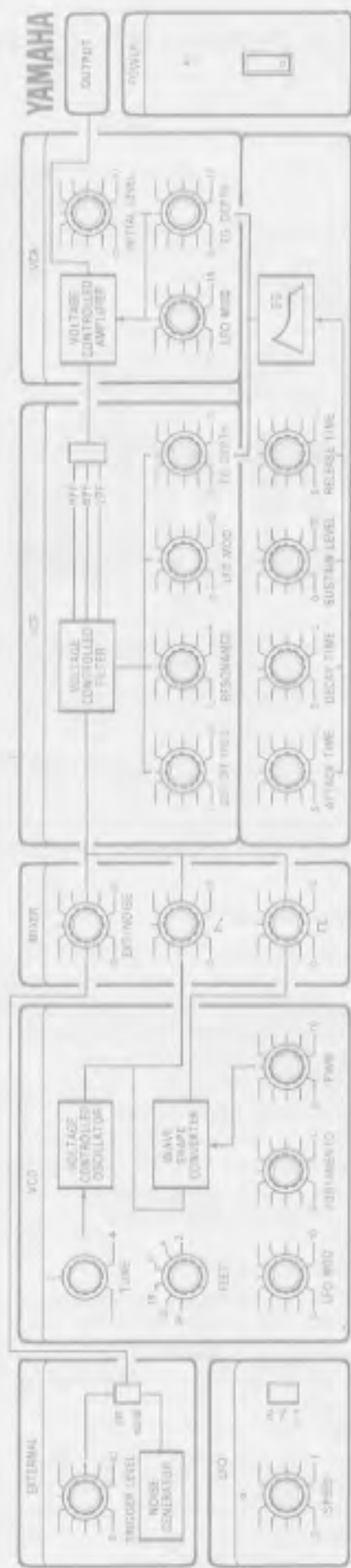

DATE: / /

BLOCK DIAGRAM/SPECIFICATIONS

BLOCK DIAGRAM

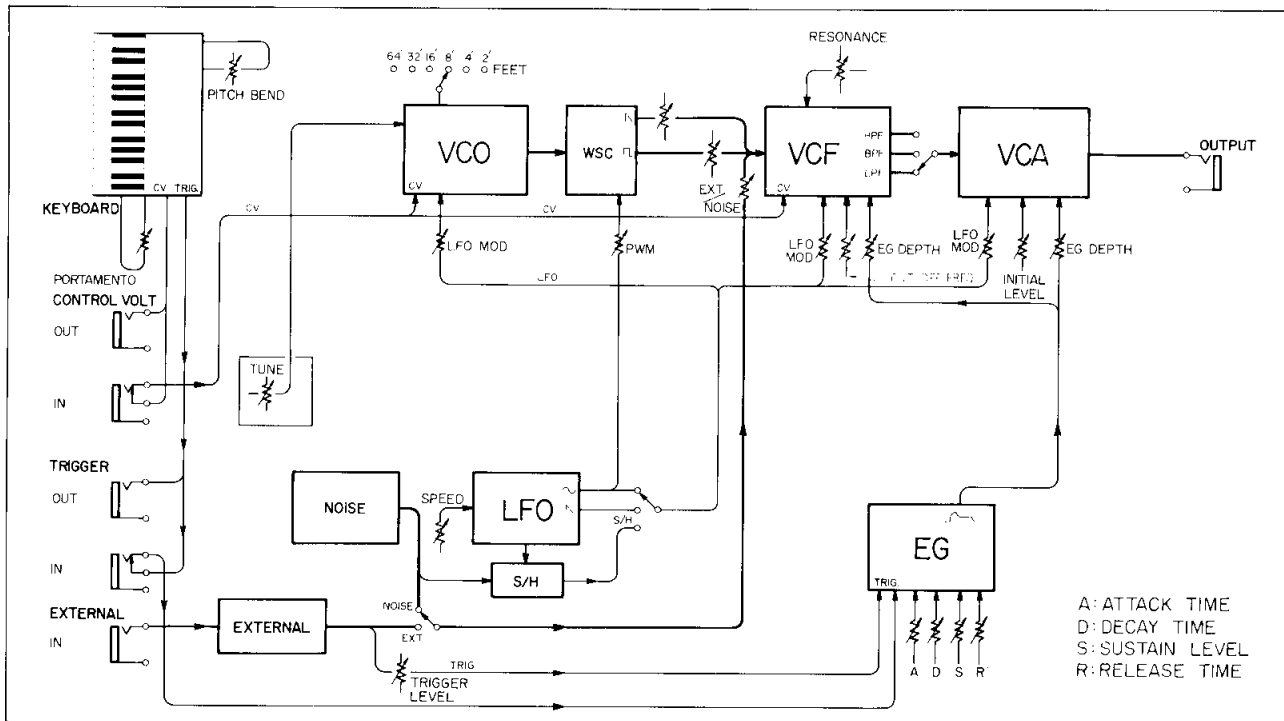

SPECIFICATIONS

KEYBOARD . . .37 keys, 3 octaves

CONTROLS

- EXTERNAL . . .TRIGGER LEVEL Control:
 - Min. -35dBm
 - Function Switch: EXT/NOISE
- LFOSPEED Control: 0.3 to 100Hz
 - Waveform Selector: \sim / \sphericalangle / S/H
- VCOFEET Switch: 2', 4', 8', 16', 32', 64'
 - TUNE Control: -200 to +200 cents
 - LFO MOD Control:
 - 200 to +200 cents
 - PWM Control: 50% to 90%
 - PORTAMENTO: Max. 3.5 sec.
- MIXEREXT/NOISE Control
 - \sphericalangle : Sawtooth wave control
 - \square : Square wave control
- VCFCUT OFF FREQ Control
 - RESONANCE Control
 - LFO MOD Control: \pm 3 octaves
 - EG DEPTH: +10 octaves
 - Filter Selector: HPF/BPF/LPF
- VCALFO MOD Control: AM modulation,
 - max. 90%
 - INITIAL LEVEL Control
 - EG DEPTH Control
- EGATTACK TIME: 0.007 to 7 sec.
 - DECAY TIME: 0.018 to 18 sec.
 - SUSTAIN LEVEL: 0 to 10 V
 - RELEASE TIME: 0.018 to 18 sec.
- PITCH BEND \pm 1 octave

TERMINALS

- EXTERNAL IN
 -Sensitivity: -35dB (Min.)
- TRIGGER OUT
 -3V (OFF) to 7V (ON)
- TRIGGER IN
 -+15V \sim +3V (OFF) to 0V \sim
 - 10V (ON)
- CONTROL VOLT OUT
 -125mV to 4V
- CONTROL VOLT IN
 -125mV to 4V
- OUTPUT -22dBm/600 ohms

OTHERS

- POWER SOURCEU.S. and Canadian models
 - 120 V 60 Hz
- General models
 - 110, 130, 220 or 240
 - V selectable,
 - 50/60 Hz
- POWER CONSUMPTION 8 watts
- DIMENSIONS 641 x 290 x 157 mm
 - (W x D x H) (25-1/4 x 11-3/8 x 6-1/8")
- WEIGHT 7 kg (15.4 lbs)
- FINISH Semi-gloss black

Specifications subject to change without notice.

TROUBLESHOOTING

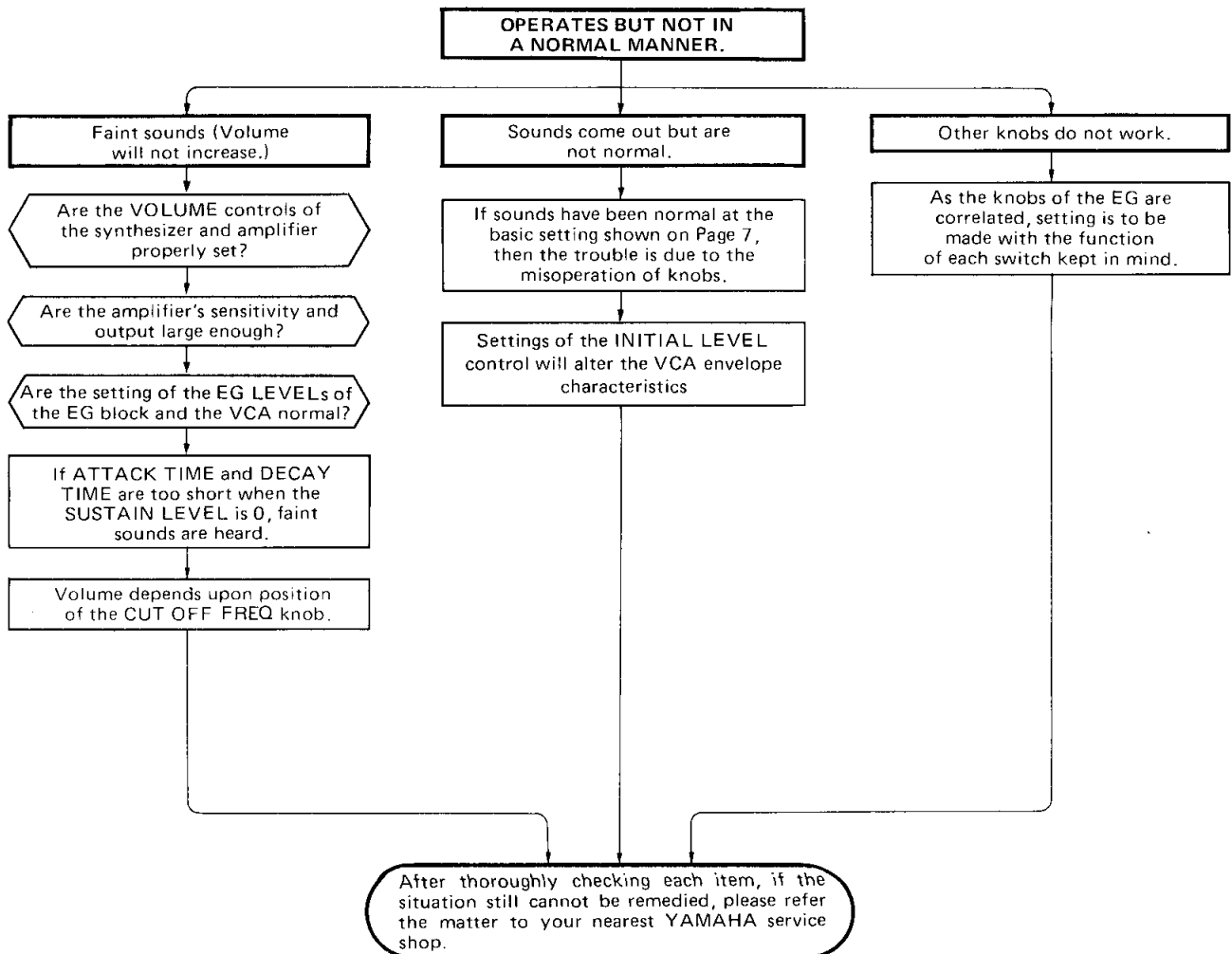
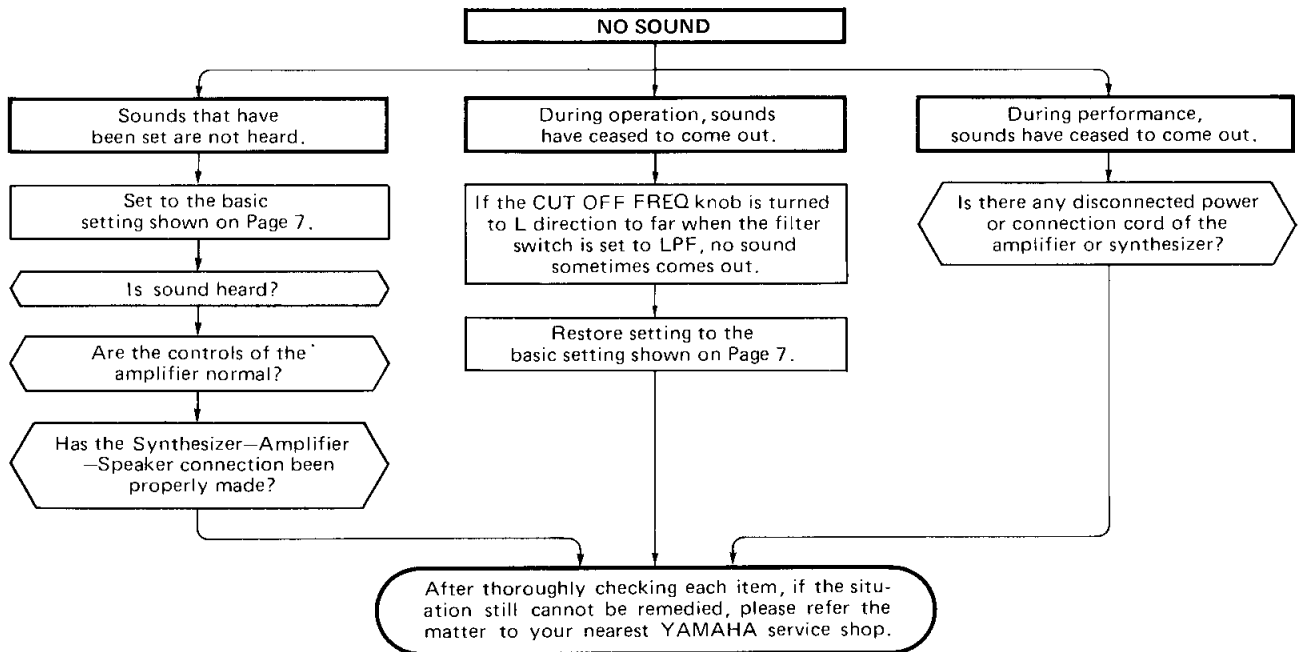

SINCE 1887  **YAMAHA**
NIPPON GAKKI CO., LTD. HAMAMATSU, JAPAN