

Technics



D	I	G	I	T	A	L	
E	N	S	E	M	B	L	E

SX-PR500/M
SX-PR600/M



WARNING: TO REDUCE THE RISK OF FIRE OR ELECTRICAL SHOCK, DO NOT EXPOSE THIS PRODUCT TO RAIN OR MOISTURE.

BEFORE YOU PLAY, PLEASE READ THE CAUTIONARY COPY APPEARING ON PAGE 2.

	CAUTION RISK OF ELECTRIC SHOCK DO NOT OPEN	
CAUTION: TO REDUCE THE RISK OF ELECTRIC SHOCK, DO NOT REMOVE SCREWS. NO USER-SERVICEABLE PARTS INSIDE. REFER SERVICING TO QUALIFIED SERVICE PERSONNEL.		



The lightning flash with arrowhead symbol, within an equilateral triangle, is intended to alert the user to the presence of uninsulated "dangerous voltage" within the product's enclosure that may be of sufficient magnitude to constitute a risk of electric shock to persons.



The exclamation point within an equilateral triangle is intended to alert the user to the presence of important operating and maintenance (servicing) instructions in the literature accompanying the appliance.

Note: This equipment has been tested and found to comply with the limits for a Class B digital device, pursuant to Part 15 of the FCC Rules. These limits are designed to provide reasonable protection against harmful interference in a residential installation. This equipment generates, uses and can radiate radio frequency energy and, if not installed and used in accordance with the instructions, may cause harmful interference to radio communications. However, there is no guarantee that interference will not occur in a particular installation. If this equipment does cause harmful interference to radio or television reception which can be determined by turning the equipment off and on, the user is encouraged to try to correct the interference by one or more of the following measures:

- Reorient or relocate the receiving antenna.
- Increase the separation between the equipment and receiver.
- Connect the equipment into an outlet on a circuit different from that to which the receiver is connected.
- Consult the dealer or an experienced radio/TV technician for help.

The model number of this product is found on the rear of the unit.

The model number and serial number are found underneath the keyboard.

Please note the model and serial numbers in the space provided below and retain this sheet as a permanent record of your purchase to aid identification in the event of theft.

MODEL NUMBER _____

SERIAL NUMBER _____

Technics

OWNER'S MANUAL

Before you play

For long and pleasurable use of this instrument, and to gain a thorough understanding of your PR series Digital Ensemble, it is strongly recommended that you read through this Owner's Manual once.

The Owner's Manual is comprised of the following parts.

BASIC FUNCTIONS	This part includes an explanation of basic procedures and points you should be aware of for proper operation of your instrument.
PRACTICAL APPLICATIONS	This part comprises a detailed explanation of sound, effect, rhythm, SEQUENCER , COMPOSER , Disk Drive and MIDI.
REFERENCE GUIDE (separate booklet)	Reference guide for the contents of the SOUND GROUP , RHYTHM GROUP , MIDI data, etc.

Important Safety Instructions

WARNING

When using electric products, basic precautions should always be followed, including the following,

- Read all the instructions before using the product

Safety

- **Power Source**—The product should be connected to a power supply only of the type described in the operating instructions or as marked on the product
- **Polarization**—This product may be equipped with a polarized line plug (one blade wider than the other). This is a safety feature. If you are unable to insert the plug into the outlet, contact an electrician to replace your obsolete outlet. Do not defeat the safety purpose of the plug.
- **Periods of Non-use**—The power-supply cord of the product should be unplugged from the outlet when left unused for a long period of time.

Installation

- **Water and Moisture**—Do not use this product near water—for example, near a bathtub, washbowl, kitchen sink, in a wet basement, or near a swimming pool, or the like.
- **Cart/Stand**—This product should be used only with a cart or stand that is recommended by the manufacturer.
- **Ventilation**—The product should be located so that its location or position does not interfere with its proper ventilation.
- **Heat**—The product should be located away from heat sources such as radiators, heat registers, or other products that produce heat.
- **Foreign Material**—Care should be taken so that objects do not fall and liquids are not spilled into the enclosure through openings.

Listening caution

This product, either alone or in combination with an amplifier and headphones or speakers may be capable of producing sound levels that could cause permanent hearing loss. Do not operate for a long period of time at a high volume level or at a level that is uncomfortable. If you experience any hearing loss or ringing in the ears, you should consult an audiologist.

Service

- **Damage Requiring Service**—The product should be serviced by qualified service personnel when:
 - a The power-supply cord or the plug has been damaged, or
 - b Objects have fallen, or liquid has been spilled onto the product, or
 - c The product has been exposed to rain, or
 - d The product does not appear to operate normally or exhibits a marked change in performance, or
 - e The product has been dropped, or the enclosure damaged.
- **Servicing**—Do not attempt to service the product beyond that described in the user-maintenance instructions. All other servicing should be referred to qualified service personnel.

Maintenance

- Be sure to switch this unit off after use, and do not switch the unit on and off in quick succession, as this places an undue load on the electronic components.
- To maintain the luster of the keys and buttons, wipe with a clean, damp cloth, and polish with a soft, dry cloth. Polish may be used, but do not use thinners or petro-chemical-based polishes.
- A wax-based polish may be used on the cabinet, although you will find that rubbing with a soft cloth will suffice.

SAVE THESE INSTRUCTIONS

Contents

Important Safety Instructions	2
-------------------------------------	---

Controls and functions	6
------------------------------	---

BASIC FUNCTIONS

Getting started	8
Listen to the demonstration	9
Playing the piano	10
Selecting other sounds	11
Playing automatic rhythms	12
Automatic accompaniment	15
Playing commercial disks	17

PRACTICAL APPLICATIONS

About the display	19
Part I Sounds and effects	24
Play Style	24
Conductor	25
Selecting sounds	25
Mixing two sounds	27
Keyboard split	27
Pedals	29
Effects	30
Transpose	32
Techni-chord	33
Part II Playing the rhythm	35
Selecting rhythms	35
Playing the rhythm	37
Auto Play Chord	38

Piano Stylist42
One Touch Play43
Music Style Select44
Music Style Arranger45
Panel Memory46
Pedal setting48
Part III Sequencer49
Outline of the Sequencer49
Song51
Easy Record52
Sequencer parts53
Realtime Record54
Sequencer Play56
Step Record58
Track Assign62
Editing the recorded performance63
Sequencer Medley66
Part IV Composer67
Outline of the Composer67
Edit a preset rhythm pattern: preparation69
Create a completely new rhythm: preparation70
Record your rhythm pattern72
Playback73
Composer mode73
Composer Chord Map74
Part V Disk Drive76
Outline of the Disk Drive function76
Outline of procedure77
Loading data78
Playing commercial disks81
Formatting a disk82
Saving data83

Part VI Adjusting the sounds	87
Outline of the Sound Setting mode	87
Part Setting	88
Touch & Tune	89
Key Scaling	90
Left Hold	91
Part VII MIDI	92
What is MIDI?	92
Outline of MIDI functions	94
Setting the functions	95
Initialize	102
Connections	104
Assembly	105
Symptoms which appear to be signs of trouble	106
Error messages	109
Index	111
Specifications	113

Controls and functions

PLAY STYLE

Select standard piano or one of various other performance styles. (Refer to page 24.)

COMPOSER

Create and store original rhythm patterns. (Refer to page 67.)

RHYTHM GROUP

Choose preset automatic rhythm patterns. (Refer to page 35.)

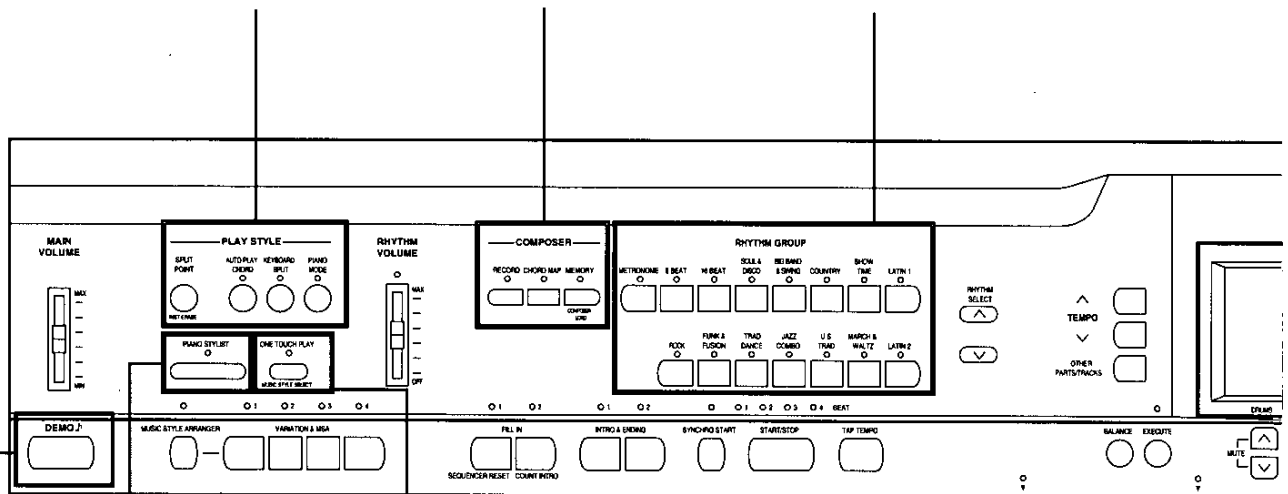

DEMO

You can listen to programmed demonstration tunes which show what your Digital Ensemble can do. (Refer to page 9.)

PIANO STYLIST

For performances using piano sounds, just select a piano style, and in seconds an appropriate panel registration is set, including the accompaniment pattern. (Refer to page 42.)

ONE TOUCH PLAY

Sounds and effects which fit the selected rhythm are automatically selected. (Refer to page 43.)

Tuning

Unlike an acoustic piano, your PR Series Digital Ensemble never needs tuning.

- The pitch of this instrument can be adjusted for when playing along with other instruments. (Refer to page 89.)

SOUND GROUP

You can select from four piano-type sounds. Or choose the sounds of various instruments. (Refer to page 26.)

SEQUENCER

Record and play back your performance. (Refer to page 49.)

Effects

Add various effects to the sounds. (Refer to page 30.)

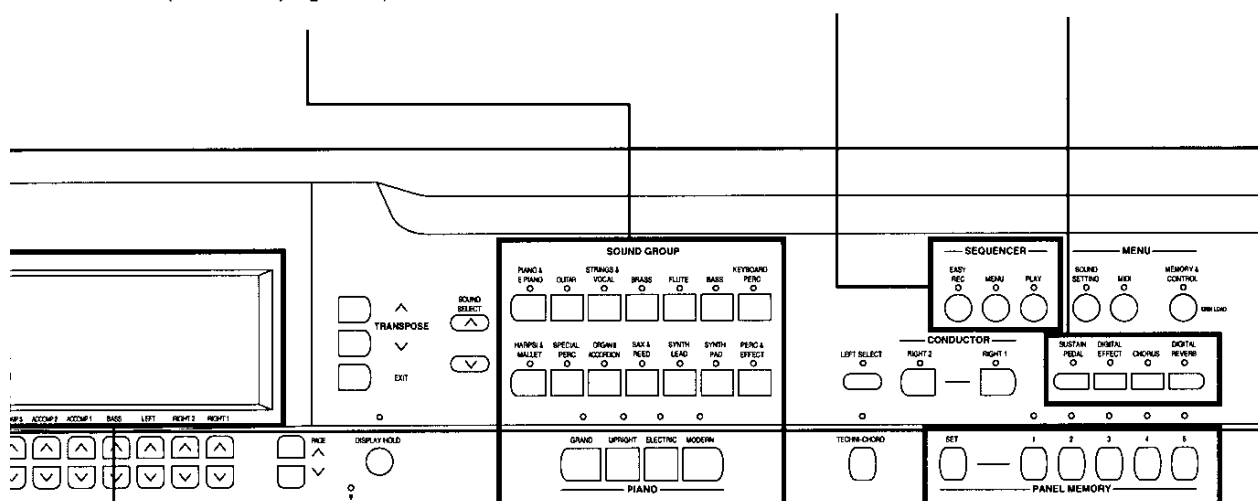

DISPLAY (LCD screen)

Displays performance information, function settings and other messages. (Refer to page 19.)

PANEL MEMORY

Store the current panel settings for instant recall. (Refer to page 46.)

■ About the backup memory

The settings and memories are maintained for approximately 80 minutes after the power to this instrument is turned off. If you wish to keep the memory contents, before you turn off the instrument, use the SAVE procedure to store the desired data on a disk for recall at a later time.

- The backup memory does not function until the power has been on for about 10 minutes.
- When you quit the operating mode, a warning display may appear to remind you to save the data.

Getting started

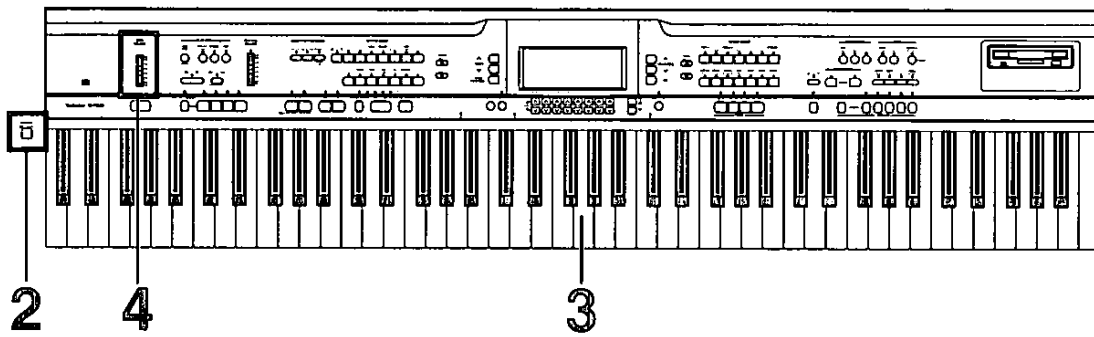

1 Plug the power cord into an outlet.

2 Press the **POWER** button to turn it on.

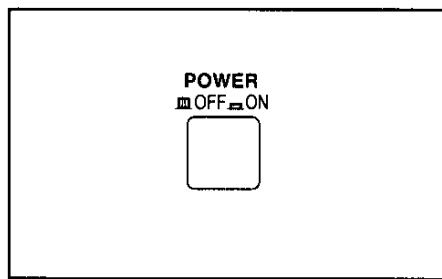

3 Touch any note on the keyboard. You will hear a **PIANO** sound.
• Your piano features Touch Response. You control the volume by playing the keys harder or softer.

4 Set the **MAIN VOLUME** to an appropriate level with the sliding control.

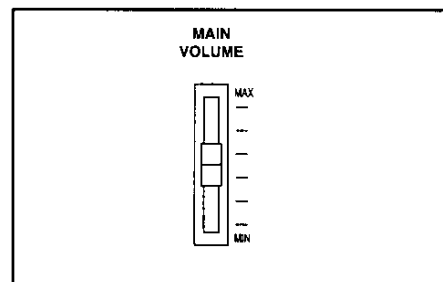

Music Stand

Insert the music stand in the two holes as shown in the diagram.

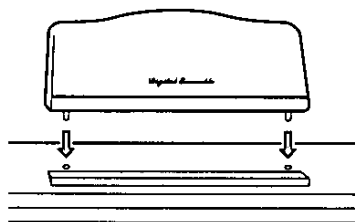

Keyboard cover (PR600)

Open and close the cover slowly.

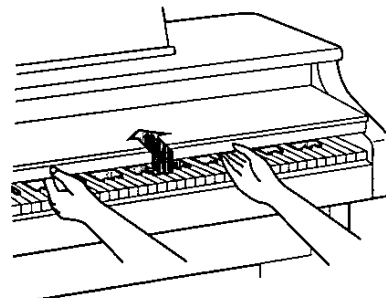

Listen to the demonstration

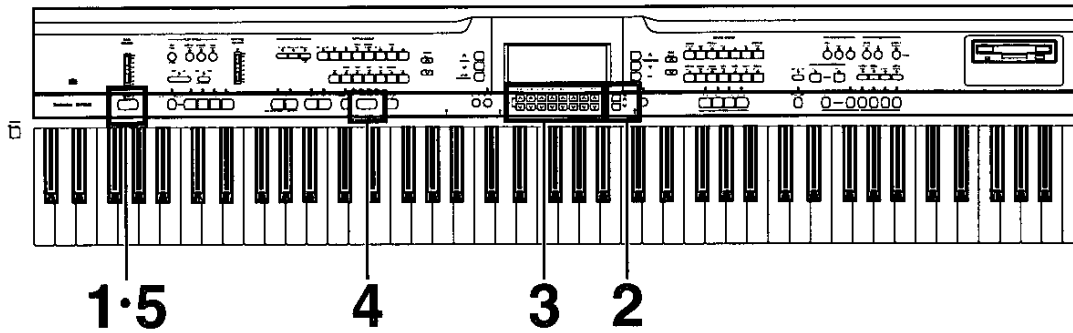

1

Press the **DEMO** button.

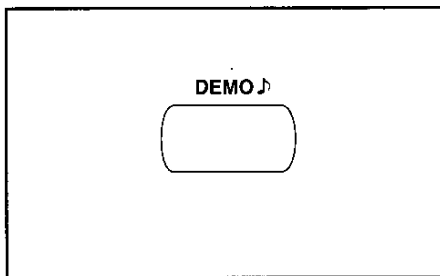

- The display changes to the DEMO display.

2

Use the **PAGE** buttons to select a category.

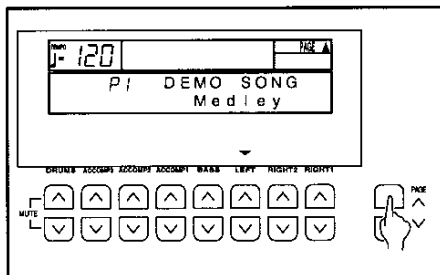

- Select from Medley, PIANO, STYLE, SOUND and RHYTHM.

3

Use the **LEFT** \wedge and \vee buttons to select a song number.

- For P1 Medley, this step is not necessary.

4

Press the **START/STOP** button.

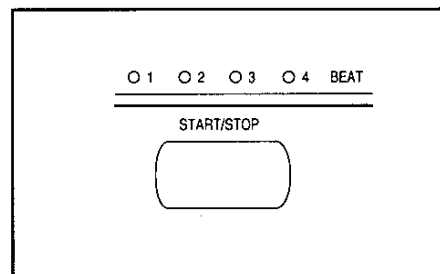

- The demonstration performance corresponding to your selection begins.
- If "Medley" was selected, all the songs are played in order in a medley performance. The medley performance continues until the **START/STOP** button or the **DEMO** button is pressed again.
- To end the demonstration before it has finished, again press the **START/STOP** button.
- To listen to other songs, repeat steps 2 to 4.

5

When you are finished listening to the demonstration tunes, press the **DEMO** button again.

- If you press and hold the **DEMO** button for a few seconds, or if you press first the **DEMO** button and then the **START/STOP** button, you can also begin a medley performance.
- During the medley performance, use the **LEFT** \wedge and \vee buttons if you wish to change to a different song.
- Some of the buttons do not function while the demonstration performances are being played.

Playing the piano

Your piano is equipped with various fine functions which make it an extremely versatile instrument. But it should be remembered that it is first of all a fine piano. Select one of the piano sounds and enjoy its excellent quality.

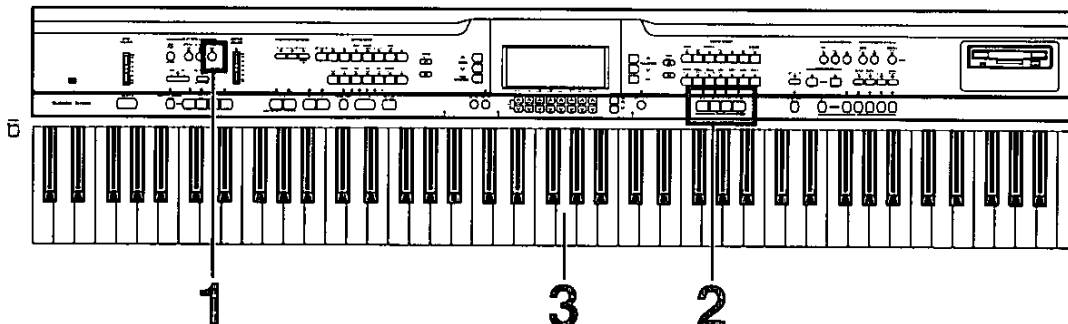

- 1 In the **PLAY STYLE** section, press the **PIANO MODE** button to turn it on.

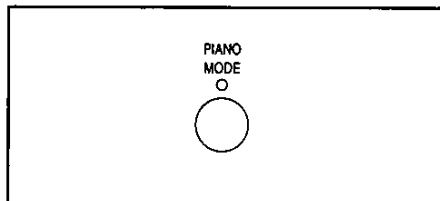

- The indicator lights.
- **PIANO MODE** is the default selection when the instrument is first turned on.

- 2 Select one of the four **PIANO** sounds by pressing the corresponding button.

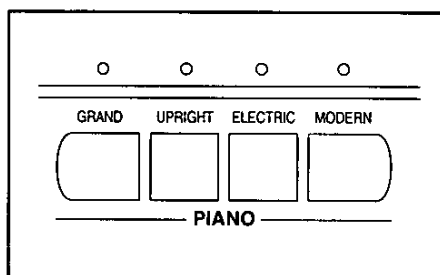

- 3 Play anywhere on the keyboard.

Selecting other sounds

In addition to piano sounds, this instrument is provided with the colorful sounds of various other instruments.

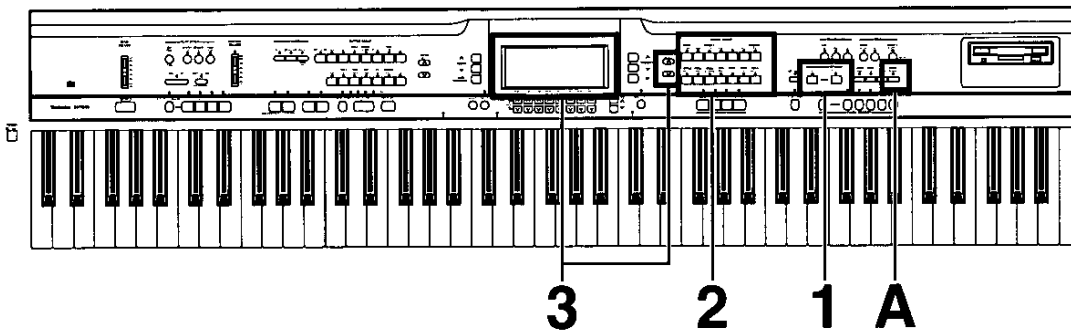

- 1** In the **CONDUCTOR** section, press the **RIGHT1** button.

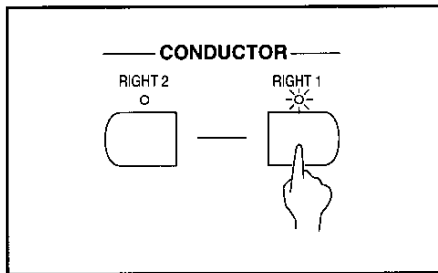

- 2** In the **SOUND GROUP** section, select a sound group.

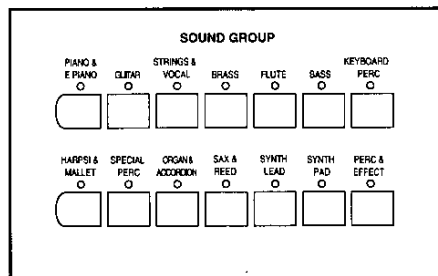

- The display changes.

- 3** Use the **SOUND SELECT** \wedge and \vee buttons to select a sound.

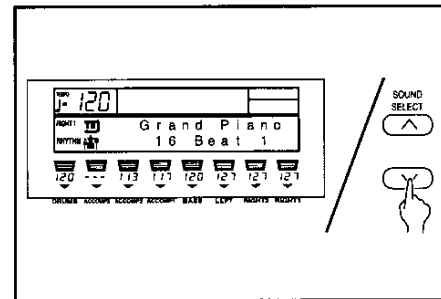

- The name of the sound is shown on the display.
- The list of sounds can be found in the separate REFERENCE GUIDE provided.

Add reverb to the sound.

- A** Press the **DIGITAL REVERB** button to turn it on.

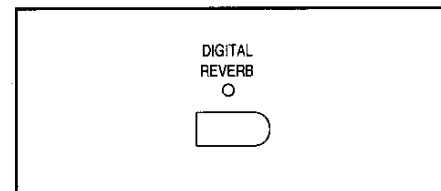

- The indicator lights.

- When one of these sounds is selected, the **PIANO MODE** indicator in the **PLAY STYLE** section automatically turns off.

- Other things you can do are mixing sounds and playing different sounds on the left and right areas of the keyboard. (Refer to page 27.)

Playing automatic rhythms

Listen to preset rhythms.

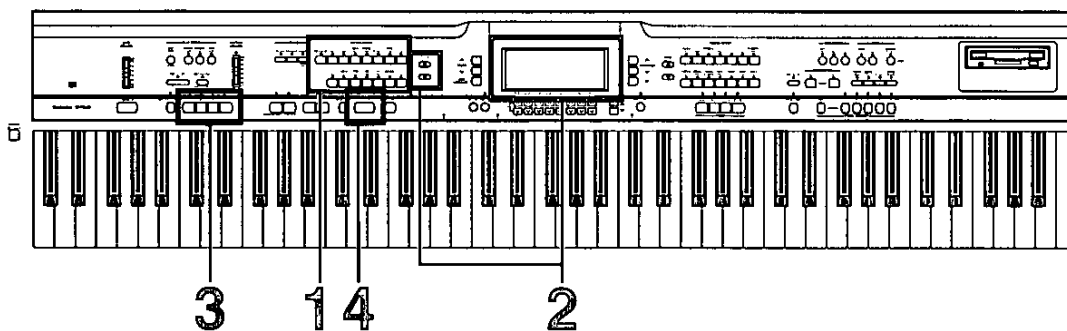

1 In the **RHYTHM GROUP** section, select a rhythm group.

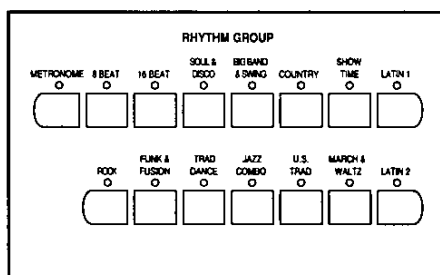

- The display changes.

2 Use the **RHYTHM SELECT** \wedge and \vee buttons to select a rhythm.

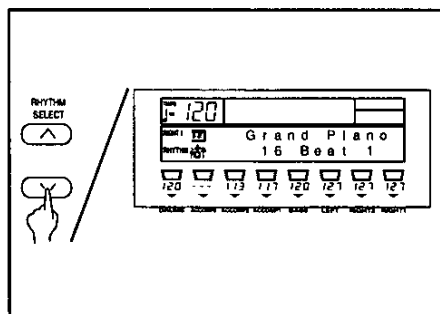

- The name of the rhythm is shown on the display.
- The list of rhythms can be found in the separate **REFERENCE GUIDE** provided.

3 Use the **VARIATION** buttons to select the variation number.

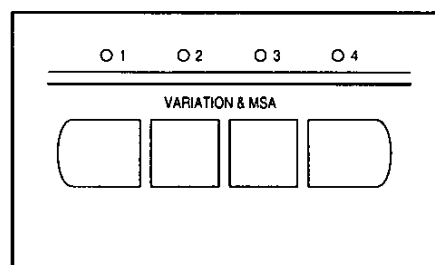

- The nuance of the pattern differs with each variation number.

4 Start the rhythm by pressing the **START/STOP** button.

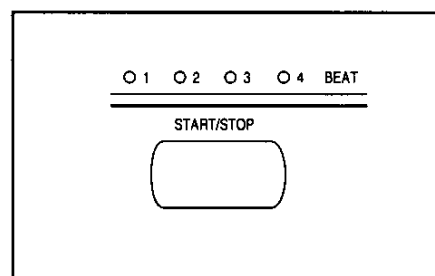

- Stop the rhythm by pressing the **START/STOP** button again.

Control the rhythm.

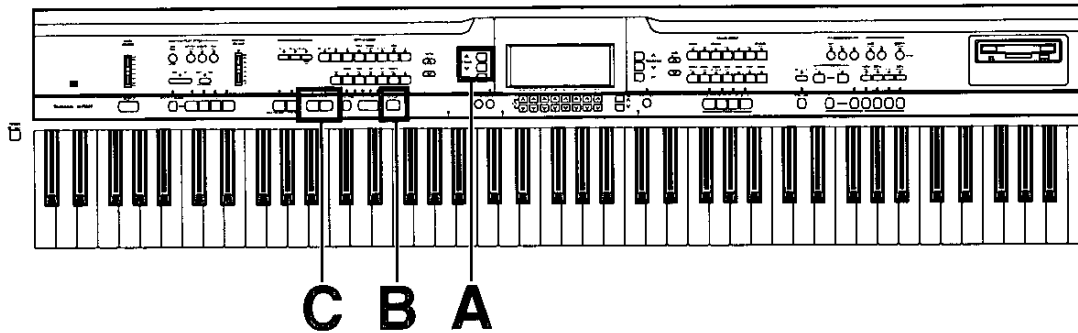

Adjust the tempo.

A Adjust the tempo with the **TEMPO** buttons.

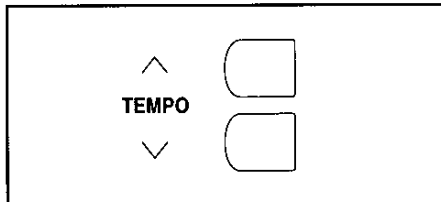

- The tempo is shown in the display as "♩ = ".

Adjust the tempo with your finger.

B You can set the tempo of the rhythm by tapping the **TAP TEMPO** button few times with your finger.

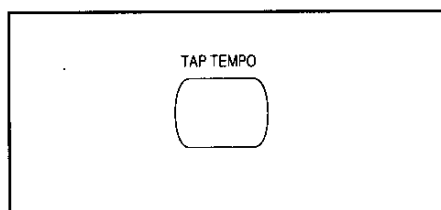

- The tempo at which the button is tapped is detected, and the tempo automatically changes correspondingly.

Insert an intro pattern.

C To start your performance with an introduction, press the **INTRO & ENDING 1** or **INTRO & ENDING 2** button before starting the rhythm.

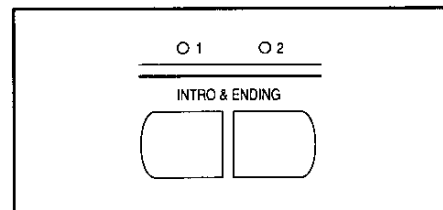

- An intro is played, after which the regular rhythm starts.

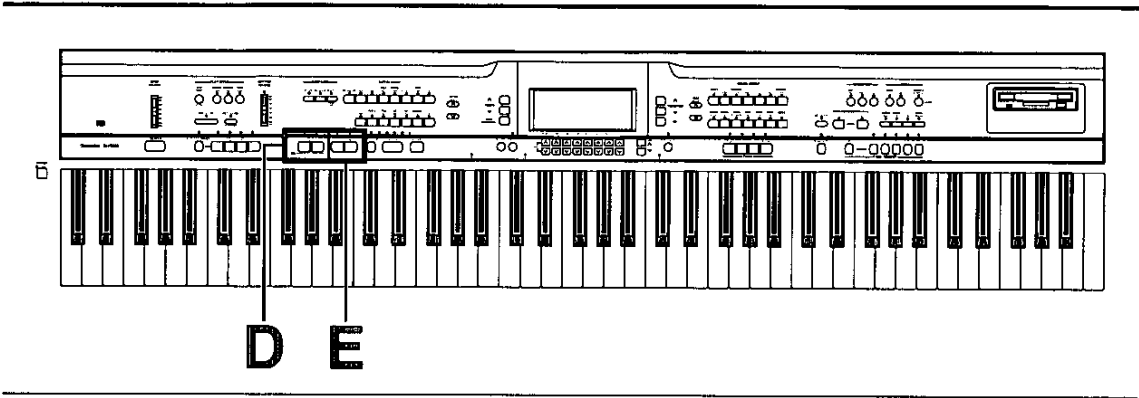

Insert a fill-in pattern.

D While the preset rhythm pattern is playing, press either the **FILL IN 1** or **FILL IN 2** button.

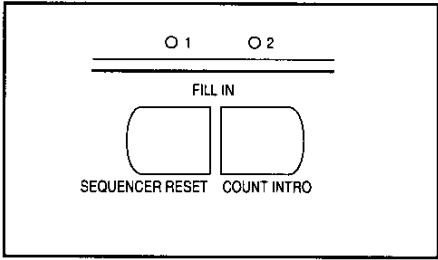

- A fill-in pattern immediately starts to play.

Insert an ending pattern.

E While the rhythm is playing, press the **INTRO & ENDING 1** or **INTRO & ENDING 2** button.

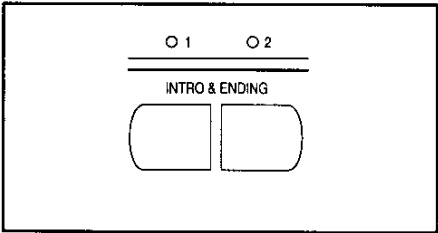

- You will hear an ending pattern, and then the rhythm stops.

Automatic accompaniment

Just by specifying a chord on the keyboard, an accompaniment pattern which matches the selected rhythm is automatically played.

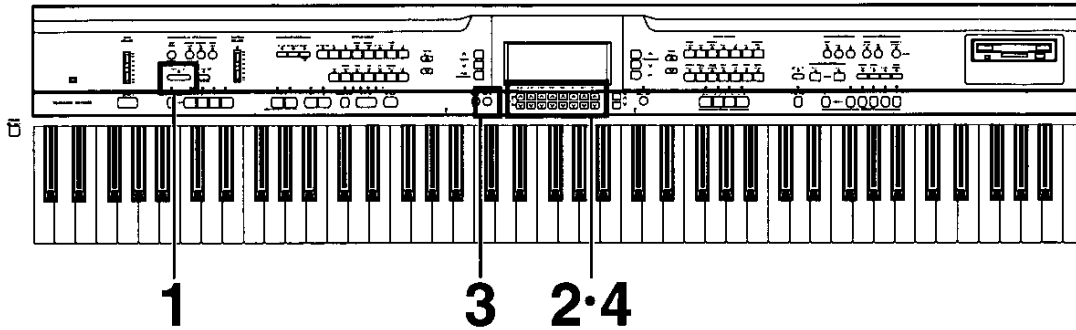

Use the **PIANO STYLIST** with the following tune.

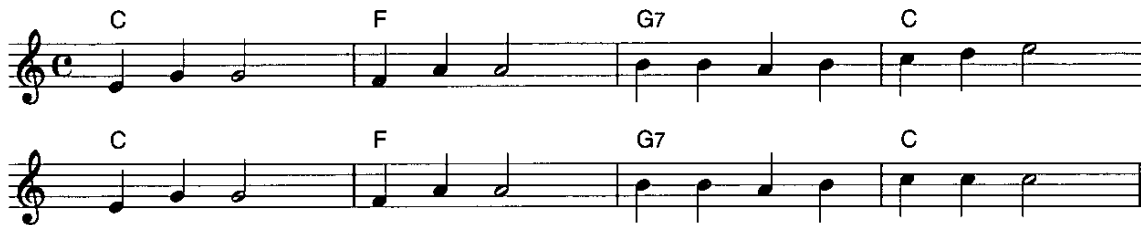

- 1** Press the **PIANO STYLIST** button to turn it on.

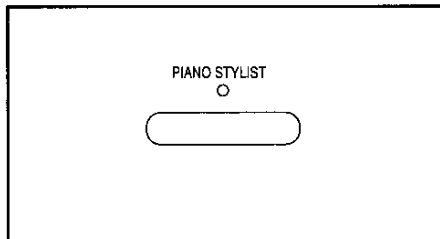

- 3** Press the **EXECUTE** button.

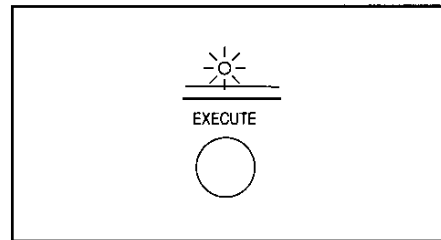

- 2** Use the **LEFT** \wedge and \vee buttons to select a **STYLE** group.

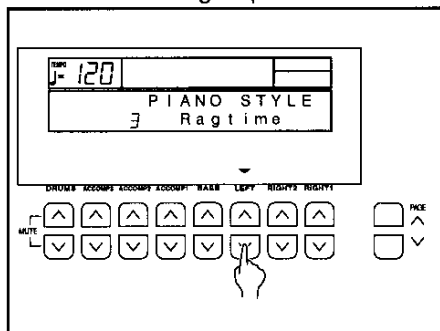

- 4** Use the **LEFT** \wedge and \vee buttons to select a style.

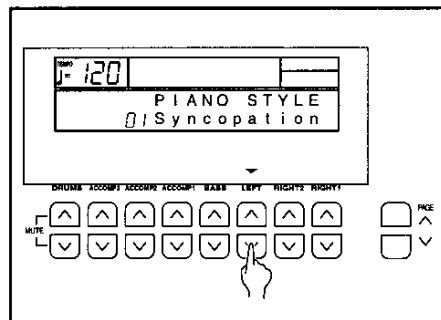

- The panel settings which are best suited for the selected style are automatically set.

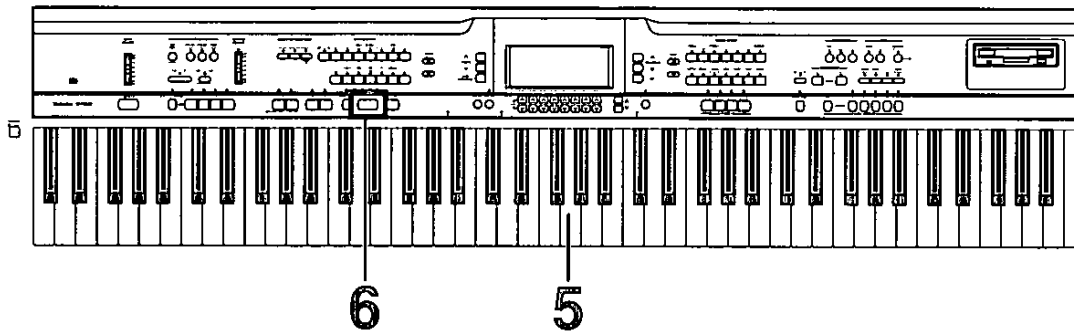

5 Use your left hand to play the chords and your right hand to play the melody.

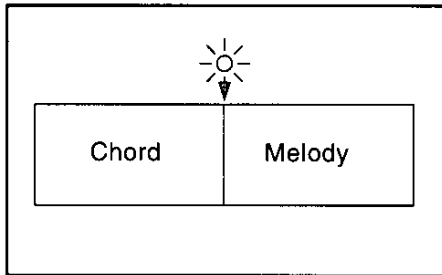

- When you press a key on the left area of the keyboard, an intro is played, after which the automatic rhythm is played (synchro start).
- When the C key is pressed on the left area of the keyboard, an accompaniment begins to play in the C major key.
- Playing the chord key (root note) and the white key to its left will produce a 7th chord.

6 At the end of your performance, press the **START/STOP** button.

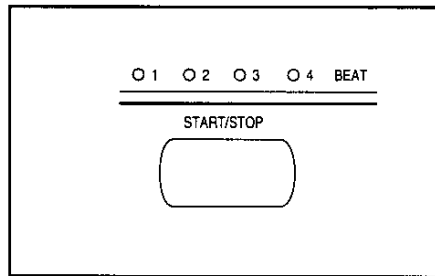

- The automatic accompaniment stops.

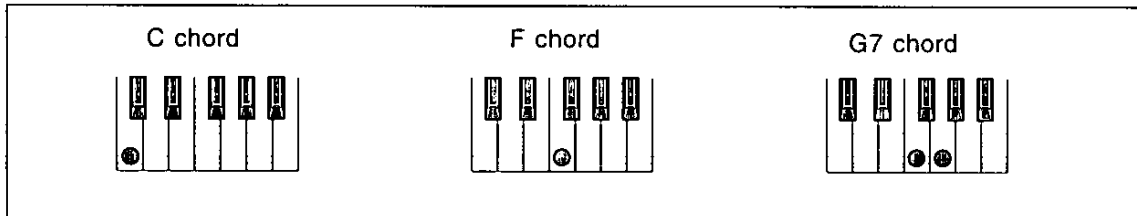

- The **PIANO STYLIST** feature explained in this chapter makes it easy to set up a performance, including rhythm, for piano sounds. Other features change the panel settings to automatically match the rhythm and music style you select. (Refer to pages 43 and 44.)

- For a more detailed explanation on how to play chords, etc., refer to the section on the **AUTO PLAY CHORD** (page 38).

Playing commercial disks

You can play commercial song disks such as Standard MIDI File (SMF) FORMAT 0, DISK ORCHESTRA COLLECTION™ (DOC) or PianoDisc™ disks on this instrument.

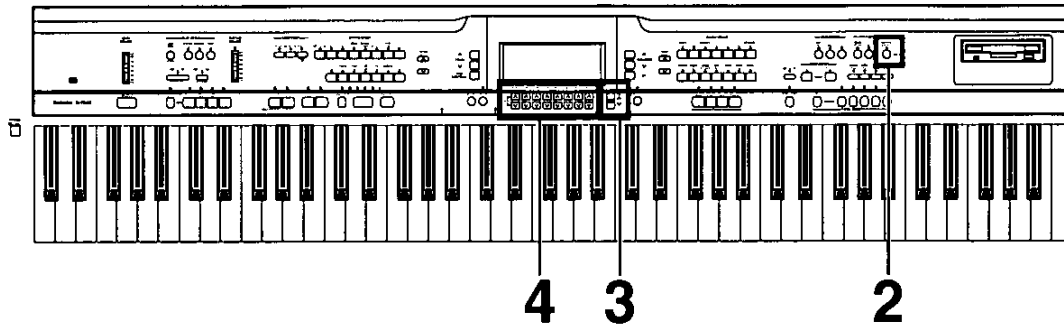

- 1** Insert the song disk into the Disk Drive slot. Push it all the way in until you hear a click.

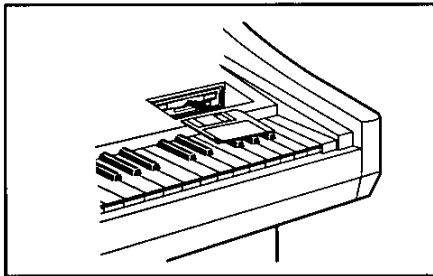

- 2** Press the **MEMORY & CONTROL** button to turn it on.

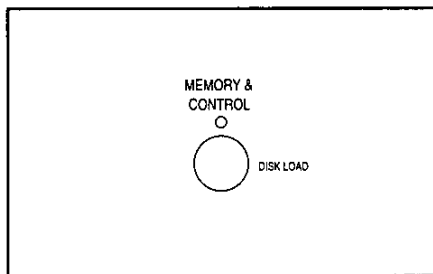

- The display changes to the MEM & CONTROL display.

- 3** Press the **PAGE ^** button to select "P2 Direct Play."

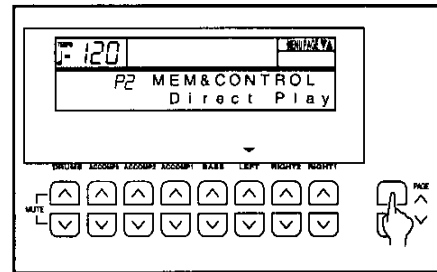

- 4** Press the **LEFT ^** or **∨** button.

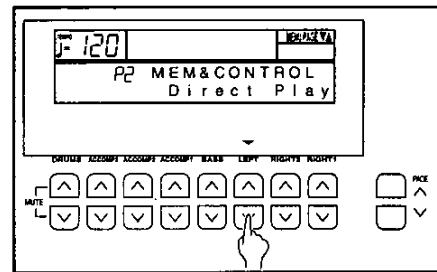

- The display changes to the DIRECT PLAY display.

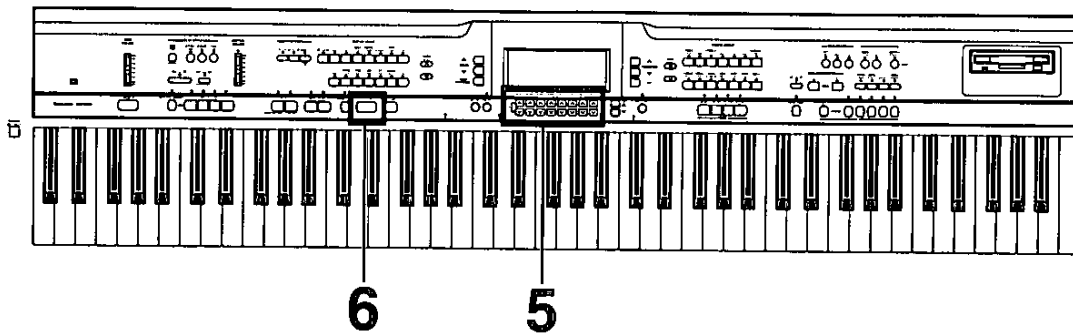

5 Use the **LEFT** \wedge and \vee buttons to select the song you wish to play.

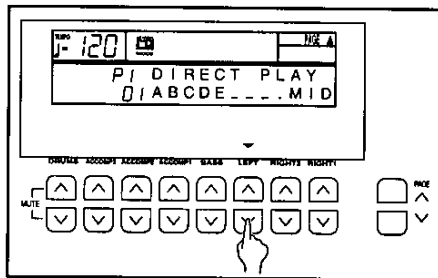

- For SMF files, if you press the **PAGE** \wedge button to display P2 Direct Play, you can use the **RIGHT 1** \wedge and \vee buttons to specify whether or not to play the song as GENERAL MIDI (GM) (On/Off).
- For DOC files, if you press the **PAGE** \wedge button to show the P2 DOC PART display, you can use the corresponding buttons to turn playback on or off for each part.
 - Rt1..... RIGHT 1 part
 - Rt2..... RIGHT 2 part
 - Orch Accompaniment part

6 Press the **START/STOP** button.

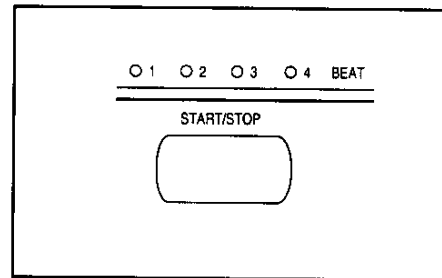

- The selected song is played back.
- To stop playback, press the **START/STOP** button again.

- You can use the same procedure to play back other songs on the disk.
- Direct play from SMF FORMAT 1 disks is not possible. To play FORMAT 1 disks, follow the SMF LOAD procedure (page 80).

* DISK ORCHESTRA COLLECTION is a trademark of the YAMAHA Corporation.

* PianoDisc is a registered trademark of Music Systems Research.

About the display

The display shows various information and is used for most of this instrument's operations.

Normal display

This illustration shows the kind of information you see on the display during a normal performance.

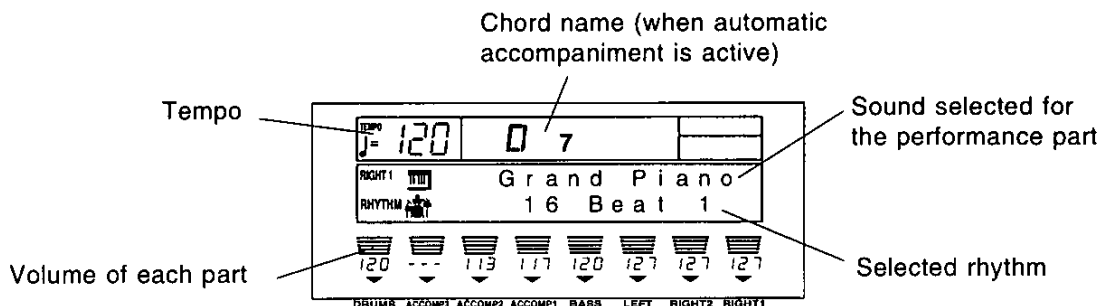

Volume balance

At the bottom half of the normal display, the volume balance of each part is shown as a bar graph and a number (0 to 127).

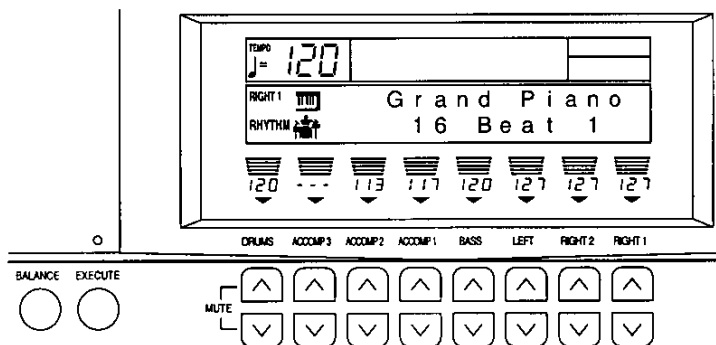

Use the \wedge and \vee buttons directly below the display to adjust the volume of each part.

- If you press and hold a button, the scrolling speed becomes fast.
- Even when the display is not the normal display, you can view the volume balance by pressing the **BALANCE** button, located to the lower left of the display.

■ MUTE

To mute a part, press both the corresponding \wedge and \vee buttons at the same time.

- The number indication for the volume of a muted part is shown as [---].
- Pressing either balance button for a muted part will cancel the mute function.

OTHER PARTS

Press the **OTHER PARTS/TRACKS** button to show the **PART BALANCE** display for [Met (Metronome), RBas (Root Bass), Chd (Chord)], [Part 1 – 8]; press again for [Part 9 – 16].

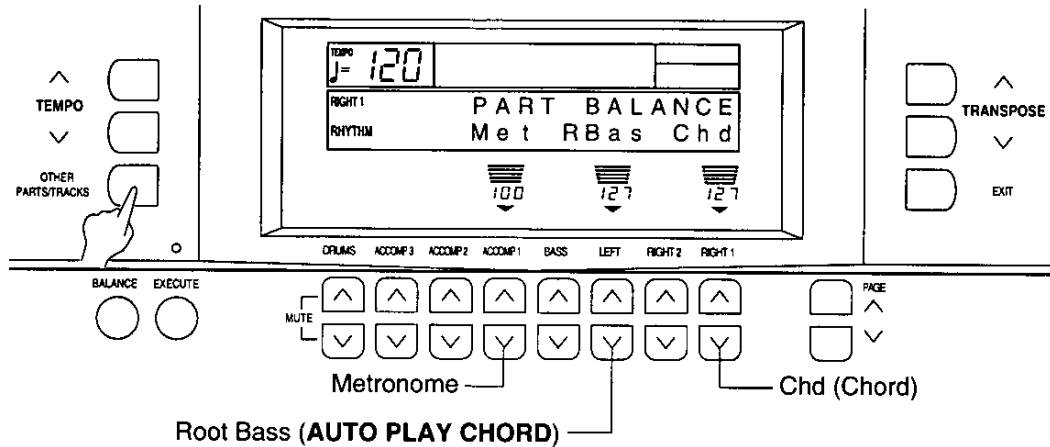

- Press the **EXIT** button to return to the display before the volume setting display.
- These parts are used when this instrument is being utilized as a 16-part timbre sound generator: during **SEQUENCER** operation, during song disk playback or when external MIDI equipment is connected.

PAGE buttons

When the current display fills more than one screen, a **PAGE** indication is shown on the display. For example, if **PAGE ▲** is shown on the display, it means that there is a following page or pages. Likewise, **PAGE ▼** indicates a previous page, and **PAGE ▼▲** indicates a previous and a following page. In this case, you can use the **PAGE ▲** and **▼** buttons to the right of the balance buttons to view different "pages" of the display.

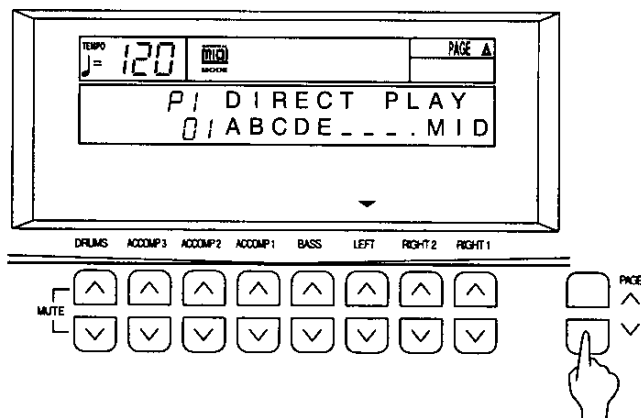

- Press the **▲** button to view the next page of the display, and the **▼** button to view the previous page of the display.
- P1, P2 etc. on the display indicates the page number.

MENU displays

The buttons shown in the illustration below for example control multiple functions. Pressing one of the buttons will access the corresponding **MENU** display.

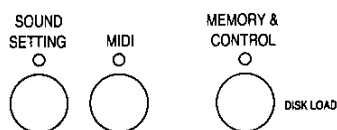

■ Example of MENU display: SOUND SETTING

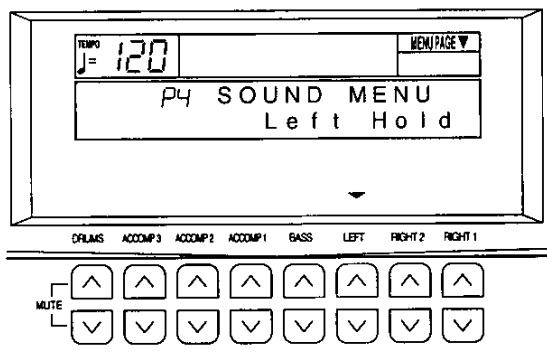

The **PAGE** buttons are also used to select the menu pages. When selecting a menu, a **MENU PAGE** indication is shown in the upper right part of the screen. For example, to select [Left Hold], use the **PAGE** \wedge button to select page 4 (P4).

- In this manual, this procedure is written as follows: "Select [P4 Left Hold]."
- To access the setting display, press the button below the display which corresponds to the ∇ indication (in this example, either **LEFT** \wedge or \vee button).

Setting display

When necessary, the buttons below the display are used to set the functions.

■ Example of setting display: Left Hold

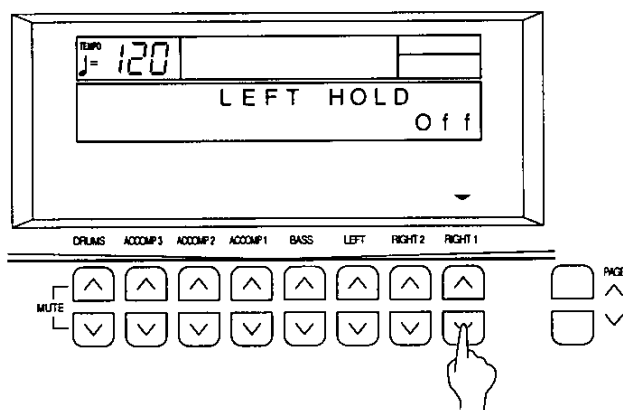

One or more ∇ indications at the bottom of the screen indicate that the corresponding balance buttons below the display are used to change the settings. In this example, the **RIGHT 1** \wedge and \vee buttons are used.

- In this manual, this procedure is written as follows: "Use the **RIGHT 1** \wedge and \vee buttons to set the mode to On or Off."

EXIT button

While the setting display is shown, press this button to go back to the previous display.

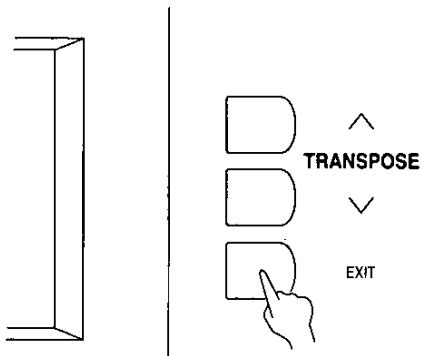

DISPLAY HOLD button

Press this button to turn it on when you wish to maintain the current display. For example, you can maintain a setting display which normally turns off automatically, or even during a performance you can monitor information which is not shown on the normal performance display.

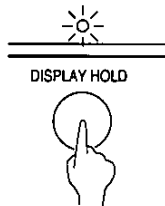

- If you are viewing a setting display which normally turns off automatically, this indicator may flash.
- If any of the **MENU** buttons, for example, is pressed, the **DISPLAY HOLD** mode is canceled.

CONTRAST

Adjust the contrast of the display.

1. Press the **MEMORY & CONTROL** button to turn it on.

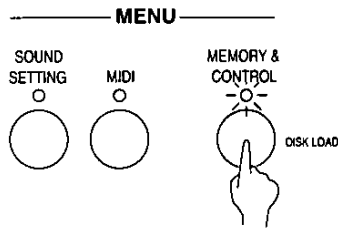

- The display looks similar to the following.

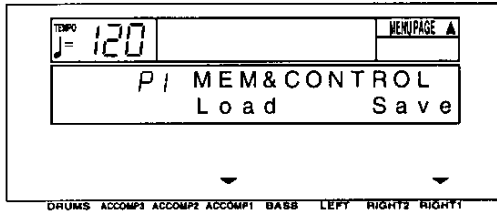

2. Use the **PAGE** buttons to select [P7 Contrast].

- The display looks similar to the following.

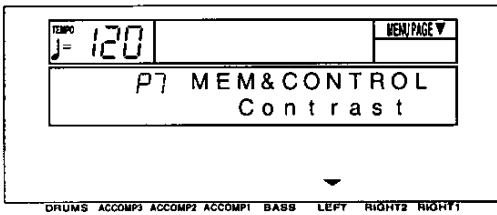

3. Press either **LEFT** button.

- The display looks similar to the following.

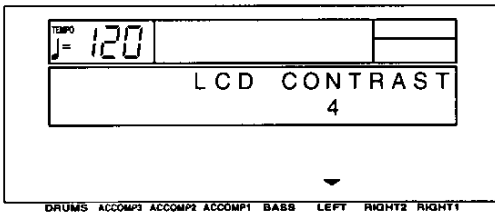

4. Use the **LEFT** ^ and v buttons to adjust the setting (1 to 20).

- Adjust the contrast of the display so that it is easy to read.

5. When you have completed making the settings, press the **MEMORY & CONTROL** button to turn it off.

Part I Sounds and effects

Play Style

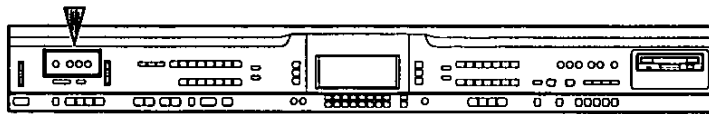

In addition to a standard piano performance, this instrument can be used to play various different performance styles. The type of keyboard is centrally controlled by the **PLAY STYLE** section.

Normal Play

PIANO MODE

When this button is on, this instrument can be played as a standard piano. (Refer to page 25.)

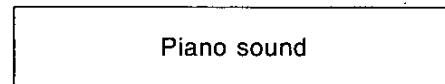
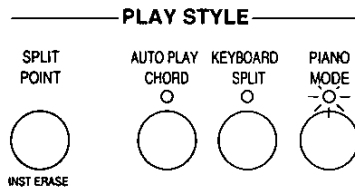

- If sounds other than piano-type sounds have been chosen, the **PLAY STYLE** indicators all go out.

KEYBOARD SPLIT

The keyboard divides into two playing areas, each with a different sound. (Refer to page 27.)

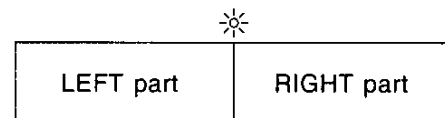
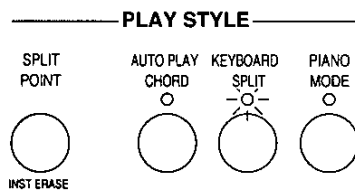

AUTO PLAY CHORD

This button is used when you perform with the automatic accompaniment. (Refer to page 38.)

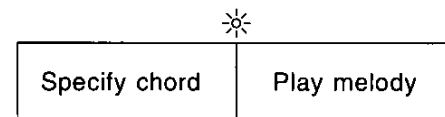
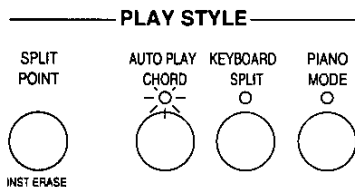

Conductor

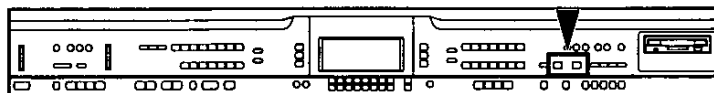

Two parts, **RIGHT 1** and **RIGHT 2**, are usually used to select the sounds you play on the keyboard. By using the **RIGHT 1** and **RIGHT 2** buttons in the **CONDUCTOR** section, you can quickly change the sound during your performance, or you can even mix two different sounds on the keyboard (page 27).

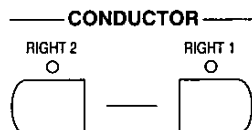

Selecting sounds

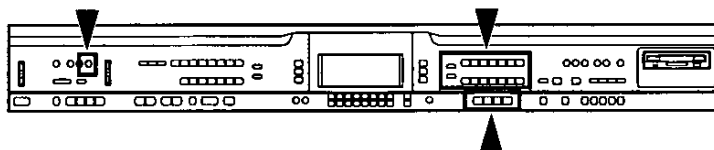

Enjoy trying the sounds of many different instruments.

PIANO MODE

When playing this instrument as a standard piano, press the **PIANO MODE** button to turn it on.

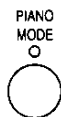

You can then select one of the piano-type sounds: **GRAND**, **UPRIGHT**, **ELECTRIC**, **MODERN**. Press the button for the desired sound.

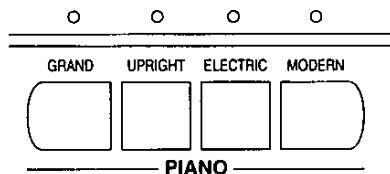

- When the piano is first turned on (initialized mode), the **PIANO MODE** is on and the default sound is **GRAND PIANO**.
- The **RIGHT 1** part is selected.
- When this button is pressed, the entire keyboard will return instantaneously to the **PIANO MODE**, regardless of the mode which is currently selected, the **KEYBOARD SPLIT** status (refer to page 27) or the **AUTO PLAY CHORD** status (refer to page 38). The sound will be set to the piano-type sound which was selected last.
- Selecting a sound other than one of the four **PIANO** sounds will cause the **PIANO MODE** to turn off automatically.

SOUND GROUP

You can select various sounds for the two parts, **RIGHT 1** and **RIGHT 2**.

1. In the **CONDUCTOR** section, choose **RIGHT 1** or **RIGHT 2**.

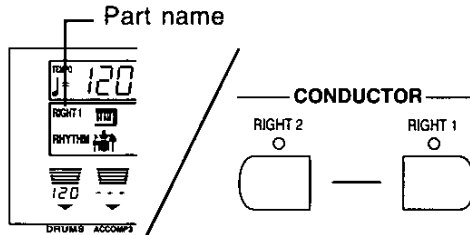

- The selected part is shown on the display.
2. In the **SOUND GROUP** section, select a sound group.

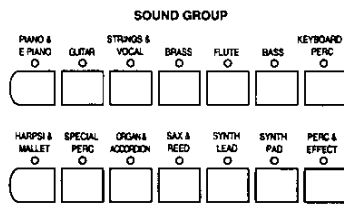

- A list of sounds available for each sound group can be found in the separate **REFERENCE GUIDE** provided.
 - Most of the sounds in the **KEYBOARD PERC** and **PERC & EFFECT** sound groups do not have scaled pitches.
3. Use the **SOUND SELECT** buttons to select the desired sound.

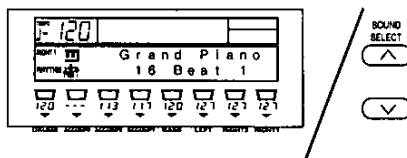

- The name of the sound is shown on the display.
- The selected sound is memorized independently for each sound group, so that whenever a **SOUND GROUP** button is pressed, the sound you chose is automatically available.

4. Repeat steps 1 to 3 for the other part.
 - The **RIGHT 1** and **RIGHT 2** parts can be mixed. (Refer to page 27.)

▣ Percussion sounds

You can create a percussion performance on your keyboard.

1. In the **SOUND GROUP** section, press the **KEYBOARD PERC** button.
2. Select the Kit of percussion instrument.
3. Play the keyboard.
 - Percussion instrument sounds are produced by the keyboard keys as indicated by the picture code above each key. (For further explanation, refer to the separate **REFERENCE GUIDE** provided.)
 - In the **Orch Kit**, the arrangement of percussion instruments is different.

Mixing two sounds

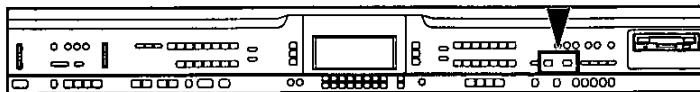

The sounds selected for the **RIGHT 1** and **RIGHT 2** parts can be mixed and played together on the keyboard.

1. Select the sounds for the **RIGHT 1** and **RIGHT 2** parts.
2. In the **CONDUCTOR** section, press the **RIGHT 1** and **RIGHT 2** buttons at the same time.

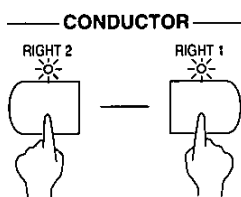

- When you play the keyboard, you hear both the **RIGHT 1** part sound and the **RIGHT 2** part sound.
- The volume balance of the **RIGHT 1** and **RIGHT 2** parts can be adjusted. (Refer to page 19.)
- Your mixed sound can be stored in the **PANEL MEMORY**. (Refer to page 46.)

Keyboard split

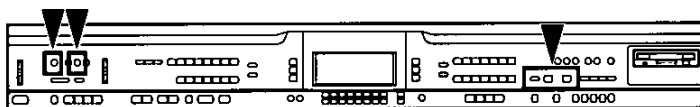

The keyboard can be divided into left and right playing sections, and a different sound played in each section.

1. Select a sound for the right part of the keyboard, and set the effects to on or off.
 - You can also turn on the **RIGHT 1** and **RIGHT 2** buttons in the **CONDUCTOR** to mix two sounds.
2. In the **PLAY STYLE** section, press the **KEYBOARD SPLIT** button to turn it on.

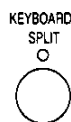

3. Press the **LEFT SELECT** button to turn it on, and select the sounds and effects for the left part.

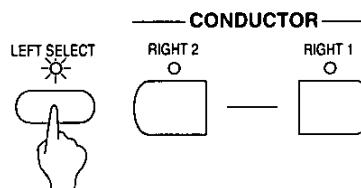

- A few seconds after you make your selection, the **LEFT SELECT** button turns off.
- You can now play different sounds for the left and right keyboard sections.

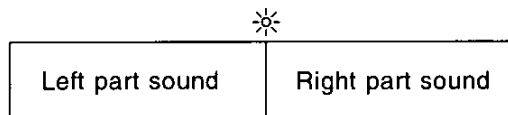

- To mute the **LEFT** part, press both the corresponding **^** and **v** buttons below the display at the same time. In this case, the left section of a split keyboard does not produce any sound.
- Press either of the **LEFT** **^** and **v** buttons to cancel the mute.

Practical applications

SPLIT POINT

When the keyboard is divided into left and right sections, the split point is indicated by the lit indicator.

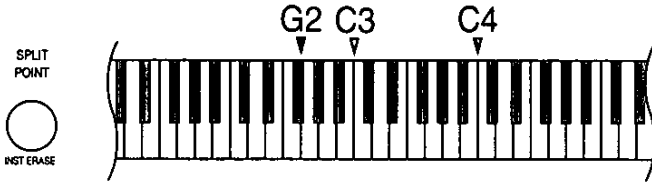

- Each time the **SPLIT POINT** button is pressed, the indication moves to the next split point in the following order: G2 → C3 → C4.

■ Customized split point

You can set the split point at a location other than G2, C3 or C4.

1. Press and hold the **SPLIT POINT** button for a few seconds.
- The following display appears.

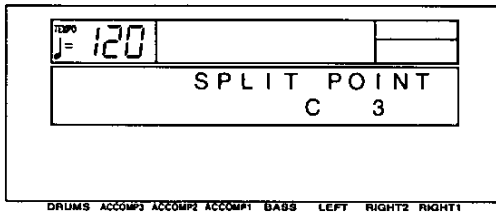

- You can select your customized split point by pressing the **SPLIT POINT** button until none of the split point indicators is lit.

2. Press a key on the keyboard to specify the desired split point.
 - The pressed key is indicated on the display, and a split point is set at the location of the pressed key, which is the lowest note of the right keyboard section.
 - The display returns to the previous display after a few seconds.

Practical applications

Pedals

■ Sustain pedal

When a key is released while this pedal is depressed, the sound is sustained so that it lingers and slowly fades out.

- If the **SUSTAIN PEDAL** button is off, the sustain effect does not work.

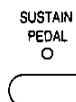

- The sustain on/off status can be set for each part independently. Select a part in the **CONDUCTOR** section and turn the **SUSTAIN PEDAL** button on or off for the part. Repeat for the other part. To select the **LEFT** part (page 27), turn on the **LEFT SELECT** button.

■ Soft pedal

When this pedal is depressed, the sound is softer and the volume is slightly lower.

- You can select a different function to control with this pedal. (Refer to page 48.)

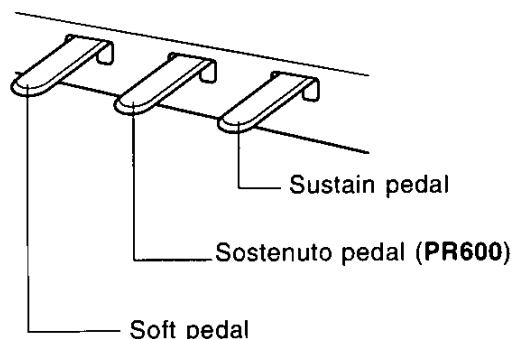

■ Sostenuto pedal (PR600)

If this pedal is pressed while the keys are pressed, the sustain effect is applied to those notes only. If the pedal is pressed first and the keys are then pressed, the sustain effect does not work for those notes.

- For continuous-type sounds, such as **ORGAN**, the notes sound as long as the pedal is pressed.
- You can select a different function to control with this pedal. (Refer to page 48.)

String resonance

String resonance is the sound heard in an acoustic piano when the struck strings produce a sympathetic resonance of the other unstruck strings. For the **GRAND PIANO** and **UPRIGHT PIANO** sounds, string resonance is produced as long as the sustain pedal is depressed. The amount of string resonance can be adjusted.

1. Press and hold the **GRAND** button for about 3 seconds.

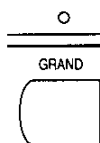

- The display looks similar to the following.

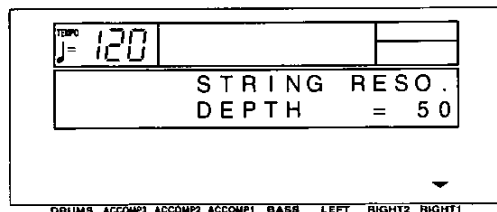

2. Use the **RIGHT 1** \wedge and \vee buttons to adjust the amount of resonance (0 to 99).

- The higher the number, the greater the amount of resonance.
- When set to 0, there is no string resonance.

3. When you have finished adjusting the string resonance, press the **GRAND** button again.

- This effect does not work when the **DIGITAL REVERB** is on.

Effects

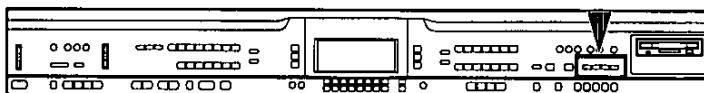

You can achieve even fuller and stirring sounds by adding various effects.

DIGITAL EFFECT

DIGITAL EFFECT gives the sound richness and enhances your performance.

1. Select a part to which this effect will be applied; turn on the **RIGHT 1** or **RIGHT 2** button in the **CONDUCTOR** section, or the **LEFT SELECT** button.
 2. Press the **DIGITAL EFFECT** button to turn it on for the selected part.
- The **DIGITAL EFFECT** on or off status is preset for each sound, so that the **DIGITAL EFFECT** automatically turns on when certain sounds are selected.
 - This effect differs depending on the selected sound.
 - This effect does not work for the **KEYBOARD PERC** sounds.

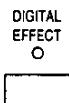

CHORUS

Add breadth to the sound.

1. Select a part to which this effect will be applied; turn on the **RIGHT 1** or **RIGHT 2** button in the **CONDUCTOR** section, or the **LEFT SELECT** button.
2. Press the **CHORUS** button to turn it on for the selected part.



- The **CHORUS** can be set to on or off for each part.

■ Effect setting

You can specify the type and adjust the parameters of this effect.

1. Press and hold the **CHORUS** button for a few seconds.
- The display looks similar to the following.

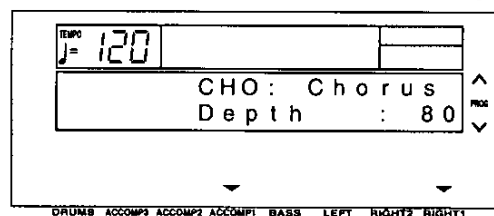

2. Use the **TRANSPOSE (PROG)** \wedge and \vee buttons to select the type.
3. Use the **ACCOMP 1** \wedge and \vee buttons to select a parameter.
4. Use the **RIGHT 1** \wedge and \vee buttons to modify the parameter.
 - An explanation of the types and their corresponding parameters can be found in the separate **REFERENCE GUIDE** provided.
 - The depth of the effect can be adjusted for each part. (Refer to page 88.)
 - The display returns to the previous display after a few seconds.

DIGITAL REVERB

DIGITAL REVERB applies a reverberation effect to the sound.

Press the **DIGITAL REVERB** button to turn it on.



- This effect is applied to all the sounds of this instrument.
- The display can also be used to adjust the depth of the reverb for each part. (Refer to page 88.)

■ Effect setting

You can select the type and volume of this effect.

1. Press and hold the **DIGITAL REVERB** button for a few seconds.
- The display looks similar to the following.

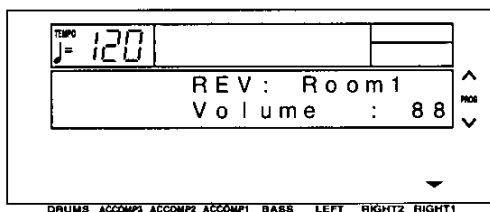

2. Use the **TRANSPOSE (PROG)** ^ and v buttons to select the type.
3. Use the **RIGHT 1** ^ and v buttons to adjust the volume of the reverb.
 - An explanation of the types can be found in the separate REFERENCE GUIDE provided.
 - The display returns to the previous display after a few seconds.

Transpose

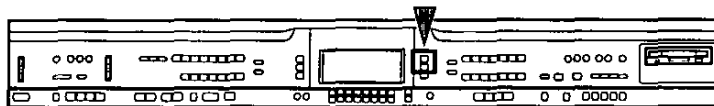

The **TRANPOSE** buttons are used to change the key of the entire instrument in semitone steps across an entire octave.

Suppose you learn to play a song—in the key of C, for example—and decide you want to sing it, only to find that it's either too high or too low for your voice. Your choice is to either learn the song all over again in a different key, or to use the **TRANPOSE** feature.

Adjust the key with the **TRANPOSE** \wedge and \vee buttons.

Practical applications

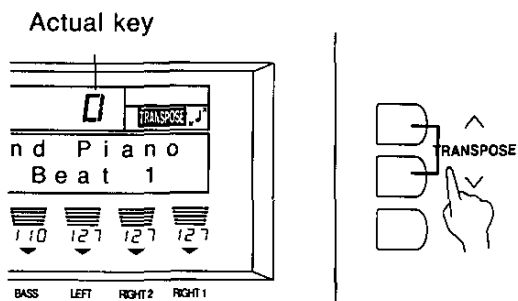

- Each press of the \wedge button raises the key in semitone steps, and each press of the \vee button lowers the key in semitone steps (G — C — F \sharp).
- If the two buttons are pressed at the same time, the key returns to C.
- When the **TRANPOSE** function is active, **TRANPOSE** is shown in the upper right part of the display and, during setting, the key is indicated.

<Example: transposed to D>

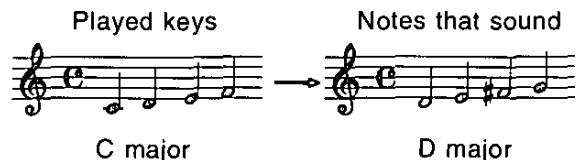

Techni-chord

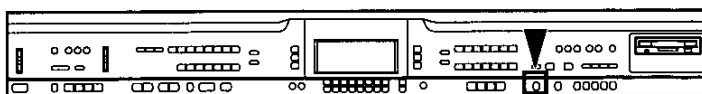

TECHNI-CHORD turns your single-note melodies into full chords and offers you a choice of 13 different types, from a simple duet which adds one harmony note to your melody note, to big band reeds which adds four harmony notes to your melody note. If **TECHNI-CHORD** is part of a **ONE TOUCH PLAY** or **MUSIC STYLE SELECT** registration, a suitable **TECHNI-CHORD** type will be selected automatically.

1. Split the keyboard into left and right sections.
(Refer to page 28.)
2. Press the **TECHNI-CHORD** button to turn it on.

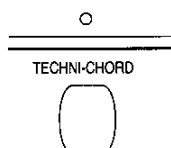

3. Play the keyboard.
 - The melody you play with your right hand is automatically played in chords which are based on the chords you play with your left hand.

Example:

Left hand (chord)

Right hand (melody)



- This feature is very effective when used with the **AUTO PLAY CHORD**. (This feature does not work in the **PIANIST** mode.)

■ Harmony type

You can select the desired harmony style for the **TECHNI-CHORD**.

1. Press and hold the **TECHNI-CHORD** button for a few seconds.
 - The display looks similar to the following.

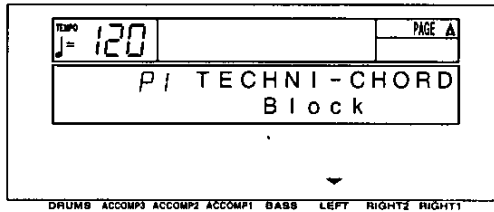

2. Use the **LEFT** \wedge and \vee buttons to select the harmony type.
 - Select from [Close], [Open 1], [Open 2], [Duet], [Country], [Theatre], [Hymn], [Block], [Big Band Brass], [Big Band Reeds], [Octave], [Hard Rock], [Fanfare].
 - When the [Octave], [Hard Rock] or [Fanfare] type is selected, the **TECHNI-CHORD** functions even when the keyboard is not split.
 - The display returns to the previous display after a few seconds.
 - An explanation of each harmony type can be found in the separate **REFERENCE GUIDE** provided.

<ORCHESTRATOR>

Use this function to specify which part plays the harmony notes. By assigning different sounds to the melody notes and harmony notes, you can achieve a striking **TECHNI-CHORD** performance.

1. While the **TECHNI-CHORD** display is shown, press the **PAGE** \wedge button.
 - The display looks similar to the following.

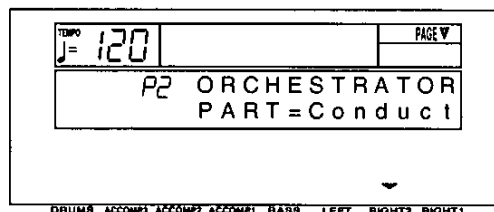

2. Use the **RIGHT 2** \wedge and \vee buttons to select the part you wish to generate the harmony notes.
 - **LEFT** and **PART 16** cannot be selected.
 - If [Conduct] is selected, the **CONDUCTOR** part which is currently selected will be specified as the part for the harmony notes. However, when **RIGHT 1** and **RIGHT 2** are both on, the harmony notes are produced in the sound for the **RIGHT 1** part.

Part II Playing the rhythm

The rhythm section enhances the capabilities of your instrument with features such as automatic performance of the preset rhythm patterns and accompaniment patterns.

Selecting rhythms

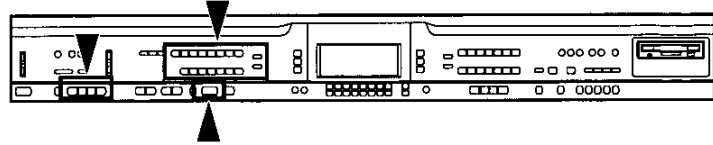

After first selecting a **RHYTHM GROUP**, choose the desired rhythm from the display.

Select a rhythm

1. In the **RHYTHM GROUP** section, select a rhythm group.

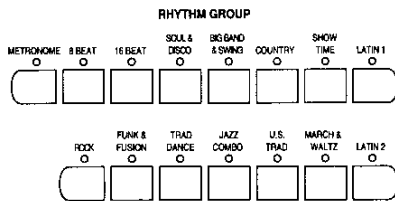

- A list of rhythms available for each rhythm group can be found in the separate **REFERENCE GUIDE** provided.
- A **COMPOSER** rhythm or **COMPOSER CHORD MAP** can also be selected as a rhythm. (Refer to pages 73 and 74.)

2. Use the **RHYTHM SELECT** buttons to select a rhythm.

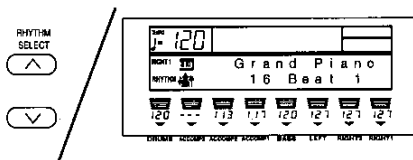

- The rhythm you selected is shown on the display.
- The selected rhythm is memorized independently for each rhythm group, so that whenever a **RHYTHM GROUP** button is pressed, the rhythm you chose is automatically available.

■ VARIATION

There are four variations available for each rhythm. Use the **VARIATION & MSA** buttons to select the desired variation.

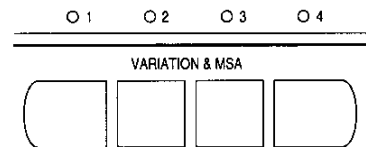

- The nuance of the pattern differs with each variation number.
- You can change to a different variation while the rhythm is playing.

METRONOME

1. In the **RHYTHM GROUP** section, select **METRONOME**.

2. Select the time signature for the metronome.
 - Select "Metronome Off" if you do not wish the first beat of the measure to be accented.
 - Press the **START/STOP** button to start the metronome.

Start the rhythm

There are two ways to start the rhythm.

■ Immediate rhythm start

1. Select a rhythm.

2. Press the **START/STOP** button to turn it on.

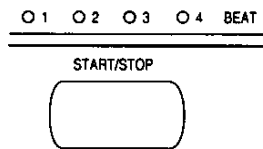

- The selected rhythm pattern immediately begins to play.
- You can stop the rhythm by pressing the **START/STOP** button again to turn it off.
- The **BEAT** indicators above the **START/STOP** button light to indicate the beat. On the first beat of the measure, the red indicator lights. On the second and succeeding beats of the measure, the green indicators light in order.

■ Synchronized start

With the synchronized start feature, the rhythm pattern starts when you play a key on the keyboard.

1. Select a rhythm.

2. Press the **SYNCHRO START** button to turn it on.

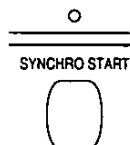

3. Play a key to the left of the keyboard split point.

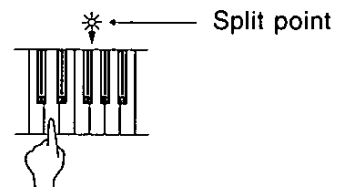

- The rhythm pattern begins to play.
- You can use the synchronized start feature even when the keyboard is not divided into left and right sections. To start the rhythm, press a key to the left of the specified split point.

■ Adjust the tempo

The tempo of the rhythm pattern is adjusted with the **TEMPO** buttons.

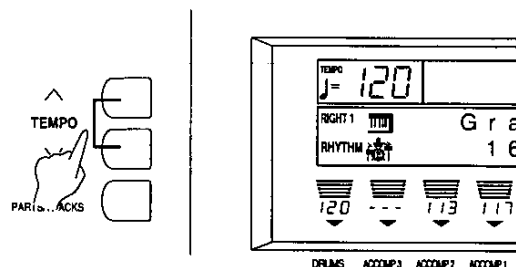

- The tempo is shown on the display as a numerical value (♩ = 40 to 300).
- Keep the button pressed to change the value quickly.
- If the two buttons are pressed at the same time, the tempo returns to the standard 120 setting.

■ **TAP TEMPO**

You can set the tempo of the rhythm by tapping this button few times with your finger.



- The tempo at which the button is tapped is detected, and the tempo automatically changes correspondingly.

Playing the rhythm

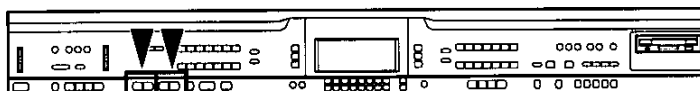

Intro, fill-in and ending patterns fitting each different rhythm pattern are permanently recorded in your instrument, thus allowing a versatile rhythm performance.

Practical applications

INTRO

Begin the rhythm performance with an intro pattern.

1. Press the **INTRO & ENDING 1** or **INTRO & ENDING 2** button to turn it on.

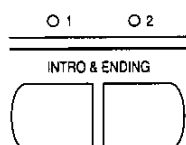

2. Press the **START/STOP** button to start the rhythm.

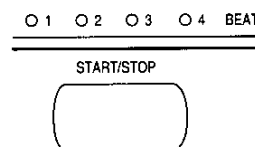

- An intro pattern is played, after which the normal rhythm pattern begins.

COUNT INTRO

You can begin the rhythm performance with a one-measure count.

1. Press the **COUNT INTRO (FILL IN 2)** button to turn it on.

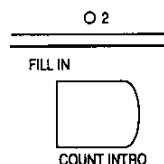

2. Press the **START/STOP** button to start the rhythm.

- A one-measure count is played, after which the normal rhythm pattern begins.

FILL IN

You can insert a fill-in pattern any time during the rhythm performance. Choose from two different fill-in patterns.

1. Select a rhythm and press the **START/STOP** button.
2. Press the **FILL IN 1** or **FILL IN 2** button.

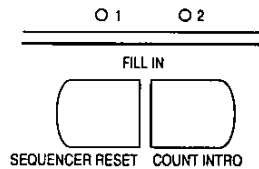

- A fill-in pattern is heard immediately for the remainder of the measure.
- When a **FILL IN** button is pressed on the last beat of the measure, the fill-in pattern continues to the end of the following measure.

ENDING

Finish the rhythm performance with an ending pattern.

1. Select a rhythm and press the **START/STOP** button.
2. Press the **INTRO & ENDING 1** or **INTRO & ENDING 2** button to turn it on.

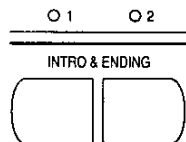

- An ending pattern is produced, and then the rhythm performance stops.
- If you accidentally press an **INTRO & ENDING** button in the middle of the tune, you can press the **FILL IN 1** or **FILL IN 2** button. The ending pattern stops, and a fill-in pattern is produced, after which the normal rhythm performance continues.

Auto Play Chord

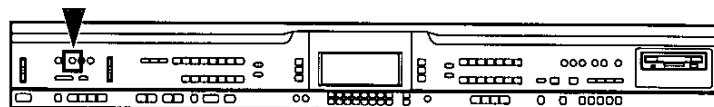

Simply by playing a chord on the keyboard, the **AUTO PLAY CHORD** function automatically plays an accompaniment pattern which matches perfectly the selected rhythm. With a real accompaniment as a background, you can concentrate on playing the melody.

How the AUTO PLAY CHORD works

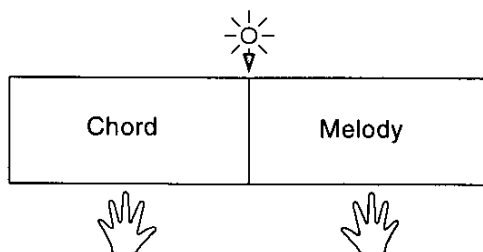

When an **AUTO PLAY CHORD** mode is selected, an automatic accompaniment which matches the rhythm which you have chosen is played in the chord which you specify with your left hand. The melody is played with your right hand.

- The accompaniment pattern of the **AUTO PLAY CHORD** is composed of five parts: **DRUMS**, **BASS**, **ACCOMP 1**, **ACCOMP 2** and **ACCOMP 3**.

How to play chords

There are four different ways to specify chords on the keyboard.

■ BASIC mode [Basic]

For beginning players, a left-hand chord can be specified with just one finger. You can either press one key on the left keyboard section to specify the root note (one-finger), or play all the notes of the chord (fingered).

- The sound selected for the left section of the keyboard is muted. If you cancel the mute for the left keyboard while in this mode, the left-part sound can then be heard, but the one-finger chord function will not work.
- When the rhythm is on, even if the keys are released, the accompaniment continues to play in the specified chord until you specify another chord.

<One-finger>

Press a key in the left keyboard section to specify the root note. The major chord corresponding to this root note is automatically played in an accompaniment pattern.

Example: C chord

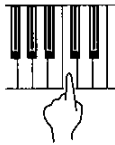

Minor, seventh and minor seventh chords are also easily produced.

Minor chord	Seventh chord	Minor seventh chord
Play the root note plus a black key to the left of it.	Play the root note plus a white key to the left of it.	Play the root note plus a black key and a white key to the left of it.
Example: Cm 	Example: C7 	Example: Cm7

<Fingered>

Specify the chord by playing all the notes in the chord. When you play chords this way, the **AUTO PLAY CHORD** recognizes more chord types, and thus the scope of your performance expression is expanded.

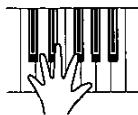

- Play chords by pressing at least three keys.
- The **AUTO PLAY CHORD** can distinguish the following played chords for each key (C is given as an example): C, C7, CM7, Caug, Caug7, Cm, Cm7, Cdim, Cm7^{b5}, CmM7, Csus4, C7sus4, C^{b5}, C7^{b5}, Cm^{b5}, C6, Cm6, CM7^{#5}, CM7^{b5}, CmM7^{b5}, etc.

Practical applications

▣ ADVANCED 1 mode [Advanced 1]

In this mode, the chord is specified by playing it (fingered) on the left part of the keyboard. Chords which the **AUTO PLAY CHORD** does not recognize are ignored.

- The keyboard automatically divides into left and right playing sections.
- The sound selected for the left section of the keyboard is produced, but you can mute this part. (Refer to page 19.)
- Play chords by pressing at least three keys.
- In this mode, the piano can also recognize chords such as 9th and 13th chords.
- When the rhythm is on, even if the keys are released, the accompaniment continues to play in the specified chord until you specify another chord.

▣ ADVANCED 2 mode [Advanced 2]

Chords are specified in the same manner as for the ADVANCED 1 mode. However, if the **AUTO PLAY CHORD** does not recognize the chord, the automatic accompaniment is based on the pitches of the pressed keys.

▣ PIANIST mode [Pianist]

In the PIANIST mode, the entire keyboard can be used to specify chords for the automatic accompaniment. This mode is used to add an automatic accompaniment to the performance on a standard piano.

- The keyboard does not split.
- Chords can be specified (fingered) anywhere on the keyboard.
- Play chords by pressing at least three keys.
- In this mode, the piano can also recognize chords such as 9th and 13th chords.
- When specifying chords, if you press a key a perfect 5th or more below the lowest note of the chord, the **BASS** part becomes a pattern based on that note.
- When the rhythm is on, even if the keys are released, the accompaniment continues to play in the specified chord until you specify another chord.

<ON BASS>

The **BASS** part is produced in the key of the lowest note of the played chord (except for One-finger). When this button is on, it is possible to specify chords such as "C on G" with just one hand.

- For example, with the ON BASS button on, if you play a C chord by pressing the keys G, C and E, the bass part is produced in the key of G.

<APC HOLD>

During a performance in the PIANIST mode, for example, if you press the pedal to which the APC HOLD function is assigned, the currently specified chord is maintained, allowing you to focus your performance on a solo melody.

- The accompaniment continues in the same chord as long as the pedal is depressed, and it does not change even if other chords are played.
- To change the pedal assignment, refer to page 48.

How to use the AUTO PLAY CHORD

1. Select the desired rhythm and sound(s), and set the tempo.
2. Press the **AUTO PLAY CHORD** button to turn it on.

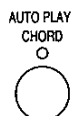

- The display looks similar to the following.

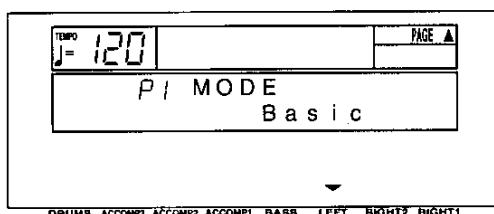

3. Use the **LEFT** \wedge and \vee buttons to select the **AUTO PLAY CHORD** mode.
- Press the **PAGE** \wedge button to show the P2 APC ON BASS display. Use the **RIGHT 1** \wedge and \vee buttons to set ON BASS to on or off.

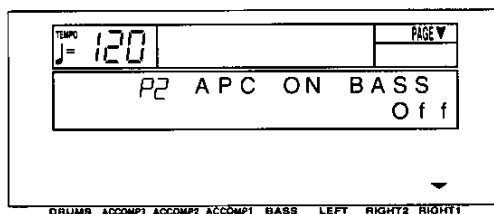

- After a few seconds, the display returns to the previous display.
4. Press the **START/STOP** button to begin the rhythm.
- You can also start the rhythm by playing a key on the keyboard. (Refer to page 36.)

5. Specify a chord.

- If the **BASIC**, **ADVANCED 1** or **ADVANCED 2** mode was selected, specify the chord on the keyboard section to the left of the split point.

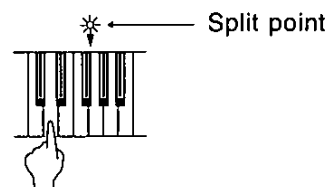

- An accompaniment pattern in the specified chord is automatically played.
- When you use **FILL IN**, **INTRO** and **ENDING**, the automatic accompaniment is also used in these patterns.
- You can set the mode which determines how the **LEFT** part sounds during an **AUTO PLAY CHORD** performance. (Refer to page 91.)
- If the **AUTO PLAY CHORD** button is pressed during an automatic accompaniment, the button does not turn off, and the display changes to the mode-setting display.

6. To stop the automatic accompaniment, press the **START/STOP** button.

- When the rhythm is off, if the **BASIC**, **ADVANCED 1** or **ADVANCED 2** mode is on and a chord is specified, the specified root note (R. BASS part) and chord notes (CHORD part) are produced. The volumes of these notes can be adjusted. (Refer to page 20.)

AUTO PLAY CHORD part volume balance

The volume of all the parts comprising the **AUTO PLAY CHORD (DRUMS, ACCOMP 1, 2, 3, BASS)** can be adjusted with the sliding **RHYTHM VOLUME** control.



- At the **MAX** setting, the volume is at its loudest. At the **OFF** setting, the automatic accompaniment parts do not sound.
- You can also adjust the volume of each part. (Refer to page 19.)
- When the actual volume level corresponds correctly to the position of the sliding controller, the indicator is lit. However, when the actual volume level and the controller position differ, the indicator is not lit, for example when a **PANEL MEMORY** has been recalled to change the panel settings (page 46).

Piano Stylist

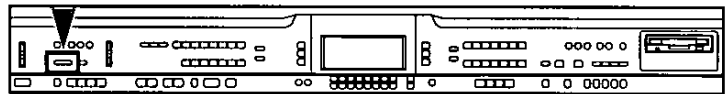

For performances using piano sounds, just select a piano style, and your panel registration, such as the sounds and effects, is set in seconds.

1. Press the **PIANO STYLIST** button to turn it on.

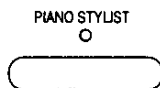

- The display looks similar to the following.

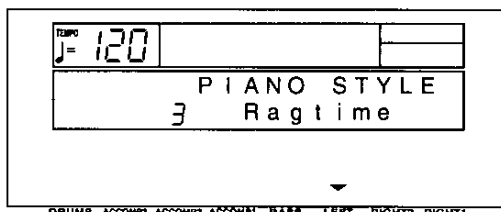

2. Use the **LEFT** \wedge and \vee buttons to select a **STYLE** group.

3. Press the **EXECUTE** button.

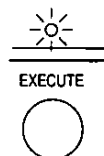

- The display looks similar to the following.

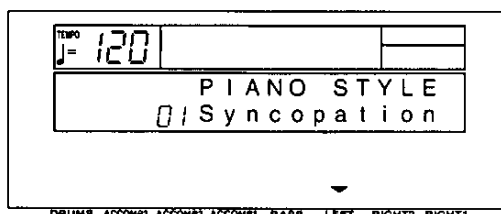

4. Use the **LEFT** \wedge and \vee buttons to select the performance style.
 - The **AUTO PLAY CHORD (BASIC mode)**, an **INTRO & ENDING** button and the **SYNCHRO START** button turn on, and the rhythm, effects and tempo which are best suited for the selected style are automatically selected. When you press a key on the left section of the keyboard, an intro is played, after which the automatic rhythm is played. Play the melody with your right hand.
 - The octave and stereo balance of the sound may change.
 - To return the functions of this instrument to their original settings, perform the **INITIAL** procedure. (Refer to page 102.)

Suggestions for using PIANO STYLIST

Use the **PIANO STYLIST** registration as a starting point for your own registration. Alter the sounds, balance and tempo to your own taste and store your new registration in the **PANEL MEMORY** for future use. (Refer to page 46.)

One Touch Play

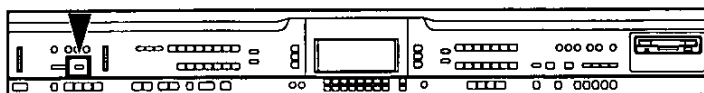

ONE TOUCH PLAY sets up the your instrument with a suitable registration for your chosen rhythm style so that you can make a great sound straight away, even if you are playing this instrument for the first time. Using **ONE TOUCH PLAY** sets a suggested combination of sounds and balances and an appropriate tempo for the rhythm style at the push of a button.

1. Select an **AUTO PLAY CHORD** mode. (Refer to page 41.)
2. Select a rhythm pattern.
 - Do not select a **COMPOSER CHORD MAP** or a rhythm from a **COMPOSER MEMORY**.
3. Press the **ONE TOUCH PLAY** button until its indicator goes out.



- The display looks similar to the following.

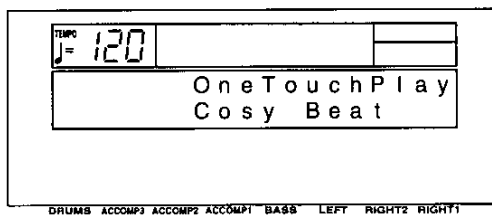

- The **AUTO PLAY CHORD** button and the **SYNCHRO START** button are automatically turned on. When a key on the left section of the keyboard is pressed, the automatic rhythm begins to play immediately.
- If an **AUTO PLAY CHORD** mode was not selected in step 1, the **BASIC** mode becomes active.
- The octave and stereo balance of the sound may change.
- The function of the left (soft) pedal is automatically set (**SOFT PEDAL**, **GLIDE**, etc.).
- To return the functions of this instrument to their original settings, perform the **INITIAL** procedure. (Refer to page 102.)

Suggestions for using ONE TOUCH PLAY

Press the **INTRO & ENDING** button before you play for a professional sounding introduction. Use the **ONE TOUCH PLAY** registration as a starting point for your own registration. Alter the sounds, balance and tempo to your own taste and store your new registration in the **PANEL MEMORY** for future use. (Refer to page 46.)

Music Style Select

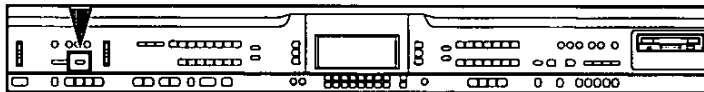

MUSIC STYLE SELECT sets up your instrument with a suitable registration for a specific style of music. Select from this instrument's list of style names and **MUSIC STYLE SELECT** does the rest for you, setting suitable sounds and volume balances, along with the appropriate rhythm, accompaniment and tempo for your chosen style.

1. Select an **AUTO PLAY CHORD** mode. (Refer to page 41.)
2. Press the **MUSIC STYLE SELECT (ONE TOUCH PLAY)** button momentarily.
 - The display looks similar to the following.

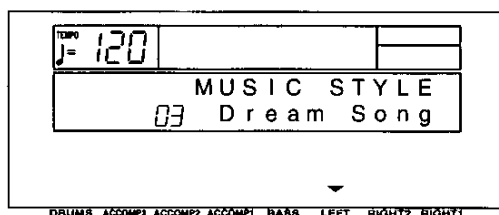

- The name of the style shown on the display may become altered.
3. In the **RHYTHM GROUP** section, select a rhythm group.

4. Use the **LEFT** \wedge and \vee buttons to select a music style.
 - The **AUTO PLAY CHORD** button and the **SYNCHRO START** button turn on, and the sounds, effects, rhythm and tempo which are best suited for the selected music style are automatically selected. When a key on the left section of the keyboard is pressed, the automatic rhythm begins to play immediately.
 - If an **AUTO PLAY CHORD** mode was not selected in step 1, the **BASIC** mode becomes active.
 - The octave and stereo balance of the sound may change.
 - The function of the left (soft) pedal is automatically set (**SOFT PEDAL**, **GLIDE**, etc.)
 - The type and number of styles that can be selected differs depending on the **AUTO PLAY CHORD** mode.

- To return the functions of this instrument to their original settings, perform the **INITIAL** procedure. (Refer to page 102.)

Suggestions for using MUSIC STYLE SELECT

Press the **INTRO & ENDING** button before you play for a professional sounding introduction. Use the **MUSIC STYLE SELECT** registration as a starting point for your own registration. Alter the sounds, volume balance and tempo to your own taste and store your new registration in the **PANEL MEMORY** for future use. (Refer to page 46.)

Music Style Arranger

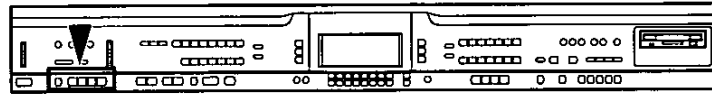

The **MUSIC STYLE ARRANGER** helps you to make professional registration changes during your performance. Select between four contrasting registrations at the push of a button, or let your instrument change the registration automatically for you when you use **FILL IN 1** or **2**. The **MUSIC STYLE ARRANGER** will also alter the accompaniment in character with the registration change, creating a polished sounding arrangement.

How to use the MUSIC STYLE ARRANGER

1. Select a rhythm pattern.
 - When the **PIANIST** mode of the **AUTO PLAY CHORD** is selected, the **MUSIC STYLE ARRANGER** does not work.
2. Press the **MUSIC STYLE ARRANGER** button to turn it on.

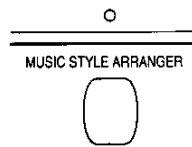

3. Use the **VARIATION & MSA** buttons to select a style (1 to 4).

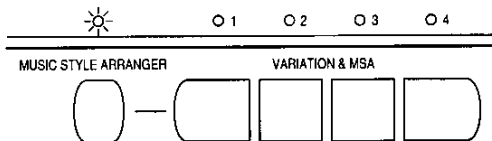

- The nuance of the pattern differs with each number.
- The panel settings (including the tempo) change according to the selected rhythm and music style. The **AUTO PLAY CHORD** button and the **SYNCHRO START** button are automatically turned on. When a key on the left section of the keyboard is pressed, the automatic rhythm begins to play immediately.
- The octave and stereo balance of the sound may change.
- The function of the left (soft) pedal is automatically set (**SOFT PEDAL**, **GLIDE**, etc.)
- To return the functions of this instrument to their original settings, perform the **INITIAL** procedure. (Refer to page 102.)
- During your performance, the style can be changed, but the tempo does not change.

How to change the music style during your performance

While you are playing the keyboard with the **MUSIC STYLE ARRANGER** on, press the **FILL IN 1** or **FILL IN 2** button.

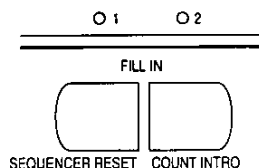

- Each time the **FILL IN 1** button is pressed, the **FILL IN 1** pattern plays, and then the music style changes in the **4 → 3 → 2 → 1** order. And each time the **FILL IN 2** button is pressed, the **FILL IN 2** pattern plays, and then the style changes in the **1 → 2 → 3 → 4** order.

▣ MUSIC STYLE ARRANGER mode

You can define which panel settings change by pressing a **FILL IN** button when the **MUSIC STYLE ARRANGER** is used.

1. Press and hold the **MUSIC STYLE ARRANGER** button for a few seconds.
 - The display changes to the following.

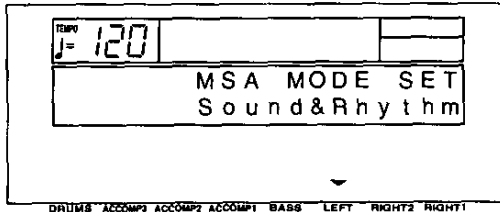

2. Use the **LEFT** \wedge and \vee buttons to select the mode.
 - Rhythm: Only the rhythm changes.
 - Sound & Rhythm: Both the sound and rhythm change.
 - Panel Memory: The **PANEL MEMORY** number (1 to 4) changes.
 - After a few seconds, the display exits the setting mode.

Panel Memory



PANEL MEMORY stores the panel set up of this instrument allowing you to make complex changes at the push of a single button.

How to store the panel settings

1. Set up the desired panel settings (sounds, volumes, etc.).
2. With the **SET** button held down, press one of the numbered buttons of the **PANEL MEMORY** (1 to 5).

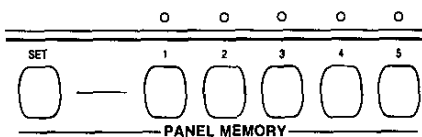

- The panel settings are now stored in the specified number.

- To recall the stored settings, just select the desired **PANEL MEMORY** number button. (You can then change the sound settings, etc. manually; however, the memory contents of the **PANEL MEMORY** remain unchanged until you store them again.)
- The **PANEL MEMORY** settings can be saved on a disk for recall at a later time. (Refer to page 83.)

■ PANEL MEMORY mode

You can define which panel settings are stored when the **PANEL MEMORY** is used.

1. Press and hold the **SET** button for a few seconds.
- The display changes to the following.

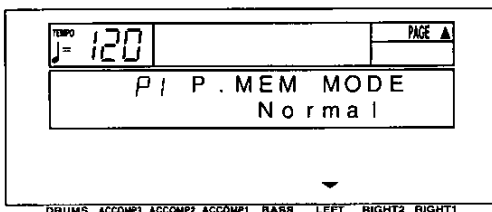

2. Use the **LEFT** \wedge and \vee buttons to select the mode.

Normal: The sounds and volume balance, effects and **CONDUCTOR** status are stored.

Expand: All the instrument's settings are stored, including the rhythm, **TRANSPOSE**, tempo, etc.

- After a few seconds, the display exits the setting mode.

■ EXPAND MODE FILTER

You can specify which data is recalled in the Expand mode.

1. While the P.MEM MODE display is shown, press the **PAGE** \wedge button.
- The display looks similar to the following.

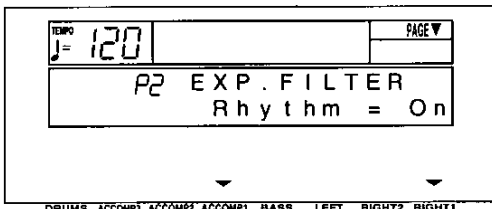

2. Use the **ACCOMP 1** \wedge and \vee buttons to select the item.
 - Select from [Rhythm], [Tempo], [Split Pt] (SPLIT POINT), [Transpos], [APC] (AUTO PLAY CHORD), [MIDI], [Key Scale], [Reverb], [CHO Set] (CHORUS Setting), [P4-P16 Set] (PART 4 to 16 Setting) and [Pedal Set].
3. Use the **RIGHT 1** \wedge and \vee buttons to recall the on or off status for the selected item (On/Off).

4. Repeat steps 2 and 3 for each item, as desired.

Suggestions for using PANEL MEMORY

- The initial factory setting of **PANEL MEMORY** contains professional settings which you may choose to use or to alter to your own taste. These can be restored at any time by initializing the **PANEL MEMORY**. (Refer to page 102.)
- You can change from one **PANEL MEMORY** to another by pressing the soft pedal.

Pedal setting

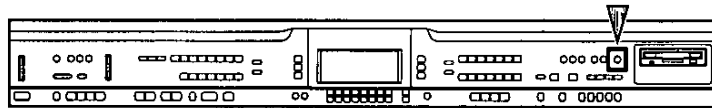

You can assign various functions to the soft (left) pedal and the sostenuto (center) pedal (**PR600**). The assigned function can then be controlled by pressing the pedal.

- The sustain pedal function cannot be changed.

Assigning functions

1. Press the **MEMORY & CONTROL** button to turn it on.

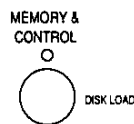

2. Use the **PAGE** buttons to select [P6 Pedal Setting].

- The display changes to the following.

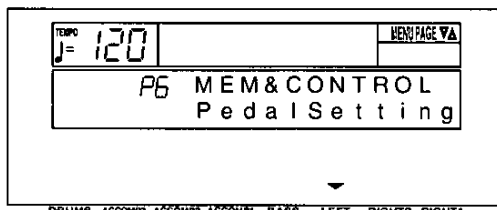

3. Press either **LEFT** button.

- The display changes to the following.

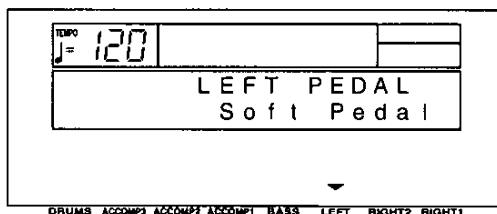

(**PR500**)

- **PR600**: Use the **PAGE** buttons to select a pedal (LEFT/CENTER).

4. Use the **LEFT** \wedge and \vee buttons to select a desired function.

[Sost. Pedal]: (Refer to page 29.)
 [Soft Pedal]: (Refer to page 29.)
 [Start/Stop]: **START/STOP** button on/off
 [Fill in 1]: **FILL IN 1** button on
 [Fill in 2]: **FILL IN 2** button on
 [Intro/Endng 1]: **INTRO & ENDING 1** button on
 [Intro/Endng 2]: **INTRO & ENDING 2** button on
 [Glide]: Glide on/off (The glide effect "bends" the pitch down by about one semitone.)
 [Sustain]: **SUSTAIN PEDAL** button on/off
 [Techni-Chord]: **TECHNI-CHORD** button on/off
 [Dig Effect]: **DIGITAL EFFECT** button on/off
 [Chorus]: **CHORUS** button on/off
 [P. Memory inc]: Increment the **PANEL MEMORY** selection by 1.
 [P. Memory dec]: Decrement the **PANEL MEMORY** selectin by 1.
 [P. Memory 1-5]: The specified **PANEL MEMORY** number is turned on.
 [APC Hold]: Maintain the specified chord during an **AUTO PLAY CHORD** performance. (Refer to page 40.)
 [Off]: No function

5. When you have completed making the settings, press the **MEMORY & CONTROL** button to turn it off.

Part III Sequencer

Outline of the Sequencer

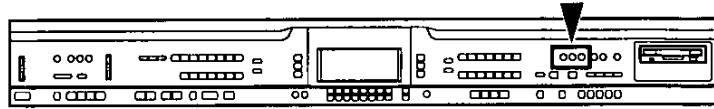

A sequencer records your performance in a similar way to a tape recorder. This instrument's **SEQUENCER** allows you to record up to 10 performances in a variety of ways. You may want to record your entire performance in one go (especially if you are using **AUTO PLAY CHORD** to provide the accompaniment), or to build up a complex arrangement with several different parts playing together, like an orchestral score. This instrument's **SEQUENCER** has 16 tracks. This means that you can record 16 different parts. However, you don't have to use all 16 tracks. For some uses you may only need to use one or two tracks. This instrument's **SEQUENCER** enables you to edit your recorded performance. Unlike a tape recorder you can change the sound or the tempo during playback, or correct wrong notes or timing errors.

SEQUENCER features

■ You can change the tempo without changing the pitch

When you record your performance at a slow tempo and play it back at a faster tempo, the pitch stays the same.

■ Consistent sound

Your performance is reproduced by a sound module as it reads digital data. So, unlike a recorded tape, the sound never deteriorates no matter how many times you play back your performance.

■ Edit your recorded performance

Comprehensive editing functions allow you to modify your recorded performance. Data can easily be erased, corrected or copied, providing an especially convenient tool for creating your original tunes.

■ Instant search

A recorded tape has to be rewound, but digital action means you can return to the beginning of your performance, or find any measure, instantly.

■ Save your performances on disks

All the data of your recorded performances can be stored on disks. The built-in Disk Drive also allows you to play back and use commercially sold disks on your own instrument.

- Features and operation of the built-in Disk Drive are explained in Part V: Disk Drive (page 76).

Popular features

■ Simplified recording method

EASY RECORD is a feature that allows you to bypass the more complex recording procedures so you can record and play back your performance quickly and easily.

- You can also record an accompaniment from the **AUTO PLAY CHORD**.

■ Create a one-man ensemble

Use the **REALTIME RECORD** function to record your performance in up to 16 tracks and create your own orchestra or band.

■ Store a chord progression

Use the **STEP RECORD** to store a chord progression for the automatic accompaniment, and the rhythm changes, note by note.

Memory capacity

Up to 10 songs can be stored in the **SEQUENCER**. Expressed in terms of notes, the total number of notes which can be stored in all the **SEQUENCER** songs and tracks is about 30,000. The remaining memory available for recording is shown on the display as a percentage.

- When "MEMORY FULL!" appears on the display, no more data can be stored in the **SEQUENCER**.

About the measure count

The measure count on the display corresponds to the time signature of the selected rhythm. However, if rhythm data is stored in the RHYTHM part and that part is played back, the measure count on the display corresponds to the stored rhythm data. (Refer to page 61.)

- If you wish to use a time signature not available in the preset rhythms, use the **COMPOSER** to create a new time signature. (Refer to page 67.)

SEQUENCER MENU

When you press the **MENU** button in the **SEQUENCER** section to turn it on, the display changes to the following.

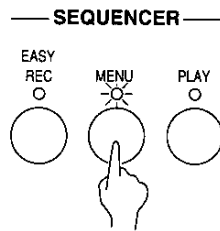

- Use the **PAGE** buttons to view the three pages of menu display.

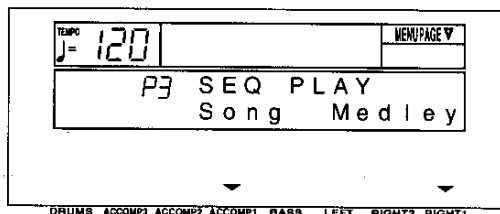
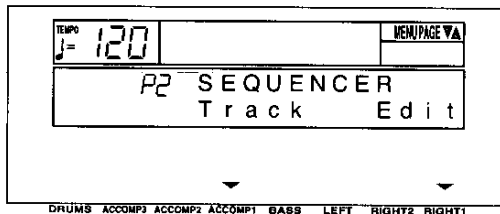
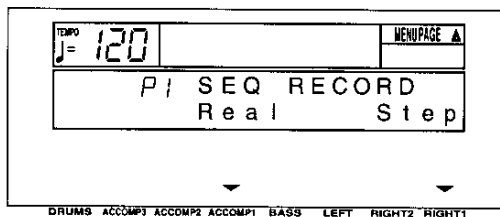
**Summary of the SEQUENCER menu items****[P1 SEQ RECORD]**

Real (REALTIME RECORD) (page 54)
Record your performance just as you play it on the keyboard.

Step (STEP RECORD) (page 58)
Store the chord progression for the automatic accompaniment, and the rhythm changes.

[P2 SEQUENCER]

Track (TRACK ASSIGN) (page 62)
Assign parts to up to 16 different tracks.

Edit (page 63)
Full-scale editing features are available.

[Song Clear]: Erase the recorded contents of a specific song.

[Track Clear]: Erase the contents of a specific track.

[Quantize]: Correct the timing of the recorded performance.

[Song Copy]: Copy specific songs.

[Panel Write]: Modify the panel status at the beginning of the song.

[P3 SEQ PLAY]

Song (page 51)
Specify the song number and name of the song to record or play back.

Medley (page 66)
Specify medley playback of songs.

Song

Up to 10 songs can be recorded in the **SEQUENCER**. The song number and song name are specified before recording begins.

1. Press the **MENU** button in the **SEQUENCER** section to turn it on.
2. Use the **PAGE** buttons to select [P3 SEQ PLAY].
 - The display looks similar to the following.

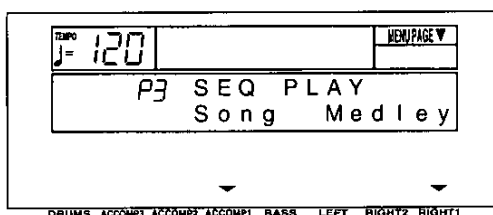

3. Press either **ACCOMP 1** button.
 - The display looks similar to the following.

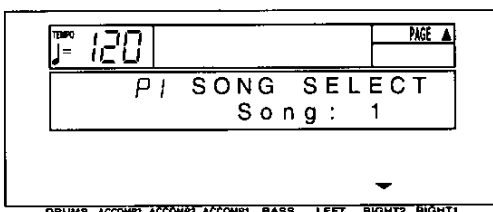

4. Use the **RIGHT 2** ^ and v buttons to select a song number (1 to 10).
5. If you wish to assign a name to the song, press the **PAGE** ^ button.
 - The display looks similar to the following.

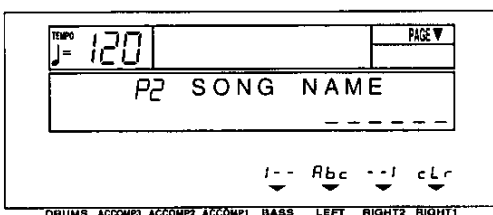

6. Assign a name to the song (up to 6 characters).
 - Use the **BASS** or **RIGHT 2** buttons to highlight the character position. Use the **LEFT** (Abc) buttons to select the alphanumeric character. Repeat these steps to type the whole name.
 - To erase the name, press either **RIGHT 1** (cLr) button.
7. Use the **EXIT** button to return to the MENU display.
8. Follow the procedures to record the song.
 - The same procedure is used to select the song to play back.
 - Until this procedure is repeated, all subsequent recording and playback procedures are associated with the specified song number.
 - To optimize memory, songs you do not wish to preserve should be deleted. (Refer to page 63.)

Easy Record

Suppose you are playing your instrument and you wish to record and play back your performance to hear how it sounds. You can bypass the set-up procedures of the full-scale sequencer and begin recording quickly and easily.

Recording procedure

1. Select the song number. (Refer to page 51.)
2. Set the desired sounds, effects, rhythms, etc.
3. In the **SEQUENCER** section, press the **EASY REC** button to turn it on.

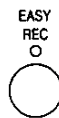

- The display changes to the following.

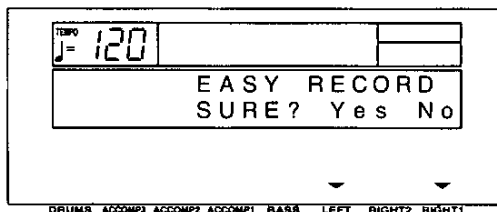

- EASY RECORD is not available if GENERAL MIDI is set to On. (Refer to page 101.)

Here is what happens when you select the **EASY RECORD** mode.

- The recorded data for the currently selected **SONG** number is erased (Song Clear).
- Tracks available for recording are selected as follows.
 - 1: RIGHT 1 part
 - 2: RIGHT 2 part
 - 3: LEFT part
 - 4: APC part
 - 5: CONTROL part
- 4. Press either **LEFT** (Yes) button.
 - To cancel the procedure, press either **RIGHT 1** (No) button.
 - The display changes to the REC display.
- 5. Play the keyboard.
 - Recording begins as soon as you start the rhythm or play the keyboard.
- 6. When you have finished recording, press the **EASY REC** button in the **SEQUENCER** section to turn it off.
 - The display changes to the SEQ PLAY display.

Playback

1. Press the **SEQUENCER RESET (FILL IN 1)** button.

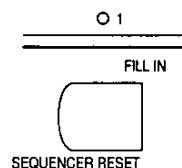

2. Press the **START/STOP** button.

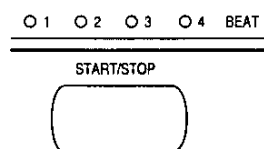

- Your recorded performance is played back automatically.
- When you are finished playing back your performance, press the **PLAY** button in the **SEQUENCER** section to turn it off.

Sequencer parts

The following summary explains what is stored in each **SEQUENCER** part.

Part name [name on display]	Used for	Recorded contents
RIGHT1 [Right 1] RIGHT2 [Right 2] LEFT [Left] PART4 [Part 4] : PART15 [Part 15]	Recording the performance of each part (REALTIME)	<ul style="list-style-type: none"> • Sound and volume settings • Pedal operation (Sustain, Soft, Sostenuto) • DIGITAL EFFECT, CHORUS, SUSTAIN PEDAL on/off • PITCH BEND, MODULATION, AFTER TOUCH, REVERB DEPTH, CHORUS DEPTH, PAN, KEY SHIFT, BEND RANGE data (when MIDI data is received)
DRUM [Drum] (PART16)	Recording the drums performance with the KEYBOARD PERC group sounds (REALTIME)	<ul style="list-style-type: none"> • Sound (drum KIT) and volume settings
CONTROL [Control]	Recording changes in the panel button status (REALTIME)	<ul style="list-style-type: none"> • Rhythm setting and selection changes • RHYTHM VOLUME setting • DIGITAL REVERB on/off • PLAY STYLE (PIANO MODE, KEYBOARD SPLIT, AUTO PLAY CHORD) settings • ON BASS on/off • MUSIC STYLE ARRANGER status • FILL IN 1, 2, INTRO & ENDING 1, 2 on • PANEL MEMORY selection changes • TRANPOSE status • START/STOP on/off • TEMPO setting • CONDUCTOR status
AUTO PLAY CHORD [APC]	Recording chords for the AUTO PLAY CHORD (REALTIME)	<ul style="list-style-type: none"> • AUTO PLAY CHORD status • ON BASS on/off • FILL IN 1, 2, INTRO & ENDING 1, 2 on • START/STOP on/off
CHORD [Chord]	Recording the chord progression for the AUTO PLAY CHORD (STEP)	<ul style="list-style-type: none"> • Chord progression • FILL IN 1, 2, INTRO & ENDING 1, 2 on
RHYTHM [Rhythm]	Settings related to rhythm (STEP)	<ul style="list-style-type: none"> • Rhythm settings and selection changes • FILL IN 1, 2, INTRO & ENDING 1, 2 on • START/STOP on/off • TEMPO setting

- You can use the **TRACK ASSIGN** function to assign parts to tracks as you wish. (Refer to page 62.)
- For the sake of compatibility when playing disks for older **PR** models, the **RKB** and **LKB** playback parts are also supported. However, these parts cannot be recorded or edited.

■ Default part settings

1: RIGHT1	5: CONTROL	9: PART5	13: PART9
2: RIGHT2	6: RHYTHM	10: PART6	14: PART10
3: LEFT	7: DRUM	11: PART7	15: PART11
4: APC/CHORD	8: PART4	12: PART8	16: PART12

Realtime Record

With REALTIME RECORD, your performance is recorded with the timing exactly as you played it on the keyboard. And with the 16 tracks, you can even record your performance one track at a time (multi-track recording).

Recording procedure

1. Select a song number. (Refer to page 51.)
2. On the **SEQUENCER** menu display, select P1.
 - The display looks similar to the following.

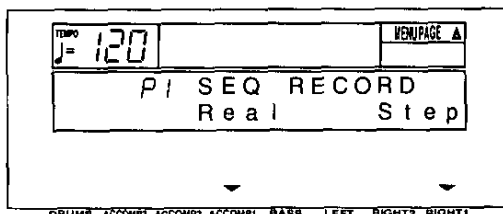

3. Press either **ACCOMP 1 (Real)** button.
 - The display looks similar to the following.

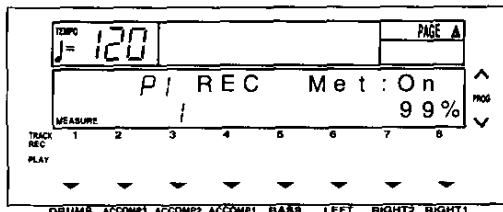

4. Use the buttons below the display to select the track numbers you are going to record.
 - In the REC row, turn on the horizontal bar for TRACK numbers you are going to record.
 - You can press the **OTHER PARTS/TRACKS** button to view the display for tracks 9 to 16.
 - While you are recording, you can play back tracks which are already recorded. In the PLAY row, turn on the horizontal bar for TRACK numbers you wish to have played back.
 - The part name for the selected recording track is shown on the display.
 - You can select two or more tracks to record at one time. For performance parts, use the **CONDUCTOR** buttons to turn on the parts for the selected tracks (you should be able to hear them).
 - When recording a track for the **AUTO PLAY CHORD (APC)** part, turn on the **AUTO PLAY CHORD** button. In this case, when recording begins, press the **START/STOP** button to begin the rhythm.
 - The track for the RHYTHM ([Rhythm]) part can be selected for recording only when STEP RECORD is active.

5. Set the sounds, effects and volume as desired.
 - The settings which are in effect at the time that recording begins are stored at the very beginning of the song.

6. Use the **TEMPO** buttons to adjust the recording tempo.
 - The tempo is shown on the display as a numerical value (J=).
 - If you wish to record the tempo setting and tempo changes, select the **CONTROL** part, or use **STEP RECORD: RHYTHM**. (Refer to page 61.)

7. Turn the metronome on or off (On/Off) as desired with the **TRANSPOSE (PROG)** ^ and v buttons.
 - The metronome sound is not recorded.

8. Play the keyboard.
 - Recording begins.
 - The current measure number is shown as "MEASURE" on the display.
 - You can also press the **START/STOP** button to start the rhythm and begin recording.
 - If the metronome is on, when you press the **START/STOP** button, a two-measure count plays, after which recording automatically begins. In this case, the rhythm does not start.
 - Recording does not start until the two-measure count is completed.
 - The remaining memory is shown on the display as "%".
 - If you wish to adjust the volume balance of each track, the metronome, etc., during recording, press the **BALANCE** button and adjust the volume on the **SEQ BALANCE** display. Press the **OTHER PARTS/TRACKS** button if you wish to view other tracks, etc.
 - If you wish to redo the recording or change the recording track, press the **EXIT** button. In this case, recording is terminated, so select the recording tracks again. You can change the panel settings at this time, if desired.

9. When you have finished recording, press the **MENU** button in the **SEQUENCER** section to turn it off.
 - When the **MENU** button is turned off, the ending command is recorded. Note that, as long as the ending command is not recorded, blank recording continues even if you stop playing.
 - The display changes to the SEQ PLAY display.

■ Multi-track recording

To record the next track immediately after the first track is completed, press the **EXIT** button. The track you just recorded changes to a "PLAY" track. Use the buttons below the display to specify "REC" for the next track you wish to record, and make the various settings (sound, etc.) for the track. Next, press the **START/STOP** button and record the track. The "PLAY" tracks are played back while you record. You can repeat these steps until your multi-track recording is complete.

- For multi-track recording, be sure to press the **START/STOP** button to begin recording.
- If after recording you wish to change the panel setting and store them as the beginning song data, follow the PANEL WRITE procedure. (Refer to page 65.)

CYCLE RECORD

This mode allows you to have specified recording measures continuously repeated. Thus you can record measures by adding notes during any cycle.

1. On the REC display, specify "REC" for the track number you are going to record, and "PLAY" for track numbers you wish to have played back.

2. Press the **PAGE** \wedge button.
 - The display looks similar to the following.

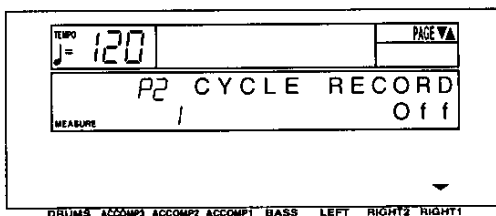

3. Press the **RIGHT 1** \wedge button to select "On".
 - The display looks similar to the following.

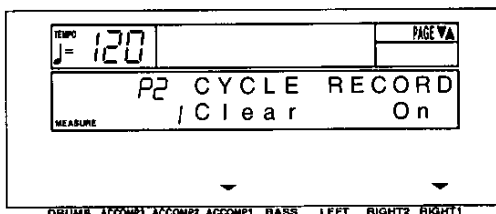

4. Press the **PAGE** \wedge button.
 - The display looks similar to the following.

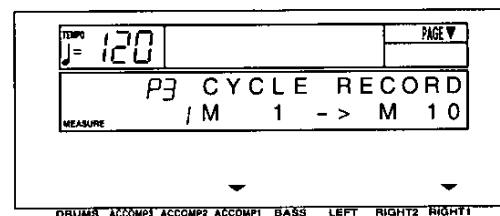

5. Use the **ACCOMP 1** \wedge and \vee buttons to specify the beginning measure number.
6. Use the **RIGHT 1** \wedge and \vee buttons to specify the ending measure number.
 - The ending measure you specify becomes the last measure of the cycle.

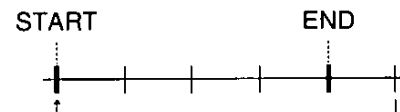

7. Press the **START/STOP** button.
 - Cycle recording of the specified measures begins. If the metronome is on, cycle recording begins after a two-measure count.
 - The rhythm does not start.

(continued on the next page)

8. Play the keyboard.
 - The specified measures are repeated, during which time you can record by adding notes little by little at the correct timing (over-dubbing).
 - If you wish to erase all the performance data from the specified measures, press either **ACCOMP 1** (Clear) button on the P2 display.
 - The maximum number of notes which can sound simultaneously for a track is 16.
9. When you have finished recording, turn off the **MENU** button in the **SEQUENCER** section.
 - The display changes to the SEQ PLAY display.

Sequencer Play

Play back your recorded performance.

1. Select a song number. (Refer to page 51.)
2. In the **SEQUENCER** section, press the **PLAY** button to turn it on.

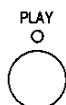

- The display looks similar to the following.

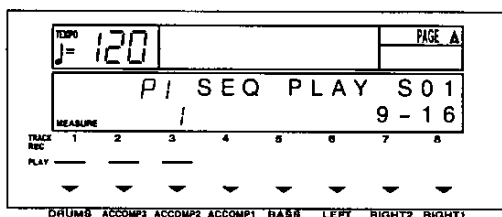

3. Use the buttons below the display to select the track numbers you wish to have played back.
 - In the **PLAY** row, turn on the horizontal bars for the **TRACK** numbers you wish to have played back.
 - You can press the **OTHER PARTS/TRACKS** button to view the display for tracks 9 to 16.
 - On the display for tracks 1–8, a “9–16” indication means that at least one track from tracks 9–16 is selected as a playback track.
 - You can select two or more tracks to play back at one time.
 - The current song number is shown on the display (S01 to S20).

- If necessary, use the **TEMPO** buttons to adjust the playback tempo.
- The tempo is shown on the display as “♩ =”.
- If the tempo was stored in the **CONTROL** or **RHYTHM** part, when that part is played back, the stored tempo data has priority.

4. Press the **SEQUENCER RESET (FILL IN 1)** button.
 - The **SEQUENCER** returns to the beginning of the song and the beginning panel settings are recalled.

5. To begin playback from a measure other than measure 1, use the **PAGE** \wedge button to select [P4 SEQ PLAY].
 - The display looks similar to the following.

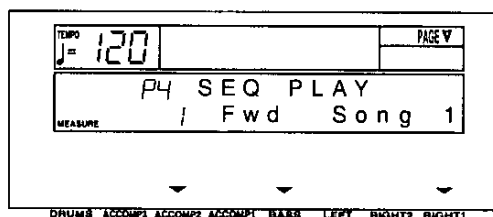

6. Use the **ACCOMP 2** \wedge and \vee buttons to select the beginning playback measure.
 - By pressing and holding either **BASS** (Fwd) button, you can fast-forward to the desired measure while listening to the sound. This button does not function during playback.
 - “MEASURE” indicates the current measure number.

7. Press the **START/STOP** button.
 - The recorded performance is played back from the specified measure.
 - When playback is begun from a measure in which an **INTRO**, **COUNT INTRO**, **FILL IN** or **ENDING** is recorded, the corresponding function does not work.
 - If you wish to adjust the volume balance of each track or each **AUTO PLAY CHORD** part, for example, press the **BALANCE** button and adjust the volume on the SEQ BALANCE display. Press the **OTHER PARTS/TRACKS** button if you wish to view other tracks and parts.
8. To stop playback, press the **START/STOP** button.
 - If the **START/STOP** button is pressed again, playback will continue from the point it was interrupted.
9. When you are finished playing back your performance, press the **PLAY** button in the **SEQUENCER** section to turn it off.
 - During STEP RECORD or EDIT operations, the MEASURE indication on the display conforms to the time signature data recorded in the RHYTHM part.
 - If you wish to play back a different song, use the **RIGHT 1** \wedge and \vee buttons on the P4 display to select a different song number.
 - Even if you press the **EXIT** button, for example, to exit the SEQ PLAY display, as long as the **PLAY** button is on, the song will be played back when the **START/STOP** button is pressed. In this case, even when the normal performance display is shown, the song may be played back without the rhythm start when the **START/STOP** button is pressed. Therefore, be sure to turn off the **PLAY** button if you do not wish to play back the record performance.

CYCLE PLAY

You can have specified measures played back repeatedly.

1. On the P1 SEQ PLAY display, specify "PLAY" for track numbers you wish to have played back.
2. Press the **PAGE** \wedge button.
 - The display looks similar to the following.

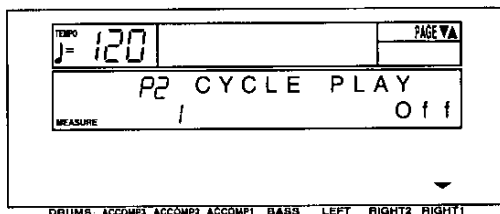

3. Press the **RIGHT 1** \wedge button to select On.
4. Press the **PAGE** \wedge button.
 - The display looks similar to the following.

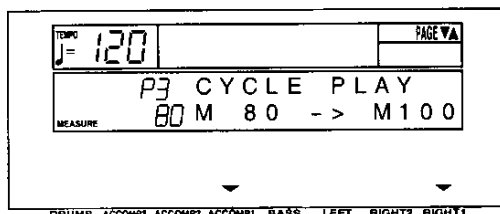

5. Use the **ACCOMP 1** \wedge and \vee buttons to specify the beginning measure number.
6. Use the **RIGHT 1** \wedge and \vee buttons to specify the ending measure number.
 - The ending measure you specify becomes the last measure of the cycle.

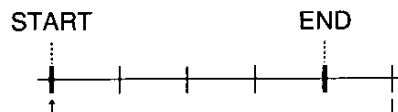

7. Press the **START/STOP** button.
 - Cycle playback of the specified measures begins.
8. To stop cycle playback, press the **START/STOP** button again.
 - During playback stop, if the **SEQUENCER RESET (FILL IN 1)** button is pressed, the **SEQUENCER** returns to the measure number specified in step 5. If the **SEQUENCER RESET** button is pressed again, the **SEQUENCER** returns to measure 1.

Step Record

Store a chord progression

Store the chord progression for the **AUTO PLAY CHORD** in the track for the **CHORD** part. Then, when the **AUTO PLAY CHORD** is used during playback, even if you do not specify the chords with your left hand, the chords change automatically.

- The chord length is specified with the **STEP RECORD** keys on the keyboard.

Practical applications

Correction keys

- ◀ Move back one step.
- ▶ Move forward one step.

Repeat key

- ↺ Press to end the chord-storing procedure and to specify automatic repeat playback of the stored progression.

End key

- ⏏ Press after the whole chord progression has been stored.

DELETE key

DELETE Press to erase data.

- To erase all the data from the current track, while pressing the **DELETE** key, press the End key (⏏).

Note value keys

- Whole note
- ◡ Dotted half-note
- ◡ Half-note
- ◡ Dotted quarter-note
- ◡ Quarter-note
- ◡ Eighth-note

Reset key

1/4 Press to begin storing from the beginning.

Example of storing a chord progression

Measure 1	2	3	4
C	C	F G7	C Am
○	○	◡ ◡	◡ ◡

- Select the song number. (Refer to page 51.)
- On the **SEQUENCER** menu display, select P1.
 - The display changes to the following.

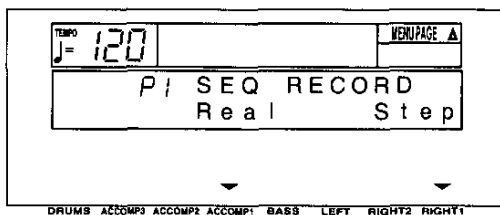

- Press either **RIGHT 1** (Step) button.
 - The display changes to the following.

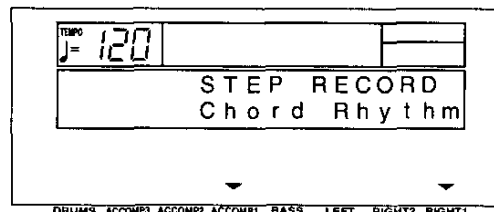

4. Press either **ACCOMP 1** (Chord) button.
 • The display changes to the following.

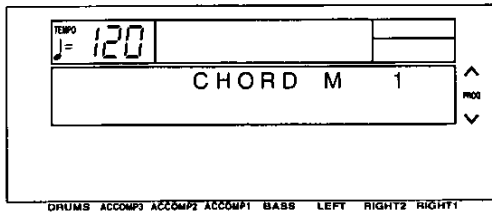

5. Store the chords.

<Measure 1, measure 2>

While playing a C chord with your left hand, press the \circ key one time with your right hand.



- A “beep” tone indicates that the chord has been successfully stored.
- The chord name is shown on the display.
- The measure automatically advances, in accordance with the specified note value.

<Measure 3>

- (1) While playing an F chord, press the \circ key one time.



- (2) While playing a G7 chord, press the \circ key one time.

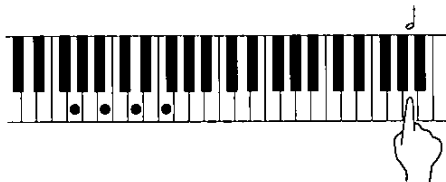

<Measure 4>

- (1) While playing a C chord, press the \circ key one time.

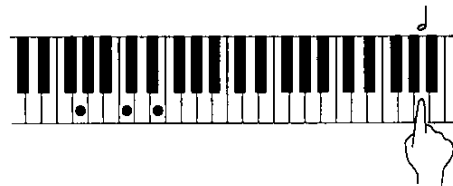

- (2) While playing an Am chord, press the \circ key one time.

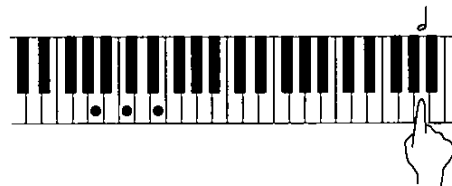

- You can press an **INTRO & ENDING** button or a **FILL IN** button on the panel to store the desired pattern at the current position. (An **INTRO** or **COUNT INTRO** can be stored only at the beginning.)

6. At the end of the chord progression, press the End key (\rightarrow).

- This instrument exits the recording mode.
- During playback, playback of the recorded chord progression stops at this point. For automatic repeat playback of the chord progression, press the Repeat key (\leftrightarrow) instead of the End key (\rightarrow).

- When you play back the track for the Chord part, the chords of the automatic accompaniment change in accordance with the stored chord progression.
- Chords can also be specified in the one-finger mode.
- If the ON BASS is on, chords such as “C on G” can also be specified. However, the ON BASS indication (on) is not shown on the display during recording.

▣ Correct the recorded chord progression

1. Follow the procedure to select the STEP RECORD: CHORD display.
2. Use the **TRANSPOSE** (PROG) \wedge and \vee buttons to go to the measure you wish to modify. Use the \blacktriangleleft and \blacktriangleright Correction keys to move the point you wish to edit.

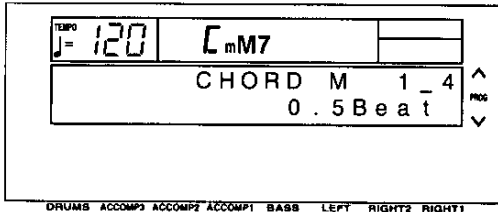

- The measure number is indicated in the upper row. (Example: [1_4] indicates the fourth beat of the first measure.)
- In the lower row, the note length of the specified note is indicated in Beat units.
- To go to the end of the chord progression, while pressing the Reset key (H), press the \blacktriangleleft key.

3. Correct the chord data.

Chord data

When the chord name is displayed, you can press the **DELETE** key to erase the data and then store a new chord.

- If you do not erase the displayed data before entering new chord data, the new data is inserted at this point, and the displayed data is merely shifted by the note value of the new chord.

Control data

The name of the stored function (INTRO, FILL, etc.) is displayed. You can press the **DELETE** key to erase the data which is displayed.

▣ TRACK CLEAR

To erase all data from the current track, hold down the **DELETE** key and press the End (H) key.

Store a rhythm progression

Changes in the rhythm selection and tempo, as well as the intro, fill-ins and the ending, can be stored by measures with the step recording method.

1. Select the song number. (Refer to page 51.)
2. On the **SEQUENCER** menu display, select P1.
 - The display looks similar to the following.

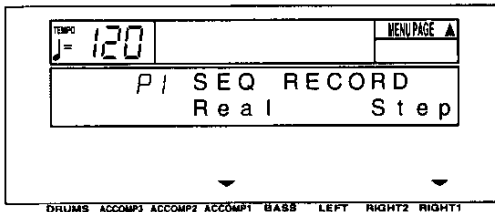

3. Press either **RIGHT 1** (Step) button.
 - The display changes to the following.

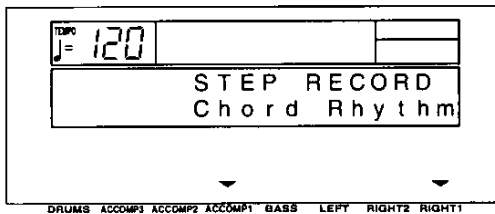

4. Press either **RIGHT 1** (Rhythm) button.
 - The display changes to the following.

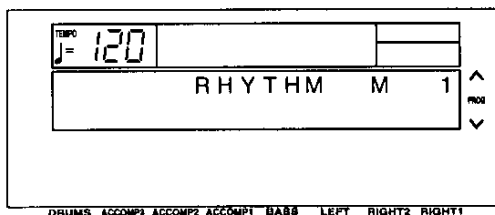

5. Use the **TRANPOSE** (PROG) ^ and v buttons to go to the measure you wish to record.
6. Store the rhythm data.
 - Data which can be stored:
 - START/STOP**
Changes in the rhythm selection
Changes in the **VARIATION** selection
 - COUNT INTRO, INTRO, FILL IN, ENDING**
Tempo changes
 - Be sure to store the **START/STOP** data in the measure in which the rhythm starts or stops.
 - If you are storing a **COUNT INTRO** or **INTRO**, store this data before the **START/STOP** data.
7. Repeat steps 5 and 6 to continue storing the rhythm progression.

8. At the end of the rhythm progression, press the End key.

- If the Repeat key is pressed instead of the End key, during playback the recorded rhythm progression is repeated.
- This instrument exits the recording mode.

■ Correct the recorded rhythm progression

1. Follow the procedure to select the **STEP RECORD: RHYTHM** display.
2. Use the **TRANPOSE** (PROG) ^ and v buttons or the ◀ and ▶ Correction keys to move the point you wish to edit.

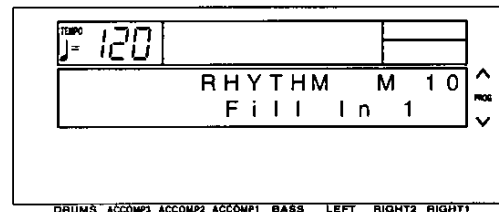

3. Correct the rhythm data.

- Press the **DELETE** key to erase data.
- If you select a rhythm with a different time signature, the time signature of all subsequent measures will also change.
- If data has already been recorded in other tracks, you cannot select a rhythm with a different time signature.

■ TRACK CLEAR

To erase all data from the current track, while the RHYTHM display is shown, hold down the **DELETE** key and press the End (—H) key.

Track Assign

Each **SEQUENCER** part is already assigned to a track number. However, you can use the **TRACK ASSIGN** function to assign parts to tracks as you wish. This function is also used to designate the tracks used for the rhythm data and chord progression data.

1. Select the song number. (Refer to page 51.)
2. On the **SEQUENCER** menu display, select P2.
 - The display looks similar to the following.

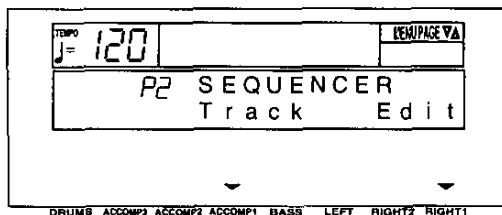

3. Press either **ACCOMP 1** (Track) button.
 - The display changes to the following.

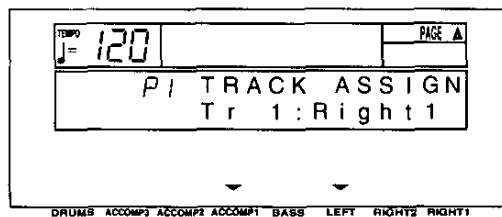

4. Use the **ACCOMP 1** ^ and v buttons to select the track.

5. Use the **LEFT** ^ and v buttons to select the part for the specified track.
 - Select one of the following parts: [Right1], [Right2], [Left], [Part4] to [Part15], [Drum], [APC], [Chord], [Control], [Rhythm]. (For an explanation of each **SEQUENCER** part, refer to page 53.)
 - For the sake of compatibility when playing disks for older **PR** models, the **RKB** and **LKB** playback parts are also supported. These parts can be changed, but the user cannot select them. In addition, when either or both the **RKB** and **LKB** parts are active, the [Right 1], [Right 2], [Left] and [APC] parts cannot be selected.
 - When a part other than the [Control], [APC/Chord] or [Rhythm] part is assigned, the track assign procedure is completed at this point.
 - The [Rhythm], [Control] and [APC/Chord] parts cannot be assigned to more than one track.

6. When assigning the [Control], [APC/Chord] or [Rhythm] part, press either **RIGHT 1** button.
 - The **ARE YOU SURE?** display appears. Press either **LEFT** (Yes) button to execute the function. Or press either **RIGHT 1** (No) button if you wish to cancel the procedure.

▣ TRACK ASSIGN PRESETS

A preset track assignment can be selected.

1. While the P1 **TRACK ASSIGN** display is shown, press the **PAGE** ^ button.
 - The display looks similar to the following.

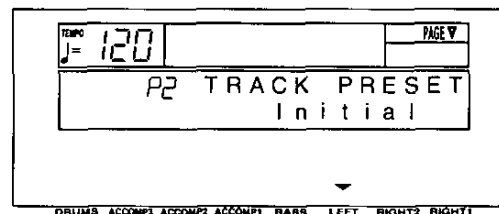

2. Use the **LEFT** ^ and v buttons to select the track assign mode.
 - Select from the following modes.

Initial: Factory-preset settings.

Tech Multi: The optimum track assignment for a 16-part multi-timbre sound generator.

GM Multi: The optimum track assignment for creating **GENERAL MIDI** data.

3. Press the **EXECUTE** button.
 - The **ARE YOU SURE?** display appears. Press either **LEFT** (Yes) button to execute the function. Or press either **RIGHT 1** (No) button if you wish to cancel the procedure.
 - If [Yes] was selected, "COMPLETED!" is shown on the display and the selected track assign mode is enabled.
 - After the **TRACK PRESET** is executed, you can use the **ACCOMP 1** ^ and v buttons to check the track assignment.

Editing the recorded performance

The edit feature allows you to erase or change portions of your performance after it has been recorded.

Select the edit function

1. Select the number of the song you wish to edit. (Refer to page 51.)
2. On the **SEQUENCER** menu display, select P2.
 - The display changes to the following.

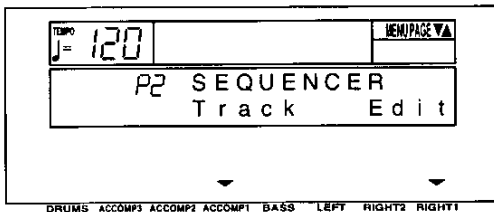

3. Press either **RIGHT 1** (Edit) button.
 - The display changes to the following SEQ EDIT menu display.

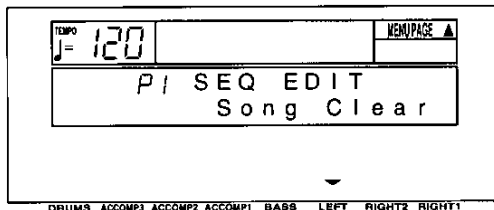

- P1: [Song Clear]
- P2: [Track Clear]
- P3: [Quantize]
- P4: [Song Copy]
- P5: [Panel Write]

5. Press either **LEFT** button.
 - The display changes in accordance with your selection.
6. Perform the editing procedures.
 - During the editing procedure, you can press the **EXIT** button to go back to the SEQ EDIT menu display.

SONG CLEAR

Erase the recorded contents of a specified song.

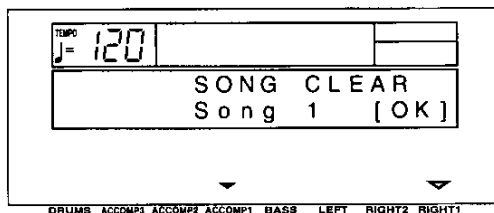

1. Use the **ACCOMP 1** ^ and v buttons to specify the number of the song to erase.
 - If [All] is selected, all the songs recorded in the **SEQUENCER** will be erased.
2. Press either **RIGHT 1** (OK) button.
 - The ARE YOU SURE? display appears. Press either **LEFT** (Yes) button to execute the function. Or press either **RIGHT 1** (No) button if you wish to cancel the procedure.
 - If [Yes] was selected, "COMPLETED!" appears on the display, the specified songs are erased, and the instrument returns to the normal performance mode.

TRACK CLEAR

Erase the contents of a specific track.

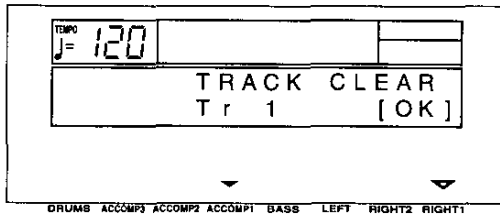

1. Use the **ACCOMP 1** \wedge and \vee buttons to select the track you wish to clear.
 - If [All] is selected, the data is erased from all the tracks.

2. Press either **RIGHT 1 (OK)** button.
 - The ARE YOU SURE? display appears. Press either **LEFT (Yes)** button to execute the function. Or press either **RIGHT 1 (No)** button if you wish to cancel the procedure.
 - If [Yes] was selected, "COMPLETED!" appears on the display, and the specified tracks are erased.
3. To erase more than one track, repeat steps 1 and 2.

QUANTIZE

The QUANTIZE function can correct the timing of your performance after it has been recorded. If the rhythm is slightly out of sync or inexact, it will automatically be corrected to the specified quantize level.

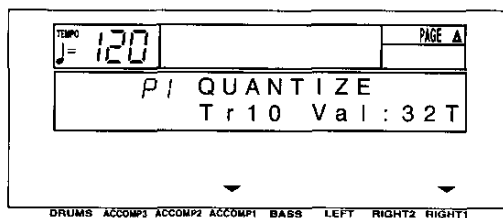

Rhythm as written in the score



Timing of actual performance



Quantized performance

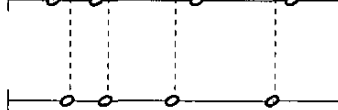

1. Use the **ACCOMP 1** \wedge and \vee buttons to specify the track number.
 - You cannot quantize the track for the [Control], [Rhythm] or [APC/Chord] part.
 - If [All] is selected, all the tracks are quantized.

2. Use the **RIGHT 1** \wedge and \vee buttons to specify the quantize level.
 - This setting specifies the timing (minimum note value) on which the quantizing will be based.
 - Select from 4, 8, 16, 32, 8T, 16T, 32T. (Example: 16=sixteenth note; T=triplet-type note.)
3. Press the **PAGE** \wedge button.
 - The display changes to the following.

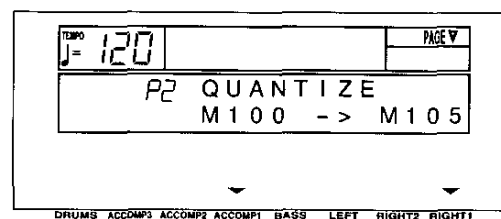

4. Use the **ACCOMP 1** \wedge and \vee buttons to specify the start point (measure number).
5. Use the **RIGHT 1** \wedge and \vee buttons to specify the end point (measure number).
6. Press the **EXECUTE** button.
 - The ARE YOU SURE? display appears. Press either **LEFT (Yes)** button to execute the function. Or press either **RIGHT 1 (No)** button if you wish to cancel the procedure.

SONG COPY

Copy the recorded data from specific tracks of a song.

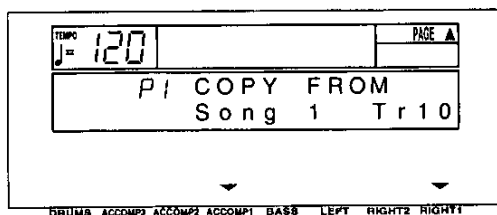

1. Use the **ACCOMP 1** \wedge and \vee buttons to specify the song number to copy from.
2. Use the **RIGHT 1** \wedge and \vee buttons to specify the number of the track to copy from.
 - If [All] is selected, all the tracks of the specified song number will be copied.

3. Press the **PAGE** \wedge button.
 - The display changes to the following.

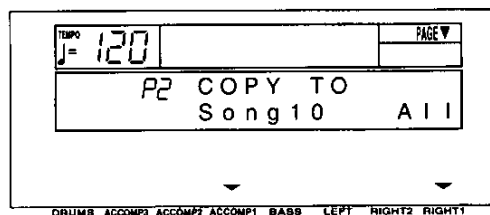

4. Use the **ACCOMP 1** \wedge and \vee buttons to specify the song number to copy to.
5. Use the **RIGHT 1** \wedge and \vee buttons to specify the number of the track to copy to.
 - If [All] is selected, the data will be copied to all the tracks of the specified song number.
6. Press the **EXECUTE** button.
 - The ARE YOU SURE? display appears. Press either **LEFT** (Yes) button to execute the function. Or press either **RIGHT 1** (No) button if you wish to cancel the procedure.

PANEL WRITE

You can change the panel status which is in effect at the beginning of the song. These are the settings which are recalled when the **SEQUENCER RESET** button is pressed.

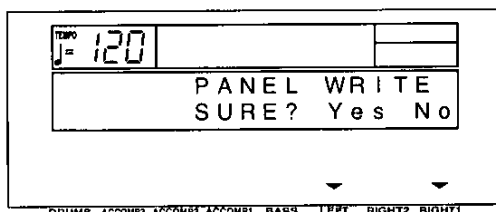

1. Use the panel buttons to change to the desired panel settings.
2. Press either **LEFT** (Yes) button.
 - To cancel the procedure, press either **RIGHT 1** (No) button.
 - If the [Yes] button is pressed, "COMPLETED!" is shown on the display.
 - **PANEL WRITE** is automatically activated at the beginning of the **REALTIME RECORD**, or when a panel setting is changed during recording standby.

Sequencer Medley

You can have the songs played back continuously in order. Songs saved on a disk can also be played back in a medley.

1. On the **SEQUENCER** menu display, select **P3 SEQ PLAY**.
 - The display looks similar to the following.

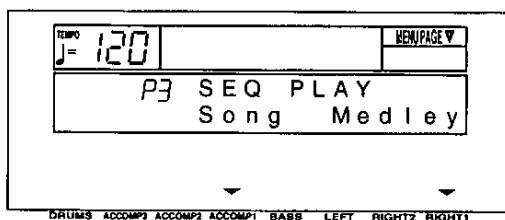

2. Press either **RIGHT 1** (Medley) button.
 - The display looks similar to the following.

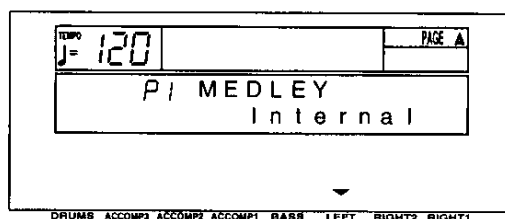

3. Use the **LEFT** ^ and v buttons to specify which songs you wish to have played.

Internal: Play back song data from this instrument's **SEQUENCER** memories.

FD Technics: Play back Technics format song data saved on the floppy disk in the disk drive.

Other FD: Play back Standard MIDI File (SMF) (Format 0), DISK ORCHESTRA COLLECTION™ (DOC) and PianoDisc™ (PDS) song data saved on the floppy disk in the disk drive.

- Note that if [FD Technics] is selected and medley play is executed, all song data (SONG 1-10) currently stored in the **SEQUENCER** memory is destroyed.

4. Press the **PAGE** ^ button.
 - The display looks similar to the following.

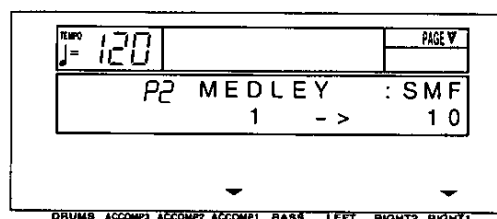

- For [Other FD], the disk type is indicated in the upper right part of the display (SMF/DOC/PDS).

5. Use the **ACCOMP 1** ^ and v buttons to specify the first song you wish to have played.

6. Use the **RIGHT 1** ^ and v buttons to specify the last song.

7. Press the **START/STOP** button.

- The songs are played back in the specified order.
- The display looks similar to the following.

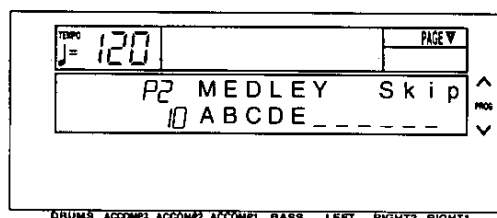

- You can use the **TRANPOSE** (PROG) ^ and v buttons to skip to the next song.

8. To stop medley play, press the **START/STOP** button.

- Features and operation of the Disk Drive are explained in "Part V Disk Drive" (page 76).

Part IV Composer

Outline of the Composer

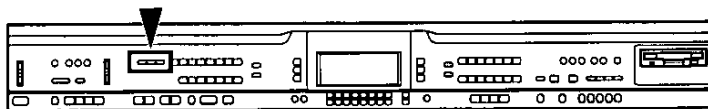

The **COMPOSER** enables you to create your own accompaniment patterns or to edit preset accompaniment patterns. A pattern is comprised of five parts: **DRUMS**, **BASS** and three **ACCOMP** parts. These parts would form the backing of a song, for example: Drums, Acoustic Bass, Piano, Jazz Guitar and Vibes. You may find it useful at first to copy and edit a preset pattern.

Rhythm components which can be stored

You can store up to 12 different rhythms (4 in each memory bank **A**, **B**, **C**).

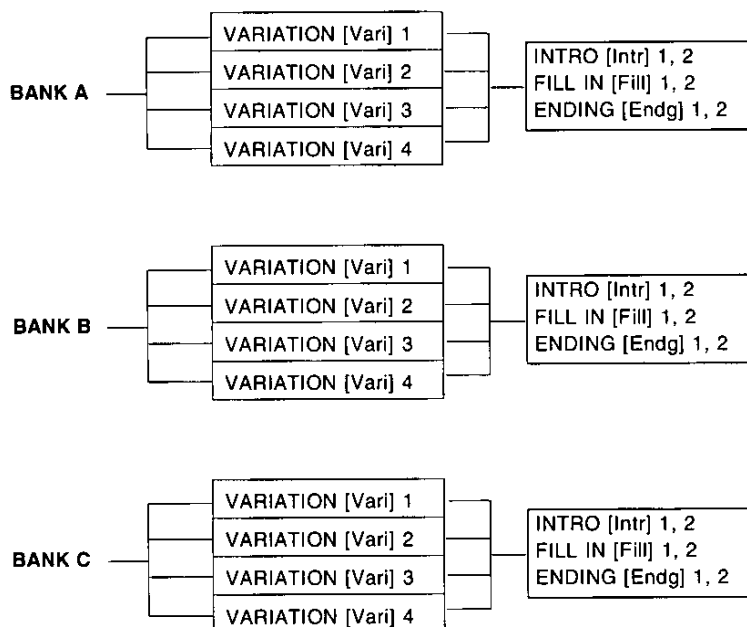

- You can also create **INTRO**, **FILL IN** and **ENDING** patterns for each bank (**A**, **B**, **C**). These patterns are played back when the **COMPOSER MODE** is set to [Expand]. (Refer to page 73.)

Memory capacity

Expressed in terms of notes, the total number of notes which can be stored in all the **COMPOSER** memories is about 10,000. The remaining memory available for recording is shown on the **RECORD** display as a percentage (**MEMORY= %**).

- When "MEMORY FULL!" appears on the display no more data can be stored in the **COMPOSER**.

- The recorded **COMPOSER** data can be saved to a disk and later quickly recalled (**COMPOSER LOAD**). (Refer to page 79.)

COMPOSER RECORD menu

When you press the **RECORD** button in the **COMPOSER** section to turn it on, the display changes to the following.

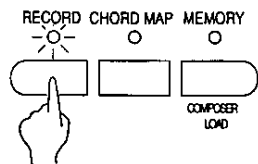

- Use the **PAGE** buttons to view the three pages of menu display.

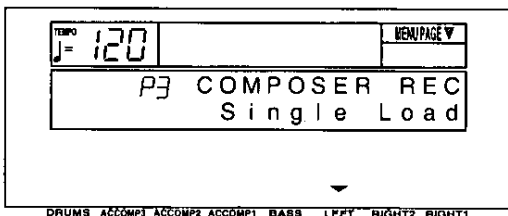
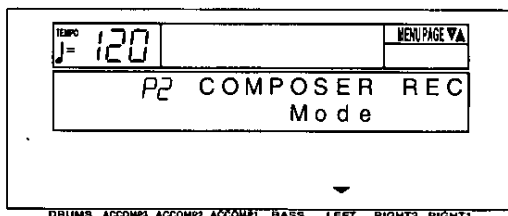
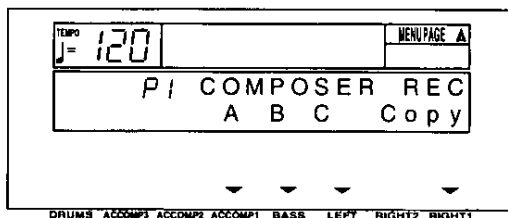

Summary of the COMPOSER menu items

[P1 COMPOSER REC]

A/B/C (pages 69 and 70)

Create a pattern in each of the A, B, C banks.

Copy (page 69)

Copy a preset rhythm pattern into a memory.

[P2 COMPOSER REC]

Mode (page 73)

Specify whether or not you are playing back your own **INTRO**, **FILL IN** and **ENDING** patterns.

[P3 COMPOSER REC]

Single Load

Recall the desired **COMPOSER** data from data saved on a disk. The items on this menu are also on the **MEMORY & CONTROL** menu, and the procedures are the same (page 80).

Two ways to record in the COMPOSER

There are two ways to create and record a rhythm.

■ Edit a preset rhythm (pages 69 and 72)

Use the copy function to copy a preset rhythm to a memory, change parts of it, and then store it as a new rhythm.

■ Create a completely new rhythm (pages 70 and 72)

Clear the memories and compose a completely new rhythm from scratch.

Edit a preset rhythm pattern: preparation

These are step-by-step instructions for preparing to create a new rhythm pattern by modifying a part of a preset rhythm pattern. First you copy one of the preset rhythm patterns to a location in the specified memory bank.

1. On the **COMPOSER RECORD** menu display, select P1.
 - The display looks similar to the following.

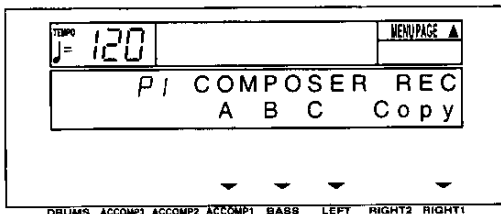

2. Press either **RIGHT 1** (Copy) button.
 - The display looks similar to the following.

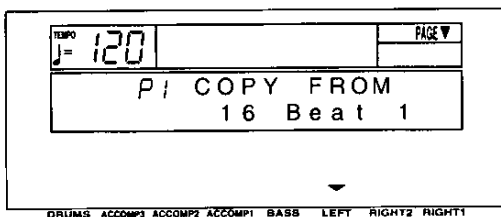

3. Use the **RHYTHM GROUP** and **RHYTHM SELECT** buttons to select a rhythm to copy.
 - You can use the **LEFT** ^ and v buttons to switch to another rhythm within the group.
4. Press the **PAGE** ^ button.
 - The display looks similar to the following.

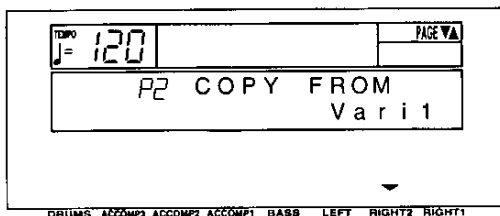

5. Use the **RIGHT 2** ^ and v buttons to select the name of the section to copy from.
 - Select from Vari (VARIATION) 1-4, Intr (INTRO) 1, 2, Endg (ENDING) 1, 2, V (VARIATION) 1FI (FILL IN) 1, 2, V2FI 1, 2, V3FI 1, 2, V4FI 1, 2.

6. Press the **PAGE** ^ button.
 - The display looks similar to the following.

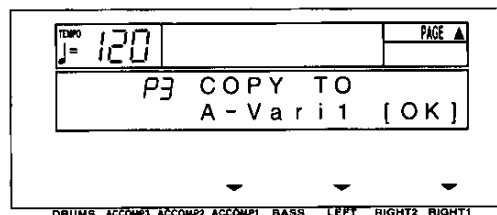

7. Use the **ACCOMP 1** ^ and v buttons to select a memory bank to copy to (A, B, C).
8. Use the **LEFT** ^ and v buttons to select the section name to copy to.
 - Select from Vari 1-4, Intr 1, 2, Fill 1, 2, Endg 1, 2.
9. Press either **RIGHT 1** (OK) button.
 - When copying has been successfully completed, "COPY COMPLETED!" appears on the display.
10. Press the **EXIT** button to view the P1 display.
11. Select the bank to which you copied the rhythm pattern (the memory bank you selected in step 7: A, B or C).
 - The display looks similar to the following.
12. Use the **BASS** ^ and v buttons to select the section name to which you copied the section (the section name you selected in step 8).

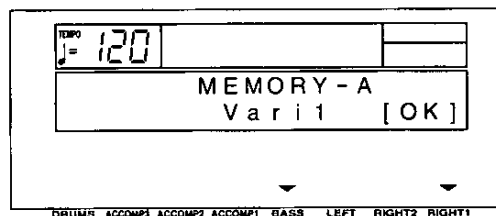

(continued on the next page)

13. Press either **RIGHT 1** (OK) button.
- The display looks similar to the following.

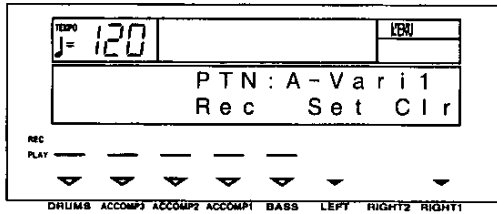

14. If you wish to name your new rhythm pattern (except for FILL IN, INTRO and ENDING), press either **LEFT** (Set) button.
- If you do not input a name for your rhythm pattern, the name becomes the same as the original rhythm from which you copied. Skip to step 18.
 - The display looks similar to the following.

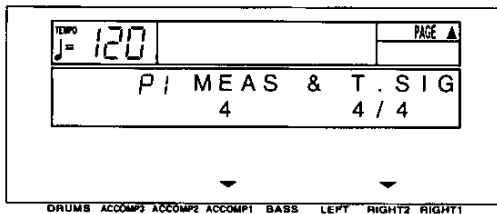

15. Press the **PAGE** ^ button to view the P2 PATTERN NAME display.
- The display looks similar to the following.

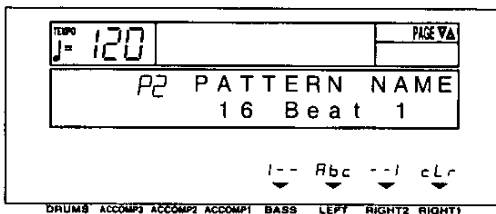

16. Type a new name for your rhythm pattern (up to 12 characters).
- Use the **BASS** or the **RIGHT 2** buttons to highlight the character position. Use the **LEFT** (Abc) ^ and v buttons to select the alphanumeric character. Repeat these steps to type the whole name.
 - To erase all the characters, press either **RIGHT 1** (cLr) button.

17. Press the **EXIT** button to return to the following display.

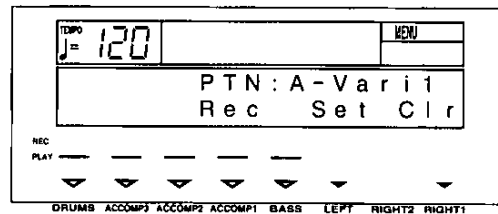

18. Press a [Rec] button to select the rhythm part you want to record first.

BASS
ACCOMP 1
ACCOMP 2
ACCOMP 3
DRUMS

- The pattern you copied and the metronome sound start, and recording begins. (Refer to page 72.)

Create a completely new rhythm: preparation

Here are the preparatory steps to compose a completely new rhythm from scratch.

1. On the **COMPOSER RECORD** menu display, select P1.
- The display looks similar to the following.

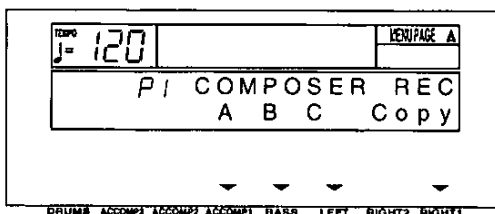

2. Select a bank in which to record the rhythm (A, B or C).
- The display looks similar to the following.

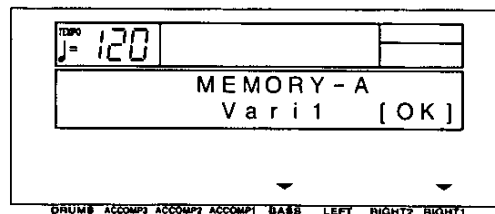

3. Use the **BASS** ^ and v buttons to specify the section you are going to create.
 - Select from Vari 1-4, Intr 1, 2, Fill 1, 2, Endg 1, 2.

4. Press either **RIGHT 1** (OK) button.
 - The display looks similar to the following.

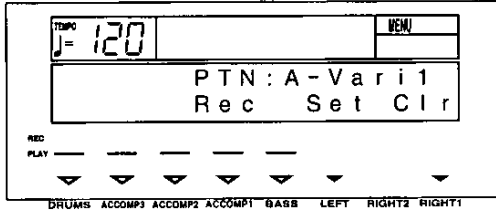

5. Press either **RIGHT 1** (Clr) button.
 - The following confirmation display appears. Press either **LEFT** (Yes) button to execute the function, or press either **RIGHT 1** (No) button to cancel the function.

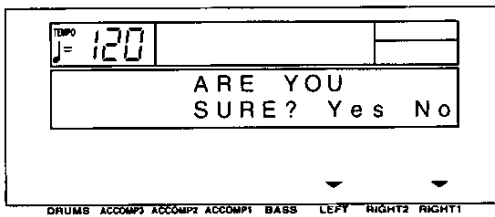

- If [Yes] was selected, "COMPLETED!" appears on the display, and the contents of all parts are cleared.

6. Press either **LEFT** (Set) button.
 - The display looks similar to the following.

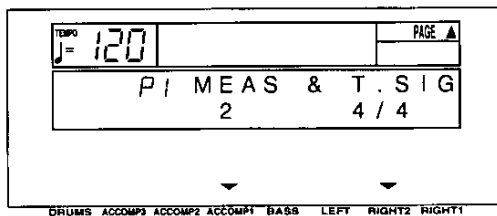

7. Use the **ACCOMP 1** ^ and v buttons to specify the number of measures in your repeating rhythm pattern (1 to 8).

8. Use the **RIGHT 2** ^ and v buttons to specify the time signature (1/4 to 8/4).
 - The settings for the number of measures and the time signature can be changed only if all the parts of the pattern were cleared in step 5.

9. Press the **PAGE** ^ button to view the P2 PATTERN NAME display (except for FILL IN, INTRO and ENDING).
 - The display looks similar to the following.

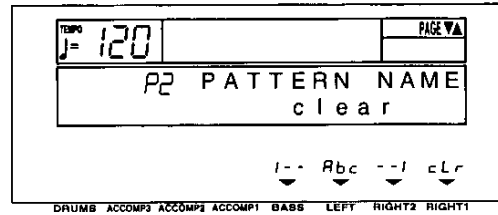

10. Type a name for your rhythm pattern (up to 12 characters).

- Use the **BASS** or **RIGHT 2** ^ and v buttons to highlight the character position. Use the **LEFT** (Abc) ^ and v buttons to select the alphanumeric character. Repeat these steps to type the whole name.
- To erase all the characters, press either **RIGHT 1** (cLr) button.

11. If you wish to record a performance in a key other than C major, or if you wish to specify the type of chord progression, press the **PAGE** ^ button to view the P3 CHORD SET 1 display.

- The display looks similar to the following.

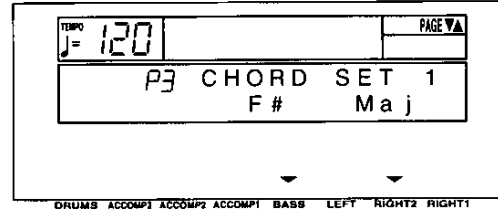

- If you do not wish to change these settings, skip to step 17.

12. Use the **BASS** ^ and v buttons to specify the root note of the chords you wish to record. Use the **RIGHT 2** ^ and v buttons to specify the type of chord you wish to record (Min or Maj).

13. Press the **PAGE** ^ button to view the P4 CHORD SET 2 display.

- The display looks similar to the following.

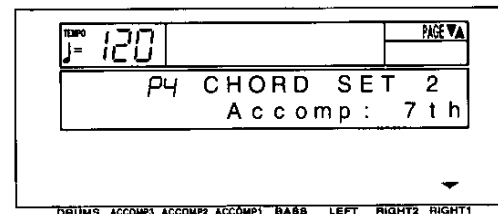

Practical applications

(continued on the next page)

14. Use the **RIGHT 1** \wedge and \vee buttons to specify the type of phrase progression for the **ACCOMP** parts (Normal [Nrm], or 7th).
15. Press the **PAGE** \wedge button to view the P5 CHORD SET 3 display.
 - The display looks similar to the following.

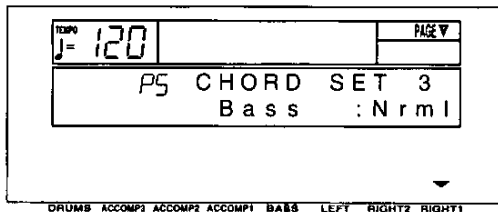

16. Use the **RIGHT 1** \wedge and \vee buttons to specify the type of phrase progression for the **BASS** part (Normal [Nrm], or 7th).

17. Press the **EXIT** button to return to the following display.

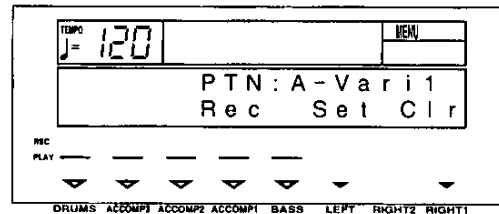

18. Press a [Rec] button to select the rhythm part you want to record first.
 - BASS**
 - ACCOMP 1**
 - ACCOMP 2**
 - ACCOMP 3**
 - DRUMS**
 - The metronome sound starts and recording begins.

Record your rhythm pattern

Store each part of the rhythm pattern as you perform it on the keyboard.

Recording procedure

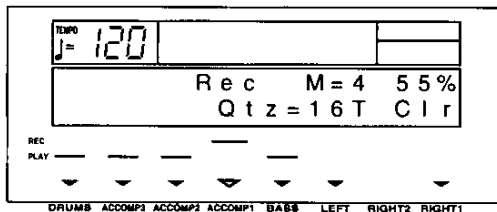

1. Adjust the tempo.
 - The tempo can be freely adjusted when you play back the rhythm pattern, so record at the tempo which is easiest for you to play.
2. Select the sound.
 - For the **DRUMS** part, select sounds from the **KEYBOARD PERC** sounds.
 - For the **ACCOMP 1 to 3** and the **BASS** parts, select sounds from groups other than the **KEYBOARD PERC** sounds. You can also set the **DIGITAL EFFECT** to on or off.
 - Depending on the selected sound, the sound quality may differ from that during a normal performance.

3. Record the part.

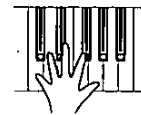

- The specified number of measures are repeatedly played back, during which time any newly played notes are added to those already recorded. The current measure number is shown on the display as "M=".
 - Record the performance in C major for correct chord progressions during playback. To record the performance in a different scale, refer to page 71.
 - The **SUSTAIN PEDAL** on/off are also recorded (except for the **DRUMS** part).
4. When you have finished recording one part, use the [Rec] buttons below the display to select the next part to record.
 - The ∇ mark for the selected part only flashes.
 5. Repeat steps 1 through 4 to record all the parts of the rhythm.
 6. When you have finished recording the rhythm, press the **RECORD** button in the **COMPOSER** section to turn it off.

■ Functions during recording

Clr

Press either **RIGHT 1** (Clr) button if you wish to erase all recorded contents of the currently selected part.

INST ERASE

When the **DRUMS** part is selected, the **DRUMS** part can be cleared instrument by instrument. Hold down the **INST ERASE (SPLIT POINT)** button and specify the instrument sound to be deleted by pressing the corresponding instrument key on the keyboard, after which only the specified instrument will be erased for as long as this button is kept pressed.

Qtz (QUANTIZE)

Set the desired quantize level to smooth out any unevenness in the timing of your performance. Use the **LEFT** \wedge and \vee buttons to specify the timing (minimum note value) on which the quantizing will be based.

- Select from 32T, 32, 16T, OFF, 16, 8T, 8, 4. (Example: 16=sixteenth note; T=triplet-type note.)

Playback

1. In the **COMPOSER** section, press the **MEMORY** button to turn it on.

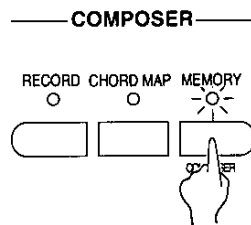

2. Use the **RHYTHM SELECT** buttons to select the desired playback rhythm on the display.

- During setting, the bank name and rhythm name are shown on the display.
- You can also use **VARIATION & MSA** buttons to select the variation.

3. Press the **START/STOP** button.

- The **DRUMS** part begins to play back.
- The **BASS** and **ACCOMP** parts are played back when you use the **AUTO PLAY CHORD**.

Composer mode

Two playback modes are available for you to choose from. If you wish to use the intro, fill-in and ending patterns from a preset rhythm when you play back your new rhythm pattern, select **NORMAL MODE**. For creating and playing back your original intro, fill-in and ending patterns, select **EXPAND MODE**.

1. On the **COMPOSER RECORD** menu display, select P2.
- The display changes to the following.

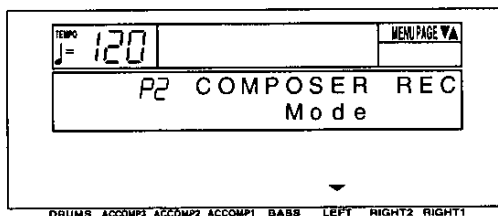

2. Press either **LEFT** button.
- The display looks similar to the following.

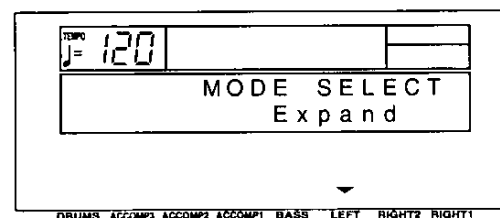

3. Use the **LEFT** \wedge and \vee buttons to select the mode.

Normal

When a **FILL IN** button or the **INTRO & ENDING** button is pressed during playback, the corresponding pattern for a preset rhythm is played back.

Expand

When a **FILL IN** button or an **INTRO & ENDING** button is pressed during playback, the corresponding pattern you created is played back.

- Only one each **FILL IN 1**, **FILL IN 2**, **INTRO 1**, **INTRO 2**, **ENDING 1** and **ENDING 2** pattern can be created for each of the three banks (A, B or C). The fill-in patterns, etc. for each bank are used for all the basic rhythms in the same bank.
- Each pattern of a bank should have the same time signature.

<BANK A>

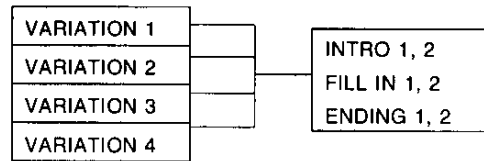

<BANK B>

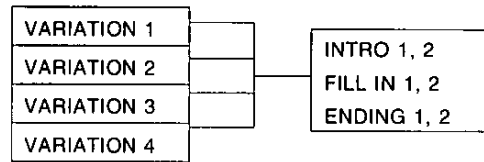

<BANK C>

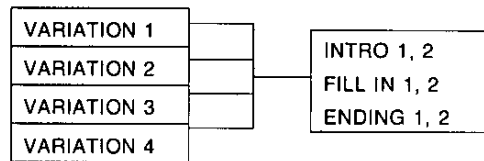

Composer Chord Map

A different accompaniment pattern can be selected for each of the four types of chords (major, minor, seventh and diminished). Then the accompaniment combination can be stored in one of five different maps.

- Store beforehand in a **COMPOSER** memory (Vari 1–4) each accompaniment pattern you are going to perform when a type of chord is selected. When recording a pattern, for the minor type for example, record it in a minor key.

1. Press and hold the **CHORD MAP** button in the **COMPOSER** section for a few seconds.

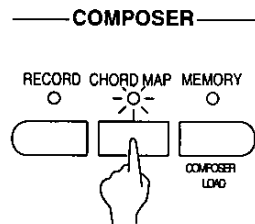

- The display looks similar to the following.

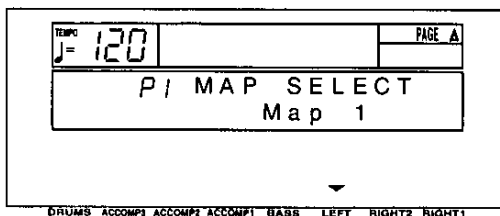

2. Use the **LEFT** ^ and v buttons to select a map number (Map 1 to 5).

3. Press the **PAGE** ^ button.

- The display looks similar to the following.

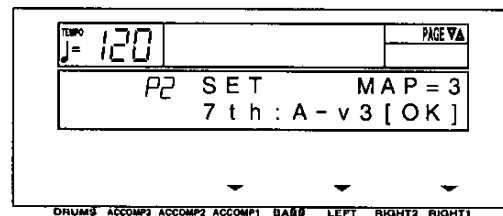

4. Use the **ACCOMP 1** buttons to select a chord type.

- Select from [Maj] (major), [Min] (minor), [7th], and [Dim] (diminished).

5. Use the **LEFT** \wedge and \vee buttons to select a pattern for the chord type (bank name–variation number).
 - The accompaniment pattern for the **INTRO**, **FILL IN** and **ENDING** is the one selected for [Maj].
 - The accompaniment pattern for chords which are set to [Off] is the same as the pattern for [Maj] chords.
6. Repeat steps 4 and 5 for each chord type, as desired.
 - Only patterns with the same number of measures and same time signature can be selected.
7. When all the settings are completed, press either **RIGHT 1** (OK) button.
 - “COMPLETED!” appears on the display, and the settings are executed.

8. Press the **PAGE** \wedge button.
 - The display looks similar to the following.

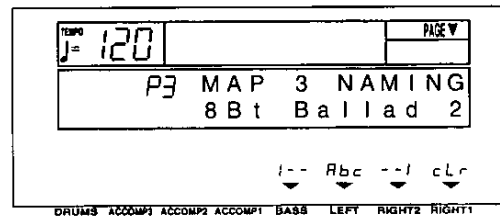

9. Assign a name to the map.
 - Use the **BASS** or **RIGHT 2** buttons to highlight the character position. Use the **LEFT** (Abc) \wedge and \vee buttons to select the alphanumeric character. Repeat these steps to type the whole name.
 - To erase all the characters, press either **RIGHT 1** (cLr) button.
10. Use the **PAGE** buttons to select P1 MAP SELECT. Repeat steps 3 to 9 to create other maps, as desired.
11. When you have finished making the map settings, press the **EXIT** button.

Recall chord map

Follow the procedure below to recall a stored chord map and use with your performance.

1. Press the **CHORD MAP** button in the **COMPOSER** section to turn it on.
2. Use the **RHYTHM SELECT** \wedge and \vee buttons to select the number of the desired map (1 to 5).
 - The selected map number and map name are shown on the display.
3. Play the keyboard using the automatic accompaniment.
 - The pattern changes according to the type of chord you play.
 - If you select a different rhythm or **COMPOSER** rhythm, the **COMPOSER CHORD MAP** function is canceled.

Part V Disk Drive

Outline of the Disk Drive function

The Disk Drive enables you to store **COMPOSER** memories, **SEQUENCER** data etc. for future use.

Internal memory and Floppy Disk Drive

The storable internal memory is fixed at a limited capacity, but this external memory device expands the storable memory infinitely.

- You can use 3.5 inch 2DD (720 KB) or 2HD (1.44 MB) floppy disks; however, 2HD disks formatted as 2DD cannot be used.
- Specific file formats are handled as follows.

		SAVE	LOAD
TECHNICS File		○	○
Standard MIDI File	FORMAT 0	○	○
	FORMAT 1	×	○

FORMAT 0: There is one track on the disk, and it contains the 16 MIDI channels.

FORMAT 1: There is an unlimited number of tracks on the disk, each of which can contain the 16 MIDI channels.

Floppy Disk Drive

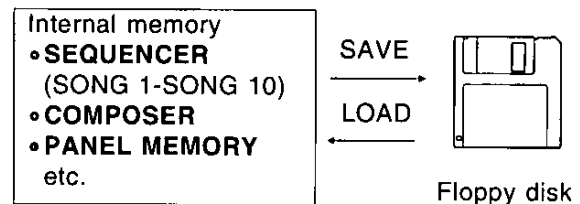
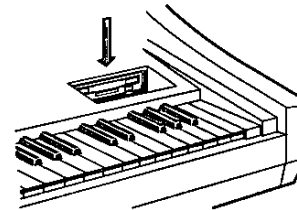

Load commercial software

Disks recorded using the Disk Drive of this instrument can, of course, be played back on your instrument (TECHNICS file). But this instrument also reads song data from floppy disks recorded in the Standard MIDI File format, enabling you to play commercial song disks on this instrument. In addition, by saving this instrument's **SEQUENCER** data in the Standard MIDI File format, you can play it back on an external sequencer.

DIRECT PLAY

You can play commercially sold song disks immediately without performing the normal load procedure.

- **DIRECT PLAY** can be used for the following disks:
 - Standard MIDI File (SMF) disks (FORMAT 0)
 - DISK ORCHESTRA COLLECTION™ (DOC)
 - PianoDisc™

□ About Standard MIDI Files

"Standard MIDI File" is a standardized data format which makes it possible for music data to be exchanged among different sequencers. Data stored in this format on sequencers of different models can be played back on this instrument, and vice versa.

- Only files with the ".MID" extension can be loaded.
- No more than 310 KB of data can be loaded into this instrument.

Warning

Standard MIDI Files ensure the compatibility of data such as key on, key off, velocity, program number. It does not guarantee 100% faithful reproduction of recorded music which is replete with such data. For exact playback of music, it may be necessary to perform extensive adjustments of all the sound generator settings. As you the listener are the ultimate judge of what sounds best, you should perform such adjustments to your satisfaction.

Main parts of the Floppy Disk Drive

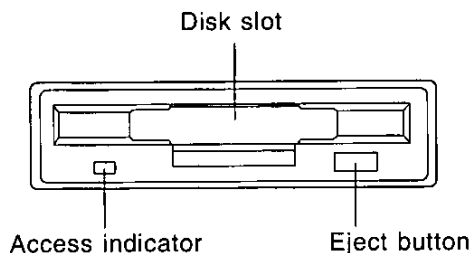

Eject button

Press to remove the disk from the Disk Drive.

Access indicator

Lights when data is being loaded from or saved to disk.

- To prevent data loss, do not remove the disk from the Disk Drive or turn off the power when the access indicator is lit.

Outline of procedure

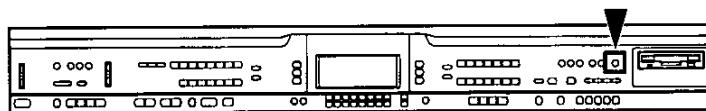

1. Press the **MEMORY & CONTROL** button to turn it on.

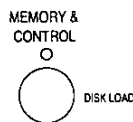

2. Use the **PAGE** buttons to select the desired menu.
 - There are six pages of the menu display.

P1 Load (page 78)

Load data in either the Technics File format or Standard MIDI File format from a disk into this instrument's memory.

P1 Save (page 83)

Save data from this instrument's memory to a disk, in either the Technics File format or the Standard MIDI File format.

P2 Direct Play (page 81)

Immediate playback of commercial song disks.

P4 FD Format (page 82)

Format new floppy disks or erase the contents of recorded disks so they can be used by this instrument.

- [P3 Medley] is explained on page 66.
- [P5 Initial] is explained on page 102.
- [P6 Pedal Setting] is explained on page 48.
- [P7 Contrast] is explained on page 23.

3. Select the desired menu and follow the procedures on the corresponding setting display.

4. When you have finished setting the functions, press the **MEMORY & CONTROL** button to turn it off.

Loading data

Recall (load) the data from the disk to this instrument's memories.

WARNING: The load procedure causes any data which is currently stored in the relevant memories to be erased.

DISK LOAD

1. Insert the disk with the stored data into the Disk Drive. Push it all the way in until you hear a click.

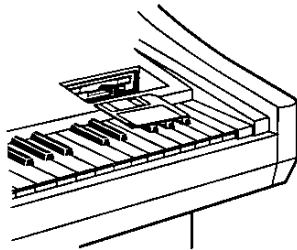

2. On the **MEMORY & CONTROL** menu display, select P1.

- The display looks similar to the following.

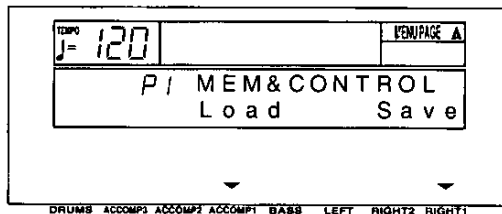

3. Press either **ACCOMP 1** (Load) button.

- The display changes to the following load menu display.
- There are two pages of the menu display.

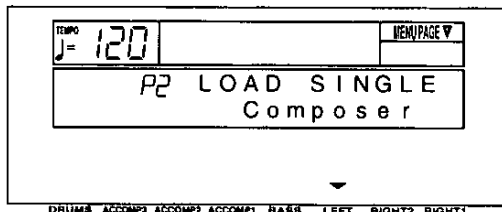
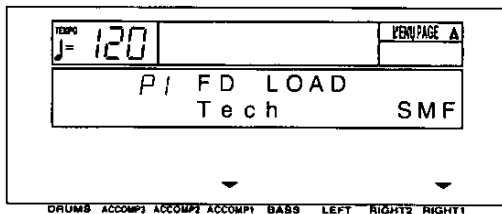

4. Select the type of data load you want.

[Tech]: Load data which was saved in the Technics File format (TECHNICS LOAD).

[SMF]: Load data which was saved in the Standard MIDI File format (SMF LOAD).

[LOAD SINGLE Composer]: Load **COMPOSER** data from a disk into a specified memory number.

5. Perform the selected disk load procedure. (Refer to the following sections.)

■ TECHNICS LOAD

Load data which was saved in the Technics File format.

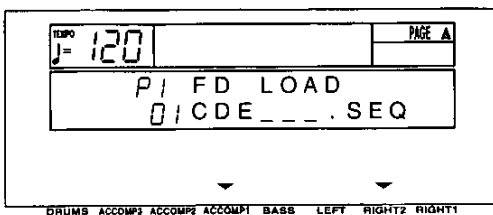

1. Use the **ACCOMP 1** \wedge and \vee buttons to select the file on the floppy disk you wish to load (copy) to this instrument's memories.
 - The file name is shown next to each file number.
2. Use the **RIGHT 2** \wedge and \vee buttons to specify the kind of data you wish to load from the disk to your instrument.

ALL: All the following data is loaded.
 SEQ: Only **SEQUENCER** data
 CMP: Only **COMPOSER** data
 PNL: Only **PANEL MEMORY** data

- The option which was specified during the **SAVE** procedure is automatically selected. Skip this step if you do not wish to change the selection.
3. For a SEQ file, press the **PAGE** \wedge button.
 - The display looks similar to the following.

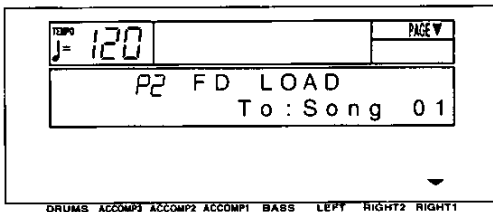

- Use the **RIGHT 1** \wedge and \vee buttons to select the song number in this instrument's memories to which you wish to have the file loaded (copied).
- If you are loading a file that was saved with the ALL option selected, this display will not appear even if SEQ is selected in step 2.
- **SEQUENCER** data is loaded one song at a time. However, if you load a file for which ALL was selected, **SEQUENCER** songs 1 to 10 are loaded at once.

4. Press the **EXECUTE** button.

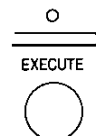

- The **LOAD** operation begins.
- When the operation has been successfully completed, "COMPLETED!" is shown on the display.
- If song data was loaded, you can press the **START/STOP** button to begin playback when the **PLAY** button of the **SEQUENCER** is on.

- You can quickly load just the **COMPOSER** data by pressing and holding the **COMPOSER LOAD (MEMORY)** button for a few seconds.
- You can also access the **FD LOAD** display by pressing the **MEMORY & CONTROL (DISK LOAD)** button for a few seconds.

▣ SMF LOAD

Load data which was saved in the Standard MIDI File (SMF) format.

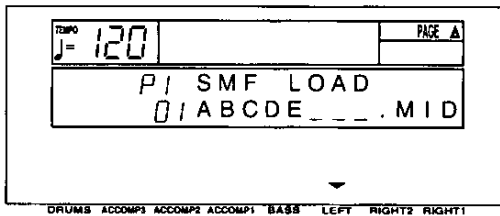

1. Use the **LEFT** \wedge and \vee buttons to select the file.
2. Press the **PAGE** \wedge button.
 - The display looks similar to the following.

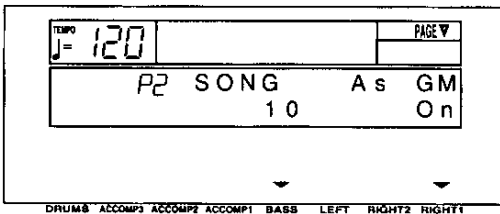

3. Use the **BASS** \wedge and \vee buttons to select the song.
 - Data is loaded one song at a time.
4. Use the **RIGHT 1** \wedge and \vee buttons to specify whether or not to load the song as GENERAL MIDI (GM) (On/Off).
 - If the GM setting you specify is different from the setting in the file, the sounds, the octave, and the arrangement of percussion sounds on the keyboard will be different.
 - Information about GENERAL MIDI can be found on page 93.
 - If playback is executed with the setting set to On, the functions of this instrument are limited in various ways. For detailed information, please refer to the separate REFERENCE GUIDE provided.
5. Press the **EXECUTE** button.

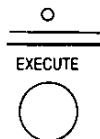

- The LOAD operation begins.
- When the operation has been successfully completed, "COMPLETED!" is shown on the display.
- Press the **START/STOP** button to begin playback.

▣ LOAD SINGLE COMPOSER

Load the desired **COMPOSER** data from a disk into a specific **COMPOSER** memory.

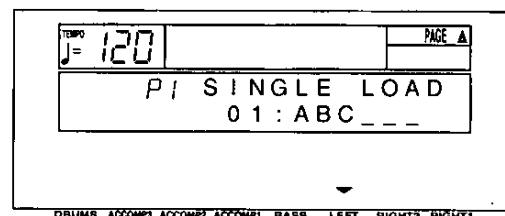

1. Use the **LEFT** \wedge and \vee buttons to select the number of the file with the data you wish to load.
2. Press the **PAGE** \wedge button.
 - The display looks similar to the following.

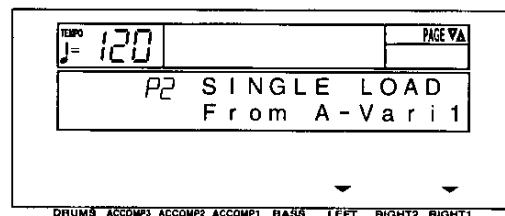

3. Select the pattern you wish to load.
 - Use the **LEFT** \wedge and \vee buttons to specify the bank name, and the **RIGHT 1** \wedge and \vee buttons to specify the section name.
4. Press the **PAGE** \wedge button.
 - The display looks similar to the following.

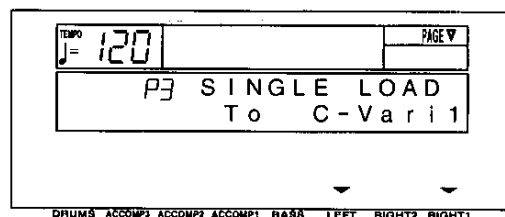

5. Select the section to load to.
 - Use the **LEFT** \wedge and \vee buttons to specify the bank name, and the **RIGHT 1** \wedge and \vee buttons to specify the section name.
6. Press the **EXECUTE** button.
 - The LOAD operation begins.
 - When the operation has been successfully completed, "COMPLETED!" is shown on the display.
 - This procedure can also be accessed from the **COMPOSER** menu display. (Refer to page 68.)

Playing commercial disks

Commercial song disks can be played back directly from a disk. The usual LOAD operation is not necessary, so playback is quicker.

DIRECT PLAY

1. Insert the disk you wish to play back into the Disk Drive.
2. On the **MEMORY & CONTROL** menu display, select [P2 Direct Play].
- The display looks similar to the following.

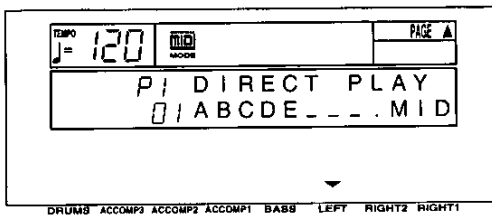

3. Use the **LEFT** ^ and v buttons to select the filename to play back.
- For SMF files, press the **PAGE** ^ button to show the following display.

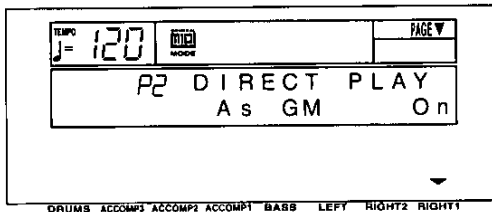

- Use the **RIGHT 1** ^ and v buttons to specify whether or not to play the song as GENERAL MIDI (GM) (On/Off).
- If the GM setting you specify is different from the setting in the file, the sounds, the octave, and the arrangement of percussion sounds on the keyboard will be different.
- Information about GENERAL MIDI can be found on page 93.
- If playback is executed with the setting set to On, the functions of this instrument are limited in various ways. For detailed information, please refer to the separate REFERENCE GUIDE provided.

- For DOC files, if you press the **PAGE** ^ button, the display changes to the following.

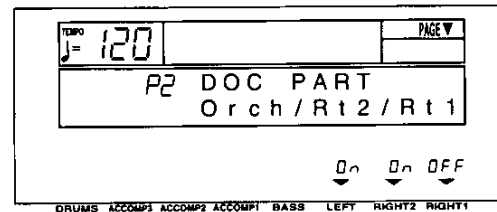

- You can use the corresponding buttons to turn playback on or off for each part.
Rt1..... RIGHT 1 part
Rt2..... RIGHT 2 part
Orch Accompaniment part

4. Press the **START/STOP** button.

- The selected song begins to play.
- Press the **START/STOP** button if you wish to stop playback before it has finished.
- You can use the same procedure to play back other songs on the disk.
- The song stops if you exit this display during playback.
- DIRECT PLAY can be used for the following disks:
Standard MIDI File (SMF) disks (FORMAT 0)
DISK ORCHESTRA COLLECTION™ (DOC)
PianoDisc™
- Standard MIDI File FORMAT 1 disks cannot be played back using DIRECT PLAY. Use SMF LOAD for these disks.

Formatting a disk

New floppy disks can be used only after they have been formatted. Follow the procedure below to format a new disk or erase the contents of a recorded disk.

FLOPPY DISK FORMAT

- This procedure clears the entire contents of the disk.
- Reformat a disk if it cannot be saved to or loaded from properly because of exposure to a magnetic field.
- You can use 3.5 inch 2DD (720KB) or 2HD (1.44MB) floppy disks.
- Be sure to specify the type of format which is suitable for the disk.
- How to distinguish the two disk types:

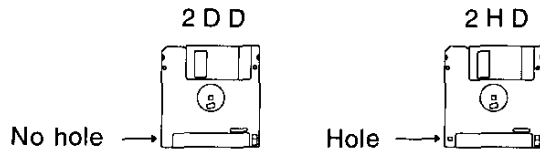

- Although 2HD floppy disks can hold more data and are convenient for quick loading and saving, 2DD disks are generally used for musical instruments. Therefore, you may not be able to use your 2HD disk data with other musical instrument models.
- To format the floppy disk, the write-protect window must be closed, as illustrated.

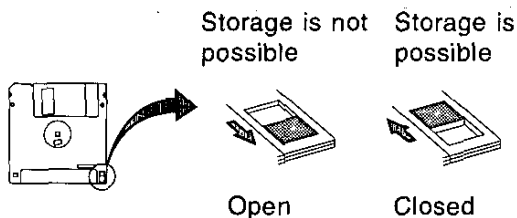

1. Insert the floppy disk into the Disk Drive slot. Push it all the way in until you hear a click.
2. On the **MEMORY & CONTROL** menu display, select [P4 FD Format] and press either **LEFT** button.

- The display changes to the following.

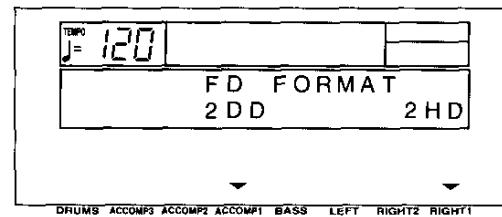

3. Select the type of format (2DD or 2HD).
- Be sure to select the type which is the same as your disk type.
 - The display changes to the following.

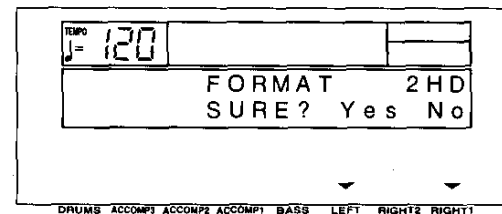

4. Press either **LEFT** (Yes) button to format the disk, or press either **RIGHT 1** (No) button to cancel the format.
- After about 1–2 minutes, formatting is completed, "COMPLETED!" is shown on the display, and this instrument returns to the normal performance mode.

Saving data

The recorded data and panel settings of this instrument can be saved on a disk.

- It is a good idea to save Technics File format data and Standard MIDI File format data in separate disks.

DISK SAVE

This procedure is used to save the performance data and settings of this instrument to a disk.

1. Insert a formatted disk into the Disk Drive slot.
Push it all the way in until you hear a click.
2. On the **MEMORY & CONTROL** menu display, select P1.
• The display looks similar to the following.

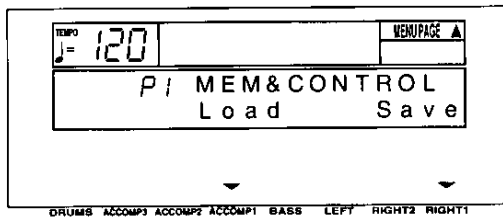

3. Press either **RIGHT 1** (Save) button.
• The display looks similar to the following.

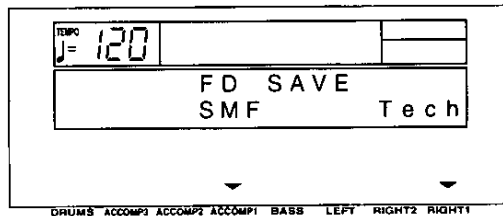

4. Select the type of data save you want.

[Tech]: Save data in the Technics File format (TECHNICS SAVE).

[SMF]: Save data in the Standard MIDI File format (SMF SAVE).

5. Perform the selected disk save procedure.
(Refer to the following sections.)

TECHNICS SAVE

Save data from this instrument in the Technics File format to a floppy disk.

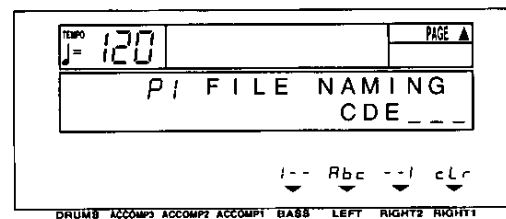

1. Type a name for the new data file (up to 6 characters).
 - Use the **BASS** and **RIGHT 2** ^ and v buttons to highlight the character position. Use the **LEFT** (Abc) ^ and v buttons to select the alphanumeric character. Repeat these steps to type the whole name.
 - To erase the name, press either **RIGHT 1** (cLr) button.
2. Press the **EXECUTE** button.
• The display looks similar to the following.

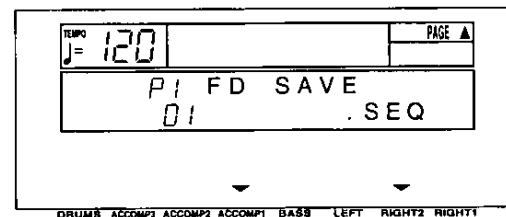

3. Use the **ACCOMP 1** ^ and v buttons to select a file number (01 to 20).
 - Files in which data is currently stored are indicated by the file name following the file number.
 - The maximum number of files which can be saved may be less than 20 if you are saving many songs which use a lot of memory.
 - More data can be saved using 2HD floppy disk.

(continued on the next page)

4. Use the **RIGHT 2** \wedge and \vee buttons to specify the kind of data you wish to save to the disk.

ALL: All the following data is saved.
 SEQ: Only **SEQUENCER** data
 CMP: Only **COMPOSER** data
 PNL: Only **PANEL MEMORY** data

- The TUNING setting is not saved.
5. If SEQ was selected in step 4, press the **PAGE** \wedge button.
- The display looks similar to the following.

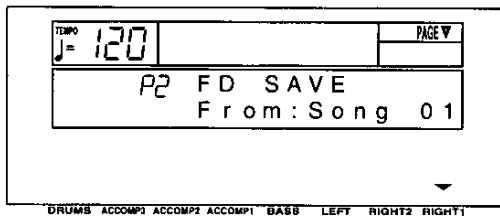

- Use the **RIGHT 1** \wedge and \vee buttons to select the song number in this instrument's memories you wish to have saved to the floppy disk.
 - SEQUENCER** data is saved one song at a time. However, if ALL is selected, the contents of **SEQUENCER** songs 1 to 10 are saved at once. In this case, you can conserve memory by deleting songs you do not wish to save.
6. Press the **EXECUTE** button.
- The SAVE operation begins.
 - When the operation has been successfully completed, "COMPLETED!" is shown on the display, and this instrument returns to the normal performance mode.
 - If you attempt to save data to a file number in which data is currently saved, the display changes to the confirmation display. Press either **RIGHT 1** (No) button if you wish to cancel the procedure. When either **LEFT** (Yes) button is pressed, the DISK SAVE operation begins.

FILE delete

Use the following procedure to clear a specific file.

- On the FILE NAMING display, press the **PAGE** \wedge button.
 - The display looks similar to the following.

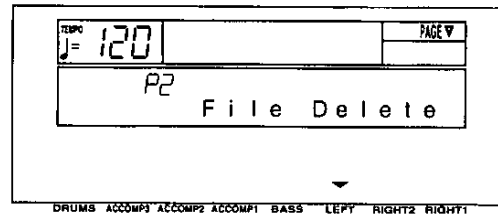

- Press either **LEFT** button.
 - The display looks similar to the following.

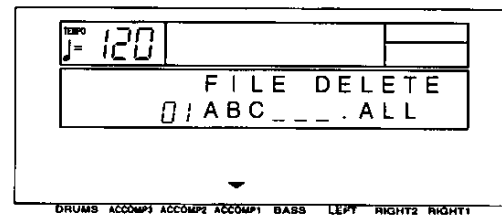

- Use the **ACCOMP 1** \wedge and \vee buttons to specify the file to erase.
- Press the **EXECUTE** button.
 - The ARE YOU SURE? display appears. Press either **LEFT** (Yes) button to execute the function. Or press either **RIGHT 1** (No) button if you wish to cancel the procedure.

■ SMF SAVE

The data from this instrument's **SEQUENCER** can be saved to a floppy disk as Standard MIDI Files (SMF) (FORMAT 0 only). (Standard MIDI Files are most commonly saved on 2DD floppy disks.) Data saved on this instrument can then be used on another instrument.

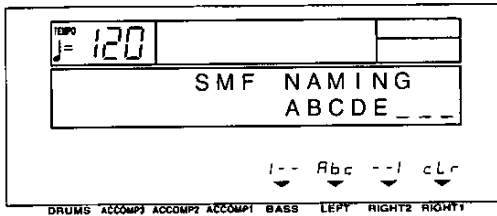

- What you can save in the Standard MIDI File format is ordinary performance data, such as note data. Data such as **SEQUENCER** data for the chord and rhythm parts, **COMPOSER** data, **PANEL MEMORY** data, etc. is not saved. If you wish to also save the special Technics data, first use the **TECHNICS SAVE** procedure to save the data to a disk, and then follow the **SMF SAVE** procedure below.
- Standard MIDI Files are generally saved in the GM mode, but can be saved in the Technics mode.

1. Type a name for the new data file (up to 8 characters).
 - Use the **BASS** and **RIGHT 2** \wedge and \vee buttons to highlight the character position. Use the **LEFT** (Abc) \wedge and \vee buttons to select the alphanumeric character. Repeat these steps to type the whole name.
 - To erase the name, press either **RIGHT 1** (cLr) button.
 - Avoid using the numbers from 01 to 20 as the first two letters of the name.

2. Press the **EXECUTE** button.

- The display looks similar to the following.

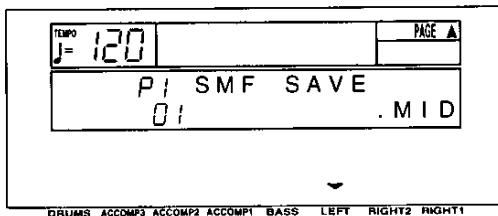

3. Use the **LEFT** \wedge and \vee buttons to select the name of the file in which to save the data.
 - To save in a new file, select a blank line.

4. Press the **PAGE** \wedge button.

- The display looks similar to the following.

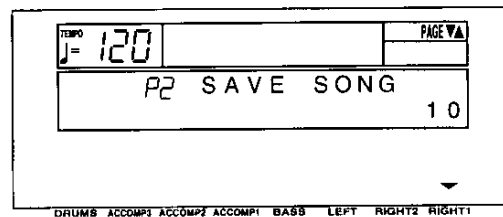

5. Use the **RIGHT 1** \wedge and \vee buttons to select the song number in this instrument's memories you wish to have saved to the floppy disk.
 - Data is saved one song at a time.

6. Press the **PAGE** \wedge button.

- The display looks similar to the following.

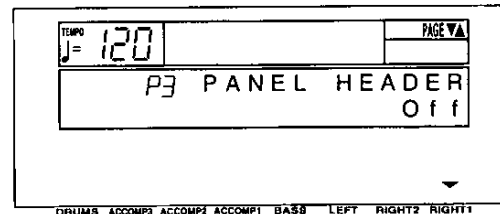

7. Use the **RIGHT 1** \wedge and \vee buttons to select **HEADER On/Off**.

- Select **On** to save the sound, volume and other settings for each part as data at the beginning of the file.

(continued on the next page)

8. Press the **PAGE** \wedge button.
- The display looks similar to the following.

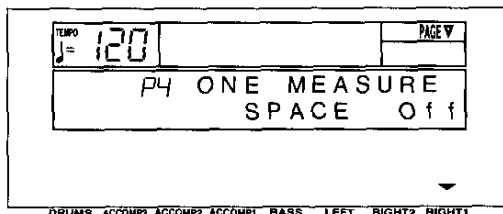

9. Use the **RIGHT 1** \wedge and \vee buttons to select **ONE MEASURE SPACE On/Off**.
- When there is various data other than performance data stored at the beginning of a file, the start of playback may be delayed. This can be avoided by inserting a one-measure space before the beginning of the performance. Select On to insert a one-measure space. Select Off if you do not wish to insert the space.
 - When set to On, a space is added each time a file is saved. Therefore, if you have already saved a file once with the **ONE MEASURE SPACE** set to On, please set it to Off each time the file is subsequently saved.

10. Press the **EXECUTE** button.
- The **SAVE** operation begins.
 - When the operation has been successfully completed, "COMPLETED!" is shown on the display.
 - If you attempt to save data to a file number in which data is currently saved, the display changes to the confirmation display. Press either **RIGHT 1** (No) button if you wish to cancel the procedure. When either **LEFT** (Yes) button is pressed, the **SMF SAVE** operation begins.

FILE delete

Use the following procedure to clear a specific file.

1. On the **SMF NAMING** display, press the **PAGE** \wedge button.
- The display looks similar to the following.

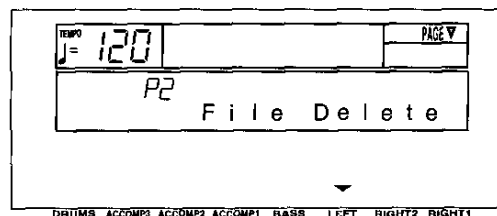

2. Press either **LEFT** button.
- The display looks similar to the following.

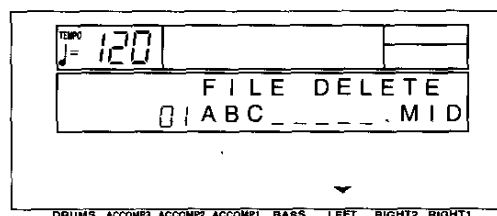

3. Use the **LEFT** \wedge and \vee buttons to specify the file to erase.
4. Press the **EXECUTE** button.
- The **ARE YOU SURE?** display appears. Press either **LEFT** (Yes) button to execute the function. Or press either **RIGHT 1** (No) button if you wish to cancel the procedure.

Part VI Adjusting the sounds

Outline of the Sound Setting mode

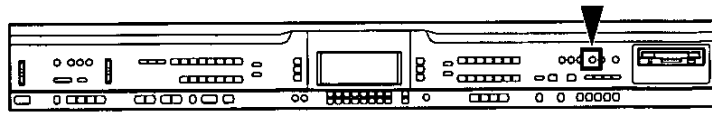

The **SOUND** mode is used for making fine adjustments to the functions related to sound, such as tone, volume and effects.

SOUND menu

1. Press the **SOUND SETTING** button to turn it on.



2. Use the **PAGE** buttons to select the menu.
 - There are four pages of the menu display.
3. Select the desired menu and follow the procedures on the corresponding setting display.
 - When the current display is a setting display, you can press the **EXIT** button to go back to the previous display. To show other menus, use the **EXIT** button to return to the **SOUND** menu display and make another selection.
4. When you have finished setting the functions, press the **SOUND SETTING** button to turn it off.

■ A word about parts

The organization of the sound parts is as follows.

Normal parts:

RIGHT 1, RIGHT 2, LEFT, PART 4 to 16
(PART 16 is reserved for the DRUM part)

AUTO PLAY CHORD parts:

ACCOMP 1, 2, 3, BASS, DRUMS, CHORD, R.BASS.

- On the **BALANCE** display, PART 1, PART 2 and PART 3 become RIGHT 1, RIGHT 2 and LEFT, respectively.

Summary of the SOUND menu items

P1 Part Setting (page 88)

Set the various sound attributes for each part.

P2 Touch & Tune (page 89)

Set the keyboard sensitivity, and adjust the tuning.

P3 Key Scaling (page 90)

Select the type of scaling (tuning).

P4 Left Hold (page 91)

Set the mode which determines how the **LEFT** part sounds during an **AUTO PLAY CHORD** performance.

- [P5 Techni-Chord] is explained on page 34.
- [P6 Reverb] is explained on page 31.
- [P7 Chorus] is explained on page 30.

Part Setting

Set the various sound attributes for each part.

1. On the **SOUND** menu display, select [P1 Part Setting].
 - The display looks similar to the following.

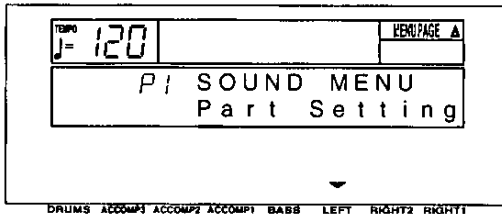

2. Press either **LEFT** button.
 - The display looks similar to the following.

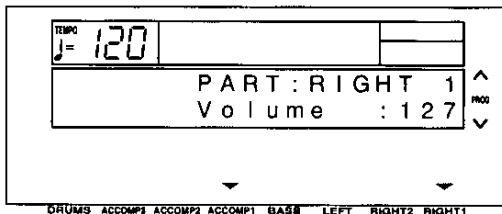

3. Use the **TRANPOSE** (PROG) \wedge and \vee buttons to select a part.
 - PART 4 to 16 are used in **SEQUENCER** and MIDI functions when playing back Standard MIDI Files. PART 16 is reserved for the DRUM part.
 - For information concerning CHORD and R. BASS, refer to page 41.
4. Assign a sound to the selected part.
 - During setting, the currently selected part and sound name are shown on the display.
 - Only sounds from the **KEYBOARD PERC** can be selected for Part 16.
 - You cannot assign sounds to the ACCOMP 1, 2, 3, BASS and DRUMS parts. (If the panel buttons are used to change the sound or effects for these parts, the RIGHT 1 settings change.)
5. Use the **ACCOMP 1** \wedge and \vee buttons to select the attribute you wish to adjust.
6. Use the **RIGHT 1** \wedge and \vee buttons to adjust the attribute.

Volume: Adjust the volume of each part (0 to 127).

Pan: Adjust the stereo balance of each part (L64–CTR–R63).

- At L64, the sound is completely to the left, at R63 completely to the right. At CTR, the sound is at the center.
- Even at the same numerical value, the stereo balance may differ slightly depending on the sound.

Reverb: Adjust the depth of the reverb for the part (0 to 127).

Chorus: Adjust the depth of the chorus for the part (0 to 127).

S. Length: Adjust the length of the sustain (1 to 8).

- For some sounds, the length of the sustain does not change even if the number is changed.

KeyShift: Specify the amount of shift in the pitch of the played keys (–12 to +12).

- A value of 1 means a shift of one semitone. A value of 12 is one octave.
- The – button is used to lower the pitch, and the + button to raise the pitch.

Tuning: Fine-tune the pitch of each part (–128 to +127).

- Slight differences in the pitches between the parts add fullness to the sound.
- The – button is used to lower the pitch, and the + button to raise the pitch.

P. Bend: Set the amount of pitch change when the **PITCH BEND** wheel is operated (0 to 12).

- Increments are in semitones. A value of 12 is one octave.

Glide Pdl: Enable or disable the glide effect of the pedal (On/Off).

- For glide pedal setting, refer to page 48.

Sust. Pdl: Specify whether or not the **SUSTAIN** effect is applied with the pedal (On/Off).

- The sustain function works in conjunction with the **SUSTAIN PEDAL** button.

Key Scale: Enable or disable key scaling (On/Off)

- For key scaling, refer to page 90.
- The settings which can be adjusted may differ depending on the selected part.
- If **KEYBOARD PERC** sounds are assigned to a part other than PART 16, even if you change the setting for the attribute (except for [Volume], [Reverb], [Chorus]), the new setting will not be in effect.
- To change the settings for a different part while the setting display is shown, use the **TRANSPOSE (PROG)** \wedge and \vee buttons to change the part.
- When you have completed adjustment of an attribute, use the **ACCOMP 1** \wedge and \vee buttons to select the next attribute you wish to adjust.

Touch & Tune

Select the keyboard touch response mode (TOUCH SENSE), fine-tune the pitch of the entire instrument (TUNING), and specify whether or not sound is generated when the keys are pressed very softly (MINIMUM RANGE).

1. On the **SOUND** menu display, select [P2 Touch & Tune].
- The display looks similar to the following.

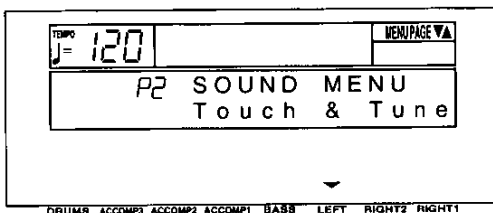

2. Press either **LEFT** button.
- The display looks similar to the following.

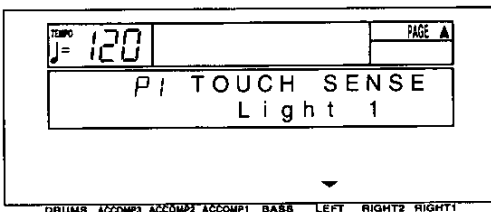

3. Use the **LEFT** \wedge and \vee buttons to select the touch mode.
- Select from Heavy 1, 2, Normal, Light 1, 2.

4. Press the **PAGE** \wedge button.
- The display looks similar to the following.

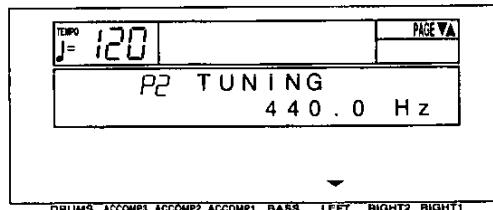

5. Use the **LEFT** \wedge and \vee buttons to adjust the pitch within a range of 427.3 to 453.0 Hz.
- The decimal can be set to 0, 3 or 6.

6. Press the **PAGE** \wedge button.
- The display looks similar to the following.

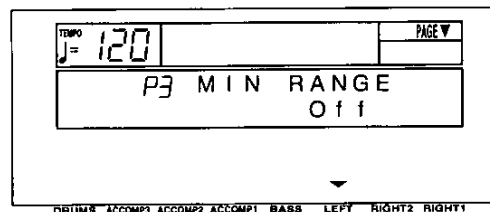

7. Use the **LEFT** \wedge and \vee buttons to select minimum range On or Off.

On: No sound is produced when the keys are pressed very softly (acoustic piano type).
Off: Sound is produced even when the keys are pressed very softly.

Key Scaling

The temperament (tuning) of this instrument can be adjusted. Various types other than standard temperament are available to choose from.

1. On the **SOUND** menu, select [P3 Key Scaling].

- The display looks similar to the following.

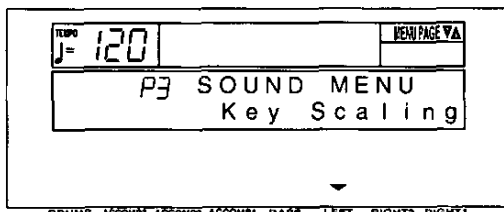

2. Press either **LEFT** button.

- The display looks similar to the following.

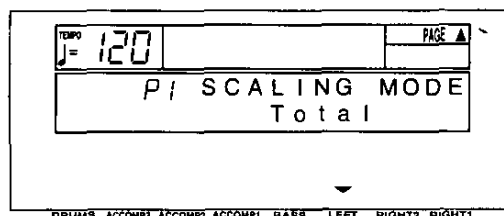

3. Use the **LEFT** \wedge and \vee buttons to select the tuning mode.

Total: The key scaling selected for this instrument is active for all parts. (Select this mode if you are selecting a tuning type.)

Sound: The preset key scaling specified for individual sounds is active.

4. Press the **PAGE** \wedge button.

- The display looks similar to the following.

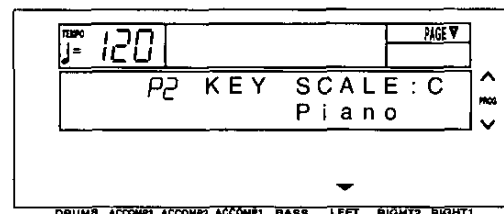

5. Use the **LEFT** \wedge and \vee buttons to select the type.

- Select from [Off], [Random], [Piano], [Orchestra], [Pythagorean], [Werckmeister], [Kirnberger], [Arabic 1] to [Arabic 5], [Slendro], [Pelog], [User].
- [Off] is standard (equal temperament) tuning.
- Select [User] if you wish to use a customized scaling (explained in the following section).

6. Use the **TRANSPOSE** (PROG) \wedge and \vee buttons to select the key in which you are going to perform.

- Set to the key of the song you are going to play.

■ User type scaling

You can adjust the instrument to a customized scaling.

- In **KEY SCALING**, the pitch of each note of the octave is slightly shifted up or down from the standard (equal temperament) tuning.

1. On the P2 display, select [User] for the type.

2. Press the **PAGE** \wedge button.

- The display looks similar to the following.

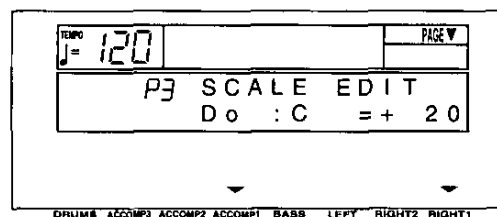

3. Adjust the key scaling.

- Use the **ACCOMP 1** \wedge and \vee buttons to specify the keyboard key, and use the **RIGHT 1** \wedge and \vee buttons to adjust the pitch of the key.
- Increments are in cents (one hundredth of an equal-tempered semitone). A + value raises the pitch and a - value lowers the pitch in relation to standard tuning (equal temperament).

Left Hold

Select the mode to specify how the left section of the keyboard sounds during an **AUTO PLAY CHORD** performance.

1. On the **SOUND** menu display, select [P4 Left Hold].
- The display looks similar to the following.

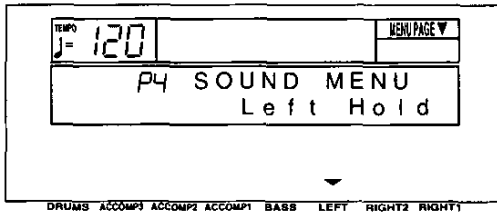

2. Press either **LEFT** button.
- The display looks similar to the following.

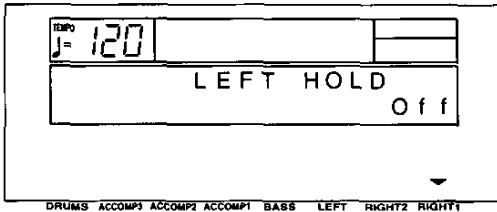

3. Use the **RIGHT 1** buttons to set the mode to On or Off.

■ **OFF**

	BASIC	ADVANCED	PIANIST
When rhythm is stopped	The specified chord sounds in the CHORD part sound.	The specified chord sounds in the CHORD part sound, and the pressed keys sounds in the LEFT part sound.	The CHORD part and the LEFT part do not sound (the entire keyboard produces the RIGHT part sound).
When rhythm is playing	The CHORD part and the LEFT part do not sound.	The CHORD part does not sound, but the pressed keys sound in the LEFT part sound.	

■ **ON**

	BASIC	ADVANCED	PIANIST
When the rhythm is stopped or playing	The specified chord sounds in the LEFT part sound.	The specified chord sounds in the LEFT part sound.	The CHORD part and the LEFT part do not sound (the entire keyboard produces the RIGHT part sound).

- In the **BASIC** and **ADVANCED** modes, you can use the mute function to specify whether the **LEFT** part sounds or not.

Practical applications

Part VII MIDI

What is MIDI?

MIDI (Musical Instrument Digital Interface) is the international standard for digital communication of electronic musical instrument data. This means that any equipment which has a MIDI terminal—such as electronic musical instruments and personal computers—can easily exchange digital data with other MIDI equipment without resorting to complicated conversions or connections.

MIDI terminals

(On the rear panel)

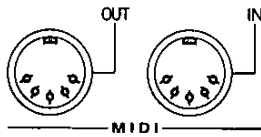

IN:

The terminal by which this instrument receives data from other equipment.

OUT:

The terminal that transmits data from this instrument to other equipment.

- For these connections, use a commercially available MIDI cable.

Practical applications

Connection examples

- To generate sound from a connected instrument by playing this instrument

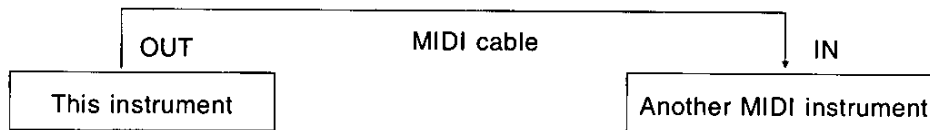

- To generate sound from this instrument by operating a connected instrument

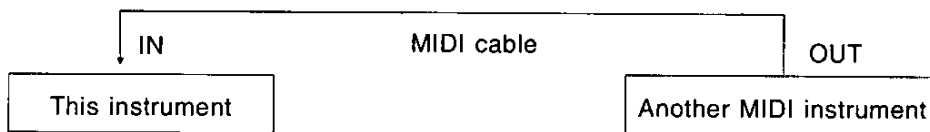

- To connect with a MIDI sequencer or a personal computer

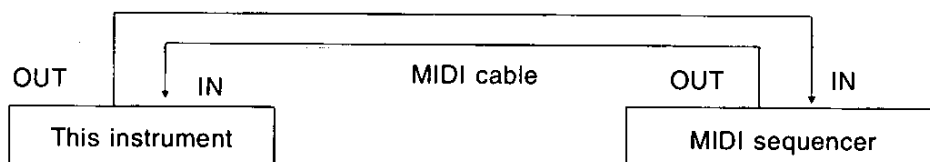

MIDI channels

Many different kinds of performance data are sent using just one MIDI cable. This is possible because MIDI signals are sent and received through 16 different “basic channels” (numbered 1 to 16). In order for the exchange of data to take

place, the channels on the transmission side must match the channels on the receiving side. This characteristic also makes it possible to link multiple sound generators and to control each by matching specific channels.

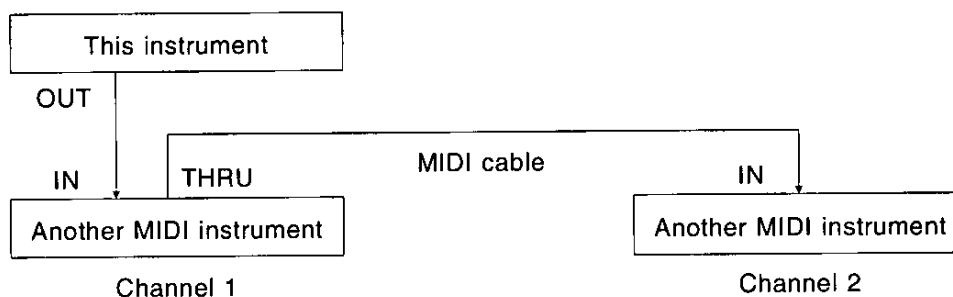

The following kinds of data can be transmitted/received.

■ NOTE data

This is the most basic kind of MIDI data which is exchanged, and is used to specify which keys are played and how hard they are played.

NOTE NUMBER: Number specifying which key is played.

NOTE ON: Specifies that a key is played.

NOTE OFF: Specifies that a key is released.

VELOCITY: Specifies how hard a key is struck.

- MIDI notes are assigned numbers from 0 to 127, with middle C (C3) as 60. Note pitches are in semitone increments, with the higher numbers assigned to the higher pitches.

■ PROGRAM CHANGE

This is sound change data. When a different sound is selected on the transmitting instrument, the sound on the receiving instrument also changes.

■ CONTROL CHANGE

These are volume, sustain, effect, etc. data used to enhance performance expression. Each function is distinguished by its control number, and the function which can be changed by the control differs depending on the instrument.

■ EXCLUSIVE data

This is sound data, etc. particular to a specific instrument model. This data can also be transmitted and received by the DUMP function.

- For details, refer to the separate REFERENCE GUIDE provided.

GENERAL MIDI

GENERAL MIDI (GM) is the standard which enables MIDI data exchange between different models or equipment of different manufacture. Program change numbers and their corresponding sounds, percussion instrument sounds, note numbers, etc. are data-compatible between equipment using this standard. Song data created on the equipment of one manufacturer can be played back on the equipment of a different manufacturer, as long as both conform to the GENERAL MIDI standard. This instrument conforms to this standard and can be used as a GENERAL MIDI sound generator.

Equipment which conforms to GENERAL MIDI standards is indicated by the following logo.



Outline of MIDI functions

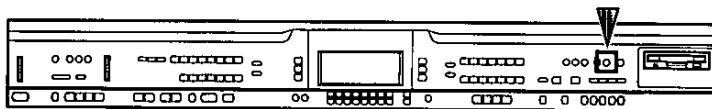

Select the various settings which are used for MIDI operation of this instrument.

1. Press the **MIDI** button to turn it on.



4. When you have finished setting the functions, press the **MIDI** button to turn it off.

2. Use the **PAGE** buttons to select the menu.
• There are nine pages of the menu display.

3. Select the desired menu and follow the procedures on the corresponding setting display.
• During the setting display, you can press the **EXIT** button to go back to the previous display. To show other menus, use the **EXIT** button to return to the **MIDI** menu display and make another selection.

Summary of the MIDI menu items

P1 Channel (page 95)

Assign a MIDI channel to each part.

P2 Part Setting (page 96)

Make the OCTAVE and LOCAL CONTROL settings for each part.

P3 Common Set (page 97)

Set the following functions which are common to all parts.

NOTE ONLY
 PROG. CHANGE TO P. MEM
 INTRO, FILL-IN, ENDING
 APC CONTROL
 TRANSPOSE
 PROGRAM CHANGE MODE
 DRUMS TYPE
 SONG SELECT
 MIDI SETUP LOAD

P4 Control Msg (CONTROL MESSAGE) (page 98)

Enable or disable the exchange of various control data.

P5 IN/OUT Set (INPUT/OUTPUT SETTING) (page 99)

Various settings related to transmission and reception of data

P6 Realtime Msg (REALTIME MESSAGE) (page 100)

Make the REALTIME COMMANDS and CLOCK settings.

P7 MIDI Presets (page 100)

Optimum MIDI settings according to the connected equipment

P8 GM Mode (page 101)

GENERAL MIDI settings

Setting the functions

MIDI CHANNEL

MIDI Basic Channel numbers have already been assigned to parts (default settings) but you can reassign channel number to parts as follows.

1. On the **MIDI** menu display, select [P1 Channel].
 - The display looks similar to the following.

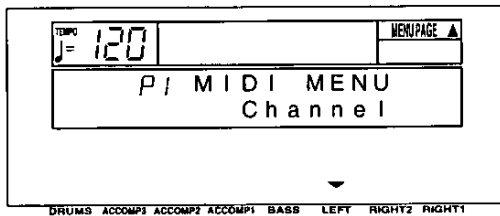

2. Press either **LEFT** button.
 - The display looks similar to the following.

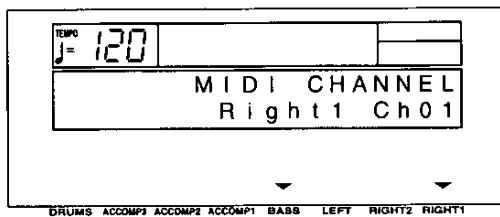

3. Use the **BASS** ^ and v buttons to select the part.
4. Use the **RIGHT 1** ^ and v buttons to select a basic channel for the part (Off, 01 to 16).
 - A part which has been set to Off cannot be used to transmit or receive MIDI data.
5. Repeat steps 3 and 4 for each part as desired.

■ Default part settings

Part	Channel	Part	Channel	Part	Channel	AUTO PLAY CHORD part	Channel
Right 1	01	Part 7	07	Part 13	13	Acmp 1	Off
Right 2	02	Part 8	08	Part 14	14	Acmp 2	Off
Left	03	Part 9	09	Part 15	15	Acmp 3	Off
Part 4	04	Part 10	10	Part 16	16	Bass	Off
Part 5	05	Part 11	11	(Drum)		Drums	Off
Part 6	06	Part 12	12	Control	Off	Chord	Off

Practical applications

PART SETTING

Set the octave shift value for key notes transmitted from this instrument (OCTAVE), and specify whether this instrument's sound generator is enabled when MIDI data is transmitted (LOCAL CONTROL)

- 1 On the **MIDI** menu display, select [P2 Part Setting]
 - The display looks similar to the following

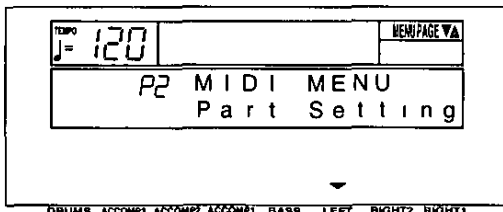

- 2 Press either **LEFT** button
 - The display looks similar to the following

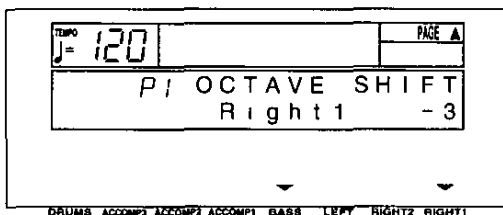

- 3 Use the **BASS** \wedge and \vee buttons to select the part
- 4 Use the **RIGHT 1** \wedge and \vee buttons to set the octave shift value (-3 to 3)
 - Octave shift is set for transmitted data only, however the transmitted and received octave shifts are linked. For example, if the transmitted octave shift is set to 1, the received octave shift is automatically set to -1
- 5 Repeat steps 3 and 4 for each part, as necessary

- 6 Press the **PAGE** \wedge button
 - The display looks similar to the following

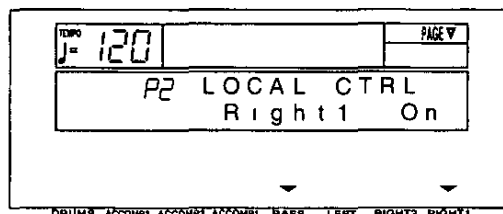

- 7 Use the **BASS** \wedge and \vee buttons to select a part

- 8 Use the **RIGHT 1** \wedge and \vee buttons to enable or disable this instrument's sound generator
 - When set to On, the performance from this instrument is transmitted as MIDI data and also sounds from this instrument. When set to Off, the performance from this instrument is transmitted as MIDI data but does not sound from this instrument

- 9 Repeat steps 7 and 8 for each part as desired

COMMON SETTING

Set the functions which are common to all parts.

1. On the **MIDI** menu display, select [P3 Common Set].

- The display looks similar to the following.

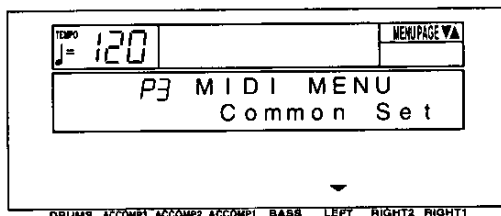

2. Press either **LEFT** button.

- The display looks similar to the following.

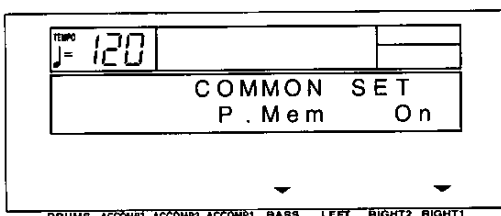

3. Use **BASS** \wedge and \vee buttons to select the item.

4. Use the **RIGHT 1** \wedge and \vee buttons to change the setting.

[P. Mem] (PROGRAM CHANGE TO PANEL MEMORY): Enable or disable the exchange of program change numbers for the **RIGHT 1** part by operation of the **PANEL MEMORY** buttons (On/Off).

- For this setting, the **PANEL MEMORY 1** to **5** program change numbers correspond to 0 to 4 setting numbers.

[Note Only]: Of the performance data, specify whether or not only note data is exchanged (On/Off).

[P. Change] (PROGRAM CHANGE MODE)

Nor: The program change numbers correspond to the sound numbers.

Tec: Program change numbers are standardized among all Technics models which are set to this mode. The program change number assigned to a given sound on one model is assigned to the same sound on all models which are set to the same mode.

GM: Program change numbers follow the GM standard.

- The program change numbers for each mode can be found in the separate **REFERENCE GUIDE** provided.

[Drums]

Nor: Keyboard percussion instrument sounds correspond to this instrument's key note numbers.

Tec: Keyboard percussion instrument sounds correspond to the same key note numbers for connected Technics models set to this type.

GM: Keyboard percussion instrument sounds follow the GM standard.

[Song Sel] (SONG SELECT)

On: Song number data can be exchanged.

Off: Song number data cannot be exchanged.

[Setup Ld] (MIDI SETUP LOAD)

On: When disk data is loaded, the MIDI settings stored on the disk are automatically recalled.

Off: MIDI settings stored on the disk are not recalled.

[Intro]: Enable or disable the exchange of intro, fill-in and ending data (On/Off).

- Data is exchanged on the channel for the **DRUMS** part.

[APC Ctrl] (APC CONTROL): Enable the exchange of data for the on/off status of the **AUTO PLAY CHORD's** BASIC, ADVANCED 1, 2 and PIANIST modes (On/Off).

- Data is exchanged on the channel for the **ACCOMP 1** part.

5. Repeat steps 3 and 4 for the other settings as desired.

CONTROL MESSAGE

Enable or disable the exchange of various control data.

1. On the **MIDI** menu display, select [P4 Control Msg].
 - The display looks similar to the following.

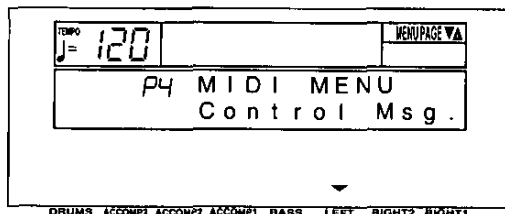

2. Press either **LEFT** button.
 - The display looks similar to the following.

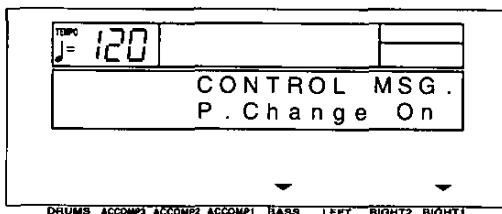

3. Use the **BASS** \wedge and \vee buttons to select the control message.
 - Select from the following: P.Change (PROGRAM CHANGE), Bank Sel (BANK SELECT), P.Bend (PITCH BEND), Volume, Express. (EXPRESSION), Panpot, Sustain, EFF&REV (EFFECT & REVERB), Modulat. (MODULATION), Tuning, Bend Rng (BEND RANGE), AftTouch (AFTER TOUCH), Rst.Cnt. (RESET ALL CONTROLLERS).
4. Use the **RIGHT 1** \wedge and \vee buttons to specify on or off for the control message.

On: Data for the control operation is exchanged.

Off: Data for the control operation is not exchanged.

- The [Bank Sel] setting is effective only when [P. Change] is set to On.
 - The [EFF&REV] setting controls the **DIGITAL EFFECT** and **DIGITAL REVERB** on/off.
 - The [Tuning] setting is the on/off setting for the Tuning and Key Shift settings.
5. Repeat steps 3 and 4 for each control as desired.

INPUT/OUTPUT SETTING

Make the settings which determine how various performance data is treated during data transmission and reception.

1. On the **MIDI** menu display, select [P5 IN/OUT Set].
- The display looks similar to the following.

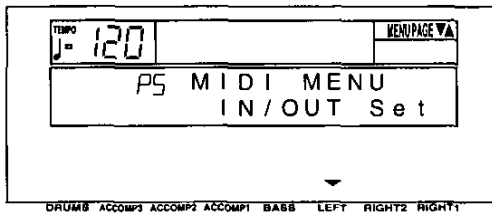

2. Press either **LEFT** button.
- The display looks similar to the following.

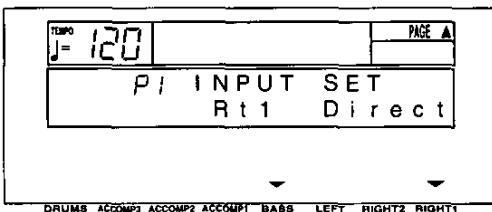

3. Use the **BASS** ^ and v buttons to select the item.
4. Use the **RIGHT 1** ^ and v buttons to change the setting.

[Rt1] (RIGHT 1 INPUT)

Cond: When data for the **RIGHT 1** part is received, the **CONDUCTOR** and **PLAY STYLE** determine which part it is used for.

Direct: When data for the **RIGHT 1** part is received, it is treated as **RIGHT 1** data, and performance data for all parts is received on their respective basic channels.

[APC] (APC INPUT)

On: Input data for the **ACCOMP 1, 2, 3, BASS, DRUMS** and **CHORD** parts is received.

Off: Data for the above parts is not received.

- Basic channels should be assigned to the above parts before exchanging data.

5. Press the **PAGE** ^ button.
- The display looks similar to the following.

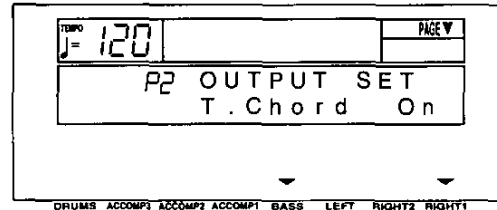

6. Use the **BASS** ^ and v buttons to select the output item.
7. Use the **RIGHT 1** ^ and v buttons to change the setting.

[T.Chord] (TECHNI-CHORD OUTPUT)

On: Keyboard notes generated by the **TECHNI-CHORD** function are also transmitted.

Off: Only key note data of the pressed keys is transmitted.

[Drums] (DRUMS OUTPUT)

On: Data from the **DRUMS** part is transmitted.

Off: Data from the **DRUMS** part is not transmitted.

[APC] (APC OUTPUT)

On: The data for the **ACCOMP 1, 2, 3, BASS** and **CHORD** parts is transmitted.

Off: The data for the above parts is not transmitted.

- Basic channels should be assigned to the above parts before exchanging data.

[Trans.] (TRANSCOPE)

On: The note number of the transposed note is transmitted/received.

Off: The note number of the played key is transmitted/received.

REALTIME MESSAGE

Enable or disable the exchange of **START/STOP** data (REALTIME COMMANDS), and select the **CLOCK** mode.

1. On the **MIDI** menu display, select [P6 Realtime Msg].
 - The display looks similar to the following.

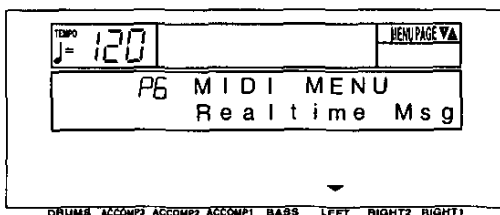

2. Press either **LEFT** button.
 - The display looks similar to the following.

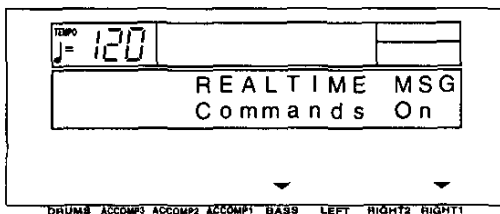

3. Use the **BASS** \wedge and \vee buttons to select a function (Commands/Clock).

4. Use the **RIGHT 1** \wedge and \vee buttons to change the setting.

[Commands]

On: Rhythm and **SEQUENCER** start/stop, continue, and song position pointer data can be transmitted/received.

Off: This data cannot be transmitted/received.

[Clock]

Int: This instrument's internal clock is used to control the performance. The clock of the connected equipment is disabled.

Mid: The clock of the connected equipment is used to control the performance. This instrument's clock is disabled. (The tempo is displayed as [J = - -].)

- The Clock is set to "Int" when the power to this instrument is turned on.

5. Repeat steps 3 and 4 for the other function if desired.

MIDI PRESETS

Establish the optimum settings depending on how this instrument is connected to other equipment, and on whether this instrument is used as the master or the slave.

1. On the **MIDI** menu display, select [P7 MIDI Presets].
 - The display looks similar to the following.

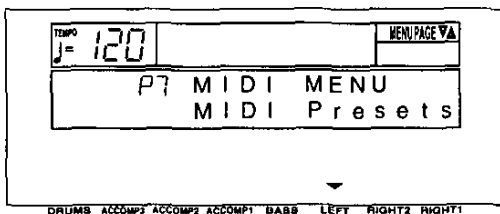

2. Press either **LEFT** button.
 - The display looks similar to the following.

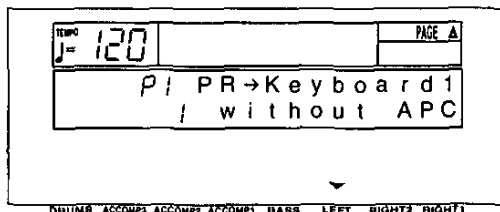

3. Use the **LEFT** \wedge and \vee buttons to select the connection setup.

- There are two pages to this display. Use the **PAGE** buttons to change the page.
- The P1 display shows connection setups for when the **AUTO PLAY CHORD** is not used (without APC). And the P2 display shows connection setups for when the **AUTO PLAY CHORD** is used (with APC).

4. Press the **EXECUTE** button.

- When the settings have been successfully stored, "COMPLETED!" appears on the display.
- Detailed information about the **PRESETS** can be found in the separate **REFERENCE GUIDE** provided.

GENERAL MIDI

GENERAL MIDI (GM) is the standard which enables MIDI data exchange between different models or equipment of different manufacture. Program change numbers and their corresponding sounds, percussion instrument sounds, note numbers, etc. are data compatible between equipment using this standard.

1. On the **MIDI** menu display, select [P8 GM Mode].
 - The display looks similar to the following.

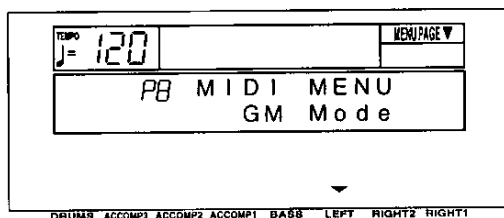

2. Press either **LEFT** button.
 - The display looks similar to the following.

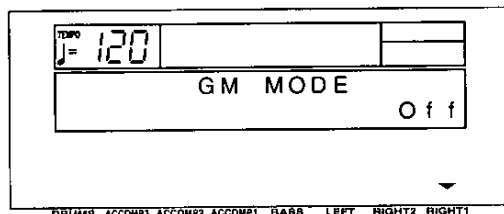

3. Use the **RIGHT 1** ^ and v buttons to specify whether or not this instrument should be compatible with GENERAL MIDI standard instruments (On/Off).
 - This setting is automatically set to Off when the power is turned on.
 - If On is selected, the status of this instrument changes to the GENERAL MIDI status, and the sounds and operations which can be selected are limited. In addition, the arrangement of percussion sounds on the keyboard changes. (Refer to the separate REFERENCE GUIDE provided.)

4. Press the **EXECUTE** button.
 - The display looks similar to the following.

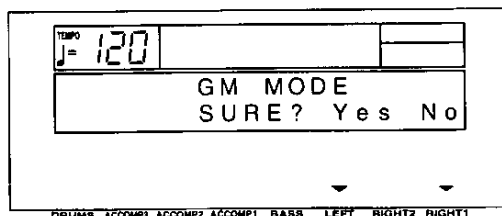

5. Press either **LEFT** (Yes) button.
 - Press either **RIGHT 1** (No) button if you wish to cancel the function.
 - If On was selected, the GENERAL MIDI logo is shown on the display.
 - If the setting is changed from Off to On, the **SEQUENCER** memory is cleared and the panel settings are reset.
 - If On is selected, this setting is automatically set to Off when the power is turned off, and all the memories are cleared.

Initialize

This instrument has many settable functions and storable memories. However, you can return the settings and memory to the factory-preset status.

INITIAL

1. Press the **MEMORY & CONTROL** button to turn it on.

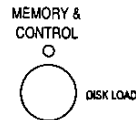

- The display changes to the following.

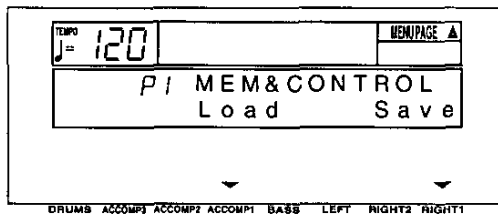

2. Use the **PAGE** ^ and v buttons to select [P5 Initial].

- This display looks similar to the following.

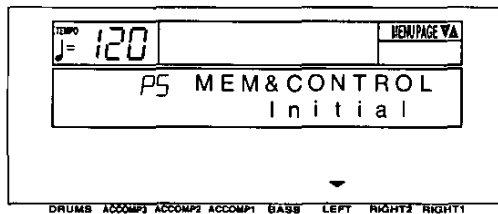

3. Press either **LEFT** button.

- The display looks similar to the following.

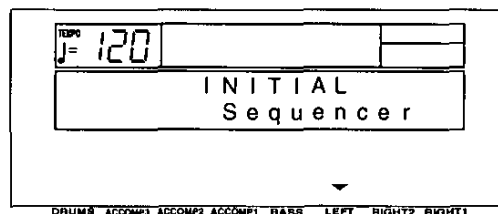

4. Use the **LEFT** ^ and v buttons to select the desired type of initialization.

- Select from [Total] (includes all the following data), [Composer], [Sequencer], [Part Setting], [MIDI Setting] or [Panel Memory].

5. Press the **EXECUTE** button.

- The display changes to the confirmation display. Press either **LEFT** (Yes) button if you wish to execute the initialization. Press either **RIGHT 1** (No) button if you wish to cancel the procedure.

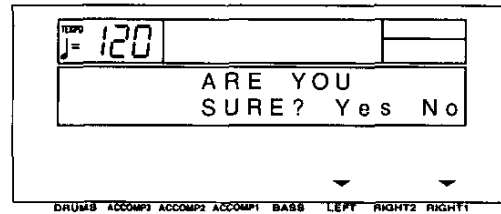

- When you press either **LEFT** (Yes) button, initialization begins. When initialization is completed, "COMPLETED!" is shown on the display and this instrument returns to the normal performance mode.

- You can also reset all the instrument settings with the following procedure: Turn off the **POWER** button once. Then, while pressing the three lower left buttons in the **RHYTHM GROUP** section (**ROCK**, **FUNK & FUSION** and **TRAD DANCE**) at the same time, turn the **POWER** button on again.

- All the instrument settings may be initialized when the power is turn on, for example, if the effective time of the backup memory has been exceeded.

■ About the backup memory

The settings and memories are maintained for approximately 80 minutes after the power to this instrument is turned off. If you wish to keep the memory contents, before you turn off the instrument, use the *SAVE* procedure to store the desired data on a disk for recall at a later time.

- The backup memory does not function until the power has been on for about 10 minutes.
- When you quit the operating mode, a warning display may appear to remind you to save the data.

Power on settings

When the **POWER** button of this instrument is turned on, the settings below are automatically set to those suitable for piano performance.

PLAY STYLE: PIANO MODE

Sound: **GRAND PIANO**

TRANSPOSE: C

SUSTAIN PEDAL: On

SYNCHRO START: Off

MINIMUM RANGE: On

All **PART SETTING** items for the **RIGHT 1** part:

Appropriate values

PEDAL SETTING:

Left: **SOFT**

Center: **SOSTENUTO (PR600)**

- When you turn the power on, you can recall all the settings which were in effect at the time you turned the instrument off: while depressing the sustain (right) pedal, turn on the power.

Connections

(On the back of the piano)

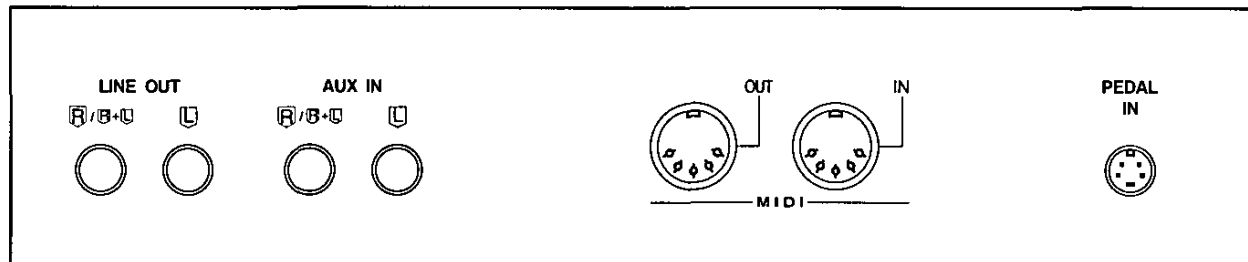

MIDI

These terminals are for connection to another MIDI instrument. (Refer to page 92.)

PEDAL IN

Connect the included pedal.

AUX IN (input level 0.5 Vrms, 6 k Ω)

Other instruments such as a rhythm machine or sound module can be connected to the piano so that the sound is output from the piano. To receive monaural sound, connect instruments to the **R/R+L** terminal.

LINE OUT (output level 1.5 Vrms, 600 Ω)

By plugging into a high-power amplifier, the sound can be reproduced at a high volume. (Use the **R/R+L** terminal when outputting monaural sound.)

phones \times 2

(Beneath the keyboard, on the left side)

For silent practice, headphones may be used. When plugged in, the speaker system is automatically switched off, and sound is heard only through the headphones.

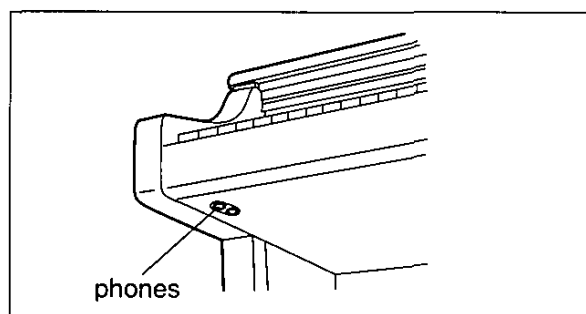

Assembly

Follow the steps below to assemble your Technics piano. Make sure you are using the correct parts and that they are in the correct direction.

- At least 2 people are required for assembly.
- To disassemble the piano, reverse the procedure.

1. Remove the packing and take the parts out of the carton. Confirm that all the parts on the printed list are present.

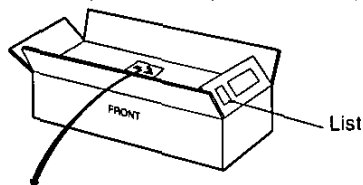

2. The following parts are in the screw kit.

	Brass-colored screws	4
	Black screws.....	8
	Clamps	3

3. Affix the right and left side planks to the pedal box.

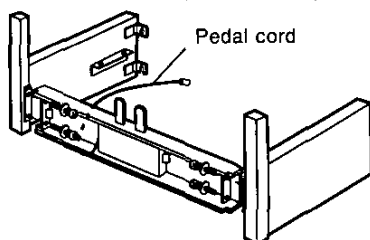

- (1) Use the 4 brass-colored screws to secure the planks.
- (2) Loosen the pedal cord, stowed on the inner side of the pedal box, and extend it.

4. Affix the cross bar.

- Use 4 black screws to affix the cross bar to the side planks.

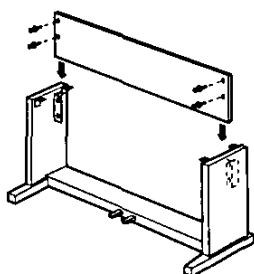

5. Place the piano body on the stand.

WARNING:
Avoid pinching your fingers.

Note 1
Holding the piano body at least 10 cm in from the edge, place it on the stand so that it does not fall off.

Note 2
If the piano body is placed too far to the right or left, or to the front or back, it will become unstable.

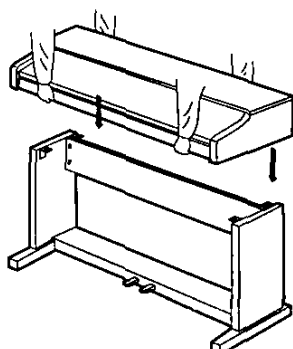

6. Secure the piano body to the stand.

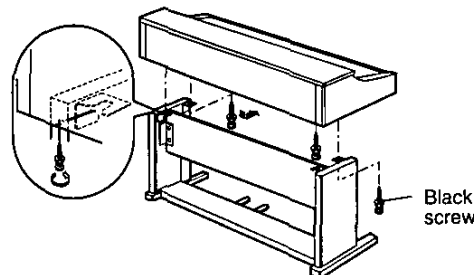

- (1) Insert 2 black screws in the 2 rear screw holes on the underside of the piano body, and turn each screw 5 or 6 times. Push the piano body forward so that the screws are fully inserted in the cutout of the metal piece on either side plank. (This enables you to easily position the piano body on the stand.)

- (2) Adjust the piano body so that the right and left sides project evenly over the stand.

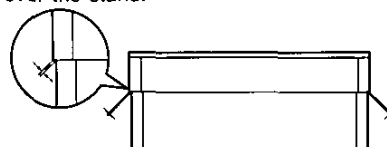

- (3) Positioning the piano body on the stand, confirm that the 4 screws can easily be inserted.
- (4) Tighten the 4 black screws securely.

7. Connect the pedal cord and power cord to the terminals.

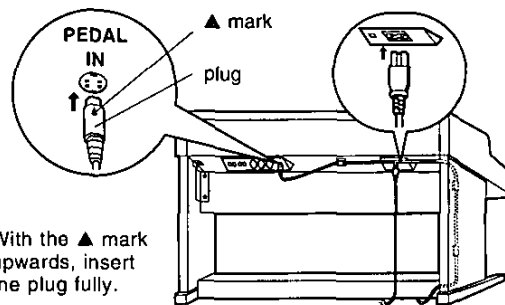

With the ▲ mark upwards, insert the plug fully.

- (1) Plug the pedal chord and power cord into the terminals on the rear of the piano.
- (2) Remove the backing from the clamps and affix them as shown in the figure. Secure the pedal cord to the clamps.

Confirm: After assembling, check these points.

- Are any parts left over?
→ Check the assembly procedure again.
- Does the piano rattle when it is rocked?
→ Make sure all the screws are securely tightened.
- Is the power cord firmly inserted?
→ Check again.
- Is the plug of the pedal cord inserted as far into the connector terminal as it will go?
→ If it is not completely inserted, the sustain and other pedal functions may not work.
- When the piano has been moved or transported, retighten the screws securely.

Symptoms which appear to be signs of trouble

The following changes in performance may occur in this instrument but do not indicate trouble.

	Phenomenon	Remedy
Sounds and effects	The buttons, keys, etc. malfunction.	<ul style="list-style-type: none"> • Turn off the POWER button once, then turn it on again. If this procedure is not successful, turn off the POWER button once. Then, while pressing the three lower left buttons in the RHYTHM GROUP section (ROCK, FUNK & FUSION, TRAD DANCE) at the same time, turn the POWER button on again. (Note that, in this case, all programmable settings, functions and memories return to their factory-preset status.)
	No sound is produced when the keys are pressed.	<ul style="list-style-type: none"> • The MAIN VOLUME is at the minimum setting. Adjust the volume with the MAIN VOLUME control. • The volumes for the selected parts are set to the minimum levels. Use the balance buttons to set the volumes of the relevant parts to appropriate levels. (Refer to page 19.) • The part is muted. (Refer to page 19.) • The local control for a part performed on the keyboard is set to OFF. Set the local control to ON. (Refer to page 96.)
	Only percussive instrument sounds are produced when the keyboard is played.	<ul style="list-style-type: none"> • In the SOUND GROUP section, the KEYBOARD PERC button is on.
	The volume is very low when the keyboard is played.	<ul style="list-style-type: none"> • The volume setting in the SEQUENCER contents is very low. Follow the INITIAL procedure to reset the settings. (Refer to page 102.)
	Some sounds cannot be selected.	<ul style="list-style-type: none"> • When the GENERAL MIDI status is set to on, The sounds which can be selected and operation which can be executed are limited. Turn the GENERAL MIDI status off to return the instrument to its normal operation. (Refer to page 101.)
	The sound you hear is different from the sound you selected.	<ul style="list-style-type: none"> • This sometimes occurs when you play back SEQUENCER or COMPOSER data which was created on a different model, or when MIDI data is received from a connected instrument. Select the desired sounds again.
	The sustain does not work even when the sustain pedal is depressed.	<ul style="list-style-type: none"> • The sustain pedal is not connected. Connect the pedal cord firmly to the PEDAL IN terminal on the back of the instrument. • When the SUSTAIN PEDAL button is off, the sustain does not work even when the pedal is depressed. Turn on the SUSTAIN PEDAL button.
	The soft/sostenuto (PR600) pedal does not operate properly. For example, when the soft pedal is depressed, the rhythm starts or a fill-in is played.	<ul style="list-style-type: none"> • Different functions can be programmed in these pedals. You can return the pedal to its original function by turning off the instrument once, or by using the PEDAL SETTING mode. (Refer to page 48.)

	Phenomenon	Remedy
Rhythm	The rhythm does not start.	<ul style="list-style-type: none"> • The RHYTHM VOLUME sliding controller is set to OFF. Set the volume to an appropriate level. • The DRUMS volume is set to the minimum level. Use the balance buttons to set the DRUMS volume to an appropriate level. • A rhythm in COMPOSER MEMORY with no stored pattern was selected. Select a different rhythm. • The PLAY button in the SEQUENCER section is on. When you are not playing back the SEQUENCER performance, turn off the PLAY button. • CLOCK is set to MIDI. Set CLOCK to INTERNAL. (Refer to page 100.) • The rhythm does not work when the GENERAL MIDI mode is set to ON. Turn the GENERAL MIDI status off to return the instrument to its normal operation. (Refer to page 101.)
AUTO PLAY CHORD	No sound is produced for the automatic accompaniment.	<ul style="list-style-type: none"> • The RHYTHM VOLUME sliding controller is set to OFF. Set the volume to an appropriate level. • A rhythm in COMPOSER MEMORY with no stored pattern was selected. Select a different rhythm.
	No sound is produced for the automatic accompaniment, or only the sounds of some parts are produced.	<ul style="list-style-type: none"> • An ACCOMP part does not sound if its corresponding volume is set to the minimum level. Use the respective balance buttons to set the ACCOMP 1, 2 and 3 volumes to appropriate levels.
SEQUENCER	Storage is not possible.	<ul style="list-style-type: none"> • The remaining memory capacity of the SEQUENCER is 0. Follow the SONG CLEAR or TRACK CLEAR procedure to erase the memory. (Refer to page 63.)
	Multi-track storage is not possible.	<ul style="list-style-type: none"> • The playback track has been selected, but the START/STOP button has not been pressed. On the recording display, the track marked with a horizontal bar in the REC row is the track which is ready for recording; a track marked with a horizontal bar in the PLAY row is a track which is ready for playback. To record one track while listening to another (playback) track, press the START/STOP button to begin playback.
	The playback measure indication is different from when the performance was recorded.	<ul style="list-style-type: none"> • The number of measures corresponds to the time signature of the rhythm selected at the start of recording. To change the rhythm in the middle of the song, record the rhythm change in the RHYTHM part. (Refer to page 61.)

	Phenomenon	Remedy
COMPOSER	Storage is not possible.	<ul style="list-style-type: none"> The remaining memory capacity of the COMPOSER is 0.
	Setting the time signature and number of measures is not possible.	<ul style="list-style-type: none"> The time signature and number of measures cannot be changed for a pattern which is currently recorded in the COMPOSER. If you wish to change the time signature and/or measure data, first follow the procedure to clear the memory. (Refer to page 70.)
	The playback timing of the rhythm pattern is different from the timing with which it was recorded.	<ul style="list-style-type: none"> The QUANTIZE function was on when the pattern was recorded and the timing was automatically corrected. Set the quantize level to a smaller note unit or to OFF when recording. (Refer to page 73.)
Disk Drive	The Disk Drive produces a noise during recording or playback.	<ul style="list-style-type: none"> This occurs when the Disk Drive is reading a disk. It does not indicate a problem.
	When the procedure to load from a disk is performed, the contents of this instrument's memory are erased.	<ul style="list-style-type: none"> When performing the load operation from a disk, this instrument's memory changes to that of the data loaded from the disk. If you wish to preserve a song which is stored in this instrument's memory, save it on a disk before performing the load procedure. (Refer to page 83)
Other	Noise from a radio or TV can be heard.	<ul style="list-style-type: none"> This sometimes occurs when electrical equipment such as a radio or TV is used near the instrument. Try moving such electrical equipment further away from the instrument. The sound may be coming from a nearby broadcast station or amateur radio station. If the sound is bothersome, consult your dealer or service center.
	The cabinet becomes warm during use.	<ul style="list-style-type: none"> This instrument has a built-in power source that heats the cabinet to some degree. This is not an indication of trouble.

Error messages

	Display	Contents
00	WRONG DISK!	The data on the disk that you are using is for a different product.
01	LOAD ERROR TRY AGAIN!	An error has occurred while the disk was loading. Please try again.
02	NO DISK!	There is no disk in the Disk Drive.
03	FILE EMPTY!	The file that you tried to load is empty.
04	SAVE ERROR TRY AGAIN!	An error has occurred while the data was being saved. Please try again.
05	WRITE PROTECTED!	The disk that you are using is write protected. Please remove the write protection and try again.
06	DISK FULL!	The disk that you are using is full. Please use another disk.
07	FORMAT ERROR TRY AGAIN!	An error has occurred while the disk was formatting. The disk that you are using may be faulty. Please try formatting another disk.
08	DATA IS COPY PROTECTED!	The data on this disk is copy protected.
09	ALREADY COPY PROTECTED!	The data on this disk is already copy protected.
11	SEQUENCER DATA ERROR!	There is an error in the SEQUENCER data. Playback is not possible.
12	MEMORY FULL!	The memory is full. No more data can be recorded.
13	CHANGE IMPOSSIBLE!	It is not possible to change the time signature of a COMPOSER pattern after it has been recorded. If you want to proceed, you must first clear the entire COMPOSER pattern.
14	TIME SIG MISMATCH!	The time signature of the pattern from which you are copying is different from the COMPOSER memory that you are using. Either: Change the time signature of the COMPOSER memory or: Copy from a pattern that has the same time signature.
15	TIME SIG ALREADY SET	The time signature has already been set. It cannot be changed.
16	TRACK EXISTS!	The specified track already exists. It is impossible to assign two tracks to that part.
17	FILE TOO LONG!	This song is too long to be saved as an SMF file.
18	SMF LOAD ERROR!	The SMF file that you tried to load exceeds the memory capacity of this instrument and cannot be loaded. The destination SEQUENCER memory has been cleared.
22	"ALL" OPTION ONLY AVAIL	To load data which was saved on an older model Technics instrument, set the load option to "ALL".
23	NO SEQUENCER DATA!	There is no data in the SEQUENCER .
24	SMF CONVERT ERROR!	An error occurred in the SMF conversion.
25	NOT STANDARD MIDI FILE!	This disk is not in the Standard MIDI File data format.
26	SMF CONVERT ERROR!	SMF conversion is possible only for files with a time base (PPQ resolution) of 24/48/96/192/288/384.

Display		Contents
27	SMF FORMAT ERROR!	FORMAT 2, 3, 4 ... SMF data cannot be used.
28	RHYTHM & CHORD ONLY!	Step record can be activated only for tracks to which the RHYTHM or CHORD part has been assigned.
31	TRACK ASSIGN MISMATCH!	Special tracks such as CHORD/APC, RHYTHM and CONTROL exist in the song from which you are copying and are incompatible with the destination song because it is in the GM mode.
32	MEAS/T. SIG MISMATCH!	The COMPOSER pattern you have chosen has a different time signature or number of measures from the other patterns in this COMPOSER CHORD MAP . All of the COMPOSER patterns used in a COMPOSER CHORD MAP must have the same time signature and number of measures.
33	NOT ENOUGH AVAIL MEMORY	The song that you have tried to load exceeds the this instrument's available memory and cannot be loaded. The selected SEQUENCER song memory has been cleared. Please clear existing songs in the instrument's memory using SONG CLEAR to make more memory available, and try again.
34	THIS FILE IS SMF FORMAT1!	This is an SMF FORMAT 1 file. Direct Play and Sequencer Medley are not available for this file.
36	RKB/LKB: REC IMPOSSIBLE!	RKB and LKB are special tracks for compatibility with sequencer data from previous PR products. They cannot be edited or recorded on.
37	RE-ASSIGN RKB/LKB!	RKB and LKB are special tracks which cannot be used in conjunction with RIGHT 1, RIGHT 2, LEFT and APC tracks. Please re-assign RKB and LKB to any other part and try again.
38	NO CHORD TRACK!	[Chord] was selected in the Step record mode of the SEQUENCER , but there is no track to which the [Chord] part has been assigned.
39	NO RHYTHM TRACK!	[Rhythm] was selected in the Step record mode of the SEQUENCER , but there is no track to which the [Rhythm] part has been assigned.

Index

A	
ADVANCED 1, 2	40
APC CONTROL, MIDI	97
AUTO PLAY CHORD	38
AUTO PLAY CHORD INPUT, MIDI	99
AUTO PLAY CHORD OUTPUT, MIDI	99
AUX IN	104

B	
Backup memory	103
BALANCE	19
BASIC CHANNEL, MIDI	95
BEAT	36

C	
CHORUS	30
CLOCK, MIDI	100
COMMON SETTING, MIDI	97
COMPOSER	67
COMPOSER CHORD MAP	74
COMPOSER COPY	69
CONDUCTOR	25
Connections	104
CONTRAST	23
CONTROL MESSAGE, MIDI	98
COUNT INTRO	37

D	
DEMO	9
DIGITAL EFFECT	30
DIGITAL REVERB	31
DIRECT PLAY	81
Disk Drive	76
DISK LOAD	78
DISK SAVE	83
Display	19
DISPLAY HOLD	22
DRUMS OUTPUT, MIDI	99
DRUMS TYPE, MIDI	97

E	
EASY RECORD	52
EDIT, SEQUENCER	63
ENDING	38
Error messages	109
EXIT	22

F	
FILL IN	38
FINGERED	39
FLOPPY DISK FORMAT	82

G	
GENERAL MIDI (GM)	101
GLIDE	48

H	
Headphones	104

I	
INITIAL	102
INPUT/OUTPUT SETTING, MIDI	99
INST ERASE	73
INTRO & ENDING	37
INTRO, MIDI	97

K	
KEY SCALING	90
KEY SHIFT	88
KEYBOARD PERC	26
KEYBOARD SPLIT	27

L	
LEFT HOLD	91
LEFT SELECT	27
LINE OUT	104
LOAD SINGLE COMPOSER PATTERN	80
LOCAL CONTROL, MIDI	96

M	
MAIN VOLUME	8
MASTER TUNING	89
MEASURE & TIME SIGNATURE	71
MEMORY & CONTROL	77
MENU	21
METRONOME	36
MIDI	92
MIDI PRESETS	100
MIDI SETUP LOAD	97
Music stand	8
MUSIC STYLE SELECT	44
MUSIC STYLE ARRANGER	45
MUTE	19

N	
NOTE ONLY, MIDI	97

O	
OCTAVE SHIFT, MIDI	96
ON BASS	40
ONE FINGER	39
ONE TOUCH PLAY	43
OTHER PARTS/TRACKS	20

P	
PAGE	20
PAN	88
PANEL MEMORY	46
PART SETTING	88
Pedal	29
PEDAL SETTING	48
PIANIST	40

PIANO MODE	25
PIANO STYLIST	42
PITCH BEND RANGE	88
PLAY STYLE	24
POWER	8
PROGRAM CHANGE MODE, MIDI	97

Q

QUANTIZE, COMPOSER	73
QUANTIZE, SEQUENCER	64

R

REALTIME COMMANDS, MIDI	100
REALTIME RECORD	54
RHYTHM GROUP	35
RHYTHM VOLUME	42
RIGHT 1 INPUT, MIDI	99

S

SET	46
SEQUENCER	49
SEQUENCER EDIT	63
SEQUENCER MEDLEY	66
SEQUENCER PLAY	56
SEQUENCER RESET	56
SMF LOAD	80
SMF SAVE	85
SONG CLEAR	63
SONG SELECT/NAME	51
SOUND GROUP	26
Specifications	113
SPLIT POINT	28
Standard MIDI File (SMF)	76
START/STOP	36, 52
STEP RECORD: CHORD	58
STEP RECORD: RHYTHM	61
SUSTAIN PEDAL	29
SYNCHRO START	36

T

TAP TEMPO	37
TECHNI-CHORD	33
TECHNI-CHORD OUTPUT, MIDI	99
TECHNI-CHORD TYPE	34
TEMPO	36
TOUCH & TUNE	89
TRACK ASSIGN	62
TRACK CLEAR	64
TRANSPOSE	32
Troubleshooting	106
TUNING	89

V

VARIATION & MSA	35
VOLUME	88
Volume balance	19

Specifications

		SX-PR500/SX-PR500M	SX-PR600/SX-PR600M
KEYBOARD		88 KEYS	
SOUND GENERATOR		PCM	
MAXIMUM NUMBER OF NOTES PRODUCED SIMULTANEOUSLY		32 NOTES	
PLAY STYLE		PIANO MODE, KEYBOARD SPLIT, AUTO PLAY CHORD	
SOUNDS	PIANO	4 SOUNDS GRAND, UPRIGHT, ELECTRIC, MODERN	
	SOUND GROUP	181 SOUNDS GROUP PIANO & E PIANO, HARPSI & MALLETT, GUITAR, SPECIAL PERC, STRINGS & VOCAL, ORGAN & ACCORDION, BRASS, SAX & REED, FLUTE, SYNTH LEAD, BASS, SYNTH PAD, KEYBOARD PERC, PERC & EFFECT	
CONDUCTOR		RIGHT 1, RIGHT 2, LEFT SELECT	
PEDAL		SUSTAIN, SOFT	SUSTAIN, SOSTENUTO, SOFT
DIGITAL EFFECT		<input type="radio"/>	
CHORUS		<input type="radio"/>	
DIGITAL REVERB		<input type="radio"/>	
TRANSPOSE		G-C-F#	
RHYTHMS		128 RHYTHMS x 4 VARIATIONS GROUP 8 BEAT, ROCK, 16 BEAT, FUNK & FUSION, SOUL & DISCO, TRAD DANCE, BIG BAND & SWING, JAZZ COMBO, COUNTRY, U S TRAD, SHOW TIME, MARCH & WALTZ, LATIN 1, LATIN 2	
METRONOME		<input type="radio"/>	
CONTROLS		MAIN VOLUME, RHYTHM VOLUME, BALANCE/MUTE, START/STOP, INTRO & ENDING 1, INTRO & ENDING 2, FILL IN 1, FILL IN 2, COUNT INTRO, SYNCHRO START, TEMPO, TAP TEMPO, SPLIT POINT, EXECUTE, SOUND SELECT, RHYTHM SELECT	
AUTO PLAY CHORD		BASIC, ADVANCED 1, ADVANCED 2, PIANIST, ON BASS, MUSIC STYLE ARRANGER	
ONE TOUCH PLAY		<input type="radio"/> (ONE TOUCH PLAY/MUSIC STYLE SELECT)	
PIANO STYLIST		<input type="radio"/>	
TECHNI-CHORD		<input type="radio"/>	
PANEL MEMORY		1-5, SET	
SEQUENCER		16 TRACKS RESOLUTION 96 PULSES PER QUARTER-NOTE STORAGE CAPACITY APPROX 30000 NOTES (10 SONGS MAX) INPUT MODES EASY RECORD, REALTIME RECORD, STEP RECORD (CHORD, RHYTHM) FUNCTIONS TRACK ASSIGN, EDIT, SONG SELECT/NAME, MEDLEY	

	SX-PR500/SX-PR500M	SX-PR600/SX-PR600M
COMPOSER	5 PARTS: BASS, ACCOMP 1, ACCOMP 2, ACCOMP 3, DRUMS STORAGE CAPACITY: APPROX.10000 NOTES INPUT MODES: REALTIME RECORD FUNCTIONS: COMPOSER CHORD MAP, MODE SELECT, PATTERN COPY, LOAD SINGLE COMPOSER PATTERN MEMORY: 3 BANKS × 10 (VARIATION 1-4, INTRO 1, 2, FILLIN 1, 2, ENDING 1, 2)	
MEMORY & CONTROL	INITIAL, DISK LOAD, DISK SAVE, DIRECT PLAY, MEDLEY, PEDAL SETTING, FLOPPY DISK FORMAT, CONTRAST	
SOUND SETTING	PART SETTING, TOUCH & TUNE, KEY SCALING, LEFT HOLD, TECHNI-CHORD, REVERB, CHORUS	
MIDI	CHANNEL, CONTROL MESSAGE, PART SETTING REALTIME MESSAGE, COMMON SET, MIDI PRESETS, IN/OUT SET, GM MODE	
EXTERNAL MEMORY	BUILT-IN 3.5 inch FLOPPY DISK DRIVE FOR 2HD (1.44 MB), 2DD (720 KB)	
DISPLAY	LCD PAGE, BALANCE, EXIT, DISPLAY HOLD, OTHER PARTS/TRACKS	
DEMO	○	
TERMINALS	PHONES, LINE OUT (R/R+L, L), AUX IN (R/R+L, L), MIDI (IN, OUT), PEDAL IN	
OUTPUT	40 W × 2	
SPEAKERS	16 cm × 2, 6.5 cm × 2	
POWER REQUIREMENT	180 W, 110 W (NORTH AMERICA AND MEXICO)	
	AC120/220/240V 50/60 Hz AC120V 60 Hz (NORTH AMERICA AND MEXICO) AC230-240V 50/60 Hz (EUROPE, AUSTRALIA, NEW ZEALAND, SINGAPORE AND PHILIPPINES)	
DIMENSIONS (W × H × D)	138.5 cm × 105.1 cm × 61.1 cm (54-17/32" × 41-3/8" × 24-1/16")	
NET WEIGHT	57 kg (125.7 lbs.)	60 kg (132.3 lbs.)
ACCESSORIES	STAND, AC CORD, MUSIC STAND	

- Design and specifications are subject to change without notice.
- In some markets, some models may not be available.

MEMO

MEMO

