

# Technics

D	I	G	I	T	A	L
P	I	A	N	O		

## SX-PC8





# Technics

## OWNER'S MANUAL

**WARNING: TO REDUCE THE RISK OF FIRE OR ELECTRICAL SHOCK, DO NOT EXPOSE THIS PRODUCT TO RAIN OR MOISTURE.**

BEFORE YOU PLAY, PLEASE READ THE CAUTIONARY COPY APPEARING ON PAGE 1.

	<b>CAUTION</b> RISK OF ELECTRIC SHOCK DO NOT OPEN	
<p>CAUTION: TO REDUCE THE RISK OF ELECTRIC SHOCK, DO NOT REMOVE SCREWS. NO USER-SERVICEABLE PARTS INSIDE. REFER SERVICING TO QUALIFIED SERVICE PERSONNEL.</p>		



The lightning flash with arrowhead symbol, within an equilateral triangle, is intended to alert the user to the presence of uninsulated "dangerous voltage" within the product's enclosure that may be of sufficient magnitude to constitute a risk of electric shock to persons.



The exclamation point within an equilateral triangle is intended to alert the user to the presence of important operating and maintenance (servicing) instructions in the literature accompanying the appliance.

Note: This equipment has tested and found to comply with the limits for a Class B digital device pursuant to Part 15 of the FCC Rules. These limits are designed to provide reasonable protection against harmful interference in a residential installation. This equipment generates, uses and can radiate radio frequency energy and, if not installed and used in accordance with the instructions, may cause harmful interference to radio communications. However, there is no guarantee that interference will not occur in a particular installation. If this equipment does cause harmful interference to radio or television reception which can be determined by turning the equipment off and on, the user is encouraged to try to correct the interference by one or more of the following measures:

- Reorient or relocate the receiving antenna.
- Increase the separation between the equipment and receiver.
- Connect the equipment into an outlet on a circuit different from that to which the receiver is connected.
- Consult the dealer or an experienced radio/TV technician for help.

The model number of this product is found on the rear of the unit.

The model number and serial number are found underneath the keyboard.

Please note the model and serial numbers in the space provided below and retain this sheet as a permanent record of your purchase to aid identification in the event of theft.

MODEL NUMBER

SERIAL NUMBER

## Before you play

For long and pleasurable use of this instrument, and to gain a thorough understanding of your PC series Digital Piano, it is strongly recommended that you read through this Owner's Manual once.

# Important Safety Instructions

## WARNING

When using electric products, basic precautions should always be followed, including the following,

- Read all the instructions before using the product

## Safety

- **Power Source**—The product should be connected to a power supply only of the type described in the operating instructions or as marked on the product
- **Polarization**—This product may be equipped with a polarized line plug (one blade wider than the other). This is a safety feature. If you are unable to insert the plug into the outlet, contact an electrician to replace your obsolete outlet. Do not defeat the safety purpose of the plug.
- **Periods of Non-use**—The power-supply cord of the product should be unplugged from the outlet when left unused for a long period of time.

## Installation

- **Water and Moisture**—Do not use this product near water—for example, near a bathtub, washbowl, kitchen sink, in a wet basement, or near a swimming pool, or the like.
- **Cart/Stand**—This product should be used only with a cart or stand that is recommended by the manufacturer.
- **Ventilation**—The product should be located so that its location or position does not interfere with its proper ventilation.
- **Heat**—The product should be located away from heat sources such as radiators, heat registers, or other products that produce heat.
- **Foreign Material**—Care should be taken so that objects do not fall and liquids are not spilled into the enclosure through openings.

## Listening caution

This product, either alone or in combination with an amplifier and headphones or speakers may be capable of producing sound levels that could cause permanent hearing loss. Do not operate for a long period of time at a high volume level or at a level that is uncomfortable. If you experience any hearing loss or ringing in the ears, you should consult an audiologist.

## Service

- **Damage Requiring Service**—The product should be serviced by qualified service personnel when:
  - a The power-supply cord or the plug has been damaged, or
  - b Objects have fallen, or liquid has been spilled onto the product, or
  - c The product has been exposed to rain, or
  - d The product does not appear to operate normally or exhibits a marked change in performance, or
  - e The product has been dropped, or the enclosure damaged.
- **Servicing**—Do not attempt to service the product beyond that described in the user-maintenance instructions. All other servicing should be referred to qualified service personnel.

## Maintenance

- Be sure to switch this unit off after use, and do not switch the unit on and off in quick succession, as this places an undue load on the electronic components.
- To maintain the luster of the keys and buttons, wipe with a clean, damp cloth, and polish with a soft, dry cloth. Polish may be used, but do not use thinners or petro-chemical-based polishes.
- A wax-based polish may be used on the cabinet, although you will find that rubbing with a soft cloth will suffice.

**SAVE THESE INSTRUCTIONS**

# How to use

## Prepare to play

**1** Plug the power cord into the wall socket

**2** Install the music stand (included)  
• Insert it into the two holes

**3** Turn on the **POWER** button

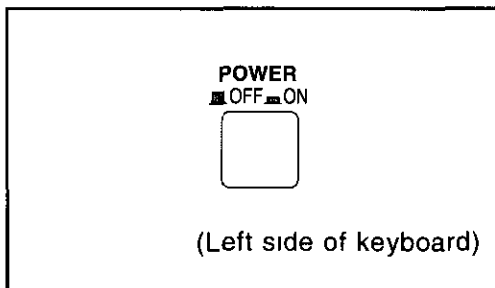

• You can now play the keyboard for a piano performance

**4** Adjust the loudness with the **VOLUME** control

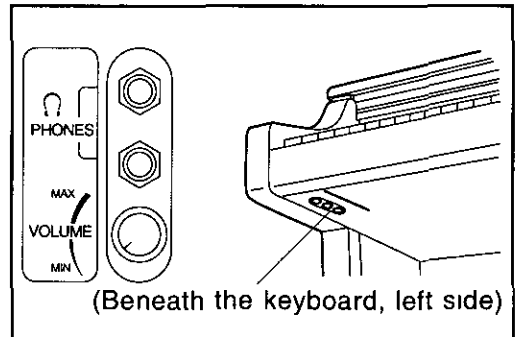

• One or two headphones sets can be connected to the **PHONES** jacks (The speakers are automatically switched off)

## Listen to the demonstration.

**1** Turn off the power once

**2** While pressing the lowest (leftmost) key on the keyboard, turn on the power again  
• Three demonstration tunes are automatically played  
• The three tunes are repeated until the power is turned off again

## Pedals

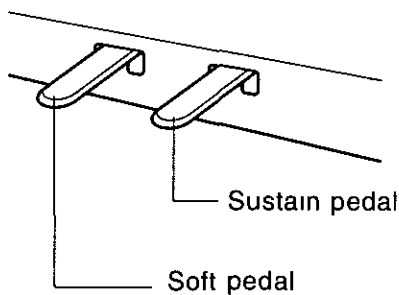

### Sustain pedal

The sound fades gradually after the keys are released

### Soft pedal

The tones are softened, and the volume is slightly lower

# Setting the functions

Turn on the power while depressing the sustain (right) pedal, and as long as the pedal is depressed, the keys to the left of C2 are used for setting the functions. Keep the sustain pedal depressed while following the procedures below.

- If the pedal is released, the function-setting mode is canceled, and the keys return to the performance mode.
- In the function-setting mode, the keys to the left of C2 produce not the normal piano tones, but a confirming "beep" when pressed.
- All settings revert to their factory-preset settings when the power is turned off.

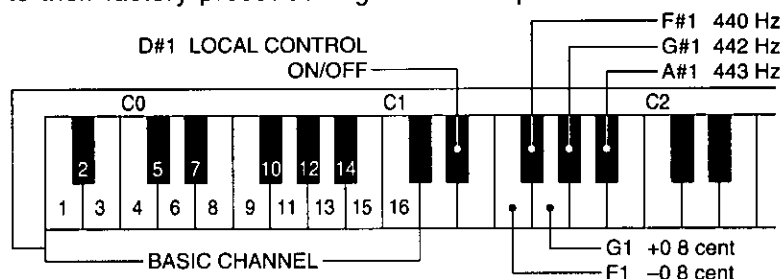

## Tuning (adjust the pitch)

You can adjust the pitch of this instrument when you are playing together with other instruments.

Press F#1 to set the pitch to 440 Hz (initial setting)

Press G#1 to set the pitch to 442 Hz

Press A#1 to set the pitch to 443 Hz

### ■ Fine tuning

Each time G1 is pressed, the pitch is raised by 0.8 cent.

Each time F1 is pressed, the pitch is lowered by 0.8 cent.

- If you attempt to raise the pitch above 453 Hz or lower it below 427.3 Hz, the confirming beep does not sound even when the key is pressed.
- You can hold the G1 or F1 key down to change the pitch quickly. In this case, the confirming beep sounds when the highest or lower pitch is reached.
- Use the keys above C2 to hear the adjusted pitch.

## Basic channel

Assign the MIDI basic channel.

Press the key corresponding to the basic channel number (Refer to the illustration above.)

- The default setting is channel 1.

## Local control

This setting is for when this instrument is used as the master keyboard.

The local control is switched between on (default) and off each time the D#1 key is pressed.

- When the local control is set to off, the signals generated by the keys and pedals of this instrument are not sent to its sound generator, but are handled only as MIDI output (this instrument generates no sound).
- Use the keys above C2 to confirm whether the local control is on or off. The local control setting is on if the piano sound is produced from this instrument, off if no sound is produced.

## Rear panel terminals

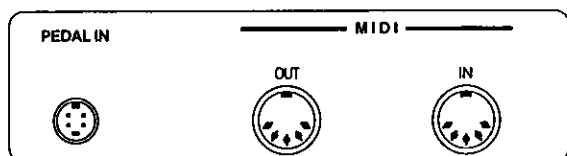

### PEDAL IN

Connect the pedal cord from the included stand to this terminal.

### MIDI IN

MIDI data from another instrument is received through this terminal.

### MIDI OUT

MIDI data from this instrument is transmitted to another instrument through this terminal.

- For these connections, use a commercially available MIDI cable.

# Assembly



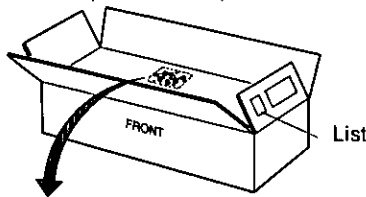

Follow the steps below to assemble your Technics piano. Make sure you are using the correct parts and that they are in the correct direction.

- At least 2 people are required for assembly.
- To disassemble the piano, reverse the procedure.

1. Remove the packing and take the parts out of the carton.  
Confirm that all the parts on the printed list are present.



2. The following parts are in the screw kit.

	Screw (long).....	8
	Screw (short) .....	4
	Clamp .....	3
	Cap .....	8

3. Affix the right and left side planks to the pedal box.

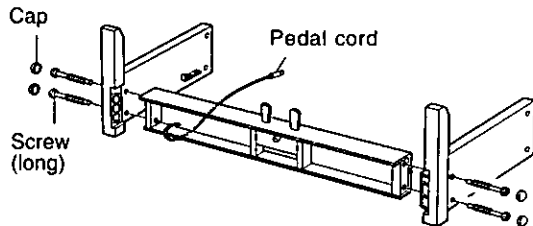

- (1) Use 4 long screws to secure them.
- (2) Cover the screw heads with the caps.
- (3) Loosen the pedal cord, stowed on the inner side of the pedal box, and extend it.

4. Use the short screws to affix the plank.

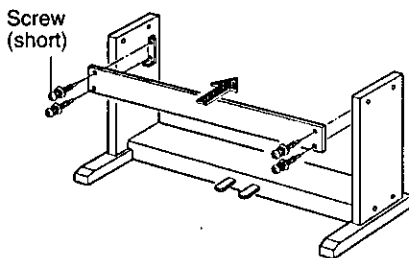

5. Place the piano body on the stand.

**WARNING:**  
Avoid pinching your fingers.

**Note 1**  
Holding the piano body at least 10 cm in from the edge, place it on the stand so that it does not fall off.

**Note 2**  
If the piano body is placed too far to the right or left, or to the front or back, it will become unstable.

**Note 3**  
Take care to align the screw holes on the keyboard unit with those on the stand.

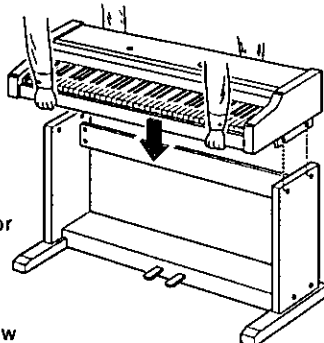

6. Secure the piano body to the stand.

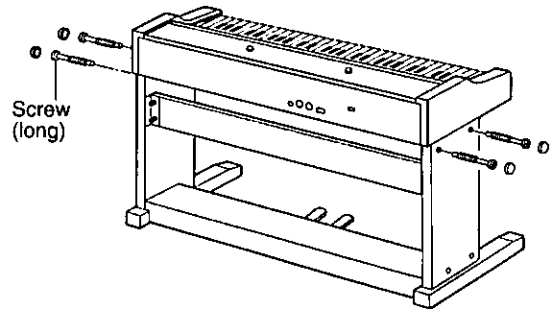

- (1) Use 4 long screws to secure the keyboard unit to the stand.
- (2) Cover the screw heads with the caps.

7. Connect the pedal cord and power cord to the terminals.

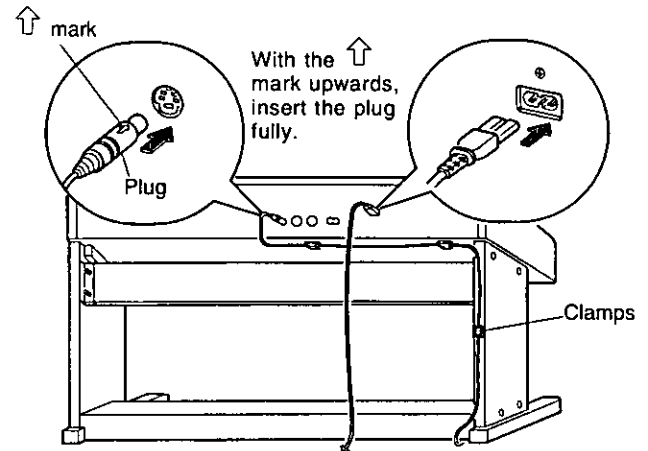

- (1) Plug the pedal cord and power cord into the terminals on the rear of the piano.
- (2) Remove the backing from the clamps and affix them as shown in the figure. Secure the pedal cord to the clamps.

**Confirm:** After assembling, check these points.

- Are any parts left over?  
→ Check the assembly procedure again.
- Does the piano rattle when it is rocked?  
→ Make sure all the screws are securely tightened.
- Is the power cord firmly inserted?  
→ Check again.
- Is the plug of the pedal cord inserted as far into the connector terminal as it will go?  
→ If it is not completely inserted, the sustain and other pedal functions may not work.
- When the piano has been moved or transported, retighten the screws securely.

# MIDI Implementation Chart

Digital piano [ SX-PC8 ]

Function		Transmitted	Recognized	Remarks
<b>Basic Channel</b>	Default Changed	1 1-16	1 1-16	
<b>Mode</b>	Default Messages Altered	3 × —	3 × —	
<b>Note Number</b>	True voice	21-108 —	0-127 0-127	
<b>Velocity</b>	Note ON Note OFF	○ × (9nh: v=0)	○ ×	
<b>After Touch</b>	Key's Ch's	× ×	× ×	
<b>Pitch Bend</b>		×	×	
<b>Control Change</b>	64	○	○	sustain pedal
	67	○	○	soft pedal
<b>Prog Change</b>	True #	×	×	
<b>System Exclusive</b>		×	×	
<b>System Common</b>	Song Pos Song Sel Tune	× × ×	× × ×	
<b>System Real Time</b>	Clock Commands	× ×	× ×	
<b>Aux Messages</b>	Local ON/OFF All Notes OFF Active Sense Reset	× × ○ ×	○ ○ ○ ×	
<b>Notes</b>				

**Mode 1:** OMNI ON, POLY  
**Mode 3:** OMNI OFF, POLY

**Mode 2:** OMNI ON, MONO  
**Mode 4:** OMNI OFF, MONO

○ : Yes  
× : No

# Specifications

	<b>SX-PC8</b>
KEYBOARD	88 KEYS (WITH TOUCH RESPONSE)
SOUND GENERATOR	PCM
MAXIMUM NUMBER OF NOTES PRODUCED SIMULTANEOUSLY	32 NOTES (16 STEREO NOTES)
SOUND	PIANO
PEDALS	SUSTAIN, SOFT
FUNCTIONS	VOLUME, DEMO (3 TUNES), TUNING, BASIC CHANNEL, LOCAL CONTROL
TERMINALS	PHONES × 2, MIDI (IN, OUT)
OUTPUT	15 W × 2
SPEAKERS	12 cm × 2
POWER REQUIREMENT	80 W, 60 W (NORTH AMERICA AND MEXICO)
	AC 120/220/240 V 50/60 Hz
	AC 120 V 60 Hz (NORTH AMERICA AND MEXICO)
	AC 230-240 V 50/60 Hz (EUROPE, AUSTRALIA, NEW ZEALAND AND PHILIPPINES)
DIMENSIONS (W × H × D)	138.1 cm × 98.6 cm × 44.9 cm (54-3/8" × 38-13/16" × 17-11/16")
NET WEIGHT	36.7 kg (80.9 lbs.)
ACCESSORIES	MUSIC STAND, AC CORD, STAND

- Design and specifications are subject to change without notice.

DEMONSTRATION TUNES		<b>TITLE</b>	<b>COMPOSER</b>
	1	ATLANTA GREEN	MIKE KENT
	2	LOVE'S DREAM No. 3	LISZT
	3	Technics original	—