



Technics

KEYBOARD

SX-KN5000



	CAUTION RISK OF ELECTRIC SHOCK DO NOT OPEN	
<p>CAUTION: TO REDUCE THE RISK OF ELECTRIC SHOCK, DO NOT REMOVE SCREWS. NO USER-SERVICEABLE PARTS INSIDE. REFER SERVICING TO QUALIFIED SERVICE PERSONNEL.</p>		

WARNING: TO REDUCE THE RISK OF FIRE OR ELECTRICAL SHOCK, DO NOT EXPOSE THIS PRODUCT TO RAIN OR MOISTURE.

BEFORE YOU PLAY, PLEASE READ THE CAUTIONARY COPY APPEARING ON PAGE 2.



The lightning flash with arrowhead symbol, within an equilateral triangle, is intended to alert the user to the presence of uninsulated "dangerous voltage" within the product's enclosure that may be of sufficient magnitude to constitute a risk of electric shock to persons.



The exclamation point within an equilateral triangle is intended to alert the user to the presence of important operating and maintenance (servicing) instructions in the literature accompanying the appliance.

Note: This equipment has been tested and found to comply with the limits for a Class B digital device, pursuant to Part 15 of the FCC Rules. These limits are designed to provide reasonable protection against harmful interference in a residential installation. This equipment generates, uses and can radiate radio frequency energy and, if not installed and used in accordance with the instructions, may cause harmful interference to radio communications. However, there is no guarantee that interference will not occur in a particular installation. If this equipment does cause harmful interference to radio or television reception which can be determined by turning the equipment off and on, the user is encouraged to try to correct the interference by one or more of the following measures:

- Reorient or relocate the receiving antenna.
- Increase the separation between the equipment and receiver.
- Connect the equipment into an outlet on a circuit different from that to which the receiver is connected.
- Consult the dealer or an experienced radio/TV technician for help.

The model number of this product is found on the rear of the unit.

The model number and serial number are found underneath the keyboard.

Please note the model and serial numbers in the space provided below and retain this sheet as a permanent record of your purchase to aid identification in the event of theft.

MODEL NUMBER _____

SERIAL NUMBER _____

Technics

OWNER'S MANUAL

Before you play

For long and pleasurable use of this instrument, and to gain a thorough understanding of your **KN5000** Keyboard, it is strongly recommended that you read through this Owner's Manual once.

The Owner's Manual is comprised of the following parts.

- | | |
|--|--|
| BASIC FUNCTIONS | This part includes an explanation of basic procedures and points you should be aware of for proper operation of your instrument. |
| PRACTICAL APPLICATIONS | This part comprises a detailed explanation of sound, effect, rhythm, SEQUENCER, COMPOSER , Disk Drive, MIDI. |
| REFERENCE GUIDE
(separate booklet) | Reference guide for the contents of the SOUND GROUP, RHYTHM GROUP , MIDI data, etc. |

Important Safety Instructions

WARNING

When using electric products, basic precautions should always be followed, including the following;

- Read all the instructions before using the product.

Safety

- **Power Source**—The product should be connected to a power supply only of the type described in the operating instructions or as marked on the product.
- **Polarization**—This product may be equipped with a polarized line plug (one blade wider than the other). This is a safety feature. If you are unable to insert the plug into the outlet, contact an electrician to replace your obsolete outlet. Do not defeat the safety purpose of the plug.
- **Periods of Non-use**—The power-supply cord of the product should be unplugged from the outlet when left unused for a long period of time.

Installation

- **Water and Moisture**—Do not use this product near water—for example, near a bathtub, washbowl, kitchen sink, in a wet basement, or near a swimming pool, or the like.
- **Cart/Stand**—This product should be used only with a cart or stand that is recommended by the manufacturer.
- **Ventilation**—The product should be located so that its location or position does not interfere with its proper ventilation.
- **Heat**—The product should be located away from heat sources such as radiators, heat registers, or other products that produce heat.
- **Foreign Material**—Care should be taken so that objects do not fall and liquids are not spilled into the enclosure through openings.

Listening caution

This product, either alone or in combination with an amplifier and headphones or speakers may be capable of producing sound levels that could cause permanent hearing loss. Do not operate for a long period of time at a high volume level or at a level that is uncomfortable. If you experience any hearing loss or ringing in the ears, you should consult an audiologist.

Service

- **Damage Requiring Service**—The product should be serviced by qualified service personnel when:
 - a. The power-supply cord or the plug has been damaged; or
 - b. Objects have fallen, or liquid has been spilled onto the product; or
 - c. The product has been exposed to rain; or
 - d. The product does not appear to operate normally or exhibits a marked change in performance; or
 - e. The product has been dropped, or the enclosure damaged.
- **Servicing**—Do not attempt to service the product beyond that described in the user-maintenance instructions. All other servicing should be referred to qualified service personnel.

Maintenance

- Be sure to switch this unit off after use, and do not switch the unit on and off in quick succession, as this places an undue load on the electronic components.
- To maintain the luster of the keys and buttons, wipe with a clean, damp cloth, and polish with a soft, dry cloth. Polish may be used, but do not use thinners or petro-chemical-based polishes.
- A wax-based polish may be used on the cabinet, although you will find that rubbing with a soft cloth will suffice.

SAVE THESE INSTRUCTIONS

Contents

Important Safety Instructions	2
Controls and functions	6

BASIC FUNCTIONS

Getting started	8
Listen to the demonstration	10
Add effects	12
Select the registration for a music style (MUSIC STYLIST)	14
Automatic panel settings (ONE TOUCH PLAY)	16
Search for a music style alphabetically	18
Store your panel settings (PANEL MEMORY)	19
Record your performance (SEQUENCER)	20
Save data on a floppy disk	22
Load rhythm data from a Technics pattern disk (COMPOSER LOAD)	24
Play back commercial song disks (DIRECT PLAY)	25
Entertainer features	26

PRACTICAL APPLICATIONS

About the display	27
Part I Sounds and effects	
Selecting sounds	32
Digital Drawbar	33
Accordion Register	35
Assigning parts to the keyboard	36
Effects	39
Transpose	42
Techni-chord	43
Entertainer	44
Part II Manual Sequence Pads	
Playing phrases	46
Record a phrase	47
Compile	48
Naming for "User" and "Compile" Banks	49
Part III Playing the rhythm	
Selecting rhythms	50
Playing the rhythm	52
Auto Play Chord	53
Fade In/Fade Out	56
Sound Arranger	58
One Touch Play	59
Music Stylist	60
Music Style Arranger	62
Panel Memory	63

Part IV Sequencer

Outline of the Sequencer	67
Sequencer parts	70
Easy Record	71
Realtime Record	72
Sequencer Play	75
Song Select/Naming	77
Punch Record	78
Step Record	80
Track Assign	86
Panel Write	87
Song Clear	88
Song/track Copy	88
After Touch Set	89
Editing the recorded performance	89

Part V Composer

Outline of the Composer	99
Simple recording method	101
Create a completely new rhythm	102
Playback	105
Step Record	106
Pattern Copy	107
Bend Range	109
Custom Copy	109

Part VI Disk Drive

Outline of the Disk Drive function	111
Outline of the procedure	113
Loading data	114
Direct Play	117
Song Medley	119
Saving data	120
Disk management	126
Set the automatic display when a disk is inserted	127

Part VII Sound

Outline of the Sound	128
Part Setting	129
Mixer	133
Master Tuning	134
Key Scaling	135
Reverb & Equalizer Presets	136
Equalizer	137
Left Hold	138

Part VIII Sound Edit	
Outline of the Sound Edit	139
Easy Edit	140
Tone Edit	141
Pitch Edit	144
Filter Edit	147
Amplitude Edit	150
Effect Edit	153
Controller Edit	154
Store the new sound	155
Drum Kit Edit	156
Recording Digital Drawbar sounds	158
Part IX Control	
Outline of Control functions	159
Overall Touch Sensitivity	160
Foot Controllers	161
Display Time Out	162
Wallpaper Setting	163
Part X MIDI	
What is MIDI?	164
Outline of MIDI functions	166
Part Setting	167
Control Messages	168
Realtime Messages	168
Common Setting	169
Input/output Setting	170
MIDI Presets	171
Sysex Bulk Dump	172
General MIDI	173
Program Change MIDI Out	174
Panel Memory Output	174
Computer Connection	175
MIDI Settings Load Option	176
Initialize	177
About the backup memory and performance data	178
Options and connections	179
Connecting to a "Vocalist Workstation"	181
Symptoms which appear to be signs of trouble	184
Error messages	187
Example of general settings	188
Index	190
Specifications	192

Controls and functions

MANUAL SEQUENCE PADS

Add various phrases to your performance with the pad buttons. (Refer to page 46.)

MUSIC STYLIST

You can choose to have all the settings of this instrument automatically set. (Refer to page 60.)

COMPOSER

Create and store original rhythm patterns. (Refer to page 99.)

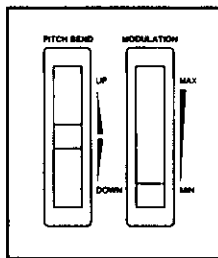
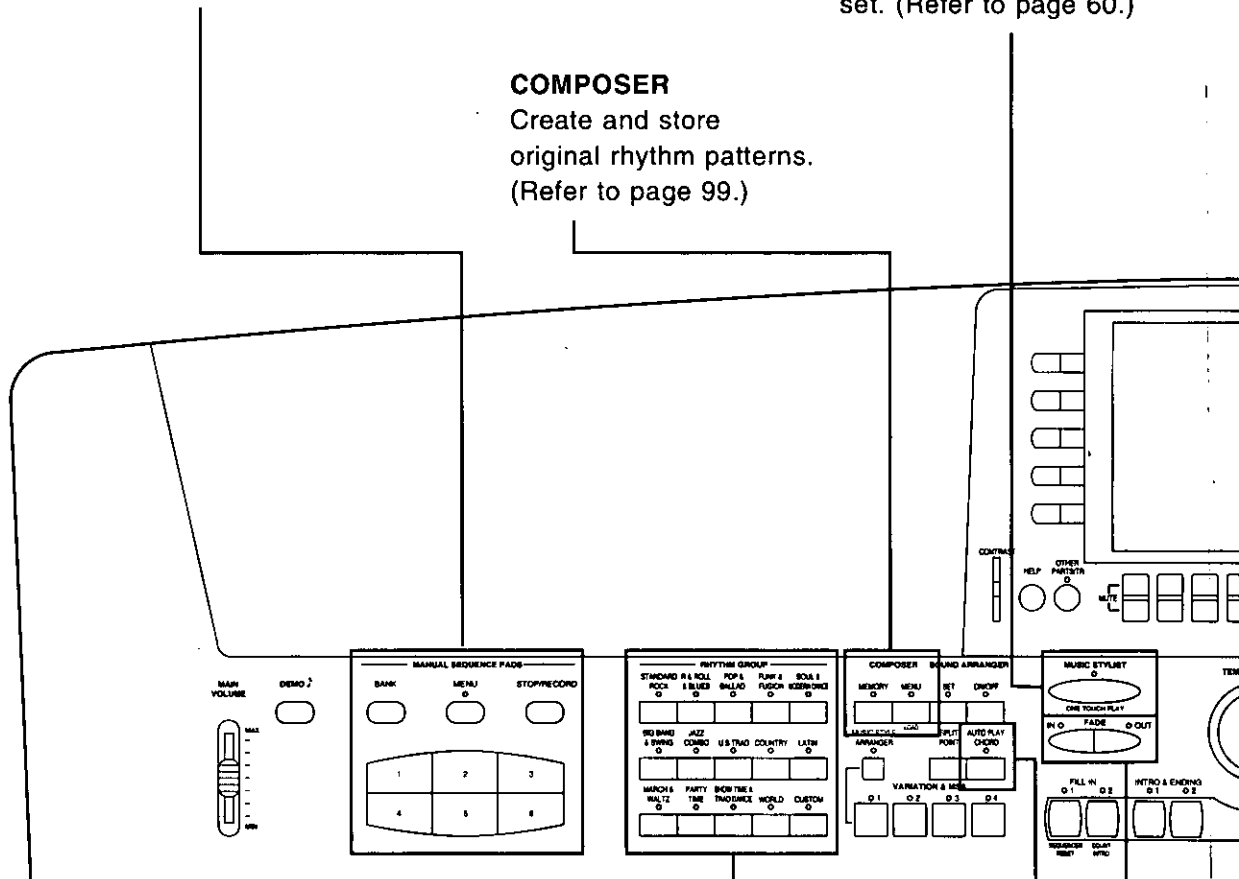

RHYTHM GROUP

Various rhythm patterns are available for each rhythm group. (Refer to page 50.)

AUTO PLAY CHORD

Add an automatic accompaniment to your selected rhythm. (Refer to page 53.)

FADE IN/OUT

Begin your song with a slowly increasing volume, or end it by having the sound slowly fade away. (Refer to page 56.)

PITCH BEND/MODULATION

The **PITCH BEND** wheel allows a "sliding" change in the pitch. The **MODULATION** wheel is used to add vibrato to the sound. (Refer to page 41.)

DISPLAY

Displays performance information, function settings and other messages
(Refer to page 27)

- Use the **CONTRAST** slider to adjust the display so that it is easy to read

SEQUENCER

Record and play back your performance
(Refer to page 67)

TRANSPOSE

Raise or lower the key of the entire keyboard
(Refer to page 42)

EFFECT

Add various effects to the sounds (Refer to page 39)

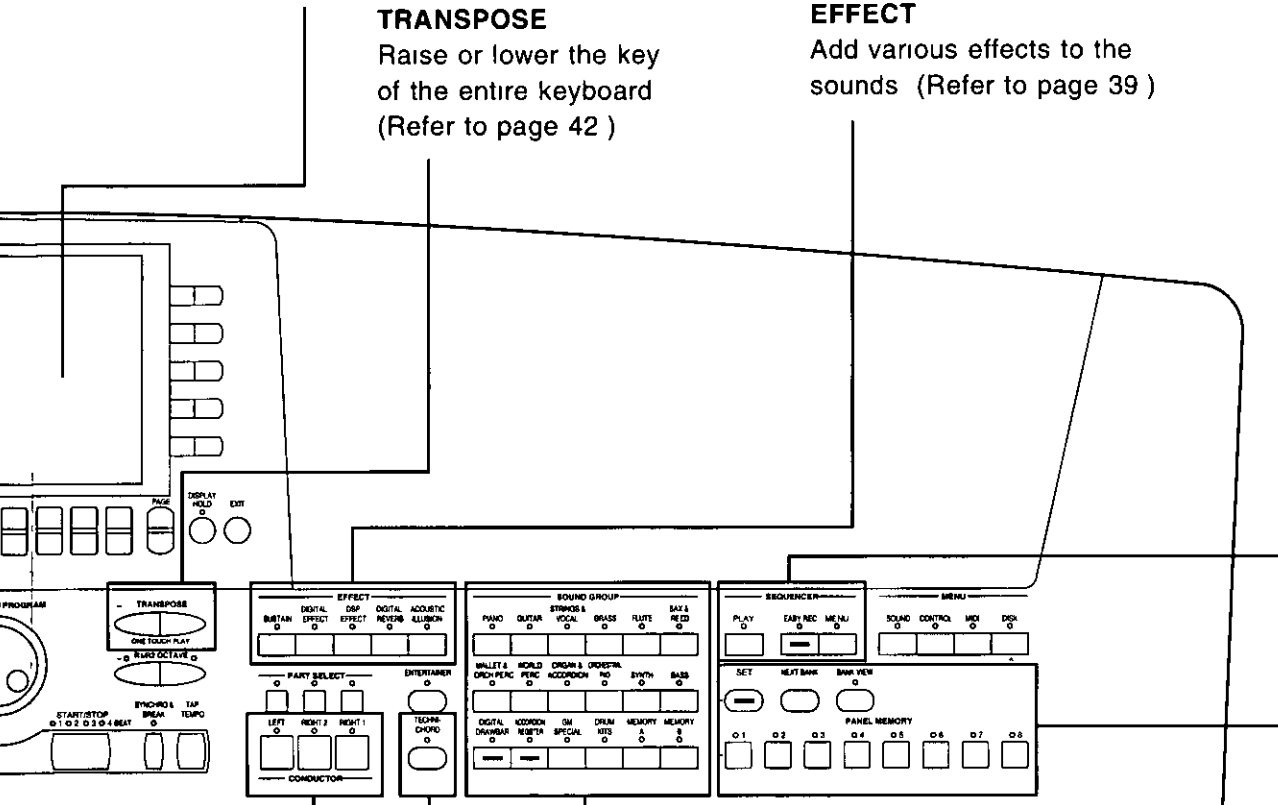

SOUND GROUP

Various sounds are available for each sound group
(Refer to page 32)

TECHNI-CHORD

Block chords are automatically added to the melody (Refer to page 43)

CONDUCTOR

Assign a different sound to each part, then assign the desired parts to sections of the keyboard
(Refer to page 36)

PANEL MEMORY

Store the panel settings, then recall them instantaneously just by pressing a button or two (Refer to page 63)

Getting started

Before you play

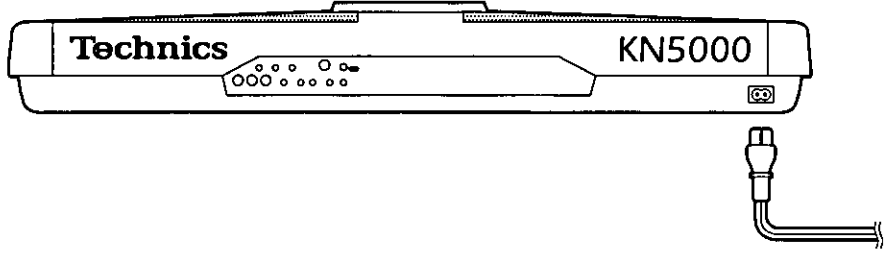

1 Plug the power cord into an outlet.

2 Affix the music stand as shown.

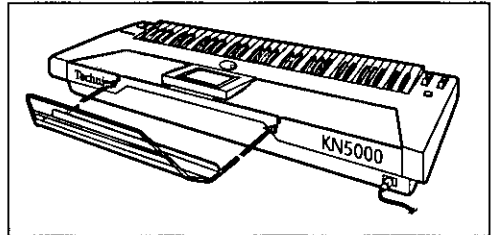

3 Press the **POWER** button to turn it on.

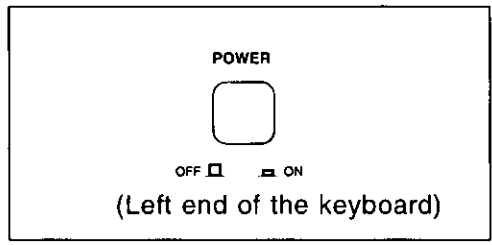

4 Adjust angle of the display.

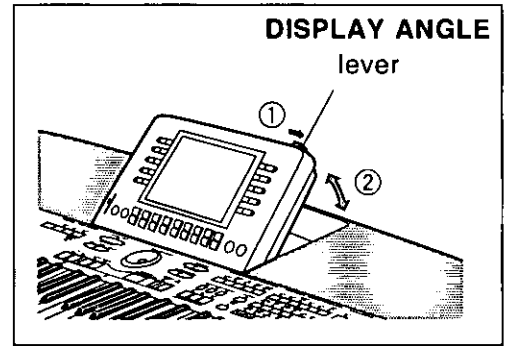

- While pressing the **DISPLAY ANGLE** lever to the right, swivel the display towards you to the angle at which it is easiest to read.
- To return the display to its original position, do so while pressing the **DISPLAY ANGLE** lever to the right. Be careful not to pinch your fingers.

- Headphones may be plugged into the **PHONES** terminal. This will automatically switch off the speaker system, and sound is heard only through the headphones.

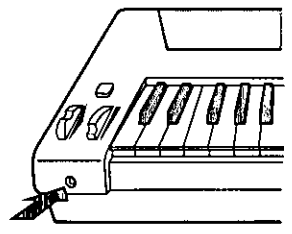

- The pitch of this instrument can be adjusted for when playing with other instruments. (Refer to page 134.)
- For information on this instrument's backup function, refer to page 178.
- Under certain conditions, the functions and memories of this instrument may be initialized when the power is turned on.

Playing

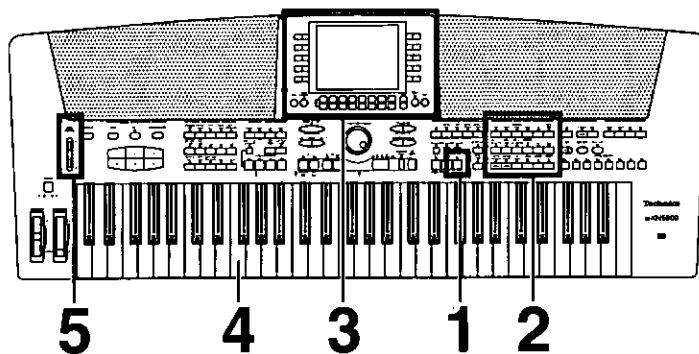

- 1** In the **CONDUCTOR** section on the panel, press the **RIGHT 1** button to turn it on.

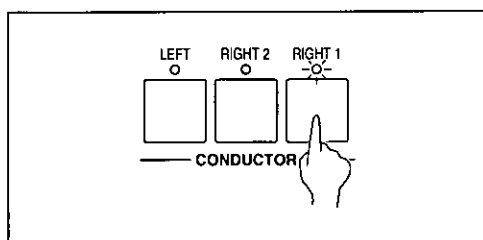

- 2** In the **SOUND GROUP** section, press one of the sound buttons.

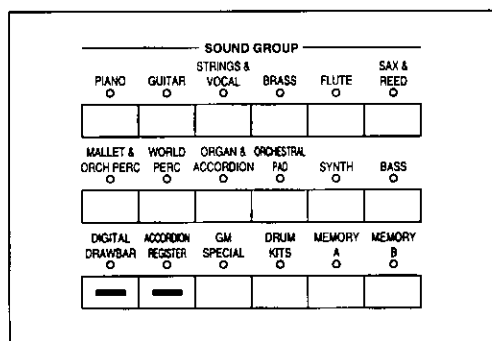

- 3** Select a sound from the list of sounds shown on the display.

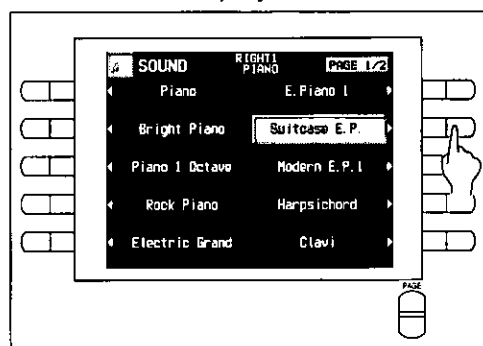

- The list of sounds is contained on two or more screen "pages". To see a different part of the list, press either **PAGE** button.

- 4** Play the keyboard.
- Your Keyboard features Touch Response. You control the volume by playing the keys harder or softer.

- 5** Set the **MAIN VOLUME** to an appropriate level with the sliding control.

- Displays such as those for selecting sounds and rhythms revert to the previous display shortly after you make your selection. You can use the **DISPLAY TIME OUT** function to adjust the time elapsed before the display reverts to the previous display or even suspend the reversion. (Refer to page 162.)

Listen to the demonstration

Select and listen to the demonstration tunes.

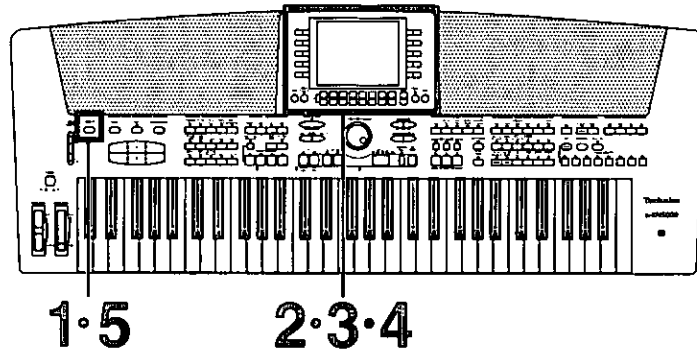

1

Press the **DEMO** button.

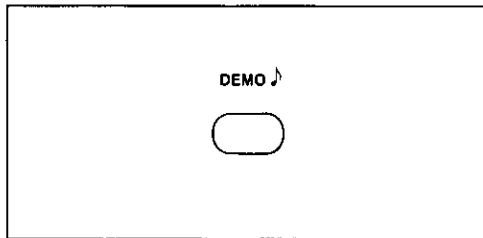

2

Select **PERFORMANCES** from the display.

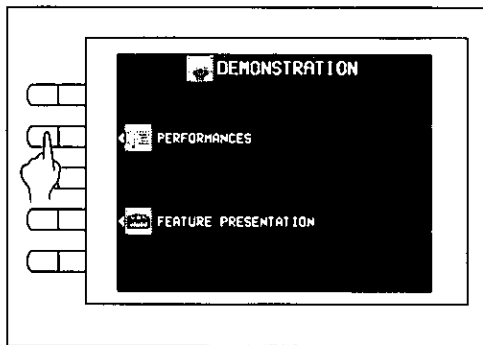

3

Use the buttons below the display to select the type of demo performance you wish to hear (**STYLE**, **SOUND**, **RHYTHM**).

4

Use the buttons to the left and right of the display to select the demonstration tune you wish to listen to.

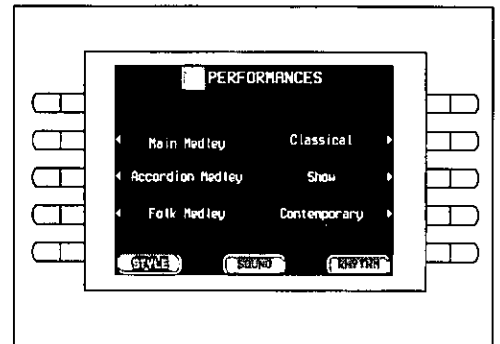

5

When you are finished listening to the demonstration tunes, press the **DEMO** button again.

- If you press and hold the **DEMO** button for a few seconds, all **PERFORMANCES** demo tunes are demonstrated in order in a medley performance. The medley performance continues until the **START/STOP** button or the **DEMO** button is pressed again.
- Some of the buttons do not function while the demonstration performances are being played.
- Even when **MIDI LOCAL** is set to **OFF** for all parts, the demonstration performances are played back.

Listen to tunes that demonstrate various features.

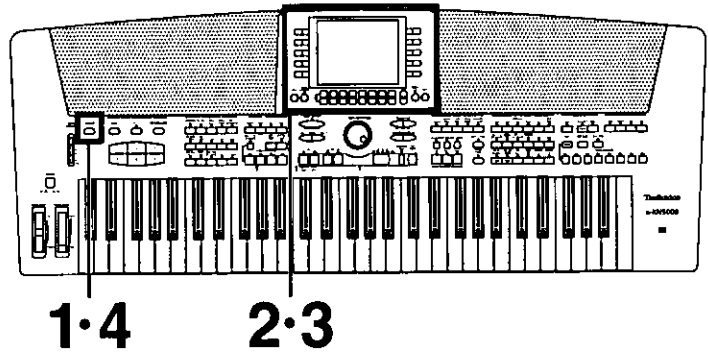

1 | Press the **DEMO** button.

- The **FEATURE PRESENTATION** demo will begin.
- You can also press the **START/STOP** button to begin the demo. In this case, the demo is repeated until the **START/STOP** button is pressed again.

2 | Select **FEATURE PRESENTATION** from the display.

■ **Demo playback from a disk**
 You can play back the **FEATURE PRESENTATION** recorded in a floppy disk. After activating the **FEATURE PRESENTATION** display, when a disk with this data is inserted into the Disk Drive slot, the display automatically changes. Press the "Start the loaded DEMO" button.

- Please note that this procedure will erase any other data recorded in the **SEQUENCER**.
- You can also press the **START/STOP** button to begin the demo. In this case, the "Internal DEMO" and "loaded DEMO" are played back in a medley until the **START/STOP** button is pressed again.

3 | Press the "Start the internal DEMO" button.

4 | When you are finished listening to the demonstration tunes, press the **DEMO** button again.

Add effects

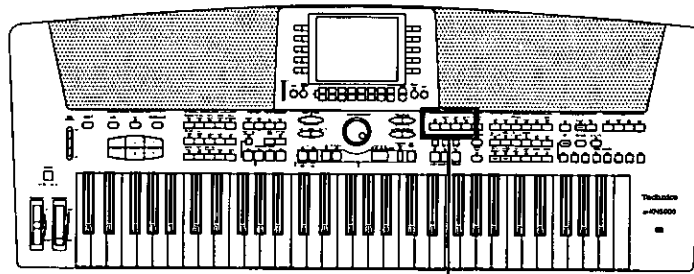

A·B·C·D

Add sustain.

A

Press the **SUSTAIN** button to turn it on.

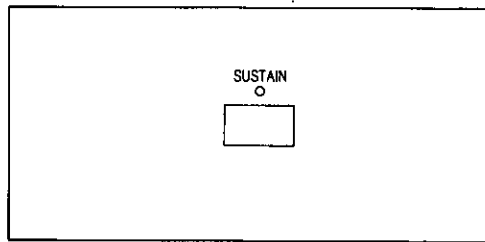

Change the quality of the sound.

C

Press the **DSP EFFECT** button to turn it on.

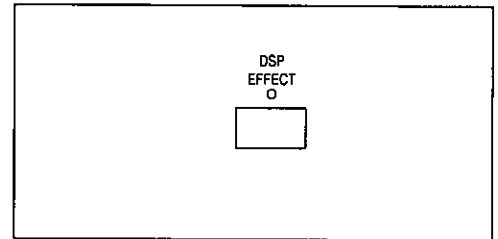

Add a feeling of spaciousness to the sound.

B

Press the **DIGITAL EFFECT** button to turn it on.

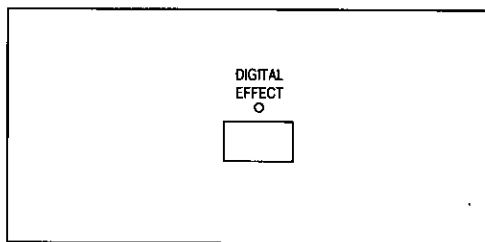

Add reverberation.

D

Press the **DIGITAL REVERB** button to turn it on.

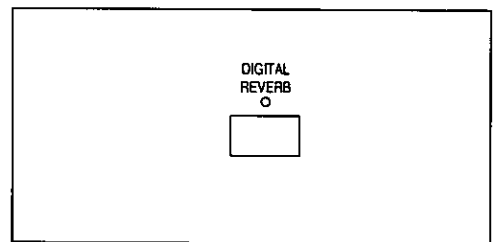

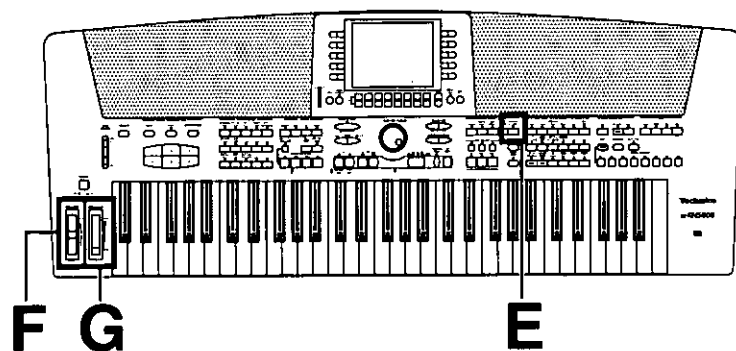

Add a dimension of expansion to the sound.

E Press the **ACOUSTIC ILLUSION** button to turn it on.

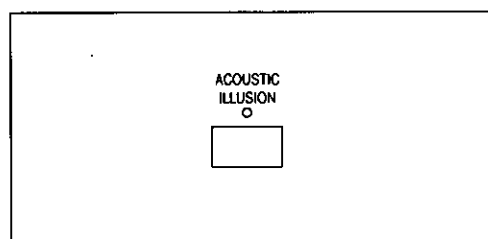

Add vibrato.

G While pressing a key on the keyboard, move the **MODULATION** wheel up to add the effect.

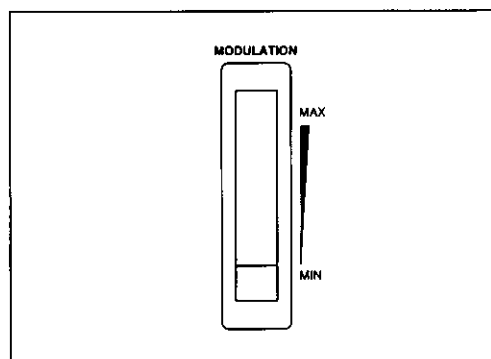

Slide the pitch up or down.

F While pressing a key on the keyboard, move the **PITCH BEND** wheel up and down to control the pitch.

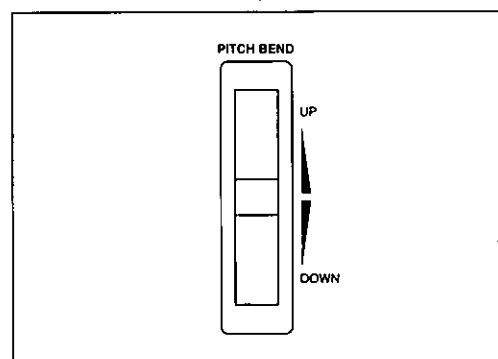

- When you release your hand from the **PITCH BEND** wheel, it returns automatically to the center position.
- When the vibrato effect is not needed, set the **MODULATION** wheel to the **MIN** position.
- You can use the **SOUND** function to change the **DIGITAL REVERB** settings by selecting from preset settings, for example, and to make fine adjustments to the various effects. (Refer to page 136.)

Select the registration for a music style (MUSIC STYLIST)

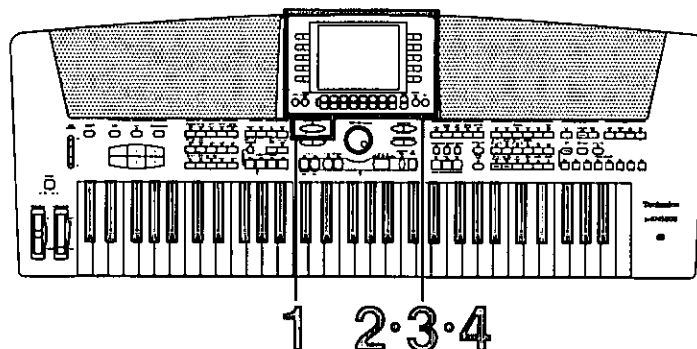

- 1** Press the **MUSIC STYLIST (ONE TOUCH PLAY)** button to turn it on.

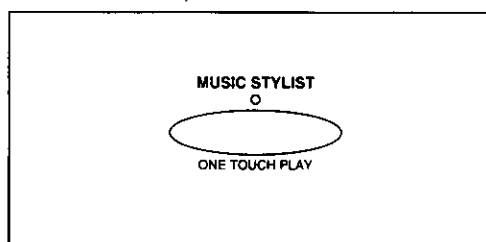

- 2** Select **STYLE EXPLORER**.

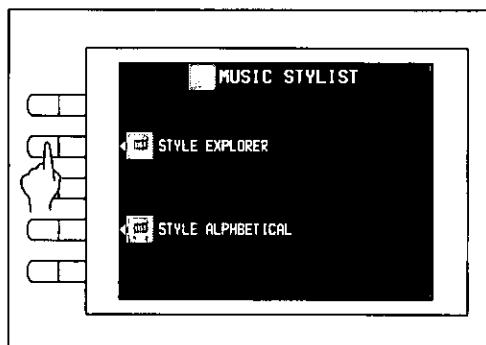

- 3** Use the **MAIN CATEGORY** Δ and ∇ buttons to select a category. Use the **SUB CATEGORY** Δ and ∇ buttons to select a subcategory.

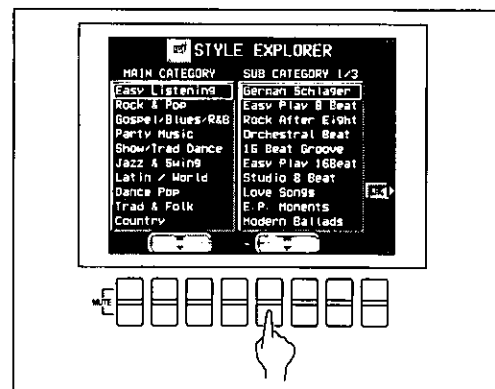

- 4** Press the **OK** button.

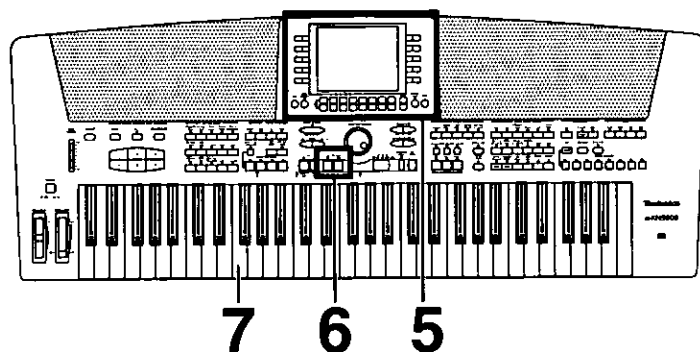

- 5** Use the ▲ and ▼ buttons to select a music style.

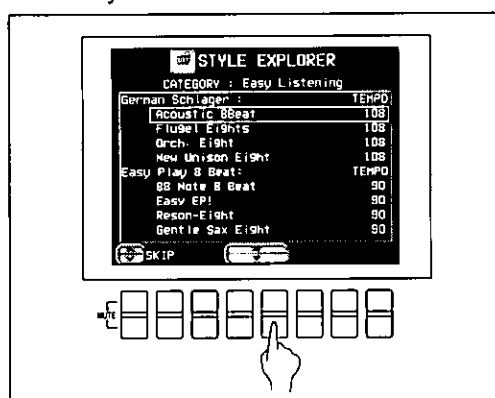

- You can use the SKIP ▲ and ▼ buttons to skip to the previous or following category.
- When you select a style, the sounds and rhythm which are best suited for the selected style are automatically selected.

- 6** Press the **INTRO & ENDING 1** or **2** button to turn it on.

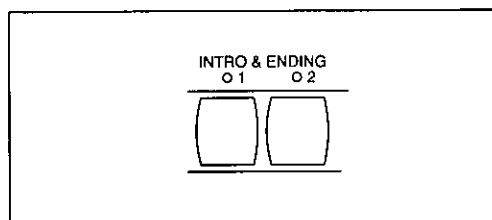

- 7** Play the keyboard.
- When you specify a chord, an intro is played, after which the automatic rhythm starts.

Automatic panel settings

(ONE TOUCH PLAY)

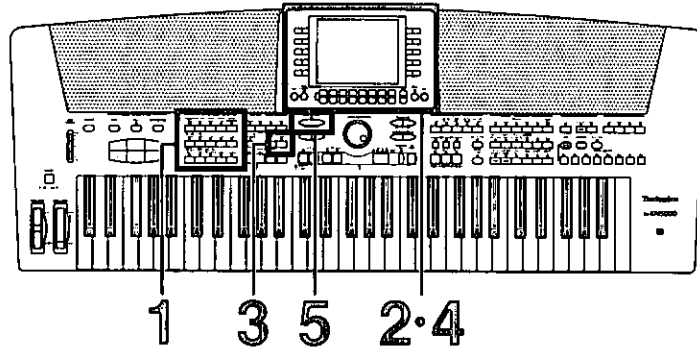

1 In the **RHYTHM GROUP** section, press the button for a desired rhythm.

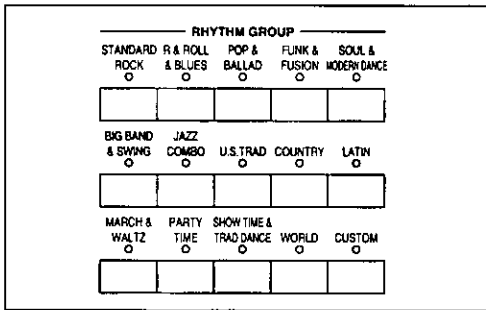

4 Select **ONE FINGER** on the display.

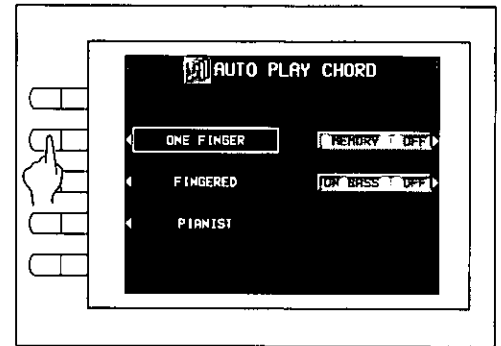

2 Select a rhythm from the list of rhythms on the display.

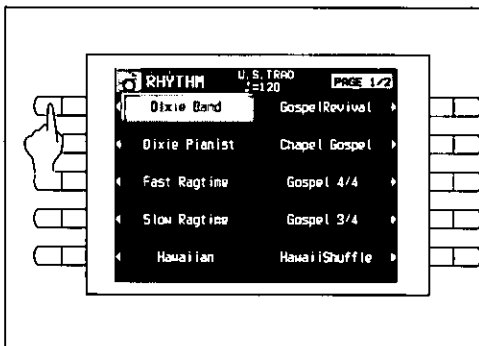

5 Press and hold the **ONE TOUCH PLAY** button for a few seconds.

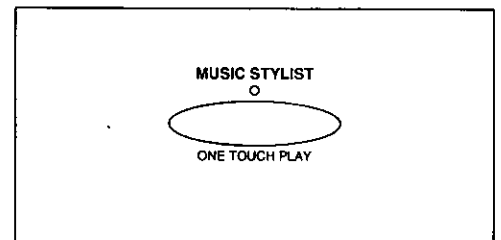

3 Press the **AUTO PLAY CHORD** button to turn it on.

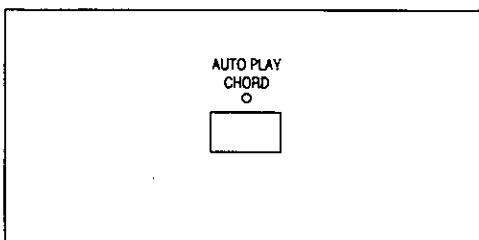

- The sound, effects and tempo suitable for the selected rhythm are automatically selected. The tempo can be adjusted with the **TEMPO/PROGRAM** dial.

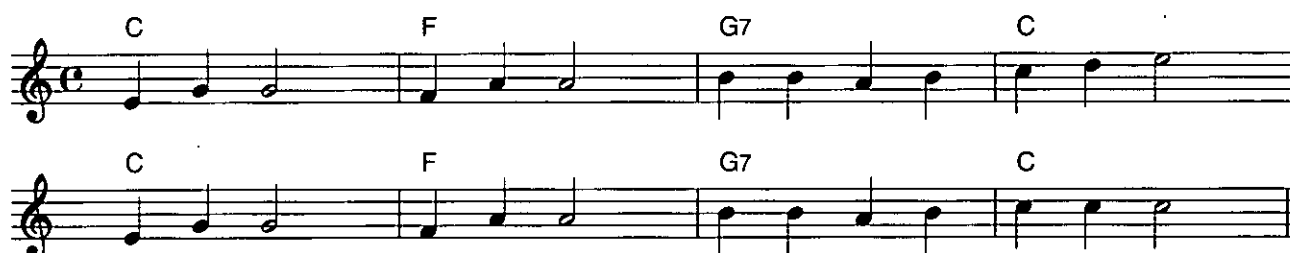
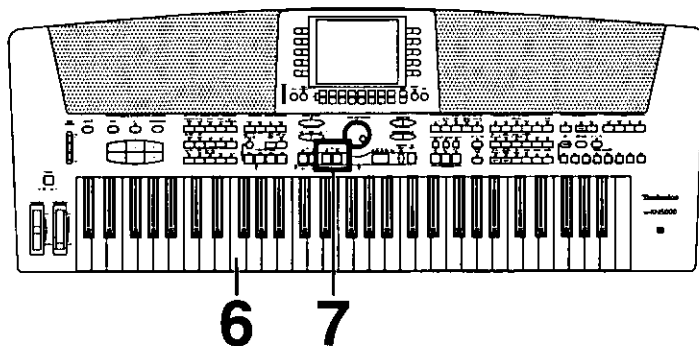

6 Use your left hand to play the chords and your right hand to play the melody.

- Pressing a key on the left area of the keyboard will cause the automatic rhythm pattern to start playing (synchro start).

7 At the end of your performance, press the **INTRO & ENDING 1** or **2** button.

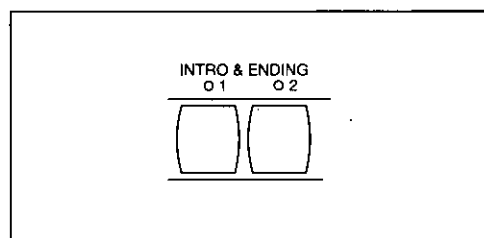

- An ending pattern is played, after which the automatic accompaniment stops.
- If the **START/STOP** button is pressed, the accompaniment stops immediately.

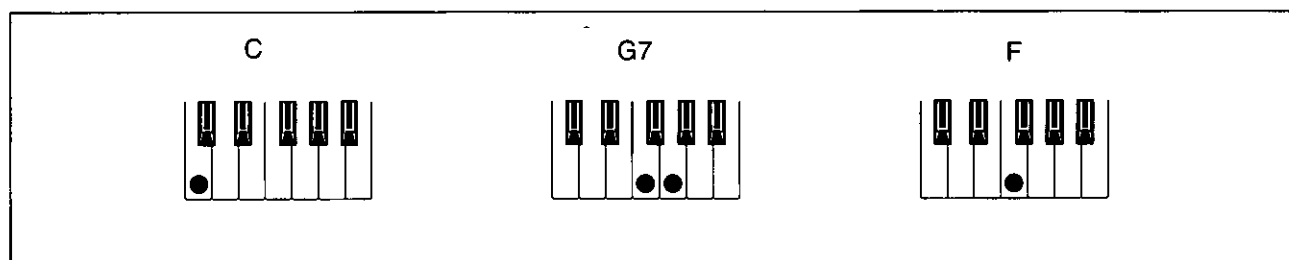

- In this example you played chords by pressing the keys for the "root notes" (ONE FINGER chords). But you can also specify the chord by playing all the notes in the chord. (Refer to page 54.)

- You can insert a fill-in pattern while the preset rhythm pattern is playing by pressing either the **FILL IN 1** or **FILL IN 2** button.

Search for a music style alphabetically.

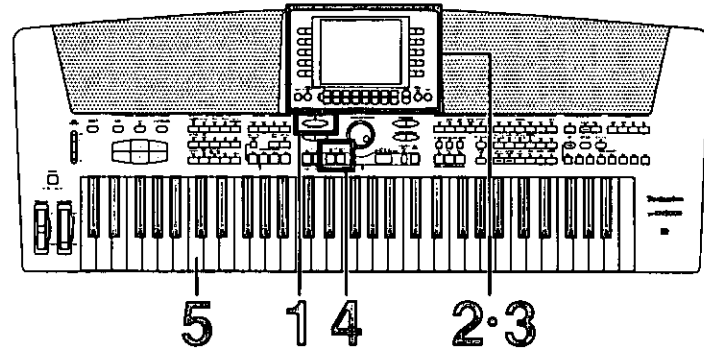

1 Press the **MUSIC STYLIST (ONE TOUCH PLAY)** button to turn it on.

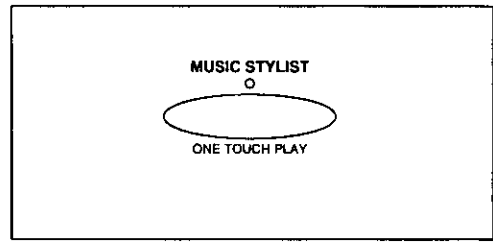

- You can use the SKIP ^ and v buttons to skip to the previous or following alphabetical or numerical heading.
- When you select a music style, the sounds and rhythm which are best suited for the selected tune are automatically selected.

2 Select **STYLE ALPHABETICAL**.

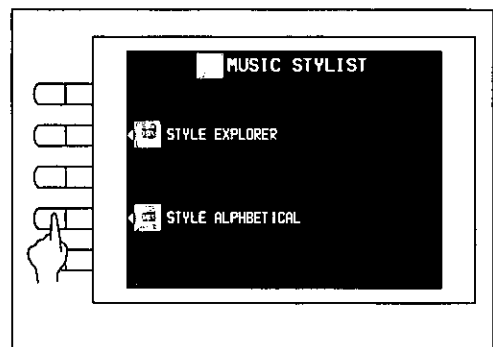

4 Press the **INTRO & ENDING 1 or 2** button to turn it on.

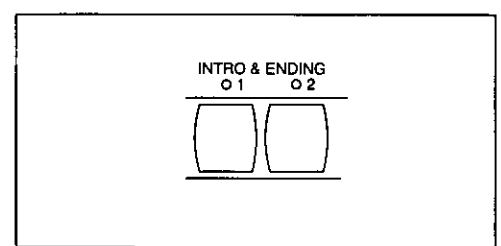

3 Use the **▲** and **▼** buttons to select a music style.

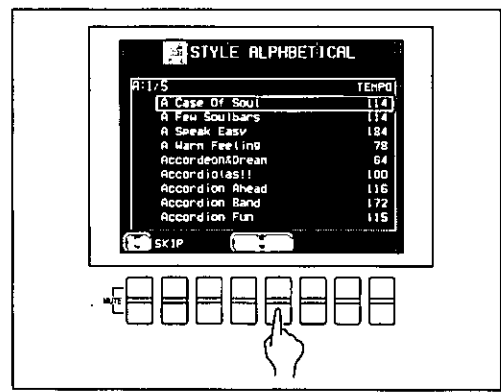

5 Play the keyboard.

- When you specify a chord, an intro is played, after which the automatic rhythm starts.

Store your panel settings

(PANEL MEMORY)

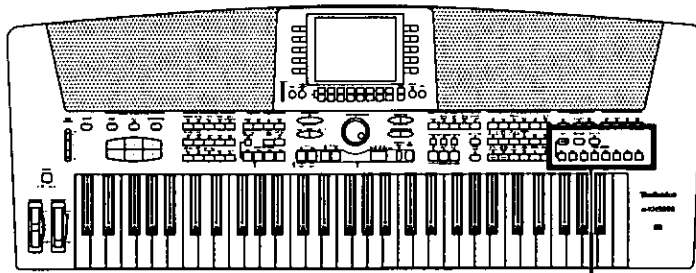

2·3

- 1 Set up the desired panel settings (sounds, volumes, etc.)
- 2 Use the **NEXT BANK** button to select a bank (1 to 10).

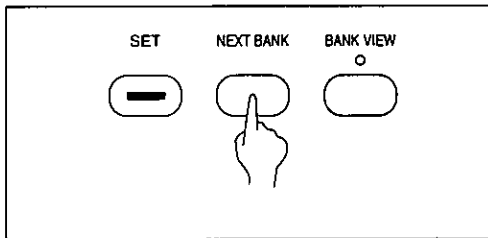

- The bank numbers are shown on the display.

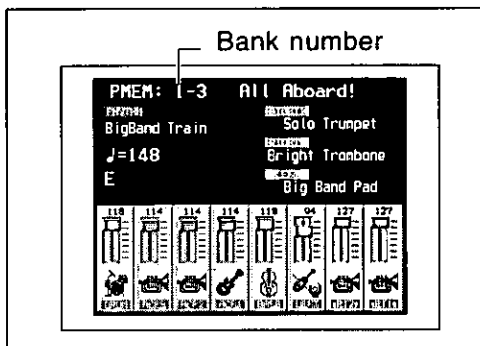

- 3 With the **SET** button held down, press one of the numbered buttons of the **PANEL MEMORY** (1 to 8).

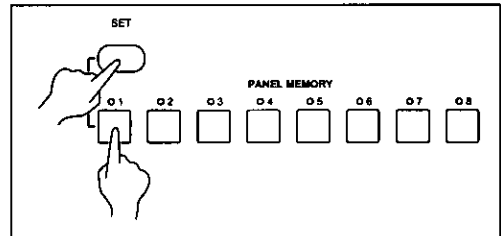

- The current panel settings are now stored in the specified bank and number. When you select the same bank and number again, the stored panel settings are recalled.

- To recall the rhythm, tempo and other settings, press and hold the **SET** button for a few seconds to show the **PANEL MEMORY MODE** display, and select **EXPAND**.

Record your performance (SEQUENCER)

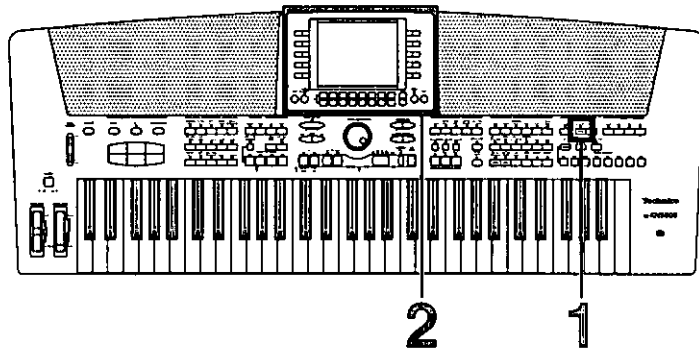

Sonatina

Sound: Piano 1 (RIGHT 1 part)

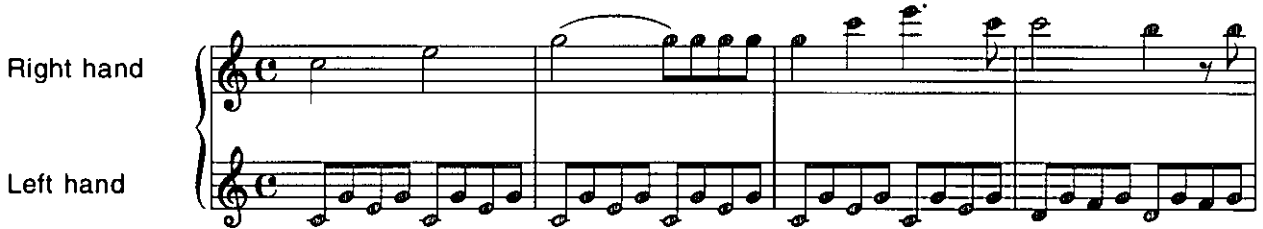

1 In the **SEQUENCER** section, press the **EASY REC** button to turn it on.

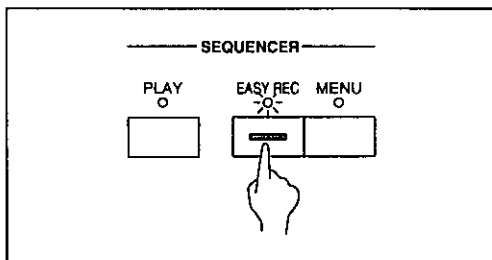

2 Press the **OK** button.

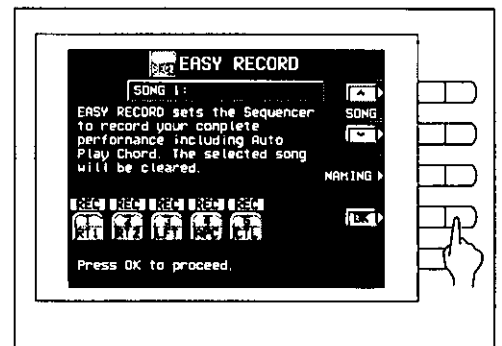

- The display changes to the **REALTIME RECORD** display.

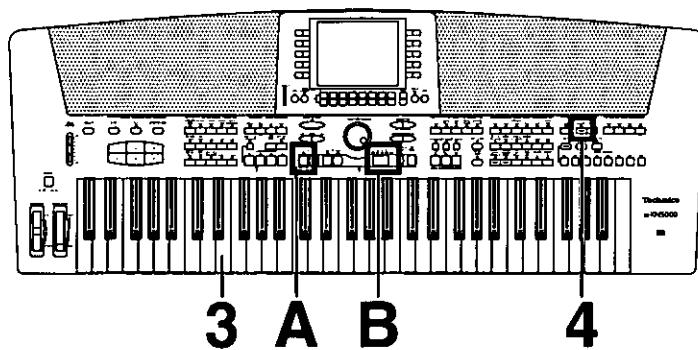

3 Play the song on the keyboard.

4 When you have finished playing, press the **EASY REC** button again to turn it off.

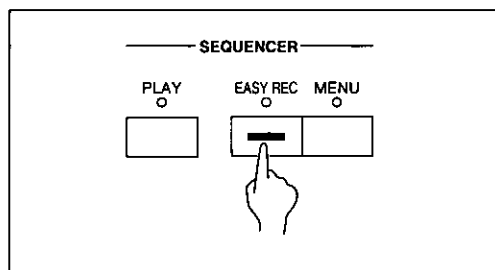

- The **PLAY** button in the **SEQUENCER** section turns on.

Playing back your recorded performance

A Press the **SEQUENCER RESET (FILL IN 1)** button.

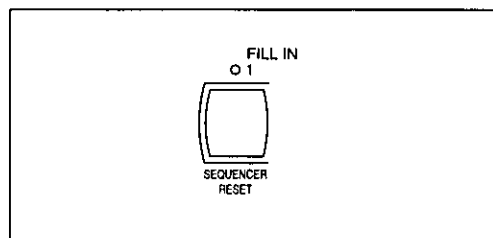

B Press the **START/STOP** button.

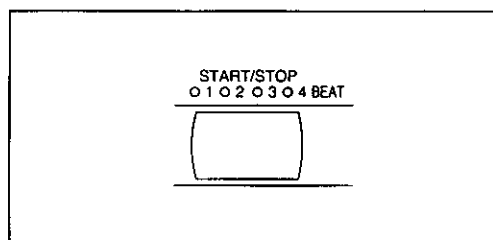

- Your performance is played back just as you recorded it.
- When you are finished playing back your performance, press the **PLAY** button in the **SEQUENCER** section to turn it off.

Save data on a floppy disk

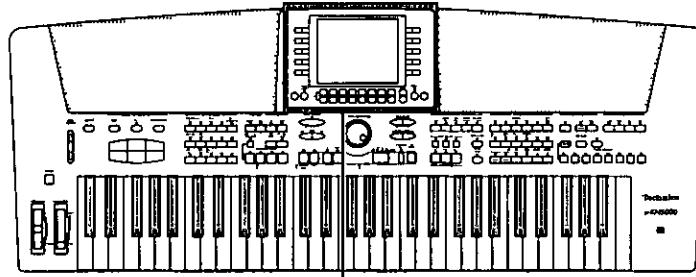

2·3·4·5

- 1** Insert a disk you wish to save to into the Disk Drive slot. Push it all the way in until you hear a click.

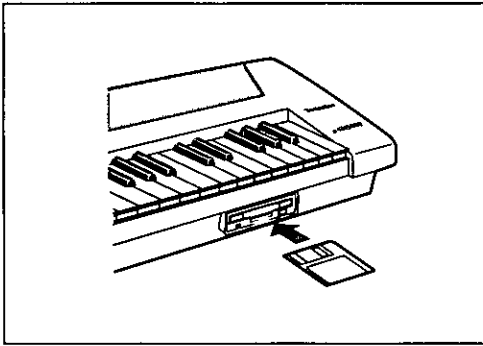

- 2** On the DISK MENU display, select **SAVE**.

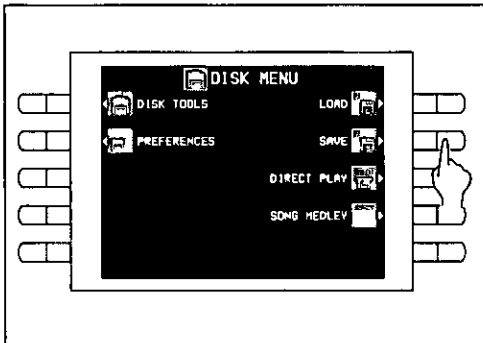

- If you attempt to use the **SAVE** procedure when an unformatted disk is inserted into the Disk Drive slot, the **FORMAT** display appears. Follow the instructions on the display to format the disk (Formatting the disk will clear any data which is currently stored on the disk.)

- 3** Select **TECHNICS FORMAT**.

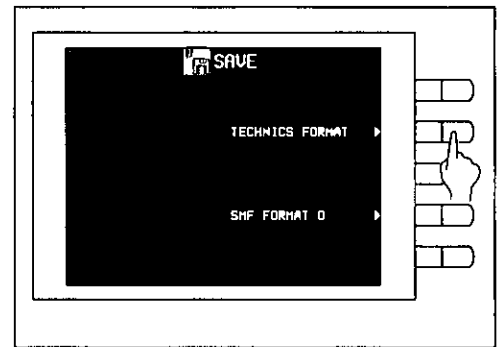

- 4** Specify a file number to save to.

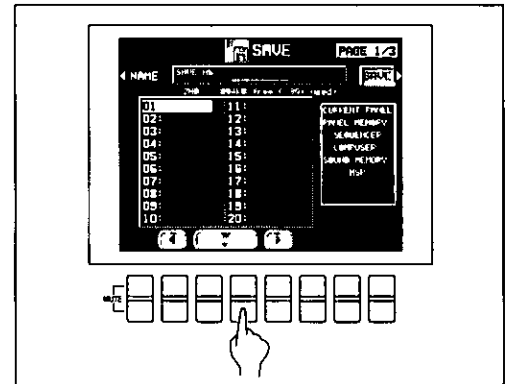

- 5** Press the **SAVE** button.

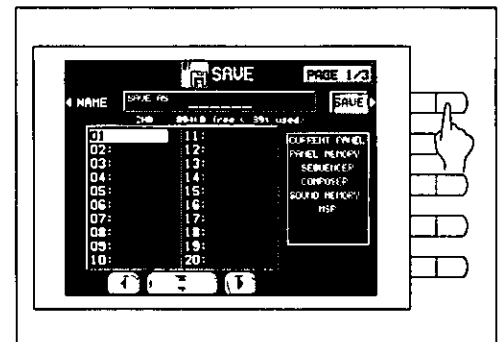

- The performance data of the song recorded in the **SEQUENCER** is saved on the floppy disk.

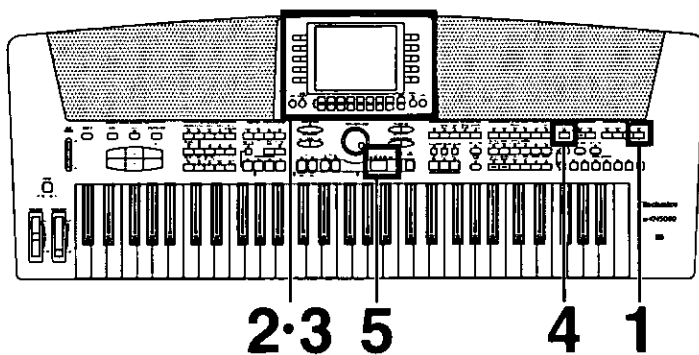

Recall data from a floppy disk

1 Press and hold the **DISK** button for a few seconds.

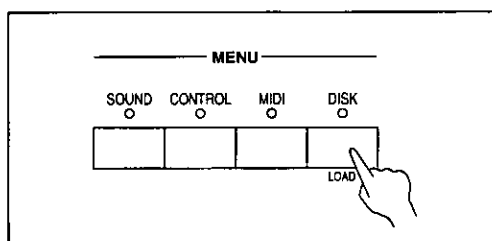

2 Select the file you wish to load.

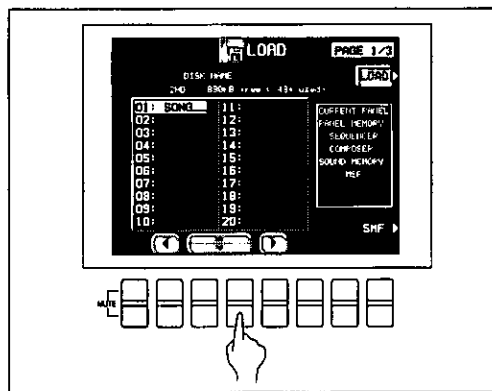

3 Press the **LOAD** button.
 • The data is copied to the internal memory of this instrument.

4 Press the **PLAY** button in the **SEQUENCER** section to turn it on.

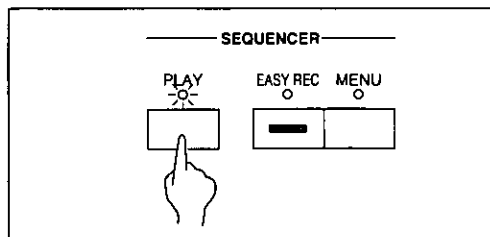

5 Press the **START/STOP** button.

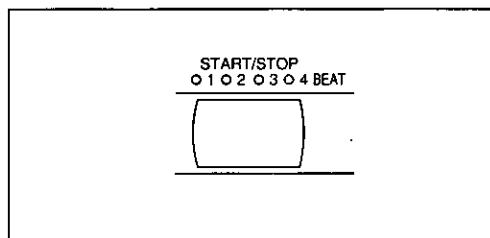

• The recalled song is played back.

■ The following data can be saved/loaded:

BACKUP	PERFORMANCE	CURRENT PANEL (The current panel settings)
		PANEL MEMORY
		SEQUENCER
		COMPOSER (MEMORY contents)
		SOUND MEMORY
		MSP (USER memories of the MANUAL SEQUENCE PADS)
		RHYTHM CUSTOM
USER MIDI SETTINGS (USER memories of the MIDI PRESETS)		

• For detailed information, refer to pages 111 and 178.

Load rhythm data from a Technics pattern disk (COMPOSER LOAD)

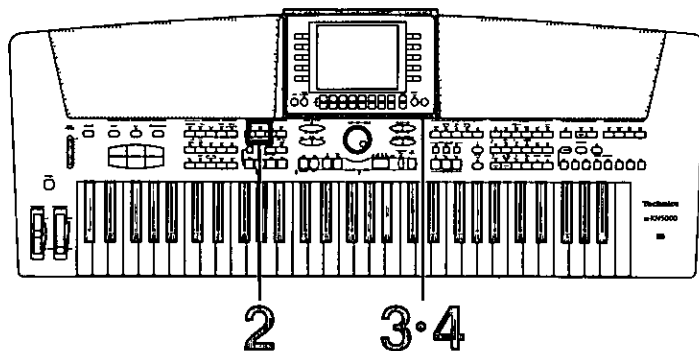

1 Insert a commercially sold Technics pattern disk into the Disk Drive slot

2 In the **COMPOSER** section, press and hold the **MENU** button for a few seconds

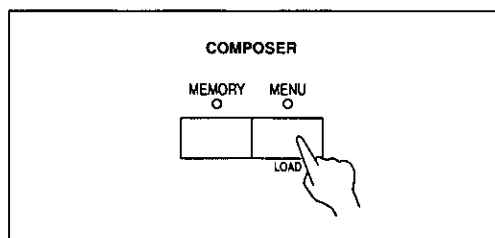

3 Select the name of the pattern to load

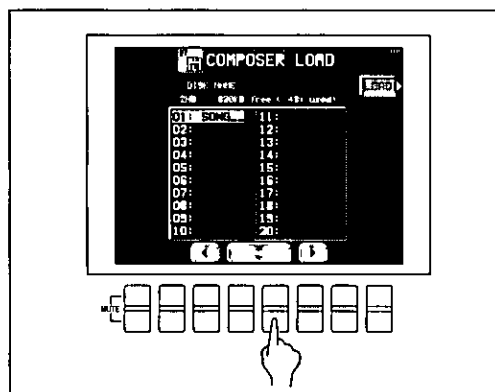

4 Press the **LOAD** button

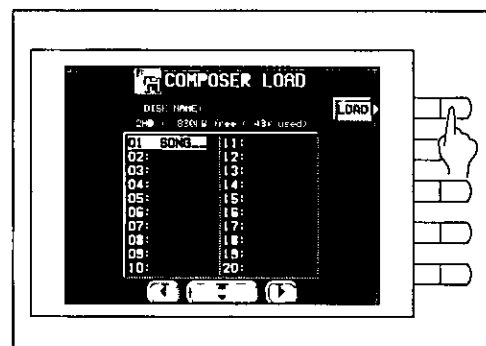

- Rhythm data is loaded to the **COMPOSER** memory (**MEMORY**)
You can use the rhythms during your performance, just like the preset rhythms

Play back commercial song disks (DIRECT PLAY)

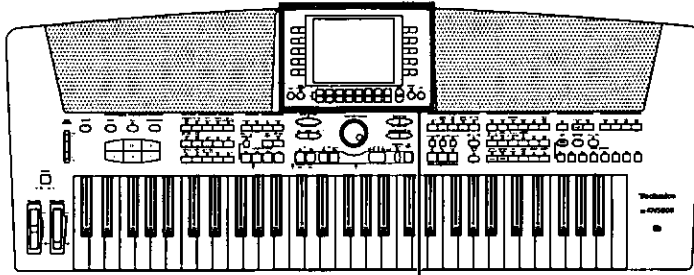

2-3

1 Insert the song disk into the Disk Drive slot.

2 On the DISK MENU display, select DIRECT PLAY.

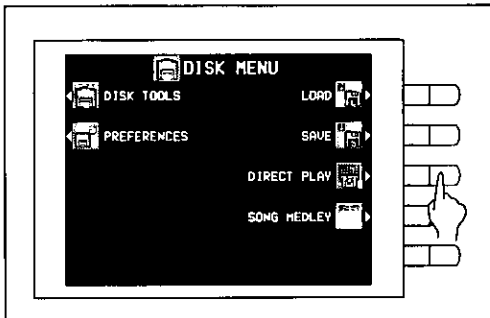

3 Use the ^ and v buttons to select a song.

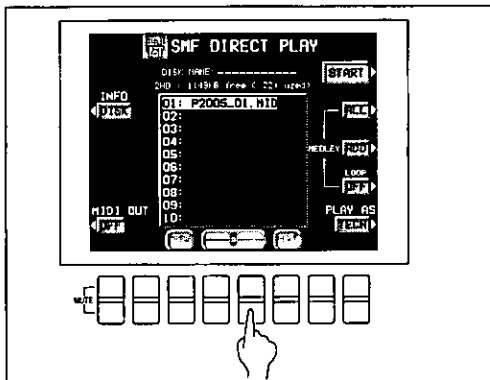

• For SMF songs, use the PLAY AS button to specify a sound arrangement mode (TECH/GM).

4 Press the START button.

- The selected song is played back.

• DIRECT PLAY is possible from the following disks:

Standard MIDI File FORMAT 0
TUNE 1000 "Standard MIDI File with Lyrics" (Format 0 only)
DISK ORCHESTRA COLLECTION™ (DOC)
PianoDisc™

* All product and company names are trademarks or registered trademarks of their respective owners.
* DISK ORCHESTRA COLLECTION is a trademark of the YAMAHA Corporation.

Entertainer features

Microphone and other connections

Rear panel terminals

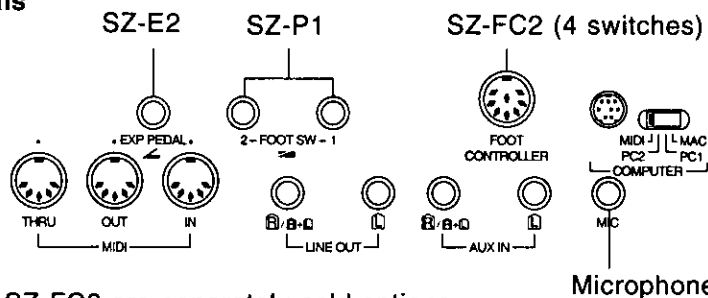

*SZ-E2, SZ-P1 and SZ-FC2 are separately sold options.

Microphone (commercially sold)

- To assign a function to a Foot Switch, turn on the **CONTROL** button and select **FOOT CONTROLLERS**.

ENTERTAINER display

- 1 Press the **ENTERTAINER** button to turn it on.

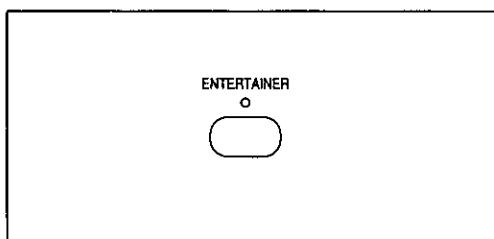

- 2 Use the **ITEM** Δ and ∇ buttons to select the item, and the **VALUE** \wedge and \vee buttons to change the setting.

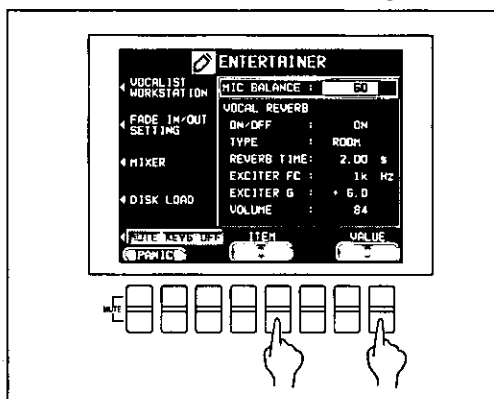

MIC BALANCE

Adjust the microphone volume.

VOCAL REVERB

Special reverb settings for the microphone input.

FADE IN/OUT SETTING

Jump to the display to make the settings related to FADE IN and FADE OUT.

MIXER

When the MIXER button is pressed, you can jump to the MIXER display to visually adjust the settings for each part.

- This display can also be used to switch the **LOCAL CONTROL** on/off setting.

DISK LOAD

You load disk data quickly by jumping to the DISK LOAD display.

MUTE KEYS

When this button is ON, the operation of the keyboard keys and the wheels is disabled. A convenient feature when you want to pretend to play the keyboard while playing back a song disk or the **SEQUENCER**, for example.

PANIC

During a MIDI performance, if you encounter a problem such as a continuous sound that does not fade, press both balance buttons below the PANIC indication at the same time.

About the display

A large-size display, easy to operate with excellent readability, is used for displaying various information such as the names of the selected sounds and rhythms etc and when setting the functions. Let's take a look

Normal display

This is the kind of information you see on the display during a normal performance

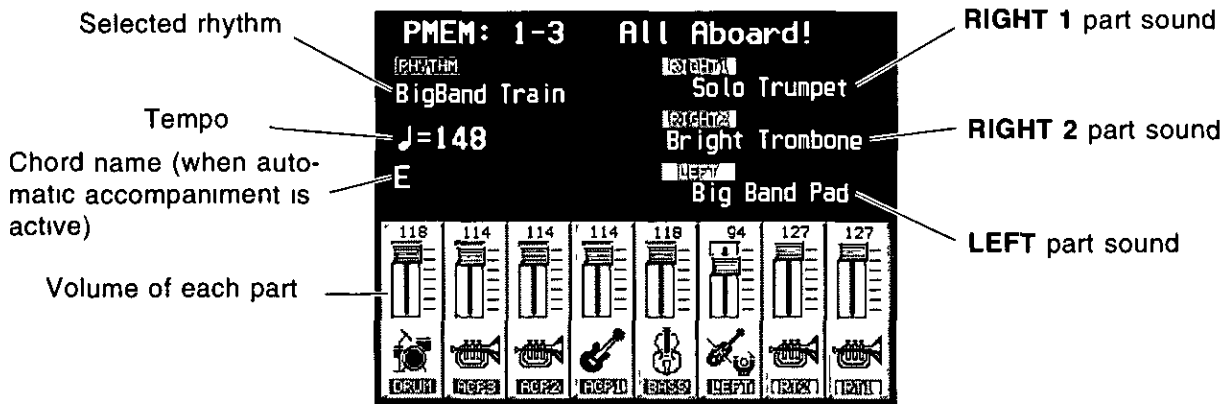

Volume balance

At the bottom half of the normal display, the volume balance of each part is represented in a fader illustration and by a number (0 to 127). You can use the balance buttons below the display to adjust the volumes

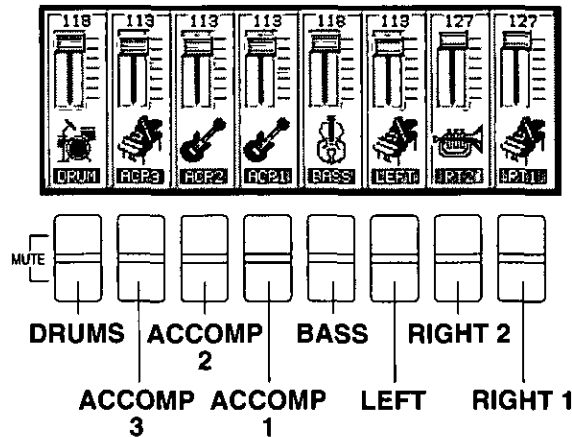

When setting the volume balance, press the ^ button to increase the volume and the v button to decrease it

- Hold a button down to scroll the volume quickly

■ MUTE

To mute a part, press both the corresponding ^ and v buttons at the same time

- The volume display for a muted part is shown as "MUTE"
- Pressing either balance button for a muted part will cancel the mute function

OTHER PARTS/TR

If you press the **OTHER PARTS/TR** button, the display changes to show the volumes of these parts. You can then adjust the volumes of these parts.

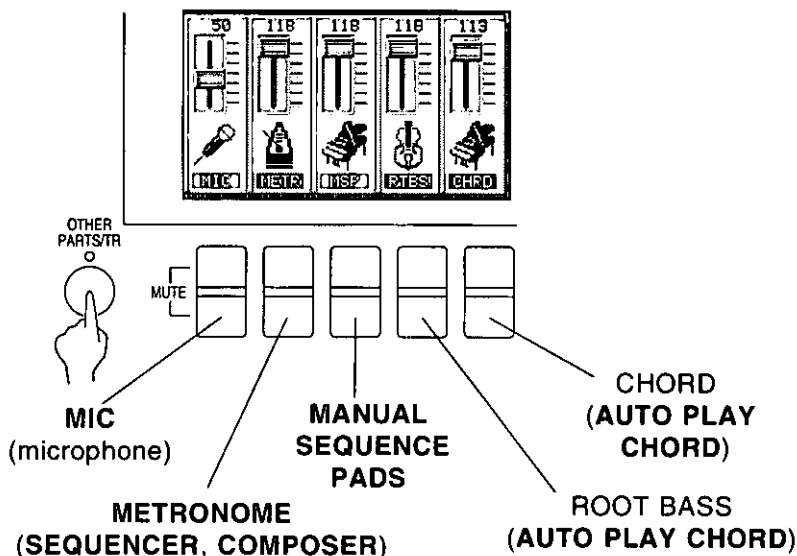

Use this button to access the RIGHT (RT) 1–PART (PT) 8 and PART 9–16 volume displays. These parts are active when playing back a song disk or when this instrument is connected to external MIDI equipment and is used as a multi-timbre sound generator.

- When there are other parts or tracks to access, the **OTHER PARTS/TR** indicator is lit.

PAGE

When there are additional parts to the current display, a page number indication, for example PAGE1/2 or P1/2, appears in the upper right corner of the screen. For example, 1/2 indicates that there are two pages of the display, and the current page is page 1. In this case, you can use the **PAGE** ^ and v buttons to the right of the balance buttons to view different “pages” of the display.

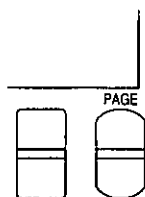

- Press the ^ button to view the next page of the display, and the v button to view the previous page of the display.
- On the last page of the display, pressing the ^ button returns to the first page. And conversely, on the first page of the display pressing the v button will skip to the last page.

Menu display

The buttons shown in the illustration below control multiple functions. Pressing one of the buttons will access the corresponding menu display.

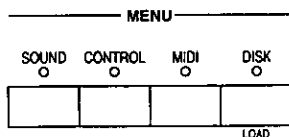

■ Example of menu display: SOUND

Select a function from the menu display by pressing the corresponding button to the left or right of the display indicated by the ◀ and ▶ arrows.

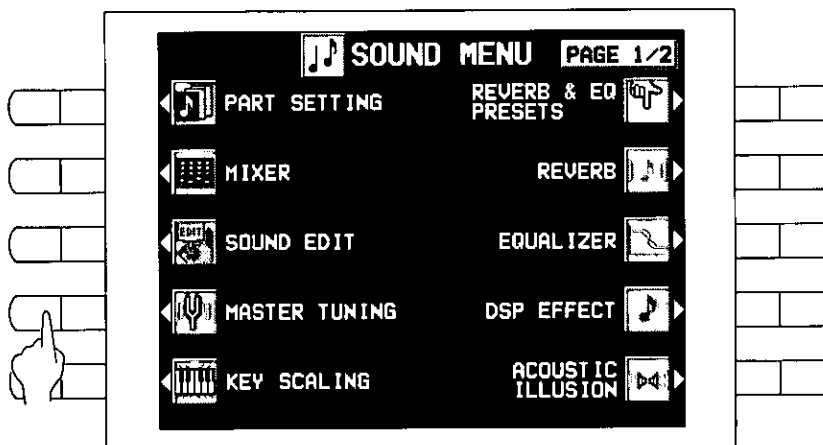

- In this manual, the steps describing how to select a function from a menu display are generally abbreviated as follows, for example: "On the SOUND MENU display, select MASTER TUNING."

Setting display

When setting various functions, the available options are shown on the display. The buttons to the right, left and/or directly below the display are used to select and adjust the settings.

■ Example of setting display: MASTER TUNING

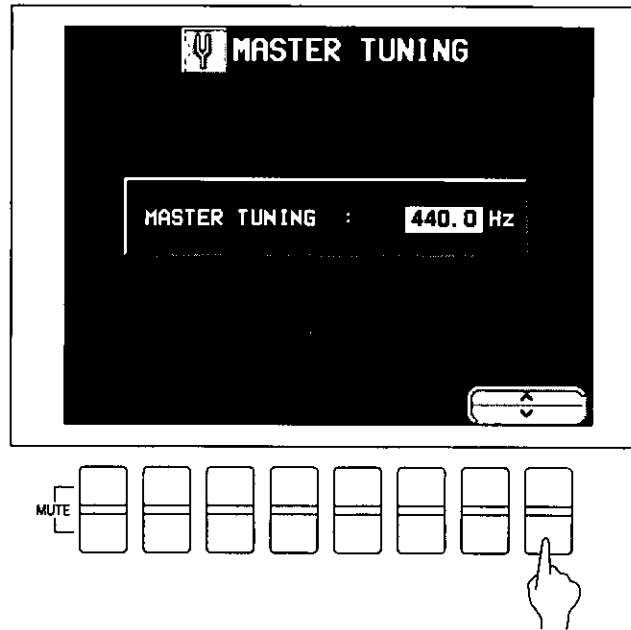

Press the button corresponding to the \wedge or \vee button on the display to change the value.

- In this manual, this procedure is written as follows: "Use the \wedge and \vee buttons to adjust the pitch."

TEMPO/PROGRAM dial

If the **TEMPO/PROGRAM** indicator is lit while you are using the display to adjust a setting, it indicates that the dial can be used to quickly change the displayed value or setting.

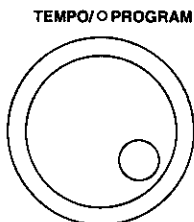

- The setting which can be adjusted is highlighted on the display.

EXIT

While the setting display is shown, press this button to go back to the previous display

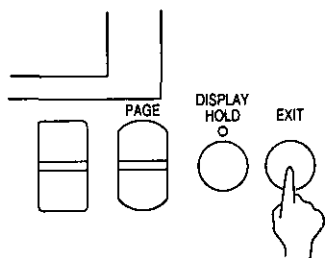

DISPLAY HOLD

Press this button to turn it on when you wish to maintain the current display. You can keep a display which is normally automatically canceled, for example, or even during a performance, you can monitor information which is not shown on the normal display

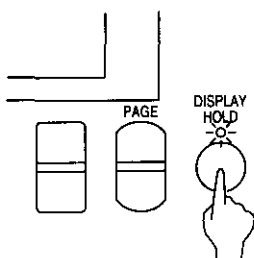

- The indicator for this button may flash if the current display is one which is normally automatically canceled
- If any of the **MENU** buttons, for example, is pressed, the **DISPLAY HOLD** mode is canceled

CONTRAST

Use the **CONTRAST** controller to adjust the readability of the display

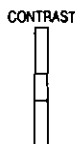

HELP

You can find an explanation of each button's function on the display

- 1 While the normal performance display is shown, press the **HELP** button

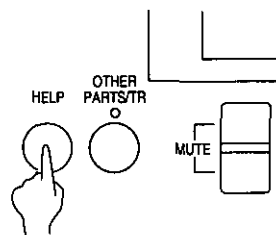

- The following display appears



- 2 Use the buttons below the display to select a language
- 3 Press the OK button
4. Press a button on the panel whose explanation you wish to read
 - An explanation of the button's function is shown on the display
- 5 Press the **HELP** button again to exit the help mode
 - Attention display messages and error messages are also shown in the selected language
 - The appearance of the display on your instrument may be different from the illustrated display in this manual depending on the region in which your instrument was purchased and the selected display language

Part I Sounds and effects

Selecting sounds

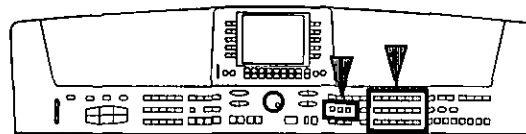

Select the sounds for the three parts you can play on the keyboard—**RIGHT 1**, **RIGHT 2** and **LEFT**. After first selecting a part and a **SOUND GROUP**, choose the desired sound from the display.

Select a sound

1. In the **PART SELECT** section, choose **RIGHT 1**, **RIGHT 2** or **LEFT**.

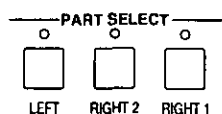

- The **CONDUCTOR** buttons are used to specify which part is heard. (Refer to page 36.)

2. In the **SOUND GROUP** section, select a sound group.

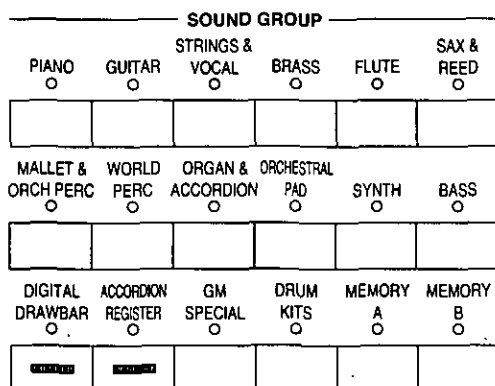

- The sounds in **GM SPECIAL** are **GENERAL MIDI** sounds that are not included in other groups.
- The sounds in **DRUM KITS** are percussion sounds that you play by striking the keyboard keys.
- **MEMORY A** and **MEMORY B** are reserved for storing sounds you modify. (Refer to page 139.)

3. Select the desired sound from the list on the display.

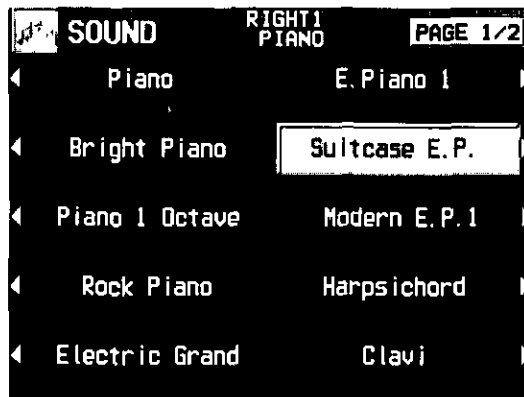

- A list of sounds available for each sound group can be found in the separate **REFERENCE GUIDE** provided.
- You can use the **PAGE** buttons to view a different part of the list.
- The sound you select is memorized for the part you selected in step 1.
- The display returns to the previous display after a few seconds.

4. Play the keyboard.
- This instrument features **INITIAL TOUCH** (the volume, for example, changes depending on how hard the keyboard is played) and **AFTER TOUCH** (effects are added by pressing the keys harder).

Digital Drawbar

You can play organ sounds while controlling the drawbars on the display.

1. In the **PART SELECT** section, select a part.
2. Press the **DIGITAL DRAWBAR** button to turn it on.

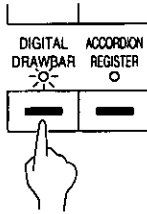

- The display looks similar to the following.

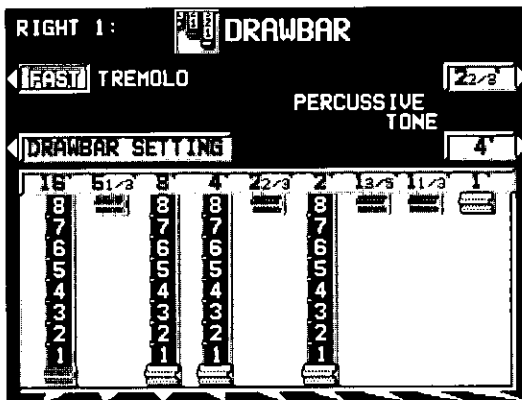

3. Use the balance buttons below the display to adjust the volume of each drawbar.
 - The volume of each drawbar is illustrated on the display and changes when you press the corresponding balance buttons to adjust the volume. The 1' setting is adjusted with the **PAGE** buttons.
 - The **DIGITAL DRAWBAR** can be selected only for the **RIGHT 1**, **RIGHT 2** and **LEFT** parts. It can not be selected for other parts, such as the **ACCOMP 1, 2, 3** and **BASS** parts of the **COMPOSER**, **MANUAL SEQUENCE PADS**, or **PART 4** to **16** of the **SEQUENCER**.

■ PERCUSSIVE TONE

PERCUSSIVE TONE adds a tone with a fast initial attack to the drawbar sounds. You can select two pitch levels of attack tones.

Use the **PERCUSSIVE TONE 2 2/3'** and **4'** buttons to turn the respective tone on or off.

- A red frame indicates that the tone is on.

■ TREMOLO

Tremolo is a rapid oscillation in volume, like the effect of a rotating speaker. The tremolo speed can be changed while you are playing.

- The **DSP EFFECT (ROTARY SPEAKER/ROCK ROTARY)** is used for the tremolo effect. This effect does not work if the **DSP EFFECT** button is turned off.

Use the **TREMOLO** button to switch between the **SLOW** and **FAST** rotating speeds.

- The **TREMOLO** setting is effective for the **RIGHT 1**, **RIGHT 2** and **LEFT** parts in common.

▣ DRAWBAR SETTING

The drawbar sounds can be adjusted more precisely

- 1 Press the DRAWBAR SETTING button
 - The display looks similar to the following

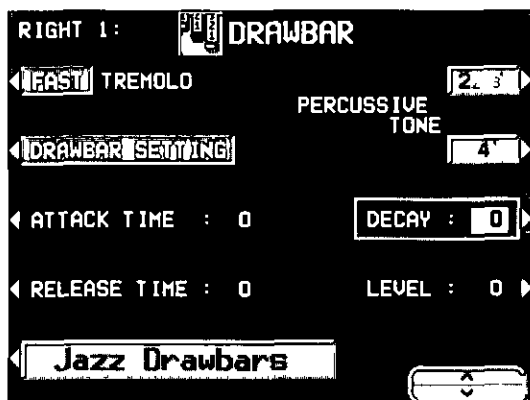

- 2 Use the Jazz Drawbars/Rock Drawbars button to select the type of sound
 - The types of **DSP EFFECT** used with the TREMOLO effect are as follows
 - Jazz Drawbars ROTARY SPEAKER
 - Rock Drawbars ROCK ROTARY
 - In case different types are selected for multiple parts, the **DSP EFFECT** for the sound type which was selected last is active

- 3 Select the item Use the ^ and v buttons to change the setting (-5 to +5)

ATTACK TIME

Adjust the time it takes for the drawbar sound to sound after a key is played

RELEASE TIME

Adjust the time it takes for the drawbar sound to die out after the keys are released

DECAY

Adjust the time it takes for the percussive tone to die out

LEVEL

Adjust the volume of the percussive tone

- The above settings are effective for the **RIGHT 1, RIGHT 2 and LEFT** parts in common

About foot marks

The foot indication on each balance button (for example 8') refers to the pitch of a rank of pipes in a pipe organ. If 8' is used as the standard (the pitch as played on the keyboard), a 16' rank pitch will be one octave below the 8' rank pitch, and a 4' rank pitch one octave above.

When the C³ key is pressed, the sounds of the different pitch ranks are as follows

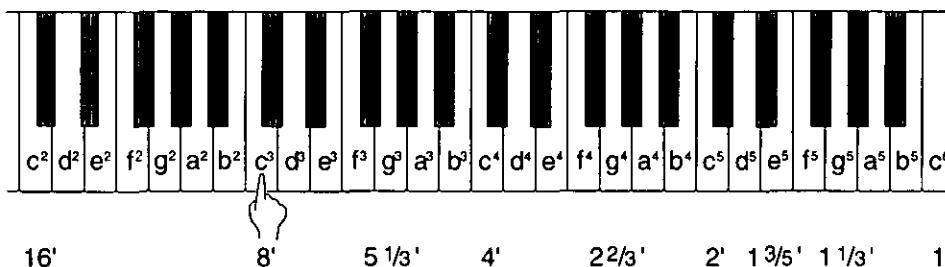

Accordion Register

You can play accordion sounds on a special display.

1. In the **PART SELECT** section, select a part.

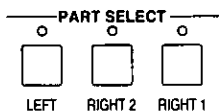

2. Press the **ACCORDION REGISTER** button to turn it on.

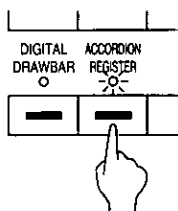

- The display looks similar to the following



3. Use the TYPE \wedge and \vee buttons to select a type of accordion (GERMAN, ITALIAN).
 4. Select the register (sound) from the lower display or from BASS1 and BASS2.
- Only one register can be selected.

Assigning parts to the keyboard

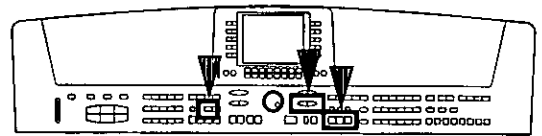

The **CONDUCTOR** buttons are used to assign the parts (**RIGHT 1**, **RIGHT 2**, **LEFT**) to the keyboard in many different ways. For example, you can split the keyboard into right and left sections (**SPLIT**), and assign a different sound to each section.

CONDUCTOR

CONDUCTOR settings	How sounds are assigned to the keyboard
	All keys produce the RIGHT 1 sound. <div style="border: 1px solid black; padding: 10px; text-align: center; margin-top: 10px;"> RIGHT 1 </div>
	All keys produce the RIGHT 2 sound. <div style="border: 1px solid black; padding: 10px; text-align: center; margin-top: 10px;"> RIGHT 2 </div>
	All keys produce both the RIGHT 1 sound and the RIGHT 2 sound. <div style="border: 1px solid black; padding: 10px; text-align: center; margin-top: 10px;"> RIGHT 1 + RIGHT 2 </div>
	The left keys produce the LEFT sound and the right keys produce the RIGHT 1 sound and the RIGHT 2 sound. <div style="display: flex; justify-content: space-around; margin-top: 10px;"> <div style="border: 1px solid black; padding: 10px; text-align: center;"> LEFT </div> <div style="border: 1px solid black; padding: 10px; text-align: center;"> RIGHT 1 + RIGHT 2 </div> </div>
	The left keys produce the LEFT sound and the right keys produce the RIGHT 1 sound. <div style="display: flex; justify-content: space-around; margin-top: 10px;"> <div style="border: 1px solid black; padding: 10px; text-align: center;"> LEFT </div> <div style="border: 1px solid black; padding: 10px; text-align: center;"> RIGHT 1 </div> </div>
	The left keys produce the LEFT sound and the right keys produce the RIGHT 2 sound. <div style="display: flex; justify-content: space-around; margin-top: 10px;"> <div style="border: 1px solid black; padding: 10px; text-align: center;"> LEFT </div> <div style="border: 1px solid black; padding: 10px; text-align: center;"> RIGHT 2 </div> </div>

- The volume for each part can be adjusted independently. (Refer to page 27.)
- The following conditions are in effect when the **AUTO PLAY CHORD** is used.
 - ONE FINGER, FINGERED mode: You cannot assign sounds to all the keys.
 - PIANIST mode: The keyboard cannot be split.

Sounds and effects

SPLIT POINT

When the keyboard is divided into left and right sections, the split point is indicated by the lit indicator. You can change the location of the split point.

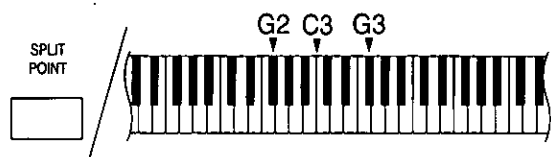

Each time the **SPLIT POINT** button is pressed, the indication moves to the next split point in the following order. G2 → C3 → G3 → customized split point (all indicators off) (see below).

■ Customized split point

Use the following procedure if you wish to store a split point at a location other than G2, C3 or G3.

1. Press and hold the **SPLIT POINT** button for a few seconds.



- The following display appears.



2. Press a key on the keyboard to specify the desired split point.
 - A split point is set at the location of the pressed key, and is indicated on the keyboard illustration on the display.
 - The key at the split point is the lowest note of the right keyboard section.
 - After a few seconds, the display exits the setting mode.

- Whenever the keyboard is split, you can select your customized split point by pressing the **SPLIT POINT** button until none of the split point indicators is lit. In this case, the customized split point is indicated on the display.

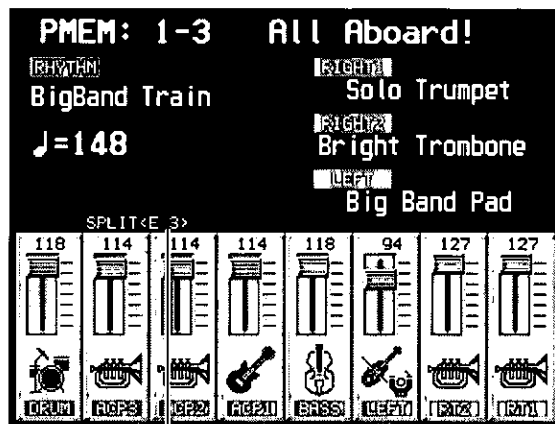

Customized split point

Sounds and effects

RIGHT 1/RIGHT 2 OCTAVE

During your performance you can quickly change the octave of the **RIGHT 1** and **RIGHT 2** parts. Use this convenient function to expand the octave range of the keyboard, especially during a split-keyboard performance.

Use the **R1/R2 OCTAVE** buttons (+ and -) to change the octave.

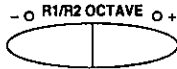

- Press the + button to raise the pitch and the - button to lower the pitch (-2 to +2).
- The display looks similar to the following.



- You can also use the ^ and v buttons on the **RIGHT 1/RIGHT 2 OCTAVE** display to change the octave.
- The display returns to the previous display after a few seconds.
- A lit + or - indicator shows that the octave has been changed.
- To cancel the octave change, press both buttons at the same time.
- The note pitches (**NOTE NUMBER**) recorded in the **SEQUENCER** and during MIDI transmission are also affected by this octave setting. However, it does not affect **SEQUENCER** playback or received MIDI data.

Effects

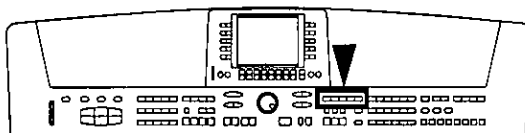

You can achieve even fuller and stirring sounds by adding various effects

SUSTAIN

SUSTAIN is the gradual fading out of musical tones after the key is released

- 1 In the **PART SELECT** section, turn on the part to which this effect will be applied
- 2 Press the **SUSTAIN** button to turn it on



- The **SUSTAIN** can be set to on or off for each part
- This effect does not work for the sounds in the **DRUM KITS** sound group
- This effect may not work for some sounds
- In the initialized state, the sustain can be turned on and off with the optional Foot Switch (1) (sold separately)

DIGITAL EFFECT

DIGITAL EFFECT gives the sound richness and enhances your performance

- 1 In the **PART SELECT** section, turn on the part to which this effect will be applied
- 2 Press the **DIGITAL EFFECT** button to turn it on

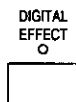

- The on or off status of the **DIGITAL EFFECT** is preset for each sound
- This effect does not work for the sounds in the **DIGITAL DRAWBAR** and **DRUM KITS** sound groups
- This effect may not work for some sounds

DSP EFFECT

You can change the quality of the sound.

1. In the **PART SELECT** section, turn on the part to which this effect will be applied.
2. Press the **DSP EFFECT** button to turn it on.



- The **DSP EFFECT** can be set to on or off for each part.
- When the **DIGITAL DRAWBAR** is on, this button is used to specify the tremolo effect type (**ROTARY SPEAKER/ROCK ROTARY**).

▣ Type and parameter settings

1. Press and hold the **DSP EFFECT** button for a few seconds.
- The display changes to the following.

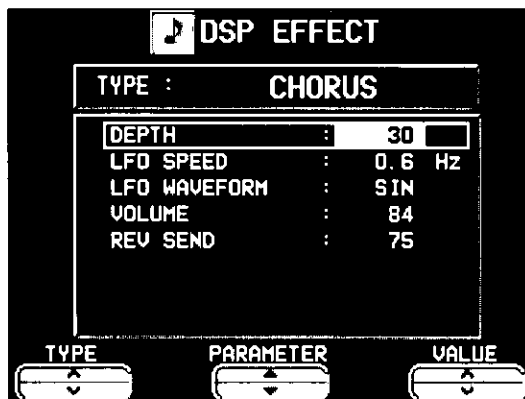

2. Use the **TYPE** \wedge and \vee buttons to select the type of effect.
 - Details about the parameters or each type can be found in the separate **REFERENCE GUIDE** provided.
3. Use the **PARAMETER** \wedge and \vee buttons to select the parameter.
4. Use the **VALUE** \wedge and \vee buttons to adjust the setting.
5. Repeat steps 3 and 4 for each parameter as necessary.
 - When a type of effect is selected, the parameters automatically revert to the factory defaults.
 - If you set very high or very low settings for **PARAMETRIC EQ** (equalizer) type effects, the sound may be distorted. In this case, adjust the **Q** or **G** setting, or lower the **MAIN VOLUME** setting.

DIGITAL REVERB

DIGITAL REVERB applies a reverberation effect to the sound.

Press the **DIGITAL REVERB** button to turn it on.



- This effect is applied to all the sounds of the keyboard.

▣ Type and parameter settings

1. Press and hold the **DIGITAL REVERB** button for a few seconds.
- The display changes to the following.

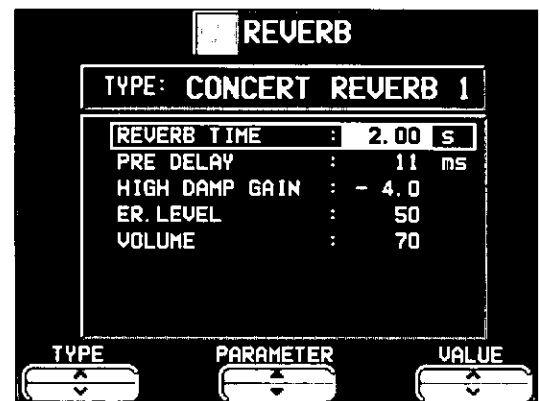

2. Use the **TYPE** \wedge and \vee buttons to select the type.
 - Details about each type and its parameters can be found in the separate "**REFERENCE GUIDE**" provided.
3. Use the **PARAMETER** \wedge and \vee buttons to select the parameter to adjust.
4. Use the **VALUE** \wedge and \vee buttons to change the setting.
5. Repeat steps 3 and 4 for the other parameters, as desired.
 - When a type of effect is selected, the parameters automatically revert to the factory defaults.

ACOUSTIC ILLUSION

The **ACOUSTIC ILLUSION** effect makes your one instrument sound like many instruments, each with a slightly different sound, with various simulated arrangements. When used with the sound of strings, for example, this effect makes your instrument sound like a whole orchestra.

Press the **ACOUSTIC ILLUSION** button to turn it on.

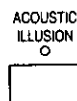

- This effect is applied to all the sounds of the keyboard.
- This effect is not applied to the **MIC** input.

■ Type and level settings

1. Press and hold the **ACOUSTIC ILLUSION** button for a few seconds.
- The display looks similar to the following.



2. Use the **TYPE** \wedge and \vee buttons to select the type.
 - Select from **STANDARD**, **PERCUSSIVE** (ideal for piano and drum sounds), **SYMPHONIC** (ideal for strings and brass sounds) and **DEEP SPACE**.
3. Use the **LEVEL** \wedge and \vee buttons to select the level (1 to 99).

PITCH BEND

The pitch of the instrument can be continuously changed with the **PITCH BEND** wheel at the left end of the keyboard. Using this control, you can produce the effect of bending the strings on a guitar.

While pressing a key on the keyboard, move the wheel up and down to control the pitch.

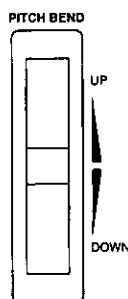

- When you release your hand from the wheel, it returns automatically to the center position and the pitch bend effect is turned off.
- The pitch bend effect does not function for the **AUTO PLAY CHORD** accompaniment pattern or during a normal performance for the sounds of the **LEFT** part.
- The amount of pitch bend can be set. (Refer to page 132.)

MODULATION

The **MODULATION** wheel is used to apply a vibrato effect, for example, to the sound.

While pressing a key on the keyboard, move the wheel up to add the effect.

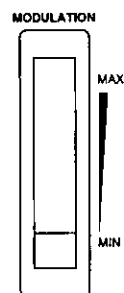

- When this effect is not needed, set the **MODULATION** wheel to the **MIN** position.
- This effect differs depending on the selected sound.
- The vibrato effect does not function for the **AUTO PLAY CHORD** accompaniment pattern or during a normal performance for the sounds of the **LEFT** part.

Transpose

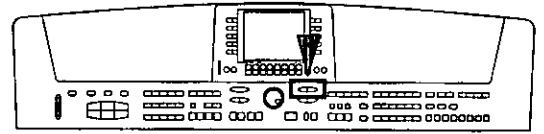

The **TRANSPOSE** buttons are used to change the key of the entire instrument in semi-tone steps across an entire octave.

Suppose you learn to play a song—in the key of C, for example—and decide you want to sing it, only to find that it's either too high or too low for your voice. Your choice is to either learn the song all over again in a different key, or to use the **TRANSPOSE** feature.

<Example: transposed to D>

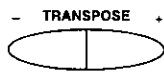

Adjust the key with the < and > buttons.

- Each press of the > button changes the key as follows: D^b → D → E^b → E → F → F[#]. Each press of the < button changes the key as follows: B → B^b → A → A^b → G.
- If the two buttons are pressed at the same time, the key returns to C.
- When the **TRANSPOSE** function is active, the transposed key is shown on the display.

Played keys



C major



Notes that sound



D major

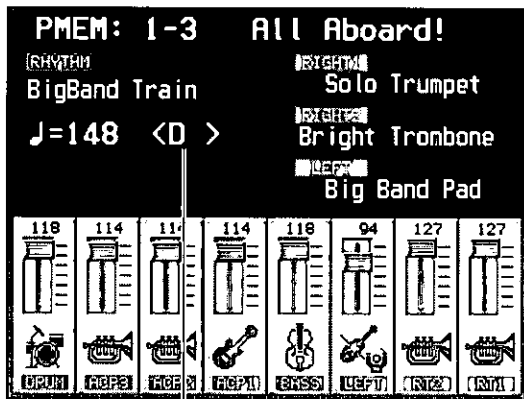

Actual key

Techni-chord

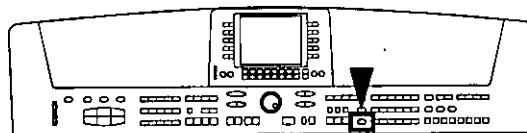

TECHNI-CHORD turns your single note melodies into full chords and offers you a choice of different types from a simple duet which adds one harmony note to your melody note, to big band reeds which adds four harmony notes to your melody note. If **TECHNI-CHORD** is part of a **ONE TOUCH PLAY** or **MUSIC STYLIST** registration, a suitable **TECHNI-CHORD** type will be selected automatically.

Example:

Left hand (chord)

Right hand (melody)



1. Split the keyboard into left and right sections.
(Refer to page 36.)
2. Press the **TECHNI-CHORD** button to turn it on.



3. Play the keyboard.
 - The melody you play with your right hand is automatically played in chords which are based on the chords you play with your left hand.
 - This feature is very effective when used with the **AUTO PLAY CHORD**.

Type setting

1. Press and hold the **TECHNI-CHORD** button for a few seconds.
 - The display looks similar to the following.



2. Use the ◀, ▲, ▼, ▶ buttons to select the harmony style.
 - When the **OCTAVE**, **HARD ROCK** or **FANFARE** style is selected, the **TECHNI-CHORD** functions even when the keyboard is not split.
 - For a detailed explanation of the different harmony styles, refer to the separate **REFERENCE GUIDE** provided.

ORCHESTRATOR

You can specify which part is used for the harmony tones. Your **TECHNI-CHORD** performance is enhanced by selecting harmony sounds different from the sounds you play and the sounds produced by the automatic accompaniment.

1. Use the **PAGE** buttons to access the **PAGE 2/2** display.

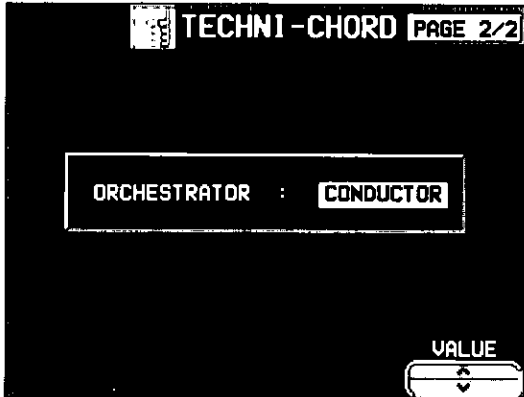

2. Use the **^** and **v** buttons to select the part for the harmony notes.

- **LEFT** and **PART 16** cannot be selected.
- If **CONDUCTOR** is selected, the harmony notes are produced in the sounds of the part which is currently selected in the **CONDUCTOR (RIGHT 1, RIGHT 2)**. In other words, the harmony notes are produced in the same sound as the melody notes. If both **RIGHT 1** and **RIGHT 2** are on, the harmony notes are produced in the sound of the **RIGHT 1** part.

Sounds and effects

Entertainer

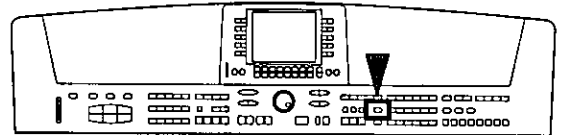

When a microphone is connected to the **MIC** input terminal on the rear panel of this instrument, for performing with vocals at gatherings, for example, the **ENTERTAINER** function lets you use this display alone to control all the necessary operations.

1. Press the **ENTERTAINER** button to turn it on.



- The display looks similar to the following.

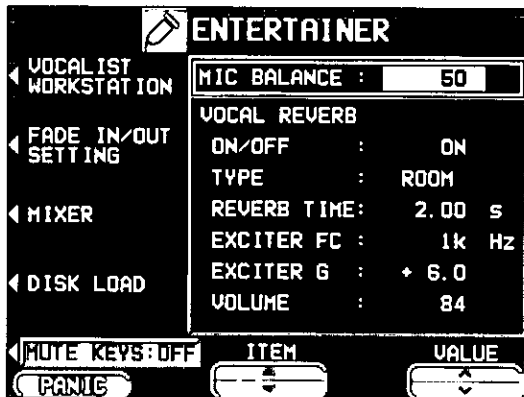

2. Use the **ITEM** **Δ** and **∇** buttons to select the item. Use the **VALUE** **^** and **v** buttons to change the setting.

MIC BALANCE

Adjust the microphone volume (0 to 127).

VOCAL REVERB

(Independent reverb for microphone input)

ON/OFF:

Turn the mic reverb to on or off.

TYPE:

Select the type of reverb (**ROOM**, **KARAOKE**, **BATH ROOM**, **STAGE**).

REVERB TIME:

The time it takes for the reverb effect to fade out (0.40s to 30.00s)

EXCITER FC

The frequency of the emphasis (100Hz to 8KHz).

EXCITER G:

The volume of the emphasis (-6.0 to +6.0)

VOLUME:

Adjust the reverb volume (0 to 127).

- The **MAIN VOLUME** setting affects the microphone input; however the expression pedal and **FADE IN/OUT** operation does not.
- During a MIDI performance, for example, if you encounter a problem such as a continuous sound that does not fade, press both balance buttons below the PANIC indication at the same time.

<Here's what happens>

MIDI OUT:

ALL NOTES OFF, ALL SOUND OFF, RESET ALL CONTROLLER messages are transmitted to all MIDI channels.

MIDI IN:

Received NOTE, CONTROL data are initialized.

Keyboard:

Keyboard input, CONTROL data are initialized.

- During your performance you can use the buttons to the left of the display for quick execution of the necessary operations.

VOCALIST WORKSTATION:

You can connect a "VOCALIST WORKSTATION" VOCAL HARMONY PROCESSOR by Digitech Corp. and have harmony added to the microphone input. (Refer to page 181.)

FADE IN/OUT SETTING:

Adjust the fade in/fade out. (Refer to page 57.)

MIXER:

Adjust the sound and volume of each part etc. (Refer to page 133.)

DISK LOAD:

Load data from a floppy disk. (Refer to page 114.)

MUTE KEYS:

Disable the operation of the keyboard keys and the wheels (ON/OFF).

- When this button is ON, you can pretend to play the keyboard while playing back a song disk or the **SEQUENCER**, for example.
- This setting is automatically set to OFF when the power is turned on.

Part II Manual Sequence Pads

Playing phrases

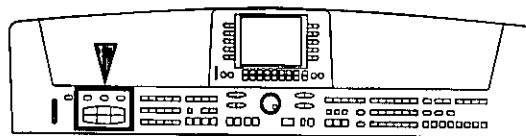

During your performance, you can insert a short recorded phrase or effect sounds by pressing a pad button. A different group of phrases is recorded in each bank.

1. Press the **BANK** button.

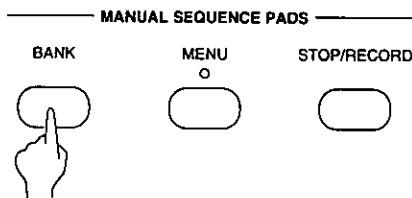

2. Select the desired bank from the display.

- The list of banks consists of two screen pages. Use the **PAGE** buttons to move from one screen page to another.



- “User Bank” 1 and 2 are for storing your original phrases.
- “Compile Bank” 1 and 2 are for assigning phrases as you desire.
- Various functions are assigned to each pad button in “Control Preset” 1 and 2.

“Control Preset 1” (foot switch functions):

- ROTARY SLOW/FAST
 - PANEL MEMORY BANK INCREMENT
 - GLIDE
 - PANEL MEMORY DECREMENT
 - PANEL MEMORY BANK DECREMENT
 - PANEL MEMORY INCREMENT
- For more information about these functions, please see to page 161.
 - When using this bank, please set the MSP BANK setting of the EXPAND MODE FILTER of the **PANEL MEMORY** to OFF. (Refer to page 66.)

“Control Preset 2” (rhythm functions):

- FILL IN 1 (SEQUENCER RESET)
 - INTRO & ENDING 1
 - SYNCHRO & BREAK
 - FILL IN 2 (COUNT INTRO)
 - INTRO & ENDING 2
 - START/STOP
- The display returns to the previous display after a few seconds.

3. Press a pad button (1 to 6).

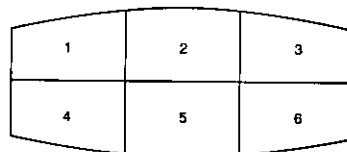

- A different phrase is assigned to each pad button.
- The selected phrase is played in the current tempo.
- To stop the phrase before it has ended, press the **STOP/RECORD** button.
- Some phrases continue to play until the **STOP/RECORD** button is pressed.
- During a rhythm performance, some phrases may play in time with the measure count.
- When the automatic accompaniment is on, the phrase is played in the specified chord.
- When the normal performance display is shown, you can press the **OTHER PARTS/TR** button to adjust the volume of the **MANUAL SEQUENCE PADS (MSP)**.
- When **GENERAL MIDI** is ON, the **MANUAL SEQUENCE PADS** do not sound. (Refer to page 173.)

Record a phrase

“User Bank” 1 and 2 are reserved for storing your original phrases.

1. Press the **BANK** button; on the MSP BANK SELECT display, select “User Bank 1” or “User Bank 2”.
2. While pressing the **STOP/RECORD** button, press the pad button in which you wish to record.

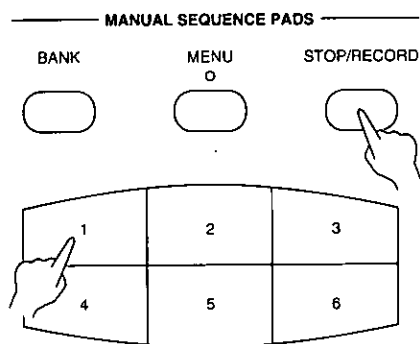

4. Use the \wedge and \vee buttons to select the phrase playback mode.

SYNC TO RHYTHM:

During a rhythm performance, the phrase starts in time with the measure.

INSTANT START:

The phrase starts as soon as the pad button is pressed, independent of a rhythm performance.

5. Select the sounds and effects for the phrase you are going to record.

6. Press the **START/STOP** button.

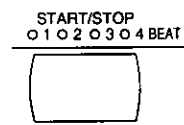

- The display looks similar to the following.
- After a two-measure count (MEASURE= -2, -1), recording begins.



7. Record the phrase.
8. When you have finished recording the phrase, press the **START/STOP** button.
- You can also stop recording by pressing the **STOP/RECORD** button.

9. Repeat steps 3 to 8 to record phrases in the other pad buttons as desired.
- The following information is stored.
 - Your keyboard performance
 - Sound settings and changes
 - **SUSTAIN** on/off setting
 - Operation of the **PITCH BEND** and **MODULATION** wheels, etc.
- The memory capacity of all the **MANUAL SEQUENCE PADS** user banks is approximately 1800 notes. The remaining memory available for recording is shown on the display as a percentage (MEMORY= %). When “Memory full!” appears on the display, no more data can be stored.
- You can assign a name to each bank. (Refer to page 49.)

3. Use the **TEMPO/PROGRAM** dial to adjust the recording tempo.
- The tempo is shown on the display as TEMPO=.

Compile

You can assign desired phrases from different banks in "Compile Bank" 1 and 2.

1. Turn on the **MENU** button in the **MANUAL SEQUENCE PADS** section.

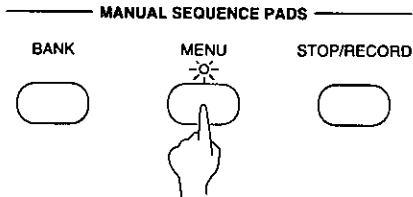

- The display looks similar to the following.



2. Select "COMPILE SET".

- The display looks similar to the following.



3. Press the **BANK** button to select a bank (COMPILE BANK: 1/2).

4. Use the **PADS** Δ and ∇ buttons to select the pad to which to assign the phrase.

5. Use the **BANK** and **PHRASE** \wedge and \vee buttons to select the desired bank and phrase you wish to assign.

- The "Control" bank cannot be selected.

6. Repeat steps 4 and 5 to assign phrases to the other pad buttons.

7. When you have finished assigning the phrases, turn off the **MENU** button.

- You can assign a name to the bank. (See the following.)

Manual Sequence Pads

Naming for "User" and "Compile" Banks

You can assign original names to "User Bank" 1, 2, "Compile Bank" 1 and 2.

1. Turn on the **MENU** button in the **MANUAL SEQUENCE PADS** section.

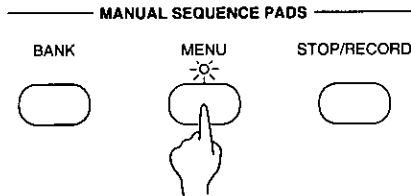

- The display looks similar to the following.



2. Use the \wedge and \vee buttons to select the bank you are going to name ("User" 1, 2, "COMPILE" 1, 2).

3. Select "Naming for User & COMPILE Banks".

- The display looks similar to the following.

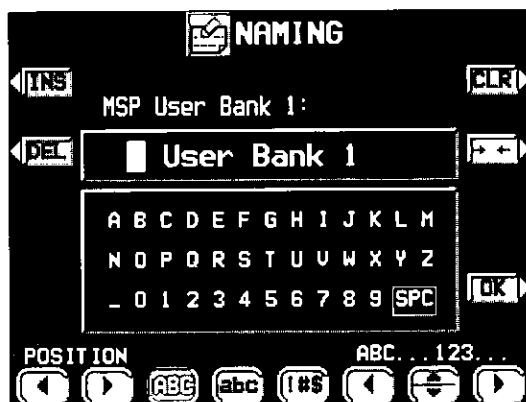

4. Assign a name to the bank.

- Use the POSITION buttons to highlight the character position in the name box. Use the \blacktriangleleft , \blacktriangleup , \blacktriangledown , \blacktriangleright buttons to select the alphanumeric character. Repeat these steps to type the whole name.
- Press the ABC button to switch to the screen for upper case (capital) letters, or the abc button to switch to the screen for lower case letters.
- Use the !#\$ button to switch to the symbols character set.
- Use the INS button to type a space.
- Use the DEL button to erase a character.
- To erase all the characters, press the CLR button.
- You can press the $\rightarrow\leftarrow$ button if you wish to have the name centered.

5. When you have finished assigning the name, press the OK button.

Part III Playing the rhythm

Selecting rhythms

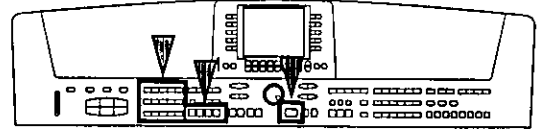

Many exciting rhythms are stored in the memory of this instrument. First select one of the rhythm groups and then choose the desired rhythm.

Select a rhythm

1. In the **RHYTHM GROUP** section, select a rhythm group.

RHYTHM GROUP				
STANDARD ROCK	R & ROLL & BLUES	POP & BALLAD	FUNK & FUSION	SOUL & MODERN DANCE
<input type="checkbox"/>	<input type="checkbox"/>	<input type="checkbox"/>	<input type="checkbox"/>	<input type="checkbox"/>
BIG BAND & SWING	JAZZ COMBO	U.S. TRAD	COUNTRY	LATIN
<input type="checkbox"/>	<input type="checkbox"/>	<input type="checkbox"/>	<input type="checkbox"/>	<input type="checkbox"/>
MARCH & WALTZ	PARTY TIME	SHOW TIME & TRAD DANCE	WORLD	CUSTOM
<input type="checkbox"/>	<input type="checkbox"/>	<input type="checkbox"/>	<input type="checkbox"/>	<input type="checkbox"/>

- **CUSTOM** is reserved for storing rhythms you create with the **COMPOSER**.

2. Select the desired rhythm from the list on the display.



- A list of rhythms available for each rhythm group can be found in the separate **REFERENCE GUIDE** provided.
- If there is more than one page to the display, use the **PAGE** buttons to move from one screen page to another.
- The display returns to the previous display a few seconds after you have made your selection.

VARIATION

There are four variations available for each rhythm. Use the **VARIATION & MSA** buttons to select the desired variation.

VARIATION & MSA			
O 1	O 2	O 3	O 4
<input type="checkbox"/>	<input type="checkbox"/>	<input type="checkbox"/>	<input type="checkbox"/>

- The nuance of the pattern differs with each variation number.
- You can change to a different variation while the rhythm is playing.

Start the rhythm

There are two ways to start the rhythm.

■ Normal start

1. Select a rhythm.
2. Press the **START/STOP** button to turn it on.

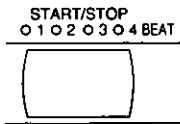

- The selected rhythm pattern immediately begins to play.
- You can stop the rhythm by pressing the **START/STOP** button again to turn it off.
- The **BEAT** indicators above the **START/STOP** button light to indicate the beat. On the first beat of the measure, the red indicator lights. On the second and succeeding beats of the measure, the green indicators light in order.
- When GENERAL MIDI is ON, the rhythm does not sound. (Refer to page 173.)

■ Synchronized start

With the synchronized start feature, the rhythm pattern starts when you play a key on the keyboard.

1. Select a rhythm.
2. Press the **SYNCHRO & BREAK** button to turn it on.

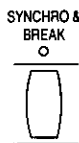

3. Play a key to the left of the keyboard split point.

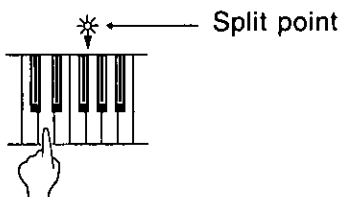

- The rhythm pattern begins to play.
- You can use the synchronized start feature even when the keyboard is not divided into left and right sections. To start the rhythm, press a key to the left of the specified split point.

■ Adjust the tempo

The tempo of the rhythm pattern is adjusted with the **TEMPO/PROGRAM** dial.

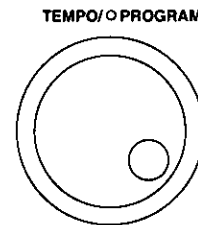

- The tempo is shown on the display as a numerical value ($\text{♩} = 40$ to 300).
- When the **TEMPO/PROGRAM** indicator is lit, the **TEMPO/PROGRAM** dial cannot be used to adjust the tempo.

■ TAP TEMPO

You can set the tempo of the rhythm by tapping this button few times with your finger at the tempo you wish to play.

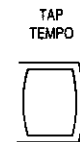

- The tempo at which the button is tapped is detected, and the tempo automatically changes correspondingly.

Playing the rhythm

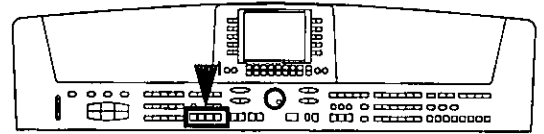

Intro, fill-in and ending patterns fitting each different rhythm pattern are permanently recorded in your Keyboard, thus allowing a versatile rhythm performance.

INTRO

Begin the rhythm performance with an intro pattern.

1. Press the **INTRO & ENDING 1** or **INTRO & ENDING 2** button to turn it on.

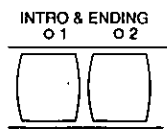

2. Press the **START/STOP** button to start the rhythm.

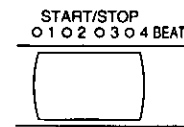

- An intro pattern is played, after which the normal rhythm pattern begins.

COUNT INTRO

You can begin the rhythm performance with a one-measure count.

1. Press the **COUNT INTRO (FILL IN 2)** button to turn it on.

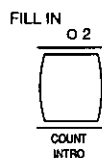

2. Press the **START/STOP** button to start the rhythm.

- A one-measure count is played, after which the normal rhythm pattern begins.

FILL IN

You can insert a fill-in pattern any time during the rhythm performance. Choose from two different fill-in patterns.

1. Select a rhythm and press the **START/STOP** button.

2. Press the **FILL IN 1** or **FILL IN 2** button.

- A fill-in pattern is heard immediately for the remainder of the measure.
- When a **FILL IN** button is pressed on the last beat of the measure, the fill-in pattern continues to the end of the following measure.

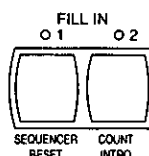

ENDING

Finish the rhythm performance with an ending pattern.

1. Select a rhythm and press the **START/STOP** button.
2. Press the **INTRO & ENDING 1** or **INTRO & ENDING 2** button to turn it on.

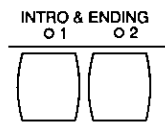

- An ending pattern is produced, and then the rhythm performance stops.
- If you accidentally press the **INTRO & ENDING** button in the middle of the tune, you can press the **FILL IN 1** or **FILL IN 2** button. The ending pattern stops, and a fill-in pattern is produced, after which the normal rhythm performance continues.

Auto Play Chord

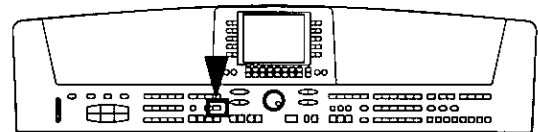

Simply by playing a chord on the keyboard, the **AUTO PLAY CHORD** function automatically plays an accompaniment pattern which matches perfectly the selected rhythm. With a real accompaniment as a background, you can concentrate on playing the melody.

How the AUTO PLAY CHORD works

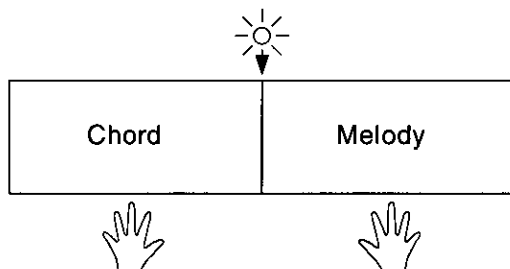

When an **AUTO PLAY CHORD** mode is selected, an automatic accompaniment which matches the rhythm you have chosen is played in the chord which you specify with your left hand. The melody is played with your right hand.

- The accompaniment pattern of the **AUTO PLAY CHORD** is composed of five parts: **DRUMS, BASS, ACCOMP 1, ACCOMP 2** and **ACCOMP 3**.
- The volume of each part can be adjusted with the buttons below the display. (Refer to page 27.)

Playing chords

Choose from three ways of playing chords.

■ ONE FINGER mode

In the ONE FINGER mode, a major chord can be played just by pressing the key for its root note.

Example: C chord

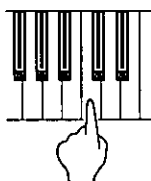

Minor, seventh and minor seventh chords are also easily produced.

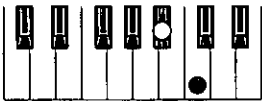
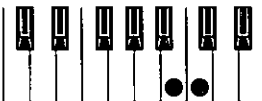
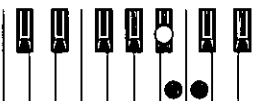
minor chord	seventh chord	minor seventh chord
Play the root note plus a black key to the left of it.	Play the root note plus a white key to the left of it.	Play the root note plus a black key and a white key to the left of it.
Example: Cm	Example: C7	Example: Cm7
		

■ FINGERED mode

In the FINGERED mode, you specify the chord by playing all the notes in the chord.

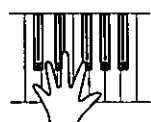

- The Keyboard can distinguish the following played chords for each key (C is given as an example): C, C7, CM7, Caug, Caug7, Cm, Cm7, Cdim, Cm7^{b9}, CmM7, Csus4, C7sus4, C^{b9}, C7^{b9}, Cm^{b9}, C6, Cm6, CM7^{b9}, CM7^{#9}, CmM7^{b9}, etc.

■ PIANIST mode

In the PIANIST mode, the entire keyboard can be used to specify chords (FINGERED mode) for the automatic accompaniment; a **RIGHT** part is assigned to all the keys, and the keyboard does not split. In addition to the chords in the FINGERED mode, the Keyboard also recognizes 9th and 13th chords.

- When specifying chords, if you press a key a perfect 5th or more below the lowest note of the chord, the **BASS** part becomes a pattern based on that note.

How to use the AUTO PLAY CHORD

1. Select the desired rhythm and sound(s), and set the tempo.
2. Press the **AUTO PLAY CHORD** button to turn it on.



- The display looks similar to the following.



3. Select an **AUTO PLAY CHORD** mode (**ONE FINGER**, **FINGERED** or **PIANIST**).

- After a few seconds, the display returns to the previous display.
- If the **ONE FINGER** or **FINGERED** mode was selected, the keyboard automatically splits into right and left sections.

■ MEMORY

When the **MEMORY** button is **ON**, even when the keys are released, the chord is memorized and the accompaniment continues to play until you specify another chord.

■ ON BASS

If the **ON BASS** button is **ON** while the **FINGERED** or **PIANIST** mode is selected, the **BASS** part is produced in the key of the lowest note of the played chord, thus making it possible to play chords such as C on G.

- For example, with the **ON BASS** button on, if you play a C chord by pressing the keys G, C and E, the **BASS** part is produced in the key of G.

4. Press the **START/STOP** button to begin the rhythm.

- You can start the rhythm by playing a key on the keyboard. (Refer to page 51.)

5. Specify a chord.

- If the **ONE FINGER** or **FINGERED** mode was selected, specify the chord on the keyboard section to the left of the split point.

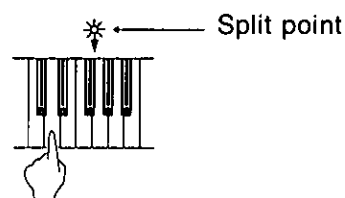

- An accompaniment pattern in the specified chord is automatically played. Play the melody with your right hand.

Example of how to play a ONE FINGER accompaniment

Play the melody with your right hand.

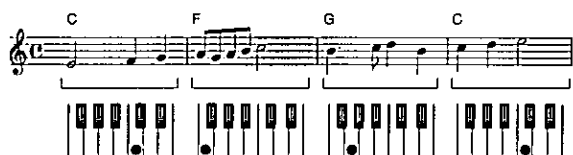

Left hand

- When you use **FILL IN**, **INTRO** and **ENDING**, the automatic accompaniment is also used in these patterns.
 - In the **ONE FINGER** mode, the sound assigned to the left section of the keyboard (**LEFT** part) does not sound in the initialized condition.
 - You can set the mode which determines how the **LEFT** part sounds during an **AUTO PLAY CHORD** performance. (Refer to page 138.)
6. To stop the automatic accompaniment, press the **START/STOP** button.
- In the initialized condition, when the rhythm is off, if an **AUTO PLAY CHORD** mode is on and a chord is specified, the specified root note (**R. BASS** part) and chord notes (**CHORD** part) are produced. The volumes of these notes can be adjusted. (Refer to page 129.)

BREAK function

With the break function, the rhythm starts when the left keyboard is played and stops when the fingers are removed from the keys.

1. Select an **AUTO PLAY CHORD** mode.
 - At this time, the **MEMORY** button should be off.
2. Press the **SYNCHRO & BREAK** button to turn it on.

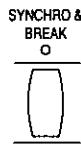

3. Specify a chord.
 - The automatic accompaniment begins to play (synchronized start).
 - For the **PIANIST** mode, play the keys to the left of the currently set split point.
4. Release the chord keys.
 - The automatic accompaniment stops. When the keys are pressed again, the rhythm starts from the first beat.

Fade In/Fade Out

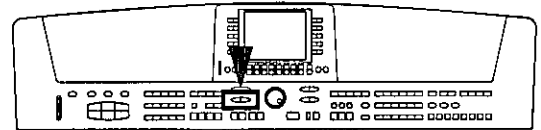

Add interest to your performance by starting a part with a fade-in or ending it with a fade-out.

FADE IN

At the beginning of the song, the volume of each part rises slowly.

1. Set up the panel settings for your performance.
2. Turn on the **FADE IN** button.

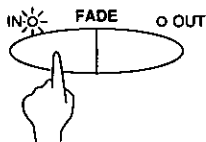

- The indicator flashes. In this condition, the volumes for all parts change to 0 and no sound is produced from this instrument until step 3 is executed.
3. Play the keyboard or press the **START/STOP** button.
 - The volume slowly builds to its preset level.
 - For the fade-in effect for a rhythm part or when playing back a **SEQUENCER** performance, turn on the **FADE IN** button before pressing the **START/STOP** button.
 - At the end of the fade-in, the **FADE IN** indicator goes out.
 - During the fade-in, **FADE IN** is shown on the normal display.

FADE OUT

At the end of the song, the volume of each part gradually fades to nothing.

1. Start the performance.
2. Turn on the **FADE OUT** button at the point you want the fade-out to start.

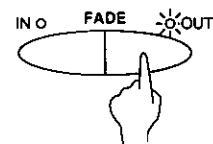

- The volumes of all the parts slowly fade to 0.
- The indicator flashes to show that fade-out is completed, and then goes out. The volumes for all parts return to their specified settings.
- If you wish to interrupt the fade-out, press the **FADE OUT** button to turn it off.

The volume balance buttons do not work while the **FADE IN** or **FADE OUT** indication is shown on the display.

FADE SET

Adjust the settings for the FADE IN and FADE OUT.

1. Press and hold the **FADE IN** or **FADE OUT** button for a few seconds.

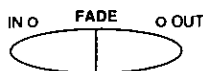

- The display looks similar to the following.

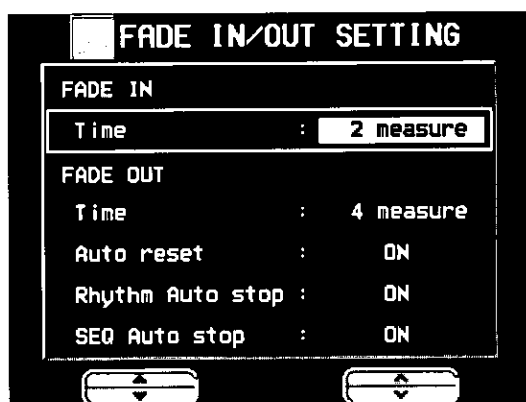

2. Use the ▲ and ▼ buttons to select the item. Use the ^ and v buttons to change the setting.

FADE IN

Time:

Specify the time elapsed between 0 volume to the set volume (1 measure to 16 measure).

FADE OUT

Time:

Specify the time elapsed between the set volume and 0 volume (1 measure to 16 measure).

Auto Reset:

Specify whether the volume of each part automatically returns to its specified setting (ON, OFF).

Rhythm Auto stop:

Specify whether the rhythm turns off after fade-out is completed (ON, OFF).

SEQ Auto stop:

Specify whether the **SEQUENCER** playback automatically stops after fade-out is completed (ON, OFF).

- The display returns to the previous display a few seconds after you have changed the settings.

Sound Arranger

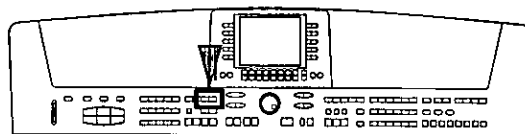

The **SOUND ARRANGER** feature lets you select other sounds for the **AUTO PLAY CHORD** parts of each rhythm.

1. Select the rhythm whose sound you wish to change.
 - Do not select **CUSTOM** or a **MEMORY** of the **COMPOSER**.
2. In the **SOUND ARRANGER**, press the **SET** button to turn it on.

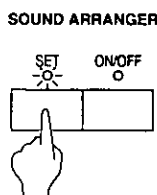

- The display looks similar to the following.

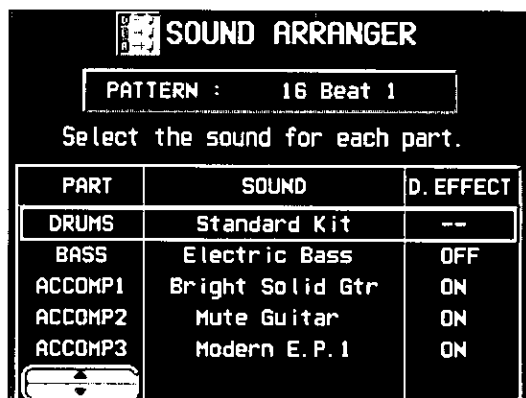

3. Use the Δ and ∇ buttons to select the part whose sound you wish to change.
4. Select the desired sound.
 - The **DIGITAL EFFECT** on/off status can also be specified (except for **DRUMS** part).
 - For the **DRUMS** part, select sounds from the **DRUM KITS** group.
 - Sounds from the **DIGITAL DRAWBAR** and **DRUM KITS** groups cannot be selected for the **ACCOMP** and **BASS** parts.
 - The sound and on/off status of the **DIGITAL EFFECT** are shown on the display.
5. Repeat steps 3 and 4 for the other parts as desired.
6. When you have finished selecting the sounds, press the **SET** button to turn it off.

Playing back the sounds

1. In the **SOUND ARRANGER**, press the **ON/OFF** button to turn it on.

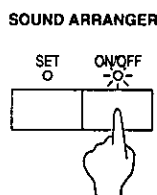

2. Start the rhythm (automatic accompaniment).
 - When the **ON/OFF** button is off, the factory-preset sounds are produced.

One Touch Play

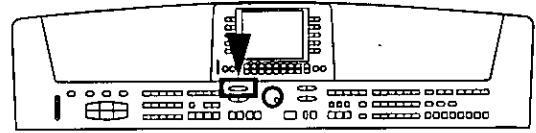

ONE TOUCH PLAY automatically sets a suggested combination of sounds and an appropriate tempo for your chosen rhythm style.

1. Select a rhythm pattern.
 - Do not select **CUSTOM** or a **MEMORY** of the **COMPOSER**.
2. Press the **ONE TOUCH PLAY (MUSIC STYLIST)** button until its indicator goes out.

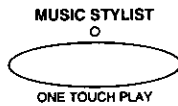

- During setting, the style name is shown on the display.
 - The **AUTO PLAY CHORD** and the **SYNCHRO & BREAK** are automatically turned on, and the sounds and effects, volume balances, tempo etc. that are ideal for your selected rhythm are automatically set.
3. Play the keyboard.
 - When you specify a chord, the automatic rhythm begins to play immediately.

Music Stylist

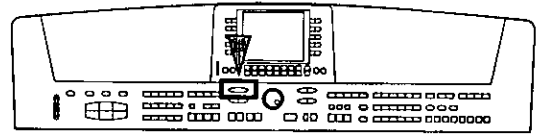

MUSIC STYLIST sets up your instrument with a suitable registration for a specific style of music or tune.

Setup by music style

1. Press the **MUSIC STYLIST (ONE TOUCH PLAY)** button to turn it on.

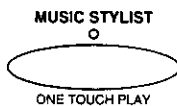

- The display looks similar to the following.



2. Select **STYLE EXPLORER**.

- The display looks similar to the following.

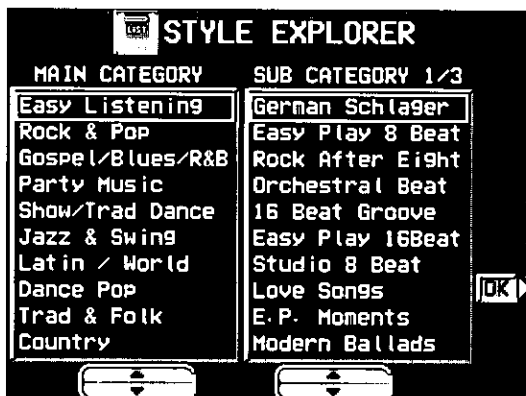

3. Use the **MAIN CATEGORY** ▲ and ▼ buttons to select a category. Use the **SUB CATEGORY** ▲ and ▼ buttons to select a subcategory.

4. Press the **OK** button.

- The display looks similar to the following.



5. Use the ▲ and ▼ buttons to select a music style.

- Each subcategory is divided into styles.
- During the search, you can use the **SKIP** ^ and v buttons to skip to the previous or following subcategory.
- The **AUTO PLAY CHORD** and the **SYNCHRO & BREAK** turn on, and the sounds, effects, volume balances, rhythm and tempo etc. which are best suited for the selected music style are automatically selected.

6. Play the keyboard.

- When you specify a chord, the automatic rhythm begins to play immediately.

Setup by alphabetical order

You can use alphabetical or numerical search to select a style name.

1. Press the **MUSIC STYLIST** button to turn it on.
 - The display looks similar to the following.



2. Select **STYLE ALPHABETICAL**.

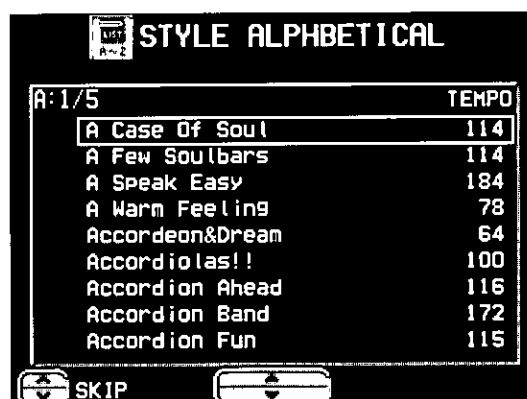

3. Use the **▲** and **▼** buttons to select a tune.
 - You can use the **SKIP ▲** and **▼** buttons to skip to the previous or following alphabetical or numerical heading.
 - The **AUTO PLAY CHORD** and the **SYNCHRO & BREAK** turn on, and the sounds, effects, volume balances, rhythm and tempo etc. which are best suited for the selected song are automatically selected.
4. Play the keyboard.
 - When you specify a chord, the automatic rhythm begins to play immediately.

After deciding on a style with the **MUSIC STYLIST**, if you record the settings in the **PANEL MEMORY**, the same style name is copied to the **PANEL MEMORY** (up to 16 characters). When you recall the **PANEL MEMORY** settings, this style name is shown at the top of the normal display. (Refer to page 63.)

Music Style Arranger

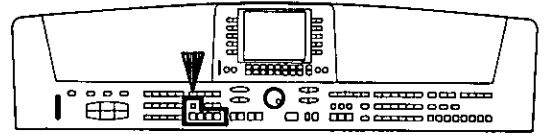

The **MUSIC STYLE ARRANGER** helps you to make professional registration changes during your performance. Select between four contrasting registrations at the push of a button, or let your instrument change the registration automatically for you when you use **FILL IN 1** or **2**. The **MUSIC STYLE ARRANGER** will also alter the accompaniment in character with the registration change creating a polished sounding arrangement.

How to use the MUSIC STYLE ARRANGER

1. Select a rhythm pattern.
 - Do not select **CUSTOM** or a **MEMORY** of the **COMPOSER**.
2. Press the **MUSIC STYLE ARRANGER** button to turn it on.



3. Use the **VARIATION & MSA** buttons to select a style (1 to 4).

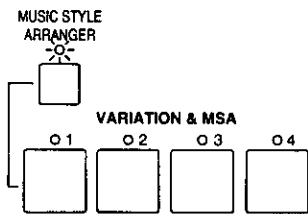

- The nuance of the pattern differs with each number.
- The panel settings (including the tempo) change according to the selected rhythm and music style. The **AUTO PLAY CHORD**, the **MEMORY** button and the **SYNCHRO & BREAK** button are automatically turned on. When a key on the left section of the keyboard is pressed, the automatic rhythm begins to play immediately.
- During your performance, the style can be changed, but the tempo does not change.

How to change the music style during your performance

While you are playing the keyboard with the **MUSIC STYLE ARRANGER** on, press the **FILL IN 1** or **FILL IN 2** button.

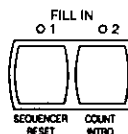

- Each time the **FILL IN 1** button is pressed, the **FILL IN 1** pattern plays, and then the music style changes in the **4 → 3 → 2 → 1** order. And each time the **FILL IN 2** button is pressed, the **FILL IN 2** pattern plays, and then the style changes in the **1 → 2 → 3 → 4** order.

■ MUSIC STYLE ARRANGER mode

You can define which panel settings change by pressing a **FILL IN** button when the **MUSIC STYLE ARRANGER** is used.

1. Press and hold the **MUSIC STYLE ARRANGER** button for a few seconds.
 - The display changes to the following.



2. Select the mode.

RHYTHM:

Only the rhythm changes.

SOUND & RHYTHM:

The sound, effects, rhythms, etc. change.

PANEL MEMORY:

The **PANEL MEMORY** number (BANK1: 1 to 4) changes.

- After a few seconds, the display exits the setting mode.
- You can also access this setting display from the **CONTROL MENU** display. (Refer to page 159.)

Panel Memory

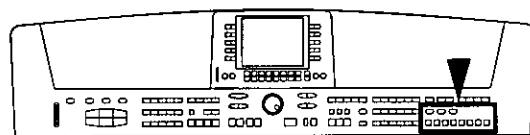

PANEL MEMORY stores all the current panel settings so you can recall them at the push of a button.

How to store the panel settings

Store up to 80 panel settings (10 banks x 8 memories). By storing all the panel settings you use for a song in the same bank, for example, you can switch from one panel setup to the next in a flash.

1. Set up the desired panel settings (sounds, volumes, etc.)
2. Press the **BANK VIEW** button to turn it on.

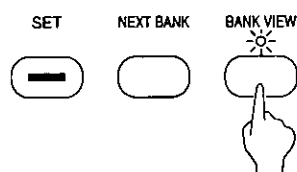

- The list of banks is shown on the display.
3. Select the desired bank.

4. With the **SET** button held down, press one of the numbered buttons of the **PANEL MEMORY** (1 to 8).

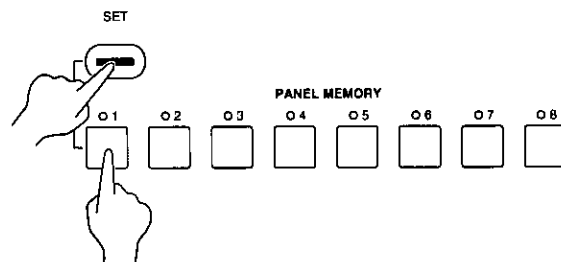

- The panel settings are now stored in the specified bank and number.

BANK VIEW

After selecting a bank, you can use the **PAGE** buttons to go to the **PAGE2 BANK VIEW** page and confirm the memory names of that bank's 8 memories.



- You can use the **BANK** ^ and v buttons to view other banks.
- You can also access this display by pressing and holding any of the **PANEL MEMORY** number buttons (1 to 8) for a few seconds.

Assign a name to the bank/memory

You can assign names to the banks and memories.

1. Select a bank or memory.
2. Use the **PAGE** buttons to go to the **PAGE2/2 BANK VIEW** page on the display.

3. Press the **BANK NAMING** button to assign a name to the bank, or the **MEMORY NAMING** button for the memory.

- The display looks similar to the following.

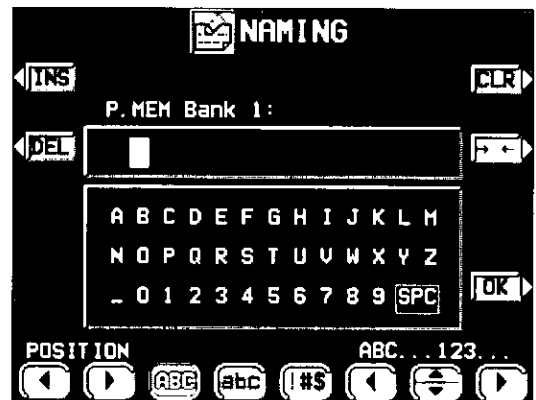

Playing the rhythm

4 Assign a name

- Use the POSITION buttons to highlight the character position in the name box Use the ◀, ▲, ▼, ▶ buttons to select the alphanumeric character Repeat these steps to type the whole name
- Press the ABC button to switch to the screen for upper case (capital) letters, or the abc button to switch to the screen for lower case letters
- Use the !#\$ button to switch to the symbols character set
- Use the INS button to type a space
- Use the DEL button to erase a character
- To erase all the characters, press the CLR button
- You can press the →← button if you wish to have the name centered

5. When you have finished assigning the name, press the OK button

Recall the panel setup

- 1 Press the **BANK VIEW** button to turn it on
Select a bank
- 2 Press the desired **PANEL MEMORY** number button (1 to 8)
 - The panel setup changes to the one stored in the specified memory
 - You can then change the sound settings, etc manually, however, the contents of the memory remain unchanged until you store them again
 - The "Control Preset 1" bank of the **MANUAL SEQUENCE PADS** or the Foot Switch (sold separately) can also be used to change from one **PANEL MEMORY** setup to another (Refer to pages 46, 161)
- The currently selected bank, memory number and memory name are shown in the top line on the normal display

■ NEXT BANK

You can press the **NEXT BANK** button to switch to the next bank This allows you to change banks without exiting the normal display

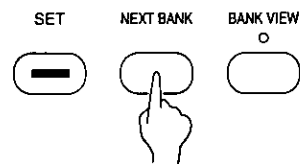

- Each time the **NEXT BANK** button is pressed, the bank number is incremented by 1 After bank 10, the bank number changes to 1
- The panel settings change when a **PANEL MEMORY** number button (1 to 8) is pressed

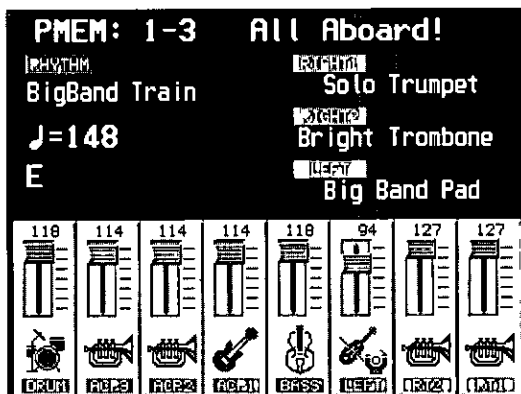

PANEL MEMORY mode

You can define which panel settings are recalled when the **PANEL MEMORY** is used

- 1 Press and hold the **SET** button for a few seconds
 - The display changes to the following

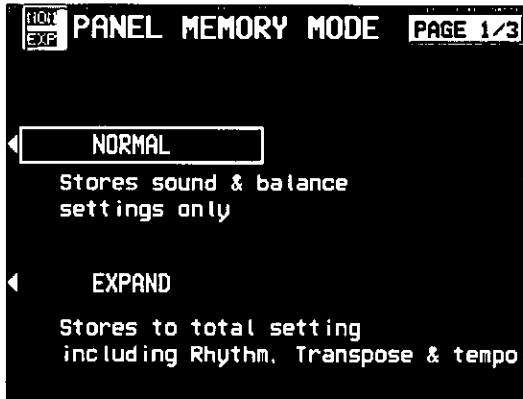

- 2 Select the mode

NORMAL

The sounds and volume balance, and **CONDUCTOR** status are stored

EXPAND

All the instrument's settings are stored, including the rhythm (except for **SOUND ARRANGER** on/off status), **TRANSPOSE**, tempo, etc

- After a few seconds, the display exits the setting mode

EXPAND MODE FILTER

You can specify which data is stored in the **EXPAND** mode

- 1 Use the **PAGE** buttons to access the **PAGE 2/3-3/3 EXPAND MODE FILTER** display
 - The display looks similar to the following

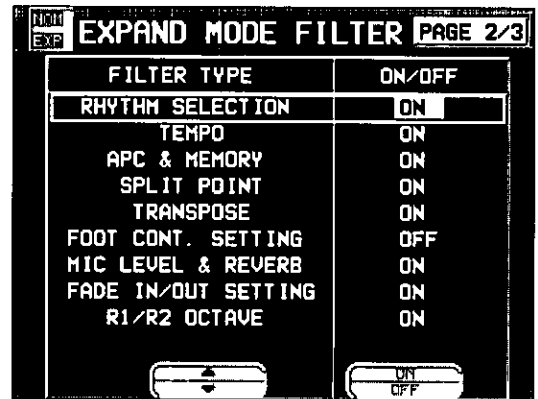

- 2 Use the **▲** and **▼** buttons to select the item
- 3 Use the **ON** and **OFF** buttons to store the on or off status for the selected item

Part IV Sequencer

Outline of the Sequencer

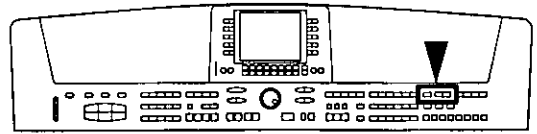

A sequencer records your performance in a similar way to a tape recorder. This instrument's **SEQUENCER** allows you to record up to 10 performances in a variety of ways. You may want to record your entire performance in one go (especially if you are using **AUTO PLAY CHORD** to provide the accompaniment), or to build up a complex arrangement with several different parts playing together, like an orchestral score. This instrument's **SEQUENCER** has 16 tracks. This means that you can record 16 different parts. However, you don't have to use all 16 tracks. For some uses you may only need to use one or two tracks. This instrument's **SEQUENCER** enables you to edit your recorded performance. Unlike a tape recorder you can change the sound or the tempo during playback, or correct wrong notes or timing errors.

SEQUENCER features

■ You can change the tempo without changing the pitch

When you record your performance at a slow tempo and play it back at a faster tempo, the pitch stays the same.

■ Consistent sound

Your performance is reproduced by a sound module as it reads digital data. So, unlike a recorded tape, the sound never deteriorates no matter how many times you play back your performance.

■ Edit your recorded performance

Comprehensive editing functions allow you to modify your recorded performance. Data can easily be erased, corrected or copied, providing an especially convenient tool for creating your original tunes.

■ Instant search

A recorded tape has to be rewound, but digital action means you can return to the beginning of your performance, or find any measure, instantly.

■ Save your performances on disks

All the data of your recorded performances can be stored on disks. The built-in Disk Drive also allows you to play commercially sold disks on your own Keyboard.

- Features and operation of the built-in Disk Drive are explained in Part VI: Disk Drive (page 111).

About the measure count

The measure count on the display corresponds to the time signature of the selected rhythm. However, if rhythm data is stored in the RHYTHM part and that part is played back, the measure count on the display corresponds to the stored rhythm data. (Refer to page 84.)

- If you wish to use a time signature not available in the preset rhythms, use the **COMPOSER** to create a new time signature. (Refer to page 99.)

Popular features

■ Simplified recording method

EASY RECORD is a feature that allows you to bypass the more complex recording procedures so you can record and play back your performance quickly and easily.

- You can also record an accompaniment from the **AUTO PLAY CHORD**.

■ Create a one-man ensemble

Use the **REALTIME RECORD** function to record your performance in up to 16 tracks and create your own orchestra or band.

■ Store individual data to create your song

For repeating patterns or those especially complicated phrases, the **STEP RECORD** feature is convenient for recording the notes one-by-one.

- This method can be used to store both the chord progression for the automatic accompaniment and the rhythm changes.

Memory capacity

Up to 10 songs can be stored in the **SEQUENCER**. Expressed in terms of notes, the total number of notes which can be stored in all the **SEQUENCER** songs and tracks is about 40,000. The remaining memory available for recording is shown on the display as a percentage (**MEMORY= %**).

- When "Memory full!" appears on the display, no more data can be stored in the **SEQUENCER**.
- The recorded contents can be saved on a disk for recall at a later time. (Refer to page 120.)

SEQUENCER menu

When you press the **MENU** button in the **SEQUENCER** section, a variety of functions are available to you

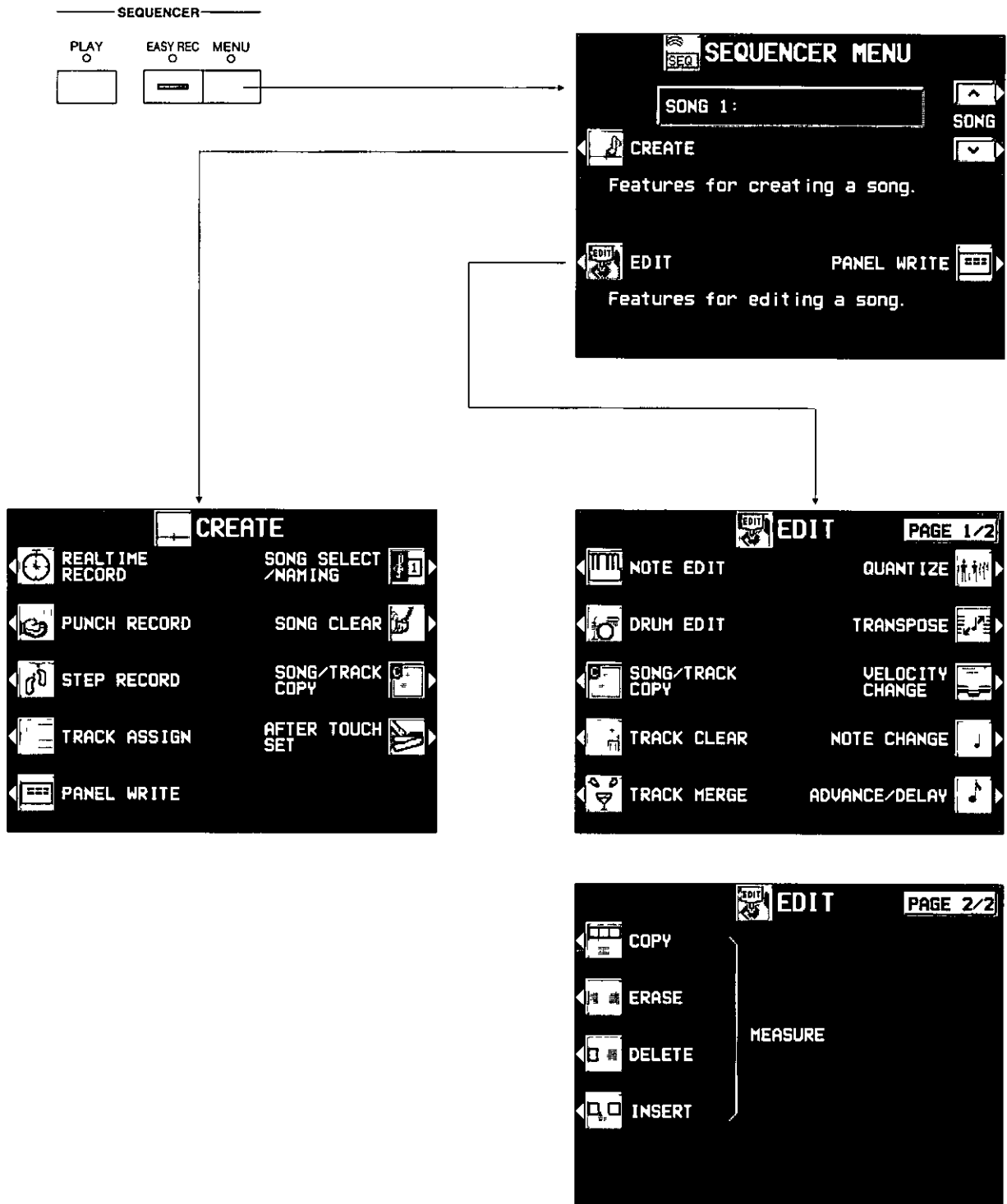

Summary of the SEQUENCER menu items

CREATE

These functions are recording operations used for creating a new performance

REALTIME RECORD (page 72)

Record each part of your performance just as you play it on the keyboard

PUNCH RECORD (page 78)

Correct a selected portion of your recorded performance

STEP RECORD (page 80)

Store the sounds note-by-note on the display

- You can also store the chord or rhythm progression for the **AUTO PLAY CHORD**

TRACK ASSIGN (page 86)

Assign parts to tracks

PANEL WRITE (page 87)

Record the panel settings, such as the sounds and volume balance, etc., at the beginning of the song

SONG SELECT/NAMING (page 77)

Specify the name of the song to record or play back

SONG CLEAR (page 88)

Erase all the recorded data of a song

SONG/TRACK COPY (page 88)

Copy data of specific songs or tracks

AFTER TOUCH SET (page 89)

Specify whether or not keyboard after touch is recorded as data

EDIT

Use these functions to edit the recorded data

NOTE EDIT (page 90)

Store and correct performance (NOTE) data on a piano roll display

DRUM EDIT (page 91)

Store and correct DRUMS part data on a special display

SONG/TRACK COPY (page 88)

Copy data of specific songs or tracks

TRACK CLEAR (page 94)

Erase the contents of a specific track

TRACK MERGE (page 95)

Merge the recorded contents of two tracks and store in a third track

QUANTIZE (page 92)

Correct the timing of your performance

TRANSPOSE (page 93)

Change the key of the performance data

VELOCITY CHANGE (page 94)

Modify the recorded velocity (how hard the keyboard was played) of performance data

NOTE CHANGE (page 95)

Change the pitch of specific notes

ADVANCE/DELAY (page 96)

Speed up or delay the sound production of performance data

MEASURE COPY (page 96)

Copy the contents of specific measures

MEASURE ERASE (page 97)

Erase the contents of specific measures

MEASURE DELETE (page 97)

Delete specific measures from the performance

MEASURE INSERT (page 98)

Insert additional measures in the performance

Sequencer parts

The following summary explains what is stored in each **SEQUENCER** part.

Part name [name on display]	Used for	Recorded contents
RIGHT1 [RT1] RIGHT2 [RT2] LEFT [LFT] PART4 [P 4] ⋮ PART15 [P15]	Recording the performance of each part (REALTIME/STEP)	<ul style="list-style-type: none"> • Sound and volume settings • DIGITAL EFFECT, DSP EFFECT, SUSTAIN on/off • PITCH BEND wheel operation • MODULATION wheel operation • AFTER TOUCH (REALTIME only) (Refer to page 89.)
DRUMS [DRM] (PART16)	Recording the drums performance with the DRUM KITS group sounds (REALTIME/STEP)	<ul style="list-style-type: none"> • Sound (drum KIT) and volume settings
CONTROL [CTL]	Recording changes in the panel button status (REALTIME/STEP)	<ul style="list-style-type: none"> • Rhythm setting and selection changes • DIGITAL REVERB on/off • AUTO PLAY CHORD status • MUSIC STYLE ARRANGER status • FILL IN 1, 2, INTRO & ENDING 1, 2 on • SPLIT status • PANEL MEMORY selection changes • TRANSPOSE status • START/STOP on/off • TEMPO setting • CONDUCTOR status • MANUAL SEQUENCE PADS operation • FADE IN/OUT operation • Expression pedal operation (separately sold option)
AUTO PLAY CHORD [APC]	Recording chords for the AUTO PLAY CHORD (REALTIME)	<ul style="list-style-type: none"> • AUTO PLAY CHORD status • START/STOP on/off • FILL IN 1, 2, INTRO & ENDING 1, 2 on
CHORD [CHD]	Recording chord progression for the AUTO PLAY CHORD (STEP)	<ul style="list-style-type: none"> • Chord progression • FILL IN 1, 2, INTRO & ENDING 1, 2 on
RHYTHM [RHY]	Settings related to rhythm (STEP)	<ul style="list-style-type: none"> • Rhythm settings and selection changes • FILL IN 1, 2, INTRO & ENDING 1, 2 on • START/STOP on/off • TEMPO setting

- You can use the TRACK ASSIGN function to assign parts to tracks as you wish. (Refer to page 86.)

▣ Default part settings

1: RIGHT1	5: CONTROL	9: PART5	13: PART9
2: RIGHT2	6: RHYTHM	10: PART6	14: PART10
3: LEFT	7: DRUMS	11: PART7	15: PART11
4: APC/CHORD	8: PART4	12: PART8	16: PART12

Easy Record

Suppose you are playing the Keyboard and you wish to record and play back your performance to hear how it sounds. You can bypass the set-up procedures of the full-scale sequencer and begin recording quickly and easily.

Recording procedure

1. Set the desired sounds, effects, rhythms, etc.
2. Press the **EASY REC** button to turn it on.

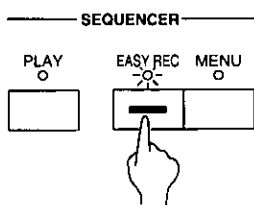

- The display changes to the following.

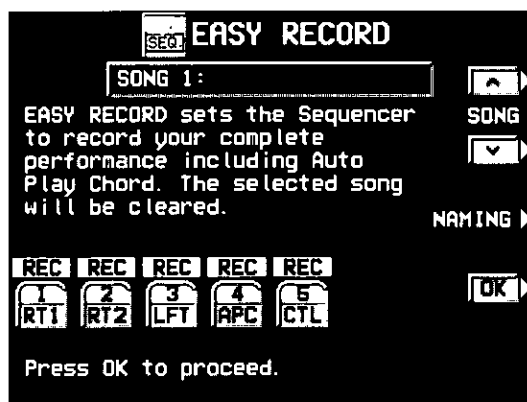

3. Use the **SONG** \wedge and \vee buttons to select the song number in which to record (1 to 10).

 - If you press the **NAMING** button, you can assign a name to your song. (Refer to page 77.)

Playback

1. Press the **SEQUENCER RESET (FILL IN 1)** button.

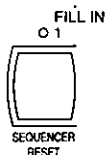

2. Press the **START/STOP** button.

 - Your recorded performance is played back automatically.
 - When you are finished playing back your performance, press the **SEQUENCER PLAY** button to turn it off.

Here is what happens when you select the EASY RECORD mode.

- The recorded data for the currently selected **SONG** number is erased (**SONG CLEAR**).
 - Tracks available for recording are selected as follows.
 - 1: **RIGHT 1** part
 - 2: **RIGHT 2** part
 - 3: **LEFT** part
 - 4: **APC** part
 - 5: **CONTROL** part
4. Press the **OK** button.
 - The display changes to the **REALTIME RECORD** display. 5. Play the keyboard.
 - Recording begins as soon as you start the rhythm or play the keyboard.
 6. When you have finished recording, press the **EASY REC** button to turn it off.
 - The **PLAY** button turns on.
 - **EASY REC** cannot be used when **GENERAL MIDI** is ON. (Refer to page 173.)

Realtime Record

With REALTIME RECORD, your performance is recorded with the timing exactly as you played it on the keyboard. Use this mode to record your performance in up to 16 tracks and create your own orchestra or band.

Recording procedure

- In the **SEQUENCER** section, press the **MENU** button.
- The display looks similar to the following.

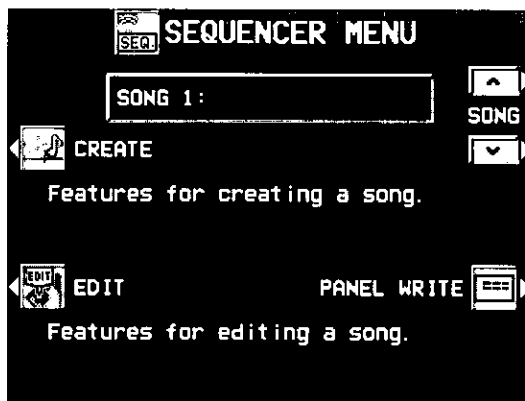

- When you press the **PANEL WRITE** button, the **PANEL WRITE** display appears. To store the currently active settings, such as the sounds, at the beginning of the song, press the **OK** button.
- Use the **SONG** \wedge and \vee buttons to select a song number in which to record. (The song number is shown on the display.)
 - Select **CREATE**.
 - The display looks similar to the following.

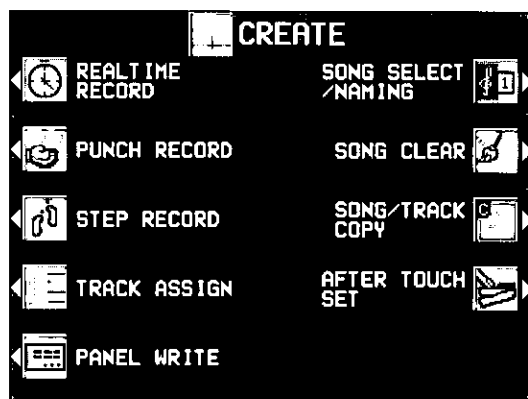

- Select **REALTIME RECORD**.

- The display looks similar to the following.

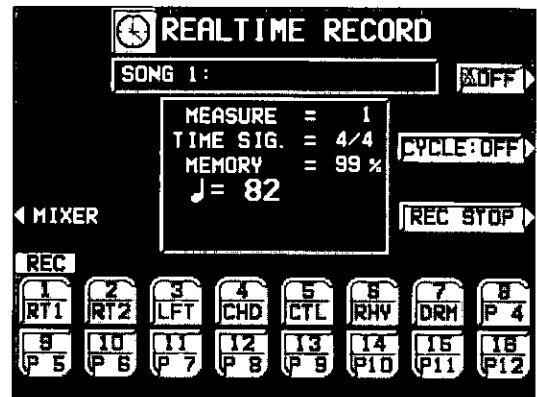

- Use the buttons below the display to turn on the "REC" indication above the track numbers you are going to record.
 - Use the upper buttons to select tracks 1 to 8, and the lower buttons to select tracks 9 to 16.
 - While you are recording, you can play back tracks which are already recorded. Press the corresponding balance buttons to display "PLAY" above the track number you wish to have played back.
 - You can select two or more tracks to record at one time; however, to monitor a performance part, the corresponding button in the **CONDUCTOR (RIGHT 1, RIGHT 2, LEFT)** must also be on.
 - To record **AUTO PLAY CHORD (APC)** parts, turn on the **AUTO PLAY CHORD** button. In this case, press the **START/STOP** button when beginning recording.
 - The track for the **RHYTHM (RHY)** part can be selected for recording only when **STEP RECORD** is active.
- Set the sounds, effects, volumes, etc. for the parts you are going to record.
 - If you press the **MIXER** button, you can use the **MIXER** display to visually adjust the settings for each track.
 - The **LOCAL ON/OFF** setting on the **MIXER** display is used to specify whether the part assigned to that track sounds when it is played on the keyboard during recording. For the **LOCAL ON/OFF** during playback, use the **TRACK ASSIGN** display to adjust the settings. (Refer to page 86.)

- The panel settings which are active at the beginning of recording are stored.
7. Use the **TEMPO/PROGRAM** dial to adjust the recording tempo.
 - The tempo is shown on the display as $\text{♩} =$.
 - If you wish to record the tempo setting and tempo changes, store them in the control (CTL) part, or use the step record to store them in the rhythm (RHY) part.
 8. Turn the metronome on or off as desired with the ON/OFF button.
 - The metronome selection alternates between ON and OFF each time the button is pressed.
 - The metronome sound is not recorded.
 9. Play the keyboard.
 - Recording begins.
 - You can also press the **START/STOP** button to start the rhythm and begin recording.
 - If the metronome is on, when you press the **START/STOP** button, a two-measure count plays, after which recording automatically begins. In this case, the rhythm does not start. Recording does not start until the two-measure count is completed.
 - The recording status is continuously updated on the display:
 - MEASURE= indicates the current measure.
 - TIME SIG.= indicates the current time signature.
 - MEMORY= indicates the remaining memory (%) available for recording.
 - If you wish to redo the recording, press the REC STOP button and then record again. To change the sounds and effects, etc. please set them again.
 - If you make a mistake in recording, you can correct a specific portion of your performance without having to redo the whole part. (Refer to page 78.)
 10. When you have finished recording, turn off the **MENU** button in the **SEQUENCER** section.
 - When the **MENU** button is turned off, the ending command (END) is recorded. Note that, as long as the ending command is not recorded, blank recording continues even if you stop playing.
 - The **SEQUENCER PLAY** button turns on.
- **Multi-track recording**
- Use the following procedure to record one track while listening to the track or tracks already recorded.
1. Follow the procedure to record the first track, and press the REC STOP button at the end of the recording.
 - The indication for the track just recorded changes from "REC" to "PLAY".
 2. Turn on the "REC" indication for the track you wish to record next, and select the sounds and effects, etc.
 3. Press the **START/STOP** button and begin recording.
 - You can also begin recording by playing the keyboard.
 - Tracks for which "PLAY" is shown are played back, and you can record in time with this.
 4. Press the REC STOP button at the end of the recording.
 5. Repeat steps 2 to 4 for other tracks, as desired.
 6. When multi-track recording is finished, turn off the **MENU** button in the **SEQUENCER** section.
 - If you wish to store part settings that you modified after recording as beginning song data, press the MIXER button and follow the PANEL WRITE procedure. (Refer to page 87.)

CYCLE RECORD

This mode allows you to have specified recording measures continuously repeated. Thus you can record measures by adding notes during any cycle.

1. On the REALTIME RECORD display, specify "REC" for track numbers you are going to record, and "PLAY" for track numbers you wish to have played back.
2. Press the CYCLE: OFF button.
 - The display looks similar to the following.

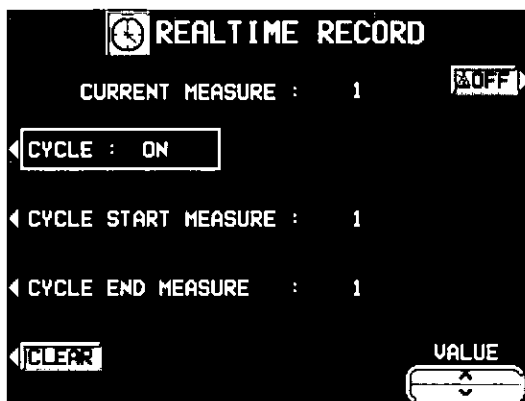

3. Select CYCLE START MEASURE, and use the VALUE \wedge and \vee buttons to specify the beginning measure number.
4. Select CYCLE END MEASURE, and use the VALUE \wedge and \vee buttons to specify the ending measure number.
 - The measure in which the END command has been stored can also be specified.

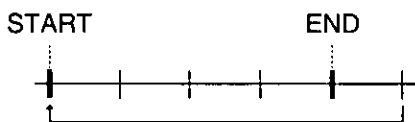

5. Press the **START/STOP** button.
 - If the metronome is on, cycle recording of the specified measures begins after a two-measure count.

6. Play the keyboard.
 - The specified measures are repeated, during which time you can record by adding notes little by little at the correct timing (over-dubbing).
 - If you wish to erase all the performance data from the specified measures, press the CLEAR button.
 - If CYCLE is selected and the \vee button used to select OFF, cycle recording is not activated. This button does not work during recording.
 - To return to the REALTIME RECORD display, press the EXIT button.
 - Cycle record can also be started from the REALTIME RECORD display whenever the CYCLE: ON indication is shown.
7. When you have finished recording, turn off the **SEQUENCER MENU** button.

Sequencer Play

Play back your recorded performance.

1. Press the **SEQUENCER PLAY** button to turn it on.

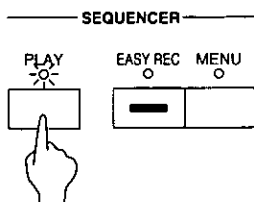

- The display looks similar to the following.

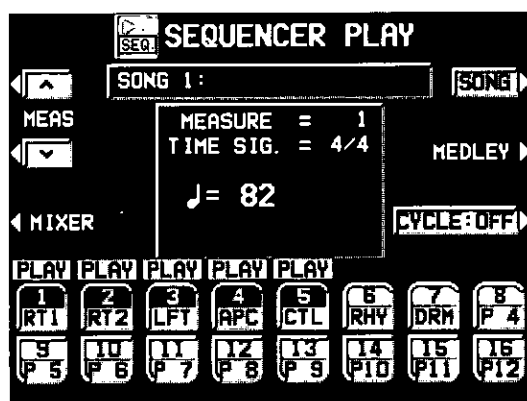

2. Use the **SONG** buttons to select the song number you wish to play back.
3. Use the balance buttons below the display to show "PLAY" above the track numbers you wish to have played back.
 - Use the upper buttons to select tracks 1 to 8, and the lower buttons to select tracks 9 to 16.
 - You can select two or more tracks to play back at one time.
4. Use the **TEMPO/PROGRAM** dial to adjust the playback tempo.
 - The tempo is shown on the display as "♩ =".
5. Press the **SEQUENCER RESET (FILL IN 1)** button.
 - The **SEQUENCER** returns to the beginning of the song and the beginning panel settings are recalled.

6. To begin playback from a measure other than measure 1, use the **MEAS** \wedge and \vee buttons to specify the beginning measure.
 - "MEASURE=" indicates the current measure number.

7. Press the **START/STOP** button.
 - The recorded performance is played back from the specified measure.
 - When playback is begun from a measure in which an **INTRO**, **COUNT INTRO**, **FILL IN** or **ENDING** is recorded, the corresponding function does not work.
 - You can press the **MIXER** button and modify the settings for each part.

8. To stop playback, press the **START/STOP** button.
 - If the **START/STOP** button is pressed again, playback will continue from the point it was interrupted.

9. When you are finished playing back your performance, press the **SEQUENCER PLAY** button to turn it off.

If "PLAY" is specified for the track to which the RHYTHM (RHY) part is assigned, the MEASURE display used in the STEP RECORD and EDIT displays is shown conforming to the time signature data stored in the RHYTHM part.

CYCLE PLAY

You can have specified measures played back repeatedly.

1. On the SEQUENCER PLAY display, specify "PLAY" for track numbers you wish to have played back.
2. Press the CYCLE button.
 - The display looks similar to the following.

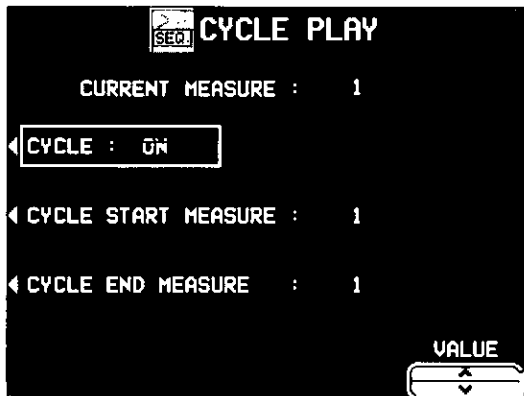

3. Select CYCLE START MEASURE, and use the VALUE ^ and v buttons to specify the beginning measure number.
4. Select CYCLE END MEASURE, and use the VALUE ^ and v buttons to specify the ending measure number.

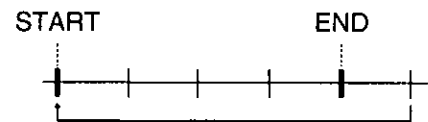

5. Press the **START/STOP** button.
 - Cycle playback of the specified measures begins.
 - The rhythm pattern is not played back.
6. To stop cycle playback, press the **START/STOP** button again.
 - During playback stop, if the **SEQUENCER RESET (FILL IN 1)** button is pressed, the **SEQUENCER** returns to the measure number specified in step 3. If the **SEQUENCER RESET** button is pressed again, the **SEQUENCER** returns to measure 1.
 - If **CYCLE** is selected and the v button is pressed to select OFF, cycle playback is not activated.
 - To return to the SEQUENCER PLAY display, press the **EXIT** button.
 - Cycle playback can also be specified on the SEQUENCER PLAY display whenever the **CYCLE: ON** indication is shown.

MEDLEY

Multiple recorded songs can be played back in a medley.

1. On the SEQUENCER PLAY display, press the **MEDLEY** button.
 - The display looks similar to the following.

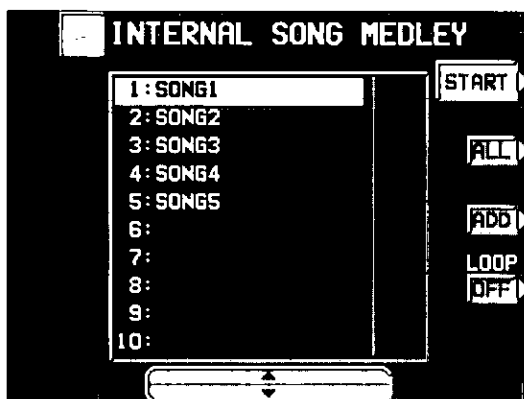

2. Specify the order of songs in the medley.

- If **ALL** is pressed, all the files are selected, and the songs are played back in order in a medley. If **ALL** is pressed again, the files are deselected.
- You can use the Δ and ∇ buttons to select a song to add to the song list, then press the **ADD** button to add it to the list. Repeat these steps to create your own list of songs to have played back. A M01, M02 etc. next to the file name indicates its order in the list.
- You can delete a marked file from the medley song list by selecting it and pressing the **ADD** button.
- Use the **LOOP** button to specify **ON** or **OFF** for repeat playback of the medley.

3. Press the **START** button.
 - During medley playback, you can use the **SKIP** button to skip to the next song.

Song Select/Naming

Here is the way to assign a name to your recorded song.

1. On the SEQUENCER MENU display, select CREATE.
2. On the CREATE menu display, select SONG SELECT/NAMING.
 - The display looks similar to the following.

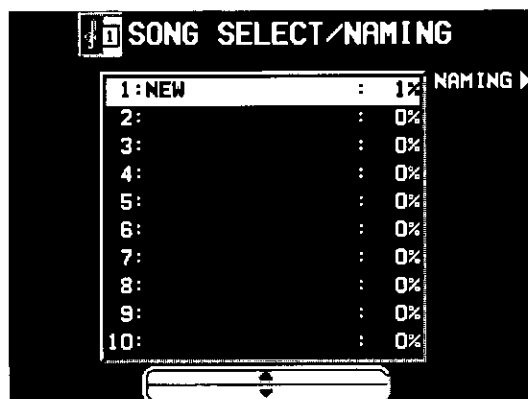

3. Use the ▲ and ▼ buttons to select the number of the song you wish to name.
 - The total amount of memory used for the current song is shown as a percentage (%) to the right of the song name.
4. Press the NAMING button.
 - The display looks similar to the following.



5. Assign a name to the song.
 - Use the POSITION buttons to highlight the character position in the name box. Use the ◀, ▲, ▼, ▶ buttons to select the alphanumeric character. Repeat these steps to type the whole name.
 - Press the ABC button to switch to the screen for upper case (capital) letters, or the abc button to switch to the screen for lower case letters.
 - Use the !#\$ button to switch to the symbols character set.
 - Use the INS button to type a space.
 - Use the DEL button to erase a character.
 - To erase all the characters, press the CLR button.
 - You can press the →← button if you wish to have the name centered.

6. Press the OK button.

7. Follow the procedures to record the song.
 - To optimize memory, songs you do not wish to preserve should be deleted. (Refer to page 88.)
 - If you wish to record the tempo for each song, record the desired tempo at the beginning of the CONTROL part. When you play back the song, be sure to also select the CONTROL part for playback.

Punch Record

If you make a playing error during REALTIME RECORD or would like to change the recording for some other reason, you can use the punch recording feature to correct a selected portion of the performance without having to redo the whole part.

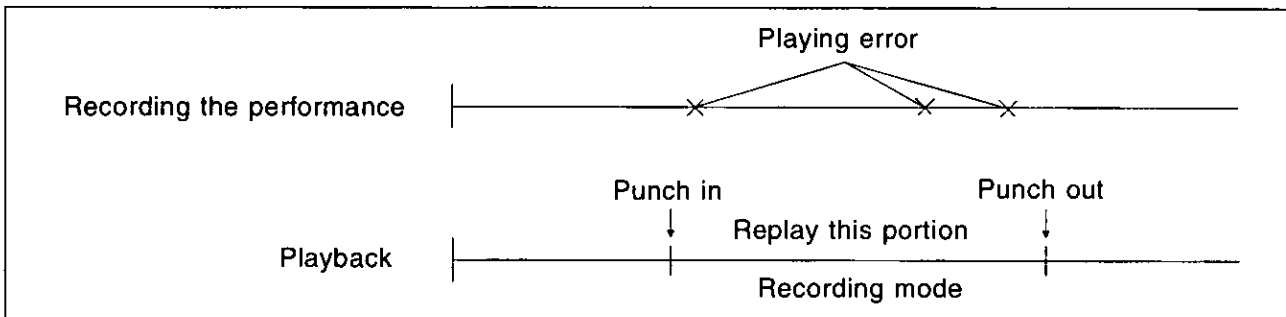

1. On the SEQUENCER MENU display, use the SONG \wedge and \vee buttons to select the song number. Then select CREATE.
2. On the CREATE menu display, select PUNCH RECORD.
 - The display looks similar to the following.

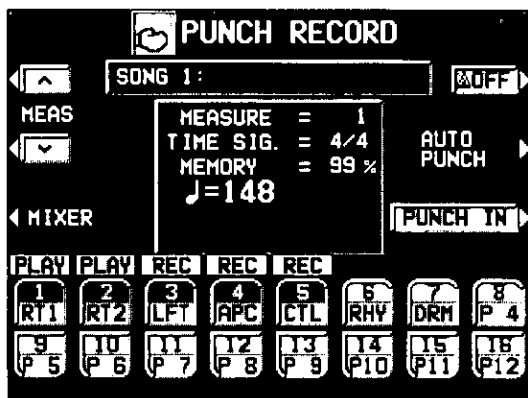

3. Select the track which contains the portion you want to correct.
 - On the display "REC" indicates tracks which are being recorded, and "PLAY" indicates tracks which are being played back.
4. Use the MEAS \wedge and \vee buttons to specify the beginning measure of playback.
 - "MEASURE=" indicates the current measure number.
5. Press the **START/STOP** button to begin playback of the specified track.

6. During playback, press the PUNCH IN button at the point you want to begin recording.
 - Recording begins as soon as the PUNCH IN button is pressed. Begin playing at this point.
 - The PUNCH IN button switches to the PUNCH OUT button.
7. Press the PUNCH OUT button at the point you want to stop recording.
 - Recording stops immediately.
8. When you have finished correcting the performance, press the **SEQUENCER MENU** button to turn it off.
 - You can also begin punch-in recording by playing the keyboard.
 - You can specify the punch-in/punch-out points with the optional Foot Switch (sold separately). (Refer to page 161.)

■ AUTO PUNCH RECORD

You can also set the punch-in and punch-out points beforehand, so that recording automatically begins and ends at the specified points.

1. On the SEQUENCER MENU display, select PUNCH RECORD. Specify the track you wish to correct.
2. Press the AUTO PUNCH button.
 - The display looks similar to the following.

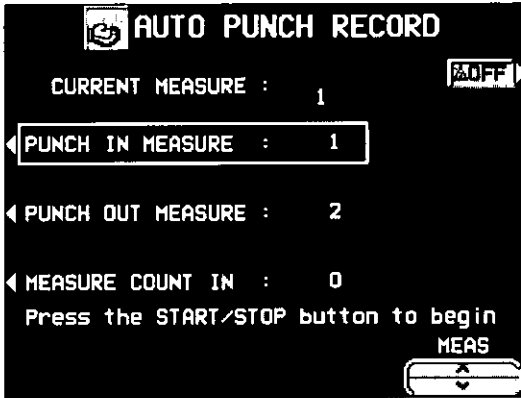

3. Select PUNCH IN MEASURE. Use the MEAS ^ and v buttons to specify the number of the punch-in measure.
4. Select PUNCH OUT MEASURE. Use the MEAS ^ and v buttons to specify the number of the punch-out measure.
 - The number of the punch-out measure must be higher than the number of the punch-in measure.
 - The specified punch-out measure is not recorded.
5. Select MEASURE COUNT IN. Use the MEAS ^ and v buttons to specify the number of lead-in measures you wish to have played back before the punch-in measure.
 - Set the metronome to on or off with the ON or OFF button.
6. Press the **START/STOP** button.
 - Playback begins from the measure indicated by CURRENT MEASURE on the display.
7. Correct the performance.
 - The mode changes automatically to the recording mode at the specified punch-in measure. Begin playing at this point. The mode automatically changes back to the playback mode at the specified punch-out measure.
 - Punch-in recording also begins if the keyboard is played before the specified PUNCH IN MEASURE.
8. When you have finished correcting the performance, press the **SEQUENCER MENU** button to turn it off.

7. Use the PHRS \wedge and \vee buttons to specify the actual length of the produced sound for the desired legato or staccato effect.

TENU (tenuto): Sound is produced for 95% of the note length.
 NORM (normal): 80%
 STAC (staccato): 50%
 CUTT (cutting): 25%

8. Specify the pitch and velocity of the note by playing the keyboard.
- The dot on the display where the note is stored changes to a * mark.
 - When recording chords, you can store multiple notes at one position.
 - Any panel setting changes—for example changes in the sound selection, button operation, wheel operation, etc.—are recorded at the cursor position.
 - When a wheel or dial is operated, the input value is indicated on the display. Confirm that this is the correct value and press the YES button to record the value or the NO button to cancel it.

REST:

To store a rest, after specifying the note LENGTH, press the REST button.

- Positions at which nothing is stored are read as rests.

ERS:

If you make a mistake, move the cursor to the error, and after displaying the data you wish to erase, press the ERS button.

BAL:

To specify the volume at the cursor position, after pressing the BAL button, use the VALUE buttons to set the volume (0 to 127).

9. Repeat steps 5 through 8 to continue storing notes.
- To input data on another track, press the button for the desired track and repeat the procedure from step 2.
10. When you have finished recording, press the **SEQUENCER MENU** button to turn it off.

■ Storing control data

Various control data can be stored at the cursor position.

1. On the STEP RECORD: MELODY display, press the CTL button.
- The display looks similar to the following.



2. Use the CTL \wedge and \vee buttons to select the control data you wish to insert.
- Select from PAN, KEY SHIFT (COARSE TUNE), TUNING (FINE TUNE), BEND SENS.
3. Use the VALUE \wedge and \vee buttons to adjust the numerical value of the setting.
4. Press YES button.

▣ Correcting the data

1. In the STEP RECORD mode, specify the track you wish to correct.
2. Use the MEAS buttons to go to the measure you wish to modify. Use the CURSOR buttons to move the cursor to the point (*) you wish to edit.
 - The data stored at that point is shown on the display.
 - When multiple data is stored at one point, different data is displayed in order each time a CURSOR button is pressed. When a chord is recorded, a different note in the chord is displayed each time a CURSOR button is pressed.
3. Correct the data.

There are three types of data:

Performance data

NOTE data (note pitch) and VEL data (how hard the key was played), etc. are displayed. Use the relevant buttons to correct the data as desired.

Sound data

The name of the sound is displayed. Change the sound as desired (the sound setting display is interposed on the current display).

Control data

The name of the function is displayed. Change the data as desired.

- Press the ERS button to erase the data which is displayed.
- You can also correct data which was stored in the REALTIME RECORD mode.
- Performance (NOTE) data can be recorded or edited on a piano roll display, and there is also a specialized display for recording and editing the DRUMS part data. (Refer to page 90.)

Store a chord progression

Store the chord progression for the **AUTO PLAY CHORD** in the track for the CHORD part. Then, when the **AUTO PLAY CHORD** is used during playback, even if you do not specify the chords with your left hand, the chords change automatically.

- The chord length is specified with the **CHORD STEP RECORD** keys on the keyboard.

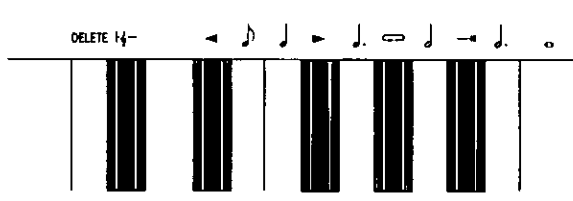

Correction keys

- ◀ Move back one step.
- ▶ Move forward one step.

Repeat key

- ↺ Press to end the chord-storing procedure and to specify automatic repeat playback of the stored progression.

End key

- H Press after the whole chord progression has been stored.

DELETE key

DELETE Press to erase data.

- To erase all the data from the current track, while pressing the **DELETE** key, press the End key (—H).

Note value keys

- Whole note
- ◡ Dotted half-note
- ◡ Half-note
- ◡ Dotted quarter-note
- ◡ Quarter-note
- ◡ Eighth-note

Reset key

- ♩— Press to begin storing from the beginning.

■ Example of storing a chord progression

Measure 1	2	3	4
C	C	F G7	C Am
o	o	♪ ♪	♪ ♪

1. On the SEQUENCER MENU display, use the SONG ^ and v buttons to select the song number. Then select CREATE.
2. On the CREATE menu display, select STEP RECORD.
 - The display changes to the PART SELECT display.
3. Using the balance buttons below the display, select the track to which the CHORD (CHD) part has been assigned.
 - The display changes to the STEP RECORD: CHORD input display similar to the following.

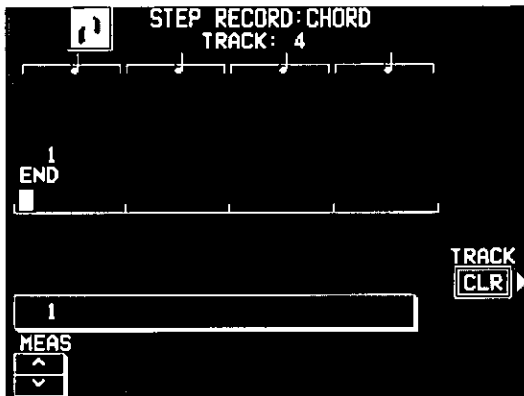

4. Store the chords.

<Measure 1, measure 2>

While playing a C chord with your left hand, press the o key one time with your right hand.

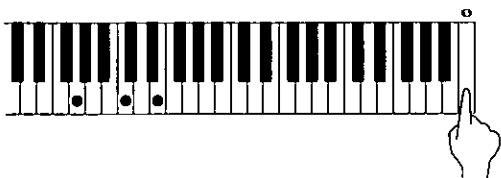

- A "beep" tone indicates that the chord has been successfully stored.
- The dot on the display where the chord is stored changes to a * mark and the cursor automatically moves forward, in accordance with the specified note value, to the next unrecorded position. The chord name is shown on the display.

<Measure 3>

- (1) While playing an F chord, press the ♪ key one time.



- (2) While playing a G7 chord, press the ♪ key one time.

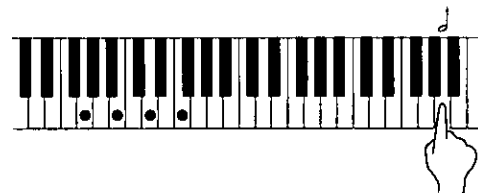

<Measure 4>

- (1) While playing a C chord, press the ♪ key one time.

- (2) While playing an Am chord, press the ♪ key one time.

- You can press the **INTRO & ENDING** button or a **FILL IN** button on the panel to store the desired pattern at the cursor position. (An **INTRO** or **COUNT INTRO** can be stored only at the beginning.)
- Store a rest by pressing a note value key without specifying a chord.

5. At the end of the chord progression, press the End key (—H).

- The Keyboard exits the recording mode.
- During playback, playback of the recorded chord progression stops at this point. For automatic repeat playback of the chord progression, press the Repeat key (↔) instead of the End key (—H).

- When you play back the track for the CHORD part, the chords of the automatic accompaniment change in accordance with the stored chord progression.
- Chords can also be specified in the ONE FINGER mode.
- If the ON BASS button is on, chords such as "C on G" can also be specified (except in the ONE FINGER mode).

▣ **Correct the recorded chord progression**

1. Follow the procedure to select the STEP RECORD: CHORD display.
2. Use the MEAS buttons to go to the measure you wish to modify. Use the ◀ and ▶ Correction keys to move the cursor to the point (*) you wish to edit.

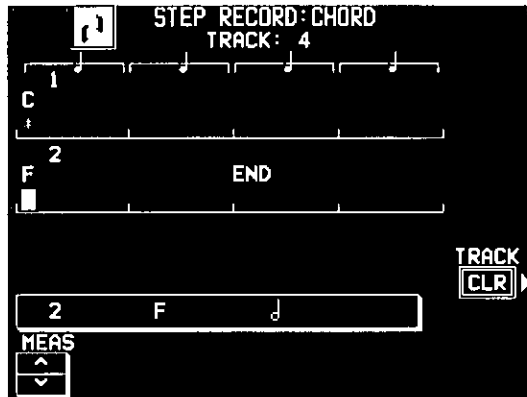

- The lengths of rests are indicated by the respective rest value x its multiplier.

Example:

- ‡ 1-beat rest (quarter rest)
- γ 1/2-beat rest (eighth rest)
- ‡ x 1 + γ 1-1/2-beat rest (dotted quarter rest)
- ‡ x 10..... 10-beat rest

- To go to the end of the chord progression, while pressing the Reset key (⏮), press the ◀ key.

3. Correct the chord data.

Chord data

When the chord name is displayed at the cursor position, you can press the **DELETE** key to erase the data and then store a new chord.

- If you do not erase the displayed data before entering new chord data, the new data is inserted at this point, and the displayed data is merely shifted by the note value of the new chord.
- Rests can also be erased. Each time the **DELETE** key is pressed, the rest is erased in units of ‡ x 1. The γ rest is erased last.
- If you wish to cancel the REPEAT, enter an **END** command.

Control data

The name of the stored function (INTRO, FILL, etc.) is displayed. You can press the **DELETE** key to erase the data which is displayed.

▣ **TRACK CLEAR**

To erase all data from the current track, press the CLR button, and then press the YES button on the confirmation display.

- If you wish to cancel the clear procedure, press the NO button.

Store a rhythm progression

Changes in the rhythm selection and tempo, as well as the intro, fill-ins and the ending, can be stored by measures with the step recording method.

1. On the SEQUENCER MENU display, use the SONG ^ and v buttons to select the song number. Then select CREATE.
2. On the CREATE menu display, select STEP RECORD.
 - The display changes to the PART SELECT display.
3. Using the balance buttons below the display, select the track to which the RHYTHM (RHY) part has been assigned.

- The display changes to the STEP RECORD: RHYTHM input display similar to the following.



Sequencer

4. Use the MEAS \wedge and \vee buttons to go to the measure you wish to record.
5. Store the rhythm data.
 - Data which can be stored:
 - START/STOP**
Changes in the rhythm selection
 - COUNT INTRO, INTRO, FILL IN, ENDING**
Tempo changes
 - Be sure to store the **START/STOP** data in the measure in which the rhythm starts or stops.
 - If you are storing a **COUNT INTRO** or **INTRO**, store this data before the **START/STOP** data.
 - If the tempo is changed, the display changes to the confirmation display. After specifying the desired tempo, Press the YES button to store the specified tempo, or press the NO button to cancel the new tempo value.
6. Repeat steps 4 and 5 to continue storing the rhythm progression.
7. At the end of the rhythm progression, press the END button.
 - If the REP button is pressed instead of the END button, during playback the recorded rhythm progression is repeated.
 - The Keyboard exits the recording mode.

■ Correct the recorded rhythm progression

1. Follow the procedure to select the STEP RECORD: RHYTHM display.
2. Use the MEAS buttons to go to the measure you wish to modify. (The * is highlighted.)



3. Correct the rhythm data.
 - Press the ERS button to erase data at the cursor position.
 - If you wish to cancel the REPEAT, enter an END command.
 - If you select a rhythm with a different time signature, the time signature of all subsequent measures will also change.
 - If data has already been recorded in other tracks, you cannot select a rhythm with a different time signature.

■ TRACK CLEAR

- To erase all data from the current track, press the CLR button, and then press the YES button on the confirmation display.
- If you wish to cancel the clear procedure, press the NO button.

Track Assign

Each **SEQUENCER** part is already assigned to a track number. However, you can use the **TRACK ASSIGN** function to assign parts to tracks as you wish.

1. On the **SEQUENCER MENU** display, use the **SONG** \wedge and \vee buttons to select the song number. Then select **CREATE**.
2. On the **CREATE** menu display, select **TRACK ASSIGN**.
 - The display looks similar to the following.

TRACK ASSIGN				SONG 1
	TRACK ASSIGN	LOCAL CONT.	MIDI OUT	PRESET ▶
TR 1	RIGHT1	ON	ON	
TR 2	RIGHT2	ON	ON	
TR 3	LEFT	ON	ON	
TR 4	CHORD	--	--	
TR 5	CONTROL	ON	ON	
TR 6	RHYTHM	ON	ON	OK ▶
TR 7	DRUMS	ON	ON	
TR 8	PART 4	ON	ON	

3. Use the **TR** Δ and ∇ buttons to select the track.

4. Use the **TRACK ASSIGN** \wedge and \vee buttons to select the part for the specified track.
 - When a part other than the **CONTROL**, **APC**, **CHORD** or **RHYTHM** part is assigned, the track assign procedure is completed at this point.
 - Either the **CHORD** part or **APC** part can be assigned to a track, but not both.
 - The **CONTROL**, **APC**, **CHORD** and **RHYTHM** parts cannot be assigned to more than one track.
 - You can use the **ON** and **OFF** buttons for **LOCAL CONT.** to specify whether or not the sound of the part assigned to this track is generated. Because no sound is generated for this instrument's parts assigned to tracks set to **OFF** through this procedure, use this setting to generate sound from an external sound source through the **MIDI** connectors.
 - You can use the **MIDI OUT ON** and **OFF** buttons to specify whether or not the data of the part assigned to this track is sent as **MIDI** data. When set to **OFF**, the data is not sent, even if **MIDI** equipment is connected.
5. When assigning the **CONTROL**, **APC**, **CHORD** or **RHYTHM** part, press the **OK** button.
 - The confirmation display appears. Press the **YES** button to confirm that you wish to execute the specified track assignment. Or press **NO** to stop the track assignment.

■ TRACK ASSIGN PRESETS

A preset track assignment can be selected.

1. On the TRACK ASSIGN display, press the PRESET button.
 - The display looks similar to the following.



2. Use the SONG ^ and v buttons to select the song number for which the preset track assignment will be effective.
 - If ALL is selected, the track assignment is effective for all the songs.

3. Select the track assign mode.

INITIAL: Factory-preset settings.

TECHNICS MULTI RECORDING: The optimum track assignment for multiplex recording.

GM MULTI RECORDING: The optimum track assignment for creating GENERAL MIDI data.

4. Press the OK button.

- A confirmation display will appear when the arrangement of sounds changes, for example by switching to GM MULTI RECORDING. Press the YES button to confirm that you wish to execute the procedure, or press the NO button to cancel the procedure.
- "COMPLETED!" is shown on the display and the selected track assign mode is enabled.
- You can confirm the track assignment settings on the TRACK ASSIGN display.

Panel Write

You can change the panel status which is in effect at the beginning of the song. These are the settings which are recalled when the **SEQUENCER RESET** button is pressed.

1. Use the panel buttons to change to the desired panel settings.
2. On the SEQUENCER MENU display, use the SONG ^ and v buttons to select the song number. Then select CREATE.
3. On the CREATE menu display, select PANEL WRITE.
 - The display looks similar to the following.



4. Press the OK button.

- "COMPLETED!" is shown on the display.
- PANEL WRITE is automatically activated at the when you start to record, or when a panel setting is changed during recording stop.
- There is also a button on the SEQUENCER display that allows you to access this function.
- For rhythm data, the data in the RHYTHM part has priority.

Song Clear

Erase the recorded contents of all tracks.

1. On the SEQUENCER MENU display, select CREATE.
2. On the CREATE menu display, select SONG CLEAR.
 - The display looks similar to the following.
3. Use the SONG NO/ALL \wedge and \vee buttons to specify the number of the song to erase.
 - The total amount of **SEQUENCER** memory or current song memory used is shown as a percentage (%) to the right of the song name.
 - If ALL is selected, all the songs recorded in the **SEQUENCER** will be erased.



4. Press the OK button.
 - The confirmation display appears. Press the YES button to execute the function, or press the NO button to cancel the function.
 - If the YES button is pressed, "COMPLETED!" appears on the display, the specified songs are erased, and the instrument returns to the normal performance mode.

Song/track Copy

Copy the recorded data from specific tracks of a song.

1. On the SEQUENCER MENU display, select CREATE.
2. On the CREATE menu display, select SONG/TRACK COPY.
 - The display looks similar to the following.
3. Specify the track you wish to copy from.
 - On the FROM side, use the ITEM Δ and ∇ buttons to select the item, and the VALUE \wedge and \vee buttons to specify the setting.
 - SONG: Song number
 - TRACK: Track number
 - If ALL is selected, all the tracks of the specified song number will be copied.



4. Specify the track you wish to copy to (TO side).
5. Press the OK button.
 - The confirmation display appears. Press the YES button to execute the function, or press the NO button to cancel the function.
 - The track assignment settings are also copied. Note that in some cases, the CONTROL, RHYTHM and CHORD part data in the destination tracks may be lost.

After Touch Set

Specify whether or not AFTER TOUCH data is recorded. The AFTER TOUCH applies a special effect to the sound depending on how hard the keys are being pressed.

1. On the SEQUENCER MENU display, use the SONG \wedge and \vee buttons to select a song number. Then select CREATE.
2. On the CREATE menu display, select AFTER TOUCH SET.
 - The display looks similar to the following.
3. Use the ON and OFF buttons to specify if the aftertouch data is recorded.
 - ON:
Aftertouch data is recorded with the performance.
 - OFF
The data is not recorded (factory-preset setting).



Editing the recorded performance

The edit feature allows you to erase or change portions of your performance after it has been recorded.

Select the edit function

1. On the SEQUENCER MENU display, use the SONG \wedge and \vee buttons to select the number of the song you wish to edit. Then select EDIT.
2. On the EDIT menu display, select an edit function.
 - The display looks similar to the following.
3. Perform the editing procedures. (See below.)
 - During the editing procedure, if the indicator for the **TEMPO/PROGRAM** dial is lit, you can use the dial for the editing function.

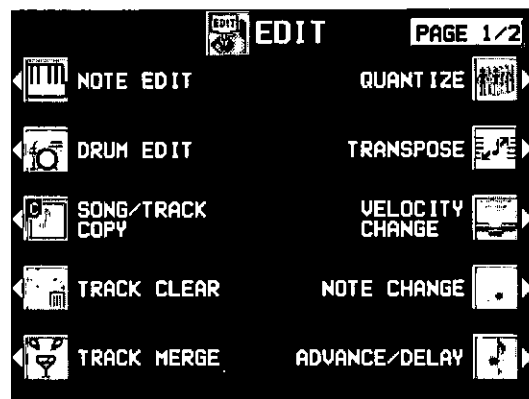

NOTE EDIT

You can edit performance (NOTE) data on a piano roll display. This differs from the normal STEP RECORD edit procedure, and is a convenient way to check the data for each note.

- Data other than NOTE data cannot be corrected or recorded. To correct or record other types of data, use the STEP RECORD display. (Refer to page 82.)

1. On the PART SELECT display, select a track.
 - The CHORD, RHYTHM and CONTROL tracks cannot be selected.
 - The display looks similar to the following.

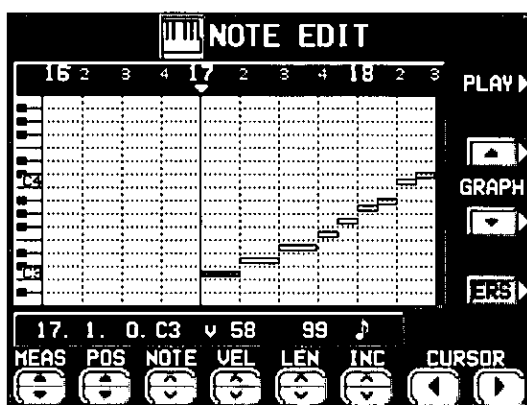

2. Use the MEAS \wedge and \vee buttons to select the measure you wish to edit.

3. Use the CURSOR \triangleleft and \triangleright buttons to move the cursor (∇) to the point you wish to edit.

- Recorded performance (NOTE) data is shown as horizontal bars. Data selected for editing is highlighted.
- You can use the INC \wedge and \vee buttons to change the increment of cursor movement. The resolution can be set at $\downarrow/96$. However, if NOTE data is present between increments, the cursor will stop.
- Use the POS \triangle and ∇ buttons to change the value.
Example: 10.2.48 indicates a point in measure 10, beat 2, point 48 (one point is $1/96$ of a quarter note [\downarrow]).
- \rightarrow is shown at the point where the END command is stored.

4. Select the data to edit (it changes to a highlighted horizontal bar). Edit the data.

- Use the POS \triangle and ∇ buttons to move the cursor, the NOTE \wedge and \vee buttons to change the note number, the VEL \wedge and \vee buttons to change the velocity (how hard the keys are played), and the LEN \wedge and \vee buttons to change the note length (1 = $1/96$ of a quarter note [\downarrow]).
- Use the GRAPH \triangle and ∇ buttons to view a higher or lower section of the keyboard (in one-octave steps).
- If the ERS button is pressed, the selected NOTE data is erased.

5. Repeat steps 2 to 4 to continue editing.

Inserting note data

You can also store note data on this display.

1. Specify the point where the new note data will be stored.
2. Use the LEN \wedge and \vee buttons to specify the note length.
 - Examples of note lengths ($\downarrow = 96$)
91: tenuto (95%)
76: normal (80%)
48: staccato (50%)
24: cutting (25%)
3. Play a key on the keyboard to specify the note pitch (NOTE NUMBER) and velocity (how hard the key is played).
4. Repeat steps 1 to 3 to input more note data.

■ CYCLE PLAY

You can aurally check the data you are editing by accessing the CYCLE PLAY display from the NOTE EDIT display.

- If you wish other tracks to be played back, they should be selected beforehand on the SEQUENCER PLAY display. (Refer to page 76.)

1. On the NOTE EDIT display, press the PLAY button.
- The display looks similar to the following.

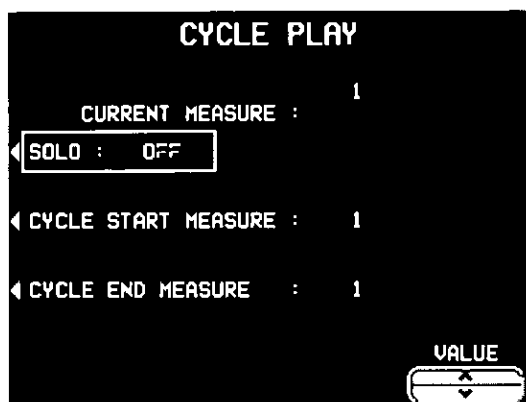

2. Select CYCLE START MEASURE, and use the ^ and v buttons to select the beginning playback measure.
3. Select CYCLE END MEASURE, and use the ^ and v buttons to select the last playback measure.
4. Press the **START/STOP** button.
 - Cycle playback of the specified measures begins.
 - If the SOLO button is turned ON, playback changes to that of the recording track only. If it is turned OFF, all the tracks specified on the SEQUENCER PLAY display are played back.
5. To stop cycle playback, press the **START/STOP** button again.
 - During playback stop, if the **SEQUENCER RESET (FILL IN 1)** button is pressed, the **SEQUENCER** returns to the measure number specified in step 2. If the **SEQUENCER RESET** button is pressed again, the **SEQUENCER** returns to measure 1.

DRUM EDIT

The DRUMS part can be edited on a specialized display. This differs from the normal STEP RECORD edit procedure, and is a convenient way to check the data for each note.

1. On the PART SELECT display, select the track for the DRUMS part.
 - The CHORD, RHYTHM and CONTROL tracks cannot be selected.
 - The display looks similar to the following.

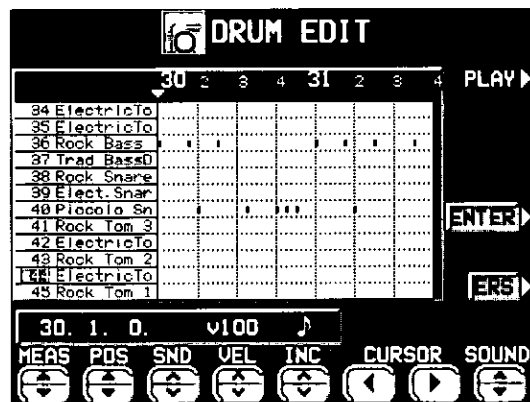

2. Use the SOUND ▲ and ▼ buttons to select the percussion instrument you wish to edit.
 - The number to the left of the instrument name is its MIDI NOTE NUMBER in the Technics arrangement.
 - If sounds other than percussion instrument sounds are assigned, they are not displayed.

3. Use the MEAS ▲ and ▼ buttons to select the measure you wish to edit.
4. Use the CURSOR ◀ and ▶ buttons to move the cursor (▼) to the point you wish to edit.
 - Recorded performance data is shown as vertical bars. Data selected for editing is shown as a longer vertical bar.
 - You can use the INC ^ and v buttons to change the increment of cursor movement. The resolution can be set at 1/96. However, if NOTE data is present between increments, the cursor will stop.
 - Use the POS ^ and v buttons to change the value.
 - Example: 10.2.48 indicates a point in measure 10, beat 2, point 48 (one point is 1/96 of a quarter note [1/96]).
 - H is shown at the point where the END command is stored.

(Continued on the next page)

5. Select the data to edit (it changes to a long bar). Edit the data.
 - Use the POS Δ and ∇ buttons to move the cursor, the SND \wedge and \vee buttons to change the percussion instrument sound, and the VEL \wedge and \vee buttons to change the velocity (how hard the keys are played).
 - If the ERS button is pressed, the selected NOTE data is erased.
6. Repeat steps 2 to 5 to continue editing.

▣ Inserting DRUMS data

You can also store DRUMS data on this display.

1. Specify the point where the new note data will be stored.
2. Use the VEL \wedge and \vee buttons to specify the velocity (how hard the key is played).

3. Press the ENTER button to store the data.
 - Instead of the ENTER button, you can store data (including velocity data) by playing the keyboard. In this case, the instrument is that specified on the display, regardless of which key is played.
 - The note length is fixed. If you wish to change the note length, use the STEP RECORD function to specify a different note length. The NOTE EDIT display can also be used to change the length (LEN). (Refer to page 90.)
4. Repeat steps 1 to 3 to input more DRUMS data.

▣ CYCLE PLAY

You can aurally check the data you are editing by accessing the CYCLE PLAY display from the DRUM EDIT display.

- The procedure is the same as for NOTE EDIT.
- If you wish other tracks to be played back, they should be selected beforehand on the SEQUENCER PLAY display. (Refer to page 76.)

QUANTIZE

The QUANTIZE function can correct the timing of your performance after it has been recorded. If the rhythm is slightly out of sync or inexact, it will automatically be corrected to the specified quantize level.

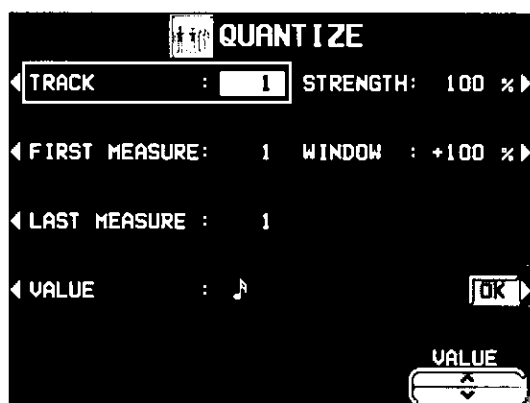

Rhythm as written
in the score

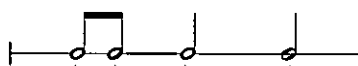

Timing of actual
performance

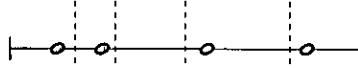

Quantized
performance

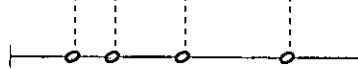

1. Select TRACK. Use the \wedge and \vee buttons to specify the track number.
 - You cannot select the track for the CONTROL, RHYTHM or CHORD part.
 - If ALL is selected, all the tracks are quantized.
2. Select FIRST MEASURE. Use the VALUE \wedge and \vee buttons to specify the start point (measure number).
3. Select LAST MEASURE. Use the VALUE \wedge and \vee buttons to specify the end point (measure number).
4. Select VALUE. Use the VALUE \wedge and \vee buttons to specify the quantize level.
 - Select from $\frac{1}{4}$, $\frac{1}{2}$, $\frac{1}{3}$, $\frac{1}{8}$, $\frac{1}{16}$, $\frac{1}{32}$. (A 3 denotes a triplet-type note.)

- Select **STRENGTH**. Use the **VALUE** \wedge and \vee buttons to select the amount of quantize (%).
 - 100% is a convenient setting. When set to 100%, the performance data is quantized exactly to the level specified for the **VALUE** ("just"). For example, at 50%, the data is quantized to a point that is half that of the just level. By this setting, you can attain an effect that is very slightly off-beat from the rhythm.
- Select **WINDOW**. Use the **VALUE** \wedge and \vee buttons to specify the range (%) affected by the quantize setting.
 - With the increment set to 100 for the **VALUE**, at a + setting, data close to the just point is corrected, and at a - setting, data far from the just point is corrected. For example, if set to -30% the quantize function affects data far from the just point, and if set to +30% the quantize function affects data close to the just point. +100% is usually a convenient setting.
 - The +100% setting and the -100% setting are the same.

Example: When **VALUE** is set to 

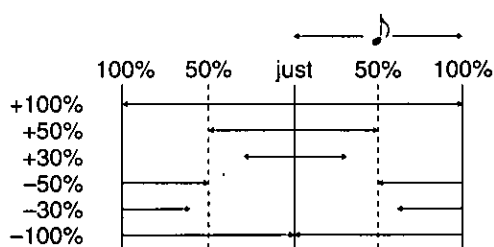

- Press the **OK** button.
 - The confirmation display appears. Press the **YES** button to execute the function, or press the **NO** button to cancel the function.

TRANSCOPE

Change of key of specific measures of specific tracks.

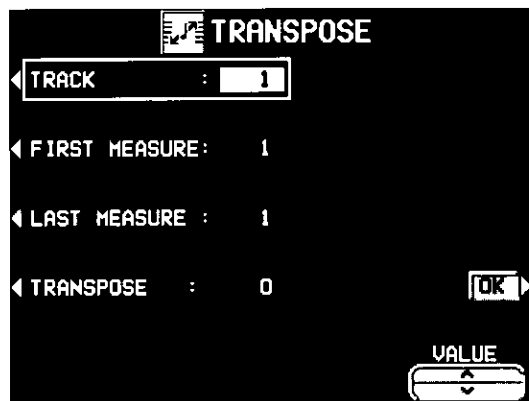

- Select **FIRST MEASURE**. Use the **VALUE** \wedge and \vee buttons to specify the start point (measure number) of the transpose.
- Select **LAST MEASURE**. Use the **VALUE** \wedge and \vee buttons to specify the end point (measure number) of the transpose.
- Select **TRANSCOPE**. Use the **VALUE** \wedge and \vee buttons to specify the change in pitch.
 - Increments are in semitones. A value of 12 is one octave. A - value lowers the pitch, and a + value raises it.
- Press the **OK** button.
 - The confirmation display appears. Press the **YES** button to execute the function, or press the **NO** button to cancel the function.

- Select **TRACK**. Use the **VALUE** \wedge and \vee buttons to select the track you wish to edit.
 - You cannot select the track for the **CONTROL**, **RHYTHM** or **CHORD** part.
 - If **ALL** is selected, all tracks will be edited.

VELOCITY CHANGE

Modify the recorded velocity in specific measures of specific tracks.

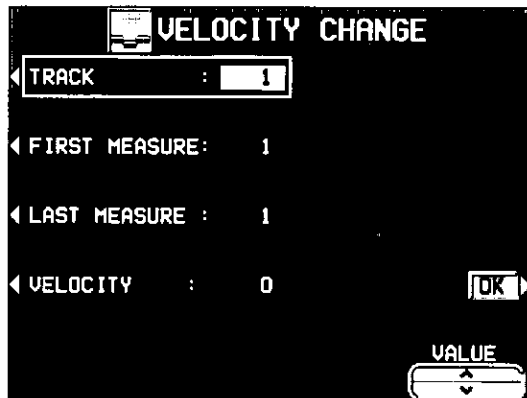

1. Select TRACK. Use the \wedge and \vee buttons to select the track you wish to edit.
 - You cannot select the track for the CONTROL, RHYTHM or CHORD part.
 - If ALL is selected, all tracks will be edited.
2. Select FIRST MEASURE. Use the VALUE \wedge and \vee buttons to specify the start point (measure number) of the velocity change.
3. Select LAST MEASURE. Use the VALUE \wedge and \vee buttons to specify the end point (measure number) of the velocity change.
4. Select VELOCITY. Use the VALUE \wedge and \vee buttons to specify the change in velocity.
 - The value you select will be added to or deleted from the current velocity.
5. Press the OK button.
 - The confirmation display appears. Press the YES button to execute the function, or press the NO button to cancel the function.

TRACK CLEAR

Erase the contents of a specific track.



1. Use the balance buttons to select the track or tracks you wish to clear.
 - A "CLR" mark is shown for the selected tracks.
2. Press the OK button.
 - The confirmation display appears. Press the YES button to execute the function, or press the NO button to cancel the function.
 - If the YES button is pressed, the specified tracks are erased.

TRACK MERGE

Merge the recorded contents of two tracks (source tracks) and store the merged contents in a third track (destination track).

- When the TRACK MERGE function is executed, the data is erased from the two source tracks.

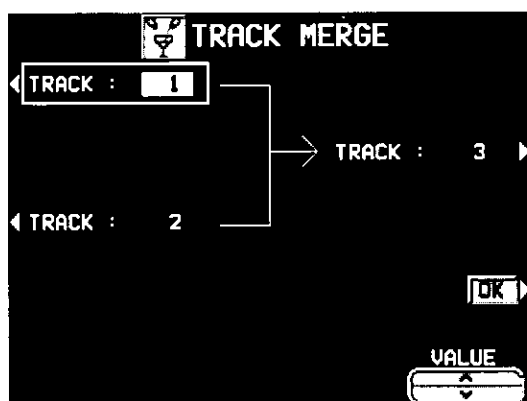

- If the part assigned to the upper source track ("upper" meaning its position on the TRACK MERGE display) is different from the part assigned to the lower source track, when the parts are merged in the destination track, the new track is assigned the same part as the upper track.

2. Select the destination track (right half of the display).
 - Press the button on the right side of the display to select the destination track, and use the VALUE ^ and v buttons to specify the track number.

3. Press the OK button.
 - The confirmation display appears. Press the YES button to execute the function, or press the NO button to cancel the function.

1. Select the two source tracks (left half of the display).
 - Use the buttons on the left side of the display to select one of the source tracks, and use the VALUE ^ and v buttons to specify the track number. Repeat for the other source track.
 - You cannot select the track to which the CONTROL, RHYTHM or CHORD part has been assigned.

NOTE CHANGE

Change of pitch of specified notes.

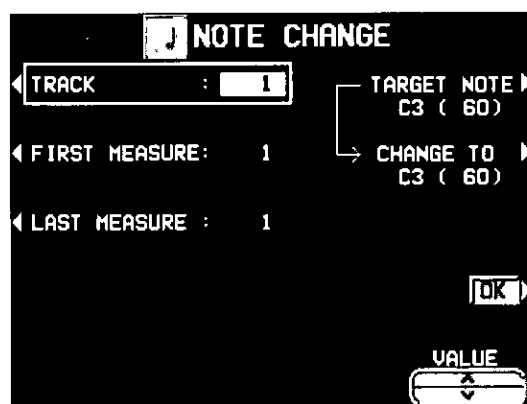

2. Select FIRST MEASURE. Use the VALUE ^ and v buttons to specify the start point (measure number) of the note change.

3. Select LAST MEASURE. Use the VALUE ^ and v buttons to specify the end point (measure number) of the note change.

4. Select TARGET NOTE. Use the VALUE ^ and v buttons to specify the pitch of the note you wish to change.
 - The number next to the note name is its note number.

5. Select CHANGE TO. Use the VALUE ^ and v buttons to specify the pitch you wish to change to.

6. Press the OK button.
 - The confirmation display appears. Press the YES button to execute the function, or press the NO button to cancel the function.

1. Select TRACK. Use the VALUE ^ and v buttons to select the track you wish to edit.
 - You cannot select the track for the CONTROL, RHYTHM or CHORD part.
 - If ALL is selected, all tracks will be edited.

ADVANCE/DELAY

Speed up or delay the sound production of specified performance data.

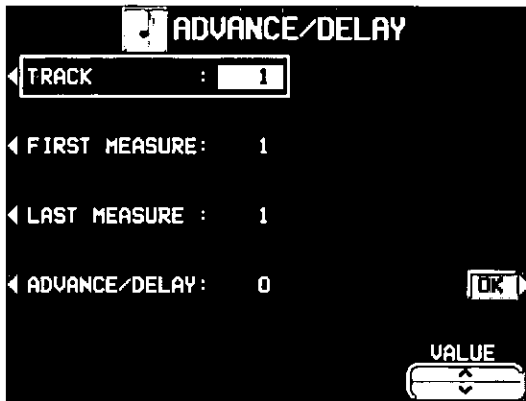

1. Select TRACK. Use the VALUE \wedge and \vee buttons to select the track you wish to edit.
 - You cannot select the track for the CONTROL, RHYTHM or CHORD part.
 - If ALL is selected, all tracks will be edited.

2. Select FIRST MEASURE. Use the VALUE \wedge and \vee buttons to specify the start point (measure number) of the change.
3. Select LAST MEASURE. Use the VALUE \wedge and \vee buttons to specify the end point (measure number) of the change.
4. Select ADVANCE/DELAY. Use the VALUE \wedge and \vee buttons to accelerate or delay the timing of the sound production (-96 to +96).
 - A + value causes the notes to sound later, and a - value causes the notes to sound earlier.
5. Press the OK button.
 - The confirmation display appears. Press the YES button to execute the function, or press the NO button to cancel the function.

MEASURE COPY

Copy recorded data of specified measures to a specified point.

- On the destination track, the new data replaces the current measure contents.

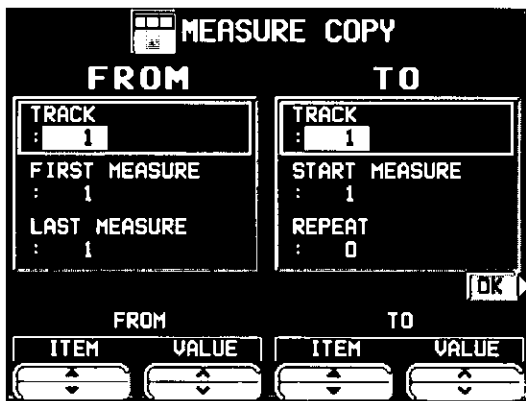

1. Specify the measures you wish to copy from the source track.
 - On the FROM side, use the ITEM Δ and ∇ buttons to select the item. Then use the VALUE \wedge and \vee buttons to specify the setting for that item.

TRACK:

Specify the track number you wish to copy the measures from.

- You cannot select the track for the RHYTHM part or CHORD part in which a repeat command has been stored.
- If ALL is selected, the specified measures are copied to all tracks at the same time.

FIRST MEASURE:

Specify the first measure to copy.

LAST MEASURE:

Specify the last measure to copy.

2. Specify where you wish to copy the selected measures to.

- On the TO side, use the ITEM Δ and ∇ buttons to select the item. Then use the VALUE \wedge and \vee buttons to specify the setting for that item.

TRACK:

Specify the track number you wish to copy to.

- Measures in a track for the CONTROL, RHYTHM or CHORD part can be copied only to the same track.

START MEASURE:

Specify the start point to copy the selected measures to.

REPEAT:

Specify the number of times the selected measures are to be repeated.

3. Press the OK button.

- The confirmation display appears. Press the YES button to execute the function, or press the NO button to cancel the function.
- Note that if the END command is included in the source data, it is also copied. Any data following the END command is not copied.

MEASURE ERASE

Erase the recorded contents of specific measures. You can also specify which type of data is to be erased.

- Note that only the contents of the measures are erased, not the measures themselves; the length of the performance remains the same.

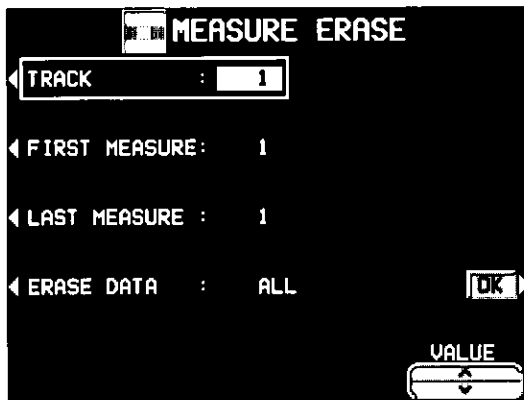

1. Select TRACK. Use the VALUE ^ and v buttons to specify the track number.
 - This function does not work for the RHYTHM part or CHORD part in which a repeat command has been stored.
 - If ALL is selected, data is erased from the specified measures of all the tracks at one time.

2. Select FIRST MEASURE. Use the VALUE ^ and v buttons to specify the start point (measure number).
3. Select LAST MEASURE. Use the VALUE ^ and v buttons to specify the end point (measure number).
4. Select ERASE DATA. Use the VALUE ^ and v buttons to specify the type of data to be erased.

ALL: All data is erased.

NOTE: Only note data.

CONTROL: Only control data (volume, effect and other panel settings as well as selection changes) is erased.

5. Press the OK button.
 - The confirmation display appears. Press the YES button to execute the function, or press the NO button to cancel the function.

MEASURE DELETE

Delete specified measures from a track.

- The length of the performance accordingly decreases by the number of deleted measures.



1. Select TRACK. Use the VALUE ^ and v buttons to select the track from which measures are to be deleted.
 - This function does not work for the CHORD or RHYTHM track in which the repeat function has been stored.
 - If ALL is selected, the specified measures are deleted from all the tracks at one time.
2. Select FIRST MEASURE. Use the VALUE ^ and v buttons, to specify the first measure to delete.
3. Select LAST MEASURE. Use the VALUE ^ and v buttons to specify the last measure to delete.
4. Press the OK button.
 - The confirmation display appears. Press the YES button to execute the function, or press the NO button to cancel the function.

MEASURE INSERT

Insert specified measures at a specified point.

- The length of the performance accordingly increases by the number of inserted measures.

1. Specify the measures you wish to copy from the source track.
 - On the FROM side, use the ITEM ▲ and ▼ buttons to select the item. Then use the VALUE ^ and v buttons to specify the setting for that item.

TRACK:

Specify the track number you wish to copy the measures from.

- This function does not work for the CHORD or RHYTHM track in which the repeat function has been stored.
- If ALL is selected, the measures are inserted in all tracks at the same time.

FIRST MEASURE:

Specify the first measure to copy.

LAST MEASURE:

Specify the last measure to copy.

2. Specify where you wish to insert the selected measures.
 - On the TO side, use the ITEM ▲ and ▼ buttons to select the item. Then use the VALUE ^ and v buttons to specify the setting for that item.

TRACK:

Specify the track number.

- Measures from the CHORD, RHYTHM or CONTROL track can only be inserted in the same track.

START MEASURE:

Specify the start point to insert the selected measures.

REPEAT:

Specify the number of times the selected measures are to be repeated.

3. Press the OK button.
 - The confirmation display appears. Press the YES button to execute the function, or press the NO button to cancel the function.
 - Note that if the END command is included in the source data, it is also inserted. Any data following the END command is not inserted.

Part V Composer

Outline of the Composer

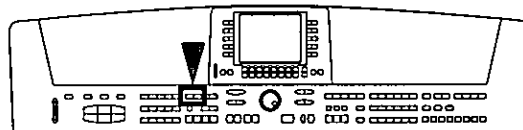

The **COMPOSER** enables you to create your own accompaniment patterns. A pattern is comprised of five parts: **DRUMS**, **BASS** and 3 **ACCOMP** parts. These parts would form the backing of a song.

Rhythm components which can be stored

You can store up to 4 types of patterns (VARIATION 1 to 4) in each **MEMORY** (A, B, C). You can also create **INTRO 1** and **2**, **FILL IN 1** and **2**, and **ENDING 1** and **2** patterns for each **MEMORY**. During **MEMORY** playback, you can press the **INTRO & ENDING 1** or **2** button, or the **FILL IN 1** or **2** button to have your original pattern played back.

- The **INTRO**, **FILL IN** and **ENDING** patterns are the same for each variation within a **MEMORY**.

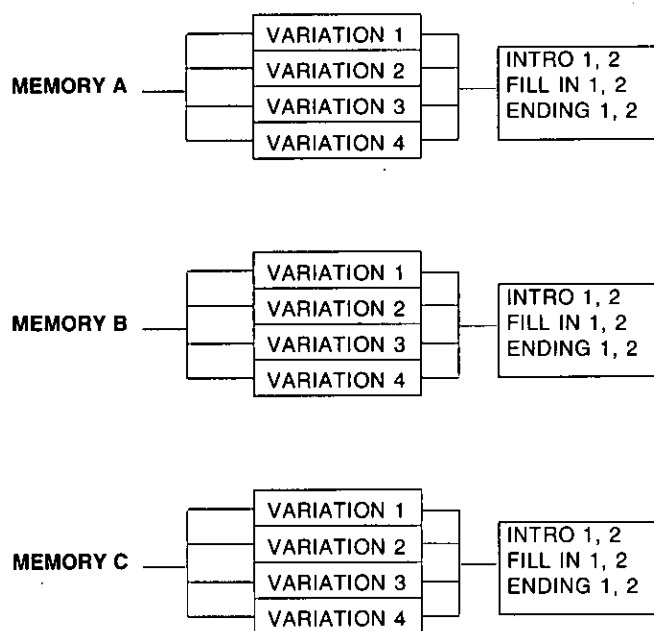

■ CUSTOM

Up to 20 original patterns can be stored in the **CUSTOM** button of the **RHYTHM GROUP**. You can use them during your performance, just like the preset rhythms.



- Copy is performed one **MEMORY** at a time.
- Because **CUSTOM** uses a large portion of the memory, it takes a long time to load from or save to a floppy disk. For this reason, it is not suitable to use in cases where data is saved to or loaded from a floppy disk, for example, performance data for creating **SEQUENCER** songs. When creating a **SEQUENCER** performance, use the **MEMORY** pattern.

Memory capacity

Expressed in terms of notes, the total number of notes which can be stored in all the **COMPOSER** memories is about 10,000. The remaining memory available for recording is shown on the recording display as a percentage (%).

- When "Memory full!" appears on the display no more data can be stored in the **COMPOSER**.
- The total number of notes that can be stored to all the **CUSTOM** memories (20) is about 70,000.

MEMORY

The memory contents of **CUSTOM** are retained even if the power to this instrument is turned off. However, because the contents of the **MEMORY** are erased after about 80 minutes after the power is turned off, you should save the data on floppy disks if you wish to keep it. (Refer to page 120.)

COMPOSER menu

When you press the **COMPOSER MENU** button to turn it on, the display changes to the following.

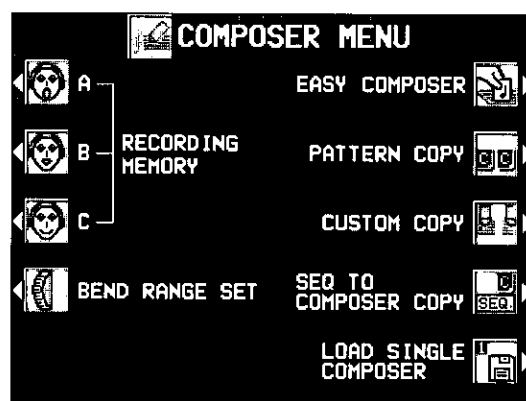
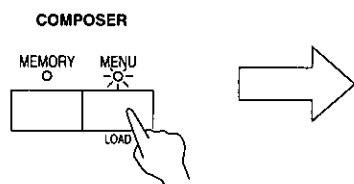

Summary of the COMPOSER menu items

RECORDING MEMORY-A

Create a memory in the **MEMORY A** bank.

RECORDING MEMORY-B

Create a memory in the **MEMORY B** bank.

RECORDING MEMORY-C

Create a memory in the **MEMORY C** bank.

EASY COMPOSER (page 101)

Create a rhythm pattern with a simplified procedure.

PATTERN COPY (page 107)

Copy a preset rhythm pattern into a memory.

CUSTOM COPY (page 109)

Copy **MEMORY** contents to **CUSTOM** area, or vice versa.

SEQ TO COMPOSER COPY (page 108)

Copy recorded data in the **SEQUENCER** to the **COMPOSER**.

BEND RANGE SET (page 109)

Set the **PITCH BEND** range effective during recording for the **ACCOMP** and **BASS** parts.

LOAD SINGLE COMPOSER

Recall the desired **COMPOSER** data from data saved on a disk. This procedure is the same as when **COMPOSER** is selected for **SINGLE LOAD**. (Refer to page 115.)

Three ways to record in the COMPOSER

There are three ways to create and record a rhythm

■ Simple recording method

Use EASY COMPOSER to quickly create a unique rhythm just by selecting a style for each part

■ Create a completely new rhythm (page 102)

Compose all the parts of a completely new rhythm from scratch

- You can use either realtime recording or step record for any part of the recording

■ Pattern Copy (page 107)

Copy a preset rhythm or **SEQUENCER** data to a **COMPOSER** memory, edit it as you like, and then store it as a new rhythm

Simple recording method

With EASY COMPOSER you can easily create a unique rhythm pattern by selecting a different style for each part of the rhythm

- 1 On the COMPOSER MENU display, select EASY COMPOSER
- The display looks similar to the following

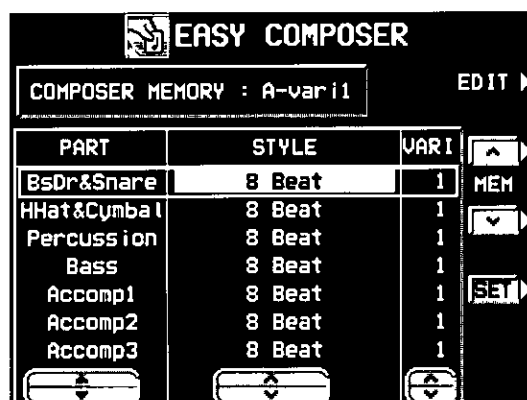

- 2 Use the MEM \wedge and \vee buttons to select the memory in which to record your rhythm
 - Select from A-vari 1 to 4, B-vari 1 to 4 and C-vari 1 to 4
- 3 Use the PART \blacktriangle and \blacktriangledown buttons to select the part
 - In the EASY COMPOSER, the new rhythm pattern is divided into 7 parts, to each of which a style and variation is assigned
- 4 Use the STYLE \wedge and \vee buttons to select a style

- 5 Use the VARI \wedge and \vee buttons to select the variation number
 - The number of variations differs depending on the selected style
 - A part which is set to OFF does not sound. Note that the "BsDr&Snare" part cannot be set to OFF
- 6 Repeat steps 3 to 5 to select styles for the other parts
- 7 Press the SET button
 - The rhythm pattern is played back
 - The RHYTHM name changes to "Easy"
 - If you are not satisfied with the rhythm pattern, repeat steps 3 to 7
 - If you wish to correct the sounds or phrases in your rhythm pattern, press the EDIT button. The display changes to the recording display (Refer to page 104)
 - For playback, refer to page 105

Create a completely new rhythm

Clear the memories and compose a completely new rhythm from scratch

- You can also use this method when copying a pattern from a preset rhythm or the **SEQUENCER** (Refer to page 107)

Prepare to record

- 1 On the COMPOSER MENU display, select a memory in which to record (RECORDING MEMORY A, B, or C)
 - The display looks similar to the following

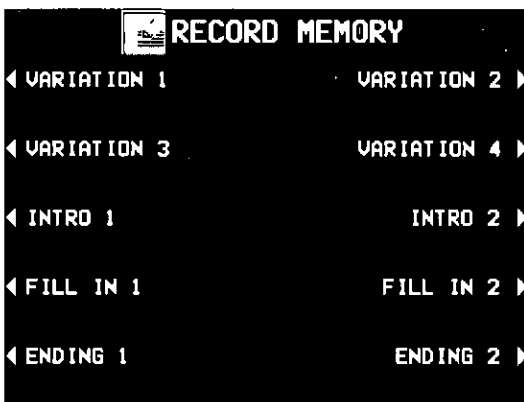

- 2 Specify the pattern you are going to create
 - The display looks similar to the following



- 3 Press the CLEAR THE ENTIRE PATTERN button

- The display looks similar to the following

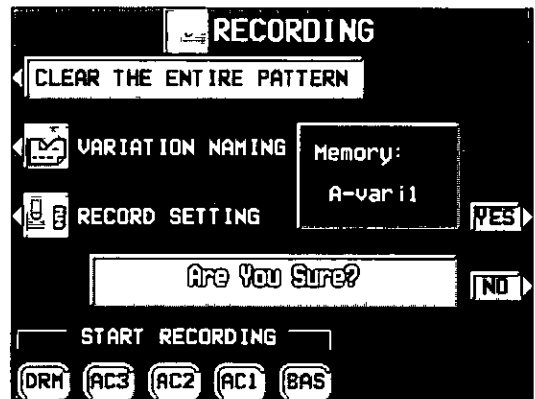

- 4 Press the YES button
 - Press the NO button to cancel the operation
- 5 Press the VARIATION NAMING button
 - FILL IN, INTRO and ENDING patterns cannot be named
 - The display looks similar to the following



- 6 Type a name for your rhythm pattern
 - Use the POSITION buttons to highlight the character position in the name box. Use the <, Δ, ∇, > buttons to select the alphanumeric character. Repeat these steps to type the whole name
 - Press the ABC button to switch to the screen for upper case (capital) letters, or the abc button to switch to the screen for lower case letters

- Use the !#\$ button to switch to the symbols character set.
- Use the INS button to type a space.
- Use the DEL button to erase a character.
- To erase all the characters, press the CLR button.
- You can press the →← button if you wish to have the name centered.

7. Press the OK button.

- The display changes to the RECORDING display.

8. Press the RECORD SETTING button.

- There are two screen pages of settings. Use the PAGE ^ and v buttons to switch between pages.

————— PAGE 1 —————

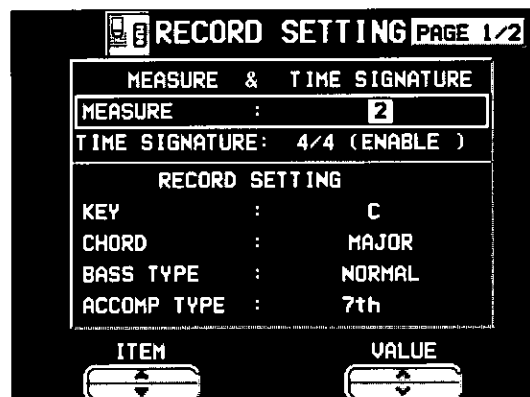

Use the ITEM ▲ and ▼ buttons to select the item. Use the VALUE ^ and v buttons to change the setting.

MEASURE & TIME SIGNATURE

MEASURE:

Specify the number of measures in your repeating rhythm pattern (1 to 8).

TIME SIGNATURE:

Specify the time signature (1/4 to 8/4).

RECORD SETTING

KEY:

Specify the root note of the recorded performance.

CHORD:

Specify the type of chord you wish to record (MAJOR or MINOR).

BASS TYPE:

Specify the type of phrase progression for the BASS part (NORMAL or 7th).

ACCOMP TYPE:

Specify the type of phrase progression for the ACCOMP parts (NORMAL or 7th).

- When 7th is selected and a chord is specified, if a 7th chord is specified during playback, the flat of the 7th tone is substituted for the 5th tone.

————— PAGE 2 —————



Use the PART ▲ and ▼ buttons to select a part, then the PANPOT and PITCH POINT ^ and v buttons to change the settings.

PANPOT:

Stereo balance (Left64–CENTER–Right63).

- At "Left64", the sound is all the way to the left, at "Right63" all the way to the right. The center point is CENTER.

PITCH POINT:

The pitch at which the pattern progression sound is lowered by one octave.

- When the root note of the specified chord is lower than the set pitch point, the pitch of that part is automatically raised by one octave, thus avoiding an unnaturally low accompaniment pitch.

9. Press the EXIT button.

- The RECORDING display is shown.

Recording procedure



1. In the START RECORDING area on the display, select the rhythm part you want to record first.

BAS: **BASS**
 AC1: **ACCOMP 1**
 AC2: **ACCOMP 2**
 AC3: **ACCOMP 3**
 DRM: **DRUMS**

- The metronome sound starts and the display looks similar to the following.

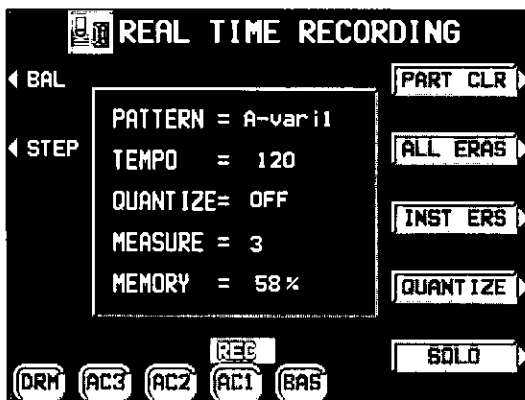

2. Adjust the tempo.

- The tempo is shown on the display as TEMPO=.
- The tempo can be freely adjusted when you play back the rhythm pattern, so record at the tempo which is easiest for you to play.

3. Select the sound.

- For the **DRUMS** part, only sounds from the **DRUM KITS** sound group can be selected.
- For the **ACCOMP** and **BASS** parts, select sounds from groups other than the **DIGITAL DRAWBAR** and **DRUM KITS** sound groups.

4. Record the part.

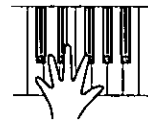

- The specified number of measures are repeatedly played back, during which time any newly played notes are added to those already recorded. The current measure number is shown on the display as "MEASURE=".
- Record the performance in C major for correct chord progressions during playback. Follow the RECORD SETTING procedure if you wish to record the performance in a different scale. (Refer to page 103.)
- **PITCH BEND** and **MODULATION** effects are also recorded (except for the **DRUMS** part).
- **AFTER TOUCH** is not recorded.

▣ Button functions

BAL:

Adjust the volume of each part on the PART BALANCE display. (These settings are not recorded.)

STEP:

Change to the STEP RECORD mode. (Refer to page 106.)

PART CLR:

Erase all recorded contents of the currently selected part.

ALL ERAS:

The performance recorded in the selected part is erased for as long as this button is pressed.

INST ERS:

During recording of the **DRUMS** part, clear the part instrument by instrument.

- Hold down this button and specify the instrument sound to be deleted by pressing the corresponding instrument key on the keyboard, after which only the specified instrument will be erased for as long as this button is kept pressed.

QUANTIZE:

Smooth out any unevenness in the timing of your performance.

- Before recording, select the note value for the desired quantize level. (The quantize level is shown on the display as **QUANTIZE=.**)

SOLO:

Mute all parts except the part which is currently being recorded.

- A **MUTE** mark is shown for the other parts on the display.
- To turn off the **SOLO** function, press this button again.

5. Use the buttons below the display to switch to a different recording part, and proceed to record each part in turn.

6. When you have finished recording the rhythm, turn off the **MENU** button in the **COMPOSER** section.

Playback

1. In the **COMPOSER** section, turn on the **MEMORY** button.

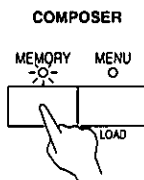

- The display looks similar to the following.

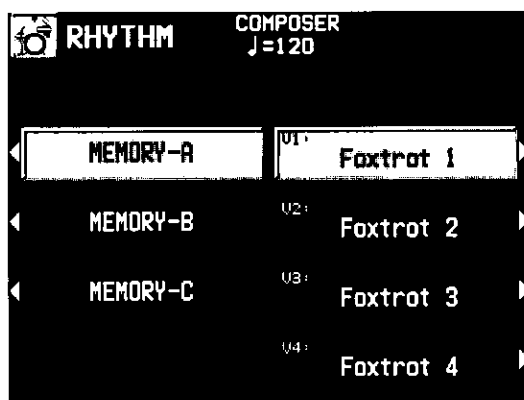

2. Use the buttons to the left of the display to select the desired memory.

3. Use the buttons to the right of the display to select a variation.

- The **VARIATION & MSA** buttons can also be used to select the desired variation number.

4. Press the **START/STOP** button.

- The **DRUMS** part begins to play back.
- The **BASS** and **ACCOMP** parts are played back when you use the **AUTO PLAY CHORD**.

Step Record

Use STEP RECORD to store the notes one-by-one on the display. This is a convenient way to store complicated patterns that are difficult to play.

Recording procedure

- While you are recording, press the STEP button.
 - The display changes to the STEP RECORD display similar to the following.

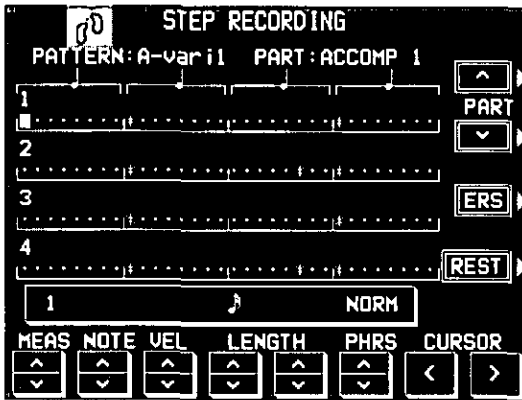

- Use the MEAS buttons to select the measure you wish to record.
 - This step is not necessary if you are recording from measure 1 of a blank part.
- Use the CURSOR < and > buttons to move the cursor to the note position (dot) you are going to store.
 - Each dot represents one-eighth of a quarter-note (a thirty-second note).
 - When storing triplets, it may not be possible to match the timing exactly with the 1/32-note steps. However, if you select triplet-type notes for the note length (LENGTH) in step 4 below, the timing is automatically corrected.
- Use the left LENGTH buttons to specify the note value. Select from $\frac{1}{3}$, $\frac{2}{3}$, $\frac{1}{4}$, $\frac{2}{4}$, $\frac{3}{4}$, $\frac{1}{2}$, $\frac{3}{8}$, $\frac{1}{8}$, $\frac{1}{16}$, $\frac{1}{32}$, $\times 2$ to 4. (A 3 denotes a triplet-type note.)
 - For note values other than these, use the right LENGTH buttons to specify the note value to be added to that which you specified with the left buttons.

Example: To record a dotted quarter-note ($\frac{1}{4}$.)



- Use the PHRS ^ and v buttons to specify the actual length of the produced sound for the desired legato or staccato effect.

TENU (tenuto):	Sound is produced for 95% of the note length.
NORM (normal):	80%
STAC (staccato):	50%
CUTT (cutting):	25%

- Specify the pitch and velocity of the note by playing the keyboard.
 - The dot on the display where the note is stored changes to a * mark.
 - When recording chords, you can store multiple notes at one position.
- REST: To store a rest, after specifying the note LENGTH, press the REST button.
 - Positions at which nothing is stored are read as rests.
- ERS: If you make a mistake, move the cursor to the error, and after displaying the data you wish to erase, press the ERS button.
- Repeat steps 3 through 6 to continue storing notes.
 - To record a different part, use the PART ^ and v buttons to select another part.
 - You can easily switch between the REALTIME mode and the STEP mode any time during recording. To return to the realtime recording display during the STEP RECORD mode, press the EXIT button.

■ Correcting the data

1. In the STEP RECORD mode, specify the part you wish to correct.
2. Use the MEAS buttons to go to the measure you wish to modify. Use the CURSOR buttons to move the cursor to the point (*) you wish to edit.
 - The data stored at that point is shown on the display.
 - When a chord is stored at one point, a different note of the chord is displayed in order each time a CURSOR button is pressed.
3. Correct the data.
 - NOTE data (note pitch) and VEL data (how hard the key was played), etc. are displayed. Use the relevant buttons to correct the data as desired.
 - Press the ERS button to erase the data which is displayed.
 - You can also correct data which was stored in the REALTIME RECORD mode.

Pattern Copy

Use this function to copy a pattern from a preset rhythm or from **SEQUENCER** data.

PATTERN COPY

Copy a preset rhythm to the **COMPOSER**.

1. On the COMPOSER MENU display, select PATTERN COPY.
 - The display looks similar to the following.

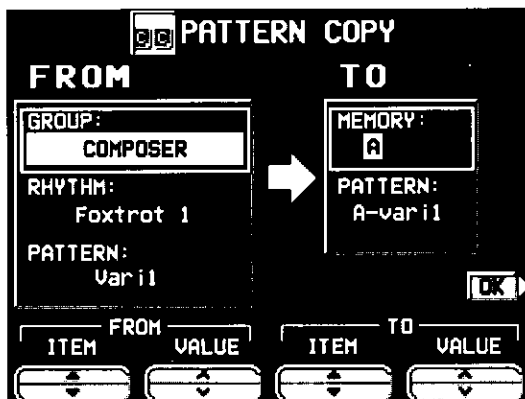

2. Select the pattern you wish to copy.
 - In the FROM box, use the ITEM ▲ and ▼ buttons to select the group, rhythm and pattern, and the VALUE ^ and v buttons to specify the name.

GROUP: Group name
 RHYTHM: Rhythm name
 PATTERN: Pattern name

- If ALL is selected, all the patterns are copied.

3. Select the memory you wish to copy to.
 - In the TO box, use the ITEM ▲ and ▼ buttons to select the memory and pattern, and the VALUE ^ and v buttons to specify the name.

MEMORY: Memory name (A, B or C)

PATTERN: Pattern name

- If ALL is selected, all the patterns are copied.

4. Press the OK button.
 - When copying has been successfully completed, "COMPLETED!" appears on the display.

- If you wish to use the **COMPOSER** functions to edit the copied data, on the COMPOSER MENU display, select the memory and pattern you copied to, and follow the procedure to record a pattern.

SEQ TO COMPOSER COPY

Data from the **SEQUENCER** can be copied to a **COMPOSER** memory. For example, you can use a rhythm pattern on a song disk as the automatic accompaniment for your own performance.

1. Play back the song you wish to copy from **SEQUENCER** to confirm the tracks, the measures and the time signature you wish to copy.
2. Follow the procedure in "Prepare to record" to prepare the **COMPOSER** memory you will be copying to. (Refer to page 102.)
 - Be sure that time signature setting in the **SEQUENCER** data you are copying from and the time signature in the **COMPOSER** memory you are copying to are the same, or the data will not be copied successfully.
3. On the **COMPOSER MENU** display, select **SEQ TO COMPOSER COPY**.
 - The display looks similar to the following.

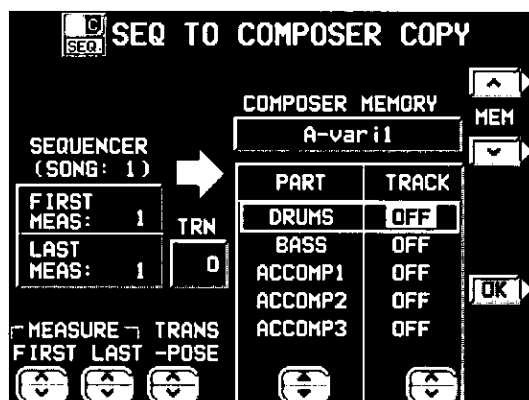

4. Use the **MEASURE FIRST** \wedge and \vee buttons to specify the number of the first measure to copy.
5. Use the **MEASURE LAST** \wedge and \vee buttons to specify the number of the last measure to copy.
 - Up to 8 measures can be copied.
6. Use the **TRANSPOSE** \wedge and \vee buttons to change the key of the copied measures (-24 to +24).
 - Units are in semitones.

7. Use the **MEM** \wedge and \vee buttons to specify the **COMPOSER** memory to copy to.
8. For each **COMPOSER** part, specify the **SEQUENCER** track from which to copy data.
 - Use the **PART** \blacktriangle and \blacktriangledown buttons to specify the part name, and the **TRACK** \wedge and \vee buttons to specify the track number.
 - Parts which are set to **CLEAR** are blank.
9. Press the **OK** button.
 - "COMPLETED!" is shown on the display.
 - If you wish to use the **COMPOSER** functions to edit the copied data, on the **COMPOSER MENU** display, select the memory and pattern you copied to, and follow the procedure to record a pattern.

Bend Range

Adjust the amount of pitch change applied to the **ACCOMP** parts and the **BASS** part when the **PITCH BEND** wheel is operated during **COMPOSER** recording.

1. On the **COMPOSER MENU** display, select **BEND RANGE SET**.
 - The display changes to the following.

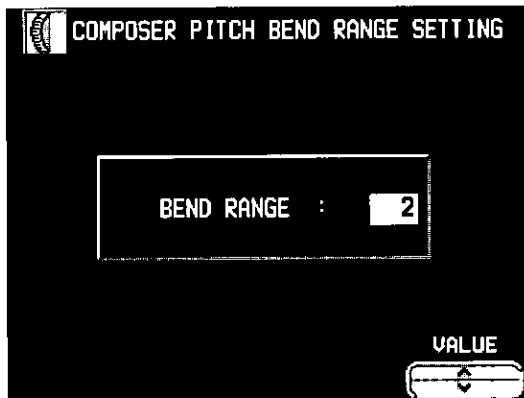

2. Use the **VALUE** \wedge and \vee buttons to specify the range (0 to 12).
 - Increments are in semitones.

Custom Copy

Up to 20 **COMPOSER** patterns can be stored in the **CUSTOM** memory area of the **RHYTHM GROUP**, one **MEMORY** at a time. The patterns stored in **CUSTOM** are retained even when the power to this instrument is turned off. You can use them during your performance, just like the preset rhythms.

- You can copy **CUSTOM** rhythms to the **COMPOSER** and edit them.

1. On the **COMPOSER MENU** display, select **CUSTOM COPY**.
 - The display looks similar to the following.

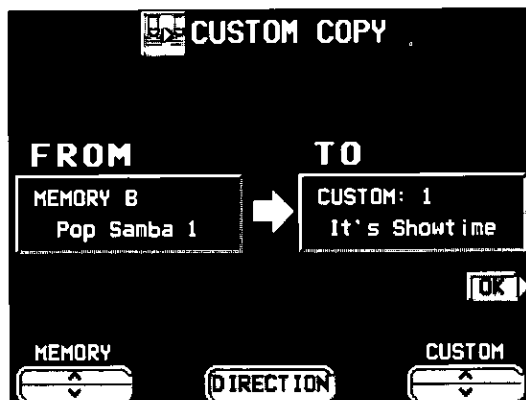

2. Use the **CUSTOM** \wedge and \vee buttons to select the **CUSTOM** number, and the **MEMORY** \wedge and \vee buttons to select the **MEMORY** name.
 - The **DIRECTION** button can be used to change the source and destination of the copied pattern (**MEMORY** → **CUSTOM**, **CUSTOM** → **MEMORY**).

3. Press the **OK** button.
 - When copying has been successfully completed, "COMPLETED!" appears on the display.

Note

- The total number of notes that can be copied to all the **CUSTOM** memories is about 70,000. The maximum number of **MEMORY** patterns which can be saved may be less than 20 if you are saving many patterns which use a lot of memory.
- If you copy a pattern which uses sounds from **SOUND GROUP MEMORY A** and **MEMORY B**, the copied sound data is operative. However, the **MEMORY** sound data capacity in the **CUSTOM** area is limited. If the capacity is exceeded, when you attempt to copy the pattern, an **ATTENTION** display appears requiring you to specify how you wish to proceed.
- If you select **CUSTOM** → **MEMORY** copy, the contents of the **SOUND GROUP MEMORY** may be replaced. In this case an **ATTENTION** display appears requiring you to specify how you wish to proceed.
- To reset the **CUSTOM** contents to the factory-preset settings, load the included "INITIAL DATA DISK" floppy disk.

Selecting a CUSTOM memory

1. In the **RHYTHM GROUP** section, turn on the **CUSTOM** button.



- The display changes to the **CUSTOM** select display.
 - There are two screen pages of the list. Use the **PAGE** \wedge and \vee buttons to switch between pages.
2. Select the desired custom number (1–20).
 - This rhythm can be used just like the preset rhythms.

Part VI Disk Drive

Outline of the Disk Drive function

The Disk Drive enables you to store recorded and stored data from this instrument's memories on floppy disks, as well as play commercial recorded disks on this instrument.

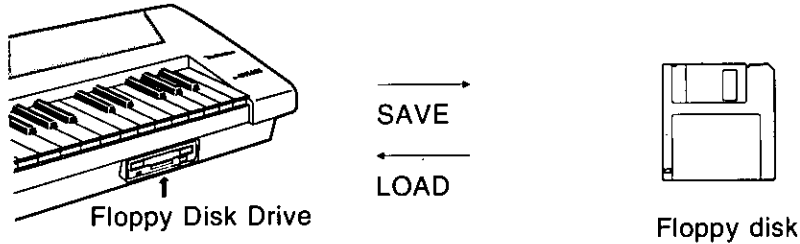

Internal memory and Floppy Disk Drive

The storable internal memory of this instrument as well as the backup time are limited. However, the Disk Drive maximizes your control of data management by allowing you to store (SAVE) this instrument's data on floppy disks, and then to recall (LOAD) it at any time.

- For more information about the backup time and performance data, please see page 178.

■ The following data can be saved/loaded:

BACKUP	PERFORM- ANCE	CURRENT PANEL (The current panel settings)
		PANEL MEMORY*
		SEQUENCER
		COMPOSER* (MEMORY contents)
		SOUND MEMORY*
		MSP (USER memories of the MANUAL SEQUENCE PADS)
		RHYTHM CUSTOM
		USER MIDI SETTINGS (USER memories of the MIDI PRESETS)

- The PERFORMANCE group includes the data used in your performance. The PERFORMANCE group along with the RHYTHM CUSTOM and USER MIDI SETTINGS comprises the BACKUP group.
- When creating or saving song data, it is recommended that you use the performance data in the PERFORMANCE group.
- Instead of using RHYTHM CUSTOM and USER MIDI SETTINGS as frequently loaded and saved data, it is recommended that you save it with other data as Keyboard backup data.
- A * mark indicates that data can be loaded to and from a specific memory (SINGLE LOAD).
- Because RHYTHM CUSTOM uses a lot of memory, the save or load time may be long. In particular, the load procedure takes some time.
- Please use 2HD disks to load/save BACKUP data.

Main parts of the Floppy Disk Drive

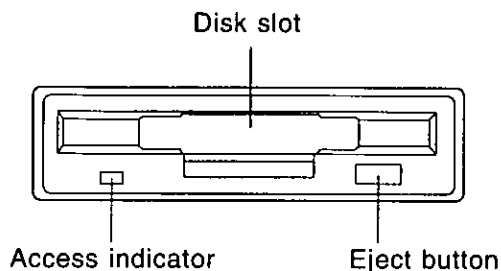

Eject button

Press to remove the disk from the Disk Drive.

Access indicator

Lights when data is being loaded from or saved to disk.

- To prevent data loss, do not remove the disk from the Disk Drive or turn off the power when the access indicator is lit.
- You can use 3.5 inch 2DD (720 KB) or 2HD (1.44 MB) floppy disks; however, 2HD disks formatted as 2DD cannot be used.

Using commercial song disks

Not only disks recorded on this instrument, but also data from commercial song disks can be read on this instrument.

- This instrument accepts the following file formats:

TECHNICS File format

Standard MIDI File format

■ Loading Technics File format disks

Using Technics file format disks allows you load new SOUND EDIT, rhythm & accompaniments, **PANEL MEMORY, MANUAL SEQUENCE PADS** and Song data into your **KN5000** to expand its potential even further. "Music Disk Collection" is the brand name for Technics software and is written to bring you the maximum benefit from your **KN5000**.

■ About Standard MIDI Files

"Standard MIDI File" (SMF) is a standardized data format which makes it possible for music data to be exchanged among different sequencers. Data stored in this format on sequencers of different models can be played back on this instrument, and vice versa. Note, however, that Standard MIDI Files ensure the compatibility of data such as NOTE data (keyboard performance data), VELOCITY (how hard the keyboard is played), PROGRAM NUMBER data (voice number data), etc. Because it does not guarantee 100% faithful reproduction of recorded music which is replete with such data, it may be necessary for you to adjust the settings to your satisfaction.

- Only files with the ".MID" extension can be loaded.
- Standard MIDI File FORMAT 1 can be loaded, but not saved.
- This instrument's **SEQUENCER** data can be saved to a disk in Standard MIDI File (FORMAT 0) and can be used by other equipment.

Playback of commercial song disks

DIRECT PLAY lets you enjoy playing commercially sold song disks directly from a disk. It's fast because you don't have to load the disk data into your instrument's memory.

- DIRECT PLAY is possible from the following disks:

Standard MIDI File FORMAT 0

TUNE 1000 "Standard MIDI File with Lyrics" (FORMAT 0 only)
--

DISK ORCHESTRA COLLECTION™ (DOC)

PianoDisc™

* All product and company names are trademarks or registered trademarks of their respective owners.

* DISK ORCHESTRA COLLECTION is a trademark of the YAMAHA Corporation.

Outline of the procedure

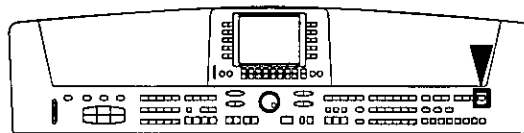

1. Insert the floppy disk into the Disk Drive slot. Push it all the way in until you hear a click.
 - On this instrument, if the normal display is active, it automatically changes to the DISK MENU display when a floppy disk is inserted into the Disk Drive (initialized settings). The PREFERENCES menu is used to specify which display is shown when a disk is inserted.
2. Select a menu on the DISK MENU display.
 - If the DISK MENU display does not appear, turn on the **DISK** button.
3. Follow the procedure for the function (see below).
 - When function is being set, if the **TEMPO/PROGRAM** indicator is lit, the dial is available for setting the current function.
4. When you have finished setting the functions, turn off the **DISK** button.

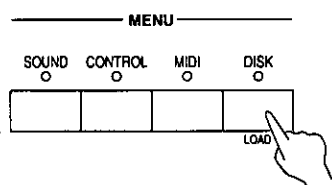

■ About the menu



LOAD (page 114)

Load data from a disk into this instrument's memory.

SAVE (page 121)

Save data from this instrument's memory to a disk.

DIRECT PLAY (page 117)

Direct playback of commercial song disks and medley playback.

SONG MEDLEY (page 119)

Medley playback of songs in the **SEQUENCER** or floppy disk.

DISK TOOLS (page 125)

Disk management procedures, such as disk format.

PREFERENCES (page 126)

Automatic display when a floppy disk is inserted.

Loading data

Recall (load) the data from the disk to this instrument's memories.

- Note that the load procedure causes any data which is currently stored in the relevant memories to be erased.

LOAD

Load data that saved to a disk into this instrument's memory.

1. Insert the disk with the stored data into the Disk Drive. Push it all the way in until you hear a click.

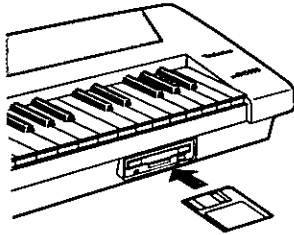

2. On the DISK MENU display, select LOAD.
 - The display looks similar to the following.



- If there are only SMF files on the disk, the display automatically changes to the SMF LOAD display. (Refer to page 115.)

3. Use the buttons below the display to select the file (Technics file) you wish to load.
 - If there are SMF files on the disk and you wish to load an SMF file, press the SMF button. (Refer to page 115.)
 - The types of data which can be loaded from the file are shown in a frame on the right side of the display. You can press the LOAD button to load all of the indicated data, or you can use the LOAD OPTION to select specific data to load.

4. Press the LOAD button.

- The LOAD operation begins.
- When the operation has been successfully completed, "COMPLETED!" is shown on the display.
- If song data was loaded, you can press the **START/STOP** button to begin playback when the **SEQUENCER PLAY** display is active.
- You can load the type of data for which only one song can be recorded in the **SEQUENCER**. (This type is available for disks used with older Technics models.) Note, however, that in this case, the song is loaded into SONG 1, but the data in SONG memories 2 to 10 are erased.
- You can also access the LOAD display by pressing the **DISK** button for a few seconds.

■ **LOAD OPTION**

Specify the kind of data you wish to load from the disk to your instrument.

1. Use the **PAGE** buttons to access the PAGE 2/3 LOAD OPTION display.
- The display looks similar to the following.



2. Use the buttons below the display to specify the types of data you wish to load (YES/NO).
 - - - - - indicates that this type of data has not been saved.
 - This setting is canceled when you quit the LOAD display or when another file is selected.

3. Press the **LOAD** button.
 - The **LOAD** operation begins.
 - If **RHYTHM CUSTOM** was selected, the load operation will take about one minute.

■ **SINGLE LOAD**

Load only the desired data from a disk into a specific **PANEL MEMORY**, **COMPOSER (MEMORY)**, **SOUND MEMORY** memory.

1. Use the **PAGE** buttons to access the PAGE 3/3 SINGLE LOAD display.
- The display looks similar to the following.

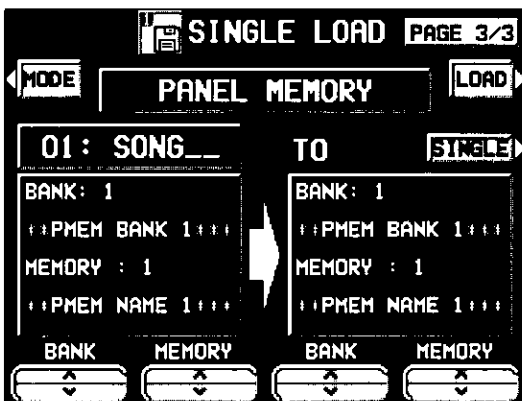

2. Use the **MODE** button to select the data you wish to load.
3. Use the **BANK/SINGLE** button to select the load increment.
 - BANK:** Load one bank at a time.
 - SINGLE:** Load the smallest data increment.
4. Follow the appropriate procedure to load the specified data.
 - Specify the data source for **FROM** (left side), and the data destination (this instrument's memory location) for **TO**.

■ **SMF LOAD**

Load data which was saved in the "Standard MIDI File" (SMF) format.

1. On the **LOAD** display, press the **SMF** button.
- The display looks similar to the following.

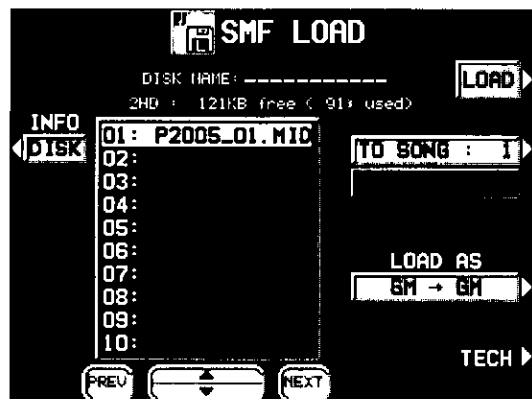

- For disks which contain SMF files only, this display appears automatically when **LOAD** is selected on the **DISK MENU** display.
2. Use the **▲** and **▼** buttons to select the filename you wish to load.
 - If the number of files is 10 or more, you can use the **PREV** and **NEXT** buttons to go back or advance 10 files at a time.
 - If you press the **TECH** button, the display changes to the **LOAD** display for Technics files.

(Continued on the next page)

- You can use the INFO button to switch the displayed data.

DISK: Disk name

SONG: Song name

3. Use the TO SONG button to select the number to load to (this instrument's **SEQUENCER** song number).

- Songs to load are specified one at a time.
- The song name to load to is shown below the TO SONG button.

4. Use the LOAD AS button to specify the load method.

- Select from the following.

GM → GM:

Treat the file as a GENERAL MIDI file and load it with this instrument's GENERAL MIDI turned ON.

GM → TECH:

Treat the file as a GENERAL MIDI file and load it with this instrument's GENERAL MIDI turned OFF.

TECH → TECH:

Treat the file as a TECHNICS file and load it with this instrument's GENERAL MIDI turned OFF.

- Information about GENERAL MIDI (GM) can be found on page 165.
- If you select the setting which is different from that in which the song was stored, the sounds, octaves, and arrangement of percussion instrument sounds will be different.

5. Press the LOAD button.

- The LOAD operation begins.
- When the operation has been successfully completed, "COMPLETED!" is shown on the display.
- If you press the **START/STOP** button, playback of the loaded data begins.

■ COMPOSER LOAD

Load **COMPOSER** data only from a disk.

1. In the **COMPOSER** section, press and hold the **LOAD (MENU)** button for a few seconds.

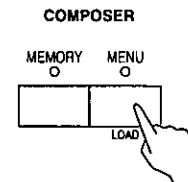

- The display looks similar to the following.



2. Select the name of the file you wish to load.

3. Press the LOAD button.

- Data is loaded to this instrument's **COMPOSER** memory (**MEMORY**).

Direct Play

You can enjoy immediate playback of “Standard MIDI File” (SMF) (FORMAT 0), “Disk Orchestra Collection” (DOC) and “PianoDisc” disks—all without loading the song data.

1. Insert the disk with the stored data into the Disk Drive.
2. On the DISK MENU display, select DIRECT PLAY.
 - The display looks similar to the following.

<Example: SMF>



3. Use the ▲ and ▼ buttons to select the song you wish to have played.
 - If the number of files is 10 or more, you can use the PREV and NEXT buttons to go back or advance 10 files at a time.
 - For SMF files, use the PLAY AS button to specify a sound arrangement mode (TECH/GM). If the playback data was saved in the GENERAL MIDI mode, select GM.
 - For SMF files, you can use the INFO button to switch the displayed data.

DISK: Disk name

SONG: Song name

- For SMF files, use the MIDI OUT button to specify whether or not MIDI data is output during playback (ON/OFF). (This cannot be changed during playback.)
3. Press the START button.
 - The selected song is played back.

■ The display during playback

<Example: SMF>



- During playback, the buttons below the display are used for player functions such as fast forward, pause, etc.
- During playback, if you press the MIXER button you can change the settings for each part.
- If the MIC button is pressed, the display changes to the setting display (ENTERTAINER) for when a microphone is connected to the MIC input terminal.
- For SMF disks:
 - For some disks, by pressing the LYRICS button, the lyrics are shown on the display.
 - For a "minus one" performance, use the CH \wedge and \vee buttons to select the channel you wish to mute. Then turn the MUTE ON/OFF button to ON. You can perform the part for the selected channel on the keyboard. Following this, you can also specify the performance part using the **CONDUCTOR** buttons.
- For DOC disks:
 - You can use the RT1 (RIGHT 1), RT2 (RIGHT 2) and ORCH (other accompaniment parts) buttons to set the respective parts to ON or OFF.
- For PIANO DISC playback:
 - You can use the RT1 (RIGHT 1) and ORCH (other accompaniment parts) buttons to set the respective parts to ON or OFF.

■ MEDLEY PLAY

With DIRECT PLAY, songs saved on a disk can be played back continuously in a medley.

1. On the DIRECT PLAY display, set the MEDLEY settings.
 - If ALL is pressed, all the files are selected, and the songs are played back in order in a medley. If ALL is pressed again, the files are deselected.
 - You can use the \blacktriangle and \blacktriangledown buttons to select a song to add to the song list, then press the ADD button to add it to the list. Repeat these steps to create your own list of songs to have played back. A M01, M02 etc. next to the file name indicates its order in the list.
 - If the number of files is 10 or more, you can use the PREV and NEXT buttons to go back or advance 10 files at a time.
 - You can delete a marked file from the medley song list by selecting it and pressing the ADD button.
 - Use the LOOP button to specify ON or OFF for repeat playback of the medley.
2. Press the START button.
 - Medley playback begins.
 - During medley playback, you can use the SKIP button to skip to the next song.

Song Medley

Songs saved from the **SEQUENCER** to a disk (disk data) in the **TECHNICS FORMAT** can be played back in a medley.

1. On the **DISK MENU** display, select **SONG MEDLEY** from the display.
 - The display looks similar to the following.



2. Select the order of files in the medley.
 - If **ALL** is pressed, all the files are selected, and the songs are played back in numerical in a medley.
 - You can select a file and song, then press the **ADD** button to add it to the song list. Repeat these steps to create your own list of songs to have played back. A M01, M02 etc. next to the file name indicates its order in the list.
 - If the number of files is 10 or more, you can use the **PREV** and **NEXT** buttons to go back or advance 10 files at a time.
 - You can delete a marked file from the medley song list by selecting it and pressing the **ADD** button.
 - Use the **LOOP** button to specify **ON** or **OFF** for repeat playback of the medley.
 - You can use the **MODE** button to select the medley mode.
 - 10 SNGS:
Songs 1 to 10 from each file are played in a medley.
 - 1 SONG:
Only song 1 from each file is played back in a medley.
3. Press the **START** button.
 - Medley playback begins.

- During the performance, the display changes to the playback display.
- During a medley performance, if you press the **MIXER** button you can change the settings for each part.
- During a medley performance, you can use the **SKIP** button to skip to the next song.

Saving data

The recorded data and panel settings of this instrument can be saved on a disk.

Floppy disks

You can use 3.5 inch 2DD (720KB) or 2HD (1.44MB) disks.

- How to distinguish the two disk types:

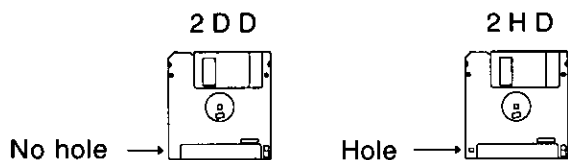

- Although 2HD disks can hold more data and are convenient for quick loading and saving, 2DD disks are generally used for musical instruments. Therefore, you may not be able to use your 2HD disk data with other musical instrument models. However, because of the large amount of BACKUP data, a 2HD disk is required when this instrument's BACKUP data is saved.

- When saving data to the disk, the write-protect window must be closed.

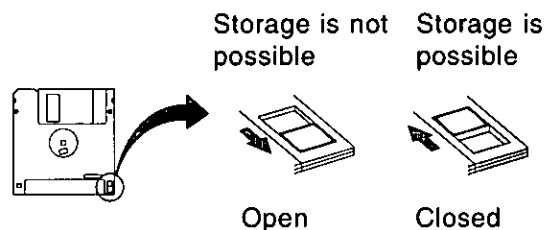

■ FORMAT

Floppy disks which are used for the first time with this instrument have to be formatted through the following procedure. When an unformatted disk is inserted into the Disk Drive slot and you attempt to execute the save or load procedure, the FLOPPY DISK FORMAT display appears. Follow the instructions shown to format the disk.

- Note that this procedure clears any data which is currently stored on the disk.

1. Select the type of format (2DD or 2HD).
 - Be sure to select the type which is the same as your disk type.
 - The display looks similar to the following.



2. Press the YES button to format the disk, or press the NO button to cancel the format.
 - When the YES button is pressed, disk format begins. After about 1–2 minutes, formatting is completed and DISK NAMING display is shown.

3. Assign a name to the disk.
 - Use the POSITION buttons to highlight the character position in the name box. Use the ABC...123 buttons to select the alphanumeric character. Repeat these steps to type the whole name.
 - Use the INS button to type a space.
 - Use the DEL button to erase a character.
 - To erase all the characters, press the CLR button.
 - You can press the →← button if you wish to have the name centered.

4. Press the OK button.

- The FORMAT display can also be accessed from the DISK TOOLS menu when, for example, you wish to reformat a disk. (Refer to page 125.)

SAVE

1. Insert a formatted disk into the Disk Drive slot. Push it all the way in until you hear a click.
 - A disk which is used with this instrument for the first time must first be formatted.
2. On the DISK MENU display, select SAVE.
 - The display looks similar to the following.

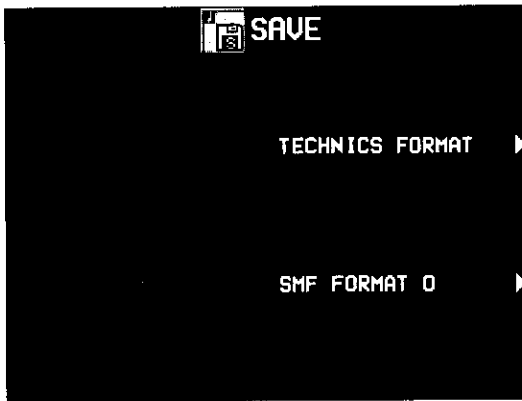

3. Select the type of data save you want.

TECHNICS FORMAT:

Save this instrument's data in the Technics File format.

SMF FORMAT 0:

Save the **SEQUENCER** data in the "Standard MIDI File" format (FORMAT 0).

■ TECHNICS FORMAT

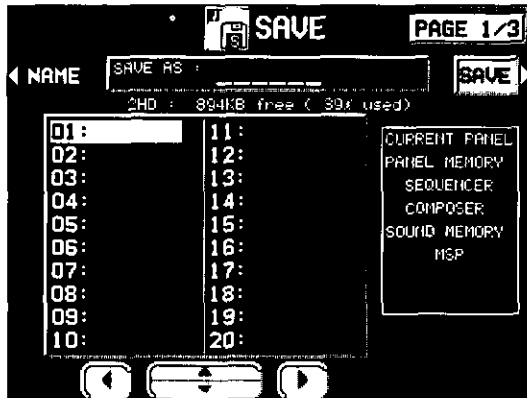

- Use the buttons below the display to specify the file number you wish to save to.
 - The types of data that can be saved are shown in a frame on the right side of the display. If you press the SAVE button, all the indicated data is saved. Ordinarily PERFORMANCE data is selected, but you can use the SAVE OPTION to select specific data to save.
- If you wish to assign a name to the file, press the NAME button.
 - The display looks similar to the following.



- Assign a name to the file.
 - Use the POSITION buttons to highlight the character position in the name box. Use the ABC...123 buttons to select the alphanumeric character. Repeat these steps to type the whole name.
 - Use the INS button to type a space.
 - Use the DEL button to erase a character.
 - To erase all the characters, press the CLR button.
 - You can press the →← button if you wish to have the name centered.
- Press the OK button.
 - The display returns to the SAVE display.

- Press the SAVE button.
 - The SAVE operation begins.
 - If you attempt to save data to a file number in which data is currently saved, the display changes to the confirmation display. Press the YES button to continue the SAVE procedure, or press the NO button if you wish to cancel it.

<SAVE OPTION>

Specify the kind of data you wish to save to the disk. To maximize effective use of disk memory or to minimize the save time, select only the type of data you wish to save.

1. Use the **PAGE** buttons to access the 2/3 SAVE OPTION display.
 - The display looks similar to the following.

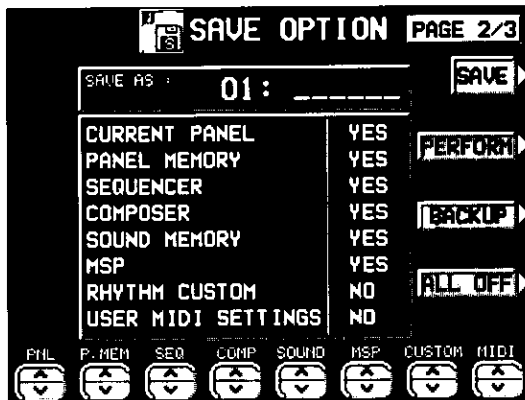

2. Use the buttons below the display to specify the types of data you wish to save (YES/NO).
 - For PANEL MEMORY, select from YES/NO/1 BANK. If you save data with 1 BANK selected, only the contents of BANK 1 are saved and when loading data, only the BANK 1 data is overwritten; the other banks are not affected.
 - Press the PERFORM button to select all the performance data (that is, all data except RHYTHM CUSTOM, USER MIDI SETTINGS), or press the BACKUP button to select all the data at once.
 - If the ALL OFF button is pressed, all the settings change to NO.
3. Press the SAVE button.
 - The SAVE operation begins.
 - If RHYTHM CUSTOM was selected, the save operation will take about one minute.

<SEQUENCER SONG SAVE>

You can specify a single song in the **SEQUENCER** to save to the disk.

1. Use the **PAGE** buttons to access the 3/3 SEQUENCER SONG SAVE display.
 - The display looks similar to the following.

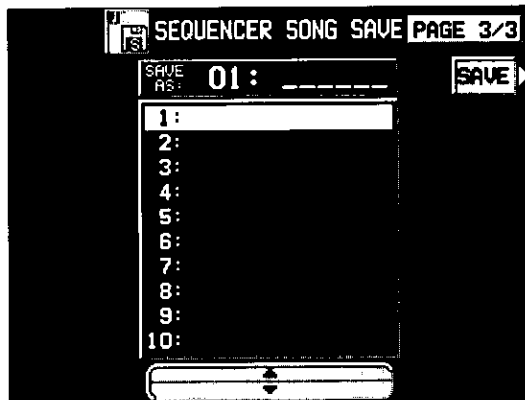

2. Use the ▲ and ▼ buttons to select the song number you wish to save.
3. Press the SAVE button.
 - The SAVE operation begins.

■ SMF FORMAT 0

This instrument's **SEQUENCER** data can be saved in the "Standard MIDI File" format (FORMAT 0) for use on other instruments.

- What you can save in the SMF format (FORMAT 0) is ordinary performance data, such as note data. Data such as chord and rhythm data, **COMPOSER** data, **PANEL MEMORY** data, etc. is not saved. If you wish to also save this special Technics data, save the data in the Technics File format.

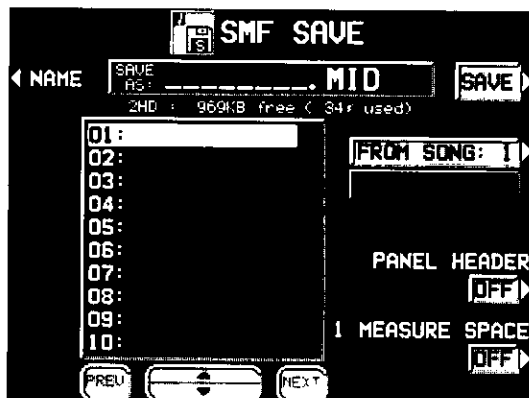

1. Use the ▲ and ▼ buttons to select the song number you wish to save to.
 - If the number of files is 10 or more, you can use the PREV and NEXT buttons to go back or advance 10 files at a time.
2. If you wish to assign a name to the file, press the NAME button.
 - The display looks similar to the following.



3. Assign a name to the file.
 - Use the POSITION buttons to highlight the character position in the name box. Use the ABC...123 buttons to select the alphanumeric character. Repeat these steps to type the whole name.
 - Use the INS button to type a space.
 - Use the DEL button to erase a character.
 - To erase all the characters, press the CLR button.
 - You can press the →← button if you wish to have the name centered.
4. Press the OK button.
 - The display returns to the SAVE display.
5. Use the FROM SONG buttons to select the **SEQUENCER** song number you wish to save.
 - The song name to save from is shown below the FROM SONG button.
6. Use the PANEL HEADER buttons to specify ON or OFF.

ON:

The sound and volume settings for each part are saved as data at the beginning of the file.

OFF:

This data is not saved.

7. Use the 1 MEASURE SPACE buttons to select ON or OFF.

ON:

A one-measure space is added to the beginning of the file.

OFF:

No space is added.

- When there is various data other than performance data stored at the beginning of a file, the start of playback may be delayed. This can be avoided by set the 1 MEASURE SPACE to ON to inserting a before the beginning of the performance.
- When set to ON, a space is added each time a file is saved. Therefore, if you have already saved a file once with the 1 MEASURE SPACE set to ON, please set it to OFF each time the file is subsequently saved.

8. Press the SAVE button.

- The SAVE operation begins.
- When the operation has been successfully completed, "COMPLETED!" is shown on the display.
- If you attempt to save data to a file number in which data is currently saved, the display changes to the confirmation display. Press the YES button to continue the SAVE procedure, or press the NO button if you wish to cancel it.

Disk management

Various disk management procedures, such as file erase, file copy, and disk format, are available from the DISK TOOLS menu.

DISK TOOLS

1. Insert the disk into the Disk Drive slot.
2. On the DISK MENU display, select DISK TOOLS from the display.
 - The display looks similar to the following.



3. Select a function and follow the procedure to execute it.
 - Use the buttons below the display to select a file.
 - Use the buttons to the left and right of the display to access the corresponding setting display.
 - You can press the SMF/TECH button to change to the display for procedures related to TECH/SMF files.

RENAME:

Assign a name to a file.

DEL:

Delete a file.

FORMAT:

Reformat the disk.

COPY:

Copy a file.

MOVE:

Replace a file.

INFO (DISK/SONG) (SMF files only):

Select whether to display the disk data or the song names.

Set the automatic display when a disk is inserted

When a disk is inserted in the Disk Drive, the display automatically changes to a disk-procedure display. Follow this procedure to customize the automatic display.

PREFERENCES

1. On the DISK MENU display, select PREFERENCES.
 - The display looks similar to the following.



2. Use the buttons to the left of the display to select the item, and the \wedge and \vee buttons to change the setting.

DISK INSERT OPTION:

The display automatically changes to a disk-procedure display when a disk is inserted in the Disk Drive (OFF, DISK MENU, LOAD, DIRECT PLAY, SONG MEDLEY).

- During playback, recording or changing the settings, the displays unrelated to the settings made here do not change.

FILE TYPE PRIORITY:

Specify the desired priority ranking of displayed files when Technics files and SMF files are both recorded on the one disk (TECHNICS/SMF).

3. Press the OK button.

Part VII Sound

Outline of the Sound

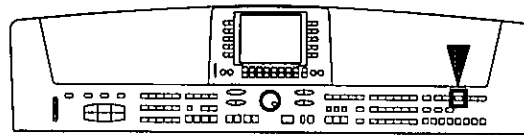

The **SOUND** mode is used for making fine adjustments to the functions related to sound, such as tone, effects and tuning.

1. Press the **SOUND** button to turn it on.

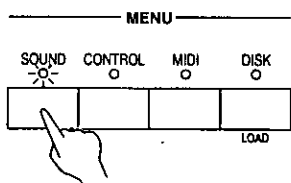

- The display looks similar to the following.
- The **SOUND MENU** display consists of two screen pages. Use the **PAGE** buttons to switch the screen page, as desired.

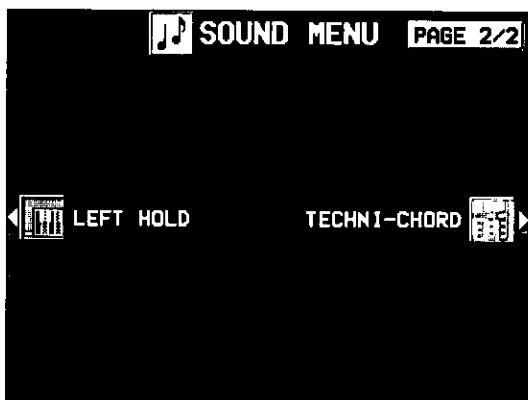
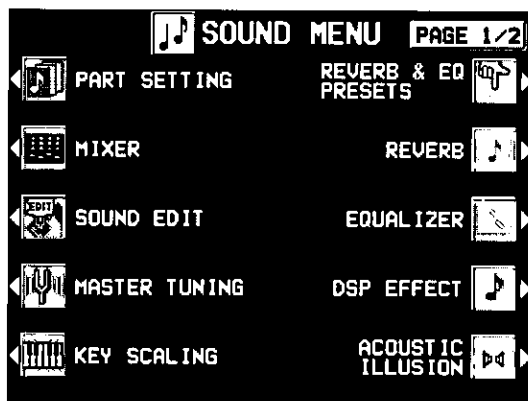

2. Select the desired menu.
3. Follow the procedures on the corresponding menu display.
 - When the **TEMPO/PROGRAM** indicator is lit, it indicates that the dial is available for setting the current function.

Summary of the **SOUND** menu items

- PART SETTING** (page 129)
Set the various sound attributes for each part.
- MIXER** (page 133)
Use the **MIXER** display to visually adjust the major settings of each part.
- SOUND EDIT:**
Edit and create new sounds. (Refer to Part VIII: Sound Edit, page 139.)
- MASTER TUNING** (page 134)
Select the type of tuning for the instrument.
- KEY SCALING** (page 135)
Select the type of scaling (tuning).
- REVERB & EQ PRESETS** (page 136)
Select the reverb and equalizer preset values.
- REVERB**
Select the type of **DIGITAL REVERB** effect and how it is applied. (Refer to page 40.)
- EQUALIZER** (page 137)
Adjust the equalizer.
- DSP EFFECT**
Select the type of **DSP EFFECT** and how it is applied. (Refer to page 40.)
- ACOUSTIC ILLUSION**
Specify the type of **ACOUSTIC ILLUSION** effect and how it is applied. (Refer to page 41.)
- LEFT HOLD** (page 138)
Set the mode which determines how the **LEFT** part sounds during an **AUTO PLAY CHORD** performance.
- TECHNI-CHORD**
Select the **TECHNI-CHORD** harmony style. (Refer to page 43.)

4. When you have finished setting the functions, press the **SOUND** button to turn it off.

■ A word about parts

The organization of the sound parts is as follows.

Normal parts (16 parts):

- RIGHT 1 (PART 1), RIGHT 2 (PART 2), LEFT (PART 3), PART 4 to 16
- PART 16 is reserved for the DRUMS part.

AUTO PLAY CHORD (automatic accompaniment) parts:

ACCOMP 1, 2, 3, BASS, DRUMS, CHORD, R.BASS.

MANUAL SEQUENCE PADS part:

MSP

Part Setting

Set the various sound attributes for each part.

Selecting an attribute

1. On the SOUND MENU display, select PART SETTING.
- The display looks similar to the following.



2. Use the ^ and v buttons to select the part.
 - PART 4 to 16 are used in **SEQUENCER** and **MIDI** functions. PART 16 is reserved for the **DRUMS** part.
 - For information concerning **CHORD** and **R.BASS**, refer to the section on the **AUTO PLAY CHORD** (page 55).
 - If necessary, assign a sound to the selected part at this time. (Only sounds from the **DRUM KITS** group can be selected for PART 16.)
 - The upper portion of the display shows the name of the selected part and the sound assigned to that part. The box in the lower portion of the display shows the status of each attribute for the selected part.

3. Use the buttons along the bottom of the display to select the attribute you wish to adjust.

VOL: VOLUME
 PAN: PAN
 EFF: EFFECT
 SUS: SUSTAIN
 KEY: KEY SHIFT
 TUN: TUNING
 BND: PITCH BEND RANGE
 OTH: OTHER SETTING

- The display changes to the setting display for the selected attribute.
 - The settings which can be adjusted may differ depending on the selected part.
4. Adjust each attribute (explained in detail following).
 - When you have completed adjustment of an attribute, use the buttons along the bottom of the display to select the next attribute you wish to adjust.
 5. When you have completed adjusting all of the settings for one part, select another part and repeat the adjustment procedure as desired.
 - The settings and effects of the PAN, EFFECT etc. may differ depending on the sound.

VOLUME

Adjust the volume of each part.



Use the VOL \wedge and \vee buttons to adjust the volume (0 to 127).

- If you wish to adjust this effect for other parts, use the PART SELECT \wedge and \vee buttons to select another part.

PAN

Adjust the stereo balance of each part.



Use the PAN \wedge and \vee buttons to adjust the stereo balance (L64–CTR–R63).

- At L64, the sound is completely to the left, at R63 completely to the right. At CTR, the sound is at the center. The display indicates the selected position.
- If you wish to adjust this effect for other parts, use the PART SELECT \wedge and \vee buttons to select another part.
- Even at the same numerical value, the stereo balance may differ slightly depending on the sound.

EFFECT

The **DIGITAL REVERB** depth, the **DSP EFFECT** depth, and the **DIGITAL EFFECT** on/off status can be set for each part.



1. Select an effect (REVERB DEPTH, DSP EFFECT or DIGITAL EFF).

2. Use the EFF \wedge and \vee buttons to change the setting.

- For the REVERB DEPTH and DSP EFFECT, specify the depth (0 to 127). For the DIGITAL EFF, set to ON or OFF.

3. Repeat steps 1 and 2 for the other effects, as necessary.

- If you wish to adjust this effect for other parts, use the PART SELECT \wedge and \vee buttons to select another part.
- Even at the same numerical value, the effect may differ depending on the sound.

SUSTAIN

Turn the sustain on or off for each part, and specify the length of the sustain.

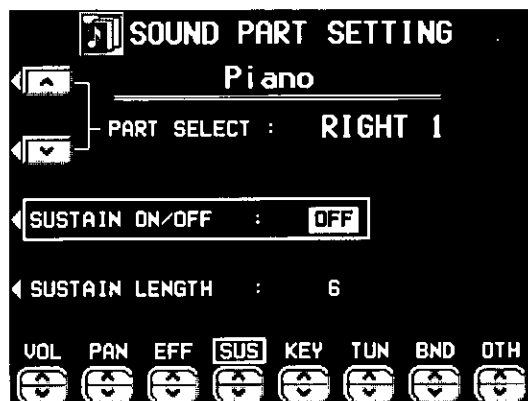

■ Sustain on/off

1. Select SUSTAIN ON/OFF.

2. Use the SUS \wedge and \vee buttons to set the sustain to on or off.

■ Sustain length

1. Select SUSTAIN LENGTH.

2. Use the SUS \wedge and \vee buttons to adjust the length of the sustain (1 to 8).

- For some sounds, the length of the sustain does not change even if the number is changed.

- If you wish to adjust this effect for other parts, use the PART SELECT \wedge and \vee buttons to select another part.

KEY SHIFT

The pitch of the part can be shifted up or down.

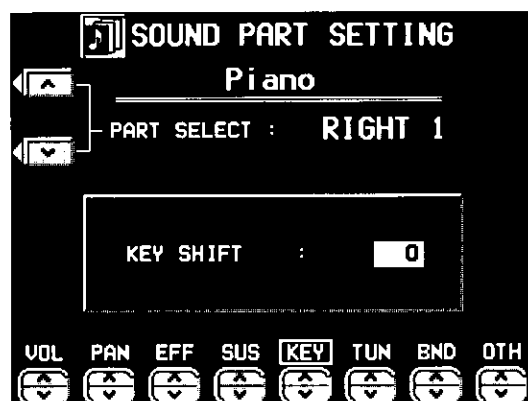

Use the KEY \wedge and \vee buttons to specify the amount of key shift (-12 to +12).

- A value of 1 means a shift of one semi-tone. To raise (or lower) the pitch one octave, set the value to +12 (or -12).
- The \vee button is used to lower the pitch, and the \wedge button to raise the pitch.
- If you wish to adjust this effect for other parts, use the PART SELECT \wedge and \vee buttons to select another part.

TUNING

Fine-tune the pitch of each part.



Use the TUN \wedge and \vee buttons to adjust the tuning (-128 to +127).

- The \vee button is used to lower the pitch, and the \wedge button to raise the pitch.
- If you wish to adjust this effect for other parts, use the PART SELECT \wedge and \vee buttons to select another part.

PITCH BEND RANGE

Set the pitch range of the **PITCH BEND** wheel.

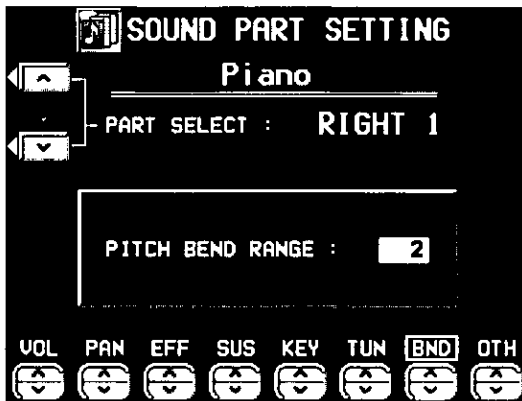

Use the **BND** \wedge and \vee buttons to specify the range (0 to 12). Increments are in semi-tones.

- The higher the number, the greater the change in pitch when the **PITCH BEND** wheel is operated.
- If you wish to adjust this effect for other parts, use the **PART SELECT** \wedge and \vee buttons to select another part.

OTHER SETTING

Modify the Foot Switch setting and other settings.

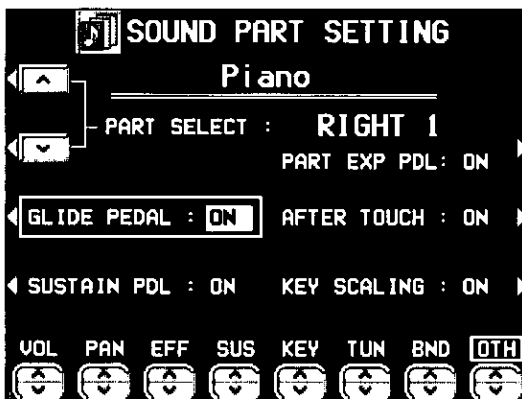

1. Select the function to adjust.

GLIDE PEDAL:

Enable or disable the glide effect, if it has been assigned to the Foot Switch (sold separately).

SUSTAIN PEDAL:

Enable or disable the sustain effect, if it has been assigned to the Foot Switch (sold separately).

PART EXP PEDAL:

Enable or disable part expression by the expression pedal (sold separately).

- To enable the ON/OFF setting for each part, it is necessary to set EXPRESS. PEDAL to PART EXPRESSION on the FOOT CONTROLLERS display. (Refer to page 162.)

AFTER TOUCH:

Enable or disable the aftertouch effect for the keyboard.

KEY SCALING:

Enable or disable key scaling (page 135).

2. Use the **OTH** \wedge and \vee buttons to select ON or OFF for each function.

- For Foot Switch settings, refer to page 161.
- To change the settings for other parts, use the **PART SELECT** \wedge and \vee buttons to select a different part.

Mixer

Use the MIXER display to visually adjust the major settings of each part. Use this display to make broad, general changes to the settings.

- On the SOUND MENU display, select MIXER.
 - The MIXER display consists of 3 pages. Use the **PAGE** buttons to switch among the pages.
 - Each time the **OTHER PARTS/TR** button is pressed, the part setting display changes in the following order: RIGHT (RT) 1 to PART (PT) 8 → PART (PT) 9 to PART 16 → Accompaniment and other parts.
- Adjust each parameter.

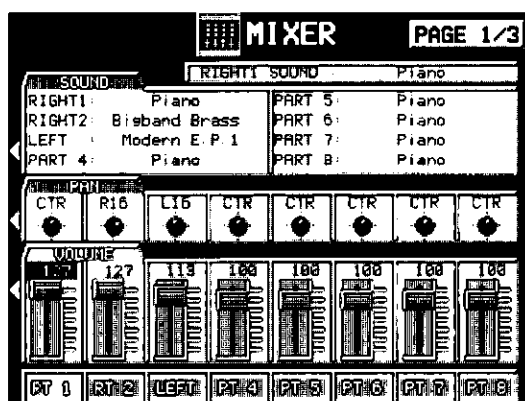

SOUND:

Select SOUND. Use the balance buttons below the display to set the sound for the corresponding part.

- The buttons in the **SOUND GROUP** can also be used to select the sound.

PAN:

Select PAN. Use the balance buttons below the display to adjust the stereo balance of the corresponding part (L64–CTR–R63).

VOLUME:

Select VOL. Use the balance buttons below the display to adjust the volume of the corresponding part (0 to 127).

- To mute a part, press both the corresponding balance buttons at the same time. To cancel the mute, press either balance button for the part.

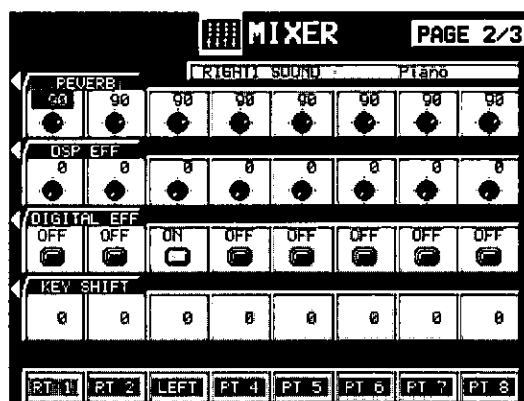

REVERB:

Select REVERB. Use the balance buttons below the display to set the level of the **DIGITAL REVERB** for the corresponding part (0 to 127).

DSP EFFECT:

Select DSP EFF. Use the balance buttons below the display to adjust the level of the **DSP EFFECT** for the corresponding part (0 to 127).

- In some cases, this setting may not be operative depending on the selected type of **DSP EFFECT**.

DIGITAL EFFECT:

Select DIGITAL EFF. Use the balance buttons below the display to set the **DIGITAL EFFECT** to ON or OFF for the corresponding part.

KEY SHIFT:

Select KEY SHIFT. Use the balance buttons below the display to adjust the shift width of the output pitch of each part (in semitone increments; -12 to +12).

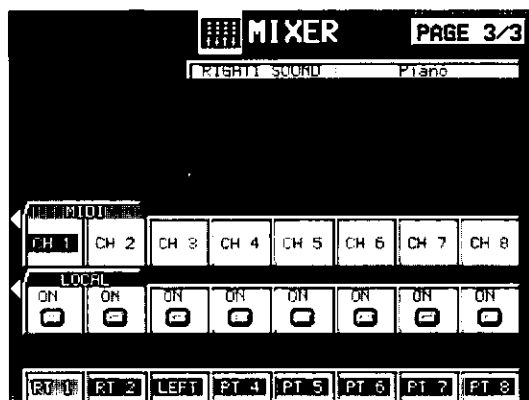
**MIDI:**

Select MIDI. Use the balance buttons below the display to set the MIDI channel for each part (CH1–CH16).

- Information about MIDI channels can be found on page 165.

LOCAL:

Select LOCAL. Use the balance buttons below the display to turn LOCAL CONTROL ON or OFF for each part.

- Even at the same numerical value, the PAN and effects may differ depending on the sound.
- For some parts, such as the automatic accompaniment parts, the items that can be adjusted are limited.

Master Tuning

This setting is used to fine-tune the pitch of the entire instrument. This is convenient when the Keyboard is played with other instruments or with a recorded performance.

1. On the SOUND MENU display, select MASTER TUNING.
 - The display changes to the following.
2. Use the \wedge and \vee buttons to adjust the pitch within a range of 427.3 to 453.0 Hz.
 - The decimal can be set to 0, 3 or 6.



Key Scaling

The type of tuning for this instrument can be changed. In addition to standard (equal temperament) tuning, other types of scaling are available.

1. On the SOUND MENU display, select KEY SCALING.
 - The display looks similar to the following.

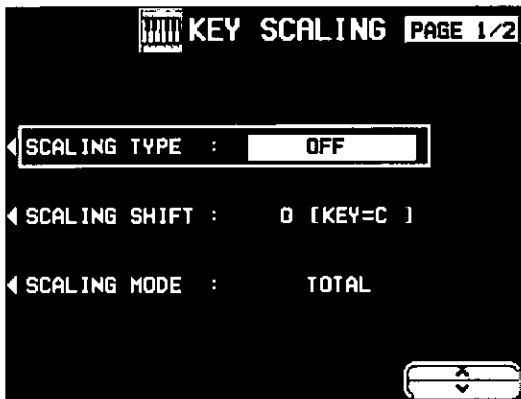

2. Use the buttons to the left of the display to select the function you wish to adjust.
 - You can use the SOUND EDIT feature to adjust the KEY SCALING for each sound. (Refer to page 144.)

SCALING TYPE

Select the type of scaling (tuning) from OFF, RANDOM, PIANO, ORCHESTRA, PYTHAGOREAN, WERCKMEISTER, KIRNBERGER, ARABIC 1 to 5, SLENDRO, PELOG, USER.

- Select OFF for the normal scaling. Select USER if you wish to use a customized scaling (see below).

SCALING SHIFT

Select the key on which the tuning will be based.

- Set to the key in which you are going to perform.

SCALING MODE (TOTAL/SOUND)

TOTAL: The selected KEY SCALING is active for all parts.

SOUND: The KEY SCALING defined for each sound is active.

3. Use the \wedge and \vee buttons to change the setting.

■ User type scaling

You can adjust the instrument to a customized scaling.

- In KEY SCALING, the pitch of each note of the octave is slightly shifted up or down from the standard (equal temperament) tuning.

1. Select USER for SCALING TYPE.
2. Select TOTAL for SCALING MODE.
3. Use the **PAGE** buttons to access the 2/2 USER KEY SCALING display.
 - The display looks similar to the following.

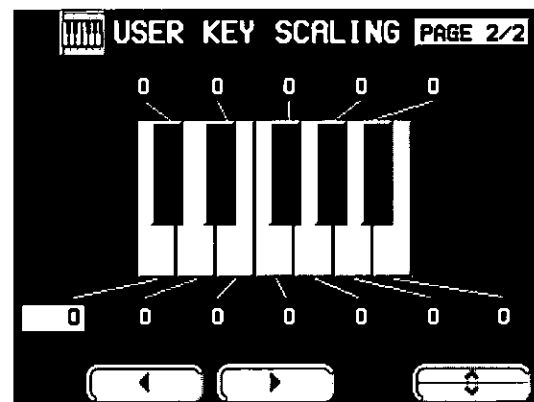

4. Adjust the scaling.
 - Use the \blacktriangleleft and \blacktriangleright buttons to select a keyboard key; use the \wedge and \vee buttons to adjust the pitch for the selected key. Repeat these steps for each keyboard key, as desired.
 - Increments are in cents (one hundredth of an equal-tempered semitone). A + value raises the pitch and a - value lowers the pitch in relation to standard (equal temperament) tuning.

Reverb & Equalizer Presets

You can select preset **DIGITAL REVERB** and equalizer settings for this instrument. This convenient feature gives you exactly the sound you want without going through complicated procedures.

1. On the **SOUND MENU** display, select **REVERB & EQ PRESETS**.
 - The display looks similar to the following.

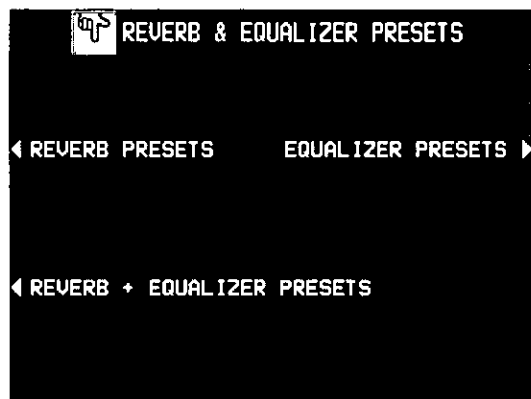

2. Select a preset type.

REVERB PRESETS:

Presets for the **DIGITAL REVERB**.

EQUALIZER PRESETS:

Presets for the equalizer.

REVERB + EQUALIZER PRESETS:

Presets used for both the **DIGITAL REVERB** and the equalizer.

3. Select the desired preset settings.
 - The display looks similar to the following.



- For the **EQUALIZER PRESETS** and the **REVERB + EQUALIZER PRESETS**, the **EQ** button can be used to turn the equalizer function on or off.

Equalizer

You can apply a 4-band equalizer to the final output of this instrument.

- The equalizer is applied to both the L and R outputs.

1. On the SOUND MENU display, select EQUALIZER.

- The display looks similar to the following.

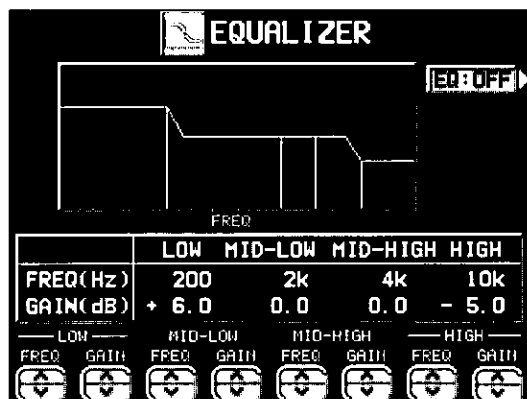

2. Use the buttons below the display to select the sound quality for the four sound ranges (LOW, MID-LOW, MID-HIGH, HIGH).

- Use the FREQ \wedge and \vee buttons to adjust the standard frequency (Hz), and the GAIN \wedge and \vee buttons to adjust the level gain (decibels).
- The EQ button can be used to turn the equalizer on or off.
- Depending on the selected sound, if you set very high GAIN setting, the sound may be distorted. In this case, lower the GAIN setting, or lower the **MAIN VOLUME** setting.

Left Hold

Select the mode to specify how the left section of the keyboard sounds during an **AUTO PLAY CHORD** performance.

- On the SOUND MENU display, select LEFT HOLD.
 - The display changes to the following.



- Use the ON and OFF buttons to set the mode to on or off.

■ OFF

	ONE FINGER	FINGERED	PIANIST
When rhythm is off	The chord note specified by the pressed key is heard (CHORD part).	The LEFT part sound and chord note specified by the pressed keys are heard.	The LEFT part notes and the chord note are not heard (the RIGHT part sound is heard for the entire keyboard).
When rhythm is on	The LEFT part notes and the chord note are not heard.	The LEFT part sound of the pressed keys is heard.	

- The **LEFT** part can be heard only when the **LEFT** button in the **CONDUCTOR** section is on.
- When you select the ONE FINGER mode, the **LEFT** button in the **CONDUCTOR** section turns off automatically.

■ ON

	ONE FINGER	FINGERED	PIANIST
When rhythm is on/off	The specified chord note is produced in the LEFT part sound.	The LEFT part sound of the pressed keys is heard.	The LEFT part notes and the chord note are not heard (the RIGHT part sound is heard for the entire keyboard).

- The **LEFT** part can be heard only when the **LEFT** button in the **CONDUCTOR** section is on.
- When the MEMORY button is on, even when the keys are released, the **LEFT** part sound continues to play.

Part VIII Sound Edit

Outline of the Sound Edit

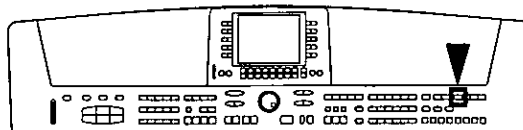

SOUND EDIT enables you to create your own new sound by altering one of the this instrument's preset sounds. Your new sound can be stored in one of the sound memory locations. SOUND EDIT has two methods of use. You can edit in detail using functions more commonly associated with a synthesizer, or you can use EASY EDIT which allows you to change some basic parameters on one page.

1. Select a sound to edit.
 - To edit **DRUM KITS** sound, refer to page 156.
 - To reserve the **DIGITAL DRAWBAR** settings, refer to page 158.
2. Turn on the **SOUND** button.

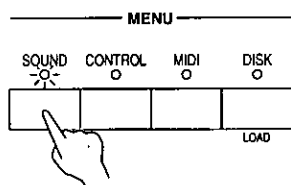

- The display looks similar to the following.



3. Select SOUND EDIT.
 - The display looks similar to the following.

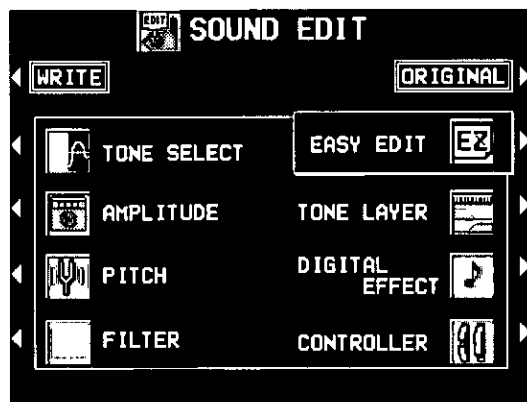

- SOUND EDIT does not function when GENERAL MIDI is set to ON.

Summary of the SOUND EDIT menu items

EASY EDIT (page 140)

The most often used edit functions—such as brightness and attack speed—are assembled on one display for easy sound modification.

TONE SELECT (page 141)

Modify the tones which make up the sound.

TONE LAYER (page 143)

Specify how the tones are assigned to the keyboard keys.

PITCH (page 144)

Adjust the settings related to the pitch of the sound.

FILTER (page 147)

Adjust the amount of frequency cut in specific frequency ranges.

AMPLITUDE (page 150)

Volume settings, such as the sound envelope.

DIGITAL EFFECT (page 153)

Select the type and degree of effects applied to the sound.

CONTROLLER (page 154)

Specify how wheel operation etc. affects the sound.

4. Select the desired menu and follow the procedures on the corresponding setting display.
 - To check the sound of a single tone, press the SOLO button to highlight the SOLO indication. Only the currently selected tone sounds when a key is played.
 - When the **TEMPO/PROGRAM** indicator is lit, it indicates that the dial is available for setting the current function.
 - The sounds created with the SOUND EDIT are also affected by the settings adjusted in the other **SOUND** menus (refer to "Part VII: Sound").

(Continued on the next page)

5. When the sound is just the way you like it, press the **EXIT** button to return to the menu display, and press the **WRITE** button to store your new sound.
- Press the **EDITED** (or **ORIGINAL**) button to switch between the modified sound (**EDITED**) and the original sound (**ORIGINAL**). This allows you to compare the edited sound to the original sound as you are modifying it.

Easy Edit

The most commonly used edit functions are consolidated on one display, providing convenient and quick editing operation.

1. On the **SOUND EDIT** menu display, select **EASY EDIT**.
- The display changes to the following.



2. Select a sound attribute to modify.
3. Use the **VALUE** \wedge and \vee buttons to specify the value of the attribute.
 - Selecting the type of **DIGITAL EFFECT** is explained in the section on **EFFECT EDIT** (page 153).
 - An effect may remain unchanged when **EASY EDIT** is used to set the value, if another **EDIT** function was first used to set the value to its upper or lower limit.
4. Repeat steps 2 and 3 to modify other sound attributes as desired.

5. Press the **WRITE** button to store your new sound.
 - Storing your new sound is explained on page 155.
 - If a sound is stored in the **EASY EDIT** mode, and is later selected in the **EASY EDIT** mode, the displayed value of an attribute may be different from the value when it was stored. The sound itself, however, is exactly as it was stored.

Easy Edit Items

- BRILLIANCE:**
Adjust the brightness of the sound (-10 to +10).
- VIBRATO DEPTH:**
Set vibrato depth (OFF, -10 to +10).
- VIBRATO SPEED:**
Set vibrato speed (-10 to +10).
- VIBRATO DELAY:**
Set time delay between key played and vibrato start (-10 to +10).
- OCTAVE SHIFT:**
Shift the octave range (-2 to +2).
- ATTACK TIME:**
Adjust attack time (-10 to +10).
- RELEASE TIME:**
Adjust time of sound fade-out after key is released (-10 to +10).
- DIGITAL EFFECT:**
Select type of effect.

Tone Edit

Modify the separate tones which comprise the sound.

About tones

A sound may be made up of at most four tones.

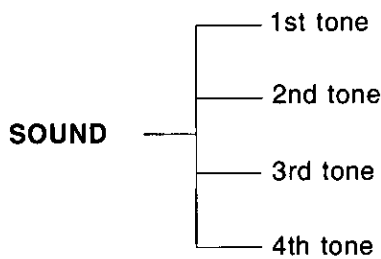

TONE SELECT

- On the SOUND EDIT menu, select TONE SELECT.
- The display looks similar to the following.

	TONE SELECT	LEVEL	KEY	DETUNE
⊙	1ST F: German Accdn 2	90	-12	- 3
⊙	2ND F: German Accdn 3	88	0	+ 5
○	3rd A: Piano (Mono)	90	0	0
○	4th A: Piano (Mono)	90	0	0

ON/OFF GROUP TONE LEVEL KEY DETUNE

- Use the buttons to the left of the display to select the tone you wish to edit (1st, 2nd, 3rd, 4th).
- Use the ON/OFF \wedge and \vee buttons to select ON or OFF.
 - ⊙ indicates that the tone is on, and ○ indicates that it is off.
 - Tones which are set to OFF are not produced.
- Select a sound for the tone.
 - Use the GROUP \wedge and \vee buttons to select the group, and the TONE \wedge and \vee buttons to select the sound.
 - A list of tone sounds can be found in the separate "REFERENCE GUIDE" provided.
- Use the LEVEL \wedge and \vee buttons to adjust the volume (0 to 127).
- Use the KEY \wedge and \vee buttons to set the output pitch (-24 to +24).
 - Increments are in semitones.
- Use the DETUNE \wedge and \vee buttons to make fine adjustments to the pitch (-50 to +50).
- Repeat steps 2 to 7 for the other tones, as desired.

■ TONE WAVEFORM

One tone may consist of up to four TONE WAVEFORMS. You can adjust the settings so that a different sound (tone waveform) is output for each tone depending on the velocity (how hard the keys are played).

1. Use the **PAGE** buttons to view the 2/3 display.
 - The display looks similar to the following.

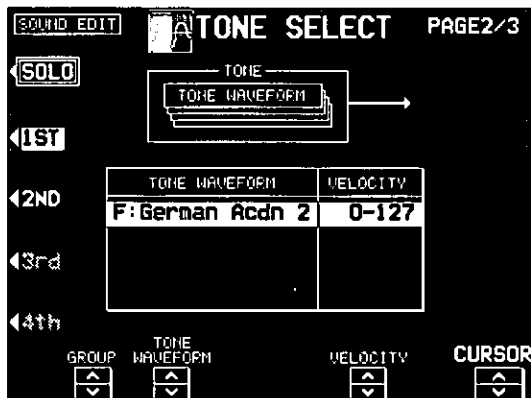

2. Use the buttons to the left of the display to select a tone.
3. Use the **CURSOR** \wedge and \vee buttons to select the column for the function you wish to adjust.

■ Other settings

1. Use the **PAGE** buttons to view the 3/3 display.
 - The display looks similar to the following.

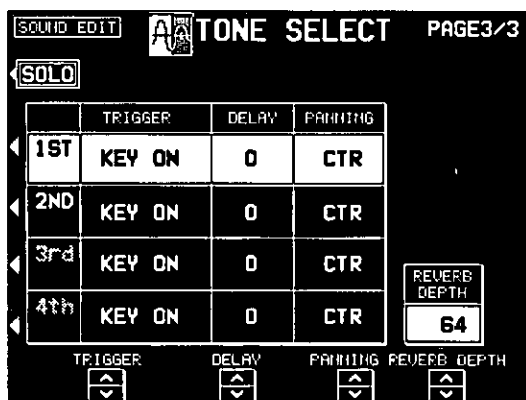

2. Use the buttons to the left of the display to select a tone.
3. Use the **TRIGGER** \wedge and \vee buttons to select a trigger mode.

KEY ON:

The normal mode, in which sound is emitted when the key is played.

4. Select the tone waveform.
 - Use the **GROUP** \wedge and \vee buttons to select the sound group. Use the **TONE WAVEFORM** \wedge and \vee buttons to select the waveform.
 - A TONE list can be found in the separate **REFERENCE GUIDE** provided.
5. Use the **VELOCITY** \wedge and \vee buttons to specify the velocity range.
 - When the upper limit of a waveform is set to 127, no more waveforms can be added.
6. Repeat steps 3 to 5 to edit the other waveforms, as desired.
 - Up to four waveforms can be set, with a different sound for each velocity range.
7. Repeat steps 2 to 6 for the other tones, as desired.

KEY OFF:

Sound is emitted when the key is released (like plucked strings, for example).

CHORD:

The sound is emphasized when chords are played (like the cutting sound of a guitar, for example).

4. Use the **DELAY** \wedge and \vee buttons to adjust the delay time of the sound (0 to 50).
 - The higher the number, the longer the delay before sound output.
5. Use the **PANNING** \wedge and \vee buttons to adjust the stereo balance (L64–CTR–R63).
 - CTR is the center point. At L64, the sound is all the way to the left, at R63 all the way to the right.
6. Use the **REVERB DEPTH** \wedge and \vee buttons to adjust the depth of the reverb (0 to 127).
7. Repeat steps 2 to 6 for the other tones, as desired.

TONE LAYER

On the SOUND EDIT menu display, select TONE LAYER.

■ KEY LAYER

Adjust the relation of tone output to keyboard location.

1. Press the KEY LAYER button.
 - The display looks similar to the following.

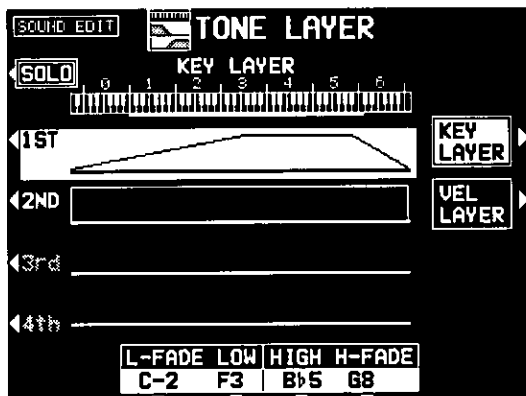

2. Use the buttons to the left of the display to select a tone (1st, 2nd, 3rd or 4th).
3. Use the L-FADE \wedge and \vee buttons and the LOW \wedge and \vee buttons to define the curve for the lower range of tone output.
 - By entering different values for the L-FADE and LOW setting, you can define a sloping volume increase to the peak output volume which corresponds to the note pitch.
4. Use the HIGH \wedge and \vee buttons and the H-FADE \wedge and \vee buttons to define the curve for the higher range of tone output.
 - By entering different values for the H-FADE and HIGH settings, you can define a sloping volume decrease from the peak output which corresponds to the note pitch.
 - By overlapping the L-FADE and H-FADE curves of each different tone, you can achieve a cross-fade effect, where the sound gradually changes in relation to pitch.
5. Repeat steps 2 to 4 for the other tones, as desired.

■ VELOCITY LAYER

Adjust these settings to regulate the tone output relative to the velocity.

1. Press the VEL LAYER button.
 - The display looks similar to the following.

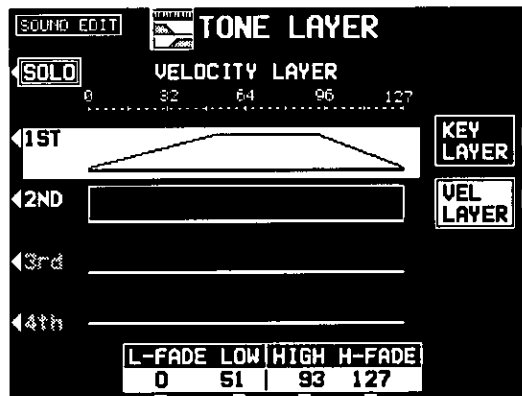

2. Use the buttons to the left of the display to select a tone (1st, 2nd, 3rd or 4th).
3. Use the L-FADE \wedge and \vee buttons and the LOW \wedge and \vee buttons to define the velocity curve for the lower range.
4. Use the HIGH \wedge and \vee buttons and the H-FADE \wedge and \vee buttons to define the velocity curve for the higher range.
 - By overlapping the L-FADE and H-FADE curves of each different tone, you can change the way the tone sounds relative to how hard or softly the keyboard is played.
5. Repeat steps 2 to 4 for the other tones, as desired.

Pitch Edit

Adjust the settings related to the pitch of the sound.

PITCH

- On the SOUND EDIT menu display, select PITCH.
 - The display looks similar to the following.

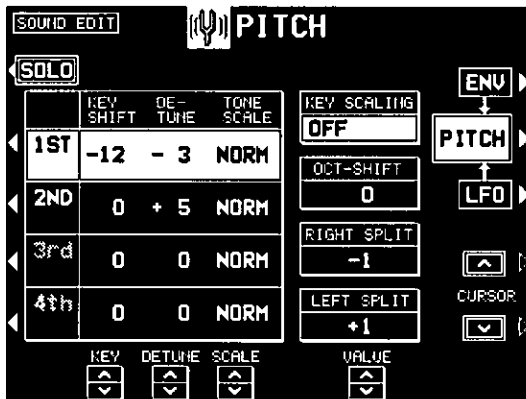

- Use the buttons to the left of the display to select a tone (1st, 2nd, 3rd or 4th).
- Use the KEY \wedge and \vee buttons to specify the output pitch (-24 to +24).
 - Units are in semitones.
- Use the DETUNE \wedge and \vee buttons to fine-adjust the pitch (-50 to +50).
 - Slight differences in the DETUNE values between the tones add fullness to the sound.
- Use the SCALE \wedge and \vee buttons to select the type of scale (NORM, 1/2, 1/4, 1/8, 1/16, 1/32, 1/64, FIX).
 - NORM is the normal scale type. For example, when 1/2 is selected, a difference in pitch between one key and the adjacent key becomes half the normal pitch difference. When FIX is selected, the pitch is the same regardless of which key is played.
- Select the type of scaling (tuning).
 - Use the CURSOR \wedge and \vee buttons to select KEY SCALING. Use the VALUE \wedge and \vee buttons to change the setting.
 - Key scaling is explained on page 135.
- Set the octave of the sound.
 - Use the CURSOR \wedge and \vee buttons to select OCT-SHIFT. Use the VALUE \wedge and \vee buttons to change the setting (-2 to +2).

- Set the octave of the right part when the keyboard is split.
 - Use the CURSOR \wedge and \vee buttons to select RIGHT SPLIT. Use the VALUE \wedge and \vee buttons to change the setting (-2 to +2).
- Set the octave of the left part when the keyboard is split.
 - Use the CURSOR \wedge and \vee buttons to select LEFT SPLIT. Use the VALUE \wedge and \vee buttons to change the setting (-2 to +2).
- Repeat steps 2 to 9 for the other tones, as desired.

■ ENVELOPE

Specify how the pitch changes over time, from the time the key is played to the time the sound dies out.

1. Press the ENV button.
- The display looks similar to the following.

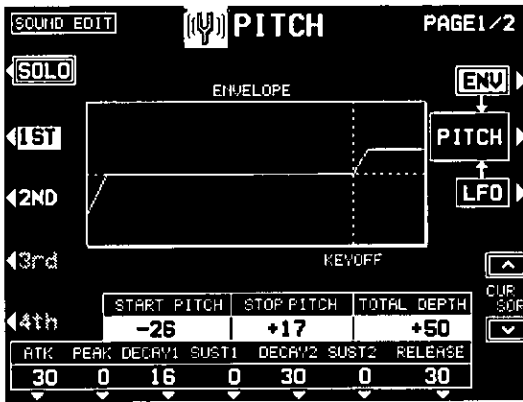

2. Use the buttons to the left of the display to select a tone.
3. Adjust the settings for the pitch change envelope.
 - Use the buttons below the display to set the corresponding values. The envelope is created on the display as you input the settings.
 - Use the CURSOR \wedge and \vee buttons switch between the upper row and lower row items.
 - Use the TOTAL DEPTH \wedge and \vee buttons to specify the maximum level (-50 to +50).
4. Repeat steps 2 and 3 for the other tones, as desired.

<ENVELOPE KEY FOLLOW>

Specify how the pitch envelope changes in relation to note pitch.

1. Use the PAGE buttons to view the 2/2 display.

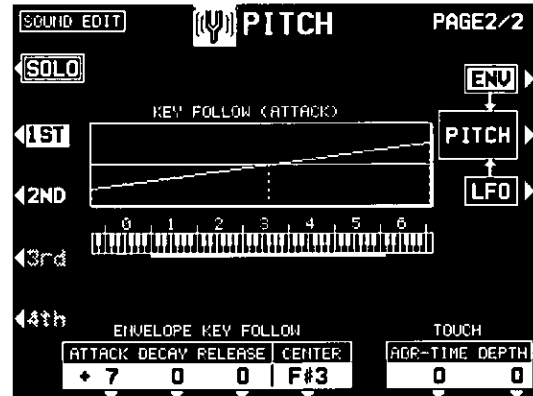

2. Use the buttons to the left of the display to select a tone.
3. Change the key follow settings for the ATTACK, DECAY and RELEASE.
 - Use the \wedge and \vee buttons corresponding to the ENVELOPE KEY FOLLOW attributes to adjust the settings (-50 to +50). Use the CENTER \wedge and \vee buttons to select the center of the bend direction.
4. Change the touch settings.
 - Use the ADR-TIME \wedge and \vee buttons to specify the time change depending on touch (-50 to +50). Use the DEPTH \wedge and \vee buttons to specify the pitch change level depending on touch (-50 to +50).
 - At a - setting, the softer the keys are pressed, the greater the change. At a + setting, the harder the keys are pressed, the greater the change.

■ LFO

Adjust the pitch LFO (cyclic modulation) settings. There are four types of LFO.

1. Press the LFO button.
 - The display looks similar to the following.

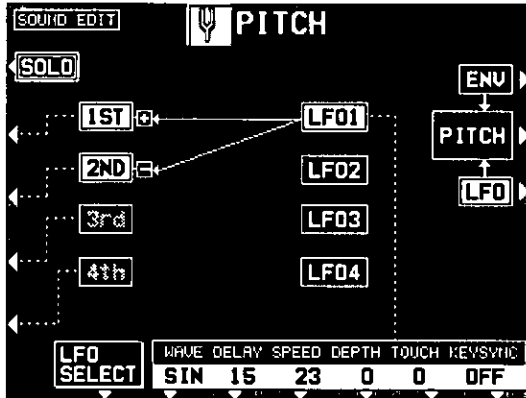

2. Use the LFO SELECT \wedge and \vee buttons to select an LFO (1–4).
3. Use the buttons below the display to adjust the settings.

WAVE

Modulate the waveform.

- SIN: Sine wave
- TRI: Triangle wave
- SQR: Square wave
- SAW: Saw tooth wave

DELAY

Delay time is the time elapsed from when the keyboard key is pressed until the modulation begins (0 to 30).

SPEED

Modulation speed (0 to 127)

DEPTH

Modulation depth (0 to 127)

TOUCH

Degree of modulation change in relation to touch (0 to 50).

KEYSYNC

When playing more than one note, specify whether the LFO starts or not each time a key is pressed (ON/OFF).

- When KEYSYNC is set to ON: if, while playing one note, you play a second note, the LFO is applied to the second note as well.

4. Use the buttons to the left of the display to specify for each tone whether or not the specified LFO is applied.
 - The LFO can be applied to multiple tones.
 - A + indicates that the LFO is on for the tone, a – indicates that the inverted-phase LFO is applied to the tone.
5. Repeat steps 2 to 4 for the other LFO types, as desired.

Filter Edit

Make major changes to the sound by eliminating specific frequency ranges.

FILTER

1. On the SOUND EDIT menu, select FILTER.
 - The display looks similar to the following.

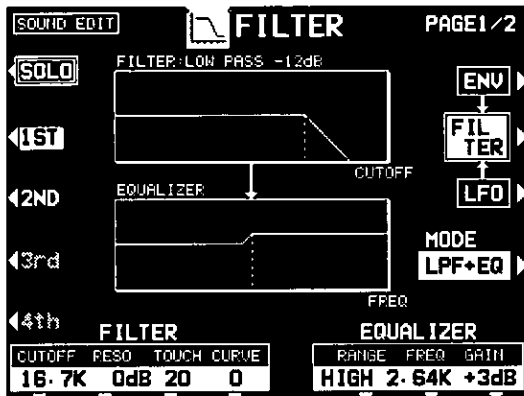

2. Use the buttons to the left of the display to select a tone.

3. Use the MODE button to select the filter mode.

LPF+EQ (low-pass filter + equalizer)

Signals higher than the cut-off frequency are cut. Normal sounds are softened.

HPF+EQ (high-pass filter + equalizer)

Signals lower than the cut-off frequency are cut. Normal sounds are sharpened.

LPF24 (low-pass filter 24)

A stronger low-pass filter than LPF+EQ.

HPF24 (high-pass filter 24)

A stronger high-pass filter than HPF+EQ.

BPF (band-pass filter)

Cuts all signals which are not in the range close to the cut-off frequency. The sound has a distinctive character.

THRU

No filter effect is applied.

4. Use the buttons below the display to adjust the filter attributes.

CUTOFF

Set the frequency range which is cut by the filter.

- The cut-off frequency is the standard frequency which is cut by the filter.

RESO

Specify the resonance value (dB).

- Resonance is effect which adds character to the sound by emphasizing the harmonic components of frequencies close to the cut-off frequency.

TOUCH

Specify the degree of change relative to keyboard touch.

CURVE

Specify the type of curve relative to keyboard touch.

<Equalizer>

For LPF+EQ/HPF+EQ filters, the sound quality can be modified by the EQUALIZER.

RANGE

Select the setting range (HIGH or LOW).

FREQ

Set the standard frequency.

GAIN

Set the level increase or decrease from the value set for FREQ (dB).

5. Repeat steps 2 to 4 for each tone, as desired.

FILTER KEY FOLLOW

Specify how the filter changes in relation to note pitch.

1. Use the **PAGE** buttons to view the 2/2 display.

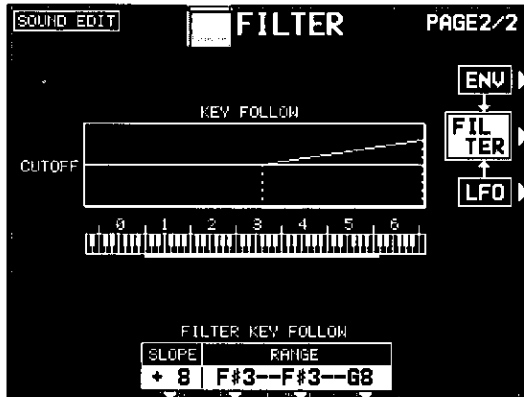

2. Use the buttons to the left of the display to select a tone.

3. Change the key follow settings.

- Use the SLOPE ^ and v buttons to adjust the bend slope (-50 to +50). Use the RANGE ^ and v buttons to specify the pitch range by note name. The center setting defines the bend direction.

4. Repeat steps 2 and 3 for the other tones, as desired.

ENVELOPE

Specify how the filter changes over time, from the time the key is played to the time the sound dies out.

1. Press the ENV button.

- The display looks similar to the following.

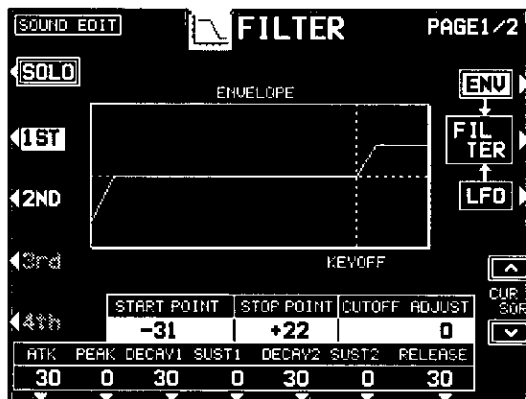

2. Use the buttons to the left of the display to select a tone.

3. Adjust the settings for the filter envelope.

- Use the buttons below the display to set the corresponding values. The envelope is created on the display as you input the settings.
- Use the CURSOR ^ and v buttons switch between the upper row and lower row items.
- Use the CUTOFF ADJUST ^ and v buttons to move the entire graph up or down to change the amount of filter effect (-50 to +50).

4. Repeat steps 2 and 3 for the other tones, as desired.

<ENVELOPE KEY FOLLOW>

Specify how the filter changes relative to note pitch over time.

1. Use the **PAGE** buttons to view the KEY FOLLOW display.

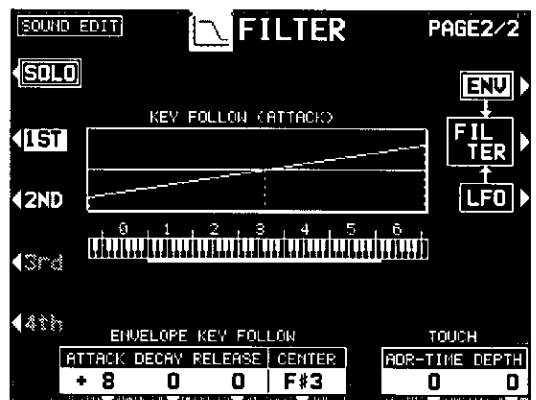

2. Use the buttons to the left of the display to select a tone.

3. Change the key follow settings for the ATTACK, DECAY and RELEASE.

- Use the ^ and v buttons corresponding to the ENVELOPE KEY FOLLOW attributes to adjust the settings (-50 to +50). Use the CENTER ^ and v buttons to select the center of the bend direction.

Sound Edit

4. Change the touch settings.

- Use the ADR-TIME \wedge and \vee buttons to specify the time change depending on touch (-50 to +50). Use the DEPTH \wedge and \vee buttons to specify the pitch change level depending on touch (-50 to +50).
- At a - setting, the softer the keys are pressed, the greater the change. At a + setting, the harder the keys are pressed, the greater the change.

■ LFO

Adjust the LFO (cyclic modulation) settings applied to the filter. There are four types of LFO.

1. Press the LFO button.

- The display looks similar to the following.

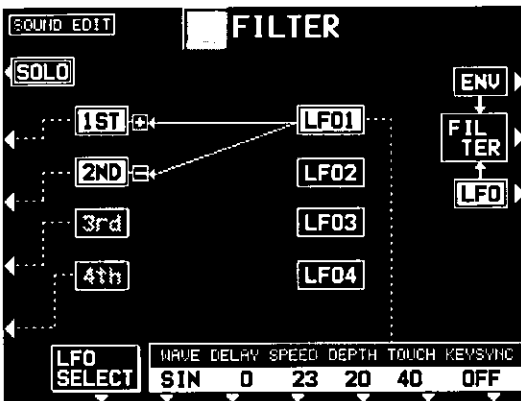

2. Use the LFO SELECT \wedge and \vee buttons to select an LFO (1-4).

3. Use the buttons below the display to adjust the settings.

WAVE

Modulate the waveform.

- SIN: Sine wave
- TRI: Triangle wave
- SQR: Square wave
- SAW: Saw tooth wave

DELAY

Delay time is the time elapsed from when the keyboard key is pressed until the modulation begins (0 to 30).

SPEED

Modulation speed (0 to 127).

DEPTH

Modulation depth (0 to 127).

TOUCH

Degree of modulation change in relation to touch (0 to 50).

KEYSYNC

When playing more than one note, specify whether the LFO starts or not each time a key is pressed (ON/OFF).

- When KEYSYNC is set to ON: if, while playing one note, you play a second note, the LFO is applied to the second note as well.

4. Use the buttons to the left of the display to specify for each tone whether or not the specified LFO is applied.

- The LFO can be applied to multiple tones.
- A + indicates that the LFO is on for the tone, a - indicates that the inverted-phase LFO is applied to the tone.

5. Repeat steps 2 to 4 for the other LFO types, as desired.

Amplitude Edit

Adjust the settings related to the volume of the sound.

AMPLITUDE

- On the SOUND EDIT menu, select AMPLITUDE.
 - The display looks similar to the following.

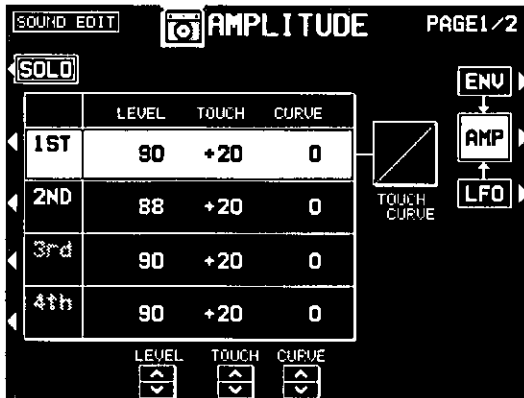

- Use the buttons to the left of the display to select a tone.
- Use the LEVEL \wedge and \vee buttons to select the volume (0 to 127).
- Use the TOUCH \wedge and \vee buttons to set the amount of volume change in relation to how hard the keyboard is played (-50 to +50).
 - At a - value, the softer the keyboard is played, the louder the sound. At a + value, the harder the keyboard is played, the louder the sound.
- Use the CURVE \wedge and \vee buttons to select the type of volume curve depending on touch (-3 to +3).
- Repeat steps 2 to 5 for the other tones, as desired.

AMPLITUDE KEY FOLLOW

Specify how the volume changes in relation to note pitch.

- Use the PAGE buttons to view the 2/2 display.

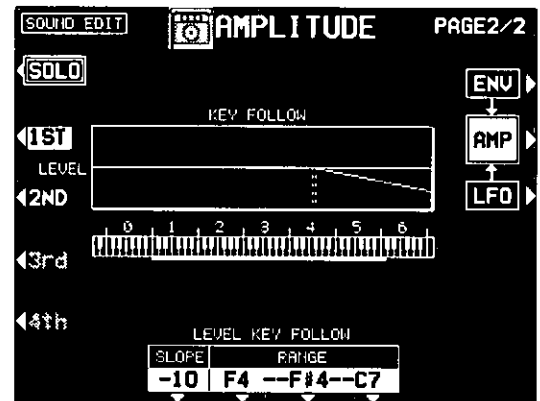

- Use the buttons to the left of the display to select a tone.
- Change the key follow settings.
 - Use the SLOPE \wedge and \vee buttons to adjust the bend slope (-50 to +50). Use the RANGE \wedge and \vee buttons to specify the pitch range by note name. The center setting defines the bend direction.

■ ENVELOPE

Specify how the volume changes over time, from the time the key is played to the time the sound dies out.

1. Press the ENV button.
 - The display looks similar to the following.

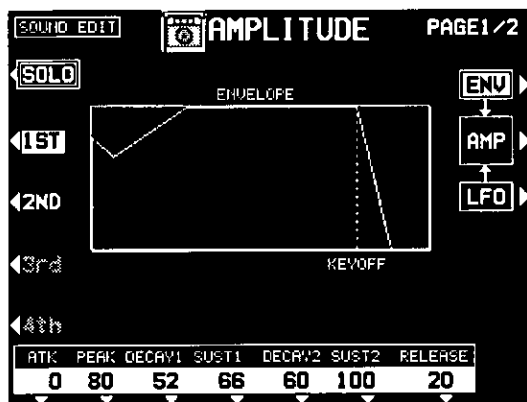

2. Use the buttons to the left of the display to select a tone.
3. Adjust the settings for the volume envelope.
 - Use the buttons below the display to set the corresponding values. The envelope is created on the display as you input the settings.
4. Repeat steps 2 and 3 for the other tones, as desired.

<ENVELOPE KEY FOLLOW>

Specify how the volume changes relative to note pitch over time.

1. Use the PAGE buttons to view the 2/2 display.

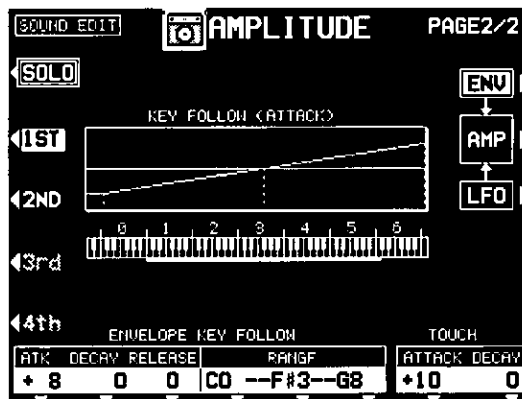

2. Use the buttons to the left of the display to select a tone.
3. Change the key follow settings for the ATTACK, DECAV and RELEASE.
 - Use the ^ and v buttons corresponding to the ENVELOPE KEY FOLLOW attributes to adjust the settings (-50 to +50). Use the RANGE buttons to specify the keyboard range.
4. Change the touch settings.
 - Use the ATTACK ^ and v buttons to specify the ATTACK time change depending on touch (-50 to +50). Use the DECAV ^ and v buttons to specify the DECAV time change depending on touch (-50 to +50).
 - At a - setting, the softer the keys are pressed, the greater the change. At a + setting, the harder the keys are pressed, the greater the change.

▣ LFO

Adjust the LFO (cyclic modulation) settings applied to the amplitude. There are four types of LFO.

1. Press the LFO button.
 - The display looks similar to the following.

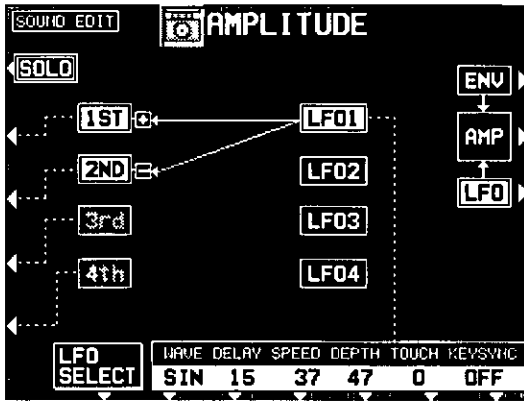

2. Use the LFO SELECT ^ and v buttons to select an LFO (1-4).
3. Use the buttons below the display to adjust the settings.

4. Use the buttons to the left of the display to specify for each tone whether or not the specified LFO is applied.
 - The LFO can be applied to multiple tones.
 - A + indicates that the LFO is on for the tone, a - indicates that the inverted-phase LFO is applied to the tone.
5. Repeat steps 2 to 4 for the other LFO types, as desired.

WAVE

Modulate the waveform.

- SIN: Sine wave
- TRI: Triangle wave
- SQR: Square wave
- SAW: Saw tooth wave

DELAY

Delay time is the time elapsed from when the keyboard key is pressed until the modulation begins (0 to 30).

SPEED

Modulation speed (0 to 127)

DEPTH

Modulation depth (0 to 127)

TOUCH

Degree of modulation change in relation to touch (0 to 50)

KEYSYNC

When playing more than one note, specify whether the LFO starts or not each time a key is pressed (ON/OFF).

- When KEYSYNC is set to ON: if, while playing one note, you play a second note, the LFO is applied to the second note as well.

Sound Edit

Effect Edit

Select the type of effect which is applied to your new sound when the **DIGITAL EFFECT** button is on, and modify the effect.

DIGITAL EFFECT

1. On the SOUND EDIT menu, select DIGITAL EFFECT.
 - The display looks similar to the following.
 - The display for the effect type which is best-suited for the sound currently being edited is selected.



2. Use the TYPE ^ and v buttons to select the type of effect.
 - Select from the following types: CELESTE 1, 2, CHORUS 1, 2, ENSEMBLE 1, 2, TREMOLO, ORGAN TREMOLO, SINGLE DELAY, REPEAT DELAY, SOLO EFFECT 1, 2.

<ON/OFF button>

Specify whether the **DIGITAL EFFECT** button turns on or off when the sound is selected. When set to ON, the **DIGITAL EFFECT** button turns on automatically when the sound is selected. The button alternates between ON and OFF each time it is pressed.

<STEREO/MONO button>

Select stereo (STEREO) or monaural (MONO) output of the effect. The button alternates between STEREO and MONO each time it is pressed.

3. Use the buttons along the bottom of the display to select the attribute you wish to adjust.
 - When the type is changed, the parameters revert to the factory defaults.
 - For a detailed explanation of the parameters of each type of effect, refer to the separate REFERENCE GUIDE provided.

Controller Edit

Specify how operation of the controllers, such as the wheels, etc., affects the sound.

CONTROLLER

1. On the SOUND EDIT menu display, select CONTROLLER.

- The display looks similar to the following.

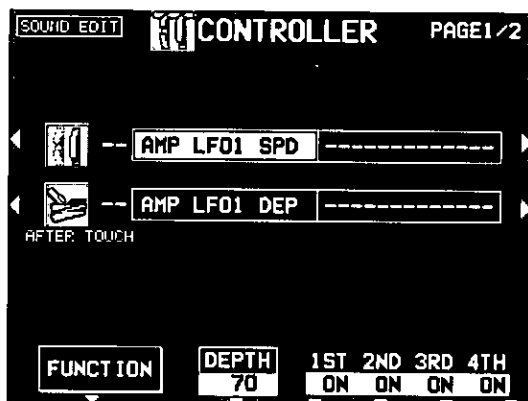

2. Use the buttons to the left and right of the display to select a controller.

- The controllers are in order from the top: MODULATION WHEEL, AFTER TOUCH.
- Two functions can be assigned to each controller.

▣ SUSTAIN PEDAL MODE, GLIDE

This setting is for when the sustain function or glide function has been assigned to the foot switch.

1. Use the PAGE buttons to view the 2/2 display.



3. Use the FUNCTION button to select a function for the controller.

4. Use the DEPTH \wedge and \vee buttons to set the depth of the function applied by the controller (0 to 127).

5. Use the 1st, 2nd, 3rd and 4th \wedge and \vee buttons to set the controller to on or off for each tone.

- When set to INV, the function is inverted for the tone.

6. Repeat steps 2 to 5 for the other controllers, as desired.

2. Use the SUSTAIN PEDAL MODE \wedge and \vee buttons to select the type of sustain.

LONG:

The release time of the sound is lengthened.

HOLD:

The sustain is continuous until the foot switch is released.

3. Use the GLIDE \wedge and \vee buttons to select whether or not the glide effect is active.

ENABLE:

The glide effect is enabled.

DISABLE:

The glide effect is disabled.

- To assigning a function to the foot switch, refer to page 161.

Store the new sound

The **MEMORY A** and **MEMORY B** buttons in the **SOUND GROUP** section are memory banks reserved for the sounds you create with the **SOUND EDIT**. You can store up to 40 original sounds—20 in each bank—then select the sounds just like the other sounds in the **SOUND GROUP**.

WARNING: Your new sound will be erased if you exit the **SOUND EDIT** mode without first storing it in a memory.

Procedure

- When you have edited the sound to just the way you like it, on the **SOUND EDIT** menu display, press the **WRITE** button.
- The display changes to the **MEMORY WRITE** display.



- To assign a name to your new sound, press the **SOUND NAMING** button.
- If you do not assign a name to your sound, the name becomes the same as the original sound from which you started. In this case, skip to step 5.
- The display changes to the **SOUND NAMING** display.



- Type a new name for your sound (up to 16 characters).

- Use the **POSITION** buttons to highlight the character position in the name box. Use the **ABC...]()** buttons to select the alphanumeric character. Repeat these steps to type the whole name.
- Use the **INS** button to type a space.
- Use the **DEL** button to erase a character.
- Use the **A/a** button to switch between upper case and lower case characters.
- To erase all the characters, press the **CLR** button.
- You can press the **→←** button if you wish to have the name centered.

- When you have finished typing the name, press the **WRITE** button.

- The display returns to the **MEMORY WRITE** display.

- Use the **^** and **v** buttons to select the **MEMORY** number in which to store the new sound.

- Select **BANK A** or **BANK B**, and number 1 through 20.

- Press the **OK** button.

- The new sound is stored, and "COMPLETED!" is shown on the display.
- The **SOUND EDIT** mode is turned off.

- The stored sound memories can be saved on a disk for recall at a later time. (Refer to page 120.)

Select a new sound

You can select your original sound just like the other sounds in the **SOUND GROUP**.

1. In the **SOUND GROUP** section, press the **MEMORY A** or **MEMORY B** button.
2. Select the desired sound from the list on the display.

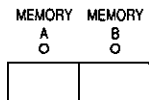

- Select the bank (A/B) in which you stored the sound during the MEMORY WRITE procedure.
- The list of sounds in the selected bank is shown on the display.

Drum Kit Edit

You can create your original drum kit.

DRUM SOUND EDIT

By editing each percussion instrument sound in the drum kit, you can create your original drum kit.

1. From the **DRUM KITS** sound group, select a drum kit to use as the foundation of your new drum kit.
2. Change to the **SOUND EDIT** mode. (Refer to page 139.)
 - The confirmation display appears. Press the **YES** button.
 - When the **YES** button is pressed, the contents of the "User Kit" are overwritten.
 - The display looks similar to the following.
3. While pressing the key for the percussion instrument sound you wish to edit, press the **NOTE SELECT** button.
4. Use the **SOUND** ^ and v buttons to select the percussion instrument sound to assign.
5. Use the buttons below the display to select the tone.
 - Percussion sounds are composed of two tones (1st and 2nd).
 - The name of the currently selected percussion instrument and the note name assigned to it are shown in the upper part of the display.
6. Edit the setting.



- ON/OFF:** Use the **ON/OFF** ^ and v buttons to specify whether or not the selected tone is output.
- TONE SELECT:** Use the **GROUP** ^ and v buttons and the **TONE** ^ and v buttons to change the tone.

LEVEL:

Use the LEVEL \wedge and \vee buttons to adjust the volume (0 to 127).

KEY:

Use the KEY \wedge and \vee buttons to adjust the pitch (-50 to + 50).

TUNE:

Use the TUNE \wedge and \vee buttons to make fine adjustments to the pitch (-50 to + 50).

PAN:

Use the PAN \wedge and \vee buttons to adjust the stereo balance (L64-CTR-R63).

REV:

Use the REV \wedge and \vee buttons to specify the amount of output to the REVERB (0 to 127).

- This setting is effective for both the 1st and 2nd tones in common.

7. Repeat steps 3 to 6 for the other keyboard keys.

- Your original drum kit is stored in the USER KIT of the **DRUM KITS** sounds in the **SOUND GROUP**.

■ DRUM DETAIL EDIT

Follow this procedure when you wish to make more precise adjustments to each tone.

1. Press the DETAIL EDIT button.

- The display looks similar to the following.



2. Select the item to edit.

- The editing procedure is basically the same as the SOUND EDIT procedure for other sounds.
- For drum kits, the number of items that can be edited is limited.
- You can press the DRUM SOUND NAMING button to assign a name to your percussion instrument sound while you are editing it.

Recording Digital Drawbar sounds

You can save your customized drawbar settings.

DIGITAL DRAWBAR EDIT

1. Follow the procedure to adjust the **DIGITAL DRAWBAR** sound. (Refer to page 33.)
2. Change to the **SOUND EDIT** mode. (Refer to page 139.)
 - The display looks similar to the following.

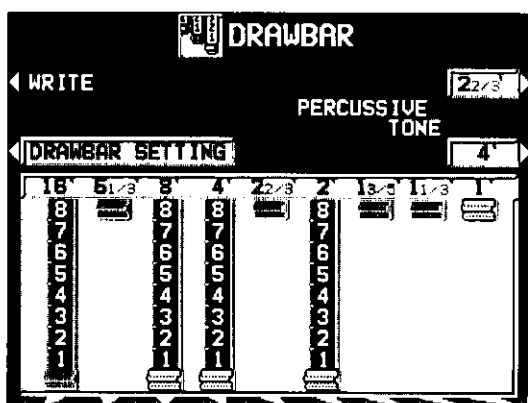

3. Press the **WRITE** button.
 - The display changes to the **MEMORY WRITE** display. Follow the procedure to store the new sound. (Refer to page 155.)

Part IX Control

Outline of Control functions

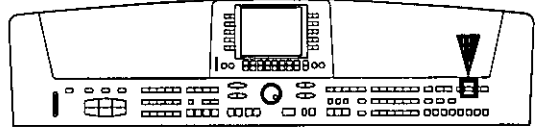

Various settings related to the operation of this instrument are adjusted with the **CONTROL** functions.

1. In the **MENU** section, press the **CONTROL** button to turn it on.

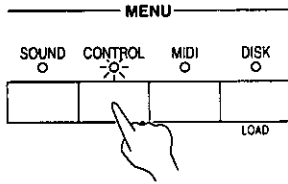

- The display looks similar to the following.



2. Select a function.

INITIAL (page 177)

Return the settings and memories to the factory-preset status.

OVERALL TOUCH SENSITIVITY (page 160)

Adjust the amount of keyboard touch response.

FOOT CONTROLLERS (page 161)

Assign functions to the separately sold Foot Switch and Foot Controller, etc.

DISPLAY TIME OUT (page 162)

Adjust settings related to the screen display.

PANEL MEMORY MODE

Define which panel settings are stored when the **PANEL MEMORY** is used. (Refer to page 66.)

MUSIC STYLE ARRANGER MODE

Define which panel settings change by pressing a **FILL IN** button when the **MUSIC STYLE ARRANGER** is used. (Refer to page 63.)

WALLPAPER SETTING (page 163)

Change the background (wallpaper) of the display.

3. Follow the procedure to adjust the settings.

- While you are adjusting the settings, when the **TEMPO/PROGRAM** indicator is lit, it indicates that the dial is available for setting the current function.

4. When you have finished setting the functions, press the **CONTROL** button to turn it off.

Overall Touch Sensitivity

This instrument features INITIAL TOUCH (the volume, for example, changes depending on how hard the keyboard is played) and AFTER TOUCH (effects are added by pressing the keys harder).

- On the CONTROL MENU display, select OVERALL TOUCH SENSITIVITY.
 - The display looks similar to the following.

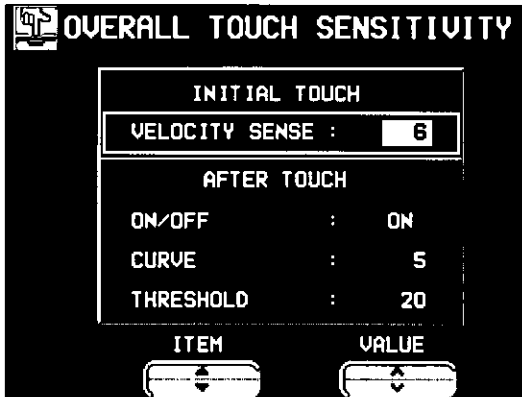

- Use the ITEM \blacktriangle and \blacktriangledown buttons to select the function.

INITIAL TOUCH

VELOCITY SENSE:

Adjust the amount of keyboard touch response (0 to 9).

- When set to 0, initial touch sensitivity is turned off.

AFTER TOUCH

ON/OFF:

Enable or disable the aftertouch effect for the keyboard (ON/OFF).

CURVE:

Adjust the curve of the sound change relative to how hard the keys are pressed (1 to 10).

THRESHOLD:

Specify how hard a key must be pressed to produce the effect (1 to 127).

- The higher the value, the hard the key must be pressed to produce the effect.

- Use the VALUE \wedge and \vee buttons to change the settings.

Foot Controllers

If an optional Foot Switch, Foot Controller and/or Expression Pedal (sold separately) is connected, you can assign it one of several functions, allowing convenient and fast control during your performance.

- This instrument allows connection of two Foot Switches and one Foot Controller (four switches) for a total of six switches, and an Expression Pedal.

1. On the CONTROL MENU display, select FOOT CONTROLLERS.

- The display looks similar to the following.

FOOT CONTROLLERS	
CONTROLLER	FUNCTION
FOOT SWITCH 1	SUSTAIN
FOOT SWITCH 2	GLIDE
FOOT CONT. SW 1	START/STOP
FOOT CONT. SW 2	P. MEM INCREMENT
FOOT CONT. SW 3	P. MEM DECREMENT
FOOT CONT. SW 4	P. MEM BANK INC.
EXPRESS. PEDAL	TOTAL EXPRESSION

2. Use the ▲ and ▼ buttons to select a switch name, and the ^ and v buttons to select its function.

■ FOOT SWITCH/FOOT CONT.SW

OFF:

No function is assigned.

P. MEM INCREMENT:

Increment the **PANEL MEMORY** number selection by 1.

P. MEM DECREMENT:

Decrement the **PANEL MEMORY** number selection by 1.

P. MEM BANK INC.:

Change to the next **PANEL MEMORY** bank in order.

P. MEM BANK DEC.:

Change to the previous **PANEL MEMORY** bank in order.

PANEL MEMORY 1 to 8:

The specified **PANEL MEMORY** number is turned on.

P. MEM INC.+DEC.:

Press the switch to increment the **PANEL MEMORY** number selection by one; release the switch to return to the previous number.

START/STOP:

START/STOP button on/off

FILL IN 1:

FILL IN 1 button on

FILL IN 2:

FILL IN 2 button on

INTRO & ENDING 1:

INTRO & ENDING 1 button on

INTRO & ENDING 2:

INTRO & ENDING 2 button on

SUSTAIN:

SUSTAIN button on/off

GLIDE:

Glide on/off (The glide effect "bends" the pitch down by about one semitone.)

TECHNI-CHORD:

TECHNI-CHORD button on/off

DIGITAL EFFECT:

DIGITAL EFFECT button on/off

DSP EFFECT:

DSP EFFECT button on/off

ROTARY SLOW/FAST:

ROTARY SLOW/FAST of the **DIGITAL DRAWBAR**

PUNCH RECORD:

Punch in/punch out (Refer to page 78.)

APC HOLD:

Memorize the chord specified for the automatic accompaniment.

FADE IN:

FADE IN button on

FADE OUT

FADE OUT button on

■ EXPRESS. PEDAL**TOTAL EXPRESSION:**

The volume for all parts changes when the expression pedal is operated.

PART EXPRESSION:

The volume changes only for parts for which PART EXP PEDAL was turned ON on the PART SETTING display for **SOUND**. (Refer to page 132.)

- The initialized settings are as follows:

FOOT SWITCH 1	SUSTAIN
FOOT SWITCH 2	GLIDE
FOOT CONT. SW 1	START/STOP
FOOT CONT. SW 2	P.MEM INCREMENT
FOOT CONT. SW 3	P.MEM DECREMENT
FOOT CONT. SW 4	P.MEM BANK INC.
EXPRESS. PEDAL	TOTAL EXPRESSION

- For connection of a Foot Switch, etc., refer to page 179.

Display Time Out

Numerous message displays and setting displays conveniently guide you through the operation steps of this instrument. Once you become familiar with the operation of your instrument, however, you may wish to shorten or even suspend the display time of the message displays.

1. On the CONTROL MENU display, select DISPLAY TIME OUT.
 - The display looks similar to the following.

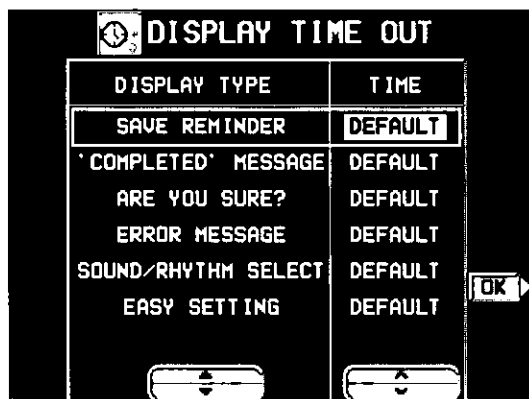

2. Use the ▲ and ▼ buttons to select the function.

SAVE REMINDER:

Reminder display (OFF, DEFAULT, HOLD, 1 to 10 sec)

'COMPLETED' MESSAGE:

Operation successfully completed (OFF, DEFAULT, HOLD, 1 to 10 sec)

ARE YOU SURE?:

Display requires user action for confirmation (OFF, DEFAULT, HOLD)

ERROR MESSAGE:

Error notification display (DEFAULT, HOLD, 1 to 10 sec)

SOUND/RHYTHM SELECT:

Sound/rhythm and MSP BANK selection display (DEFAULT, HOLD, 1 to 10 sec)

EASY SETTING:

Display time when the setting display was accessed pressing and holding a panel button (DEFAULT, HOLD, 1 to 10 sec)

- When set the OFF, the display will not appear.
- When set to DEFAULT, the display time returns to the initialized setting.
- You can specify 1 to 10 seconds for the display time.
- When set to HOLD, the **DISPLAY HOLD** automatically turns on.

3. Use the ▲ and ▼ buttons to change the setting.

4. Press the OK button.

- Some messages may be displayed even if they are set to OFF.

Wallpaper Setting

You can load desired bitmap (.BMP) data to display your favorite background pattern (wallpaper) on the display.

1. On the CONTROL MENU display, select WALLPAPER SETTING.
 - The display looks similar to the following.



2. Select a display category.

HOME PAGE/SOUND & RHYTHM SELECT:

The standard display and the displays to select the sound and rhythm.

MENU PAGES:

MENU display

OTHERS:

A simple pattern is active in the initialized state.

3. Use the VALUE ^ and v buttons to select a mode.

DEFAULT:

Select the initialized settings.

USER:

Select the user-specified wallpaper data.

- When USER is selected, after inserting a disk with .BMP data in the Disk Drive and pressing the LOAD button, the .BMP data is displayed. Select the desired file to load and press the LOAD button. The background pattern changes. An error message is displayed if the data cannot be loaded.

- The data which can be loaded is as follows:
 - Files with a .BMP extension
 - Bitmap data for Windows
 - Data for 320 × 240 dot screen size
 - 192 colors, bitmap data of the first 192 colors on the color pallet

4. Press the OK button.

- The initial pattern for USER is PLAIN BLACK. This pattern is recommended if you do not care for the default wallpaper. To select this pattern, press the USER INITIAL button. A confirmation display appears. Press the YES button to activate the selected pattern or NO to cancel it.
- Note that some displays use the fixed default wallpaper regardless of the selected setting.

Part X MIDI

What is MIDI?

MIDI (Musical Instrument Digital Interface) is the international standard for digital communication of electronic musical instrument data. This means that any equipment which has a MIDI terminal—such as electronic musical instruments and personal computers—can easily exchange digital data with other MIDI equipment without resorting to complicated conversions or connections.

MIDI terminals

(On the rear panel)

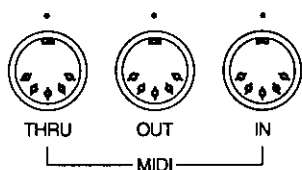

IN:

The terminal by which this instrument receives data from other equipment.

OUT:

The terminal that transmits data from this instrument to other equipment.

THRU:

The terminal that transfers data from the IN terminal directly.

- For these connections, use a commercially available MIDI cable.
- Exchange of normal data through these terminals is enabled only when the **COMPUTER** terminal switch is set to **MIDI**. (Refer to page 179.)

Connection examples

- To generate sound from a connected instrument by playing this instrument

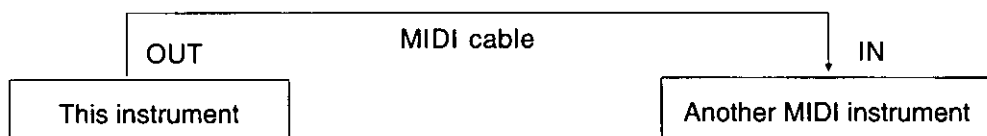

- To generate sound from this instrument by operating a connected instrument

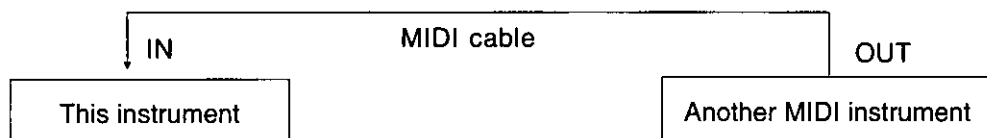

- To connect with a MIDI sequencer

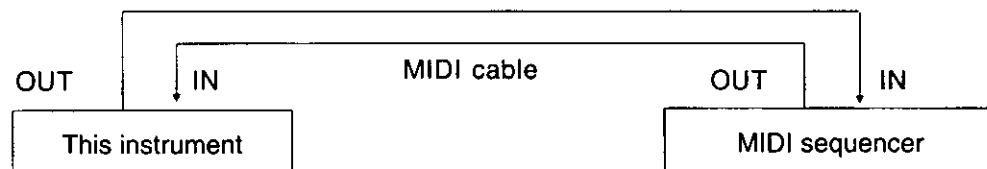

MIDI channels

Many different kinds of performance data are sent using just one MIDI cable. This is possible because MIDI signals are sent and received through 16 different “basic channels” (numbered 1 to 16). In order for the exchange of data to take

place, the channels on the transmission side must match the channels on the receiving side. This characteristic also makes it possible to link multiple sound generators and to control each by matching specific channels.

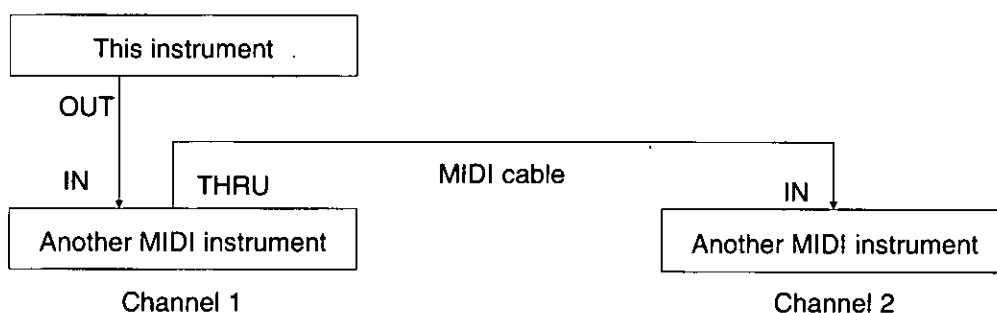

The following kinds of data can be transmitted/received.

■ NOTE data

This is the most basic kind of MIDI data which is exchanged, and is used to specify which keys are played and how hard they are played.

NOTE NUMBER: Number specifying which key is played.

NOTE ON: Specifies that a key is played.

NOTE OFF: Specifies that a key is released.

VELOCITY: Specifies how hard a key is struck.

- MIDI notes are assigned numbers from 0 to 127, with middle C (C3) as 60. Note pitches are in semitone increments, with the higher numbers assigned to the higher pitches.

■ PROGRAM CHANGE

This is sound change data. When a different sound is selected on the transmitting instrument, the sound on the receiving instrument also changes.

■ CONTROL CHANGE

These are volume, sustain, effect, etc. data used to enhance performance expression. Each function is distinguished by its control number, and the function which can be changed by the control differs depending on the instrument.

■ EXCLUSIVE data

This is sound data, etc. particular to a specific instrument model. This data can also be transmitted and received by the DUMP function.

- For details, refer to the separate “REFERENCE GUIDE” provided.

GENERAL MIDI

GENERAL MIDI (GM) is the standard which enables MIDI data exchange between different models or equipment of different manufacture. Program change numbers and their corresponding sounds, percussion instrument sounds, note numbers, etc. are data-compatible between equipment using this standard. Song data created on the equipment of one manufacturer can be played back on the equipment of a different manufacturer, as long as both conform to the GENERAL MIDI standard. This instrument conforms to this standard and can be used as a GENERAL MIDI sound generator.

Equipment which conforms to GENERAL MIDI standards is indicated by the following logo.



- GENERAL MIDI can be set to ON or OFF. (Refer to page 173.)

Outline of MIDI functions

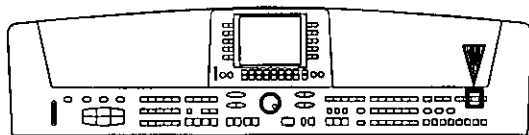

1. In the **MENU** section, press the **MIDI** button to turn it on.

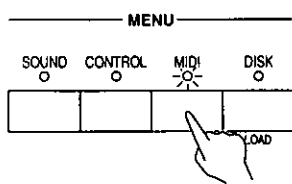

- The display looks similar to the following.
- The menu display consists of two screen pages. Use the **PAGE** button to switch between pages.

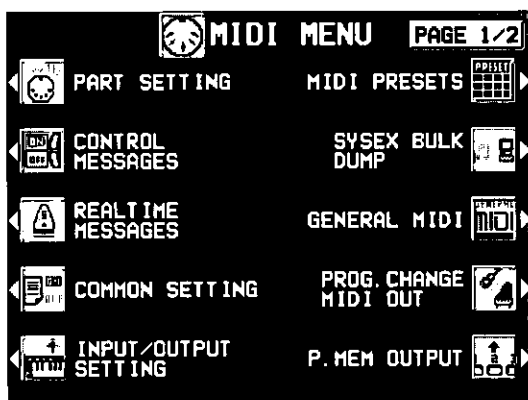

2. Select a function.
3. Follow the procedure to adjust the settings.
 - While you are adjusting the settings, when the **TEMPO/PROGRAM** indicator is lit, it indicates that the dial is available for setting the current function.
4. When you have finished setting the functions, press the **MIDI** button to turn it off.

Summary of the MIDI menu items

PART SETTING (page 167)

Set the MIDI BASIC CHANNEL, OCTAVE and LOCAL CONTROL settings for each part.

CONTROL MESSAGES (page 168)

Enable or disable the exchange of various CONTROL data.

REALTIME MESSAGES (page 168)

Enable or disable the exchange of REALTIME COMMANDS, and select the CLOCK mode.

COMMON SETTING (page 169)

Set the functions which are common to all parts.

INPUT/OUTPUT SETTING (page 170)

Settings which determine how various performance data is treated during data transmission and reception.

MIDI PRESETS (page 171)

Establish the optimum settings depending on how this instrument is connected to other equipment.

- You can save the settings you specify yourself.

SYSEX BULK DUMP (page 172)

Data exchange of SYSTEM EXCLUSIVE data.

GENERAL MIDI (page 173)

Settings when this instrument is used as a GENERAL MIDI instrument.

PROG. CHANGE MIDI OUT (page 174)

Settings for transmitting the desired PROGRAM CHANGE data on the specified MIDI channel.

P. MEM OUTPUT (page 174)

Settings that affect the transmission data when the **PANEL MEMORY** buttons are operated.

COMPUTER CONNECTION (page 175)

Mode settings related to the flow of MIDI signals when this instrument is connected to a personal computer.

MIDI SETTINGS LOAD OPTION (page 176)

Specify how MIDI data is handled when data is loaded from a disk.

Part Setting

Follow this procedure to set the functions which can be set for each part: MIDI CHANNELs, the OCTAVE data to NOTE data during transmission, and LOCAL CONTROL (whether or not the sound generator of this instrument is active during transmission).

1. On the MIDI MENU display, select PART SETTING.

- The display looks similar to the following.

PART SETTING PAGE 1/3			
PART	CHANNEL	OCTAVE	LOCAL
RIGHT1	1	0	ON
RIGHT2	2	0	ON
LEFT	3	0	ON
PART4	4	0	ON
PART5	5	0	ON
PART6	6	0	ON
PART7	7	0	ON
PART8	8	0	ON

2. Use the PART \wedge and \vee buttons to select a part.

- The list of parts covers three pages. Use the **PAGE** buttons to view different pages of the list.

3. Use the CHANNEL \wedge and \vee buttons to select a MIDI CHANNEL for the part (OFF, 1 to 16).

- A part which has been set to OFF cannot be used to transmit or receive MIDI data.
- The initialized settings are as follows:

RIGHT 1	1
RIGHT 2	2
LEFT	3
PART 4	4
PART 5	5
PART 6	6
PART 7	7
PART 8	8
PART 9	9
PART 10	10
PART 11	11
PART 12	12
PART 13	13
PART 14	14
PART 15	15
PART 16	16

CONTROL	OFF
ACCOMP 1	OFF
ACCOMP 2	OFF
ACCOMP 3	OFF
BASS	OFF
DRUMS	OFF
CHORD	OFF

4. Use the OCTAVE \wedge and \vee buttons to set the octave shift value (-3 to 3).

- Octave shift is set for transmitted data only; however the transmitted and received octave shifts are linked. For example, if the transmitted octave shift is set to 1, the received octave shift is automatically set to -1.

5. Use the LOCAL ON and OFF buttons to enable or disable this instrument's sound generator.

- When set to ON, the performance from this instrument is transmitted as MIDI data and also sounds from this instrument. When set to OFF, the performance from this instrument is transmitted as MIDI data but does not sound from this instrument.

6. Repeat steps 2 to 5 for each part as desired.

Control Messages

Enable or disable the exchange of various control data.

- On the MIDI MENU display, select CONTROL MESSAGES.
 - The display looks similar to the following.
 - The CONTROL MESSAGES display consists of 2 pages. Use the PAGE buttons to switch between pages.

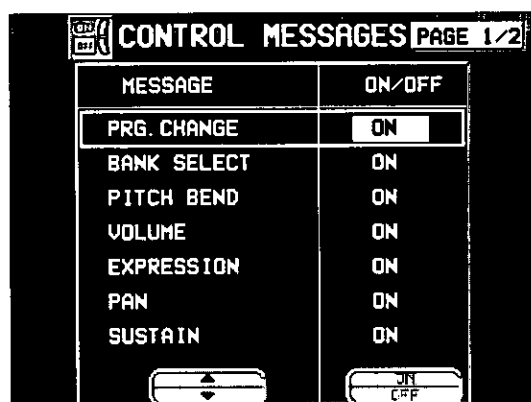

- Use the MESSAGE ▲ and ▼ buttons to select the control message.

- Use the ON and OFF buttons to specify on or off for the control message.

ON:

Data for the control operation is exchanged.

OFF:

Data for the control operation is not exchanged.

- The BANK SELECT setting is effective only when PRG. CHANGE is set to ON.
- The EFFECT & REVERB setting controls the **DIGITAL EFFECT**, **DSP EFFECT** and **DIGITAL REVERB** on/off.
- The TUNING setting is the on/off setting for the TUNING and KEY SHIFT settings.

- Repeat steps 1 and 2 for each control as desired.

Realtime Messages

Enable or disable the exchange of START/STOP data (REALTIME COMMANDS), and select the CLOCK mode.

- On the MIDI MENU display, select REALTIME MESSAGES.
 - The display looks similar to the following.



- Use the buttons on the left side of the display to select a function.
- Use the VALUE ▲ and ▼ buttons to change the setting.

REALTIME COMMANDS

ON:

Rhythm and **SEQUENCER** start/ stop, continue, and song position pointer data can be transmitted/received.

OFF:

This data cannot be transmitted/received.

CLOCK

INTERNAL:

This instrument's internal clock is used to control the performance. The clock of the connected equipment is disabled.

MIDI:

The clock of the connected equipment is used to control the performance. This instrument's clock is disabled. (The tempo is displayed as "♩ = - - -.")

- The CLOCK is set to INTERNAL when the power to this instrument is turned on.
- Repeat steps 2 and 3 for the other function if desired.

Common Setting

Set the functions which are common to all parts.

1. On the MIDI MENU display, select **COMMON SETTING**.

- The display looks similar to the following.

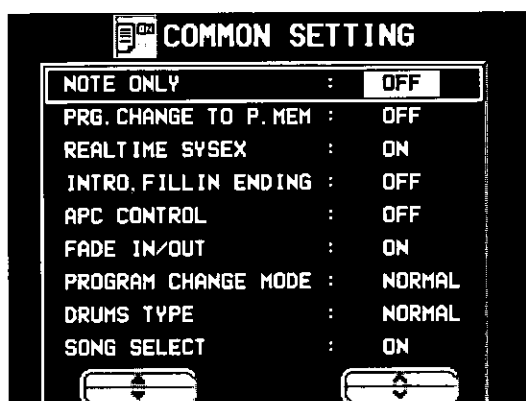

2. Use ▲ and ▼ buttons to select the item.

NOTE ONLY:

Of the performance data, specify whether or not only note data is exchanged.

PROG. CHANGE TO P. MEM:

Enable or disable the exchange of program change numbers for the **RIGHT 1** part by operation of the **PANEL MEMORY** buttons.

- For this setting, the **PANEL MEMORY 1** to **8** program change numbers correspond to the bank numbers as follows:

BANK 1 = 0 to 7

BANK 2 = 8 to 15 ...

REALTIME SYSEX:

Specify whether or not MIDI data is exchanged as system exclusive data during the performance.

- For details about REALTIME SYSEX, refer to the pages on MIDI in the separate "REFERENCE GUIDE" provided.

INTRO, FILL-IN, ENDING:

Enable or disable the exchange of intro, fill-in and ending data.

- Data is exchanged on the channel for the **DRUMS** part.

APC CONTROL:

Enable the exchange of data for the on/off status of the **AUTO PLAY CHORD**'s **ONE FINGER**, **FINGERED** and **PIANIST** modes.

- Data is exchanged on the channel for the **AC-COMP 1** part.

FADE IN/OUT:

Specify whether or not FADE IN/OUT data is exchanged.

PROGRAM CHANGE MODE

NORMAL:

The program change numbers are as indicated in the "REFERENCE GUIDE."

TECH:

Program change numbers are standardized among all Technics models which are set to this mode. The program change number assigned to a given sound on one model is assigned to the same sound on all models which are set to the same mode.

GM:

Program change numbers follow the GM standard.

- The program change numbers for each mode can be found in the separate "REFERENCE GUIDE" provided.

DRUMS TYPE

NORMAL:

Keyboard percussion instrument sounds correspond to this instrument's key note numbers

TECH:

Keyboard percussion instrument sounds correspond to the same key note numbers for connect Technics models set to this type.

GM:

Keyboard percussion instrument sounds follow the GM standard.

SONG SELECT

ON:

Song number data can be exchanged.

OFF:

Song number data cannot be exchanged.

3. Use ^ and v buttons to change the setting.

ON:

Data exchange is enabled.

OFF:

Data exchange is disabled.

4. Repeat steps 2 and 3 for the other settings as desired.

Input/output Setting

Make the settings which determine how various performance data is treated during data transmission and reception.

- On the MIDI MENU display, select INPUT/OUTPUT SETTING.
 - The display looks similar to the following.

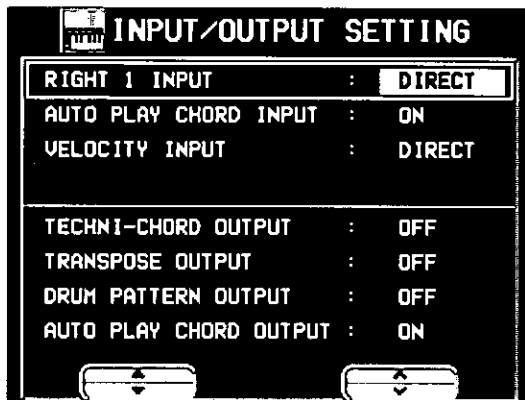

- Use the ▲ and ▼ buttons to select the item.

RIGHT 1 INPUT

CONDUCTOR:

When data for the **RIGHT 1** part is received, the **CONDUCTOR** determines which part it is used for.

DIRECT:

When data for the **RIGHT 1** part is received, it is treated as **RIGHT 1** data, and performance data for all parts is received on their respective basic channels.

AUTO PLAY CHORD INPUT

ON:

Input data for the **ACCOMP 1, 2, 3, BASS, DRUMS** and **CHORD** parts is received.

OFF:

Data for the above parts is not received.

- Basic channels should be assigned to the above parts before exchanging data.

VELOCITY INPUT

DIRECT:

The **VELOCITY** value of received **NOTE ON** data is treated as is.

OFFSET:

The **VELOCITY** value of received **NOTE ON** data is offset (-50 to 50).

- Select **VELOCITY OFFSET VALUE**. Use the ▲ and ▼ buttons to change the value.
- All the values are offset from the current value by the fixed amount.

- The upper (127) and lower (1) limits cannot be exceeded.

FIX:

The **VELOCITY** value of all received **NOTE ON** data is set to a fixed value. (1 to 127)

- Select **VELOCITY FIXED VALUE**. Use the ▲ and ▼ buttons to change the value.

TECHNI-CHORD OUTPUT

ON:

Keyboard notes generated by the **TECHNI-CHORD** function are also transmitted.

OFF:

Only key note data of the pressed keys is transmitted.

TRANSCOPE OUTPUT

ON:

The note data of the transposed notes is transmitted.

OFF:

The note data of the played keys is transmitted.

DRUM PATTERN OUTPUT

ON:

Data from the **DRUMS** part is transmitted.

OFF:

Data from the **DRUMS** part is not transmitted.

AUTO PLAY CHORD OUTPUT

ON:

The data for the **ACCOMP 1, 2, 3, BASS** and **CHORD** parts is transmitted.

OFF:

The data for the above parts is not transmitted.

- Basic channels should be assigned to the above parts before exchanging data.

- Use the ▲ and ▼ buttons to select the setting.

- Repeat steps 2 and 3 for each item as desired.

MIDI Presets

Establish the optimum settings depending on how this Keyboard is connected to other equipment, and on whether this Keyboard is used as the master or the slave.

1. On the MIDI MENU display, select MIDI PRESETS.
 - The display looks similar to the following.

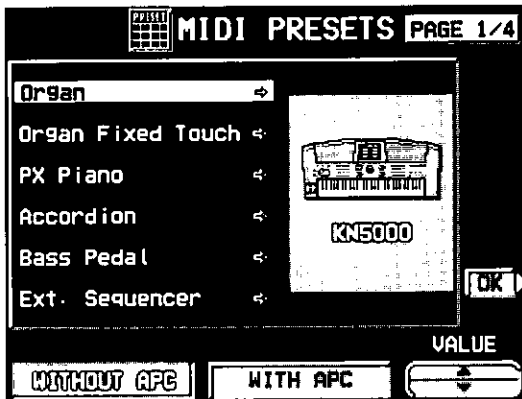

2. Use the VALUE ▲ and ▼ buttons to select the connection setup.
 - The PAGE 1/4 display shows connection setups with this instrument as the SLAVE. And the PAGE 2/4 display shows connection setups with this instrument as the MASTER.
 - The MASTER is the instrument used to transmit data, and the SLAVE is the instrument used to receive the data.
 - Use the buttons below the display to select WITHOUT APC (the AUTO PLAY CHORD is not used) or WITH APC (the performance includes AUTO PLAY CHORD).

3. Press the OK button.

- When the settings have been successfully stored, "COMPLETED!" appears on the display.
- Detailed information about the MIDI PRESETS can be found in the separate "REFERENCE GUIDE" provided.

■ Storing user settings

After you change the MIDI settings, you can store your customized settings in USER preset memories (3 USER memories).

1. Adjust the various MIDI settings.
2. Go to PAGE 4/4 of the MIDI PRESETS display.
 - The display looks similar to the following.

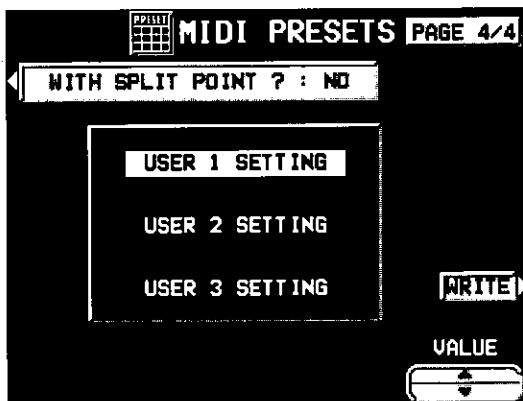

4. Use the WITH SPLIT POINT? button to specify whether or not to also store the keyboard split point (YES/NO).

Notice

When an instrument such as an organ or accordion with separate or divided keyboards dedicated to melody and chords is used as the master instrument, if this instrument's split point is set to a note below the lowest note of the melody keyboard of the master instrument, it is possible to produce melody notes on multiple parts by this instrument's **CONDUCTOR** settings.

- Assign the RIGHT 1 channel as the BASIC CHANNEL for the melody keyboard. Assign the CHORD channel (or if you also wish the played note to be produced, CHORD + LEFT) as the BASIC CHANNEL for the chord keyboard.
- You will also have to specify CONDUCTOR as the RIGHT 1 INPUT for the INPUT/OUTPUT SETTING. (Refer to page 170.)

3. Use the ▲ and ▼ buttons to select the memory in which to store the settings (USER SETTING 1, 2, 3).

5. Press the WRITE button.

▣ Recalling the USER settings

1. Go to PAGE 3/4 of the MIDI PRESETS display.
2. Use the Δ and ∇ buttons to select a number.
3. Press the OK button.

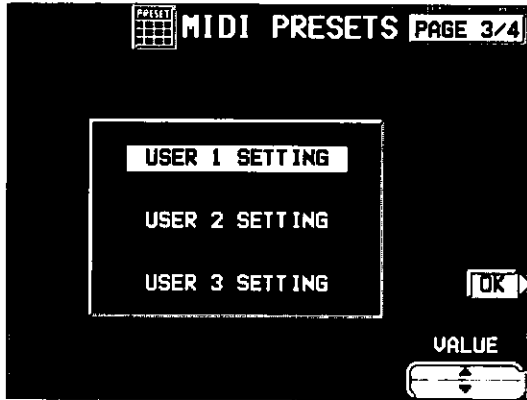

Sysex Bulk Dump

This instrument's internal data such as panel settings, performance data, etc. can be transmitted to and received from another KN5000 or other MIDI equipment with BULK DUMP capability as SYSTEM EXCLUSIVE data.

- Sound is not generated from this instrument during this procedure.
- The operations on this display are executed, even if REALTIME SYSEX is set to OFF on the COMMON SETTING display.

▣ Transmitting

1. Follow the procedure necessary to prepare the receiving instrument for data reception.
2. On the MIDI MENU display, select SYSEX BULK DUMP.
 - The display looks similar to the following.
4. Press the SEND button.
 - During transmission, the transmitting status is shown on the display.
 - You can also receive data with this instrument. After accessing this display on this keyboard, follow the transmission procedure on the transmission side. During reception, the receiving status is shown on the display.
 - If data transmission/reception is unsuccessful, an error message appears on the display. In this case, repeat the procedure from the beginning.

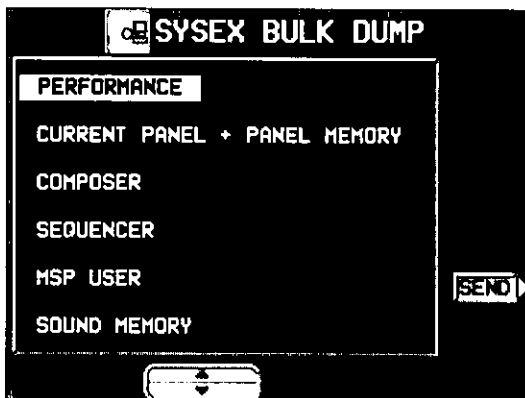

3. Use the Δ and ∇ buttons to select the type of data to transmit.
 - The **SEQUENCER** data for all 10 songs are transmitted at once. You can decrease the time it takes to transmit by deleting beforehand any songs you do not wish to transmit.

General MIDI

GENERAL MIDI (GM) is the standard which enables MIDI data exchange between different models or equipment of different manufacture. Program change numbers and their corresponding sounds, percussion instrument sounds, note numbers, etc. are data compatible between equipment using this standard.

1. On the MIDI MENU display, select GENERAL MIDI.
 - The display looks similar to the following.

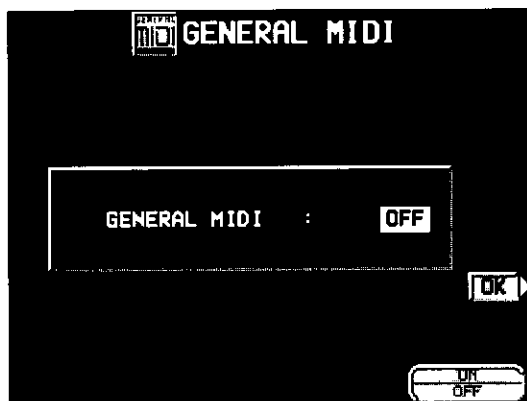

2. Use the ON and OFF buttons to specify whether or not this Keyboard should be compatible with GENERAL MIDI standard instruments.
 - This setting is automatically set to OFF when the power is turned on.
 - If ON is selected, the status of this Keyboard changes to the GENERAL MIDI status, and the sounds and operations which can be selected are limited. In addition, the arrangement of percussion sounds on the keyboard changes. (Refer to the separate "REFERENCE GUIDE" provided.)
 - This setting is automatically set to ON if disk data other than Technics data is loaded.
3. Press the OK button.
 - The confirmation display appears. Press the YES button to execute the function, or press the NO button to cancel the function.
 - If ON was selected, GENERAL MIDI is shown on the normal performance display.
 - When this function is executed, the **SEQUENCER** memory is cleared and the panel settings are reset.
 - If ON is selected, this setting is automatically set to OFF when the power is turned off, and the **SEQUENCER** memory and panel settings are cleared.

Program Change MIDI Out

Use this function to immediately transmit specific PROGRAM CHANGE and BANK SELECT data from this display on a specified MIDI channel.

1. On the MIDI MENU display, select PROG. CHANGE MIDI OUT.

- The display looks similar to the following.

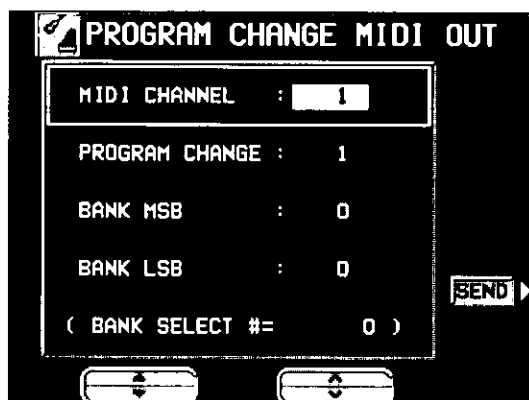

2. Use the Δ and ∇ buttons to select a function.

MIDI CHANNEL:

The MIDI channel to transmit to (1 to 16).

PROGRAM CHANGE:

Specify the PROGRAM CHANGE number to transmit (1 to 128).

BANK MSB:

Specify the BANK SELECT MSB to transmit (0 to 127).

BANK LSB:

Specify the BANK SELECT LSB to transmit (OFF, 0 to 127).

- When set to OFF, neither the LSB nor the MSB are transmitted.

3. Use the \wedge and \vee buttons to change the setting.

4. Press the SEND button.

- The specified data is transmitted.
- The data is unconditionally transmitted regardless of the other settings.

Panel Memory Output

These settings affect the transmission data when the **PANEL MEMORY** buttons are operated.

1. On the MIDI MENU display, select P.MEM OUTPUT.

- The display looks similar to the following.

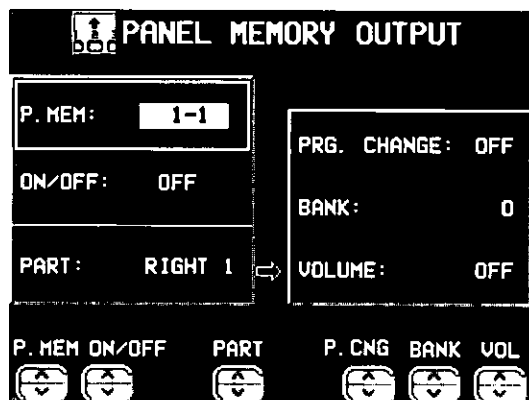

2. Use the P.MEM \wedge and \vee buttons to select a **PANEL MEMORY** number.

3. Use the ON/OFF \wedge and \vee buttons to specify whether the data in the selected **PANEL MEMORY** number is transmitted or not.

4. Use the PART \wedge and \vee buttons to select a part (RIGHT 1, RIGHT 2 or LEFT).

5. Use the P.CNG \wedge and \vee buttons to specify a program change number (0 to 127, or OFF).

6. Use the BANK \wedge and \vee buttons to specify a bank select number (0 to 255).

7. Use the VOL \wedge and \vee buttons to specify the volume (0 to 127, or OFF).

8. Repeat steps 4 to 7 for each part, as necessary.

9. Repeat steps 2 to 8 for each **PANEL MEMORY** number, as necessary.

Computer Connection

These settings are used to select the mode related to MIDI signal flow when a personal computer is connected to the **COMPUTER** terminal of this instrument.

1. Turn off the power to this instrument.
2. Connect a personal computer to the **COMPUTER** terminal on the rear of this instrument. Set the switch to the correct position. (Refer to page 179.)
3. Turn on the power to this instrument.
4. On the MIDI MENU display, select **COMPUTER CONNECTION**.
 - The display looks similar to the following.

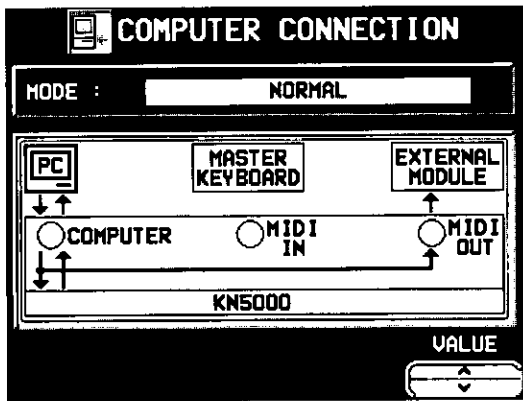

5. Use the VALUE \wedge and \vee buttons to select a mode.

NORMAL:

The normal mode for data exchange.

KN as master:

The mode when this instrument is used as the master keyboard.

KN as slave:

The mode when this instrument is used as a slave instrument.

- The data received through the **MIDI IN** terminal is always transferred and output from the **MIDI THRU** terminal.

MIDI Settings Load Option

Specify how MIDI data is handled when data is loaded from a disk.

1. On the MIDI MENU display, select MIDI SETTINGS LOAD OPTION.
 - The display looks similar to the following.
3. Use the \wedge and \vee buttons to change the setting.
4. Press the OK button.

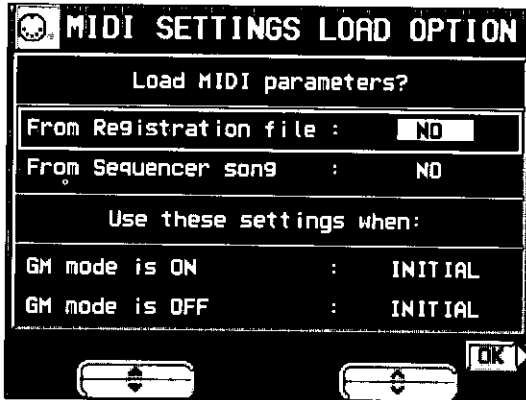

2. Use the \blacktriangle and \blacktriangledown buttons to select an item.

■ Load MIDI Parameters?

From Registration file:

Specify whether MIDI data is also loaded when panel data is loaded (NO/YES).

From Sequencer Song:

Specify whether MIDI data is loaded or changed when **SEQUENCER** data is loaded or when the **SONG** is changed by the **SEQUENCER SONG SELECT**, **SONG COPY** or **TRACK ASSIGN** (NO/YES).

- The MIDI settings are always stored at the start of each recorded **SEQUENCER SONG** and when **PANEL WRITE** is executed. In the initialized state, the MIDI settings are not loaded even when the **SONG** is changed. However, changing this setting to **YES** will cause the stored MIDI settings to also load in these cases.

□ Use these settings when:

GM mode is ON:

Specify how the MIDI settings of this instrument are affected when **GENERAL MIDI ON** data is loaded.

- Select from **INITIAL** (initialized settings), **USER** (MIDI PRESETS) 1, 2 and 3.

GM mode is OFF:

Specify how the MIDI settings of this instrument are affected when **GENERAL MIDI OFF** data is loaded.

- Select from **INITIAL** (initialized settings), **USER** (MIDI PRESETS) 1, 2 and 3.

Initialize

This Keyboard has many settable functions and storable memories. However, you can return the settings and memory to the factory-preset status.

INITIAL

1. Press the **CONTROL** button to turn it on.

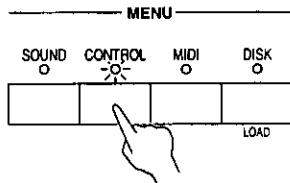

The display changes to the following.



2. Select **INITIAL**.

This display changes to the following.

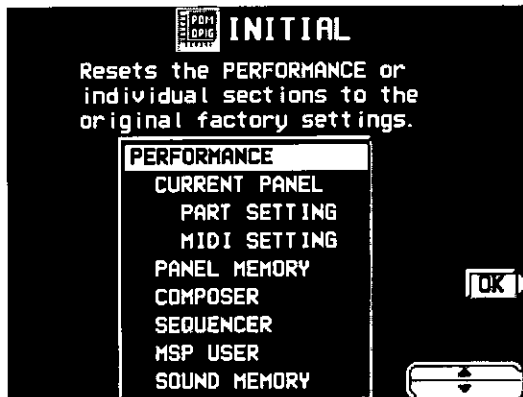

3. Use the **▲** and **▼** buttons to select the desired type of initialization.

PERFORMANCE includes all the items which are listed below it.

4. Press the **OK** button.

The display changes to the confirmation display. Press the **YES** button if you wish to execute the initialization. Press the **NO** button if you wish to cancel the procedure.

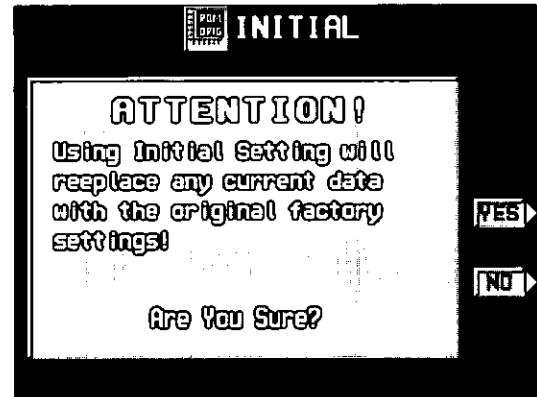

Initialization begins. When initialization is completed, "COMPLETED!" is shown on the display and the Keyboard returns to the normal performance mode.

You can also reset all the instrument settings (excluding RHYTHM CUSTOM and USER MIDI SETTINGS) with the following procedure: Turn off the power to this instrument once. Then, while pressing the three lower left buttons in the **RHYTHM GROUP** section (**MARCH & WALTZ**, **PARTY TIME** and **SHOWTIME & TRAD DANCE**) at the same time, turn the power on again.

About the backup memory and performance data

When the power to this instrument is turned off, the various settings and memory contents of this instrument are maintained in the backup memory as follows:

BACKUP	PERFORM- ANCE	CURRENT PANEL settings	1 week
		PANEL MEMORY	1 week
		SEQUENCER	80 minutes
		COMPOSER (MEMORY contents)	80 minutes
		SOUND MEMORY	1 week
		MSP (USER memories of the MANUAL SEQUENCE PADS)	1 week
		RHYTHM CUSTOM	indefinitely
		USER MIDI SETTINGS (USER memories for the MIDI PRESETS)	indefinitely

- When GENERAL MIDI is ON (the logo is shown on the normal display), the CURRENT PANEL and SEQUENCER data are lost when the power is turned off.
- If you wish to retain the settings and stored memory contents for recall at a later time, store the desired data on a floppy disk. (Refer to page 120.)
- The backup memory does not function until the power has been on for about 10 minutes (except for RHYTHM CUSTOM, USER MIDI SETTINGS, WALLPAPER SETTING).
- The PERFORMANCE data are returned to the initialized state by the initialization procedure but the RHYTHM CUSTOM and USER MIDI SETTINGS are retained.
- MIDI SYSEX deals only with the PERFORMANCE data.
- Data from previous Technics models limited to PERFORMANCE data.

Options and connections

This page shows the optional accessories that are available for your Technics Keyboard. These can make your instrument more versatile and fun to play than it already is. Also indicated are the many possible connections to the rear accessory panel.

Connections

(on the rear panel)

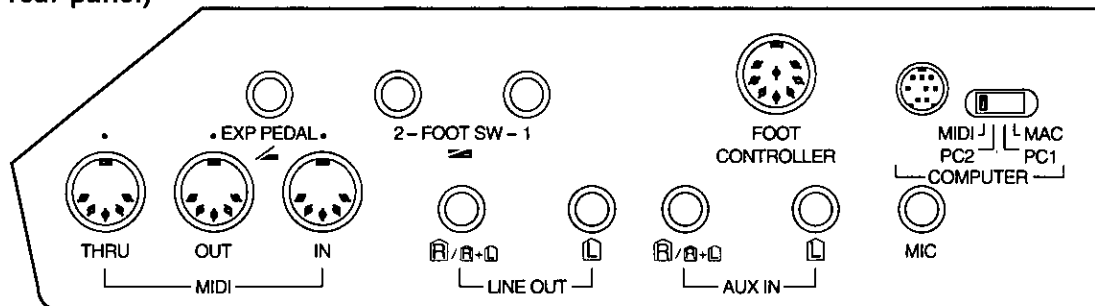

EXP PEDAL

The optional SZ-E2 Expression Pedal (sold separately) can be connected to this terminal to control the volume.

FOOT SW 1, 2

An optional SZ-P1 Foot Switch (sold separately) can be connected to each terminal to control various functions. (Refer to page 161.)

AUX IN (input level 0.5 Vrms, 6 k Ω)

Other instruments such as a sound generator can be connected to this terminal, and the sound will be output from the Keyboard's speakers. To receive monaural sound, connect the other instrument to the **R/R+L** terminal. (Do not connect the **L** terminal.)

LINE OUT (output level 1.5 Vrms, 600 Ω)

By connecting an external high-power amplifier, the sound can be reproduced at a high volume. To output monaural sound, connect the external equipment to the **R/R+L** terminal. (Do not connect the **L** terminal.)

MIDI

These terminals are for connection to another MIDI instrument. (Refer to page 164.)

FOOT CONTROLLER

An optional SZ-FC2 Foot Controller (sold separately) can be connected to this terminal to control various functions. (Refer to page 161.)

MIC

A microphone can be connected to this terminal for voice output through the speakers.

- With the **ENTERTAINER** function, you can change various settings for a performance that uses a microphone. (Refer to page 44.)

COMPUTER

By connecting this terminal to the serial port of a computer, performance data can be exchanged. Use the switch to select the type of computer.

- Be sure that the power to this instrument is turned off when connecting to a computer or when changing the switch setting.

Caution:

Failure to turn off the power before changing the switch setting may result in malfunction.

- When no computer is connected, or when a MIDI interface is used, the switch should be set to **MIDI**.

Connection to a Macintosh series computer

Use an **ACCESSORY CABLE** (SZ-JJAP1: sold separately) to connect the **COMPUTER** terminal of this instrument to the modem port or printer port of a Macintosh Series computer. Set the switch to **MAC**.

- Set the MIDI interface clock of the Macintosh software to 1 MHz.
- Do not remove the core at either end of the cable.

Connection to a PC

Use an **ACCESSORY CABLE** (SZ-JJAT1: sold separately) to connect the **COMPUTER** terminal of this instrument to the RS232C terminal of a PC. Set the switch to **PC2**.

- The MIDI driver included with the cable should be installed in the computer. (Refer to the manual accompanying the cable.)
- Do not remove the core at either end of the cable.

* All product and company names are trademarks or registered trademarks of their respective owners.

Separately sold options



SZ-E2
Expression Pedal



SZ-P1
Foot Switch

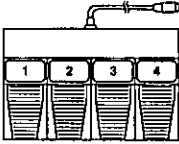

SZ-FC2
Foot Controller

- Be sure to turn off the power before connecting the Foot Controller.

Connecting to a "Vocalist Workstation"

By connecting a "VOCALIST WORKSTATION" VOCAL HARMONY PROCESSOR by Digitech Corp. to this instrument, harmony can be added to the microphone input. The settings for the connection are executed using this instrument's display.

Connection diagram

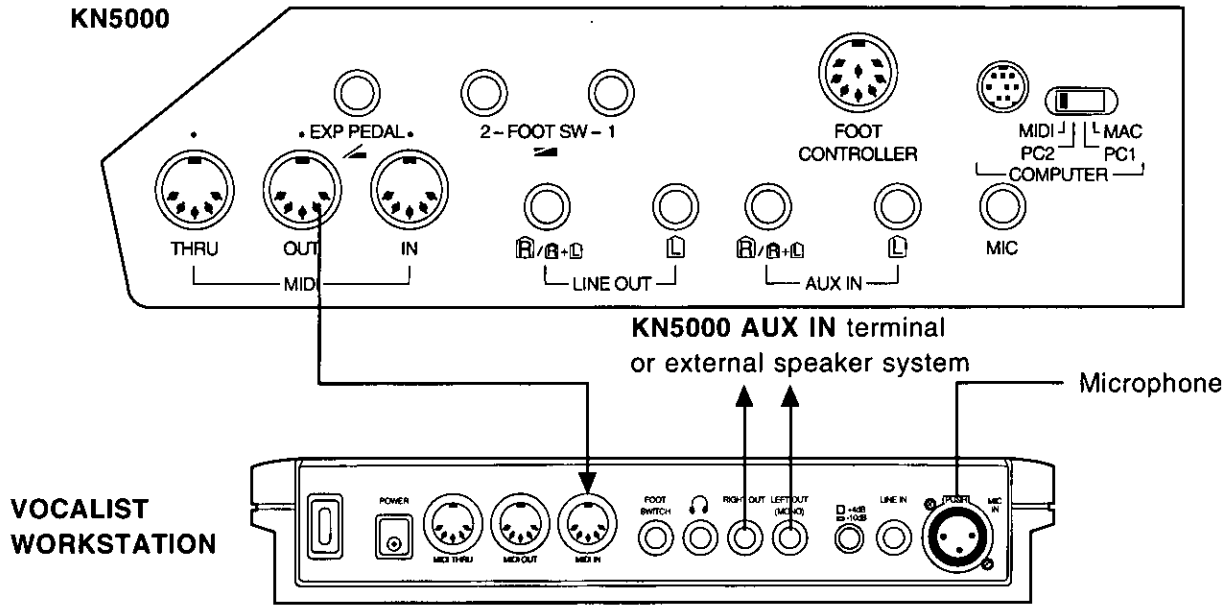

- If sounds are input to the **AUX IN** terminal of the **KN5000**, set the output on the **VOCALIST WORKSTATION** side to a suitable level.

Settings

The settings for connecting are as follows:

1. Press the **ENTERTAINER** button to turn it on.



- The display looks similar to the following.

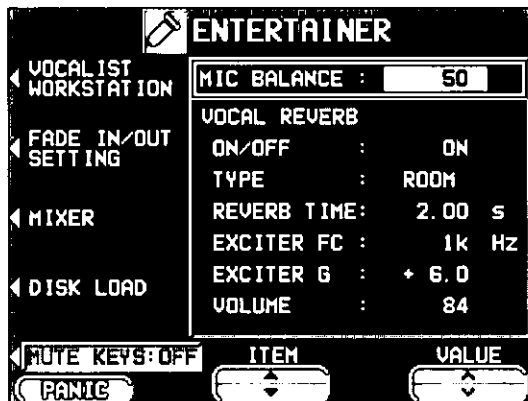

2. Press the **VOCALIST WORKSTATION** button.

- The display looks similar to the following.

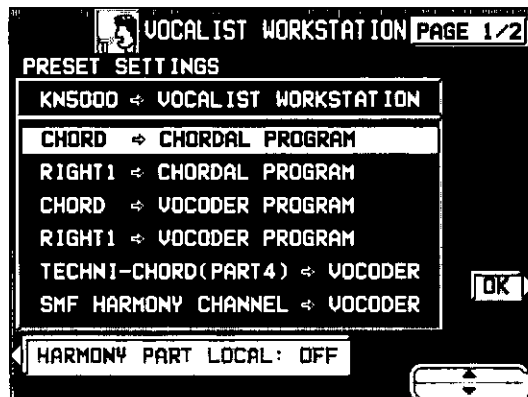

3. Use the Δ and ∇ buttons to select the desired presets.

CHORD→CHORDAL PROGRAM:

The chords of the **AUTO PLAY CHORD** are developed as harmony data in the CHORDAL mode.

RIGHT 1→CHORDAL PROGRAM:

The melody of the RIGHT 1 part is developed as harmony data in the CHORDAL mode.

CHORD→VOCODER PROGRAM:

The chords of the **AUTO PLAY CHORD** are developed as harmony data in the VOCODER mode.

RIGHT 1→VOCODER PROGRAM:

The melody of the RIGHT 1 part is developed as harmony data in the VOCODER mode.

TECHNI-CHORD (PART 4)→VOCODER:

The **TECHNI-CHORD** is developed as harmony data in the VOCODER mode.

- The ORCHESTRATOR becomes PART 4.

SMF HARMONY CHANNEL→VOCODER

The SMF (TUNE 1000) harmony track is developed as harmony data in the VOCODER mode.

- The MIDI OUT of DIRECT PLAY turns ON.

<HARMONY PART LOCAL>

Specify whether the sound for the part which is sent from MIDI output as harmony data is generated from this instrument (ON/OFF).

- This setting is automatically set when one of the above presets is selected; however, it can be changed.

4. Press the OK button.

- The MIDI settings of this instrument and the VOCALIST WORKSTATION settings are automatically set.

■ Detailed settings

The VOCALIST WORKSTATION parameters can be set on the PAGE 2/2 display.

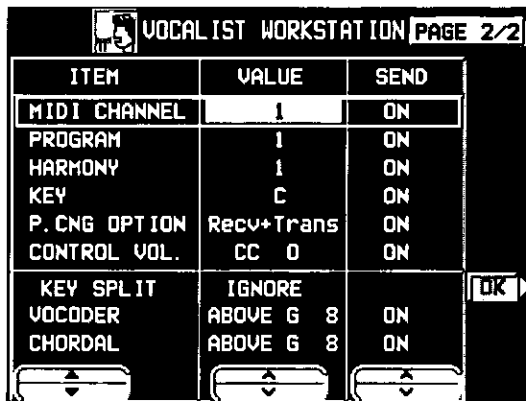

ITEM	VALUE	SEND
MIDI CHANNEL	1	ON
PROGRAM	1	ON
HARMONY	1	ON
KEY	C	ON
P. CNG OPTION	Recv+Trans	ON
CONTROL VOL.	CC 0	ON
KEY SPLIT	IGNORE	
VOCODER	ABOVE G 8	ON
CHORDAL	ABOVE G 8	ON

1. Use the ITEM ▲ and ▼ buttons to select a parameter.
2. Use the VALUE ^ and v buttons to change the setting.
3. Use the SEND ^ and v buttons specify whether or not to send those parameter settings to the VOCALIST WORKSTATION (ON/OFF).
4. Repeat steps 1 to 3 as necessary.
5. Press the OK button.
 - The settings are transmitted to the VOCALIST WORKSTATION
 - If the OK button on PAGE 1/2 was not pressed, the appropriate MIDI CHANNEL settings may not have been executed. In this case, even if the OK button is pressed now, the settings may not be transmitted to the VOCALIST WORKSTATION. If this happens, press the OK button on PAGE 1/2.

Symptoms which appear to be signs of trouble

The following changes in performance may occur in the Technics Keyboard but do not indicate trouble.

	Phenomenon	Remedy
Sounds and effects	The buttons, keys, etc. malfunction.	<ul style="list-style-type: none"> • Turn off the POWER button once, then turn it on again. If this procedure is not successful, turn off the POWER button once. Then, while pressing the three lower left buttons in the RHYTHM GROUP section (MARCH & WALTZ, PARTY TIME and SHOW TIME & TRAD DANCE) at the same time, turn the POWER button on again. (Note that, in this case, all programmable settings, functions and memories return to their factory-preset status.)
	No sound is produced when the keys are pressed.	<ul style="list-style-type: none"> • The MAIN VOLUME is at the minimum setting. Adjust the volume with the MAIN VOLUME control. • The volumes for the selected parts are set to the minimum levels. Use the balance buttons to set the volumes of the relevant parts to appropriate levels. (Refer to page 27.) • The part is muted. (Refer to page 27.) • The LOCAL CONTROL for a part performed on the keyboard is set to OFF. Set the local control to ON. (Refer to page 167.)
	Only percussive instrument sounds are produced when the keyboard is played.	<ul style="list-style-type: none"> • In the SOUND GROUP section, the DRUM KITS button is on.
	The volume is very low when the keyboard is played.	<ul style="list-style-type: none"> • The volume setting in the SEQUENCER contents is very low. Follow the INITIAL procedure to reset the settings. (Refer to page 177.)
	Some sounds cannot be selected.	<ul style="list-style-type: none"> • When the GENERAL MIDI status is set to on, The sounds which can be selected and operation which can be executed are limited. Turn the GENERAL MIDI status off to return the instrument to its normal operation. (Refer to page 173.)
	The sound you hear is different from the sound you selected.	<ul style="list-style-type: none"> • This sometimes occurs when you play back SEQUENCER or COMPOSER data which was created on a different model, or when MIDI data is received from a connected instrument. Select the desired sounds again.
Rhythm	The rhythm does not start.	<ul style="list-style-type: none"> • The DRUMS volume is set to the minimum level. Use the balance buttons to set the DRUMS volume to an appropriate level. • In the RHYTHM GROUP section, a rhythm in CUSTOM with no stored pattern was selected. Select a different rhythm. • A SEQUENCER PLAY button is on. When you are not playing back the SEQUENCER performance, turn off the SEQUENCER PLAY button. • CLOCK is set to MIDI. Set CLOCK to INTERNAL. (Refer to page 168.) • The rhythm does not work when the GENERAL MIDI mode is set to ON. Turn the GENERAL MIDI status OFF to return the instrument to its normal operation. (Refer to page 173.)

	Phenomenon	Remedy
AUTO PLAY CHORD	No sound is produced for the automatic accompaniment.	• In the RHYTHM GROUP section, a rhythm in CUSTOM with no stored pattern was selected. Select a different rhythm.
	No sound is produced for the automatic accompaniment, or only the sounds of some parts are produced.	• An ACCOMP part does not sound if its corresponding volume is set to the minimum level. Use the respective balance buttons to set the ACCOMP 1, 2 and 3 volumes to appropriate levels.
SEQUENCER	Storage is not possible.	• The remaining memory capacity of the SEQUENCER is 0. Follow the SONG CLEAR or TRACK CLEAR procedure to erase the memory. (Refer to pages 88, 94.)
	The playback measure indication is different from when the performance was recorded.	• The number of measures corresponds to the time signature of the rhythm selected at the start of recording. To change the rhythm in the middle of the song, record the rhythm change in the RHYTHM part. (Refer to page 84.)
COMPOSER	Storage is not possible.	• The remaining memory capacity of the COMPOSER is 0.
	Setting the time signature and number of measures is not possible.	• The time signature and number of measures cannot be changed for a pattern which is currently recorded in the COMPOSER . If you wish to change the time signature and/or measure data, first follow the procedure to clear the memory. (Refer to page 102.)
	The playback timing of the rhythm pattern is different from the timing with which it was recorded.	• The QUANTIZE function was on when the pattern was recorded and the timing was automatically corrected. Set the quantize level to a smaller note unit or to OFF when recording. (Refer to page 104.)
Disk Drive	The Disk Drive produces a noise during recording or playback.	• This occurs when the Disk Drive is reading a disk. It does not indicate a problem.
	When the procedure to load from a disk is performed, the contents of the keyboard memory are erased.	• When performing the load operation from a disk, the keyboard memory changes to that of the data loaded from the disk. If you wish to preserve a song which is stored in the keyboard memory, save it on a disk before performing the load procedure. (Refer to page 120.)
MIDI	Data cannot be exchanged through MIDI terminals.	• The switch for the COMPUTER terminal is not set to MIDI . Turn off the power to this instrument and set the switch to MIDI . (Refer to page 179.) • Match the channels on the transmitting side and the receiving side. (Refer to page 167.)
	The sound quavers or is distorted.	• When the COMPUTER terminal or both the MIDI IN and OUT terminals are connected to a computer, depending on the computer software the received data may be sent back to the instrument just as it is. Because of this the sound generated from the keys and the sound generated from the returned data are both produced, causing undesirable effects, such as the sounds canceling each other out, for example. In this case, either change the software settings to prevent received data from being returned, or set the MIDI LOCAL CONTROL to off.

Phenomenon		Remedy
Other	Noise from a radio or TV can be heard.	<ul style="list-style-type: none"> • This sometimes occurs when electrical equipment such as a radio or TV is used near the instrument. Try moving such electrical equipment further away from the instrument. • The sound may be coming from a nearby broadcast station or amateur radio station. If the sound is bothersome, consult your dealer or service center.
	The cabinet becomes warm during use.	<ul style="list-style-type: none"> • This instrument has a built-in power source that heats the cabinet to some degree. This is not an indication of trouble.

Error messages

No.	Contents
00	The data on the disk that you are using is for a different product.
01	An error has occurred while the disk was loading. Please try again!
02	There is no disk in the Disk Drive.
03	The file that you tried to load is empty.
05	An error has occurred while the disk was saving. Please try again!
06	The disk that you are using is write protected. Please remove the write protection and try again.
07	The disk that you are using is full. Please use another disk.
08	An error has occurred while the disk was formatting. The disk that you are using may be faulty. Please try formatting another disk.
10	The data is already copy protected.
20	A problem has occurred with your SEQUENCER Data. This might be due to a damaged or faulty disk.
21	Memory full
22	It is necessary to press PUNCH OUT to complete this procedure.
23	It is impossible to change the time signature because it has already been set in the existing tracks.
24	A rhythm track already exists. It is impossible to assign two tracks to rhythm.
25	It is only possible to change the velocity on a melody track.
26	It is only possible to merge melody tracks. Tracks such as rhythm, chord and control cannot be merged.
27	It is only possible to copy melody tracks. Tracks such as rhythm, chord and control cannot be copied.
28	This song is too long to be saved as a MIDI file.
29	The MIDI file that you have tried to load exceeds the memory capacity of the KN5000 and cannot be played. The SEQUENCER memory has been cleared.

No.	Contents
30	It is not possible to change the time signature or measure length of a COMPOSER pattern after it has been recorded. If you want to proceed, you must first clear the entire COMPOSER pattern.
31	The time signature of the pattern from which you are copying is different from the COMPOSER memory that you are using. Either: Change the time signature of the COMPOSER memory or: Copy from a pattern that has the same time signature
32	Memory full
40	The Identification (ID) code of the system exclusive data received by the KN5000 is for a different product.
41	An error has occurred during system exclusive data reception. The data from the transmitting device may be incomplete. Please try again.
42	An error has occurred during system exclusive transmission. The data has not been received correctly. Please try again.
43	The file that you are trying to load was saved on a previous KN keyboard. It is only possible to load using the "ALL" option.
47	Please select a preset pattern.
54	Please select a USER bank.
55	Special tracks such as CHORD (APC), RHY and CTL exist in the song from which you are copying and are incompatible with the destination song because it is in the GM mode.
56	AUTO PUNCH recording has been unsuccessful because SEQUENCER operation was interrupted before the PUNCH OUT measure was reached.
58	The song that you have tried to load exceeds the KN5000's available memory and cannot be loaded. The selected song memory has been cleared. Please clear existing songs in the instrument's memory using SONG CLEAR to make more memory available, and try again.

Examples of general settings

▣ Discontinue the display background (wallpaper) when the characters are difficult to read.

1. On the CONTROL MENU display, select WALLPAPER SETTING.
2. Press the USER INITIAL button, and press the YES button on the confirmation display.
3. Set all three categories to USER, and press the OK button.
 - The wallpaper changes to an unpatterned background, making the characters easier to read.

▣ Discontinue the messages such as "Are You Sure?" because they are bothersome.

1. On the CONTROL MENU display, select DISPLAY TIME OUT.
2. Set the message categories you do not wish to appear to OFF, and press the OK button.

▣ Retain the sound and rhythm select displays.

1. On the CONTROL MENU display, select DISPLAY TIME OUT.
2. Set the SOUND/RHYTHM SELECT to HOLD, and press the OK button.

▣ Arrange your favorite MUSIC STYLE selections in the desired order.

1. Use the MUSIC STYLIST to select a favorite MUSIC STYLE.
2. Immediately store the settings in the PANEL MEMORY.
 - The style name is also copied.
3. Repeat steps 1 and 2 to store the music styles in the desired order.
4. Press and hold the SET button, and select EXPAND on the PANEL MEMORY MODE display.

▣ Minimize the floppy disk load/save time.

1. Insert a floppy disk into the Disk Drive slot.
2. On the DISK MENU display, select LOAD or SAVE.
3. On the PAGE 2 (LOAD OPTION/SAVE OPTION) display, set unessential data to NO.
4. Press the LOAD/SAVE button.
 - In the initialized state, all the PERFORMANCE data is selected to be saved, and all the saved data is selected to be loaded. In order to avoid unnecessarily large data size and/or to shorten the load time, it is suggested that you use this method to collectively save only the necessary data. Then when you load data from the disk, only the data you selected to save is loaded without your having to access the LOAD OPTION.
 - The SAVE OPTION allows only BANK 1 of the PANEL MEMORY to be saved. When data is loaded, only the BANK 1 data is overwritten; the other banks are not affected.

▣ Name a floppy disk.

1. Format a floppy disk.
2. On the DISK NAMING display, enter a name.
 - The current contents of the disk are erased when the disk is formatted.

▣ Use part of commercially sold GM (SMF) song data as a COMPOSER pattern.

1. On the SMF LOAD display, set LOAD AS to GM→TECH, and load the song to the SEQUENCER.
 - The sound numbers, drum kit instrument arrangement, octave, volumes, etc. for GM are automatically changed to the Technics standard settings.
2. Use the SEQ TO COMPOSER COPY of the COMPOSER, to copy the desired portion of the loaded data to the COMPOSER.
 - You can use the TRANSPOSE function on this display to adjust the octave.

■ **Switch the TREMOLO SLOW/FAST of the DIGITAL DRAWBAR without accessing the DIGITAL DRAWBAR display.**

On the CONTROL MENU, for FOOT CONTROLLERS, assign the ROTARY SLOW/FAST function to the desired FOOT SWITCH.

For MANUAL SEQUENCE PADS, select Control Preset 1 Bank, and press pad 1.

■ **Pretend to play the keyboard while playing back the SEQUENCER.**

Press the ENTERTAINER button to turn it on, and set the MUTE KEYS to ON.

- Setting MUTE KEYS to ON will disable this instrument's keyboard and wheels.

■ **Block storing of MIDI settings at beginning of each SONG stored in the SEQUENCER.**

The MIDI settings for each part or for parts in common are stored at the start of each recorded SEQUENCER SONG and when PANEL WRITE is executed. Normally, these MIDI settings are not recalled when data is loaded; however, the setting can be changed to allow these MIDI settings to be loaded.

1. On the MIDI SETTING LOAD OPTION display of the MIDI MENU, set "From Sequence Song" to YES.
2. After adjusting the MIDI settings, follow the procedure to record in the SEQUENCER.
3. If you wish to change and store the MIDI settings after recording in the SEQUENCER, change the settings and then execute the PANEL WRITE function.
 - Load the MIDI settings after selecting a different SONG, after using SEQUENCER SONG LOAD to load from a floppy disk, after executing SONG COPY to copy to the currently selected SONG, etc.

■ **Specify directly PROGRAM CHANGE NUMBERS of connected external MIDI equipment.**

On the PROG. CHANGE MIDI OUT display of the MIDI MENU, set each parameter, and press the SEND button.

■ **Use the PANEL MEMORY to switch settings and connections to VOCALIST WORKSTATION (sold separately, manufactured by Digitech Corp.)**

1. Press the ENTERTAINER button to turn it on, and press the VOCALIST WORKSTATION button.
2. Change the settings on the VOCALIST WORKSTATION display.
3. Store the settings in the PANEL MEMORY.
 - The VOCALIST WORKSTATION settings and the MIDI settings are both stored.
4. Set the PANEL MEMORY MODE to EXPAND.
 - When the VOCALIST of the EXPAND MODE FILTER is set to ON, the PANEL MEMORY can be used to change the VOCALIST WORKSTATION settings. When MIDI is set to ON, the PANEL MEMORY can be used to change the MIDI settings of this instrument.
 - If a VOCALIST WORKSTATION is again connected and the MIDI channels do not match, automatic setting is not executed. In this case, on PAGE 1/2 of the VOCALIST WORKSTATION display, select one of the presets, and press the OK button to effect automatic MIDI CHANNEL matching.

Index

A	
ACOUSTIC ILLUSION	41
ACCORDION REGISTER	35
AFTER TOUCH SET	89
AMPLITUDE	150
APC CONTROL	169
AUTO PLAY CHORD	53
AUTO PLAY CHORD INPUT	170
AUTO PLAY CHORD OUTPUT	170
AUX IN	179

B	
BACKUP	178
Backup memory	178
BANK	46
BANK VIEW	63
BEAT	51
BEND RANGE SET	132

C	
CHORD STEP RECORD	82
CLOCK	168
COMMON SETTING	169
COMPOSER	99
COMPUTER CONNECTION	175
CONDUCTOR	36
Connections	179
CONTRAST	31
CONTROL	159
CONTROL MESSAGES	168
CONTROLLER	154
COUNT INTRO	52
CREATE	69
CUSTOM	99
CUSTOM COPY	109

D	
DEMO	10
DIGITAL DRAWBAR	33
DIGITAL EFFECT	39
DIGITAL REVERB	40
DIRECT PLAY	117
Disk Drive	111
DISK	113
Display	27
DISPLAY TIME OUT	162
DISPLAY HOLD	31
DRUM EDIT	91
DRUM PATTERN OUTPUT	170
DRUMS TYPE	169
DSP EFFECT	40

E	
EASY COMPOSER	101
EASY EDIT	140
EASY REC	71

EDIT	69
ENTERTAINER	44
EQUALIZER	137
Error messages	187
EXIT	31
EXP PEDAL	179
Expression Pedal	179

F	
FADE IN/OUT	56
FILL IN	52
FILTER	147
FINGERED	54
FLOPPY DISK FORMAT	120
FOOT CONTROLLERS	161
FOOT SW 1, 2	179
Foot Switch	179

G	
GENERAL MIDI	165
GLIDE	161

H	
Headphones	8
HELP	31

I	
Initialize	177
INPUT/OUTPUT SETTING	170
INTRO & ENDING	52
INTRO, FILL IN, ENDING	169

K	
KEY SCALING	135
KEY SHIFT	131

L	
LANGUAGE SELECT	31
LEFT HOLD	138
LINE OUT	179
LOAD	114
LOCAL (MIDI)	167

M	
MAIN VOLUME	9
MANUAL SEQUENCE PADS	46
MASTER TUNING	134
MEASURE COPY	96
MEASURE ERASE	97
MEASURE & TIME SIGNATURE	103
MEMORY, AUTO PLAY CHORD	55
MEMORY, COMPOSER	105
MEMORY, SOUND GROUP	156
MEMORY WRITE	155
Menu	29
Metronome	73

MIDI	164
MIDI PRESETS	171
MIDI SETTING LOAD OPTION	176
MIXER	133
MODULATION	41
Music stand	8
MUSIC STYLIST	60
MUSIC STYLE ARRANGER	62
MUTE	27

N

NOTE EDIT	90
NOTE ONLY	169

O

OCTAVE (MIDI)	167
ON BASS	55
ONE FINGER	54
ONE TOUCH PLAY	59
Options	180
OTHER PARTS/TR	28
OVERALL TOUCH SENSITIVITY	160

P

PAGE	28
PAN	130
PANEL MEMORY	63
PANEL MEMORY OUTPUT	174
PART SELECT	32
PART SETTING	129
PATTERN COPY	107
PERFORMANCE	178
PIANIST	54
PITCH	144
PITCH BEND	41
PITCH BEND RANGE	132
POWER	8
PROGRAM CHANGE MODE	169
PUNCH RECORD	78

Q

QUANTIZE, COMPOSER	105
QUANTIZE, SEQUENCER	92

R

R1/R2 OCTAVE	38
REALTIME COMMANDS	168
REALTIME RECORD	72
REALTIME SYSEX	169
RECORD SETTING	103
REVERB	40
RHYTHM GROUP	50
RIGHT 1 INPUT	170

S

SAVE	120
SET	63
SEQUENCER	67
SEQUENCER EDIT	89
SEQUENCER PLAY	75

SEQUENCER RESET	75
SEQUENCER SONG SAVE	123
SINGLE LOAD	115
SMF LOAD	115
SMF SAVE	124
SONG CLEAR	88
SONG SELECT/NAMING	77
SOUND	128
SOUND ARRANGER	58
SOUND EDIT	139
SOUND GROUP	32
Specifications	192
SPLIT POINT	37
Standard MIDI File	112
START/STOP	51
STEP RECORD	80
STEP RECORD: CHORD	82
STEP RECORD: RHYTHM	84
STOP/RECORD	47
SUSTAIN	39
SYNCHRO & BREAK	51
SYSEX BULK DUMP	172

T

TAP TEMPO	51
TECHNI-CHORD	43
TEMPO/PROGRAM	51
TONE	141
TONE SELECT	141
TONE LAYER	143
Touch Response	160
TRACK ASSIGN	86
TRACK CLEAR	94
TRACK MERGE	95
TRANSPOSE	42
Troubleshooting	184
TUNING	131

V

VARIATION	50
VELOCITY CHANGE	94
VOCALIST WORKSTATION	181
VOLUME	130
Volume balance	27

W

WALLPAPER SETTING	163
WRITE	155

Specifications

	SX-KN5000
KEYBOARD	61 KEYS (WITH INITIAL/AFTER TOUCH)
SOUND GENERATOR	PCM
MAXIMUM NUMBER OF NOTES PRODUCED SIMULTANEOUSLY	64 NOTES
SOUNDS	290 SOUNDS + 15 DRUM KITS GROUP PIANO, GUITAR, STRINGS & VOCAL, BRASS, FLUTE, SAX & REED, MALLETT & ORCH PERC, WORLD PERC, ORGAN & ACCORDION, ORCHESTRAL PAD, SYNTH, BASS, GM SPECIAL, DRUM KITS
	DIGITAL DRAWBAR (DRAWBARS 16', 5-1/3', 8', 4', 2-2/3', 2', 1-3/5', 1-1/3', 1', 2 SOUNDS) ACCORDION REGISTER (2 TYPES x 10 SOUNDS)
EFFECTS	DIGITAL EFFECT, DSP EFFECT, SUSTAIN, DIGITAL REVERB, ACOUSTIC ILLUSION
PART SELECT	RIGHT 1, RIGHT 2, LEFT
TRANSPOSE	G-C-F#
RHYTHM	200 RHYTHMSx4 VARIATIONS GROUP STANDARD ROCK, R&ROLL & BLUES, POP & BALLAD, FUNK & FUSION, SOUL & MODERN DANCE, BIG BAND & SWING, JAZZ COMBO, US TRAD, COUNTRY, LATIN, MARCH & WALTZ, PARTY TIME, SHOW TIME & TRAD DANCE, WORLD
CONTROLS	MAIN VOLUME, BALANCE, MUTE, CONDUCTOR, START/STOP, INTRO & ENDING 1, INTRO & ENDING 2, FILL IN 1, FILL IN 2, COUNT INTRO, SYNCHRO & BREAK, TEMPO/PROGRAM, TAP TEMPO, FADE IN/OUT, SPLIT POINT, R1/R2 OCTAVE
MANUAL SEQUENCE PADS	19 BANKS x 6 (USER BANKS x 2 STORAGE CAPACITY APPROX 1800 NOTES, COMPILER BANKS x 2) STOP/RECORD
AUTO PLAY CHORD	ONE FINGER, FINGERED, PIANIST, MEMORY, ON BASS, MUSIC STYLE ARRANGER, SOUND ARRANGER
MUSIC STYLIST	<input type="radio"/> (MUSIC STYLIST/ONE TOUCH PLAY)
TECHNI-CHORD	<input type="radio"/>
PANEL MEMORY	10 BANKS x 8, SET, NEXT BANK, BANK VIEW
ENTERTAINER	<input type="radio"/>
SEQUENCER	16 TRACKS RESOLUTION 96 PULSES PER QUARTER-NOTE STORAGE CAPACITY APPROX 40000 NOTES (10 SONGS MAX) INPUT MODES EASY RECORD, REALTIME RECORD, STEP RECORD FUNCTIONS CREATE, EDIT
COMPOSER	5 PARTS BASS, ACCOMP 1, ACCOMP 2, ACCOMP 3, DRUMS STORAGE CAPACITY APPROX 10000 NOTES INPUT MODES EASY COMPOSER, REALTIME RECORD, STEP RECORD FUNCTIONS PATTERN COPY, CUSTOM COPY, SEQ TO COMPOSER COPY, LOAD SINGLE COMPOSER, BEND RANGE SET MEMORY 3 BANKS x 10 (VARIATION 1-4, INTRO 1, 2, FILL IN 1, 2, ENDING 1, 2) CUSTOM 20 MEMORIES
DISK	LOAD, SAVE, DIRECT PLAY, SONG MEDLEY, DISK TOOLS, PREFERENCES
CONTROL	INITIAL, FOOT CONTROLLERS, OVERALL TOUCH SENSITIVITY, DISPLAY TIME OUT, PANEL MEMORY MODE, MUSIC STYLE ARRANGER MODE, WALLPAPER SETTING
SOUND	PART SETTING (VOLUME, SUSTAIN, EFFECT, PAN, KEY SHIFT, TUNING, PITCH BEND RANGE, OTHERS), MIXER, MASTER TUNING, KEY SCALING, TECHNI-CHORD, LEFT HOLD, REVERB, DSP EFFECT, REVERB & EQ PRESETS, EQUALIZER, ACOUSTIC ILLUSION SOUND EDIT EASY EDIT, TONE SELECT, TONE LAYER, PITCH, FILTER, AMPLITUDE, DIGITAL EFFECT, CONTROLLER 2 BANKS x 20 MEMORIES, 1 USER DRUM KIT

SX-KN5000	
MIDI	PART SETTING, CONTROL MESSAGES, REALTIME MESSAGES, COMMON SETTING, P MEM OUTPUT, MIDI PRESETS, INPUT/OUTPUT SETTING, SYSEX BULK DUMP, GENERAL MIDI, PROG CHANGE MIDI OUT COMPUTER CONNECTION, MIDI SETTINGS LOAD OPTION
EXTERNAL MEMORY	BUILT-IN 3.5 inch FLOPPY DISK DRIVE FOR 2HD (1.44 MB), 2DD (720 KB)
DISPLAY	LCD PAGE, CONTRAST, EXIT, DISPLAY HOLD
HELP	○
DEMO	○
TERMINALS	PHONES, LINE OUT (R/R+L, L), AUX IN (R/R+L, L), MIC, FOOT SW 1, 2, FOOT CONTROLLER, EXP PEDAL, MIDI (IN, OUT, THRU), COMPUTER
OUTPUT	66 W (18 W × 2 FOR MID/HIGH, 30 W × 1 FOR BASS)
SPEAKERS	12 cm × 2, 6.5 cm × 2 FOR MID/HIGH 14 cm × 1 FOR BASS
POWER REQUIREMENT	195 W, 100 W (CANADA), 85 W (U S A AND MEXICO)
	AC120/220/240V 50/60 Hz AC120V 60 Hz (NORTH AMERICA AND MEXICO) AC230-240V 50/60 Hz (EUROPE, AUSTRALIA, NEW ZEALAND, SINGAPORE AND PHILLIPPINES)
DIMENSIONS (W×H×D)*	106.2 cm × 17.4 cm × 41.4 cm (41-13/16" × 6-27/32" × 16-5/16")
NET WEIGHT*	15.1 kg (33.3 lbs)
ACCESSORIES	MUSIC STAND, AC CORD

* Without MUSIC STAND

● Design and specifications are subject to change without notice

PANASONIC CONSUMER ELECTRONICS COMPANY
DIVISION OF MATSUSHITA ELECTRIC CORPORATION OF AMERICA
One Panasonic Way, Secaucus, New Jersey 07094

Printed in Japan