

XV-5080

128 VOICES **8x EXPANSION/SAMPLE PLAYBACK**

QUICK START

Thank you for purchasing the Roland XV-5080 synthesizer module.

Before using this unit, carefully read the sections entitled: "IMPORTANT SAFETY INSTRUCTIONS" (Owner's manual p. 2), "USING THE UNIT SAFELY" (Owner's manual p. 3, 4), and "IMPORTANT NOTES" (Owner's manual p. 5). These sections provide important information concerning the proper operation of the unit. Additionally, in order to feel assured that you have gained a good grasp of every feature provided by your new unit, Owner's Manual and Quick Start should be read in its entirety. The manual should be saved and kept on hand as a convenient reference.

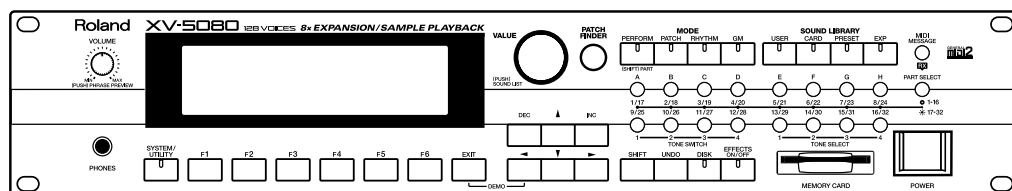

The guide comprises three sections, a "Quick Start" manual, an "Owner's Manual" and a "Q&A, Sound List."

The "Quick Start" manual (this volume) explains the XV-5080's basic functions using examples that are clear and easy to grasp. Read this volume first.

In addition to the XV-5080's basic operations, the "Owner's Manual" provides descriptions of more advanced uses and applications. When referring to the Owner's Manual, you can find the information you are looking for by checking the Table of Contents, and Index in each page.

The "Q&A, Sound List" contains frequently asked questions about the XV-5080, along with answer to those questions.

* *The display screens printed in this owner's manual are based on the factory settings. However, please be aware that in some cases they may differ from the actual factory settings.*

Contents

Getting Ready to Play	3
Installing the Wave Expansion Board	3
Precautions to Observe When Installing Wave Expansion Boards	3
Installing the Wave Expansion Board (SRX/SR-JV80 Series)	4
Installation de la carte d'extension Wave (French language for Canadian Safety Standard)	7
Connecting to MIDI Devices and Audio Equipment	11
Turning the Power On and Off	12
Restoring the Factory Settings (Factory Reset)	13
Listening to the Demo Songs	14
Try Out the Sounds	15
Playing Patches (Phrase Preview Function)	15
Selecting Patches	16
Selecting Categories (Patch Finder Function)	16
Selecting from the Sound List	18
Making Selections with Basic Operations	19
Switching Modes	20
Selecting Sound Libraries	21
Playing Sounds Using a MIDI Keyboard	22
Connecting a MIDI Keyboard	22
Setting the MIDI Channels	22
Playing Multiple Layered Patches (Layer)	24
Selecting Performance "PR-B:01 Dulcimar&Gtr"	24
Turning a Part On or Off	25
Assigning a different Patch to a Part	26
Changing the MIDI Reception Channel of Each Part	27
Having Different Patches Play In Separate Ranges of the Keyboard (Split)	28
Selecting a Performance "PR-B:29 Organ/Lead"	28
Setting the Note Range of Each Part	29
Try Using an External MIDI Device to Switch Patches and Other Settings	30
Using an External MIDI Device to Switch Patches and Rhythm Sets	30
Using an External MIDI Device to Switch Performances	33
Turning Effects On and Off	35
Let's Play Sounds From a Sampler Library	37
Installing the SIMM (Memory Module)	37
Cautions When Installing SIMM	37
Removing SIMMs	40
Confirming That the SIMM Is Properly Installed	40
Augmenter la modules SIMM (French language for Canadian Safety Standard)	41
Enlever une carte modules SIMM	44
Assurez-vous que les modules SIMM sont installés correctement	44
Connecting the CD-ROM Drive	45
Loading Sampler Libraries (Patches)	46
Playing Back Sampler Libraries (Patches)	48
Let's Make a List of Your Favorite Patches	49
Registering a Patch in the FAVORITE LIST	49
Selecting Patches from the FAVORITE LIST	51
Using the XV-5080 in Live Performance	52
Using the XV-5080 with Another Synthesizer to Play Sounds	52
Using an External MIDI Device to Change Effects in the Multi-Effects	52
For More Advanced Use of the XV-5080	54

Getting Ready to Play

Installing the Wave Expansion Board

The XV-5080 can be further expanded with the installation of up to eight optional wave expansion boards (up to four SRX Series boards and four SR-JV80 Series boards). Wave data is stored in these wave expansion boards. Also stored are Patches and Rhythm Sets that use the Wave data from the wave expansion boards, allowing these to be called up directly for use.

Precautions to Observe When Installing Wave Expansion Boards

- To avoid the risk of damage to internal components that can be caused by static electricity, please carefully observe the following whenever you handle the board.
 - Before you touch the board, always first grasp a metal object (such as a water pipe), so you are sure that any static electricity you might have been carrying has been discharged.
 - When handling the board, grasp it only by its edges. Avoid touching any of the electronic components or connectors.
 - Save the bag in which the board was originally shipped, and put the board back into it whenever you need to store or transport it.
- Use a Philips screwdriver that is suitable for the size of the screw (a number 2 screwdriver). If an unsuitable screwdriver is used, the head of the screw may be stripped.
- To remove the screws, rotate the screwdriver counterclockwise. To tighten the screws, rotate the screwdriver clockwise.



- When installing Wave Expansion Boards, remove only the specified screws.
- Be careful that the screws you remove do not drop into the interior of the XV-5080.
- Do not leave the top cover in a detached state. Be sure to reattach it after the Wave Expansion Boards have been installed.
- Do not touch any of the printed circuit pathways or connection terminals.
- Be careful not to cut your hand on the edge of the installation bay.
- Never use excessive force when installing a circuit board. If it doesn't fit properly on the first attempt, remove the board and try again.
- When circuit board installation is complete, double-check your work.

Getting Ready to Play

Wave expansion boards (SR-JV80 Series and SRX Series; sold separately) are installed after removing the cover at the top of the unit. Insert SRX Series boards in the EXP-E through -H slots, and SR-JV80 Series boards in the EXP-A through -D slots.

Installing the Wave Expansion Board (SRX/SR-JV80 Series)

1 Before installing any Wave Expansion Board, turn off the power on the XV-5080 and all devices connected to it.

2 Remove only the top panel screws indicated in the following figure.

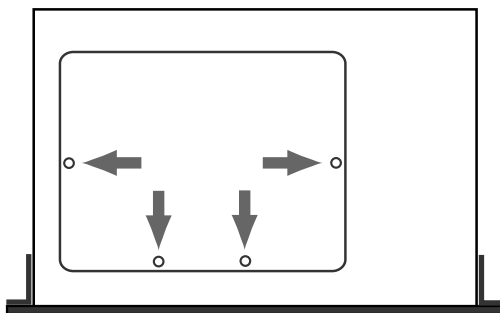

3 Remove the cover.

4 Position the board holders as shown in the illustration.

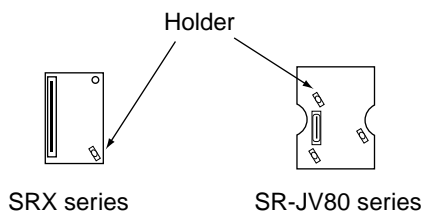

- 5** Slots are provided inside the XV-5080 for SRX Series and SR-JV80 Series boards. Referring to the diagram below, plug the wave expansion board's connector into the connector at the wave expansion board slot, and simultaneously insert the board holder into the hole in the Wave expansion board.

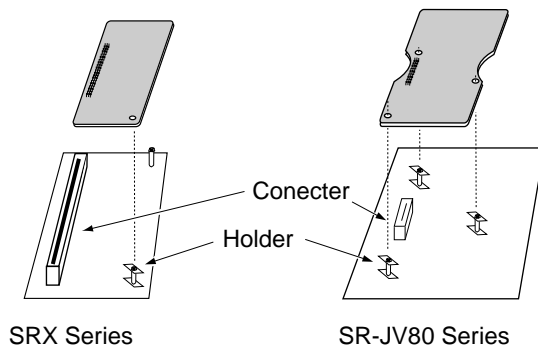

- 6** Use the Installation Tool supplied with the Wave Expansion Board to turn the holders in the LOCK direction, so the board will be fastened in place.

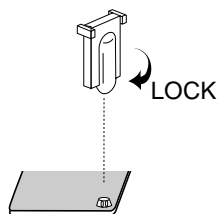

- 7** Use the screws that you removed in step 2 to fasten the cover back in place.
This completes the installation of the wave expansion board.

Getting Ready to Play

Next, check to make sure the board has been installed properly.

1 Turn on the power, as described in “Turning On the Power” (p. 12).

2 Press the [SYSTEM] button, getting the indicator to light, and then press the [F6 (Info)] button.

The System Information page will appear.



* If the indicator is blinking, you are in Utility mode. Press the [SYSTEM/UTILITY] button once again, so the indicator is steadily lit.

3 Verify that the name of the Wave Expansion Board is displayed next to the slot name.

If no board has been installed, or if the wave expansion board is not being recognized properly, “-----” appears in the display.

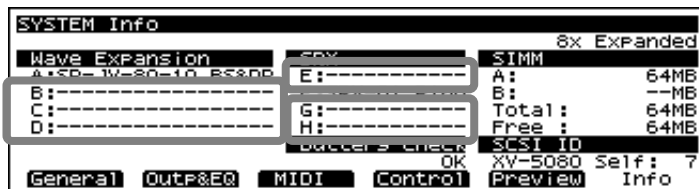

* Should you see the above, it's likely that the Wave Expansion Board is not being recognized properly. Use the procedure in “Turning Off the Power” (p. 12) to turn the power off, then reinstall the wave expansion board correctly.

Installation de la carte d'extension Wave (French language for Canadian Safety Standard)

Les cartes d'extension Wave contiennent des données Wave, aussi bien que des morceaux musicaux et des ensembles rythmiques utilisant ces données, auxquelles on peut directement accéder dans la zone temporaire et les faire jouer.

Précautions lors de l'installation de la carte d'extension Wave

- Pour éviter tout dommage des composants internes pouvant provenir de l'électricité statique, veuillez suivre les conseils suivants quand vous installez la carte.
 - Avant de toucher la carte, saisissez toujours un objet métallique (tuyau d'eau ou autre) pour être sûr que l'électricité statique se décharge.
 - Quand vous saisissez la carte, prenez-la par les bords. Évitez de toucher les composants électroniques ou les connecteurs.
 - Conservez le sac dans lequel la carte était emballée et remettez la carte dedans pour l'expédier ou l'entreposer.
- Utiliser un tournevis cruciforme correspondant à la taille de la vis (un tournevis numéro 2). En cas d'utilisation d'un tournevis inapproprié, la tête de la vis pourrait être endommagée.
- Pour enlever les vis, tourner le tournevis dans le sens contraire des aiguilles d'une montre. Pour resserrer, tourner dans le sens des aiguilles d'une montre.



- Lors de l'insertion de la carte d'extension Wave, enlevez seulement les vis indiquées dans les instructions.
- Veillez à ne pas laisser tomber de vis dans le châssis du XV-5080.
- Ne pas laisser le panneau de protection avant détaché. S'assurer de l'avoir rattacher après avoir installé le disque dur.
- Ne touchez aucun des circuits imprimés ni les bornes de connexion.
- Veillez à ne pas vous couper les doigts sur le bord de l'ouverture d'installation.
- Ne jamais forcer quand vous installez une carte de circuits. Si la carte ne rentre pas correctement, ressortez-la et ressayer.
- Quand la carte est installée, vérifiez si l'installation est correcte.

Getting Ready to Play

French language

for Canadian Safety Standard

Pour installer une carte d'extension (vendue en option dans les séries SR-JV80 et SRX), détacher la plaque du dessus. La carte de série SRX s'installe dans l'emplacement EXP-E-H et la carte de série SR-JV80, dans l'emplacement EXP-A-D.

1 Avant d'installer la carte d'extension, éteindre le XV-5080 et tous les appareils qui y sont reliés.

2 N'enlever que les vis spécifiées sur le schéma suivant.

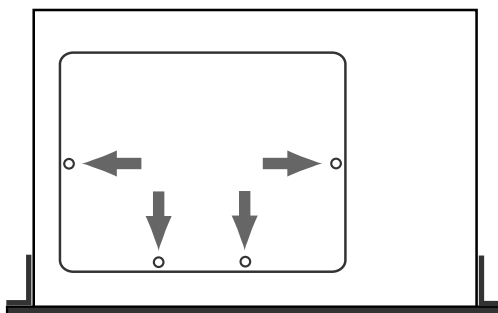

3 Enlever la plaque protectrice.

4 Orienter le support à carte tel qu'indiqué sur le schéma.

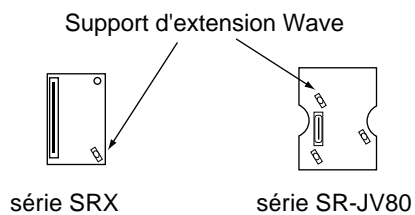

- 5** Dans l'appareil, vous trouverez des emplacements pour carte à extension de série SRX et SR-JV80. En vous référant au schéma ci-dessous, insérer le connecteur de la carte d'extension à l'emplacement correspondant tout en enfonçant simultanément le support à carte dans les trous de celle-ci.

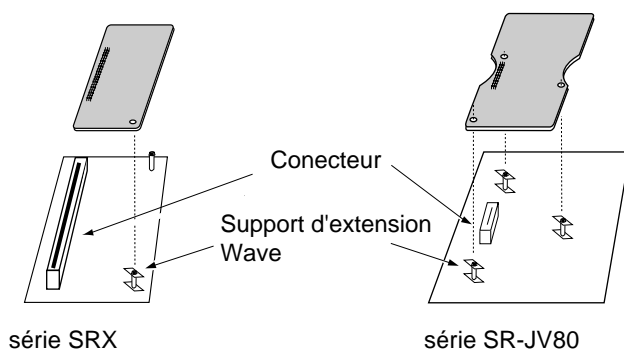

- 6** À l'aide de l'outil fourni à cet effet avec la carte, faire tourner en position "LOCK" le support à carte afin de bien la fixer.

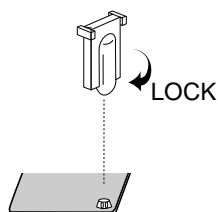

- 7** Remettre la plaque à sa place et la fixer à l'aide des vis enlevées à l'étape 2.

Ceci complète l'installation de la carte d'extension.

Getting Ready to Play

French language

for Canadian Safety Standard

S'assurer ensuite que la carte a été installée correctement.

1 Mettre l'appareil sous tension, comme indiqué dans "Mise sous tension" (p. 12).

2 Appuyer sur la touche [SYSTEM] de manière à allumer le témoin et appuyer sur le bouton [F6 (Info)].

La page d'information du système apparaît.



* Si le témoin clignote, le mode Utilitaire est utilisé. Appuyer une nouvelle fois sur le bouton [SYSTEM/UTILITY] pour que le témoin reste allumé.

3 Vérifier si le nom de la carte d'extension Wave est indiqué à côté du nom de créneau.

Si aucune carte n'est installée, ou si la carte d'extension Wave n'est pas reconnue correctement, "-----" apparaîtra sur l'afficheur.



* Le cas échéant, c'est probablement que la carte d'extension n'est pas reconnue correctement. Procéder comme indiqué dans "Mise hors tension" (p. 12) pour éteindre l'appareil et réinstaller la carte d'extension correctement.

Connecting to MIDI Devices and Audio Equipment

The XV-5080 does not contain an amp or speaker. To hear sound, you will need to connect it to a keyboard amp or audio system, or connect headphones. Refer to the following figure when connecting the XV-5080 with external devices.

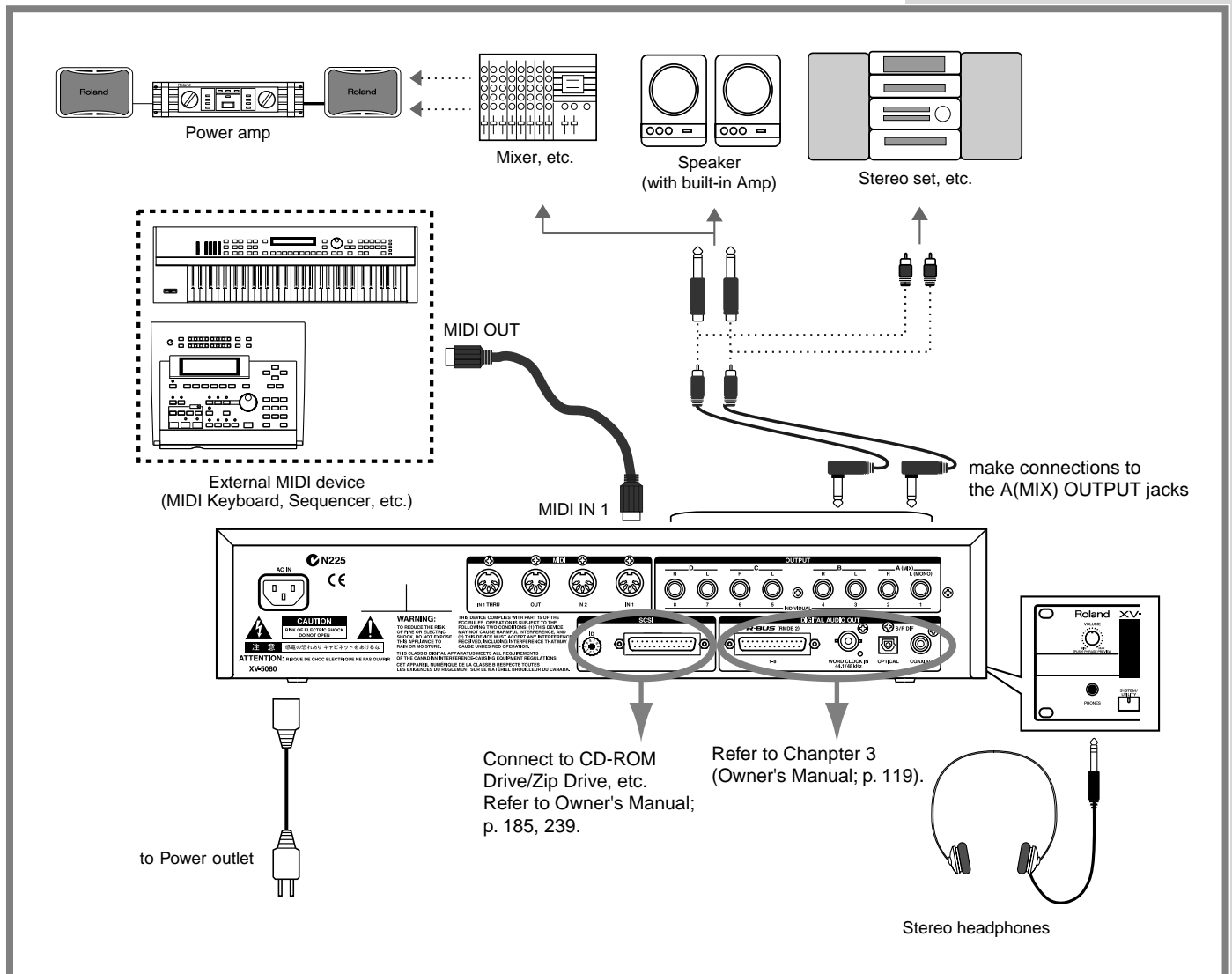

- 1 Before you make connections, make sure that power is turned off for all devices.
- 2 Connect supplied AC power cable to the XV-5080, and plug the other end into an AC power outlet.
- 3 Connect audio and MIDI cables as shown in the diagram. If you are using headphones, plug them into the PHONES jack.

NOTE

To prevent malfunction and/or damage to speakers or other devices, always turn down the volume, and turn off the power on all devices before making any connections.

Turning the Power On and Off

Turning On the Power

Once the connections have been completed (p. 11), turn on power to your various devices in the order specified. By turning on devices in the wrong order, you risk causing malfunction and/or damage to speakers and other devices.

NOTE

This unit is equipped with a protection circuit. A brief interval (a few seconds) after power up is required before the unit will operate normally.

1 Before you turn the power on, check to make sure that:

- Are all devices connected properly?
- Are the volume levels on the XV-5080 and any amp or mixer that is connected turned down to the lowest settings?

2 Turn on the power to connected SCSI devices.

3 Press the XV-5080's [POWER] switch to turn on the power.

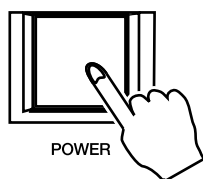

4 Turn on the power to connected audio devices.

Turning Off the Power

1 Before turning off the power, confirm the following.

- Are the volume levels on the XV-5080 and any amp or mixer that is connected turned down to the lowest settings?
- Have you saved your data, including data for any sounds you have created? (Owner's Manual; p. 194)

2 Turn off the power to connected external devices.

3 Press the XV-5080's [POWER] switch to turn off the power.

Restoring the Factory Settings (Factory Reset)

To ensure the XV-5080 operates correctly as described in the procedures found in the Owner's Manual when using the XV-5080 for the first time, be sure to restore the settings to their initial status as shipped.

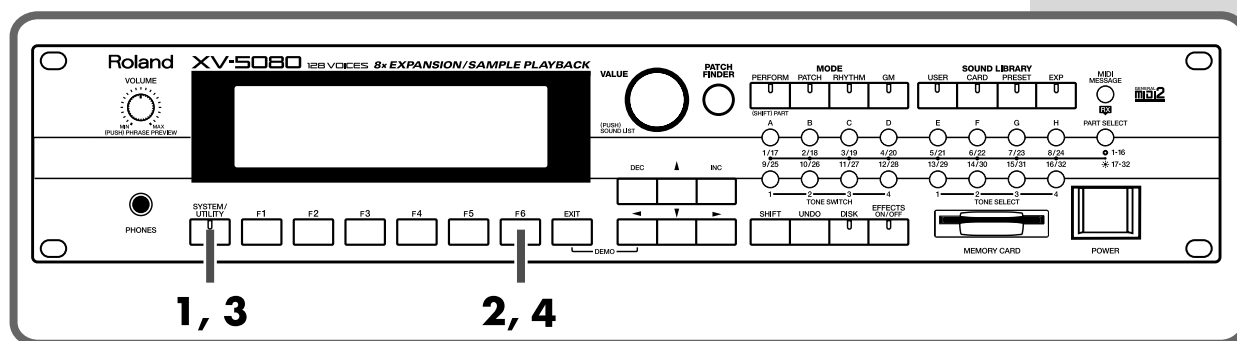

1 Press the [SYSTEM/UTILITY] button, getting its indicator to start blinking.

* If the indicator is steadily lit, you are in SYSTEM mode. Press the [SYSTEM/UTILITY] button once again, so the indicator is blinking.

2 Press the [F6 (Menu)] button to select Menu 3.

3 Press the [F1 (Factory)] button.
The Factory Reset page will appear.

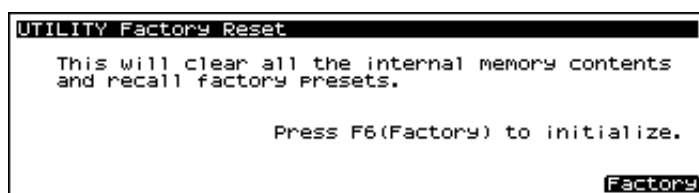

4 Press [F6 (EXEC)] to execute the Factory Reset.

If you decide not to execute Factory Reset, press the [EXIT] button.

After the Factory Reset operation has been executed, the PATCH PLAY page will appear.

* The message "Write Protect ON" may appear in a window. If you want to continue with the Factory Reset, press [DEC] to set Write Protect to "OFF," and press [F6 (OK)] to close the window. Then press [F6 (Factory)] once more to execute the save. Once set to "OFF," Write Protect remains disabled until the power to the instrument is turned off.

NOTE

If any important data you may have created is stored in memory, then running this operation will cause such data to be lost. If there is any data you wish to retain, then save the data to a commercially available memory card or external MIDI device.

MEMO

For more information about the Internal Write Protect, please refer to Owner's Manual; p. 205.

Listening to the Demo Songs

The XV-5080 features internal demo songs. Now let's listen to the XV-5080's awesome sounds and effects in Demo mode.

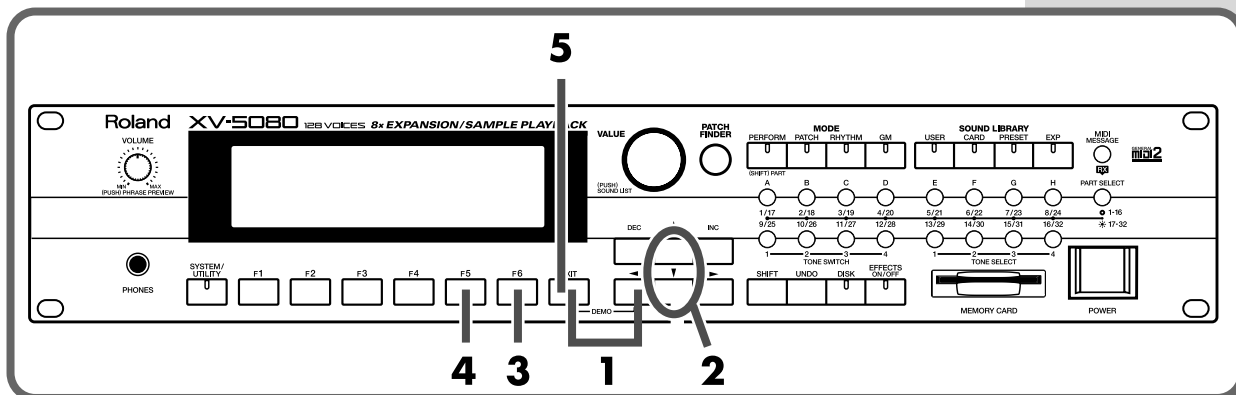

- 1 Hold down [EXIT] and press [◀].
- 2 Press [▲] or [▼] to select the song that you wish to hear. If you select “Chain of Songs,” the songs will playback successively, beginning from the first.
- 3 Press [F6 (Start)] to begin playback.
- 4 Press [F5 (Stop)] to stop playback.
- 5 Press [EXIT] to return to the condition the XV-5080 was in before the DEMO PLAY page was selected.

- * No data for the music that is played will be output from MIDI OUT.
- * When the DEMOPLAY page is displayed, MIDI messages received from an external device will be ignored.

NOTE

All rights reserved.
Unauthorized use of this material for purposes other than private, personal enjoyment is a violation of applicable laws.

Try Out the Sounds

The XV-5080 comes with a full palette of onboard sounds. The sounds that are used for ordinary play are called “Patches.” To begin with, you’ll want to listen to the Patches in Patch mode.

Playing Patches (Phrase Preview Function)

Even with no MIDI keyboard or sequencer connected, the XV-5080 allows you to check sounds using a number prepared phrases that are perfectly matched to highlight each type of Patch.

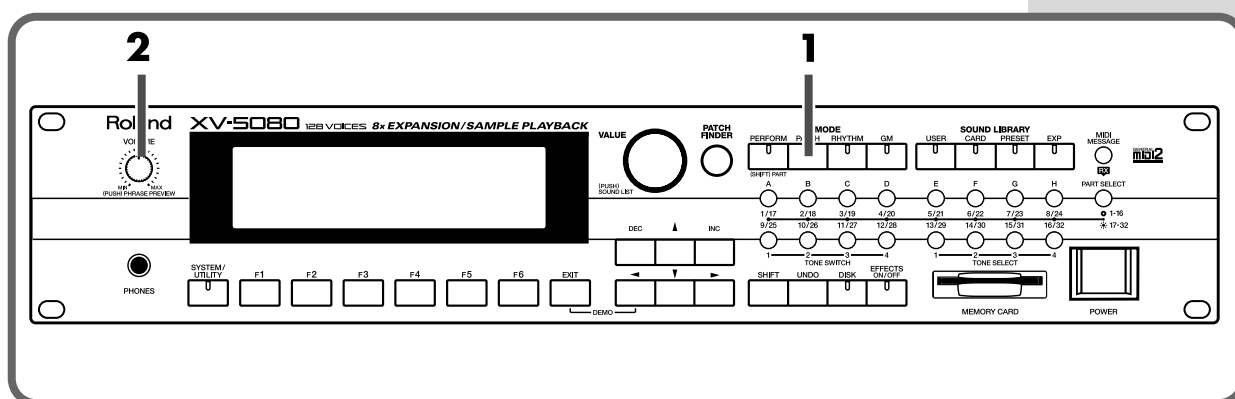

- 1 Press the [PATCH] button, lighting the indicator.
The PATCH Play page appears in the display.



- 2 Press and hold down the [VOLUME] knob.
The phrase prepared for the Patch will play while the knob is pushed.

NOTE

Certain Patches may not sound within a suitable range. In such cases, press

the [▲]/[▼] buttons to adjust the range to something more appropriate. (Octave Shift function: Owner’s Manual, p. 23)

MEMO

You can select other Patches by rotating the VALUE dial or pressing the [INC]/[DEC] buttons. Try selecting some other Patches and check out the many sounds available.

NOTE

The chord phrases played for Patches for which “MONO” is selected for Key Assign Mode (Owner’s Manual; p. 129) may not be the most suitable.

Try Out the Sounds

Selecting Patches

The XV-5080 comes with a **Patch Finder** feature that allows you to quickly find any Patch.

Selecting Categories (Patch Finder Function)

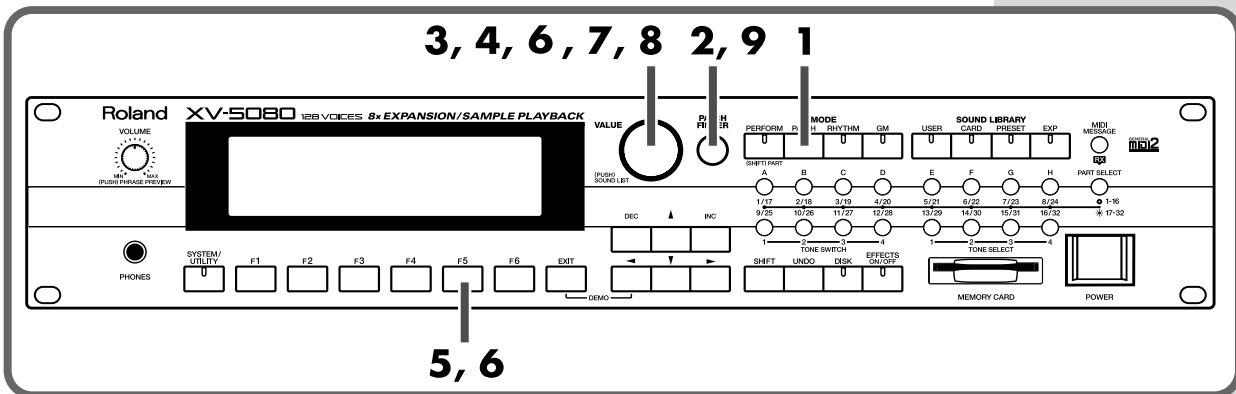

- 1 Press the [PATCH] button, lighting the indicator.
- 2 Press the [PATCH FINDER] button, lighting the indicator.
The categories will appear in the PATCH PLAY page.



You can press [▲]/[▼] to select the desired category.

At this point, you can select patches within the currently selected category, either by rotating the VALUE dial, or by using the [INC]/[DEC] button.

If you want to get even more information, carry out the following operation.

- 3 Press the VALUE dial.
The Category Group window will appear.
- 4 Rotate the VALUE dial to select a group.
- 5 Press [F6 (Select)] to call up the Category window.



For details on the categories you can select, refer to p. 20 in the Owner's Manual.

- 6 After turning the VALUE dial to select the category, press [F6 (Select)] button to display the Patches in that category, in groups of ten Patches.



- 7 By rotating the VALUE dial, move the cursor to the desired Patch.

- 8 Press the VALUE dial (SOUND LIST) to return to the PATCH PLAY page.

- 9 Press the [PATCH FINDER] button, extinguishing the indicator.

What is a Patch?

On the XV-5080, the basic unit of sound used in performances is called a Patch. There are two types of Patches, Four-Tone Patches and Multi-Partial Patches. A single Four-Tone Patch can be created by combining up to four different tones. Although a Patch could consist of only a single tone, using multiple tones allows you to create Patches with more complexity and vividness. Not only can you get fat, rich sounds by layering sounds using the internal Patches already available with the XV-5080 as is, you can also enjoy a high degree of control in creating sounds, for example having different tones sound depending on the range used, or the strength with which the keys are played. Furthermore, the XV-5080's parameters are arranged in sets for even more effective management of elements used in editing Patches, including the manner in which sounds are output, control of the outputs, and effects processing.

Multi-Partial Patches are made up of constituent sounds called Partials, which are assigned to a maximum of 88 keys and contain the settings for the parameters needed for the performance. When loading S-700 Series Patches to the XV-5080 from a CD-ROM or other source, these are automatically treated as Multi-Partial Patches.

MEMO

In steps 4, 6 and 7, you could also use the [INC]/[DEC] buttons, or the [▲]/[▼]/[◀]/[▶] buttons.

MEMO

In Pressing the [VOLUME] knob (PHRASE PREVIEW) allows you to audition the selected Patch.

Try Out the Sounds

What is a Tone?

The smallest unit of a Four-Tone Patch is called a Tone. Although a sound could be created using simply one tone, the XV-5080 handles the sounds used for performances in terms of Patches, which are a combination of a number of tones. In other words, tones are the components of sound from which Patches are composed.

What is a Partial?

Partials are combinations of up to four samples (with a number of other parameters added, such as setting of loop points to Wave data) that comprise the sounds from which Multi-Partial Patches are composed.

What is a Category?

The XV-5080's sounds are organized into Categories, depending on their characteristics. The XV-5080 features 38 Categories divided into 10 Category Groups.

Selecting from the Sound List

By displaying the Patch list, you can quickly find the desired Patch.

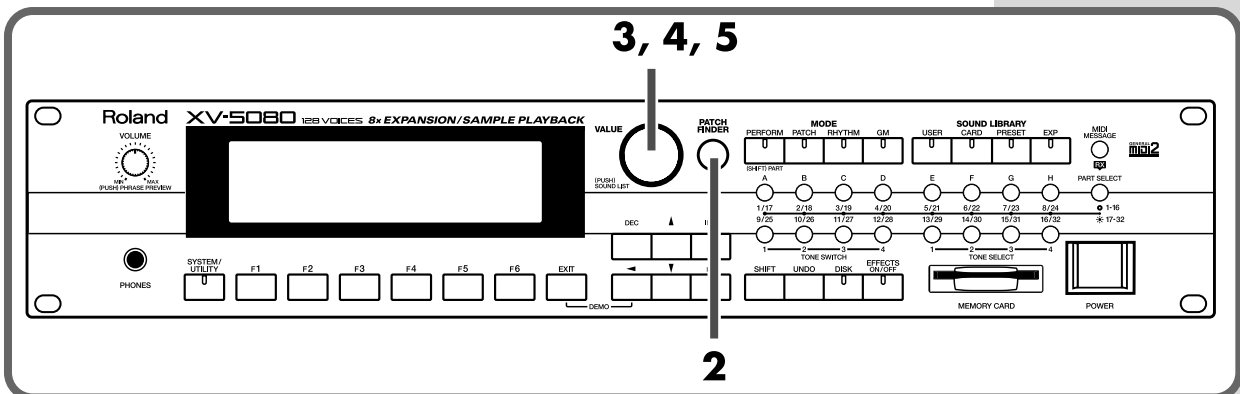

- 1 Make sure that the PATCH PLAY page is displayed.
- 2 Make sure that the [PATCH FINDER] button is extinguished.
- 3 Press the VALUE dial (SOUND LIST).
Ten Patches including the currently selected Patch will be displayed in sequence.

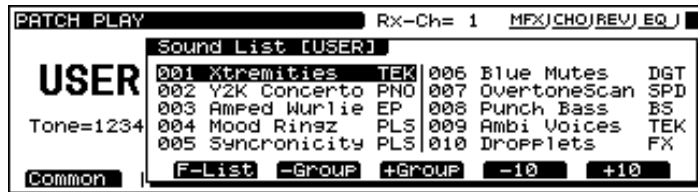

[F3 (-Bank)]/[F4 (+Bank)]: Switches the banks.

[F5 (-10)]/[F6 (+10)]: Switches the displayed Patched in steps of 10.

MEMO

In step 3, you could also use the [INC]/[DEC]

buttons, or the [▲]/[▼]/[◀]/[▶] buttons.

4 By rotating the VALUE dial, move the cursor to the desired Patch.

5 Press the VALUE dial (SOUND LIST) to return to the PATCH PLAY page.

Making Selections with Basic Operations

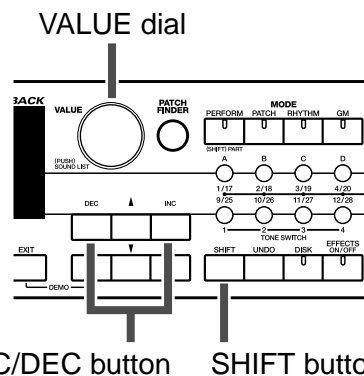

On the PATCH PLAY page

Selecting with the VALUE Dial

Rotate the VALUE dial to select. Holding down the VALUE dial while rotating it changes the value by tens (the value can be similarly changed by tens by holding down the [SHIFT] button while rotating the VALUE dial).

Selecting with the [INC] and [DEC] Buttons

Press the [INC]/[DEC] buttons to select. Holding down one button while pressing the other changes the value more rapidly.

Holding down the [SHIFT] button while pressing the [INC]/[DEC] button changes the value by tens.

When the [INC]/[DEC] button is held down continuously, the value stops at the top (001) of the current bank (A-H). To advance to the next bank, release the button then press it again.

Switching Modes

In addition to Patch mode, the XV-5080 also features three other modes: Performance mode, Rhythm Set mode, and GM2 mode. Let's try switching the modes and listen to the sounds in each one.

You can easily switch modes simply by pressing the MODE button (PERFORM/PATCH/RHYTHM/GM) for each mode.

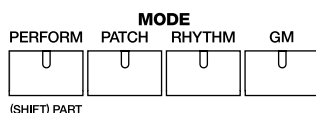

PERFORM (Performance Mode)

In this mode, the XV-5080 functions as a multi-timbral sound generator, and Performance settings can be modified. If you're using an external MIDI device to control the XV-5080 in this mode, it will function as a multi-timbral sound generator.

PATCH (Patch Mode)

In this mode, you can play an individual Patch from the keyboard or modify Patch settings. If you're using an external MIDI device to control the XV-5080 in this mode, it will function as a single-patch sound generator.

RHYTHM (Rhythm Set Mode)

This is how you can play a Rhythm Set from the keyboard and modify the Rhythm Set settings. As with Patches, the XV-5080 can also be used as a sound module for playing individual Rhythm Sets when controlled with an external MIDI device. You can also modify Rhythm Sets in this mode, as well as their effects. XV-5080 Rhythm Sets can also be used for any Part in a Performance when in Performance mode.

GM (General MIDI2 Mode)

General MIDI is a set of recommendations which seeks to provide a way to go beyond the limitations of proprietary designs, and standardize the MIDI capabilities of sound generating devices. Sound generating devices and music files that meet the

General MIDI standard bear the General MIDI logo (). Music files bearing the General MIDI logo can be played back using any General MIDI sound generating unit to produce essentially the same musical performance.

The upwardly compatible General MIDI 2 () recommendations pick up where the original General MIDI left off, offering enhanced expressive capabilities, and even greater compatibility. Issues that were not covered by the original General MIDI recommendations, such as how sounds are to be edited, and how effects should be handled, have now been precisely defined. Moreover, the available sounds have been expanded. General MIDI 2 compliant sound generators are capable of reliably playing back music files that carry either the General MIDI or General MIDI 2 logo. In some cases, the conventional form of General MIDI, which does not include the new enhancements, is referred to as "General MIDI 1" as a way of distinguishing it from General MIDI 2.

What is a Performance?

With Performances, you can combine a total of up to 32 separate Patches and Rhythm Sets to enjoy ensemble performances featuring rich tones. In other words, using Performances allows you to control 32 separate tones with a single XV-5080. A sound module that can simultaneously produce multiple sounds is called a multitimbral sound module.

What is a Rhythm Set?

Rhythm sets are groups of a number of different percussion instrument sounds. Percussion sounds are not generally used in performing melodies, so it is immaterial that they cannot be played at different pitches on the keyboard. However, it is important that, as much as possible, a number of percussion instruments perform together. Therefore, the Rhythm Sets are set up so that you can get different sets of percussion sounds by pressing different keys (note numbers).

Selecting Sound Libraries

On the XV-5080, tone data is stored in what are called “SOUND LIBRARY.” The SOUND LIBRARY is divided into four “groups”: USER, CARD, PRESET, and EXP.

You can easily select the desired group simply by pressing the SOUND LIBRARY button (USER/CARD/PRESET/EXP) for each group.

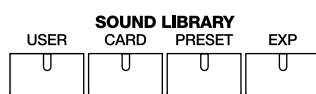
**USER (User Memory)**

This is the XV-5080's group of internal rewritable tones. Save the tones that you create to this library.

CARD (Memory Card)

This library uses sounds from a commercially available memory card (SmartMedia) inserted into the MEMORY CARD slot.

When saving a file to the card, you can directly select Tones contained on the card — even without loading the files into the USER memory — by specifying the Bank (CD-A through CD-H). (Saving All Data to Memory Card, Owner's Manual; p. 195)



CARD can be selected only if a formatted memory card is inserted in the MEMORY CARD slot.

Try Out the Sounds

PRESET (Preset Memory)

The PRESET library group contains the sounds that are permanently stored in the XV-5080's memory.

EXP (Wave Expansion Board)

Select this group to use the tones stored on wave expansion boards (SRX Series, SR-JV80 Series; sold separately) inserted in the EXP-A through -H slots.

To select an installed wave expansion board, press the [A]–[H] button.

The EXP-A through EXP-D slots are for cards from the SR-JV80 Series. The EXP-E through EXP-H slots are for SRX Series boards.



It is not possible to select EXP unless a wave expansion board is inserted into the corresponding slot.

Playing Sounds Using a MIDI Keyboard

Now, try connecting your MIDI keyboard and playing sounds from the XV-5080.

Connecting a MIDI Keyboard

Connect the MIDI keyboard as shown in the following.

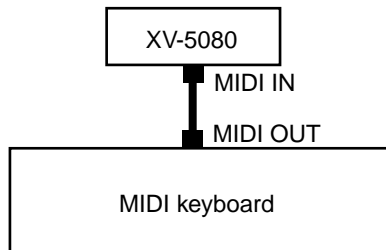

Setting the MIDI Channels

If you intend to have this unit play when it receives MIDI data sent by an external MIDI device, you need to have the MIDI channel set to the same channel on both the sending device (the MIDI keyboard or other device) and on the XV-5080.

Here, in Patch mode, let's set both MIDI channels to "1."



Executing Factory Reset sets the receive channel in Patch and Rhythm Set modes to "1."

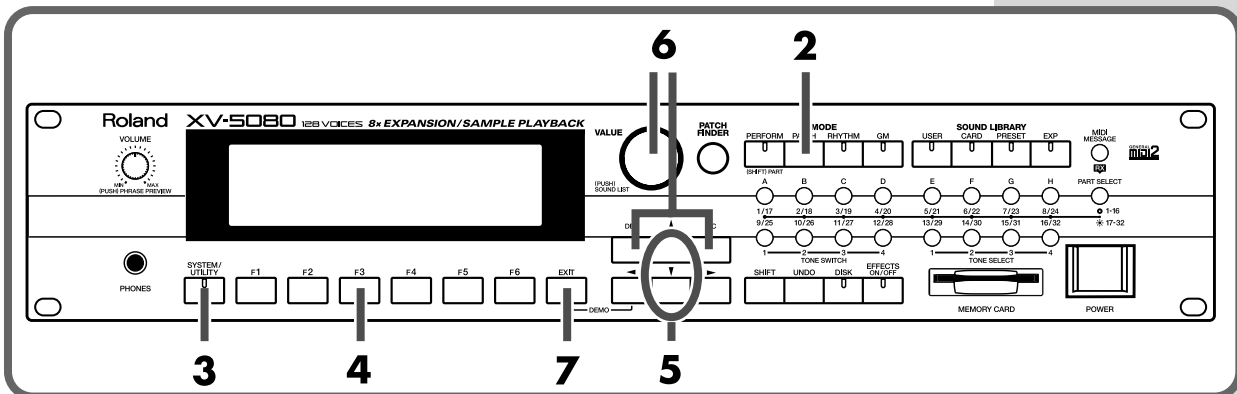

1 Set the send channel of the sending MIDI keyboard to “1.”

For instructions on making this setting, refer to the owner’s manual for the MIDI keyboard.

2 Press the [PATCH] button, lighting the indicator.

** As the receive channel is set to “1” when Factory Reset is executed, the following step is not necessary.*

Now play the MIDI keyboard to produce the sounds.

3 Press the [SYSTEM] button, lighting the indicator.

4 Press the [F3 (MIDI)] button.

The following page appears in the display.

SYSTEM MIDI		
MIDI Receive Ch	MIDI TX	Rx Switch
Perform Ctrl Ch 16	Edit Data OFF	Program Change ON
Patch/Rhy Rx Ch 1		Bank Select ON
System Exclusive	Stack	GM1 System ON ON
Device ID 17	Mode OFF	GM2 System ON ON
Receive Sw	ON Number 1	GS Reset ON
<div style="display: flex; justify-content: space-between; padding: 0;"> General Outp&EQ MIDI Control Preview Info </div>		

5 Press the [▲]/[▼]/[◀]/[▶] buttons to move the cursor to the “Patch/Rhy Rx Channel” setting.

6 Rotate the VALUE dial or press the [INC]/[DEC] button to set the value to “1.”

7 When you have finished making the settings, press the [EXIT] button.

Play the MIDI keyboard to produce the sounds.

Playing Multiple Layered Patches (Layer)

The collected assignments of Patches or Rhythm Sets to the 32 parts is referred to as a “Performance.”

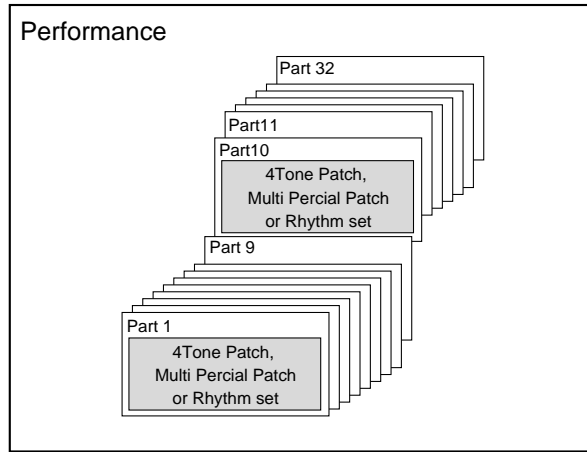

Setting a number of parts to the same MIDI receive channel while overlapping multiple Patches is referred to as **Layer**.

Here, let's try this layering technique using Performance “PR-B:01 Dulcimar&Gtr” playing two overlapping Patches.

Selecting Performance “PR-B:01 Dulcimar&Gtr”

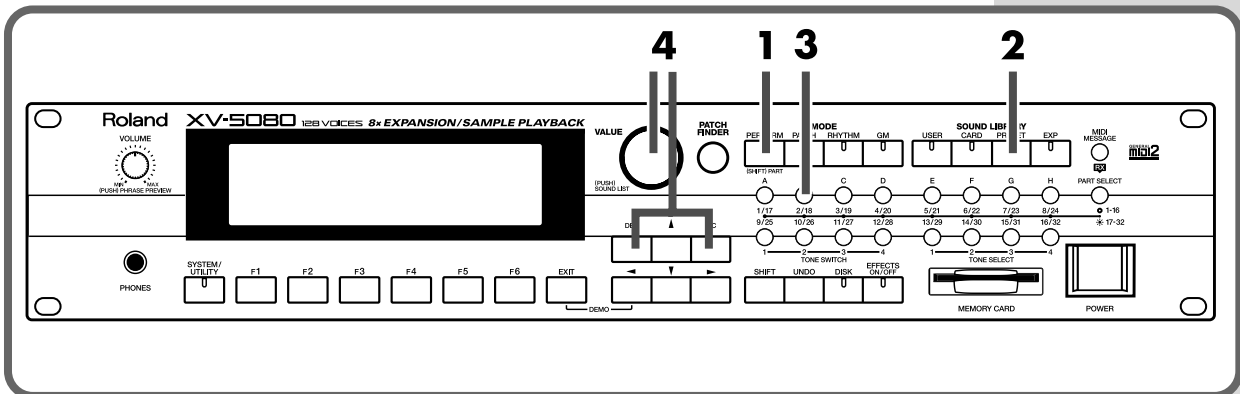

- 1 Press the [PERFORM] button, getting its indicator to light.
- 2 Press the [PRESET] button, getting its indicator to light.
- 3 Press the [B] button, getting its indicator to light.
The page for selecting Preset-B Performances appears.



By pressing the VALUE dial (SOUND LIST), you can select from the Performance list. The method is the same as when selecting from the Patch list. (p. 18)

4

Turn the VALUE dial or press the [INC]/[DEC] button to select “PR-B:01 Dulcimar&Gtr.”

Set the MIDI keyboard send channel to “1,” and play the keyboard. The Patches for Part 1 and Part 2 are layered and played.

Turning a Part On or Off

Let's try turning the Parts used in a Performance on and off.

In Performance PR-B:01 Dulcimar&Gtr, Parts 1, 2 and 10 are turned on.

Let's try turning Part 2 on and off.

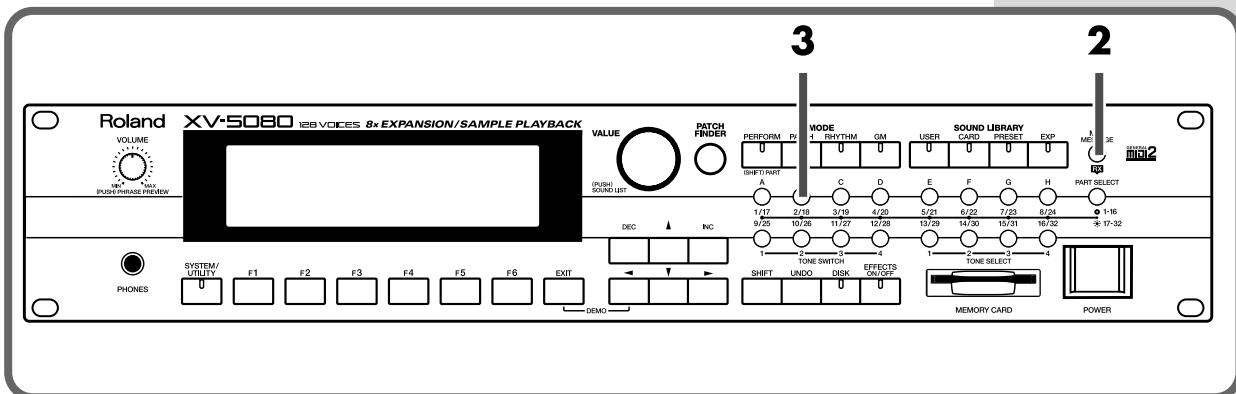

1

Make sure that Performance PR-B:01 Dulcimar&Gtr is selected.

2

Press the [RX] button, lighting the indicator.

Try Out the Sounds

- 3 Make sure that the [1-16/17-32] indicator is dark, and then press the PART SELECT [2/18] button to make the indicator go dark (off).

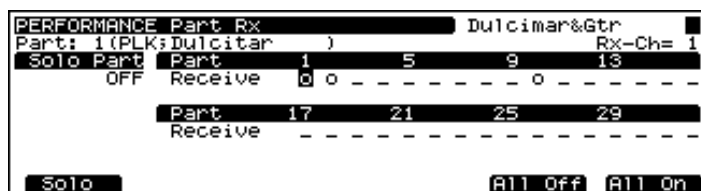

MEMO

To select Parts 17-32, press [1-16/17-32], getting its indicator to light, and then press the desired PART SELECT [1/17]-[16/32] button.

- 4 When you press the same button again, the indicator lights and turns Part 2 back on.

Assigning a different Patch to a Part

This is how to change the Patch assigned to a Part in a Performance.

Here, we will switch the Patch in Part 2 of the Performance PR-A:01Seq:Template to 018 (Slap Bass).

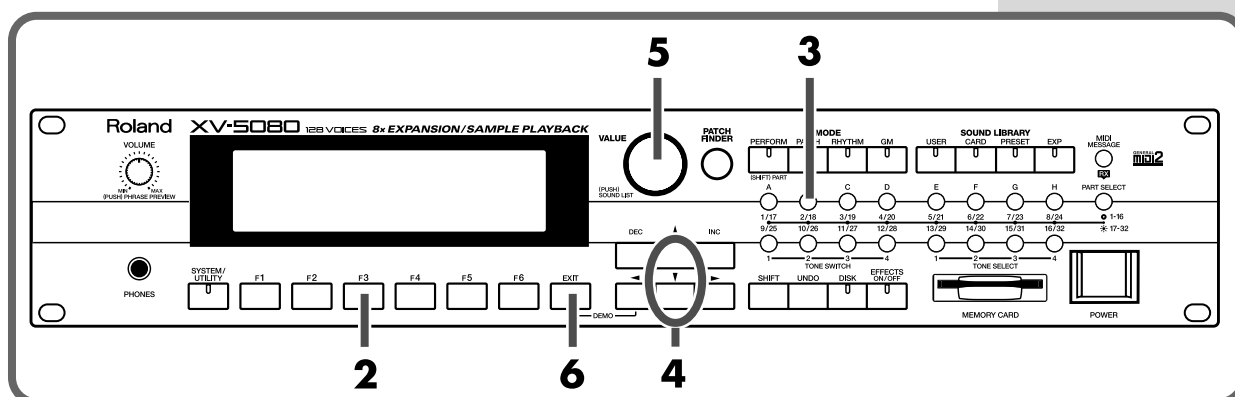

- 1 At the PERFORM Play page, choose Performance “PR-A:01Seq:Template.”
- 2 Press the [F3 (PART)] button.
- 3 Make sure that the [1-16/17-32] indicator is not lit, and then press the PART SELECT [2/18] button to select Part 2. The indicator will light, and the Part number will appear in the upper left of the screen.

You can switch the Part by moving the cursor here and turning the VALUE dial.



MEMO

You can also select a Part for setting by pressing the [◀]/[▶] button in the PERFORM Play page. The currently selected Part number and the Patch or Rhythm Set name will appear in the lower right of the screen.

4 Press the [▲]/[▼] button to move the cursor to Patch Number.

5 Turn the VALUE dial to select 018 (Slap Bass).

Play your MIDI keyboard, and listen to how the sound has been changed.

* Pressing the [UNDO] button restores Number to its original value, reselecting the original Patch.

6 Press the [EXIT] button to return to the PERFORM Play page.

Changing the MIDI Reception Channel of Each Part

1 Select the Performance you wish to use.

2 Press [F4 (MIDI)] button.
The Part MIDI page will appear.

3 Press the PART SELECT [1/17]-[16/32] button to select the Part you wish to set.

To select Parts 17-32, press [1-16/17-32], getting its indicator to light, and then press the desired PART SELECT [1/17]-[16/32] button.

The indicator will blink, and the Part number will appear in the upper left of the screen.

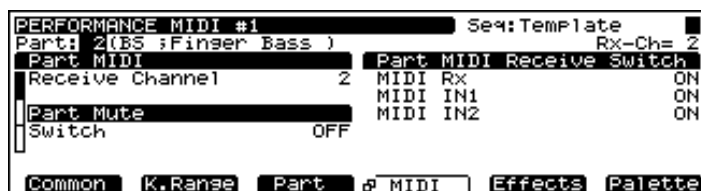

MEMO

To select Parts 17-32, press [1-16/17-32], getting its indicator to light, and then press the desired PART SELECT [1/17]-[16/32] button.

Try Out the Sounds

- 4 Press the [▲]/[▼] button to move the cursor to the “Receive Channel” setting.
- 5 Turn the VALUE dial or press the [INC]/[DEC] button to select the desired MIDI channel.
- 6 Press the [EXIT] button to return to the PERFORM Play page.

Having Different Patches Play In Separate Ranges of the Keyboard (Split)

In a Performance, by selecting the same MIDI receive channel for a number of parts and then changing the pitch range over which each part is to be played, you can thus divide the keyboard into separate ranges and assign a different Patch to each range. This is referred to as a **Split**.

The split is one application of the layer technique (Playing Multiple Layered Patches). The split works by changing the sounding range of each patches of the layered parts.

Now, try a creating a split using Performance “PR-B:29 Organ/Lead.”

Selecting a Performance “PR-B:29 Organ/Lead”

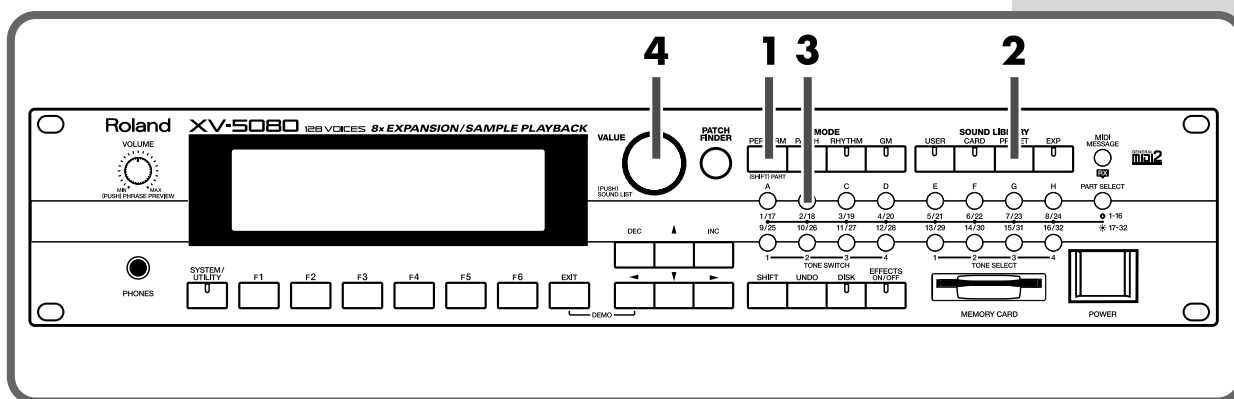

- 1 Press the [PERFORM] button, getting its indicator to light.
- 2 Press the [PRESET] button, getting its indicator to light.

- Press the [B] button, getting its indicator to light.
The page for selecting Preset-B Performances appears.

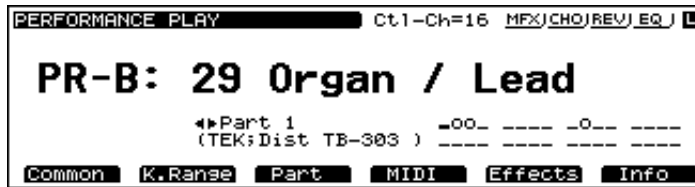

- Turn the VALUE dial to select "29."
Play your MIDI keyboard (MIDI transmit channel = 1).
In this Performance, the note range settings for Part 2 and Part 3 are shown below.
Part 2: C4-G9
Part 3: C -1-B3

Setting the Note Range of Each Part

Now let's modify the settings so that Part 2 will sound in the C5-G9 range and Part 3 will sound in the C -1-B4 range.

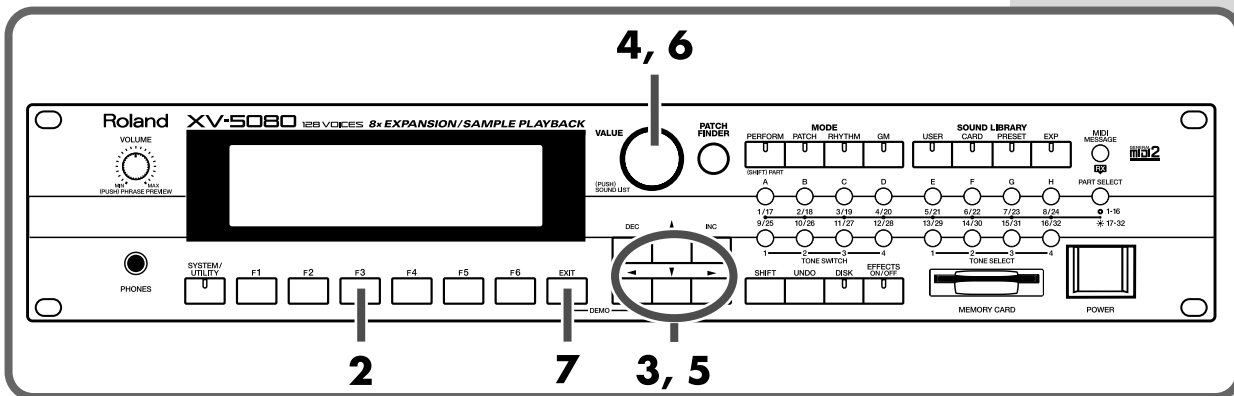

- Make sure that Performance PR-B:29 Organ/Lead is selected.
- Press the [F2 (K.Range)] button.

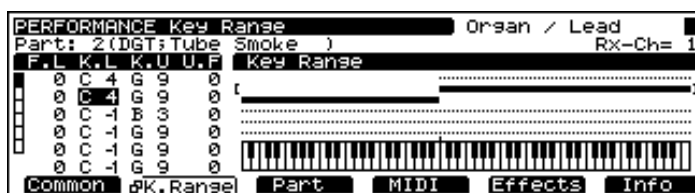

Try Out the Sounds

- 3 Press [▲]/[▼]/[◀]/[▶] to move the cursor to K.L of Part 2.
- 4 Turn the VALUE dial to select “C5.”
- 5 Press [▲]/[▼]/[◀]/[▶] to move the cursor to K.U of Part 3.
- 6 Turn the VALUE dial to select “B4.”
- 7 Press the [EXIT] button to return to the PERFORM PLAY page. Play your MIDI keyboard and notice how the Parts’ ranges have changed.

Try Using an External MIDI Device to Switch Patches and Other Settings

Using an External MIDI Device to Switch Patches and Rhythm Sets

By receiving MIDI messages, the XV-5080 can switch Patches (including the Patches for each Part of a Performance) or Rhythm Sets.

Here, after setting the send channel for the external MIDI device and the XV-5080’s receive channel (??Patch/Rhy Rx Ch??) to “1,” try sending a MIDI message from the external MIDI device to switch the XV-5080’s Patch to PR-A:002 Bright Piano.

- 1 Use a MIDI cable to connect the the MIDI OUT connector of the external MIDI device to MIDI IN connector of the XV-5080.
- 2 Press the [PATCH] button, lighting the indicator.
- 3 Set the channel used for transmission by the external MIDI device and the XV-5080’s receive channel to the same channel. (See p. 22.)
Since the receive channel is always set to “1” when a Factory Reset is

executed, it may not be necessary to set the receive channel.

- 4** Send a Bank Select MSB (Control Number 0) value of “87” to the XV-5080.

If you want to switch Rhythm Sets, send “86” as the value.

- 5** Next, send a Bank Select LSB (Control Number 32) value of “64.”

- 6** Send a Program Change with a value of “2.”

The Patch name appearing in the page changes to PR-A:002 Bright Piano.



* Each Patch or Rhythm Set has a corresponding Bank Select number and Program number, as shown below.

Patches

Patch Group	Patch Number	Bank Select Number		Program Number
		MSB	LSB	
USER	001-128	87	00	001-128
PR-A	001-128	87	64	001-128
PR-B	001-128	87	65	001-128
PR-C	001-128	87	66	001-128
PR-D	001-128	87	67	001-128
PR-E	001-128	87	68	001-128
PR-F	001-128	87	69	001-128
PR-G	001-128	87	70	001-128
CD-A	001-128	87	32	001-128
	:	:	:	::
CD-H	001-128	87	39	001-128
XP-A	*1	*1	*1	*1
	:	:	:	:
XP-H	*1	*1	*1	*1

* 1 Depends on the Wave Expansion Board installed.

Fixed Bank Select numbers are assigned to the Wave Expansion Board itself.

Try Out the Sounds

The MSB and LSB are determined according to the series number, as follows:

<u>SR-JV80 Series</u>	<u>Patch No.</u>	<u>MSB</u>	<u>LSB</u>
SR-JV80-01	1-128	89	00
SR-JV80-01	129-256	89	01
SR-JV80-02	1-128	89	02
SR-JV80-02	129-256	89	03
:			
SR-JV80-65	1-128	91	00
SR-JV80-65	129-256	91	01

* For details on the SRX series, refer to the owner's manual for the SRX.

Rhythm Sets

<u>Rhythm Set Group</u>	<u>Rhythm Set Number</u>	<u>Bank Select Number</u>		<u>Program Number</u>
		<u>MSB</u>	<u>LSB</u>	
USER	1, 2, 3, 4	86	00	1, 2, 3, 4
PR-A	001, 002	86	64	001, 002
PR-B	001, 002	86	65	001, 002
PR-C	001, 002	86	66	001, 002
PR-D	001, 002	86	67	001, 002
PR-E	001, 002	86	68	001, 002
PR-F	001, 002	86	69	001, 002
PR-G	001, 002	86	70	001, 002
CD-A	1, 2, 3, 4	86	32	1, 2, 3, 4
:	:	:	:	:
CD-H	1, 2, 3, 4	86	39	1, 2, 3, 4
XP-A	*1	*1	*1	*1
:	:	:	:	:
XP-H	*1	*1	*1	*1

* 1 Depends on the Wave Expansion Board installed.

Fixed Bank Select numbers are assigned to the Wave Expansion Board itself.

<u>SR-JV80 Series</u>	<u>Rhythm No.</u>	<u>MSB</u>	<u>LSB</u>
SR-JV80-01	1-128	88	00
SR-JV80-01	129-256	88	01
SR-JV80-02	1-128	88	02
SR-JV80-02	129-256	88	03
:			
SR-JV80-65	1-128	90	00
SR-JV80-65	129-256	90	01

* For details on the SRX series, refer to the owner's manual for the SRX.

Using an External MIDI Device to Switch Performances

To switch Performances, after matching the send channel for the external MIDI device with the XV-5080's Performance Control channel (Performance Control Channel), send the Bank Select number and Program Change messages.

Upon execution of Factory Reset, Performance Control Channel is set to "16." Here, set the external MIDI device's send channel to "16," then try switching the Performance to PR-A:02 Seq:Pop.

1 Use a MIDI cable to connect the the MIDI OUT connector of the external MIDI device to MIDI IN connector of the XV-5080.

2 Press the [PERFORM] button, getting its indicator to light. The PERFORM Play page will appear.

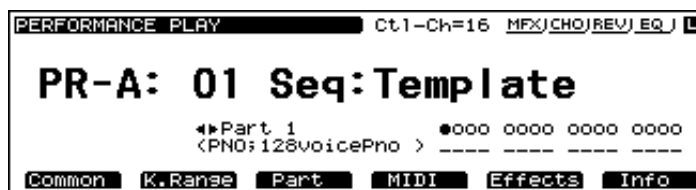

3 Set the external MIDI device's transmit channel to "16." For instructions on making this setting, refer to the owner's manual for the external MIDI device.

4 Send a Bank Select MSB (Control Number 0) with a value of "85" to the XV-5080.

5 Next, send a Bank Select LSB (Control Number 32) value of "64."

6 Send a Program Change with a value of "2." The Performance name appearing in the page changes to PR-A:02 Seq:Pop.

Try Out the Sounds

Each Performance has a corresponding Bank Select number and Program number, as shown below.

Performances

<u>Performance Group</u>	<u>Performance Number</u>	<u>Bank Select Number</u>		<u>Program Number</u>
		<u>MSB</u>	<u>LSB</u>	
USER	001-064	85	00	001-064
PR-A	001-032	85	64	001-032
PR-B	001-032	85	65	001-032
CD-A	001-064	85	32	001-064
:	:	:	:	:
CD-H	001-064	85	39	001-064

Turning Effects On and Off

On/off settings for each of the XV-5080's built-in effects processors (multi-effects, chorus, reverb, and EQ) can be applied to the entire XV-5080, regardless of the mode (Performance, Patch, or Rhythm Set).

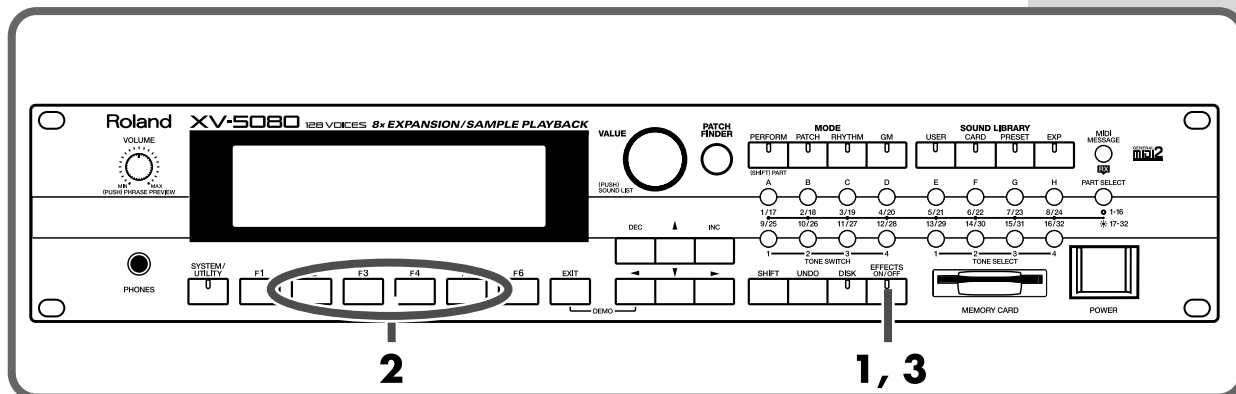

- 1 Press the [EFFECTS ON/OFF] button, getting its indicator to light.

The EFFECTS ON/OFF window will appear.

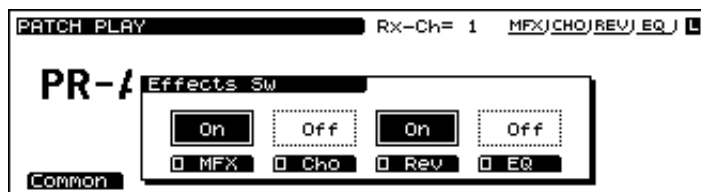

- 2 Press the [F2]–[F5] button corresponding to the effect to switch that effect on or off.

The display of the setting will be turned on and off.

- 3 Press the [EFFECTS ON/OFF] button, getting its indicator light to go out.

MFX (Multi-effects)

The Multi-effects offers 90 different effects. In addition to effects constructed with individual effect processors, such as distortion and delay, the 90 types also include a number of compound effect types created by combining simpler effects. Furthermore, the multi-effects effect types also include chorus and reverb, although the chorus and reverb described below can be applied as separate effects systems.

* The XV-5080 features three Multi-effects systems; you can simultaneously turn all of the Multi-effects on and off using this operation.

Turning Effects On and Off

Chorus

Chorus adds depth and spaciousness to the sound.

Reverb

Reverb is an effect that adds reverberation resembling that created when sounds are played in a hall.

EQ

An equalizer lets you boost or cut specified frequency ranges of a sound to adjust the tone.

** Although you can add equalization to each of the XV-5080's output jacks, this operation turns the EQ for all of the outputs on and off simultaneously.*

Let's Play Sounds From a Sampler Library

Now let's try loading a sampler library (such as the optional L-CDX Series) into the XV-5080 and playing some sounds.

Playing sampler libraries with the XV-5080 requires a SCSI-type CD-ROM drive, and commercially available SIMMs (memory modules).

* *At least 16 MB (32 MB or more recommended) of additional memory is required.*



The Akai S1000/3000 CD-ROM sound libraries can also be loaded. For more on this, "Chapter 7 Loading Each Type of Data" in the Owner's Manual.

Installing the SIMM (Memory Module)

Loading commercial sampler libraries into the XV-5080 requires installation of a SIMM memory module. The XV-5080 is equipped with two slots for SIMMs, allowing you to expand memory capacity by 128 MB (with two 64-megabyte SIMMs installed).

SIMMs for use with the XV-5080 must match the following specifications.

Number of pins: 72

Access time: 60 ns or faster

Access protocol: FPM or EDO

Voltage: 5 V

Capacity: 64 MB/32 MB/16 MB (can be mixed)

* *Both parity and non-parity are supported.*

SIMM Height: 36 mm or lower

Cautions When Installing SIMM

- To avoid the risk of damage to internal components that can be caused by static electricity, please carefully observe the following whenever you handle the board.
 - Before you touch the board, always first grasp a metal object (such as a water pipe), so you are sure that any static electricity you might have been carrying has been discharged.
 - When handling the board, grasp it only by its edges. Avoid touching any of the electronic components or connectors.
 - Save the bag in which the board was originally shipped, and put the board back into it whenever you need to store or transport it.
- Use a Philips screwdriver that is suitable for the size of the screw. If an unsuitable screwdriver is used, the head of the screw may be stripped.
- To remove a screw, rotate the screwdriver counter-clockwise. To tighten the screws, rotate the screwdriver clockwise.



- Be careful not to cut your hands on the edges of the opening while removing the cover.
- When adding SIMMs, remove only the specified screws.

Let's Play Sounds From a Sampler Library

- Be careful that the screws you remove do not drop into the interior of the XV-5080.
- Do not touch any of the printed circuit pathways or connection terminals.
- Never use excessive force when installing a circuit board. If it doesn't fit properly on the first attempt, remove the board and try again.
- When circuit board installation is complete, double-check your work.
- Do not leave the cover removed. Be sure to reattach it after the SIMM has been installed.

1 Turn off the power on the XV-5080 and any connected devices, and disconnect any cables connected to the XV-5080.

2 Detach the cover on the top of the XV-5080.

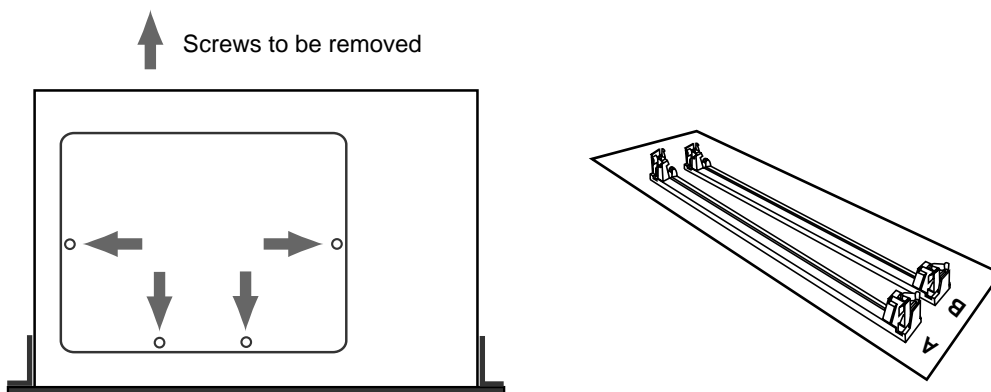

3 The order in which the slots are used when installing the SIMMs depends on the number of SIMMs added. Refer to the table below.

SIMM Slot Installation Order

Two cards: A, then B

One card: A

4 After confirming the position of the SIMM's notch and its orientation, insert the SIMM at an angle into the slot.

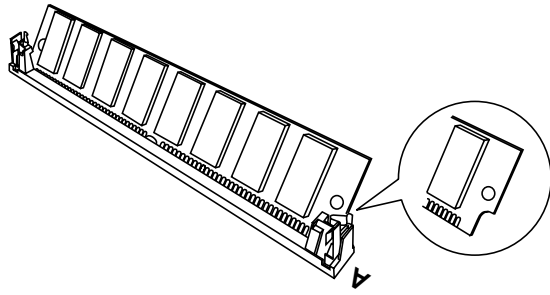

- 5** Using your fingers, push up on the SIMM until it stands upright in the slot.

The SIMM is then held in place with the silver-colored latches on both sides of the slot.

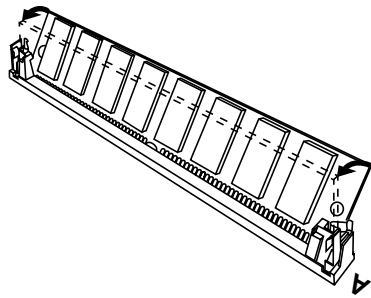

- 6** When installing more than one SIMM, repeat Steps 4 and 5.

- 7** Return the XV-5080's top cover to its original position.
This completes installation of the SIMM or SIMMs.

Let's Play Sounds From a Sampler Library

Removing SIMMs

Remove SIMMs in the reverse order of that used for installation.

NOTE

Before beginning this procedure, turn off the power to the XV-5080 and all connected devices.

1

Simultaneously push the silver-colored latches on both sides of the slot outwards.

The SIMM is released from the latches, and remains in the slot, at an angle.

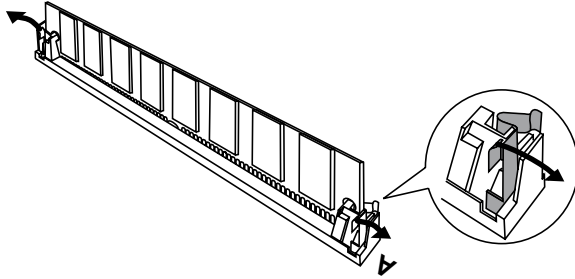

2

Pull the SIMM out of the slot.

Confirming That the SIMM Is Properly Installed

1

Press the [SYSTEM/UTILITY] button, getting its indicator to light.

* If the indicator is blinking, you are in *UTILITY* mode. Press the [SYSTEM/UTILITY] button again, so the indicator lights steadily.

2

Press the [F6 (Info)] button.

The SYSTEM Info page will appear.

SYSTEM Information	
Wave Expansion Board	2x Expanded
A:SR-JV80-15 SFX	E:SIMM
B:-----	A 64.0MB
C:-----	F:SRX-01DynamicDrm
D:-----	B 0KB
	Total 64.0MB
	Free 64.0MB
Battery Check	SCSI ID
OK	XU-5080 Self
7	
General	Outp&EQ
MIDI	Control
Preview	Info

Confirm that the capacity of the SIMM appears next to the slot in which it is placed.

* If no SIMM has been installed, or if the installed SIMM is not being recognized properly, "-----" appears in the display.

Augmenter la modules SIMM (French language for Canadian Safety Standard)

Des modules SIMM doivent être installés si vous désirez importer dans le XV-5080 des bibliothèques d'échantillonneurs offertes dans le commerce. Les deux fentes pour modules SIMM du périphérique permettent l'expansion jusqu'à un maximum de 128 Mo (deux modules SIMM de 64 Mo chacun).

Vous pouvez utiliser des modules SIMM aux spécifications suivantes.

Nombre de broches :72

Temps d'accès :60 ns ou plus rapide

Méthode d'accès :FPM ou EDO

Tension :5 V

Taille de la mémoire :64 Mo, 32 Mo ou 16 Mo (peut être mixte)

* *Compatible avec les modules SIMM de parité et d'imparité.*

Hauteur des modules SIMM : 36 mm ou moins

Précautions à prendre lorsque vous augmentez la modules SIMM

- Veuillez suivre attentivement les instructions suivantes quand vous manipulez la carte afin d'éviter tout risque d'endommagement des pièces internes par l'électricité statique.
 - Toujours toucher un objet métallique relié à la terre (comme un tuyau par exemple) avant de manipuler la carte pour vous décharger de l'électricité statique que vous auriez pu accumuler.
 - Lorsque vous manipulez la carte, la tenir par les cotés. Évitez de toucher aux composants ou aux connecteurs.
 - Conservez le sachet d'origine dans lequel était la carte lors de l'envoi et remettez la carte dedans si vous devez la ranger ou la transporter.
- Choisir un tournevis cruciforme de taille appropriée. Utiliser un tournevis qui ne correspond pas à la bonne taille pourrait endommager la tête des vis.
- Faire tourner le tournevis dans le sens contraire des aiguilles d'une montre pour desserrer les vis. Faire tourner le tournevis dans le sens des aiguilles d'une montre pour resserrer.



- Attention de ne pas vous couper les mains sur les côtés de l'ouverture lorsque la plaque protectrice est enlevée.

Let's Play Sounds From a Sampler Library

French language

for Canadian Safety Standard

- Enlevez seulement les vis indiquées (p. 42).
- Veiller à ne pas échapper les vis enlevées dans le XV-5080.
- Ne pas toucher aux circuits imprimés ou aux connecteurs.
- Ne jamais forcer lors de l'installation de la carte de circuits imprimés. Si la carte s'ajuste mal au premier essai, enlevez la carte et recommencez l'installation.
- Quand l'installation de la carte de circuits imprimés est terminée, vérifiez si tout est bien installé.
- Ne pas laisser l'appareil sans sa plaque protectrice. S'assurer de bien la remettre en place une fois la carte correctement installée.

1 Éteindre le XV-5080 et tout l'équipement qui y est relié. Ensuite, déconnecter tous les câbles qui sont reliés au XV-5080.

2 Enlever la plaque protectrice du dessus du XV-5080.

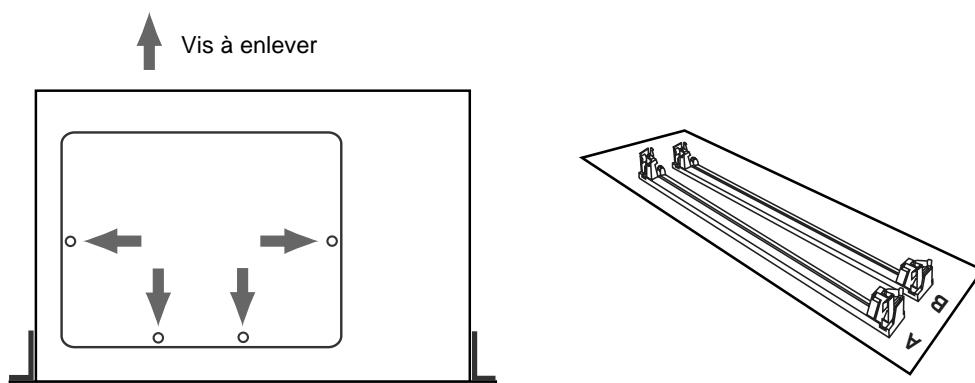

3 L'emplacement et l'ordre d'installation sont déterminés par le nombre de cartes que vous désirez ajouter. Se référer au tableau ci-dessous pour procéder à l'installation:

Nombre de cartes mémoire	Wave Emplacement et ordre d'installation
2	A et B dans cet ordre
1	A

4 Vérifier la position des encoches sur la carte mémoire et leur orientation puis, insérer la carte de biais.

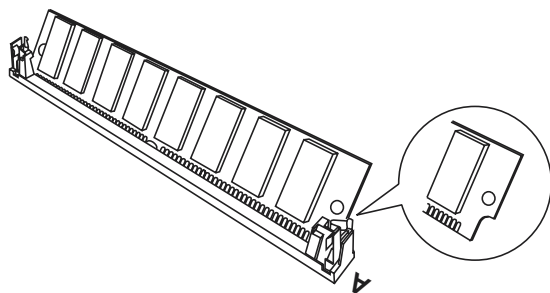

5 Orienter la carte en position verticale avec vos doigts.

La carte mémoire est fixée dans les ressorts argentés à chaque extrémité de l'emplacement.

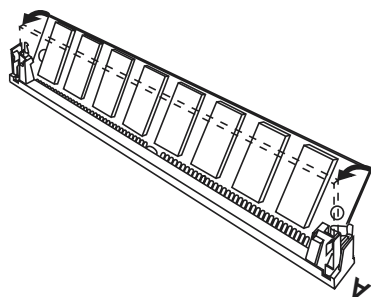

6 Pour ajouter plus d'une carte mémoire, répéter les étapes 4 et 5.

7 Replacer la plaque du dessus du XV-5080.

Ceci complète les procédures d'installation pour augmenter la mémoire.

Let's Play Sounds From a Sampler Library

French language

for Canadian Safety Standard

Enlever une carte modules SIMM

Enlever les cartes de mémoire des emplacements dans l'ordre inverse que celui effectué lors de l'installation.

1

Pousser simultanément vers l'extérieur les ressorts argentés aux deux extrémités des emplacements.

Cette manipulation détache la carte des ressorts et la laisse de biais dans l'emplacement.

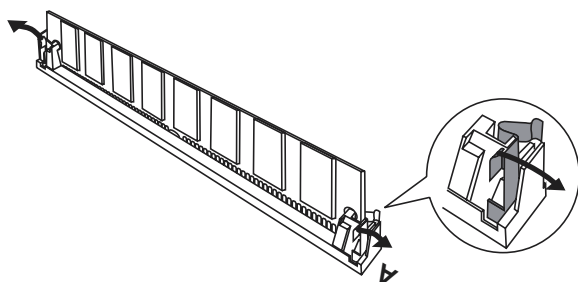

2

Retirer la carte de l'emplacement

Assurez-vous que les modules SIMM sont installés correctement

1

Appuyez sur le bouton [SYSTEM/UTILITY] pour que le voyant lumineux s'allume.

* Si le voyant clignote, l'appareil est en mode « Utilitaire ». Appuyez à nouveau sur le bouton [SYSTEM/UTILITY] pour que le voyant lumineux reste allumé sans clignoter.

2

Appuyez sur le bouton [F6 (Info)].

L'écran Information Système apparaît.

SYSTEM Information	
Wave Expansion Board	2x Expanded
A: SR-JV80-15 SFX	E: SIMM A 64.0MB
B: -----	F: SRX-01DynamicDrm B 0KB
C: -----	G: Total 64.0MB
D: -----	H: Free 64.0MB
Battery Check	SCSI ID
OK	XU-5080 Self 7
General	Outp&EQ
MIDI	Control
Preview	Info

Assurez-vous que la taille du module SIMM est affichée à côté du nom de la fente dans laquelle il est installé.

* «-----» s'affiche à côté du nom de la fente si aucun module SIMM n'y est installé ou si un module SIMM y est installé incorrectement.

Connecting the CD-ROM Drive

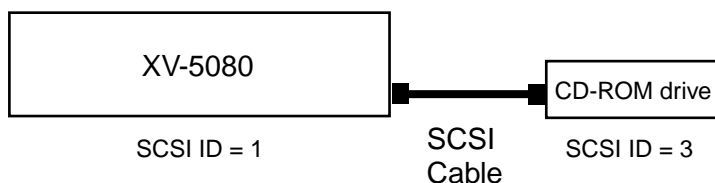

1 Turn off the power of the XV-5080 and any connected external devices.

2 Using a SCSI cable, connect the XV-5080 and the CD-ROM drive.

3 Set the SCSI ID with the SCSI switch on the rear panel. Any number is acceptable as long as each device has a different SCSI ID.

Make the settings as shown below.

* For more on the CD-ROM drive SCSI ID settings, please refer to the owner's manual for the device you are using.

SCSI ID

XV-5080:	1
CD-ROM Drive:	3

4 Set the CD-ROM drive's terminator to ON.

* For more on the CD-ROM drive terminator settings, please refer to the owner's manual for the device you are using.

* For more on making SCSI connections, please refer to p. 239 of the Owner's Manual.

MEMO

You can check the XV-5080's currently selected SCSI ID in the SYSTEM Info screen. (p. 216)

NOTE

The SCSI ID switch settings "8" and "9" cannot be used with the XV-5080.

Loading Sampler Libraries (Patches)

Here's how you can load Patches from a library (optional L-CDX Series) designed for use with the XV-5080 (S-760).

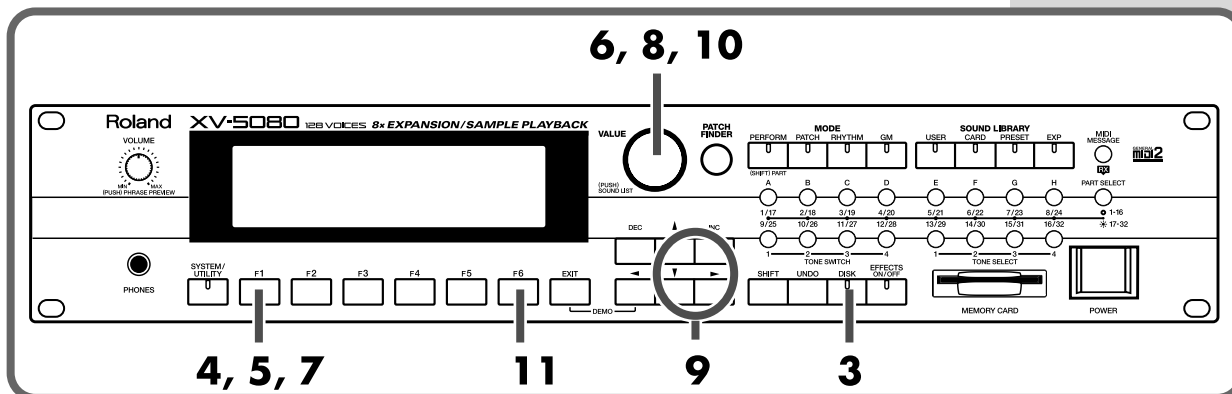

1 Turn on the power to the CD-ROM drive, then to the XV-5080.

2 Place the CD-ROM (sampler library) that you want to load in the CD-ROM drive.

3 Press [DISK] button.
The Disk Menu page appears.



4 Press [F1 (Load)] button.
The Load page will appear.



5 Press [F1 (Drive)] button.
The Drive window will appear.

MEMO

For more detailed information and instructions for loading data, refer to “Chapter 7 Loading Each Type of Data” in the Owner’s Manual.

6 Turn the VALUE dial to select "SCSI3: (Volume Name)."

7 Press the [F6 (OK)] button.

The CD-ROM's contents are displayed.

Folders appear within the <> symbols. Folders cannot be load.

The types of folders appearing on the screen may differ according to the library that has been loaded.

8 Turn the VALUE dial or press [▲] or [▼] to select the folder containing the file you want to load.

9 Press [▶] to display the files that can be loaded.

* Press [◀] to move up one level.

10 Turn the VALUE dial or press [▲] or [▼] to select the Patch to be loaded, then press [F5 (Mark)] button to place a "*" marker.

To place a marker on all categories, press [F4 (Mk All)] button. Press this once more to remove all markers.

11 Press the [F6 (Select)] button.

12 Press the [F6 (Load)] button.

The message "Overwrite the following USER data. Sure?" and a window showing the number of the Patch in the User Group that will be overwritten appear in the display.

In this window, you can specify the Patch number to which the Patch is to be loaded.

13 Here, press [F6 (OK)] to overwrite and load.

* To cancel the operation, press the [EXIT] button.

MEMO

If you want to restore overwritten User Group Patches to the original settings, carry out the Factory Reset procedure (p. 13).

Playing Back Sampler Libraries (Patches)

Patches and Performances loaded from CD-ROMs are recorded in the USER Group.

After selecting a Patch or Performance in the USER Group, you can then play the sounds.

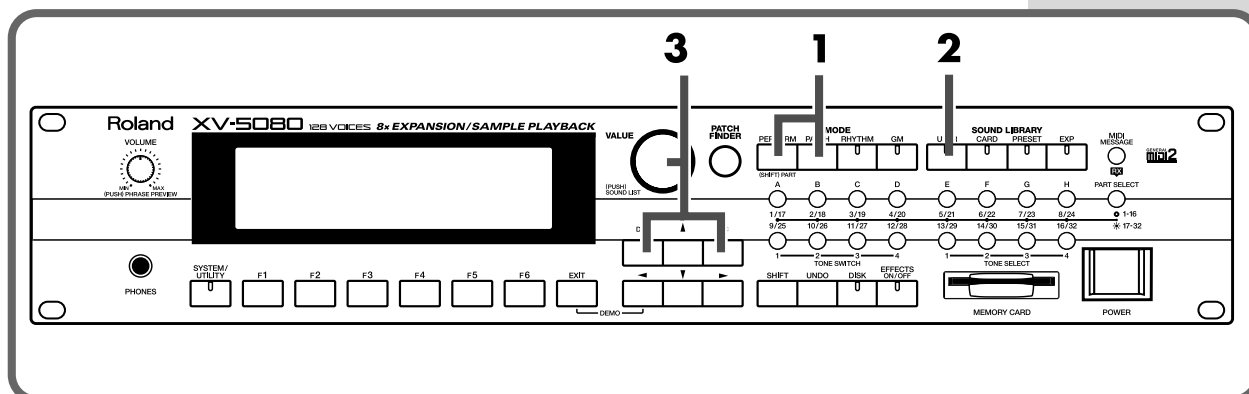

1 Press [PATCH] button or [PERFORM] button to make its indicator light.

2 Press [USER] button, getting the indicator to light.

3 Turn the VALUE dial, or press [INC]/[DEC] button to select the Patch or Performance you want to play.

You can play the sounds using a connected MIDI keyboard or other such device.

* You can also press the VOLUME knob to listen to the sound. When a Performance is selected, this plays the Patch phrase of the currently selected part.

Let's Make a List of Your Favorite Patches

Registering a Patch in the FAVORITE LIST

You can bring together your favorite and most frequently used Patches in one place by registering them in the FAVORITE LIST. The FAVORITE LIST gives you immediate access to your favorite Patches, whether they are in the XV-5080 itself, on Wave Expansion Boards, or on memory cards. You can register up to 64 Patches in this list.

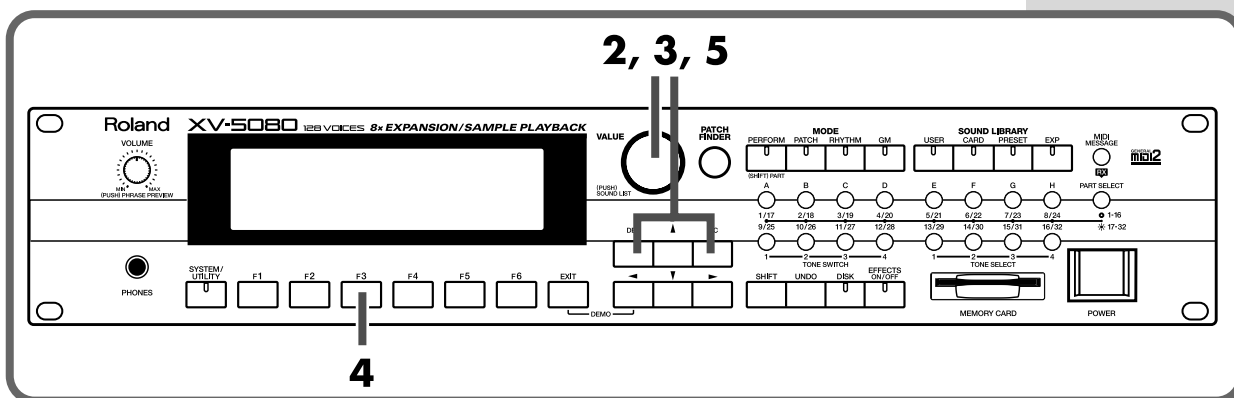

1 At the PATCH PLAY page, choose the Patch you want to register.

2 Press the VALUE dial.
The Sound List or Favorite window will appear.

* When the SOUND LIST is displayed, press the [F2 (F-List)] button.

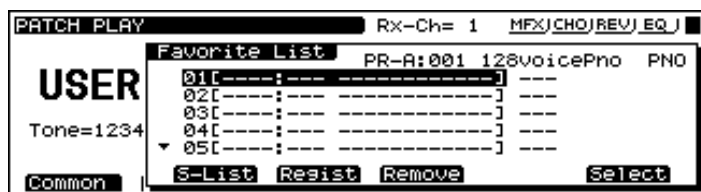

3 Turn the VALUE dial or press the [INC]/[DEC] button to select the desired registration destination number.

* No data is registered at the factory settings.

4 Press the [F3 (Regist)] button.
The Patch will be registered to the Favorite List.
To cancel the registration, press the [EXIT] button.

NOTE

If a Patch on a Wave Expansion Board or memory card is registered in the list and selected, no sound will be produced for the Patch unless the required Wave Expansion Board or memory card is inserted.

MEMO

On this page, pressing the VOLUME knob allows you to audition the Patch being registered.

Let's Make a List of Your Favorite Patches

* To cancel the registration, select the file you want to cancel, and then press the [F4 (Remove)] button.

5

Press the [EXIT] button or the VALUE dial to return to the PATCH PLAY page.

Directly registering to the list on the PATCH/RHYTHM PLAY page

The following display appears when [SHIFT] is pressed while on the PATCH/RHYTHM PLAY page.

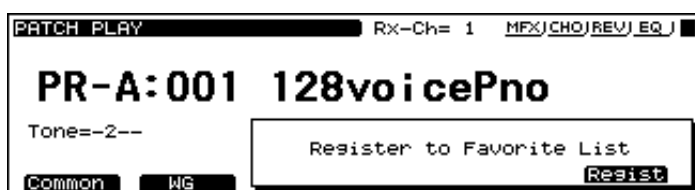

If [F6 (Register)] is pressed at this stage, the data is registered to the lowest-numbered opening on the list.

Although the message "COMPLETED" instantly appears in the display when the registration is executed, if the registration cannot be carried out because the list is full, the message "Favorite List Full" is displayed instead.

MEMO

You can also register the Rhythm Set in the same way.

Selecting Patches from the FAVORITE LIST

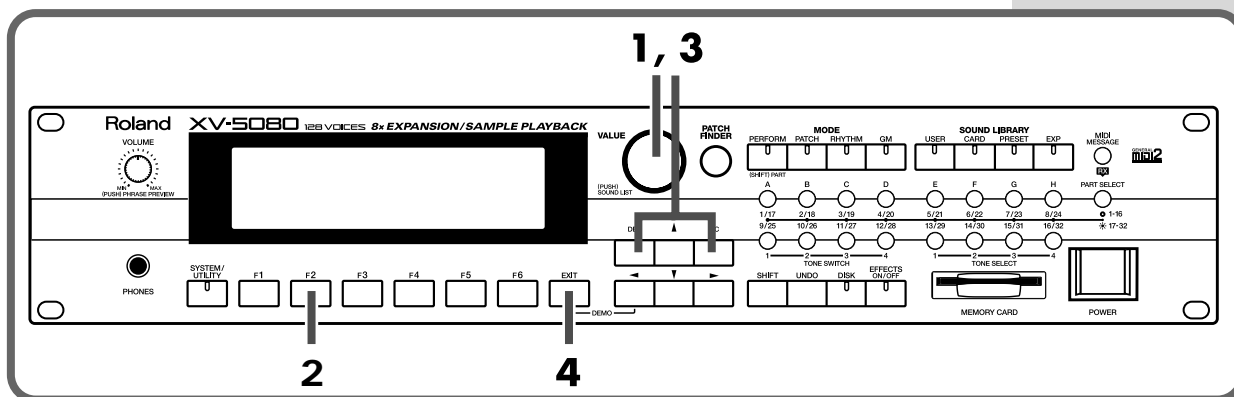

1

Press the VALUE dial.

The Sound List or Favorite List window will appear.

If the Sound List window will appear, Press the [F2 (F-List)] button.

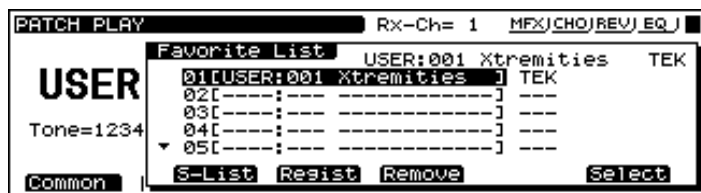

2

Turn the VALUE dial or press the [INC]/[DEC] button to select the desired Patch.

* If you want to cancel the selection, simply press the [UNDO] button. The value of the parameter will be restored to what it was when you first positioned the cursor there.

3

Press the [EXIT] button to return to the previous page.

Using the XV-5080 in Live Performance

Using the XV-5080 with Another Synthesizer to Play Sounds

Playing the XV-5080's patches together with the sounds from your synthesizer allows you to enjoy an even greater variety of sounds.

When layering the synthesizer's sounds with the XV-5080's Patches to create sounds, set the synthesizer's transmission channel to the same channel as the XV-5080's receive channel.

- 1 Use a MIDI cable to connect your synthesizer's MIDI OUT connector to the MIDI IN connector on the XV-5080.
- 2 Select a tone on your synthesizer.
- 3 Select a Patch on the XV-5080.
- 4 Set the synthesizer's send channel and the XV-5080's receive channel so they are matched up.

When you have finished making the settings, start playing.

Using an External MIDI Device to Change Effects in the Multi-Effects

With the XV-5080, you can use an external MIDI device's controller (such as a modulation lever, foot switch, or expression pedal) as a simple way to change the multi-effects settings while you play.

Here is an example of using the modulation lever — or modulation wheel on some MIDI keyboards — to modify the speed of the Rotary effect.

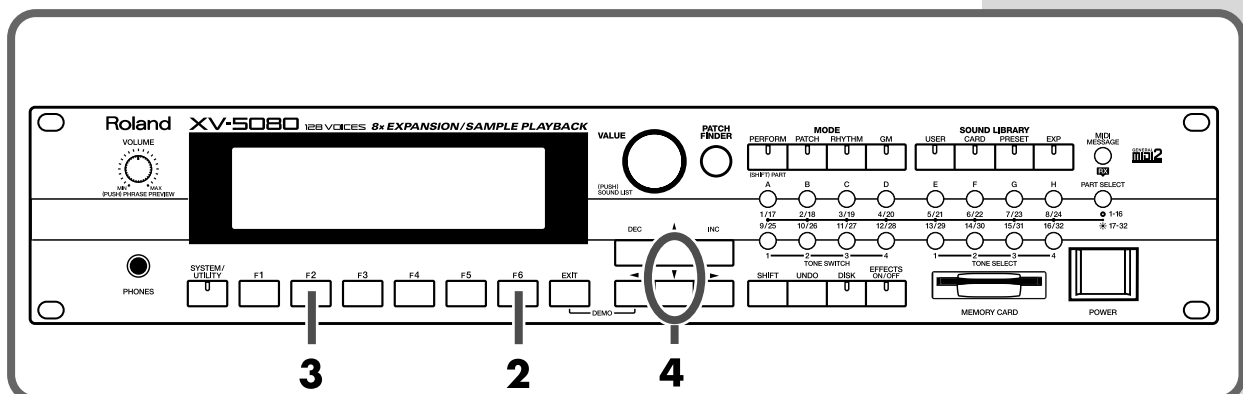

- 1** Select PR-A:050 Perky B on the PATCH Play page.
This Patch uses 8: ROTARY as its Multi-Effect type.

- 2** Press [F6 (Effects)] button.

- 3** Press [F3 (MFX Ctl)] button.

PATCH Effects MFX Control		ORG:Perky B	
Type:08(ROTARY)			
MFX Control	Source	Destination	Sens
Control 1	CC01:MODULATION	SPEED	+63
Control 2	00:OFF	LEVEL	0
Control 3	00:OFF	OFF	0
Control 4	00:OFF	OFF	0

General MFX Prm MFX Ct1 Chorus Reverb

- 4** Use [▲][▼] to move the cursor to the item that you wish to set, and turn the VALUE dial to select the following values.

MFX Control 1

Source: MODULATION

Destination: SPEED

Sens: +63

Notice how the Rotary speed becomes faster when you press the modulation lever (or raise the modulation wheel).

Press the [EXIT] button to return to the PATCH PLAY page.

For More Advanced Use of the XV-5080...

The XV-5080 includes numerous other functions that could not be covered in this volume. Such functions are explained in detail in the Owner's Manual.

Furthermore, for more advanced ways to use the XV-5080, we recommend reading the Owner's Manual and referring to the following items.

Editing Patches

Four-Tone Patch (p. 134)

Multi-partial Patch (p. 148)

Editing Tones (p. 134)

Editing Partials (p. 149)

Editing Samples (p. 150)

Creating Performances (p. 159)

Creating Rhythm Sets (p. 168)

Changing effect settings (p. 24)

Setting the output connectors (p. 107)

Using the Digital Interface (p. 119)

Using the XV-5080 as a General MIDI sound module (p. 224)

Saving the data you create (p. 194)

Controlling the XV-5080 in realtime (p. 217)

Changing the Part settings from an external MIDI device (p. 221)

Saving on a memory card (p. 195)

Memo

Demo Song and Profile of the Composer

Epic Passage

Scott Tibbs

© 2000 Roland Corporation

Scott Tibbs has performed and conducted for several orchestral groups, including the Atlanta Symphony Orchestra, throughout the United States, Canada, Latin America, and Japan. His diverse compositional output ranges from numerous film, theater and

television projects to the symphonic concert stage. He has received a Ph.D. degree in composition from UCLA and has recently composed music for recordings with Clare Fisher and Bill Holman. He has performed with well-known artists Dizzy Gillespie, Bill Cosby, Jerry Sienfeld, and Bobby Shew, amongst numerous others.

A Better Day

Igor Len

© 2000 Roland Corporation

Igor Len, pianist and composer, started playing piano at the age of four. He graduated with a Masters Degree in Performing Arts from prestigious Moscow Tchaikovsky Conservatory, and later toured as a pop-keyboardist in Asia, Europe and the United States.

He has appeared in concert with the C. Santana Band, Doobie Brothers, J.Taylor, B.Raitt, T.Dolby, and others. Since relocating to the US, Igor has composed a wide variety of music, ranging from contemporary ballet to dance remixes.

Igor joined Roland Corporation U.S. 1994, and has contributed music and sounds for various Roland products.

Xtra Vaganza

Hans-Joerg Scheffler

© 2000 Digital Audio Design

Born and raised in the Ruhr valley, the biggest industrial area in Germany, Hans's attraction to noise and rhythm came naturally.

Today he runs his own company, DIGITAL AUDIO DESIGN, which produces sampling CDs and CD ROMs.

He works for Roland as a pro audio product specialist, as a sound designer for expansion boards, and as a composer of demo songs. He has released several CDs that use the Roland RSS system.

Soundclips of his work can be downloaded at: <http://www.united-sound.com/usmaster/cell2downde.htm>

* *All rights reserved. Unauthorized use of this material for purposes other than private, personal enjoyment is a violation of applicable laws.*