

Roland®

DIGITAL STUDIO WORKSTATION VS-880



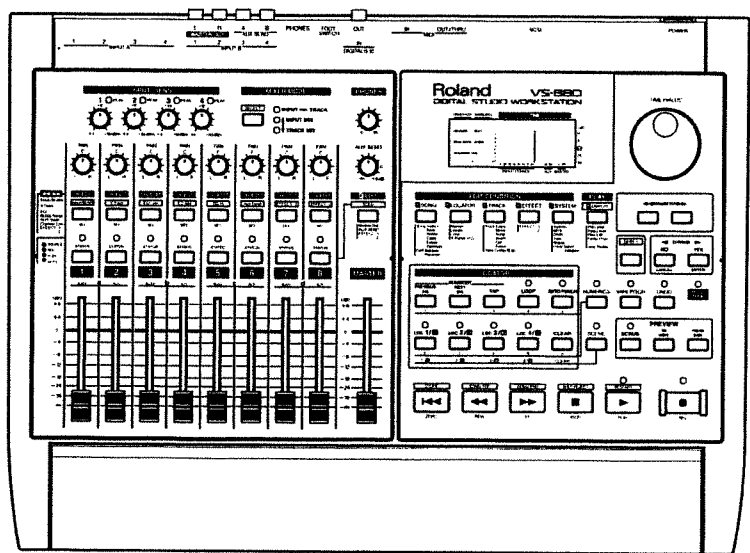

OWNER'S MANUAL

Before using this unit, carefully read the sections entitled: "IMPORTANT SAFETY INSTRUCTIONS" (p. 2), "USING THE UNIT SAFELY" (p. 3), and "IMPORTANT NOTES" (p. 11). These sections provide important information concerning the proper operation of the unit. Additionally, in order to feel assured that you have gained a good grasp of every feature provided by your new unit, this manual should be read in its entirety. The manual should be saved and kept on hand as a convenient reference.



Copyright © 1996 ROLAND CORPORATION
All rights reserved. No part of this publication may be reproduced in
any form without the written permission of ROLAND CORPORATION.

	CAUTION RISK OF ELECTRIC SHOCK DO NOT OPEN	
ATTENTION: RISQUE DE CHOC ELECTRIQUE NE PAS OUVRIE		
<p>CAUTION: TO REDUCE THE RISK OF ELECTRIC SHOCK, DO NOT REMOVE COVER (OR BACK). NO USER-SERVICEABLE PARTS INSIDE. REFER SERVICING TO QUALIFIED SERVICE PERSONNEL.</p>		



The lightning flash with arrowhead symbol, within an equilateral triangle, is intended to alert the user to the presence of uninsulated "dangerous voltage" within the product's enclosure that may be of sufficient magnitude to constitute a risk of electric shock to persons.



The exclamation point within an equilateral triangle is intended to alert the user to the presence of important operating and maintenance (servicing) instructions in the literature accompanying the product.

INSTRUCTIONS PERTAINING TO A RISK OF FIRE, ELECTRIC SHOCK, OR INJURY TO PERSONS.

IMPORTANT SAFETY INSTRUCTIONS SAVE THESE INSTRUCTIONS

WARNING - When using electric products, basic precautions should always be followed, including the following:

1. Read all the instructions before using the product.
2. Do not use this product near water — for example, near a bathtub, washbowl, kitchen sink, in a wet basement, or near a swimming pool, or the like.
3. This product should be used only with a cart or stand that is recommended by the manufacturer.
4. This product, either alone or in combination with an amplifier and headphones or speakers, may be capable of producing sound levels that could cause permanent hearing loss. Do not operate for a long period of time at a high volume level or at a level that is uncomfortable. If you experience any hearing loss or ringing in the ears, you should consult an audiologist.
5. The product should be located so that its location or position does not interfere with its proper ventilation.
6. The product should be located away from heat sources such as radiators, heat registers, or other products that produce heat.
7. The product should be connected to a power supply only of the type described in the operating instructions or as marked on the product.
8. The power-supply cord of the product should be unplugged from the outlet when left unused for a long period of time.
9. Care should be taken so that objects do not fall and liquids are not spilled into the enclosure through openings.
10. The product should be serviced by qualified service personnel when:
 - A. The power-supply cord or the plug has been damaged; or
 - B. Objects have fallen, or liquid has been spilled onto the product; or
 - C. The product has been exposed to rain; or
 - D. The product does not appear to operate normally or exhibits a marked change in performance; or
 - E. The product has been dropped, or the enclosure damaged.
11. Do not attempt to service the product beyond that described in the user-maintenance instructions. All other servicing should be referred to qualified service personnel.

For the USA

GROUNDING INSTRUCTIONS

This product must be grounded. If it should malfunction or breakdown, grounding provides a path of least resistance for electric current to reduce the risk of electric shock.

This product is equipped with a cord having an equipment-grounding conductor and a grounding plug. The plug must be plugged into an appropriate outlet that is properly installed and grounded in accordance with all local codes and ordinances.

DANGER: Improper connection of the equipment-grounding conductor can result in a risk of electric shock. Check with a qualified electrician or serviceman if you are in doubt as to whether the product is properly grounded. Do not modify the plug provided with the product — if it will not fit the outlet, have a proper outlet installed by a qualified electrician.

For the U.K.

WARNING: THIS APPARATUS MUST BE EARTHED
IMPORTANT: THE WIRES IN THIS MAINS LEAD ARE COLOURED IN ACCORDANCE WITH THE FOLLOWING CODE.
GREEN-AND-YELLOW: EARTH, BLUE: NEUTRAL, BROWN: LIVE

As the colours of the wires in the mains lead of this apparatus may not correspond with the coloured markings identifying the terminals in your plug, proceed as follows:

The wire which is coloured GREEN-AND-YELLOW must be connected to the terminal in the plug which is marked by the letter E or by the safety earth symbol  or coloured GREEN or GREEN-AND-YELLOW.

The wire which is coloured BLUE must be connected to the terminal which is marked with the letter N or coloured BLACK.



The wire which is coloured BROWN must be connected to the terminal which is marked with the letter L or coloured RED.

The product which is equipped with a THREE WIRE GROUNDING TYPE LINE PLUG must be grounded.







USING THE UNIT SAFELY

INSTRUCTIONS FOR THE PREVENTION OF FIRE, ELECTRIC SHOCK, OR INJURY TO PERSONS

About WARNING and CAUTION Notices









 WARNING	Used for instructions intended to alert the user to the risk of death or severe injury should the unit be used improperly.
 CAUTION	Used for instructions intended to alert the user to the risk of injury or material damage should the unit be used improperly. * Material damage refers to damage or other adverse effects caused with respect to the home and all its furnishings, as well to domestic animals or pets.

About the Symbols

	The  symbol alerts the user to important instructions or warnings. The specific meaning of the symbol is determined by the design contained within the triangle. In the case of the symbol at left, it is used for general cautions, warnings, or alerts to danger.
	The  symbol alerts the user to items that must never be carried out (are forbidden). The specific thing that must not be done is indicated by the design contained within the circle. In the case of the symbol at left, it means that the unit must never be disassembled.
	The  symbol alerts the user to things that must be carried out. The specific thing that must be done is indicated by the design contained within the circle. In the case of the symbol at left, it means that the power-cord plug must be unplugged from the outlet.

ALWAYS OBSERVE THE FOLLOWING









WARNING

- Before using this unit, make sure to read the instructions below, and the Owner's Manual. 
- Do not open or perform any internal modifications on the unit. (The only exception would be where Quick Start manual provides specific instructions which should be followed in order to put in place user-installable options; see p. 3.) 
- Make sure you always have the unit placed so it is level and sure to remain stable. Never place it on stands that could wobble, or on inclined surfaces. 
- Avoid damaging the power cord. Do not bend it excessively, step on it, place heavy objects on it, etc. A damaged cord can easily become a shock or fire hazard. Never use a power cord after it has been damaged. 
- In households with small children, an adult should provide supervision until the child is capable of following all the rules essential for the safe operation of the unit. 
- Protect the unit from strong impact. (Do not drop it!) 
- Do not force the unit's power-supply cord to share an outlet with an unreasonable number of other devices. Be especially careful when using extension cords—the total power used by all devices you have connected to the extension cord's outlet must never exceed the power rating (watts/amperes) for the extension cord. Excessive loads can cause the insulation on the cord to heat up and eventually melt through. 
- Before using the unit in a foreign country, consult with your dealer, or qualified Roland service personnel. 

WARNING

- Always turn the unit off and unplug the power cord before attempting installation of the Hard disk drive unit (HDP88 series) or Effect expansion board VS8F-1. 

CAUTION

- Always grasp only the plug on the power-supply cord when plugging into, or unplugging from an outlet. 
- Try to prevent cords and cables from becoming entangled. Also, all cords and cables should be placed so they are out of the reach of children. 
- Never climb on top of, nor place heavy objects on the unit. 
- Never handle the power cord or its plugs with wet hands when plugging into, or unplugging from, an outlet or this unit. 
- Before moving the unit, disconnect the power plug from the outlet, and pull out all cords from external devices. 
- Before cleaning the unit, turn off the power and unplug the power cord from the outlet. 
- Whenever you suspect the possibility of lightning in your area, pull the plug on the power cord out of the outlet. 
- When installing the Hard disk drive unit (HDP88 series) or Effect expansion board VS8F-1, remove only the specified screws. 

Introduction

Thank you for purchasing the Roland VS-880 V-XPANDED Digital Studio Workstation or the VS-880-S1 System Expansion Kit.

The VS-880 V-XPANDED is a revolution in home studio equipment that makes a cutting-edge studio environment available to the musician. Disk recorder, digital mixer, and multi effects are brought together in a unified system that allows the entire process from recording to mixdown, effects and output to PA equipment to take place entirely in the digital domain.

The VS-880-S1 is an expansion kit that **enhances** the system software of the VS-880 that you have been using to full V-XPANDED functionality. In addition to the superb digital studio functionality that you have already been enjoying, you will now be able to experience even more powerful functions and even easier operation.

The documentation for VS-880 V-XPANDED consists of two manuals: "Quick Start" and "Owner's Manual" (this document). If you are using the VS-880 for the first time, please read "Quick Start" first.

About the package contents

■ If you purchased the VS-880 V-XPANDED

The VS-880 V-XPANDED package includes the following items. Make sure that you have all the items.

- VS-880
- Power cable
- Quick Start
- Owner's Manual (this manual)
- VS8F-1 Preset Patch List
- Leaflet "Notes when using a Zip drive"
- V-XPANDED sticker

■ If you purchased the VS-880-S1

The VS-880-S1 package includes the following items. Make sure that you have all the items.

- VS-880-S1 (Zip disk)
- Expanding the functionality of the VS-880
- Owner's Manual (this manual)
- VS8F-1 Preset Patch List
- V-XPANDED sticker

How this manual is organized

This manual is organized as follows.

■ Chapter 1 Trying out the expanded functions

This chapter provides some simple examples which explain the operation of the expanded VS-880. If you have purchased the VS-880-S1, read this first to learn which functions are added by the V-XPANDED upgrade.

If you purchased the VS-880 V-XPANDED, read the separate "Quick Start" first.

■ Chapter 2 Before you start (VS-880 terminology)

This chapter explains basic **concepts** that you will need to understand in order to use the VS-880. It also explains various **terms** that you should know.

■ Chapter 3 Basic operation (as a replacement for a tape MTR)

This chapter explains the actual steps in the procedure of creating a master tape.

■ Chapter 4 Editing a recorded performance (track editing)

This chapter explains the procedure for “editing sound,” something which was not possible on conventional tape MTR units.

■ Chapter 5 Use with MIDI devices

This chapter explains the procedures for using the VS-880 in conjunction with MIDI devices. Read this chapter when you wish to use the VS-880 in synchronization with other MIDI devices.

■ Chapter 6 Use with a Zip drive

This chapter explains the procedures for using the VS-880 with a Zip drive. Read this chapter when you wish to use a Zip drive to record a performance. This chapter also explains how to use the VS-880 with a hard disk or magneto-optical disk.

■ Chapter 7 Use with a DAT recorder

This chapter explains the procedures for using the VS-880 in conjunction with a DAT recorder. Read this chapter when you wish to save your performance on a DAT recorder.

■ Chapter 8 Using the internal effects

This chapter explains the operating procedures when a VS8F-1 effect expansion board is installed. Read the VS8S-1 owner’s manual in conjunction with this chapter.

■ Chapter 9 Other convenient functions

This chapter explains operation of functions which were not discussed in earlier chapters, such as sounding the metronome during recording, or when a foot switch is connected.

■ Chapter 10 Overall settings and status checking

This chapter explains how to make the settings which affect the overall operation of the VS-880.

■ Chapter 11 Taking advantage of the VS-880 (ideas and examples)

This chapter combines some of the functions discussed in earlier chapters, and gives some actual examples of how you can take advantage of the VS-880.

■ Appendices

This chapter contains material which will help you make the best use of the VS-880, such as “Troubleshooting” and “Error message list.”

Contents

Main features	10
Important notes	11
Front and rear panels	13
Mixer section	13
Recorder section	14
Display section	15
Rear panel	16
Chapter 1 Trying out the expanded functions	
Mixer-related	17
Using auto mix	17
Using the 3-band equalizer in INPUT MIX/TRACK MIX	20
Mixing in a stereo source (Stereo In)	21
Adjusting the level of each track (Track Level)	21
Causing top panel fader and pan knob operations to take effect immediately	21
Recorder related functions	22
When the Recording mode is set to Mastering	22
When a digital signal with emphasis is input	22
Creating a master tape which disables digital copying	22
Effect related	23
Newly added preset patches	23
Newly added algorithms	23
Adjusting the send level and balance for all effects	33
Inserting an effect	34
Display related	37
Holding the level meter peaks	37
Checking the remaining disk capacity	37
Disk drive related	38
Checking the reliability of a disk	38
Checking that a disk is not damaged	38
Synchronization related	40
Assign mark points according to the tempo	40
When using the sync track	40
Using the tempo map	42
Adding an offset to the sync track/tempo map	42
MIDI related	43
Using program change messages to select scenes	43
Using program change messages to select effects	43
Using control change messages to control effects	43
Other	44
Using the numeric keys ([NUMERIC])	44
Holding the function of [SHIFT] (Shift Lock)	44
Easy time adjustment	45
Chapter 2 Before you start (VS-880 terminology)	
Sources, tracks, and channels	46
Doing everything in the digital domain (Digital Studio Workstation)	46
Signal flow (busses)	46
Where a performance is recorded (Song)	47
Mixer section	48
About mixer modes	48
Switching the mixer mode	51
Recording the current condition of the mixer (Scene)	51
Recorder section	53
Differences with a tape-type MTR	53
Number of tracks that can be recorded/played simultaneously	53
Virtual tracks provided for each track (V-tracks)	53
Effects section	54
About the effect expansion board (VS8F-1)	54
VS-880 operation	54
How operations are organized (Conditions)	54
Switching conditions	54

Selecting the operation menu	55
Selecting parameters	55
Modifying the value of settings	55
Executing an operation	55
Switching the track status (Track Status)	55
Changing the current time	56
Storing a time location, method 1 (Locate Point)	57
Storing a time location	57
Moving to a stored time location	58
Modifying a stored time location	58
Deleting a stored time location	58
Storing a time location, method 2 (Mark Points)	59
Marking a time location	59
Moving to a marked time location	59
Modifying a marked time location	60
Clearing a mark	60
Chapter 3 Basic operation (as a replacement for a tape MTR)	
Before you begin	61
When you turn the power on	61
Listening to the demo song	61
Listening to the variations of the demo song	61
Making a new recording	62
Specifying the recording mode (Song New)	62
Naming the song (Song Name)	62
General procedure for multitrack recording	63
Connect the instruments	63
Record a performance onto a track	63
Switching V-tracks	63
Recording additional tracks while listening to the performance (Overdubbing)	64
Re-recording only your mistakes (Punch-in/out)	64
Specify beforehand the location for re-recording (Auto punch-in)	65
Repeatedly recording over the same area (Loop recording)	66
Combining the performances of two or more tracks into another track (Track bouncing)	67
Creating a master tape	67
Digital recording	72
Concerning copyright	72
About SCMS	72
Connecting digital devices	72
Matching the sampling frequency	72
Selecting digital input as the source	73
Select an input source	73
When digital recording is not possible	73
Before you finish operations	74
Saving the performance to disk (Song Store)	74
Preventing accidental erasure of your performance (Song Protect)	74
Selecting a song (Song Select)	75
Turning the power off (Shut Down)	75
Re-starting the VS-880	75
Chapter 4 Editing a recorded performance (track editing)	
What is editing?	76
Finding a desired location (Preview)	76
Using [TO] and [FROM]	76
Scrub playback ([SCRUB])	76
Basic procedure	77
Re-using part of the performance (Copy)	78
Modifying the organization of the performance (Move)	79
Erasing part of a performance (Erase)	81
Exchanging performance data between tracks (Exchange)	81
Inserting blank space into a performance (Insert)	82
Deleting a portion of a performance (Cut)	83
Modifying the playback time of the performance (Time compression/expansion)	84

Chapter 5 Use with MIDI devices	
About MIDI	85
What is MIDI	85
MIDI connectors	85
MIDI channels	85
MIDI messages	85
MIDI implementation chart	85
Using MIDI to switch the track status	86
Synchronizing with a MIDI sequencer	86
Using MTC	86
New operation of the offset time setting	89
Using the tempo map	89
Using the sync track	91
When you experience problems with synchronization	92
Chapter 6 Use with a Zip drive	
Connecting a Zip drive	93
Initializing the disk (Drive Initialize)	93
Select the Zip drive as the recording destination (Drive Select)	93
Saving performance data on a Zip disk (Song Copy)	94
Saving on a single disk (Playable)	94
When the data cannot be saved on a single disk (Archive)	95
If you have problems saving the data	96
Chapter 7 Use with a DAT recorder (DAT backup)	
Saving performance data to a DAT recorder (Backup)	97
Loading performance data from a DAT recorder (Recover)	98
In case DAT recover operation is halted	99
Checking the names of the performance data that was saved (Name)	99
Checking the storage status of performance data that was saved (Verify)	100
Chapter 8 Using the internal effects	
Examples of how the effects can be used	101
Applying reverb to a recorded performance (Loop)	101
Applying reverb as you record (Loop)	103
Applying a vocoder while you record (Insert)	105
Applying reverb while bouncing tracks (Loop)	106
If the effect does not sound as you expect	108
Chapter 9 Other convenient functions	
Sounding the metronome	109
Using an external MIDI sound source to play the metronome	109
Using a foot switch to playback/stop	110
Stopping automatically (Marker stop)	110
Changing the pitch during playback (Vari-pitch)	111
Listening only to a specific channel (Solo)	111
Simultaneously adjusting a stereo source (Channel Link)	112
Undoing a recording or editing operation	112
Recording/editing operations which can be undone (Undo)	112
Canceling the last-performed Undo (Redo)	113
Canceling only the last-performed operation	113
When the disk has little remaining space	113
Deleting only unneeded performance data (Song Optimize)	113
Deleting one song of performance data (Song Erase)	113
Chapter 10 Overall settings and status checking	
If the display area is difficult to read (Contrast)	114
Switching the contents of the display (Bar Display)	114
Creating a song which maintains the current system settings (System Parameter Keep Switch)	115
Displaying measures/beats	115
Constantly monitoring the input source	116
Changing the VS-880's SCSI ID number	116

Checking the size of a recorded performance	116
Restoring the mixer settings to the initial state	117
If there is no internal hard disk	117

Chapter 11 Taking advantage of the VS-880 (ideas and examples)

Recording multiple sources to one track	118
Collecting just the sections that you like	119
Copying an 8-track MTR performance to the VS-880	120
Controlling the mixer from a MIDI sequencer	121
Operating the VS-880 from another device (MMC)	123
Synchronizing the operation of two VS-880 units	123
Operating the VS-880 from an MMC-compatible device	126
If you have problems with synchronization	127
Using external effect units	127
Applying an effect during playback	127
Applying an effect while you re-record	128

Appendices

Using an external disk drive (About SCSI)	130
Troubleshooting	132
Error messages	134
Special key operations	136
Parameter list	138
MIDI implementation chart	143
Mixer section block diagram	144
Glossary	145
Specifications	146
About the V-XPANDED sticker	147
Index	149

* Iomega is a registered trademark of Iomega Corporation.

* Zip is a trademark of Iomega Corporation.

* All product names mentioned in this document are trademarks or registered trademarks of their respective owners.

Main features

■ Digital audio workstation

The digital disk recorder section provides 8 tracks, and allows four tracks to be recorded simultaneously. Each track has eight virtual tracks (V-tracks), allowing a total maximum of 64 tracks to be recorded. This means that you can use convenient techniques such as recording numerous takes of guitar solos, vocals, or chorus.

Editing operations such as copy, move and erase which were impossible for a tape MTR can be easily accomplished. For example, a four-measure drum pattern that was recorded can be repeated several times as a break-beat. Or, you might place the same chorus at the beginning and end of a song.

The VS-880 uses non-destructive editing, a method unique to disk recorders. Previously performed recording or editing operations can be undone up to 999 steps backward (the Undo/Redo function).

Up to eight sets of all mixer settings (scenes) can be stored for each song. When you wish to adjust the balance during mixdown, or to compare effect settings, you can easily recall the previous settings.

For each song, up to 32 time locations (locate points) can be stored. If you register times such as the end of the introduction or the beginning of a break, you will be able to jump immediately to desired points in a song without having to fast-forward or rewind.

Up to 1000 time locations in each song can be marked (mark points). It is useful to place marks at the beginning of each measure, or at locations that you wish to listen to.

A sync track can be created from mark points that were assigned along with the tempo. By transmitting MIDI clock messages according to the sync track, you can easily synchronize the VS-880 with a MIDI sequencer.

Time-based movements of channel faders and pan etc. can be recorded (auto mix). With no additional equipment, the VS-880 can perform mixing operations such as fade in and fade out.

■ Easy-to-operate controls

The VS-880 can be operated as easily as conventional analog multi-track recorders. You will be able to enjoy the advantages of digital recording from the day that you purchase it.

The large LCD screen provides visual confirmation of many settings at once. In particular, the bar display provides a graphical indication of the level meter, pan and fader settings, and the track record status.

■ A full complement of connectors

Four analog audio inputs are provided, and you have the choice of using either 1/4" phone jacks or RCA phono type jacks. The input sensitivity of each jack can be adjusted from line level (+4 dBm) to mic level (-50 dBm). For output, RCA phono type master out jacks (stereo) and AUX send jacks (two output) are provided.

A SCSI connector is standard, allowing you to connect external disk drives such as hard disks or removable disks.

Coaxial type digital I/O connectors are provided, allowing recording/playback of digital audio with another digital audio device (CD player, DAT recorder, MD recorder, etc.)

MIDI connectors (IN, OUT/THRU) allow MIDI messages to be transmitted and received. The VS-880 can be used with a MIDI sequencer for compu-mix, or synchronized with a MIDI sequencer.

In addition to the tracks which record the audio signals, the VS-880 has a sync track which can record MIDI Clock data. By using this sync track, the VS-880 can be synchronized even with a MIDI sequencer which does not implement MTC (MIDI Time Code) or MMC (MIDI Machine Control).

■ A full array of options

If an HDP-88 series hard disk (2.5 inch) is installed internally, the VS-880 will be a self-contained, compact, and portable recording system. In contrast to when external disk drives are used, there will be no possibility of problems resulting from faulty connections. We recommend that you install an internal hard disk when using the VS-880.

If a VS8F-1 effect expansion board is installed, a wide variety of effects will be available for use on the VS-880.

Important notes

In addition to the items listed under "IMPORTANT SAFETY INSTRUCTIONS" and "USING THE UNIT SAFELY" on pages 2 and 3, please read and observe the following:

Power Supply

- Do not use this unit on the same power circuit with any device that will generate line noise (such as an electric motor or variable lighting system).
- Before connecting this unit to other devices, turn off the power to all units. This will help prevent malfunctions and/or damage to speakers or other devices.

Placement

- Using the unit near power amplifiers (or other equipment containing large power transformers) may induce hum. To alleviate the problem, change the orientation of this unit; or move it farther away from the source of interference.
- This device may interfere with radio and television reception. Do not use this device in the vicinity of such receivers.
- Do not expose the unit to direct sunlight, place it near devices that radiate heat, leave it inside an enclosed vehicle, or otherwise subject it to temperature extremes. Excessive heat can deform or discolor the unit.

Maintenance

- For everyday cleaning wipe the unit with a soft, dry cloth or one that has been slightly dampened with water. To remove stubborn dirt, use a cloth impregnated with a mild, non-abrasive detergent. Afterwards, be sure to wipe the unit thoroughly with a soft, dry cloth.
- Never use benzene, thinners, alcohol or solvents of any kind, to avoid the possibility of discoloration and/or deformation.

Repairs and Data

- Please be aware that all data contained in the unit's memory may be lost when the unit is sent for repairs. Important data should always be backed up on a DAT recorder or an external disk drive (e.g., hard disk or MO disk). During repairs, due care is taken to avoid the loss of data. However, in certain cases (such as when circuitry related to memory itself is out of order), we regret that it may not be possible to restore the data, and Roland assumes no liability concerning such loss of data.

Disk drive handling

Disk drives are precision devices. When handling a VS-880 that has an internal hard disk installed, or when handling an external disk drive, observe the following precautions.

- For details on hard disk handling, refer also to the instructions that accompanied your hard disk.
- Before performing the following actions, be sure to perform the shut-down operation. If you fail to perform the shut-down operation, not only the data recorded on the hard disk, but also the hard disk itself may be damaged.
 - Turning off the power of the disk drive
 - Turning off the power of the VS-880
 - Removing a disk from a removable disk drive
- While the MIDI/DISK indicator of the VS-880 or the disk drive busy indicator is lit, data is being transferred to or from the disk drive. If you are using a removable disk drive, make sure that this indicator is dark before removing the disk.
- Place the unit in a stable and level location that is not affected by vibration from external sources. If the unit is tilted severely, this may have harmful effects on the operation of the disk drive.
- While using the VS-880, be careful not to subject the unit to vibration or shock, and avoid moving the unit while the power is turned on. When transporting the unit, pack it in its original shipping carton.
- Avoid using the unit immediately after it has been moved to a location with a level of humidity that is greatly different than its former location. Rapid changes in the environment can cause condensation to form inside the drive, which will adversely affect the operation of the drive and/or damage removable disks. When the unit has been moved, allow it to become accustomed to the new environment (allow a few hours) before operating it.

Concerning copyright

The law prohibits the unauthorized recording, public performance, broadcast, sale, or distribution etc. of a work (CD recording, video recording, broadcast, etc.) whose copyright is owned by a third party.

The VS-880 does not implement SCMS. This design decision was made with the intent that SCMS should not restrict the creation of original compositions which do not violate copyright law. Roland will take no responsibility for any infringement of copyright that you may commit in using the VS-880.

< About SCMS >

"SCMS" stands for "Serial Copy Management System." This is a function that protects the rights of copyright holders by prohibiting recording via a digital connection for more than two generations. When digital connections are made between digital recorders that implement this function, SCMS data will be recorded along with the audio data. Digital audio data which contains this SCMS data cannot again be recorded via a digital connection.

Disclaimer of liability

Roland will take no responsibility for any "direct damages," "consequential damages," or "any other damages" which may result from your use of the VS-880. These damages may include but are not limited to the following events which can occur when using the VS-880.

- Any loss of profit that may occur to you
- Permanent loss of your music or data
- Inability to continue using the VS-880 itself or a connected device

Additional Precautions

- Please be aware that the contents of memory can be irretrievably lost as a result of a malfunction, or the improper operation of the unit. To protect yourself against the risk of losing important data, we recommend that you periodically save a backup copy of important data you have stored in the unit's memory on a DAT recorder or an external disk drive (e.g., hard disk or MO disk).
- Unfortunately, it may be impossible to restore the contents of data that was stored on a DAT recorder or an external disk drive (e.g., hard disk or MO disk) once it has been lost. Roland Corporation assumes no liability concerning such loss of data.
- Use a reasonable amount of care when using the unit's buttons, sliders, or other controls; and when using its jacks and connectors. Rough handling can lead to malfunctions.
- Never strike or apply strong pressure to the display.
- When connecting / disconnecting all cables, grasp the connector itself—never pull on the cable. This way you will avoid causing shorts, or damage to the cable's internal elements.
- A small amount of heat will radiate from the unit during normal operation.
- To avoid disturbing your neighbors, try to keep the unit's volume at reasonable levels. You may prefer to use headphones, so you do not need to be concerned about those around you (especially when it is late at night).
- When you need to transport the unit, package it in the box (including padding) that it came in, if possible. Otherwise, you will need to use equivalent packaging materials.

Front and rear panels

Mixer section

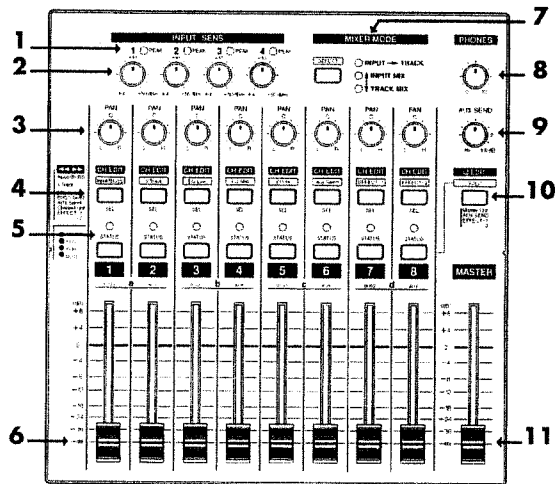

1. PEAK indicators

These indicators allow you to avoid distortion of the sound being input at the input jacks (1–4). The peak indicators will light red when the signal reaches -6 dB before clipping level. Adjust the input sensitivity so that the peak indicators do not light.

2. INPUT SENS (input sensitivity) knobs

These knobs adjust the sensitivity of the input jacks (1–4). Rotate a knob fully right for mic level (-50 dBm), and fully left for line level (+4 dBm).

3. PAN knobs

These knobs adjust the pan (location in the stereo output) of each channel.

4. CH EDIT / SEL (channel edit/select) buttons

Use these buttons when you wish to make settings for a mixer channel. The names of the parameter groups that can be set for each channel are printed below CH EDIT. To directly specify a particular group, you can hold down [SHIFT] and press the button for that group name.

When editing a song, use these buttons to select tracks for editing.

5. STATUS buttons

These buttons switch the status of each channel. The current status is shown by the button indicator.

SOURCE (orange): The input source assigned to the channel is being output.

REC (blinking red): Recording is selected for the track assigned to the channel. During playback, the track data is normally output. If you once again press [STATUS] during playback, the indicator will blink alternately red and orange, and you will be able to listen to the input source.

PLAY (green): The track assigned to the channel will playback.

MUTE (dark): The channel is muted (silent).

6. Channel faders

Use these faders to adjust the volume level of each channel.

7. SELECT button

This button switches the operating mode of the mixer. The current mixer mode is shown by the indicators located at the right of the button. Each time you press the button, you will alternate between INPUT MIX mode and TRACK MIX mode. To change from INPUT→TRACK mode to INPUT MIX mode / TRACK MIX mode, hold down [SHIFT] and press the button. Use the same operation to move in the other direction.

INPUT→TRACK mode

INPUT MIX mode

TRACK MIX mode

8. PHONES knob

This knob adjusts the volume of the headphones.

9. AUX SEND knob

This knob adjusts the output level of the AUX SEND jacks.

10. EDIT/SOLO button

Press this button to make settings for the master section of the mixer.

To use the Solo function to monitor only a specific channel, hold [SHIFT] while you press the button.

11. Master fader

Use this fader to adjust the overall output level.

Recorder section

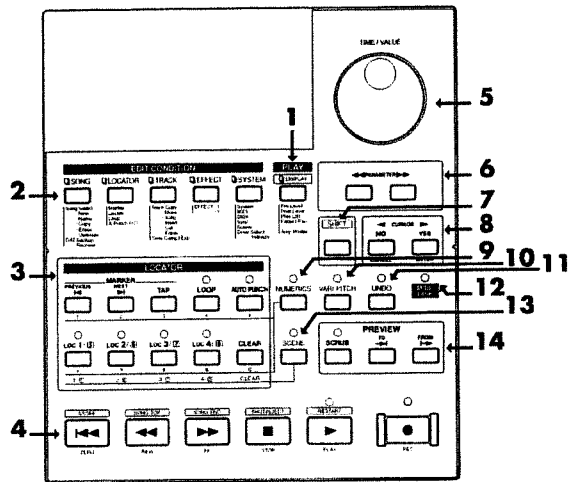

1. PLAY/DISPLAY button

Press this button to return from making a setting (edit condition) back to normal status (play condition). To switch display items in the bar display, hold down [SHIFT] and press this button.

2. EDIT CONDITION buttons

The functions and parameters of the VS-880 are organized within these buttons. To use a desired operation, press the appropriate button.

3. LOCATOR buttons

Press these buttons when using the Locator function or the Tap Marker function.

When the NUMERICS indicator is lit, these buttons function as numeric keys to directly input numbers. When the SCENE indicator is lit, these buttons are used to store and recall scenes (snapshots of mixer settings).

4. Transport control buttons

These buttons are used to operate the recorder.

[ZERO]: Return the current time to "00h00m00s00" (zero return).

[REW]: While the button is held down, the current time will be moved backward. This corresponds to the rewind button on a tape recorder.

[FF]: While the button is held down, the current time will be moved forward. This corresponds to the fast-forward button on a tape recorder.

[STOP]: Stop song recording/playback.

[PLAY]: Start song recording/playback from the current time.

[REC]: Press this button to record a song.

5. TIME/VALUE dial

Normally (i.e., in Play condition), this dial is used to move the current time. When making settings (i.e., in Edit condition), this dial is used to modify parameter values.

6. PARAMETER buttons

Use these buttons to switch the parameter display.

7. SHIFT button

This button is used in conjunction with other buttons to access additional functions of that button. For details refer to "Special key operations" (p.136).

8. CURSOR buttons, NO/YES buttons, CANCEL/ENTER buttons

When a YES/NO response is required during an operation, use these button to reply. When two or more parameters are shown in the display, use these buttons to select parameters.

9. NUMERICS button

When this button is pressed to make the indicator light, the ten LOCATOR buttons will act as numeric keys to enter numerical values.

10. VARI PITCH button

Press this button when you wish to change the playback pitch.

11. UNDO button

Press this button to cancel a recording that you have made. Also, after performing a song edit operation, you can press this button to return to the condition before editing. When undo is executed, the button indicator will light.

12. MIDI/DISK indicator

This indicator will light green when MIDI messages are being received, and red when data is being written or read on the disk drive. If both of these are occurring, the indicator will light orange.

13. SCENE button

Press this button when you wish to memorize or recall scenes (snapshots of the mixer settings).

14. PREVIEW button

Press this button to use the Preview function that plays back a specific length before and after the current location.

Display section

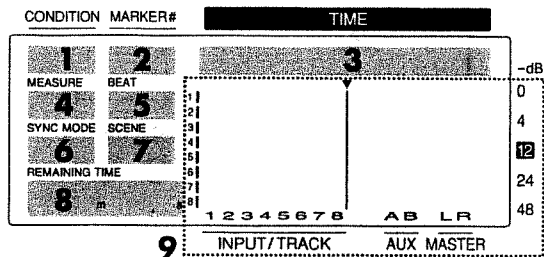

1. CONDITION

This indicates the current condition.

- PLY: Play (normal. When turn the Song Protect on, "Ply" will be indicated.)
- CHn: Channel edit (n=1-8, a-d) (in INPUT→TRACK MIX mode)
- INn: Channel edit (n=1-6, a-c) (in INPUT MIX mode)
- TRn: Channel edit (n=1-8, a-d) (in TRACK MIX mode)
- MST: Master block edit
- SNG: Song edit
- LOC: Locator edit
- TRK: Track edit
- EFF: Effect edit
- SYS: System edit

* The channel edit display will depend on the currently selected mixer mode. Also, channels for which Channel Link is OFF will be displayed as 1-8, and channels for which it is ON will be displayed as a-d.

2. MARKER

This shows the mark point number for the current time. If a mark point has not been assigned to the current time, the closest mark point number located before the current time will be shown.

3. TIME

This shows the current time of the song.

4. MEASURE

This shows the current measure of the song.

5. BEAT

This shows the current beat of the song.

6. SYNC MODE

This indicates the current sync mode (method of synchronization).

7. SCENE

This shows the currently used scene number (mixer setting). An asterisk "*" shown at the beginning of the scene number indicates that the current mixer settings have been modified since the scene was recalled.

8. REMAINING TIME

This shows the remaining length of time available for recording.

9. Bar display

In Play condition, the item selected by [DISPLAY (PLAY)] are shown graphically. While you are making a setting, data for the setting being made is displayed graphically.

Rear panel

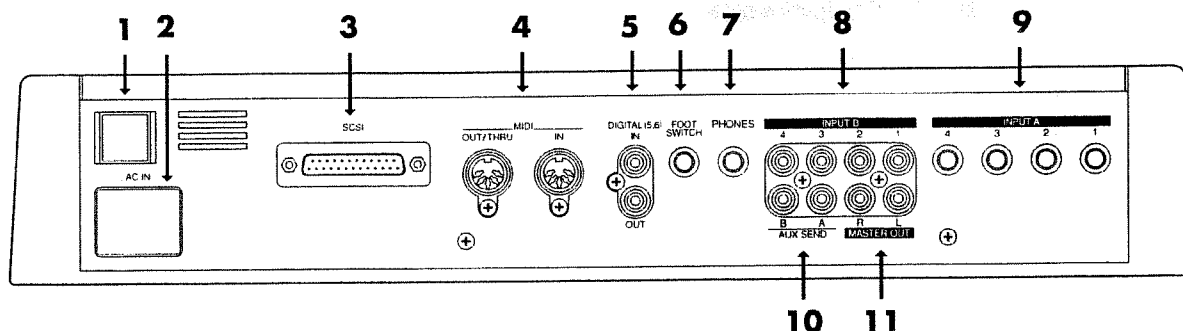

1. POWER switch

This switch turns the VS-880 power on/off.

2. AC IN (AC inlet)

Connect the included power cable here.

3. SCSI connector

This is a DB-25 type SCSI connector for connecting disk drives such as hard disks or removable disks. If you wish to connect a disk drive, refer to "Use with a Zip drive" (p.93).

4. MIDI connectors (IN, OUT/THRU)

External MIDI devices (MIDI controllers, MIDI sequencers, etc.) can be connected here.

IN: This connector receives MIDI messages. Connect it to the MIDI OUT connector of the external MIDI device.

OUT/THRU: This connector can be used either as a MIDI OUT or as a MIDI THRU connector. With the factory settings, it will function as a MIDI OUT connector.

5. DIGITAL (5,6) connectors (IN, OUT)

These are coaxial-type digital I/O connectors (conforms to S/P DIF).

IN: This inputs a digital audio signal (stereo).

OUT: This outputs a digital audio signal (stereo). The sound is the same as that of the MASTER OUT jacks.

* To record a digital audio signal, it is not sufficient to simply connect a digital audio device to the DIGITAL IN connector. When inputting a digital audio signal, refer to "Digital recording" (p.72).

* The DIGITAL connector is not able to input or output analog audio signals.

6. FOOT SWITCH jack

An optional foot switch can be connected here to control recorder operations, mark point settings, and punch in/out operations etc. by foot switch. With the factory settings, a foot switch will start/stop the recorder. To change this function, refer to "Using a footswitch to playback/stop" (p.110).

7. PHONES jack

An optional set of headphones can be connected here. The PHONES jack outputs the same sound as the MASTER OUT jack.

8. INPUT B jacks (1-4)

9. INPUT A jacks (1-4)

These are input jacks for analog audio signals. INPUT A are 1/4" phone jacks, and INPUT B are RCA phono jacks. You may use either type of jack. If cables are connected to both types, the INPUT A jacks will take priority. Use the INPUT SENS knob to adjust the input sensitivity of each input.

10. AUX SEND jacks (A,B)

11. MASTER OUT jacks (L,R)

These are output jacks for analog audio signals (RCA phono type).

With the factory settings, all signals will be output from the MASTER OUT jacks, and there will be no output from the AUX SEND jacks. The output will be determined by the settings of the mixer's master section and the settings of each channel.

The AUX SEND jacks can also be used as send jacks for connecting external effect units (p.127).

Chapter 1 Trying out the expanded functions

This chapter provides some simple examples which explain the operation of the expanded VS-880. Read the explanations in sequence to learn about the newly added functions.

- * If a song created on the VS-880 V-XPANDED is loaded by VS-880 Ver.1, data for the functions added in V-XPANDED (Auto Mix etc.) may be lost. To prevent this from happening, turn Song Protect on (p.74).

Mixer-related

■ Using auto mix

Time based movements such as channel faders and pan can now be recorded to mark points (auto mix). When you move to a mark point, the recorded mixer settings will be reproduced.

Auto mix can be recorded separately in each mixer mode. The mixer settings which can be recorded are as follows.

- * The items printed in bold type can be adjusted directly from the faders or pan knobs on the top panel. By operating these while a song is playing back, you can record time-based mixer movements such as fade-in or panning. When Channel Link is on, the channel faders and pan knobs of even-numbered channels will respectively adjust AUX level and AUX balance.

INPUT→TRACK

MIX Level

MIX Pan/MIX Bal (Mix Balance)

AUX Level

AUX Pan/AUX Bal (AUX Balance)

EFFECT1 Send (Effect 1 Send Level)

EFFECT1 Pan/EFFECT1 Bal (Effect 1 Balance)

EFFECT2 Send (Effect 2 Send Level)

EFFECT2 Pan/EFFECT2 Bal (Effect 2 Balance)

INPUT MIX

BUSS Level

BUSS Pan/BUSS Bal (BUSS Balance)

AUX Level

AUX Pan/AUX Bal (AUX Balance)

EFFECT1 Send (Effect 1 Send Level)

EFFECT1 Pan/EFFECT1 Bal (Effect 1 Balance)

EFFECT2 Send (Effect 2 Send Level)

EFFECT2 Pan/EFFECT2 Bal (Effect 2 Balance)

TRACK MIX

BUSS Level

BUSS Pan/BUSS Bal (BUSS Balance)

AUX Level

AUX Pan/AUX Bal (AUX Balance)

EFFECT1 Send (Effect 1 Send Level)

EFFECT1 Pan/EFFECT1 Bal (Effect 1 Balance)

EFFECT2 Send (Effect 2 Send Level)

EFFECT2 Pan/EFFECT2 Bal (Effect 2 Balance)

Master Block

MasterLevel

Master Bal (Master Balance)

AUX Level

AUX Bal (AUX Balance)

EFFECT1 SND Lev (Effect 1 Send Level)

EFFECT1 SND Bal (Effect 1 Send Balance)

EFFECT1 RTN Lev (Effect 1 Return Level)

EFFECT1 RTN Bal (Effect 1 Return Balance)

EFFECT2 SND Lev (Effect 2 Send Level)

EFFECT2 SND Bal (Effect 2 Send Balance)

EFFECT2 RTN Lev (Effect 2 Return Level)

EFFECT2 RTN Bal (Effect 2 Return Balance)

Effect

EFFECT-1 (Effect 1 Number)

EFFECT-2 (Effect 2 Number)

< How auto mix differs from scenes >

In that auto mix "records mixer settings," its functionality is **similar to scenes**.

It differs from scenes in the following ways. Use the two functions as appropriate for your needs.

1000 can be recorded (the number of mark points).

Valid even during song playback.

Cannot switch the mixer mode.

Cannot switch V-tracks.

Preparations for auto mix

1. Press [SYSTEM] several times until "SYS Scene/Auto Mix?" is displayed.
2. Press [YES].
3. Press PARAMETER [▶▶] several times until "SYS A.Mix Mode=" appears.

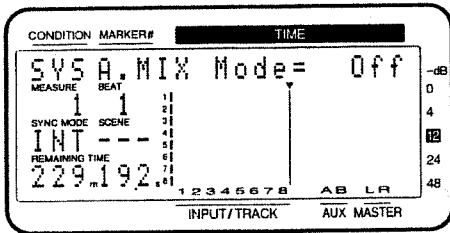

4. Rotate the TIME/VALUE dial. When the setting is on, the [SELECT] indicator will blink.

A.Mix Mode (Auto mix mode)

Off: Auto mix mode will not be used (same as in Ver.1).
 On: Auto mix mode will be used.

5. Press [PLAY(DISPLAY)]. Return to Play condition.
- * By holding down [SCENE] and pressing [SELECT], you can turn Auto Mix Mode on/off in a single operation.

Recording the mixer settings, method 1 (Snapshot)

Mixer settings can be recorded in a Mark point. When you move to that Mark point, the mixer settings that were recorded will be reproduced.

For example, this is convenient when you want the intro and ending to have different volume levels for the guitar part or different effect send levels etc.

1. Move to the time location at which you wish to record the auto mix.
2. Make sure that Auto Mix is on, press holding down [SCENE] and pressing [TAP]. A mark point will be added at the current time location. At the same time, the settings of the mixer will be recorded at the mark point. A mark point in which mixer settings are recorded will be indicated by an "*" following it.

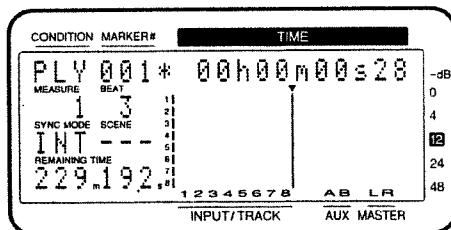

- * If a mark point already exists within 0.1 seconds before the time location at which you are attempting to place a new mark point (i.e., the current time), the auto mix data will be recorded at the earlier mark point. A mark point will not be newly assigned.

Recording the mixer settings, method 2 (Gradation)

This method creates an auto mix that smoothly connects the mixer settings recorded in two adjacent mark points.

For example, this is convenient when you wish to fade-in or fade-out at a specified time.

1. Move to the time location at which you wish to begin the auto mix.
 2. Perform the procedure for "Recording the mixer settings, method 1".
 3. Move to the time location at which you wish to end the auto mix.
 4. Perform the procedure for "Recording the mixer settings, method 1" once again. Two mark points have now been assigned.
 5. Make sure that auto mix is on, holding down [SCENE] and pressing [PREVIOUS]. A mark point will be automatically added between the two mark points, and the mixer settings will be interpolated.
- * If you wish to interpolate with the previous mark point, press [SCENE]+[PREVIOUS]. If you wish to interpolate with the next mark point, holding down [SCENE] and pressing [NEXT].

Recording the mixer settings, method 3 (Realtime)

With this method, only those the mixer settings which can be adjusted from the top panel will be recorded to mark points in realtime. For example, this is convenient when you wish to fade-in or fade-out individual tracks.

1. Move to the time location at which you wish to record the auto mix.
 2. Make sure that auto mix is on, holding down [SCENE] and pressing [REC]. The CONDITION column display will alternate between the current condition name and "mix," indicating that preparations have been made for realtime recording of the auto mix.
 3. Specify the channels for with auto mix will be recorded. Move the faders and pan knobs of the top panel to the desired locations.
- * When the Fader Match (P.21) in the System parameters is set to "Null," and the current locations of fader and pan knob do not match the actual volume level or panning, please move them to the actual value at first in order to record the auto mix data.
4. Press [PLAY]. Playback will begin.
 5. Operate the channel faders, pan knobs, and master fader of the top panel. Auto mix data will be recorded only for those channels which were modified.
 6. When the mix is finished, press [STOP]. Mark points will be automatically created in the area which was played back. If you wish to redo the auto mix, repeat steps 1-5.

If you do not wish to record top panel settings (Mask Fader)

In "Recording the mixer settings, method 1 (Snapshot)", you can specify that the settings adjustable from the top panel will not be recorded.

For example, this is convenient when you have made fade-in settings according to "Recording the mixer settings, method 2", and then wish to modify the effect send levels, etc.

1. Press [SYSTEM] several times until "SYS Scene/Auto Mix?" appears.
2. Press [YES].
3. Press PARAMETER [▶▶] several times until "SYS A.Mix Snap=" appears.

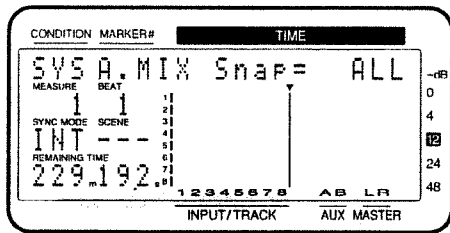

4. Rotate the TIME/VALUE dial.

A.Mix Snap (Auto Mix Snapshot Mode)

Select the settings that will be recorded by the snapshot.

- All: All settings will be recorded.
- MaskF: Settings which can be adjusted by the top panel (channel faders etc.) will be ignored.

5. Press [PLAY(DISPLAY)]. You will return to Play condition.
6. Perform the procedure of "Recording the mixer settings, method 1".

Playing back the auto mix

1. Make sure that auto mix is on.
2. Press [PLAY].
The auto mix will playback.
While the auto mix is playing back, operating a fader or pan knob will cause auto mix to be defeated for that channel. If you stop and then playback again, auto mix will once again take effect. Alternatively, you can temporarily turn Auto Mix off during playback and then turn it on again, causing Auto Mix to again be valid.

Erasing the auto mix

1. Press [SYSTEM] several times until "SYS Scene/Auto Mix?" appears.
2. Press [YES].
3. Press PARAMETER [▶▶] several times until "SYS A.Mix Erase?" appears.
4. Press [YES].

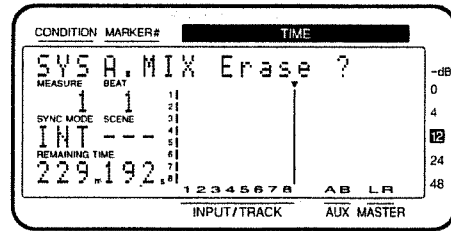

5. Use the TIME/VALUE dial to specify the first mark point of the area in which you wish to erase the auto mix.
6. Press CURSOR[▶].
The cursor will move toward the right.
7. Use the TIME/VALUE dial to specify the last mark point of the area in which you wish to erase the auto mix.

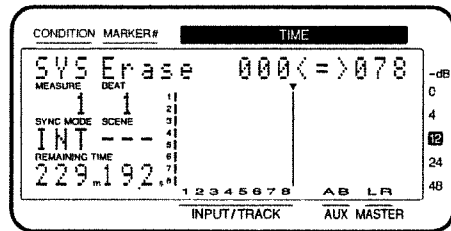

8. Press PARAMETER [▶▶].
The display will indicate "SYS EraseMode=".
9. Rotate the TIME/VALUE dial.

EraseMode (Auto Mix Erase Mode)

Select the auto mix data which will be erased.

- Event: Only auto mix events will be erased.
- Marker: Both mark points and auto mix events will be erased.

10. Press PARAMETER [▶▶].
The display will indicate "SYS Erase__<=>__?". The underlined area will display the mark points specified in steps 5-7.
11. Press [YES].
A message will ask you to confirm that you really wish to erase the data.
12. Press [YES] once again.
The auto mix will be erased.

< What is an event? >
The smallest unit of memory used by the VS-880 to store recorded results on disk is the **event**. A newly created song provides approximately 12,000 events per song. For each track, one recording pass uses two events. Operations such as punch-in/out or track copy also use up events. The number of events that are used up will fluctuate in a complex way. For example, auto mix uses up five events for each mark point. Even if there is capacity remaining on the disk, further recording or track editing will not be possible if all of the events are used up. In such cases, an error message such as "Event Mem Full" will appear (p.134).

About “!!! Lack of EVENT !!!” display

“!!! Lack of EVENT !!!” will be appeared in the display in the following cases, and you cannot continue the current operation.

- If you push [SCENE]+[REC] buttons to record AutoMix data in **realtime**, when the remaining number of EVENT is **less than 1000**.
- If you try to **UNDO** or **REDO** when the remaining number of Event is **less than 200**.

The smallest unit of memory used by the VS-880 to store recorded results on disk are the **events**. A newly created song provides approximately 12,000 events per song. For each track, one recording pass uses two events. Operations such as punch-in/out or track copy also use up events. The number of events that are used up will fluctuate in a complex way. For example, auto mix uses up five events for each mark point.

When you do a lot of recording, editing (Track Copy, Track Move) or record AutoMix of long period, please check the remaining number of Events frequently. Procedure is as follows.

1. Press [SYSTEM] several times until “SYS System PRM?” appears.
2. Press [YES].
3. Press PARAMETER [▶▶] several times until “SYS RemainDsp=” appears.
4. Select “Event” with TIME/VALUE dial.

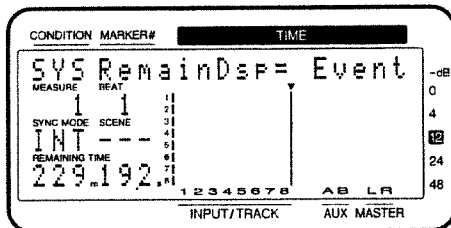

Remaining number of Events can be saved with the following procedures. Please try the most appropriate one with your situation.

- **Execute Song Store (Owner's manual p.74)**
Please Execute Song Store if in UNDO condition ([UNDO] indicator is lit.). Events served for REDO will be released. But please note that you cannot cancel (REDO) the last UNDO if you once execute STORE.
- **Execute Song Optimize (Owner's manual p.113)**
Please execute Song Optimize if you have done a lot of Punch In recording. Events served for unnecessary audio data will be released. But please note that you can only do single level UNDO.
- **Erase AutoMix data (Owner's manual p.19)**
If you have recorded AutoMix data, erase unnecessary data. Events served for unnecessary AutoMix data will be released.

Using the 3-band equalizer in INPUT MIX/TRACK MIX

From the total of fourteen INPUT MIX/TRACK MIX channels, you can now use a 3-band equalizer on any eight selected channels.

- * If equalizer is turned on for more than 8 channels, it will not be possible to use the 3-band equalizer. Please turn off the equalizer switch for channels on which equalization is not required.

Turning the equalizer on/off

1. Make sure that the mixer mode is INPUT MIX/TRACK MIX.
2. Hold down [SHIFT], and press channel 3 [EQ Low(CH EDIT)].
3. Press PARAMETER [◀◀].
4. Press [CH EDIT] for the channels or tracks for which you wish to turn the equalizer off.

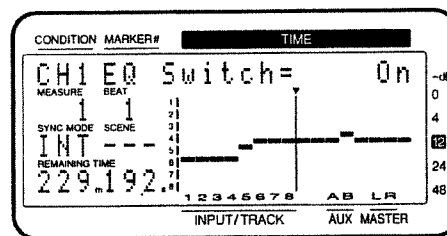

5. Rotate the TIME/VALUE dial.

EQ Switch (equalizer switch)

If you wish to use the equalizer, set this “On.” If not, set this “Off.” When equalizer settings are being made, the equalization curve will be shown graphically in the bar display. If this is “Off” the equalizer-related parameters will not be available.

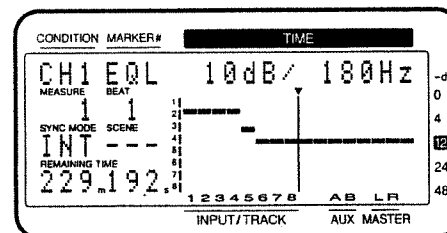

Using the 3-band equalizer

1. Make sure that the mixer mode is INPUT MIX/TRACK MIX.
If it is INPUT→TRACK, holding down [SHIFT] and pressing [SELECT].
2. Press [EDIT(SOLO)] several times until "MST EQ Sel=" appears.
3. Rotate the TIME/VALUE dial.

EQ Sel (Equalizer Select)

Select the type of equalizer that you wish to use.

2BandEQ: 14 channels of 2-band equalizers (same as Ver.1).

3BandEQ: 8 channels of 3-band equalizers.

■ Mixing in a stereo source (Stereo In)

Even when playing back all 8 tracks in INPUT→TRACK, you can now mix in a stereo source for output to master out.

For example, this is convenient when two VS-880 units are being operated in synchronization.

1. Press [EDIT(SOLO)] several times until "MST StereoIn=" appears.
2. Select the input source for the stereo source. Rotate the TIME/VALUE dial.

StereoIn (Stereo In)

Off: Stereo In will not be used.

Input12: Inputs 1 and 2 will be input in stereo.

Input34: Inputs 3 and 4 will be input in stereo.

Digital: The digital input will be input in stereo.

3. Press PARAMETER [▶▶].
The display will indicate "MST StIn Level=".
4. Adjust the volume level of the stereo input. Rotate the TIME/VALUE dial.
5. Press PARAMETER [▶▶].
The display will indicate "MST StIn Bal=".
6. Adjust the left/right balance of the stereo input. Rotate the TIME/VALUE dial.

■ Adjusting the level of each track (Track Level)

It is now possible to adjust the volume level of each track independently from the channel faders.

For example, this is convenient when you wish to raise the track level for playback of a track which was recorded at a low volume level.

1. Press [CH EDIT] for the track whose volume you wish to adjust.
2. Press PARAMETER [▶▶] several times until "TrackLevel=" appears.
3. Rotate the TIME/VALUE dial.

TrackLevel (Track Level)

The volume level of each track can be adjusted over a range of -12-12dB.

■ Causing top panel fader and pan knob operations to take effect immediately

When the volume or pan has been adjusted in Channel Edit condition, switching between INPUT MIX and TRACK MIX can cause the fader or pan knob locations to no longer match the actual volume level or pan. In such cases, an "*" symbol will be appended to the displayed values of the settings. Also, when the fader or pan locations are shown in the bar display, the current channel fader locations will blink.

1. Press [SYSTEM] several time until "SYS System PRM ?" appears.
2. Press [YES].
3. Press PARAMETER [▶▶] several times until "SYS FaderMatch" appears.
4. Rotate the TIME/VALUE dial.

FaderMatch (Fader Match)

Select how the faders will act when the fader or pan knob locations do not match the actual volume level or panning.

Null: Changes will not occur until the channel fader or pan knob is moved to the actual value (same as Ver.1).

Jump: The actual value will change at the instant that the fader or pan knob is moved.

5. Press [PLAY(DISPLAY)].
You will return to Play condition.

Recorder related functions

■ When the Recording mode is set to Mastering

When the Recording mode (p.62) is set to Mastering (MAS), it is now possible to playback up to six tracks simultaneously. At this time, the VS-880 will function as a 6-track recorder (tracks 1-6). Tracks 7-8 cannot be used.

Previously, only four tracks could be played back simultaneously when the Recording mode was set to Mastering (MAS).

< When using a Zip drive >

A Zip drive is not able to read or write data with sufficient speed. For this reason, when it is being used as the current drive (i.e., the drive for recording or playback), it will not be possible to playback six tracks simultaneously. Refer to the following table, and limit the number of simultaneously played back tracks accordingly. For details refer to the enclosed leaflet "Notes when using a Zip drive."

* Numbers are guidelines for numbers of tracks that can be played back simultaneously.

Numbers in parentheses () are guidelines for numbers of tracks in song in which operations such as punch-in recording or track copy are performed repeatedly.

Recording mode	Sample rate		
	48.0kHz	44.1kHz	32.0kHz
Mastering	3(2)	4(2)	5(4)
Multitrack 1	7(6)	7(5)	8(6)
Multitrack 2	7(6)	8(7)	8(8)
Live	8(8)	8(8)	8(8)

■ When a digital signal with emphasis is input

When a digital signal with emphasis is input from the digital in connector, it will be automatically de-emphasized.

■ Creating a master tape which disables digital copying

When digitally mixing down from the VS-880 to a DAT recorder etc., you can now prohibit digital copies from being made from the mixdown tape.

For example, a single-generation of digital recording from a CD player to a DAT recorder is permitted. It will not be possible to make a digital copy from the digitally-recorded DAT to another digital device (p.72). This function causes a tape which is digitally recorded from the VS-880 to behave in the same way as a tape digitally recorded from a CD.

1. Press [SYSTEM] several times until "SYS System PRM?" appears.
2. Press [YES].
3. Press PARAMETER [▶▶] several times until "SYS D.CpyProtect=" appears.

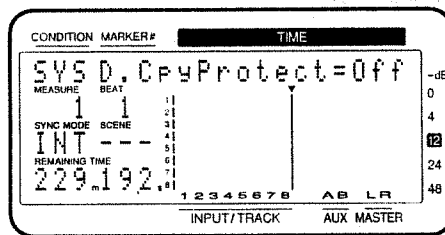

4. Rotate the TIME/VALUE dial. If you wish to prohibit digital copying, turn the setting on.

D.CpyProtect (Digital Protect Switch)

Specify whether or not digital copying of a digitally-mixed down tape will be permitted or not.

Off: Digital copying will be permitted (same as Ver.1).
On: Digital copying will be prohibited.

5. Press [PLAY(DISPLAY)].
You will return to Play condition.
 6. Digitally mixdown from the VS-880 to a DAT recorder etc. (p.72).
It will not be possible to digitally copy this master tape to another DAT recorder etc.
- * Some DAT recorders do not respond to SCMS or cannot be digitally-connected to the CD players. You cannot record the digital output from the VS-880 V-XPANDED to this type of DAT recorders if the Digital Protect is on. Please try with Digital Protect off.

Effect related

When a VS8F-1 effect expansion board is installed, a single VS-880 now allows you to use two stereo effects. Please read the VS8F-1 owner's manual together with this explanation.

■ Newly added preset patches

One hundred preset patches have been added to the effect patches. Refer to the included "Preset Patch List." Due to the increased number of preset patches, the patch numbers have changed as follows.

Ver.1	V-XPANDED
Preset 001-100 (newly added)	Preset A00-A99
User 101-200	Preset B00-B99
	User U00-U99

■ Newly added algorithms

The following effect algorithms have been added.

- Reverb 2 (p.23)
- Space Chorus (p.24)
- Lo-Fi Processor (p.25)
- 4-Band Parametric Equalizer (p.26)
- 10-Band Graphic Equalizer (p.27)
- Hum Canceler (p.28)
- Vocal Canceller (p.28)
- Vocoder 2 (p.29)
- Voice Transformer (p.30)
- Mic Simulator (p.32)

● Reverb 2

This is a reverb that provides a gating function and a ducking function. It can be used in either EFFECT-1 or EFFECT-2. You can use two reverbs with different settings, or use it in combination with a previous reverb.

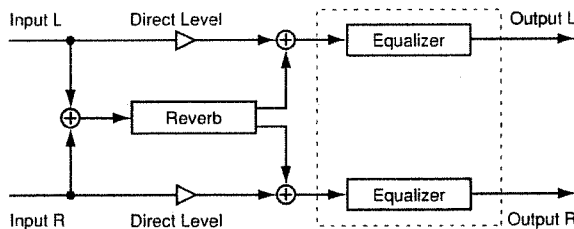

REV (Reverb)

Reverb	On, Off
Type	Room1, Room2, Hall1, Hall2, Plate
Time	0.1-10.0 sec
PreDLY	0-200 msec
Density	0-100
HPF	Thru, 20-2000 Hz
LPF	1.0-20.0 kHz, Thru
EFLevel	0-100
DiLevel	0-100
Gate	Off, On

Mode	Gate, Ducking
Thresh	0-100
Attack	1-100
Release	1-100
HoldTime	1-100

Reverb

Turn reverb on/off. When turned off, the following items will not be displayed.

Type (Reverb Type)

Select the type of reverb.

- Room1: Normal room reverb.
- Room2: Room reverb with a softer tone than Room1.
- Hall1: Normal hall reverb.
- Hall2: Hall reverb with a softer tone than Hall1.
- Plate: Plate reverb.

Time

Adjust the length (time) of the reverberation.

PreDLY (Pre delay)

Adjust the time until the reverb is output.

Density

Adjust the density of the reverb.

HPF (High pass filter)

Adjust the frequency at which the high pass filter will begin to take effect. With a setting of Thru, the high pass filter will not function.

LPF (Low pass filter)

Adjust the frequency at which the low pass filter will begin to take effect. With a setting of Thru, the low pass filter will not function.

EFLevel (Effect level)

Adjust the volume of the reverb.

DiLevel (Direct level)

Adjust the volume of the direct sound.

Gate

Turn the gate function on/off. When this is off, the following items will not be displayed.

Mode (Gate mode)

Select the way in which the gate function will operate.

Gate: The gate will begin to open when the direct signal level exceeds the threshold level, and will begin to close when it falls below the threshold level.

Ducking: The function will be the opposite of the Gate setting. The gate will begin to close when the direct signal level exceeds the threshold level, and will begin to open when it falls below the threshold level.

Thresh (Threshold)

Adjust the basic level at which opening and closing of the gate will be controlled.

Attack

Adjust the time from when the direct sound level exceeds the threshold level until when the gate is completely open.

Release

Adjust the time from when the hold time has elapsed until the sound is completely muted.

HoldTime

Adjust the time from when the input falls below the threshold level until when the release begins.

EQ (Equalizer)

EQ	Off, On
LowType	Shlv, Peak
Low.G	-12-12 dB
Low.F	20-2000 Hz
Low.Q	0.3-10
Mid.G	-12-12 dB
Mid.F	200-8000 Hz
Mid.Q	0.3-10
HiType	Shlv, Peak
Hi.G	-12-12 dB
Hi.F	1.4-20.0 kHz
Hi.Q	0.3-10
OutLevel	0-100

EQ (Equalizer)

Turn the equalizer on/off. If this is turned off, the following items will not be displayed.

LowType

Select the type of the low range equalizer.

Shlv:	Shelving type
Peak:	Peaking type

Low.G (Low gain)

Specify the gain (amount of boost/cut) for the low range equalizer.

Low.F (Low frequency)

Specify the center frequency of the low range equalizer.

Low.Q (Low Q)

Specify the width of the band around the center frequency specified for the low range equalizer in which the gain adjustment will occur. As this setting is raised, the width of the band affected will become narrower.

Mid.G (Middle gain)

Specify the gain (amount of boost/cut) for the mid-range equalizer.

Mid.F (Middle frequency)

Specify the center frequency of the mid-range equalizer.

Mid.Q (Middle Q)

Specify the width of the band around the center frequency specified for the middle range equalizer in which the gain adjustment will occur. As this setting is raised, the width of the band affected will become narrower.

HiType (High type)

Select the type of high range equalizer.

Shlv:	Shelving type
Peak:	Peaking type

Hi.G (High gain)

Specify the gain (amount of boost/cut) for the high range equalizer.

Hi.F (High frequency)

Specify the center frequency of the high range equalizer.

Hi.Q (High Q)

Specify the width of the band around the center frequency specified for the high range equalizer in which the gain adjustment will occur. As this setting is raised, the width of the band affected will become narrower.

OutLevel (Output level)

Adjust the volume level after the sound has passed through the equalizer.

● Space Chorus

This is a chorus which simulates the Roland SDD-320.

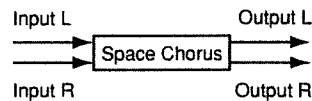

SCH (Space Chorus)

SpaceCho	Off, On
InMod	Mono, Stereo
Mode	1, 2, 3, 4, 1+4, 2+4, 3+4
MixBal	0-100

SpaceCho (Space Chorus)

Turn space chorus on/off. If this is turned off, the following items will not be displayed.

InMod (Input mode)

Specify whether the input signal is stereo or mono.

Mode (Space mode)

Select the way in the chorus will change.

MixBal (Mix balance)

Adjust the balance between the chorus volume and the direct sound volume.

● Lo-Fi Processor

This allows you to create a “lo-fi” sound by lowering the sample rate and/or decreasing the number of bits. Realtime modify filters connected in series allow you to reshape the sound freely.

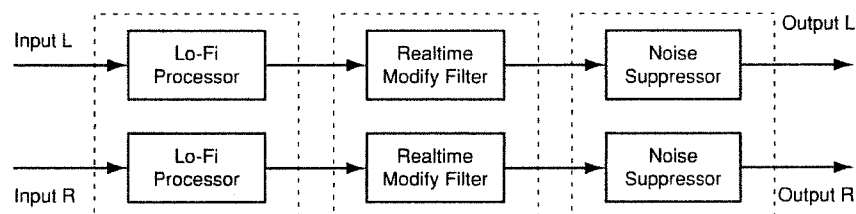

LFP (Lo-fi processor)

LoFiPros	Off, On
PreFilt	Off, On
Rate	Off, 1/2–1/32
Bit	Off, 15–1 bit
PostFilt	Off, On
EFLevel	0–100
DiLevel	0–100

LoFiPros (Lo-fi processor)

Turn the Lo-fi Processor on/off. If this is turned off, the following items will not be displayed.

PreFilt (Pre filter)

This filter decreases digital distortion. By turning this off, you can create an extremely lo-fi sound that includes aliasing.

Rate

Modify the sample rate. If this is turned off, the sample rate will be the same as the sample rate of the currently selected song.

Bit

Modify the number of data bits. If this is turned off, the number of data bits will be unchanged. If an extremely low number of bits is selected, loud noise may appear even when there is no sound, depending on the input source. In such cases, raise the threshold of the noise suppressor.

PostFilt (Post filter)

This filter decreases the digital distortion produced by lo-fi. By turning this off, you can create an extremely lo-fi sound.

EFLevel (Effect level)

Adjust the volume of the lo-fi sound.

DiLevel (Direct level)

Adjust the volume of the direct sound.

RMF (Realtime modify filter)

RMF	Off, On
Type	LPF, BPF, HPF
CutOff	0-100
Reso	0-100
Gain	0-24 dB

RMF (Realtime modify filter)

Turn the realtime modify filter on/off. If this is turned off, the following items will not be displayed.

Type (Filter type)

Select the filter type.

LPF:	Low pass filter
BPF:	Band pass filter
HPF:	High pass filter

CutOff

Adjust the cutoff frequency.

Reso (Resonance)

Adjust the resonance.

Gain

Adjust the volume level of the sound that has passed through the realtime modify filter.

NS (Noise suppressor)

Thresh	0-100
Release	0-100

Thresh (Threshold)

Adjust the level at which the noise suppressor will begin to take effect.

Release

Adjust the time from when the noise suppressor begins to take effect until the volume reaches 0.

4-Band Parametric Equalizer

This is a 4-band parametric equalizer. It can be used either as two monaural units or as one stereo unit.

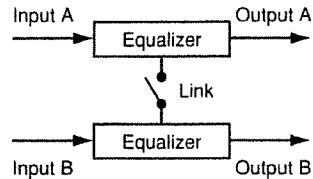

LNK (Link)

EQLink Off, On

EQLink (Equalizer link switch)

This is a link switch for channels A and B. If this is turned off, the channels will function independently as two monaural channels.

If this is turned on, both channels will be controlled simultaneously by the settings of channel A.

EQA/EQB (Parametric equalizer channel A / channel B)

EQAch(EQBch)	Off, On
InputG	-60-12dB
LowType	Shlv, Peak
LowG	-12-12 dB
LowF	20-2000 Hz
LowQ	0.3-10
LoMidG	-12-12 dB
LoMidF	200-8000 Hz
LoMidQ	0.3-10
HiMidG	-12-12 dB
HiMidF	200-8000 Hz
HiMidQ	0.3-10
HiType	Shlv, Peak
HiG	-12-12 dB
HiF	1.4-20.0 kHz
HiQ	0.3-10
Level	-60-12 dB

EQA/EQB (Equalizer channel A / channel B)

Turn the equalizer on/off. When this is turned off, the following items will not be displayed.

InputG (Input gain)

Adjust the overall volume level of the sound before it enters the equalizer.

LowType (Low type)

Select the type of the low range equalizer.

Shlv:	Shelving type
Peak:	Peaking type

LowG (Low gain)

Specify the gain (amount of boost/cut) for the low range equalizer.

LowF (Low frequency)

Specify the center frequency of the low range equalizer.

LowQ (Low Q)

Specify the width of the band centered on the low range equalizer center frequency in which the gain adjustment will occur. As this setting is raised, the width of the band affected will become narrower.

LoMidG (Low middle gain)

Specify the gain (amount of boost/cut) for the low middle range equalizer.

LoMidF (Low middle frequency)

Specify the center frequency of the low middle range equalizer.

LoMidQ (Low middle Q)

Specify the width of the band centered on the low middle range equalizer center frequency in which the gain adjustment will occur. As this setting is raised, the width of the band affected will become narrower.

HiMidG (High middle gain)

Specify the gain (amount of boost/cut) for the high middle range equalizer.

HiMidF (High middle frequency)

Specify the center frequency of the high middle range equalizer.

HiMidQ (High middle Q)

Specify the width of the band centered on the high middle range equalizer center frequency in which the gain adjustment will occur. As this setting is raised, the width of the band affected will become narrower.

HiType (High type)

Select the type of high range equalizer.

Shlv: Shelving type
Peak: Peaking type

HiG (High gain)

Specify the gain (amount of boost/cut) for the high range equalizer.

HiF (High frequency)

Specify the center frequency of the high range equalizer.

HiQ (High Q)

Specify the width of the band centered on the high range equalizer center frequency in which the gain adjustment will occur. As this setting is raised, the width of the band affected will become narrower.

Level (Output level)

Adjust the overall volume level of the sound that has passed through the equalizer.

● 10-Band Graphic Equalizer

This simulates a 10-band graphic equalizer. It can be used either as two monaural units or as one stereo unit.

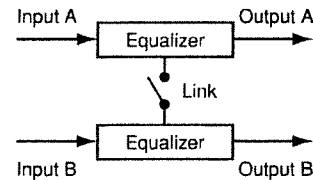
**LNK (Link)**

EQLink Off, On

EQLink (Equalizer link)

This is the link switch for channels A and B. When this is turned off, the channels will function independently as two monaural equalizers.

When this is turned on, both channels will be controlled simultaneously by the settings of channel A.

EQA/eqB (Graphic equalizer channel A / channel B)

EQAch(EQBch)	Off, On
InputG	-60-12 dB
31.2Hz	-12-12 dB
62.5Hz	-12-12 dB
125Hz	-12-12 dB
250Hz	-12-12 dB
500Hz	-12-12 dB
1kHz	-12-12 dB
2kHz	-12-12 dB
4kHz	-12-12 dB
8kHz	-12-12 dB
16kHz	-12-12 dB
Level	-60-12 dB

EQA/eqB (Equalizer channel A / channel B)

Turn the equalizer on/off. If this is turned off, the following items will not be displayed.

InputG (Input gain)

Adjust the overall volume level of the sound before it passes through the equalizer.

31.2Hz-16kHz (Gain)

Adjust the gain (amount of boost/cut) of the equalizer for each frequency.

Level (Output level)

Adjust the volume level of the sound which has passed through the equalizer.

● Hum Canceler

This removes unwanted hum (electrical “buzz” or “drone”).

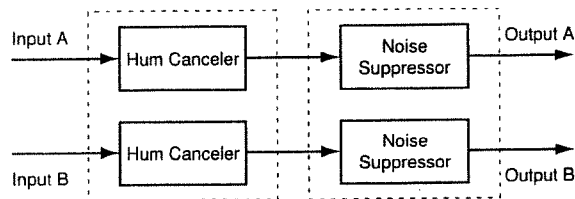

HC (Hum canceller)

HumCancel	Off, On
Freq	20.0–800.0 Hz
Width	10–40 %
Depth	0–100
Thresh	0–100
RngL	Unlimit, 20–2000 Hz
RngH	1.0–20.0 kHz, Unlimit

HumCancel (Hum canceller)

Turn the hum canceller on/off. If this is turned off, the following items will not be displayed.

Freq (Frequency)

Hum will be removed at the specified frequency and at multiples of that frequency. Set it to match the frequency of your power supply.

Width

Specify the width of the filter which will remove the hum.

Depth

Specify the depth of the filter which will remove the hum.

Thresh (Threshold)

Adjust the level at which the hum canceller will begin to take effect. If the signal falls below the specified level, only the hum will be removed from the signal. With the maximum setting, hum will always be removed regardless of the level of the signal.

RngL (Range low)

Specify the lower limit of the frequency range in which the hum canceller will operate. With a setting of Unlimit, the limit will be the lowest frequency that the VS-880 is capable of playing back.

RngH (Range high)

Specify the upper limit of the frequency range in which the hum canceller will operate. With a setting of Unlimit, the limit will be the highest frequency that the VS-880 is capable of Playing back.

NS (Noise suppressor)

NoiseSup	Off, On
Thresh	0–100
Release	0–100

Thresh (Threshold)

Adjust the level at which the noise suppressor will begin to operate.

Release

Adjust the time from when the noise suppressor begins to operate to when the volume reaches 0.

● Vocal Canceller

When a stereo source is being input from CD or DAT etc., this cancels the sound which is located in the stereo center, such as the vocal or bass.

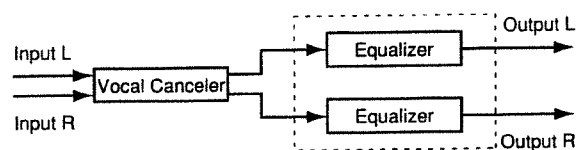

* Depending on the musical source, sounds that you do not wish to be canceled may be canceled as well. In particular if the musical source has heavy reverb or if the sound that you wish to delete is not located in the center, the vocal canceller may not produce the desired result.

VC (Vocal canceller)

VclCancel	Off, On
Balance	0–100
RngL	Unlimit, 20–2000 Hz
RngH	1.0–20.0 kHz, Unlimit

VclCancel (Vocal canceller)

Turn the vocal canceller on/off. If this is turned off, the following items will not be displayed.

Balance

If the sound that you wish to cancel is not located in the center, find the point at which it is most effectively canceled.

RngL (Range low)

Specify the lower limit of the frequency range from which you wish to cancel a sound. Use this setting when you wish to decrease the volume of the vocal without affecting a low-frequency instrument (such as bass) located in the center. With a setting of Unlimit, the lowest frequency which the VS-880 is capable of Playing back will be the lower limit.

RngH (Range high)

Specify the upper limit of the frequency range from which you wish to cancel a sound. Use this setting when you wish to decrease the volume of the vocal without affecting a high-frequency instrument located in the center. With a setting of Unlimit, the highest frequency which the VS-880 is capable of Playing back will be the upper limit.

EQ (Equalizer)

EQ	Off, On
LowType	Shlv, Peak
Low.G	-12-12 dB
Low.F	20-2000 Hz
Low.Q	0.3-10
Mid.G	-12-12 dB
Mid.F	200-8000 Hz
Mid.Q	0.3-10
HiType	Shlv, Peak
Hi.G	-12-12 dB
Hi.F	1.4-20.0 kHz
Hi.Q	0.3-10
OutLevel	0-100

EQ (Equalizer)

Turn the equalizer on/off. When this is off, the following items will not be displayed.

LowType

Select the type of the low range equalizer.

Shlv:	Shelving type
Peak:	Peaking type

Low.G (Low gain)

Specify the gain (amount of boost/cut) for the low range equalizer.

Low.F (Low frequency)

Specify the center frequency of the low range equalizer.

Low.Q (Low Q)

Specify the width of the band centered on the low range equalizer center frequency in which the gain adjustment will occur. As this setting is raised, the width of the band affected will become narrower.

Mid.G (Middle gain)

Specify the gain (amount of boost/cut) for the mid range equalizer.

Mid.F (Middle frequency)

Specify the center frequency of the mid range equalizer.

Mid.Q (Middle Q)

Specify the width of the band centered on the mid range equalizer center frequency in which the gain adjustment will occur. As this setting is raised, the width of the band affected will become narrower.

HiType (High type)

Select the type of the high range equalizer.

Shelv:	Shelving type
Peak:	Peaking type

Hi.G (High gain)

Specify the gain (amount of boost/cut) for the high range equalizer.

Hi.F (High frequency)

Specify the center frequency of the high range equalizer.

Hi.Q (High Q)

Specify the width of the band centered on the high range equalizer center frequency in which the gain adjustment will occur. As this setting is raised, the width of the band affected will become narrower.

OutLevel (Output level)

Adjust the volume level of the sound that has passed through the equalizer.

● Vocoder 2

This is a 19 band vocoder. A clear sound that was not possible with conventional vocoders can be obtained.

Input an instrumental sound into the left channel, and a voice into the right channel.

* Vocoder 2 can be used only for EFFECT-1. Also, EFFECT-2 will not be available for use.

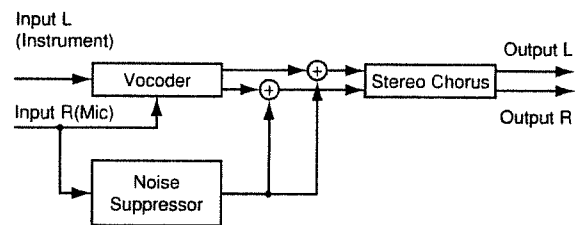
**VOC (Vocoder)**

Env	Sharp, Soft, Long
Pan	Mono, Stereo, L→R, R→L
Hold	Off, MIDI
MicSens	0-100
SynInLev	0-100
V.Char1-19	0-100
MHPF	Thru, 1.0-20.0 kHz
MHPFPan	L63-R63
MicMix	0-100
NSTresh	0-100

Env (Envelope)

Sharp:	The human voice will be emphasized.
Soft:	The instrumental sound will be emphasized.
Long:	A vintage sound with long decay will be produced.

Pan

Select Mono, Stereo, L→R or R→L. With a setting of Mono, the components of each frequency band will be located in the center. With a setting of Stereo, the odd-numbered frequency bands will be located at the left, and the even-numbered components at the right. With a setting of L→R, the low frequency bands will be located increasingly toward the left, and the high frequency bands will be located increasingly toward the right. With a setting of R→L, the low frequency bands will be located increasingly toward the right, and the high frequency bands will be located increasingly toward the left.

Hold

This turns the Hold function on/off. When MIDI is selected, the MIDI control change message Hold will be received. The MIDI channel is fixed at 1. If you turn Hold on while a voice is being input into the mic, the instrument will sound with the vocal formats that are fixed at that time.

MicSens (Mic sensitivity)

Adjust the input sensitivity of the mic.

SynInLev (Synthesizer in level)

Adjust the input level of the instrument.

V.Char1-19 (Voice character)

Adjust the volume of each frequency band. This setting adjusts the tone of the vocoder.

As the value is increased, the frequency will rise.

MHPF (Mic HPF)

When mic mix is used, this adjusts the frequency at which the high pass filter (HPF) will begin to affect the mic audio. Higher values for this setting will allow you to mix only the consonants. With a setting of Thru, the HPF will not be applied.

MHPFPan (Mic HPF pan)

Adjust the panning of the mic audio.

MicMix (Mic mix)

Adjust the amount of the mic audio (R channel input) which has passed through the mic HPF that will be added to the output of the vocoder.

NSThresh (Noise suppressor threshold)

Adjust the level at which the noise suppressor applied to the instrumental input (R channel input) will begin to function.

CHO (Chorus)

Chorus	Off, On
Rate	0.1-10.0 Hz
Depth	0-100
PreDLY	0-50.0 msec
MixBal	0-100

Chorus

Turn the chorus on/off. If this is turned off, the following items will not be displayed.

Rate

Adjust the modulation rate of the chorus.

Depth

Adjust the modulation depth of the chorus.

PreDLY (Pre delay)

Adjust the time from when the direct sound is output until the chorus sound is output.

MixBal (Mix balance)

Adjust the balance between the chorus volume and the direct volume.

● **Voice Transformer**

This independently controls the basic pitch and the formants, allowing a variety of voice characters to be created.

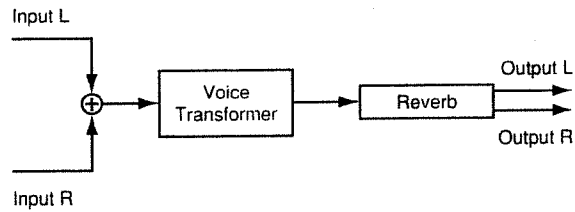

* Voice Transformer can be used only in EFFECT-1. Also, EFFECT-2 will not be available for use.

< Hints for voice input >

Input only a single voice. If several voices are input, the VS-880 will not operate properly.

Be sure that sound from a speaker does not enter the microphone you are using. This will have the same effect as if several voices were input to the unit (i.e. the VS-880 will not function properly).

We recommend that you use a unidirectional microphone; speak or sing as close to the microphone as possible.

VT (Voice transformer)

VoiceTrns	Off, On
Robot	Off, On
C.Pitch	-12-36
F.Pitch	-100-100
C.Formant	-12-12
F.Formant	-100-100
MixBal	0-100

VoiceTrns (Voice transformer)

Turn the voice transformer on/off. If this is off, the following items will not be displayed.

Robot

Turn the robot function on/off. When this is on, the audio will be output at a fixed pitch regardless of the pitch that is input, producing a voice character without inflection.

C.Pitch (Coarse pitch)

Adjust the pitch of the voice character in semitone steps. This can be adjusted over a range of 1 octave down to three octaves up.

F.Pitch (Fine pitch)

Make fine adjustments to the pitch of the voice character.

C.Formant (Coarse formant)

Adjust the formant of the voice character in semitone steps.

F.Formant (Fine formant)

Make fine adjustments to the formant of the voice character.

< Formants >

A formant is an important element which determines the character of a vocal sound. It is a fixed overtone whose location is determined by the size of the vocal chords.

Conventional pitch shifters modify the pitch in a way that changes even the location of the formants (which by nature do not change). For example when a conventional pitch shifter raises the pitch, a "duck voice" is produced as if the vocal chords had shrunk, and when the pitch is lowered a "giant voice" is produced as if the vocal chords had expanded.

The Voice Transformer modifies the basic pitch and the formant separately, allowing a variety of voice characters to be created.

MixBal (Mix balance)

Adjust the balance between the voice character volume and the normal voice volume.

REV (Reverb)

Reverb	Off, On
Time	0.1–10.0 sec
PreDLY	0–200 msec
Density	0–100
RevLevel	0–100

Reverb

Turn reverb on/off. If this is off, the following items will not be displayed.

Time

Adjust the reverb time.

PreDLY (Pre delay)

Adjust the time until the reverb sound is heard.

Density

Adjust the density of the reverb sound.

RevLevel (Reverb level)

Adjust the volume of the reverb sound.

FE (Fader edit)

FaderEdit	Off, On
-----------	---------

FaderEdit

This switch allows you to use the channel faders of the top panel to modify the various settings of the Voice Transformer. If this is on, channel faders 1–5 will control the following settings.

* Fader Edit is valid only when you are in Effect Edit condition. In other conditions, the faders will control the volume level of each channel as usual. Also, it will fail to operate in Auto Mix (p.17).

Channel 1:	Robot
Channel 2:	C.Pitch+F.Pitch
Channel 3:	C.Formant+F.Formant
Channel 4:	MixBal
Channel 5:	RevLevel

< Channel 1(Robot) >

Moving the fader above the middle will turn this on, and downward will turn it off.

< Channel 2(C.Pitch+F.Pitch) >

Coarse Pitch and Fine Pitch will change simultaneously to smoothly change the pitch.

< Channel 3 (C.Formant+F.Formant) >

Coarse Formant and Fine Formant will change simultaneously to smoothly change the formant.

MID (MIDI control)

MIDCtrl	Off, On
PitchBnd	Off, 1–12
Portamen	Off, 1–100

MIDCtrl (MIDI control)

Turn MIDI control on/off. When this is on, MIDI note on messages and pitch bend messages will adjust the pitch and formant. This is effective when a MIDI keyboard etc. is connected.

MIDI channel 1: C.Pitch+F.Pitch (C2–C6, original key is C3)

MIDI channel 2: C.Formant+F.Formant (C2–C4, original key is C3)

* The MIDI channels on which the pitch and formant are adjusted are fixed respectively at 1 and 2. They cannot be changed to other channels.

PitchBnd (Pitch bend)

Specify the maximum change produced by pitch bend (bend range), in semitone steps.

Portamen (Portamento)

Specify the speed at which the portamento effect will change.

● Mic Simulator

This modifies sound that was recorded by a conventional dynamic mic, laval mic or direct line, causing it to sound as though it had been recorded by an expensive condenser mic or a special studio mic. The mic simulator can add effects of proximity or distance.

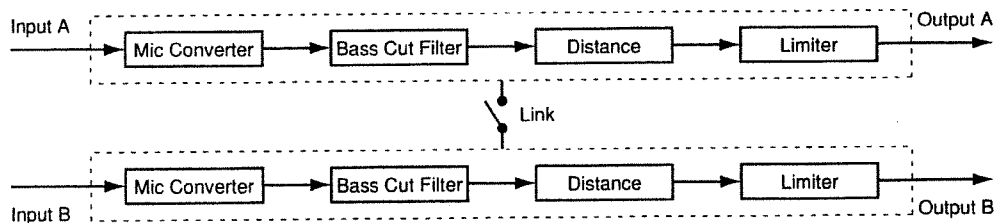

LNK (Link)

MSLink Off, On

MSLink (Mic simulator link)

This is the link switch for channels A and B. If this is off, the two channels will function independently as two monaural channels.

If this is on, both channels will be controlled simultaneously by the settings of channel A.

MCA/MCB (Mic converter channel A / channel B)

MicConv Off, On
 Input DR-20, Sml.Dy, Hed.Dy, Min.Cn, Flat
 Out Sml.Dy, Voc.Dy, Lrg.Dy, Sml.Cn, Lrg.Cn, Vnt.Cn, Flat
 Phase Normal, Invers

< Microphone → Microphone conversion >
 This converts the characteristics of an inexpensive general purpose mic into the characteristics of an expensive studio mic. For an already-recorded sound, it can create the same tonal change as if the type or distance of the mic had been changed.

< Line → Microphone conversion >
 This adds a feeling of "air" to an instrumental sound that was recorded by direct line input, causing it to sound as though it had been recorded with a microphone.

MicConv (Mic converter)

Turn the mic converter on/off. If this is off, the following items will not be displayed.

Input

Select the type of mic that was actually used to record.

DR-20: Roland DR-20
 Sml.Dy: Small Dynamic Microphone
 Hed.Dy: Head-worn Dynamic Microphone
 Min.Cn: Miniature Condenser Microphone
 Flat: Line Input

Out

Specify the mic that will be simulated.

Sml.Dy: General purpose dynamic mic for instruments or vocals.
 Ideal for guitar amp or snare drum.
 Voc.Dy: A popular dynamic mic for vocals.
 Characterized by a tight mid-range. Use for vocals.
 Lrg.Dy: Dynamic mic with extended low end.
 Use for bass drum or tom, etc.
 Sml.Cn: Small condenser mic for instruments.
 Characterized by a sparkling high range. Use for metallic percussion or acoustic guitar.
 Lrg.Cn: Condenser mic with flat response.
 Use for vocals, narration, or acoustic instruments etc.

Vnt.Cn: Vintage condenser mic.
Use for vocals or acoustic instruments etc.

Flat: Mic with flat frequency response.
For cancelling the characteristics of the mic used for recording.

* When you select a condenser-type mic simulator, the low range response is strengthened. This may cause noise transmitted from the mic stand to be emphasized. In this case, either use a bass cut filter to cut the unwanted low range, or equip the mic stand that you use at the time of recording with an isolation mount (a mic holder that uses rubber etc. to absorb vibration).

Phase

Normally you will set this to Normal.

In cases such as when mics are placed both in front of and behind the instrument for recording, setting one of them to Invert will produce a solid sound with a unified phase.

Normal: Same phase as the input
Invers: Opposite phase as the input

BCA/BCB (Bass cut filter channel A / channel B)

BassCut Off, On
Freq Thru, 20–2000 Hz

< Bass cut filter >

This is a filter that cuts unwanted low range noise, such as pops. It simulates the bass cut switch that is found on some mics.

BassCut (Bass cut)

Turn the bass cut on/off. If this is off, the following items will not be displayed.

Freq (Frequency)

Normally you will select Thru, and you can adjust the frequency if the attack contains a section of low volume.

DSA/DSB (Distance channel A / channel B)

Distance Off, On
Prox.Fx -12+12
Time 0–3000 cm

< Distance (proximity effect) >

Microphones have a characteristic which causes the low frequency range to be boosted when the sound source is nearby. This setting simulates this phenomenon.

Distance

Turn Distance on/off. If this is off, the following items will not be displayed.

Prox.Fx (Proximity effects)

Adjust the low frequency response that is affected by the mic distance from the sound source. Adjustment in the [+] direction will move the mic closer to the sound source, and in the [-] direction will move it away from the sound source.

Time

This simulates the time difference due to distance from the sound source.

LMA/LMB (Limiter channel A / channel B)

Limiter Off, On
Freq Thru, 20–2000 Hz
Level -60–24 dB
Thrsh -60–0 dB
Attack 0–100
Release 0–100

Limiter

Turn the limiter on/off. If this is off, the following items will not be displayed.

Freq (Frequency)

Adjust the cutoff frequency of the level detection section. With a setting of Thru, this will operate as a conventional limiter.

Level

Adjust the output level.

Thrsh (Threshold)

Adjust the level at which the limiter will begin to function.

Attack

Adjust the time from when the input level exceeds the threshold level until the limiter begins to be applied.

Release

Adjust the time from when the input level falls below the threshold level until the limiter ceases to apply.

■ Adjusting the send level and balance for all effects

You can now adjust the overall send level and balance of each effect without affecting the effect send level (VS8F-1 owner's manual p.9) and effect pan (VS8F-1 owner's manual p.9) that were set for each channel.

1. Press [EDIT(SOLO)] several times until the "MST EFF1 SND Lev=" display appears.

This display will not appear (the setting cannot be made) if EFFECT-1 is inserted into another channel, or inserted into the MASTER OUT jack.

2. Rotate the TIME/VALUE dial.

EFF1 SND Lev (Effect 1 send level)

Adjust the send level. The default value is 100.

3. Press PARAMETER [▶▶].

The display will indicate "MST EFF1 SND Bal=".

This display will not appear (the setting cannot be made) if EFFECT-1 is inserted into another channel, or into the MASTER OUT jack.

4. Rotate the TIME/VALUE dial.

EFF1 SND Bal (Effect 1 send balance)

Adjust the left/right volume balance. The initial value is 0 (center).

5. Press [PLAY(DISPLAY)].

You will return to Play condition.

The send level and balance can be adjusted for EFFECT-2 in the same way.

■ Inserting an effect

When you wish to use an effect such as compressor or distortion which modifies the direct sound itself, insert the effect between the equalizer and the fader. When an effect is inserted into one of the channels, that effect will be unavailable for use by other channels. For example if you insert EFFECT-1 into channel 1, it will not be possible for other channels to use EFFECT-1.

* If you insert different effects in each channel, or mix a channel in which effects are inserted with a channel in which effects are not inserted, time differences may occur depending on the type of effect, and the result may not always be as you expect.

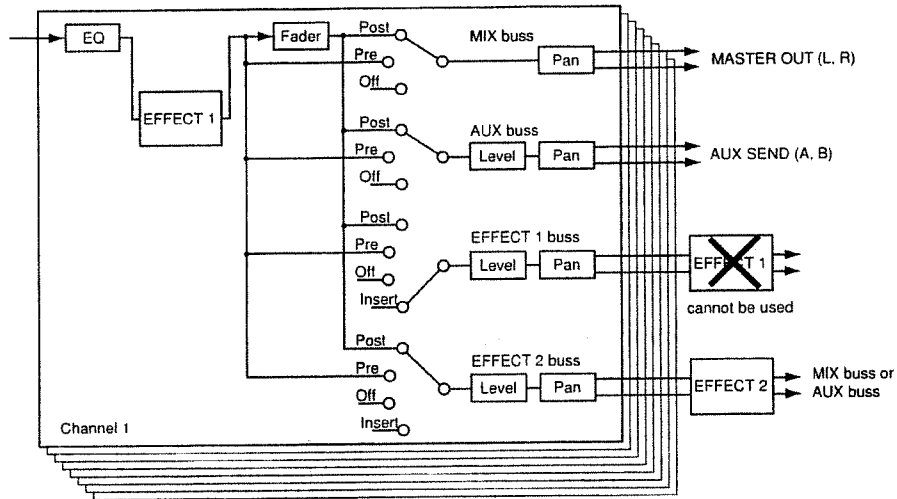

1. Press [CH EDIT] for the channel to which you wish to apply the effect.
2. Hold down [SHIFT] and press channel 7 [EFFECT-1(CH EDIT)].

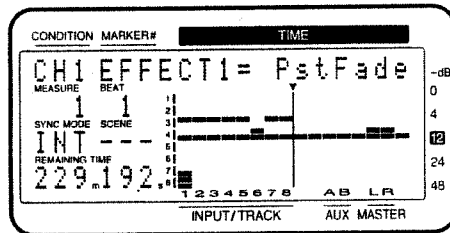

3. Rotate the TIME/VALUE dial.

EFFECT1 (Effect 1 switch)

Select how the signal will be sent to the EFFECT1 buss.

- Off: Not sent.
- PreFade: The signal before the channel fader will be sent.
- PstFade: The signal after the channel fader will be sent.
- Insert: Insert between the equalizer and the fader.
- InsertL: Insert into the L side of a stereo effect.
- InsertR: Insert into the R side of a stereo effect.
- InsertS: Insert the L side and R side of a stereo effect in series.

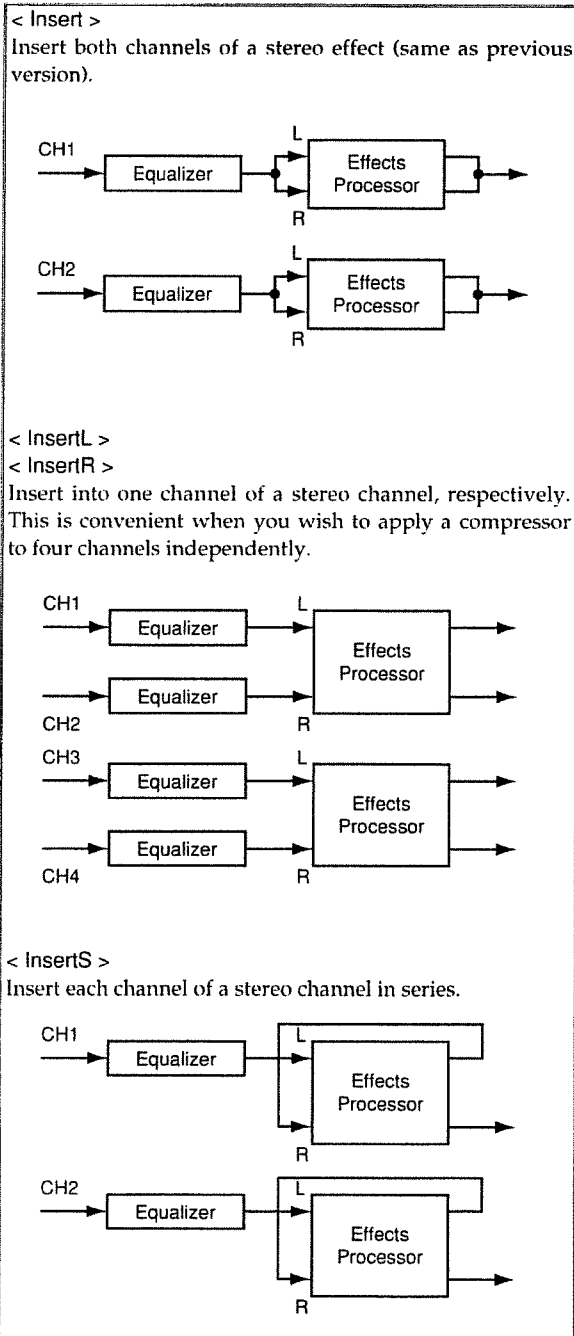

The processing when InsertL or InsertR is selected is the same as if an effect were inserted with Channel Link (p.112) turned on. Also, InsertL, InsertR, InsertS will not be displayed if Channel Link is on.

4. Press PARAMETER [▶▶].
The display will indicate "EFF1 InsSend=."
5. Adjust the effect send level. Rotate the TIME/VALUE dial.
6. Press PARAMETER [▶▶].
The display will indicate "EFF1 InsRtn=."
7. Adjust the effect return level. Rotate the TIME/VALUE dial.

* Steps 4-7 will be displayed only if the effect is being inserted.

EFFECT-2 can be inserted in the same way. In this case, hold down [SHIFT] and press channel 8 [EFFECT-2(CH EDIT)] in step 2.

Recording while an effect is inserted

When recording guitar or vocals, it will often be convenient to insert an effect such as a guitar multi or a vocal multi. This type of "wet recording" can now be done in INPUT→TRACK.

Here we will explain the procedure for connecting a guitar to input 1, using a guitar multi Patch to apply stereo effects, and recording the result to tracks 1 and 2.

1. Connect a guitar to input 1.

< When connecting a guitar >
In order to record the guitar with the best possible sound quality, please use an active-type guitar. Alternatively, use a direct box (such as the BOSS DI-1) or a compact-type effect unit.
In this case, the compact effect unit will be used to lower the impedance. Thus, turn the power on and the effect off if you do not need to use the effect.

2. Make sure that the mixer mode is INPUT→TRACK. If it is INPUT MIX/TRACK MIX, press [SHIFT]+[SELECT].
3. Press track 1 [CH EDIT].
4. Hold down [SHIFT] and press track 1 [Input/Buss(CH EDIT)].
5. Select the input which will be recorded onto track 1. Rotate the TIME/VALUE dial. For this example, select INPUT-1.
6. Hold down [SHIFT] and press track 7 [EFFECT-1(CH EDIT)].
7. Select how you wish to use the effect. Rotate the TIME/VALUE dial. For this example, select InsertL.
8. Press PARAMETER [▶▶] several times until the display indicates "CH1 EQ/Eff Pre Ins=."
9. Rotate the TIME/VALUE dial. For this example, select "On."

EQ/EffPreIns (Equalizer/effect pre-insert switch)

Select whether the equalizer and effect will be inserted during recording.

Off: They will not be inserted (same as Ver.1).

On: The signal into which the equalizer and effect have been inserted will be recorded.

10. Press track 2 [CH EDIT].
11. Repeat steps 5–9 to make the same settings as for track 1. However in step 7, select InsertR.
12. Press [EFFECT] several times until the display indicates "EFF EFFECT-1 PRM?"
13. Press [YES].
14. Select the effect that you wish to use. Rotate the TIME/VALUE dial.
For this example, a selection such as A51 GT:Country will make it easy to hear the results.
15. Press [YES].
16. Following the procedure for "Recording" (Quick start, p.10), record onto tracks 1 and 2.

Inserting two effects into one channel

It is now possible to insert two effects into the same channel.

Follow the procedure for "Inserting an effect" (p.34) and "Inserting an effect into master out," and insert EFFECT-1 and EFFECT-2 into the same channel.

* The effects will always be inserted in the order of EFFECT-2→EFFECT-1. It is not possible to change the order of connection.

Inserting in stereo

If you wish to insert an effect (with a stereo patch algorithm) in stereo, turn on Channel Link (p.112).

If you insert an effect into a channel for which Channel Link is turned off, it will become a mono input/output effect regardless of the patch.

* It is also possible to insert in stereo by selecting InsertL for the L side and InsertR for the R side, as in "Recording while an effect is inserted" (p.35).

Inserting to the master out

It is now possible to insert effect into the MASTER OUT jacks. This is convenient when you wish to apply a compressor or equalizer to the combined output of the channels that have been mixed.

1. Press [EDIT(SOLO)] until the "MST EFF1 INS Sw=" display appears.

If EFFECT-1 is already inserted into another channel, the display will indicate "MST EFF1 INS Sw=—" (the setting cannot be made).

2. Rotate the TIME/VALUE dial.

EFF1 INS Sw (Effect 1 insert switch)

Off: The effect will not be inserted into the master out (same as Ver.1).

On: The effect will be inserted into the master out.

3. Press [PLAY(DISPLAY)].
You will return to Play condition.

EFFECT-2 can be inserted in the same way.

Display related

■ Holding the level meter peaks

When the bar display (p.114) is the level meter, you can now cause the maximum volume value (peak) to remain (be held) in the display.

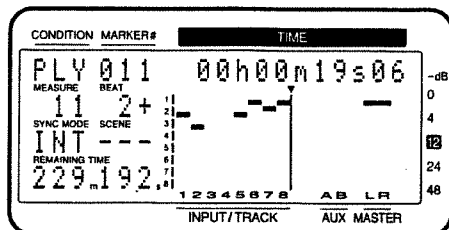

1. Press [SYSTEM] several times until "SYS System PRM?" appears.
2. Press [YES].
3. Press PARAMETER [▶▶] several times until the display indicates "SYS PeakHoldSw=".

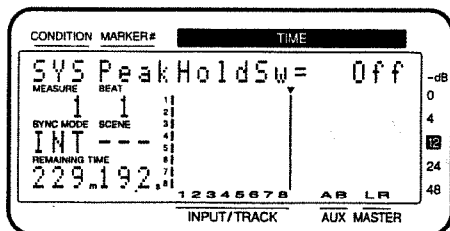

4. Rotate the TIME/VALUE dial.

PeakHoldSw (Peak hold switch)

When Pre Level or Post Level is displayed in the bar display, you can specify whether the peaks will be held.

OFF: Peaks will not be held (same as Ver.1).

ON: Peaks will be held.

5. Press [PLAY(DISPLAY)].
You will return to Play condition.
To reset the peak display, press [PLAY(DISPLAY)].

■ Checking the remaining disk capacity

The REMAINING TIME column indicates the approximate time (capacity) remaining for recording in the current song. You can now specify the type of this display.

1. Press [SYSTEM] several times until the "SYS System PRM?" display appears.
2. Press [YES].
3. Press PARAMETER [▶▶] several times until the "SYS RemainDsp=" display appears.
4. Rotate the TIME/VALUE dial.

RemainDsp (Remaining display)

Specify how the remaining disk capacity will be displayed.

Time: Displayed as recording time (minutes/seconds) (same as Ver.1).

CapaMB: Displayed as actual capacity (MB).

Capa%: Displayed as percentage (%) of capacity of the entire disk.

Event: Displayed as the number of events used for recording.

5. Press [PLAY(DISPLAY)].
You will return to Play condition.

Disk drive related

■ Checking the reliability of a disk

When a disk drive is initialized, the entire area of that drive is now checked (surface scanned) to determine whether reading and writing can be performed correctly. If a location which cannot be correctly read or written is found, the VS-880 will flag that location as **unusable memory**. Subsequently, such locations will not be used for recording or playback etc.

When this procedure is performed, the contents that were saved on the disk **will all be lost**. Perform this procedure on a newly purchased disk, or on a disk that had been used on another computer etc. but is now to be used on the VS-880. Before performing this procedure on the disk that you are currently using, be sure to make a backup.

* The surface scan operation requires a substantial amount of time. For example, the internal IDE drive (540 MB) will require approximately 30 minutes. This will give you an idea of how much time will be required for the capacity of your disk drive.

1. Press [SYSTEM] several times until "SYS DriveInitialize?" is displayed.
2. Press [YES].
3. Select the drive that will be initialized. Rotate the TIME/VALUE dial.

Init.Drive (Initialize drive)

Select the disk drive that will be initialized.

4. Press PARAMETER [▶▶] several times until "SYS SurfaceScan=" appears.
For physical formatting (PhysicalFmt) and partitioning (Partition), refer to "Initializing the disk" (p.93).
5. Rotate the TIME/VALUE dial.

SurfaceScan (Surface scan)

Off: Read and write test will not be performed (same as Ver.1).

On: Read and write test will be performed.

6. Press [YES].
A message will ask you to confirm that you really want to initialize the disk.
7. Press [YES] two more times.
Disk initialization will begin.
8. When initialization ends, surface scan will begin automatically.

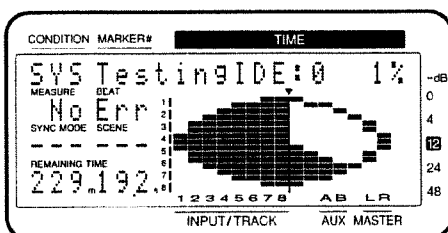

To halt during the procedure

To halt surface scan during the procedure, press [CANCEL(NO)]. However, even if unusable memory had been found, it will not be registered.

If the display indicates "File System Err"

A read or write failure has occurred in a location which stores basic data used by the VS-880 for recording and playback. **This disk drive cannot be used by the VS-880.**

- 9-1. Press [YES].
The VS-880 will restart.

If the display indicates "___ Defect"

The underlined portion will indicate the number of **unusable memory locations** in this drive. The larger this number is, the lower the reliability of this drive.

- 9-2. Press [YES].
The VS-880 will restart.

If the display indicates "— Complete —"

This drive has no unusable memory.

- 9-3. Press [YES].
The VS-880 will restart.

■ Checking that a disk is not damaged

It is now possible to check that the drive you are using can be read correctly (Drive Check).

This provides a way to determine whether a failure during Song Copy (p.94) or DAT Backup (p.97) is due to a problem in the song itself that was saved on disk, or whether the problem is with the connections etc.

If data cannot be read correctly, the display will indicate the song in which the error occurred.

1. Press [SYSTEM] until the "SYS Drive Check ?" display appears.
2. Press [YES].
3. Select the drive that you wish to check. Rotate the TIME/VALUE dial.

CheckDrive (Check drive)

Select the disk drive that you wish to check.

4. Press [YES].
A message will ask you to confirm that you wish to check the drive.
5. Press [YES] once again.
The display will indicate "STORE Current?"
6. If you wish to save the current song, press [YES].
If you wish to perform the test without storing the current song, press [NO].

7. Drive check will begin.

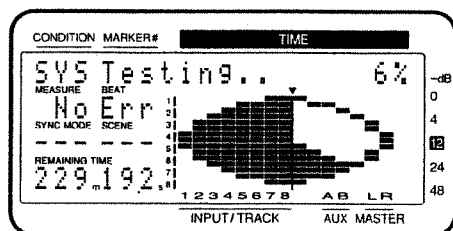

8. When drive check ends, the following display will appear. Rotate the TIME/VALUE dial.

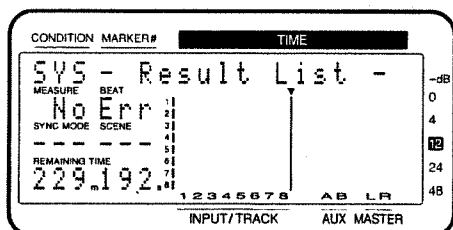

To stop during the procedure

To stop the drive check during the procedure, press [CANCEL(NO)].

If the display indicates "No Err"

- 9-1. The entire disk could be read correctly. Press [YES].
You will return to Play condition.

If the display indicates "___ Err"

The underlines portion will display the number of times that a read error occurred. Rotate the TIME/VALUE dial. The display will indicate "Err" for locations where an error was found. Locations for which "OK" was displayed have no problems.

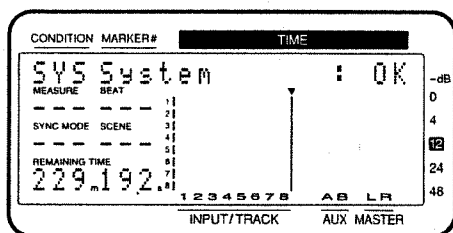

Result List (Drive check results)

- System: Location where basic data used by the VS-880 for recording and playback is stored
Song List: Location where the saved songs are managed
InitSong 001:
InitSong 002: Each song (in actual use, the song name is displayed)
:
InitSong 200:

Cluster Info. (Cluster information)

- Total: Number of clusters on the entire disk
Defect: Number of clusters tagged as **unusable memory**
Used: Number of clusters currently being used
Free: Number of clusters currently not being used
X-Link Err: Number of cross-linked clusters
Loose Area: Number of clusters whose links are lost
IllegalDIR: Number of directories with incorrect content.
Read Error: Number of read errors detected by this operation

< Clusters >

These are the smallest unit of memory that the VS-880 uses to manage data on a disk drive.

The smallest physical units on a disk drive are called either **sectors** or **blocks**, and depending on the device, the size that is handled can be selected. For example, the VS-880 is designed to use disks with 512 bytes/sector.

When the VS-880 manages song data, it handles 64 sectors as a single unit (1 cluster). This means that 512 (bytes) x 64 (sectors) = 32768 bytes (32 kilobytes) is one cluster.

< Cross link >

This is an error in which a cluster is detected as being included in two or more songs. In such a case, a completely different song may be heard in the middle of a song. Such an error condition is referred to as a **cross link**.

< Loose Areas >

An error in which clusters not included in any song are detected as containing valid data. In this case, the VS-880 will not store data in those clusters. A situation which causes this error to occur is called a **Loose Area**.

< Directories >

The VS-880 stores data such as audio data or parameter values on disk in units called **files**. In order to manage large numbers of files, the VS-880 keeps lists of filenames and the locations on disk in which the data of these files is stored. These lists are called **directories**.

The **Illegal Directory** message will appear when this list is incorrect. For example, this message will appear if the data of a certain file is supposed to be recorded in an area of the disk which does not actually exist, or if the list itself becomes permanently unreadable.

If a disk error is found, it is possible to erase only the data that was lost as a result of the error. I.e., the disk can be restored to a correct operating condition while keeping as much possible of the non-error data.

- * This procedure does not correct the disk error. All error locations will be erased. This means that depending on the location in which the error occurred, a take that was recorded may no longer be playable, auto mix data may be lost, or even the entire song itself may be erased. If the error has occurred in the system or song list, the probability of this danger is especially high.

9-2. Press PARAMETER [▶▶].

The display will indicate "RecoverDriveTry?"

9-3. Press [YES].

9-4. If any data will be lost, the display will indicate "You'll Lose Data". Press [YES]. To cancel the operation press [NO].

9-5. Rotate the TIME/VALUE dial.

Songs that have been partially modified will be marked as "Adj," and songs that were deleted will be marked as "Del." Songs which were not affected will not be displayed.

RecoverResult (Recovery result)

InitSong 001:

InitSong 003: Modified songs (in actual operation, the song name)

:

InitSong 200:

Cluster Info. (Cluster information)

Total: Number of clusters on the entire disk

Defect: Number of clusters marked as **unusable memory**

Used: Number of clusters currently being used

Free: Number of clusters currently unused

9-6. Press [YES].

You will return to Play condition.

Synchronization related

There may be cases in which you wish to use MIDI Clock messages to synchronize an external MIDI sequencer etc. to a song which was recorded without using the metronome. In such cases, it is now possible to assign mark points according to the tempo of the recorded performance, and then generate a **sync track** or **tempo map** from these mark points.

■ Assign mark points according to the tempo

1. Press [ZERO].
 2. Press [PLAY].
The song will begin to playback.
 3. While listening to the song, press [TAP] at the beginning of each measure or beat.
 4. When you finish assigning mark points, press [STOP].
- * If you wish to assign mark points precisely to the beginning of measures or beats, use the Preview function (p.76).

■ When using the sync track

Generating a sync track from mark points

A sync track can be generated from mark points that were assigned according to the tempo of a previously recorded performance. This is convenient when you have already recorded a performance of an acoustic instrument such as guitar or vocal, and now wish to synchronize a MIDI sequencer etc. to the recording.

1. Press [SYSTEM] several times until "SYS Sync/Tempo?" appears.
2. Press [YES].
3. Press PARAMETER [▶▶].
The display will indicate "SYS Syn:Gen".
4. Rotate the TIME/VALUE dial. In this case, choose SyncTr.

Gen (Sync generator)

This selects the type of synchronization signal that will be transmitted from the MIDI OUT connector. When using a synchronization signal from the VS-880 to synchronize external MIDI devices, set this to the desired type of synchronization signal.

- Off: Synchronization signals will not be transmitted.
- MTC: MIDI Time Code will be transmitted.
- MIDIClk: MIDI Clock will be transmitted.
- SyncTr: MIDI Clock data recorded on the sync track will be transmitted.

5. Press PARAMETER [▶▶] several times to get the "SYS Sync.Tr Cnv?" display.
6. Press [YES].

7. Rotate the TIME/VALUE dial. In this case, choose CV1.

CV (Convert)

- CV1=Tap → S.Tr: Create a sync track from mark points.
 - CV2=Tap → T.Map: Create a tempo map from mark points.
 - CV3=S.Tr → T.Map: Create a tempo map from the sync track.
 - CV4=Time → S.Tr: Automatically create a sync track.
8. Press PARAMETER [▶▶].
The display will indicate "SYS CV:Beat=".
 9. Specify the number of beats in one measure. Rotate the TIME/VALUE dial.
 10. Press PARAMETER [▶▶].
The display will indicate "SYS CV:Tap Beat=".
 11. Specify the number of mark points in each measure. Rotate the TIME/VALUE dial.
 12. Press [YES].
A message will ask you to confirm that you wish to re-create the sync track and tempo track.
 13. Press [YES] one (or two) more times.
The sync track will be created.

Generating the tempo map from the sync track

A tempo map can be created from the sync track recorded by the VS-880.

This is convenient when you wish to convert the synchronization signal of the sync track on the VS-880.

1. Press [SYSTEM] several times until "SYS Sync/Tempo?" appears.
2. Press [YES].
3. Press PARAMETER [▶▶].
The display will indicate "SYS Syn:Gen".
4. Rotate the TIME/VALUE dial. In this case, choose MIDIClk.

Gen (Sync generator)

This selects the type of synchronization signal that will be transmitted from the MIDI OUT connector. When using a synchronization signal from the VS-880 to synchronize external MIDI devices, set this to the desired type of synchronization signal.

- Off: Synchronization signals will not be transmitted.
 - MTC: MIDI Time Code will be transmitted.
 - MIDIClk: MIDI Clock will be transmitted.
 - SyncTr: MIDI Clock data recorded on the sync track will be transmitted.
5. Press PARAMETER [▶▶] several times to get the "SYS Sync.Tr Cnv?" display.
 6. Press [YES].
 7. Rotate the TIME/VALUE dial. In this case, choose CV3.

CV (Convert)

- CV1=Tap → S.Tr: Create a sync track from mark points.
 - CV2=Tap → T.Map: Create a tempo map from mark points.
 - CV3=S.Tr → T.Map: Create a tempo map from the sync track.
 - CV4=Time → S.Tr: Automatically create a sync track.
8. Press PARAMETER [▶▶].
The display will indicate "SYS CV3:S.TrBeat=".
 9. Specify the number of beats per measure in the synchronization signal that is recorded in the sync track. Rotate the TIME/VALUE dial.
 10. Press [YES].
A message will ask you to confirm that you wish to re-create the tempo map.
 11. Press [YES] once again.
The tempo map will be created.

Creating the sync track automatically

You can automatically create a sync track by specifying the start and end times of the song, and the number of measures that it contains. This is convenient when you already know the length of the song, such as for commercials.

1. Press [SYSTEM] several times until "SYS Sync/Tempo?" appears.
2. Press [YES].
3. Press PARAMETER [▶▶].
The display will indicate "SYS Syn:Gen".
4. Rotate the TIME/VALUE dial. In this case, choose SyncTr.

Gen (Sync generator)

This selects the type of synchronization signal that will be transmitted from the MIDI OUT connector. When using a synchronization signal from the VS-880 to synchronize external MIDI devices, set this to the desired type of synchronization signal.

- Off: Synchronization signals will not be transmitted.
 - MTC: MIDI Time Code will be transmitted.
 - MIDIClk: MIDI Clock will be transmitted.
 - SyncTr: MIDI Clock data recorded on the sync track will be transmitted.
5. Press PARAMETER [▶▶] several times to get the "SYS Sync.Tr Cnv?" display.
 6. Press [YES].
 7. Rotate the TIME/VALUE dial. In this case, choose CV4.

CV (Convert)

- CV1=Tap → S.Tr: Create a sync track from mark points.
- CV2=Tap → T.Map: Create a tempo map from mark points.
- CV3=S.Tr → T.Map: Create a tempo map from the sync track.
- CV4=Time → S.Tr: Automatically create a sync track.

8. Press **PARAMETER** [▶▶].
The display will indicate "SYS St=".
9. Specify the start time of the song. Rotate the **TIME/VALUE** dial.
10. Press **PARAMETER** [▶▶].
The display will indicate "SYS End=".
11. Specify the end time of the song. Rotate the **TIME/VALUE** dial.
12. Press **PARAMETER** [▶▶].
The display will indicate "SYS CV4:Mesure=".
13. Specify the number of measures within the specified time span. Rotate the **TIME/VALUE** dial.
14. Press **PARAMETER** [▶▶].
The display will indicate "SYS CV4:Beat=".
15. Specify the number of beats in each measure. Rotate the **TIME/VALUE** dial.
16. Press **[YES]**.
A message will ask you to confirm that you wish to re-create the sync track.
17. Press **[YES]** once again.
The sync track will be created.

■ Using the tempo map

Generating a tempo map from mark points

A tempo map can be created from mark points that were assigned according to the tempo of an already-recorded song. This is convenient when you wish to synchronize a MIDI sequencer to a previously-recorded performance of an acoustic instrument such as guitar or vocal.

1. Press **[SYSTEM]** several times until "SYS Sync/Tempo?" appears.
2. Press **[YES]**.
3. Press **PARAMETER** [▶▶].
The display will indicate "SYS Syn:Gen".
4. Rotate the **TIME/VALUE** dial. In this case, choose **MIDIclk**.

Gen (Sync generator)

This selects the type of synchronization signal that will be transmitted from the MIDI OUT connector. When using a synchronization signal from the VS-880 to synchronize external MIDI devices, set this to the desired type of synchronization signal.

- Off: Synchronization signals will not be transmitted.
- MTC: MIDI Time Code will be transmitted.
- MIDIclk: MIDI Clock will be transmitted.
- SyncTr: MIDI Clock data recorded on the sync track will be transmitted.

5. Press **PARAMETER** [▶▶] several times to get the "SYS Sync.Tr Cnv?" display.

6. Press **[YES]**.
7. Rotate the **TIME/VALUE** dial. In this case, choose **CV2**.

CV (Convert)

- CV1=Tap → S.Tr: Create a sync track from mark points.
- CV2=Tap → T.Map: Create a tempo map from mark points.
- CV3=S.Tr → T.Map: Create a tempo map from the sync track.
- CV4=Time → S.Tr: Automatically create a sync track.

8. Press **PARAMETER** [▶▶].
The display will indicate "SYS CV:Beat=".
9. Specify the number of beats in one measure. Rotate the **TIME/VALUE** dial.
10. Press **PARAMETER** [▶▶].
The display will indicate "SYS CV:Tap Beat=".
11. Specify the number of mark points in each measure. Rotate the **TIME/VALUE** dial.
12. Press **[YES]**.
A message will ask you to confirm that you wish to re-create the tempo map.
13. Press **[YES]** once again.
The tempo map will be created.

■ Adding an offset to the sync track/tempo map

It is now possible to create the sync track / tempo map starting from the time location at which recording began. The sync track / tempo map will be created starting at "00h00m00s00". However in actuality, recording does not usually start at "00h00m00s00".

For example if you began recording at "00h00m10s00", you can move the beginning of the sync track / tempo track to "00h00m10s00".

* During recording or playback, when the starting time location of the sync track/tempo track is reached, a Start message will be transmitted from the MIDI OUT connector. This is convenient when you wish to synchronize operation with an external MIDI sequencer, etc.

1. Press **[SYSTEM]** several times until the "SYS Sync/Tempo ?" display appears.
2. Press **[YES]**.
3. Press **PARAMETER** [▶▶] several times until the "SYS Ofs=00000000" display appears.
4. Input the time at which you want the sync track / tempo track to begin. Rotate the **TIME/VALUE** dial.

< Using [NUMERICS] >

By using [NUMERICS], you can use the ten LOCATOR buttons as numeric keys to directly enter numbers. Refer to "Using the numeric keys" (p.44).

5. Press **[PLAY]**.
You will return to Play condition.

MIDI related

■ Using program change messages to select scenes

MIDI program change messages transmitted from an external MIDI controller can now select Scenes.

1. Press [SYSTEM] several times until the display indicates "SYS MIDI PRM?".
2. Press [YES].
3. Press PARAMETER [▶▶] several times until the display indicates "SYS MID:P.C.Scene=".
4. Rotate the TIME/VALUE dial.

P.C.Scene (Program change scene)

Off: Program change messages will not be received (same as Ver.1)

On: Program change messages will be received to select Scenes

5. Press [PLAY(DISPLAY)].
You will return to Play condition.

Use the MIDI channel 15 to switch Scene.

The following chart shows the relationship between the Program Number received by the VS-880, and the Scene Number that is switches to.

Program No.	Scene No.
1-8	1-8

* For details refer to the separately sold MIDI Implementation.

< While a song is playing back >
It is not possible to change Scenes while a song is playing back.
Thus, if a program change message for selecting Scenes is received while a song is playing back, the song will be halted. Then the Scene will be switched, and playback will resume. During recording, program change messages are not received.

■ Using program change messages to select effects

MIDI program change messages transmitted from an external MIDI controller can now select effects.

1. Press [SYSTEM] several times until the display indicates "SYS MIDI PRM?".
2. Press [YES].
3. Press PARAMETER [▶▶] several times until the "SYS MID:P.C.Eff=" display appears.
4. Rotate the TIME/VALUE dial.

P.C.Eff (Program change effect)

Off: Program change messages will not be received (same as Ver.1).

On: Program change messages will be received to select effects.

5. Press [PLAY(DISPLAY)].
You will return to Play condition.

Use the MIDI channel 1 to switch EFFECT1, and use the MIDI channel 2 to switch EFFECT2.

The following chart shows the relationship between the Bank Number and Program Number received by the VS-880, and the Effect Patch Number that is switches to.

Bank No.MSB	Bank No.LSB	Program No.	Patch No.
0	0	1-100	Preset A00-A99
0	1	1-100	Preset B00-B99
0	2	1-100	User U00-U99

* For details refer to the separately sold MIDI Implementation.

■ Using control change messages to control effects

MIDI control change messages transmitted from an external MIDI controller can now control effects.

1. Press [SYSTEM] several times until "SYS MIDI PRM?" appears.
2. Press [YES].
3. Press PARAMETER [▶▶] several times until "SYS MID:C.C.Eff=" appears.
4. Rotate the TIME/VALUE dial.

C.C.Eff (Control change effect) [Off, On]

Off: Control change messages will not be received (same as Ver.1).

On: Control change messages will be received to control effects.

5. Press [PLAY(DISPLAY)].
You will return to Play condition.

* If you wish to use control change messages to switch effects, use NRPN (Non Registered Parameter Numbers). For details refer to the separately sold MIDI Implementation.

Other

■ Using the numeric keys ([NUMERIC])

When modifying the time locations of a locate point or punch-in point, you can use the ten LOCATOR buttons as numeric keys to input numbers directly. When doing so, you may now choose one of two methods of input.

1. Press [SYSTEM] several times until "SYS System PRM ?" appears.
2. Press [YES].
3. Press PARAMETER [▶▶] several times until "SYS NUMERIC Type=" appears.

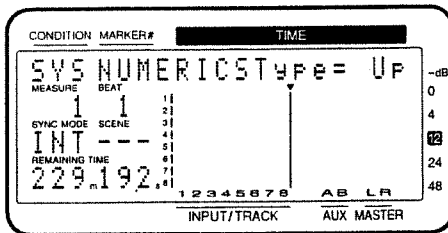

4. Rotate the TIME/VALUE dial.

NUMERIC Type (Numeric key type)

Select the input method for when using the LOCATOR buttons as numeric keys.

- Up: Input from the lowest place.
- Dwn: Input from the highest place.

5. Press [PLAY(DISPLAY)].
You will return to Play condition.

Example procedure when NUMERIC Type=Up

Suppose that you wish to input 01h23m45s00f.

1. Press [NUMERIC].
Indicator will light, and the current time location will be displayed.
2. The cursor will be displayed in the lowest place. Press LOCATOR buttons in the order of [1][2][3][4][5][0][0].
The numbers will scroll upward from low to high places as they are input.
3. When you finish inputting, press [ENTER(YES)].

Example procedure when NUMERIC Type=Dwn

Suppose that you wish to enter 01h23m45s00f.

1. Press [NUMERIC]. The indicator will light, and the current time will be displayed.
2. The cursor will appear at the highest decimal place. Press the LOCATOR buttons in the order of [0][1][2][3][4][5][0][0].
The numbers will be input from highest to lowest place.
3. When you finish input, press [ENTER(YES)].

< Using PARAMETER [◀◀][▶▶] >
You can use PARAMETER [◀◀][▶▶] to move the cursor. For example if you wish to enter a time that is 10 minutes later than the present time, you can simply move the cursor to "00m" and input the number without having to input all of the digits.

■ Holding the function of [SHIFT] (Shift Lock)

It is now possible to temporarily hold the function of when [SHIFT] is pressed.

This makes it possible to switch the mixer modes or V-tracks etc. with one hand.

1. Press [SYSTEM] several times until "SYS System PRM?" appears.
2. Press [YES].
3. Press PARAMETER [▶▶] several times until "SYS Shift Lock=" appears.

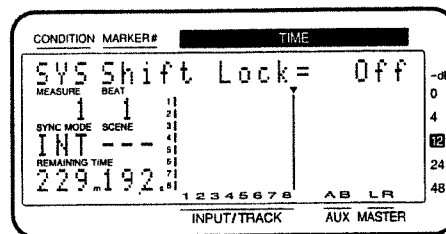

4. Rotate the TIME/VALUE dial.

Shift Lock (Shift lock switch) [Off, On]

Specify whether the function of [SHIFT] will be held.

- Off: [SHIFT] will not be held (same as Ver.1).
- On: [SHIFT] will be held.

5. Press [PLAY(DISPLAY)].
You will return to Play condition.

Example procedure when switching the mixer mode

1. In INPUT→TRACK, press [SHIFT] and immediately release it.
The display will briefly indicate "Shift Lock." Also, the CONDITION field will alternately display the current condition name and "sft" to indicate that Shift Lock is on.

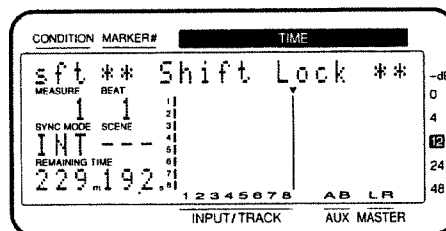

2. Press [SELECT].

The mixer mode will change to INPUT MIX/TRACK MIX. At the same time, the display will indicate "Shift Unlock," indicating that Shift Lock has been canceled.

< If [SHIFT] is held down during an operation >
 If [SHIFT] is **held down** during an operation, the Shift Lock function will be ignored. For example if you hold down [SHIFT] and press [SELECT], Shift Lock will not be turned on when you take your finger off [SHIFT]. The function of [SHIFT] itself remains in effect, so the mixer mode will change if you hold down [SHIFT] and press [SELECT].

Easy time adjustment

It is now possible to change only the desired decimal places of a number that you wish to change, such as when specifying the range for Track Copy or when modifying the time of a Locate Point.

Example procedure when modifying a Locate Point

* If a particular Locate Point has not been specified, the display will indicate "-- h -- m -- s --". In this case, it will not be possible to move the cursor to the desired digit.

Suppose that you wish to change the time of Locate Point 1 to "01h00m00s00".

1. Press [LOCATOR] several times until "LOC Loc1 ** h ** m ** s **" appears (numbers will be displayed in **).

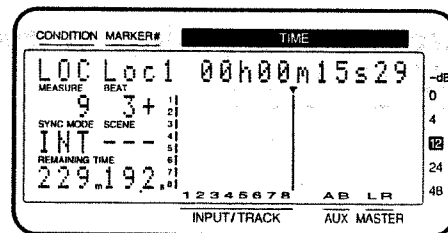

2. Hold down [SHIFT] and press CURSOR[◀].
The cursor will appear at the lowest decimal place.
3. Hold down [SHIFT] and press CURSOR[◀][▶].
The cursor will move. Move the cursor to the desired decimal place.
4. Rotate the TIME/VALUE dial to modify the number.
5. Press [PLAY(DISPLAY)].
You will return to Play condition.

Chapter 2 Before you start (VS-880 terminology)

This chapter explains basic concepts, internal structure, and basic operation that you will need to know in order to operate the VS-880. Please read this chapter to gain a better understanding of the VS-880.

Sources, tracks, and channels

On the VS-880, the recorder section and mixer section use the terms "sources," "tracks," and "channels." These terms may appear similar to each other, and will be confusing unless their differences are clarified.

Source: A signal which is input to the mixer section or recorded in the recorder section. On the VS-880, this term refers in particular to the signals of the analog input jacks and the digital in connector.

Track: A signal that is being recorded or is already recorded on the hard disk. On the VS-880, this term is used in particular in reference to the signals of the recorder section.

Channel: A signal that is being input or output. On the VS-880, this term is used in particular in reference to the signals of the mixer section.

Doing everything in the digital domain (Digital Studio Workstation)

The VS-880 is a multi-track digital disk recorder that combines a digital disk recorder and a digital mixer in a single unit. The VS-880 provides the same basic functionality expected of conventional analog tape recorders, such as "simultaneous recording of multiple tracks" and "synchronization with MIDI devices." In addition, it has features that are possible only with digital recording, such as "data transfer that minimizes deterioration of sound quality" and "undo-able editing," providing a high level of convenience in music production and video editing.

If an optional VS8F-1 effect expansion board is installed, you will be able to use two high-quality stereo effects.

In addition to the full set of effects such as reverb and chorus that are already provided, the effects now include limiter, enhancer, and a guitar amp simulator that utilizes the **COSM** technology made famous by the Roland V-Guitar System VG-8. This means that the entire range of studio procedures from recording to overdubbing and mixdown can now be performed with just the VS-880 alone.

Signal flow (busses)

On the VS-880, signals flow through **busses**. Busses are "shared lines through which multiple signals can be routed efficiently to multiple tracks/channels." It may be easier to understand this if we use the analogy of water pipe.

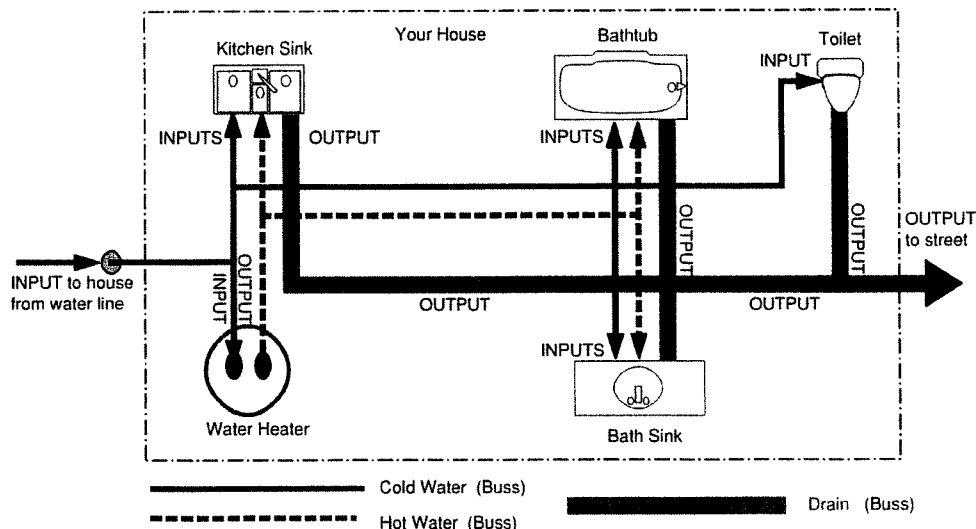

For example, the water that is supplied by the water company to your house is branched to a variety of locations within the house (kitchen, bathroom, toilet etc.). Then, the water that is used at each of these locations is collected into the sewer, and carried away.

If we think of the VS-880 as the house, the water being supplied from the water company corresponds to inputs such as mic or guitar. Some of these inputs are sent to recording tracks and are recorded. Other portions are sent to the effects, and reverb or chorus are applied before they are output.

The basic principle of the VS-880 is that by specifying in this way "from where" and "to where" the common lines run, you can determine which input signals will be recorded on which track or sent to which effects, and where they will be output.

Where a performance is recorded (Song)

On the VS-880, the location where a performance is recorded is referred to as a **song**. For example on a cassette MTR, this would correspond to cassette tape. Up to four partitions can be created in one disk drive, and up to 200 songs can be created in each partition.

< Partitions >

The disk drive capacity that the VS-880 is able to manage at one time is either 500 megabytes or 1000 megabytes. This means that if you are using a disk drive with a capacity greater than this, you will need to divide it into two or more areas. Each of these areas is referred to as a **partition**.

The VS-880 handles each partition of a disk drive as an independent disk drive. Thus, you can specify which partition of which disk drive you wish to use.

The disk drive that is currently being used is referred to as the **current drive**.

Song data includes the following data. Up to 200 songs can be stored in each partition of a disk drive.

- Playback data of all V-tracks
- MIDI clocks of the sync track
- Points specified for the song (marker points, locate points, loop points, auto punch-in/punch-out points)
- Scene memory (mixer settings)
- Vari-pitch settings
- System settings (system, MIDI, disk, sync, scene)
- Effect 1/2 settings (if the VS8F-1 effect expansion board is installed)
- Auto Mix Data

Mixer section

■ About mixer modes

The digital mixer specifies the input/output status of the recorder section.

As external inputs, the VS-880 provides four analog input jacks and 1 digital in connector. As external outputs, two master out jacks and two AUX send jacks are provided. You can freely specify which external input will be recorded on which track, and output from which output jack.

The way in which the digital mixer functions is selected by the mixer mode. The available mixer modes can be broadly divided into two types, based on their internal structure. One of these is further divided into another two, because of differences in the panel controls.

- INPUT→TRACK mode
- INPUT MIX mode and TRACK MIX mode

In INPUT→TRACK, the mixer is placed after the recorder section, and the mixer and recorder have a one-to-one correspondence. The top panel contains only channel faders and pan knobs, but you can also make equalizer and effect settings. A conceptual diagram showing all the settings in tabular form is given below.

Input Sources Include:

Analog Inputs 1-4,
Digital Inputs L & R,
Mix Buss L & R,
Tracks 1 - 8.

KEY TO KNOBS:

- ⊕ Trim
- ⊖ Pan
- ⊕ Level
- ⊖ Frequency
- ⊕ Resonance
- ⊖ Boost or Cut
- ⊖ Selector Switch

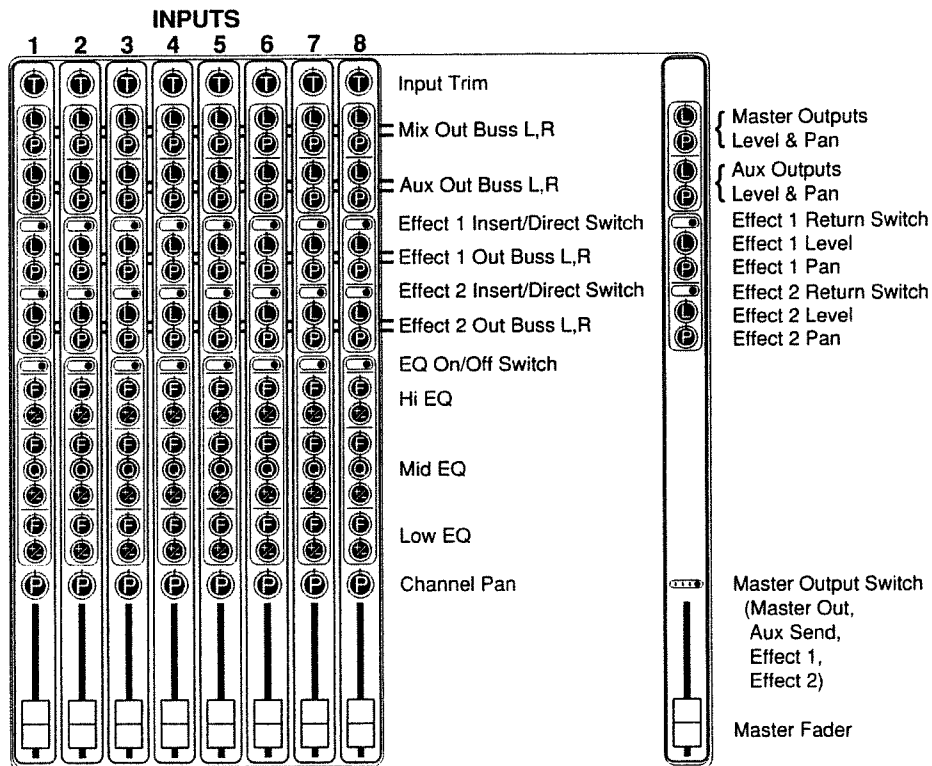

In INPUT MIX and TRACK MIX, the mixer is placed both before and after the recorder section. A conceptual diagram showing all the settings in tabular form is given below.

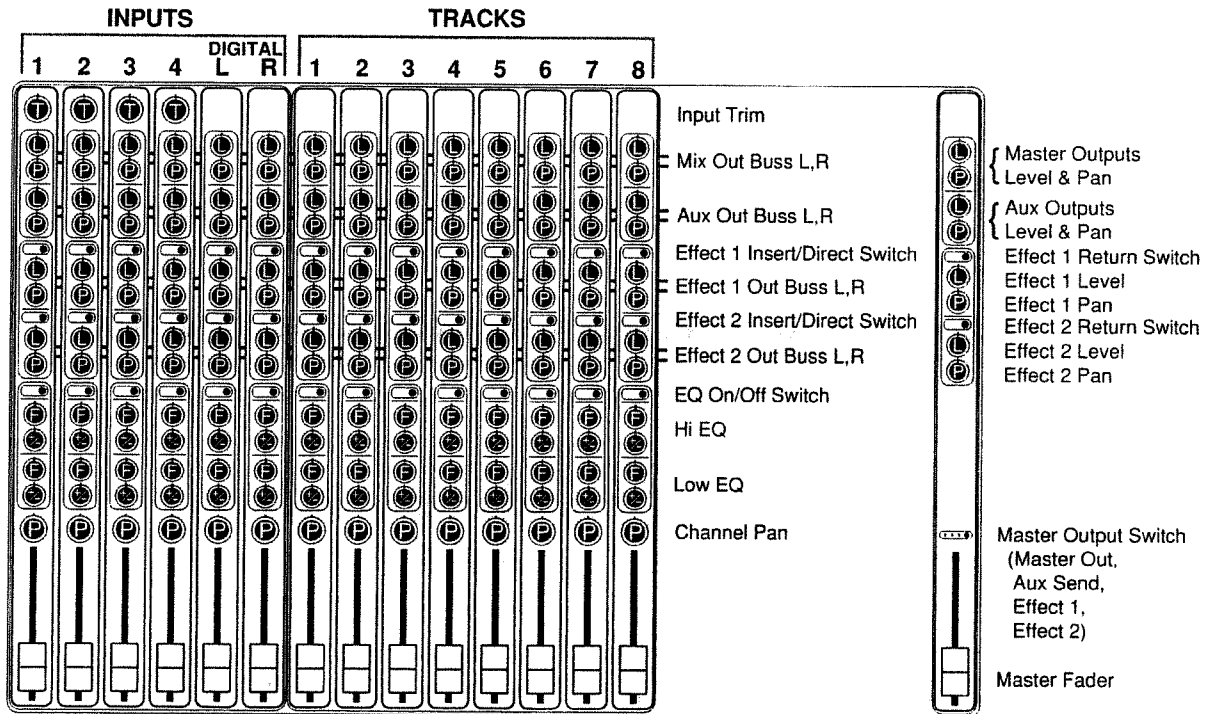

KEY TO KNOBS: Trim Pan Level Frequency Boost or Cut Selector Switch

The first stage of the mixer is adjusted by INPUT MIX, and the later stage of the mixer by TRACK MIX.

However since the VS-880 has the hardware limitation of having only eight channel faders, it is not possible to adjust both INPUT MIX and TRACK MIX simultaneously. This means that you will need to switch between INPUT MIX and TRACK MIX during use.

When the mixer and recorder are in one-to-one correspondence (INPUT→TRACK)

In this mode, the channels (1-8) of the mixer section correspond respectively to the tracks (1-8) of the recorder section in a one-to-one correspondence.

This is a "simple mixer mode" that you can use when you want to record a performance in the easiest way. For details refer to "Mixer section block diagram" (p.144).

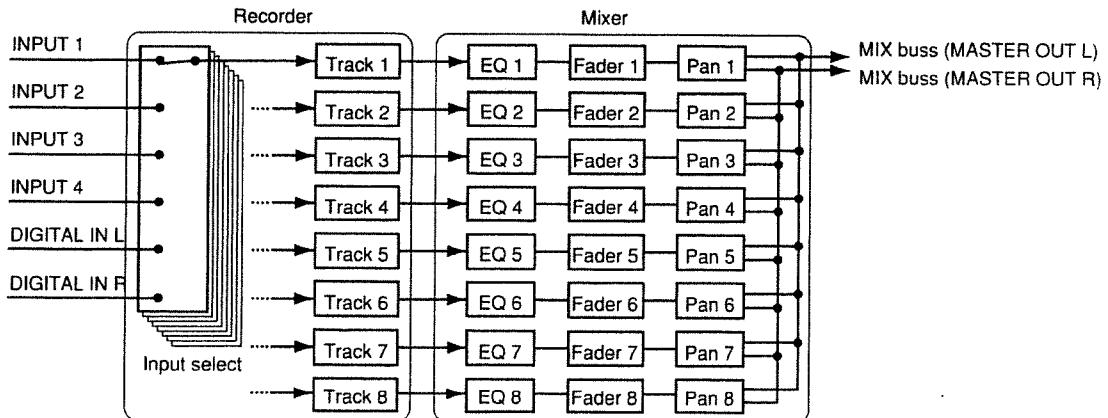

Input:

For each track, make one selection from INPUT1-4, DIGITAL-L or DIGITAL-R. You can also specify that the signals of the MIX buss or AUX buss be recorded.

Equalizer:

For each channel, the equalizer functions as a 3-band parametric equalizer with high (shelving type), middle (peaking type), and low (shelving type) bands. This can be turned off if you do not wish to use it.

Output:

The outputs of each channel are collected into a stereo signal by the MIX buss and output from the MASTER OUT jack. The same signal is also sent from the PHONES jack and the DIGITAL OUT connector.

When the mixer corresponds to the input sources (INPUT MIX)

The mixer will function as a 6-in/10-out mixer placed before the recorder section. The mixer inputs will correspond to the external input sources.

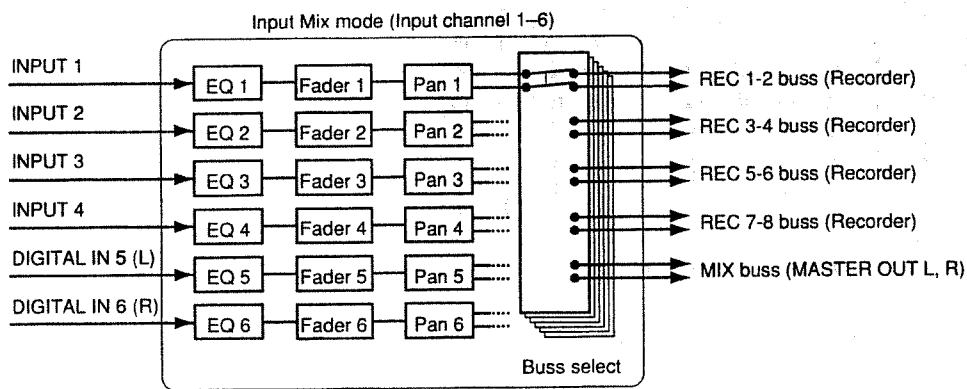

Input:

Channels 1-4 correspond to INPUT1-4, and channels 5 and 6 correspond to DIGITAL IN (5, 6). Moving the faders or pan knobs of channels 7 or 8 will not cause anything to happen.

Equalizer:

Normally the equalizer section will function as 2-band parametric equalizers with high (shelving type) and low (shelving type) bands. This can be turned off if you do not wish to use it. The V-XPANDED enhancement also allows the equalizers to be used as 3-band parametric equalizers. Refer to "Using 3-band equalizer in INPUT MIX/TRACK MIX" (p.20).

Output:

The output of each channel will be sent to REC busses 1-8, and will be recorded just as they are on tracks 1-8 of the recorder section. If signals are not sent to the REC busses, it will not be possible to record on the corresponding tracks.

If you wish to output directly to the MASTER OUT jacks, such as when simply mixing without recording into the recorder section, select the MIX buss.

When the mixer corresponds to recorded tracks (TRACK MIX)

In this mode the mixer will function as an 8-in/10-out mixer placed after the recorder section. The mixer channels will correspond to recorded tracks.

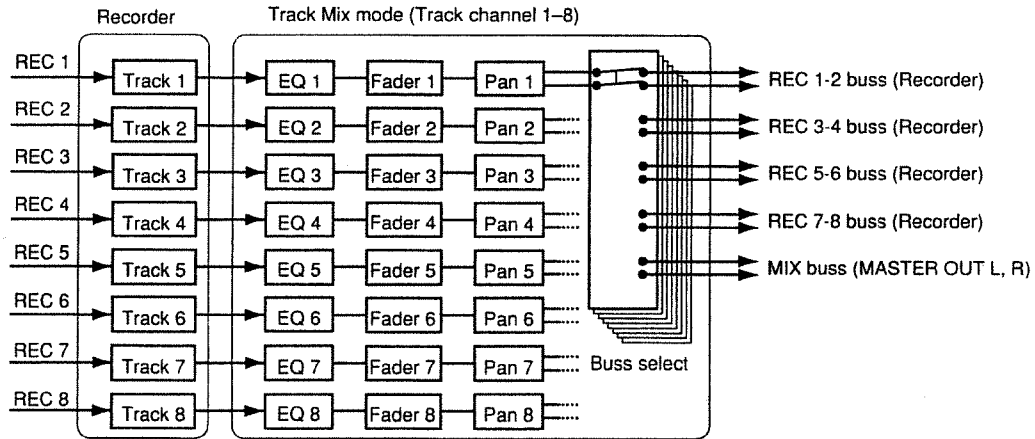

Input:

The track output (1–8) of the recorder section will be in one-to-one correspondence with the channels (1–8) of the mixer section.

Equalizer:

The equalizer section will normally function as 2-band parametric equalizers with high (shelving type) and low (shelving type) bands. These can be turned off if you do not wish to use them. The V-XPANDED enhancement also allows the equalizers to be used as 3-band parametric equalizers. Refer to "Using 3-band equalizer in INPUT MIX/TRACK MIX" (p.20).

Output:

The outputs of each channel are combined into a stereo signal by the MIX buss, and output from the MASTER OUT jacks. The same signal will also be sent from the PHONES jack and the DIGITAL OUT connector.

■ Switching the mixer mode

The current mixer mode is shown by the indicator located at the right of MIXER MODE [SELECT]. Use the following procedure to switch the mixer mode. The reason that this procedure is required is to prevent you from accidentally selecting a mixer mode that radically changes the internal structure of the mixer.

To switch from INPUT→TRACK mode to INPUT MIX mode or TRACK MIX mode, hold down [SHIFT] and press [SELECT]. If you once again hold down [SHIFT] and press [SELECT], you will return to INPUT→TRACK mode. INPUT MIX mode and TRACK MIX mode will alternate each time the [SELECT] button is pressed.

■ Recording the current condition of the mixer (Scene)

Up to 8 sets of mixer settings can be stored for each song. A stored set of mixer settings is called a "scene," and can be recalled at the touch of a button. For example if during mixdown you wish to compare different mixing balances, you can store each different mixer setting as a scene.

Storing the current mixer settings

1. Press [SCENE] to make the button indicator light.
When the SCENE indicator is lit, the [LOC 1/5]–[LOC 4/8] LOC buttons will act to store or recall scenes. The bar display will indicate the current settings of the mixer.
2. Store the current mixer settings as a scene.
To store the settings to a scene 1–4, press a button [LOC 1/5]–[LOC 4/8]. To store the settings to a scene 5–8, hold down [SHIFT] and press a button [LOC 1/5]–[LOC 4/8].
When the mixer settings have been stored, the button indicator will light.
3. When you finish storing the scene, press [SCENE] once again to turn off the button indicator.

< About the display >

The SCENE field in the display indicates the currently selected scene number. If an asterisk "*" appears at the beginning of the scene number, this indicates that the current mixer settings differ from the scene settings. I.e., after recalling the scene, the faders or PAN knobs etc. have been moved to change the mixer settings.

Recalling a scene

* Before selecting a scene, you must stop song recording/playback. It is not possible to select a scene during recording/playback.

1. Press [SCENE] to make the indicator light.
When you press the button, the current settings of the faders and pan will appear in the bar display.
2. Press a LOC button to specify the scene that you wish to recall.
3. When the scene has been recalled, press [SCENE] to turn off the button indicator.

Recalling a scene without affecting the current fader values

When a scene is recalled, the fader values will change to the recalled settings, but the locations of the faders will not change. This means that the locations of the faders will not match their actual values. When the locations do not match the values, the bar display will blink to indicate the actual fader values.

If you want just the fader values to remain unchanged when you recall a scene, make the following settings.

1. Press [SYSTEM].
If a message with a question mark such as "SYS System PRM?" does not appear, press [SYSTEM] once again.
2. Use PARAMETER [◀◀] [▶▶] to get the "SYS Scene/Auto Mix?" display, and press [YES].
3. In the "SYS Scene Mode=" display, use the TIME/VALUE dial to select "KeepF."

SYS Scene Mode

This setting determines the fader settings when a Scene is recalled.

All: Fader settings will change to the settings of the scene that was recalled. In this case, when a scene is recalled, the location of the faders on the front panel will no longer match the actual fader settings.

KeepF: The mixer settings of the scene that was recalled will be applied with the exception of the fader settings. This means that even when a scene is recalled, fader settings will still match the location of the faders on the front panel.

4. After making the setting, press [PLAY (DISPLAY)] to return to Play condition.

Clearing the settings of a scene

1. Press [SCENE] to make the button indicator light.
2. Clear the scene settings.
While holding down [CLEAR], press the LOC button for the scene that you wish to clear. The settings will be cleared and the button indicator will go dark.
3. After the settings have been cleared, press [SCENE] to make the button indicator go dark.

Recorder section

■ Differences with a tape-type MTR

Unlike DAT recorders, which use tape, digital disk recorders record sound (music) on a disk, as do MD recorders. Music that is recorded on disk can be recalled and played back immediately, no matter where it is located on the disk. This is also obvious from the difference in speed at which you can move to the beginning of a song on a DAT recorder and on an MD recorder.

The ability to freely move to data regardless of the time or sequence at which it was recorded is known as "random access." In contrast, having to move to data in the order of the time or sequence at which it was recorded is known as "sequential access."

random access

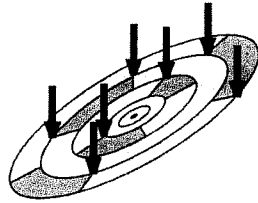

sequential access

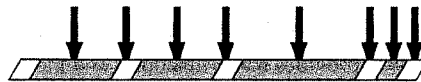

■ Number of tracks that can be recorded/played simultaneously

The recorder section of the VS-880 has eight tracks for recording/playing back a performance. Of these, four tracks can be recorded simultaneously.

■ Virtual tracks provided for each track (V-tracks)

Each track consists of eight virtual tracks, and you can select one of these as the object for recording or playback. I.e., you can record a performance on $8 \times 8 = 64$ tracks, and select 8 of these for playback. The virtual tracks that make up each track are referred to as **V-tracks**.

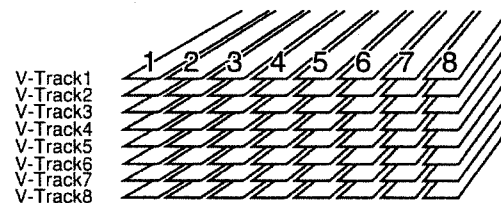

* You may find it useful to copy the blank virtual track sheet from the appendix of this Owner's Manual to keep track of your virtual track recordings.

Effects section

■ About the effect expansion board (VS8F-1)

The VS8F-1 effect expansion board which allows high-quality stereo effects to be created within the VS-880 is available as an option.

The VS8F-1 has two stereo effect units, and allows you to use two different types of effect simultaneously. For each channel you can specify the effect that will be used. Of course it is also possible to use two effects in one channel.

For effect operation, refer also to the VS8F-1 owner's manual.

VS-880 operation

■ How operations are organized (Conditions)

The VS-880 provides many functions, and these functions are grouped into "Conditions." In order to perform an operation, you must select the condition in which the desired operation is found. The VS-880 has the following eight conditions.

- **Play condition:**
Here you can perform normal playback/recording. Each time the power is turned on, the VS-880 will be in Play condition.
- **Channel Edit condition:**
Here you can set the status of each mixer channel, select input sources, switch V-tracks, and make equalizer settings, etc.
- **Master Block Edit condition:**
Here you can make settings for the master section of the mixer, such as master level and AUX send level.
- **Song Edit condition:**
Here you can perform song-related operations, such as naming a song, switching songs, and creating a new song.
- **Locator Edit condition:**
Here you can modify the times of the various points specified in a song, such as locate points and mark points.
- **Track Edit condition:**
Here you can edit the playback data recorded in a track, for example by copying data between tracks or erasing it.
- **Effect Edit condition:**
Here you can make effect settings. This condition can be selected only if the VS8F-1 effect expansion board (sold separately) is installed.
- **System Edit condition:**
Here you can make settings that affect the entire VS-880, such as disk drive settings and settings related to MIDI synchronization.

■ Switching conditions

This section explains basic operation of the VS-880. Please be sure to read this section, so that you will understand each type of operation.

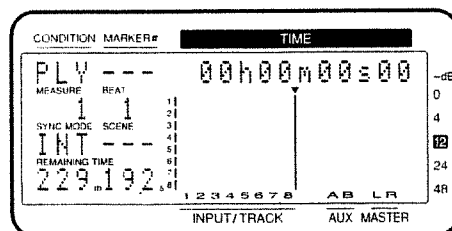

Button	Condition	Display
[CH EDIT] for each channel	Channel Edit	CH (n) (INPUT→TRACK mode) IN (n) (INPUT MIX mode) TR (n) (TRACK MIX mode)
master section [EDIT]	Master Block Edit	MST
[SONG]	Song Edit	SNG
[LOCATOR]	Locator Edit	LOC
[TRACK]	Track Edit	TRK
[EFFECT]	Effect Edit	EFF
[SYSTEM]	System Edit	SYS

* For Channel Edit condition, the channel numbers (n) will be displayed as 1–8 if Channel Link is off, and as a–d if Channel Link is on. Channel Link is a function that makes it easier to control adjacent channels as a stereo source (p.112).

■ Selecting the operation menu

If Song Edit, Track Edit, or System Edit conditions are selected, messages ended by a question mark such as “SYS System PRM?” will appear. This indicates the operation menu. Use PARAMETER [◀◀][▶▶] to select the operation menu, and press [YES] to finalize. When you press [YES], the parameters which can be set from that menu will appear.

If System Condition is selected, there will be cases in which parameters are displayed directly, without an operation menu being displayed. This is so that the previously selected parameter can be selected. To return to the menu, press [SYSTEM] once again.

■ Selecting parameters

Use PARAMETER [◀◀][▶▶] to select the parameter that you wish to change. If two or more parameters are displayed simultaneously, use CURSOR [◀][▶] to make the value of the desired parameter blink.

■ Modifying the value of settings

When the value that you wish to modify is blinking, use the TIME/VALUE dial to modify the value. Rotating the dial to the left will decrease the value, and rotating it to the right will increase the value. If you rotate the TIME/VALUE dial while holding down [SHIFT], the value will increase or decrease at ten times the normal rate.

■ Executing an operation

To execute an operation such as switching songs or copying a track, use the following procedure.

In Song Edit condition, make settings for each parameter and press [YES]. A message will ask you to confirm execution. To execute, respond by pressing [YES]. To cancel, press [NO].

In Track Edit condition, make settings for each parameter in order, and at the end a message will ask you to confirm execution. To execute, press [YES]. To cancel, press [NO].

For some operations, an additional message will ask for confirmation. In this case, press [YES] again to execute. A second confirmation message will appear for operations which cannot be undone using the Undo function (p.112).

■ Switching the track status (Track Status)

The status of each track (track status) is shown by the button indicators. The track status can be switched by the [STATUS] button of each channel. To switch directly to REC track status, hold down [REC] and press [STATUS]. To switch directly to PLAY track status, hold down [STOP] and press [STATUS]. The track status can be switched regardless of the mixer mode you are in.

SOURCE (orange): The specified input source can be monitored.

REC (blinking red): Recording is selected for the track.

PLAY (green): The track will playback.

MUTE (dark): The track is muted (silent).

* The VS-880 can record up to 4 tracks simultaneously. This means that it is not possible to select a track status of REC for five or more tracks.

■ Changing the current time

About the current time display

The current time shown in the display is MTC (MIDI Time Code), and is shown in the format “** hours ** minutes ** seconds ** frames.” This corresponds to SMPTE time code as well. SMPTE time code is a standard created by SMPTE (Society of Motion Picture and Television Engineers) in the United States, and is used to indicate each frame of a video image. SMPTE time code is used in video editing, etc.

The type of time code that is used differs between devices. If you use MTC to synchronize the VS-880 with another device, you will have to set both devices to the same type of time code. With the factory settings, the VS-880 is set to 30 frames (non-drop) per second (p.86).

Moving to the beginning of the performance (Song Top)

To move to the earliest location in the song that contains recorded sound, use the following procedure.

1. Hold down [SHIFT] and press [SONG TOP (REW)].
The V-track selected for each track will be checked, and you will move to the location that contains the first sound recorded in the song.

Moving to the end of the performance (Song End)

To move to the last location in the song that contains recorded sound, use the following procedure.

1. Hold down [SHIFT] and press [SONG END (FF)].
The V-track selected for each track will be checked, and you will move to the location that contains the last sound recorded in the song.

Moving in measure/beat units

The MEASURE field in the display will indicate the measure number of the current location, and the BEAT field will indicate the beat number of the current location. With the factory settings, these values will be calculated for a tempo of 120 (quarter notes per minute) and a time signature of 4/4. For details on setting the measure and beat, and how they correspond to the song, refer to “Sounding the metronome” (p.109).

1. Select the value that you wish to change.
To move in steps of a measure, use CURSOR [◀][▶] to make the number in the MEASURE field blink. To move in steps of a beat, make the number in the BEAT field blink.
2. Change the value.
Use the TIME/VALUE dial to select the measure number or beat number to which you want to move. To return to using the TIME/VALUE dial to move in steps of a frame, press CURSOR [▶] several times to make the display stop blinking.

Moving in frame units

- To move in steps of 1 frame, rotate the TIME/VALUE dial.
- To move in steps of 10 frames, hold down [SHIFT] and rotate the TIME/VALUE dial.
- To move in steps of approximately 1/10 frame, press CURSOR [▶] and then rotate the TIME/VALUE dial. When you press CURSOR [▶], an arrow “←” will appear at the beginning of the displayed time code, and the frame number display will change to a sub-frame number display (approximately 1/100 frame). To return to the frame display, press CURSOR [◀] once.
- To move in steps of approximately 1/100 frame, press CURSOR [▶] and then hold down [SHIFT] and rotate the TIME/VALUE dial.

Storing a time location, method 1 (Locate Point)

The [LOC 1/5]–[LOC 4/8] buttons allow you to memorize up to 8 time locations within the song. Also, there are four banks of locate points, allowing you to register a maximum of 8 (locate points) × 4 (banks) = 32 (locate points) time locations. The time locations memorized by these LOC buttons are referred to as “locate points.” Since you can jump to these locations simply by pressing a button, it is convenient to use them to memorize locations which you will want to access frequently. Locate points are also a convenient way to specify areas for looping or for auto punch-in recording.

■ Storing a time location

1. Specify the locate point number that you wish to use.
To use a locate point 1–4, press a [LOC 1/5]–[LOC 4/8] button. To use a locate point 5–8, hold down [SHIFT] and press a [LOC 1/5]–[LOC 4/8]. When the time has been memorized, the button indicator will light.

Changing the Locate Bank

1. Continuing to hold down [LOCATOR].
The current Locate Bank number will be displayed as “Locate Bank = 1” etc. At the same time, one of the [LOC1/5]–[LOC4/8] indicators which corresponds to the current bank number will blink.

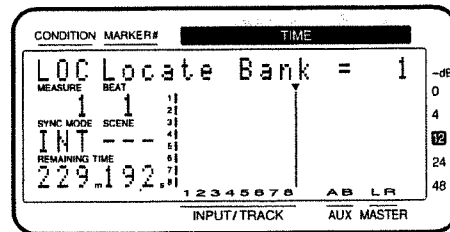

2. While continuing to hold down [LOCATOR], press the [LOC1/5]–[LOC4/8] button corresponding to the desired bank number.
The [LOCATOR] button is used both to access Locate Edit condition, and to switch the Locate Bank. If you release your finger from [LOCATOR] without switching the Locate Bank, the display screen may change.
3. Release the [LOCATOR] button.
4. Use the procedure “Storing a time location” to register the Locate Point.

< If you are using a VS-880 of version 1.06 or earlier >

Locate Bank is a function that was newly added in VS-880 V-XPANDED. Thus, when using a Zip disk or DAT backup to exchange song data with a VS-880 of version 1.06 or earlier, please be aware of the following points.

1. Songs created on VS-880 V-XPANDED can be read correctly even by a VS-880 of version 1.06 or earlier.
However in this case, the Locate Points that were stored in the Locate Bank that was in use when the data was last stored will be the Locate Points for the VS-880 of version 1.06 or earlier.
2. When Song Store is executed on a version 1.06 or earlier VS-880, only the Locate Points that were valid at that time will be valid on the VS-880 V-XPANDED as well. Locate Points stored in the expanded Locate Banks will be lost.

■ Moving to a stored time location

1. Use the LOC buttons to specify the locate point of the time to which you want to move.

■ Modifying a stored time location

1. Move to the Locate Point that you wish to modify. Press [LOC1/5]–[LOC4/8].
2. Press [LOCATOR] several times until "LOC Loc *" appears (* will be the locate point number that you wish to modify).
3. Input the desired time. Rotate the TIME/VALUE dial.

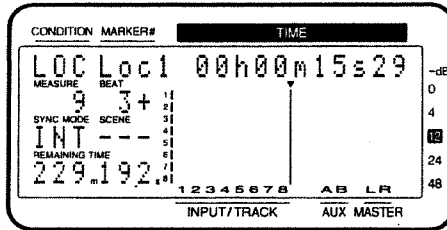

■ Deleting a stored time location

1. While holding down [CLEAR], use the LOC buttons to specify the locate point that you wish to clear. When a locate point has been cleared, the button indicator will go dark.

Storing a time location, method 2 (Mark Points)

The Tap Marker function lets you assign up to 1000 marks (mark points) to each song. To move to a mark point, you can either directly specify the mark point number, or move to successive mark points. This lets you move through a song in a way similar to using the index search buttons of a CD player. Mark points can also be used to specify loop areas or the area for auto punch-in recording.

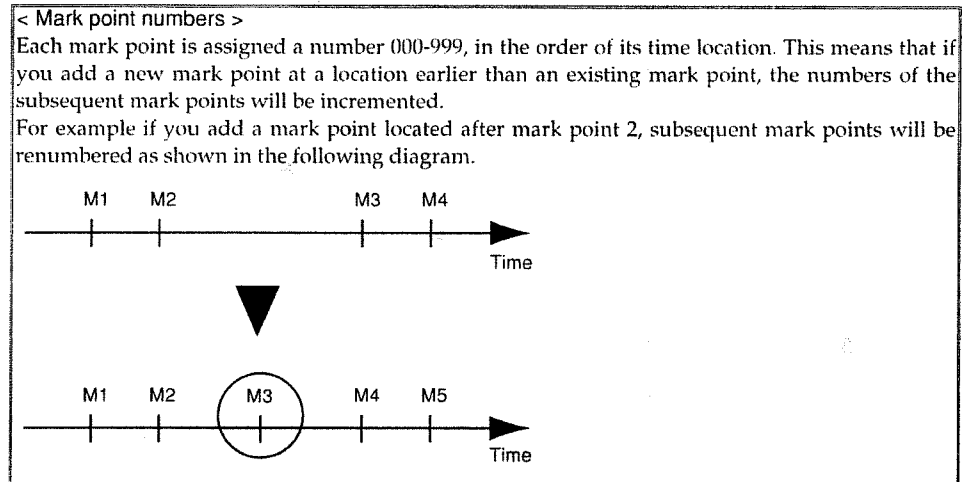

* An interval of at least 0.1 seconds must exist between mark points. It will not be possible to add a new mark point if a mark point already exists at a location closer than 0.1 seconds away.

■ Marking a time location

Adding a Mark Point to the current time

1. Press [TAP], and a mark point will be added to the current location.

Adding a Mark Point while playing back/recording a song

1. Begin playing back / recording a song, and press [TAP] when you reach the desired location. A mark point will be added at the time at which you pressed the button.

■ Moving to a marked time location

Moving to a Mark Point

1. To move to the mark point located before the current time, press [PREVIOUS]. Each time you press the button you will move to the next mark point. To move to the mark point located after the current time, press [NEXT].

Directly specifying a Mark Point

1. Use CURSOR[◀ | ▶] to make the mark point number displayed in the MARKER field of the display blink.
2. Use the TIME/VALUE dial to specify the mark point number to which you wish to move.

■ Modifying a marked time location

1. Move to the Mark Point whose time you wish to modify. Use [PREVIOUS][NEXT].
2. Press [LOCATOR].
3. Press PARAMETER[◀] several times until "LOC ***" appears (***) is the mark point number that you wish to modify).
4. Input the desired time. Rotate the TIME/VALUE dial.
The time of a mark point can be modified only within the range that lies between the preceding and following mark points.

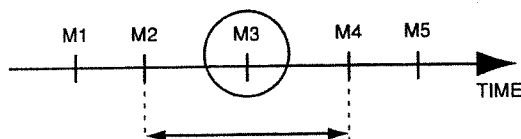

■ Clearing a mark

Clearing a Mark Point

Assigning mark points makes searching convenient, but creating too many mark points can actually make searching less convenient. It is a good idea to clear (erase) mark points that are no longer necessary.

1. Move to the mark point that you wish to clear (erase).
2. While holding down [CLEAR], press [TAP] and the mark point will be cleared.
If mark points exist after the mark point that was cleared, the subsequent mark point numbers will be incremented.

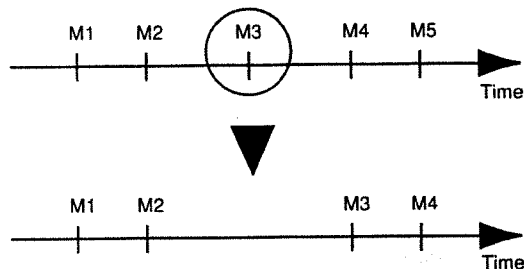

Clearing all Mark Points

1. While holding down [SHIFT], hold down [CLEAR] and press [TAP].
The display will ask "Clear ALL Marker?" so press [YES]. To cancel without clearing, press [NO].

Chapter 3 Basic operation (as a replacement for a tape MTR)

In this chapter we will begin by listening to the demo song that is saved on the hard disk. Then we will explain the procedure for multi-track recording, all the way to creating a master tape. We suggest that you follow the steps and actually try out each operation.

Before you begin

■ When you turn the power on

When all connections have been made correctly, turn on the power in the following procedure.

* After a hard disk has been installed, the operation that will occur when the VS-880 is turned on for the first time will depend on the type of internal hard disk. The explanation is divided into two sections: "● If a hard disk containing a demo song was installed" and "● If an un-initialized hard disk was installed." Please read the section that is appropriate for your situation.

● If a hard disk containing a demo song was installed

Hard disks which contain a demo song have already been initialized, and can be used by the VS-880 just as they are.

1. Turn on the VS-880 power.
When the VS-880 starts up correctly, "PLY" will appear in the upper left of the display.
This condition is called "play condition."
- * After power is turned on, the disk drive(s) must be properly identified, then certain required data must be loaded. Thus, a short amount of time is needed before the unit is ready for operation. If the display shows "SYS Init. Drive = NoDrv," the internal hard disk is not being detected. Turn the power off, and make sure that the hard disk is installed correctly.
2. Turn on the power of your audio devices, and raise the volume of the audio devices to appropriate levels.

● If an un-initialized hard disk was installed

New hard disks or hard disks which have been used by some other device cannot be used by the VS-880 as they are. Before such hard disks can be used by the VS-880, they must be initialized. Use the following procedure to initialize the hard disk.

- * When a hard disk that has been used by another device is initialized, all data that was stored on that disk will be lost. Backup the data if necessary.
1. Turn on the VS-880 power.
The upper line of the display will indicate "SYS Init. Drive=IDE: U."
 - * If the display shows "SYS Init. Drive = NoDrv," the internal hard disk is not being detected. Turn the power off, and make sure that the hard disk is installed correctly.
 2. Press [YES].
A message of "SYS Init. IDE: U Sure?" will ask for confirmation.

3. Press [YES] once again.

The hard disk will be initialized. If you decide not to initialize, press [NO].

* Initialization of a hard disk will take a considerable amount of time. This is not a malfunction. Do not turn the power off until initialization is complete.

When initialization has been completed correctly, the VS-880 will automatically be restarted. When the VS-880 starts up correctly, "PLY" will appear in the upper left of the display.

This condition is called "play condition."

4. Turn on the power of your audio devices, and raise the volume of the audio devices to appropriate levels.

Listening to the demo song

If a hard disk containing a demo song is installed, you can listen to the demo song. Listen to the demo song before you continue.

* If a new hard disk, or a hard disk that formerly was used by a different device is installed, it will not be possible to hear the demo song.

1. Move all channel faders to the 0 dB position, and pull down the master fader.
2. Press [PLAY] to begin playback of the song.
3. Gradually raise the master fader to adjust the volume. The current time will be displayed in the TIME field, and the bar display will indicate the level changes of each track (lever meter).
4. When playback ends, press [STOP] to stop.

■ Listening to the variations of the demo song

The demo song contains various Scenes (p.51). Each scene contains settings for different V-tracks, mixer settings, and effect settings. In a manner of speaking, these are **variations** of the demo song. Switch scenes and compare the playback.

1. Make sure that the song is stopped. If it is playing, press [STOP].
2. Press [SCENE].
The Scene indicator will light.
3. Press the LOC button for the desired scene number. For example if you wish to recall scene 2, press [LOC2/6].
4. Press [PLAY].
The song will playback.
5. Press [STOP].
6. Repeat steps 3-5 to compare the variations of the song.

Making a new recording

It is not possible to make a new recording while the demo song is selected. In order to record, you will have to prepare a new song. On a cassette tape MTR, this corresponds to inserting a new cassette tape.

■ Specifying the recording mode (Song New)

The VS-880 allows you to create up to 200 songs on one disk drive. To create a new song on the currently selected disk drive, use the following procedure.

1. Press [SONG], use PARAMETER [◀▶] to get the "SNG Song New?" display, and press [YES].
2. The display will indicate "SNG SampleRate=," so use the TIME/VALUE dial to select the sample rate (48, 44.1, 32 kHz). If you will be recording digital audio signals from an external digital audio device, set this parameter to match the sample rate of the external device.
3. Press PARAMETER [▶]. The display will show "Record Mode=," so use the TIME/VALUE dial to select the record mode.
4. Press [YES]. A confirmation message of "SNG Create NewSong ?" will appear, so press [YES] twice. To cancel, press [NO].

When the new song has been created, you will automatically return to Play condition, and the created song will be selected.

< Recording mode >

On the VS-880, the recording mode setting allows you to select a sound quality appropriate for the material being recorded and a recording time appropriate for the remaining capacity of your disk drive. This recording mode setting is set when you create a new song. The following recording modes are available. Use the mode appropriate for your situation.

* The recording mode cannot be changed after a song has been recorded.

Mastering (MAS): Of the four modes, this provides the highest sound quality; equal to a CD player or a DAT recorder. However a song for which this mode is selected will function as a 6-track recorder (tracks 1-6). Tracks 7-8 cannot be used. This mode is suitable for a recording in which you will use mainly 2-channel stereo editing.

Multitrack 1 (MT1): While preserving high sound quality, the recording time will be approximately twice that of "mastering" mode. This mode is suitable for when you will be doing a lot of track bouncing.

Multitrack 2 (MT2): While preserving high sound quality, this mode offers longer recording times than "multitrack 1." Normally you should use this mode.

Live (LIV): Of the four modes, this allows the longest recording times. For example if you are recording 4 tracks onto a 1 G byte disk, this mode allows more than 2 hours of continuous recording. Since this mode allows long recording without worrying about disk drive capacity, it is especially suitable for recording a live performance.

< Recording time >

When you create a new song, you must set the Sample Rate in addition to the Recording Mode. The recording times for each setting are as follows (1 G byte capacity, 1 track).

Recording mode	Sample rate		
	48.0 kHz	44.1 kHz	32.0 kHz
Mastering	185 minutes	202 minutes	278 minutes
Multitrack 1	371 minutes	404 minutes	557 minutes
Multitrack 2	495 minutes	539 minutes	742 minutes
Live	594 minutes	646 minutes	891 minutes

* The above-listed recording times are approximate. Times may be slightly shorter depending on the specifications of the disk drive and on the number of songs that were created.

< If the display indicates "Disk Too Slow!" >

If this message appears while recording or playing back a song, the disk drive was not able to keep up with the rate at which the data needed to be written or read. In this case, create a new song with a lower sample rate or recording mode than the current song, and try the recording once again.

< Song numbers >

Newly created songs will be given a name such as "InitSong 001." The number following the name is the song number. This name can be modified later.

On the VS-880, songs on each disk drive are managed by their song number. A newly created song will be assigned the lowest unused song number. For example if the current drive contains songs up to song number 5, a newly created song will be number 6. If an earlier-numbered song had been erased, the new song would have that number.

■ Naming the song (Song Name)

When you create a song, it will automatically be given a name like "InitSong001." However this makes it difficult to remember what song it is. We recommend that you assign a unique name to your song so that data management will be easier.

1. Press [SONG] several times until "SNG Song Name/Prct?" appears.
2. Press [YES].
The name of the song (Song Name) will appear.
3. Move the cursor so that the character that you wish to modify will blink. Use CURSOR[◀▶].

4. Modify the character. Rotate the TIME/VALUE dial. By holding down [SHIFT] as you rotate the TIME/VALUE dial you can make the characters change more rapidly.

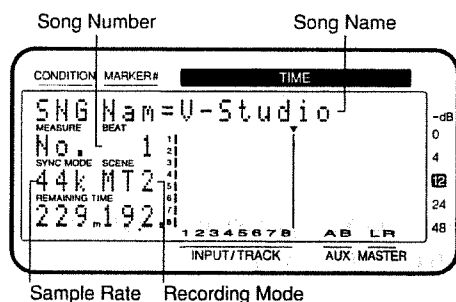

5. When the procedure is completed, press [PLAY (DISPLAY)] to return to Play condition.

General procedure for multi-track recording

Although the VS-880 is a digital multitrack recorder, recording procedure is the same as for an analog multitrack recorder, as shown below.

1. Record the basic tracks of the song; drums and bass, etc.
2. While playing back the drums and bass tracks, record instruments such as guitar etc. on other tracks (overdubbing).
3. The VS-880 can simultaneously playback up to 8 tracks. If you wish to simultaneously playback more than 8 tracks, you will need to record two or more tracks onto a different track in order to reduce the data to 8 or fewer tracks (track bouncing).
4. Adjust equalization, pan, and volume level for each track, and mix down to your master recorder.
5. When the procedure is completed, press [PLAY (DISPLAY)] to return to Play condition.

■ Connect the instruments

1. Turn down the master fader of the VS-880, and connect your instrument to the INPUT 1 jack. There are two types of input jacks: INPUT A and B. Connect to the type that matches the connector on your cable.

■ Record a performance onto a track

1. Make sure that the INPUT→TRACK indicator is lit. Whenever this indicator is lit, it means you are in the INPUT→TRACK mode (p. 49). If the indicator is dark, hold down [SHIFT] and press MIXER MODE [SELECT].
2. Use the INPUT SENS 1 knob to adjust the input sensitivity.

Raise the volume of your instrument as high as possible so that the input level is high. Raise the input sensitivity as high as possible without causing the PEAK indicator to light. Try to get it so the level normally moves within the range of -12 to 0 on the level meter.

In INPUT→TRACK mode, the channel faders and MASTER fader affect the output level. This means that even if you move these faders during recording, the recorded sound will not be affected. You may adjust the sound to a volume convenient for listening.

3. Press the channel 1 [STATUS] to make the button indicator blink in red. Track 1/V-track 1 has now been specified for recording. At the default settings for channel 1, INPUT 1 is selected as the input source, so in this case it will not be necessary to select the input source.
4. Press [REC] to make the button indicator blink in red, and press [PLAY] to start recording. If you wish to apply effects as you record, refer to "Recording while an effect is inserted" (p.35)
5. When you finish recording, press [STOP].
6. Listen to the performance that you just recorded. Press channel 1 [STATUS] to make the button indicator light in green (the condition in which a recorded performance can be played back). Press [ZERO] to return to the beginning of the song, and press [PLAY] to start playback.

■ Switching V-tracks

The VS-880 has eight tracks on which music can be recorded and played back. Each of these tracks has eight V-tracks on which music can be recorded. When playing back a song, you can select one V-track for each track. In other words, you can use up to 64 tracks to record a performance, and select up to 8 of these tracks for playback.

In this way, unlike when using a conventional multitrack tape recorder, there is no need for you to erase previously-recorded material. Also, you are free to record different "takes" or variations of the same material to different V-tracks, and switch between V-tracks to compare the performances.

To switch V-tracks, use the following procedure.

1. Press [CH EDIT] for the track whose V-track you wish to switch, and use PARAMETER [◀◀] [▶▶] to get the "V.Track=" display.

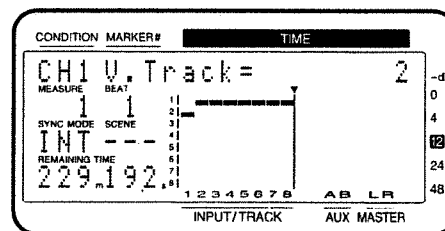

2. Use the TIME/VALUE dial to select a V-track.
3. When the procedure is completed, press [PLAY (DISPLAY)] to return to Play condition.

■ Recording additional tracks while listening to the performance (Overdubbing)

The process of newly recording a track while playing back previously recorded tracks is called "overdubbing." Here we will explain the procedure using the example of playing back a stereo recording that was recorded on tracks 1 and 2, and recording other instruments on tracks 3 and 4. Connect INPUT 3-4 jacks to the instruments that you wish to newly record.

1. Make sure that the mixer mode is set to INPUT→TRACK mode (the INPUT→TRACK indicator is lit). If another mixer mode is selected, hold down [SHIFT] and press [SELECT].
2. Make sure that the track status for tracks 1/2 (the tracks for playback) is set to PLAY (the STATUS indicator is lit green). If the status is not PLAY, press the [STATUS] button for that channel several times.
3. Set the track status for tracks 3/4 (the tracks for recording) to REC (the STATUS indicator is blinking red). For track 3, press [STATUS 3] several times, and for track 4 press [STATUS 4].
4. Select input 3 as the input source for track 3, and input 4 as the input source for track 4. For track 3, press channel 3 [CH EDIT], then press PARAMETER [◀◀] several times until "CH3 Input=" is displayed, and use the TIME/VALUE dial to select "INPUT 3." In the same way, select "INPUT 4" as the input source for track 4.
5. Make pan settings for tracks 3/4. In this example we will be recording tracks 3/4 in stereo, so set the PAN 3 knob fully left (L63), and the PAN 4 knob fully right (R63).
6. While producing sound on the instruments to be recorded, adjust the input levels. Adjust input 3 using the INPUT SENS 3 knob, and input 4 using the INPUT SENS 4 knob.
7. Press [ZERO] to return to the beginning of the song. Then press [REC] to enter record ready mode (the REC indicator blinks red), and press [PLAY] to begin recording.
8. When you finish recording press [STOP].
9. Listen to the recorded result. Press [ZERO] to return to the beginning of the song, and make the channel 3 and 4 STATUS indicators light green. Press [PLAY] to playback.

Input (input select)

This selects the input source of each channel. If Channel Link is on, stereo sources can be selected.

When Channel Link is off:

INPUT 1-4, DIGITAL-L, DIGITAL-R, MIX-L, MIX-R, AUX-A, AUX-B

When Channel Link is on:

INPUT-12, INPUT 34, DIGITAL, MIX, AUX-AB

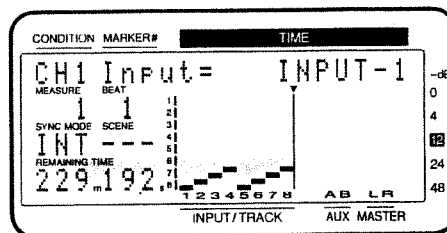

■ Re-recording only your mistakes (Punch-in/out)

Sometimes a recording will contain just one or two sections that were not played correctly, or that you wish to re-record. In such cases, you can use punch-in recording to re-record only a specific area.

"Punch-in" refers to the action of switching from playback mode to record mode. Conversely, "punch-out" refers to the switch back to play mode. In other words, you will punch-in at the beginning of the area that you wish to re-record, and punch-out at the end of the area.

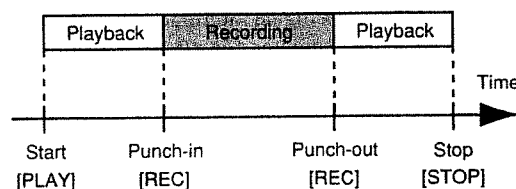

* By using the Undo function (p.112) you can return to the condition before re-recording.

Re-recording manually (Manual punch-in)

In this method, you punch-in and punch-out by pressing a button or a footswitch. When you are both playing the instrument and operating the recorder by yourself, it is usually not practical to reach over and press a button. In such cases, use an optional footswitch.

Using the record button

1. Set the track status to REC for the track that you wish to re-record (the STATUS indicator blinks red).
2. Playback the song from the beginning, and use the INPUT SENS knob to adjust the level of the input source. During song playback, you can press [STATUS] to switch between monitoring the input source and the track. Listen to compare the track to be re-recorded with the input source, and adjust the level so that there is no volume difference.
3. Playback the song from a location slightly before where re-recording will begin.
4. At the point where you wish to re-record, press [REC] to punch-in, and re-record the vocal or instrumental part. To punch-out, press [REC] (or [PLAY]) once again. Each time you press [REC], you will alternately punch-in and punch-out, so if there is another area that you wish to re-record, repeat the same operation.

5. When you finish recording, press [STOP].
6. Check the re-recorded result. After switching the track status of the newly recorded tracks back to PLAY (the STATUS indicator lights green), playback from the beginning of the song.

Using the foot switch

If you wish to use an optional footswitch to punch-in/out, connect the footswitch to the FOOT SWITCH jack. Then use the following procedure to set the function of the FOOT SWITCH jack so that it can be used for punching in/out.

1. Press [SYSTEM]. If a message with a question mark such as "SYS System PRM?" does not appear, press [SYSTEM] once again.
2. Use PARAMETER [◀][▶] to get the "SYS System PRM?" display, and press [YES].
3. Use PARAMETER [◀][▶] to get the "SYS FootSW=" display, and use the TIME/VALUE dial to select "Record."
4. Press [PLAY (DISPLAY)] to return to Play condition.

FootSw (Foot switch assign)

This sets the function of the foot switch connected to the FOOT SWITCH jack.

- Play/Stop: The song will alternately playback and stop each time the foot switch is pressed.
- Record: The foot switch will have the same function as the [REC]. Use this to switch between recording and playback during manual punch-in recording.
- TapMarker: The foot switch will have the same function as the [TAP]. A Mark point will be placed at the time location where you press the foot switch.
- Next: The foot switch will have the same function as the [NEXT]. Each time you press the foot switch, you will move to the next Mark point.
- Previous: The foot switch will have the same function as the [PREVIOUS]. Each time you press the foot switch, you will move to the previous Mark point.
- GPI: A GPI trigger signal received from the FOOT SWITCH jack will control song playback/stop.

< About GPI >

"GPI" stands for "General Purpose Interface." This is a control jack provided on professional and consumer video devices such as video editors and title superimposers. By connecting this control jack to the foot switch jack of the VS-880 and setting the Foot Switch Assign to "GPI," the connected device will be able to playback/stop the VS-880.

■ Specify beforehand the location for re-recording (Auto punch-in)

Auto punch-in recording lets you automatically punch-in and punch-out at previously specified locations. This is convenient when you need to punch-in/out at a precise time, or when you want to punch-in/out automatically so that you can concentrate on your playing.

Specify the location for recording

Before you begin recording, set the times for punch-in and punch-out. There are three ways to set these times. Use the method appropriate for your situation.

Using locate points

1. While holding down [AUTO PUNCH], specify the locate point for the time at which you want to punch-in, and then without releasing [AUTO PUNCH], specify the locate point for the punch-out time.

Using mark points

Adjacent mark points can be used to set the punch-in and punch-out times.

1. Move to the mark point located at the desired punch-in time.
2. While holding down [AUTO PUNCH], press [NEXT], and then without releasing [AUTO PUNCH], press [PREVIOUS].

Specifying the points while the song plays back

1. Playback the song. When you reach the desired punch-in location, hold down [AUTO PUNCH] and press [TAP]. Continue holding down [AUTO PUNCH], wait for the desired punch-out location, and then press [TAP] once again.

Recording procedure

1. For the track to be re-recorded, set the track status to REC (the STATUS indicator blinks red).
2. Use the INPUT SENS knob to adjust the level of the input source. During song playback, you can press [STATUS] to switch between monitoring the input source and the track. Listen to compare the track to be re-recorded with the input source, and adjust the level so that there is no volume difference.
3. If you press [AUTO PUNCH] while the song is stopped, the AUTO PUNCH indicator will light and you will be ready to use auto punch-in recording.
4. Move to a time before the location that you wish to re-record, press [REC] to enter record ready mode, and press [PLAY]. When the specified punch-in location is reached, punch-in will occur automatically, so re-record the vocal or instrumental part. When the specified punch-out location is reached, the channel will automatically return to playback mode.
5. When you finish recording, press [STOP].

6. Check the re-recorded result. After switching the track status of the newly recorded tracks back to PLAY (the STATUS indicator lights green), playback from the beginning of the song.

■ Repeatedly recording over the same area (Loop recording)

The loop function lets you repeatedly playback a specified area (the loop). If the loop function is used for punch-in recording, you will be able to hear the recorded result immediately. If the result is not what you wanted, you can continue re-recording.

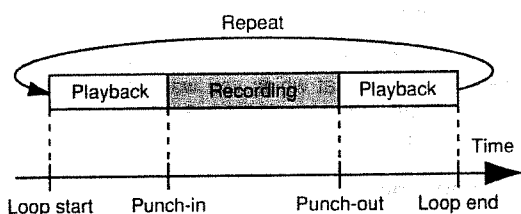

- * To specify the area for re-recording (the punch-in point and punch-out point), refer to the previous section "Auto punch-in."

Specify the area to be repeated

Before you begin recording, specify the begin and end times for the loop. There are three ways to specify the loop times. Use the method appropriate for your situation.

- * Make settings so that the loop completely includes the area to be re-recorded (i.e., from the punch-in point to the punch-out point). If the area to be re-recorded is not completely within the loop, recording may not start at the specified location, or may be interrupted in the middle of the area for recording.

Using locate points

1. While holding down [LOOP], specify the locate point for the time at which you want to begin the loop, and then without releasing [LOOP], specify the locate point for the end of the loop.

Using mark points

Adjacent mark points can be used to set the beginning and end of the loop.

1. Move to the mark point located at the desired time for the beginning of the loop.
2. While holding down [LOOP], press [NEXT], and then without releasing [LOOP], press [PREVIOUS].

Specifying the points while the song plays back

1. Playback the song. When you reach the desired location for the beginning of the loop, hold down [LOOP] and press [TAP]. Continue holding down [LOOP], wait for the desired location for the end of the loop, and then press [TAP] once again.

Recording procedure

1. For the track to be re-recorded, set the track status to REC (the STATUS indicator blinks red).
2. Use the INPUT SENS knob to adjust the level of the input source. During song playback, you can press [STATUS] to switch between monitoring the input source and the track. Listen to compare the track to be re-recorded with the input source, and adjust the level so that there is no volume difference.
3. With playback stopped, press [LOOP] to make the LOOP indicator light. Then press [AUTO PUNCH] to make the AUTO PUNCH indicator light. You are now ready to record.
4. Press [PLAY]. Playback will begin from the current time. When the loop end location is reached, playback will return to the loop start location and continue.
5. If you wish to re-record, press [REC] to begin recording. When [REC] is pressed, recording will occur in the specified area the next time the song is played back. Re-record the new performance. On the next playback, you can hear the newly re-recorded performance. If you are not satisfied, press [REC] and try again.
6. When you finish recording, press [STOP]. Playback the song from the beginning to check the result once again. Press [LOOP] to turn off the LOOP indicator, and press [AUTO PUNCH] to turn off the AUTO PUNCH indicator. After switching the track status of the newly recorded track back to PLAY (the STATUS indicator lights green), playback from the beginning of the song.

■ Combining the performances of two or more tracks into another track (Track bouncing)

The VS-880 can simultaneously playback up to 8 tracks. If you wish to playback the contents of more than 8 tracks, or if you run out of empty tracks, you can merge the contents of two or more tracks onto a different track. This procedure is called “track bouncing.”

In this section, we will give the example of using the MIX buss to mix the contents of two stereo pairs on tracks 1/2 and tracks 3/4 to tracks 5/6.

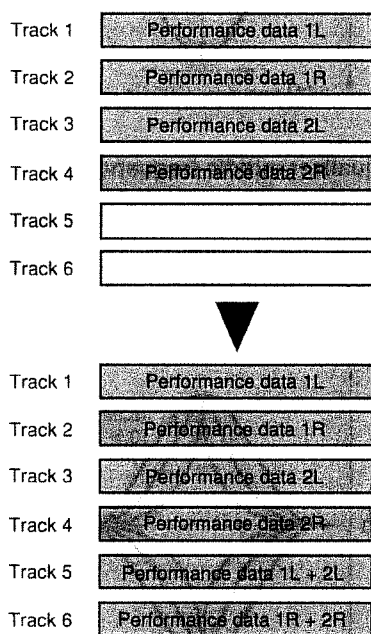

1. Assign the outputs of tracks 1–4 to the MIX buss. Press channel 1 [CH EDIT], and then use PARAMETER [◀◀][▶▶] to get the “CH1 MIX Sw=” display. Use the TIME/VALUE dial to select a setting of “PstFade.” In the same way, set the outputs of tracks 2–4 to “PstFade” as well.
 2. Rotate the PAN 1 and PAN 3 knobs fully left (L63), and the PAN 2 and PAN 4 knobs fully right (R63).
 3. Select the MIX buss as the input source to be recorded for tracks 5 and 6. Press channel 5 [CH EDIT]. Then use PARAMETER [◀◀][▶▶] to get the “CH5 Input=” display. Use the TIME/VALUE dial to select “MIX-L.” In the same way, set the output of track 6 to “MIX-R.”
- * With these settings, it will not be possible to monitor the output of channels 5/6. This is because the output of tracks 5/6 that is routed through the MIX buss is not re-input into tracks 5/6, to avoid creating a feedback loop.

4. Make settings so that the signal of the MIX buss is output from the MASTER OUT jacks. Press [EDIT] in the master section, and use PARAMETER [◀◀][▶▶] to get the “MST Master Mode=” display. Then use the TIME/VALUE dial to select “MIX.”
5. Set the track status of tracks 1–4 to PLAY, and the track status of tracks 5/6 to REC. Playback the song, and use the faders of channels 1–4 to adjust the volume balance. At this time, raise the volume level as far as possible without causing distortion.
6. Return to the beginning of the song, press [REC], and then press [PLAY] to begin recording.
7. When you finish recording, press [STOP].
8. Check the result that was recorded on tracks 5/6. In this example, tracks 1–4 and tracks 5/6 have the same contents, so set the track status of tracks 1–4 to MUTE, and the track status of tracks 5/6 to PLAY.

MIX Sw (mix switch)

This selects how the signal will be sent to the MIX buss. If “Off” is selected, the MIX Level and MIX Pan/MIX Bal parameters will not be available.

- Off: not sent.
- PreFade: The signal before passing through the channel fader will be sent to the MIX buss.
- PstFade: The signal after passing through the channel fader will be sent to the MIX buss.

■ Creating a master tape

When you finish recording the song, adjust the balance of each track (equalizer, pan, and volume level), and record the mix to a two-channel stereo master tape. This process is called “mixdown.”

Adjusting the tone (Equalizer)

A parametric equalizer is provided for each channel. First make equalizer adjustments separately for each channel. If you have recorded any stereo pairs, be sure that the same settings are made for both tracks. Then, while paying attention to the overall balance, make final adjustments for equalizer, pan, and volume level for each channel.

* If you adjust the equalizer while listening to the sound, you may notice a clicking noise. This is not a malfunction. If the noise is objectionable, make adjustments while the sound is not playing.

1. Press [CH EDIT] for the channel whose equalizer setting you wish to adjust.
2. Use PARAMETER [◀◀][▶▶] to step through the parameters that can be set for each channel. Select the equalizer-related parameters, and use the TIME/VALUE dial to modify the value. Use CURSOR [◀][▶] to select the parameter to be adjusted; gain or center frequency (or Q). The bar display will graphically show the equalizer settings.

- EQ Switch: To use the equalizer, first turn this "On." Unless this is "On" you will not be able to select equalizer-related parameters.
- EQ Low: Gain and center frequency for the low range
- EQ Mid: Gain for the middle range
- EQM F: Center frequency and Q (the sharpness of the change) for the middle range
- EQ Hi: Gain and center frequency for the high range

3. Make adjustments for the other channels in the same way. When you finish making settings for all channels, press [PLAY (DISPLAY)] to return to Play condition.

EQ Switch (equalizer switch)

If you wish to use the equalizer, set this "On." If not, set this "Off." When equalizer settings are being made, the equalization curve will be shown graphically in the bar display. If this is "Off" the equalizer-related parameters will not be available.

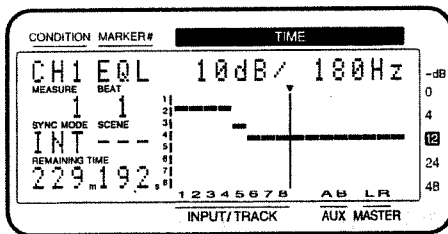

EQL (equalizer low)

This sets the gain (-12-12 dB) and center frequency (40 Hz -1.5 kHz) for the low-range equalizer (shelving type).

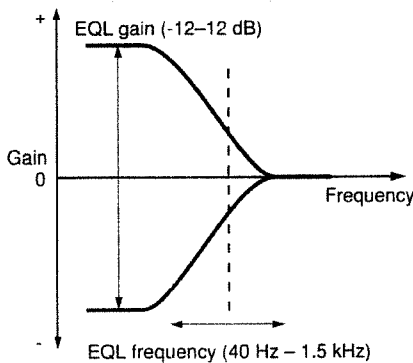

EQM (equalizer middle)

This sets the gain (-12-12 dB) for the middle-range equalizer (peaking type).

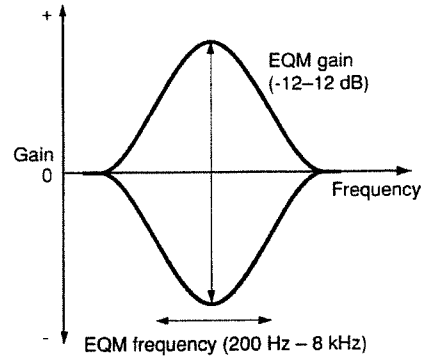

EQM F (equalizer middle frequency / Q)

This sets the center frequency (200 Hz-8 kHz) and the Q (0.5-16) for the middle-range equalizer (peaking type). Q determines the way in which the gain of the frequency range is affected. Higher values will produce a sharper change.

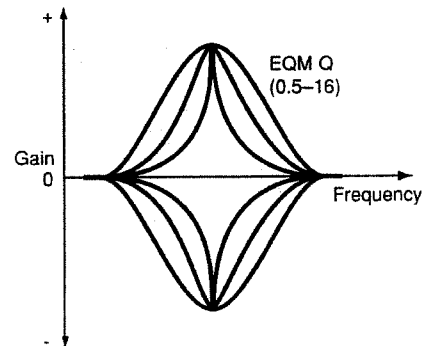

EQH (equalizer high)

This sets gain (-12-12 dB) and center frequency (500 Hz-18 kHz) for the high-range equalizer (shelving type).

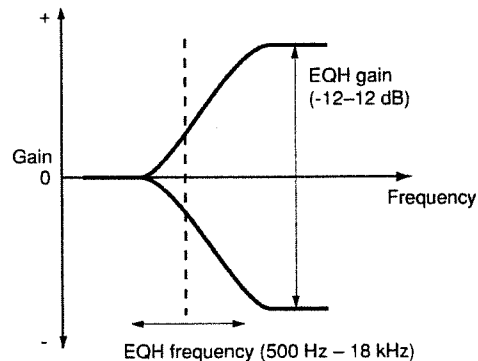

Adjusting the volume and pan (Level/Pan)

You can use the channel faders to adjust the volume level of each track, and the PAN knobs to adjust the pan of each track, but here we will explain how to make adjustments when in Channel Edit condition.

To adjust the volume level of each track, first adjust the volume level for the track containing the most important part of the song (e.g., the vocal or melodic instrument). Then, relative to the volume level of that track, lower the volume levels of other tracks to create the desired balance.

1. Press [CH EDIT] for the channel whose volume level and pan you want to adjust.
2. Use PARAMETER [◀][▶] to step through the parameters that can be set for each channel. Select the desired parameter, and use the TIME/VALUE dial to modify the value.

The bar display will graphically show the volume level and pan settings of each channel.

- MIX Sw: Select "PstFade" so that the channel faders can be used.
- MIX Level: Adjust the volume level.
- MIX Pan: Adjust the pan.

3. In the same way, make adjustments for the other channels as well. When you finish making adjustments for all channels, press [PLAY (DISPLAY)] to return to Play condition.

< About the display >

If you modify the volume levels in Channel Edit condition, the position of the channel faders may not match the actual volume level settings. In this case, an asterisk "*" will be displayed after the displayed position. When the bar display shows the fader position, the current position of the channel fader will blink. The same applies to the pan display.

To make the channel faders match the actual value, move the channel faders to the actual value.

MIX Level

This sets the volume level (0–127) of the signal output to the MIX buss.

MIX Pan

MIX Bal (Mix balance)

On channels for which Channel Link is "Off," this sets the panning (L63–0–R63) of the stereo signal which is output to the MIX buss. A setting of "L63" is full left, "0" is center, and "R63" is full right. On channels for which Channel Link is "On," this sets the left/right volume balance (L63–0–R63) at which the stereo signal of the paired channels is output to the MIX buss.

Applying effects (Loop)

If an optional VS8F-1 effect expansion board is installed in the VS-880, high quality stereo effects will be available for your use.

If a VS8F-1 has been installed in your VS-880, here's how to apply reverb or delay to the entire song.

1. Press [CH EDIT] for the channel to which you wish to apply an effect. The specified channel number will appear in the upper left of the display.
2. Hold down [SHIFT] and press channel 7 [CH EDIT (EFFECT-1)]. The upper line of the display will indicate "EFFECT 1=," allowing you to make effect settings.

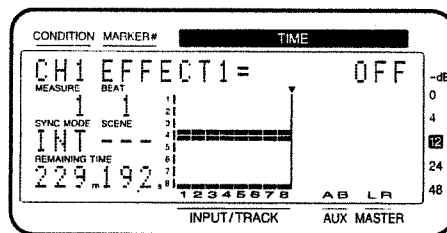

* If the display indicates "No Effect Board," a VS8F-1 has not been installed in your VS-880. If this message is displayed, it will not be possible to make effect settings.

If this message appears even though a VS8F-1 is installed, the VS8F-1 has not been installed correctly. Perform the shutdown procedure (p.75) and turn the power off. Then re-install the VS8F-1 correctly.

- Use the TIME/VALUE dial to select "PstFade."
This will cause effects to be applied. With this selection, the signal flow will be as follows.

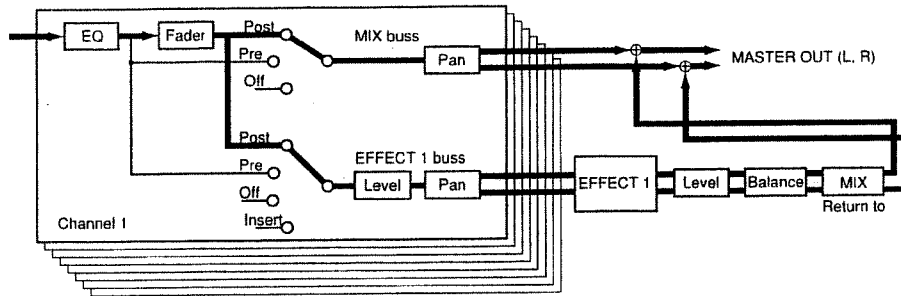

- Adjust the send level (input level) for the effect. Press PARAMETER [▶▶] to get the "EFFECT1 Send" display. Rotate the TIME/VALUE dial to adjust the send level. Play back the song and adjust the volume balance between the direct sound and the sound processed by the effect.
- Press [EFFECT]. In response to the "EFFECT-1 PRM?" message, press [YES]. The number and name of the currently selected effect will appear, allowing you to select the type of effect. If the display shows "EFFECT-2 PRM?," press PARAMETER [◀◀] to get the "EFFECT-1 PRM?" display and then press [YES].

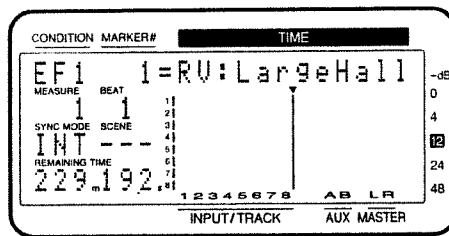

- Use the TIME/VALUE dial to select the type of effect (Patch), and press [YES]. As you rotate the TIME/VALUE dial, the number and name of the displayed effect will change, and will be blinking. When you press [YES], the display will stop blinking, and the effect that is displayed will be selected. Each of the 300 effects is assigned a number A00–A99, B00–B99 and U00–U99. They are referred to as "Patches." A00–A99 and B00–B99 are Preset Patches (which cannot be modified), and U00–U99 are User Patches (whose settings can be modified). At the factory settings, the User Patches contain the same effects as the Preset Patches A00–A99. The contents of the Preset Patches are listed in the included VS8F-1 Preset Patch list sheet. Some of the Preset Patches are of a type which add an effect sound to the original sound (Loop), while others are of a type which modifies the original sound itself (Insert). Since in this example we want to apply an effect to the entire song, select a Loop type effect patch.
- After you have selected an effect patch, press [PLAY (DISPLAY)] to return to Play condition.

Each channel settings

EFFECT 1 (Effect 1 switch)

Specify how the signal is sent to the EFFECT 1 buss.

- Off: The signal will not be sent.
- PreFade: The signal will be taken before the channel fader.
- PstFade: The signal will be taken after the channel fader.
- Insert: The effect will be inserted between the equalizer and fader of the channel.
- InsertL: Insert into the L side of a stereo effect.
- InsertR: Insert into the R side of a stereo effect.
- InsertS: Insert the L side and R side of a stereo effect in series.

* If the effect is inserted in another channel, the value will appear as "—," and cannot be selected.

EFFECT 1 Send (Effect 1 send level)

Specify the volume level (0–127) of the signal that is sent to the EFFECT 1 buss. The default setting is 100.

EFFECT 1 Pan (Effect 1 pan)**EFFECT 1 Bal (Effect 1 balance)**

For channels on which Channel Link is “Off,” this sets the panning (L63–0–R63) of the stereo signal which is output to the EFFECT 1 buss. “L63” is far left, and “R63” is far right. For channels on which Channel Link is “On,” this sets the left/right volume balance (L63–0–R63) of the stereo signal from the paired channels which is output to the EFFECT 1 buss.

The default value is “0” (center).

EFFECT 2 (Effect 2 switch)

Specify how the signal is sent to the EFFECT 2 buss.

- Off: The signal will not be sent.
- PreFade: The signal will be taken before the channel fader.
- PstFade: The signal will be taken after the channel fader.
- Insert: The effect will be inserted between the equalizer and fader of the channel.
- InsertL: Insert into the L side of a stereo effect.
- InsertR: Insert into the R side of a stereo effect.
- InsertS: Insert the L side and R side of a stereo effect in series.

* If the effect is inserted in another channel, the value will appear as “—,” and cannot be selected.

EFFECT 2 Send (Effect 2 send level)

Specify the volume level (0–127) of the signal that is sent to the EFFECT 2 buss. The default setting is 100.

EFFECT 2 Pan (Effect 2 pan)**EFFECT 2 Bal (Effect 2 balance)**

For channels on which Channel Link is “Off,” this sets the panning (L63–0–R63) of the stereo signal which is output to the EFFECT 2 buss. “L63” is far left, and “R63” is far right. For channels on which Channel Link is “On,” this sets the left/right volume balance (L63–0–R63) of the stereo signal from the paired channels which is output to the EFFECT 2 buss.

The default value is “0” (center).

Master block settings**EFF1 INS Sw (Effect 1 insert switch)**

- Off: The effect will not be inserted into the master out (same as Ver.1).
- On: The effect will be inserted into the master out.

EFF1 SND Lev (Effect 1 send level)

Adjust the send level. The default value is 100.

EFF1 SND Bal (Effect 1 send balance)

Adjust the left/right volume balance. The initial value is 0 (center).

EFF1 RTN to (Effect 1 return to)

Select the output destination of effect 1. The busses that can be selected will depend on the current mixer mode.

When in INPUT→TRACK mode

- MIX: the MIX buss (stereo)
- AUX: the AUX buss (stereo)

When in INPUT MIX mode / TRACK MIX mode

- MIX: the MIX buss (stereo)
- 1-2: REC buss 1-2
- 3-4: REC buss 3-4
- 5-6: REC buss 5-6
- 7-8: REC buss 7-8

EFF1 RTN Lev (Effect 1 return level)

Set the output level (0–127) of effect 1.

EFF1 Bal (Effect 1 balance)

Set the left/right volume balance (L63–0–R63) of effect 1.

EFF2 INS Sw (Effect 2 insert switch)

- Off: The effect will not be inserted into the master out (same as Ver.1).
- On: The effect will be inserted into the master out.

EFF2 SND Lev (Effect 2 send level)

Adjust the send level. The default value is 100.

EFF2 SND Bal (Effect 2 send balance)

Adjust the left/right volume balance. The initial value is 0 (center).

EFF2 RTN to (Effect 2 return to)

Select the output destination of effect 2. The busses that can be selected will depend on the current mixer mode.

When in INPUT→TRACK mode

- MIX: the MIX buss (stereo)
- AUX: the AUX buss (stereo)

When in INPUT MIX mode / TRACK MIX mode

- MIX: the MIX buss (stereo)
- 1-2: REC buss 1-2
- 3-4: REC buss 3-4
- 5-6: REC buss 5-6
- 7-8: REC buss 7-8

EFF2 RTN Lev (Effect 2 return level)

Set the output level (0–127) of effect 2.

EFF2 Bal (Effect 2 balance)

Set the left/right volume balance (L63–0–R63) of effect 2.

Recording to tape (Mixdown)

When the balance of the tracks has been completed, use your stereo recorder (cassette tape recorder, DAT recorder, MD recorder, etc.) to create a stereo master tape.

* The digital interface of the VS-880 conforms to S/P DIF. If you wish to record the digital signal, use a digital recorder that is compatible with these standards.

● If you are using a cassette tape

1. Connect the recorder to the VS-880.
Use an RCA phono type cable to connect the input jacks of your recorder to the MASTER OUT jacks of the VS-880.
2. Adjust the recording level of the recorder.
Use the master fader to adjust the output level of the VS-880, setting it as high as possible without overloading the input of the recorder. Set the recording level of the recorder so that the level meters indicate as high as possible without causing distortion.
3. Press [ZERO] on the VS-880 to return to the beginning of the song, and put your recorder in record ready mode.
4. Press [PLAY] on the VS-880, and begin recording on your recorder. If you wish to produce a fade-in or fade-out, use the master fader of the VS-880.
5. When you finish recording, stop the recorder and the VS-880.

● If you are using a DAT

1. Connect the recorder to the VS-880.
Use an RCA phono type coaxial cable to connect the digital input connector (coaxial) of your digital recorder to the DIGITAL OUT connector of the VS-880.
2. If you have connected a digital recorder by a digital connection, make settings on your digital recorder so that it will record from its digital input. Also, set the sample rate of the recorder to match the sample rate at which the song was recorded (44.1 kHz). Many digital recorders automatically sense the sample rate of the recording source, so that it is unnecessary to make this setting manually.

* Some DAT recorders are not able to record a digital signal at a sample rate of 44.1 kHz. In this case, use analog connections instead, and set the digital recorder to record from its analog input.

* If you do not know the song's sample rate and recording mode, Hold down [SHIFT] and press [SONG].
3. Press [ZERO] on the VS-880 to return to the beginning of the song, and put your recorder in record ready mode.
4. Press [PLAY] on the VS-880, and begin recording on your recorder. If you wish to produce a fade-in or fade-out, use the master fader of the VS-880.
5. When you finish recording, stop the recorder and the VS-880.

Digital recording

In order to record the output of a digital audio device such as a CD player, DAT recorder, MD recorder, or DCC recorder directly into the VS-880 as a digital audio signal, you must make the appropriate settings. There are also several points which you must be aware of. This section explains the process from the preparations for recording a digital audio signal to specifying the digital audio signal as the input source. The rest of the recording procedure is the same as when recording an analog signal, and will be omitted from the explanation.

* The digital interface of the VS-880 conforms to S/P DIF. If you wish to record a digital signal, use a digital audio device that is compatible with these standards.

■ Concerning copyright

The law prohibits the unauthorized recording, public performance, broadcast, sale, or distribution etc. of a work (CD recording, video recording, broadcast, etc.) whose copyright is owned by a third party.

The VS-880 does not implement SCMS. This design decision was made with the intent that SCMS should not restrict the creation of original compositions which do not violate copyright law. Roland will take no responsibility for any infringement of copyright that you may commit in using the VS-880.

■ About SCMS

"SCMS" stands for "Serial Copy Management System." This is a function that protects the rights of copyright holders by prohibiting recording via a digital connection for more than two generations. When digital connections are made between digital recorders that implement this function, SCMS data will be recorded along with the audio data. Digital audio data which contains this SCMS data cannot again be recorded via a digital connection.

■ Connecting digital devices

Use a RCA phono type coaxial cable to connect the DIGITAL IN connector of the VS-880 to the digital output connector (coaxial) of your digital audio device.

■ Matching the sampling frequency

In order to record a digital audio signal, the sample rate of the song must be set to match the sample rate of the input source. The song created when a disk drive is initialized will have a sample rate of 44.1 kHz. If the sample rate of the input source is other than 44.1 kHz, create a new song with that sample rate (p.62).

■ Selecting digital input as the source

If you wish to record a digital signal, make the following setting so that the sample rate of the incoming digital audio signal will determine the sample rate of the VS-880's master clock.

* With this setting, the VS-880 will not operate in the following situations; if no external digital device is connected, or if the external digital audio device is turned off, or if the sample rate of the external digital audio device is different than the VS-880's song. If you are not recording from an external digital audio device, set this to "INT".

1. Press [SYSTEM]. If a message with a question mark such as "SYS System PRM?" does not appear, press [SYSTEM] once again.
2. Use PARAMETER [◀▶] to get the "SYS System PRM?" display, and press [YES].
3. Press PARAMETER [◀] to get the "SYS MasterClk=" display, and use the TIME/VALUE dial to select "DIG-ITL."

* If the display indicates "Digital In UnLock," a digital audio signal is not being sent from the external digital audio device, or the sample rate of the external digital audio device differs from the sample rate of the song. Determine the reason for this display and take the appropriate action.

4. Press [PLAY (DISPLAY)] to return to Play condition.

MasterClk (Master clock)

This sets the master clock for the sample rate. When inputting an analog source, select "INT." When inputting a digital source, select "DIGITL." When "DIGITL" is selected, it will not be possible to playback or record a song unless a digital signal is being sent to the DIGITAL IN connector.

INT: The sample rate will be determined by the VS-880's internal clock.

DIGITL: The sample rate will be determined by the digital signal being input from the DIGITAL IN connector.

< Digital recording >

When you set Master Clock to Digital, the VS-880 will operate according to the clock that is transmitted from an external digital audio device. This means that even if an external MIDI device is connected, it will not be possible to synchronize the VS-880 to MTC that is transmitted from the external MIDI device. When recording digitally, the VS-880 must be the master for synchronized operation (p.87).

■ Select an input source

Here we will explain how to select an input source, using the example of recording a digital signal on tracks 1/2.

1. Specify the DIGITAL IN connector as the input source. For track 1, press channel 1 [CH EDIT] and then use PARAMETER [◀▶] to get the "CH1 Input=" display. Use the TIME/VALUE dial to select "DIGITAL-L." In the same way, select "DIGITAL-R" for track 2.

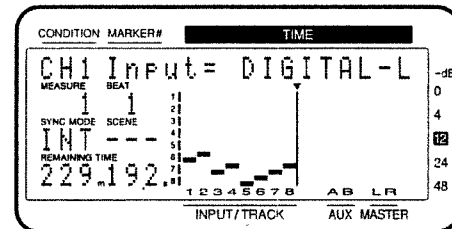

■ When digital recording is not possible ...

- Is the digital audio device connected correctly?
- Is a digital signal being output from the digital out connector of the digital audio device?
- Does the sample rate of the song match the sample rate of the digital audio device?
- Are you using Vari-pitch?
- Is the VS-880 operating as a slave to MTC from an external sequencer?

Turn off the Vari-pitch function

The VS-880 has a Vari-pitch function (p.111) that allows you to change the playback pitch of the song. Although the audible result is that the pitch is being changed, in actuality, the sample rate is being modified. This means that if you are using the Vari-pitch function, the sample rate will not match the input source, and digital signals cannot be recorded. Before recording, make sure that the VARI PITCH indicator is dark. If it is lit, press [VARI PITCH].

VariPitch

This sets the playback pitch when the Vari-pitch function is used. The value is displayed as a sample rate. Make vari-pitch settings while actually listening to the song playback.

* Although the audible result of Vari-pitch is that the pitch is being changed, in actuality, the sample rate is being modified. This means that you cannot use Vari-pitch while recording digital audio signals to a digital audio device. If this is set to other than the standard pitch, digital recording will not be possible.

Before you finish operations

■ Saving the performance to disk (Song Store)

Song data that you recorded or edited will be lost if you simply turn the power off. You must be sure to use the Shutdown procedure before turning the power off, so that the data will be saved onto the disk drive. When you switch songs or change the current drive, a message will ask you to confirm whether the song should be saved.

If you wish to save the currently selected song data to a disk drive separately from these operations, use the following procedure.

* It is not possible to recover lost song data. When handling important song data, or when using the VS-880 for an extended session, we recommend that you save song data frequently.

1. Hold down [SHIFT] and press [STORE (ZERO)].
2. A message will ask "STORE OK?" If you wish to store the song data, press [YES]. When the song has been stored, you will return to the previous condition.

■ Preventing accidental erasure of your performance (Song Protect)

Even if you have stored your performance to disk, it is still possible that the performance can be lost by being accidentally recorded over or deleted. To prevent such accidents, you can protect the performance from accidental erasure (Song Protect).

Protecting a performance

1. Press [SONG] several times until "SNG Song Name/Prtct?" appears.
2. Press [YES].
The name of the song (Song Name) will appear.
3. Press PARAMETER[▶▶].
The display will indicate "SNG ChangePrtct→On".

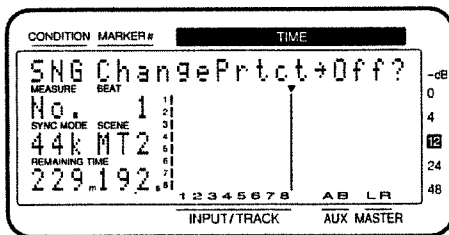

4. Press [YES].
You can press [NO] to cancel Song Protect.
5. The display will indicate "STORE Current?" If you wish to store the current song and then protect it, press [YES].
If you do not wish to store the current song, but prefer to protect the song in the condition in which it was when Song Store was last executed, press [NO].

6. The song will be protected.
The display will indicate "SNG Complete" and you will return to Play condition.

Removing protection from a performance

1. Press [SONG] several times until "SNG Song Name/Prtct?" appears.
2. Press [YES].
The name of the song (Song Name) will appear.
3. Press PARAMETER[▶▶].
The display will indicate "SNG ChangePrtct→Off?".

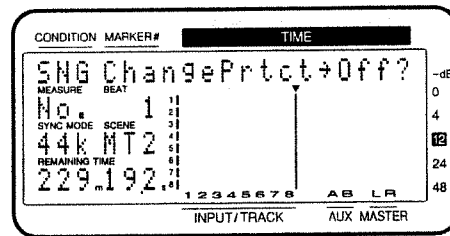

4. Press [YES].
You can press [NO] to cancel the removal of Protect (i.e., it will remain protected).
5. Protect will be turned off for the song.
The display will indicate "SNG Complete" and you will return to Play condition.

< Song Protect >
This function corresponds to the write protect switch of a floppy disk or magneto-optical disk. This means that even if the protect switch is on, it will be possible to perform that shown as below.

- Track Edit
- Locate Point
- Mark Point
- Scene
- Auto Mix

However if you attempt to save the results, the display will indicate "Err SONG Protected."

* When turn the Song Protect ON, the display in the CONDITION field will be indicate "Ply."

■ Selecting a song (Song Select)

This selects a different song that was saved on the current drive (the currently selected disk drive).

If you wish to select a song that was saved on another disk drive, first switch the current drive (p.93).

1. Press [SONG], select "SNG Song Select?," and press [YES].
2. The names of the songs saved on the current drive will be displayed. Select a song and execute.
An asterisk "*" will be displayed at the beginning of the currently selected song. The sample rate of the song will be displayed in the SYNC MODE field, and the recording mode of the song will be displayed in the SCENE field.

■ Turning the power off (Shut Down)

The recorded performance will be lost if you simply turn the power off. In order to turn the power off safely, you must first make sure that the performance has been saved to hard disk, and that the hard disk heads are parked. This procedure is referred to as Shutdown. Before turning off the power, perform the following shutdown procedure.

* If you turn off the power without performing the shutdown operation, the data may not be saved correctly, or the hard disk may be damaged.

1. While holding down [SHIFT], press [SHUT/EJECT (STOP)].
The upper line of the display will indicate "SHUT/EJECT?."
2. Press [YES]. (To cancel, press [NO].)
The display indicate "STORE Current?."
3. If you wish to save the current song, press [YES]. If you do not wish to save it, press [NO]. If you have selected the demo song, press [NO].
When shut down is complete, the display will indicate "PowerOFF/RESTART."
4. Turn off the VS-880 power.

* The disk platter inside a hard disk will continue to rotate for a time by its momentum after the power is turned off. If a physical shock is applied to the unit during this time, the hard disk may be damaged. Avoid moving the unit for about 30 seconds after turning the power off.

If the display asks "STORE Current?"

When you execute an operation such as creating a new song, selecting a different song, or song copy on the VS-880, a confirmation message of "STORE Current?" will appear. This is asking you whether you wish to store the currently selected song to the disk drive.

If you wish to store the currently selected song and then execute the operation, press [YES]. If you wish to execute the operation without saving the current song, press [NO].

If the Song Protect setting of the song is ON, pressing [YES] will cause a message of "Song Protected" to be displayed briefly. Then, without executing the operation, the VS-880 will return to the status it was in before execution was attempted. Song Protect is a setting which can be made for each song, to prevent accidental rewriting of a song stored on the disk drive.

If you wish to execute the operation without saving the currently selected song, repeat the procedure once again, and press [NO] in reply to the "STORE Current?" message. If you wish to save the currently selected song and then execute the operation, turn Song Protect OFF (p.74).

Re-starting the VS-880

To restart the VS-880 without turning off the power, use the following procedure.

1. Execute the shut-down procedure.
2. The display will indicate "PowerOFF/RESTART," so hold down [SHIFT] and press [RESTART (PLAY)].

Chapter 4 Editing a recorded performance (track editing)

This chapter explains the content and procedures for editing sound that has been recorded. Please read this chapter to gain an understanding of the concepts of "editing" that were impractical with conventional tape MTR units.

What is editing?

One of the most important features of digital disk recorders is that they allow re-recording and editing that does not affect the sound quality.

On a multi-track analog tape recorder, it is necessary to erase a previously made recording in order to modify it. Also if you wish to change the organization of a song, you must re-record it from the beginning. This type of editing which re-writes the original data is known as "destructive editing."

In contrast, multi-track digital disk recorders allow you to use an Undo function to cancel the editing operation and return to the data as it was before editing. Furthermore, since copying data has negligible effect on the sound, you can copy the original data before editing and save it. It is also easy to copy parts of the data to different locations, or to erase specified portions of the data. Editing of this type which allows the original data to be recovered is known as "non-destructive editing."

Finding a desired location (Preview)

When editing a song, you will often need to determine precise times such as where the sound begins, the beginning of a break, or the area for auto punch-in recording, etc. On the VS-880 you can use the Preview function to find precise time locations.

The Preview function has three buttons, each with a different operation. Use the one appropriate for your situation.

■ Using [TO] and [FROM]

The [TO] and [FROM] buttons let you playback a specified area of time (1.0-10.0 sec) before and after the current time. By using this function as you gradually move the area, you can accurately determine the desired time.

Each button performs the following function. The preview length is initially set to 1.0 seconds, but you may change this as necessary.

- [TO]: The preview length length ending at the current time will playback once.
- [FROM]: The preview length length beginning at the current time will playback once.
- [TO]+[FROM]: Through the current time, playback one time for double the Preview Length

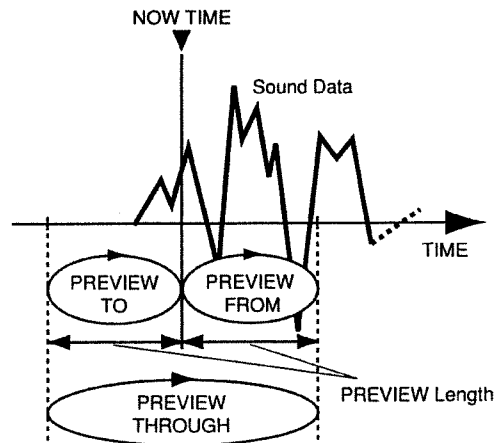

Finding the location where the sound begins (example)

1. Make settings so that the track(s) you wish to monitor will playback, start the song playing back, and stop at the time where the sound begins.
2. First press [TO] or [FROM] to playback the recorded before and after the current time, to determine whether the beginning of the sound is earlier or later than the current time. Next, move the current time until you can hear a bit of the beginning of the sound when you press [TO]. Finally, move the current time until the sound begins precisely when you press [FROM].
3. When you find the precise location where the sound begins, place a mark point at the current time or store the current time in a locate point so that you will be able to easily find it later.

Adjusting the preview length

1. Hold down [SHIFT] and press either [TO] or [FROM] to adjust the preview length. While pressing [TO] or [FROM] to check the actual playback time, use the TIME/VALUE dial to adjust the time.
2. When you finish making settings, press [PLAY (DISPLAY)] to return to Play condition.

PreviewLen (Preview length)

This sets the time length (1.0-10.0 sec) that is played back when the [TO] or [FROM] button of the Preview function is pressed.

■ Scrub playback ([SCRUB])

Press [SCRUB] when you wish to determine more accurately the location where sound begins. Similarly to [TO] and [FROM], [SCRUB] lets you playback a specified area before and after the current time. To select whether the area before or the area after the current time will be played back, press [TO] or [FROM].

When you press [SCRUB] the button indicator will light, and the specified area will be played back repeatedly. When you are finished, press [SCRUB] once again to make the button indicator go dark.

Only the single track that is specified will be played back. If you wish to playback other tracks, press the [SEL (CH EDIT)] button of that track to select it. The playback time (25–100 msec) is shorter than when [TO] and [FROM] are used. The initial value of 45 msec, but you may change this as necessary.

The waveform of the sound being played back is displayed in the bar display, providing a visual check.

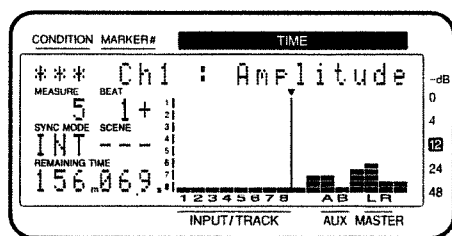

Finding the location where sound begins (example)

1. Press [SCRUB] to make the button indicator light, and the specified area will be played back repeatedly. To select whether the area before or the area after the current time will be played back, press [TO] or [FROM].
2. Use [SEL (CH EDIT)] to select the track that you wish to check.
3. If you are playing back the area before the current time, adjust the time so that you just miss hearing the sound. If you are playing back the area following the current time, adjust the time so that you hear the very beginning of the sound.
4. When you have found the precise location where the sound begins, press [SCRUB] once again to end the procedure. Also, place a mark point at the current time or store the current time in a locate point so that you will be able to easily find it later.

Adjusting the scrub length

1. Hold down [SHIFT] and press [SCRUB], and you will be able to adjust the scrub length. Press [SCRUB] once again to hear the actual playback area, and use the TIME/VALUE dial to adjust the setting.
2. When you finish, press [PLAY (DISPLAY)] to return to Play condition.

Scrub Len (Scrub length)

This sets the time length (25–100 ms) that is played back when the Preview function [SCRUB] button is pressed.

Basic procedure

Here is the basic procedure for Track Edit condition. In the explanations which follow, this basic procedure will be abbreviated.

1. If you are performing a Copy/Move/Exchange operation, select the V-track that contains the source data, so that that data can be played back.
2. Press [TRACK], and the Track Edit condition functions will appear in the upper line of the display. Use [TRACK] or PARAMETER [◀] [▶] to select the desired function, and press [YES].
3. First you will select the track and V-track to which the operation will apply. To select a track, press the [SEL (CH EDIT)] button for that track. To select a V-track, use the TIME/VALUE dial.

If you are performing a Copy/Move/Exchange operation, specify both the source track and the destination track. To do this, use CURSOR [◀] [▶] to make the blinking area to a selection, and specify the desired track. For the various operations of Track Edit condition, you can execute an operation with the same settings for two or more tracks.

When selecting tracks, tracks which contain playback data will be shown in the bar display. The numbers in the horizontal axis are track numbers, and the numbers in the vertical axis are V-track numbers. Track areas that contain playback data will be lit. Tracks which are selected for modification will blink.

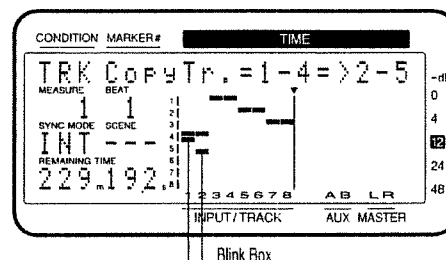

4. Press PARAMETER [▶] to step through the items, and use the TIME/VALUE dial to make settings for each one. To return to a previous item, press PARAMETER [◀].

In items that require you to specify a time, you can do so by selecting a Mark point or a Locate point, or by using the operations explained in “Changing the current time” (p.56).

To addition the playback before and after the point, use the Preview function (p.76).

5. As you press PARAMETER [▶▶] to step through the settings, a message will appear at the end, asking you to confirm execution. If you wish to execute, press [YES]. A re-confirmation message will blink, so press [YES] once again to execute. When execution is complete, you will return to Play condition. To cancel execution, press [NO]. You will return to the previous condition.
- * If after hearing the results of the operation you wish to return to the original data, use the Undo function (p.112).

< About the bar display >

When tracks are being selected, the bar display will indicate the status of track selection. At this time, you can view the play list in the bar display by holding down [SHIFT] and pressing [PLAY (DISPLAY)]. To return to the previous display, once again hold down [SHIFT] and press [PLAY (DISPLAY)].

When an item requiring a time setting is selected, the bar display will show the play list. At this time, you can view the amplitude profile and the track selection status by holding down [SHIFT] and pressing [PLAY (DISPLAY)]. The amplitude profile lets you view the waveform recorded in the selected track. Use the [(SEL) CH EDIT] buttons to select the track whose amplitude profile will be displayed.

Re-using part of the performance (Copy)

This operation copies the playback data of a specified area to another location. This operation lets you copy the data of two or more tracks at once, or copy the specified data to a specified location two or more times in succession. When you wish to use a phrase that is recorded in a track, or when a song contains a phrase that is repeated, the Copy operation will let you create the song more efficiently.

Normally, the data will be copied starting at the specified copy destination time. However it is also possible to specify the copy destination time as a base time at which a specific sound occurs. This is done using the "Frm (From)" setting item.

For example suppose that you wish to copy a sound effect of a time bomb ticking and then exploding, and that you want to place the explosion at a specific timing location. Normally, you would have to calculate the time until the explosion in order to specify the copy destination time. However in such cases, you can specify "From" as "the copy source time at which the explosion begins," and specify "To" (the base time of the copy destination) as "the copy destination time at which you want the explosion to occur." This lets you copy the data with the explosion placed at precisely the right timing.

Example 1: Copying twice to the same track

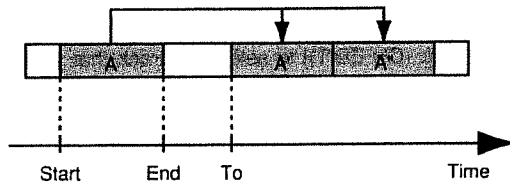

Example 2: Copying twice to a different track

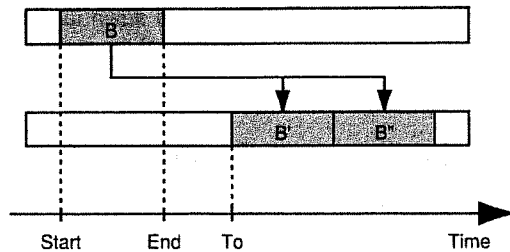

Example 3: Copying using the "Frm" setting

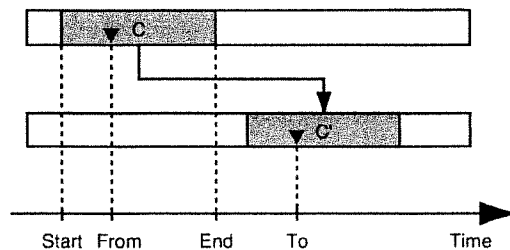

- * If playback data exists at the copy destination, that data will be overwritten.
 - * Playback data of a channel for which Channel Link is ON cannot be copied to a track whose channel has a Channel Link setting of OFF. Nor is the converse possible.
 - * The length of the data to be copied must be greater than 0.5 seconds. If data shorter than 0.5 seconds is copied, the sound will not playback.
1. Select the V-track that contains the copy source playback data, and prepare that data for playback.
 2. Press [TRACK], select "TRK Track Copy?," and press [YES]. The display will let you select the copy source track, and the copy destination track and V-track.

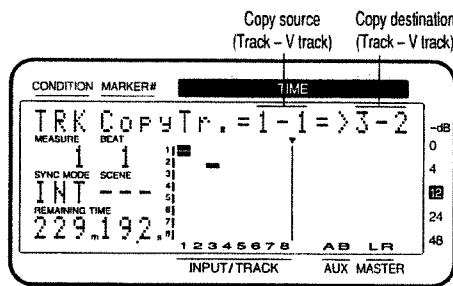

3. Use [SEL (CH EDIT)] to select the copy source track. When the copy source track is selected, the V-track selected for that channel will be the copy source V-track. Next, press CURSOR [▶] to make the copy destination field blink, use [SEL (CH EDIT)] to select the copy destination track, and use the TIME/VALUE dial to select the copy destination V-track

If you wish to perform a copy operation with the same settings for other tracks, select the copy source and copy destination tracks, and press CURSOR [▶] once again. Now you can specify the new copy source and copy destination tracks. In this case, it will not be possible to select copy destination tracks that have already been selected as copy source tracks.

If you wish to cancel the copy operation for a track, use PARAMETER [◀◀ || ▶▶] to display the settings for that track, and press [CANCEL (NO)] twice.

4. Set the following items, and execute the copy operation.
 - St (start point): Specify the starting time of the copy source playback data.
 - End (end point): Specify the ending time of the copy source playback data.
 - Frm (from point): Specify the time of the copy source playback data that will correspond to the To point. Normally you will set this to be the same as the Start point.
 - To (to point): Specify the base time of the copy destination.
 - Copy Time: Specify the number of copies (1-99).

< An easy way to specify the time settings >
 Times for the Start point, From point, End point, and To point can be specified directly without having to display the Track Copy page. In Play condition, use the following procedure.

1. Move to the beginning (Start point) of the copy source performance data.
2. Hold down [TRACK] and press [LOC1/5].
3. Move to the time location in the destination to which the performance data will be copied (From point).
4. Hold down [TRACK] and press [LOC2/6].
5. Move to the end location of the copy source performance data (End point).
6. Hold down [TRACK] and press [LOC3/7].
7. Move to the basic time of the copy destination (To point).
8. Hold down [TRACK] and press [LOC4/8].

If you now access the Track Copy page, the times that were specified in steps 1-8 will be input as the time settings for the respective points.

Modifying the organization of the performance (Move)

This operation moves the playback data of the specified area to another location. This can be used to correct skewed timing that occurred during recording. This operation can move the timing of two or more tracks of playback data at once.

Normally when moving playback data, the data will be moved so that it begins at the move destination timing. However it is also possible to move the data relative to a location within the data at which a specific sound occurs. To do so, use the "Frm (From)" setting.

For example suppose that you wish to move a sound effect of a time bomb ticking and then exploding, so that the explosion occurs at a specific timing location. Normally, you would have to calculate the time until the explosion in order to specify the move destination time. However in such cases, you can specify "From" as "the move source time at which the explosion begins," and specify "To" (the base time of the move destination) as "the move destination time at which you want the explosion to occur." This lets you move the data with the explosion placed at precisely the right timing.

Example 1: Moving within the same track

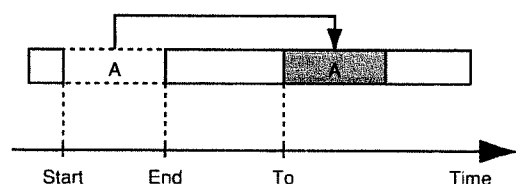

Example 2: Moving to a different track

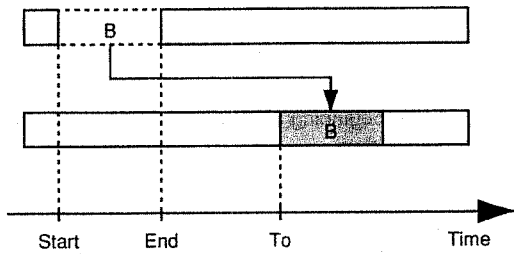

Example 3: Moving using the "Frm" setting

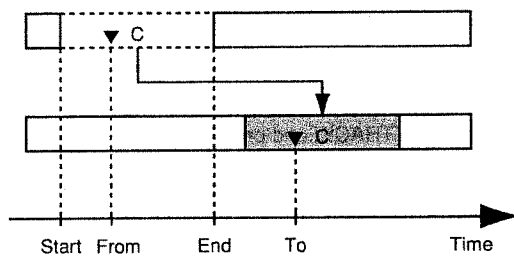

- * If playback data exists at the move destination, that data will be overwritten.
- * Playback data of a channel for which Channel Link is ON cannot be moved to a track whose channel has a Channel Link setting of OFF. Nor is the converse possible.
- * The length of the data to be moved must be greater than 0.5 seconds. If data shorter than 0.5 seconds is moved, the sound will not playback.
- * Do not leave sound within 0.5 seconds before or after the section of data that is moved. Any sound which was within 0.5 seconds of the moved data will not playback.

1. Select the V-track that contains the move source playback data, and prepare that data for playback.
2. Press [TRACK], select "TRK Track Move?," and press [YES]. The display will let you select the move source track, and the move destination track and V-track.

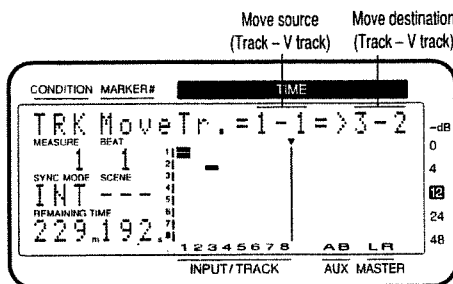

3. Use [SEL (CH EDIT)] to select the move source track. When the move source track is selected, the V-track selected for that channel will be the move source V-track. Next, press CURSOR [▶] to make the move destination field blink, use [SEL (CH EDIT)] to select the move destination track, and use the TIME/VALUE dial to select the move destination V-track.

If you wish to perform a move operation with the same settings for other tracks, select the move source and move destination tracks, and press CURSOR [▶] once again. Now you can specify the new move source and move destination tracks. In this case, it will not be possible to select move destination tracks that have already been selected as move source tracks.

If you wish to cancel the move operation for a track, use PARAMETER [◀◀ || ▶▶] to display the settings for that track, and press [CANCEL (NO)] twice.

4. Set the following items, and execute the copy operation.
 - St (start point): Specify the starting time of the move source playback data.
 - End (end point): Specify the ending time of the move source playback data.
 - Frm (from point): Specify the time of the move source playback data that will correspond to the To point. Normally you will set this to be the same as the Start point.
 - To (to point): Specify the base time of the move destination.

< An easy way to specify the time settings >
 Times for the Start point, From point, End point and To point can be specified directly without having to display the Track Move page. In Play condition, use the following procedure.

1. Move to the beginning (Start point) of the move source performance data.
2. Hold down [TRACK] and press [LOC1/5].
3. Move to the time location in the destination to which the performance data will be moved (From point).
4. Hold down [TRACK] and press [LOC2/6].
5. Move to the end location of the performance data that is being moved (End point).
6. Hold down [TRACK] and press [LOC3/7].
7. Move to the basic time of the move destination (To point).
8. Hold down [TRACK] and press [LOC4/8].

If you now access the Track Move page, the times that were specified in steps 1-8 will be input as the time settings for the respective points.

Erasing part of a performance (Erase)

This operation erases playback data from the specified area. If this operation is used to erase playback data, even if playback data exists after the area that was erased, it will not be moved forward. To use the analogy of a tape recorder, this operation is like recording silence over an unwanted section of the tape.

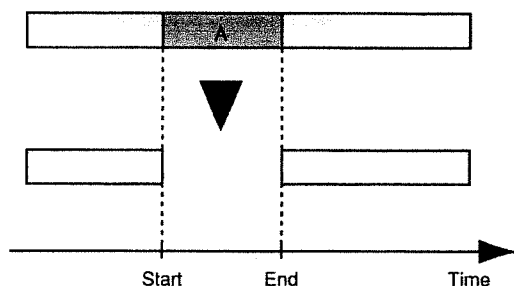

* Do not leave sound within 0.5 seconds before or after the area to be erased. Any sound which was within 0.5 seconds of the erased data will not playback.

1. Press [TRACK], select "TRK Track Erase?," and press [YES]. The display will allow you to select the track and V-track from which playback data will be erased.

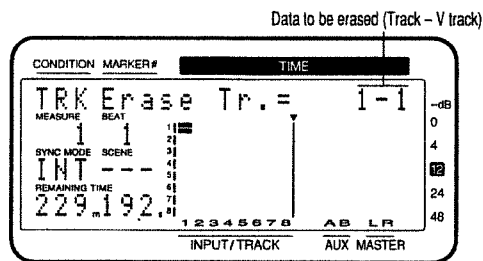

2. Use [SEL (CH EDIT)] to select the track from which data will be erased, and use the TIME/VALUE dial to select the V-track.

If you wish to execute the Track Erase operation with the same settings for other tracks as well, press [SEL (CH EDIT)] for the additional tracks that you wish to erase, and use the TIME/VALUE dial to specify the V-track that you wish to erase. If you wish to cancel the erase operation for a track, use PARAMETER [<<< || >>>] to display the setting of that track, and press [CANCEL (NO)].

If you wish to select all V-tracks of a specified track, use the TIME/VALUE dial to select "*". If you wish to select all V-tracks of all tracks, select "* - *".

3. Make settings for the following items, and execute the track erase operation.

St (start point): Specify the time location at which the data to be erased begins.

End (end point): Specify the time location at which the data to be erased ends.

< An easy way to specify the time settings >

Times for the Start point and End point can be specified directly without having to display the Track Erase page. In Play condition, use the following procedure.

1. Move to the beginning (Start point) of the performance data that you wish to erase.
2. Hold down [TRACK] and press [LOC1/5].
3. Move to the end of the performance data that you wish to erase (End point).
4. Hold down [TRACK] and press [LOC3/7].

If you now access the Track Erase page, the times that were specified in steps 1-4 will be input as the time settings for the respective points.

Exchanging performance data between tracks (Exchange)

This operation exchanges the playback data of two tracks.

Example: Exchanging tracks 1 and 2

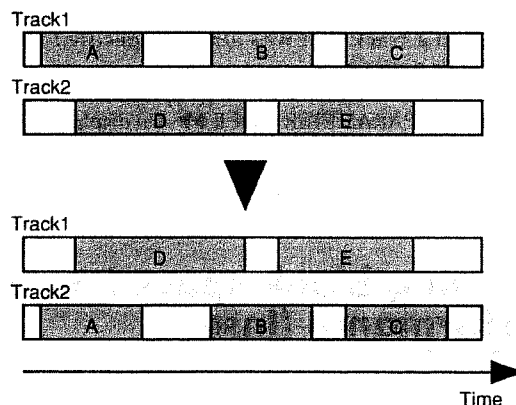

* Playback data of a channel for which Channel Link is ON cannot be exchanged with a playback data whose channel has a Channel Link setting of OFF. Nor is the converse possible.

1. Select one of the V-tracks that you wish to exchange, and prepare that data for playback.
2. Press [TRACK], select "TRK Track Exchange?", and press [YES]. The display will let you select the exchange source track and the exchange destination track and V-track.

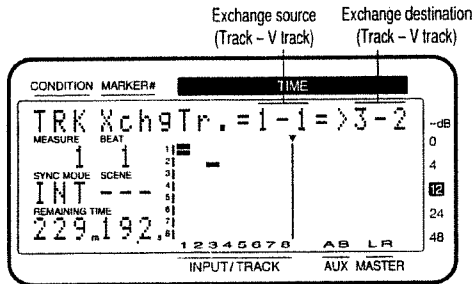

3. Use [SEL (CH EDIT)] to select the exchange source track. When you select the exchange source track, the V-track selected for that channel will be selected as the exchange source V-track. Next, press CURSOR [▶] to make the exchange destination blink, use [SEL (CH EDIT)] to select the exchange destination track, and use the TIME/VALUE dial to select the exchange destination V-track.

If you wish to execute the Track Exchange operation with the same settings for other tracks as well, select the exchange source and exchange destination tracks, and then press CURSOR [▶] once again. You will be able to specify a new set of tracks to be exchanged. In this case, it is not possible to set the exchange destination track to a track that was already specified as an exchange source track.

If you wish to cancel the exchange operation for certain tracks, use PARAMETER [◀◀][▶▶] to display the settings for those tracks, and press [CANCEL (NO)] twice.

4. Execute the track exchange operation.

Inserting blank space into a performance (Insert)

This operation inserts blank space at the specified location. When you wish to add a phrase into the playback data, you can insert a blank of the appropriate length, and then record the phrase into the blank area.

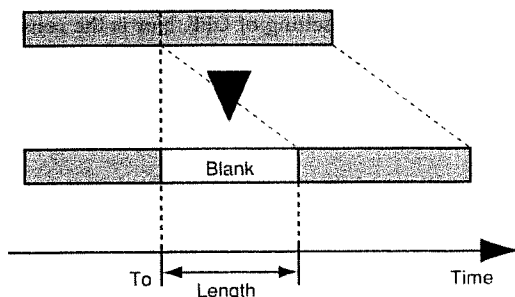

* Do not leave sound within 0.5 seconds before or after the area into which the data will be inserted. Any sound which was within 0.5 seconds of the inserted data will not playback.

1. Press [TRACK], select "TRK Insert?", and press [YES]. The display will let you select the track and V-track into which the blank will be inserted.

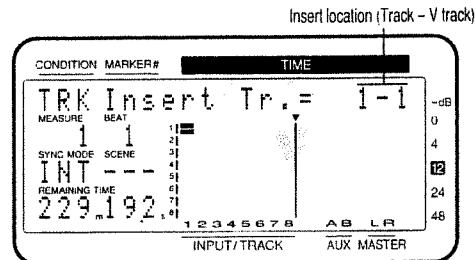

2. Use [SEL (CH EDIT)] to select the insert destination track, and use the TIME/VALUE dial to select the insert destination V-track.

If you wish to execute the Track Insert operation with the same settings for other tracks as well, press [SEL (CH EDIT)] for the additional tracks that you wish to insert, and use the TIME/VALUE dial to specify the insert destination V-track. If you wish to cancel the insert operation for a track, use PARAMETER [◀◀][▶▶] to display the setting of that track, and press [CANCEL (NO)]. If you wish to insert a blank into all V-tracks of the specified track, use the TIME/VALUE dial to select "****". If you wish to insert a blank into all V-tracks of all tracks, select "*-***".

3. Make settings for the following items, and execute the track insert operation.

To (to point): Specify the time location at which the blank will be inserted.

Len (length): Specify the time length of the blank.

< An easy way to specify the time settings >
 The time for the To point can be specified directly without having to display the Track Insert page. In Play condition, use the following procedure.

1. Move to the time location into which you wish to insert the blank (To point).
2. Hold down [TRACK] and press [LOC4/8].

If you now access the Track Erase page, the time that was specified in steps 1-2 will be input as the time setting for the To point. Just specify the length of the blank (Length), and execute Track Erase.

Deleting a portion of a performance (Cut)

This operation cuts playback data from the specified area. When playback data is cut using this operation, any playback data following the data that was cut will move forward to fill the gap. To use the analogy of a tape recorder, this operation is like cutting an unwanted portion out of an audio tape, and splicing the ends.

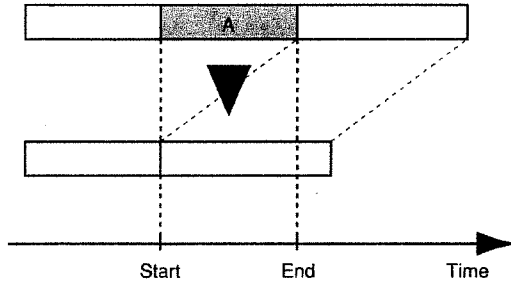

* Do not leave sound within 0.5 seconds before or after the area to be cut. Any sound which was within 0.5 seconds of the cut data will not playback.

1. Press [TRACK], select "TRK Cut?", and press [YES]. The display will let you select the track and V-track from which playback data will be cut.

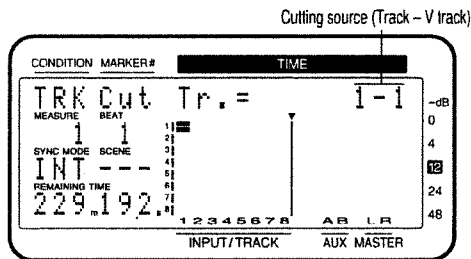

2. Use [SEL (CH EDIT)] to select the track from which data will be cut, and use the TIME/VALUE dial to select the V-track from which data will be cut.

If you wish to execute the Track Cut operation with the same settings for other tracks as well, press [SEL (CH EDIT)] for the additional tracks that you wish to cut, and use the TIME/VALUE dial to specify the V-track that you wish to cut. If you wish to cancel the cut operation for a track, use PARAMETER [◀◀][▶▶] to display the setting of that track, and press [CANCEL (NO)].

If you wish to cut data from all V-tracks of the specified track, use the TIME/VALUE dial to select "*". If you wish to cut data from all V-tracks of all tracks, select "*-*".

3. Make settings for the following items, and execute the track cut operation.

St (starting point): Specify the starting time location of the data which is to be cut.
 End (end point): Specify the ending time location of the data which is to be cut.

< An easy way to specify the time settings >

Times for the Start point and End point can be specified directly without having to display the Track Cut page. In Play condition, use the following procedure.

1. Move to the beginning of the area that you wish to delete (Start point).
2. Hold down [TRACK] and press [LOC1/5].
3. Move to the end of the area that you wish to delete (End point).
4. Hold down [TRACK] and press [LOC3/7].

If you now access the Track Cut page, the times that were specified in steps 1-4 will be input as the time settings for the respective points.

Modifying the playback time of the performance (Time compression/expansion)

This operation allows you to expand or compress the playback time of a song to the specified time length. You can specify a compression/expansion of 75–125%, but extreme settings will produce a more adverse effect on the sound quality. We recommend that you normally keep compression/expansion within a range of 93–107%.

Usually when playback time is compressed or expanded, the playback pitch is affected correspondingly. For example if the playback time is halved, the playback pitch will rise one octave. On the VS-880, you can select whether the playback pitch will change in correspondence to the compression/expansion ratio, or whether the original playback pitch will be preserved.

- * Time Compression/Expansion creates a new song with a different playback time. For this reason, it will not be possible to execute it if the current drive does not have sufficient space.
- * It is not possible to make settings where the times from the Start Point to the End Point or from the Start Point to the To Point are less than 0.5 seconds.
- * When compressing the data, do not compress it to a time length of 0.5 seconds or shorter. If it is compressed to 0.5 seconds or less, it will not be played.

Example 1: Compression

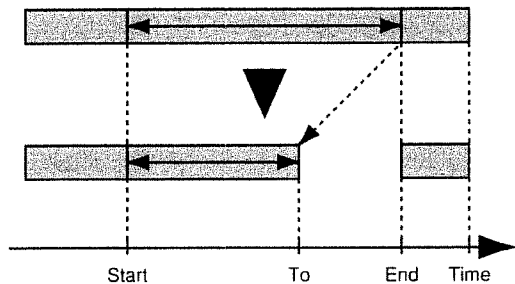

Example 2: Expansion

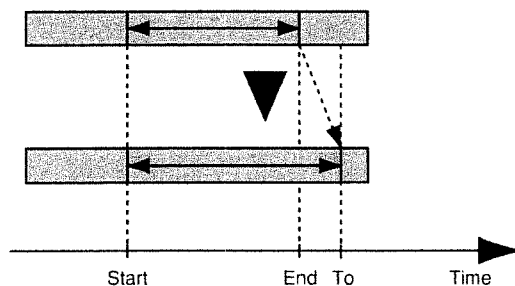

1. Press [TRACK], select "TRK Time Comp/Exp.?", and press [YES]. The display will let you select the track and V-track to which the operation will apply.

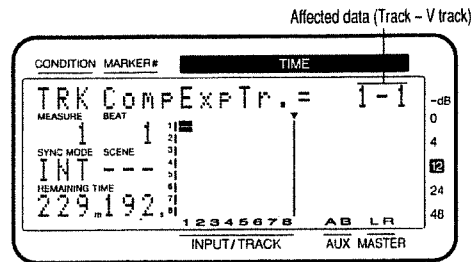

2. Use [SEL (CH EDIT)] to select the track to be affected, and use the TIME/VALUE dial to select the V-track. If you wish to select all V-tracks of the selected track, use the TIME/VALUE dial to select "* - *".

If you wish to execute the Time Compression/Expansion operation with the same settings for other tracks as well, press [SEL (CH EDIT)] for the additional tracks that you wish to compress or expand, and use the TIME/VALUE dial to specify the V-track that will be compressed or expanded. If you wish to cancel the Compression/Expansion operation for a track, use PARAMETER [◀◀ || ▶▶] to display the setting of that track, and press [CANCEL (NO)].

3. Make settings for the following items, and execute the operation.

Strt (start point): Specify the time location at which the change in playback time will start.

End (end point): Specify the time location at which the change in playback time will end.

To (to point): Specify the ending time location that will result from the compression/expansion.

Pitch: If you want the playback pitch to change as a result of the compression/expansion, set this to "Vari." If not, set this to "Fix."

Type: Specify the type of conversion. Select "A" for vocals or narrations, "B" for slow-tempo songs such as slow ballads, and "C" for fast-tempo songs such as rock.

Amplitude: Specify the volume level ratio (50, 60, 70, 80, 90, 100%) that will result from conversion. Normally you should use the default value of "60%." If the volume level after conversion is too low, use the Undo function to return to the original data, increase the amplitude settings, and try the operation again. However be aware that excessively high settings can cause noise to occur in the data.

- * To cancel the operation, press [CANCEL (NO)].

Chapter 5 Use with MIDI devices

This chapter explains how the VS-880 handles MIDI messages, and the following operations that can be done using MIDI messages.

- Using a MIDI sound source to play the metronome
- Synchronized operation with a MIDI sequencer
- Controlling the mixer from a MIDI sequencer (Compu-mix)

About MIDI

This section explains the basic concepts of MIDI, and how the VS-880 handles MIDI messages.

■ What is MIDI

MIDI stands for "Musical Instrument Digital Interface." It is a worldwide standard that allows electronic musical instruments and personal computer to exchange musical performance data and messages such as sound selections. Any MIDI-compatible device can transmit musical data (as appropriate for the type of device) to any other MIDI-compatible device, regardless of its manufacturer or model type.

■ MIDI connectors

MIDI messages (the data handled by MIDI) are transmitted and received using the following three types of connectors. On the VS-880, MIDI OUT and MIDI THRU are handled by a single connector, which can be switched to act as the desired connector. (p.90)

- MIDI IN: This receives MIDI messages from external MIDI devices.
- MIDI OUT: This transmits MIDI messages from the VS-880.
- MIDI THRU: This re-transmits all MIDI messages that were received at MIDI IN, without modifying them.

■ MIDI channels

MIDI is able to send information over a single MIDI cable independently to two or more MIDI devices. This is made possible by the concept of MIDI channels. You can think of MIDI channels as being somewhat similar in function to the channels on a television. By changing the channel of a TV set, you can view a variety of programs being transmitted by different broadcast stations. This is because data is received only from the transmitter whose channel is selected on the receiver.

In the same way, a MIDI device whose receive channel is set to "1" will receive only the data being transmitted by another MIDI device whose transmit channel is also set to "1."

■ MIDI messages

The VS-880 uses the following types of MIDI message.

Note messages

These messages are used to play notes. On a keyboard, these messages transmit the key (note number) that was pressed, and how strongly it was pressed (velocity). On the VS-880, these messages are used when you use a MIDI sound source to play the metronome sound.

Program Change messages

These messages are for the purpose of selecting sounds, and contain a program number of 1–128. The VS-880 V-XPANDED uses these messages to select scenes and effects.

Control Change messages

In general, these messages are used to transmit information such as vibrato, hold, and volume etc., that makes a performance more expressive. The various functions are differentiated by a controller number from 0–127, and the controller number is defined for each function. The functions that can be controlled on any given device will depend on that device.

On the VS-880, these messages are used in a completely different way than on most instruments; they are used to control mixer parameters.

Exclusive messages

Unlike note messages and control change messages, exclusive messages are used to transmit settings that are unique to a particular device. On the VS-880, exclusive messages can be used to control mixer parameters (in the same way as control change messages). Normally, control change messages are easier to handle, so they should be used rather than exclusive messages. Exclusive messages intended for different units are distinguished by their Device ID, rather than by MIDI channel. When exclusive messages are to be transmitted or received, you must set the Device ID of both units to a matching setting.

■ MIDI implementation chart

MIDI allows a variety of electronic musical instruments to communicate with each other. However it is not necessarily the case that all devices will be able to communicate using all types of MIDI message. They can only communicate using those types of MIDI message that they have in common.

Each owner's manual for a MIDI device includes a MIDI Implementation Chart. This chart shows you at a glance the types of MIDI message that can be transmitted and received. By comparing the implementation charts of two devices, you will be able to see the types of message with which they will be able to communicate.

Using MIDI to switch the track status

You can use MIDI control change messages to switch the status of each track (Track Status). MIDI channels 1-8 correspond to tracks 1-8 respectively. Use controller number 29 to switch the track status.

Depending on the data value of controller number 29, the track status will change as follows.

● When stopped

VALUE	0-31	32-63	64-95	96-127
STATUS	MUTE→MUTE	MUTE→PLAY	MUTE→REC	MUTE→SOURCE
	PLAY→MUTE	PLAY→PLAY	PLAY→REC	PLAY→SOURCE
	REC→MUTE	REC→PLAY	REC→REC	REC→SOURCE
	SOURCE→MUTE	SOURCE→PLAY	SOURCE→REC	SOURCE→SOURCE

● During playback or recording

VALUE	0-31	32-63	64-95	96-127
STATUS	— (*1)	MUTE→PLAY	— (*1)	— (*1)
	PLAY→MUTE	PLAY→PLAY	— (*1)	— (*1)
	— (*1)	— (*1)	REC→REC	REC→SOURCE (*2)
	SOURCE→MUTE	— (*1)	SOURCE→REC (*2)	SOURCE→SOURCE

(*1) Ignored.

(*2) Cannot be switched while recording. Also, "SOURCE" here indicates "the status in which the track indicator blinks alternately red and orange (p.13)", and is valid only when Record Monitor (p.116) is set to "AUTO".

Synchronizing with a MIDI sequencer

The VS-880 can be operated in synchronization with a MIDI sequencer. Synchronization can be accomplished in one of the following three ways. Use the method that is appropriate for your situation. However if MIDI Clock (Tempo Map, or Sync Track) is used, it will be possible to synchronize a MIDI sequencer from the VS-880 (VS-880 as master), but it will not be possible to synchronize the VS-880 from the sequencer (VS-880 as slave).

- Using MTC (MIDI time code)
- Using the tempo map
- Using the sync track

* For details on MIDI sequencer operation, refer to the owner's manual for your sequencer.

■ Using MTC

This section explains how the VS-880 can be synchronized with a MIDI sequencer that implements MTC (MIDI Time Code). When using MTC, you can choose whether to have the VS-880 be the master that controls the MIDI sequencer, or whether the MIDI sequencer will be the master that controls the VS-880.

< Types of MTC >

The VS-880 allows you to select the following types of MTC. Check the specifications of the MIDI devices that you are using, and select the appropriate type of MTC on the VS-880.

- 30: 30 frames per second non-drop format. This is used by audio devices such as analog tape recorders, and for NTSC format black and white video (used in the US and Japan, etc.).
- 29N: 29.97 frames per second non-drop format. This is used for NTSC format color video (used in the US and Japan, etc.).
- 29D: 29.97 frames per second drop format. This is used for NTSC format broadcast color video (used in the US and Japan, etc.).
- 25: 25 frames per second frame rate. This is used in SECAM format / PAL format video (used in Europe, etc.), and for audio equipment and film.
- 24: 24 frames per second frame rate. This is used for film in the US.

Synchronizing to the VS-880 (Master)

When you want to synchronize the MIDI sequencer to the VS-880, use the following procedure.

1. Use a MIDI cable to connect the VS-880 and the MIDI sequencer as follows.

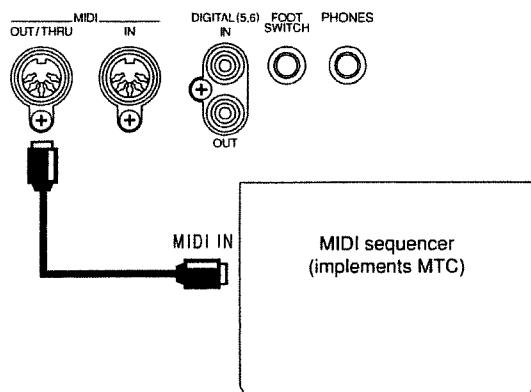

2. Make sure that the MIDI OUT/THRU connector is set for use as a MIDI OUT connector. With the factory settings, MIDI OUT is selected. Press [SYSTEM], select "SYS MIDI PRM?", select "SYS MID: MIDIThr=", and make sure that it is set to "Out."
3. Make settings so that MTC will be used for synchronization. Press [SYSTEM], select "SYS Sync/Tempo ?", and set the following parameters.
Gen.: Set this to "MTC."
MTC Type: Select the desired type of MTC.
4. This completes synchronization settings for the VS-880. Press [PLAY (DISPLAY)] to return to Play condition.
5. Make settings on your MIDI sequencer so that it will synchronize to incoming MTC, and prepare it to begin playback of MIDI song data. When you start playback on the VS-880, the MIDI sequencer will begin playback in synchronization.

Gen (Sync generator)

This selects the type of synchronization signal that will be transmitted from the MIDI OUT connector. When using a synchronization signal from the VS-880 to synchronize external MIDI devices, set this to the desired type of synchronization signal.

- Off: Synchronization signals will not be transmitted.
- MTC: MIDI Time Code will be transmitted.
- MIDIClk: MIDI Clock will be transmitted.
- SyncTr: MIDI Clock data recorded on the sync track will be transmitted.

MTC Type

This sets the type of MTC. Check the specifications of the MIDI devices that you are using, and select the appropriate type of MTC on the VS-880.

- 30: 30 frames per second non-drop format. This is used by audio devices such as analog tape recorders, and for NTSC format black and white video (used in the US and Japan, etc.).
- 29N: 29.97 frames per second non-drop format. This is used for NTSC format color video (used in the US and Japan, etc.).
- 29D: 29.97 frames per second drop format. This is used for NTSC format broadcast color video (used in the US and Japan, etc.).
- 25: 25 frames per second frame rate. This is used in SECAM format / PAL format video (used in Europe, etc.), and for audio equipment and film.
- 24: 24 frames per second frame rate. This is used for film in the US.

< Non-drop format and drop format >

NTSC format VCRs use two formats; non-drop and drop. In non-drop format, the frames are continuous. However in drop format, two frames are skipped at the beginning of each minute except for the minutes which fall at ten-minute intervals.

In most video production and music production, continuous frames are easier to handle, so non-drop format is widely used. However in broadcast studios, where time code must match actual clock time, drop format is widely used.

Synchronizing to a MIDI sequencer (Slave)

When you want to synchronize the VS-880 to the MIDI sequencer, use the following procedure.

* In particular when using computer-based MIDI sequencing software, the MTC that is transmitted may be unstable. As far as possible, we recommend that the VS-880 be used as the timing standard (Master).

1. Use a MIDI cable to connect the VS-880 and the MIDI sequencer as follows.

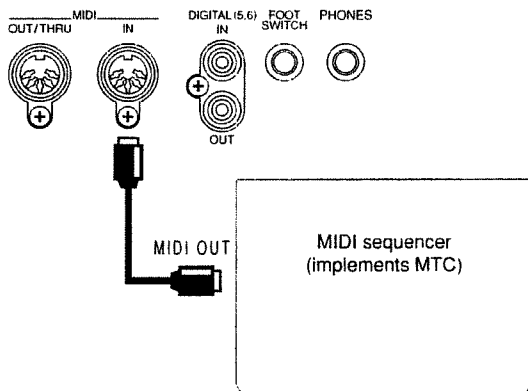

2. Make settings so that the VS-880 will synchronize to incoming MTC messages.
Hold down [SHIFT] and press [SYSTEM]. The display in the SYNC MODE field will change from "INT" to "EXT," and the VS-880 will synchronize to MTC messages from an external device.
3. Select the type of MTC.
Press [SYSTEM], select "SYS Sync/Tempo ?", select "SYS Syn: MTC Type=", and select the type of MTC.
4. This completes synchronization settings on the VS-880. Press [PLAY (DISPLAY)] to return to Play condition.
5. Make settings on your MIDI sequencer so that it will transmit MTC. On the VS-880, press [PLAY] to prepare for playback. Start playback on the MIDI sequencer, and the VS-880 will begin playback in synchronization.

Source (Sync source)

This determines how the VS-880 will synchronize with other devices.

- INT: The VS-880 will be controlled by its own internal clock. Select this setting when you are not synchronizing with other devices, or when you want external MIDI devices to be controlled by synchronization signals from the VS-880.
- EXT: The VS-880 will be controlled by synchronization signals (MTC) from an external MIDI device. In this case, the VS-880 will not operate unless it is receiving MTC signals. Select this setting when you want to use MTC from an external MIDI device to control the VS-880.

Gen (Sync generator)

This selects the type of synchronization signal that will be transmitted from the MIDI OUT connector. When using a synchronization signal from the VS-880 to synchronize external MIDI devices, set this to the desired type of synchronization signal.

- Off: Synchronization signals will not be transmitted.
- MTC: MIDI Time Code will be transmitted.
- MIDIClk: MIDI Clock will be transmitted.
- SyncTr: MIDI Clock data recorded on the sync track will be transmitted.

ErrLevel (Error level)

When MTC from an external MIDI device is used to synchronize the VS-880, this parameter sets the interval (0-10) at which the MTC reception status will be checked. If MTC is not transmitted continuously, the VS-880 will check the MTC, and will halt synchronized operation if a problem is found. In such cases, increase the checking interval so that synchronized operation will continue even if there are slight problems with MTC reception.

MTC Type

This sets the type of MTC. Check the specifications of the MIDI devices that you are using, and select the appropriate type of MTC on the VS-880.

- 30: 30 frames per second non-drop format. This is used by audio devices such as analog tape recorders, and for NTSC format black and white video (used in the US and Japan, etc.).
- 29N: 29.97 frames per second non-drop format. This is used for NTSC format color video (used in the US and Japan, etc.).
- 29D: 29.97 frames per second drop format. This is used for NTSC format broadcast color video (used in the US and Japan, etc.).
- 25: 25 frames per second frame rate. This is used in SECAM format / PAL format video (used in Europe, etc.), and for audio equipment and film.
- 24: 24 frames per second frame rate. This is used for film in the US.

< Non-drop format and drop format >
 NTSC format VCRs use two formats; non-drop and drop. In non-drop format, the frames are continuous. However in drop format, two frames are skipped at the beginning of each minute except for the minutes which fall at ten-minute intervals.
 In most video production and music production, continuous frames are easier to handle, so non-drop format is widely used. However in broadcast studios, where time code must match actual clock time, drop format is widely used.

< Switching the display of the TIME field >

When MTC is being received from an external MIDI device for synchronization, you can select whether the time displayed in the TIME field will be "based on the external MIDI device" or "based on the VS-880."

1. Press [SYSTEM] several times until "SYS System PRM ?" appears.
2. Press [YES].
3. Press PARAMETER[▶▶].
4. The display will indicate "TimeDispFmt=". Rotate the TIME/VALUE dial.

TimeDispFmt (Time display format)

This sets the way in which the standard time is shown in the TIME field of the display. Normally, leave this set to "REL." If you are using MTC to synchronize the VS-880 from an external MIDI device, set this to "ABS" if appropriate.

- REL: The starting time of the song will be displayed as "00h00m00s00."
 ABS: The time specified by Offset will be added to the display.

5. Press PARAMETER[▶▶].
6. The display will indicate "Ofs=." Rotate the TIME/VALUE dial.

Ofs (Offset)

When using MTC from an external device to synchronize the VS-880, the Offset setting lets you match the song playback timing with the MTC timing.

Set the Offset to the difference between "MTC time" and the "time that you want the song to playback." For example if you want song time "00h10m00s00" to playback when MTC time "01h00m00s00" is reached, set the offset as follows.

$$(01h00m00s00) - (00h10m00s00) = (00h50m00s00)$$

7. Press [PLAY(DISPLAY)].

■ New operation of the offset time setting

When you set the Ofs (offset) among the System parameters, you can edit it with the TIME/VALUE dial turning backward (left).

With the VS-880 V-XPANDED, when you play the VS-880 in synchronization with the MTC from the external device, you can match the playback time of the VS-880 Song and MTC time.

For instance, to match "00h01m00s00" of the VS-880 to "00h00m59m00" of external MTC, operation is as follows.

$$\begin{aligned} & \text{Ofs (offset)} \\ & = (\text{MTC time}) - (\text{destined time of the Song}) \\ & = (00h00m59s00) - (00h01m00s00) \\ & = \{ (24h00m00s00) + (00h00m59s00) \} - (00h01m00s00) \\ & = (23h59m59s00) \end{aligned}$$

If you move the dial slightly to the left at "00h00m00s00," the value will turn to "23h59m59s***".

Operation is as follows.

1. Press [SYSTEM] several times until "SYS System PRM?" is displayed.
2. Press [YES].
3. Press PARAMETER [▶▶] several times until "Ofs=" is displayed.

Ofs= 00h00m00s00

4. Set the offset time with TIME/VALUE dial.
5. Press [PLAY (DISPLAY)] to go back to Play condition.

* Available range of offset varies depending on the MTC type (Sync parameter) of the current Song (p.86).

■ Using the tempo map

Even if your MIDI sequencer does not support MTC or MMC, you can use MIDI Clock for synchronization if the sequencer supports Song Position Pointer messages. There are two methods of synchronization using MIDI Clock; using the tempo map and using the sync track. In this section, the method of using the tempo map is explained.

< Notice when using the tempo map for synchronization >

When using the tempo map, use a song that was recorded using the metronome. The tempo and time signature of the metronome are determined by the tempo map, so if you have been recording in time with the metronome, the recorded performance will match the timing of the tempo map. However if you created the tempo map after recording the song, the timing of the song will not match the tempo map, and correct synchronization will not be possible.

For details on using the metronome, refer to "Sounding the metronome" (p.109).

What is the tempo map?

The tempo of a song is determined by the "Tempo Map." The tempo map lets you specify changes in tempo for each measure. Starting at the specified measure, it changes to a given tempo at the given beat. Tempo maps are numbered sequentially from the beginning of the song as tempo map 1, tempo map 2, and tempo map 3, etc.

Tempo map 1 is already specified at the beginning of the song, and determines the initial tempo of the song. To change the tempo at a subsequent measure, create a new tempo map at each location where you want the tempo to change. Up to 50 tempo maps can be created.



Tempo Map 1

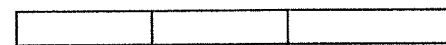

Tempo Map 1 Tempo Map 2 Tempo Map 3

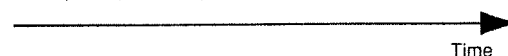

Creating a tempo map

To change the initial tempo of the song, use the following procedure to change the setting of tempo map 1.

1. Press [SYSTEM]. If a message with a question mark such as "SYS System PRM?" does not appear, press [SYSTEM] once again.
2. Use PARAMETER [◀◀][▶▶] to get the "SYS Sync/tempo?" display, and press [YES].
3. Use PARAMETER [◀◀][▶▶] to make the display read "SYS Syn: Tmap1=120."

The display below means that tempo map 1 starts at measure 1, and specifies a time signature of 4/4 and a tempo of 120 quarter notes per minute.

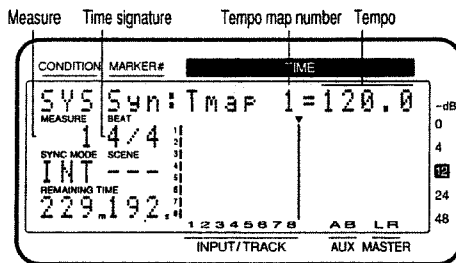

4. Set the tempo and time signature. Each time you press CURSOR [▶], the blinking area will step through the tempo map number, tempo, starting measure, and time signature. Move the blinking area to the value that you wish to change, and use the TIME/VALUE dial to modify the value. (It is not possible to change the starting measure of tempo map 1.) When you press CURSOR [◀], the tempo map number will blink.
5. Press [PLAY (DISPLAY)] to return to Play condition.

Tempo

This sets the tempo (25.0–250.0) of the tempo map. The measure and beat shown in the display, the metronome sound, and the MIDI Clock signals sent from the VS-880 will be according to this tempo setting.

Measure

This sets the starting measure (1–999) of the tempo map. The measure and beat shown in the display, the metronome sound, and the MIDI Clock signals sent from the VS-880 will be according to this tempo setting.

Beat

This sets the time signature (1/1–8/1, 1/2–8/2, 1/4–8/4, 1/8–8/8) of the tempo map. The beats shown in the display, the metronome sound, and the MIDI Clock signals sent from the VS-880 will be according to this time signature setting.

Synchronized operation

1. Use a MIDI cable to connect the VS-880 and the MIDI sequencer as follows.

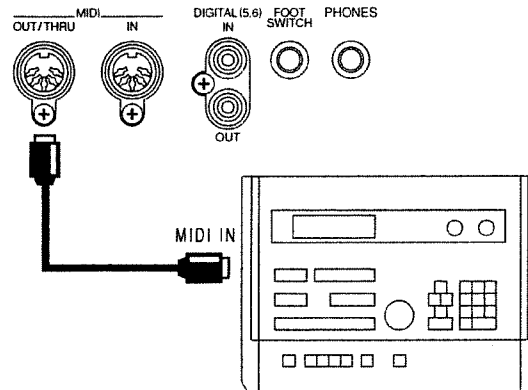

2. Make sure that the MIDI OUT/THRU connector is set for use as a MIDI OUT connector. With the factory settings, MIDI OUT is selected. Press [SYSTEM], select "SYS MIDI PRM?", select "SYS MID: MIDIThr=", and make sure that it is set to "Out."
3. Make settings so that MIDI Clock will be used for synchronization. Press [SYSTEM], select "SYS Sync/Tempo ?", select "SYS Syn:Gen.=", and set this to "MIDIclk."
4. This completes synchronization settings for the VS-880. Press [PLAY (DISPLAY)] to return to Play condition.
5. Make settings on your MIDI sequencer so that it will synchronize to incoming MIDI clock messages, and prepare it to begin playback of MIDI song data. When you start playback on the VS-880, the MIDI sequencer will begin playback in synchronization.

MIDIThr (MIDI thru switch)

This selects the function of the MIDI OUT/THRU connector. With the factory settings, this is set to "Out."

- Out: The connector will transmit MIDI messages from the VS-880. Select this when you want to transmit metronome Note messages or mixer parameter settings (control change messages or exclusive messages).
- Thru: MIDI messages received at the MIDI IN connector will be retransmitted from the connector without change.

Gen (Sync generator)

This selects the type of synchronization signal that will be transmitted from the MIDI OUT connector. When using a synchronization signal from the VS-880 to synchronize external MIDI devices, set this to the desired type of synchronization signal.

- Off: Synchronization signals will not be transmitted.
- MTC: MIDI Time Code will be transmitted.
- MIDIcIk: MIDI Clock will be transmitted.
- SyncTr: MIDI Clock data recorded on the sync track will be transmitted.

Changing the tempo during the performance

To modify tempo map settings, use the following procedure.

< Limitations on changing the starting measure >
Tempo maps are numbered from the beginning of the song as tempo map 1, tempo map 2, tempo map 3, etc. This means that it is not possible to modify the starting measure of a tempo map to make it earlier than the starting measure of the previous tempo map, or later than the starting measure of the following tempo map. For example if tempo map 2 has a starting measure of "8" and tempo map 4 has a starting measure of "16," the starting measure of tempo map 3 can be modified only in the range of "9-15."

1. Press [SYSTEM].
If a message with a question mark such as "SYS System PRM?" does not appear, press [SYSTEM] once again.
 2. Use PARAMETER [◀◀ || ▶▶] to get the "SYS Sync/tempo?" display, and press [YES].
 3. Use PARAMETER [◀◀ || ▶▶] to get the "SYS Syn: Tmap1=" display, and use the TIME/VALUE dial to select the tempo map that you wish to change.
 4. Press CURSOR [▶] to make the blinking area to the item (tempo, starting measure, time signature) that you wish to change, and use the TIME/VALUE dial to modify the value.
- * Since tempo map 1 is the initial tempo of the song, it is not possible to modify the starting measure setting of "1."
5. When you finish making settings, press CURSOR [◀] to make the tempo map number blink, and press [PLAY (DISPLAY)] to return to Play condition.

■ Using the sync track

In this section, the method of using the sync track is explained.

In addition to the tracks for recording audio signals, the VS-880 has a separate sync track for recording MIDI Clock signals. This means that unlike conventional analog multitrack recorders, it is not necessary to reserve one of the audio tracks for recording the sync signal.

To use the sync track, the MIDI clock of the MIDI song data to which you want to synchronize must first be recorded onto the sync track. Then, transmit the recorded MIDI clock data to the MIDI sequencer to synchronize the MIDI song data. In this way, while the method of using the tempo map explained in the previous section synchronizes the performance to the VS-880 song, this method of using the sync track synchronizes the performance to the MIDI song data. Thus, this is a convenient method to use when the MIDI song data has been created earlier than the VS-880 song.

In particular, when synchronizing to MIDI song data in which the tempo gradually becomes faster or slower, using the tempo map allows more precise following of tempo changes, compared to the tempo map in which tempo is set for each measure.

< Notice for synchronization >
The MIDI clock data recorded in the sync track is transmitted after song playback or recording begins. This means that if the music begins at the moment that playback begins, the MIDI sequencer will have to start playing back the MIDI song data at the same time that it receives the first MIDI clock data. In some cases, this can cause synchronization to be initially unstable.
If this problem occurs, insert several measures of blank space at the beginning of the VS-880 song and the MIDI sequencer song.

Recording MIDI clock messages

1. Use a MIDI cable to connect the VS-880 and the MIDI sequencer as follows.

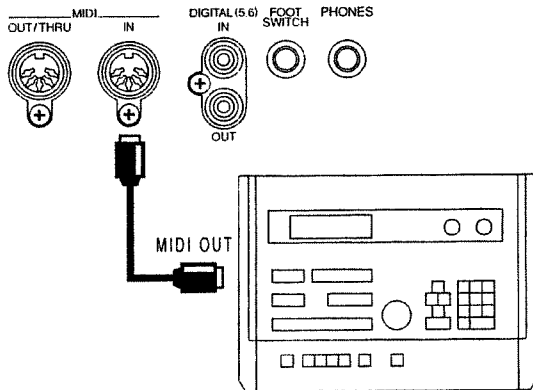

2. Press [SYSTEM], select "SYS Sync/Tempo ?", and select "SYS SYN: Sync Tr.Rec?". Press [YES], and the display will indicate "Wait for Start," and the sync track will be ready to record MIDI clock data.
3. Start playback of the MIDI song data, and the MIDI clock data will be recorded on the sync track.
 - * While MIDI clock data is being recorded onto the sync track, the input sources can be monitored, but audio tracks cannot be recorded or played back.
4. When the MIDI song data finishes playing back, the VS-880 will automatically stop recording MIDI clock data, and will return to Play condition.

Synchronized operation

1. Use a MIDI cable to connect the VS-880 and the MIDI sequencer as follows.

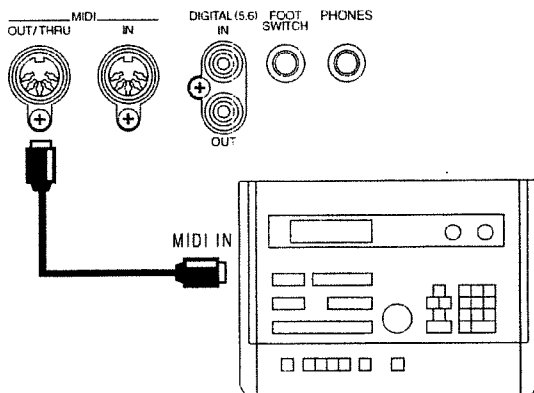

2. Make sure that the MIDI OUT/THRU connector is set for use as a MIDI OUT connector.

With the factory settings, MIDI OUT is selected.

Press [SYSTEM], select "SYS MIDI PRM?", select "SYS MID: MIDIThr=", and make sure that it is set to "Out."

3. Make settings so that the MIDI clock data recorded on the sync track will be used for synchronization. Press [SYSTEM], select "SYS Sync/Tempo ?", select "SYS Syn:Gen.=", and set this to "SyncTr."
4. This completes synchronization settings for the VS-880. Press [PLAY (DISPLAY)] to return to Play condition.
5. Make settings on your MIDI sequencer so that it will synchronize to incoming MIDI clock messages, and prepare it to begin playback of MIDI song data. When you start playback on the VS-880, the MIDI sequencer will begin playback in synchronization.

MIDIThr (MIDI thru switch)

This selects the function of the MIDI OUT/THRU connector. With the factory settings, this is set to "Out."

Out: The connector will transmit MIDI messages from the VS-880. Select this when you want to transmit metronome Note messages or mixer parameter settings (control change messages or exclusive messages).

Thru: MIDI messages received at the MIDI IN connector will be retransmitted from the connector without change.

Gen (Sync generator)

This selects the type of synchronization signal that will be transmitted from the MIDI OUT connector. When using a synchronization signal from the VS-880 to synchronize external MIDI devices, set this to the desired type of synchronization signal.

Off: Synchronization signals will not be transmitted.

MTC: MIDI Time Code will be transmitted.

MIDIClk: MIDI Clock will be transmitted.

SyncTr: MIDI Clock data recorded on the sync track will be transmitted.

When you experience problems with synchronization

- Is the MIDI Thru switch set to Out?
- Is the sync generator set correctly?
- Is the sync source set correctly?
- If you are using MTC, are both devices set to the same type of MTC?
- If you are using the sync track, are MIDI clock messages recorded in the sync track?

Chapter 6 Use with a Zip drive

Disk drives such as hard disks or magneto-optical disks can be connected to the SCSI connector of the VS-880.

This chapter will explain the procedure for using the VS-880 with a Zip drive in particular. Read this chapter when you wish to record a performance on a Zip drive. If you are using the VS-880 with a hard disk or magneto-optical disk instead, read "Zip drive" as "hard disk" or "magneto-optical disk."

Connecting a Zip drive

Zip drives can be connected to the SCSI connector of the VS-880. For details on how to make Zip drive connections, and how to make the necessary settings, refer to "Using an external disk drive" (p.130).

Initializing the disk (Drive Initialize)

Before using a new disk drive or a disk drive that was used by another device, you must initialize the disk drive so that it can be used by the VS-880. Use the following procedure.

* Some people may have divided up their disk drive so it has two or more partitions. If you are using such a partitioned drive, please note that you will not be able to choose a particular partition that you wish to initialize. When you carry out a drive initialization, the whole drive and all its partitions will be initialized at once.

1. Insert a disk into the Zip drive.
2. Press [SYSTEM].
If a message with a question mark such as "SYS System PRM?" does not appear, press [SYSTEM] once again.
3. Use PARAMETER [◀◀ || ▶▶] to get the "SYS Drive Initialize" display, and press [YES].
4. The display will indicate "Init.Drive," so use the TIME/VALUE dial to select the disk drive that you wish to initialize (IDE, SC0-SC7).
The internal hard disk is displayed as "IDE," and external disk drives are displayed as "SC0-SC7" (the number is the SCSI ID number). Numbers following the disk drive name are partition numbers. For example to select the Zip drive, specify "SC5:0."
5. Press PARAMETER [▶▶] to get the "PhysicalFmt" display, and use the TIME/VALUE dial to select whether or not the disk will be physically formatted.
If the disk drive has been used by another device, select "On." If the disk drive is new, physical formatting has probably been performed, so in this case select "Off."
6. Press PARAMETER [▶▶] to get the "Partition" display. Use the TIME/VALUE dial to select the size of the partition. Normally you will select "1000 MB."
7. Press [YES] to get the "SYS Init.SC5:U OK ?" display. Press [YES], and a message of "SYS Init.SC5: U Sure?" will ask for confirmation. Press [YES] once again to execute initialization. To cancel initialization, press [NO].

When initialization ends correctly, the VS-880 will automatically re-start, and enter Play condition.

- * When initializing a large-capacity disk drive, be aware that some time will be required. This is not a malfunction. The progress of initialization will be shown in the display, so be sure not to turn the power off until initialization is complete.

Select the Zip drive as the recording destination (Drive Select)

If you wish to record a song on another disk drive or partition, use the following procedure to switch the current drive.

1. If you wish to specify a removable disk drive as the current drive, insert the disk.
2. Press [SYSTEM].
If a message with a question mark such as "SYS System PRM?" does not appear, press [SYSTEM] once again.
3. Use PARAMETER [◀◀ || ▶▶] to get the "SYS Drive Select" display, and press [YES]. When you press [YES], the connected disk drives will be scanned.
4. Use the TIME/VALUE dial to select the disk drive. The internal hard disk is displayed as "IDE," and external disk drives are displayed as "SC0-SC7" (the number is the SCSI ID number). Numbers following the disk drive name are partition numbers. For example to select the Zip drive, specify "SC5:0".
5. When you have made your selection, press [YES]. The display will indicate "SYS Change to," so press [YES] once again to execute the change of current drive. To cancel, press [NO].

Saving performance data on a Zip disk (Song Copy)

The VS-880 allows you to copy song data to another disk drive. By connecting a magneto-optical disk drive or a removable hard disk drive (hereafter referred to as removable disk drives) to the VS-880 and copying song data to that disk, you can backup song data.

The VS-880 also allows you to backup song data to a DAT recorder. However when the time required to perform the backup and questions of reliability are considered, it is better to use a removable disk drive. Roland recommends that you use this method to make your backups.

If you are using a removable disk drive as a place to backup song data, you may use a slower drive that is not suitable for song recording or playback.

* To verify the size of the current song, you can hold down [SHIFT] and press [SONG] (p.116). Select either Playable or Archive, depending on the capacity of the disk (approximately 100 MB for a Zip disk).

■ Saving on a single disk (Playable)

Normally you will use this method to copy song data. With this method, even if song data already exists in the copy destination disk drive, the newly copied song will be added to the data.

1. When copying song data to an external disk drive, connect the disk drive as explained in "Connecting a disk drive" (p.130).
2. Press [SONG], use PARAMETER [◀◀ || ▶▶] to get the "SNG Song Copy" display, and press [YES]. If you have connected a removable disk drive, the display will indicate "SNG CpyMode=." Use the TIME/VALUE dial to set this to "Playable."
3. Press PARAMETER [▶▶] to get the "SNG CpyTarget=" display, and use the TIME/VALUE dial to select the song that you wish to copy. If you wish to copy the currently selected song, select "1 Song." To copy all songs from the current drive, select "All."

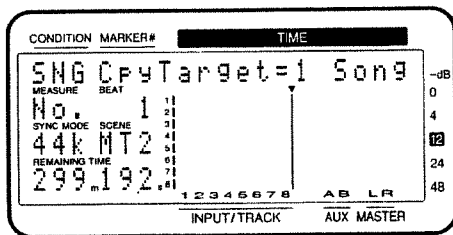

4. Press PARAMETER [▶▶] to get the "SNG Dest.Drive=" display, and use the TIME/VALUE dial to select the copy destination disk drive.

The internal hard disk will be shown as "IDE," and external disk drives will be shown as "SC0-SC7." The number following each disk drive indicates the partition number.

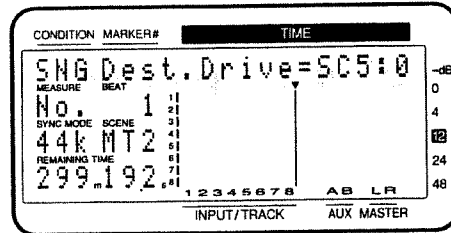

5. Press [YES], and "SNG Copy to ***:*" will appear ("***:*" indicates the disk drive and partition number of the copy destination). If it is OK to copy the data, press [YES] twice. To cancel the operation, press [NO]. If "ALL" is specified as the target, a confirmation message will ask you whether you want to initialize the copy destination disk drive. If you wish to initialize the copy destination disk drive and copy the song data, press [YES]. In this case, all song data that had been saved on the copy destination disk drive will be lost. If you wish to copy without initializing, press [NO]. When the copy operation is successfully completed, you will return to Play condition.

< If the display indicates "Disk Memory Full" >
 If this message appears during copying, the copy operation has been halted either because the disk drive has insufficient free space, or the copy destination disk drive would contain more than 200 songs (the maximum number of songs). However any song data which has been completely copied before this message appeared will still be usable.

● Playable

Normally you will use this method to copy song data. If song data is copied using this method, you can specify the copy destination disk drive as the current drive, and directly perform operations such as playback or undoing a recording.

■ When the data cannot be saved on a single disk (Archive)

● Archive

Use this method when you are using a removable disk drive and several disks will be required to copy the specified song data.

When song data is copied using this method, the song data will be converted into a data format specifically for saving (archive format). This means that it will not be possible to directly playback etc. the song data by specifying the saving destination disk drive as the current drive. If you wish to use the song data which was copied, you will need to load the archive data into the current drive using the appropriate procedure.

< Optimize >

Even when overdubbing and punch-in recording are repeated, the original data that was rewritten (the unwanted data) will remain on the disk. By erasing this unwanted data from the disk, you can decrease the size occupied by the song.

If the song will not fit on a single disk, try using Optimize (p.113). In some cases this will make the song data compact enough to be saved on a single disk.

Procedure for saving on multiple disks (Store In)

Use this method when using a removable disk drive and two or more disks are required in order to copy the specified song data.

In order to use song data which has been copied with this method, you must use the procedure of the following page to load the archived song data from the removable disk back into the current drive.

< Disk handling >

When using this operation to copy song data, the disk will be initialized to hold archive-type song data. This means that this operation can be executed using even a disk which has not been initialized by the VS-880. However be aware that if you use this operation to copy data to a disk which already contains song data, all of the previously saved song data will be lost.

A disk on which song data has been archived cannot be selected as the current drive in the way that a disk containing conventional song data can be. If you attempt to select an archive disk as the current drive, it will be recognized as an un-initialized disk drive.

This section explains the procedure for copying song data to a Zip drive (SCSI ID number 5) as an external disk drive.

1. Connect the Zip drive as explained in "Using an external disk drive" (p.130).
2. Press [SONG], use PARAMETER [◀] [▶] to get the "SNG Song Copy" display, and press [YES].
3. The display will indicate "SNG CpyMode=," so use the TIME/VALUE dial to set this to "Archive."
4. Press PARAMETER [▶] to get the "SNG ArcTarget=" display, and use the TIME/VALUE dial to select the song that you wish to copy.
If you wish to copy the currently selected song, select "1 Song." To copy all songs from the current drive, select "All."

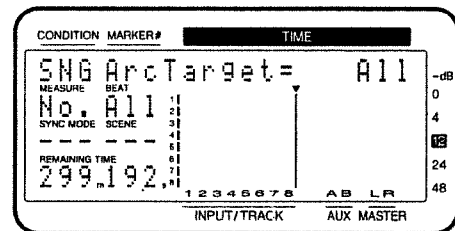

5. Press PARAMETER [▶] to get the "SNG Arc.Drive=" display, and use the TIME/VALUE dial to select the copy destination disk drive.
Here we will copy the data to a Zip drive, so select "SC5:U."

For this operation, you will be able to select only removable disk drives which are connected to the SCSI connector. It is not possible to select the current drive (the internal hard disk) as the copy destination drive.

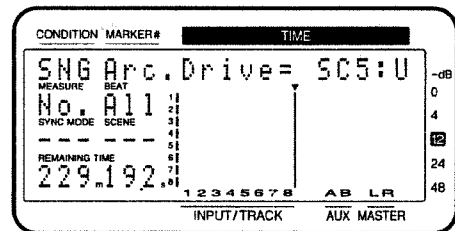

6. Press PARAMETER [▶] to get the "SNG Arc.Func=" display, and use the TIME/VALUE dial to select "Stow In."

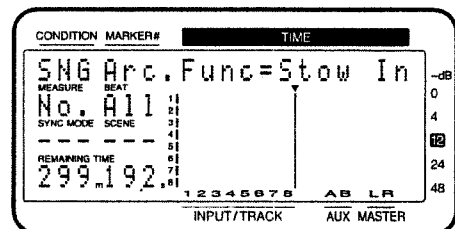

7. Insert a Zip disk into the Zip drive, and press [YES]. The display will ask "SNG Stow In SC5:U?" If it is OK to copy the data, press [YES] twice. To cancel the operation, press [NO].
 8. The display will ask, "Store Current?" If you wish to store the current song, press [YES]. If you decide not to store, press [NO].
 9. The display will ask, "You'll Lose Data/Continue ?" If you press [YES] the Song Copy operation will be executed. If you decide to cancel the Song Copy operation, press [NO].
- * All data stored on the Zip disk will be lost. Do not use a Zip disk that contains song data you wish to keep.
10. If the amount of song data is more than can be copied onto one Zip disk, the disk will be ejected, and the display will request "PleaseInsertDisk." Insert the next disk, and press [YES].
You will return to step 9.
At this time, write the disk numbers on the disk labels so that you will remember the sequence in which they were inserted.
 11. If the copy operation involved two or more disks, the display will say "Insert Disk #" (# indicating the disk insertion sequence) at the end. Insert each disk in the correct order, and press [YES].
When copying has been completed successfully, you will return to Play condition.

Procedure for loading from multiple disks (Extract)

When you wish to use archive-song data that was saved to a removable disk drive, use the following procedure to load the song data into the current drive.

1. Press [SONG], use PARAMETER [◀◀][▶▶] to get the "SNG Song Copy?" display, and press [YES].
2. The display will indicate "SNG CpyMode=." Use the TIME/VALUE dial to select "Archives."
3. Press PARAMETER [➤➤] to get the "SNG ArcTarget=" display, and use the TIME/VALUE dial to select the song that you wish to load.
To load the data of a single song, select "1 Song." To load all the song data, select "All."
4. Press PARAMETER [▶▶] to get the "SNG Arc.Drive=" display, and use the TIME/VALUE dial to select the disk drive from which the data will be loaded.
Here we will read from a Zip drive, so select SC5:U.
5. Press PARAMETER [▶▶] to get the "SNG Arc.Func=" display, use the TIME/VALUE dial to select "Extract."
6. Insert a Zip disk into the Zip drive, and press [YES]. The display will ask "SNG Extract SC5:0?" If it is OK to copy the data, press [YES] twice. To cancel the operation, press [NO].

In step 3, select "1 Song." If two or more songs were saved to the Zip disk, the names of the saved songs will also be displayed. Use the TIME/VALUE dial to select the name of the song you wish to copy, and press [YES] twice.

7. The display will ask "Store Current?" If you wish to store the current song, press [YES]. If you decide not to store, press [NO].
 8. If you have selected "All" in step 3, the display will ask "Init. IDE:0 OK?" This message is asking you to confirm that you wish to initialize the loading destination drive (the internal hard disk). If you wish to initialize the drive and then load, press [YES]. If you decide not to initialize, press [NO].
- * If at this point you press [YES], all songs saved on the internal hard disk will be lost. Normally you should press [NO]. If the loading destination hard disk does not have sufficient space, you should first make a backup copy of the internal hard disk, and then press [YES].
9. Loading will be executed. If the copy operation involved two or more disks, the disk will be ejected, and you will be prompted to "PleaseInsertDisk." Insert the next disk and press [YES].
When the data has been loaded correctly, you will return to Play condition.

If you have problems saving the data

- Is the Zip drive connected correctly?
- Is the copy destination drive specified correctly?
- Does the disk drive have enough free area?
- Is the destination drive writeable?

Chapter 7 Use with a DAT recorder (DAT backup)

This chapter explains the procedures for using a DAT recorder in conjunction with the VS-880. Read this chapter when you wish to save a song to a DAT recorder.

Song data created on the VS-880 can be saved using a DAT recorder. This procedure is referred to as "backup." The procedure of loading the previously backed up song data into the VS-880 is referred to as "recover." The song data that is backed up includes the data of all V-tracks, and song settings such as locate points, mark points, and scene settings.

Make backups of your data as a precaution against unforeseen problems, or when your disk drive is full and no more recording is possible. We recommend that important data be backed up twice, using separate tapes.

Since DAT tapes are easily transported, this is convenient when you wish to exchange song data with a friend who also has a VS-880, or when you have a VS-880 both at home and in the studio.

< Cautions for backup >

Backup cannot be done using devices other than a DAT recorder, such as an MD recorder or a DCC recorder.

If a backup requires two or more tapes, use tapes of identical length so that they will be used most effectively. Also, be sure to note the recorded sequence on the labels of each tape.

Do not use 180 minute DAT tapes, since they contain thinner tape and are prone to problems such as stretching and becoming entangled in the recorder mechanism.

If your DAT recorder processes the data internally so that the playback data is different than the recorded data, backup cannot be performed correctly.

When song data is being backed up, sound will not be output from the analog output jacks of the VS-880.

When backing up song data, turn the volume down to the minimum position for any playback equipment (amps etc.) that are connected to the DAT recorder. The song data being sent to the DAT recorder consists of special signals that are recorded on disk. If this sound is monitored from the DAT recorder at a high volume, your speakers and/or your hearing may be damaged.

Roland will take no responsibility in the event that data is lost due to a backup failure. Also, Roland can not guarantee any backed up data regardless of the capabilities or condition of the DAT recorder.

Saving performance data to a DAT recorder (Backup)

This procedure backs up the data of the specified song from the currently drive.

1. Connect your DAT recorder to the VS-880.
Use an RCA phono type coaxial cable to connect the VS-880's DIGITAL OUT connector to the digital input connector (coaxial) of your DAT recorder. Set your DAT recorder to record digital signals.
* Normally, the sample rate at which data is transmitted is set at 48 kHz. This sample rate has no relation to the sample rate of the song data. If your DAT recorder requires you to set the sample rate, set it to 48 kHz.
2. Press [SONG]. Then use PARAMETER [◀◀ || ▶▶] to get the "SNG DAT Backup?" display, and press [YES].
3. The display will indicate "SNG Bak=," so use the TIME/VALUE dial to select the song that you wish to backup. If you wish to backup all song data in the current drive, select "ALL."

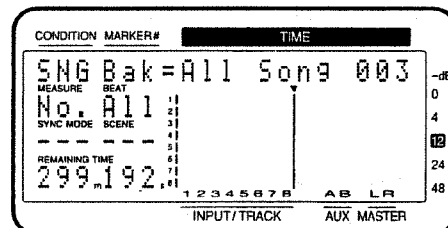
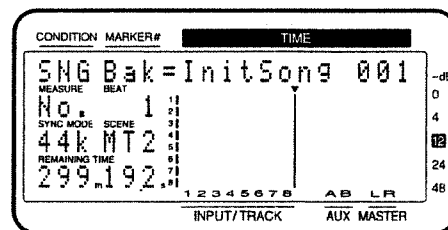

4. Specify the time at which the backup operation will be paused.
Press PARAMETER [▶▶] to get the "SNG Tape Len=" display. Use the TIME/VALUE dial to set a time that is slightly shorter than the maximum length of your tape. If you are using two or more tapes of different recording lengths, specify the length of the shortest tape.
5. Specify whether or not the data transmission will be slowed down.
Press PARAMETER [▶▶] to get the "SNG Backup Wait=" display. If you are using a disk drive that reads and writes data more slowly, such as a magneto-optical disk drive, set this "ON." If this setting is "ON," the backup will take longer, but there will be fewer problems with data transmission.

- Have ready the required number of tapes. The MEASURE field will show the approximate length of time required to perform the backup. The SYNC MODE field will show the number of tapes required for the backup. Prepare the displayed number of tapes.

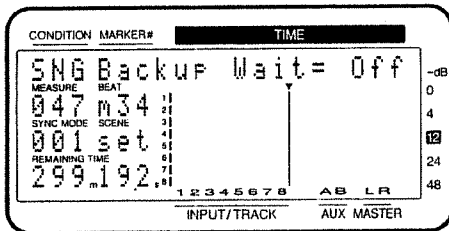

- Begin the backup. Press [YES] to get the "Backup Ready?" display, and press [YES]. The display will indicate "Please Rec DAT," so put your DAT recorder in record mode. Press [YES] once again, the backup will begin. At this time, time displayed in the MEASURE field will begin counting down. If the backup does not fit on a single tape, the backup will be paused at the specified time. At that time, insert the next tape, resume recording on the DAT recorder, and press [YES]. The backup will continue.
- To halt the operation, press [NO]. You can halt the operation even during the backup, but in this case it will not be possible to recover the song data back into the VS-880.
- When the backup operation is completed, the display will indicate "Please Stop DAT." Press [YES] to end the procedure, and stop the DAT recorder.
- Press [PLAY (DISPLAY)] to return to Play condition.

Bak (backup):

Select the song that you wish to backup. If you wish to backup all song data on the current drive, select "ALL."

Tape Len (Tape length):

Specify the interval at which backup will be paused. Set this appropriately for the length of tape on which you are recording.

Backup Wait:

If this is "On," the data transmission speed will be slower. When using a disk drive whose data read/write speed is slower, turn this "On."

SampleRate:

Specify the sample rate used for the backup. Normally you will set this to 48 kHz.

< Capacity that can be backed up and time required >
 A 60 minute tape can save a song of approximately 330 MB. For example if the internal hard disk (540 MB) is used to its full capacity, a 120 minute tape (or two 60 minute tapes) will be necessary. However as the number of songs increases, the capacity that can be stored will decrease. For your reference, the backup operation will display the number of tapes that will be necessary. Since a 120 minute tape can backup a 660MB song, it will take approximately 100 minutes to backup the internal hard disk (540 MB) if it has been used to its full capacity (approximately 36 minutes, calculated with 8 tracks of MT2 at 44.2kHz).

Loading performance data from a DAT recorder (Recover)

To load song data that was backed-up on a DAT recorder, use the following procedure. If two or more songs were saved together during the backup, the data of all songs will be loaded.

- Connect the recorder to the VS-880. Using an RCA phono type coaxial cable, connect the DIGITAL IN connector of the VS-880 to the digital output of your DAT recorder.
- Insert the tape which contains the song data into the DAT recorder. If the song data is backed up on two or more tapes, insert the first tape. Then prepare the tape to playback from the beginning.
- Press [SONG]. Then use PARAMETER [<< || >>] to get the "SNG DAT Recover?" display, and press [YES].
- Begin the recover operation. Use PARAMETER [<< || >>] to get the "SNG Recover Ready?" display, and press [YES]. The display will indicate "Init ***: OK?." If you wish to initialize the current drive and recover the song data, press [YES]. In this case, all song data which had been saved on the current drive will be lost. If you wish to recover without initializing, press [NO].
- The display will indicate "Please Play DAT." Begin playback of the song data, and loading will begin. If the data was backed up on two or more tapes, the recover operation will pause when the tape finishes playing back. Insert the next tape, press [YES], and begin playback.
- To halt the operation, press [NO].
- When the recover operation is completed, the display will indicate "Please Stop DAT." Press [YES] to end the procedure, and stop the DAT recorder.
- Press [PLAY (DISPLAY)] to return to Play condition.

■ In case DAT recover operation is halted

It becomes possible to restore a song even in the following cases while recovering a song data that was backed-up on a DAT recorder with the system software Ver.2.04 or later.

- When canceling the DAT recovery operation in the middle
 - When there is an error in the song data
- * This procedure does not correct the disk error, but tries to restore the song data while keeping as much possible of the non-error data. Depending on the location in which the error occurred, some noises may generated or settings for mixer, tempo map and sync track may be lost.
- * Loud noise may injure your audio equipment such as amplifier and speakers. Please make sure to turn down the headphones' level and master volume of the VS-880 when you check the errors in the song data.

In case you cancel the DAT recovery operation in the middle

1. While proceeding DAT recovery, you can halt the operation with pressing [CANCEL (NO)].
2. "Delete Err Song?" will be displayed.

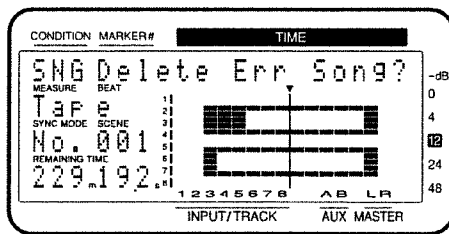

3. If you would like to delete the song data of which the recovery operation was halted from the hard disk, press [ENTER (YES)]. If you would like to keep it as it is though the recovery is not completed, press [CANCEL (NO)].

In case an error is found in the song data

1. If an error is found in the song data which was recovered with DAT recovery operation, "Recover Err Retry?" will be displayed.

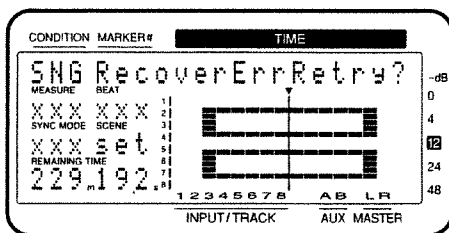

2. If you try to recover it again, press [ENTER (YES)]. If not, press [CANCEL (NO)].
3. If you press [CANCEL (NO)], "Delete Err Song?" will be displayed.
4. If you would like to delete the song data with the error from the hard disk, press [ENTER (YES)]. If you would like to keep it as it is though the error is included, press [CANCEL (NO)].

■ Checking the names of the performance data that was saved (Name)

This operation lets you check the names of song data that was saved to a DAT recorder. Even if you have saved the data of two or more songs in a single backup operation, you can check the name of each song.

This operation also allows you to load selected song data into the VS-880. When the Recover operation is used, the data for all songs which were saved together by the backup operation will be loaded. However with this operation (Name), only the song data that you specify will be loaded.

1. Digitally connect the DAT recorder to the VS-880, and cue the song.
2. Press [SONG], select "SNG DAT Recover?" and press [YES].
3. Select "SNG Name Ready?" and press [YES]. The display will indicate "Please Play DAT."
4. Begin tape playback, and the song names will be checked.

When checking is completed, the song names will be displayed. If two or more song names were saved together, rotate the TIME/VALUE dial to check the song names.

If you only wanted to check the song names, press [PLAY (DISPLAY)] to return to Play condition.

5. If you wish to load song data, select the desired song name, and press [YES].
A confirmation message will appear, asking you whether you want to initialize the current drive. If you wish to initialize, press [YES]. If not, press [NO]. The display will indicate "Please Play DAT."
6. Playback the song data from the beginning, and the song data will be loaded.
If the backup occupies two or more tapes, the operation will pause when a tape finishes playing back. At this time, the display will indicate the number of the tape that should now be inserted. Insert the specified tape and press [YES], and start tape playback.
- * If you wish to cancel the operation, press [NO].
7. When the recover operation is completed, the display will indicate "Please Stop DAT." Press [YES] to end the procedure, and stop the DAT recorder.
8. Press [PLAY (DISPLAY)] to return to Play condition.

■ Checking the storage status of performance data that was saved (Verify)

This operation checks the condition of song data that was recorded to DAT tape.

If the data is not recorded correctly, it is possible that the tape has been scratched or stretched. If the original song data still exists in the disk drive, perform the backup operation once again to a different DAT tape.

1. Press [SONG], select "SNG DAT Recover?" and press [YES].
2. Select "SNG Verify Ready?" and press [YES]. The display will indicate "Please Start DAT."
3. Start tape playback, and checking of the song data will begin.

If the backup occupies two or more tapes, the operation will pause when the tape playback ends. Insert the next tape and press [YES], and start tape playback again.

If no problems were found with the condition of the backed up song data, the display will indicate "Complete." If a problem was found, a warning message will be displayed. Song data for which a warning message was displayed could not be read correctly.

4. When the "Please Stop DAT" message appears, press [YES] and stop the DAT recorder.
5. Press [PLAY (DISPLAY)] to return to Play condition.

Chapter 8 Using the internal effects

When a VS8F-1 effect expansion board is installed, you will be able to use two stereo effect units. This chapter explains various examples of how the effects can be used. Read it in conjunction with the VS8F-1 owner's manual and "Effect related" (p.23) on this manual.

Examples of how the effects can be used

Here are several examples of ways in which the effects can be used. Apply these examples as appropriate for your situation.

■ Applying reverb to a recorded performance (Loop)

Here we will explain the settings for adding reverb to the playback of track 1. In this case, the signal flow will be as follows.

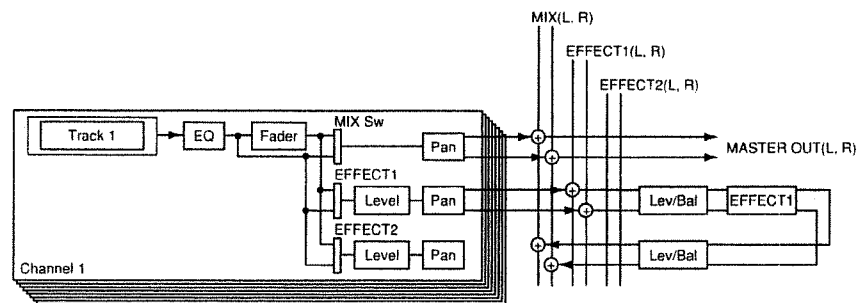

1. Make sure that the mixer mode is INPUT→TRACK.
2. Press channel 1 [CH EDIT(Input/BUSS)].
3. Use PARAMETER [◀◀][▶▶] to get the "MIX Sw=" display.
4. Rotate the TIME/VALUE dial. For this example, select "PstFade" so that the channel faders will adjust the playback level.
If you do not want the direct sound to be output from the MIX buss, select "Off."

MIX Sw (mix switch)

This selects how the signal will be sent to the MIX buss. If "Off" is selected, the MIX Level and MIX Pan/MIX Bal parameters will not be available.

Off: not sent.

PreFade: The signal before passing through the channel fader will be sent to the MIX buss.

PstFade: The signal after passing through the channel fader will be sent to the MIX buss.

5. Hold down [SHIFT] and press channel 7 [EFFECT-1(CH EDIT)].
6. The signal will be sent to the EFFECT buss. Rotate the TIME/VALUE dial. For this example, select "PstFade."

EFFECT 1 (Effect 1 switch)

Specify how the signal is sent to the EFFECT 1 buss.

Off: The signal will not be sent.

PreFade: The signal will be taken before the channel fader.

PstFade: The signal will be taken after the channel fader.

Insert: The effect will be inserted between the equalizer and fader of the channel.

InsertL: Insert into the L side of a stereo effect.

InsertR: Insert into the R side of a stereo effect.

InsertS: Insert the L side and R side of a stereo effect in series.

* If the effect is inserted in another channel, the value will appear as "—," and cannot be selected.

7. Press PARAMETER [▶▶].
The display will indicate "EFFECT1 Send=".

8. Adjust the send level to effect 1. Rotate the TIME/VALUE dial.
This adjusts the amount of effect for each channel.

EFFECT 1 Send (Effect 1 send level)

Specify the volume level (0–127) of the signal that is sent to the EFFECT 1 buss. The default setting is 100.

9. Press PARAMETER [▶▶].
The display will indicate “EFFECT1 Pan=”.
10. Adjust the panning of the input to effect 1. Rotate the TIME/VALUE dial.

EFFECT 1 Pan (Effect 1 pan)

For channels on which Channel Link is “Off,” this sets the panning (L63–0–R63) of the stereo signal which is output to the EFFECT 1 buss. “L63” is far left, and “R63” is far right.

For channels on which Channel Link is “On,” this sets the left/right volume balance (L63–0–R63) of the stereo signal from the paired channels which is output to the EFFECT 1 buss. The default value is “0” (center).

11. Press [EDIT(SOLO)] several times until “MST EFF1 RTN to=” is displayed.
12. Rotate the TIME/VALUE dial. For this example, select “MIX” so that the signal will be sent from master out.

EFF1 RTN to (Effect 1 return to)

Select the output destination of effect 1. The busses that can be selected will depend on the current mixer mode.

When in INPUT→TRACK mode
MIX: the MIX buss (stereo)
AUX: the AUX buss (stereo)

13. Press PARAMETER [▶▶].
The display will indicate “EFF1 RTN Lev=”.
14. Adjust the output level of effect 1. Rotate the TIME/VALUE dial.
This adjusts the overall amount of effect.

EFF1 RTN Lev (Effect 1 return level)

Set the output level (0–127) of effect 1.

15. Press PARAMETER [▶▶].
The display will indicate “EFF1 RTN Bal=”.
16. Adjust the left/right volume balance of effect 1. Rotate the TIME/VALUE dial.

EFF1 Bal (Effect 1 balance)

Set the left/right volume balance (L63–0–R63) of effect 1.

17. Press [EFFECT] several times until “EFF EFFECT-1 PRM ?” is displayed.
18. Press [YES].
19. Select effect 1. Rotate the TIME/VALUE dial. For this example, select an effect such as A00 RV:LargeHall.
20. Press [YES].
When the song is played back, you will hear reverb applied to it.

■ Applying reverb as you record (Loop)

Here we will explain how an effect can be applied to the input source of INPUT 1, and the direct sound and effect sound recorded in stereo on tracks 1 and 2. This is convenient when you wish to record a vocal with reverb applied, etc. In this case, the signal flow will be as follows.

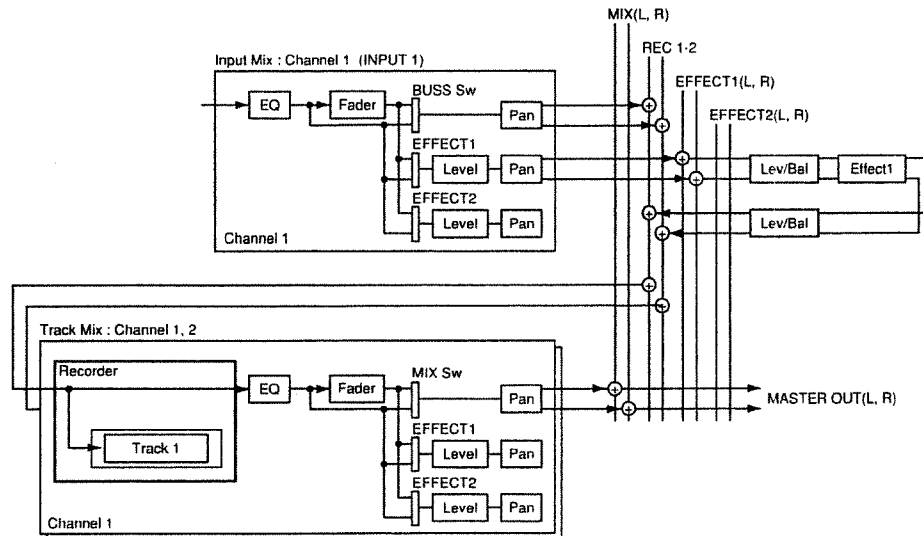

1. Make sure that the mixer mode is INPUT MIX.
2. Press channel 1 [CH EDIT(Input/BUSS)].
3. Use PARAMETER [◀◀] [▶▶] to get the "IN1 BUSS Sw=" display.
4. Rotate the TIME/VALUE dial. For this example, select "PstFade" so that the channel faders will adjust the recording level.

BUSS Sw (buss switch)

This selects the way in which the signal is sent to the buss selected by Buss Select. If "Off" is selected, the BUSS Sel, BUSS Level, and BUSS Pan/BUSS Bal parameters will not be available.

Off: not sent.

PreFade: The signal before passing through the channel fader will be sent to the buss.

PstFade: The signal after passing through the channel fader will be sent to the buss.

5. Press PARAMETER [▶▶].
The display will indicate "IN1 BUSS Sel".
6. Select the track(s) that you wish to record. Rotate the TIME/VALUE dial. For this example, select "1-2" since we want to record on tracks 1 and 2.

BUSS Sel (buss select)

This selects the output destination buss (MIX, 1-2, 3-4, 5-6, 7-8). The numerals of the value indicate the REC buss numbers.

INPUT MIX mode

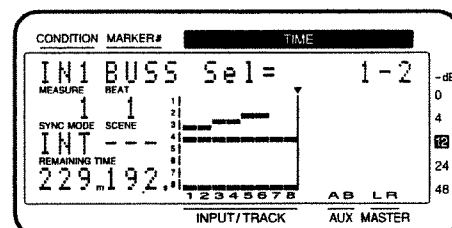

7. Hold down [SHIFT] and press channel 7 [EFFECT-1(CH EDIT)].
8. The signal will be sent to the EFFECT buss. Rotate the TIME/VALUE dial. For this example, select "PstFade" so that the channel faders will adjust the send level.

EFFECT1 (Effect 1 switch)

Select how the signal will be sent to the EFFECT1 buss.

- Off: The signal will not be sent.
- PreFade: The signal from before the channel fader will be sent.
- PstFade: The signal that passed through the channel fader will be sent.
- Insert: Insert between the equalizer and fader.
- InsertL: Insert into the L side of a stereo effect.
- InsertR: Insert into the R side of a stereo effect.
- InsertS: Insert the L side and R side of a stereo effect in series.

* If the effect is inserted in another channel, the value will appear as "—" and cannot be selected.

9. Press PARAMETER [>>>].
The display will indicate "EFFECT1 Send=".
10. Adjust the send level to effect 1. Rotate the TIME/VALUE dial.

EFFECT 1 Send (Effect 1 send level)

Specify the volume level (0–127) of the signal that is sent to the EFFECT 1 buss. The default setting is 100.

11. Press PARAMETER [>>>].
The display will indicate "EFFECT1 Pan=".
12. Adjust the pan of the signal being input to effect 1. Rotate the TIME/VALUE dial.

EFFECT 1 Pan (Effect 1 pan)

For channels on which Channel Link is "Off," this sets the panning (L63–0–R63) of the stereo signal which is output to the EFFECT 1 buss. "L63" is far left, and "R63" is far right. For channels on which Channel Link is "On," this sets the left/right volume balance (L63–0–R63) of the stereo signal from the paired channels which is output to the EFFECT 1 buss. The default value is "0" (center).

13. Switch the mixer mode to TRACK MIX. Press [SELECT].
14. Use PARAMETER [<<< || >>>] to make the display read "TR1 BUSS Sw=".
15. Rotate the TIME/VALUE dial. For this example, select "PstFade" so that the channel faders will adjust the recording level.

BUSS Sw (buss switch)

This selects the way in which the signal is sent to the buss selected by Buss Select. If "Off" is selected, the BUSS Sel, BUSS Level, and BUSS Pan/BUSS Bal parameters will not be available.

- Off: not sent.
- PreFade: The signal before passing through the channel fader will be sent to the buss.
- PstFade: The signal after passing through the channel fader will be sent to the buss.

16. Press PARAMETER [>>>].
The display will indicate "TR1 BUSS Sel".

17. Rotate the TIME/VALUE dial. For this example, select "MIX" so that the signal will be sent from master out.

BUSS Sel (buss select)

This selects the output destination buss (MIX, 1-2, 3-4, 5-6, 7-8). The numerals of the value indicate the REC buss numbers.

TRACK MIX mode

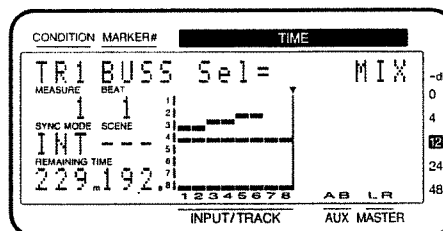

18. Press [EDIT(SOLO)] several times until the display reads "MST EFF1 RTN to=".
19. Rotate the TIME/VALUE dial. For this example, select "1-2" since we will be recording on tracks 1 and 2.

EFF1 RTN to (Effect 1 return to)

Select the output destination of effect 1. The busses that can be selected will depend on the current mixer mode.

- When in INPUT MIX mode / TRACK MIX mode
- MIX: the MIX buss (stereo)
- 1-2: REC buss 1-2
- 3-4: REC buss 3-4
- 5-6: REC buss 5-6
- 7-8: REC buss 7-8

20. Press PARAMETER [>>>].
The display will indicate "EFF1 RTN Lev=".
21. Adjust the output level of effect 1. Rotate the TIME/VALUE dial.

EFF1 RTN Lev (Effect 1 return level)

Set the output level (0–127) of effect 1.

22. Press PARAMETER [>>>].
The display will indicate "EFF1 RTN Bal=".
23. Adjust the left/right volume balance of effect 1. Rotate the TIME/VALUE dial.

EFF1 Bal (Effect 1 balance)

Set the left/right volume balance (L63–0–R63) of effect 1.

24. Press [EFFECT] several times until the display reads "EFF EFFECT-1 PRM ?".
25. Press [YES].
26. Select effect 1. Rotate the TIME/VALUE dial. For this example, select an effect such as A00 RV:LargeHall.
27. Press [YES].
28. Set the track status of tracks 1 and 2 to REC.
When you begin recording, the direct sound and reverb sound will be recorded.

■ Applying a vocoder while you record (Insert)

Here we will explain how you can connect an instrument such as a keyboard to INPUT 1 and a mic to INPUT 2, and record a vocoded sound in stereo onto tracks 1 and 2. In this case the signal flow will be as follows.

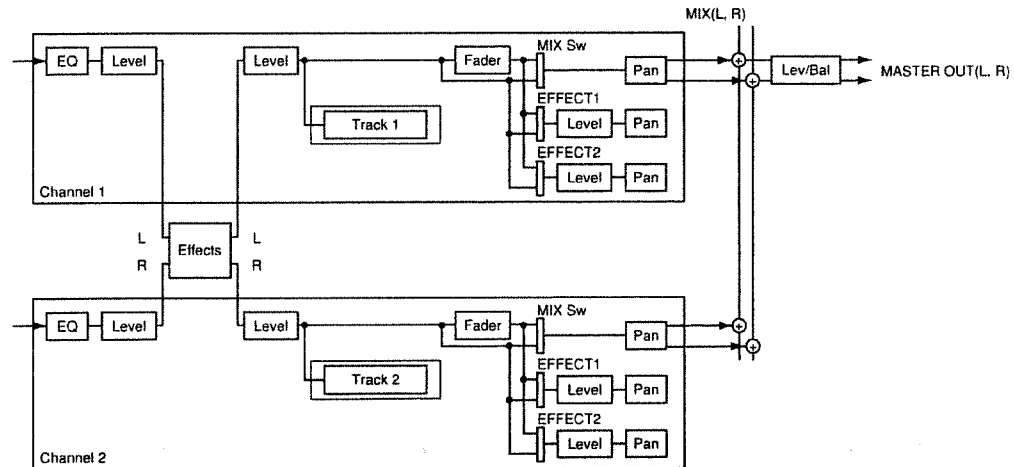

1. Make sure that the mixer mode is INPUT→TRACK.
2. Connect an instrument such as a keyboard to the INPUT1 jack, and a mic to the INPUT2 jack.
3. Press channel 1 [CH EDIT].
4. Hold down [SHIFT] and press channel 7 [EFFECT-1(CH EDIT)].
The display will indicate "EFFECT1=".
5. Insert the effect. Rotate the TIME/VALUE dial. For this example, select "InsertL" so that the sound of the instrument will be inserted into the left channel.

EFFECT1 (Effect 1 switch)

Select how the signal will be sent to the EFFECT1 buss.

- Off: The signal will not be sent.
- PreFade: The signal from before the channel fader will be sent.
- PstFade: The signal that passed through the channel fader will be sent.
- Insert: Insert between the equalizer and fader.
- InsertL: Insert into the L side of a stereo effect.
- InsertR: Insert into the R side of a stereo effect.
- InsertS: Insert the L side and R side of a stereo effect in series.

* If the effect is inserted in another channel, the value will appear as "—," and cannot be selected.

6. Press PARAMETER [▶▶].
The display will indicate "EFF1 InsSend=".
7. Adjust the send level to effect 1 (Vocoder). Rotate the TIME/VALUE dial.

EFF1 InsSend (Effect 1 insert send level)

Specify the volume level (0–127) of the signal that will be inserted into the effect. The default value is 100.

8. Press PARAMETER [▶▶].
The display will indicate "EFF1 InsRtn=".
9. Adjust the return level from effect 1 (Vocoder). Rotate the TIME/VALUE dial.

EFF1 InsRtn (Effect 1 insert return level)

Specify the volume level (0–127) of the signal that is output from the effect. The default value is 100.

10. Press PARAMETER [▶▶] twice.
The display will indicate "EQ/EffPreIns".

11. Rotate the TIME/VALUE dial. For this example, select "On" so that the sound that has passed through the effect will be recorded.

EQ/EffPreIns (Equalizer/effect pre-insert switch)

Select whether the equalizer and effect will be inserted during recording.

Off: They will not be inserted (same as Ver.1).

On: The signal into which the equalizer and effect have been inserted will be recorded.

12. Press channel 2 [CH EDIT].

13. As in steps 4–11, make settings as when inserting an effect. However in step 5, select "InsertR" so that the mic sound will be inserted into the right channel.

14. Press [EFFECT] several times until "EFF EFFECT-1 PRM ?" appears.

15. Press [YES].

16. Select effect 1. Rotate the TIME/VALUE dial. For this example, select an effect such as A84 Vocoder.

17. Press [YES].

18. Set the track status of tracks 1 and 2 to REC.
When you begin recording, the vocoded sound will be recorded.

■ **Applying reverb while bouncing tracks (Loop)**

Here we will explain the settings for applying an effect to previously-recorded tracks and recording the sound to another track. For example, this will be convenient when you wish to apply reverb to an entire song and mix it down.

In this example we will apply reverb to tracks 1–6 and bounce them to tracks 7 and 8. In this case, the signal flow will be as follows.

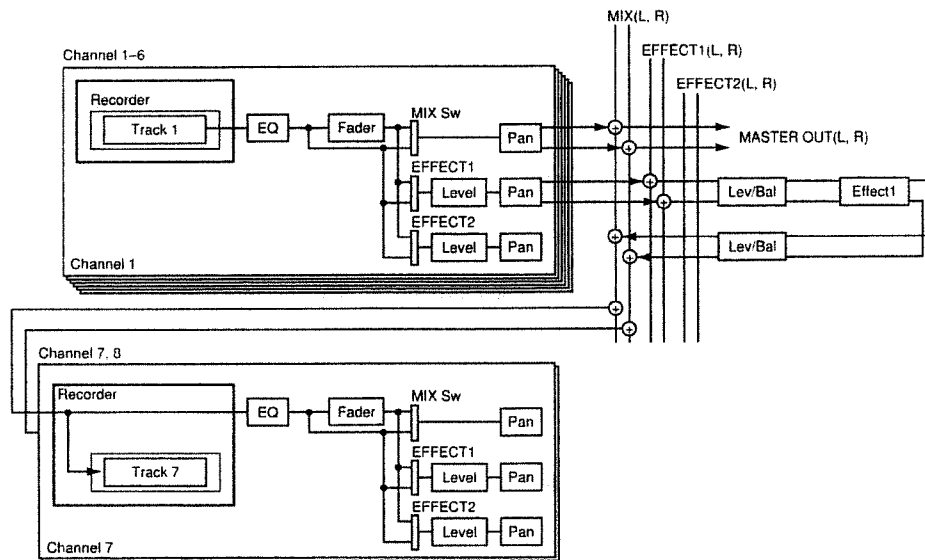

1. Make sure that the mixer mode is INPUT→TRACK.
2. Press channel 1 [CH EDIT(Input/BUSS)].
3. Use PARAMETER [◀▶] to make the display read "CH1 MIX Sw=".
4. Rotate the TIME/VALUE dial. For this example, select "PstFade" so that the channel faders will adjust the recording level.

MIX Sw (mix switch)

This selects how the signal will be sent to the MIX buss. If "Off" is selected, the MIX Level and MIX Pan/MIX Bal parameters will not be available.

Off: not sent.

PreFade: The signal before passing through the channel fader will be sent to the MIX buss.

PstFade: The signal after passing through the channel fader will be sent to the MIX buss.

5. Hold down [SHIFT] and press channel 7 [EFFECT-1(CH EDIT)].
6. Send the signal to the EFFECT buss. Rotate the TIME/VALUE dial. For this example, select "PstFade" so that the channel faders will adjust the send levels.

EFFECT1 (Effect 1 switch)

Select how the signal will be sent to the EFFECT1 buss.

- Off: The signal will not be sent.
- PreFade: The signal from before the channel fader will be sent.
- PstFade: The signal that passed through the channel fader will be sent.
- Insert: Insert between the equalizer and fader.
- InsertL: Insert into the L side of a stereo effect.
- InsertR: Insert into the R side of a stereo effect.
- InsertS: Insert the L side and R side of a stereo effect in series.

* If the effect is inserted in another channel, the value will appear as "—," and cannot be selected.

7. Press PARAMETER [▶▶].
The display will indicate "CH1 EFFECT1 Send=".
8. Adjust the send level to effect 1. Rotate the TIME/VALUE dial.

EFFECT 1 Send (Effect 1 send level)

Specify the volume level (0–127) of the signal that is sent to the EFFECT 1 buss. The default setting is 100.

9. Press PARAMETER [▶▶].
The display will indicate "CH1 EFFECT1 Pan=".
10. Adjust the panning of the signal that will be input to effect 1. Rotate the TIME/VALUE dial.

EFFECT 1 Pan (Effect 1 pan)

For channels on which Channel Link is "Off," this sets the panning (L63–0–R63) of the stereo signal which is output to the EFFECT 1 buss. "L63" is far left, and "R63" is far right.

For channels on which Channel Link is "On," this sets the left/right volume balance (L63–0–R63) of the stereo signal from the paired channels which is output to the EFFECT 1 buss. The default value is "0" (center).

11. Repeat steps 2–10 to make settings for channels 2–6 in the same way.
12. Press channel 7 [CH EDIT].
13. Hold down [SHIFT] and press channel 1 [EFFECT-1(Input/BUSS)].
14. Rotate the TIME/VALUE dial. For this example, select "MIX-L" so that the signal of the MIX bus will be recorded.

Input (input select)

This selects the input source of each channel. If Channel Link is on, stereo sources can be selected.

When Channel Link is off: INPUT 1–4, DIGITAL-L, DIGITAL-R, MIX-L, MIX-R, AUX-A, AUX-B

When Channel Link is on: INPUT-12, INPUT 34, DIGITAL, MIX, AUX-AB

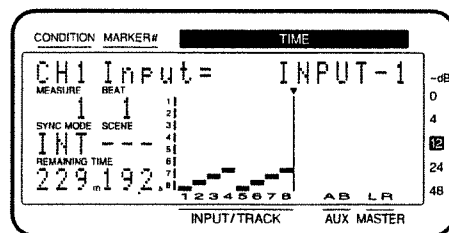

15. Press channel 8 [CH EDIT].
16. Repeat steps 13, 14 to make settings for channel 8 in the same way. However in step 16, select "MIX-R" so that the R side of the MIX buss will be recorded.
17. Press [EDIT(SOLO)] several times until "MST EFF1 RTN to=" appears.

18. Rotate the TIME/VALUE dial. For this example, select "MIX".

EFF1 RTN to (Effect 1 return to)

Select the output destination of effect 1. The busses that can be selected will depend on the current mixer mode.

When in INPUT→TRACK mode

MIX: the MIX buss (stereo)

AUX: the AUX buss (stereo)

19. Press PARAMETER [>>>].

The display will indicate "EFF1 RTN Lev=".

20. Adjust the output level of effect 1. Rotate the TIME/VALUE dial.

EFF1 RTN Lev (Effect 1 return level)

Set the output level (0–127) of effect 1.

21. Press PARAMETER [>>>]. The display will indicate "EFF1 RTN Bal=".

22. Adjust the left/right volume balance of effect 1. Rotate the TIME/VALUE dial.

EFF1 Bal (Effect 1 balance)

Set the left/right volume balance (L63–0–R63) of effect 1.

23. Press [EFFECT] several times until the display reads "EFF EFFECT-1 PRM ?".

24. Press [YES].

25. Select effect 1. Rotate the TIME/VALUE dial. For this example, select an effect such as A00
RV:LargeHall.

26. Press [YES].

27. Set the track status of tracks 7 and 8 to REC.

When you begin recording, the direct sound and reverb sound will be recorded.

If the effect does not sound as you expect

- Is a signal being sent to the EFFECT buss?
- Is the send level to the effect raised?
- Is the return level from the effect raised?
- Is the return from the effect set correctly?
- Is the effect level raised?
- Is the direct level raised?
- Are the left/right channels inserted correctly?
- Is the send level to the effect raised for each channel?
- Is the master send level to the effect raised?

Chapter 9 Other convenient functions

Sounding the metronome

No matter how accurately one tries to play, listening to the recording play back sometimes reveals inaccuracies in rhythm or tempo. The VS-880 provides a metronome (click) that can be sounded at a specified tempo. By listening to the metronome as you play your instrument, you will be able to record a more accurate performance.

When using the metronome, you will need to set the tempo and time signature. For a newly created song, the time signature is 4/4 and the tempo is 120 quarter notes per minute. By making the appropriate settings, you can change this tempo/time signature or make the tempo change mid-way through the song.

This tempo setting will also be the basis for the measure number and beat number that appears in the display. If you first set the tempo for a song before you start recording, and then use the metronome as you record, you will be able to view and move the current time location as measures and beats. Also, you will be able to use measure numbers to specify the area for song editing, so that you can edit the song in a more musical way.

< Using the metronome during recording >

The metronome will begin sounding when recording or playback begins. However you may sometimes wish to hear a count-in on the metronome to help you catch the tempo before recording begins. In such cases, you can set aside the first few measures of the recording to be only for the count-in, and not record on those measures.

The metronome sound is only for the purpose of helping you keep your playing in time, and will not be recorded with the sound of your instrument.

Here's how to specify how the metronome will sound.

1. Press [SYSTEM]. If a message with a question mark such as "SYS System PRM?" does not appear, press [SYSTEM] once again.
2. Use PARAMETER [◀◀ || ▶▶] to get the "SYS System PRM?" display, and press [YES].
3. Use PARAMETER [◀◀ || ▶▶] to access the following parameters, and use the TIME/VALUE dial to set each parameter.

MetroOUT (Metronome output)

When you wish to use a metronome to keep time as you record, the metronome sound (click) can be output from the VS-880. The timing of the metronome sound will depend on the tempo map settings (p.89).

- Off: The metronome sound will not be output.
- INT: The metronome sound will be output from the MASTER OUT jacks.
- MIDI: A Note message will be transmitted from MIDI OUT connector as the metronome. Select this when you wish to play the metronome using a sound of an external MIDI sound source.

- * When transmitting a Note message as the metronome, set the MIDI Thru switch to "Out." You will also need to make settings for the Metronome Channel, Accent Note, Accent Velocity, Normal Note, and Normal Velocity (p.110).

MetroLevel (Metronome level)

Adjust the volume level (0-127) of the metronome sound.

MetroMd (Metronome mode)

Specify how the metronome will sound.

- RecOnly: The metronome will sound only during recording.
- Rec&Play: The metronome will sound during both recording and playback.

4. This completes the metronome settings. Press [PLAY (DISPLAY)] to return to Play condition.

■ Using an external MIDI sound source to play the metronome

A MIDI sound source can be used to play the metronome with a sound of your choosing.

1. Use a MIDI cable to connect the VS-880 and your MIDI sound source as follows.

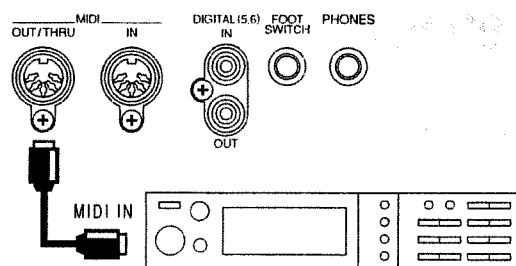

2. Make sure that the MIDI OUT/THRU connector is set for use as a MIDI OUT connector. With the factory settings, MIDI OUT is selected. Press [SYSTEM], select "SYS MIDI PRM?", select "SYS MID: MIDIThr=", and make sure that it is set to "Out."
3. Make settings so that the metronome will sound using MIDI. Press [SYSTEM], select "SYS System PRM?", and set the following parameters.

MetroOUT: Set this to "MIDI." If this is not set to "MIDI," the parameters of the following step can not be selected.

MetroMd: If you want the metronome to sound only during recording, select "Rec Only." If you want it to sound during both recording and playback, select "Rec&Play."

4. Make settings for the MIDI messages that will produce the metronome sound. Press [SYSTEM], select "SYS MIDI PRM?", and set the following parameters.

- MetroCh: Select the MIDI channel on which the metronome note messages will be transmitted. Set this to match the MIDI receive channel of your MIDI sound source.
- Acc.Note: Select the note number (C_0-G_9) for the downbeat of the metronome. If you are playing a drum set, this will select the percussion instrument.
- Acc.Velo: Specify the velocity (1-127) of the metronome downbeat.
- Nrm.Note: Select the note number (C_0-G_9) for the upbeats of the metronome. If you are playing a drum set, this will select the percussion instrument.
- Nrm.Velo: Specify the velocity (1-127) of the upbeats of the metronome.

5. This completes metronome settings. Press [PLAY (DISPLAY)] to return to Play condition.

Using a foot switch to playback/stop

A foot switch connected to the FOOT SWITCH jack can be used instead of the [PLAY] button. This is convenient when both hands are occupied, such as when playing the guitar on stage.

1. Press [SYSTEM] several times until the display indicates "SYS System PRM ?".
2. Press [YES].
3. Press PARAMETER [▶▶] several times until "SYS Foot Sw=" appears.
4. Rotate the TIME/VALUE dial. For this example, select "Play/Stop".

FootSw (Foot switch assign)

This sets the function of the foot switch connected to the FOOT SWITCH jack.

- Play/Stop: The song will alternately playback and stop each time the foot switch is pressed.
- Record: The foot switch will have the same function as the [REC]. Use this to switch between recording and playback during manual punch-in recording.
- TapMarker: The foot switch will have the same function as the [TAP]. A Mark point will be placed at the time location where you press the foot switch.
- Next: The foot switch will have the same function as the [NEXT]. Each time you press the foot switch, you will move to the next Mark point.

Previous: The foot switch will have the same function as the [PREVIOUS]. Each time you press the foot switch, you will move to the previous Mark point.

GPI: A GPI trigger signal received from the FOOT SWITCH jack will control song playback/stop.

< About GPI >

"GPI" stands for "General Purpose Interface." This is a control jack provided on professional and consumer video devices such as video editors and title superimposers. By connecting this control jack to the foot switch jack of the VS-880 and setting the Foot Switch Assign to "GPI," the connected device will be able to playback/stop the VS-880.

5. Press [PLAY(DISPLAY)].
You will return to Play condition.

Stopping automatically (Marker stop)

You can cause song playback to stop automatically at a mark point.

1. Press [SYSTEM] several times until "SYS System PRM ?" appears.
2. Press [YES].
3. Press PARAMETER [▶▶] several times until "SYS Marker Stop=" appears.
4. Rotate the TIME/VALUE dial. For this example, select "On".

Marker Stop

Turn this "On" when you want song playback to automatically halt at time locations where a Mark point exists.

5. Press [PLAY(DISPLAY)].
You will return to Play condition.

Changing the pitch during playback (Vari-pitch)

When recording an ensemble, all the instruments normally tune to an instrument such as an acoustic piano whose tuning cannot easily be changed. However it is sometimes necessary to record (overdub) an acoustic piano onto an existing recording. In this case if the pitch of the recording is different than the pitch of the acoustic piano, something must be done about it.

In such cases, use the Vari-pitch function. Vari-pitch changes the playback speed of the recorder. When the playback speed changes, the pitch of the playback will also change. In this way, by changing the playback speed, you can make the pitch of the recording match the pitch of the instrument to be newly recorded. Vari-pitch can be used not only to compensate for pitch differences, but also creatively to produce special effects.

If you wish to use the Vari-pitch function, use the following procedure to set the pitch.

* The audible result of Vari-pitch is a change in playback speed, but in actuality the sample rate is being modified. This means that when recording a digital signal into the VS-880 or when recording the digital output of the VS-880 into another device, you must return Vari-pitch to the normal pitch. Recording will not be possible with settings other than normal pitch.

1. Press [VARI PITCH] to make the button indicator light. When the button indicator is lit, the playback pitch will change in accordance with the Vari-pitch setting. Since Vari-pitch is initially set to normal pitch, the playback pitch will not change yet.
2. To modify the Vari-pitch setting, hold down [SHIFT] and press [VARI PITCH]. The display will indicate the current Vari-pitch setting (sample rate). While playing back the song to check the actual pitch, use the TIME/VALUE dial to modify the setting.

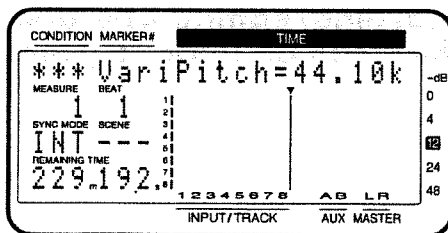

3. When you finish making settings, press [PLAY (DISPLAY)] to return to Play condition. You can also return to Play condition by holding down [SHIFT] and pressing [VARI PITCH] once again.
4. Now when you press [VARI PITCH] to make the indicator light, playback will occur at the specified pitch.

VariPitch

This sets the playback pitch when the Vari-pitch function is used. The value is displayed as a sample rate. Make vari-pitch settings while actually listening to the song playback.

* Although the audible result of Vari-pitch is that the pitch is being changed, in actuality, the sample rate is being modified. This means that you cannot use Vari-pitch while recording digital audio signals to a digital audio device. If this is set to other than the standard pitch, digital recording will not be possible.

Listening only to a specific channel (Solo)

When making equalizer adjustments or during mixdown, it is often convenient to be able to monitor just the sound of a specific channel. Although it would be possible to individually mute each of the channels that you didn't want to hear, this is inconvenient. In such cases, you can use the Solo function to monitor only a specific channel and mute all the other channels.

To use the Solo function, use the following procedure.

1. On the channel that you wish to monitor, press [STATUS] to select the signal that you wish to monitor; either the input source or the track.
 2. Hold down [SHIFT] and press [SOLO (EDIT)] in the master section. The display will briefly indicate "SOLO Mode ON," indicating that the Solo function is on. The display in the CONDITION field will alternate between the name of the current condition and "sol," also indicating that the Solo function is on.
 3. Press [STATUS] for the channel that you wish to monitor, and only that channel will be monitored. The STATUS indicator will light green if you are monitoring the recorder, or blink orange if you are monitoring the input source. At this time you can make adjustments to the channel fader, pan, and equalizer. Monitor and Mute will alternate each time you press [STATUS], allowing you to monitor two or more channels. Channels which were muted before the Solo function was turned on cannot be monitored even if their [STATUS] button is pressed. Also, when you are monitoring just one channel, pressing the [STATUS] button of that channel will let you monitor all channels.
 4. To turn off the Solo function, hold down [SHIFT] and press the [SOLO (EDIT)] button of the master section once again. The display will briefly indicate "EXIT SOLO Mode," and the Solo function will be turned off.
- * If you begin punch-in recording when Solo is on, Solo will automatically be turned off.

Simultaneously adjusting a stereo source (Channel Link)

When recording or playing back a stereo source, normal mixer operation requires you to control the left and right channels separately. This makes it inconvenient to control the left/right volume balance or equalizer settings. In such cases, turn on the Channel Link function so that a pair of channels can be controlled in stereo.

When Channel Link is on, odd- and even-numbered adjacent channels will be paired as shown below, and the settings of each odd-numbered channel will be the same as the settings of the corresponding even-numbered channel. When the settings of one channel are modified, the settings of the paired channel will change in the same way.

- Channel 1: stereo a (left)
- Channel 2: stereo a (right)
- Channel 3: stereo b (left)
- Channel 4: stereo b (right)
- Channel 5: stereo c (left)
- Channel 6: stereo c (right)
- Channel 7: stereo d (left)
- Channel 8: stereo d (right)

The PAN knob and faders of each channel will function as follows.

Odd-numbered channel faders:
will adjust the volume level of the stereo signal output to the MIX buss or the REC buss.

Odd-numbered channel PAN knobs:
will adjust the left/right volume balance of the stereo signal output to the MIX buss or the REC buss.

Even-numbered channel faders:
will adjust the volume level of the stereo signal output to the AUX buss (A, B).

Even-numbered channel PAN knobs:
will adjust the left/right volume balance of the stereo signal output to the AUX buss (A, B).

To turn on Channel Link, use the following procedure.

1. Press [CH EDIT] for one of the channels for which you want to turn on Channel Link.
2. Press PARAMETER [▶▶] to get the "Channel Link=" display, and use the TIME/VALUE dial to turn it "On." In the bar display, the channels for which Channel Link was turned on will blink.

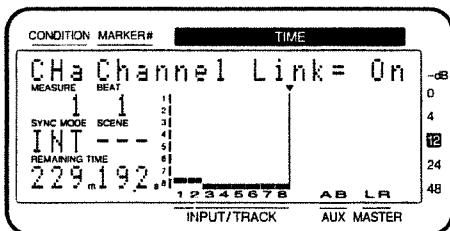

3. Press [PLAY (DISPLAY)] to return to Play condition.

Undoing a recording or editing operation

While using the VS-880, there may be times when a recording does not proceed as you wish, or when you would like to re-do an operation. In such cases, use the Undo function. The Undo function cancels the operation that you have performed, and returns the data to its previous condition. To cancel the last-performed Undo operation, you can use the Redo function.

When using the Undo function, you will specify the number of previous steps that will be undone. For example, suppose that you use punch-in recording to perform five consecutive re-recordings of the same location. If you later decide to return to the condition of the second recording (step 2), you would set the Undo function to return to the condition of three steps earlier (Undo Level 3).

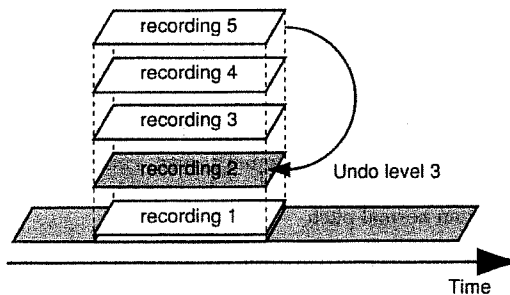

If, after executing the Undo operation, you decide to return to the condition of step 5, execute the Redo operation. However if you once again record (step 3') after returning to the condition of recording number 2, the recordings 3-5 that were canceled by the Undo operation will be lost. This means that if after step 3' you use the Undo operation to return to the previous step, you will return to the condition of step 2.

Recording/editing operations which can be undone (Undo)

Recording or editing operations performed after creating a song are recorded together with the song data as its operation history, and the data itself is also preserved without being erased. For example, suppose that you perform 10 recording operations on song 1 and then create song 2. The operation history of song 2 is newly recorded from the time when song 2 was created. If you subsequently select song 1 again, the history of the 10 previous recording operations will still be there.

The Undo function refers to the operation history of the currently selected song, and restores the song to the condition in which it was the specified number of operations ago. In the case of song 1 in this example, you will be able to cancel the 10 recording operations that were performed. A maximum of 999 levels of operation history is recorded for each song.

■ Canceling the last-performed Undo (Redo)

The Redo function can be executed if the UNDO indicator is lit. If the song data is saved, for example by your doing STORE Current or selecting another song, the UNDO indicator will go out and the Undo function will no longer be available.

1. Hold down [SHIFT] and press [UNDO]. When Redo is executed, the UNDO indicator will go dark.

■ Canceling only the last-performed operation

If you most frequently use the Undo function to undo just the previously performed recording/editing operation (i.e., undo level 1), you may prefer not to be bothered with the messages that appear when the [UNDO] button is pressed. In this case, make the following settings so that just the previous operation will be undone immediately when the [UNDO] button is pressed.

1. Press [SYSTEM]. If a message with a question mark such as "SYS System PRM?" does not appear, press [SYSTEM] once again.
2. Use PARAMETER [◀◀][▶▶] to get the "SYS System PRM?" message, and press [YES].
3. Use PARAMETER [◀◀][▶▶] to get the "SYS UNDO MESSAGE=" and use the TIME/VALUE dial to set this "Off."
4. When the setting has been made, press [PLAY (DIS-PLAY)] to return to Play condition.

UNDO MSG (Undo message)

If, when [UNDO] is pressed, you want the previous operation to be undone immediately without a confirmation message appearing, set this "Off." Normally you should set this "On."

When the disk has little remaining space

■ Deleting only unneeded performance data (Song Optimize)

When operations such as overdubbing and punch-in recording are repeated, the old data will remain in the disk drive. In some cases, significant amounts of memory can be occupied by this unnecessary data, decreasing the available space on the current drive, and shortening the length of time available for recording.

The Optimize operation erases this unnecessary data from the disk drive, increasing the available disk space.

1. Press [SONG], and select "SNG Song Optimize?," press [YES].
2. The display will ask "SongOptimize Ok?," so press [YES].
3. The display will ask "Optimize Sure?," so press [YES] and the Optimize operation will be executed. Depending on the situation, an appreciable length of time will be required for the Optimize operation to be completed. This is not a malfunction. Do not turn the power off until the Optimize operation is completed.

■ Deleting one song of performance data (Song Erase)

This erases song data from the current drive.

1. Press [SONG], select "SNG Song Erase?," and press [YES].
2. The names of the songs stored on the current drive will appear. Select the song that you wish to erase, and execute. An asterisk "*" will appear at the beginning of the currently selected song. If the currently selected song has been erased, the lowest-numbered song in the current drive will be selected.

Chapter 10 Overall settings and status checking

If the display area is difficult to read (Contrast)

Depending on the location where the VS-880 is placed, the display may sometimes be difficult to read. In such cases, use the following procedure to adjust the display contrast (0-15).

Adjustment procedure 1

1. Press [SYSTEM]. If a message with a question mark such as "SYS System PRM?" does not appear, press [SYSTEM] once again.
2. Use PARAMETER [◀|▶] to get the "SYS System PRM?" display, and press [YES].
3. Use PARAMETER [◀|▶] to get the "SYS LCD Contrast=" display and then use the TIME/VALUE dial to adjust the contrast.
4. When you finish making the setting, press [PLAY (DISPLAY)] to return to Play condition.

Adjustment procedure 2

1. Press [PLAY (DISPLAY)] once. Then hold down [PLAY (DISPLAY)] and rotate the TIME/VALUE dial to adjust the contrast. The display will show the current setting.
2. When you finish making the setting, release [PLAY (DISPLAY)].

Switching the contents of the display (Bar Display)

In Play condition, you can hold down [SHIFT] and press [DISPLAY (PLAY)] to switch the contents of the bar display. In Edit condition, the contents of the display will change depending on the selected parameter or operation.

● Pre Level

The volume of each channel before passing through the channel faders will be displayed. The AUX and MASTER fields indicate the respective volume levels of the signal after passing through the AUX knob and the master fader.

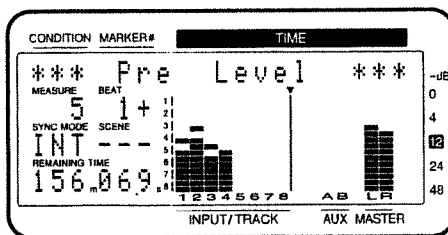

● Post Level

The volume of each channel after passing through the channel faders will be displayed. The AUX and MASTER fields indicate the respective volume levels of the signal after passing through the AUX knob and the master fader.

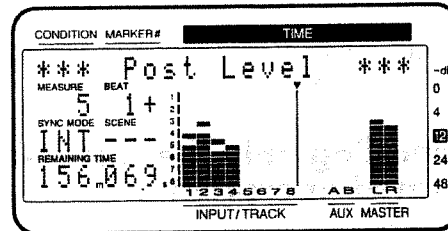

● Play List

The way in which sound is recorded in the various tracks before and after the current time will be displayed.

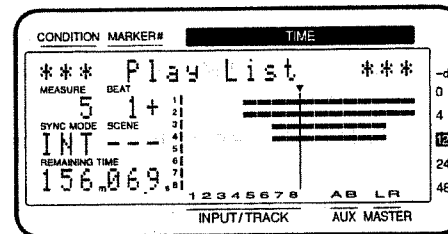

● Fader/Pan

The settings of the master fader and the PAN knob and fader of each channel will be displayed. If the displayed location of the PAN knobs or faders is different than the actual location (as when the mixer mode has been switched), the current location of the PAN knob or fader will blink.

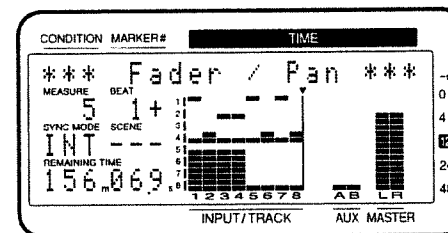

Creating a song which maintains the current system settings (System Parameter Keep Switch)

It is possible to create a new Song (Song New), with the current system parameter setting remained. You can start recording/editing with the current environment of system parameters, without re-customizing the Preview Length (p.76) or Metronome (p.109) settings. Operation is as follows.

1. Press [SYSTEM] several times until "SYS System PRM?" is displayed.
2. Press [YES].
3. Press PARAMETER [▶▶] several times until "SysPrmKeepSw=" is displayed.

SysPrmKeepSw=Off

4. Operate TIME/VALUE dial.

SysPrmKeepSw (System Parameter Keep Switch)

This setting determines whether the system parameter setting should be maintained or not in the newly created Song, upon executing Song New,

- Off: Create a new Song with all the parameters initialized (p.142).
- On: Create a new Song which maintains the system parameters of the current Song.

* Vari Pitch setting (p.111) cannot be maintained, but initialized to the sample rate you select upon Song New.

5. Press [PLAY (DISPLAY)] to go back to Play condition.
6. Create a new Song according to "Specifying the recording mode (Song New)." (p.62)

* If you press [NO] to "STORE Current?" message, the new Song will contain the last-stored system parameters. But only for the following parameters, current status will be maintained.

- Display contrast (p.114)
- Shift Lock (p.44)
- Numeric type (p.44)
- System Parameter Keep Switch
- IDE drive (p.116)
- SCSI self ID number (p.117)

Displaying measures/beats

If both the metronome is being used and MIDI clock messages are being transmitted, the measure and beat of the song can be displayed in the MEASURE field and BEAT field of the display screen. When you are running in synchronization with an external device or recording a song along with a previously-created tempo map, this allows you to operate the VS-880 just as though you were operating a MIDI sequencer.

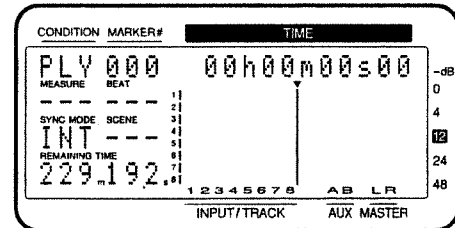

1. Press [SYSTEM] several times until "SYS System PRM ?" appears.
2. Press [YES].
3. Press PARAMETER [▶▶] several times until "SYS MetroOut=" appears.
4. Rotate the TIME/VALUE dial. Here you can select either "INT" or "MIDI."

MetroOut (Metronome output)

When you wish to use a metronome to keep time as you record, the metronome sound (click) can be output from the VS-880. The timing of the metronome sound will depend on the tempo map settings (p.90).

- Off: The metronome sound will not be output.
- INT: The metronome sound will be output from the MASTER OUT jacks.
- MIDI: A Note message will be transmitted from MIDI OUT connector as the metronome. Select this when you wish to play the metronome using a sound of an external MIDI sound source.

* When transmitting a Note message as the metronome, set the MIDI Thru switch (p.109) to "Out." You will also need to make settings for the Metronome Channel, Accent Note, Accent Velocity, Normal Note, and Normal Velocity (p.110).

5. Press PARAMETER [▶▶] several times until "SYS MeasureDisp=" appears.
6. Rotate the TIME/VALUE dial. For this example, select "Auto".

MeasureDisp (Measure Display)

- Always: Always display the MEASURE field and BEAT field.
- Auto: Do not display the MEASURE field and BEAT field when not necessary.

7. Press [SYSTEM] several times until "SYS Sync/Tempo ?" appears.

8. Press [YES].
9. Press PARAMETER [▶▶] several times until "SYS Syn:Gen=" appears.
10. Rotate the TIME/VALUE dial. For this example, select either "MIDIClk" or "SyncTr".

Gen (Sync generator)

This selects the type of synchronization signal that will be transmitted from the MIDI OUT connector. When using a synchronization signal from the VS-880 to synchronize external MIDI devices, set this to the desired type of synchronization signal.

- Off: Synchronization signals will not be transmitted.
- MTC: MIDI Time Code will be transmitted.
- MIDIClk: MIDI Clock will be transmitted.
- SyncTr: MIDI Clock data recorded on the sync track will be transmitted.

11. Press [PLAY(DISPLAY)].
You will return to Play condition.

* "+" next to the beat number display means the current time is not at the top of the measure or beat. If the time is exactly at the top of the measure or beat, "+" will not be displayed.

Constantly monitoring the input source

On channels for which Track Status is set to REC, playing back the song in record ready mode (REC indicator blinking) will allow you to monitor the performance that is recorded in the track, and during recording (REC indicator lit) you will be able to monitor the input source. At this time, pressing [STATUS] will let you switch between monitoring the track and monitoring the input source. It is also possible to make settings so that the input source is always monitored.

1. Press [SYSTEM] several times until "SYS System PRM ?" appears.
2. Press [YES].
3. Press PARAMETER [▶▶] several times until "SYS Record Mon=" appears.
4. Rotate the TIME/VALUE dial.

Record mon (Record monitor)

- AUTO: Switch between monitoring the track and monitoring the input source.
- SOURCE: Always monitor the input source.

	Stopped	Playing	Recording
AUTO	Input source	Track/Input source	Input source
SOURCE	Input source	Input source	Input source

5. Press [PLAY (DISPLAY)].
You will return to Play condition.

Changing the VS-880's SCSI ID number

You must make settings so that the VS-880's own SCSI ID number does not conflict with the SCSI ID number of any other SCSI device which is connected to the VS-880 (p.131). When shipped from the factory, the VS-880's SCSI ID number is set to "7." Set the connected disk drive(s) to an ID number other than "7."

If no other SCSI ID number is vacant, it is also possible to change the SCSI ID number of the VS-880.

1. Press [SYSTEM] several times until "SYS DISK PRM ?" appears.
2. Press [YES].
3. Press PARAMETER [▶▶] several times until "SYS DSK:SCSI Self=" appears.
4. Rotate the TIME/VALUE dial.

SCSI Self (SCSI self ID number)

Set the SCSI ID number (0-7) of the VS-880 itself

5. Press [PLAY (DISPLAY)].
You will return to Play condition.

* The newly specified SCSI ID number will take effect the next time the power is turned on.

Checking the size of a recorded performance

You can see the Song Name, Song Number, Sample Rate, Recording Mode, and the actual used capacity of the current song by the following operation.

1. Stop the song playback. When the song is performed, press [STOP].
2. Press [PLAY (DISPLAY)] to return to Play condition.
3. Hold down [SHIFT] and press [SONG]. The display will indicate Song Information briefly.

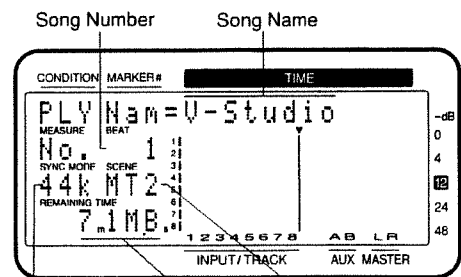

Sample Rate Recording Mode
Song Capacity (In the example, 71 MB is shown.)

* The actual used capacity of the song is displayed as 1 MB = 1,000,000 bytes. The displayed value is the approximate standard value.

Restoring the mixer settings to the initial state

After you have made repeated tries at mixing, you can restore the various condition settings of Channel edit, Master Block edit and System edit to the initial state in which they were when the song was created.

However the volume level and pan of each channel and the volume level of the master section will be according to the positions of the pan knobs and fader on the top panel.

* Even if you restore the mixer settings to their initial state, the song, scene, tempo map and sync track data will not be lost. Furthermore, the IDE drive, SCSI self ID, scene, Shift Lock, and Numerics Type settings will not return to their default state.

1. Press [SYSTEM] several times until "SYS System PRM ?" is displayed.
2. Press [YES].
3. Press PARAMETER [▶▶] several times until "SYS Init Mix/SysPRM ?" is displayed.
4. Press [YES].
A message will ask you to confirm that you really want to restore the mixer to the initial settings.
5. Press [YES]. To cancel the operation press [NO].
When the mixer settings return to the initial state, you will be in Play condition.

If there is no internal hard disk

Even if there is no internal hard disk, the VS-880 can be used by connecting only an external drive such as a Zip drive to the SCSI connector. In this case, approximately 30 seconds extra time will be required for the system to start up after the power is turned on, while the system checks to see whether an internal hard disk is connected. You can avoid having to wait this extra time by making settings so that an IDE drive is not used.

1. Press [SYSTEM] several times until "SYS DISK PRM ?" appears.
2. Press [YES].
The display will indicate "SYS DSK:IDE Drv=".
3. Rotate the TIME/VALUE dial.

IDE Drv (IDE drive)

On: The internal hard disk will be used.
Off: The internal hard disk will not be used.

4. Press [PLAY(DISPLAY)].
You will return to Play condition.

Chapter 11 Taking advantage of the VS-880 (ideas and examples)

Along with the functions explained in earlier chapters, this chapter explains some actual ways in which the VS-880 can be used effectively.

Recording multiple sources to one track

Here we will explain how the sources input to INPUT 1-3 can be recorded on track 1. This is convenient, for example, when you wish to put up a separate mic for hi-hat, snare and cymbal and record the sound of the entire drum set onto a single track. In this case, the signal flow will be as follows.

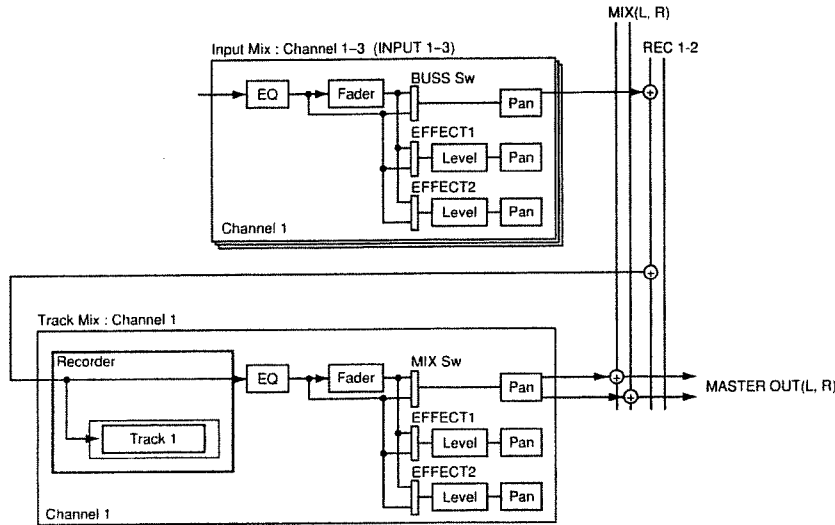

1. Make sure that the mixer mode is INPUT MIX.
2. Press channel 1 [CH EDIT(Input/BUSS)].
3. Use PARAMETER [◀▶] to make the display read "IN1 BUSS Sw=".
4. Rotate the TIME/VALUE dial. For this example, select "PstFade" so that the channel faders will adjust the recording level.

BUSS Sw (buss switch)

This selects the way in which the signal is sent to the buss selected by Buss Select. If "Off" is selected, the BUSS Sel, BUSS Level, and BUSS Pan/BUSS Bal parameters will not be available.

Off: not sent.

PreFade: The signal before passing through the channel fader will be sent to the buss.

PstFade: The signal after passing through the channel fader will be sent to the buss.

5. Press PARAMETER [▶▶].
The display will indicate "IN1 BUSS Sel".
6. Select the track(s) on which you wish to record. Here we want to record on track 1, so select "1-2".

BUSS Sel (buss select)

This selects the output destination buss (MIX, 1-2, 3-4, 5-6, 7-8). The numerals of the value indicate the REC buss numbers.

INPUT MIX mode

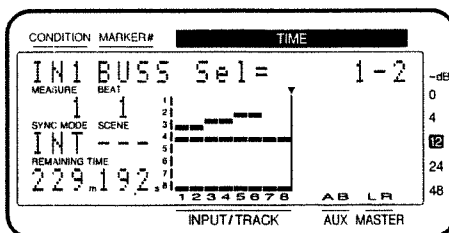

7. Since we are recording on track 1, turn the pan knob of channel 1 fully toward the L position.
8. As in steps 2–8, make the same settings for channels 2 and 3.
9. Set the track status of track 1 to REC.
When you begin recording, the sources being input to INPUT 1–3 will be recorded together onto track 1.

Collecting just the sections that you like

After listening to the recordings on each V-track, suppose that you wanted to use the intro from V-track 1 and the break from V-track 2, etc. In such cases, copy the desired sections to a different V-track to assemble the sections into a single V-track.

The following procedure shows an example in which sections recorded on V-tracks 1, 2, and 3 of track 1 are assembled by copying them onto V-track 4.

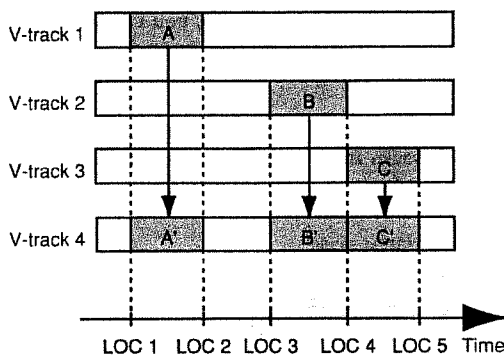

1. Switch V-tracks in INPUT→TRACK mode or in TRACK MIX mode, and register Locate points for the times at which you wish to copy data from them (p.57). For this example, use LOC 1–5.
2. Prepare V-track 1 of track 1 for playback.
3. Press [TRACK], use PARAMETER [◀] [▶] to get the "TRK Track Copy?" display, and press [YES]. The display will allow you to select the copy source track, and copy destination track and V-track.
4. Specify the copy source and copy destination track. Press [SEL (EDIT)] of track 1, and V-track 1 of track 1 will be selected as the copy source. Next, press CURSOR [▶] to make the copy destination field blink, press [SEL (EDIT)] of track 1, and use the TIME/VALUE dial to select V-track 4 as the copy destination.
5. As you repeatedly press PARAMETER [▶▶], the copy setting items will be displayed consecutively. For these items, use [LOC 1/5]–[LOC 4/8] to make settings.

- St (Start point): Specify the starting time of the copy source data. For V-track 1 specify "LOC 1."
- Frm (From point): Specify the time of the copy source data which will be copied to the To Point. For V-track 1, specify "LOC 1" just as you did for the Start Point.
- End (End point): Specify the ending time of the copy source data. For V-track 1, specify "LOC 2."
- To (To point): Specify the base time of the copy destination. For V-track 1, specify "LOC 1" just as you did for the Start Point.
- Copy Time: Specify the number of copies (1–99). In this example, specify "1."

6. As you repeatedly press PARAMETER [▶▶], a confirmation message will appear at the end. Press [YES] to execute the copy.
When the copy has been completed, you will return to Play condition.
7. Using the same procedure as steps 2–6, copy the desired areas of V-tracks 2 and 3 to V-track 4. When you have finished copying, select V-track 4 and check the playback of the assembled data.

< If noise between segments is obtrusive >

In the seams or breaks that occur when recording is begun or ended or when a phrase is copied, obtrusive noise may occur. The VS-880 fades-in and fades-out these breaks so that this noise will not be heard. If objectionable noise occurs, you can adjust the length of the fade-in and fade-out.

* It is not possible to set the fade-in/fade-out time to 0. Thus in some cases, such as if you copy a sustained sound such as strings and use it elsewhere, the break may be even more noticeable than if there had been no fade.

1. Press [SYSTEM] several times until "SYS System PRM ?" appears.
2. Press [YES].
3. Press PARAMETER [▶▶] several times until "FadeLength" appears.
4. Specify the fade-in/fade-out time. Rotate the TIME/VALUE dial.

FadeLength (Fade length)

When recording is begun or ended, unpleasant noise may occur. So that this noise is not heard when the song is played back, the VS-880 fades the start and end of the recording in and out. This parameter sets the fade in/out time (2, 10, 20, 30, 40, 50 ms).

* The Fade Length that was specified on a VS-880 Ver.1 will be modified as follows when the system is expanded. Reset the value as necessary.

Ver.1	V-XPANDED
10	2
20	10
30	20
40	30
50	40
-	50

5. Press [PLAY(DISPLAY)].
You will return to Play condition.

Copying an 8-track MTR performance to the VS-880

If you wish to re-record a recording of more than 4 channels from another MTR to the VS-880, it will not be possible to record all tracks at once. This means that in some cases, the recorded data will become skewed in time. This section explains how to correct the skew that may occur in such cases.

The VS-880 can record up to 4 track simultaneously. This means that, for example, if you wish to record from an 8-track MTR onto the VS-880, you will have to record in two passes of 4 channels each. If your MTR implements MTC (MIDI Time Code) or MMC (MIDI Machine Control), the MTR and the VS-880 can be synchronized for recording so that the timing of the two passes is identical. However if your MTR cannot be synchronized with the VS-880, the timing at which recording begins will be slightly different.

In such cases, you should record a sound on all tracks which will act as a marker before re-recording the performance to the VS-880. The marker sound should be one that it is easy to cue to, such as a clock striking the hour. After recording all the data to the VS-880, you can slide the data of the tracks so that the marker sounds are precisely aligned, thus correcting any time deviation that the tracks may have.

Here, we will explain in broad outline the procedure for re-recording 8 tracks from an MTR to the VS-880. For details on each step, refer to the relevant pages given.

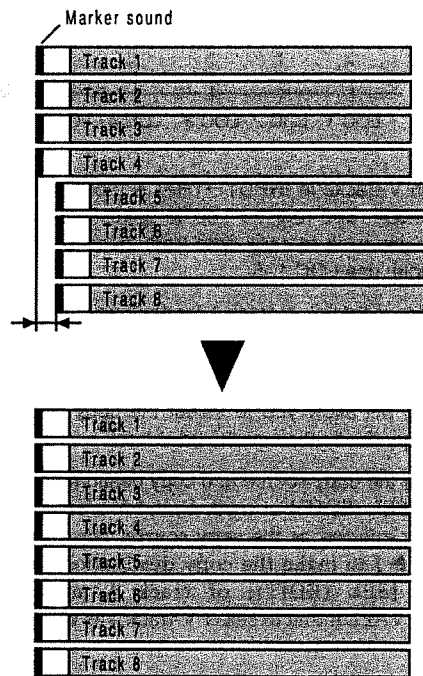

1. Re-record the playback of tracks 1–4 from the MTR to tracks 1–4 of the VS-880. Then register the time at which the marker sound appears as locate point 1.
 “Storing a time location” (p.57)
 “Finding a desired location (Preview)” (p.76)
2. Re-record the playback of tracks 5–8 from the MTR to tracks 5–8 of the VS-880. In the same way for this data as well, register the time at which the marker sound appears as locate point 2.
3. If there is a difference in timing between locate points 1 and 2, move one of the sets of tracks forward or backward so that both marker sounds will sound simultaneously.
 For example if you wish to move tracks 5–8 to the timing of tracks 1–4, select tracks 5–8 as move source, and select the same tracks as the move destination. Then set “St” to locate point 2, “End” as the end of the playback data, “Frm” as locate point 2, “To” as locate point 1, and then execute the move operation.
 “Modifying the organization of the performance (Move)” (p.79)
4. Press [PLAY (DISPLAY)] to return to Play condition. Playback the song, and check that the tracks are all aligned correctly.

Controlling the mixer from a MIDI sequencer

The VS-880 can transmit mixer settings and operations as MIDI messages. If VS-880 mixer settings and operations during song playback are recorded as MIDI song data to a MIDI sequencer, the song can later be played back to automatically control the VS-880’s mixer from the MIDI sequencer. This type of control is called “Compu-mix.”

The mixer can be controlled using Control Change messages or System Exclusive messages.

Here, we will explain the general process for when using control change messages. For details refer to the appropriate pages.

< When using exclusive messages >
 When performing a compu-mix, you should normally use control change messages. However if the use of control change messages would affect other MIDI devices in your setup, you may use system exclusive messages instead.

Correspondence between MIDI channels and controller numbers

MIDI channels correspond with mixer channels as follows. Channels for which Channel Link is on will use control change messages of the MIDI channel of the odd-numbered mixer channel. Control change messages received on the MIDI channel of the even-numbered mixer channel will be ignored.

INPUT→TRACK mode

MIDI channel	Mixer channel
1	1
2	2
3	3
4	4
5	5
6	6
7	7
8	8
15	master

INPUT MIX mode / TRACK MIX mode

MIDI channel	Mixer channel
1	track channel 1
2	track channel 2
3	track channel 3
4	track channel 4
5	track channel 5
6	track channel 6
7	track channel 7
8	track channel 8
9	input channel 1
10	input channel 2
11	input channel 3
12	input channel 4
13	input channel 5
14	input channel 6
15	master

Controller numbers correspond to the channel parameters as follows.

Controller numbers	Mixer parameters
16	EQ L Gain
17	EQ L Freq.
18	EQ M Gain
19	EQ M Freq.
20	EQ M Q
21	EQ H Gain
22	EQ H Freq.
7	MIX Send Level
10	MIX Send Pan/Bal
23	AUX Send Level
24	AUX Send Pan/Bal
25	EFF1 SND Level
26	EFF1 SND Balance
27	EFF2 SND Level
28	EFF2 SND Balance
29	TRACK STATUS

Controller numbers correspond to the master section parameters as follows.

Controller numbers	Mixer parameters
7	Master Level
10	Master Balance
23	AUX Level
24	AUX Balance
25	EFF1 RTN Level
26	EFF1 RTN Balance
27	EFF2 RTN Level
28	EFF2 RTN Balance
16	EFF1 SND Level
17	EFF1 SND Balance
18	EFF2 SND Level
19	EFF2 SND Balance

Preparations

1. Use two MIDI cables to connect the VS-880 and the MIDI sequencer as follows.

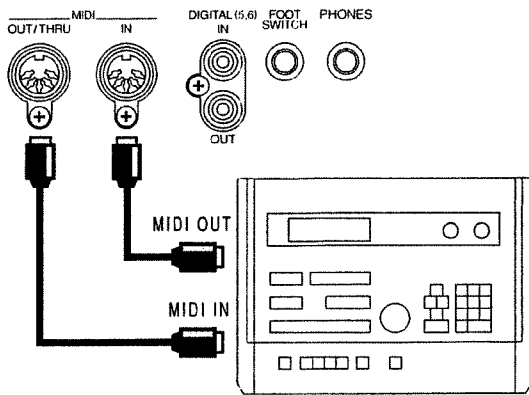

2. Press [SYSTEM], select "SYS MIDI PRM?", and press [YES]. Make the following settings for the relevant parameters.
MIDIThr: Out
CtrLocal: On
CtrType: C.C.
3. When you finish making settings, press [PLAY (DIS-PLAY)] to return to Play condition.
4. Make settings on both devices so that the MIDI sequencer will synchronize to the VS-880. On the MIDI sequencer, make settings so that MIDI messages received at its MIDI IN connector will not be re-transmitted from its MIDI OUT connector.
"Synchronizing with a MIDI sequencer" (p.86)

< Notice for synchronization >
So that the compu-mix will be accurately played back, record the initial settings of the mixer at the beginning of the MIDI song data. However if the music begins at the moment that playback begins, the VS-880 will have to adjust its mixer settings at the same moment that song playback begins. In some cases, this can cause the initial operation to slow down.
If this problem occurs, insert several measures of blank space at the beginning of the VS-880 song and the MIDI sequencer song.

Recording mixer operations

1. Make the initial mixer settings in preparation for playing back the song.
2. Put the MIDI sequencer in record mode, and begin playback on the VS-880.
3. When playback begins, immediately hold down [SHIFT] and press [SCENE] to record the initial settings of the mixer. Then, as you listen to the song, adjust the faders etc. of the mixer as appropriate.

4. When the song playback ends, stop the VS-880.
The mixer settings have now been recorded. Save the MIDI song data on a floppy disk, etc.

< Recording the initial settings of the mixer beforehand >
If you want to record just the initial settings of the mixer before playing back the song, use the following procedure.

1. After making the initial settings for song playback, store the settings as a scene. In this case, make settings so that fader settings will also change when a scene is recalled.
"Storing the current mixer settings" (p.52)
2. Start recording on the MIDI sequencer, and recall the VS-880 scene.
When the scene is recalled, the settings of the scene will be transmitted and recorded on the MIDI sequencer. Recall the scene while the song is stopped. It is not possible to recall a scene while a song is playing back.
After storing the scene, do not change the settings of the mixer until you start recording mixer operations. If you change the mixer settings before you start recording, the compu-mix will not reproduce the mixer operations correctly.

Performing a compu-mix

1. Cue the MIDI song data and the VS-880 song.
2. Start playback on the VS-880, and the mixer will be controlled by the MIDI song data as the song plays back.
3. When playback ends, stop the VS-880.

< If you want channel fader and pan knob operations to be ignored >
While playing back a compu mix, there may be times when you want the actual volume level and pan to remain unaffected even if the channel faders and pan knobs of the top panel are operated. In such cases, use the following procedure.

1. Press [SYSTEM] several times until "SYS MIDI PRM ?" appears.
2. Press [YES].
3. Press PARAMETER [▶▶] until "SYS MID:CtrLocal=" appears.

CtrLocal (Mixer control local switch)
On: Settings will change.
Off: Settings will not change.

4. Press [PLAY].
You will return to Play condition.

Operating the VS-880 from another device (MMC)

The VS-880 supports MMC. This means that when two VS-880 units are synchronized or when a VS-880 is used in conjunction with an MMC-supporting MIDI sequencer etc., operations such as song playback, stop and fast-forward can be performed by operating only the master device.

* Depending on the MIDI device that you are using, some devices may not support the MMC functionality of the VS-880. In this case, the VS-880 cannot be operated as explained in this owner's manual. The MMC functionality supported by the VS-880 is described in detail in the separately sold MIDI Implementation. If you wish to purchase a copy, contact a nearby Roland service center or your dealer.

< About MMC >

MMC is an acronym for "MIDI Machine Control." This is a rule that defines how MIDI system exclusive messages can be used to control multiple recording devices from a single device. The VS-880 supports MMC. In addition to song playback, stop and fast-forward, you can also select the tracks for recording, etc.

■ Synchronizing the operation of two VS-880 units

Here we will explain how the operation of two VS-880 units can be synchronized. One VS-880 will be the master, and the other VS-880 will be the slave. Make connections as follows.

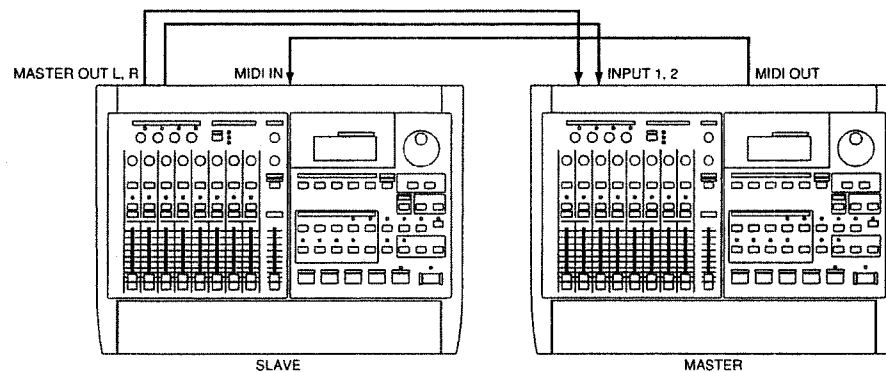

Settings for the master VS-880

1. Press [SYSTEM] several times until "SYS MIDI PRM ?" appears.
2. Press [YES].
3. The display will indicate "SYS MID:DeviceID=". Make sure that the device ID number is "17".

DeviceID (Device ID)

This sets the Device ID number (1-32) that is used when exchanging exclusive messages (mixer parameters) with an external MIDI device. Exclusive messages can be transmitted and received between devices which have the same Device ID number setting.

4. Press PARAMETER [▶▶].
5. The display will indicate "SYS MID:MIDIThr=". For this example, select "Out" so that MTC can be transmitted.

MIDIThr (MIDI thru switch)

This selects the function of the MIDI OUT/THRU connector. With the factory settings, this is set to "Out."

- Out: The connector will transmit MIDI messages from the VS-880. Select this when you want to transmit metronome Note messages or mixer parameter settings (control change messages or exclusive messages).
- Thru: MIDI messages received at the MIDI IN connector will be retransmitted from the connector without change.

6. Press PARAMETER [▶▶] twice.
7. The display will indicate "SYS MID:SysEx.Tx.= ". For this example, select "On" so that MMC can be transmitted.

SysEx.Tx (System exclusive transmit switch)

If you wish to transmit exclusive messages, set this "On." In order for exclusive messages to be transmitted, the MIDI Thru Switch must also be turned "Out."

8. Press PARAMETER [▶▶].
9. The display will indicate "SYS MID:MMC=". For this example, select "MASTER" so that MMC can be transmitted.

MMC (MMC mode)

This setting determines how the VS-880 will implement MMC.

- Off: MMC will neither be transmitted nor received.
- MASTER: MMC will be transmitted. The VS-880 will be the master device for external MIDI equipment.
- SLAVE: MMC will be received. The VS-880 will be a slave device for external MIDI equipment.

10. Press PARAMETER [▶▶] twice.
11. The display will indicate "SYS MID:CtrType=". For this example, select "Off".

CtrType (Mixer control type)

Select the type of MIDI messages that will be used when transmitting mixer settings to an external MIDI device, or when MIDI messages from an external MIDI device are used to control the mixer. Normally, you should select Control Change messages.

- Off: MIDI messages related to mixer operation will not be transmitted or received.
- C.C.: Control Change messages
- Excl: Exclusive messages

< About mixer control type >
 When mixer settings of the master unit are transmitted via control change message or exclusive message to the slave unit, operating the channel faders or pan of the master unit will cause the channel faders of the slave unit to be modified in the same way. To prevent this, we will turn the setting "Off" in this example.

12. Press [SYSTEM] three times.
 The display will indicate "SYS Sync/Tempo ?".
13. Press [YES].
 The display will indicate "SYS Syn:Source=".
14. Make sure that Sync Source is "INT".

Source (Sync source)

This determines how the VS-880 will synchronize with other devices.

- INT: The VS-880 will be controlled by its own internal clock. Select this setting when you are not synchronizing with other devices, or when you want external MIDI devices to be controlled by synchronization signals from the VS-880.
- EXT: The VS-880 will be controlled by synchronization signals (MTC) from an external MIDI device. In this case, the VS-880 will not operate unless it is receiving MTC signals. Select this setting when you want to use MTC from an external MIDI device to control the VS-880.

15. Press PARAMETER [▶▶].
16. The display will indicate "SYS Syn:Gen=". For this example, select "MTC" so that MTC can be transmitted.

Gen (Sync generator)

This selects the type of synchronization signal that will be transmitted from the MIDI OUT connector. When using a synchronization signal from the VS-880 to synchronize external MIDI devices, set this to the desired type of synchronization signal.

- Off: Synchronization signals will not be transmitted.
- MTC: MIDI Time Code will be transmitted.
- MIDIClk: MIDI Clock will be transmitted.
- SyncTr: MIDI Clock data recorded on the sync track will be transmitted.

17. Press PARAMETER [▶▶] twice.
 The display will indicate "SYS Syn:MTC Type=".
18. Make sure that MTC Type is "30".

MTC Type

This sets the type of MTC. Check the specifications of the MIDI devices that you are using, and select the appropriate type of MTC on the VS-880.

- 30: 30 frames per second non-drop format. This is used by audio devices such as analog tape recorders, and for NTSC format black and white video (used in the US and Japan, etc.).
- 29N: 29.97 frames per second non-drop format. This is used for NTSC format color video (used in the US and Japan, etc.).
- 29D: 29.97 frames per second drop format. This is used for NTSC format broadcast color video (used in the US and Japan, etc.).
- 25: 25 frames per second frame rate. This is used in SECAM format / PAL format video (used in Europe, etc.), and for audio equipment and film.
- 24: 24 frames per second frame rate. This is used for film in the US.

< Non-drop format and drop format >

NTSC format VCRs use two formats; non-drop and drop. In non-drop format, the frames are continuous. On the other hand, drop format skips the first two frames at the beginning of each minute (except for 10, 20, 30, 40 and 50 minutes), in order to be compatible with NTSC format color video.

In most video production and music production, continuous frames are easier to handle, so non-drop format is widely used. However in broadcast studios, where time code must match actual clock time, drop format is widely used.

19. Press [PLAY(DISPLAY)].

You will return to Play condition.

Settings for the slave VS-880

1. Press [SYSTEM] several times until "SYS MIDI PRM ?" appears.
2. Press [YES].
The display will indicate "SYS MID:DeviceID=".
3. Set the device ID number to match the setting of the master unit. For this example, set it to "17."

DeviceID (Device ID)

This sets the Device ID number (1-32) that is used when exchanging exclusive messages (mixer parameters) with an external MIDI device. Exclusive messages can be transmitted and received between devices which have the same Device ID number setting.

4. Press PARAMETER [▶▶] twice.
 5. The display will indicate "SYS MID:SysEx.Rx.= ". For this example, select "On" so that MMC can be received.
- SysEx.Rx (System exclusive receive switch)**
If you wish to receive exclusive messages, set this "On." Exclusive messages can be received when in Play condition.
6. Press PARAMETER [▶▶].
 7. The display will indicate "SYS MID:MMC=". For this example, select "SLAVE" so that MMC will be received.

MMC (MMC mode)

This setting determines how the VS-880 will implement MMC.

- Off: MMC will neither be transmitted nor received.
- MASTER: MMC will be transmitted. The VS-880 will be the master device for external MIDI equipment.
- SLAVE: MMC will be received. The VS-880 will be a slave device for external MIDI equipment.
8. Press [SYSTEM] three times.
The display will indicate "SYS Sync/Tempo ?".
 9. Press [YES].
The display will indicate "SYS Syn:Source=".
 10. For this example, select "EXT" so that the unit will operate according to the MTC that is received.

Source (Sync source)

This determines how the VS-880 will synchronize with other devices.

- INT: The VS-880 will be controlled by its own internal clock. Select this setting when you are not synchronizing with other devices, or when you want external MIDI devices to be controlled by synchronization signals from the VS-880.
- EXT: The VS-880 will be controlled by synchronization signals (MTC) from an external MIDI device. In this case, the VS-880 will not operate unless it is receiving MTC signals. Select this setting when you want to use MTC from an external MIDI device to control the VS-880.

11. Press PARAMETER [▶▶] three times.

The display will indicate "SYS Syn:MTC Type=".

12. Set the MTC type to match the setting of the master unit. For this example, set it to "30."**MTC Type**

This sets the type of MTC. Check the specifications of the MIDI devices that you are using, and select the appropriate type of MTC on the VS-880.

- 30: 30 frames per second non-drop format. This is used by audio devices such as analog tape recorders, and for NTSC format black and white video (used in the US and Japan, etc.).
- 29N: 29.97 frames per second non-drop format. This is used for NTSC format color video (used in the US and Japan, etc.).
- 29D: 29.97 frames per second drop format. This is used for NTSC format broadcast color video (used in the US and Japan, etc.).
- 25: 25 frames per second frame rate. This is used in SECAM format / PAL format video (used in Europe, etc.), and for audio equipment and film.
- 24: 24 frames per second frame rate. This is used for film in the US.

< Non-drop format and drop format >

NTSC format VCRs use two formats; non-drop and drop. In non-drop format, the frames are continuous. On the other hand, drop format skips the first two frames at the beginning of each minute (except for 10, 20, 30, 40 and 50 minutes), in order to be compatible with NTSC format color video.

In most video production and music production, continuous frames are easier to handle, so non-drop format is widely used. However in broadcast studios, where time code must match actual clock time, drop format is widely used.

13. Press [PLAY(DISPLAY)].

You will return to Play condition.

With these settings, operating the master VS-880 unit will cause the slave VS-880 unit to operate in synchronization.

■ Operating the VS-880 from an MMC-compatible device

Here we will explain the settings for operating the VS-880 in synchronization with a computer-based sequencer program that supports MMC and MTC. Make connections as follows.

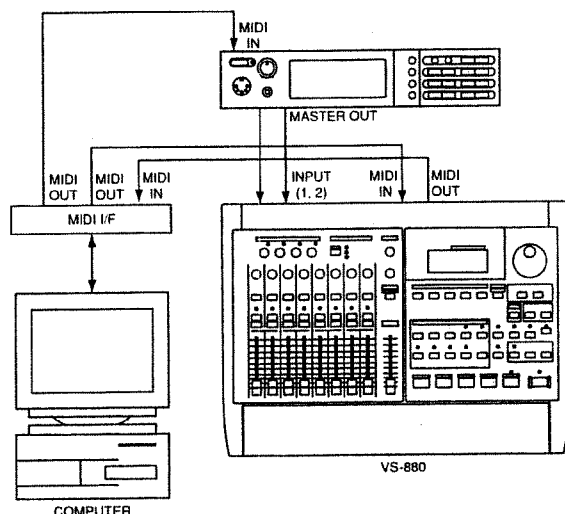

With these settings, the sequencer program will be the master for MMC, and the VS-880 will be the master for MTC. The sequencer program will be able to control playback, stop, and track status selection etc. on the VS-880.

Make settings for the VS-880

1. Press [SYSTEM] several times until "SYS MIDI PRM ?" appears.
2. Press [YES].
3. Press PARAMETER [▶▶].
The display will indicate "SYS MID:MIDIThr=".
4. For this example, select "Out" so that MTC can be transmitted.

MIDIThr (MIDI thru switch)

This selects the function of the MIDI OUT/THRU connector. With the factory settings, this is set to "Out."

Out: The connector will transmit MIDI messages from the VS-880. Select this when you want to transmit metronome Note messages or mixer parameter settings (control change messages or exclusive messages).

Thru: MIDI messages received at the MIDI IN connector will be retransmitted from the connector without change.

5. Press PARAMETER [▶▶].
The display will indicate "SYS MID:SysEx.Rx.=".
6. For this example, select "On" so that MMC can be received.

SysEx.Rx (System exclusive receive switch)

If you wish to receive exclusive messages, set this "On." Exclusive messages can be received when in Play condition.

7. Press PARAMETER [▶▶] twice.
The display will indicate "SYS MID:MMC=".
8. For this example, select "SLAVE" so that MMC can be received.

MMC (MMC mode)

This setting determines how the VS-880 will implement MMC.

- Off: MMC will neither be transmitted nor received.
- MASTER: MMC will be transmitted. The VS-880 will be the master device for external MIDI equipment.
- SLAVE: MMC will be received. The VS-880 will be a slave device for external MIDI equipment.

9. Press PARAMETER [▶▶] twice.
10. Press [SYSTEM] three times.
The display will indicate "SYS Sync/Tempo ?".
11. Press [YES].
The display will indicate "SYS Syn:Source=".
12. Make sure that the Sync Source is "INT".

Source (Sync source)

This determines how the VS-880 will synchronize with other devices.

- INT: The VS-880 will be controlled by its own internal clock. Select this setting when you are not synchronizing with other devices, or when you want external MIDI devices to be controlled by synchronization signals from the VS-880.
- EXT: The VS-880 will be controlled by synchronization signals (MTC) from an external MIDI device. In this case, the VS-880 will not operate unless it is receiving MTC signals. Select this setting when you want to use MTC from an external MIDI device to control the VS-880.

13. Press PARAMETER [▶▶].
The display will indicate "SYS Syn:Gen.=".

14. For this example, select "MTC" so that MTC can be transmitted.

Gen (Sync generator)

This selects the type of synchronization signal that will be transmitted from the MIDI OUT connector. When using a synchronization signal from the VS-880 to synchronize external MIDI devices, set this to the desired type of synchronization signal.

- Off: Synchronization signals will not be transmitted.
- MTC: MIDI Time Code will be transmitted.
- MIDIClk: MIDI Clock will be transmitted.
- SyncTr: MIDI Clock data recorded on the sync track will be transmitted.

15. Press PARAMETER [▶▶] twice.
The display will indicate "SYS Syn:MTC Type=".

16. Set the MTC type to match the setting of the master unit. For this example, set it to "30."

MTC Type

This sets the type of MTC. Check the specifications of the MIDI devices that you are using, and select the appropriate type of MTC on the VS-880.

- 30: 30 frames per second non-drop format. This is used by audio devices such as analog tape recorders, and for NTSC format black and white video (used in the US and Japan, etc.).
- 29N: 29.97 frames per second non-drop format. This is used for NTSC format color video (used in the US and Japan, etc.).
- 29D: 29.97 frames per second drop format. This is used for NTSC format broadcast color video (used in the US and Japan, etc.).
- 25: 25 frames per second frame rate. This is used in SECAM format / PAL format video (used in Europe, etc.), and for audio equipment and film.
- 24: 24 frames per second frame rate. This is used for film in the US.

< Non-drop format and drop format >

NTSC format VCRs use two formats; non-drop and drop. In non-drop format, the frames are continuous. On the other hand, drop format skips the first two frames at the beginning of each minute (except for 10, 20, 30, 40 and 50 minutes), in order to be compatible with NTSC format color video.

In most video production and music production, continuous frames are easier to handle, so non-drop format is widely used. However in broadcast studios, where time code must match actual clock time, drop format is widely used.

17. Press [PLAY(DISPLAY)].
You will return to Play condition.

Make settings for the sequencer program

Make the following settings for the sequencer program that you are using. For details on making the settings, refer to the owner's manual for your sequencer program.

Device ID number	17
MTC	Receive
MTC Type	30 fps
MMC	Transmit (Master)

■ If you have problems with synchronization

- Does the device you are using support the VS-880's MMC?
- Do the device ID numbers match?
- Is the MIDI Thru switch set to Out?
- Is the Sync Generator set correctly?
- Is the Sync Source set correctly?
- Is the same type of MTC selected for both devices?

Using external effect units

This section gives two examples of using external effect devices. Refer to these explanations when you wish to use your own effect devices.

■ Applying an effect during playback

When using external effects, use the AUX SEND jacks as effect send jacks. Here, we will use the example of applying effects to a stereo performance recorded on tracks 1/2. We will use the INPUT 1 and 2 jacks as effect return jacks. Connect your effect device as shown below.

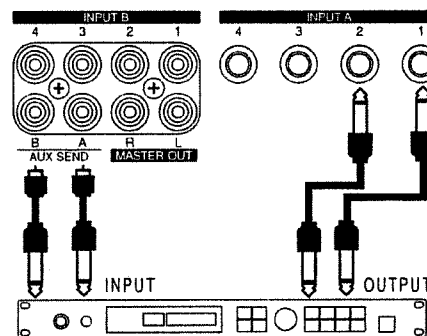

1. Switch the mixer mode to TRACK MIX mode. Hold down [SHIFT] and press [SELECT]. When TRACK MIX mode is selected, the TRACK MIX indicator will light. If the INPUT MIX indicator is lit, press [SELECT] once again.
2. Assign the outputs of tracks 1 and 2 to the AUX buss alone. Press channel 1 [CH EDIT], and set the relevant parameters as follows. Use PARAMETER [◀◀][▶▶] to select the parameters, and use the TIME/VALUE dial to set the values. Make the same settings for channel 2.
TR1 BUSS Sw=Off
TR1 AUX Sw=PreFade
TR1 AUX Pan=L63 (TR2 Pan=R63)
3. Press [Select] to switch to INPUT MIX mode.
4. Assign the output of inputs 1 and 2 to the MIX buss. Make settings using the same procedure as in step 2.
IN1 BUSS Sw=PstFade
IN1 BUSS Sel=MIX
IN1 BUSS Pan=L63 (IN2 BUSS Pan=R63)

5. Make settings so that the signal of the MIX buss is output from the MASTER OUT jacks.
Press the master block [EDIT]. Then use PARAMETER [◀◀][▶▶] to get the "MST Master Mode=" display, and use the TIME/VALUE dial to select "MIX."
6. Now the effects can be applied. Press [PLAY (DISPLAY)] to return to Play condition.
7. Playback the song, and adjust the way in which effects are applied.
Use the "AUX Level" parameters of track channels 1 and 2 and the AUX knob of the master section to adjust the level of the signal sent to the external effect unit. Use the faders of channel 1 and 2 to adjust the signal level from the effect sound. However this balance will depend on the effect that you use, so you should adjust the volume level on the external effect unit, and leave the VS-880 fixed at an appropriate volume level.
7. Make settings so that the signals of the MIX buss are output from the MASTER OUT jacks.
Press the master section [EDIT], and then use PARAMETER [◀◀][▶▶] to get the "MST Master Mode=" display, and use the TIME/VALUE dial to select "MIX."
8. Now effects can be applied. Press [PLAY (DISPLAY)] to return to play condition.
9. Set the track status of track 1–4 to PLAY, and the track status of tracks 7 and 8 to REC. Then playback the song and adjust the way in which effects are applied. When you finish adjusting, record.
Use the track channels 1 and 2 "AUX Level" and the master section AUX knob to adjust the signal level sent to the external effect unit. Use the faders of input channels 1 and 2 to adjust the signal level from the effect. However this will change depending on the effect device that you use, so it is best to adjust the volume level on the external effect device, and fix the VS-880 at an appropriate volume level.

■ Applying an effect while bouncing tracks

Track bouncing is the procedure by which the data recorded on two or more tracks is merged. At this time, you may apply effects to specific tracks.

Here, we will give the example of bouncing two stereo recordings made on tracks 1/2 and tracks 3/4 onto tracks 7/8 as you apply effects only to tracks 1/2.

Connect your effect device as explained in the previous section.

1. Switch the mixer mode to TRACK MIX mode. Hold down [SHIFT] and press [SELECT].
When you switch to TRACK MIX mode, the TRACK indicator will light. If the INPUT MIX indicator is lit, press [SELECT] once again.
2. Assign the outputs of tracks 1 and 2 to the AUX buss alone.
Press channel 1 [CH EDIT], and set the relevant parameters as follows. Use PARAMETER [◀◀][▶▶] to select parameters, and use the TIME/VALUE dial to set the value. Make the same settings for channel 2.
TR1 BUSS Sw=Off
TR1 AUX Sw=PreFade
TR1 AUX Pan=L63 (TR2 AUX Pan=R63)
3. Assign the outputs of tracks 3 and 4 to REC buses 7-8. Make settings in the same way as in step 2.
TR3 BUSS Sw=PstFade
TR3 BUSS Sel=7-8
TR3 BUSS Pan=L63 (TR4 BUSS Pan=R63)
4. Assign the outputs of tracks 7 and 8 to the MIX buss.
TR7 BUSS Sw=PstFade
TR7 BUSS Sel=MIX
TR7 BUSS Pan=L63 (TR8 BUSS Pan=R63)
5. Press [SELECT] to switch to INPUT MIX mode.
6. Assign the outputs of inputs 1 and 2 to REC buses 7-8.
IN1 BUSS Sw=PstFade
IN1 BUSS Sel=7-8
IN1 BUSS Pan=L63 (IN2 BUSS Pan=R63)



DIGITAL STUDIO WORKSTATION VS-880

Appendices

Using an external disk drive (About SCSI) ...	130
Troubleshooting	132
Error messages	134
Special key operations	136
Parameter list	138
MIDI implementation chart	143
Mixer section block diagram	144
Glossary	145
Specifications	146
About the V-XPANDED sticker	147
Index	149
Track sheet	152

Using an external disk drive (About SCSI)

The SCSI connector of the VS-880 allows you to connect disk drives such as hard disks and magneto-optical disk drives. This section explains the procedure required for using an external disk drive.

- * Disk drives are precision devices. If they are connected or used incorrectly, not only may they fail to operate correctly, but the data on the disk can be lost or even the disk drive itself may be damaged. In addition to the explanation in this section, please be sure to read and observe the explanations in the manual for your disk drive.
- * A disk drive being used for the first time with the VS-880 must be initialized by the VS-880. When a disk drive is initialized, all data on that disk drive will be lost. Before using a disk drive that has been used by another device, make sure that it is OK to erase the data.

< About IDE >

"IDE" stands for "Integrated Device and Electronics." This is the standard data transmission method used by the hard disk drives of recent personal computers. The HDP88 series hard disk drives (sold separately) that can be installed in the VS-880 are IDE compatible.

< About SCSI >

"SCSI" stands for "Small Computer System Interface." This is a data transmission method that can transmit large amounts of data in a short time. Since the VS-880 has a SCSI connector, external SCSI devices such as hard disks or removable disk drive etc. can be connected.

< Removable disk drives >

Many types of disk drive allow you to remove the disks. In this manual, these disk drives are referred to as "removable disk drives."

The VS-880 can use 512 bytes/sector removable disks (magneto-optical disks etc.). Disks used by the VS-880 cannot be used by any other device.

Connecting a disk drive

Up to 7 disk drives can be connected to the SCSI connector of the VS-880. This section will explain how to make disk drive connections, and how to make the necessary settings. Whenever you connect a SCSI device, be sure to check the following points.

- Connectors and cables
- Terminators
- SCSI ID numbers

■ Connectors and cables

SCSI cables are used to connect disk drives as shown below. Since there is no difference between a SCSI input and output, it does not matter which connector you use. This type of connections is referred to as a "SCSI chain" or a "daisy chain."

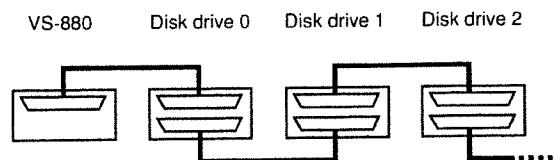

Use the following SCSI cables (optional) to connect disk drives. There are two types of SCSI cables, depending on the shape of their connector. Purchase the type of cable that is appropriate for your disk drive.

- C-5025-6: Amphenol 50-pin connector ↔ 25-pin D-sub type connector, 6 feet (approximately 182 cm)
- C-5050-3: Amphenol 50-pin connector ↔ Amphenol 50-pin connector, 3 feet (approximately 91 cm)

When making connections, observe the following points.

- Keep SCSI cables as short as possible, and use only cables which have an impedance (110 ohms +/-10%) that is compatible with the SCSI standard, and are completely shield.
- Do not allow the total length of all SCSI cables connecting the chain of disk drives to exceed 6.5 meters.
- Do not connect or disconnect SCSI cables when the power of any device is turned on.

■ Terminators

The device at each end of a SCSI chain must have a terminator (a terminating resistance). Since the VS-880 is one end of the SCSI chain, it contains an internal terminator. This means that a terminator must be connected only to the external drive which is the last in the chain. For details on attaching a terminator, refer to the owner's manual of your disk drive.

If your disk drive takes an external terminator, make settings so that the +5 terminator power is supplied from the SCSI connector (terminator) of that disk drive. Unless the terminator power is supplied, the operation of the SCSI chain will not be stable. However if the fuse inside the disk drive has been blown, etc., so that power is not being supplied, attaching a terminator will have the opposite effect of causing operation to become more unstable. In such cases, consult the manufacturer of your disk drive.

■ SCSI ID numbers

Each disk drive is distinguished by its SCSI ID number (0–7). This means that when two or more disk drives are connected, you must make settings so that the SCSI ID numbers of the disk drives do not conflict (coincide). If the SCSI ID numbers conflict, the VS-880 will not be able to correctly recognize the disk drives.

With the factory settings, the VS-880 is set to SCSI ID number 7. Set the disk drives you are connected to ID numbers other than 7.

■ Partitions

The VS-880 is able to manage either 500 M bytes or 1000 M bytes of disk space at one time. If you use a disk drive that is larger than this, the disk must be partitioned into 500 M bytes / 1000 M bytes partitions. (A partition is a way of dividing a disk into separate areas.) Unless you have a special reason to divide a disk into smaller areas, you should use 1000 M bytes partitions. The VS-880 can divide a disk drive into up to 4 partitions.

- If a 420 M bytes disk drive is partitioned with a 500 M bytes partition, a single 420 M bytes partition will be created.
- If a 1.2 G bytes disk drive is partitioned with 1000 M bytes partitions, a 1000 M bytes partition and a 200 M bytes partition will be created.
- If a 4.2 G bytes disk drive is partitioned with 1000 M bytes partitions, four 1000 M bytes partitions will be created. The remaining 200 M bytes cannot be used.

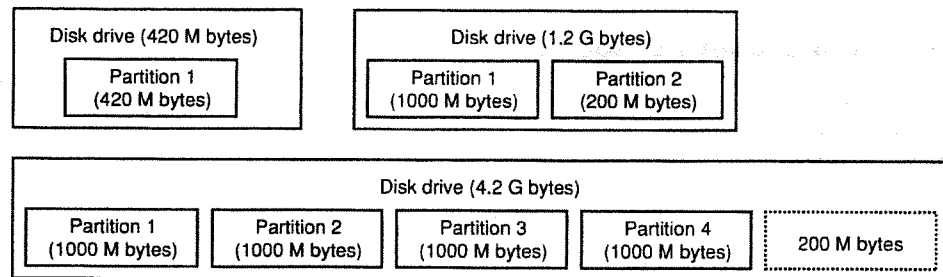

In this way, each partition of a disk drive is handled by the VS-880 as a separate disk drive. When using the VS-880, you must specify which partition of which disk drive is to be used. The currently used partition is referred to as the "current drive."

Troubleshooting

When the VS-880 does not perform the way you expect, check the following points before you suspect a malfunction. If this does not resolve the problem, contact servicing by your dealer or qualified Roland service personnel.

■ Problems with sound

No sound

- The power is not turned on for the VS-880 and the connected devices.
- The audio cables are not connected correctly.
- The audio cables are broken.
- The volume is turned down on the connected mixer or amp.
- The master fader of the VS-880 is turned down.
- The output jacks which are connected are different than the output jacks selected in the master section of the mixer.
- Short phrases less than 0.5 seconds cannot be played back.

Specific channel does not sound

- The volume level of the channel is turned down.
When the mixer mode is switched etc., the actual volume levels may not match the position of the faders. In this case, move the faders up and down to match the settings.
- The track status is set to MUTE (the STATUS indicator is dark).
- The Solo function (p.111) is being used.
Channels which were muted before the Solo function was used cannot be monitored even if [STATUS] is pressed.

Cannot record

- The track status of the recording destination is not set to REC (STATUS indicator blinks red).
- The disk drive has insufficient capacity.
- If the mixer mode is INPUT→TRACK, the specified input source is not selected for the recording destination (p.50).
- In INPUT MIX mode or TRACK MIX mode, the REC buss is not selected for the input source to be recorded (p.50).

Cannot record digitally

- The master clock is not set to "DIGITL" (p.73).
- The sampling rate of the recording destination song is different than the sampling rate of the digital audio device.
Match the sample rate setting of the digital audio device to the setting of the song. If it is not possible to change the sample rate of the digital audio device, you must create a new song with that sample rate.
- The Vari-pitch function is on (the VARI PITCH indicator is lit).
Press [VARI PITCH] to turn off the button indicator.

- Digital signal is not being transmitted from the digital audio device.
Some digital audio devices do not output a digital signal unless they are in play mode. If this is the case, put your digital audio device in standby (pause) mode before putting the VS-880 into record mode.
- Digital signal format is different.
Some digital audio devices may use a special digital signal format. Please use a digital audio device that is compatible with S/P DIF.

Noise and distortion appear in the recorded sound

- Input sensitivity settings are inappropriate.
If input sensitivity settings are too high, the recorded sound will be distorted. If they are too low, the recorded sound will be buried by noise. Adjust the INPUT SENS knob so that the level meters move as high as possible without causing the PEAK indicator to light.
- In INPUT MIX mode or TRACK MIX mode, the equalizer is being used.
Some equalizer settings may cause the sound to distort even if the PEAK indicator does not light. Re-adjust the equalizer.
- If noise or distortion occurred as a result of track bouncing, the track output levels were too high.
- A mic is connected directly to the VS-880.
The VS-880 is designed with a large headroom margin. Also, since INPUT-1-4 jacks are 10 k-ohm low impedance, the recording level may be low, depending on the characteristics of your mic. Pass the mic signal through a mic preamp before connecting it to the VS-880, to convert the signal to line level for recording.
Alternatively, you can set the mixer mode to INPUT MIX/TRACK MIX and raise the channel fader in INPUT MIX when recording.

Playback pitch is wrong

- The Vari-pitch function is on (the VARI PITCH indicator is lit).
Press [VARI PITCH] to turn off the button indicator.

■ Disk drive problems

Internal hard disk is not detected

- The IDE drive switch is set Off (p.117).

External drive is not detected

- The disk drive is not connected correctly (p.93).
- The device ID numbers of two or more disk drives are conflicting.
- The disk drive has not been initialized on the VS-880 (p.93).
- If you are using a removable disk drive, re-select the disk drive after inserting the disk (p.93).

Disk drive does not operate correctly

- A terminator is not correctly attached to the disk drive (p.130).

■ Synchronization problems (does not synchronize)

When synchronizing a MIDI sequencer to the VS-880

- The MIDI cable is not connected correctly.
- The MIDI cable is broken.
- The MIDI Thru switch is not set to "Out" (p.87).
- The sync generator is not set to the appropriate synchronization method (MTC, MIDI Clock, Sync Track) (p.87, 90, 92).
- The sync source is not set to "INT" (p.88).
- If you are using MTC, the two devices are not set to the same type of MTC (p.86).
- If you are using the sync track, MIDI clock data has not been recorded on the sync track.
- The settings of the MIDI sequencer are not correct.
- The MIDI sequencer is not ready to playback.

When synchronizing the VS-880 to a MIDI sequencer

- The MIDI cable is not connected correctly.
- The MIDI cable is broken.
- The VS-880 cannot be synchronized using a method other than MTC (p.86).
- The sync source is not set to "EXT" (p.88).
- The two devices are not set to the same type of MTC (p.86).
- The settings of the MIDI sequencer are not correct.
- The VS-880 is not ready to playback.
- If synchronization is interrupted, it is possible that either MTC reception is poor or the MIDI cable is broken. If MTC reception is only slightly defective, you can set the Error Level (p.88) to get around the problem.

■ Other problems

When the power is turned on, the previous data was not saved correctly

It is likely that the VS-880 power was turned off without performing the shut-down process. The lost data cannot be recovered.

Data on the disk drive was damaged

The following situations can result in damage to the data on a disk drive. Re-initialize the disk drive (and also execute physical formatting) (p.93).

Also, we recommend that you execute Surface Scan (p.38) as well.

- The VS-880 power was turned off without performing the shut-down process.
- The power was turned off while the disk drive was operating.
- A strong shock was applied to the disk drive.
- The disk drive or SCSI cable was connected or disconnected while the power was still turned on.

Error messages

If an error occurs in operation, or if an operation could not be processed correctly, an error message will appear. Refer to the displayed error message and take the appropriate action.

Aborted Command

Illegal Request

Situation: This disk drive cannot be used by the VS-880.

Already Selected

Situation: The currently selected disk drive was selected.

Action: If you wish to switch to another disk drive, re-select the disk drive.

Arbitration Fail

Busy Status

Check Condition

Status Error

Wait For BUSS Free

Situation: Normal communication with the disk drive could not be accomplished.

Action: Make sure that the disk drive is connected correctly.

Can't Communicate

Drive Time Out

Message Error

Phase Mismatch

Undefined Sense

Unit Attention

? Unknown Error

Situation: There is a problem with the connections to the disk drive.

Action: Make sure that the disk drive is connected correctly.

Can't Recover

Situation: The drive check Recover procedure could not be executed because there was insufficient free space on the disk.

Action: Delete unneeded songs. Alternatively, perform the Song Optimize procedure.

Digital In Unlock

Situation 1: A digital signal is not being input to the DIGITAL IN connector.

Action 1: Press [YES], and then make sure that power of the digital equipment is turned on and that the digital equipment is connected correctly.

Situation 2: The sample rate specified for the song is different than the sample rate of the digital device connected to the DIGITAL IN connector.

Action 2: Press [YES], and set the sample rates of both devices to match.

Disk Memory Full

Situation 1: There is insufficient free area on the disk.

Action 1: Erase unneeded data. Or, select a different disk drive.

Situation 2: The maximum number of songs that can be recorded on a disk drive (200) has been exceeded.

Action 2: Delete unneeded songs. Or, select a different disk drive.

Disk Write Error

Situation: An error occurred while writing data to the disk drive.

Action: The song data has not been correctly saved to disk. Back up the song data to a DAT recorder, initialize the disk drive, and restore the backed up song data to the disk drive.

Drive Too Slow

Situation 1: If this message appears when you first begin using a disk drive with the VS-880, the disk drive is not fast enough.

Action 1: When using this disk, create a new song with a lower sample rate or recording mode, and record using this song.

Situation 2: If this message appears after you have been using the disk drive with the VS-880, the data on the disk drive has become fragmented, causing delays in reading and writing data.

Action 2: Either use the track bouncing operation to re-record playback data to another track, or use the optimize operation. If the same message appears even after these measures have been taken, copy the song data to another disk drive and initialize the disk drive that produced the problem.

Event Mem Full

Situation: The VS-880 has used up all the events that can be handled by one song.

Action: Delete unneeded auto mix data. Alternatively, perform the Song Optimize operation.

MarkerMemory Full

Situation: The VS-880 has used up all Marker Memory (1000 Markers) that can be handled by one song.

Action: Delete unneeded Marker.

Hardware Error

Situation: There is a problem with the disk drive.

Action: Contact the manufacturer or dealer of the disk drive.

Medium Error

Situation: There is a problem with the disk drive media.

Action: This disk cannot be used by the VS-880. In some cases recovery can be achieved by executing Drive Check (p.38).

Memory Full

Reason: There is no further free space in the internal memory of the VS-880.

Action: Use the Track Bouncing operation to combine two or more tracks of playback data into a single track, and delete the original playback data. Alternatively, perform the Song Optimize operation (p.113).

No Effect Board

Situation: A VS8F-1 effect expansion board (sold separately) is not installed.

Action: This operation can be performed only if a VS8F-1 is installed.

Not 512byte/sector

Situation: The disk that you are using is not 512 bytes/sector.

Action: This disk cannot be used by the VS-880.

Not Formatted

Situation 1: The disk drive has not been initialized by the VS-880.

Action 1: Initialize the disk drive.

Situation 2: If this appears for a disk drive that has been initialized by the VS-880, there is a problem with the connections to the disk drive.

Action 2: Make sure that the disk drive is connected correctly.

Not Ready

Situation: The disk drive is not ready.

Action: Wait a short time.

No Drive Ready

Situation: No disk drive is connected. Or, an internal hard disk is not installed.

Action: Make sure that the disk drive is connected correctly.

SCSI ID Error

Situation: The SCSI ID numbers of two or more disk drives are conflicting.

Action: Make settings so that the SCSI ID numbers do not conflict (p.131).

Song Protected

Reason: Since Song Protect is ON, the operation cannot be executed.

Action: Turn the Song Protect OFF (p.74).
If you wish to execute the operation without saving the currently selected song, repeat the procedure, and press [NO] in reply to the "STORE Current?" message.

SPC Not Available

Situation: The SCSI components of the VS-880 have malfunctioned.

Action: Contact servicing by your dealer or qualified Roland service personnel.

Write Protected

Situation: The disk drive is protected.

Action: If you are using a removable disk drive, perform the shut-down procedure, and remove the disk and set its protect tab to the write permit position. Then re-insert the disk, and start up the VS-880 once again.

Special key operations

Here is a list of the functions that can be performed by pressing multiple buttons, or by using the TIME/VALUE dial in conjunction with a button.

■ MIXER MODE buttons

[SHIFT] + [SELECT] Switch between INPUT→TRACK mode and INPUT MIX / TRACK MIX mode

■ CH EDIT buttons

[SHIFT] + [Input/BUSS (CH EDIT)] To the input select setting page (in INPUT→TRACK mode)
To the buss select setting page (in INPUT MIX / TRACK MIX mode)
[SHIFT] + [V.Track (CH EDIT)] To the V-track setting page (in INPUT→TRACK / TRACK MIX mode)
[SHIFT] + [EQ Low (CH EDIT)] To the equalizer low gain / frequency setting page
[SHIFT] + [EQ Mid (CH EDIT)] To the equalizer mid gain setting page (in INPUT→TRACK mode)
[SHIFT] + [EQ Hi (CH EDIT)] To the equalizer high gain / frequency setting page
[SHIFT] + [AUX Send (CH EDIT)] To the AUX switch setting page
[SHIFT] + [EFFECT-1 (CH EDIT)] To the effect 1 switch setting page (if a VS8F-1 is installed)
[SHIFT] + [EFFECT-2 (CH EDIT)] To the effect 2 switch setting page (if a VS8F-1 is installed)
[SHIFT] + [SOLO (EDIT)] Solo function on/off

■ EDIT CONDITION buttons

[SHIFT] + [SYSTEM] Switch sync sources
[SHIFT] + [SONG] Display various information about the song.
[SHIFT] + [EFFECT] Switch between the effect select page, effect name page, and effect on/off page.

■ Transport control buttons

[SHIFT] + [STORE (ZERO)] Store song data to the disk drive
[SHIFT] + [SONG TOP (REW)] Move to the time where the first sound of the song is recorded
[SHIFT] + [SONG END (FF)] Move to the time where the last sound of the song is recorded
[SHIFT] + [SHUT/EJECT (STOP)] Shut-down
[SHIFT] + [RESTART (PLAY)] Re-start (after shut-down)
[REC] + [STATUS] Switch the track status to REC (indicator blinks red)
[STOP] + [STATUS] Switch the track status to PLAY (indicator lights green)

■ LOCATOR buttons

[SHIFT] + LOC button Register a locate point 5-8
[CLEAR] + LOC button Clear the setting of a locate point 1-4
[SHIFT] + [CLEAR] + LOC button Clear the setting of a locate point 5-8
[SHIFT] + [TAP] To the Tempo Map setting page
[CLEAR] + [TAP] Erase a mark point
[SHIFT] + [CLEAR] + [TAP]→[YES] Erase all mark points
[LOCATOR] + [LOC1/5]-[LOC4/8] Switch locate banks.
[TRACK] + [LOC1/5] Direct input of Start point
[TRACK] + [LOC2/6] Direct input of End point
[TRACK] + [LOC3/7] Direct input of From point
[TRACK] + [LOC4/8] Direct input of To point

■ SCENE button

[SCENE] + [SELECT] Auto mix on/off
[SCENE] + [TAP] Execute snapshot
[SCENE] + [PREVIOUS] Gradation to mixer settings of previous mark point
[SCENE] + [NEXT] Gradation to mixer settings of next mark point
[SCENE] + [REC] Auto Mix realtime recording

■ Other

[SHIFT] + [VARI PITCH]

[SHIFT] + [UNDO]

[SHIFT] + [SCENE]

[SHIFT] + [SCRUB]

[SHIFT] + [TO]

[SHIFT] + [FROM]

[SHIFT] + [PLAY (DISPLAY)]

[PLAY] and TIME/VALUE dial

[SHIFT] and TIME/VALUE dial

[TO] + [FROM]

[SHIFT] + CURSOR[◀]

[SHIFT] + CURSOR[▶]

[SHIFT] + PARAMETER [◀◀]

[SHIFT] + PARAMETER [▶▶]

To the vari pitch setting page

Execute Redo (if the UNDO indicator is lit)

Transmit the condition of the digital mixer as MIDI data from the MIDI OUT connector

To the Scrub Length setting page

To the Preview Length setting page

To the Preview Length setting page

Switch the bar display

To the Display Contrast setting page

Modify the value at 10 times the usual speed

In Play condition, move the current time in 10-frame units

In Play condition when an "" is displayed at the beginning of the time code display, move the current time in units of approximately 1/100 frame.

Execute preview thru

When modifying the time, move the cursor left.

When modifying the time, move the cursor right.

Select previous effect parameter

Select next effect parameter

Parameter list

Parameters that have been added and setting ranges that have been expanded by the V-XPANDED enhancement are printed in bold type.

■ Mixer Parameters (channel)

* If channel link is ON, the Pan parameter will change to the Balance parameter.

INPUT→TRACK Mode

Parameter name	Display	Value	Initial value
Input Select	Input	INPUT-1 – INPUT-4, DIGITAL-L, DIGITAL-R, MIX-L, MIX-R, AUX-A, AUX-B	INPUT-1 – 4 (*1)
Mix Switch	MIX Sw	Off, PreFade, PstFade	PstFade
Mix Level	MIX Level	0–127	current panel settings
Mix Pan/Balance	MIX Pan/MIX Bal	L63–0–R63	current panel settings
V-Track	V.Track	1–8	1
Equalizer Switch	EQ Switch	Off, On	On
Equalizer Low Gain	EQL	-12–12 dB	0 dB
Equalizer Low Frequency	EQL	40 Hz – 1.5 kHz	300 Hz
Equalizer Mid Gain	EQM	-12–12 dB	0 dB
Equalizer Mid Q	EQM Q	0.5–16	0.5
Equalizer Mid Frequency	EQM F	200 Hz – 8 kHz	1.4 kHz
Equalizer High Gain	EQH	-12–12 dB	0 dB
Equalizer High Frequency	EQH	500 Hz – 18 kHz	4 kHz
AUX Switch	AUX Sw	Off, PreFade, PstFade	Off
AUX Level	AUX Level	0–127	100
AUX Pan/Balance	AUX Pan/AUX Bal	L63–0–R63	0
Channel Link	Channel Link	Off, On	Off
Effect 1 Switch	EFFECT1	Off, Prefade, PstFade, Insert, InsertL, InsertR, InsertS	Off
Effect 1 Send Level	EFFECT1 Send	0–127	100 (*2)
Effect 1 Pan/Balance	EFFECT1 Pan/EFFECT1 Bal	L63–0–R63	0 (*2)
Effect 1 Insert Level	EFFECT1 InsSend	0–127	100 (*3)
Effect 1 Insert Return Level	EFFECT1 InsRtn	0–127	100 (*3)
Effect 2 Switch	EFFECT2	Off, Prefade, PstFade, Insert, InsertL, InsertR, InsertS	Off
Effect 2 Send Level	EFFECT2 Send	0–127	100 (*2)
Effect 2 Pan/Balance	EFFECT2 Pan/EFFECT1 Bal	L63–0–R63	0 (*2)
Effect 2 Insert Level	EFFECT2 InsSend	0–127	100 (*3)
Effect 2 Insert Return Level	EFFECT2 InsRtn	0–127	100 (*3)
Equalizer/Effect Pre-Insert Switch	EQ/Eff PreIns	Off, On	Off
Track Level	TrackLevel	-12–12 dB	0 dB

* 1 If channel link is ON, the Input Select setting values will be INPUT-12, INPUT-34, DIGITAL, MIX, and AUX-AB.

* 2 Valid when Effect Switch is "Prefade, PstFade."

* 3 Valid when Effect Switch is "Insert, InsertL, InsertR, InsertS."

INPUT MIX Mode

Parameter name	Display	Value	Initial value
BUSS Switch	BUSS Sw	Off, PreFade, PstFade	PstFade
BUSS Select	BUSS Sel	MIX, 1-2, 3-4, 5-6, 7-8	1-2, 3-4, 5-6, 7-8
BUSS Level	BUSS Level	0–127	100
BUSS Pan/Balance	BUSS Pan/BUSS Bal	L63–0–R63	0
Equalizer Switch	EQ Switch	Off, On	On
Equalizer Low Gain	EQL	-12–12 dB	0 dB
Equalizer Low Frequency	EQL	40 Hz – 1.5 kHz	300 Hz
Equalizer Mid Gain	EQM	-12–12 dB	0 dB (*1)
Equalizer Mid Q	EQM Q	0.5–16	0.5 (*1)
Equalizer Mid Frequency	EQM F	200 Hz–8 kHz	1.4 kHz (*1)
Equalizer High Gain	EQH	-12–12 dB	0 dB
Equalizer High Frequency	EQH	500 Hz – 18 kHz	4 kHz

Parameter name	Display	Value	Initial value
AUX Switch	AUX Sw	Off, PreFade, PstFade	Off
AUX Level	AUX Level	0-127	100
AUX Pan/Balance	AUX Pan/AUX Bal	L63-0-R63	0
Channel Link	Channel Link	Off, On	Off
Effect 1 Switch	EFFECT1	Off, Prefade, PstFade, Insert, InsertL, InsertR, InsertS	Off
Effect 1 Send Level	EFFECT1 Send	0-127	100 (*2)
Effect 1 Pan/Balance	EFFECT1 Pan/EFFECT1 Bal	L63-0-R63	0 (*2)
Effect 1 Insert Level	EFFECT1 InsSend	0-127	100 (*3)
Effect 1 Insert Return Level	EFFECT1 InsRtn	0-127	100 (*3)
Effect 2 Switch	EFFECT2	Off, Prefade, PstFade, Insert, InsertL, InsertR, InsertS	Off
Effect 2 Send Level	EFFECT2 Send	0-127	100 (*2)
Effect 2 Pan/Balance	EFFECT2 Pan/EFFECT1 Bal	L63-0-R63	0 (*2)
Effect 2 Insert Level	EFFECT2 InsSend	0-127	100 (*3)
Effect 2 Insert Return Level	EFFECT2 InsRtn	0-127	100 (*3)

* 1 Valid only for 8 channels of INPUT MIX/TRACK MIX (When the master block Equalizer Select is "3 Band EQ").

* 2 Valid when Effect Switch is "Prefade, PstFade."

* 3 Valid when Effect Switch is "Insert, InsertL, InsertR, InsertS."

TRACK MIX Mode

Parameter name	Display	Value	Initial value
BUSS Switch	BUSS Sw	Off, PreFade, PstFade	PstFade
BUSS Select	BUSS Sel	MIX, 1-2, 3-4, 5-6, 7-8	MIX
BUSS Level	BUSS Level	0-127	100
BUSS Pan/Balance	BUSS Pan/BUSS Bal	L63-0-R63	0
V-Track	V.Track	1-8	1
Equalizer Switch	EQ Switch	Off, On	On
Equalizer Low Gain	EQL	-12-12 dB	0 dB
Equalizer Low Frequency	EQL	40 Hz - 1.5 kHz	300 Hz
Equalizer Mid Gain	EQM	-12-12 dB	0 dB (*1)
Equalizer Mid Q	EQM Q	0.5-16	0.5 (*1)
Equalizer Mid Frequency	EQM F	200 Hz-8 kHz	1.4 kHz (*1)
Equalizer High Gain	EQH	-12-12 dB	0 dB
Equalizer High Frequency	EQH	500 Hz - 18 kHz	4 kHz
AUX Switch	AUX Sw	Off, PreFade, PstFade	Off
AUX Level	AUX Level	0-127	100
AUX Pan/Balance	AUX Pan/AUX Bal	L63-0-R63	0
Channel Link	Channel Link	Off, On	Off
Effect 1 Switch	EFFECT1	Off, Prefade, PstFade, Insert, InsertL, InsertR, InsertS	Off
Effect 1 Send Level	EFFECT1 Send	0-127	100 (*2)
Effect 1 Pan/Balance	EFFECT1 Pan/EFFECT1 Bal	L63-0-R63	0 (*2)
Effect 1 Insert Level	EFFECT1 InsSend	0-127	100 (*3)
Effect 1 Insert Return Level	EFFECT1 InsRtn	0-127	100 (*3)
Effect 2 Switch	EFFECT2	Off, Prefade, PstFade, Insert, InsertL, InsertR, InsertS	Off
Effect 2 Send Level	EFFECT2 Send	0-127	100 (*2)
Effect 2 Pan/Balance	EFFECT2 Pan/EFFECT1 Bal	L63-0-R63	0 (*2)
Effect 2 Insert Level	EFFECT2 InsSend	0-127	100 (*3)
Effect 2 Insert Return Level	EFFECT2 InsRtn	0-127	100 (*3)
Equalizer/Effect Pre-Insert Switch	EQ/Eff PreIns	Off, On	Off
Track Level	TrackLevel	-12-12 dB	0 dB

* 1 Valid only for 8 channels of INPUT MIX/TRACK MIX.

* 2 Valid when Effect Switch is "Prefade, PstFade."

* 3 Valid when Effect Switch is "Insert, InsertL, InsertR, InsertS."

Parameter list

Master Block

Parameter name	Display	Value	Initial value
Master Out Mode	Master Mode	MIX, M+A, M+B, MAB, -A-, -B-, A+B MIX, M+A, M+B, MAB, -A-, -B-, A+B, 1-2, 3-4, 5-6, 7-8	MIX (in INPUT→TRACK) MIX (in INPUT MIX /TRACK MIX)
Master Level	Masterlevel	0-127	current panel settings
Baster Balance	Master Bal	L63-0-R63	current panel settings
AUX Level	AUX Level	0-127	current panel settings
AUX Balance	AUX Bal	L63-0-R63	0
Effect 1 Insert Switch	EFF1 INS Sw	Off, On	Off
Effect 1 Send Level	EFF1 SND Lev	0-127	100 (*1)
Effect 1 Send Balance	EFF1 SND Bal	L63-0-R63	0 (*1)
Effect 1 Return To	EFF1 RTN to	MIX, AUX	MIX (*1) (in INPUT→TRACK)
		MIX, 1-2, 3-4, 5-6, 7-8	MIX (*1) (in INPUT MIX/TRACK MIX)
Effect 1 Return Level	EFF1 RTN Lev	0-127	100 (*1)
Effect 1 Send Balance	EFF1 SND Bal	L63-0-R63	0 (*1)
Effect 2 Insert Switch	EFF2 INS Sw	Off, On	Off
Effect 2 Send Level	EFF2 SND Lev	0-127	100 (*2)
Effect 2 Send Balance	EFF2 SND Bal	L63-0-R63	0 (*2)
Effect 2 Return To	EFF2 RTN to	MIX, AUX	MIX (*2) (in INPUT→TRACK)
		MIX, 1-2, 3-4, 5-6, 7-8	MIX (*2) (in INPUT MIX/TRACK MIX)
Effect 2 Return Level	EFF2 RTN Lev	0-127	100 (*2)
Effect 2 Send Balance	EFF2 SND Bal	L63-0-R63	0 (*2)
Stereo In	StereoIn	Off, Input12, Input34, Digital	Off (in INPUT→TRACK)
Stereo In Level	StIn Level	0-127	100 (in INPUT→TRACK)
Stereo In Balance	StIn Bal	L63-0-R63	0 (in INPUT→TRACK)
Equalizer Select	EQ Sel	2BandEQ, 3BandEQ	2BandEQ (in INPUT MIX/TRACK MIX)

* 1 Valid when Effect 1 Insert Switch is "OFF."

* 2 Valid when Effect 2 Insert Switch is "OFF."

■ System Parameters

System

Parameter name	Display	Value	Initial value
Master Clock	MasterClk	INT, DIGITL	INT
Time Display Format	TimeDispFmt	ABS, REL	ABS
Offset	Ofs	00h00m00s00 - 23h59m59s29	00h00m00s00
Maker Stop	Marker Stop	Off, On	Off
Record Monitor	RecordMon	AUTO, SOURCE	AUTO
Vari Pitch	VariPitch	24.06-50.43 kHz (32 kHz) 24.06-50.48 kHz (44.1 kHz) 24.06-50.43 kHz (48 kHz)	32.00 kHz 44.10 kHz 48.00 kHz
Foot Switch Assign	FootSw	Play/Stop, Record, TapMarker, Next, Previous, GPI	Play/Stop
Fade Length	FadeLength	2, 10, 20, 30, 40, 50 ms	10 ms
Scrub Length	Scrub Len	25-100 ms	45 ms
Preview Length	PreviewLen	1.0-10.0 s	1.0 s
Metronome Output	MetroOut	Off, INT, MIDI	Off
Metronome Level	MetroLevel	0-127	100
Metronome Mode	MetroMd	Rec Only, Rec&Play	Rec Only
Undo Message	UNDO MSG	Off, On	On
Contrast	LCD Contrast	0-15	7

Parameter name	Display	Value	Initial value
Remaining Display	RemainDisp	Time, CapaMB, Capa %, Event	TimeMeasure/Beat
Display	MeasurDsp	Always, Auto	Always
Digital Copy Protect	D.CpyProtect	Off, On	Off
Shift Lock	Shift Lock	Off, On	Off
Numerics Type	NUMERICSType	Up, Dwn	Up
Fader Match	FaderMatch	Null, Jump	Jump
Peak Hold Switch	PeakHoldSw	Off, On	Off
System Parameter Keep Switch	SysPrmKeepSw	Off, On	Off

* The settable range for Offset will change slightly depending on the MTC type (sync parameter).

MIDI

Parameter name	Display	Value	Initial value
Device ID	DeviceID	1-32	17
MIDI Thru Switch	MIDIThr	Out, Thru	Out
System Exclusive Receive Switch	SysEx.Rx	Off, On	Off
System Exclusive Transmit Switch	SysEx.Tx	Off, On	Off
MMC Mode	MMC	Off, MASTER, SLAVE	MASTER
Metronome Channel	MetronmCh	1-16	10 (*)
Accent Note	Acc.Note	C_0-G_9	C#2 (*)
Accent Velocity	Acc.Velo	1-127	100 (*)
Normal Note	Nrm.Note	C_0-G_9	C#2 (*)
Normal Velocity	Nrm.Velo	1-127	60 (*)
Mixer Control Local Switch	CtrLocal	Off, On	On
Mixer Control Type	CtrType	Off, C.C., Excl	C.C.
Program Change Scene	P.C.Scne	Off, On	Off
Program Change Effect	P.C.Eff	Off, On	Off
Control Change Effect	C.C.Eff	Off, On	Off

* Valid when Metronome Output is "MIDI."

Disk

Parameter name	Display	Value	Initial value
IDE Drive	IDE Drv	Off, On	On
SCSI Self ID	SCSI Self	0-7	7

Sync/Tempo

Parameter name	Display	Value	Initial value
Sync Source	Source	INT, EXT	INT
Sync Generator	Gen.	Off, MTC, MIDIClk, SyncTr	Off
Error Level	ErrLevel	0-10	5
MTC Type	MTC Type	30, 29N, 29D, 25, 24	30
Tempo Map Number	-	1-50	1
Tempo	-	25.0-250.0	120.0
Measure	-	1-999	-
Beat	-	1/1-8/1, 1/2-8/2, 1/4-8/4, 1/8-8/8	4/4
Offset	Ofs	00h00m00s00-23h59m59s29	00h00m00s00

Sync Track Convert

Parameter name	Display	Value	Initial value
Convert	-	CV1 Tap→S.Tr, CV2 Tap→T.Map, CV3 S.Tr→T.Map, CV4 Time→S.Tr	CV1 Tap→S.Tr
Beat	Beat	1/1-8/1, 1/2-8/2, 1/4-8/4, 1/8-8/8	4/4
Tap Beat	Tap Beat	1-8	4
Sync Track Beat	S.TrBeat	1/1-8/1, 1/2-8/2, 1/4-8/4, 1/8-8/8	4/4
Start Time	St	00h00m00s00-23h59m59s29	00h00m00s00
End Time	End	00h00m00s00-23h59m59s29	00h00m00s00
Measure	Measure	1-999	1

Parameter list

Scene/Auto Mix

Parameter name	Display	Value	Initial value
Scene Mode	Scene Mode	All, KeepF	ALL
Auto Mix Mode	A.MIX Mode	Off, On	Off
Auto Mix Snapshot	A.MIX Snap	ALL, MaskF	ALL

Auto Mix Erase

Parameter name	Display	Value	Initial value
Starting Mark Piont	-	0-999	-
Ending Mark Piont	-	0-999	-
Erase Mode	EraseMode	Event, Marker	Event

Drive Select

Parameter name	Display	Value	Initial value
Select Drive	Select Drv	IDE :0-3, SC0: 0-SC7: 3	-

Drive Initialize

Parameter name	Display	Value	Initial value
Initialize Drive	Init.Drive	IDE: 0-3, SC0: 0-SC7: 3	-
Physical Format	PhysicalFmt	Off, On	Off
Partition	Partition	500, 1000 MB	1000 MB
Surface Scan	SurfaceScan	Off, On	Off

Drive Check

Parameter name	Display	Value	Initial value
Check Drive	CheckDrive	IDE:0-3, SC0:0-SC7:3	-

Mixer section block diagram

INPUT → TRACK mode

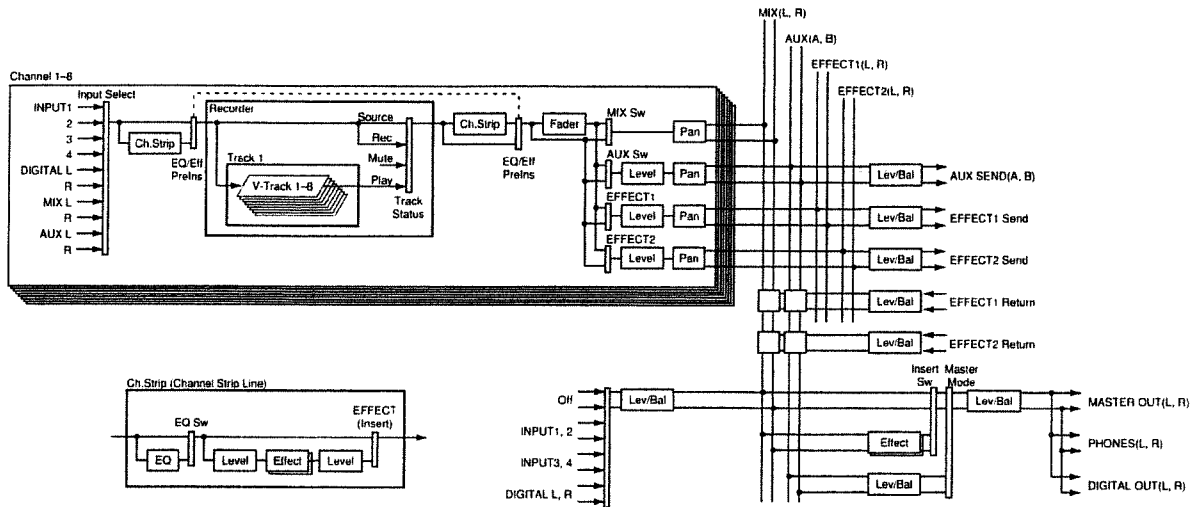

INPUT MIX mode and TRACK MIX mode

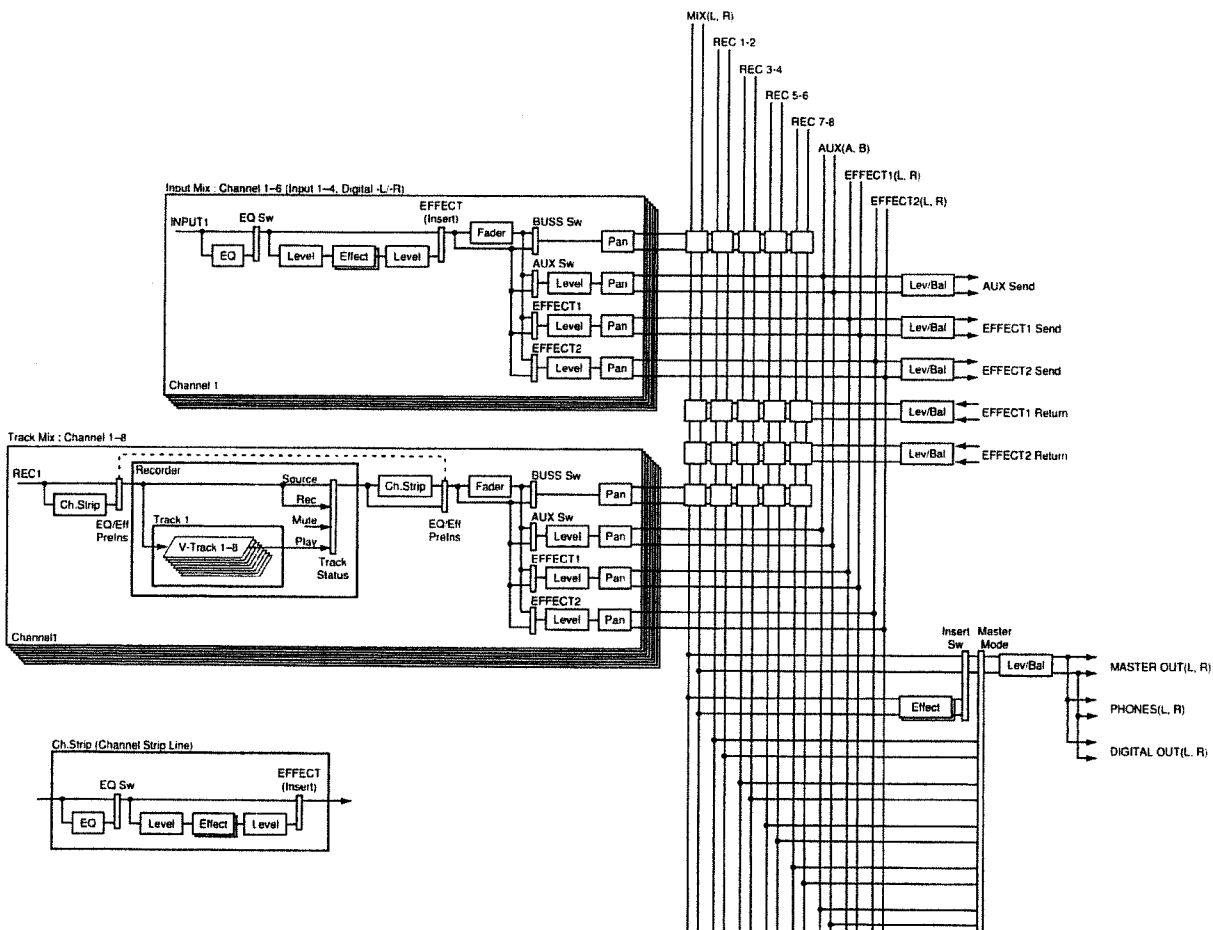

Glossary

COSM

COSM stands for Composite Object Sound Modeling. This is "a technology which combines multiple sound models to create new sounds," which was first used on the Roland's VG-8 V-Guitar System. For example, sounds created on the VG-8 are the result of a variety of sound models (elements) such as the pickup, the body of the guitar, the guitar amp, mic, and speaker etc.

When a VS8F-1 effect expansion board is installed, the VS-880 will be able to apply effects using COSM (such as guitar amp simulation) without the need for any other equipment. (p.46)

MTC

MTC stands for MIDI Time Code. This is a group of messages which are transmitted and received between MIDI devices to synchronize their operation. Unlike MIDI Clock messages, MTC specifies an absolute time. Like SMPTE time code, MTC also supports a variety of frame rates. If you wish to use MTC to synchronize the operation of two devices, both devices must be set to the same frame rate. (p.86)

RSS

RSS stands for Roland Sound System. This is an effect which allows a sound source to be placed in three-dimensional space when played back on a conventional stereo system. The sound can be placed not only in front of the listener, but also directly to the side, above, below, and behind the listener. (VS8F-1 Owner's manual p.33)

S/P DIF

S/P DIF stands for Sony/Philips Digital Interface Format. This is a specifications for transmitting and receiving stereo digital audio signals between digital audio devices. The VS-880 provides coaxial connectors which support S/P DIF. (p.72)

SMPTE time code

This is a signal format defined by the American organization SMPTE (Society of Motion Picture and Television Engineers) which is used to synchronize the operation of video or audio devices. SMPTE specifies "hours:minutes:seconds:frames" to indicate the address of each frame of a video image. For this reason, there are a variety of frame rates.

Auto mix

This is data which records INPUT→TRACK, INPUT MIX, TRACK MIX and Master block settings of the mixer. Mixer settings for a specific time location are referred to as a Snapshot. Data which records time-variant changes in mixer settings such as fade-in or fade-out is referred to as Realtime data.

Scene

This is data which records INPUT→TRACK, INPUT MIX, TRACK MIX and Master block mixer settings and effect settings for a specific moment in time. Even after mixing operations have been performed repeatedly, a Scene can be recalled to instantly restore the settings for fader, pan and effect algorithm etc. that were in use when the Scene was stored. (p.51)

Sync track

This is a track provided separately from the audio recording track, for the purpose of recording MIDI Clock data. The Sync track records the MIDI Clock messages that are transmitted from a MIDI sequencer etc. By transmitting these MIDI Clock messages back to the MIDI sequencer, it will be possible to synchronize even to a song that contains complex tempo changes. In this case, the VS-880 will be the master and the MIDI sequencer will be the slave. (p.91)

Scrub

This is an editing technique in which a very short section of audio is played back repeatedly while you move the current time location, similar to the result of manually moving a reel of analog tape while it remains in contact with the playback head. This is a convenient way to "cue" a desired location in the recording. Since the playback pitch and formats will not change, cueing is possible with substantial accuracy. (p.77)

Tempo map

Data describing the song's measures, beats and tempo. By transmitting this data to a MIDI sequencer etc., synchronized operation with an external MIDI device is possible. (p.89)

Vari-pitch

When a song is played back on the VS-880, this function allows the playback speed of the song can be adjusted in order to match the pitch with instruments whose tuning is not easily changed.

Specifications

VS-880: Digital Studio Workstation

● Tracks

Track: 8

V-Track: 64 (8 V-Tracks per each Track)

* Up to 4 tracks can be recorded simultaneously, and up to 8 tracks can be played back simultaneously.

● Maximum Useful Capacity

32 G bytes: 1 G bytes x 4 (Partition) x 8 (Disk Drive)

● Internal Memory

Songs: 200 (each partition)

● Equalizer

HI, MID, LOW (at INPUT→TRACK mode)

HI, LOW (at INPUT MIX or TRACK MIX mode)

● Recording Mode

Mastering (MAS)

Multitrack 1 (MT1)

Multitrack 2 (MT2)

Live (LIV)

● Signal Processing

AD Conversion: 18 bit, 256 times oversampling

DA Conversion: 18 bit, 8 times oversampling

Internal Processing: 24 bit (mixer section)

● Sample Rate

48.0 kHz, 44.1 kHz, 32.0 kHz

● Frequency Response

Sample Rate

48.0 kHz 10 Hz - 22.6 kHz (+0/-3 dB)

44.1 kHz 10 Hz - 21.0 kHz (+0/-3 dB)

32.0 kHz 10 Hz - 15.5 kHz (+0/-3 dB)

● Total Harmonic Distortion

0.08 % or less (INPUT SENS = -10 dBm, 1 kHz at nominal output level, recording mode: MAS)

● Recording Time (at 1 G bytes, 1 track)

Recording mode	Sample rate		
	48.0 kHz	44.1 kHz	32.0 kHz
Mastering	185 minutes	202 minutes	278 minutes
Multitrack 1	371 minutes	404 minutes	557 minutes
Multitrack 2	495 minutes	539 minutes	742 minutes
Live	594 minutes	646 minutes	891 minutes

* The above-listed recording times are approximate. Times may be slightly shorter depending on the specifications of the disk drive and on the number of songs that were created.

● Nominal Input Level (Variable)

Input A: -50 - +4 dBm

Input B: -50 - +4 dBm

● Input Impedance

Input A: 20 k Ω

Input B: 20 k Ω

● Nominal Output Level

AUX Send: -10 dBm

Master Out: -10 dBm

● Output Impedance

AUX Send: 1.6 k Ω

Master Out: 1.6 k Ω

Headphone: 100 Ω

● Recommended load Impedance

AUX Send: 10 k Ω or greater

Master Out: 10 k Ω or greater

Headphone: 8-50 Ω

● Residual Noise Level

AUX Send: -91 dBm or less

Master Out: -91 dBm or less

(input terminated with 1 k Ω , INPUT SENS = +4 dBm, IHF-A, typ.)

● Interface

SCSI: DB-25 type

Digital I/O: Coaxial (conforms to S/P DIF)

● Display

70.6 x 24.5 mm (LCD)

● Connectors

SCSI Connector (DB-25 type)

MIDI Connectors (IN, OUT/THRU)

Digital In Connector (coaxial type)

Digital Out Connector (coaxial type)

Foot Switch Jack (1/4 inch phone type)

Headphone Jack (1/4 inch phone type)

Input A Jacks 1 to 4 (1/4 inch phone type)

Input B Jacks 1 to 4 (RCA phono type)

AUX Send Jacks A, B (RCA phono type)

Master Out Jacks L, R (RCA phono type)

● Power Supply

AC 117 V, AC 230 V, or AC 240 V

● Power Consumption

22 W (including Internal hard disk)

● Dimensions

434 (W) x 317 (D) x 88 (H) mm

17-1/8 (W) x 12-1/2 (D) x 3-1/2 (H) inches

● Weight

4.0 kg (excluding Internal Hard Disk)

8 lbs 14 oz

● Accessories

AC Cord

Owner's Manual

V-XPANDED Sticker

● Options

Internal Hard Disk Drive Unit: HDP88 Series

Effect Expansion Board: VS8F-1

0 dBm = 0.775 V rms

* In the interest of product improvement, the specifications and/or appearance of this unit are subject to change without prior notice.

About the V-XPANDED sticker

The VS-880 system software update adds several special operations to the top panel. Affix the included sticker to the top panel as follows for your reference.

■ Channel faders

When the Voice Transformer effect is being used, the effect can be adjusted by the channel faders (p.31).

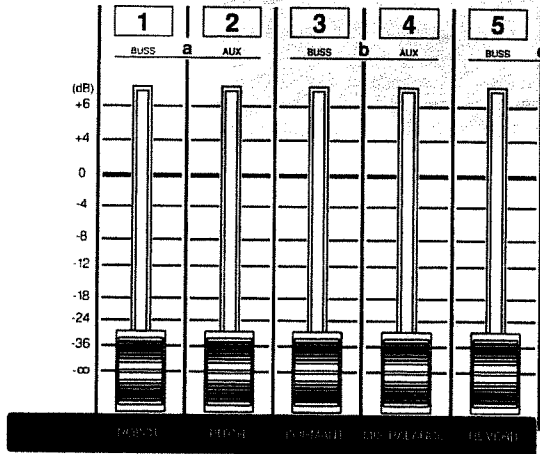

■ SELECT (Select button)

[SCENE]+[SELECT] will turn auto mix on/off (p.18).

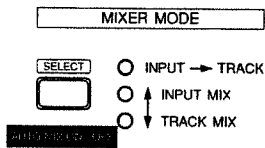

■ EDIT CONDITION buttons

The number of items selectable by [SYSTEM] has increased.



■ LOCATOR buttons

[SCENE]+[TAP] will take a snapshot of the auto mix (p.18).

[SCENE]+[PREVIOUS] will create a gradation in the auto mix (with the previous mark point) (p.18).

[SCENE]+[NEXT] will create a gradation in the auto mix (with the next mark point) (p.18).

[TRACK]+[LOC1/5] allows direct entry of the Track Edit condition Start point (p.79).

[TRACK]+[LOC2/6] allows direct entry of the Track Edit condition From point (p.79).

[TRACK]+[LOC3/7] allows direct entry of the Track Edit condition End point (p.79).

[TRACK]+[LOC4/8] allows direct entry of the Track Edit condition To point (p.79).

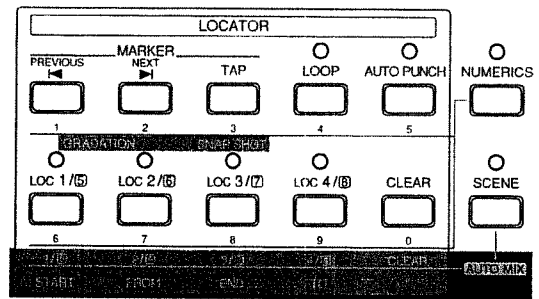

■ Transpose control

[SCENE]+[REC] initiates realtime recording of auto mix (p.18).

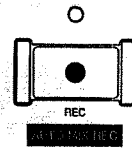

■ Special key operations

From the list of special Key operations (p.136), those of special usefulness are given below.

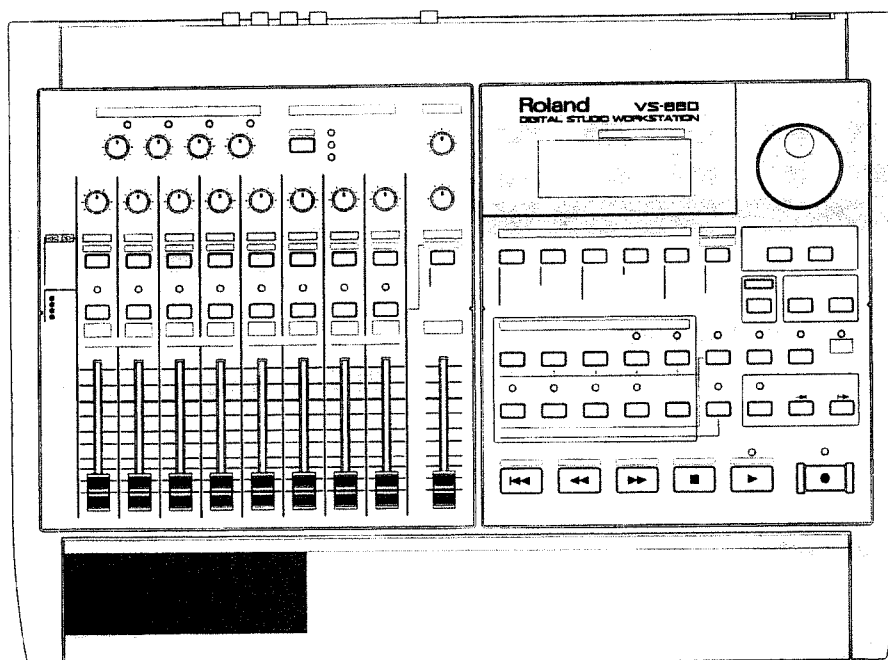

Index

[A]

Analog tape recorder	46
Auto mix	17
Using auto mix	17
Recording auto mix (Snapshot)	18
Recording time-varying changes in auto mix (Realtime)	18

[B]

Bar display	114
Switching the bar display	114

[C]

Channel	46
Channel edit	54
Channel fader	
Using the channel faders to adjust the effect	31
Recording channel fader movements (auto mix)	18
Storing channel fader settings (Scene)	51
Channel link	112
Compu mix	
Storing compu mix	122
Playing back compu mix	122
Contrast	114
Control change messages	
Using control change messages to modify effect settings	43
Using control change messages to modify mixer settings	121
Current drive	93
Changing the current drive	93

[D]

DAT	
Recording from DAT	72
Mixing down to DAT	72
Saving a song to DAT (Backup)	97
Loading a song from DAT (Recover)	98
Checking song names that were saved to DAT (Name)	99
Checking the status of performance data that was saved to DAT (Verify)	100
Destructive editing	76
Digital compact cassette	97
Digital disk recorder	46
Digital device	
Connecting a digital device	97
Recording from a digital device	72
DIGITAL IN connector	
Recording from the DIGITAL IN connector	72
Digital interface	145
Disk drive	
Connecting a disk drive	130
Initializing the disk (Drive Initialize)	93
Saving a song to a disk drive (Song Copy)	94
Loading a song from a disk drive	96
Checking the reliability of a disk drive (Surface Scan)	38
Checking whether a disk drive is damaged (Drive Check)	38

Display	
Switching the contents of the display	114
Adjusting the brightness of the display	114
Drop format	86

[E]

Equalizer	
Adjusting an equalizer	67
Using a 3-band equalizer	20
Error level	88
Events	19
Exclusive messages	85
External disk drives	
Connecting an external disk drive	130
Initializing an external disk drive (Drive Initialize)	93
Saving a song to an external disk drive (Song Copy)	94
Loading a song from an external disk drive	96
External effect devices	127
Applying an external effect device during song playback	127
Applying an external effect device during track bouncing	128

[F]

Fader edit	31
Fader match	21
Foot switch	
Using a foot switch to playback/stop a song	110
Using a foot switch to punch-in	65
Frames	
Moving in steps of a frame	57
Moving in steps of 1/10th of a frame	57

[G]

GPI	65, 110
Guitar amp simulator	
Applying the guitar amp simulator during recording	35

[H]

Hum canceller	28
Headphones	16

[I]

IDE	130
Initialize (Mixer/System)	117
INPUT MIX	
Using 3-band equalizers in INPUT MIX	20
INPUT→TRACK	
Inserting effects in INPUT→TRACK during recording	35
Mixing a stereo source in INPUT→TRACK	21

[L]

- Locate bank
 - Switching the locate bank 57
- Locate point
 - Registering a locate point 57
 - Moving to a locate point 58
 - Modifying the location of a locate point 57
 - Deleting a locate point 58
- Lo-fi processor 25

[M]

- Loop recording 66
- Mark point
 - Registering a mark point 59
 - Moving to a mark point 59
 - Modifying the location of a mark point 60
 - Deleting a mark point 60
 - Creating a sync track from mark points 40
 - Creating a tempo map from mark points 41
- Master fader 13
- MASTER OUT
 - Inserting effect into the MASTER OUT 36
- Master out mode 140
- Master tape 67
- Metronome
 - Sounding the metronome 109
 - Sounding the metronome on an external MIDI device 109
- Mic simulator 32
- MIDI
 - Using MIDI to switch the track status 86
- MIDI sequencers
 - Synchronizing a MIDI sequencer to the VS-880 88
 - Synchronizing the VS-880 to a MIDI sequencer 87
 - Using the tempo map to synchronize with a MIDI sequencer 89
 - Using the sync track to synchronize with a MIDI sequencer 91
- MIDI implementation chart 143
- MIDI clock
 - Recording MIDI clock on the sync track 92
- MIDI time code (MTC)
 - Changing the frame rate of MIDI time code (MTC) 86
 - Using MIDI time code (MTC) to synchronize operation 86
- MIX buss 50
- Mix down 72
- Mixer
 - Storing mixer settings (Scene) 51
 - Storing mixer settings (Auto mix) 17
 - Initializing mixer settings 117
- Mixer mode
 - Switching the mixer mode 51
- MMC 123
- Mute 55

[N]

- Noise suppressor 26, 28
- Non-destructive editing 76
- Non-drop format 86
- Note messages 85

- Numeric keys 44

[O]

- Overdubbing 64

[P]

- PAN knobs
 - Recording PAN knob movements (Auto mix) 18
 - Recording PAN knob settings (Scene) 51
- Partitions
 - Specifying the size of a partition 131
 - Switching partitions 131
- Peaking type (equalizer) 50
- Play list 114
- Post level 114
- Pre level 114
- Preview
 - Changing the preview length (time) 76
- Program change messages
 - Using program change messages to select effects 43
 - Using program change messages to select scenes 43
- Punch-in
 - Punching-in manually (Manual punch-in) 64
 - Punching-in automatically (Auto punch-in) 65
- Punch-out
 - Punching-out manually (Manual punch-in) 64
 - Punching-out automatically (Auto punch-in) 65

[R]

- Random access 53
- Realtime modify filter 26
- REC buss 50
- Reverb
 - Applying reverb 101
 - Applying reverb while recording 103
- Removable disk 130
- RSS 145

[S]

- S/P DIF 145
- Sample rate
 - Changing the sample rate 62
 - Checking the sample rate 72
- Scene
 - Registering a scene 52
 - Switching scenes 52
 - Deleting a scene 52
- SCMS 72
- SCSI cables 130
- SCSI devices
 - Setting the ID number of a SCSI device 131
 - Connecting two or more SCSI devices (SCSI chain) 130
- Scrub
 - Scrub length (changing the time) 77
- Sequential access 53
- Shelving type (equalizer) 50
- Shut-down 75
- SMPTE time code 56
- Solo 111

- Song**
- Creating a new song (Song New) 62
 - Naming a song (Song Name) 62
 - Saving a song (Song Store) 74
 - Selecting a different song (Song Select) 75
 - Copying a song (Song Copy) 94
 - Erasing a song (Song Erase) 113
 - Protecting a song from erasure (Song Protect) 74
 - Erasing only unneeded data from a song (Song Optimize) 113
 - Moving to the beginning of a song (Song Top) 56
 - Moving to the end of a song (Song End) 56
- Sources** 46
- Space chorus** 24
- Stereo in** 21
- Sub frame** 57
- Sync source** 91
- Sync track**
- Recording MIDI clock on the sync track 92
 - Using the sync track to synchronize operation with an external MIDI device 91
 - Specifying an offset for the sync track 42
 - Creating a tempo map from the sync track 41
 - Creating the sync track automatically 41
- [T]**
- Tap marker function** 59
- Tempo map**
- Creating a tempo map 90
 - Changing the initial tempo of the tempo map 90
 - Changing the tempo mid-way through the tempo map 91
 - Specifying an offset for the tempo map 42
- Terminator** 130
- Terminator power supply** 130
- Time compression/expansion** 84
- Tracks**
- Erasing a track (Track Erase) 81
 - Inserting blank space into a track (Track Insert) 82
 - Exchanging track contents with another track (Track Exchange) 81
 - Deleting part of a track (Track Cut) 83
 - Re-using part of a track (Track Copy) 78
 - Changing the time at which a track begins to sound (Track Move) 79
 - Re-recording several tracks onto another track (Track Bouncing) 67
- TRACK MIX**
- Using 3-band equalizers in TRACK MIX 20
- Track status**
- Switching the track status 55
 - Using MIDI to switch the track status 86
- [U]**
- Undo**
- Preventing the undo message from being displayed .. 113
 - Canceling undo (Redo) 113
- [V]**
- Vari-pitch** 111
- Vocal canceller** 28
- Vocoder**
- Applying the vocoder while recording 105
- Voice transformer**
- Using the channel faders to adjust the voice transformer 31
 - Using a MIDI keyboard to adjust the voice transformer 31
- VS8F-1** 54
- V-tracks**
- Switching V-tracks 63
- [Z]**
- Zero return** 14
- Zip disks**
- Initializing a Zip disk (Initialize) 93
 - Saving a song on a single Zip disk (Playable) 94
 - Saving a song on multiple Zip disks (Archive) 95
 - Loading a song from multiple Zip disks (Extract) 96
- Zip drive**
- Connecting a Zip drive 93

Roland® VS-880 TRACK SHEET

Project _____ Artist _____ Client _____ Date _____
 VS-880 Song Name _____ Backed up to _____
 (Circle one) Internal Drive -or- Removable Media

Virtual Track ↓	Track 1	Track 2	Track 3	Track 4	Track 5	Track 6	Track 7	Track 8
1								
2								
3								
4								
5								
6								
7								
8								

LOCATOR

Blank area for recording track locator information.

SCENE

Blank area for recording scene information.

NOTES

Blank area for recording general notes.



This product complies with the requirements of European Directives EMC 89/336/EEC and LVD 73/23/EEC.

For EU Countries

FEDERAL COMMUNICATIONS COMMISSION RADIO FREQUENCY INTERFERENCE STATEMENT

This equipment has been tested and found to comply with the limits for a Class B digital device, pursuant to Part 15 of the FCC Rules. These limits are designed to provide reasonable protection against harmful interference in a residential installation. This equipment generates, uses, and can radiate radio frequency energy and, if not installed and used in accordance with the instructions, may cause harmful interference to radio communications. However, there is no guarantee that interference will not occur in a particular installation. If this equipment does cause harmful interference to radio or television reception, which can be determined by turning the equipment off and on, the user is encouraged to try to correct the interference by one or more of the following measures:

- Reorient or relocate the receiving antenna.
- Increase the separation between the equipment and receiver.
- Connect the equipment into an outlet on a circuit different from that to which the receiver is connected.
- Consult the dealer or an experienced radio/TV technician for help.

Unauthorized changes or modification to this system can void the users authority to operate this equipment. This equipment requires shielded interface cables in order to meet FCC class B Limit.

For the USA

NOTICE

This Class B digital apparatus meets all requirements of the Canadian Interference-Causing Equipment Regulations.

For Canada

AVIS

Cet appareil numérique de la classe B respecte toutes les exigences du Règlement sur le matériel brouilleur du Canada.

Information

When you need repair service, call your nearest Roland Service Center or authorized Roland distributor in your country as shown below.

ARGENTINA

Instrumentos Musicales S.A.
Florida 638
(1005) Buenos Aires
ARGENTINA
TEL: (01) 394 4029

BRAZIL

Roland Brasil Ltda.
R. Coronel Octaviano da Silveira
203 05522-010
Sao Paulo BRAZIL
TEL: (011) 843 9377

CANADA

Roland Canada Music Ltd.
(Head Office)
5480 Parkwood Way Richmond
B. C., V6V 2M4 CANADA
TEL: (604) 270 6626

Roland Canada Music Ltd.
(Toronto Office)

Unit 2, 109 Woodbine Downs
Blvd., Etobicoke, ON
M9W 6Y1 CANADA
TEL: (416) 213 9707

MEXICO

Casa Veerkamp, s.a. de c.v.
Av. Toluca No. 323 Col. Olivar de
los Padres 01780 Mexico D.F.
MEXICO
TEL: (525) 668 04 80

La Casa Wagner de

Guadalajara s.a. de c.v.
Av. Corona No. 202 S.J.
Guadalajara, Jalisco Mexico
C.P. 44100 MEXICO
TEL: (03) 613 1414

PANAMA

Productos Superiores, S.A.
Apartado 655 - Panama 1
REP. DE PANAMA
TEL: 26 3322

U. S. A.

Roland Corporation U.S.
7200 Dominion Circle
Los Angeles, CA. 90040-3696,
U. S. A.
TEL: (0213) 685 5141

VENEZUELA

Musiland Digital C.A.
Av. Francisco de Miranda,
Centro Parque de Cristal, Nivel
C2 Local 20 Caracas
VENEZUELA
TEL: (02) 285 9218

AUSTRALIA

Roland Corporation
Australia Pty. Ltd.
38 Campbell Avenue
Dee Why West. NSW 2099
AUSTRALIA
TEL: (02) 982 8266

NEW ZEALAND

Roland Corporation (NZ) Ltd.
97 Mt. Eden Road, Mt. Eden,
Auckland 3, NEW ZEALAND
TEL: (09) 3098 715

CHINA

Beijing Xinghai Musical
Instruments Co., Ltd.
2 Huangmunchang Chao Yang
District, Beijing, CHINA
TEL: (010) 6774 7491

HONG KONG

Tom Lee Music Co., Ltd.
Service Division
22-32 Pun Shan Street, Tsuen
Wan, New Territories,
HONG KONG
TEL: 2415 0911

INDONESIA

PT Galestra Inti
Kompleks Perkantoran
Duta Merlin Blok E No.6-7
Jl. Gajah Mada No.3-5,
Jakarta 10130,
INDONESIA
TEL: (021) 6335416

KOREA

Cosmos Corporation
Service Station
261 2nd Floor Nak-Won Arcade
Jong-Ro ku, Seoul, KOREA
TEL: (02) 742 8844

MALAYSIA

Bentley Music SDN BHD
No.142, Jalan Bukit Bintang 55100
Kuala Lumpur, MALAYSIA
TEL: (03) 2443333

PHILIPPINES

G.A. Yupangco & Co. Inc.
339 Gil J. Puyat Avenue
Makati, Metro Manila 1200,
PHILIPPINES
TEL: (02) 899 9801

SINGAPORE

Sweet Lee Company
BLOCK 231, Bain Street #03-23
Bras Basah Complex,
SINGAPORE 0718
TEL: 3367886

CRISTOFORI MUSIC PTE

LTD
335, Joo Chiat Road SINGAPORE
1542
TEL: 3450435

TAIWAN

ROLAND TAIWAN
ENTERPRISE CO., LTD.
Room 5, 9th. No. 112 Chung Shan
N. Road Sec.2, Taipei, TAIWAN,
R.O.C.
TEL: (02) 561 3339

THAILAND

Theera Music Co., Ltd.
330 Veeng Nakorn Kasem, Soi 2,
Bangkok 10100, THAILAND
TEL: (02) 2248821

BAHRAIN

Moon Stores
Bad Al Bahrain Road,
P.O.Box 20077
State of BAHRAIN
TEL: 211 005

IRAN

TARADIS
Mir Emad Ave. No. 15, 10th street
P. O. Box 15875/4171 Teheran,
IRAN
TEL: (021) 875 6524

ISRAEL

Haliit P. Greenspoon &
Sons Ltd.
8 Retzif Ha'aliya Hashnya St.
Tel-Aviv-Yafo ISRAEL
TEL: (03) 6823666

JORDAN

AMMAN Trading Agency
Prince Mohammed St. P. O. Box
825 Amman 11118 JORDAN
TEL: (06) 641200

KUWAIT

Easa Husain Al-Yousifi
P.O. Box 126 Safat 13002
KUWAIT
TEL: 5719499

LEBANON

A. Chahine & Fils
P.O. Box 16-5857 Gergi Zeidan St.
Chahine Building, Achrafieh
Beirut, LEBANON
TEL: (01) 335799

OMAN

OHI Electronics & Trading
Co. LLC
P. O. Box 889 Muscat
Sultanate of OMAN
TEL: 706 010

QATAR

Badie Studio & Stores
P.O.Box 62,
DOHA QATAR
TEL: 423554

SAUDI ARABIA

Abdul Latif S. Al-Ghamdi
Trading Establishment
Middle East Commercial Center
Al-Khubar Dharan Highway
W/hamood st.
P. O. Box 3631 Al-Khober
31952 SAUDIARABIA
TEL: (03) 898 2332

SYRIA

Technical Light & Sound
Center
Khaled Ebn Al Walid St.
P.O.Box 13520
Damascus - SYRIA
TEL: (011) 2235 384

TURKEY

Barkat Sanayi ve Ticaret
Siraselvler Cad. Guney Ishani No.
86/6 Taksim, Istanbul TURKEY
TEL: (0212) 2499324

U.A.E

Zak Electronics & Musical
Instruments Co.
Zabeel Road, Al Sherooq Bldg.,
No. 14, Grand Floor DUBAI
U.A.E
P.O. Box 8050 DUBAI, U.A.E
TEL: (04) 360715

EGYPT

Al Fanny Trading Office
9, Ebn Hagar Al Askalany Street,
Ard El Golf, Heliopolis, Cairo,
11341 EGYPT
TEL: (02) 4171828
(02) 4185531

KENYA

Musik Land Limited
P.O.Box 12183 Moi Avenue
Nairobi Republic of KENYA
TEL: (2) 338 346

REUNION

FO - YAM Marcel
25 Rue Jules MermanZL
Chaudron - BP79 97491
Ste Clotilde REUNION
TEL: 28 29 16

SOUTH AFRICA

That Other Music Shop
(PTY) Ltd.
11 Melle Street (Cnr Melle and
Juta Street)
Braamfontein 2001
Republic of SOUTH AFRICA
TEL: (011) 403 4105

Paul Bothner (PTY) Ltd.
17 Werdmuller Centre Claremont
7700
Republic of SOUTH AFRICA
TEL: (021) 64 4030

AUSTRIA

E. Dematte & Co.
Neu-Rum Siemens-Strasse 4
A-6040 Innsbruck P.O.Box 83
AUSTRIA
TEL: (0512) 26 44 260

BELGIUM/HOLLAND/ LUXEMBOURG

Roulant Benelux N. V.
Houtstraat 1 B-2260 Oevel-
Westerlo BELGIUM
TEL: (014) 575811

BELORUSSIA

TUSHE
UL. Rabkorovskaya 17
220001 MINSK
TEL: (0172) 764-911

CYPRUS

Radex Sound Equipment Ltd.
17 Diagorou St., P.O.Box 2046,
Nicosia CYPRUS
TEL: (02) 453 426
(02) 466 423

DENMARK

Roland Scandinavia A/S
Langebrogade 6 Post Box 1937
DK-1023 Copenhagen K.
DENMARK
TEL: 32 95 3111

FRANCE

MUSIKENGRO
Zac de Follieuses 01706
Les Echets Miribel FRANCE
TEL: 472 26 2700

FINLAND

Roland Scandinavia As,
Filial Finland
Lauttaasaarentie 54 B
Fin-00201 Helsinki, FINLAND
P. O. Box No. 109
TEL: (0) 682 4020

GERMANY

Roland Elektronische
Musikinstrumente
Handelsgesellschaft mbH.
Oststrasse 96, 22844 Norderstedt,
GERMANY
TEL: (040) 52 60090

GREECE

V. Dimitriadis & Co. Ltd.
20, Alexandras St. & Bouboulinas
54 St. 106 82 Athens, GREECE
TEL: (01) 8232415

HUNGARY

Intermusica Ltd.
Warehouse Area 'DEPO' P/83
H-2046 Torokbalint, HUNGARY
TEL: (23) 338 041

IRELAND

The Dublin Service Centre
Audio Maintenance Limited
11 Brunswick Place Dublin 2
Republic of IRELAND
TEL: (01) 677322

ITALY

Roland Italy S. p. A.
Viale delle Industrie, 8
20020 Arese Milano, ITALY
TEL: (02) 93581311

NORWAY

Roland Scandinavia Avd.
Kontor Norge
Lilleakerveien 2 Postboks 95
Lilleaker N-0216 Oslo
NORWAY
TEL: 273 0074

POLAND

P. P. H. Brzostowicz Marian
UL. Blokowa 32, 03624 Warszawa
POLAND
TEL: (022) 679 44 19

PORTUGAL

Caius - Tecnologias Audio e
Musica, Lda.
Rue de Catarina 131
4000 Porto, PORTUGAL
TEL: (02) 38 4456

RUSSIA

Slami Music Company
Sadojava-Triumfalnaja st., 16
103006 Moscow, RUSSIA
TEL: 095 209 2193

SPAIN

Roland Electronics
de España, S. A.
Calle Bolivia 239 08020 Barcelona,
SPAIN
TEL: (93) 308 1000

SWEDEN

Roland Scandinavia A/S
Danvik Center 28 A, 2 tr.
S-131 30 Nacka SWEDEN
TEL: (08) 702 0020

SWITZERLAND

Roland (Switzerland) AG
Musitronic AG
Gerberstrasse 5, CH-4410 Liestal,
SWITZERLAND
TEL: (061) 921 1615

UKRAINE

TIC-TAC
Mira Str. 19/108
P.O.Box 180
295400 Mukachevo, UKRAINE
TEL: (03131) 414-40

UNITED KINGDOM

Roland (U.K.) Ltd., Swansea
Office
Atlantic Close, Swansea
Enterprise Park SWANSEA
West Glamorgan SA7 9FJ,
UNITED KINGDOM
TEL: (01792) 702701

As of June, 12, 1997

Read with the Owner's manual.

Following is important additional information to the VS-880 V-XPANDED Owner's manual. Please read with Owner's manual.

About "!!! Lack of EVENT !!" display

"!!! Lack of EVENT !!" will be appeared in the display in the following cases, and you cannot continue the current operation.

- If you push [SCENE]+[REC] buttons to record AutoMix data in **realtime**, when the remaining number of EVENT is **less than 1000**.
- If you try to **UNDO** or **REDO** when the remaining number of Event is **less than 200**.

The smallest unit of memory used by the VS-880 to store recorded results on disk are the **events**. A newly created song provides approximately 12,000 events per song.

For each track, one recording pass uses two events. Operations such as punch-in/out or track copy also use up events. The number of events that are used up will fluctuate in a complex way. For example, auto mix uses up five events for each mark point.

When you do a lot of recording, editing (Track Copy, Track Move) or record AutoMix of long period, please check the remaining number of Events frequently. Procedure is as follows.

1. Press [SYSTEM] several times until "SYS System PRM?" appears.
2. Press [YES].
3. Press PARAMETER [▶▶] several times until "SYS RemainDsp=" appears.
4. Select "Event" with TIME/VALUE dial.

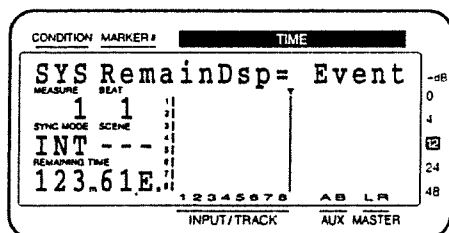

Remaining number of Events can be saved with the following procedures. Please try the most appropriate one with your situation.

- **Execute Song Store (Owner's manual p.74)**
Please Execute Song Store if in UNDO condition ([UNDO] indicator is lit.). Events served for REDO will be released. But please note that you cannot cancel (REDO) the last UNDO if you once execute STORE.
- **Execute Song Optimize (Owner's manual p.114)**
Please execute Song Optimize if you have done a lot of Punch In recording. Events served for unnecessary audio data will be released. But please note that you can only do single level UNDO.
- **Erase AutoMix data (Owner's manual p.19)**
If you have recorded AutoMix data, erase unnecessary data. Events served for unnecessary AutoMix data will be released.

Errata

Regretfully, a number of inaccuracies appear in the Quick Start for the Roland Digital Studio Workstation VS-880 V-XPANDED. It should read as shown below. We apologize inconveniences this may cause.

Page 2 "<Cautions when installing an internal hard disk>" Step 3

Please remove the following text:

"The Temporary fastening screws include with the hard disk are not required for installation into the VS-880. When installing the hard disk into the VS-880, use the screws that are attached to the disk slot of the VS-880."

Notes when using a Zip drive

A Zip drive manufactured by Iomega Corporation USA can be connected to the VS-880 via the SCSI connector and used as an external removable disk drive. Follow the instructions in the section "Connecting a disk drive" of the owner's manual (p.130) and connect the Zip drive to the VS-880. When connections are complete, follow the procedure "Initializing the disk (Drive Initialize)" (p.93) to initialize the disk of the Zip drive (including physical formatting).

* The SCSI ID number of the Zip drive can be set either to "5" or "6." If other disk drives are also connected, make sure that their SCSI ID numbers do not conflict.

Using a Zip drive for backup

If you wish to use a Zip drive to backup song data, there are particular limitations. Refer to "Saving performance data on a Zip disk (Song Copy)" (owner's manual p.94) to copy song data from the internal hard disk.

Using a Zip drive as the current drive

The VS-880 can use a Zip drive as the current drive (the drive for recording and playback). In this case, please note the following points.

● Number of tracks

A Zip drive is not able to write or read data as fast as a hard disk. This means that if you are using a Zip drive as the current drive (the drive for recording and playback), you may get a message of "Disk Too Slow!" in some cases, and correct playback will not be possible.

In order to avoid such problems as far as possible when playing back a song from a Zip drive, refer to the following table and limit the number of simultaneously played back tracks as appropriate for the sample rate and recording mode settings of the song.

Recording mode	Sample rate		
	48.0 kHz	44.1 kHz	32 kHz
Mastering	3 (2)	4 (2)	4 (4)
Multitrack 1	7 (6)	7 (5)	8 (6)
Multitrack 2	7 (6)	8 (7)	8 (8)
Live	8 (8)	8 (8)	8 (8)

* Numbers in parentheses () are guidelines for numbers of tracks in songs in which operations such as punch-in recording or track copy are performed repeatedly.

* If the "Disk Too Slow" message appears, refer to the "Error messages" (owner's manual p.134) and take the appropriate action.

* A sample rate of "44.1 kHz" and a recording mode of "MT2 (multitrack 2)" will be set for the song which is created automatically when a disk is initialized, or for a newly created song if you do not specify the sample rate and recording mode.

● Automatic sleep mode

When data reading or writing operations have not occurred for a specific interval of time on the Zip drive, it will automatically reduce the disk rotation speed to reduce power consumption and extend the life of the disk. This is referred to as automatic sleep mode.

When a Zip drive is used with the VS-880, if a 30 minute interval elapses without data being written to or read from the Zip drive, the rotation speed of the disk will automatically be reduced. If you begin recording in this state, the first part of the recording may not be recorded correctly, since a certain interval of time is required for the disk to return to its normal rotational speed. In order to avoid such problems, press [STOP] before you begin recording. When you press [STOP] the disk will return to its normal rotational speed.

● Approximate recording times

The following table shows the approximate recording times that are possible on a single disk (100 M bytes) with the Zip drive (times shown are for a single track).

Recording mode	Sample rate		
	48.0 kHz	44.1 kHz	32 kHz
Mastering	17 minutes	18 minutes	26 minutes
Multitrack 1	34 minutes	37 minutes	52 minutes
Multitrack 2	46 minutes	50 minutes	69 minutes
Live	55 minutes	60 minutes	83 minutes

(recording times are approximate)

* Iomega is a registered trademark of Iomega Corporation USA.

* Zip is a trademark of Iomega Corporation USA.

Expanding the system functions of the VS-880

Here we will explain how to use the VS-880-S1 Zip disk to expand the system functions of the VS-880.

VS-880 V-XPANDED adds a rich array of new and expanded functionality. However in order to take advantage of this potential, connections and settings must be made correctly. The procedure for performing the expansion is very simple. Please read this leaflet carefully before you turn on the power.

* The VS-880-S1 Zip disk contains a program for expanding the functionality of the VS-880. Do not initialize this disk.

Before you perform the expansion

When expanding the functionality of your VS-880, please be aware of the following points.

■ Hard disk

The hard disk drive(s) that you have been using will continue to be usable after the expansion is performed. It is not necessary to initialize the hard disk drive(s).

■ Songs

The songs saved in the disk drive(s) that you have been using will still be playable after the expansion is performed.

■ Effects (if a VS8F-1 is installed)

Patches that are stored as User Patches or Scenes before performing the expansion will still be usable after the expansion is performed.

The expansion will add 100 additional preset effect Patches. For this reason, the Patch numbers will change as follows.

Before expansion	After expansion
Preset 1-100	Preset A00-A99
(newly added)	Preset B00-B99
User 101-200	User U00-U99

Performing the expansion

Here's how to perform the expansion for your VS-880. Use the following procedure.

* A Zip drive is required in order to add the new functionality to your VS-880.

1. Make sure that the power of all equipment is turned off.
2. Disconnect all cables (audio, SCSI, digital etc.) that are connected to the VS-880.
3. Use a SCSI cable to connect the Zip drive to the VS-880. Do not connect any disk drive other than the Zip drive.
4. Turn on the power of the Zip drive.
5. Insert the VS-880-S1 Zip disk into the Zip drive.
6. Connect the power cable to the VS-880.
7. Using the power switch located on the rear panel, turn on the power of the VS-880.
The following message will appear.

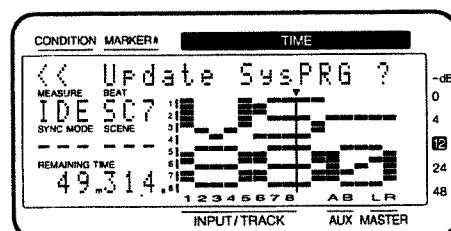

< If the message does not appear >
The VS-880 has not detected the VS-880-S1 Zip disk. Turn the power off once again, re-insert the system expansion disk correctly, and turn the power on again.

please turn over...

8. Press [YES].

The system expansion will take approximately 20 seconds. During the process, progress will be indicated by a countdown in the display.

- * The power must **never** be turned off until the system expansion process has been completed. This could damage the VS-880 system.

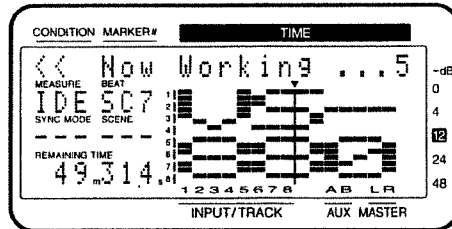

9. When the system expansion ends correctly, the following message will appear. Turn off the power of the VS-880.

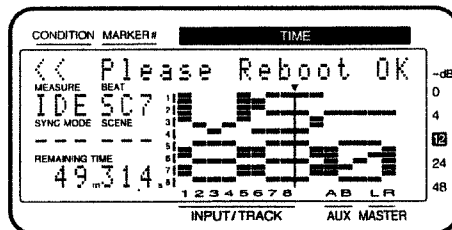

10. Turn the power on once again.

11. When the "Verify SysPRG ?" message appears, press [YES].

The VS-880 will perform a self-check to verify that the system expansion was performed correctly. During this time, a count-down will appear in the display to indicate the progress.

- * The power must **never** be turned off until the self-check process has been completed. This could damage the VS-880 system.

12. If the self-check determines that the system expansion has been performed correctly, the VS-880 will re-start automatically.

The system software version number will be displayed in the REMAINING field of the display. Make sure that the version number is 2.00 or higher.

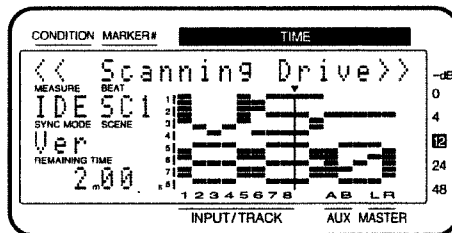

< If the display does not appear >
The system expansion was not performed correctly. Follow the procedure of "Performing the expansion," and perform the procedure once again.

The VS-880 system has now been expanded.

Please read VS-880 owner's manual "Chapter 1, Trying out the expanded functions."

- * Thereafter, you will not need the VS-880-S1 Zip disk when starting up the VS-880. The Zip disk should be put away for safekeeping. Note that the VS-880-S1 Zip disk can only be used with the VS-880.

* Zip is a trademark of Iomega Corporation.

Preset Patch List

Roland®

By installing a VS8F-1 on the VS-880, you can access the range of effects listed below.

No.	Patch Name	Algorithm	Type	Input	Comment
-----	------------	-----------	------	-------	---------

<Reverb2> (20 preset)

B00	R2:LargeHall	Reverb2	Loop	Mono	see Preset A00 (Effects 1 and 2 can be used simultaneously)
B01	R2:SmallHall	Reverb2	Loop	Mono	see Preset A01 (Effects 1 and 2 can be used simultaneously)
B02	R2:Strings	Reverb2	Loop	Mono	see Preset A02 (Effects 1 and 2 can be used simultaneously)
B03	R2:PianoHall	Reverb2	Loop	Mono	see Preset A03 (Effects 1 and 2 can be used simultaneously)
B04	R2:Orch Room	Reverb2	Loop	Mono	see Preset A04 (Effects 1 and 2 can be used simultaneously)
B05	R2:VocalRoom	Reverb2	Loop	Mono	see Preset A05 (Effects 1 and 2 can be used simultaneously)
B06	R2:MediumRm	Reverb2	Loop	Mono	see Preset A06 (Effects 1 and 2 can be used simultaneously)
B07	R2:LargeRoom	Reverb2	Loop	Mono	see Preset A07 (Effects 1 and 2 can be used simultaneously)
B08	R2:CoolPlate	Reverb2	Loop	Mono	see Preset A08 (Effects 1 and 2 can be used simultaneously)
B09	R2:Short Plt	Reverb2	Loop	Mono	see Preset A09 (Effects 1 and 2 can be used simultaneously)
B10	R2:Vocal Plt	Reverb2	Loop	Mono	see Preset A10 (Effects 1 and 2 can be used simultaneously)
B11	R2:Soft Amb.	Reverb2	Loop	Mono	see Preset A11 (Effects 1 and 2 can be used simultaneously)
B12	R2:Room Amb.	Reverb2	Loop	Mono	see Preset A12 (Effects 1 and 2 can be used simultaneously)
B13	R2:Cathedral	Reverb2	Loop	Mono	see Preset A13 (Effects 1 and 2 can be used simultaneously)
B14	R2:Long Cave	Reverb2	Loop	Mono	see Preset A14 (Effects 1 and 2 can be used simultaneously)
B15	R2:GarageDr.	Reverb2	Loop	Mono	see Preset A15 (Effects 1 and 2 can be used simultaneously)
B16	R2:Rock Kick	Reverb2	Loop	Mono	see Preset A16 (Effects 1 and 2 can be used simultaneously)
B17	R2:RockSnare	Reverb2	Loop	Mono	see Preset A17 (Effects 1 and 2 can be used simultaneously)
B18	R2:BrteGte2	Reverb2	Loop	Mono	A high-density and bright sounding gated reverb. Adjust Threshold.
B19	R2:Fat Gat2	Reverb2	Loop	Mono	A high-density and warm sounding gated reverb. Adjust Threshold.

<Mic Simulator> (22 preset)

B20	MS:57→58	Mic Simulator	Insert	2ch	Converts a general-purpose D. mic to a vocal D. mic. Rich mid/low range.
B21	MS:57→421	Mic Simulator	Insert	2ch	Converts a general-purpose D. mic to a large D. mic. For drums and guitar amp.
B22	MS:57→451	Mic Simulator	Insert	2ch	Converts a general-purpose D. mic to a small C. mic. For acoustic guitar and cymbals.
B23	MS:57→87	Mic Simulator	Insert	2ch	Converts a general-purpose D. mic to a large C. mic. For vocals and acoustic inst.
B24	MS:57→47	Mic Simulator	Insert	2ch	Converts a general-purpose D. mic to a vintage C. mic. For vocals and acoustic inst.
B25	MS:57→Line	Mic Simulator	Insert	2ch	Cancels the characteristics of D.mic, giving the sound a flat frequency response.
B26	MS:DR20→421	Mic Simulator	Insert	2ch	Converts a Roland DR-20 to an instrumental D. mic. For drums and guitar amp.
B27	MS:DR20→451	Mic Simulator	Insert	2ch	Converts a Roland DR-20 to a small C. mic. For acoustic guitar and cymbals.
B28	MS:DR20→87	Mic Simulator	Insert	2ch	Converts a Roland DR-20 to a large C. mic. For vocals and acoustic inst.
B29	MS:10→58	Mic Simulator	Insert	2ch	Converts a headset mic to a vocal D. mic.
B30	MS:10→87	Mic Simulator	Insert	2ch	Converts a headset mic to a large C. mic.
B31	MS:Mini→57	Mic Simulator	Insert	2ch	Converts a miniature C. mic to a general-purpose D. mic.
B32	MS:Mini→87	Mic Simulator	Insert	2ch	Converts a miniature C. mic to a large C. mic.
B33	MS:Kick&Snr1	Mic Simulator	Insert	2ch	For the bass drum (L channel) and snare drum (R channel) of a drum set (1).
B34	MS:Kick&Snr2	Mic Simulator	Insert	2ch	For the bass drum (L channel) and snare drum (R channel) of a drum set (2).
B35	MS:H.Hat&Tom	Mic Simulator	Insert	2ch	For the hi-hat (L channel) and tom (R channel) of a drum set.
B36	MS:Dr.OvrTop	Mic Simulator	Insert	2ch	A patch for placing mics above the drums mainly to mic the cymbals.
B37	MS:Dr.OvrAll	Mic Simulator	Insert	2ch	A patch for placing mics above the front of the drums to mic the entire set.
B38	MS:Ac.Guitar	Mic Simulator	Insert	2ch	For acoustic guitar. InsertL: brighter, InsertR: warmer.
B39	MS:StudioVcl	Mic Simulator	Insert	2ch	For vocals. InsertL: natural, InsertR: Rock.
B40	MS:StereoMic	Mic Simulator	Insert	2ch	Gives time-lag to a sound miked in stereo, emphasizing spaciousness.
B41	MS:Ambience	Mic Simulator	Insert	2ch	Simulates ambience mics. Add reverb and mix with original source.

<Parametric Equalizer > (26 preset)

B42	PEQ:BassDrum	Parametric Equalizer	Insert	Stereo	For bass drum. Adjust LowQ and HiG.
B43	PEQ:RockBD	Parametric Equalizer	Insert	Stereo	For bass drum. A sound suitable for rock with mid-lows emphasized.
B44	PEQ:RockSD	Parametric Equalizer	Insert	Stereo	For snare drum. Drops the mid-lows and emphasizes the attack and snares.
B45	PEQ:RimShot	Parametric Equalizer	Insert	Stereo	For rim shot. Emphasizes the feeling of attack unique to a rim shot.
B46	PEQ:Toms	Parametric Equalizer	Insert	Stereo	For toms. Adjust LowF and LowMidF.
B47	PEQ:Hi Hat	Parametric Equalizer	Insert	Stereo	For the crisper hi-hat. Adjust bell sound with HiMidG.
B48	PEQ:Cymbals	Parametric Equalizer	Insert	Stereo	For cymbals. Emphasizes the difference in tone between cymbals and their clarity.
B49	PEQ:Overhead	Parametric Equalizer	Insert	Stereo	For drum kit. Use when miking the sound of the entire kit.
B50	PEQ:Bass 1	Parametric Equalizer	Insert	Stereo	For electric bass. Wide-range and tight bass sound.
B51	PEQ:Bass 2	Parametric Equalizer	Insert	Stereo	For electric bass. Fatter and with more punch than B50. For rock.
B52	PEQ:SlapBass	Parametric Equalizer	Insert	Stereo	For electric bass. Settings that emphasize the accent of pulled notes with slap technique.
B53	PEQ:Sax	Parametric Equalizer	Insert	Stereo	For alto/soprano sax. Lower HiG for mellow sound.
B54	PEQ:Bari.Sax	Parametric Equalizer	Insert	Stereo	For baritone sax. Adjust LoMidF.
B55	PEQ:ElecGtr	Parametric Equalizer	Insert	Stereo	Settings that keep the lead guitar from being buried in the mix.
B56	PEQ:NylonGtr	Parametric Equalizer	Insert	Stereo	Emphasize the tone of nylon strings. Adjust fret sound with HiG.
B57	PEQ:BluesGtr	Parametric Equalizer	Insert	Stereo	Adds a delicate nuance suitable when playing blues on an acoustic guitar.

VS8F-1

EFFECT EXPANSION BOARD FOR VS-880

A52-A99

Preset Patch List

Roland®

No.	Patch Name	Algorithm	Type	Input	Comment
-----	------------	-----------	------	-------	---------

<Guitar Amp Simulator> (9 preset)

A52	GA:JazChorus	Guitar Amp Simulator	Insert	Mono	Roland JC-120 amp. Sounds more authentic when used with chorus for mixdown.
A53	GA:CleanTwin	Guitar Amp Simulator	Insert	Mono	U.S. tube combo amp circa "black panel."
A54	GA:Vin.Tweed	Guitar Amp Simulator	Insert	Mono	'50s U.S. tube amp overdrive.
A55	GA:BluesDrv.	Guitar Amp Simulator	Insert	Mono	Old British amp crunchy overdrive.
A56	GA:MatchLead	Guitar Amp Simulator	Insert	Mono	Hot-rodded British combo amp.
A57	GA:StudioCmb	Guitar Amp Simulator	Insert	Mono	Favourite late '70s amp of studio musicians.
A58	GA:JMP-Stack	Guitar Amp Simulator	Insert	Mono	Late '60s British stacks.
A59	GA:SLDN Lead	Guitar Amp Simulator	Insert	Mono	An '80s amp known for versatile distortion.
A60	GA:5150 Lead	Guitar Amp Simulator	Insert	Mono	Big tube amp standard for American heavy metal.

<Bass> (5 preset)

A61	BS:DI'edBass	Vocal Multi	Insert	Mono	Slight limiting and equalization optimized, ideal for line recording applications.
A62	BS:MikedBass	Guitar Amp Simulator	Insert	Mono	A miked speaker box with four 12"s.
A63	BS:CompBass	Stereo Multi	Insert	Stereo	Hard-compressed sound optimized for slaps.
A64	BS:Auto Wah	Guitar Multi 2	Insert	Mono	Synth bass like sound added with auto wah essential for '70s funk.
A65	BS:EFX Bass	Stereo Delay Chorus	Insert	Stereo	Solo-optimized sound with depth and spaciousness added through delay and chorus.

<Stereo Multi> (5 preset)

A66	CL:Comp	Stereo Multi	Insert	Stereo	Stereo type compression optimized for broadcast mixing.
A67	CL:Limiter	Stereo Multi	Insert	Stereo	A convenient effect for analog mastering because it can limit peak signals.
A68	EQ:Loudness	Stereo Multi	Insert	Stereo	Applies EQ curve with slightly boosted lows and highs.
A69	EQ:Fat Dance	Stereo Multi	Insert	Stereo	Hard compression plus equalizing for dance music.
A70	EQ:ThinJingl	Stereo Multi	Insert	Stereo	Limiter and EQ processing for FM radio and TV broadcasting.

<Chorus/Flanger/Phaser/PitchShifter> (9 preset)

A71	CH:Lt Chorus	Stereo Delay Chorus	Insert	Stereo	Natural stereo chorus with shallow depth for spacious, crystal-clear sound.
A72	CH:Deep Cho	Stereo Delay Chorus	Insert	Stereo	Intense stereo chorus that adds depth and spaciousness to the sound.
A73	CH:DetuneCho	Stereo Pitch Shifter Delay	Insert	Stereo	Chorus with left and right channels separately pitch shift-detuned up and down.
A74	FL:LtFlanger	Stereo Flanger	Insert	Stereo	Stereo flanger with slight modulation.
A75	FL:Deep Fl	Stereo Flanger	Insert	Stereo	Deeper stereo flanger for metallic jet swooshing sound.
A76	PH:Lt Phaser	Stereo Phaser	Insert	Stereo	Lighter 4-stage stereo phaser suitable for synth strings.
A77	PH:DeepPhase	Stereo Phaser	Insert	Stereo	Deep phaser effective for electronic piano and clavinet sounds.
A78	PS:4thVoice	Vocal Multi	Insert	Mono	Adds sound down a fourth to the direct sound.
A79	PS:ShimmerUD	Stereo Pitch Shifter Delay	Insert	Stereo	A special effect with left channel pitch rising and right channel pitch dropping over time.

<Same as Algorithm> (20 preset)

A80	Reverb	Reverb	Loop	Mono	Refer to page 16 of the VS8F-1 Owner's Manual.
A81	Delay	Delay	Loop	Mono	Refer to page 17 of the VS8F-1 Owner's Manual.
A82	StDly-Chorus	Stereo Delay Chorus	Insert	Stereo	Refer to page 18 of the VS8F-1 Owner's Manual.
A83	StPS-Delay	Pitch Shifter Delay	insert	Stereo	Refer to page 19 of the VS8F-1 Owner's Manual.
A84	Vocoder	Vocoder	Insert	Mono	Refer to page 19 of the VS8F-1 Owner's Manual.
A85	2ch RSS	2ch RSS	Insert	2ch	Refer to page 20 of the VS8F-1 Owner's Manual.
A86	Delay RSS	Delay RSS	Insert	Mono	Refer to page 20 of the VS8F-1 Owner's Manual.
A87	Chorus RSS	Chorus RSS	Insert	Mono	Refer to page 21 of the VS8F-1 Owner's Manual.
A88	GuitarMulti1	Guitar Multi 1	Insert	Mono	Refer to page 21 of the VS8F-1 Owner's Manual.
A89	GuitarMulti2	Guitar Multi 2	Insert	Mono	Refer to page 22 of the VS8F-1 Owner's Manual.
A90	GuitarMulti3	Guitar Multi 3	Insert	Mono	Refer to page 23 of the VS8F-1 Owner's Manual.
A91	Vocal Multi	Vocal Multi	Insert	Mono	Refer to page 24 of the VS8F-1 Owner's Manual.
A92	Rotary	Rotary	Insert	Mono	Refer to page 25 of the VS8F-1 Owner's Manual.
A93	GuitarAmpSim	Guitar Amp Simulator	Insert	Mono	Refer to page 25 of the VS8F-1 Owner's Manual.
A94	St Phaser	Stereo Phaser	Insert	Stereo	Refer to page 26 of the VS8F-1 Owner's Manual.
A95	St Flanger	Stereo Flanger	Insert	Stereo	Refer to page 26 of the VS8F-1 Owner's Manual.
A96	DualComp/Lim	Dual Compressor/Limiter	Insert	2ch	Refer to page 27 of the VS8F-1 Owner's Manual.
A97	Gate Reverb	Gate Reverb	Loop	Mono	Refer to page 27 of the VS8F-1 Owner's Manual.
A98	MultiTapDly	Multi Tap Delay	Insert	Mono	Refer to page 28 of the VS8F-1 Owner's Manual.
A99	Stereo Multi	Stereo Multi	Insert	Stereo	Refer to page 29 of the VS8F-1 Owner's Manual.

Preset Patch List

Roland®

By installing a VS8F-1 on the VS-880, you can access the range of effects listed below.

No.	Patch Name	Algorithm	Type	Input	Comment
-----	------------	-----------	------	-------	---------

<Reverb> (18 preset)

A00	RV:LargeHall	Reverb	Loop	Mono	Large concert hall reverberation.
A01	RV:SmallHall	Reverb	Loop	Mono	Small hall reverberation.
A02	RV:Strings	Reverb	Loop	Mono	Reverberation optimized for delicate highs of strings.
A03	RV:PianoHall	Reverb	Loop	Mono	Rich and warm reverberation optimized for pianos.
A04	RV:Orch Room	Reverb	Loop	Mono	Reverberation of large-capacity rooms such as big banquet halls.
A05	RV:VocalRoom	Reverb	Loop	Mono	Room reverb suitable for vocals and chorus.
A06	RV:MediumRm	Reverb	Loop	Mono	Warm and naturally spacious room reverb.
A07	RV:LargeRoom	Reverb	Loop	Mono	Simulated acoustics of wide rooms with lots of reverberation.
A08	RV:CoolPlate	Reverb	Loop	Mono	Distinctive bright plate reverb.
A09	RV:Short Plt	Reverb	Loop	Mono	Shorter plate reverb.
A10	RV:Vocal Plt	Reverb	Loop	Mono	Crystal-clear reverb optimized for vocals.
A11	RV:Soft Amb.	Reverb	Loop	Mono	Simulated reverberation of a room with minimal wall reflections.
A12	RV:Room Amb.	Reverb	Loop	Mono	Natural reverberation of rooms with good acoustics, suitable for drums and guitars.
A13	RV:Cathedral	Reverb	Loop	Mono	Acoustics of a very large, high-ceilinged church.
A14	RV:Long Cave	Reverb	Loop	Mono	Simulated reverberation of deep caves.
A15	RV:GarageDr.	Reverb	Loop	Mono	Natural reverb that enhances unique drum sounds.
A16	RV:Rock Kick	Reverb	Loop	Mono	Reverb with many low-frequency components, suitable for rock kicks.
A17	RV:RockSnare	Reverb	Loop	Mono	Rich and thick sounding reverb suitable for rock snares.

<Gate Reverb> (4 preset)

A18	RV:BriteGate	Gate Reverb	Loop	Mono	Slightly brighter gate reverb.
A19	RV:Fat Gate	Gate Reverb	Loop	Mono	Dynamic reverb sound with powerful mids and lows.
A20	RV:ReverseGt	Gate Reverb	Loop	Mono	A reverse gate commonly used as a special effect.
A21	RV:PanningGt	Gate Reverb	Loop	Mono	A special effect with gate reverb shifting from left to right.

<Delay> (9 preset)

A22	DL:Short Dly	Delay	Loop	Mono	An ambience effect that adds depth to the sound by doubling.
A23	DL:MediumDly	Delay	Loop	Mono	Natural echo optimized for vocals.
A24	DL:LongDelay	Delay	Loop	Mono	Long delay suited for brass and analog synth solos.
A25	DL:AnalogDly	Delay	Loop	Mono	Analog sound with gradually diminishing feedbacking highs.
A26	DL:Tape Echo	Stereo Delay Chorus	Loop	Stereo	Simulated tape echo with distinctive wow flutter.
A27	DL:Karaoke	Stereo Delay Chorus	Loop	Stereo	Intense reverberation that effectively enhances karaoke vocals.
A28	DL:Multi-Tap	Stereo Delay Chorus	Loop	Stereo	Spacious reflections using positioning delay at any point along the stereo soundfield.
A29	DL:MultTapAmb	Multi Tap Delay	Loop	Mono	An ambience effect using 10 short delay units.
A30	DL:Ping Pong	Multi Tap Delay	Loop	Mono	A special effect using tap delay.

<Vocal> (10 preset)

A31	VO:Vocal Efx	Vocal Multi	Insert	Mono	Basic setup for recording/mixdown of vocals.
A32	VO:JazzVocal	Vocal Multi	Insert	Mono	A natural sounding jazz club-like ambience for warm reverb well-suited for vocals.
A33	VO:RockVocal	Vocal Multi	Insert	Mono	Sound featuring limiter/enhancer processing as well as a unison effect.
A34	VO:Narration	Vocal Multi	Insert	Mono	An effect with heavy compression, used for narration.
A35	VO:BigChorus	Vocal Multi	Insert	Mono	A spacious-sounding stereo effect similar to increasing the number of vocalists.
A36	VO:Club DJ	Vocal Multi	Insert	Mono	A club DJ-tailored effect that uses a pitch shifter to make voices lower.
A37	VO:AM-Radio	Vocal Multi	Insert	Mono	Sound featuring hard compression and narrower frequency range.
A38	VO:PlusTwo	Stereo Pitch Shifter Delay	Insert	Stereo	A special effect that adds two more voices using a pitch shifter.
A39	VO:Robot Efx	Stereo Pitch Shifter Delay	Insert	Stereo	SF movie-like effect using a pitch shifter.
A40	VO:Bull Horn	Guitar Multi 3	Insert	Mono	Simulated effect of sound produced from a Bull Horn or old radio.

<Guitar > (11 preset)

A41	GT:Rock Lead	Guitar Multi 2	Insert	Mono	Straight distortion sound with delay.
A42	GT:LA Lead	Guitar Multi 2	Insert	Mono	Lead guitar sound with tasty compression and chorus applied.
A43	GT:MetallLead	Guitar Multi 1	Insert	Mono	Metal sound with dynamic, ultrahigh gain distortion.
A44	GT:Metall Jet	Guitar Multi 1	Insert	Mono	Distortion together with a metallic effect achieved by flanging.
A45	GT:CleanRthm	Guitar Multi 1	Insert	Mono	Clean sound with compression and chorus applied.
A46	GT:DledClean	Vocal Multi	Insert	Mono	Superclean sound like line recording directly into the console.
A47	GT:Delay Rif	Guitar Multi 2	Insert	Mono	Delay sounds at dotted eighth note intervals when a 120 BPM riff is played.
A48	GT:Acoustic	Vocal Multi	Insert	Mono	Optimized for electroacoustic guitars.
A49	GT:BluesDrv.	Guitar Multi 3	Insert	Mono	Crunchy overdrive sound suited to blues and R&R.
A50	GT:Liverpool	Guitar Multi 3	Insert	Mono	Crunchy sound often heard on '60s British rock.
A51	GT:Country	Guitar Multi 3	Insert	Mono	Clean sound featuring distinctive compression and delay.

Preset Patch List

No.	Patch Name	Algorithm	Type	Input	Comment
-----	------------	-----------	------	-------	---------

B58	PEQ:SlideGtr	Parametric Equalizer	Insert	Stereo	Adds a rich feel to acoustic slide guitar. Adjust HiF.
B59	PEQ:LineGtr	Parametric Equalizer	Insert	Stereo	For piezo pickups. Adjust brightness with HiG.
B60	PEQ:Male	Parametric Equalizer	Insert	Stereo	Improves the tone quality of a male vocal. Adjust HiG.
B61	PEQ:RockMale	Parametric Equalizer	Insert	Stereo	Equalizer that adds energy to a male vocal. Best for rock. Try with Comp.
B62	PEQ:Female	Parametric Equalizer	Insert	Stereo	Improves the tone quality of a female vocal. Adjust LoMidG.
B63	PEQ:RockFeml	Parametric Equalizer	Insert	Stereo	Equalizer that adds energy to a female vocal. Best for rock. Try with Comp.
B64	PEQ:Narrator	Parametric Equalizer	Insert	Stereo	Standard equalizer for male narration. Brings out the character of the voice.
B65	PEQ:Organ	Parametric Equalizer	Insert	Stereo	Settings to bring out the character of a church organ.
B66	PEQ:St.Piano	Parametric Equalizer	Insert	Stereo	For miking piano in stereo. Left: low range, right: high range.
B67	PEQ:SmallCho	Parametric Equalizer	Insert	Stereo	Settings that bring out the chorus without letting it conflict with the main vocal.

<Graphic Equalizer> (3 preset)

B68	GEQ:TotalEQ1	Graphic Equalizer	Insert	Stereo	Boosts the low and high ranges.
B69	GEQ:TotalEQ2	Graphic Equalizer	Insert	Stereo	Attenuates the lows and highs to narrow the range, tightening up the sound.
B70	GEQ:Space EQ	Graphic Equalizer	Insert	Stereo	Special settings that turn a monaural source into stereo.

<Space Chorus> (3 preset)

B71	SPCHO:MODE1	Space Chorus	Insert	Stereo	Simulates MODE1 of the classic SDD-320 ambience processor.
B72	SPCHO:MODE2	Space Chorus	Insert	Stereo	Simulates MODE2 of the classic SDD-320 ambience processor.
B73	SPCHO:MODE3	Space Chorus	Insert	Stereo	Simulates MODE3 of the classic SDD-320 ambience processor.

<Special Effects> (16 preset)

B74	LFP:BreakBts	Lo-Fi Processor	Insert	Stereo	Reproduces the tonal change produced by lowering the bit/rate of a sampled sound.
B75	LFP:1bitDist	Lo-Fi Processor	Insert	Stereo	Extreme distortion sound produced by lowering the number of bits.
B76	LFP:TeknoFlt	Lo-Fi Processor	Insert	Stereo	Emphasizes the out-of-band noise that occurs with low sampling rates.
B77	LFP:Reso Flt	Lo-Fi Processor	Insert	Stereo	Filter with resonance as found on synthesizers. Adjust CutOff.
B78	LFP:FatBotom	Lo-Fi Processor	Loop	Stereo	Add heavy low-range for the groove. Mix with original source.
B79	VT:M to Fm	Voice Transformer	Insert	Mono	Converts a male voice into a female voice.
B80	VT:Fm to M	Voice Transformer	Insert	Mono	Converts a female voice into a male voice.
B81	VT:Male Duo	Voice Transformer	Insert	Mono	Turns a single male voice into a duet (by adding a female voice).
B82	VT:FemaleDuo	Voice Transformer	Insert	Mono	Turns a single female voice into a duet (by adding a male voice).
B83	VT:Robot	Voice Transformer	Insert	Mono	Special effect like a robot speaking.
B84	VOC2:M19Band	Vocoder2	Insert	Mono	Clear and crisp vocoder.
B85	VOC2:S19Band	Vocoder2	Insert	Mono	Special stereo vocoder with long decay.
B86	HC:Quiet60Hz	Hum Canceler	Insert	Stereo	Cancel 60 Hz hum noise.
B87	HC:Quiet50Hz	Hum Canceler	Insert	Stereo	Cancel 50 Hz hum noise.
B88	VC:Vocal Cnl	Vocal Canceler	Insert	Stereo	Cancel a vocal located in the center.
B89	VC:CenterCnl	Vocal Canceler	Insert	Stereo	Cancel all sound located in the center.

<Same as Algorithm> (10 preset)

B90	Reverb2	Reverb2	Loop	Mono	Refer to page 23 of the VS-880 Owner's Manual.
B91	Space Chorus	Space Chorus	Insert	Stereo	Refer to page 24 of the VS-880 Owner's Manual.
B92	Lo-Fi Proces	Lo-Fi Processor	Insert	Stereo	Refer to page 25 of the VS-880 Owner's Manual.
B93	ParametricEQ	Parametric Equalizer	Insert	2ch	Refer to page 26 of the VS-880 Owner's Manual.
B94	Graphic EQ	Graphic Equalizer	Insert	2ch	Refer to page 27 of the VS-880 Owner's Manual.
B95	Hum Canceler	Hum Canceler	Insert	Stereo	Refer to page 28 of the VS-880 Owner's Manual.
B96	Vocal Cancel	Vocal Canceler	Insert	Stereo	Refer to page 28 of the VS-880 Owner's Manual.
B97	Voice Trans	Voice Trancefomer	Insert	Mono	Refer to page 30 of the VS-880 Owner's Manual.
B98	Vocoder2 (19)	Vocoder2	Insert	Mono	Refer to page 29 of the VS-880 Owner's Manual.
B99	MicSimulator	Mic Simulator	Insert	2ch	Refer to page 32 of the VS-880 Owner's Manual.

TYPE

Loop: Direct Level is set to "0." Connect this Patch to the effects buss.

Insert: This Patch mixes the direct sound and effected sound. Insert it into a channel.

D. mic: dynamic microphone

C. mic: condenser microphone

For details regarding connection, refer to page 8 of the VS8F-1 Owner's Manual.

You cannot select preset Patches A00 through A21, A80 and A97 for EFFECT2.

These Patches must be used for EFFECT1.

Roland