

DIGITAL STUDIO WORKSTATION VS-840EX

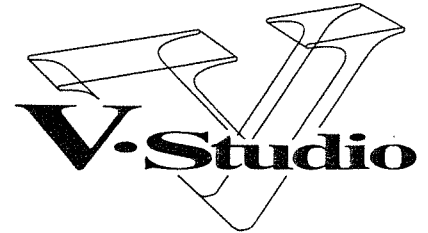

QUICK START

Thank you for purchasing the Roland VS-840EX Digital Studio Workstation. The VS-840EX is an all-in-one multi-track digital disk recorder which combines a digital disk recorder, digital mixer and digital effect unit into a single package. All processes from editing and effect processing to mixdown can be performed in the digital domain. It also makes possible various editing techniques which are not possible with conventional multitrack analog tape recorders. The documentation for the VS-840EX consists of two manuals: "Quick Start" and "Owner's Manual." Quick Start explains the sequence of operations from setting up the VS-840EX to recording/playback and mixdown.

Before using this unit, carefully read the sections entitled: "IMPORTANT SAFETY INSTRUCTIONS" (Owner's manual page 2), "USING THE UNIT SAFELY" (Owner's manual page 3), and "IMPORTANT NOTES" (Owner's manual page 10). These sections provide important information concerning the proper operation of the unit. Additionally, in order to feel assured that you have gained a good grasp of every feature provided by your new unit, Quick start and Owner's manual should be read in its entirety. The manual should be saved and kept on hand as a convenient reference.

Printing conventions in this manual

- Individual buttons are enclosed in square brackets []. Groups of buttons are referred to as the ** buttons, without enclosing them in square brackets.
Examples: [INPUT], CHANNEL PARAMETER buttons
However, the CURSOR buttons are referred to as follows.
[CURSOR]: Use any of the four CURSOR buttons.
[CURSOR ◀ ▶]: Use the [◀] or [▶] buttons.
[CURSOR ▲ ▼]: Use the [▲] or [▼] buttons.
- Some of the buttons share two or more button names. The function of these buttons will differ according to whether they are pressed together with [SHIFT], or depending on the current state. Since listing only this "sub-function" name might leave it unclear as to which button was being referred to, both button names are listed, with the name of the current function given first.
Examples: [IN(1/5)], [ENTER/TAP]
- In the mixer section or the recorder section, knobs/buttons/indicator/faders are sometimes referred to with their channel number or track number.
Example: TRACK CUE 1 knob, Fader 3
- Paragraphs headed by an asterisk * contain explanations to which you should pay careful attention. In the Quick Start manual, an attention mark is used instead of an asterisk *.
- The contents of the screen displays printed in the documentation may differ from the factory settings.

Contents

Preparations	3
■Connections with audio device	3
■Turning the power on.....	3
■Turning the power off.....	4
Listening to the demo song.....	5
Your first recording	6
■Create a new song	6
■Recording on track 1	7
■Saving your recorded performance	10
■Canceling a recording.....	11
■Re-recording a portion of your performance	12
■Recording to V-track 2	14
■Applying effects while you record	17
■Multi-track recording.....	20
Editing a recorded performance	23
■Selecting the song for editing	23
■Using the equalizer to adjust the tone.....	25
■Apply an effect to the track playback and record the result.....	27
■Combining the performance of multiple tracks into another track.....	31
■Saving the mixer settings	34
■Mixing down to 2-channel stereo.....	35
Various cueing techniques	40
When you want to... (Topical index to the owner's manual)	41

■ Connections with audio device



Before making connections, make sure that the volume controls of all devices are turned down, and that the power is turned off. If connections are made with the power turned on, the disk drive or your speakers may be damaged.

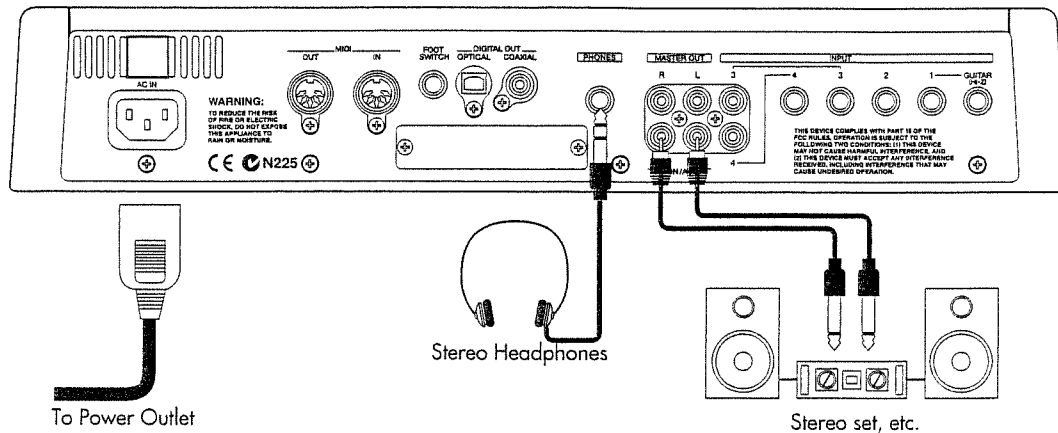

Connect the VS-840EX's MON/AUX jacks to the input jacks of your audio system. The MON/AUX jacks are RCA phono type jacks. Use cables with the appropriate type of jacks for your equipment.

If you are using headphones, connect them to the PHONES jack located on the rear panel. The PHONES jack is set to output the same sound as the MON/AUX jacks. The volume of the headphones is adjusted by the PHONES knob.



With the factory settings, the MON/AUX jack will output both the signal from the MASTER OUT jacks and the monitor signals from each track (mixed together).

■ Turning the power on

When you have made connections correctly, use the following procedure to turn the power on. By turning on devices in the wrong order, you risk causing malfunction and/or damage to speakers and other devices.

1 Turn on the power of the VS-840EX.

When the VS-840EX starts up correctly, the display will indicate "[Pst]MIXER," and the post-fader level for each channel will be displayed. This condition is called "Play mode."

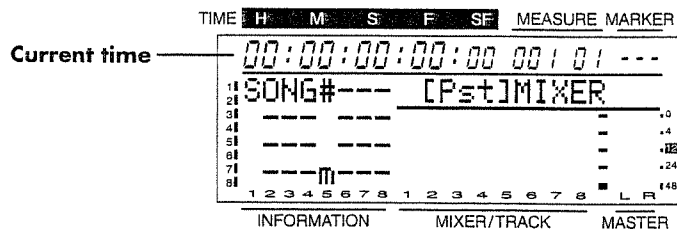

When the power is turned on, the disk drive will be detected, and data required for operation will be read. For this reason, there will be a short interval before operation actually begins.

2 Turn on your audio equipment, and raise the volume of the audio devices to an appropriate level.



If the VS-840EX ever fails to operate correctly, first refer to "Troubleshooting" (owner's manual page 173) and check the relevant points.

If an incorrect operation has been performed, or if an operation could not be processed as specified, the display will show an error message. Refer to the "Error message" (owner's manual page 175) and take the appropriate action.

If this does not resolve the problem, contact Roland service or your dealer.

■ Turning the power off

Recorded data will be lost if you simply turn off the power. Before turning off the power, you must perform the shut-down process to ensure that song data is correctly saved to disk. When the shut-down process has been performed, the disk will be ejected. When you wish to turn off the power, use the following procedure.



When you perform the shut-down operation, you will be asked whether or not you wish to save the song data. Also, please be aware that it is not possible to remove the disk when the power is off. Be sure to perform the shut-down operation and remove the disk before turning off the power.

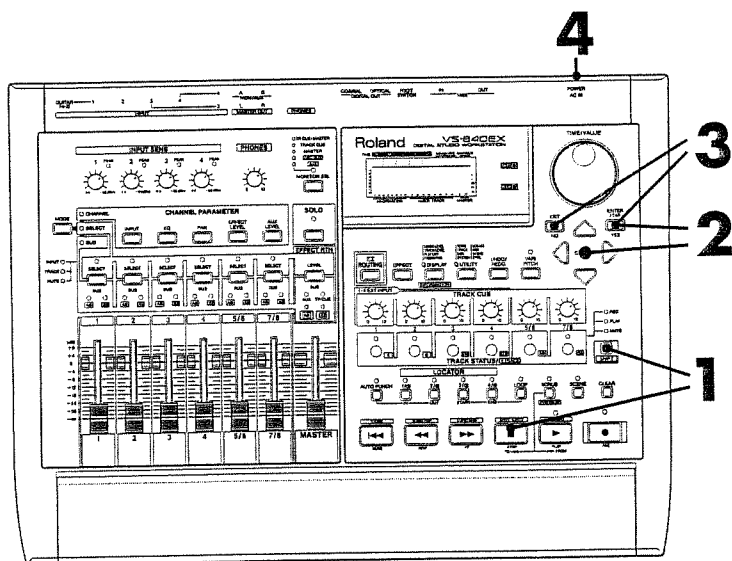

- 1 Hold down [SHIFT] and press [SHUT/EJECT(STOP)].**
The display will ask "SHUT/EJECT ?"

- 2 Use [CURSOR] to select the "SHUT" icon, and press [ENTER/TAP]. (To cancel the shut-down operation, press [EXIT] at left.)**
The display will ask "STORE Current ?"

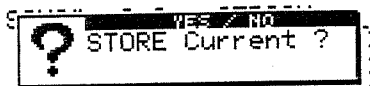

Selecting the "EJECT" icon will have the same result as pressing the eject button located on the side of the VS-840EX.

- 3 If you wish to save the current song, press [YES]. If you do not wish to save it, press [NO]. If you have selected a demo song, press [NO].**
When shut-down is complete, the display will ask "Power OFF/RESTART," and the disk will be ejected.

- 4 Turn off the power of the VS-840EX.**



If you turn off the power before removing the disk and later need to remove the disk, be sure to turn the power on again and press the eject button to remove the disk. Attempting to remove the disk by force can damage the disk drive.

Listening to the demo song

The disk included with the VS-840EX contains a pre-recorded demo song. First, let's listen to this demo song.



Use of the song data supplied with this product for any purpose other than private, personal enjoyment without the permission of the copyright holder is prohibited by law. Additionally, this data must not be copied, nor used in a secondary copyrighted work without the permission of the copyright holder.

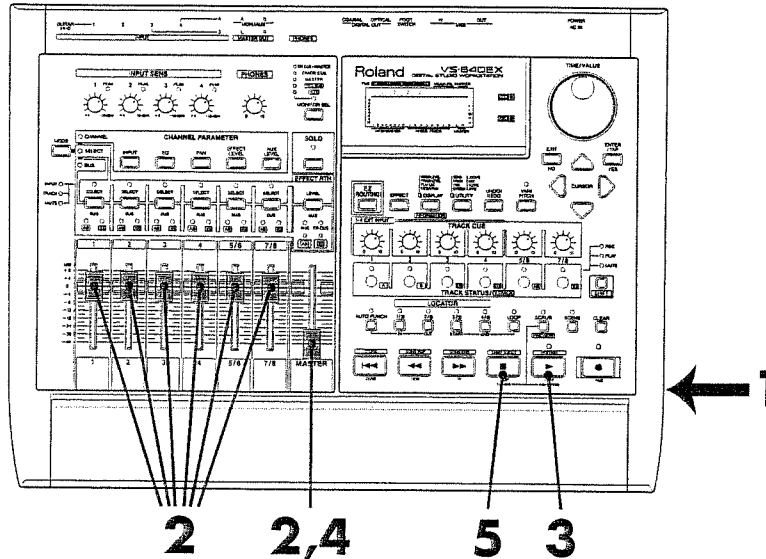

- 1** Insert the included disk into the disk drive.
- 2** Move all channel faders to the 0dB position, and then lower the **MASTER** fader.
- 3** Press **[PLAY]** to begin song playback.
- 4** Gradually raise the **MASTER** fader to adjust the volume.
The **TIME** field will show the current time, and the display will show the changes in level for each channel (level meter).

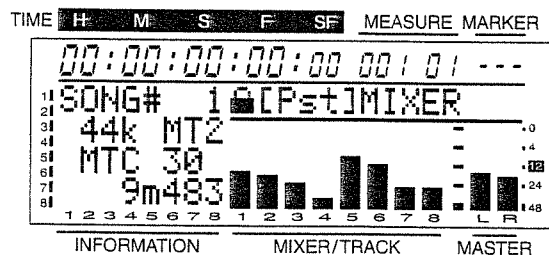

- 5** When playback ends, press **[STOP]**.

Your first recording

Here we will explain the basic operations for actually recording a performance.

■ Create a new song

Recording is not possible when the demo song is selected. In order to begin recording, use the following procedure to create a new song.

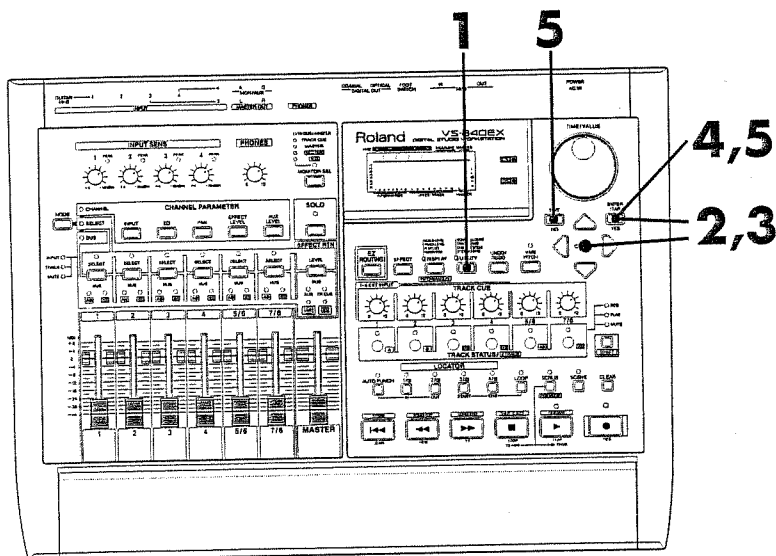

1 Press [UTILITY].

2 Use [CURSOR] to select the Song Edit icon, and press [ENTER/TAP].



3 Use [CURSOR] to select the Song New icon, and press [ENTER/TAP].



4 A page in which you can set the sample rate and recording mode will appear. For this example, we will use the default settings, so simply press [ENTER/TAP].



When creating a new song, you can specify the sample rate and recording mode of the song. If you need to make special settings, refer to "Creating a new song" (page 54) in the owner's manual.

5 The display will ask "STORE Current ?" This message is asking you whether you wish to save the current song to disk. If you wish to save the current song (the currently selected song), press [YES].



For the demo song, the Write Protect setting is turned on so that the contents cannot be rewritten (owner's manual page 29). For this reason, the display will not indicate "Store Current ?" if a demo song is selected.

When a new song has been created, you will automatically return to Play mode, and the newly created song will be selected.

■ Recording on track 1

Now you can connect your instrument, and record your playing. In this example, we will explain how the sound that is input to the INPUT 1 jack can be recorded on track 1.

We will make use the Easy Routing function to make mixer settings. The basic procedure is to use [CURSOR] to move the cursor to the item that you wish to modify, and use the TIME/VALUE dial to modify the value. To advance to the next page press [ENTER/TAP]. To return to the previous page press [EXIT].



With the Easy Routing function, pressing [ENTER/TAP] while the recorder is operating will automatically stop the recorder as necessary.



Howling could be produced depending on the location of microphones relative to speakers. This can be remedied by:

1. Changing the orientation of the microphone(s).
2. Relocating microphone(s) at a greater distance from speakers.
3. Lowering volume levels.

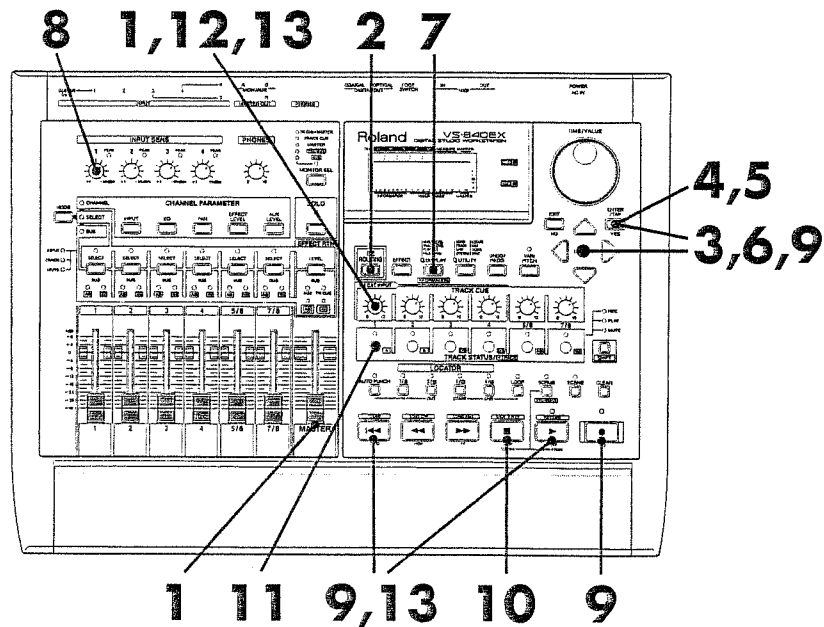

1 Turn down the VS-840EX's MASTER fader, and the TRACK CUE 1 knob, and connect your instrument to the INPUT 1 jack.

* If you are connecting a guitar, use the jack marked GUITAR (Hi-Z).

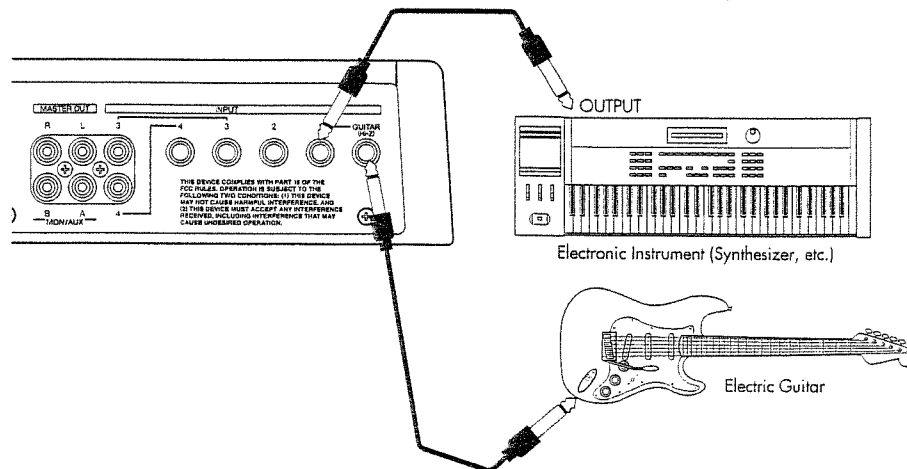

2 Press [EZ ROUTING].

3 Use [CURSOR] to select the Quick Recording icon, then press [ENTER/TAP].

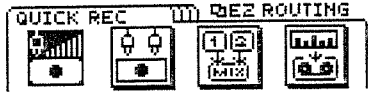

4 The display will indicate the input jack and the channel fader connection. The display will show the current set up. Generally select the INPUT 1 jack, but since default setting is the INPUT 1 jack, no further setting is required here. Press [ENTER/TAP].



*When a stereo source is plugged into INPUT jack 1 and 2, set the value to "1/2."
Use the SELECT button to select the channel.*

5 Set recording destination by the track number. Generally select "1" to the recording destination track, but since default setting is "1," no further setting is required here. Press [ENTER/TAP].



*The display will indicate the setting value. The right half of the page will indicate track connections.
You can also use TRACK STATUS/V.TRACK button to select a track.*

6 In this page you can specify whether or not you wish to use effects. In this example we will not be using effects, so use [CURSOR] to select the "NO" icon. Then press [ENTER/TAP].

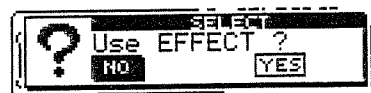

7 The final page will appear. If you have finished making settings, press [DISPLAY] to return to Play mode.

EZ ROUTING is finished ✓
Please set levels using
the Sens Knobs and Faders
DISP

8 Use the INPUT SENS 1 knob to adjust the input sensitivity.

Raise the volume of your instrument as high as possible to achieve a high input level. At this time, adjust the input sensitivity as high as possible without causing the PEAK indicator to light.

Normally you should adjust the input sensitivity so that the level meter moves in the range of -12–0 dB when the channel fader is at the 0dB position.



Since the post-fader sound will be recorded, leave the channel fader at the 0 dB position. If you wish to adjust the volume for listening, use the TRACK CUE 1 knob. Moving the TRACK CUE 1 knob will not affect the sound that will be recorded.

9 Settings are now complete. Press [ZERO] to return to the beginning of the song, press [REC] to enter record-ready mode (the REC indicator will blink red), and press [PLAY] to begin recording.

10 When you finish recording, press [STOP] to stop.

11 Now let's listen to the performance that you recorded. First select playback for track 1. Press the track 1 [TRACK STATUS/V.TRACK] to make the button indicator light green.

12 Turn down the TRACK CUE 1 knob.

13 Press [ZERO] to return to the beginning of the song, and then press [PLAY] to playback the song. Use the TRACK CUE 1 knob to adjust the volume of track 1.

If you wish to monitor the output of TRACK CUE, listen to the headphones or the output of the MON/AUX jack. With the current settings, the TRACK CUE output will not be output from the MASTER OUT jack.

How was it? Was the recording satisfactory? If you are happy with the results, use the procedure explained in "Saving your recorded performance" (page 10) to save the song. If you would like to cancel the recording, refer to "Canceling a recording" (page 11). If you would like to re-record only a portion of the performance, refer to "Re-recording a portion of your performance" (page 12).

■ Saving your recorded performance

If you simply turn off the power, the performance which you recorded will be lost. The recorded performance will also be lost if the power goes off by accident. In such cases, it is not possible to restore the data to its original state.

To avoid such accidents, use the following procedure to save your data to disk from time to time.



When handling important song data, or when using the VS-840EX for an extended period of time, we recommend that you save song data frequently.



When you change songs or performance the shut-down operation, a message will ask "STORE Current ?" This is asking you whether you wish to save the current song. For the response to this message, refer to "Turning the power off" (page 4).

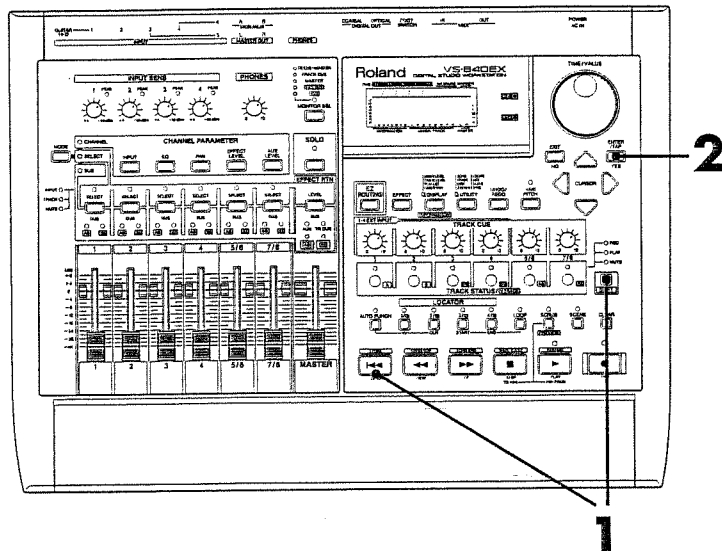

1 Hold down [SHIFT] and press [STORE(ZERO)].

2 The display will ask "STORE OK ?" If you wish to store the song data, press [YES].

When the song has been saved, you will return to the previous condition.

■ Canceling a recording

When using the VS-840EX, there may be times when you would like to re-do an operation, such as if recording did not take place as you would like, or if the wrong editing settings were used. In such cases you can use the "Undo function." By using the Undo function, you can cancel the previous operation and return to the original state. To cancel the previously-executed Undo, use the "Redo function" (owner's manual page 101).

You can specify the number of previous steps that will be undone. For example, suppose that you used punch-in recording to re-record the same location five times. Then, if you wanted to go back to the data that you recorded on the second try (step 2), you would specify that the Undo operation restore the last three operations (Undo Level 3), and then execute.

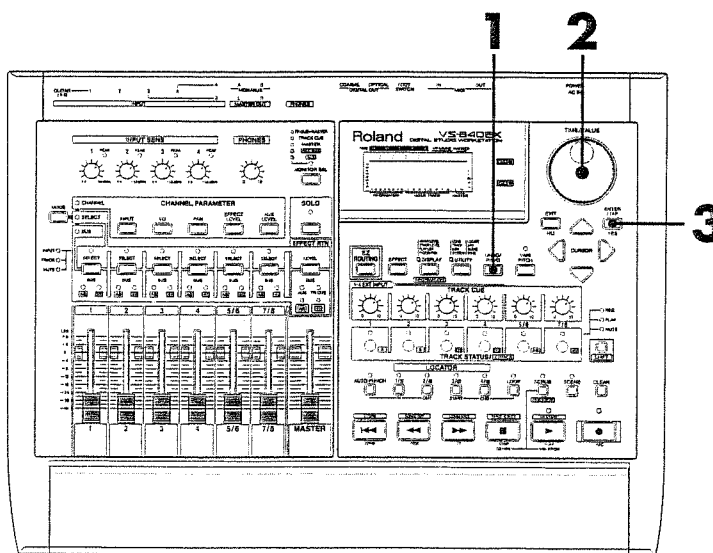
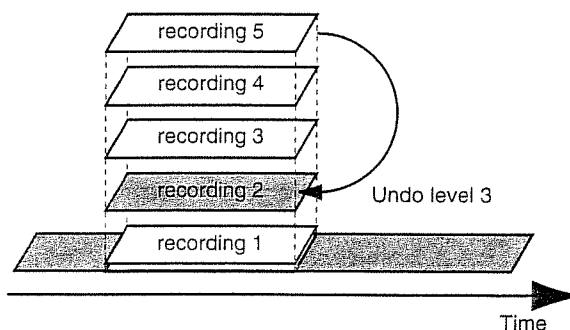

1 Press [UNDO/REDO].

2 The display will indicate "UNDO Level." Use the TIME/VALUE dial to select the number of steps that you wish to undo.

3 To execute the Undo operation, press [ENTER/TAP]. To cancel, press [EXIT].

■ Re-recording a portion of your performance

When recording, there may be times when a wrong note was played, or when you are not happy with part of the recording. In such cases, you can use the Punch-in Recording operation to re-record only a specified portion of your performance.

“Punch-in” refers to the act of switching from playback to recording status. Conversely, “punch-out” is when you return from recording to playback status. In other words, you punch-in at the location where you wish to begin re-recording, and punch-out when you finish recording.

Here we will explain the procedure for Auto Punch-in Recording. Auto Punch-in Recording will automatically punch-in/out at the locations that you have specified ahead of time.

This explanation will assume that the mixer settings are in the condition of having completed steps 1–13 of “Recording to track 1” (page 7). When you perform punch-in recording, listen to the headphones or to the output of the MON/AUX jacks.

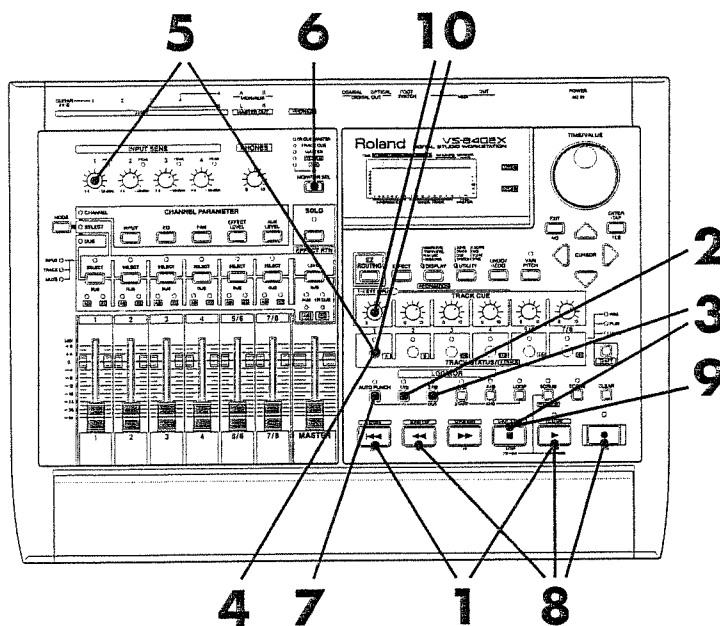

- 1** Press [ZERO] to return to the beginning of the song, and then press [PLAY] to playback the song.
- 2** When you arrive at the location where you wish to punch-in, press LOCATOR button [IN(1/5)]. The punch-in location will be stored.
- 3** When you arrive at the location where you wish to punch-out, press LOCATOR button [OUT(2/6)]. The punch-out location will be stored. When you have finished setting the times, press [STOP] to stop the song.
- 4** Press the track 1 [TRACK STATUS/V.TRACK] to set the track status to REC (the TRACK STATUS indicator will blink red).

-
- 5** Use the **INPUT SENS 1** knob to adjust the level of the input source. While the song is playing back, you can press the **TRACK STATUS/V.TRACK** button to switch between monitoring the input source and monitoring the track. Listen to the track being re-recorded and to the input source, and make adjustments so that there is no volume difference between them.

When the **TRACK STATUS** indicator blinks red, the input source is being monitored. When it blinks alternately red/green, the track playback is being monitored.

-
- 6** After you have adjusted the level of the input source, press **[MONITOR SEL]** several times to set Monitor Select to **TRACK CUE+MASTER** (the button indicator will light orange).

If while recording, you wish to hear the sound that is being played, raise the master fader.

-
- 7** With the song stopped, press **[AUTO PUNCH]**, and the **AUTO PUNCH** indicator will light and you will be ready to perform auto punch-in recording.

-
- 8** Press **[REW]** to move to a location earlier than the time where you will begin re-recording, press **[REC]** to enter record-ready mode, and then press **[PLAY]**.

When you come to the location to be re-recorded, punch-in will automatically occur. Play your instrument or sing, and your performance will be re-recorded. When you come to the punch-out location, the track will automatically return to playback mode.

-
- 9** When you finish recording, press **[STOP]**.

-
- 10** Now let's listen to the re-recorded performance. Press the track 1 **[TRACK STATUS/V.TRACK]** to switch the track status to **PLAY** (the **TRACK STATUS** indicator will light green), and playback the song from the beginning. Use the **TRACK CUE 1** knob to adjust the volume of track 1.

If you wish to monitor the **TRACK CUE** output, use headphones or listen to the output of the **MON/AUX** jacks. With the current settings, the **TRACK CUE** output is not output from the **MASTER OUT** jacks.

When you have finished auto punch-in recording, press **[AUTO PUNCH]** to make the **AUTO PUNCH** indicator go dark.

■Recording to V-track 2

The VS-840EX has eight tracks, and each of these tracks consists of eight additional tracks. These "additional" tracks are referred to as "V-tracks." By taking full advantage of these tracks, you can record performances on up to 64 (8 x 8) tracks.

This section shows how you can record a performance on V-track 2 of track 1.

We will use the Easy Routing function to make mixer settings. The basic procedure is to use [CURSOR] to move the cursor to the item that you wish to modify, and use the TIME/VALUE dial to modify the value. To advance to the next page press [ENTER/TAP]. To return to the previous page press [EXIT].

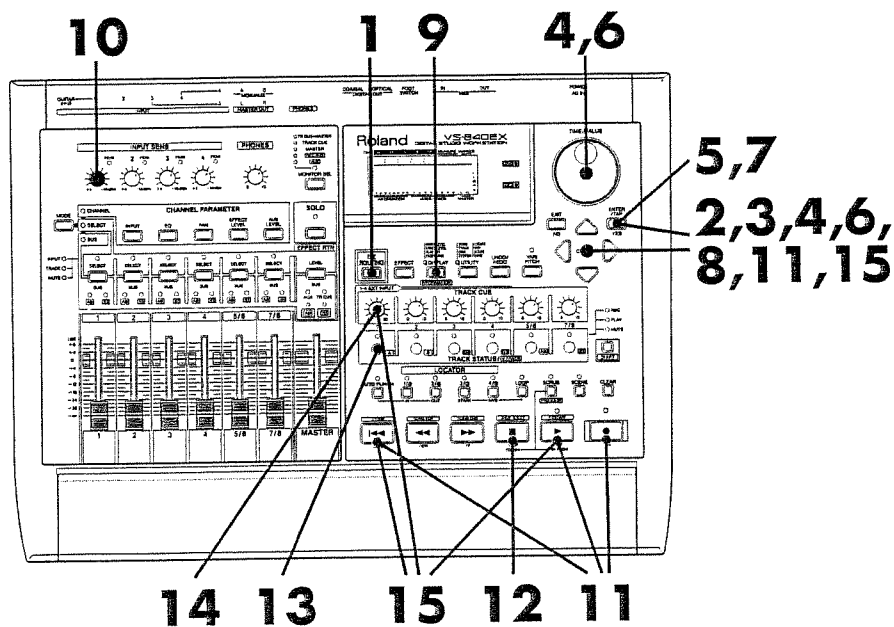

1 Press [EZ ROUTING].

2 Use [CURSOR] to select the Recording icon and press [ENTER/TAP].

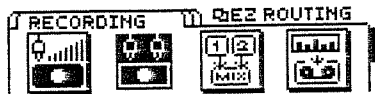

3 In this page you can specify whether or not you wish to modify the parameter values (default values) that were set automatically by Easy Routing. In order to modify the settings, use [CURSOR] to select the "YES" icon. When you finish making settings, press [ENTER/TAP].



- 4** The V-track setting page will appear. The display will show the current settings. Make settings so that V-track 2 of track 1 is the current track. Use [CURSOR<>] to select track 1, and use the TIME/VALUE dial to select V-track 2. When you finish making settings, press [ENTER/TAP].

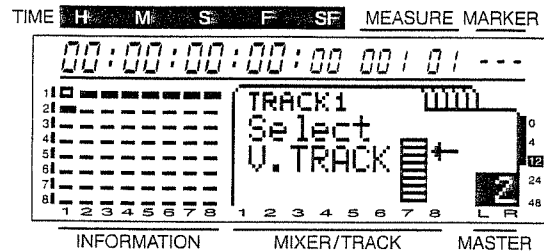

- 5** In this page you can specify the input for each channel. We want the INPUT 1 jack to be the input for channel 1, but since this is already the default setting, we do not need to change this. Press [ENTER/TAP].



- 6** In this page you can set the recording destination track for each channel. For this example, use [CURSOR] and the TIME/VALUE dial to select "1" (track 1) as the recording destination track for channel 1. When you finish making settings, press [ENTER/TAP].

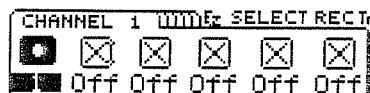

- 7** In this page you can set the pan for each channel. On each channel for which you specified a recording destination track, the pan will be set automatically. For this example, make sure that the channel 1 pan is set to full left (L63). Then press [ENTER/TAP].



- 8** In this page you can specify whether or not you wish to use effects. In this example we will not be using effects, so use [CURSOR] to select the "NO" icon. Then press [ENTER/TAP].



9 The final page will appear. If you have finished making settings, press [DISPLAY] to return to Play mode.

EZ ROUTING is finished!
Please set levels using
the Sens Knobs and Faders
DISPLAY

10 Use the **INPUT SENS 1** knob to adjust the input sensitivity.

Raise the volume of your instrument as high as possible to achieve a high input level. At this time, adjust the input sensitivity as high as possible without causing the PEAK indicator to light.

Normally you should adjust the input sensitivity so that the level meter moves in the range of -12-0 dB when the channel fader is at the 0dB position.

NOTE

Since the post-fader sound will be recorded, leave the channel fader at the 0 dB position. If you wish to adjust the volume for listening, use the TRACK CUE 1 knob. Moving the TRACK CUE 1 knob will not affect the sound that will be recorded.

11 Settings are now complete. Press [ZERO] to return to the beginning of the song, press [REC] to enter record-ready mode (the REC indicator will blink red), and press [PLAY] to begin recording.

12 When you finish recording, press [STOP] to stop.

13 Now let's listen to the performance that you recorded. First select playback for track 1. Press the track 1 [TRACK STATUS/V.TRACK] to make the button indicator light green.

14 Turn down the TRACK CUE 1 knob.

15 Press [ZERO] to return to the beginning of the song, and then press [PLAY] to playback the song. Use the TRACK CUE 1 knob to adjust the volume of track 1.

If you wish to monitor the output of TRACK CUE, listen to the headphones or the output of the MON/AUX jack. With the current settings, the TRACK CUE output will not be output from the MASTER OUT jack.

How was it? Was the recording satisfactory? If you are happy with the results, use the procedure explained in "Saving your recorded performance" (page 10) to save the song. If you would like to cancel the recording, refer to "Canceling a recording" (page 11). If you would like to re-record only a portion of the performance, refer to "Re-recording a portion of your performance" (page 12).

■Applying effects while you record

Here we will explain how you can apply an effect to the input source of INPUT 1, and record the sound on track 3.

We will use the Easy Routing function to make mixer settings. The basic procedure is to use [CURSOR] to move the cursor to the item that you wish to modify, and use the TIME/VALUE dial to modify the value. To advance to the next page press [ENTER/TAP]. To return to the previous page press [EXIT].

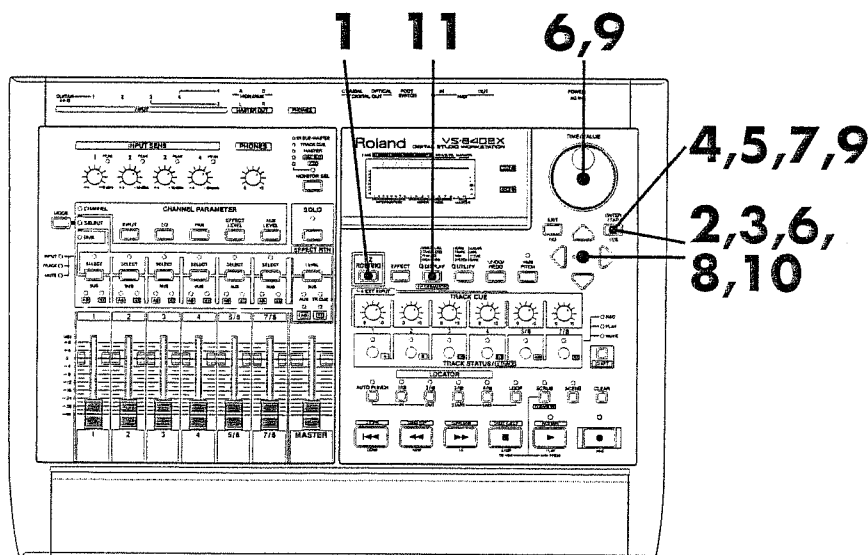

1 Press [EZ ROUTING].

2 Use [CURSOR] to select the Recording icon and press [ENTER/TAP].



3 In this page you can specify whether or not you wish to modify the parameter values (default values) that were set automatically by Easy Routing. In order to modify the settings, use [CURSOR] to select the "YES" icon. When you finish making settings, press [ENTER/TAP].



4 The V-track setting page will appear. The display will show the current settings. We want V-track 1 of track 3 to be the current track, but since this is already the setting that was made when a new song was created, you can simply press [ENTER/TAP].

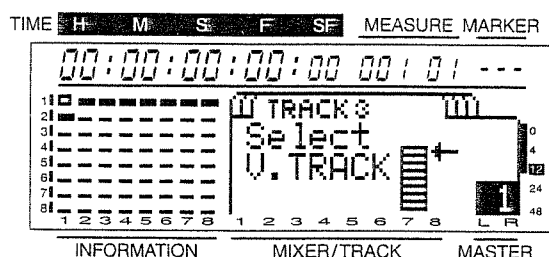

5 In this page you can specify the input for each channel. We want to select the INPUT 1 jack as the input for channel 1, but since this is the default setting, we do not need to change it. Simply press [ENTER/TAP].



6 In this page you can specify the recording destination track for each channel. In this example, use [CURSOR] and the TIME/VALUE dial to select "3" (track 3) as the recording destination track for channel 1. When you finish making settings, press [ENTER/TAP].

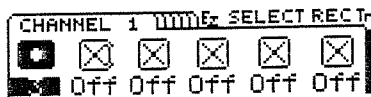

7 In this page you can specify the pan for each channel. Pan has been automatically set for each channel for which a recording destination track was selected in step 6. For this example, make sure that the channel 1 pan is set to full left (L63). Then press [ENTER/TAP].



The pan setting you make here does not set the position of the sound when the recorded song is played back. Rather, it assigns the input sound to a track on which it will be recorded. Pan is assigned as follows: track 1 is L63, track 2 is R63, track 3 is L63, and track 4 is R63.

8 In this page you can specify whether or not you wish to use effects. In this example we will use effects, so use [CURSOR] to select the "YES" icon. When you finish making settings, press [ENTER/TAP].



- 9** In this page, you can specify the location at which the effect will be connected. For this example, we will insert the effect between the EQ and fader of channel 1. Use the TIME/VALUE dial to select "CH1 INSERT" as the connection location. When you finish making settings, press [ENTER/TAP].

```
-----
Select Effect Position
POSITION: CH1 INSERT
-----
```

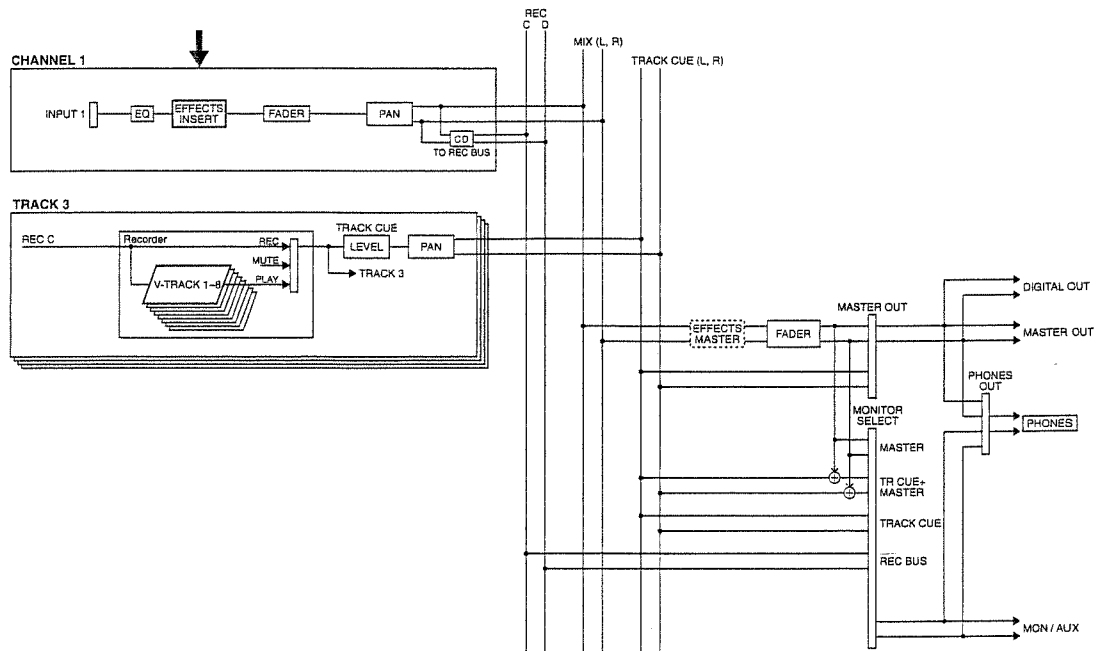

For details on effect connections, refer to "Effect connections" (owner's manual page 75).

- 10** In this page you can select the effect patch that will be used. First move the cursor to "TYPE," and select the algorithm (Guitar Multi 1) type that you wish to use. Next, move the cursor to "PATCH" and select the patch. Press [ENTER/TAP], and the specified patch will be selected. Press [ENTER/TAP] once again to move to the next page.

For this example, select the INSERT type patch "A-80:ROCK LEAD."

```
-----
Select Effect
TYPE : INSERT
PATCH: A-80:ROCK LEAD
CHANGE OK?
-----
```

- 11** The final page will appear. If you have finished making settings, press [DISPLAY] to return to Play mode.

```
-----
EZ ROUTING is finished!
Please set levels using
the Sens Knobs and Faders
01:32:30
-----
```

- 12** Record using the same procedure as steps 8-13 of "Recording on track 1" (page 7).

■ Multi-track recording

To create a multi-track recording, you will listen to previously-recorded tracks while you record additional new tracks. This process is called "overdubbing."

Here we will explain how you can listen to a performance that was recorded on track 1 while you record an additional performance on track 2. Connections between the VS-840EX and your instrument can be left just as they are described in "Recording on track 1" (page 7).

We will use the Easy Routing function to make mixer settings. The basic procedure is to use [CURSOR] to move the cursor to the item that you wish to modify, and use the TIME/VALUE dial to modify the value. To advance to the next page press [ENTER/TAP]. To return to the previous page press [EXIT].

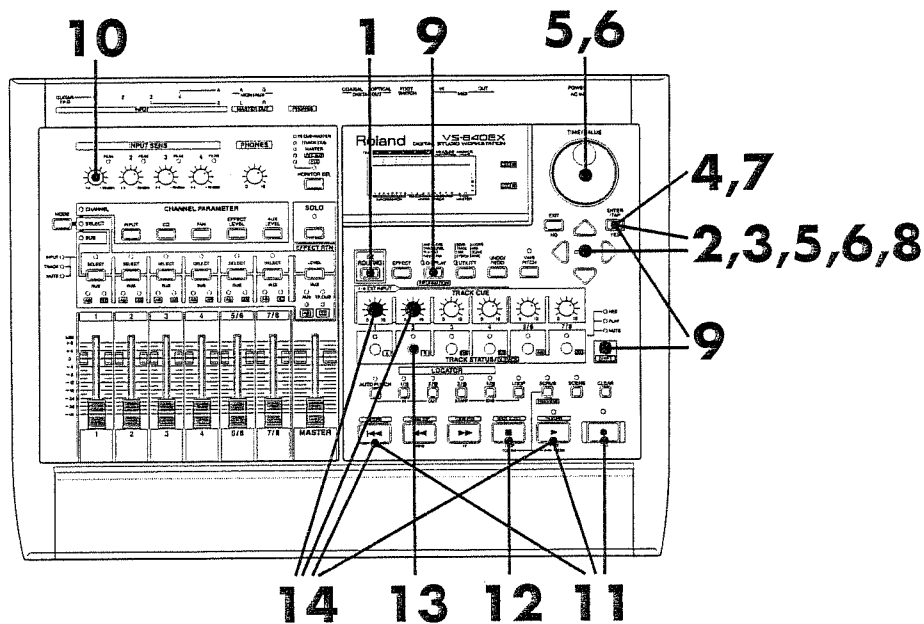

1 Press [EZ ROUTING].

2 Use [CURSOR] to select the Recording icon and press [ENTER/TAP].

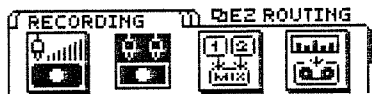

3 In this page you can specify whether or not you wish to modify the parameter values (default values) that were set automatically by Easy Routing. In order to modify the settings, use [CURSOR] to select the "YES" icon. When you finish making settings, press [ENTER/TAP].



- 4** The V-track setting page will appear. The display will show the current settings. We want to make settings so that V-track 1 of track 2 will be the current track, but since this is the setting when the new song was created, we will simply press [ENTER/TAP].

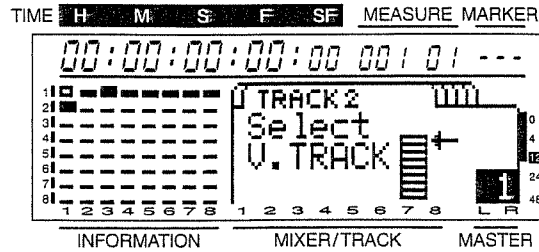

- 5** In this page you can specify the input for each channel. Use [CURSOR] and the TIME/VALUE dial to select "1" (track 1) as the input for channel 1, and "IN1" (the INPUT 1 jack) as the input for channel 2. When you finish making settings, press [ENTER/TAP].



- 6** In this page you can specify the recording destination track for each channel. For this example, use [CURSOR] and the TIME/VALUE dial to select "2" (track 2) as the recording destination track for channel 2. After making the setting, press [ENTER/TAP].

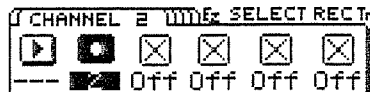

- 7** In this page you can set the pan for each channel. Pan has been set automatically for each channel for which a recording destination track was specified in step 6. For this example, make sure that channel 2 pan is set to full right (R63). Then press [ENTER/TAP].



- 8** In this page you can specify whether or not effects will be used. Since we will not be using effects in this example, use [CURSOR] to select the "NO" icon. Then press [ENTER/TAP].



9 The final page will appear. If you are finished making settings, hold down [SHIFT] and press [ENTER/TAP] to return to Play mode.

EZ ROUTING is finished!
Please set levels using
the Sens Knobs and Faders
DISPLAY



Normally when you press [DISPLAY], the track status of all tracks which can be played back will be set to PLAY (green), but since in this example we are not going to allow this operation, hold down [SHIFT] and press [ENTER/TAP].

10 Use the INPUT SENS 1 knob to adjust the input sensitivity.

Raise the volume of your instrument as high as possible to achieve a high input level. At this time, adjust the input sensitivity as high as possible without causing the PEAK indicator to light.

Normally you should adjust the input sensitivity so that the level meter moves in the range of -12-0 dB when the channel fader is at the 0dB position.



Since the post-fader sound will be recorded, leave the channel fader at the 0 dB position. If you wish to adjust the volume for listening, use the TRACK CUE 2 knob. Moving the TRACK CUE 2 knob will not affect the sound that will be recorded.

11 Settings are now complete. Press [ZERO] to return to the beginning of the song, press [REC] to enter record-ready mode (the REC indicator will blink red), and press [PLAY] to begin recording.

When you begin recording, the performance that is recorded on track 1 will playback. Listen to this playback, and play along to record your additional performance on track 2. Use the TRACK CUE 1 knob to adjust the volume of track 1.

12 When you finish recording, press [STOP] to stop.

13 Now let's listen to the performance that was recorded. First set track 2 to playback mode. Press the track 2 [TRACK STATUS/V.TRACK] to make the button indicator light green.

14 Press [ZERO] to return to the beginning of the song, and then press [PLAY] to playback the song. Use the TRACK CUE 1 knob to adjust the volume of track 1, and the TRACK CUE 2 knob to adjust the volume of track 2.

How did it go? Are you happy with the recorded result? If so, follow the procedure of "Saving your recorded performance" (page 10) to save the song. If you would like to cancel the performance you just recorded, refer to "Canceling a recording" (page 11). If you would like to re-record just a portion of your performance, refer to "Re-recording a portion of your performance" (page 12).

In addition to the demo song, the disk which is included with the VS-840EX also contains a song for editing. In this section, we will use this song to explain how to edit a recorded performance.

The editing song consists of the following performance data.

- Track 1 (V-track 1) guitar 1 (mono)
- Track 1 (V-track 2) guitar 2 (mono)
- Track 2 (V-track 1) bass (mono)
- Track 3,4 (V-track 1) drums (stereo)
- Track 7/8 (V-track 1) keyboard (stereo)

■ Selecting the song for editing

Select the editing song that has been saved on the disk.

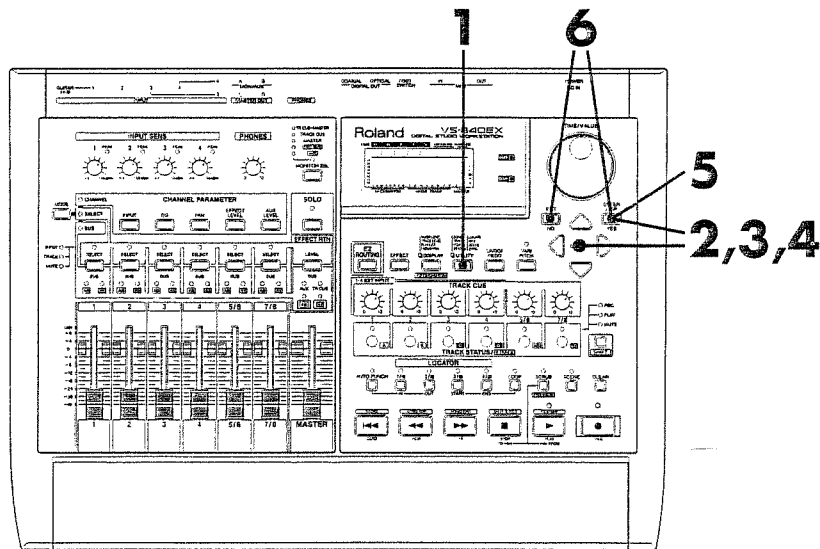

1 Press [UTILITY].

2 Use [CURSOR] to select the Song Edit icon, and press [ENTER/TAP].



3 Use [CURSOR] to select the Song Select icon, and press [ENTER/TAP].



4 A list of the names of the songs saved on the disk will appear. For this example, use [CURSOR] to move the cursor to "EditSONG", and press [ENTER/TAP].



5 The display will ask "Select SONG Sure ?", so press [YES].

6 The display will ask "STORE Current ?" This message is asking whether you wish to save the current song to disk. If you wish to save the current song before loading the selected song, press [YES]. If you wish to load the selected song without saving the current song, press [NO].

The editing song is now the current song.

5 If you wish to make adjustments for other channels as well, use [CURSOR◀▶] to select the channel, and use the same procedure to make adjustments. When you have finished making settings for each channel, press [DISPLAY] to return to Play mode.

Were you able to adjust the tone as desired? If so, refer to "Saving your recorded performance" (page 10) and save the song.

■ Apply an effect to the track playback and record the result

In this section, we will explain how to apply an effect to the guitar sound that has been recorded in track 1/V-track 1, and record the result on track 2/V-track 2.

We will use the Easy Routing function to make mixer settings. The basic procedure is to use [CURSOR] to move the cursor to the item that you wish to modify, and use the TIME/VALUE dial to modify the value. To advance to the next page press [ENTER/TAP]. To return to the previous page press [EXIT].

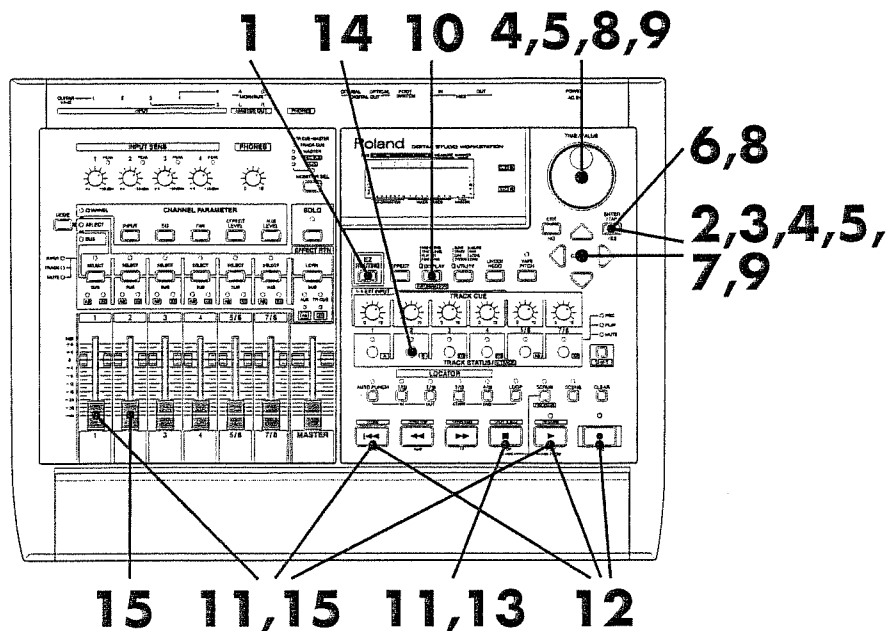

1 Press [EZ ROUTING].

2 Use [CURSOR] to select the Track Bouncing icon and press [ENTER/TAP].



3 In this page you can specify whether or not you wish to modify the parameter values (default values) that were set automatically by Easy Routing. In order to modify the settings, use [CURSOR] to select the "YES" icon. When you finish making settings, press [ENTER/TAP].



- 4** In this page you can specify the input for each channel. Use [CURSOR] and the TIME/VALUE dial to select "TR1-1"(track 1/V-track 1) as the input for channel 1. When you finish making settings, press [ENTER/TAP].

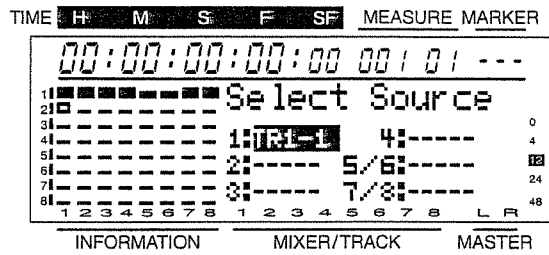

- 5** In this page you can specify the recording destination track. For this example, we want to select track 2/V-track 2 as the recording destination. Use [CURSOR] and the TIME/VALUE dial to make settings as shown in the following screen page. When you finish making settings, press [ENTER/TAP].

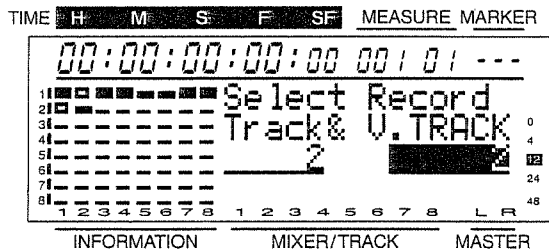

- 6** In this page you can set the pan for each channel. Pan has been set automatically for each channel for which a recording destination track was specified in step 5. For this example, make sure that the channel 1 pan is set to full right (R63). Then press [ENTER/TAP].

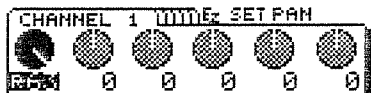

- 7** In this page you can specify whether you wish to use an effect or not. Since we will use an effect in this example, use [CURSOR] to select the "YES" icon. Then press [ENTER/TAP].



- 8** In this page you can choose where the effect will be connected. For this example, we will insert the effect between the EQ and fader of channel 1. Use the **TIME/VALUE** dial to select "CH1 INSERT" as the connection destination. When you finish making settings, press **[ENTER/TAP]**.

Select Effect Position

POSITION: CH1 INSERT

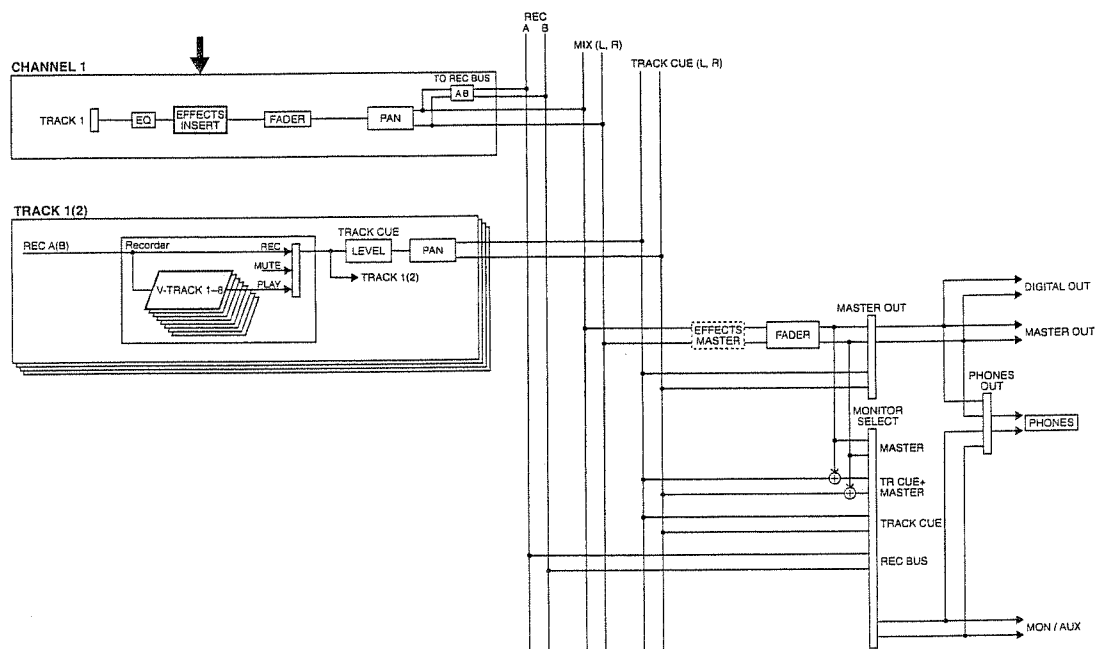

For details on effect connections, refer to "Effect connections" (owner's manual page 75).

- 9** In this page you can select the effect patch that will be used. For this example, select a guitar-multi algorithm. First, move the cursor to "TYPE" and select "Guitar Multi 1" as the algorithm type. Next, move the cursor to "PATCH" and select the patch. For this example, select a patch such as "A-81:Smokin' GTR". Press **[ENTER/TAP]** and that patch will be selected. Press **[ENTER/TAP]** once again to advance to the next page.

Select Effect
 TYPE: Guitar Multi 1
 PATCH: A-81:Smokin' GTR
 CHANGE OK?

- 10** The final page will appear. If you have finished making settings, press **[DISPLAY]** to return to Play mode.

EZ ROUTING is finished!
 Please set levels using
 the Sens Knobs and Faders
[DISPLAY]

-
- 11** the recording level. Press [ZERO] to return to the beginning of the song, and then press [PLAY] to playback the song. Use the channel 1 fader to adjust the recording level. When you have finished making the adjustment, press [STOP].

 - 12** Press [ZERO] to return to the beginning of the song, then press [REC] to make the button indicator blink red, and then press [PLAY] to begin recording.

 - 13** When you finish recording, press [STOP] to stop.

 - 14** Now let's listen to the performance that you just recorded. First, set track 2 to playback status. Press the track 2 TRACK STATUS/V.TRACK button to make the button indicator light green.

 - 15** Press [ZERO] to return to the beginning of the song, and then press [PLAY] to playback the song. Turn down the channel 1 fader, and use the channel 2 fader to adjust the volume of track 2.
-

How is the recording? If you are happy with the recorded result, use the procedure explained in "Saving your recorded performance" (page 10) to save the song. If you would like to cancel the recording that you just made, refer to "Canceling a recording" (page 11).

■ Combining the performance of multiple tracks into another track

In this section we will explain how the monaural bass sound that is recorded on track 2/V-track 1 can be combined with the stereo drum sound that is recorded on V-track 1 of track 3/4, and recorded on V-track 2 of track 5/6.

We will use the Easy Routing function to make mixer settings. The basic procedure is to use [CURSOR] to move the cursor to the item that you wish to modify, and use the TIME/VALUE dial to modify the value. To advance to the next page press [ENTER/TAP]. To return to the previous page press [EXIT].

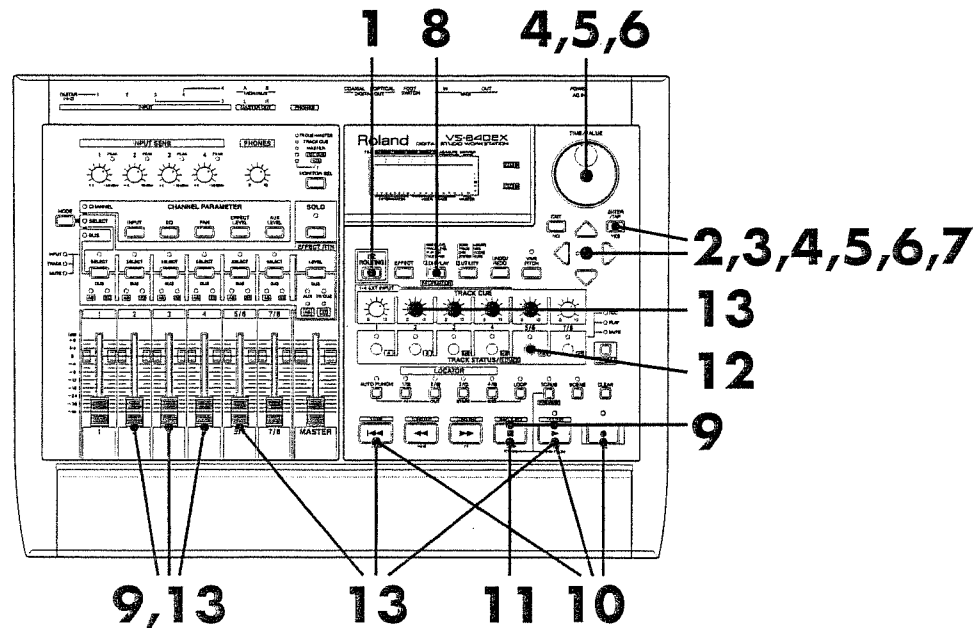

1 Press [EZ ROUTING].

2 Use [CURSOR] to select the Track Bouncing icon and press [ENTER/TAP].

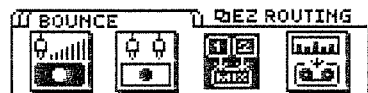

3 In this page you can specify whether or not you wish to modify the parameter values (default values) that were set automatically by Easy Routing. In order to modify the settings, use [CURSOR] to select the "YES" icon. When you finish making settings, press [ENTER/TAP].

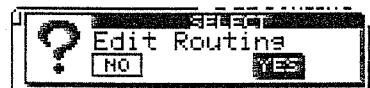

- 4** A screen page will appear in which you can select the recording destination tracks. Use [CURSOR] and the TIME/VALUE dial to select "TR2-1"(track 2/V-track 1), "TR3-1" (track 3/V-track 1), and "TR4-1" (track 4/V-track 1). When you finish making settings, press [ENTER/TAP].

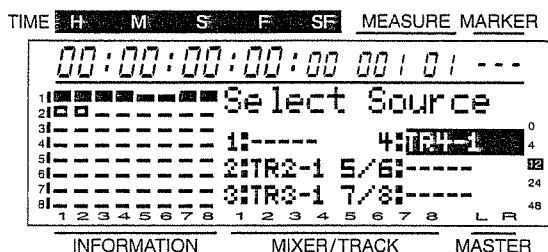

- 5** In this page you can specify the recording destination tracks. For this example, select V-track 2 of track 5/6 as the recording destination. Use [CURSOR] and the TIME/VALUE dial to make settings as shown in the screen page below. When you finish making settings, press [ENTER/TAP].

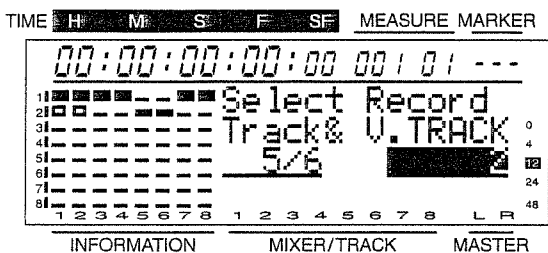

- 6** In this page you can set the pan for each channel. Pan has been set automatically for each channel according to the recording destination track that was specified in step 5. For this example, channel 2 pan is set to center (0), channel 3 pan to full left (L63), and channel 4 pan to full right (R63). If you wish to modify these settings, use [CURSOR] and the TIME/VALUE dial to make settings. When you are finished, press [ENTER/TAP].

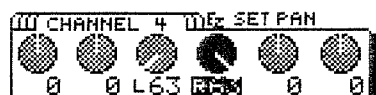

- 7** In this page you can specify whether you wish to use an effect or not. For this example we will not be using an effect, so use [CURSOR] to select the "NO" icon. Then press [ENTER/TAP].

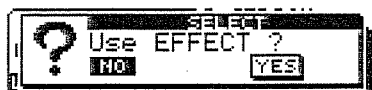

-
- 8** The final page will appear. If you have finished making settings, press [DISPLAY] to return to Play mode.

EZ ROUTING is finished!
Please set levels using
the Sens Knobs and Faders
DISPLAY

-
- 9** Press [PLAY] to begin playback, and use channel faders 2–4 to adjust the volume balance. When you finish adjusting the balance, press [STOP].

-
- 10** Press [ZERO] to return to the beginning of the song, press [REC] to make the button indicator blink red, and then press [PLAY] to begin recording.

-
- 11** When you finish recording, press [STOP] to stop.

-
- 12** Listen to the performance that was recorded. First, set track 5/6 to playback condition. Press the track 5/6 [TRACK STATUS/V.TRACK] to make the button indicator light green.

-
- 13** Press [ZERO] to return to the beginning of the song, and then press [PLAY] to playback the song. Turn down the channel 2–4 faders, and use the channel 5/6 fader to adjust the volume of track 5/6.
-

How did it go? If you are happy with the results, use the procedure described in “Saving your recorded performance” (page 10) to save the song. If you wish to cancel this recording, refer to “Canceling a recording” (page 11).

■ Saving the mixer settings

In the case of an analog multitrack mixer, the only way of reproducing the state of the mixer settings is to write them down on paper. However on the VS-840EX, the Scene function provides a way for you to easily recall and reproduce a previously-stored set of mixer settings. Since up to eight Scenes in each song can be used to store the state of the mixer, you can also use this function to compare various mixing balances. Scenes also contain the effect settings. Use the following procedure to store the mixdown settings of the mixer.

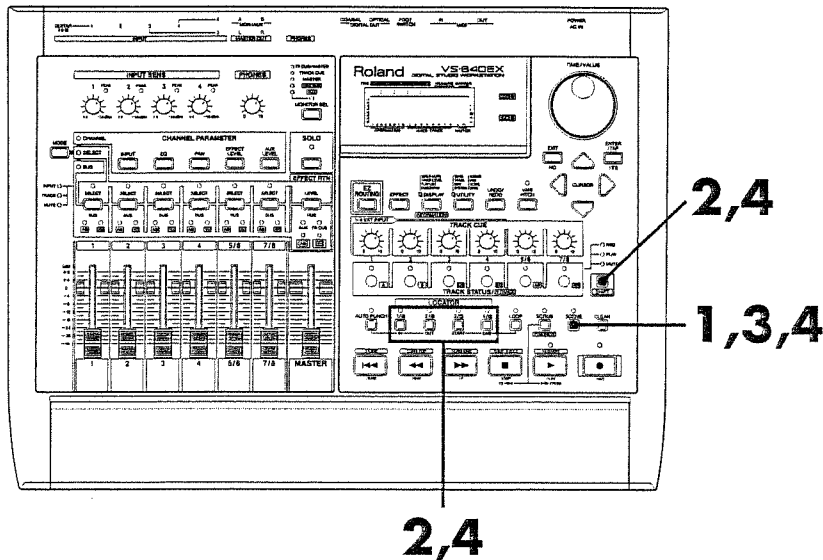

1 Press [SCENE] to make the button indicator light.

The SCENE indicator will light, and the LOCATOR buttons [1/5]–[4/8] will have the function of storing or recalling scenes.

2 Store the current mixer settings in a scene.

To store the settings to a scene 1–4, press a button [1/5]–[4/8]. To store the settings to a scene 5–8, hold down [SHIFT] and press [1/5]–[4/8]. The mixer settings will be stored, and the button indicator will light.

3 After storing a scene, press [SCENE] once again to make the button indicator go dark.

4 To select the mixer settings that were saved, press [SCENE] to make the button indicator light, and press a LOCATOR button [1/5]–[4/8] to specify the desired scene number.



When you recall mixer settings, the mixer settings will change, but the locations of the knobs and faders will remain as they were. This means that the actual settings will differ from the locations of the knobs and faders.

Clearing the settings of a scene

1. Press [SCENE] to make the button indicator light.

2. Clear the scene settings.

While holding down [CLEAR], press the LOCATOR button [1/5] to [4/8] for the scene that you wish to clear. The settings will be cleared and the button indicator will go dark.

3. After the settings have been cleared, press [SCENE] to make the button indicator go dark.

■ Mixing down to 2-channel stereo

In this section we will explain how you can adjust the volume level and pan (or balance, for a stereo track) of the signals recorded on tracks 2, 5/6 and 7/8, apply reverb to all of the sound while you mix the signals to 2-channel stereo, and record the result on your recorder (cassette tape recorder, DAT recorder, MD recorder, etc.). This procedure is referred to as "mixdown."

We will use the Easy Routing function to make mixer settings. The basic procedure is to use [CURSOR] to move the cursor to the item that you wish to modify, and use the TIME/VALUE dial to modify the value. To advance to the next page press [ENTER/TAP]. To return to the previous page press [EXIT].



Here we will be explaining how to record the analog signal from the MASTER OUT jacks. If you wish to record the digital signal from the DIGITAL OUT jack on a digital recorder, refer to "Mixing down to 2-channel stereo" (owner's manual page 64).

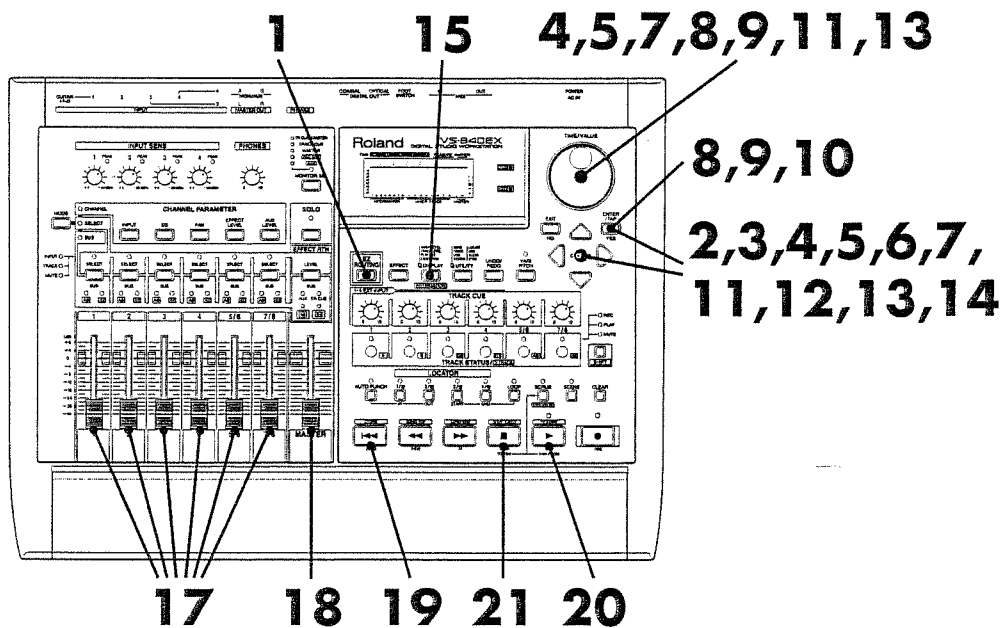

1 Press [EZ ROUTING].

2 Use [CURSOR] to select the Mixdown icon and press [ENTER/TAP].

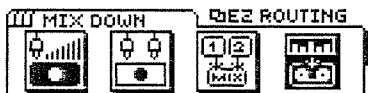

3 In this page you can specify whether or not you wish to modify the parameter values (default values) that were set automatically by Easy Routing. In order to modify the settings, use [CURSOR] to select the "YES" icon. When you finish making settings, press [ENTER/TAP].



4 In this page you can specify the input for each channel. Use [CURSOR] and the TIME/VALUE dial to select "TR1-2" (V-track 2 of track 1) as the input for channel 1, "TR2-2" (V-track 2 of track 2) as the input for channel 2, "TR5/6-2" (V-track 2 of track 5/6) as the input for channel 5/6, and "TR7/8-1" (V-track 1 of track 7/8) as the input for channel 7/8. Set other tracks to "MUTE." When you finish making settings, press [ENTER/TAP].

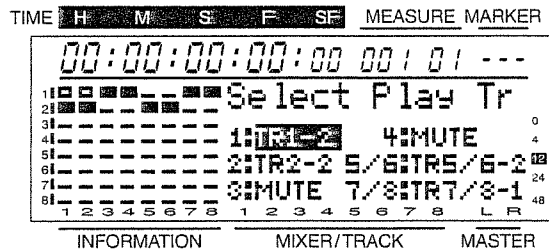

5 In this page you can specify the pan (or balance, for a stereo track) for each channel. Modify the settings if necessary. When you finish making settings, press [ENTER/TAP].

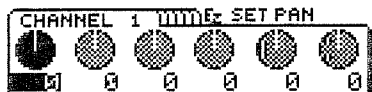

6 In this page you can specify whether you wish to use an effect or not. Since we will be using an effect for this example, use [CURSOR] to select the "YES" icon. Then press [ENTER/TAP].



7 In this page you can specify where the effect will be connected. For this example, we will connect the effect to the **EFFECT** bus (Loop connection), and turn off the direct sound of the effect. Use the **TIME/VALUE** dial to set the connection location to **"LOOP, DIR:Off."** When you finish making settings, press **[ENTER/TAP]**.

Select Effect Position

POSITION: **[0] [1] [2] [3] [4] [5] [6] [7] [8] [9]**

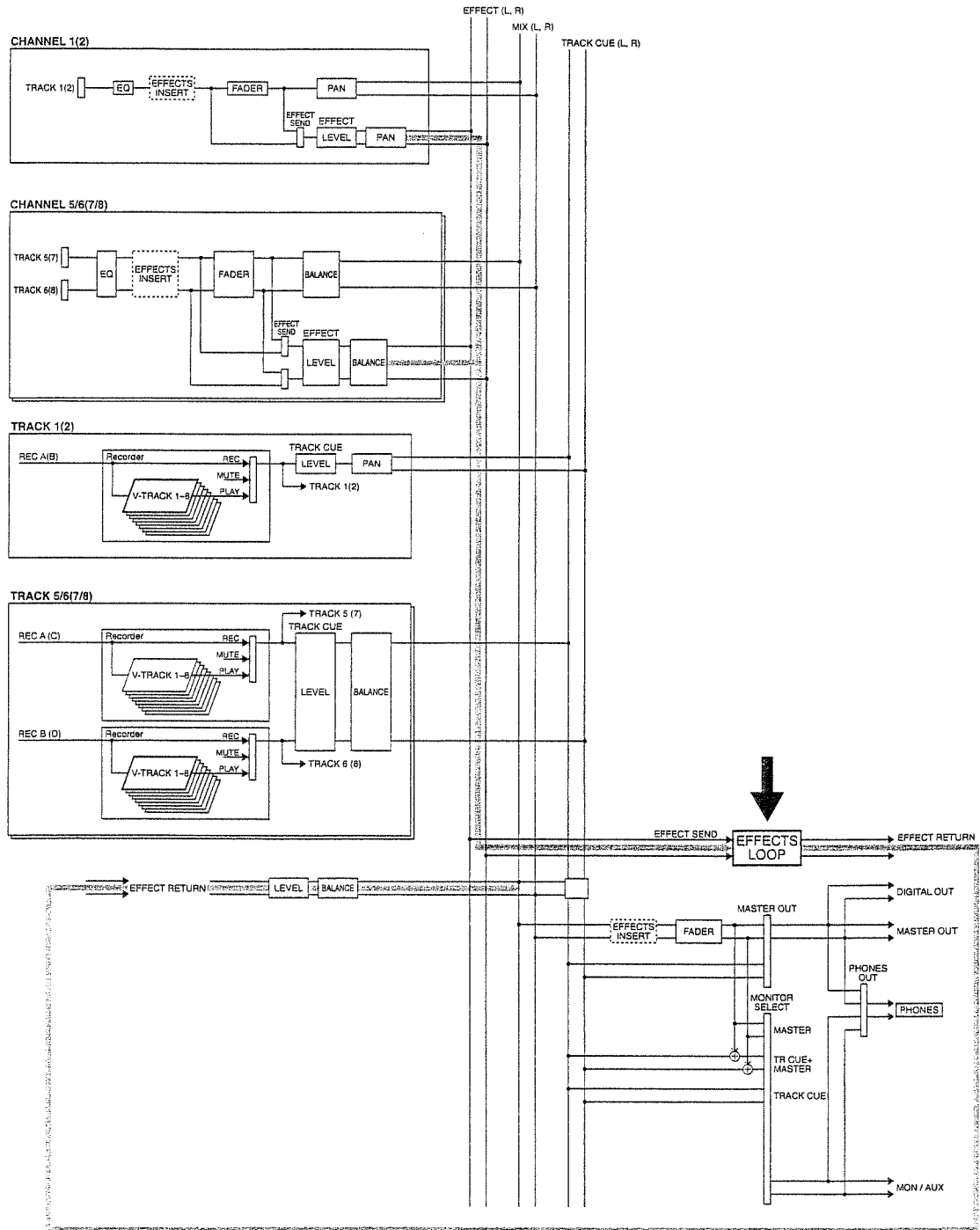

For details on effect connection location, refer to "Effect connections" (owner's manual page 75).

- 8** In this page you can select the effect patch that will be used. For this example, we will use reverb. First move the cursor to "TYPE," and select algorithm type "Reverb1." Next, move the cursor to "PATCH" and select the patch. For this example, select a patch such as "A-00:Medium Room." Press [ENTER/TAP] and that patch will be recalled. Press [ENTER/TAP] once again to advance to the next page.

```

Select Effect
TYPE : Reverb 1 w/Gate
PATCH: A-00:Medium Room
CHANGE OK?

```

- 9** In this page you can specify the monitor output destination of the effect sound. Here we will be using the MIX bus which is always connected, so use the TIME/VALUE dial to select "Off." When you finish making settings, press [ENTER/TAP].

- 10** In this page you can specify whether the signal that is sent to the EFFECT bus from each channel will be taken from before the channel fader or after the fader. For this example, we will use the default setting (post-fader), so simply press [ENTER/TAP].

```

CHANNEL 1 TIME: SELECT EFX SW
Pst Pst Pst Pst Pst Pst

```

- 11** In this page you can specify the volume level at which the output of each channel will be sent to the effect (effect send level). Use [CURSOR] and the TIME/VALUE dial to adjust the send level for channels to which you wish to apply the effect. When you finish making settings, press [ENTER/TAP].

```

CHANNEL 2 TIME: SET EFX LEVEL
50 50 0 0 50 50

```

- 12** In this page you can specify the pan setting for sending the output of each channel to the effect. Make adjustments as necessary. When you are finished, press [ENTER/TAP].

```

CHANNEL 2 TIME: SET EFX PAN
0 0 0 0 0 0

```

-
- 13** In this page you can specify the effect return level and balance. Use [CURSOR] and the TIME/VALUE dial to make adjustments. When you are finished, press [ENTER/TAP].

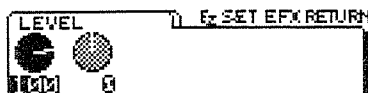

-
- 14** In this page you can specify whether or not the signals that are input to the INPUT jacks 1-4 will be used in the mixdown. In this example we will not be using the signals from the INPUT jacks, so select the "NO" icon and press [ENTER/TAP].

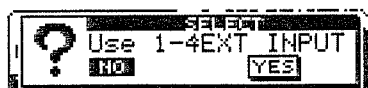

-
- 15** The final page will appear. If you have finished making settings, press [DISPLAY] to return to Play mode.

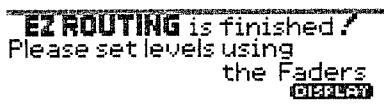

-
- 16** Connect the recorder to the MASTER OUT of the VS-840EX.
For details on connections, refer to the owner's manual of your recorder.

-
- 17** Use the channel faders to adjust the volume of each track.
First determine the volume for the central track of your song (the vocal or melody part guitar, etc.) It is best to adjust the volume of the other tracks to a lower volume than the main track.

-
- 18** Adjust the recording level of your recorder.
Use the master fader to adjust the volume of the VS-840EX as high as possible without causing an input level overload on your recorder.

-
- 19** Press the VS-840EX's [ZERO] to return to the beginning of the song, and put the recorder in record-ready mode.

-
- 20** Put the recorder in record mode, and then press the VS-840EX's [PLAY] to playback the song.

-
- 21** When recording is completed, stop the recorder and the VS-840EX.
-

Various Editing Techniques

The VS-840EX lets you store time locations within a song. If you register the location of places that you would like to hear again or re-record, you will be able to jump instantly to those places using a simple operation. This is called the Locate function. Up to eight locations can be memorized in each song.

Some analog tape recorders have a similar function, but since the VS-840EX is a digital disk recorder, you do not have to wait while the tape is being rewound or fast-forwarded.

Here we will explain how to register a Locate point, and how to recall it.

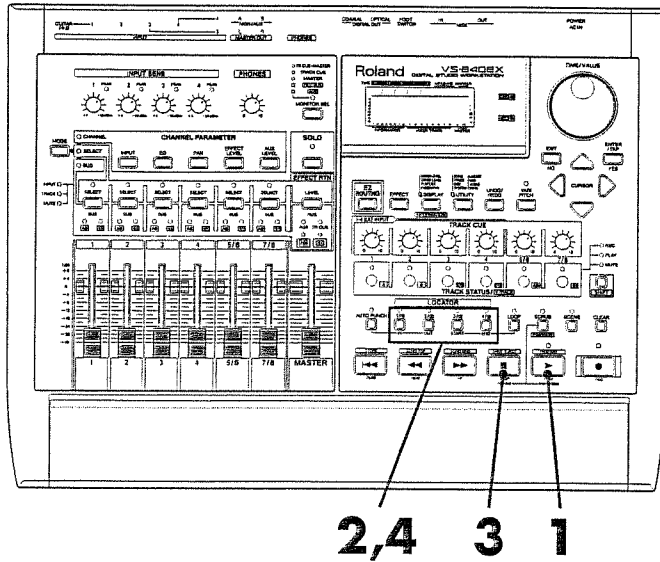

1 Press [PLAY] to playback the song.

2 When you come to a location that you wish to store, use the LOCATOR buttons [1/5]–[4/8] to specify the locate point number. If there is more than one location that you wish to store, continue using the same procedure.

To store a location in a locate point 1–4, press the appropriate button [1/5]–[4/8]. To store a location in a locate point 5–8, hold down [SHIFT] and press the appropriate button [1/5]–[4/8]. When a time has been registered for a button, the indicator of that button will light.

3 When you are finished storing locate points, press [STOP] to stop playback.

4 To move to a previously-stored location, press a LOCATOR button [1/5]–[4/8] to specify the desired locate point number.



LOCATOR buttons whose indicator is dark do not contain a time location. Pressing such a button will not change the current time location.

Deleting a stored time location

1. While holding down [CLEAR], use the LOC buttons to specify the locate point that you wish to clear.

When a locate point has been cleared, the button indicator will go dark.

The functions which were introduced in Quick Start are only part of the functions provided by the VS-840EX. This section lists the reference page of the owner's manual that explains the things you can do using the VS-840EX. Please take full advantage of the VS-840EX's functionality and enjoy multitrack recording.

Recording

Re-record part of a performance (Punch-in recording).....	58
Use the metronome and record at a specified tempo.....	95
Monitor only a specific channel (Solo function).....	98
Cancel a recording/edit operation (Undo/Redo functions).....	100

Playback

Move the current time.....	31
Place marks in a song (Locate function and Tap Marker function)	35
Mix the recorder with external input sources	51
Find an exact time location (Preview function).....	65
Modify the playback pitch of the song	97
Synchronize with a MIDI sequencer.....	111

Edit

Copy performance data in a track.....	68
Move performance data in a track	69
Exchange performance data between tracks	71
Insert a blank into a track	72
Cut performance data from a track.....	73
Delete performance data from a track	74

Other

About buses	22
Structure of the digital mixer	24
What is a digital disk recorder?.....	25
Basic operation of the VS-840EX.....	27
Protect song data (Song Protect).....	29
Re-start the VS-840EX	30
Name a song	55
Delete unneeded data (Song Optimize)	101
Erase song data (Song Erase)	102
Adjust the brightness of the display	119
Switch the screen display	119
Using external effect units	127

Roland®

DIGITAL STUDIO WORKSTATION VS-840EX

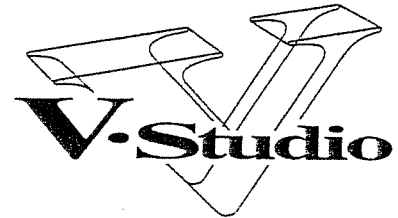

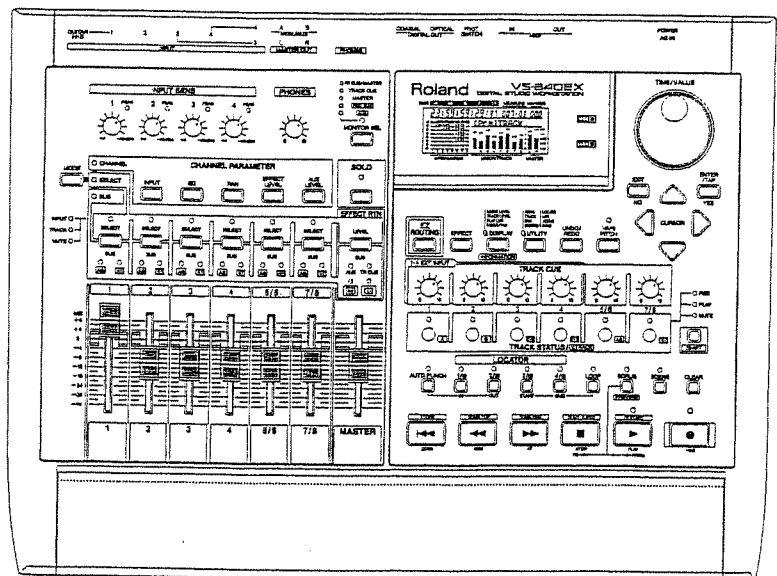

OWNER'S MANUAL

Before using this unit, carefully read the sections entitled: "IMPORTANT SAFETY INSTRUCTIONS" (Owner's manual p. 2), "USING THE UNIT SAFELY" (Owner's manual p. 3), and "IMPORTANT NOTES" (Owner's manual p. 10 - 11). These sections provide important information concerning the proper operation of the unit. Additionally, in order to feel assured that you have gained a good grasp of every feature provided by your new unit, Quick start and Owner's manual should be read in its entirety. The manual should be saved and kept on hand as a convenient reference.



Copyright © 1999 ROLAND CORPORATION
All rights reserved. No part of this publication may be reproduced in any form without the written permission of ROLAND CORPORATION.

	CAUTION RISK OF ELECTRIC SHOCK DO NOT OPEN	
ATTENTION: RISQUE DE CHOC ELECTRIQUE NE PAS OUVRIR		
CAUTION: TO REDUCE THE RISK OF ELECTRIC SHOCK, DO NOT REMOVE COVER (OR BACK). NO USER-SERVICEABLE PARTS INSIDE. REFER SERVICING TO QUALIFIED SERVICE PERSONNEL.		



The lightning flash with arrowhead symbol, within an equilateral triangle, is intended to alert the user to the presence of uninsulated "dangerous voltage" within the product's enclosure that may be of sufficient magnitude to constitute a risk of electric shock to persons.



The exclamation point within an equilateral triangle is intended to alert the user to the presence of important operating and maintenance (servicing) instructions in the literature accompanying the product.

INSTRUCTIONS PERTAINING TO A RISK OF FIRE, ELECTRIC SHOCK, OR INJURY TO PERSONS.

IMPORTANT SAFETY INSTRUCTIONS SAVE THESE INSTRUCTIONS

WARNING - When using electric products, basic precautions should always be followed, including the following:

1. Read all the instructions before using the product.
2. Do not use this product near water — for example, near a bathtub, washbowl, kitchen sink, in a wet basement, or near a swimming pool, or the like.
3. This product should be used only with a cart or stand that is recommended by the manufacturer.
4. This product, either alone or in combination with an amplifier and headphones or speakers, may be capable of producing sound levels that could cause permanent hearing loss. Do not operate for a long period of time at a high volume level or at a level that is uncomfortable. If you experience any hearing loss or ringing in the ears, you should consult an audiologist.
5. The product should be located so that its location or position does not interfere with its proper ventilation.
6. The product should be located away from heat sources such as radiators, heat registers, or other products that produce heat.
7. The product should be connected to a power supply only of the type described in the operating instructions or as marked on the product.
8. The power-supply cord of the product should be unplugged from the outlet when left unused for a long period of time.
9. Care should be taken so that objects do not fall and liquids are not spilled into the enclosure through openings.
10. The product should be serviced by qualified service personnel when:
 - A. The power-supply cord or the plug has been damaged; or
 - B. Objects have fallen, or liquid has been spilled into the product; or
 - C. The product has been exposed to rain; or
 - D. The product does not appear to operate normally or exhibits a marked change in performance; or
 - E. The product has been dropped, or the enclosure damaged.
11. Do not attempt to service the product beyond that described in the user-maintenance instructions. All other servicing should be referred to qualified service personnel.

For the USA

GROUNDING INSTRUCTIONS

This product must be grounded. If it should malfunction or breakdown, grounding provides a path of least resistance for electric current to reduce the risk of electric shock.

This product is equipped with a cord having an equipment-grounding conductor and a grounding plug. The plug must be plugged into an appropriate outlet that is properly installed and grounded in accordance with all local codes and ordinances.

DANGER: Improper connection of the equipment-grounding conductor can result in a risk of electric shock. Check with a qualified electrician or serviceman if you are in doubt as to whether the product is properly grounded. Do not modify the plug provided with the product — if it will not fit the outlet, have a proper outlet installed by a qualified electrician.

For the U.K.

WARNING: THIS APPARATUS MUST BE EARTHED
IMPORTANT: THE WIRES IN THIS MAINS LEAD ARE COLOURED IN ACCORDANCE WITH THE FOLLOWING CODE.
 GREEN-AND-YELLOW: EARTH, BLUE: NEUTRAL, BROWN: LIVE

As the colours of the wires in the mains lead of this apparatus may not correspond with the coloured markings identifying the terminals in your plug, proceed as follows:

The wire which is coloured GREEN-AND-YELLOW must be connected to the terminal in the plug which is marked by the letter E or by the safety earth symbol  or coloured GREEN or GREEN-AND-YELLOW.

The wire which is coloured BLUE must be connected to the terminal which is marked with the letter N or coloured BLACK.



The wire which is coloured BROWN must be connected to the terminal which is marked with the letter L or coloured RED.

The product which is equipped with a THREE WIRE GROUNDING TYPE LINE PLUG must be grounded.







USING THE UNIT SAFELY

INSTRUCTIONS FOR THE PREVENTION OF FIRE, ELECTRIC SHOCK, OR INJURY TO PERSONS

About WARNING and CAUTION Notices









 WARNING	Used for instructions intended to alert the user to the risk of death or severe injury should the unit be used improperly.
 CAUTION	Used for instructions intended to alert the user to the risk of injury or material damage should the unit be used improperly. * Material damage refers to damage or other adverse effects caused with respect to the home and all its furnishings, as well to domestic animals or pets.

About the Symbols

	The  symbol alerts the user to important instructions or warnings. The specific meaning of the symbol is determined by the design contained within the triangle. In the case of the symbol at left, it is used for general cautions, warnings, or alerts to danger.
	The  symbol alerts the user to items that must never be carried out (are forbidden). The specific thing that must not be done is indicated by the design contained within the circle. In the case of the symbol at left, it means that the unit must never be disassembled.
	The  symbol alerts the user to things that must be carried out. The specific thing that must be done is indicated by the design contained within the circle. In the case of the symbol at left, it means that the power-cord plug must be unplugged from the outlet.

ALWAYS OBSERVE THE FOLLOWING









WARNING

- Before using this unit, make sure to read the instructions below, and the Owner's Manual. 
- Do not open or perform any internal modifications on the unit. (The only exception would be where this manual provides specific instructions which should be followed in order to put in place user-installable options; see p. 196.) 
- Make sure you always have the unit placed so it is level and sure to remain stable. Never place it on stands that could wobble, or on inclined surfaces. 
- Avoid damaging the power cord. Do not bend it excessively, step on it, place heavy objects on it, etc. A damaged cord can easily become a shock or fire hazard. Never use a power cord after it has been damaged. 
- In households with small children, an adult should provide supervision until the child is capable of following all the rules essential for the safe operation of the unit. 
- Protect the unit from strong impact. (Do not drop it!) 
- Do not force the unit's power-supply cord to share an outlet with an unreasonable number of other devices. Be especially careful when using extension cords—the total power used by all devices you have connected to the extension cord's outlet must never exceed the power rating (watts/ampères) for the extension cord. Excessive loads can cause the insulation on the cord to heat up and eventually melt through. 
- Before using the unit in a foreign country, consult with your retailer, the nearest Roland Service Center, or an authorized Roland distributor, as listed on the "Information" page. 

WARNING

- Always turn the unit off and unplug the power cord before attempting installation of the circuit board (VS4S-1; p. 196). 

CAUTION

- Always grasp only the plug on the power-supply cord when plugging into, or unplugging from, an outlet or this unit. 
- Try to prevent cords and cables from becoming entangled. Also, all cords and cables should be placed so they are out of the reach of children. 
- Never climb on top of, nor place heavy objects on the unit. 
- Never handle the power cord or its plugs with wet hands when plugging into, or unplugging from, an outlet or this unit. 
- Before moving the unit, disconnect the power plug from the outlet, and pull out all cords from external devices. 
- Before cleaning the unit, turn off the power and unplug the power cord from the outlet (p. 19). 
- Whenever you suspect the possibility of lightning in your area, pull the plug on the power cord out of the outlet. 
- Install only the specified circuit board (VS4S-1). Remove only the specified screws (p. 196). 

Introduction

Thank you for purchasing the Roland VS-840EX Digital Studio Workstation.

The documentation for VS-840EX consists of two manuals: "Quick Start" and "Owner's Manual" (this document). If you are using the VS-840EX for the first time, please read "Quick Start" first.

■ About the package contents

The VS-840EX package includes the following items. Make sure that you have all the items.

- VS-840EX
- Power cable
- Quick Start
- Owner's Manual (this manual)
- Preset Patch List
- Demo Disk

■ Using an external Zip drive with the VS-840EX

When the VS4S-1 (sold separately) is installed in the VS-840EX, songs created on the VS-840EX can be saved on an external Zip drive. For details refer to "Using an external Zip drive" (page 200).

■ To those who have purchased VS-840-UP1

To understand what functions have been added by the VS-840 to VS-840EX upgrade, we recommend that you read the section entitled "VS-840EX expanded functions" (p. 13) first.

* *Iomega is a registered trademark of Iomega Corporation.*

* *Zip is a trademark of Iomega Corporation.*

Contents

IMPORTANT SAFETY INSTRUCTIONS SAVE THESE INSTRUCTIONS	2
USING THE UNIT SAFELY	3
Introduction	4
IMPORTANT NOTES.....	10
Chapter 1. Introducing the VS-840EX	12
Main features	12
VS-840EX expanded functions	13
Disks that can be used by the VS-840EX (Zip disks).....	14
Chapter 2. Front and rear panels	15
Mixer section.....	15
Recorder section	16
Display section.....	18
Rear panel.....	19
Disk Drive	20
Chapter 3. Before you start (VS-840EX terminology)	21
Sources, tracks, and channels	21
Doing everything in the digital domain (Digital Studio Workstation)	21
Signal flow (buses).....	22
About songs	23
Mixer section.....	24
■ How the mixer is organized.....	24
■ Recording the current condition of the mixer (Scene)	25
Recorder section	25
■ Differences with a tape-type MTR	25
■ Number of tracks that can be recorded/played simultaneously	25
■ Virtual tracks provided for each track (V-tracks)	25
Effects section.....	26
■ Effect connections (Insert/Loop).....	26
Event	26
■ "Lack of EVENT!!" Display.....	26
Chapter 4. Basic operation of the VS-840EX.....	27
Before you begin.....	27
■ Turning on the power	27
■ Inserting the disk	27
■ Initializing a disk (Disk Initialize).....	28
Listening to the demo song.....	28
■ Listening to the variations of the demo song	28
Before you finish operations.....	29
■ Saving the performance to disk (Song Store)	29
■ To protect a song (Song Protect).....	29
■ Turning the power off (Shut Down)	29
Re-starting the VS-840EX	30
Basic operations in the display screen	30
Selecting a song (Song Select).....	31
Changing the current time.....	31
Changing the input of a channel.....	32
Monitoring the track playback	33
Changing the track status (Track Status).....	33
Switching the monitor output (Monitor Select).....	33
Registering the current mixer settings (Scene)	34
Storing a time location, method 1 (Locate Point)	35
■ Storing a time location	35
■ Moving to a stored time location.....	35
■ Modifying a stored time location	35
■ Deleting a stored time location.....	35
Storing a time location, method 2 (Mark Points).....	35

■ Marking a time location.....	35
■ Moving to a marked time location.....	36
■ Modifying a marked time location.....	36
■ Clearing a mark.....	36
Chapter 5. Using the EZ ROUTING function.....	37
About the Easy Routing function.....	37
Using the Easy Routing function.....	37
■ Quick Recording Icon.....	37
■ Recording icon.....	38
■ Track Bouncing icon.....	40
■ Mixdown icon.....	42
■ User Routing icon.....	44
■ AUX Routing icon.....	45
■ External In Icon.....	46
An example of using Easy Routing.....	47
■ Recording to track 1.....	47
■ Recording in stereo to tracks 5/6.....	48
■ Recording additional tracks while listening to playback (Overdubbing).....	49
■ Bouncing tracks while applying reverb (Loop).....	50
■ Mixing down to 2-channel.....	51
About the default values set by Easy Routing.....	52
Chapter 6. Multitrack recording techniques (Using the VS-840EX like a tape-based MTR)....	54
Making a new recording.....	54
■ Creating a new song (Song New).....	54
■ Naming the song (Song Name).....	55
■ Connect the instruments.....	55
■ Record a performance onto a track.....	56
Switching V-tracks.....	57
Recording additional tracks while listening to the performance (Overdubbing).....	57
Re-recording only your mistakes (Punch-in/out).....	58
■ Punch-in/out using the record button.....	58
■ Punch-in/out using a foot switch.....	59
Recording a previously-specified section (Auto Punch-in).....	60
Repeatedly recording the same location (Loop Recording).....	61
Combining the performances of two or more tracks into another track (Track bouncing)....	62
Creating a master tape.....	62
■ Adjusting the tone (Equalizer).....	62
■ Adjusting the volume and pan (Level/Pan).....	63
■ Mixing down to 2-channel stereo (Mix Down).....	64
Chapter 7. Editing a recorded performance (track editing).65	65
What is editing?.....	65
Finding a desired location (Preview).....	65
■ Using [TO] and [FROM].....	65
■ Scrub playback ([SCRUB]).....	66
Basic procedure.....	67
Re-using part of the performance (Copy).....	68
Modifying the organization of the performance (Move).....	69
Exchanging performance data between tracks (Exchange).....	71
Inserting blank space into a performance (Insert).....	72
Deleting a portion of a performance (Cut).....	73
Erasing part of a performance (Erase).....	74
Chapter 8. Using the internal effects.....	75
Effect connections.....	75
Switching effects (Patch Change).....	78
Using effects.....	79

Creating a new effect sound	80
■ Creating an effect sound	80
■ Saving effect settings	81
Examples of how the effects can be used	82
■ Applying reverb to a recorded performance (Loop)	82
■ Applying reverb as you record (Loop)	84
■ Applying reverb while bouncing tracks (Loop)	86
■ During recording, apply effects only to the monitor sound (Loop)	88
■ Applying chorus to the Lch, reverb to the Rch, and mixing them (Loop)	90
■ Recording with an effect inserted (Insert)	92
■ Recording while you apply Vocoder (Insert)	93
If the effect does not function as you expect	94

Chapter 9. Other convenient functions.....95

Sounding the metronome	95
■ Using an external MIDI sound source to play the metronome	95
Using a foot switch to playback/stop	96
Stopping automatically (Marker stop)	97
Changing the pitch during playback (Vari-pitch)	97
Listening only to a specific channel (Solo)	98
Making front-panel fader and TRACK CUE knob operation active immediately	98
Switching the source for output to the PHONES jack	99
Undoing a recording or / editing operation	100
■ Recording/editing operations which can be undone (Undo)	100
■ Canceling the last-performed Undo (Redo)	101
■ Canceling only the last-performed operation	101
When the disk has little remaining space	101
■ Deleting only unneeded performance data (Song Optimize)	101
■ Deleting one song of performance data (Song Erase)	102
Copying performance data (Song Copy)	102
Duplicating a disk (Disk Copy)	103
Exchanging data between the VS-840EX and VS-880 (Song Convert)	104
Creating a master tape which disables digital copying	105
■ About SCMS	106
How to use the tuner	106
■ Switching to the tuner	106
■ About the display content during tuning	106
■ Tuning procedure	106
■ Tuner settings	107
Copy between Channel Pan and Track Cue Pan	107
■ Copying the Channel Pan	107
■ Copying the Track Cue Pan	107
Switching the INFORMATION display content	108
External In functions	108
SCSI ID Scan	109
Quick search	109

Chapter 10. Use with MIDI devices110

About MIDI	110
■ What is MIDI	110
■ MIDI connectors	110
■ MIDI channels	110
■ MIDI messages	110
■ MIDI implementation chart	110
Synchronizing with a MIDI sequencer	111
■ Using MTC	111
■ Using the tempo map	113
■ Using the sync track	114
■ Assigning an offset to the sync track / tempo map	116
Sync Edit	116
■ Creating a Sync Track from Mark Points	116

- Creating a Tempo Map from a Sync Track117
- Creating a Sync Track automatically117
- Creating a Tempo Map from Mark Points118
- When you experience problems with synchronization118

Chapter 11. Overall settings and status checking119

- If the display area is difficult to read (Contrast).....119
- Switching the contents of the display (Display)119
 - Displaying song-related information121
- Restoring the VS-840EX settings to the initial state122

**Chapter 12. Taking advantage of the VS-840EX
(ideas and examples)123**

- Recording multiple sources to one track123
- Bringing together the desired sections124
- Using Mark points to rearrange song data (Song Arrange)125
- Operating the VS-840EX from another device (MMC)126
 - Operating the VS-840EX from an MMC-compatible device126
 - If you have problems with synchronization127
- Using external effect units127
 - Applying an effect during playback128
 - Applying an effect while bouncing tracks129

Appendices130

- Algorithm list130
 1. Reverb 1130
 2. Reverb 2131
 3. Tap Delay132
 4. Stereo Delay Chorus133
 5. Stereo Pitch Shifter Delay134
 6. 2 ch RSS135
 7. Panner135
 8. Delay RSS136
 9. Chorus RSS137
 10. Guitar Multi 1138
 11. Guitar Multi 2139
 12. Vocal Multi 1140
 13. Vocal Multi 2141
 14. Keyboard Multi142
 15. Rotary143
 16. Stereo Phaser144
 17. Stereo Flanger144
 18. Tremolo Pan145
 19. Stereo Multi145
 20. Lo-Fi Box146
 21. Vocoder147
 22. Space Chorus147
 23. Reverb + Reverb148
 24. Delay + Reverb149
 25. Chorus + Reverb150
 26. Delay + Chorus151
 27. Bass Multi 1152
 28. Bass Multi 2153
 29. Mic Simulator154
 30. Acoustic Simulator155
 31. Bass Simulator156
 32. 10 Band Graphic Equalizer156
- Functions of each parameter157
 - Acoustic Guitar Simulator157
 - Chorus157

Compressor/Limiter.....	158
De-esser.....	158
Delay.....	159
Enhancer.....	159
Equalizer.....	160
Flanger.....	160
Lo-Fi Box.....	161
Noise Suppressor.....	162
Overdrive.....	162
Phaser.....	162
Pitch Shifter.....	163
PreAmp.....	163
Reverb.....	164
Ring Modulator.....	165
Rotary.....	166
RSS (2ch).....	166
RSS (Panner).....	167
Space Chorus.....	167
Speaker Simulator.....	167
Tremolo / Pan.....	168
Vocoder.....	168
Wah.....	168
Defretter.....	169
Distortion.....	169
Mic Converter.....	170
Bass Cut Filter.....	170
Distance.....	170
Bass Guitar Simulator.....	171
Graphic EQ.....	171
Before using RSS.....	172
Product package notice for when RSS is used.....	172
Troubleshooting.....	173
Error messages.....	175
Special key operations.....	177
Parameter List.....	178
MIDI Implementation.....	180
MIDI Implementation Chart.....	186
Block Diagram.....	187
Glossary.....	188
Specifications.....	189
Index.....	190
TRACK SHEET.....	194
Installation of the VS4S-1 (optional SCSI board).....	196
Installation du VS4S-1 (carte SCSI optionnelle).....	198
Using an external Zip drive (About SCSI).....	200
Before You Use a Zip Drive.....	200
Connecting all external Zip drive.....	201
Restarting the external Zip drive.....	201
Shutting down the external Zip drive.....	202
Initializing the Zip disk.....	202
Copying songs from the VS-840EX to the external Zip disk.....	203
Copying songs from the external Zip disk to the VS-840EX.....	203
Deleting a song that was saved on an external Zip disk.....	204
Using an external Zip drive to perform a disk copy.....	204
Using an external Zip drive to convert data between VS-840EX/VS-880 formats (Song Convert).....	205
Select the SCSI drive.....	206
When the Data Cannot be Saved on a Single Disk (Archives).....	206
Copying a Performance Data from a Song Saved on a SCSI Device (Track Import).....	208
Copying a specified track of a Current Song to a Song Saved (or a New Song) on a SCSI Device (Track Export).....	209
VS4S-1 Specifications.....	209

IMPORTANT NOTES

In addition to the items listed under “IMPORTANT SAFETY INSTRUCTIONS” and “USING THE UNIT SAFELY” on pages 2 and 3, please read and observe the following:

Power Supply

- Do not use this unit on the same power circuit with any device that will generate line noise (such as an electric motor or variable lighting system).
- Before connecting this unit to other devices, turn off the power to all units. This will help prevent malfunctions and/or damage to speakers or other devices.

Placement

- Using the unit near power amplifiers (or other equipment containing large power transformers) may induce hum. To alleviate the problem, change the orientation of this unit; or move it farther away from the source of interference.
- This device may interfere with radio and television reception. Do not use this device in the vicinity of such receivers.
- Observe the following when using the unit’s zip disk drive. For further details, refer to “Before Using Zip Disks” (page 11).
 - Do not place the unit near devices that produce a strong magnetic field (e.g., loudspeakers).
 - Do not move the unit or subject it to vibration while the drive is operating.
- Do not expose the unit to direct sunlight, place it near devices that radiate heat, leave it inside an enclosed vehicle, or otherwise subject it to temperature extremes. Excessive heat can deform or discolor the unit.
- To avoid possible breakdown, do not use the unit in a wet area, such as an area exposed to rain or other moisture.

Maintenance

- For everyday cleaning wipe the unit with a soft, dry cloth or one that has been slightly dampened with water. To remove stubborn dirt, use a cloth impregnated with a mild, non-abrasive detergent. Afterwards, be sure to wipe the unit thoroughly with a soft, dry cloth.
- Never use benzine, thinners, alcohol or solvents of any kind, to avoid the possibility of discoloration and/or deformation.

Additional Precautions

- Please be aware that the contents of memory can be irretrievably lost as a result of a malfunction, or the improper operation of the unit. To protect yourself against the risk of losing important data, we recommend that you periodically save a backup copy of important data you have stored in the unit’s memory on a Zip disk.
- Unfortunately, it may be impossible to restore the contents of data that was stored on a Zip disk once it has been lost. Roland Corporation assumes no liability concerning such loss of data.
- Use a reasonable amount of care when using the unit’s buttons, sliders, or other controls; and when using its jacks and connectors. Rough handling can lead to malfunctions.
- Never strike or apply strong pressure to the display.
- When connecting / disconnecting all cables, grasp the connector itself—never pull on the cable. This way you will avoid causing shorts, or damage to the cable’s internal elements.
- A small amount of heat will radiate from the unit during normal operation.
- To avoid disturbing your neighbors, try to keep the unit’s volume at reasonable levels. You may prefer to use headphones, so you do not need to be concerned about those around you (especially when it is late at night).
- When you need to transport the unit, package it in the box (including padding) that it came in, if possible. Otherwise, you will need to use equivalent packaging materials.

Before Using Zip Disks

Handling the Zip Disk Drive

- Install the unit on a solid, level surface in an area free from vibration. Tilting the unit may affect the operation of the Zip drive.
- Avoid using the unit immediately after it has been moved to a location with a level of humidity that is greatly different than its former location. Rapid changes in the environment can cause condensation to form inside the drive, which will adversely affect the operation of the drive and/or damage Zip disks. When the unit has been moved, allow it to become accustomed to the new environment (allow a few hours) before operating it.
- When turning off the power, please use the procedure given in "Turning the power off" (page 29).
- To prevent damage to the disk drive's heads, always try to hold the Zip disk in a level position (not tilted in any direction) while inserting it into the drive. Push it in firmly, but gently. Never use excessive force.
- To avoid the risk of malfunction and/or damage, insert only Zip disks into the disk drive. Never insert any other type of disk. Avoid getting paper clips, coins, or any other foreign objects inside the drive.

Handling Zip Disks

- Zip disks contain a plastic disk with a thin coating of magnetic storage medium. Microscopic precision is required to enable storage of large amounts of data on such a small surface area. To preserve their integrity, please observe the following when handling Zip disks:
 - Never touch the magnetic medium inside the disk.
 - Do not use or store Zip disks in dirty or dusty areas.
 - Do not subject Zip disks to temperature extremes (e.g., direct sunlight in an enclosed vehicle). Recommended temperature range: -22 to 51° C (-7.6 to 123.8° F).
 - Do not expose Zip disks to strong magnetic fields, such as those generated by loudspeakers.
- The identification label should be firmly affixed to the disk. Should the label come loose while the disk is in the drive, it may be difficult to remove the disk.
- Store all disks in a safe place to avoid damaging them, and to protect them from dust, dirt, and other hazards. By using a dirty or dust-ridden disk, you risk damaging the disk, as well as causing the disk drive to malfunction.

Concerning copyright

The law prohibits the unauthorized recording, public performance, broadcast, sale, or distribution etc. of a work (CD recording, video recording, broadcast, etc.) whose copyright is owned by a third party.

Roland will take no responsibility for any infringement of copyright that you may commit in using the VS-840EX.

About SCMS

"SCMS" stands for "Serial Copy Management System." This is a function that protects the rights of copyright holders by prohibiting recording via a digital connection for more than two generations. When digital connections are made between digital recorders that implement this function, SCMS data will be recorded along with the audio data. Digital audio data which contains this SCMS data cannot again be recorded via a digital connection.

Disclaimer of liability

Roland will take no responsibility for any "direct damages," "consequential damages," or "any other damages" which may result from your use of the VS-840EX. These damages may include but are not limited to the following events which can occur when using the VS-840EX.

- Any loss of profit that may occur to you
- Permanent loss of your music or data
- Inability to continue using the VS-840EX itself or a connected device

Chapter 1. Introducing the VS-840EX

Main features

■ Digital audio workstation

All processes are fully digital

The VS-840EX contains a digital disk recorder, a digital mixer and digital effects. By connecting a DAT or MD to the DIGITAL OUT, you can perform all processes in fully digital form — from editing and track bouncing, to effect processing and mixdown — allowing you to create high-quality master tapes.

Featuring “V-tracks”

The digital recorder section of the VS-840EX provides eight tracks, and allows simultaneous recording of four tracks, or simultaneous playback of eight tracks. Each track has eight virtual tracks (“V-tracks”), meaning that you can record on up to 64 tracks. This allows you to use techniques such as recording multiple takes of guitar solos, vocals or chorus.

Built-in digital effects

A digital multi-effect unit is built in to the VS-840EX, providing high-quality effects which rival dedicated units. This lets you bring songs to a high level of completion without connecting external effect devices. The wide variety of effects include multi-type effects such as guitar-multi, vocal-multi and keyboard-multi, and also provide carefully selected spatial-type effects such as reverb and delay. From creative sounds to sound-field simulation, you can use just the right effect in any situation.

Editing functions

You can use editing operations such as Copy, Move and Erase which were unthinkable on tape-based multi-track recorders. For example you can repeat a four-measure drum pattern several times as “break-beats,” or use the same chorus at the beginning and end of a song.

Non-destructive editing

The VS-840EX allows non-destructive editing — something possible only for disk recorders. Editing and recording operations can be undone (Undo/Redo function).

Mixer settings can be saved

For each song, up to 8 sets of all mixer settings can be registered as a “Scene.” During mixdown, this provides a convenient way to recall the previous settings after you have adjusted the balance or compared different effect settings.

Quick movement to Locate Points

For each song, up to 8 time locations (Locate Points) can be stored in the locate buttons. By registering time locations such as the end of the introduction or the beginning of a break, you can move instantly to the desired location, without having to rewind or fast-forward.

Up to 1000 points in each song can be indicated with a marker (Mark Point). It is useful to mark locations such as the beginning of a measure, or places that you will later wish to hear repeatedly.

■ Easy operation

The VS-840EX features easy operation that is modeled on that of a conventional analog multi-track recorder. A large LCD screen is featured, which allows you to view a large amount of information at once. In particular, level meters, pan and fader settings and track record status is shown graphically for ease of operation.

■ EZ Routing function

Recording settings and internal connections for track bouncing and mixdown can be made easily in an interactive manner. From the day that you purchase the VS-840EX, you can start experiencing the convenience of digital recording.

■ A rich array of connectors

Four analog audio signals can be input. In addition to phone plug inputs, INPUT 1 provides a high-impedance input to which a guitar can be connected directly, and INPUT 3/4 provide RCA phono jacks. Either can be selected for use. Input sensitivity can be adjusted over a broad range from line level (+4dBm) to mic level (-50dBm). As output jacks, RCA phono type MASTER OUT jacks (stereo) and MON (monitor output, stereo) / AUX (AUX send, two systems) output jacks are provided.

Since both coaxial and optical DIGITAL OUT connectors are provided, digital signals can be recorded on digital audio devices (DAT recorder or MD recorder, etc.).

VS-840EX expanded functions

* If a song created on the VS-840EX is loaded on VS-840 Ver.1.0, data for the functions added in VS-840EX will be lost.

Featuring 250 MB Zip drive

The Internal Zip drive has been changed to the type that supports 250 MB media, increasing by 2.5 times the length of material that can be stored.

Built-in chromatic tuner

(tuning range: C0–B4) (page 106)

Since a chromatic tuner is built right in, you can tune the guitar without ever unplugging it from the unit.

Additional internal effects (page 152–156)

The following effects have been added:

- Bass Multi 1
- Bass Multi 2
- Mic Simulator
- Acoustic Simulator
- Bass Simulator
- 10-Band Equalizer

4 ways of sync editing (page 116)

First, place mark points, then use these mark points to create sync track and tempo map.

Quick search (page 109)

Search the approximate time location where the sound begins on a pre-selected track.

INFORMATION display (page 108)

You can select INFORMATION display content.

Redoable icon display (page 101)

When redoable, the display will show the icon.

Copy between channel pan and track pan (page 107)

Pan setting may be copied between channel/track.

[COPY] + [INSERT], [MOVE] + [INSERT] added to track edit (page 68, 70)

Copy and insert, move and insert, which required two operations can now be accomplished with one procedure.

“TUNER,” “EFX PREV,” and “EFX NEXT” are added to the foot switch (page 96)

You can select tuner on/off and effect patch with the foot switch.

Track editing supports the measure number input method on time location input (page 69, 70, 72–74)

During editing, you can switch the display between time and measure.

Song optimize functions expanded (page 101)

Deleting the sound data, which was previously erased, exceeding certain length, opens up disk area and securing remaining disk storage capacity.

SCSI functions expanded (SCSI I/F is necessary)

Track import/export (page 208)

As a mean of managing track data within a song, Track Import/Export function enables you to Store/Read data on external SCSI disks. You can leave multiple takes on external disks in a fashion similar to V-tracks. During export, you can name the track which was selected.

Archive copy (page 206)

You can copy a song to a removable SCSI media with less disk capacity than the unit.

EZ routing expanded

Featuring quick recording (page 37)

New feature “Quick Recording Mode” enables you to create settings for a recording in a speedy manner. There are fewer input parameters and steps required to make a recording. Also, you can confirm the signal flow on the screen and overall recording operation is simplified.

Independent external input (page 46, 108)

Without using the Mix Down mode from the EZ Routing, External Input mode features independently operable External Input functions.

Using SELECT button or TRACK STATUS/V.TRACK button to select or input (page 37)

Use the buttons on the panel ([SELECT], [TRACK STATUS/V.TRACK]) to make settings for the EZ Routing parameter. Inspirational settings are now possible.

Disks that can be used by the VS-840EX (Zip disks)

The VS-840EX can use (record/playback) Zip disks. Zip disks are generally used as storage media for computer data. They can be purchased at computer shops, etc.

■ About the disk storage capacities

Zip disks come in two disk storage capacities, 100 MB and 250 MB. On the VS-840EX, 100 MB disks become playback only and can not be used for recording. In order to play back/record on the VS-840EX, you must use 250 MB disks.

	play back	record
100 MB	OK	NG
250 MB	OK	OK

■ Disk formatting

A disk that you newly purchased at a computer shop or a disk that has been used by a computer cannot be used by the VS-840EX as it is. This is because the disk format used by a computer is different than the format used by the VS-840EX. In order to use such disks on the VS-840EX, you must first format the disk. For details refer to "Initializing a disk" (page 28).

* *A Zip disk on which song data created on the VS-840EX was saved must not be inserted into any device other than the VS-840EX.*

Chapter 2. Front and rear panels

Mixer section

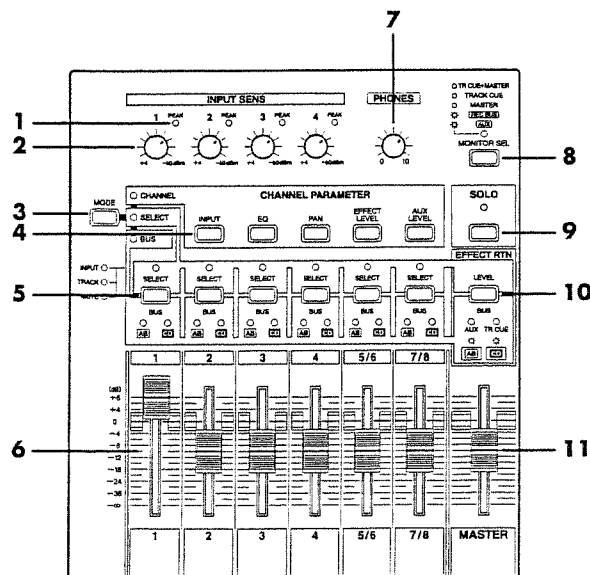

1. PEAK indicators

These indicators allow you to avoid distortion of the sound being input at the input jacks (1 to 4). The peak indicators will light red when the signal reaches -6 dB before clipping level. Adjust the input sensitivity so that the peak indicators do not light.

2. INPUT SENS (input sensitivity) knobs

These knobs adjust the sensitivity of the input jacks (1 to 4). Rotate a knob fully right for mic level (-50 dBm), and fully left for line level (+4 dBm).

3. MODE button

This selects the function of the [SELECT] buttons and the [EFFECT RTN] button. The indicator for the selected mode will light.

CHANNEL mode:

Select this mode when you wish to modify channel parameters. [SELECT] will function as channel select buttons. The [EFFECT RTN] button will access the setting page for effect return / balance.

SELECT mode:

Select this mode when you wish to change the channel inputs. [SELECT] will select channel inputs. The [EFFECT RTN] button will access the effect return / balance setting page.

BUS mode:

Select this when you wish to change the output destination REC bus (recording bus). [SELECT] will function as REC bus select buttons. [EFFECT RTN] will function as the REC bus / AUX bus / TRACK CUE bus select button.

4. CHANNEL PARAMETER buttons

[INPUT]:

Press this when you wish to change the input source (INPUT1,2,3,4) of each channel.

[EQ]:

Press this when you wish to make equalizer settings for each channel.

[PAN]:

Press this when you wish to set the pan (stereo output location) for each channel. For a stereo channel, this will be the left/right balance.

[EFFECT LEVEL]:

Press this when you wish to set the amount sent from each channel to the EFFECT bus (SEND LEVEL).

[AUX LEVEL]:

Press this when you wish to set the amount sent from each channel to the AUX bus (SEND LEVEL).

5. SELECT buttons

The function of these buttons will depend on the mode selected by the [MODE] button. When the [SOLO] button has been used to select the SOLO function, these buttons function as channel select buttons.

When [MODE] has selected CHANNEL mode

The SELECT buttons function as channel select buttons that allow you to modify channel parameter settings. The six [SELECT] buttons correspond to channels 1, 2, 3, 4, 5/6 and 7/8 respectively.

When [MODE] has selected SELECT mode

The SELECT buttons will select the input for each channel. The current status is indicated by the SELECT indicators located above the button.

INPUT (orange):

The input source assigned to each channel (INPUT 1,2,3,4) is selected.

TRACK (green):

The playback sound of the track corresponding to each channel is selected.

MUTE (dark):

Muted (no sound is being input).

When BUS mode is selected by [MODE]

The SELECT buttons will select the output destination REC bus (recording bus).

If you select REC bus A/B, the BUS AB indicator will light. If you select REC bus C/D, the BUS CD indicator will light. It is also possible to select both.

6. Channel faders

Use these faders to adjust the volume level of each channel.

However, fader 5/6 and fader 7/8 are stereo faders.

7. PHONES knob

This knob adjusts the volume of the headphones.

8. MONITOR SEL (monitor select) button

This button selects the signal that is output from the MON/AUX jacks. The selected signal is shown by the button indicator. To select the REC BUS or AUX, hold down [SHIFT] and press [MONITOR SEL].

TR CUE+MASTER (orange):

The signals of the TRACK CUE bus and the master out signal will be mixed and output.

TRACK CUE (green):

The TRACK CUE bus signal will be output.

MASTER (red):

The master out signal will be output.

REC BUS (blinking red):

The REC (recording) bus signal will be output.

AUX (blinking green):

The AUX bus signal will be output. Select this when you wish to use external effects.

9. SOLO button

Press this when you wish to use the Solo function to monitor only a specific channel. While the Solo function is operating, the button indicator will light red.

10. EFFECT RTN (effect return) button

The function of this button will depend on the mode selected by the [MODE] button.

When [MODE] has selected BUS mode

The button will select the bus to which the output of the internal effect will be connected.

When [MODE] has selected other than BUS mode

[EFFECT RTN] will access the Effect Return / Balance setting page.

11. Master fader

Use this fader to adjust the overall output level.

Recorder section

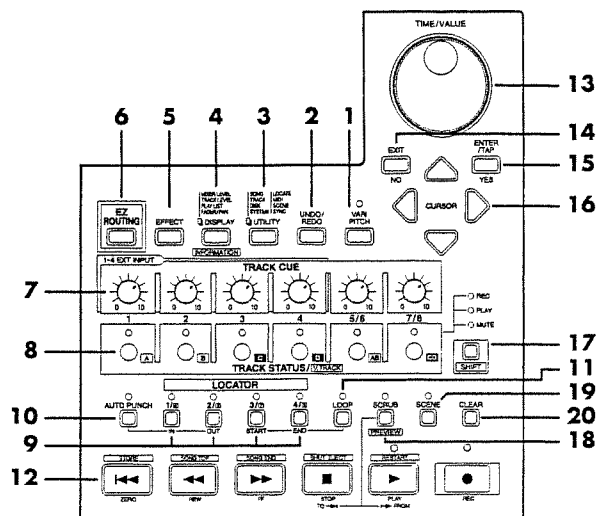

1. VARI PITCH button

Press this button when you wish to change the playback pitch.

2. UNDO/REDO button

Press this button when you wish to cancel a recording. Also, pressing this button after editing a song allows you to return to the un-edited state. Pressing it once again will return to the un-cancelled state.

3. UTILITY button

Press this button when you wish to manage song data, perform track editing, disk management, or modify system-related settings.

4. DISPLAY button

This button changes the display of the Play mode screen. When pages such as EZ ROUTING, EFFECT, or UTILITY etc. are displayed, pressing this button will return to the Play mode display.

5. EFFECT button

Press this button when you wish to change internal effect patching, connections, or parameters.

6. EZ ROUTING (Easy Routing) button

Press this button when you wish to use the Easy Routing function.

7. TRACK CUE knob

This adjusts the volume of each track when monitoring the track playback. The sound that is adjusted here is sent to the TRACK CUE bus, and is output from TRACK CUE if [MONITOR SEL] button has selected TRACK CUE, or from monitor out if TR CUE+MASTER has been selected. This adjustment has no effect on the recording level when tracks are being recorded.

8. TRACK STATUS/V.TRACK button

These select the tracks for recording/playback. The numeral above each button is the track number. The status of each track is indicated by the button indicator.

PLAY (green):

The sound that has been recorded in the track will playback. If nothing has been recorded in the track, it will not enter PLAY mode.

REC (red):

The track will be recorded. Up to 4 tracks can be recorded simultaneously. For example if you put tracks 5/6 and tracks 7/8 in REC mode, it will not be possible to select REC mode for tracks 1 to 4.

MUTE (dark):

The track will be muted (will not produce sound).

By using the [SHIFT] button in conjunction with these buttons, you can select V-tracks, or access the display pages which allow you to specify pan/balance settings when monitoring the track playback.

9. LOCATOR button

Press this button when you wish to use the Locate function. If the SCENE indicator is lit, this button can be used to register and recall scenes (mixer settings).

10. AUTO PUNCH button

Press this button when you wish to use the Auto Punch-in function. Locate button 1 will be the punch-in time, and locate button 2 will be the punch-out time. If these times have not been specified, the indicator will not light.

11. LOOP button

Press this button when you wish to use the Loop function. Locate point 3 will be the start time, and locate point 4 will be the end time. If these times have not been specified, the indicator will not light.

12. Transport control buttons

These buttons are used to operate the recorder.

[ZERO]:

Return the current time to "00:00:00:00:00" (zero return).

[REW]:

While the button is held down, the current time will be moved backward. This corresponds to the rewind button on a tape recorder.

[FF]:

While the button is held down, the current time will be moved forward. This corresponds to the fast-forward button on a tape recorder.

[STOP]:

Stop song recording/playback.

[PLAY]:

Start song recording/playback from the current time.

[REC]:

Press this button to record a song.

13. TIME/VALUE dial

Normally, this dial is used to change the current time. When the cursor is at a marker location, this dial will move between mark points. When you are modifying some type of setting, this dial is used to modify the setting (value).

14. EXIT button, NO button

Press this to return to the previous page or to cancel an operation.

15. ENTER/TAP button, YES button

Press this to finalize a selection or a value that you have input. If the cursor is at a marker location, this button is used to assign a mark point.

16. CURSOR button

These buttons move the cursor.

17. SHIFT button

This button is used in conjunction with other buttons to access additional functions of that button. For details refer to "Special key operations" (page 177).

18. SCRUB button

Press this button when you wish to use the Scrub/Preview function to playback a specific area in the vicinity of the current time location.

19. SCENE button

Press this button when you wish to memorize or recall scenes (snapshots of the mixer settings).

20. CLEAR button

This button clears a locator/scene setting. If the cursor is at a marker, pressing this button together with the [SHIFT] button will delete the mark point.

Display section

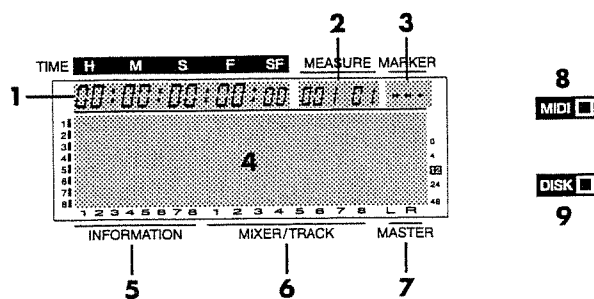

1. TIME

This shows the current time of the song.

2. MEASURE

This indicates the measure number and beat number of the current time location in the song. The number at left is the measure number, and the number at right is the beat number. If the current time location does not fall precisely on the beat, a “-” will be displayed at the right of the beat number.

3. MARKER

This shows the mark point number for the current time. If a mark point has not been assigned to the current time, the closest mark point number located before the current time will be shown.

If a time location earlier than mark point number “000” is specified, or if no mark point number has been registered, this will indicate “—”.

4. Display

Settings and other information in the various menu screens and parameter setting screens are graphically displayed here.

* For details on the contents of the display, refer to “Switching the screen (Display)” (p.119).

5. INFORMATION

In Play mode, V-track pages or song information pages will be displayed.

6. MIXER/TRACK

In Play mode, the volume levels of the mixer and tracks will be displayed graphically.

7. MASTER

In Play mode, the volume level of the sound after the master fader will be displayed graphically.

8. MIDI indicator

This will light when MIDI channel messages or exclusive messages are received.

9. DISK indicator

This will light when the disk is being accessed.

Rear panel

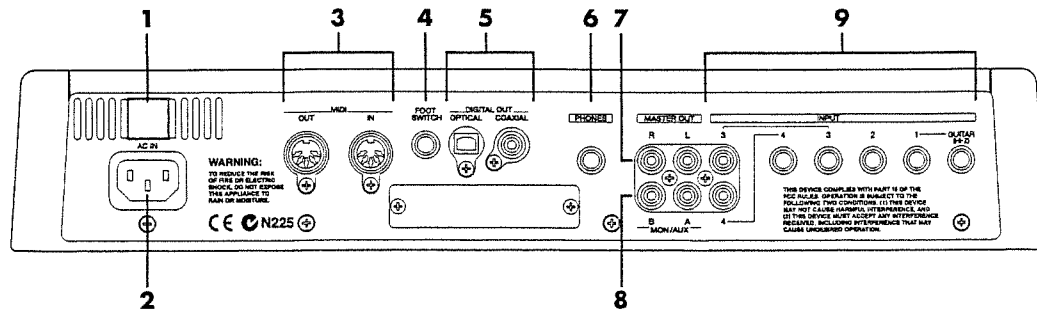

1. POWER switch

This switch turns the VS-840EX power on/off.

2. AC IN (AC inlet)

Connect the included power cable here.

3. MIDI connectors (IN, OUT)

External MIDI devices (MIDI controllers, MIDI sequencers, etc.) can be connected here.

IN:

This connector receives MIDI messages. Connect it to the MIDI OUT connector of the external MIDI device.

OUT:

MIDI messages are transmitted from this connector. Connect it to the MIDI IN connector of an external MIDI device.

4. FOOT SWITCH jack

An optional foot switch can be connected here to control recorder operations, mark point settings, and punch in/out operations etc. by foot switch. With the factory settings, a foot switch will start/stop the recorder. To change this function, refer to "Using a footswitch to playback/stop" (page 96).

5. DIGITAL OUT connector

Two types of connector are provided; COAXIAL type (compatible with S/P DIF and EIAJ CP-1201) and OPTICAL type. These jacks output digital audio signals (stereo). Both output the same sound as the MASTER OUT jacks.

* The DIGITAL connector is not able to input or output analog audio signals.

6. PHONES jack

Separately sold headphones (PH-120 etc.) can be connected here. The PHONES jack will output the same sound as the MASTER OUT jacks if [MONITOR SEL] is selecting AUX, and will output the same sound as the MON/AUX jacks if the selection is other than AUX.

7. MASTER OUT jacks (L, R)

These are output jacks for analog audio signals (RCA phono type).

8. MON/AUX (monitor/AUX) jack (A, B)

These are output jacks (RCA phono type) for analog audio signals. By pressing [MONITOR SEL] you can switch the monitor output. By setting [MONITOR SEL] to AUX, you can also use these as send jacks for when you wish to connect external effects.

9. INPUT jacks (1 to 4)

In addition to standard phone plug inputs, INPUT 1 is a high impedance input jack to which a guitar can be connected directly, and INPUT 3/4 provides RCA phono jacks. You can select and use either of these. If both types of jack are connected for INPUT 1 and INPUT 3/4, the input of the phone jacks will take priority. The input sensitivity can be adjusted by the INPUT SENS knobs.

Disk Drive

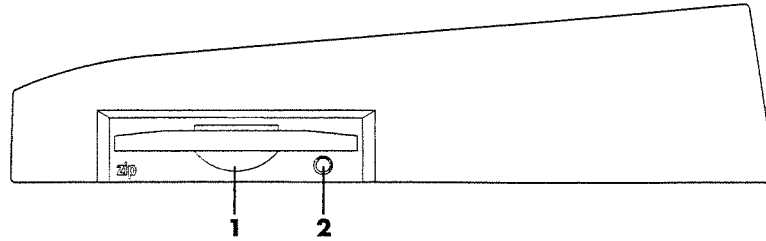

1. Zip disk drive

A Zip disk can be inserted here for saving or reading song data.

* Automatic sleep mode

When data reading or writing operations have not occurred for a specific interval of time on the Zip drive, it will automatically reduce the disk rotation speed to reduce power consumption and extend the life of the disk. This is referred to as automatic sleep mode.

When a Zip drive is used with the VS-840EX, if a 30 minute interval elapses without data being written to or read from the Zip drive, the rotation speed of the disk will automatically be reduced. If you begin recording in this state, the first part of the recording may not be recorded correctly, since a certain interval of time is required for the disk to return to its normal rotational speed. In order to avoid such problems, press [STOP] before you begin recording. When you press [STOP] the disk will return to its normal rotational speed.

2. Eject button /

Zip disk drive access indicator LED

Press this when you wish to remove the Zip disk from the Zip disk drive. A Zip disk cannot be removed unless the power is turned on.

While the Zip disk drive is operating this will light green.

* *If it becomes necessary to remove the disk after the power has been turned off, you must turn the power on again and press the eject button to remove the disk. If you attempt to take the disk out by force, the disk drive may be damaged.*

Chapter 3. Before you start (VS-840EX terminology)

This chapter explains basic concepts, internal structure, and basic operation that you will need to know in order to operate the VS-840EX. Please read this chapter to gain a better understanding of the VS-840EX.

Sources, tracks, and channels

On the VS-840EX, the recorder section and mixer section use the terms "sources," "tracks," and "channels." These terms may appear similar to each other, and will be confusing unless their differences are clarified.

Source:

A signal which is input to the mixer section or recorded in the recorder section. On the VS-840EX, this term refers in particular to the signals of the analog input jacks.

Track:

This is a term used to describe groups of signals that are input/output by the recorder section. The recorder section consists of 8 tracks. Tracks 1 to 4 are monaural, and tracks 5/6, 7/8 are stereo. The term "track" is also used to indicate a place within a song where audio data is recorded. Up to 64 tracks can be recorded in each song.

Channel:

This is a term used to distinguish signals that are input/output by the mixer section. The mixer section consists of 8 channels. Channels 1 to 4 are monaural, and channels 5/6, 7/8 are stereo.

Doing everything in the digital domain (Digital Studio Workstation)

The VS-840EX is a multi-track digital disk recorder that combines a digital disk recorder and a digital mixer in a single unit. The VS-840EX provides the same basic functionality expected of conventional analog tape recorders, such as "simultaneous recording of multiple tracks" and "synchronization with MIDI devices." In addition, it has features that are possible only with digital recording, such as "data transfer that minimizes deterioration of sound quality" and "undo-able editing," providing a high level of convenience in music production. In addition, an effect unit is built in, allowing you to use a high-quality stereo effect. In addition to the full set of effects such as reverb and chorus that are already provided, the effects now include limiter, enhancer, and a preamp simulator/a speaker simulator that utilizes the COSM technology made famous by the Roland V-Guitar System VG-8. This means that the entire range of studio procedures from recording to overdubbing and mixdown can now be performed with just the VS-840EX alone.

Signal flow (buses)

On the VS-840EX, signals flow through buses. Buses are “shared lines through which multiple signals can be routed efficiently to multiple tracks/channels.” It may be easier to understand this if we use the analogy of water pipe.

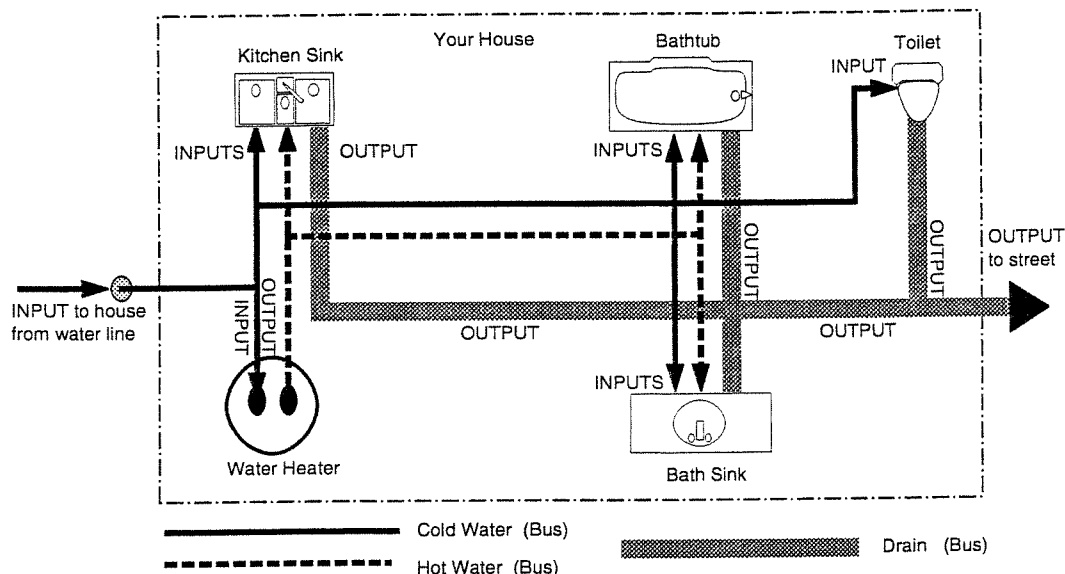

For example, the water that is supplied by the water company to your house is branched to a variety of locations within the house (kitchen, bathroom, toilet etc.). Then, the water that is used at each of these locations is collected into the sewer, and carried away.

If we think of the VS-840EX as the house, the water being supplied from the water company corresponds to inputs such as mic or guitar. Some of these inputs are sent to recording tracks and are recorded. Other portions are sent to the effects, and reverb or chorus are applied before they are output.

Similarly to the way in which water flows through a system of pipes, the VS-840EX has five routes of signal flow, called "buses": Effect, AUX, Recording, MIX and Track Cue. The VS-840EX allows you to adjust the amount of water (signal) that flows through each pipe (bus).

The VS-840EX has the following buses.

Effect bus

This is a path used to send signals to the effect unit so that effects can be applied. For each channel of the channel mixer, you can adjust the amount that is sent to this bus (Effect Send Level).

AUX buses

These are paths used to send signals to the AUX SEND jack for supplemental monitoring. There are two buses (AUX A and AUX B). For each channel of the channel mixer, you can adjust the amount that is sent to this bus (AUX send levels A/B).

Recording bus

This is a path used to send signals from the channel mixer to be recorded. For each channel of the channel mixer, you can use the faders to adjust the amount of signal that is sent to the bus.

MIX buses

These are paths used to send signals to the MASTER jack for monitoring. There are two MIX buses (L and R). For each channel of the channel mixer you can adjust the output, and you can also adjust the output (return) from the effect. The output of the channel mixer is controlled by the fader levels of each channel.

Track cue buses

These are paths used to send signals to the MONITOR (MON/AUX) jacks for monitoring. There are two buses (L, R), and you can set the amount of output from each track of the recorder and the amount of the output (return) from the effects. The output of each track is controlled by the TRACK CUE knobs.

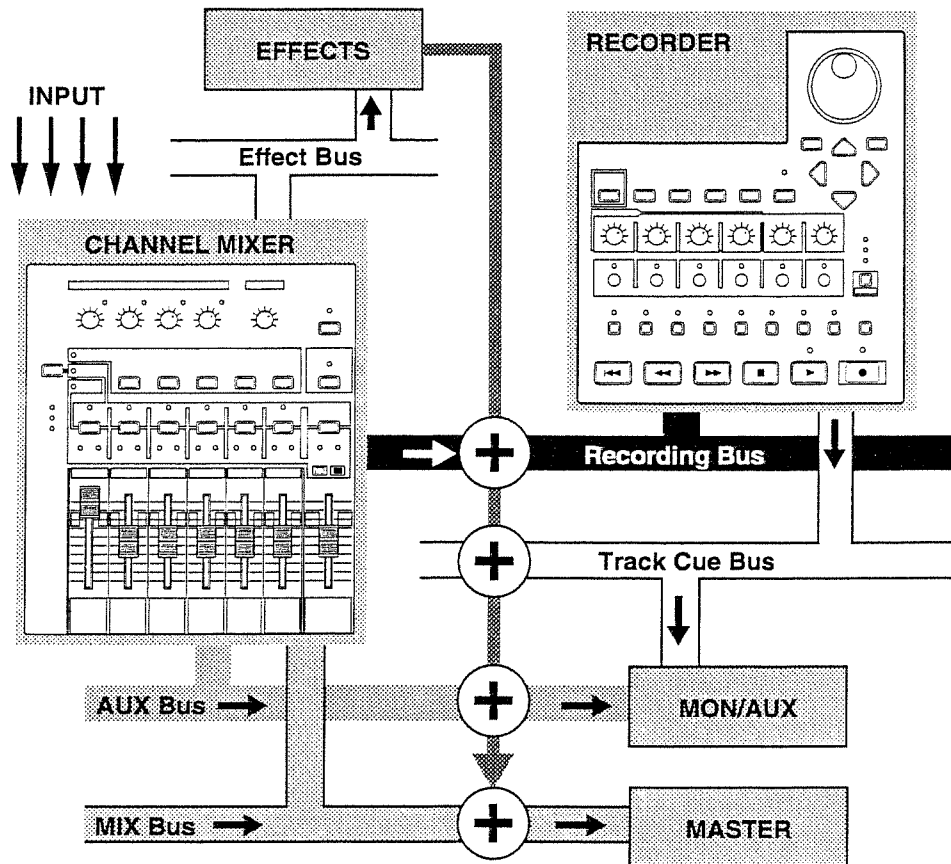

About songs

You can use the VS-840EX to record your performance on multiple tracks, and these tracks are collectively referred to as a "song." Up to 64 tracks can be recorded for each song. Up to 200 songs can be created on each disk.

Song data includes the following data.

- Playback data of all V-tracks
- MIDI clocks of the sync track
- Points specified for the song (marker points, locate points, loop points, auto punch-in/punch-out points)
- Scene memory (mixer settings)
- Vari-pitch settings
- System settings (system, MIDI, disk, sync, scene)
- Effect settings

Mixer section

■ How the mixer is organized

You can make settings in the digital mixer to specify the input/output state of the recorder section.

For external input, jacks are provided for inputting four analog audio signals. Each INPUT 1 to 4 provides an INPUT SENS knob and a PEAK indicator.

For external output, there are MASTER OUT jacks (stereo) and two MON/AUX jacks. Coaxial-type and optical-type DIGITAL OUT connectors are also provided, and these will output the same sound as the MASTER OUT jacks. You can freely specify which external input will be recorded on which track, and output from which output jack.

The following diagram shows how the mixer and recorder sections are related. For details refer to the "Block diagram" (page 187).

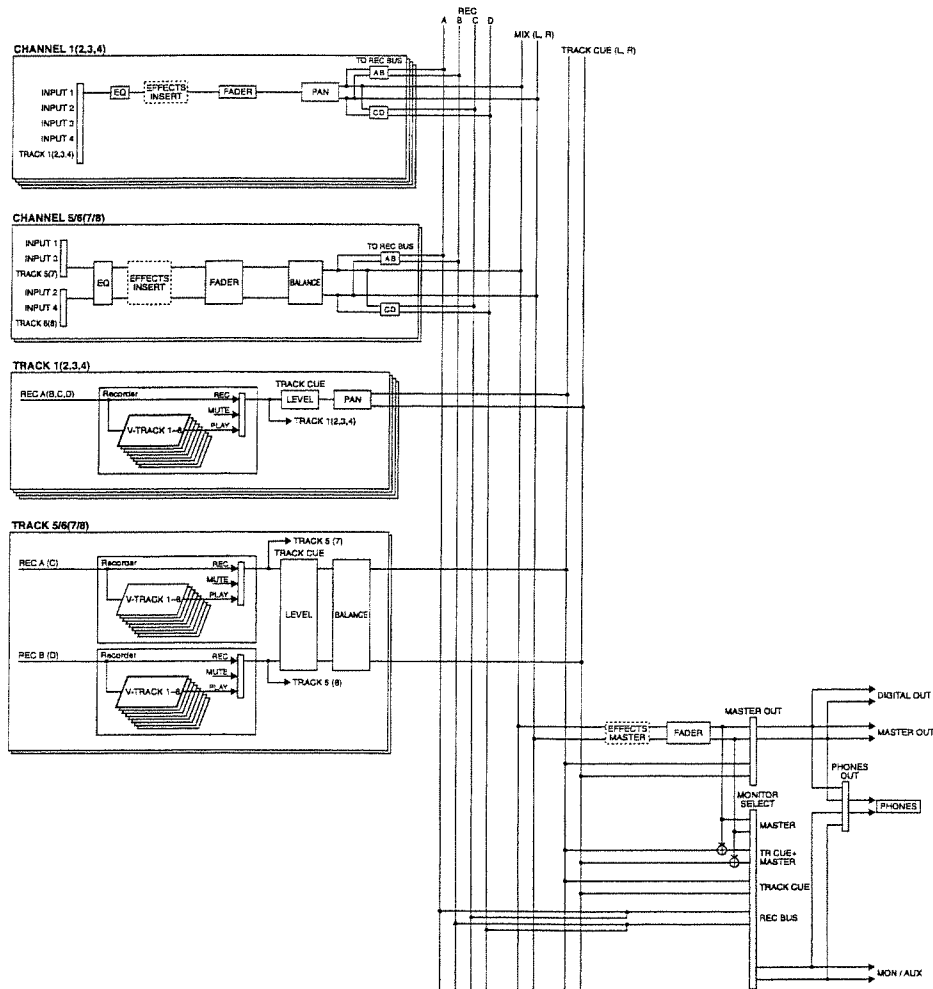

Input

Channels 1 to 4 are monaural channels, and channels 5/6 and 7/8 are stereo channels. As the input to each channel, you can specify either an INPUT jack or the playback sound from a track. The [SELECT] buttons and [INPUT] buttons of the mixer section allow you to easily specify which signal will be input to which channel.

Equalizer

For each channel, the equalizer functions as a 3-band parametric equalizer with high (shelving type), middle (peaking type), and low (shelving type) bands. This can be turned off if you do not wish to use it.

Output

The output of each channel is sent to REC buses A to D, and recorded on TRACK 1 to 8 of the recorder. Unless signals are sent to a REC bus, they cannot be recorded on the corresponding track. The [SELECT] buttons of the mixer section and the TRACK STATUS/V.TRACK buttons of the recorder section allow you to easily specify the REC bus to which each signal will be sent, and the track on which it will be recorded. Also, the output of each channel is connected to the MIX bus, and with the factory settings, will be output from the MASTER OUT jacks.

■ Recording the current condition of the mixer (Scene)

Up to 8 sets of mixer settings can be stored for each song. A stored set of mixer settings is called a "scene," and can be recalled at the touch of a button. For example if during mixdown you wish to compare different mixing balances, you can store each different mixer setting as a scene.

Recorder section

■ Differences with a tape-type MTR

Unlike DAT recorders, which use tape, digital disk recorders record sound (music) on a disk, as do MD recorders. Music that is recorded on disk can be recalled and played back immediately, no matter where it is located on the disk. This is also obvious from the difference in speed at which you can move to the beginning of a song on a DAT recorder and on an MD recorder. The ability to freely move to data regardless of the time or sequence at which it was recorded is known as "random access." In contrast, having to move to data in the order of the time or sequence at which it was recorded is known as "sequential access."

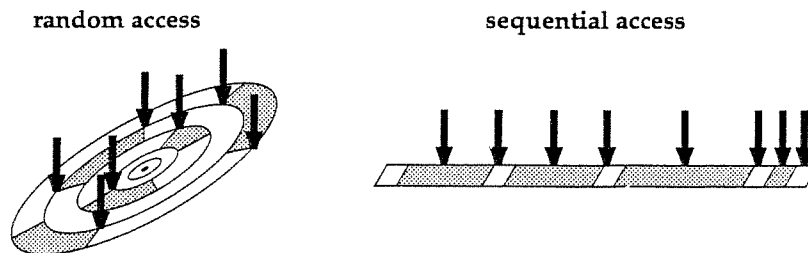

■ Number of tracks that can be recorded/played simultaneously

The recorder section of the VS-840EX has eight tracks for recording/playing back a performance.

Of these, four tracks can be recorded simultaneously.

■ Virtual tracks provided for each track (V-tracks)

Each track consists of eight virtual tracks, and you can select one of these as the object for recording or playback. I.e., you can record a performance on $8 \times 8 = 64$ tracks, and select 8 of these for playback. The virtual tracks that make up each track are referred to as V-tracks.

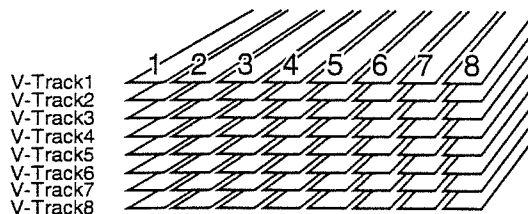

* You may find it useful to copy the blank virtual track sheet from the appendix of this Owner's Manual to keep track of your virtual track recordings.

Effects section

■ Effect connections (Insert/Loop)

On the VS-840EX, there are two ways to connect an effect. One is to insert it between the equalizer and fader of a channel, or to insert it before the master fader (Insert). The other is to use the EFFECT bus (Loop). When using an effect such as distortion or overdrive which modifies the original sound itself, insert the effect between the equalizer and fader. When using an effect such as reverb or delay which adds effect sound to the direct sound, use the EFFECT bus to make connections.

* *A single effect unit is built-in. Therefore, it is not possible to use different effects on each track at one time.*

Event

What is an event?

The smallest unit of memory used by the VS-840EX to store recorded results on disk is the event. A newly created song provides approximately 1,400 events per song.

For each track, one recording pass uses two events. Operations such as punch-in/out or track copy also use up events. The number of events that are used up will fluctuate in a complex way.

Even if there is capacity remaining on the disk, further recording or track editing will not be possible if all of the events are used up. In such cases, an error message such as "Event Mem Full" will appear.

■ "Lack of EVENT!!" Display

When the number of events is less than 200, Undo or Redo command can not be executed and "Lack of EVENT!!" will be displayed. If you are performing numerous recording sessions or repeatedly editing using functions such as Track Copy/Track Move, use the following procedures and monitor the remaining number of Events.

1. Press [UTILITY].
2. Use [CURSOR] to select system icon, then press [ENTER/TAP].
3. Use [CURSOR] to select Play/Rec parameter icon, then press [ENTER/TAP].
4. Use [CURSOR] to select "INFO type" parameter.
5. Use dial and set "INFO type" to "Event."
6. Press [DISPLAY] to return to Play mode.

Remaining number of Events can be saved with the following procedures. Please try the most appropriate one with your situation.

Execute Song Store

Please Execute Song Store if in UNDO condition ([REDO] icon is displayed.). Events served for REDO will be released. But please note that you cannot cancel (REDO) the last UNDO if you once execute STORE.

Execute Song Optimize

Please execute Song Optimize if you have done a lot of Punch In recording. Events served for unnecessary audio data will be released. But please note that you can only do single level UNDO.

Chapter 4. Basic operation of the VS-840EX

This chapter explains basic operation of the VS-840EX.

Before you begin

■ Turning on the power

- * To prevent malfunction and/or damage to disk drive, speakers or other devices, always turn down the volume, and turn off the power on all devices before making any connections.
- * Once the connections have been completed, turn on power to your various devices in the order specified. By turning on devices in the wrong order, you risk causing malfunction and/or damage to disk drive, speakers and other devices.
- * This unit is equipped with a protection circuit. A brief interval (a few seconds) after power up is required before the unit will operate normally.

1. Turn on the VS-840EX power.

When the power is turned on, the disk drive will be detected, and the data necessary for operation will be read. This means that a certain interval of time will elapse before operation will begin.

When the VS-840EX starts up successfully, the display will indicate "[Pst]MIXER." This display page shows the levels immediately following each channel fader.

2. Turn on the power of your audio devices, and raise the volume of the audio devices to appropriate levels.

■ Inserting the disk

- * Before using a brand new disk, or a disk that was previously used for a computer, first read "Initializing a disk" (page 28) before initializing the disk.

Insert the disk into the disk drive located on the side of the unit. When a disk is inserted, the VS-840EX will first check to see whether that disk is one which the VS-840EX is able to use. If the VS-840EX is able to use the disk, it will read the necessary data from disk and enter Play mode (the normal screen display).

If the disk cannot be used by the VS-840EX (e.g., a disk which has not been initialized by the VS-840EX) the following display will appear.



This display indicates that the inserted disk is not in a state which can be used by the VS-840EX, and asks whether you wish to initialize (format) the disk now. Use the following procedure.

- * If you insert a Zip disk that has been used by the VS-880, the display will ask "VS-880's DISK! DISK Convert?" Refer to "Exchanging data between the VS-840EX and VS-880" (page 104), and follow the instructions that appear in the screen.

If you select "NO," the display will indicate "VS-880's DISK! Initialize OK?" If you wish to initialize the disk for use with the VS-840EX, press [YES] to execute initialization.

1. If you wish to initialize the disk, press [YES]. If you do not wish to initialize the disk, press [NO]. If you press [NO], the inserted disk will be ejected.
2. If you press [YES] in step 1, you will be asked again "Are you sure ?" If you wish to initialize, press [YES]. If you press [NO], the Initialize operation will be halted, and the inserted disk will be ejected.

- * When a disk is initialized, all data on that disk will be lost. Before initializing a disk, make sure that it does not contain any data you wish to keep.

■ Initializing a disk (Disk Initialize)

Before a disk that you purchase at a computer shop or a disk which had been used by a different device (such as a computer) can be used by the VS-840EX, the disk must be initialized. This is because the format of the disk is different depending on whether it is used by a computer or used by the VS-840EX. Please be aware that when you execute the Disk Initialize operation, all contents of the disk will be lost. To initialize a disk, use the following procedure.

* Do not initialize the disk which is included with the VS-840EX, since this would erase important data such as demo songs.

1. Press [UTILITY].
2. Use [CURSOR] to select the Disk Utility icon, and press [ENTER/TAP].



3. Use [CURSOR] to select the Disk Initialize icon, and press [ENTER/TAP].



4. The display will indicate "Physical Format," so use the TIME/VALUE dial to specify whether or not you wish to use physical formatting.

Turn this "On" for a disk which produced a display of "Medium Error" when inserted into the VS-840EX, or a disk for which "Write Protected" was displayed and did not allow you to write data. For other cases, turn this "Off."

5. Press [CURSOR ▾] to move the cursor to the "GO" icon, and press [ENTER/TAP].
6. A message will ask "Are you sure ?" so press [YES] to execute. When initialization is completed successfully, you will return to Play mode.
If you press [NO], the Initialize operation will be canceled.

* If you initialize with the "Physical Format" setting "On," a certain length of time will be required for the operation. This is not a malfunction. The progress of initialization will be shown in the display, so be sure not to turn the power off until initialization is complete.

Listening to the demo song

The disk included with the VS-840EX contains pre-recorded demo songs. First let's listen to the demo songs.

* Use of the song data supplied with this product for any purpose other than private, personal enjoyment without the permission of the copyright holder is prohibited by law. Additionally, this data must not be copied, nor used in a secondary copyrighted work without the permission of the copyright holder.

1. Move all channel faders to the 0 dB position, and pull down the master fader.
2. Press [PLAY] to begin playback of the song.
3. Gradually raise the master fader to adjust the volume.
The current time will be displayed in the TIME field, and the display will indicate the level changes of each channel (level meter).
4. When playback ends, press [STOP] to stop.

■ Listening to the variations of the demo song

The demo song contains various Scenes (page 34). Each scene contains settings for different V-tracks, mixer settings, and effect settings. In a manner of speaking, these are variations of the demo song. Switch scenes and compare the playback.

1. Make sure that the song is stopped. If it is playing, press [STOP].
2. Press [SCENE].
The Scene indicator will light.
3. Press the LOCATOR button for the desired scene number. For example if you wish to recall scene 2, press [2/6OUT].
4. Press [PLAY].
The song will playback.
5. Press [STOP].
6. Repeat steps 3 to 5 to compare the variations of the song.

Before you finish operations

■ Saving the performance to disk (Song Store)

Song data that you recorded or edited will be lost if you simply turn the power off.

This means that before turning off the power, you must be sure to perform the Shutdown procedure so that song data will be safely saved to disk. A message will also ask you whether or not you wish to save the song when you switch songs or remove the disk.

If you wish to save the currently selected song data to a disk separately from these operations, use the following procedure.

* *It is not possible to recover lost song data. When handling important song data, or when using the VS-840EX for an extended session, we recommend that you save song data frequently.*

1. Hold down [SHIFT] and press [STORE (ZERO)].
2. A message will ask "STORE OK?" If you wish to store the song data, press [YES].
When the song has been saved, the VS-840EX will return to its previous condition.

■ To protect a song (Song Protect)

Even if you have stored your performance to disk, it is still possible that the performance can be lost by being accidentally recorded over or deleted. To prevent such accidents, you can protect the performance from accidental erasure (Song Protect).

Protecting a performance

1. Press [UTILITY].
2. Use [CURSOR] to select the Song Edit icon, and press [ENTER/TAP].



3. Use [CURSOR] to select the Song Protect icon, and press [ENTER/TAP].



4. The display will indicate "SONG Protect ?" Use [CURSOR] to select the "ON" icon and press [ENTER/TAP].
If you select the "OFF" icon, the song will not be protected.

5. The display will indicate "STORE Current?" If you wish to store the current song and then protect it, press [YES].

If you do not wish to store the current song, but prefer to protect the song in the condition in which it was when Song Store was last executed, press [NO].

6. The song will be protected.
The display will indicate "SONG Complete" and you will return to Play mode.

Removing protection from a performance

1. Follow steps 1 to 3 of "Protecting a song."
2. When the display indicates "SONG Protect ?," use [CURSOR] to select the "OFF" icon and press [ENTER/TAP].
If you select the "ON" icon, the song will remain protected.
3. Protect will be turned off for the song.
The display will indicate "SONG Complete" and you will return to Play mode.

< Song Protect >

This function corresponds to the write protect switch of a floppy disk or magneto-optical disk. This means that even if the protect switch is on, it will be possible to perform that shown as below.

- Track Edit
- Locate Point
- Mark Point
- Scene

However if you attempt to save the results, the display will indicate "SONG Protected."

* *When song protect is turned on, The display in Play mode will indicate song protect symbol.*

■ Turning the power off (Shut Down)

The recorded performance will be lost if you turn the power off now. For this reason, you must perform the Shutdown operation before turning off the power, so that song data is safely saved to disk. When the Shutdown process is completed, the disk will be ejected. When you wish to turn off the power, use the following procedure.

* *If there is unsaved song data when you perform the Shutdown procedure, a message will ask whether you wish to save the song data. It is not possible to remove the disk when the power is turned off. Be sure to perform the Shutdown operation and remove the disk before turning off the power.*

1. While holding down [SHIFT], press [SHUT/EJECT (STOP)].

The line of the display will indicate "SHUT/EJECT ?."

2. Press [CURSOR] to select the "SHUT" icon, and press [ENTER/TAP] (to cancel, press [EXIT] located at the left).

The display will indicate "STORE Current ?"

- * If you select the "EJECT" icon, the result will be the same as if you had pressed the Eject button located on the side of the unit.

3. If you wish to save the current song, press [YES]. If you do not wish to save it, press [NO]. If you have selected the demo song, press [NO].

When Shutdown is complete, the display will indicate "Power OFF/RESTART," and the disk will be ejected.

4. Turn off the VS-840EX power.

- * If you turn off the power without ejecting the disk and subsequently need to remove that disk, you must turn on the power again and press the Eject button to remove the disk. If you attempt to remove the disk by force, the disk drive may be damaged.

If the display asks "STORE Current ?"

When you execute an operation such as creating a new song, selecting a different song, or song copy on the VS-840EX, a confirmation message of "STORE Current ?" will appear. This is asking you whether you wish to store the currently selected song to the disk.

If you wish to store the currently selected song and then execute the operation, press [YES]. If you wish to execute the operation without saving the current song, press [NO].

If the Song Protect setting of the song is ON, pressing [YES] will cause a message of "Song Protected" to be displayed briefly. Then, without executing the operation, the VS-840EX will return to the status it was in before execution was attempted. Song Protect is a setting which can be made for each song, to prevent accidental rewriting of a song stored on the disk.

If you wish to execute the operation without saving the currently selected song, repeat the procedure once again, and press [NO] in reply to the "STORE Current?" message. If you wish to save the currently selected song and then execute the operation, turn Song Protect OFF (page 29).

Re-starting the VS-840EX

To restart the VS-840EX without turning off the power, use the following procedure.

1. Execute the shut-down procedure.
2. The display will indicate "Power OFF/RESTART," so hold down [SHIFT] and press [RESTART (PLAY)].

Basic operations in the display screen

Selecting the operating menu

When you press [EZ ROUTING] or [UTILITY], the Menu page will appear, and menu icons will be displayed. Use [CURSOR] to select from the menu, and press [ENTER/TAP]. If there are five or more menu icons, you can press [CURSOR] to move to the next/previous page. In the right side of the screen there is an indication of the current page.

Selecting parameters

Use [CURSOR] to select a parameter. The selected parameter will be highlighted. If the parameters extend across two or more pages, the right side of the screen will indicate the current page.

Modifying the value of settings

When the parameter that you wish to modify is reversed, use the TIME/VALUE dial to modify the value. Rotating the dial to the left will decrease the value, and rotating it to the right will increase the value. If you rotate the TIME/VALUE dial while holding down [SHIFT], the value will increase or decrease at ten times the normal rate.

Executing an operation

In operations such as changing songs or copying tracks, a confirmation message with "?" will appear. In this case, press [YES] to execute the operation, or press [NO] to stop the operation. For some operations, a confirmation message may be displayed twice.

A second confirmation message will appear for operations which cannot be undone using the Undo function (page 100).

Selecting a song (Song Select)

Here's how to select another song that was saved on disk.

1. Press [UTILITY].
2. Use [CURSOR] to select the Song Edit icon, and press [ENTER/TAP].

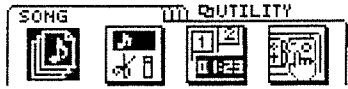

3. Use [CURSOR] to select the Song Select icon, and press [ENTER/TAP].



4. A list of the song names that are saved on disk will be displayed. Select the desired song and press [ENTER/TAP].

An asterisk "*" will be displayed at the beginning of the currently selected song (the Current Song). The song protect symbol (🔒) will be displayed at the right of song names which have been protected. If you press [EXIT] you will return to the Song Edit icon display.



5. Open the Song Select confirmation window, and you will be asked "Select SONG Sure ?" If you have selected the desired song, press [YES]. If you press [NO] you will return to the Song Select page.
6. If the selected song is the same as the current song, the Reload Confirm window will appear. If not, the Store Confirm window will appear.

If the Reload Confirm window appeared (the display indicates "Re-Load Current ?")

To reload the current song, press [YES]. If you press [NO], you will return to the Song Select page.

If the Store Confirm window appeared (the display indicates "STORE Current ?")

If you wish to save the current song and then load the selected song, press [YES]. If you wish to load the selected song without saving the current song, press [NO].

Changing the current time

About the current time display

The current time shown in the display is MTC (MIDI Time Code), and is shown in the format "** hours ** minutes ** seconds ** frames ** sub frames."

The type of time code that is used differs between devices. If you use MTC to synchronize the VS-840EX with another device, you will have to set both devices to the same type of time code. With the factory settings, the VS-840EX is set to 30 frames (non-drop) per second (page 112).

Moving to the beginning of the performance (Song Top)

To move to the earliest location in the song that contains recorded sound, use the following procedure.

1. Hold down [SHIFT] and press [SONG TOP (REW)].

The V-track selected for each track will be checked, and you will move to the location that contains the first sound recorded in the song.

Moving to the end of the performance (Song End)

To move to the last location in the song that contains recorded sound, use the following procedure.

1. Hold down [SHIFT] and press [SONG END (FF)].

The V-track selected for each track will be checked, and you will move to the location that contains the last sound recorded in the song.

In hours/minutes/seconds/frames/subframes

The TIME field of the display shows the current time location in hours/minutes/seconds/frames/subframes.

1. Select the value that you wish to change.

Use [CURSOR] to select the number in TIME (H/M/S/F/SF) that you wish to change. The selected number will blink.

2. Change the value.

Use the TIME/VALUE dial to change the time. If you rotate the TIME/VALUE dial without any number blinking, TIME(F) (frames) will change.

Moving in measure/beat units

The MEASURE field of the display will indicate the measure number and beat number of the current location. With the factory settings, a value calculated from a tempo of 120 (quarter notes per minute) and a 4/4 time signature will be displayed.

For details on setting the measure and beat, and how they correspond to the song, refer to "Sounding the metronome" (page 95).

1. **Select the value that you wish to change.**
To move in steps of a measure, use [CURSOR] to make the number at the left of the MEASURE field blink. To move in steps of a beat, make the number at the right of the MEASURE field blink.
2. **Change the value.**
Use the TIME/VALUE dial to select the measure number or beat number to which you want to move.

Using mark point numbers

The MARKER field of the display indicates the Mark Point number of the current location. If no mark points are registered, this will indicate "----".

Use [CURSOR] to make the number in the MARKER field blink, and use the TIME/VALUE dial to select the mark point number to which you wish to move.

Changing the input of a channel

The input status of each channel is shown by the SELECT indicator of the corresponding channel.

Procedure for changing the channel input

1. Press [MODE] to enter SELECT mode. The SELECT mode indicator will light.
The [SELECT] buttons will function as channel input select buttons.
2. To switch the channel input, press the [SELECT] button for the channel whose input you wish to change.

INPUT (orange):

The input source (INPUT 1,2,3,4) assigned to each channel is selected.

TRACK (green):

The playback sound of the track corresponding to each channel is selected.

MUTE (dark):

Muted (no sound is input).

Switching the input source (INPUT 1,2,3,4)

For each channel, you can specify the INPUT jack whose signal will be input. This is valid only for channels for which INPUT is selected as the channel input.

1. Select [CHANNEL] mode. Press [MODE] to make the CHANNEL mode indicator light.
2. Press the CHANNEL PARAMETER button [INPUT] to access the input source select page.

3. Use [CURSOR ◀ ▶] or the [SELECT] button for each channel to select the channel whose input source you wish to change.
4. Use the TIME/VALUE dial to select the input source (INPUT 1,2,3,4). For channels 5/6, 7/8, select either INPUT 1/2 or 3/4.
5. If you wish to make settings for other channels, repeat steps 3 to 4.
6. Press [DISPLAY] to return to Play mode.

Switching the recording bus

In order to record on a track, the signal from the channel that you wish to record must be output to one of the recording buses. There are four recording buses A to D, and A/B and C/D are paired respectively. Use the following procedure to switch the setting.

1. Press [MODE] to select BUS mode. The BUS mode indicator will light.
2. Press the [SELECT] button for the channel whose recording bus you wish to change, and select the bus. The signal of that channel will be output to the bus whose indicator is lit.

Setting the channel pan

To set the channel pan (or balance, for a stereo channel), use the following procedure.

1. Select [CHANNEL] mode. Press [MODE] to make the CHANNEL mode indicator light.
2. Press the CHANNEL PARAMETER button [PAN] to access the Pan setting page.
3. Use [CURSOR ◀ ▶] or the [SELECT] buttons for each channel to select the channel whose pan you wish to adjust.
4. Use the TIME/VALUE dial to adjust the pan (or balance, for a stereo channel).
5. If you wish to make settings for another channel, repeat steps 3 to 4.
6. Press [DISPLAY] to return to Play mode.

* If the signal from a channel is being output to recording bus A/B and C/D, set the channel pan full left (L63) to send the signal to recording bus A and C, or set the channel pan full right (R63) to send the signal to recording bus B and D.

Monitoring the track playback

You can monitor the playback of each track without routing the signal through a mixer channel. For tracks which are being recorded, you can also listen to the sound that is being recorded.

1. Press [MONITOR SEL] to select TRACK CUE (indicator lit green).
You will be able to monitor the TRACK CUE bus in the headphones or the MON/AUX jacks.
2. For tracks which you do not wish to monitor, press [TRACK STATUS/V.TRACK] to set the track status to PLAY (TRACK STATUS indicator lit green).
* In this case, if you set the track status to REC (TRACK STATUS indicator blinking red), you can monitor the sound that is being recorded on that track.
3. Press [PLAY] to playback the song.
4. Use the TRACK CUE knob of the track you wish to monitor to adjust the volume level of the monitor sound.
5. If you wish to adjust the pan of a track which you are monitoring, first hold down [SHIFT] and press [TRACK STATUS/V.TRACK] of the track which you are monitoring. The V-track setting page will appear. Then press [CURSOR ▽] to access the TRACK CUE pan setting page, and use the TIME/VALUE dial to adjust the pan.
6. When you finish adjusting the pan, press [DISPLAY] to return to Play mode.

Changing the track status (Track Status)

To change the track status of each track, press the TRACK STATUS/V.TRACK button. The status is shown by the button indicator.

PLAY (green):

The sound that was recorded in the track will playback. If nothing has been recorded, it will not be possible to select PLAY condition.

REC (red):

Record to the track. Up to 4 tracks can be recorded simultaneously. For example if you set tracks 5/6 and tracks 7/8 to REC condition, it will not be possible to select REC condition for the remaining tracks 1 to 4.

MUTE (dark):

Muted (no sound is output).

Recording standby (blinking red):

Recording standby mode.

Playback mode for punch-in (alternately blinking red/green):

Playback mode during punch-in/out.

Switching the monitor output (Monitor Select)

To switch the signal that is output to the MON/AUX jacks, press [MONITOR SEL]. To select the REC BUS or AUX, hold down [SHIFT] and press [MONITOR SEL]. The selected signal is shown by the button indicator.

TR CUE+MASTER (orange):

The TRACK CUE bus and master out will be combined and output.

TRACK CUE (green):

The signal of the TRACK CUE bus will be output.

MASTER (red):

The signal of the master output will be output.

REC BUS (blinking red):

The signal of the REC bus (recording bus) will be output.

AUX (blinking green):

The signal of the AUX bus will be output. Select this when you wish to use an external effect device.

- * With the factory settings, the same signal will be output from the PHONES jack and from the MON/AUX jacks. If you wish to use an external effects device, you will use Monitor Select to choose AUX. However even in this case, there will be times when you wish to use headphones to monitor the TRACK CUE bus or the master out. In such situations, refer to "Switching the source for output to the PHONES jack" (page 99).

Registering the current mixer settings (Scene)

Up to 8 sets of mixer settings can be stored for each song. A stored set of mixer settings is called a “scene,” and can be recalled at the touch of a button. For example if during mixdown you wish to compare different mixing balances, you can store each different mixer setting as a scene.

Here's how to register the current settings of the mixer.

1. Press [SCENE] to make the button indicator light.
When the SCENE indicator is lit, the LOCATOR buttons [1/5] to [4/8] can be used to register and recall scenes.
2. Store the current mixer settings as a scene.
To store the settings to a scene 1 to 4, press a button [1/5] to [4/8]. To store the settings to a scene 5 to 8, hold down [SHIFT] and press a button [1/5] to [4/8].
When the mixer settings have been stored, the button indicator will light.
3. When you finish storing the scene, press [SCENE] once again to turn off the button indicator.

Recalling a scene

* Before selecting a scene, you must stop song recording/playback. It is not possible to select a scene during recording/playback.

1. Press [SCENE] to make the indicator light.
2. Press a LOCATOR button [1/5] to [4/8] to specify the scene that you wish to recall.
3. When the scene has been recalled, press [SCENE] to turn off the button indicator.

Recalling a scene without affecting the current fader values

When a scene is recalled, the fader values will change to the recalled settings, but the locations of the faders will not change. This means that the locations of the faders will not match their actual values.

If you want just the fader values to remain unchanged when you recall a scene, make the following settings.

1. Press [UTILITY].
2. Use [CURSOR] to select the Scene Parameter icon, and press [ENTER/TAP].



3. Use [CURSOR] to move the cursor to “Scene Mode,” and use the TIME/VALUE dial to set this to “Keep Fader.”

Scene Mode

This setting determines the fader settings when a Scene is recalled.

All:

Fader settings will change to the settings of the scene that was recalled. In this case, when a scene is recalled, the location of the faders on the front panel will no longer match the actual fader settings.

Keep Fader:

The mixer settings of the scene that was recalled will be applied with the exception of the fader settings. This means that even when a scene is recalled, fader settings will still match the location of the faders on the front panel.

4. After making the setting, press [DISPLAY] to return to Play mode.

Clearing the settings of a scene

1. Press [SCENE] to make the button indicator light.
2. Clear the scene settings.
While holding down [CLEAR], press the LOCATOR button [1/5] to [4/8] for the scene that you wish to clear. The settings will be cleared and the button indicator will go dark.
3. After the settings have been cleared, press [SCENE] to make the button indicator go dark.

Storing a time location, method 1 (Locate Point)

The LOCATOR [1/5] to [4/8] buttons allow you to memorize up to 8 time locations within the song. The time locations memorized by these LOC buttons are referred to as "locate points." Since you can jump to these locations simply by pressing a button, it is convenient to use them to memorize locations which you will want to access frequently. Locate points are also a convenient way to specify areas for looping or for auto punch-in recording.

■ Storing a time location

1. Specify the locate point number that you wish to use.

To use a locate point 1 to 4, press a [1/5] to [4/8] button. To use a locate point 5 to 8, hold down [SHIFT] and press a [1/5] to [4/8]. When the time has been memorized, the button indicator will light.

■ Moving to a stored time location

1. Use the LOCATOR buttons to specify the locate point of the time to which you want to move.

■ Modifying a stored time location

1. Press [UTILITY].
2. Use [CURSOR] to select the Locate Edit icon, and press [ENTER/TAP].



3. Use [CURSOR] to select the Locator icon, and press [ENTER/TAP].



4. Use the TIME/VALUE dial to specify the locate point number that you wish to modify.
5. Use [CURSOR] to move the cursor, and use the TIME/VALUE dial to modify the time.

■ Deleting a stored time location

1. While holding down [CLEAR], use the LOC buttons to specify the locate point that you wish to clear.

When a locate point has been cleared, the button indicator will go dark.

Storing a time location, method 2 (Mark Points)

The Tap Marker function lets you assign up to 1000 marks (mark points) to each song. This lets you move through a song in a way similar to using the index search buttons of a CD player.

< Mark point numbers >

Each mark point is assigned a number 000 to 999, in the order of its time location. This means that if you add a new mark point at a location earlier than an existing mark point, the numbers of the subsequent mark points will be incremented.

For example if you add a mark point located after mark point 2, subsequent mark points will be renumbered as shown in the following diagram.

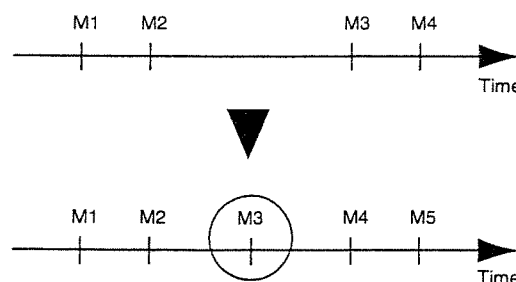

* An interval of at least 0.1 seconds must exist between mark points. It will not be possible to add a new mark point if a mark point already exists at a location closer than 0.1 seconds away.

■ Marking a time location

Adding a Mark Point to the current time.

1. Press [ENTER/TAP], and a mark point will be added to the current location.

Adding a Mark Point while playing back/recording a song

1. Begin playing back / recording a song, and press [ENTER/TAP] when you reach the desired location.

A mark point will be added at the time at which you pressed the button.

■ Moving to a marked time location

1. Use [CURSOR] to make the mark point number displayed in the MARKER field of the display blink.

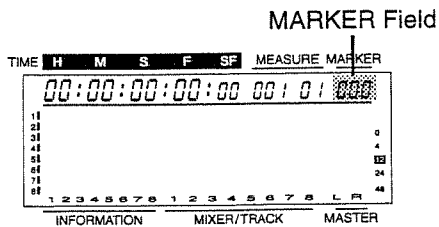

2. Use the TIME/VALUE dial to specify the mark point number to which you wish to move.

■ Modifying a marked time location

1. Press [UTILITY].
2. Use [CURSOR] to select the Locate Edit icon, and press [ENTER/TAP].



3. Use [CURSOR] to select the Marker icon, and press [ENTER/TAP].



4. Use the TIME/VALUE dial to specify the mark point number that you wish to modify.
5. Use [CURSOR] to move the cursor, and use the TIME/VALUE dial to modify the time.
The time of a mark point can be modified only within the range that lies between the preceding and following mark points.

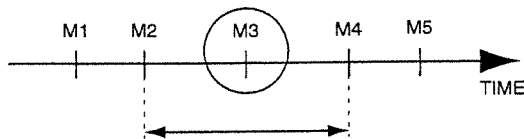

■ Clearing a mark Clearing a Mark Point

Assigning mark points makes searching convenient, but creating too many mark points can actually make searching less convenient. It is a good idea to clear (erase) mark points that are no longer necessary.

1. Move to the mark point that you wish to clear (erase).
2. While holding down [CLEAR], press [ENTER/TAP] and the mark point will be cleared.
If mark points exist after the mark point that was cleared, the subsequent mark point numbers will be incremented.

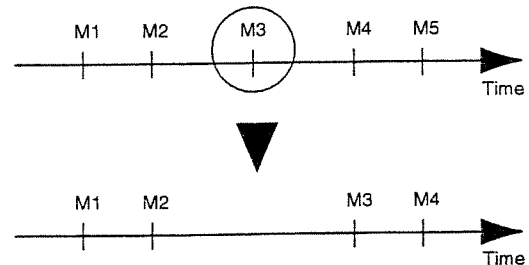

Clearing all Mark Points

1. While holding down [SHIFT], hold down [CLEAR] and press [ENTER/TAP].
The display will ask "Clear ALL Marker?" so press [YES]. To cancel without clearing, press [NO].

Chapter 5. Using the EZ ROUTING function

About the Easy Routing function

This function lets you make mixer settings automatically, simply by responding to easy interactive guidance.

The basic procedure is to use [CURSOR] to move the cursor to the item that you wish to modify, and use the TIME/VALUE dial to modify the value. When you finish making settings in one page, press [ENTER/TAP] to advance to the next page, and perform a similar operation. To return to the previous page, press [EXIT].

If you wish to halt the automatic settings, press [DISPLAY]. Since parameters which have been set will retain their settings even if [DISPLAY] is pressed, you can halt the automatically settings at any time you like.

* When using the Easy Routing function, pressing [ENTER/TAP] to advance to the next screen page while the recorder is running will cause the recorder to stop automatically as needed.

Easy Routing uses the following seven types of menu icons. When using Easy Routing to make settings automatically, there are several parameters which are set by default.

1. Quick Recording icon
2. Recording icon
3. Track Bouncing icon
4. Mix Down icon
5. User Routing icon
6. AUX Routing icon
7. External In icon

Using the Easy Routing function

■ Quick Recording Icon

Quickly start your recording by selecting the input channel and the recording track. Each page screen, while Quick Recording icon is selected, will be explained here. Page screen sequence will be displayed in this sequence on actual operations.

1. Press [EZ ROUTING].
2. Use [CURSOR] to select Quick Recording icon, press [ENTER/TAP].

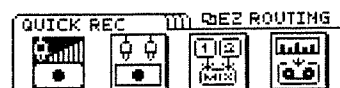

3. Select the input channel on this page. Press [SELECT] and select the channel.

As you select the channel, auto selection of the input channel and the track recording limitation will be executed.



Channel	Input Jack	Recordable Track
1	1	1, 2, 3, 4
2	2	1, 2, 3, 4
3	3	1, 2, 3, 4
4	4	1, 2, 3, 4
5/6	1/2	5/6, 7/8
7/9	3/4	5/6, 7/8

4. Select the track you want to record with [TRACK STATUS], then press [ENTER/TAP].

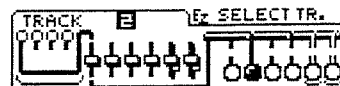

5. Set whether or not you like to use effects on this page. To use them, select the "YES" icon. Page 6 will appear. You can make settings for effects on this page.

By selecting the "NO" icon, 9., the last page will be displayed.

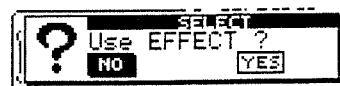



6. In this page you can specify the recording destination track for each channel. Use [CURSOR] and the TIME/VALUE dial to specify the recording destination track for each channel. If you select "Off," that channel will not be recorded.

- * If you specify a monaural track as a recording destination, pan will be set to full left (L63) or full right (R63). If you specify a stereo track, pan will be set to center (0).
- * In the screen page of step 5, tracks you select for channel input will be set to "playback," and cannot be selected as recording destination tracks. The VS-840EX allows up to four tracks to be specified for recording simultaneously. For example if TRACK 1, 2 and 5/6 are already specified as recording tracks, it will not be possible to specify TRACK 4 as the recording destination of channel 4.
- * Select a channel using [SELECT] or select a track using [TRACKSTATUS/V.TRACK].

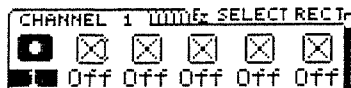

7. In this page you can make pan settings (balance settings for stereo tracks) for each channel. Pan will be set automatically for the track that you selected in step 6 as the recording destination. Modify this if necessary.

- * Select a channel using [SELECT] or [TRACK STATUS/V.TRACK].

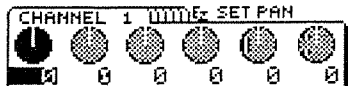

8. In this page you can specify whether or not you wish to use effects. If you wish to use effects, select the "YES" icon. The screen page of step 9 will appear, and you will be able to make effect settings.

If you selected the "NO" icon, the final screen page of step 18 will appear.

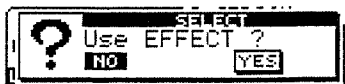

9. In this page you can select the location at which the effect will be connected. Use the TIME/VALUE dial to select the connection destination. For details on connections, refer to "Effect connections" (page 75).

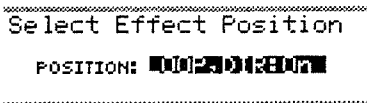

10. In this page you can select the patch which the effect will use. First, move the cursor to "TYPE," and select the algorithm type that you wish to use. Next, move the cursor to "PATCH," and select the patch. Press [ENTER/TAP], and the specified patch will be selected. Press [ENTER/TAP] once again to advance to the next page. If you select a loop connection (Loop, DIR:Off, or LOOP, DIR:On) in step 9, you will then move to the screen page of step 11. For any other selection, you will advance to the final screen page of step 18.



11. In this page you can specify whether or not the effect sound will be recorded. If you wish to record it, select the "YES" icon. The page of step 12 will appear, and you will be able to specify the recording destination (REC bus).

If you select the "NO" icon, the effect sound monitor output destination page of step 13 will appear.

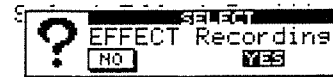

12. In this page you can specify the recording destination of the effect sound. Select the REC bus to which the effect sound will be output.

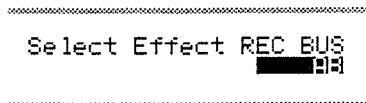

13. In this page you can specify the monitor output destination of the effect sound. Select the bus to which the effect sound will be output.

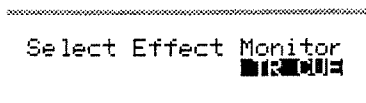

14. In this page you can specify how the signal will be sent to the EFFECT bus. Use [CURSOR] and the TIME/VALUE dial to make settings for each channel.

- * Select a channel using [SELECT] or [TRACK STATUS/V.TRACK].

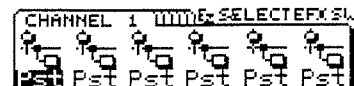

EFFECT SEND Switch

For each channel, select how the signal will be sent to the EFFECT bus.

Off:

The signal will not be sent.

Pre (Pre FADER):

The pre-fader signal will be sent.

Pst (Post FADER):

The post-fader signal will be sent.

- * *Effect Send Level/Pan for channels which are turned "Off" will be displayed as "—," and their value cannot be modified. However when you exit Easy Routing and return to Play mode, the value which is set will be displayed, and can be modified freely. In Play mode, the Effect Send Level/Pan values of channels for which the EFFECT SEND Switch is selected OFF will be underlined.*

15. In this page you can specify the volume level at which the output of each channel will be sent to the effect. Adjust the volume level of the channels to which you wish to apply the effect.

- * *Select a channel using [SELECT] or [TRACK STATUS/V.TRACK].*



16. In this page you can specify the panning for sending the output of each channel to the effects. Make this setting as necessary.

- * *Select a channel using [SELECT] or [TRACK STATUS/V.TRACK].*



17. In this page you can specify the return level and balance of the effect. Use [CURSOR] and the TIME/VALUE dial to make adjustments.

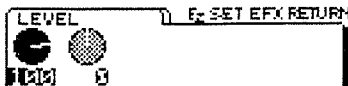

18. This is the final page. If you have finished making settings, press [DISPLAY] to return to Play mode.

- * *The Track Status of all playable tracks will be set to PLAY (green). If this is undesirable (not in PLAY status), hold down [SHIFT] and press [ENTER/TAP].*
- * *If you wish to save the current settings, refer to "User Routing icon" (page 44) in this chapter.*

.....
EZ ROUTING is finished!
 Please set levels using
 the Sens Knobs and Faders
DISPLAY

19. Press [REC] to make the button indicator blink red, and then press [PLAY] to begin recording.

Track Bouncing icon

Select this when you wish to combine the performance of two or more tracks into a separate single track. This can also be used to apply effects to the performance of a track and re-record it onto another track.

Here we will explain the various pages which will appear when you select the Track Bouncing icon. The pages will also appear in this order when you actually perform the procedure.

The basic procedure is to use [CURSOR] to move the cursor to the item that you wish to modify, and use the TIME/VALUE dial to modify the value. To advance to the next page press [ENTER/TAP], or to return to the previous page press [EXIT].

1. Press [EZ ROUTING].
2. Use [CURSOR] to select the Track Bouncing icon and press [ENTER/TAP].

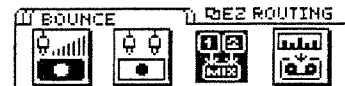

3. In this page you can specify whether or not you wish to modify the parameter values (default values) that were set automatically by Easy Routing. If you wish to make changes, select the "YES" icon. The page of step 4 will appear, and you will be able to set the parameters.

If you select the "NO" icon, the page of step 7 will appear, in which you can specify how effects will be used.



4. In this page you can select the recording source tracks. Use [CURSOR] and the TIME/VALUE dial to select the recording source tracks. Tracks which are set to "—" will not be recorded.

- * *Select a track using [TRACK STATUS/V.TRACK].*

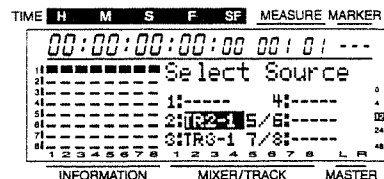

5. In this page you can select the recording destination track. Use [CURSOR] and the TIME/VALUE dial to specify the recording destination track and V-track.

- * If you specify a monaural track as the recording destination, the channel panning that you specified in the screen page of step 4 will be set either to full left (L63) or full right (R63). If you specify a stereo track, the pan of channels 1 and 3 will be set to full left (L63), the pan of channels 2 and 4 will be set to full right (R63), and the pan of channels 5/6 and 7/8 will be set to center (0).
- * Tracks that you selected for channel input in the screen page of step 4 will be set to "playback," and cannot be selected as a recording destination track.
- * Select a track using [TRACK STATUS/V.TRACK].

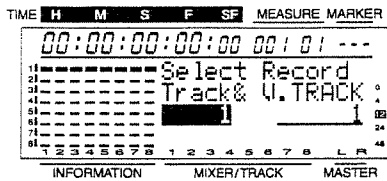

6. In this page you can specify the pan (or balance, for a stereo track) of each channel. Pan will be set automatically for each channel, according to the recording destination track which was specified in step 5. Modify the settings as needed.

- * Select a channel using [SELECT] or [TRACK STATUS/V.TRACK].



7. In this page you can specify whether or not you wish to use effects. If you wish to use effect, select the "YES" icon. The screen page of step 8 will appear, and you will be able to make effect settings.

If you select the "NO" icon, the final screen page of step 17 will appear.



8. In this page you can select the location at which the effect will be connected. Use the TIME/VALUE dial to select the connection destination. For details on connections, refer to "Effect connections" (page 75).

Select Effect Position

POSITION: **MONITOR**

9. In this page you can select the patch which the effect will use. First, move the cursor to "TYPE," and select the algorithm type that you wish to use. Next, move the cursor to "PATCH," and select the patch. Press [ENTER/TAP], and the specified patch will be selected. Press [ENTER/TAP] once again to advance to the next page. If you select a loop connection (LOOP, DIR:Off, or LOOP, DIR:On) in step 8, you will then move to the screen page of step 10. For any other selection, you will advance to the final screen page of step 17.



10. In this page you can specify whether or not the effect sound will be recorded. If you wish to record it, select the "YES" icon. The page of step 11 will appear, and you will be able to specify the recording destination (REC bus).

If you select the "NO" icon, the effect sound monitor output destination page of step 12 will appear.

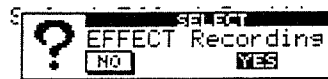

11. In this page you can specify the recording destination of the effect sound. Select the REC bus to which the effect sound will be output.

Select Effect REC BUS

12. In this page you can specify the monitor output destination of the effect sound. Select the bus to which the effect sound will be output.

Select Effect Monitor

13. In this page you can specify how the signal will be sent to the EFFECT bus. Use [CURSOR] and the TIME/VALUE dial to make settings for each channel.

- * Select a channel using [SELECT] or [TRACK STATUS/V.TRACK].

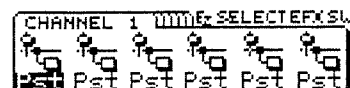

EFFECT SEND Switch

For each channel, select how the signal will be sent to the EFFECT bus.

Off:

The signal will not be sent.

Pre (Pre FADER):

The pre-fader signal will be sent.

Pst (Post FADER):

The post-fader signal will be sent.

- * *Effect Send Level/Pan for channels which are turned "Off" will be displayed as "--," and their value cannot be modified. However when you exit Easy Routing and return to Play mode, the value which is set will be displayed, and can be modified freely. In Play mode, the Effect Send Level/Pan values of channels for which the EFFECT SEND Switch is selected OFF will be underlined.*

14. In this page you can specify the volume level at which the output of each channel will be sent to the effect. Adjust the volume level of the channels to which you wish to apply the effect.

- * *Select a channel using [SELECT] or [TRACK STATUS/V.TRACK].*



15. In this page you can specify the panning for sending the output of each channel to the effects. Make this setting as necessary.

- * *Select a channel using [SELECT] or [TRACK STATUS/V.TRACK].*



16. In this page you can specify the return level and balance of the effect. Use [CURSOR] and the TIME/VALUE dial to make adjustments.

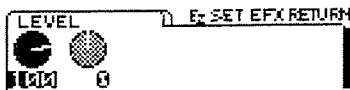

17. This is the final page. If you have finished making settings, press [DISPLAY] to return to Play mode.

- * *After setting the track status to PLAY (green) for all tracks which can be played back, hold down [SHIFT] and press [ENTER/TAP] if you wish to return to Play mode.*
- * *If you wish to save the current settings, refer to "User Routing icon" (page 44) in this chapter.*

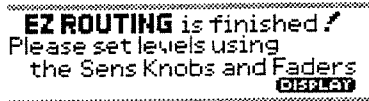

18. Press [REC] to make the button indicator blink red, and then press [PLAY] to begin recording.

■ Mixdown icon

Select this when you wish to adjust the balance of each track and record the 2-channel stereo result to your recorder (cassette tape recorder, DAT recorder, MD recorder, etc.).

Alternatively, you may sometimes wish to playback all eight channels on the VS-840EX, mix in the output from a sequencer which is playing back in synchronization with the VS-840EX, and record the result to cassette tape etc. In such cases, you can make settings to use TRACK CUE knobs 1 to 4 as external input level knobs (printed on the panel as "1-4 EXT INPUT"), so that you can playback all eight tracks of the VS-840EX and in addition, mix in the signals from INPUT jacks 1 to 4 as two stereo pairs. In other words during mixdown, the VS-840EX can be used as a 12 channel mixer.

- * *The function which assigns TRACK CUE knobs 1 to 4 to function as external input knobs is accessible only in the Mixdown icon of Easy Routing. When you press [MONITOR SEL] to switch the monitor output to TR CUE+MASTER or TRACK CUE, the TRACK CUE knobs 1 to 4 will return to their usual function.*

Here we will explain each of the screen pages that will appear when you select the Mixdown icon. These will also appear in the same order when you actually perform the procedure.

The basic procedure is to use [CURSOR] to move the cursor to the item that you wish to modify, and use the TIME/VALUE dial to modify the value. To advance to the next page, press [ENTER/TAP]. To return to the previous page, press [EXIT].

1. Press [EZ ROUTING].
2. Use [CURSOR] to select the Mixdown icon and press [ENTER/TAP].

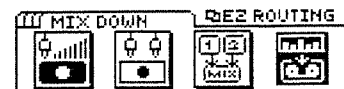

3. In this page you can specify whether or not you wish to modify the parameter values (default values) that were set automatically by Easy Routing. If you wish to make changes, select the "YES" icon. The page of step 4 will appear, and you will be able to set the parameters.

If you select the "NO" icon, the page of step 6 will appear, in which you can specify how effects will be used.

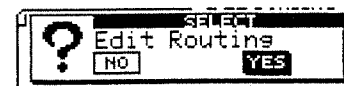

- In this page you can select the input for each channel. Use [CURSOR] and the TIME/VALUE dial to select the track which will be input to each channel. If you select MUTE, no sound will be input to that channel.

* Select a track using [TRACK STATUS/V.TRACK].

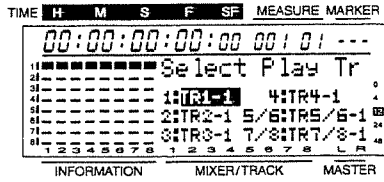

- In this page you can make pan settings (balance settings for stereo tracks) for each channel. Modify these settings if desired.

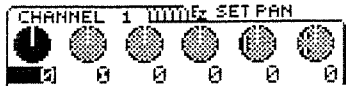

- In this page you can specify whether or not you wish to use effects. If you wish to use effects, select the "YES" icon. The screen page of step 7 will appear, and you will be able to make effect settings.

If you selected the "NO" icon, the final screen page of step 14 will appear.

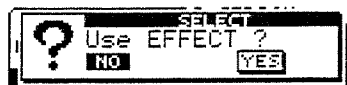

- In this page you can select the location at which the effect will be connected. Use the TIME/VALUE dial to select the connection destination. For details on connections, refer to "Effect connections" (page 75).

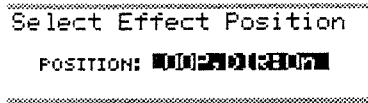

- In this page you can select the patch which the effect will use. First, move the cursor to "TYPE," and select the algorithm type that you wish to use. Next, move the cursor to "PATCH," and select the patch. Press [ENTER/TAP], and the specified patch will be selected. Press [ENTER/TAP] once again to advance to the next page. If you select a loop connection (LOOP, DIR:Off, or LOOP, DIR:On) in step 7, you will then move to the screen page of step 9. For any other selection, you will advance to the final screen page of step 15.



- In this page you can specify the monitor output destination of the effect sound. Select the bus to which the effect sound will be output.

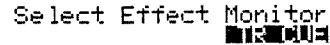

- In this page you can specify how the signal will be sent to the EFFECT bus. Use [CURSOR] and the TIME/VALUE dial to make settings for each channel.

* Select a channel using [SELECT] or [TRACK STATUS/V.TRACK].

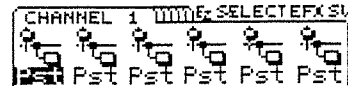

EFFECT SEND Switch

For each channel, select how the signal will be sent to the EFFECT bus.

Off:

The signal will not be sent.

Pre (Pre FADER):

The pre-fader signal will be sent.

Pst (Post FADER):

The post-fader signal will be sent.

* Effect Send Level/Pan for channels which are turned "Off" will be displayed as "—" and their value cannot be modified. However when you exit Easy Routing and return to Play mode, the value which is set will be displayed, and can be modified freely. In Play mode, the Effect Send Level/Pan values of channels for which the EFFECT SEND Switch is selected OFF will be underlined.

- In this page you can specify the volume level at which the output of each channel will be sent to the effect. Adjust the volume level of the channels to which you wish to apply the effect.

* Select a channel using [SELECT] or [TRACK STATUS/V.TRACK].

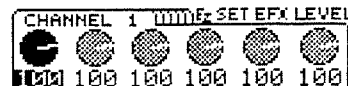

- In this page you can specify the panning for sending the output of each channel to the effects. Make this setting as necessary.

* Select a channel using [SELECT] or [TRACK STATUS/V.TRACK].

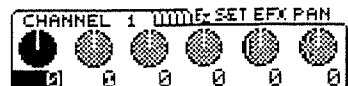

13. In this page you can specify the return level and balance of the effect. Use [CURSOR] and the TIME/VALUE dial to make adjustments.



14. In this page you can specify whether or not the signals which are input to INPUT jacks 1 to 4 will be used during mixdown. If you wish to use the signals from the INPUT jacks, select the "YES" icon. If not, select the "NO" icon.

* If you select the "YES" icon, use TRACK CUE knobs 1 to 4 to adjust the volume levels of INPUT jacks 1 to 4 for mixing.

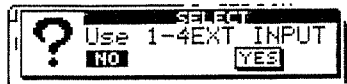

15. This is the final page. If you have finished making settings, press [DISPLAY] to return to Play mode.

* If you wish to save the current settings, refer to "User Routing icon" (page 44) in this chapter.

.....
EZ ROUTING is finished!
 Please set levels using
 the Faders

 [DISPLAY]

16. Refer to the procedure of "Mixing down to 2-channel stereo" (page 64) and record the mix on your cassette tape recorder etc..

■ User Routing icon

The current mixer settings that you have made using Easy Routing etc. can be saved as a User Routing in one of ten memories. By storing frequently-used mixer settings, you can record and edit more efficiently, without having to make the same settings each time.

Procedure for saving the current mixer settings as a User Routing

1. Press [EZ ROUTING].
2. Use [CURSOR] to select the User Routing icon and press [ENTER/TAP].

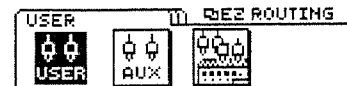

3. The User Routing page will appear. Use [CURSOR] to select the "SAVE" icon, and press [ENTER/TAP].
4. A currently-unused number will automatically be assigned, and a screen page allowing you to input a User Routing Name will appear. Use [CURSOR] and the TIME/VALUE dial to input a new User Routing Name.
5. When you finish inputting the name, move the cursor to the "GO" icon, and press [ENTER/TAP]. The current mixer settings will be stored, and you will return to Play mode.

Procedure for recalling mixer settings that were stored as a User Routing

1. Press [EZ ROUTING].
2. Use [CURSOR] to select the User Routing icon and press [ENTER/TAP].

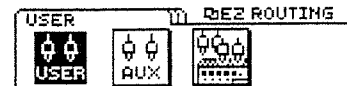

3. The User Routing page will appear. Use the TIME/VALUE dial to select the User Routing number that you wish to recall.
4. Use [CURSOR] to select the "GO" icon, and press [ENTER/TAP].
5. The User Routing settings will be recalled, and you will return to Play mode.

Deleting mixer settings that were saved as a User Routing

1. Press [EZ ROUTING].
2. Use [CURSOR] to select the User Routing icon and press [ENTER/TAP].

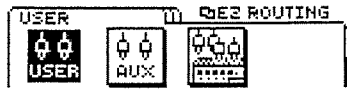

3. The User Routing page will appear. Use the TIME/VALUE dial to select the User Routing number that you wish to delete.
4. Use [CURSOR] to select the "DEL" icon, and press [ENTER/TAP].
5. The display will ask "Are you sure ?", so select the "YES" icon.
If you wish to cancel the Delete operation, select the "NO" icon.
6. If you wish to delete another User Routing, repeat steps 3 to 5.
7. If you are finished deleting, press [DISPLAY] to return to Play mode.

■ AUX Routing icon

Select this when you wish to use the MON/AUX jacks and the PHONES jack to monitor different signals respectively, or when you wish to use external effects.

If you wish to use the MON/AUX jacks as effect send jacks, use the INPUT jacks 1 to 4 as effect return jacks.

- * If when Monitor Select is set to AUX, you select the "MON" icon in the first page of AUX Routing, or if you attempt to change it to a setting other than AUX, the following warning message will appear.



If this message is displayed and you are using the MON/AUX jacks as effect send jacks and are using any of the INPUT jacks 1 to 4 as effect return jacks, you must immediately disconnect the effect return cables which are connected to the INPUT jacks. If you continue operation, feedback may occur. After disconnecting the cables, press [ENTER/TAP] and continue operation.

This is because when the MON/AUX jacks are used as effect send jacks and any of the INPUT jacks 1 to 4 are used as effect return jacks, changing Monitor Select to a setting other than AUX will cause the output from the MON/AUX jacks to be input to the INPUT jacks, which could cause feedback depending on the mixer settings. Also, even if Monitor Select is set to AUX, raising the AUX Send Level of the channel which is inputting the effect return signal may cause feedback. Be sure to set the AUX Send Level to minimum (0) for all channels which are inputting the effect return signal.

Here we will explain each of the screen pages which will appear when you select the AUX Routing icon. When you actually perform the procedure, the pages will appear in this order.

The basic procedure is to use [CURSOR] to move the cursor to the item that you wish to modify, and simply press [ENTER/TAP]. To return to the menu page, press [EXIT].

1. Press [EZ ROUTING].
2. Use [CURSOR] to select the AUX Routing icon, and press [ENTER/TAP].



- Use [CURSOR] to select the output signal for the MON/AUX jack, then press [ENTER/TAP].



If the "MON" icon is selected

If AUX is selected for Monitor Select, TR CUE+MASTER will be selected, and if the selection is other than AUX, it will remain unchanged. The signal of the MIX bus will be set for output from the MASTER OUT jacks, and the PHONES jack will output the same signal as the MON/AUX jacks. When settings are complete, you will return to Play mode.

If the "AUX" icon is selected

MONITOR SEL button indicator will blink green, then MON/AUX jack will output AUX bus signal.

- This page sets the route for the AUX bus signal. Use [CURSOR] and the TIME/VALUE dial to set each channel.

* Select a channel using [SELECT] or [TRACK STATUS/V.TRACK].

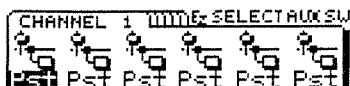

AUX SEND Switch

This switch selects how the signal will be sent to the AUX buses. If "Off" is selected, an underline will be displayed as the AUX level for that channel.

Off:

No signal will be sent.

Pre EQ:

The signal from before the EQ will be sent to the AUX bus.

Pre (Pre FADER):

The signal from before the channel fader will be sent to the AUX bus.

Pst (Post FADER):

The signal from after the channel fader will be sent to the AUX bus.

- This page sets the volume level of each channel output to the AUX buss. Use [CURSOR] and the TIME/VALUE dial to adjust the volume level for the channel.

* Select a channel using [SELECT] or [TRACK STATUS/V.TRACK].



- In this page you can select the signal that will be output from the PHONES jack.

If the "MASTER" icon is selected

The MIX bus signal will be output from the PHONES jack and the MASTER OUT jacks. When settings are complete, you will return to Play mode.

If the "TR CUE" icon is selected

The TRACK CUE bus signal will be output from the PHONES jack and the MASTER OUT jacks. When settings are complete, the display will indicate "MASTER OUTPUT is TR CUE sound." Press [ENTER/TAP] to return to Play mode.

When using an external effect, you will normally select this icon.

If the "AUX" icon is selected

The same signal as the MON/AUX jack (i.e., the AUX bus signal) will be output to the PHONES jack, and the MIX bus signal will be output to the MASTER OUT jack. When settings are complete, you will return to Play mode.

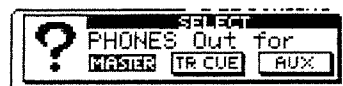

External In icon

Directly select whether to use External In function (page 108). This operation changes the Play/Rec External Input parameter in the system parameter.

- Press [EZ ROUTING].
- Use [CURSOR] to select External Input icon, then press [ENTER/TAP].



- When using External In function, select the "YES" icon. If not, select the "NO" icon, then press [ENTER/TAP].

An example of using Easy Routing

■ Recording to track 1

In this example, we will explain how the sound being input to the INPUT 1 jack can be recorded on track 1. In this case, select the Recording icon.

The basic procedure is to use [CURSOR] to move the cursor to the item that you wish to modify, and use the TIME/VALUE dial to modify the value. To advance to the next page press [ENTER/TAP]. To return to the previous page press [EXIT].

1. Press [EZ ROUTING].
2. Use [CURSOR] to select the Recording icon and press [ENTER/TAP].

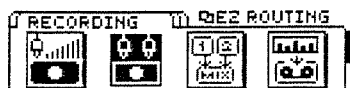

3. In this page you can specify whether or not you wish to modify the parameter values (default values) that were set automatically by Easy Routing. For this example, select the "YES" icon. The page of step 4 will appear, and you will be able to set the parameters.

If you select the "NO" icon, the page of step 8 will appear, in which you can specify how effects will be used.



4. The V-track setting page will appear. The screen will show the current settings. Use [CURSOR] and the TIME/VALUE dial to select the V-track for track 1 on which you wish to record.

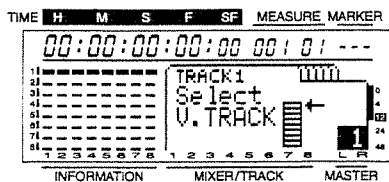

5. In this page you can specify the input for each channel. You want to specify the INPUT 1 jack as the default setting, but since this is the default setting, there is no need to modify it here.



6. In this page you can specify the recording destination track for each channel. For this example, use [CURSOR] and the TIME/VALUE dial to select "1" as the recording destination track for channel 1.

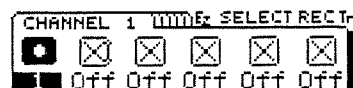

7. In this page you can specify the pan (or for a stereo track, the balance) of each channel. Pan will be set automatically for channels for which a recording destination track was specified in step 6. Make sure that the pan of channel 1 is set full left (L63).



8. In this page you can specify whether or not you wish to use effects. Since in this example we will not be using effects, select the "NO" icon.

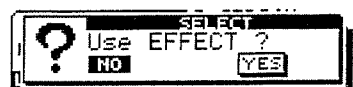

9. This is the last page. If you have finished making settings, press [DISPLAY] to return to Play mode.

* If you wish to keep the current settings, refer to "User Routing icon" (page 44) in this channel.

~~~~~  
**EZ ROUTING** is finished!  
 Please set levels using  
 the Sens Knobs and Faders  
**DISPLAY**  
 ~~~~~

10. Settings are now completed. Press [ZERO] to return to the beginning of the song, press [REC] to enter record-ready mode (the REC indicator will blink red), and then press [PLAY] to begin recording.

■ Recording in stereo to tracks 5/6

5/6

In this example, we will explain how the sound which is input to INPUT jacks 1/2 can be recorded in stereo on tracks 5/6. For this example, select the Recording icon.

The basic procedure is to use [CURSOR] to move the cursor to the item that you wish to modify, and use the TIME/VALUE dial to modify the value. To advance to the next page press [ENTER/TAP]. To return to the previous page press [EXIT].

1. Press [EZ ROUTING].
2. Use [CURSOR] to select the Recording icon and press [ENTER/TAP].

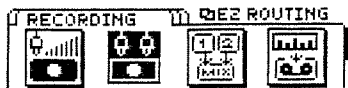

3. In this page you can specify whether or not you wish to modify the parameter values (default values) that were set automatically by Easy Routing. For this example, select the "YES" icon. The page of step 4 will appear, and you will be able to set the parameters.

If you select the "NO" icon, the page of step 8 will appear, in which you can specify how effects will be used.

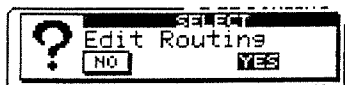

4. The V-track setting page will appear. The display will show the current settings. Use [CURSOR] and the TIME/VALUE dial to select the V-tracks of tracks 5/6 on which you wish to record.

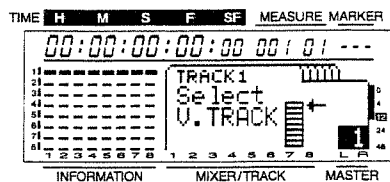

5. In this page you can specify the input for each channel. We want to specify INPUT jacks 1/2 as the input for channels 5/6, but since this is the default setting, there is no need to change it here.



6. In this page you can specify the recording destination track for each channel. For this example, use [CURSOR] and the TIME/VALUE dial to select "5/6" as the recording destination track for channels 5/6.

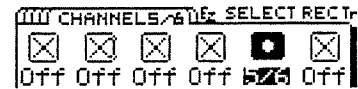

7. In this page you can set the pan (or for a stereo track, the balance) of each channel. Pan (or balance) is set automatically for channels for which a recording destination track was specified in step 6. Make sure that the balance of channels 5/6 is set to center (0).

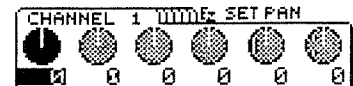

8. In this page you can specify whether or not you wish to use effects. For this example we will not be using effects, so select the "NO" icon.

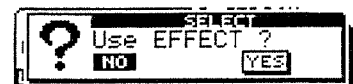

9. This is the final page. If you have finished making settings, press [DISPLAY] to return to Play mode.

* If you wish to save the current settings, refer to "User Routing icon" (page 44) in this chapter.

EZ ROUTING is finished!
Please set levels using
the Sens Knobs and Faders
DISPLAY

10. Settings are now complete. Press [ZERO] to return to the beginning of the song, press [REC] to enter record-ready mode (the REC indicator will blink red), and press [PLAY] to begin recording.

■ Recording additional tracks while listening to playback (Overdubbing)

The process of recording new additional tracks while listening to previously-recorded tracks is known as “overdubbing.” In this section we will show an example of recording an additional stereo performance to tracks 1/2 while you listen to a previously-recorded stereo performance only on tracks 5/6. Connect the instrument that you wish to newly record to INPUT jacks 1/2. For this example, select the Recording icon. The basic procedure is to use [CURSOR] to move the cursor to the item that you wish to modify, and use the TIME/VALUE dial to modify the value. To advance to the next page press [ENTER/TAP]. To return to the previous page press [EXIT].

1. Press [EZ ROUTING].
2. Use [CURSOR] to select the Recording icon and press [ENTER/TAP].

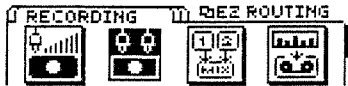

3. In this page you can specify whether or not you wish to modify the parameter values (default values) that were set automatically by Easy Routing. For this example, select the “YES” icon. The page of step 4 will appear, and you will be able to set the parameters. If you select the “NO” icon, the page of step 8 will appear, in which you can specify how effects will be used.



4. The V-track setting page will appear. The display will show the current settings. Use [CURSOR] and the TIME/VALUE dial to select the V-track of track 1/2 on which you wish to record, and the V-track for track 5/6 that you wish to playback.

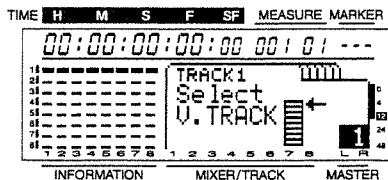

5. In this page you can select the input for each channel. Select INPUT 1 jack for channel 1, INPUT 2 jack for channel 2, and tracks 5/6 as the input for channel 5/6. However since channel 1/2 is the default setting, here we will only need to make the setting for channel 5/6. Use [CURSOR] to move the cursor to “Channel 5/6” and use the TIME/VALUE dial to select “5/6.”



6. In this page you can specify the recording destination track for each channel. For this example, use [CURSOR] and the TIME/VALUE dial to set the recording destination track of channels 1 and 2 to “1” and “2” respectively.

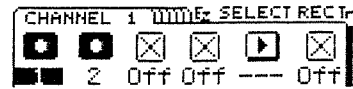

7. In this page you can set the pan (or for a stereo track, the balance) of each channel. The pan will be set automatically for channels for which you specified a recording destination track in step 6. Make sure that the pan of channel 1 is set to full left (L63), and the pan of channel 2 is set to full right (R63).

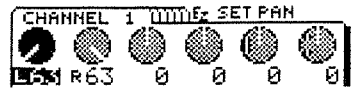

8. In this page you can specify whether you wish to use effects or not. Since we will not be using effects in this example, select the “NO” icon.



9. This is the final page. If you have finished making settings, hold down [SHIFT] and press [ENTER/TAP] to return to Play mode.

* If you wish to save the current settings, refer to “User Routing icon” (page 44) in this chapter.

* Normally when you press [DISPLAY], the track status of all tracks which can be played back will be set to PLAY (green), but since in this example we are not going to allow this operation, hold down [SHIFT] and press [ENTER/TAP].

EZ ROUTING is finished!
Please set levels using
the Sens Knobs and Faders
DISPLAY

10. Settings are now complete. Press [ZERO] to return to the beginning of the song, press [REC] to enter record-ready mode (the REC indicator will blink red), and press [PLAY] to begin recording.

■ Bouncing tracks while applying reverb (Loop)

In this section we will explain how you can apply effects to a previously-recorded track, and record the result to another track.

Here we will apply reverb to tracks 1/2 and tracks 5/6, and record the result to tracks 7/8. For this example, select the Track Bouncing icon.

The basic procedure is to use [CURSOR] to move the cursor to the item that you wish to modify, and use the TIME/VALUE dial to modify the value. To advance to the next page press [ENTER/TAP]. To return to the previous page press [EXIT].

1. Press [EZ ROUTING].
2. Use [CURSOR] to select the Track Bouncing icon and press [ENTER/TAP].

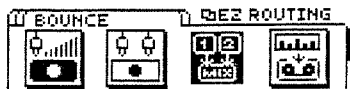

3. In this page you can specify whether or not you wish to modify the parameter values (default values) that were set automatically by Easy Routing. For this example, select the "YES" icon. The page of step 4 will appear, and you will be able to set the parameters.

If you select the "NO" icon, the page of step 7 will appear, in which you can specify how effects will be used.



4. In this page you can select the recording source tracks. Use [CURSOR] and the TIME/VALUE dial to select the recording source tracks as shown in the following display. For the purposes of this explanation, we will use V-track 1. For example, a display of "TR5/6-1" indicates V-track 1 of tracks 5/6 V-track 1.

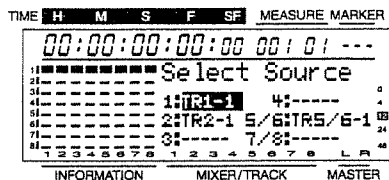

5. In this page you can specify the recording destination tracks. Use [CURSOR] and the TIME/VALUE dial to specify the recording destination track and V-track, following the settings of the screen page shown below.

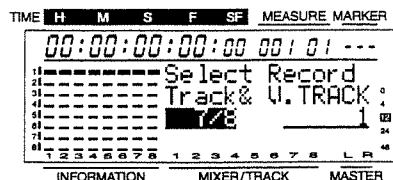

6. In this page you can set the pan (or for a stereo track, the balance) of each channel. The pan of each channel will be set automatically, according to the recording destination track that you specified in step 5. For this example, make sure that the channel 1 pan is set full left (L63), the channel 2 pan is set full right (R63), and the channel 5/6 balance is set to center (0).

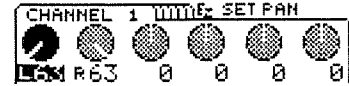

7. In this page you can specify whether you wish to use effects or not. Since we will use effects in this example, select the "YES" icon.



8. In this page you can select the location where the effect will be connected. For this example, use the TIME/VALUE dial to set the connection destination to "LOOP, DIR:Off." For details on the connection destination, refer to "Effect connections" (page 75).

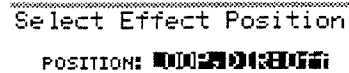

9. In this page you can select the effect patch which will be used. For this example we will use reverb. Move the cursor to "TYPE," and select "Reverb1" as the algorithm type. Next, move the cursor to "PATCH" and select the patch. For this example, select a patch such as "A-00:Medium Room," etc. Press [ENTER/TAP] to recall the selected patch. Press [ENTER/TAP] once again to advance to the next page.



10. In this page you can specify whether or not the effect sound will be recorded. If you wish to record it, select the "YES" icon. The page of step 11 will appear, and you will be able to specify the recording destination (REC bus).

If you select the "NO" icon, the effect sound monitor output destination page of step 12 will appear.

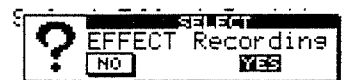

11. In this page you can specify the recording destination of the effect sound. Select the REC bus to which the effect sound will be output. Here you will select "CD."

```
.....
Select Effect REC BUS
          CD
.....
```

12. In this page you can specify the monitor output destination of the effect sound. Select the bus to which the effect sound will be output. Here you will select "Off."

```
.....
Select Effect Monitor
          Off
.....
```

13. In this page you can specify how the signal will be sent to the EFFECT bus. Use [CURSOR] and the TIME/VALUE dial to make settings for each channel.

```
CHANNEL 1 TIME: SELECT EFX SW
Pst Pst Pst Pst Pst Pst
```

EFFECT SEND Switch

For each channel, specify how the signal will be sent to the EFFECT bus.

Off: The signal will not be sent.

Pre (Pre FADER): The pre-fader signal will be sent.

Pst (Post FADER): The post-fader signal will be sent.

* The Effect Send Level/Pan of channels which are turned "Off" will be displayed as "—" and the setting cannot be modified. However when you exit Easy Routing and return to Play mode, the specified values will be displayed and you will be able to modify them freely. In Play mode, the Effect Send Level/Pan for channels whose EFFECT SEND Switch is selected Off will be underlined.

14. In this page you can specify the volume level at which the output of each channel will be sent to the effect. Use [CURSOR] and the TIME/VALUE dial to adjust the Effect Send Level for channels 1, 2 and 5/6.

```
CHANNEL 1 TIME: SET EFX LEVEL
50 50 0 0 50 0
```

15. In this page you can adjust the pan of the output of each channel that will be sent to the effect. Adjust these settings as necessary.

```
CHANNEL 1 TIME: SET EFX PAN
0 0 0 0 0 0
```

16. In this page you can set the Effect Return Level and Balance. Use [CURSOR] and the TIME/VALUE dial to make adjustments.

```
LEVEL F: SET EFX RETURN
0 0
```

17. This is the final page. If you have finished making settings, press [DISPLAY] to return to Play mode.

* If you wish to save the current settings, refer to "User Routing icon" (page 44) in this chapter.

```
.....
EZ ROUTING is finished!
Please set levels using
the Sens Knobs and Faders
[EXIT]
.....
```

18. Press [REC] to make the button indicator blink red, and then press [PLAY] to begin recording.

■ Mixing down to 2-channel

In this section we will explain how you can adjust the volume level and pan (or balance, for a stereo track) of the stereo-recorded signals of tracks 3/4, 5/6 and 7/8, and combine them into a 2-channel stereo mix. For this example, select the Mixdown icon.

The basic procedure is to use [CURSOR] to move the cursor to the item that you wish to modify, and use the TIME/VALUE dial to modify the value. To advance to the next page press [ENTER/TAP]. To return to the previous page press [EXIT].

1. Press [EZ ROUTING].
2. Use [CURSOR] to select the Mixdown icon and press [ENTER/TAP].

```
MIX MIX DOWN EZ ROUTING
[?] [MIX] [1] [2] [MIX] [MIX]
```

3. In this page you can specify whether or not you wish to modify the parameter values (default values) that were set automatically by Easy Routing. For this example, select the "YES" icon. The page of step 4 will appear, and you will be able to set the parameters.

If you select the "NO" icon, the page of step 6 will appear, in which you can specify how effects will be used.

```
SELECT
? Edit Routines
NO YES
```

4. In this page you can select the input for each channel. Use [CURSOR] and the TIME/VALUE dial to select the track which will be input to each channel, as shown in the display page below. For the purposes of this explanation, we will use V-track 1. For example, a display of "TR5/6-1" indicates V-track 1 of track 5/6.

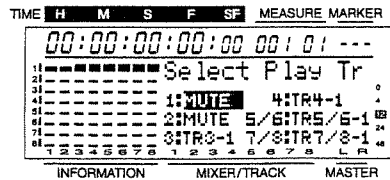

5. In this page you can set the pan (or for a stereo track, the balance) of each channel. Modify the settings if necessary.

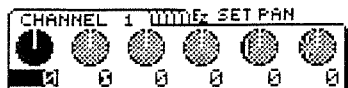

6. In this page you can specify whether you wish to use effects or not. Since we will not be using effects in this example, select the "NO" icon.



7. In this page you can specify whether the signals that are input from INPUT jack 1 to 4 will be used in the mixdown. In this example we will not be using the signals from the INPUT jacks, so select the "NO" icon.

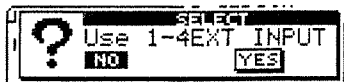

8. This is the final page. If you have finished making settings, press [DISPLAY] to return to Play mode.

* If you wish to save the current settings, refer to "User Routing icon" (page 44) in this chapter.

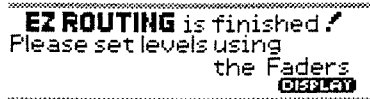

9. Follow the procedure described in "Mixing down to 2-channel stereo" (page 64), and record the mix on a cassette tape, etc.

About the default values set by Easy Routing

When you select one of the Easy Routing menus, one or more of the parameters shown below will be set to default values. Subsequently, these values will be changed as you proceed through the Easy Routing pages and make parameter settings.

* No parameters are set to a default when you select the User Routing icon.

Parameter which are automatically set

1. CHANNEL INPUT 1-7/8
2. CHANNEL PAN 1-7/8
3. CHANNEL EQ 1-7/8
4. REC BUS SELECT(CHANNEL 1-7/8)
5. REC BUS SELECT(EFFECT RTN)
6. TRACK STATUS 1-7/8
7. MONITOR SELECT
8. EFFECT SW
9. EFFECT POSITION
10. EFFECT PATCH TYPE
11. EFFECT PATCH NO.
12. EFFECT SEND Switch
13. EFFECT SEND LEVEL
14. EFFECT SEND PAN
15. EFFECT RETURN LEVEL
16. EFFECT RETURN BALANCE
17. AUX SEND Switch
18. AUX SEND LEVEL
19. MASTER OUT SELECT
20. PHONES SELECT
21. SOLO
22. LOOP
23. SCRUB
24. SCENE
25. VARI PITCH
26. MODE
27. TRACK CUE LEVEL

Default values which are set when you select the Recording icon

DEFAULT PARAMETER LIST

PARAMETER	VALUE
CHANNEL INPUT 1-7/8	CHANNEL1-4: INPUT1-4, CHANNEL5/6-7/8: INPUT1/2-3/4
CHANNEL PAN 1-7/8	all 0
CHANNEL EQ 1-7/8	all Off
REC BUS SELECT(CHANNEL 1-7/8)	AB, CD
REC BUS SELECT(EFFECT RTN)	Off
TRACK STATUS 1-7/8	all MUTE
MONITOR SELECT	TR CUE
EFFECT SW	Pst
EFFECT SEND LEVEL	all 0

EFFECT SEND PAN	all 0
EFFECT RETURN LEVEL	100
EFFECT RETURN BALANCE	0
MASTER OUT SELECT	MASTER
PHONES OUT	MON/AUX
SOLO	Off
LOOP	Off
SCRUB	Off
SCENE	Off
VARI PITCH	Off
MODE	SELECT
TRACK CUE LEVEL	100

Default values which are set when you select the Track Bouncing icon

DEFAULT PARAMETER LIST

<u>PARAMETER</u>	<u>VALUE</u>
CHANNEL INPUT 1-7/8	all TRACK
CHANNEL PAN 1-7/8	all 0
CHANNEL EQ 1-7/8	all Off
REC BUS SELECT(CHANNEL 1-7/8)	AB, CD
REC BUS SELECT(EFFECT RTN)	Off
TRACK STATUS 1-7/8	all PLAY, (nothing DATA) MUTE
MONITOR SELECT	MASTER
EFFECT SW	Pst
EFFECT SEND LEVEL	all 0
EFFECT SEND PAN	all 0
EFFECT RETURN LEVEL	100
EFFECT RETURN BALANCE	0
MASTER OUT SELECT	MASTER
PHONES OUT	MON/AUX
SOLO	Off
LOOP	Off
SCRUB	Off
SCENE	Off
VARI PITCH	Off
MODE	SELECT
TRACK CUE LEVEL	100

Default values which are set when you select the Mixdown icon

DEFAULT PARAMETER LIST

<u>PARAMETER</u>	<u>VALUE</u>
CHANNEL INPUT 1-7/8	all TRACK
CHANNEL PAN 1-7/8	all 0
CHANNEL EQ	all Off
REC BUS SELECT(CHANNEL 1-7/8)	all Off
REC BUS SELECT(EFFECT RTN)	Off
TRACK STATUS 1-7/8	all PLAY, (nothing DATA) MUTE
MONITOR SELECT	MASTER
EFFECT SW	Pst
EFFECT SEND LEVEL	all 0

EFFECT SEND PAN	all 0
EFFECT RETURN LEVEL	100
EFFECT RETURN BALANCE	0
MASTER OUT SELECT	MASTER
PHONES OUT	MON/AUX
SOLO	Off
LOOP	Off
SCRUB	Off
SCENE	Off
VARI PITCH	Off
MODE	SELECT
TRACK CUE LEVEL	100

Default values which are set when you select the AUX Routing icon

If you select the "MON" icon in "MON/AUX Out for" page

DEFAULT PARAMETER LIST

<u>PARAMETER</u>	<u>VALUE</u>
MONITOR SELECT	If the current setting is other than AUX, that setting will remain. If the current setting is AUX, it will be changed to TR CUE+MASTER.
PHONES OUT	MON/AUX
MASTER OUT	MASTER

If you select the "AUX" icon in "MON/AUX Out for" page

DEFAULT PARAMETER LIST

<u>PARAMETER</u>	<u>VALUE</u>
MONITOR SELECT	AUX

If you select the "MASTER" icon in "PHONES OUT for" page

PHONES OUT	MASTER
MASTER OUT	MASTER

If you select the "TR CUE" icon in "PHONES OUT for" page

PHONES OUT	MASTER
MASTER OUT	TR CUE

If you select the "AUX" icon in "PHONES OUT for" page

PHONES OUT	MON/AUX
MASTER OUT	MASTER

Chapter 6. Multitrack recording techniques (Using the VS-840EX like a tape-based MTR)

Although the VS-840EX is a digital multitrack recorder, recording procedure is the same as for an analog multitrack recorder, as shown below.

1. Record the basic tracks of the song; drums and bass, etc.
2. While playing back the drums and bass tracks, record instruments such as guitar etc. on other tracks (overdubbing).
3. The VS-840EX can simultaneously playback up to 8 tracks. If you wish to simultaneously playback more than 8 tracks, you will need to record two or more tracks onto a different track in order to reduce the data to 8 or fewer tracks (track bouncing).
4. Adjust equalization, pan, and volume level for each track, and mix down to your master recorder.

Making a new recording

In order to record, you will have to prepare a new song. On a cassette tape MTR, this corresponds to inserting a new cassette tape.

■ Creating a new song (Song New)

The VS-840EX allows up to 200 songs to be created on one disk. To create a new song on the disk, use the following procedure.

1. Press [UTILITY].
2. Use [CURSOR] to select the Song Edit icon, and press [ENTER/TAP].



3. Use [CURSOR] to select the Song New icon, and press [ENTER/TAP].



4. The display will indicate "Sample Rate" and "Record Mode." Select the sampling rate (44.1, 32.0kHz) and the recording mode (MT1, MT2, LV1, LV2). Use the TIME/VALUE dial and [CURSOR] to make your selections.
5. Press [ENTER/TAP].
If you press [EXIT], a new song will not be created.

6. The display will indicate "STORE Current ?" If you wish to save the currently selected song (the Current Song), press [YES]. If you do not wish to save it, press [NO].

When the new song has been created, you will automatically return to Play mode, and the created song will be selected.

< Recording mode >

On the VS-840EX, the recording mode setting allows you to select a sound quality appropriate for the material being recorded and a recording time appropriate for the remaining capacity of your disk. This recording mode setting is set when you create a new song. The following recording modes are available. Use the mode appropriate for your situation.

* It is not possible to change the recording mode after the song has been created.

- **Multitrack 1 (MT1):**
This mode lets you record with the highest sound quality of any of the four modes. This mode is suitable for when you will be doing a lot of track bouncing.
- **Multitrack 2 (MT2):**
While preserving high sound quality, this mode offers longer recording times than "multitrack 1." Normally you should use this mode.
- **Live 1 (LV1):**
This mode allows longer recording times than "Multitrack 2." Select this mode when your disk capacity is limited, or when you wish to record a live performance, etc.
- **Live 2 (LV2):**
Of the four modes, this allows the longest recording times.

< Recording time >

When you create a new song, you must set the Sample Rate in addition to the Recording Mode. The recording times for each setting are as follows (250 M byte capacity, 1 track).

Recording mode	Sample rate	
	44.1 kHz	32.0 kHz
Multitrack 1	94 minutes	129 minutes
Multitrack 2	125 minutes	172 minutes
Live 1	150 minutes	207 minutes
Live 2	188 minutes	259 minutes

* The above-listed recording times are approximate. Times may be slightly shorter depending on the number of songs that were created.

< Limitations on simultaneous recording and vari-pitch >

Depending on the recording mode you use, and on whether or not vari-pitch is used, there are limits on the number of tracks which can be recorded simultaneously and on the upper limit of vari-pitch.

	Number of tracks which can be recorded simultaneously		
	VARI PITCH not used	VARI PITCH used	VARI PITCH upper limit
Multitrack 1	2 tracks	1 track	47.07 kHz
Multitrack 2	4 tracks	2 tracks	47.07 kHz
Live 1	4 tracks	2 tracks	50.46 kHz
Live 2	4 tracks	2 tracks	50.46 kHz

< Capability for simultaneous recording / simultaneous playback >

When creating a new song using Multitrack 1 (MT1), Multitrack 2 (MT2) or Live 1 (LV1) recording modes, we recommend that you do not exceed the following numbers of tracks for simultaneous recording and playback. If you attempt to simultaneously playback or record more than the following number of tracks, and if the disk drive cannot keep up with the speed at which data must be written or read, the display will indicate "Drive Busy," and the recorder may stop.

	Tracks for simultaneous recording	Tracks for simultaneous playback
Multitrack 1 (MT1)	2 [4]	6
Multitrack 2 (MT2)	2 [6]	8
Live 1 (LV1)	3 [5]	8

The number in square brackets [] indicates the number of playback tracks during recording.

* In cases of unfavorable disk access conditions, such as when track editing or punch-in recording etc. is used to connect phrases (musical data) of several seconds, the "Drive Busy" display may appear even within the above limits on recording and playback.

* If the display indicates "Drive Busy," refer to the "Error message" (p.175) and take the appropriate action.

< Song numbers >

Newly created songs will be given a name such as "InitSong 001." The number following the name is the song number. This name can be modified later. The VS-840EX manages songs on disk by "song numbers." A newly created song will be assigned the lowest song number for which no song is stored. For example if the disk contains songs up through song number 5, the newly created song will be stored as song number 6. If a song numbered 1 to 4 had been deleted, the newly created song would be stored as that song number.

■ Naming the song (Song Name)

When you create a song, it will automatically be given a name like "InitSong001." However this makes it difficult to remember what song it is. We recommend that you assign a unique name to your song so that data management will be easier.

1. Press [UTILITY].
2. Use [CURSOR] to select the Song Edit icon, and press [ENTER/TAP].

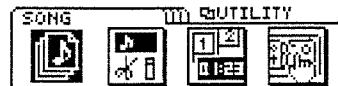

3. Use [CURSOR] to select the Song Name icon, and press [ENTER/TAP].



4. The name of the song (Song Name) will be displayed. Use [CURSOR] to move the cursor to the character that you wish to change.
5. Modify the character. Rotate the TIME/VALUE dial. By holding down [SHIFT] as you rotate the TIME/VALUE dial you can make the characters change more rapidly.
6. When you are finished, press [DISPLAY] to return to Play mode.

■ Connect the instruments

1. Turn down the master fader of the VS-840EX, and connect your instrument to the INPUT 1 jack.

If you wish to connect a guitar, connect it to the INPUT 1 (Hi-Z) jack.

- * Howling could be produced depending on the location of microphones relative to speakers. This can be remedied by:
 1. Changing the orientation of the microphone(s).
 2. Relocating microphone(s) at a greater distance from speakers.
 3. Lowering volume levels.

■ Record a performance onto a track

Here we will explain the procedure for recording the sound that is being input to the INPUT 1 jack on track 1 / V-track 1.

The default settings in this explanation refer to the condition that the VS-840EX will be in when a new song is created.

1. Specify the INPUT jack as the input for channel 1. Make sure that the channel 1 SELECT indicator is lit orange.

If the indicator is not lit orange, refer to "Changing the input of a channel" (page 32).

With the default settings, the SELECT indicators of all channels will be lit orange.

2. Select the input source for channel 1. Press [MODE] to make the CHANNEL mode indicator light. Next, press channel 1 [SELECT] to select channel 1, and press the CHANNEL PARAMETER button [INPUT] to access the input source select page. Here we want to select the INPUT 1 jack, so use the TIME/VALUE dial to select "IN 1."

With the default settings, the INPUT 1 jack is selected as the input source for channel 1.

3. Specify the panning of channel 1. Press [MODE] to make the CHANNEL mode indicator light. Next, press channel 1 [SELECT] to select channel 1, and press the CHANNEL PARAMETER button [PAN] to access the Pan setting page. Here we want to record only on track 1, so use the TIME/VALUE dial to set this to full left (L63). When you finish making the setting, press [DISPLAY] to return to Play mode.

With the default settings, panning of channel 1 will be full center (0).

4. Use the INPUT SENS 1 knob to adjust the input sensitivity.

Raise the volume of your instrument as high as possible so that the input level is high. Raise the input sensitivity as high as possible without causing the PEAK indicator to light.

Normally you should make settings so that the level meter moves in the range of -12 to 0 dB when the channel fader is at 0dB.

Since the sound that passes through the channel fader will be recorded, leave the channel fader in the 0dB position. If you wish to adjust the volume to a level that is comfortable for listening, use the master fader. Moving the master fader will not affect the sound that is being recorded.

5. Send the output of channel 1 from recording bus A/B. Make sure that the BUS AB indicator is lit. If it is not lit, press [MODE] to select BUS mode, and then press channel 1 [SELECT] to make the BUS AB indicator light.

With the default settings, the BUS AB/CD indicators of all channels will be lit.

6. Put track 1 in recording condition. Press the track 1 TRACK STATUS/V.TRACK button to make the button indicator blink red.

With the default settings, V-track 1 is selected for all tracks, so it will not be necessary to select the V-track at this time.

7. Press [REC] to make the button indicator blink in red, and press [PLAY] to start recording.

8. When you finish recording, press [STOP].

9. Audition the performance that you recorded. Put track 1 in playback mode. Press the track 1 [TRACK STATUS/V.TRACK] to make the button indicator light green.

10. Check the performance that was recorded. Press [MODE] to make the SELECT mode indicator light. Next, press channel 1 [SELECT] to make the SELECT indicator light green (the playback sound of track 1 will be input to channel 1).

Press [ZERO] to return to the beginning of the song, and press [PLAY] to start playback.

Switching V-tracks

The VS-840EX has eight tracks on which music can be recorded and played back. Each of these tracks has eight V-tracks on which music can be recorded. When playing back a song, you can select one V-track for each track. In other words, you can use up to 64 tracks to record a performance, and select up to 8 of these tracks for playback.

* *Tracks 5/6 and 7/8 are respectively stereo pairs. This means that it is not possible to (for example) select V-track 1 for track 5 and V-track 2 for track 6. The same V-track will always be selected.*

In this way, unlike when using a conventional multitrack tape recorder, there is no need for you to erase previously-recorded material. Also, you are free to record different "takes" or variations of the same material to different V-tracks, and switch between V-tracks to compare the performances.

To switch V-tracks, use the following procedure.

1. Hold down [SHIFT] and press [TRACK STATUS/V.TRACK] for the track whose V-track you wish to switch.

The V-track select page will appear.

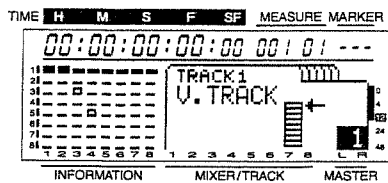

- (■): Currently selected V-track (playback data exists).
- (▬): Currently selected V-track (no playback data).
- (□): V-tracks which contain playback data.
- (-): V-tracks which contain no playback data.

2. Use the TIME/VALUE dial to select a V-track.

If you wish to continue making settings for other track, use [CURSOR] to select the track whose V-track you wish to change, and use the TIME/VALUE dial to select the V-track.

3. When the procedure is completed, press [DISPLAY] to return to Play mode.

Recording additional tracks while listening to the performance (Overdubbing)

The process of newly recording a track while playing back previously recorded tracks is called "overdubbing." Here we will explain the procedure using the example of playing back a stereo recording that was recorded on tracks 1 and 2, and recording other instruments on tracks 7 and 8. Connect INPUT 3 to 4 jacks to the instruments that you wish to newly record.

In this explanation, "default settings" refers to the setting condition of the VS-840EX when a new song is created.

* *The disk will contain old data that existed before the overdubbing operation. If this data is not needed, use Song Optimize (page 101) to delete the unwanted data. That way, you can utilize disk storage space more efficiently.*

1. Make sure that the track status for tracks 1/2 (the tracks for playback) is set to PLAY (the TRACK STATUS indicator is lit green). If the status is not PLAY, press [TRACK STATUS/V.TRACK] for that track several times.

2. Set the track status of the recording destination tracks 7/8 to REC (the TRACK STATUS indicator will blink red). Press the track 7/8 [TRACK STATUS/V.TRACK] several times.

3. Set the input of channels 1/2 to TRACK, and the input of channels 7/8 to INPUT. Press [MODE] to make the SELECT mode indicator light. Next, press channel 1 [SELECT] to make the SELECT indicator light green (the playback of track 1 will be input to channel 1). In the same way, select TRACK as the input of channel 2.

In addition, press channel 7/8 [SELECT] to make the SELECT indicator light orange (the input of the INPUT jacks will be the input for channels 7/8).

4. Select the input source for channels 7/8. Press [MODE] to make the CHANNEL mode indicator light. Next, press channel 7/8 [SELECT] to select channel 7/8, and press the CHANNEL PARAMETER button [INPUT] to access the input source select page. Here you want to select the INPUT 3/4 jack, so use the TIME/VALUE dial to select "3/4."

With the default settings, the INPUT 3/4 jacks are selected as the input source for channels 7/8.

5. Set the balance of channels 7/8. Press [MODE] to make the CHANNEL mode indicator light. Next, press channel 7/8 [SELECT] to select channel 7/8, and then press the CHANNEL PARAMETER button [PAN] to access the balance setting page. Here you want to record in stereo to tracks 7/8, so use the TIME/VALUE dial to set the parameter to center (0). When you finish making settings, press [DISPLAY] to return to Play mode. With the default settings, the panning of channel 7/8 is set to center (0).
6. While producing sound on the instruments to be recorded, adjust the input levels. Adjust input 3 using the INPUT SENS 3 knob, and input 4 using the INPUT SENS 4 knob.
7. Send the output of channel 7/8 to recording bus C/D. Make sure that the BUS CD indicator for channel 7/8 is lit. If it is not lit, press [MODE] to select BUS mode, and then press channel 7/8 [SELECT] to make the BUS CD indicator light. With the default settings, the BUS AB/CD indicators for all channels will be lit.
8. Press [ZERO] to return to the beginning of the song. Then press [REC] to enter record ready mode (the REC indicator blinks red), and press [PLAY] to begin recording.
9. When you finish recording press [STOP].
10. Verify the recorded result. Set the track status of track 7/8 to PLAY, and select TRACK as the input for channel 7/8. Press [ZERO] to return to the beginning of the song, and press [PLAY] to playback.

Re-recording only your mistakes (Punch-in/out)

Sometimes a recording will contain just one or two sections that were not played correctly, or that you wish to re-record. In such cases, you can use punch-in recording to re-record only a specific area.

“Punch-in” refers to the action of switching from playback mode to record mode. Conversely, “punch-out” refers to the switch back to play mode. In other words, you will punch-in at the beginning of the area that you wish to re-record, and punch-out at the end of the area.

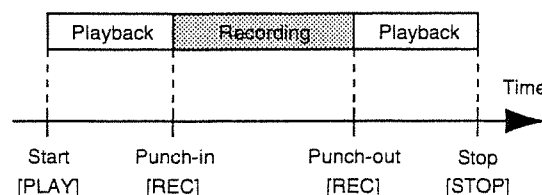

* The disk will contain old data that existed before the punch-in operation. If this data is not needed, use *Song Optimize* (p. 101) to delete the unwanted data. That way, you can utilize disk storage space more efficiently.

* By using the *Undo* function (page 100) you can return to the condition before re-recording.

There are two types of punch-in/out: manual punch-in/out and auto punch-in/out. Here we will explain how to use manual punch-in/out.

What is manual punch-in?

In this method, you punch-in and punch-out by pressing a button or a footswitch. When you are both playing the instrument and operating the recorder by yourself, it is usually not practical to reach over and press a button. In such cases, use an optional footswitch.

■ Punch-in/out using the record button

Here we will explain the procedure for sending the input from INPUT 1 to channel 1, and re-recording part of track 1.

* When you perform punch-in recording, listen to the headphones or to the output of the MON/AUX jacks.

1. Select the INPUT 1 jack as the input for channel 1. (page 32)
2. Specify REC AB as the recording bus for output. (page 32)
3. Set the channel 1 pan to full left (L63). (page 32)

4. Set the track 1 track status to REC (the TRACK STATUS indicator will blink red). (page 33)
5. Press [MONITOR SEL] several times to set Monitor Select to TRACK CUE (the button indicator will light green).
6. Playback the song from the beginning, and use the INPUT SENS 1 knob to adjust the level of the input source. During song playback, you can press [TRACK STATUS/V.TRACK] to switch between monitoring the input source and the track. Listen to compare the track to be re-recorded with the input source, and adjust the level so that there is no volume difference.
When the TRACK STATUS indicator blinks red, the input source can be monitored. When red and green are blinking alternately, the track playback sound can be monitored.
7. After you have adjusted the level of the input source, press [MONITOR SEL] several times to set Monitor Select to "TR CUE+MASTER" (the button indicator will light orange).
** If while recording, you wish to hear the sound that is being played, raise the master fader.*
8. Playback the song from a location slightly before where re-recording will begin.
9. At the point where you wish to re-record, press [REC] to punch-in, and re-record the vocal or instrumental part. To punch-out, press [REC] (or [PLAY]) once again. Each time you press [REC], you will alternately punch-in and punch-out, so if there is another area that you wish to re-record, repeat the same operation.
10. When you finish recording, press [STOP].
11. Check the re-recorded result. Switch the track status of track 1 to PLAY (the TRACK STATUS indicator will light green), and playback the song from the beginning.
Use TRACK CUE 1 to adjust the volume of track 1.

■ Punch-in/out using a foot switch

Using the foot switch

If you wish to use an optional footswitch to punch-in/out, connect the footswitch to the FOOT SWITCH jack. Then use the following procedure to set the function of the FOOT SWITCH jack so that it can be used for punching in/out.

1. Press [UTILITY].

2. Use [CURSOR] to select the System Utility icon, and press [ENTER/TAP].

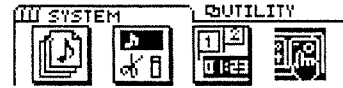

3. Use [CURSOR] to select the Global Parameter icon, and press [ENTER/TAP].

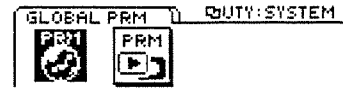

4. Use [CURSOR] to move the cursor to "Foot Switch," and use the TIME/VALUE dial to select "Record."
5. Press [DISPLAY] to return to Play mode.

Foot Switch

This sets the function of the foot switch connected to the FOOT SWITCH jack.

Play/Stop:

The song will alternately playback and stop each time the foot switch is pressed.

Record:

The foot switch will have the same function as the [REC]. Use this to switch between recording and playback during manual punch-in recording.

Tap Marker:

The foot switch will have the same function as the [TAP]. A Mark point will be placed at the time location where you press the foot switch.

Previous:

Each time you press the foot switch, you will move to the previous Mark point.

Next:

Each time you press the foot switch, you will move to the next Mark point.

Effect:

One parameter specified by each algorithm is assigned to the foot switch.

TUNER:

Pressing on the foot switch will alternately switch the On/Off status of the tuner.

Efx Prev:

Each time you press the foot switch, you will move to the previous effect patch.

Efx Next:

Each time you press the foot switch, you will move to the next effect patch.

Recording a previously-specified section (Auto Punch-in)

Auto punch-in recording lets you automatically punch-in and punch-out at previously specified locations. This is convenient when you need to punch-in/out at a precise time, or when you want to punch-in/out automatically so that you can concentrate on your playing.

* *The disk will contain old data that existed before the punch-in operation. If this data is not needed, use Song Optimize (page 101) to delete the unwanted data. That way, you can utilize disk storage space more efficiently.*

Specify the location for recording

Before you begin recording, set the times for punch-in and punch-out.

1. Locate points 1/2 will be the punch-in and punch-out points respectively. Set locate points 1/2 to the desired punch-in and punch-out times.

* *If you wish to punch-in/punch-out at Mark Point locations, first move to the mark point where you wish to punch-in, and register that time for locate point 1. Next move to the mark point where you wish to punch-out, and register that time for locate point 2.*

* *For the procedure of registering a time for a locate point, refer to "Storing a time location" (page 35). For details on moving between mark points, refer to "Moving to a marked time location" (page 36).*

Recording procedure

Here we will explain the procedure of sending the input of INPUT 1 to channel 1, and using auto-punch to re-record a portion of track 1.

* *When you perform punch-in recording, listen to the headphones or to the output of the MON/AUX jacks.*

- 1.** Select the INPUT 1 jack as the input for channel 1. (page 32)
- 2.** Specify the REC AB bus as the recording bus for output. (page 32)
- 3.** Set the panning of channel 1 to full left (L63). (page 32)
- 4.** Set the track 1 track status indicator to REC (the TRACK STATUS indicator will blink red). (page 33)
- 5.** Press [MONITOR SEL] several times to set Monitor Select to TRACK CUE (the button indicator will light green).

6. Use the INPUT SENS 1 knob to adjust the level of the input source. During song playback, you can press [TRACK STATUS/V.TRACK] to switch between monitoring the input source and the track. Listen to compare the track to be re-recorded with the input source, and adjust the level so that there is no volume difference.

When the TRACK STATUS indicator is blinking red, the input source can be monitored. When it is blinking alternately red and green, the track playback can be monitored.

7. After you have adjusted the level of the input source, press [MONITOR SEL] several times to set Monitor Select to "TR CUE+MASTER" (the button indicator will light orange).

* *If while recording, you wish to hear the sound that is being played, raise the master fader.*

8. If you press [AUTO PUNCH] while the song is stopped, the AUTO PUNCH indicator will light and you will be ready to use auto punch-in recording.

9. Move to a time before the location that you wish to re-record, press [REC] to enter record ready mode, and press [PLAY].

When the specified punch-in location is reached, punch-in will occur automatically, so re-record the vocal or instrumental part. When the specified punch-out location is reached, the channel will automatically return to playback mode.

10. When you finish recording, press [STOP].

11. Check the re-recorded result. Switch the track status of track 1 to PLAY (the TRACK STATUS indicator will light green), and playback the song from the beginning.

Use TRACK CUE 1 to adjust the volume of track 1.

Repeatedly recording the same location (Loop Recording)

The loop function lets you repeatedly playback a specified area (the loop). If the loop function is used for punch-in recording, you will be able to hear the recorded result immediately. If the result is not what you wanted, you can continue re-recording.

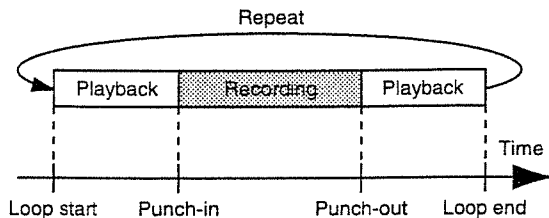

- * To specify the area for re-recording (the punch-in point and punch-out point), refer to the previous section "Auto punch-in."

Specify the area to be repeated

Before you begin recording, specify the begin and end times for the loop.

- * Make settings so that the loop completely includes the area to be re-recorded (i.e., from the punch-in point to the punch-out point). If the area to be re-recorded is not completely within the loop, recording may not start at the specified location, or may be interrupted in the middle of the area for recording.

1. Locate points 3/4 are the loop start / loop end points respectively. Register the loop start / loop end times in locate points 3/4.

- * If you wish to use Mark Point time locations as the loop start / loop end times, you must first move to the mark point that will be the loop start, and register that time for locate point 3. Then move to the mark point that will be the loop end, and register that time for locate point 4.

Recording procedure

Here we will explain the procedure for sending the input of INPUT 1 to channel 1, and using the Loop function and Auto Punch-in to re-record a portion of track 1.

- * When you perform punch-in recording, listen to the headphones or to the output of the MON/AUX jacks.
1. Select the INPUT 1 jack as the input for channel 1. (page 32)
 2. Specify the REC AB bus as the recording bus for output. (page 32)

3. Set the channel 1 pan to full left (L63). (page 32)
4. Set the track status of track 1 to REC (the TRACK STATUS indicator will blink red. (page 33)
5. Press [MONITOR SEL] several times to set Monitor Select to TRACK CUE (the button indicator will light green).
6. Use the INPUT SENS knob to adjust the level of the input source. During song playback, you can press [TRACK STATUS/V.TRACK] to switch between monitoring the input source and the track. Listen to compare the track to be re-recorded with the input source, and adjust the level so that there is no volume difference. While the TRACK STATUS indicator is blinking red, the input status can be monitored. While it is blinking alternately red and green, the track playback can be monitored.
7. After you have adjusted the level of the input source, press [MONITOR SEL] several times to set Monitor Select to "TR CUE+MASTER" (the button indicator will light orange).
 - * If while recording, you wish to hear the sound that is being played, raise the master fader.
8. With playback stopped, press [LOOP] to make the LOOP indicator light. Then press [AUTO PUNCH] to make the AUTO PUNCH indicator light. You are now ready to record.
9. Press [PLAY]. Playback will begin from the current time. When the loop end location is reached, playback will return to the loop start location and continue.
10. If you wish to re-record, press [REC] to begin recording. Press [REC], and you will be able to record from the first-appearing punch-in point until the punch-out point. Re-record as desired. On the next playback, you can hear the newly re-recorded performance. If you are not satisfied, press [REC] and try again.
11. When you finish recording, press [STOP]. Playback the song from the beginning to check the result once again. Press [LOOP] to make the LOOP indicator go dark, and press [AUTO PUNCH] to make the AUTO PUNCH indicator go dark. Switch the track status of track 1 to PLAY (the TRACK STATUS indicator will light green), and then playback the song from the beginning. Use TRACK CUE 1 to adjust the volume of track 1.

Combining the performances of two or more tracks into another track (Track bouncing)

The VS-840EX can simultaneously playback up to 8 tracks. If you wish to playback the contents of more than 8 tracks, or if you run out of empty tracks, you can merge the contents of two or more tracks onto a different track. This procedure is called "track bouncing."

Here we will explain the example of mixing two stereo performances that were recorded on tracks 1/2 and tracks 3/4, and "bouncing" them to tracks 5/6.

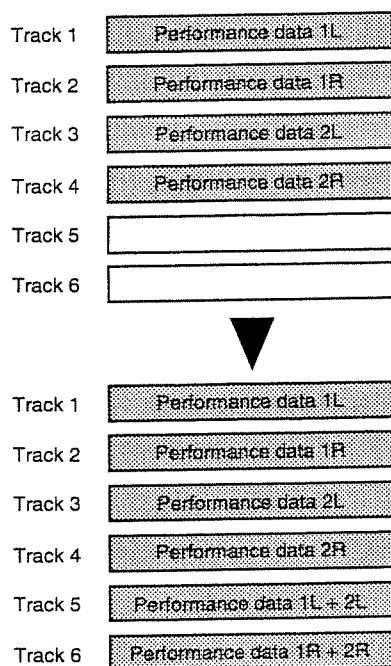

1. Select TRACK as the input for channels 1 to 4. (page 32)
2. Select REC AB bus as the output recording bus for channels 1 to 4. (page 32)
3. Set pan to full left (L63) for channels 1/3, and full right (R63) for channels 2/4. (page 32)
4. Set the track status of tracks 1 to 4 to PLAY, and the track status of tracks 5/6 to REC. Playback the song, and use the faders of channels 1 to 4 to adjust the volume balance. At this time, raise the volume level as far as possible without causing distortion. (page 33)
5. Return to the beginning of the song, press [REC], and then press [PLAY] to begin recording.
6. When you finish recording, press [STOP].
7. Check the result that was recorded on tracks 5/6. In this example, tracks 1 to 4 and tracks 5/6 have the same contents, so set the track status of tracks 1 to 4 to MUTE, and the track status of tracks 5/6 to PLAY.

Creating a master tape

When you finish recording the song, adjust the balance of each track (equalizer, pan, and volume level), and record the mix to a two-channel stereo master tape. This process is called "mixdown."

* If you wish to add an effect such as reverb during mixdown, refer to "Applying reverb while bouncing tracks" (page 86). When mixing down, it is convenient to use the "Mixdown icon" (page 42) of the Easy Routing function to easily make all necessary settings, from mixer settings to effect settings.

■ Adjusting the tone (Equalizer)

A parametric equalizer is provided for each channel. First make equalizer adjustments separately for each channel. If you have recorded any stereo pairs, be sure that the same settings are made for both tracks. Then, while paying attention to the overall balance, make final adjustments for equalizer, pan, and volume level for each channel.

* If you adjust the equalizer while listening to the sound, you may notice a clicking noise. This is not a malfunction. If the noise is objectionable, make adjustments while the sound is not playing.

1. Press [MODE] to make the CHANNEL mode indicator light.
2. Press [SELECT] for the channel whose equalizer you wish to adjust.
3. Press the CHANNEL PARAMETER button [EQ].
4. Use [CURSOR] to select parameters, and use the TIME/VALUE dial to modify the value. The display will graphically indicate the equalizer setting.
5. If you wish to adjust other channels as well, use [CURSOR] to select the desired channel and perform the same procedure to make adjustments. When you finish making adjustments for each desired channel, press [DISPLAY] to return to Play mode.

Switch	Off, On
Low Gain	-12dB to +12dB
Low Freq	40Hz to 1.5kHz
Mid Gain	-12dB to +12dB
Mid Freq	200Hz to 8kHz
Mid Q	0.5 to 16
Hi Gain	-12dB to +12dB
Hi Freq	500Hz to 18kHz

Switch

If you wish to use the equalizer, set this "On." If not, set this "Off."

Low Gain

Low Freq (low frequency)

This sets the gain (-12 to +12 dB) and center frequency (40 Hz to 1.5 kHz) for the low-range equalizer (shelving type).

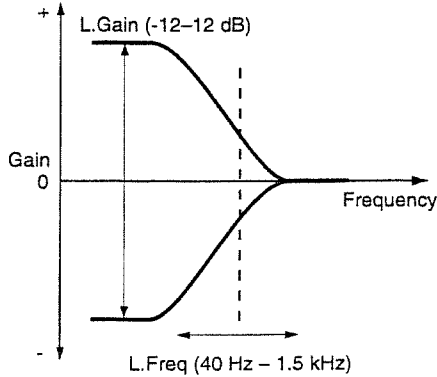

Hi Gain (high gain)

Hi Freq (high frequency)

For the equalizer (shelving type) which adjusts the tone of the high frequency range, adjust the Gain (-12 to 12 dB) and the center frequency (500 Hz to 18 kHz).

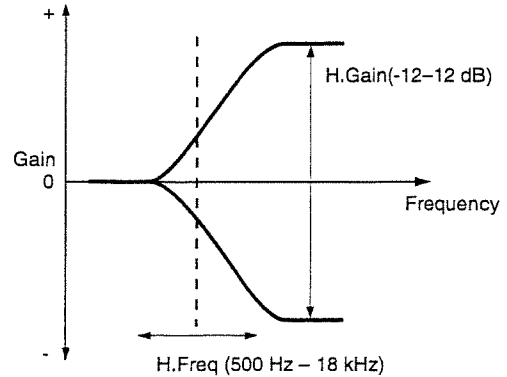

Mid Gain (middle gain)

Mid Freq (middle frequency)

Mid Q (middle Q)

For the equalizer (peaking type) which adjusts the tone of the mid-frequency range, adjust the Gain (-12 to +12 dB), the center frequency at which the gain will be adjusted (200 Hz to 8 kHz), and the Q (0.5 to 16).

Q determines the way in which the gain of the frequency range is affected. Higher values will produce a sharper change.

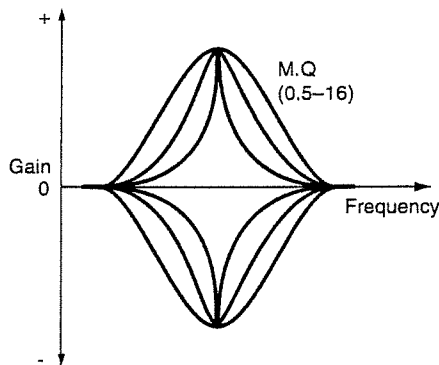
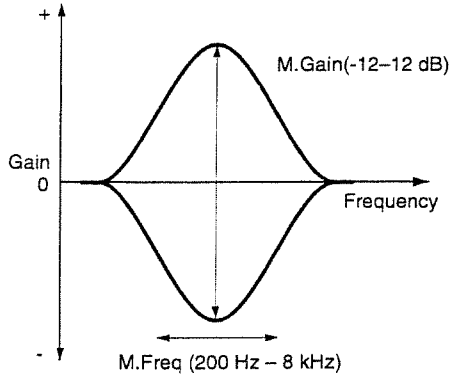

■ Adjusting the volume and pan (Level/Pan)

Use the channel faders to adjust the volume level of each channel, and use the pan setting page to adjust the pan for each channel.

To adjust the volume level of each track, first adjust the volume level for the track containing the most important part of the song (e.g., the vocal or melodic instrument). Then, relative to the volume level of that track, lower the volume levels of other tracks to create the desired balance.

Pan setting procedure

1. Press [MODE] to make the CHANNEL mode indicator light. Next, press [SELECT] for the channel whose pan you wish to adjust, and press the CHANNEL PARAMETER button [PAN] to access the pan setting page. Use the TIME/VALUE dial to adjust the setting.
2. In the same way, make pan settings for the other channels as well. To access the pan setting page for other channels, simply press [SELECT] for the desired channel, or use [CURSOR ⏪ ⏩] to select the channel.
3. When you finish making adjustments for all channels, press [DISPLAY] to return to Play mode.

■ Mixing down to 2-channel stereo (Mix Down)

When the balance of the tracks has been completed, use your stereo recorder (cassette tape recorder, DAT recorder, MD recorder, etc.) to create a stereo master tape.

* *The digital interface of the VS-840EX conforms to S/P DIF. If you wish to record the digital signal, use a digital recorder that is compatible with these standards.*

If you are using a cassette tape

- 1. Connect the recorder to the VS-840EX.**
Use an RCA phono type cable to connect the input jacks of your recorder to the MASTER OUT jacks of the VS-840EX.
- 2. Adjust the recording level of the recorder.**
Use the master fader to adjust the output level of the VS-840EX, setting it as high as possible without overloading the input of the recorder. Set the recording level of the recorder so that the level meters indicate as high as possible without causing distortion.
- 3. Press [ZERO] on the VS-840EX to return to the beginning of the song, and put your recorder in record ready mode.**
- 4. Press [PLAY] on the VS-840EX, and begin recording on your recorder. If you wish to produce a fade-in or fade-out, use the master fader of the VS-840EX.**
- 5. When you finish recording, stop the recorder and the VS-840EX.**

If you are using a DAT (MD)

- 1. Connect the recorder to the VS-840EX.**
Connect the digital input connector (coaxial, optical) of your digital recorder to the DIGITAL OUT connector (coaxial, optical) of the VS-840EX.
- 2. If you have connected a digital recorder by a digital connection, make settings on your digital recorder so that it will record from its digital input. Also, set the sample rate of the recorder to match the sample rate of the recording source song. Many digital recorders automatically sense the sample rate of the recording source, so that it is unnecessary to make this setting manually.**
 - * *Some DAT recorders are not able to record a digital signal at a sample rate of 44.1 kHz. In this case, use analog connections instead, and set the digital recorder to record from its analog input.*
 - * *If you do not know the song's sample rate and recording mode, Hold down [SHIFT] and press [INFORMATION (DISPLAY)].*
- 3. Press [ZERO] on the VS-840EX to return to the beginning of the song, and put your recorder in record ready mode.**
- 4. Press [PLAY] on the VS-840EX, and begin recording on your recorder. If you wish to produce a fade-in or fade-out, use the master fader of the VS-840EX.**
- 5. When you finish recording, stop the recorder and the VS-840EX.**

Chapter 7. Editing a recorded performance (track editing)

This chapter explains the content and procedures for editing sound that has been recorded. Please read this chapter to gain an understanding of the concepts of "editing" that were impractical with conventional tape MTR units.

What is editing?

One of the most important features of digital disk recorders is that they allow re-recording and editing that does not affect the sound quality.

On a multi-track analog tape recorder, it is necessary to erase a previously made recording in order to modify it. Also if you wish to change the organization of a song, you must re-record it from the beginning. This type of editing which re-writes the original data is known as "destructive editing."

In contrast, multi-track digital disk recorders allow you to use an Undo function to cancel the editing operation and return to the data as it was before editing. Furthermore, since copying data has effect on the sound, you can copy the original data before editing and save it. It is also easy to copy parts of the data to different locations, or to erase specified portions of the data. Editing of this type which allows the original data to be recovered is known as "non-destructive editing."

The VS-840EX uses non-destructive editing. In other words, even if you perform an operation such as deleting a portion of the playback data, or record over a track which already contained playback data, the previously recorded data will be preserved.

This means that simply deleting playback data will not increase the remaining time available for recording. Also, the remaining recording time will decrease even if you record over an existing track.

If you wish to increase the remaining recording time by deleting the playback data that was saved to allow recovery of the original data, refer to "Deleting only unneeded performance data (Song Optimize)" (p.101).

Finding a desired location (Preview)

When editing a song, you will often need to determine precise times such as where the sound begins, the beginning of a break, or the area for auto punch-in recording, etc. On the VS-840EX you can use the Preview function to find precise time locations.

The Preview function has three buttons, each with a different operation. Use the one appropriate for your situation.

■ Using [TO] and [FROM]

The [TO] and [FROM] buttons let you playback a specified area of time (1.0 to 10.0 sec) before and after the current time. By using this function as you gradually move the area, you can accurately determine the desired time.

Each button performs the following function. The preview length is initially set to 1.0 seconds, but you may change this as necessary.

[TO]:

The preview length ending at the current time will playback once.

[FROM]:

The preview length beginning at the current time will playback once.

[TO]+[FROM]:

Through the current time, playback one time for double the Preview Length

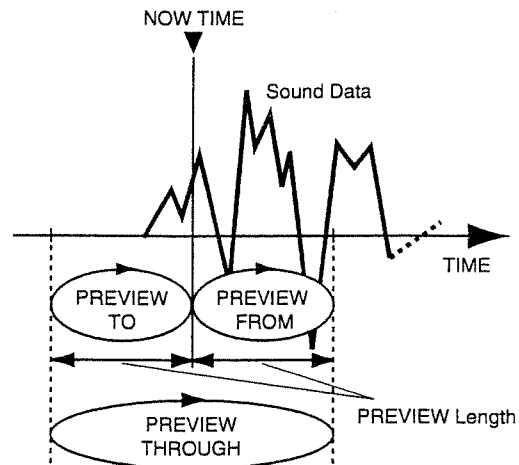

Finding the location where the sound begins (example)

1. Make settings so that the track(s) you wish to monitor will playback, start the song playing back, and stop at the time where the sound begins.
2. Enable the Preview function. Hold down [SHIFT] and press [PREVIEW(SCRUB)] to make the SCRUB indicator blink.
The [STOP]/[PLAY] buttons will function as the [TO]/[FROM] buttons respectively.
3. First press [TO] or [FROM] to playback the recorded before and after the current time, to determine whether the beginning of the sound is earlier or later than the current time. Next, move the current time until you can hear a bit of the beginning of the sound when you press [TO]. Finally, move the current time until the sound begins precisely when you press [FROM].
4. When you find the precise location where the sound begins, place a mark point at the current time or store the current time in a locate point so that you will be able to easily find it later.

Adjusting the preview length

1. Press [UTILITY].
2. Use [CURSOR] to select the System Utility icon, and press [ENTER/TAP].



3. Use [CURSOR] to select the Play/Rec Parameter icon, and press [ENTER/TAP].



4. Use [CURSOR] to move the cursor to "PREVIEW Length," and use the TIME/VALUE dial to adjust the preview length.
5. When you finish making settings, press [DISPLAY] to return to Play mode.

PREVIEW Length

This sets the time length (1.0 to 10.0 sec) that is played back when the [TO] or [FROM] button of the Preview function is pressed.

■ Scrub playback ([SCRUB])

Press [SCRUB] when you wish to determine more accurately the location where sound begins.

Similarly to [TO] and [FROM], [SCRUB] lets you playback a specified area before and after the current time. To select whether the area before or the area after the current time will be played back, press [TO] or [FROM].

When you press [SCRUB] the button indicator will light, and the specified area will be played back repeatedly. When you are finished, press [SCRUB] once again to make the button indicator go dark. Only the single track that is specified will be played back.

If you wish to playback other tracks, press the TRACK STATUS/V.TRACK buttons to specify this.

The playback time (25 to 100 msec) is shorter than when [TO] and [FROM] are used. The initial value of 45 msec, but you may change this as necessary.

The waveform of the sound being played back is displayed in the display, providing a visual check.

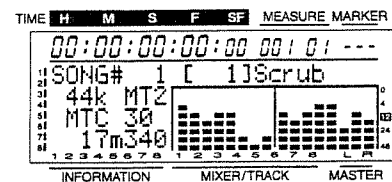

Finding the location where sound begins (example)

1. Press [SCRUB] to make the button indicator light, and the specified area will be played back repeatedly. To select whether the area before or the area after the current time will be played back, press [TO] or [FROM].
2. Use [TRACK STATUS/V.TRACK] to select the track that you wish to check.
In the case of track 5/6, track 5 and track 6 will alternate each time you press the button. The same applies to track 7/8. The display will indicate which track is currently being "scrubbed."
3. If you are playing back the area before the current time, adjust the time so that you just miss hearing the sound. If you are playing back the area following the current time, adjust the time so that you hear the very beginning of the sound.
4. When you have found the precise location where the sound begins, press [SCRUB] once again to end the procedure. Also, place a mark point at the current time or store the current time in a locate point so that you will be able to easily find it later.

Adjusting the scrub length

1. Press [UTILITY].
2. Use [CURSOR] to select the System Utility icon, and press [ENTER/TAP].



3. Use [CURSOR] to select the Play/Rec Parameter icon, and press [ENTER/TAP].



4. Use [CURSOR] to move the cursor to "SCRUB Length," and use the TIME/VALUE dial to adjust the scrub length.
5. When you finish, press [DISPLAY] to return to Play mode.

SCRUB Length

This sets the time length (25 to 100 ms) that is played back when the Preview function [SCRUB] button is pressed.

Basic procedure

Here is the basic procedure for Track Edit. In the explanations which follow, this basic procedure will be abbreviated.

1. Press [UTILITY].
2. Use [CURSOR] to select the Track Edit icon, and press [ENTER/TAP].

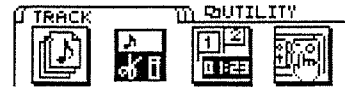

3. The following icons will appear. Use [CURSOR] to select the desired icon, and press [ENTER/TAP].

Track Copy icon
 Track Move icon
 Track Exchange icon
 Track Insert icon
 Track Cut icon
 Track Erase icon
 Track Copy + Insert icon
 Track Move + Insert icon

4. A display screen will appear in which you can select the track / V-track to which the operation will apply. Use [CURSOR] and the TIME/VALUE dial to select the track / V-track.

Multiple tracks / V-tracks can be selected as the object of the operation. If two or more are selected, the operation will be executed with the same settings for each of the tracks / V-tracks.

5. Specify the area or time that will be affected. Move the cursor to the "TIME" icon, and press [ENTER/TAP].

Times can also be specified using mark points or locate points. To audition the performance in the vicinity of the current time location, use the Preview function (page 65).

* There is no "TIME" icon for Track Exchange.

6. When you have finished making all settings, move the cursor to the "GO" icon, and press [ENTER/TAP]. The operation will be executed and you will return to Play mode.

* If after auditioning the result of the operation, you would like to return to the original state before the operation, use the Undo function (page 100).

Re-using part of the performance (Copy)

This operation copies the playback data of a specified area to another location. This operation lets you copy the data of two or more tracks at once, or copy the specified data to a specified location two or more times in succession. When you wish to use a phrase that is recorded in a track, or when a song contains a phrase that is repeated, the Copy operation will let you create the song more efficiently.

Normally, the data will be copied starting at the specified copy destination time. However it is also possible to specify the copy destination time as a base time at which a specific sound occurs. This is done using the "FROM" setting item.

For example suppose that you wish to copy a sound effect of a time bomb ticking and then exploding, and that you want to place the explosion at a specific timing location. Normally, you would have to calculate the time until the explosion in order to specify the copy destination time. However in such cases, you can specify "FROM" as "the copy source time at which the explosion begins," and specify "TO" (the base time of the copy destination) as "the copy destination time at which you want the explosion to occur." This lets you copy the data with the explosion placed at precisely the right timing.

Example 1: Copying twice to the same track

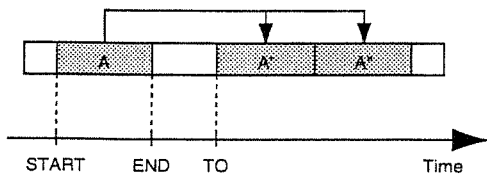

Example 2: Copying twice to a different track

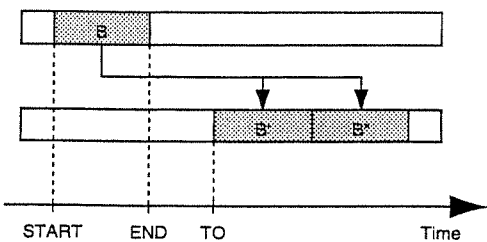

Example 3: Copying using the "FROM" setting

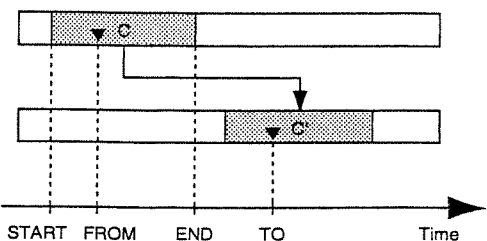

- * If playback data exists at the copy destination, that data will be overwritten.
- * The length of the data to be copied must be greater than 1.0 seconds. If data shorter than 1.0 seconds is copied, the sound will not playback.

1. Press [UTILITY].
2. Use [CURSOR] to select the Track Edit icon, and press [ENTER/TAP].



3. Use [CURSOR] to select the Track Copy icon or the Track Insert icon, and press [ENTER/TAP].

Track Copy icon



Track Copy +Insert icon



If you select the Track Insert icon, a blank space will be inserted to the specified area of the copy destination, then copy will execute.

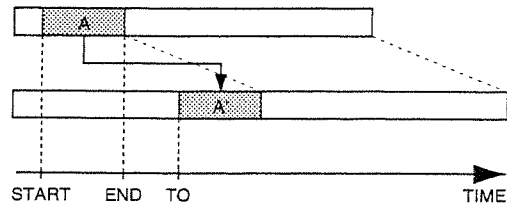

4. The track copy page will appear, allowing you to specify the track / V-track that will be the copy source and copy destination. Use [CURSOR] and the TIME/VALUE dial to select the copy source and copy destination track / V-track.

If there are other tracks that you would like to copy with the same settings, press [CURSOR ▾]. Now you can specify the new copy source and copy destination tracks. In this case, it will not be possible to select copy destination tracks that have already been selected as copy source tracks. If there are any tracks for which you would like to cancel the Copy operation, use the TIME/VALUE dial to display "?." The Copy operation will not be executed for lines which contain even one "?"

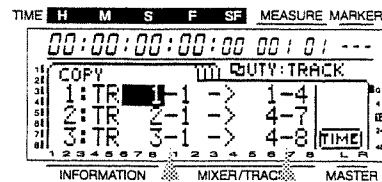

Copy destination (Track - V track) Copy source (Track - V track)

- Specify the copy range and the time location of the copy destination. Move the cursor to the "TIME" icon, and press [ENTER/TAP] to access the Track Copy (TIME) page. Make settings for the following items.

START (start point):

Specify the starting time of the copy source playback data.

END (end point):

Specify the ending time of the copy source playback data.

FROM (from point):

Specify the time of the copy source playback data that will correspond to the To point. Normally you will set this to be the same as the Start point.

TO (to point):

Specify the base time of the copy destination.

COPY (copy Time):

Specify the number of copies (1 to 99).

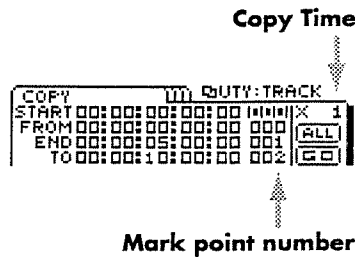

You can also use Mark Points to specify time locations. Move the cursor to the mark point number area in each line, and use the TIME/VALUE dial to make a selection. To specify a time as a Locate Point, move the cursor to the line that you wish to modify, and press a LOCATOR button to specify the time location.

If you wish to specify the entire area between the song top and the song end as the Copy range, select the "ALL" icon and press [ENTER/TAP].

Pressing [ENTER/TAP] outside the "ALL" icon or the "GO" icon and the Measure display page will appear, press one more time for the Time display page.

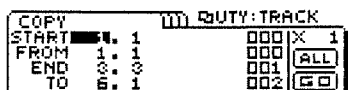

- When you have finished making settings, move the cursor to the "GO" icon and press [ENTER/TAP] to execute the Copy operation.

Modifying the organization of the performance (Move)

This operation moves the playback data of the specified area to another location. This can be used to correct skewed timing that occurred during recording. This operation can move the timing of two or more tracks of playback data at once.

Normally when moving playback data, the data will be moved so that it begins at the move destination timing. However it is also possible to move the data relative to a location within the data at which a specific sound occurs. To do so, use the "FROM" setting.

For example suppose that you wish to move a sound effect of a time bomb ticking and then exploding, so that the explosion occurs at a specific timing location. Normally, you would have to calculate the time until the explosion in order to specify the move destination time. However in such cases, you can specify "FROM" as "the move source time at which the explosion begins," and specify "TO" (the base time of the move destination) as "the move destination time at which you want the explosion to occur." This lets you move the data with the explosion placed at precisely the right timing.

Example 1: Moving within the same track

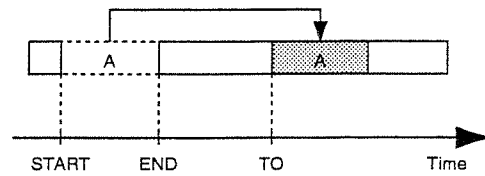

Example 2: Moving to a different track

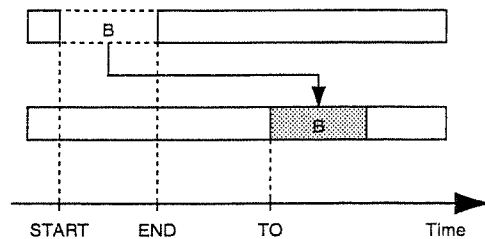

Example 3: Moving using the "FROM" setting

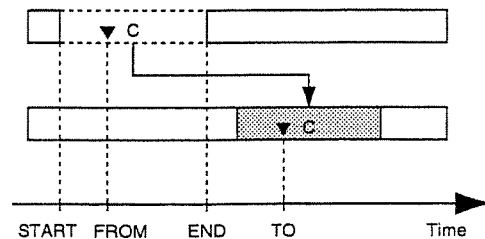

- * If playback data exists at the move destination, that data will be overwritten.
- * The length of the data to be moved must be greater than 1.0 seconds. If data shorter than 1.0 seconds is moved, the sound will not play back.
- * Before and after the region being moved, do not leave sound that is 1.0 seconds or shorter. Any material of a second or less that has remained there will no longer play back.

1. Press [UTILITY].
2. Use [CURSOR] to select the Track Edit icon, and press [ENTER/TAP].



3. Use [CURSOR] to select the Track Move icon or Track Move + Insert icon, and press [ENTER/TAP].

Track Move icon



Track Move + Insert icon



If you select the Track Insert icon, a blank space will be inserted to the specified area of the move destination, then move will execute.

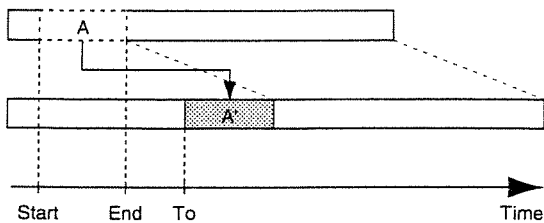

4. The Track Move page will appear, allowing you to select the move source and move destination tracks/V-tracks. Use [CURSOR] and the TIME/VALUE dial to select the move source and move destination track/V-track.

If there are other tracks that you wish to move with the same settings, press [CURSOR \heartsuit]. Now you can specify the new move source and move destination tracks. In this case, it will not be possible to select move destination tracks that have already been selected as move source tracks. If there are any tracks for which you wish to cancel the Move operation, use the TIME/VALUE dial to make the display read "?". The Move operation will not be executed for lines which contain a "?".

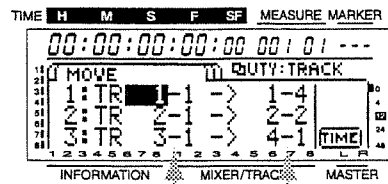

Move destination (Track - V track) Move source (Track - V track)

5. Specify the area to be moved and the time location to which the data will be moved. Move the cursor to the "TIME" icon, and press [ENTER/TAP] to access the Track Move (TIME) page. Make settings for the following items.

START (start point):

Specify the starting time of the move source playback data.

END (end point):

Specify the ending time of the move source playback data.

FROM (from point):

Specify the time of the move source playback data that will correspond to the To point. Normally you will set this to be the same as the Start point.

TO (to point):

Specify the base time of the move destination.



Mark point number

You can also use Mark Points to specify time locations. Move the cursor to the mark point number in each line, and use the TIME/VALUE dial to make a selection. To use a Locate Point to specify a time, move the cursor to the line that you wish to change, and press a LOCATOR button to specify the time.

To specify the entire area from the beginning to the end of the song as the area to be moved, select the "ALL" icon and press [ENTER/TAP].

Pressing [ENTER/TAP] outside the "ALL" icon or the "GO" icon and the Measure display page will appear, press one more time for the Time display page.

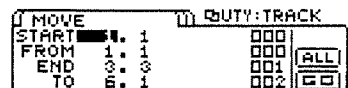

6. When you finish making settings, move the cursor to the "GO" icon and press [ENTER/TAP] to execute the Move operation.

Exchanging performance data between tracks (Exchange)

This operation exchanges the playback data of two tracks.

Example: Exchanging tracks 1 and 2

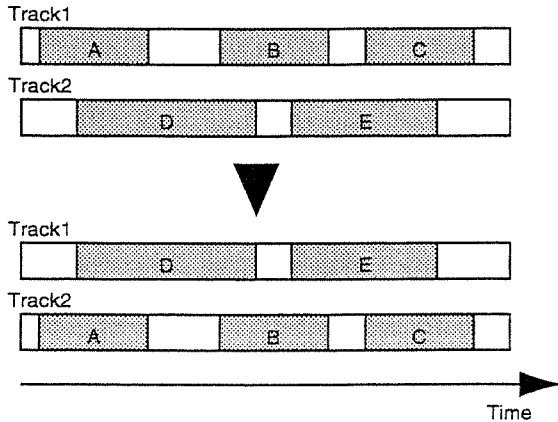

1. Press [UTILITY].
2. Use [CURSOR] to select the Track Edit icon, and press [ENTER/TAP].



3. Use [CURSOR] to select the Track Exchange icon, and press [ENTER/TAP].

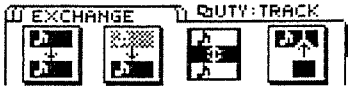

4. The Track Exchange page will appear, allowing you to select the exchange source and destination tracks/V-tracks. Use [CURSOR] and the TIME/VALUE dial to select the exchange source and destination tracks/V-tracks.

If there are other tracks that you wish to exchange, press [CURSOR ∇].

You will be able to specify a new set of tracks to be exchanged. In this case, it is not possible to set the exchange destination track to a track that was already specified as an exchange source track.

If you wish to cancel the Exchange operation for a track, use the TIME/VALUE dial to select "?". The Exchange operation will not be executed for a line on which there is even one "?".

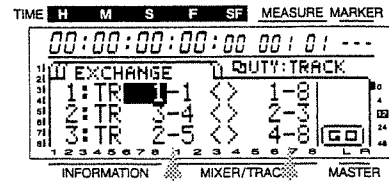

Exchange destination (Track - V track) Exchange source (Track - V track)

5. When you finish specifying the tracks, move the cursor to the "GO" icon and press [ENTER/TAP] to execute the Exchange operation.

Inserting blank space into a performance (Insert)

This operation inserts blank space at the specified location. When you wish to add a phrase into the playback data, you can insert a blank of the appropriate length, and then record the phrase into the blank area.

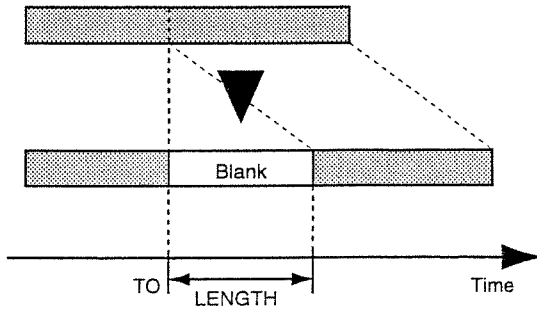

* Do not leave sound within 1.0 seconds before or after the area into which the data will be inserted. Any sound which was within 1.0 seconds of the inserted data will not playback.

1. Press [UTILITY].
2. Use [CURSOR] to select the Track Edit icon, and press [ENTER/TAP].

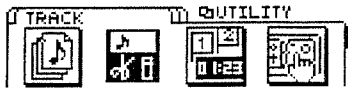

3. Use [CURSOR] to select the Track Insert icon, and press [ENTER/TAP].

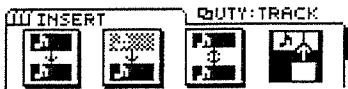

4. The Track Insert page will appear, allowing you to specify the track/V-track into which the data will be inserted. Use [CURSOR] and the TIME/VALUE dial to select the track/V-track into which the data will be inserted.

If there are other tracks into which you wish to insert data with the same settings, press [CURSOR ▾]. Specify the additional insert destination track(s).

To cancel the Insert operation for a track, use the TIME/VALUE dial to select "?". The Insert operation will not be executed for lines which contain even a single "?".

By using the TIME/VALUE dial to select "*", you can select all tracks or V-tracks. If you wish to select all V-tracks of all tracks, select "*.*".

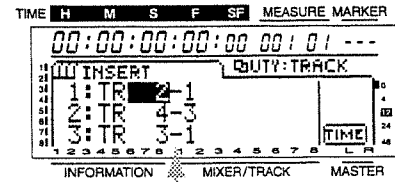

Insert location
(Track - V track)

5. Specify the time location and length of the blank which will be inserted. Move the cursor to the "TIME" icon, and press [ENTER/TAP] to access the Track Insert (TIME) page. Make settings for the following items.

START (start point):

Specify the time location at which the blank will be inserted.

LENGTH:

Specify the time length of the blank.

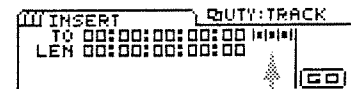

Mark point number

You can also use Mark Points to specify times. Move the cursor to the Mark Point number in each line, and use the TIME/VALUE dial to make your selection. To use a Locate Point to specify a time, move the cursor to the line that you wish to modify, and press the LOCATOR button to specify the time.

Pressing [ENTER/TAP] outside the "ALL" icon or the "GO" icon and the Measure display page will appear, press one more time for the Time display page.

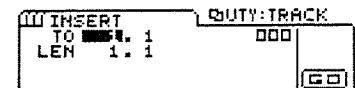

6. When you finish making settings, move the cursor to the "GO" icon and press [ENTER/TAP] to insert the blank.

Deleting a portion of a performance (Cut)

This operation cuts playback data from the specified area. When playback data is cut using this operation, any playback data following the data that was cut will move forward to fill the gap. To use the analogy of a tape recorder, this operation is like cutting an unwanted portion out of an audio tape, and splicing the ends.

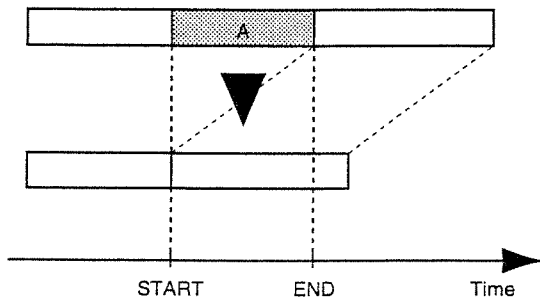

- * The disk will contain old data that existed before the cut operation. If this data is not needed, use Song Optimize (page 101) to delete the unwanted data. That way, you can utilize disk storage space more efficiently.
- * Do not leave sound within 1.0 seconds before or after the area to be cut. Any sound which was within 1.0 seconds of the cut data will not playback.

1. Press [UTILITY].
2. Use [CURSOR] to select the Track Edit icon and press [ENTER/TAP].



3. Use [CURSOR] to select the Track Cut icon, and press [ENTER/TAP].



4. The Track Cut page will appear, allowing you to specify the track/V-track from which data will be cut. Use [CURSOR] and the TIME/VALUE dial to select the track/V-track from which data will be cut.

If there are other tracks from which you wish to cut data with the same settings, press [CURSOR ▾]. Specify the additional track(s) from which data will be cut.

If there is a track for which you wish to cancel the Cut operation, use the TIME/VALUE dial to select "?". The operation will not be executed for a line which has even one "?".

By using the TIME/VALUE dial to select "*", you can select all tracks or all V-tracks. If you wish to select all V-tracks of all tracks, specify "*.*".

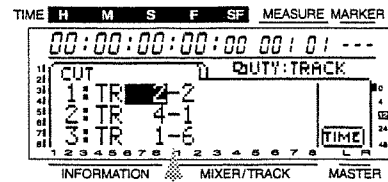

**Cutting source
(Track - V track)**

5. Specify the area of time that you wish to cut. Move the cursor to the "TIME" icon, and press [ENTER/TAP] to access the Track Cut (TIME) page. Make settings for the following items.

START (starting point):

Specify the starting time location of the data which is to be cut.

END (end point):

Specify the ending time location of the data which is to be cut.

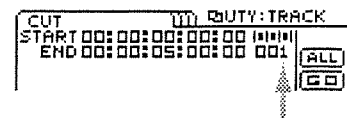

Mark point number

You can also use Mark Points to specify times. Move the cursor to the Mark Point number in each line, and use the TIME/VALUE dial to make your selection. To use a Locate Point to specify a time, move the cursor to the line that you wish to modify, and press the LOCATOR button to specify the time.

If you wish to specify the area from the beginning to the end of the song as the area for cutting, select the "ALL" icon and press [ENTER/TAP]. Pressing [ENTER/TAP] outside the "ALL" icon or the "GO" icon and the Measure display page will appear, press one more time for the Time display page.

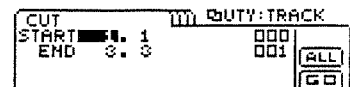

6. When you finish making settings, move the cursor to the "GO" icon and press [ENTER/TAP] to execute the Cut operation.

Erasing part of a performance (Erase)

This operation erases playback data from the specified area. If this operation is used to erase playback data, even if playback data exists after the area that was erased, it will not be moved forward. To use the analogy of a tape recorder, this operation is like recording silence over an unwanted section of the tape.

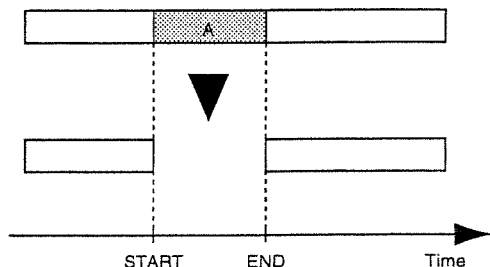

- * The disk will contain old data that existed before the erase operation. If this data is not needed, use Song Optimize (page 101) to delete the unwanted data. That way, you can utilize disk storage space more efficiently.
- * Do not leave sound within 1.0 seconds before or after the area to be erased. Any sound which was within 1.0 seconds of the erased data will not playback.

1. Press [UTILITY].
2. Use [CURSOR] to select the Track Edit icon and press [ENTER/TAP].

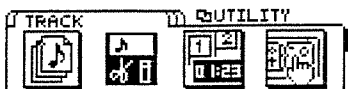

3. Use [CURSOR] to select the Track Erase icon, and press [ENTER/TAP].



4. The Track Erase page will appear, allowing you to specify the track/V-track from which you wish to erase performance data. Use [CURSOR] and the TIME/VALUE dial to select the track/V-track from which data will be erased.

If there are other tracks that you wish to erase with the same settings, press [CURSOR ▾]. Specify the additional tracks that you wish to erase.

If you wish to cancel the Erase operation for a track, use the TIME/VALUE dial to display "?". The Erase operation will not be executed for a line on which even a single "?" appears.

By using the TIME/VALUE dial to select "?", you can select all tracks or all V-tracks. If you wish to select all V-tracks of all tracks, specify "*-*".

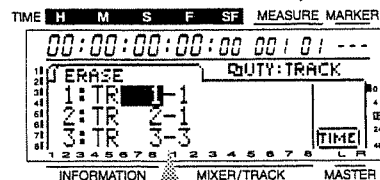

Data to be erased (Track - V track)

5. Specify the area of time that you wish to erase. Move the cursor to the "TIME" icon, and press [ENTER/TAP] to access the Track Erase (TIME) page. Make settings for the following items.

START (start point):

Specify the time location at which the data to be erased begins.

END (end point):

Specify the time location at which the data to be erased ends.

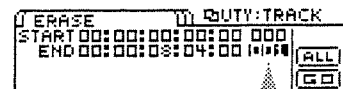

Mark point number

You can also use Mark Points to specify times. Move the cursor to the Mark Point number in each line, and use the TIME/VALUE dial to make your selection. To use a Locate Point to specify a time, move the cursor to the line that you wish to modify, and press the LOCATOR button to specify the time.

If you wish to specify the area from the beginning to the end of the song as the area for erasure, select the "ALL" icon and press [ENTER/TAP]. Pressing [ENTER/TAP] outside the "ALL" icon or the "GO" icon and the Measure display page will appear, press one more time for the Time display page.

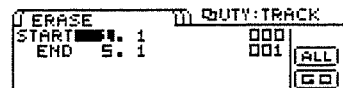

6. When you finish making settings, move the cursor to the "GO" icon and press [ENTER/TAP] to execute the Erase operation.

Chapter 8. Using the internal effects

The VS-840EX contains a stereo effect unit. The effect unit can be connected to the effect bus or inserted into a specific channel.

* *A single effect unit is built-in. Therefore, it is not possible to use different effects on each track at one time.*

Effect settings are referred to as "Patches," and the VS-840EX provides 200 preset patches (A-00 to A-99, B-00 to B-99) and 200 user patches (M-00 to M-99, U-00 to U-99). Simply by selecting a patch, you can instantly switch between a variety of effects.

* *Patches M-00 to M-99 are stored in the VS-840EX's internal memory. Patches U-00 to U-99 stored on disk for each song.*

* *With the factory settings, the user patches (M-00 to M-99, U-00 to U-99) contain frequently-selected patches from the preset patches (A-00 to A-99, B-00 to B-99). When you create a new song, the contents of (M-00 to M-99) will be copied to (U-00 to U-99).*

Original effect settings that you yourself create can be saved as a User patch. Also, some of the mixer settings can be saved as a Scene.

In addition to basic effects such as reverb and delay, effects that are optimized for vocals or guitar, and even special effects such as RSS are also included. Combinations of these effects are provided as 32 types of algorithm. This allows you to easily create effect sound without having to be concerned with complicated connections.

Data Compatibility

If a song created on the VS-840EX is loaded on VS-840 Ver.1.0, effect data added in VS-840EX will be rewritten into the VS-840 Ver.1.0 effect data.

Effect connections

Broadly speaking, there are three ways in which the effects can be connected. Select the method of connection that is appropriate for the type of effect or for your situation.

Here's the procedure for specifying the effect connection method.

1. Press [EFFECT] to access the effect setting page.
2. Use [CURSOR] to move the cursor to "MODE".
3. Select the effect connection method. Use [CURSOR] to move the cursor to "POSITION," and use the TIME/VALUE dial to select the effect connection method.
4. Select the effect output destination bus. Press [MODE] to make the BUS mode indicator light. Press [EFFECT RTN], and you will be able to select the connection status between the monitor destination AUX bus and the TRACK CUE bus by switching the BUS indicator between lit/dark. Also, you can hold down [SHIFT] and press [EFFECT RTN], to switch the BUS indicator between blinking/dark in order to select either REC bus A/B or REC bus C/D as the recording destination for the effect sound.

The bus to which the effect output is currently connected is shown by the BUS indicator of the EFFECT RTN section. When the BUS indicator is dark, the effect is not connected. However it will always be connected to the MIX bus.

AUX (AB): dark

The effect output is not connected to the AUX bus or REC bus A/B.

AUX (AB): lit

The effect output is connected to the AUX bus.

AUX (AB): brief blinking while lit

The effect output is connected to REC bus A/B.

AUX (AB): blinking

The effect output is connected to the AUX bus and to REC bus A/B.

TR CUE (CD): dark

The effect output is not connected to the TR CUE bus or the REC bus C/D.

TR CUE (CD): lit

The effect output is connected to the TR CUE bus.

TR CUE (CD): brief blinking while lit

The effect output is connected to REC bus C/D.

TR CUE (CD): blinking

The effect output is connected to the TR CUE bus and REC bus C/D.

- * Each time you press [EFFECT RTN], the monitor destination (AUX bus, TRACK CUE bus) of the effect sound will alternate as follows.

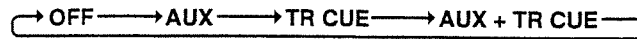

Also, each time you hold down [SHIFT] and press [EFFECT RTN], the effect sound recording destination (REC bus A/B, REC bus C/D) will alternate as follows.



- * The Send Level/Pan that you set by pressing [EFFECT LEVEL] and the Return Level/Balance that you set by pressing [EFFECT RTN] are valid only for Loop connection. If you are using an Insert connection, it is not necessary to perform step 3 of the procedure.

POSITION (Effect Position)

Select the way in which the effect is connected.

CH1 INSERT:

Insert the effect between the equalizer and fader of channel 1.

CH2 INSERT:

Insert the effect between the equalizer and fader of channel 2.

CH3 INSERT:

Insert the effect between the equalizer and fader of channel 3.

CH4 INSERT:

Insert the effect between the equalizer and fader of channel 4.

CH5/6 INSERT:

Insert the effect between the equalizer and fader of channel 5/6.

CH7/8 INSERT:

Insert the effect between the equalizer and fader of channel 7/8.

LOOP, DIR:Off:

Connect the effect to the EFFECT bus. Also, set the direct-level-related parameters of the effect so that the effect will output only the effect sound. Select this if you have chosen an algorithm type which would normally be connected (Loop connection) to the EFFECT bus.

LOOP, DIR:On:

Connect the effect to the EFFECT bus. Also, since direct-level-related parameters of the effect are not set, the effect will output a mixture of the effect sound and the direct sound. However if the effect parameters have set the direct level to 0, the direct sound will not be output. Select this if you have chosen an algorithm type which would normally be connected (Loop connection) to the EFFECT bus.

MASTER OUT:

Connect the effect before the master fader.

- * If you connect the effect to the EFFECT bus (Loop connection), you will normally set the effect to output only the effect sound, and use the output of each channel as the direct sound. In such cases, you can select "LOOP, DIR:Off" to conveniently cut the direct sound.

Inserting the effect between the equalizer and fader (Insert connection)

When using an effect such as compressor or distortion, which modifies the original sound itself, insert the effect between the equalizer and fader of the desired channel. If you insert the effect into a channel 1 to 4, the effect will be mono in/out regardless of the effect patch that you use. If the effect is inserted into channels 5/6 to 7/8, it can be used as a stereo effect depending on the algorithm of the patch.

* If you mix a channel into which the effect has been inserted with another channel into which no effect has been inserted, there may be time lag for some types of effect, and the results may not be as you expect.

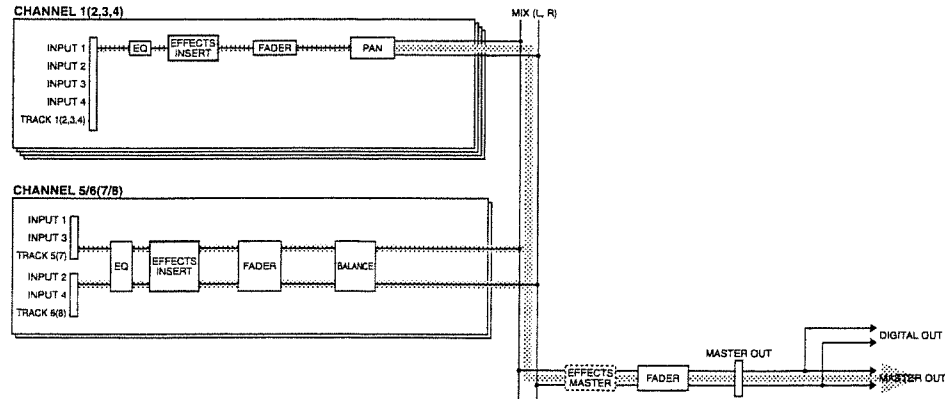

Connecting the effect to the EFFECT bus (Loop connection)

When you use an effect such as reverb or delay which adds an effect sound to the direct sound, connect the effect to the EFFECT bus.

Some effects are able to output both the effect sound and the direct sound. However normally, you should make settings so that the effect produces only the effect sound, and the output of each channel is used as the direct sound. To adjust the balance between the direct sound and the effect sound, use the channel faders to adjust the volume of both the direct sound and the effect sound, and then use the Send Level / Return Level parameters located before and after the effect to adjust the volume of the effect sound.

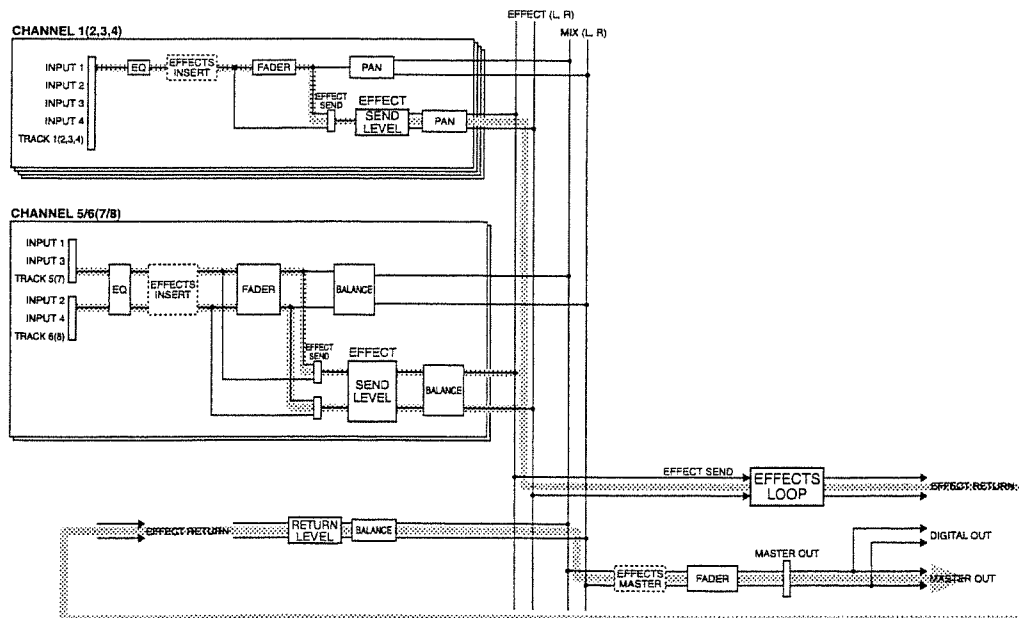

Inserting the effect before the master fader (Insert connection)

If you wish to apply the effect to the entire 2-channel stereo mix, insert the effect before the master fader. If the effect is connected here, it can be used as a stereo effect, depending on the algorithm of the effect patch.

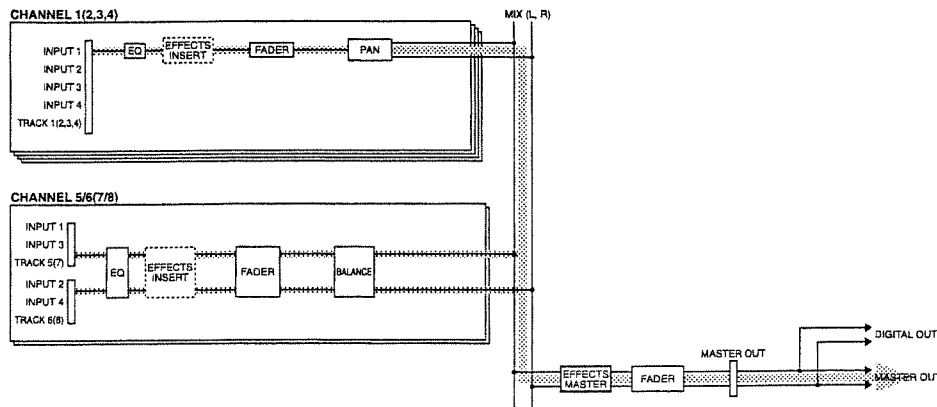

Switching effects (Patch Change)

There are 400 different effect settings, and each of these are referred to as a "Patch." There are 200 preset patches (A-00 to A-99, B-00 to B-99) and 200 user patches (M-00 to M-99, U-00 to U-99).

* Some effects are not intended to output the direct sound, or require special settings. For details refer to "Examples of how the effects can be used" (page 82).

Patch change procedure

1. Press [EFFECT] to access the Effect setting page.
2. Select the algorithm type. Use [CURSOR] to move the cursor to the "TYPE" icon. The Type Select page will appear, so use the TIME/VALUE dial to select the algorithm type.
 - * If you select "ALL TYPE" as the algorithm type, no restrictions will apply to your patch selection, and you will be able to choose from all patches.
3. Select the desired patch. Use [CURSOR] to move the cursor to the "PATCH" icon. The patch select page will appear, so use the TIME/VALUE dial to select a patch. Only patches which match the algorithm type you specified in step 2 can be selected here.
 - * If you specified "ALL TYPE" as the algorithm type, you will be able to select from all patches.
4. You will be asked "CHANGE OK ?" so confirm by pressing [YES].
If you press [NO], you will return to the previous patch.
5. When you have finished making settings, press [DISPLAY] to return to Play mode.

Using effects

Here we will explain the procedure using the example of connecting the effect to the EFFECT bus (Loop connection), applying the effect to the sound of channel 1, and outputting it from the MASTER OUT jacks. We will use reverb as the effect in this explanation.

Once you understand the procedure, you can try selecting other effect patches.

* *If you are using the vari-pitch function, delay times may be slightly different, or the tone quality of distortion-type effects may change.*

1. Make settings so that the playback sound of track 1 is input to channel 1. (page 32)
2. Use the channel 1 fader to adjust the playback level of track 1.
3. Use the procedure for "Switching effects" explained above to select an effect patch which uses the reverb algorithm.
For this example, you can select A-00:Medium Room, etc.
4. Turn on the effect. Press [EFFECT] to access the effect setting page. Make sure that the cursor is located at "EFFECT," and use the TIME/VALUE dial to turn it "On."
5. Select the effect connection method. For this example, connect the effect to the EFFECT bus (Loop connection), and cut the direct sound. Use [CURSOR] to move the cursor to "POSITION," and use the TIME/VALUE dial to select "LOOP, DIR:Off."
- * *In the case of Loop connection, the effect output will always be output to the MIX bus, so here it is not necessary to specify the output destination bus for the effect.*
6. While playing back the song, use the following procedure to adjust the level.
7. Set the send level (input level) to the effect. Press [MODE] to make the CHANNEL indicator light. Next, press channel 1 [SELECT] to select channel 1, and press the CHANNEL PARAMETER button [EFFECT LEVEL] to access the Effect Send Level setting page. Use the TIME/VALUE dial to adjust the channel 1 effect send level.
* *The send level/pan that you set by pressing [EFFECT LEVEL], the effect output destination that you set by pressing [EFFECT RTN], and the return level/balance setting are valid only when Loop connection is used. When Insert connection is used, steps 7. to 9. are not necessary.*
8. Set the panning. With the Effect Send Level setting page displayed, press [CURSOR ◀] to access the page for setting the panning for output to the EFFECT bus. Use the TIME/VALUE dial to set the panning for channel 1.
9. Set the effect return level (output level) and balance. With the CHANNEL mode indicator or the SELECT mode indicator lit, press [EFFECT RTN] to access the page for setting the return level and balance. Use [CURSOR] and the TIME/VALUE dial to set the return level and balance.
10. This completes effect settings.
* *For each channel, you can specify how the signal will be sent to the EFFECT bus. By default, all channels are set to "Pst" (post fader). If you wish to change this, first press [MODE] to make the CHANNEL mode indicator light. Next, press the CHANNEL PARAMETER button [EFFECT LEVEL] to access the Effect Send Level setting page, and press [CURSOR ◀] twice. This will access the page in which you can specify how signals will be sent to the EFFECT bus. Use [CURSOR] to select the channel, and use the TIME/VALUE dial to specify how the signal will be sent.*

EFFECT SEND Switch

For each channel, you can select how the signal will be sent to the EFFECT bus.

Off:

The signal will not be sent.

Pre (Pre FADER):

The pre-fader signal will be sent.

Pst (Post FADER):

The post-fader signal will be sent.

Creating a new effect sound

To create a new effect sound, select an existing patch that is close to the effect that you want to create, and modify its settings.

Since the modified effect settings are temporary, they will be lost if you select another patch or recall a scene. If you wish to keep the modified effect settings, you must either save them as a User Patch, or as mixer settings in a Scene.

<Algorithm>

The "algorithm" determines the structure of the effect. The VS-840EX provides 32 different algorithms. Each patch uses one of these algorithms. The algorithm used by each patch can be verified by moving the cursor to the "TYPE" icon in the effect setting page. Alternatively, you can consult the list of preset patches. For details on each algorithm, refer to "Algorithm list" (page 130).

<How effect settings are handled>

On the VS-840EX, the settings of the currently selected patch and the user patches (U-00 to U-99) are saved on disk for each song.

<Patch name>

Be sure to assign a new patch name to each new effect sound that you create. Patches can be distinguished by their patch number and patch name, but if you do not modify the patch name when you create a new effect sound, the patch number and patch name will be the same as the original patch, and you will have no way to distinguish them.

■ Creating an effect sound

1. Press [EFFECT] to access the effect setting page.
2. Use the procedure of "Switching effects" (page 78) to select the effect patch that will be the basis for your editing.
3. Use [CURSOR] to move the cursor to the "EDIT" icon, and press [ENTER/TAP].
4. A block diagram of the effect will be displayed graphically. You can use [CURSOR] to select a block and use the TIME/VALUE dial to turn each block on/off. Blocks which are on are displayed in uppercase characters, and blocks which are off will be displayed in lowercase characters. Turn on each effect block that you wish to use.
 - * If the algorithm of the effect consists of multiple effects, the block diagram will be shown graphically. However if it consists of only one effect, the block diagram will not appear, and the parameter setting page will be shown.
5. Move the cursor to the effect block whose parameters you wish to modify, and press [ENTER/TAP].
6. Now you can modify the parameters of the selected effect block. Use [CURSOR] to select the desired parameter, and use the TIME/VALUE dial to modify the value.
7. If you wish to modify other effect blocks, press [EXIT] to return to the previous page, and repeat steps 5. to 6.
8. Assign a patch name. In the parameter page, press [CURSOR ◀] until the "NAME" icon and the "SAVE" icon are displayed.
 - Use [CURSOR] to move the cursor to the "NAME" icon, and press [ENTER/TAP]. Now you can modify the patch name. Use [CURSOR] and the TIME/VALUE dial to input the patch name.
 - * It is also possible to access the "NAME" icon and the "SAVE" icon by pressing [CURSOR ◀] in the page that is displayed first when you press [EFFECT]. In this way, the same icons can be selected from several pages, but the functions of these icons are the same.
9. If you wish to save the current effect settings, continue with the procedure explained in the following section. There are two methods of saving the effect settings: in a User Patch, or in a Scene.

■ Saving effect settings

If you wish to save the effect settings which you have modified, you can either save them in a User Patch or as part of the Mixer settings. If you wish to use the effect settings with other songs as well, save them as a User Patch. If you will be using the effect settings only with the currently selected song, save them as a Scene.

Saving to a User Patch

When you save settings to a user patch, the settings that were previously in that user patch will be overwritten. However when the VS-840EX is shipped, the user patches contain the same data as the preset patches, so you do not need to be concerned about losing this data.

* A User Patch (M-00 to M-99) can be saved only while the recorder is stopped.

1. Press [EFFECT] to access the Effect Setting page.
2. Press [CURSOR ▾] several times, and the three icons "NAME," "SAVE" and "COPY" will appear.
 - * The "NAME" icon and "SAVE" icon will also appear in the Effect parameter setting page and in various other pages. The function of these icons is identical.
 - * If you wish to copy the contents that have been saved in a patch, select the "COPY" icon. By selecting the "COPY" icon, you can copy the unmodified contents of a patch to a user patch, even while you are modifying the contents of the patch.
3. The Patch Save page will appear. Use the TIME/VALUE dial to select the save destination User Patch, and press [ENTER/TAP].
4. The display will ask "Sure ?", so confirm by pressing [YES].
If you press [NO] the Save procedure will be halted.

Saving to a Scene

For details on saving effect settings to a scene and recalling a scene, refer to "Registering the current mixer settings" (page 34).

1. Press [SCENE] to make the button indicator light.
When the SCENE indicator is lit, the LOCATOR buttons [1/5] to [4/8] are used to store and recall scenes.
2. Store the current mixer settings as a scene.
To store the settings to a scene 1 to 4, press a button [1/5] to [4/8]. To store the settings to a scene 5 to 8, hold down [SHIFT] and press a button [1/5] to [4/8].
When the mixer settings have been stored, the button indicator will light.
3. When you finish storing the scene, press [SCENE] once again to turn off the button indicator.
4. The effect settings have now been saved together with the mixer settings in the Scene.

Examples of how the effects can be used

Here are several examples of ways in which the effects can be used. Apply these examples as appropriate for your situation.

* Since we will accept the default settings of the EFFECT SEND Switch, we have omitted the procedure. If you wish to modify the EFFECT SEND Switch settings, refer to "Using effects" (page 79).

■ Applying reverb to a recorded performance (Loop)

Here we will explain the settings for adding reverb to the playback of track 1. In this case, the signal flow will be as follows.

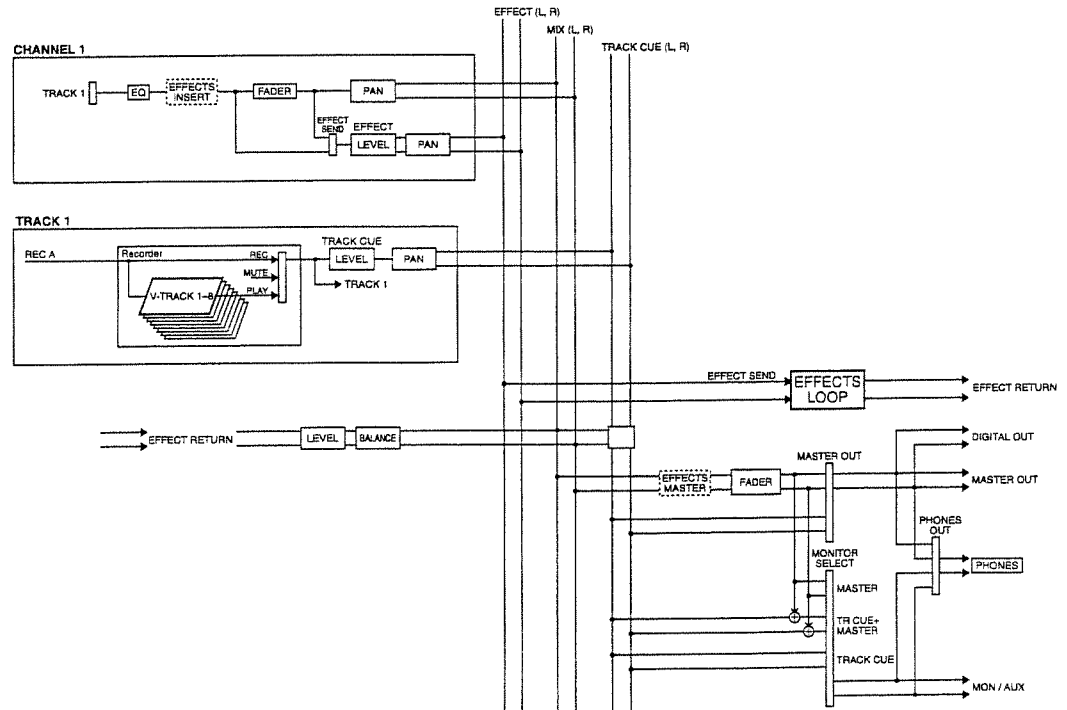

- 1.** Make settings so that the playback of track 1 is input to channel 1. (page 32)
- 2.** Use the channel 1 fader to adjust the playback level of track 1. Set the pan of channel 1 to the center (0). (page 32)
- 3.** Use the procedure "Switching effects" (page 78) to select a patch which uses the Reverb algorithm.
- 4.** Turn on the effect. Press [EFFECT] to access the Effect Setting page. Make sure that the cursor is located at "EFFECT," and use the TIME/VALUE dial to turn it "On."
- 5.** Select the method of effect connection. For this example, connect the effect to the EFFECT bus (Loop connection), and cut the direct sound. Use [CURSOR] to move the cursor to "POSITION," and use the TIME/VALUE dial to set "LOOP, DIR:Off."
 - * *In the case of Loop connection, the effect output will always be output to the MIX bus, so here it is not necessary to specify the output destination bus for the effect.*
- 6.** While playing back the song, use the following procedure to adjust the level.
- 7.** Set the send level (input level) to the effect. Press [MODE] to make the CHANNEL mode indicator light. Next, press channel 1 [SELECT] to select channel 1, and press the CHANNEL PARAMETER button [EFFECT LEVEL] to access the effect send level setting page. Use the TIME/VALUE dial to set the effect send level of channel 1.
- 8.** Set the pan. From the Effect Send Level setting page, press [CURSOR ▾] to access the page in which you can set the panning for output to the EFFECT bus. Use the TIME/VALUE dial to set the pan for channel 1.
- 9.** Set the effect return level (output level) and balance. With the CHANNEL mode indicator or the SELECT mode indicator lit, press [EFFECT RTN] to access the return level and balance setting page. Use [CURSOR] and the TIME/VALUE dial to set the return level and the balance.
- 10.** With these settings, reverb will be applied to the playback sound of track 1.

■ Applying reverb as you record (Loop)

Here we will explain how an effect can be applied to the input source of INPUT 1, and the direct sound and effect sound recorded in stereo on tracks 7 and 8. This is convenient when you wish to record a vocal with reverb applied, etc. In this case, the signal flow will be as follows.

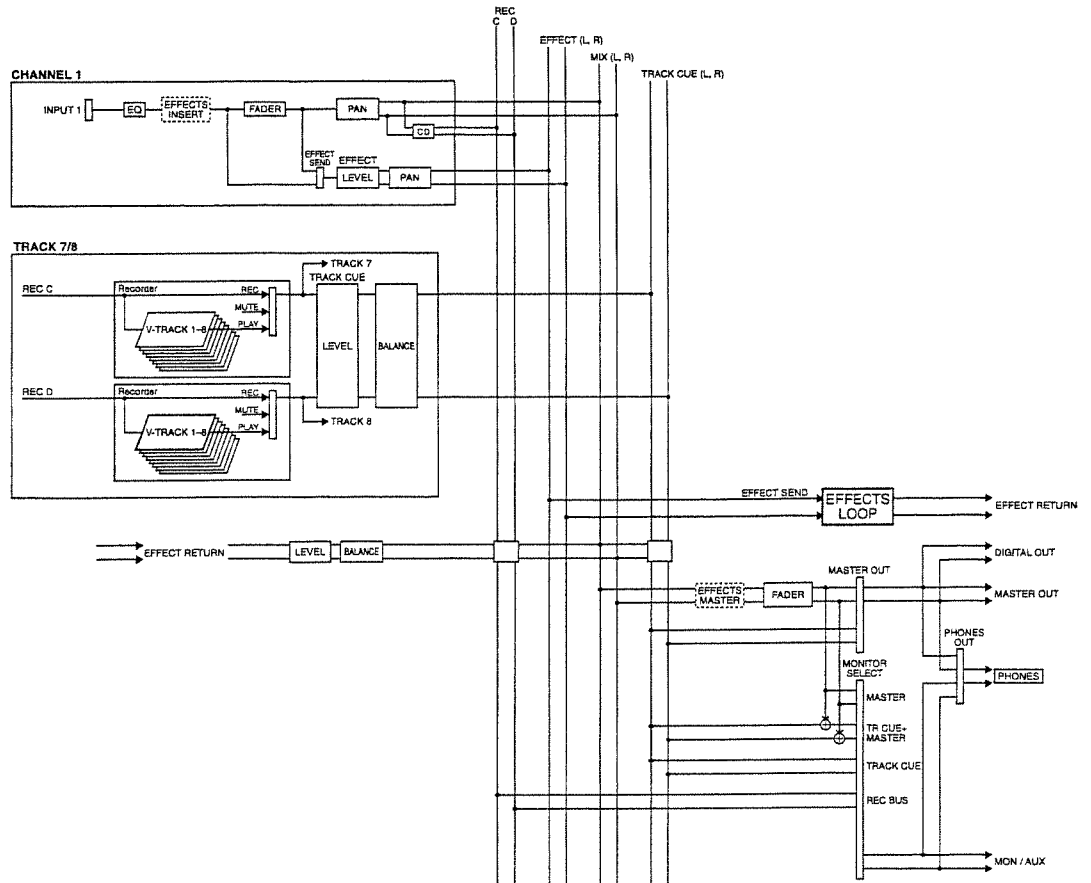

1. Make settings so that the signal from INPUT 1 jack will be sent to channel 1. (page 32)
2. Use the channel 1 fader to adjust the level of direct sound that will be recorded. Set the channel 1 pan to center (0). (page 32)
3. Use the procedure of "Switching effects" (page 78) to select a patch which uses a reverb algorithm.
For this example, select a patch such as A-00:Medium Room, etc.
4. Turn on the effect. Press [EFFECT] to access the effect setting page. Make sure that the cursor is located at "EFFECT," and use the TIME/VALUE dial to turn it "On."
5. Select the effect connection method. For this example, connect the effect to the EFFECT bus (Loop connection) and cut the direct sound. Use [CURSOR] to move the cursor to "POSITION," and use the TIME/VALUE dial to select "LOOP, DIR:Off."
6. Connect the output of the effect to REC bus C/D. Press [MODE] to make the BUS mode indicator light. Hold down [SHIFT] and press [EFFECT RTN] several times to make the BUS TR CUE (CD) indicator blink.
7. While actually inputting a signal into the INPUT 1 jack, use the following procedure to adjust the level.
8. Set the send level (input level) to the effect. Press [MODE] to make the CHANNEL mode indicator light. Next, press channel 1 [SELECT] to select channel 1, and press the CHANNEL PARAMETER button [EFFECT LEVEL] to access the Effect Send Level setting page. Use the TIME/VALUE dial to set the effect send level of channel 1.
** The send level/pan that you set by pressing [EFFECT LEVEL], the effect output destination that you set by pressing [EFFECT RTN], and the return level/balance settings are valid only when Loop connection is used. When you use Insert connection, steps 8. to 10. are not necessary.*
9. Set the panning. From the effect send level setting page, press [CURSOR ▾] to access the page in which you can specify the panning for output to the EFFECT bus. Use the TIME/VALUE dial to set the panning for channel 1.
10. Set the return level from the effect (output level) and the balance. With either the CHANNEL mode indicator or the SELECT mode indicator lit, press [EFFECT RTN] to access the page for setting the return level and balance. Use [CURSOR] and the TIME/VALUE dial to set the return level and balance.
11. Set the output of channel 1 to be sent from REC bus C/D. (page 32)
12. Set the track status of tracks 7/8 to REC. Press the track 7/8 [TRACK STATUS/V.TRACK] to make the button indicator blink red.
When you begin recording, the direct sound and reverb sound will be recorded.

■ Applying reverb while bouncing tracks (Loop)

Here we will explain the settings for applying an effect to previously-recorded tracks and recording the sound to another track. For example, this will be convenient when you wish to apply reverb to an entire song and mix it down.

In this example we will apply reverb to tracks 1 to 6 and bounce them to tracks 7/8. In this case, the signal flow will be as follows.

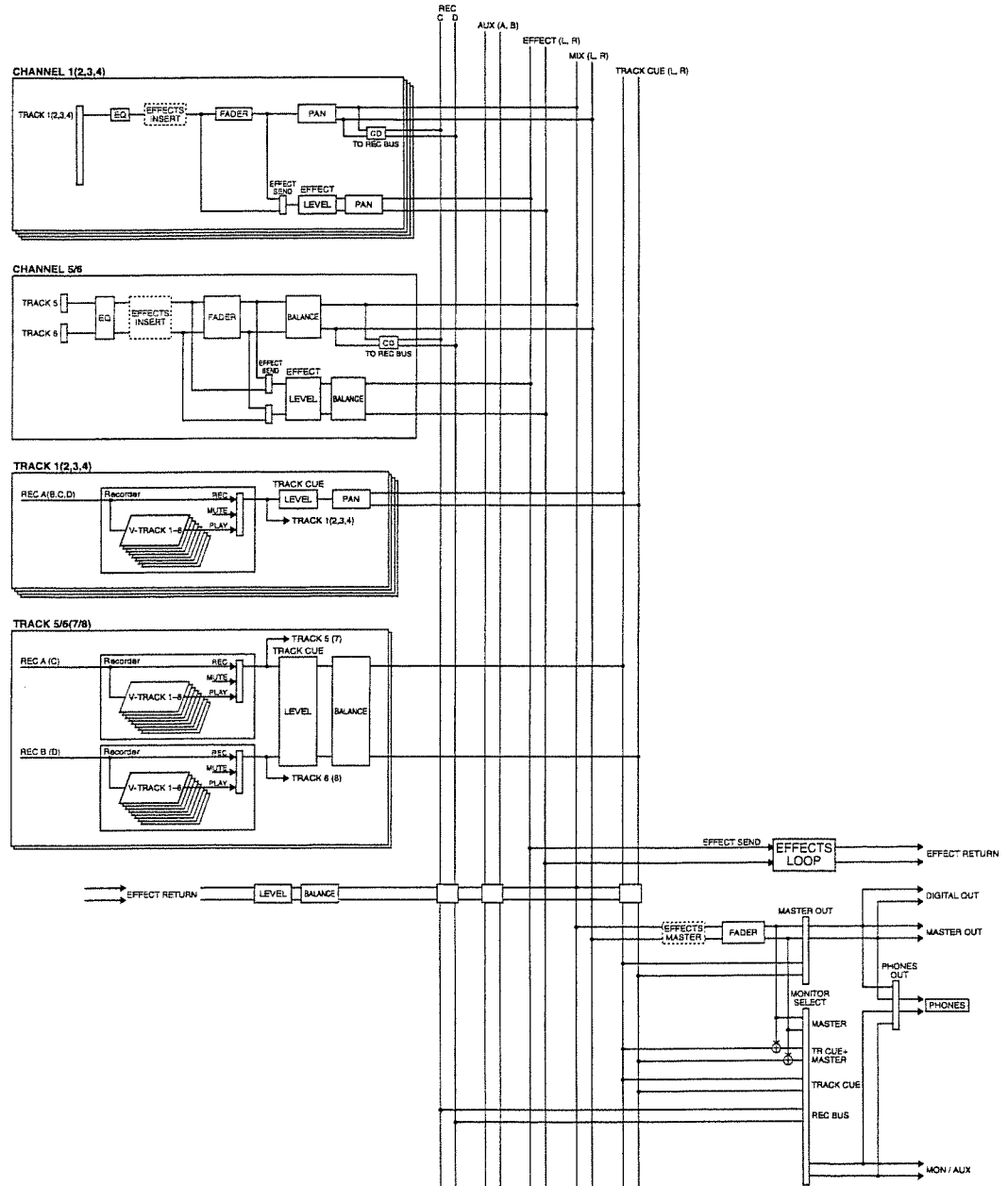

1. Make settings so that the playback of tracks 1 to 6 is input to channels 1 to 6 respectively. (page 32)
2. Use the channel 1 to 6 faders and pan to adjust the volume and pan of each channel.
3. Use the procedure of "Switching effects" (page 78) to select a patch which uses the reverb algorithm.
4. Turn the effect on. Press [EFFECT] to access the Effect Setting page. Make sure that the cursor is located at "EFFECT," and use the TIME/VALUE dial to turn it "On."
5. Select the effect connection method. For this example, connect the effect to the EFFECT bus (Loop connection), and cut the direct sound. Use [CURSOR] to move the cursor to "POSITION," and use the TIME/VALUE dial to set "LOOP, DIR:Off."
6. Connect the output of the effect to REC bus C/D. Press [MODE] to make the BUS mode indicator light. Hold down [SHIFT] and press [EFFECT RTN] several times to make the BUS TR CUE (CD) indicator blink.
7. While playing back the song, use the following procedure to adjust the level.
8. Set the send level to the effect (input level). Press [MODE] to make the CHANNEL mode indicator light. Next, press channel 1 [SELECT] to select channel 1, and press the CHANNEL PARAMETER button [EFFECT LEVEL] to access the Effect Send Level setting page. Use the TIME/VALUE dial to set the channel 1 effect send level. Use [CURSOR] to successively select channels 2 to 6, and set the effect send level for them as well.
 - * *The send level/pan that you set by pressing [EFFECT LEVEL], the effect output destination that you set by pressing [EFFECT RTN], and the return level/balance settings are valid only for Loop connection. If you are using Insert connection, steps 8. to 10. are not necessary.*
9. Set the panning. From the effect send level setting page, press [CURSOR ▾] to access the page in which you can set the pan for output to the EFFECT bus. Use [CURSOR] and the TIME/VALUE dial to make pan settings for channels 1 to 6.
10. Set the return level from the effect (output level) and the balance. With either the CHANNEL mode indicator or the SELECT mode indicator lit, press [EFFECT RTN] to access the page in which you can set the return level and balance. Use [CURSOR] and the TIME/VALUE dial to adjust the return level and balance.
11. Make settings to send the output of channels 1 to 6 to REC bus C/D. (page 32)
12. Set the track status of tracks 7 /8 to REC. Press the track 7/8 [TRACK STATUS/V.TRACK] to make the button indicator blink red.

When you begin recording, the direct sound and reverb sound will be recorded.

■ During recording, apply effects only to the monitor sound (Loop)

Here we will explain how when recording an input source from channel 1, you can record only the direct sound on track 1 while monitoring the sound to which an effect has been applied. The example shown here is useful when you would like to record while envisioning the effect processing of the mixdown, but wish to record only the direct sound on the track. In this explanation, we will use a reverb algorithm as the effect.

In this case, signal flow will be as follows.

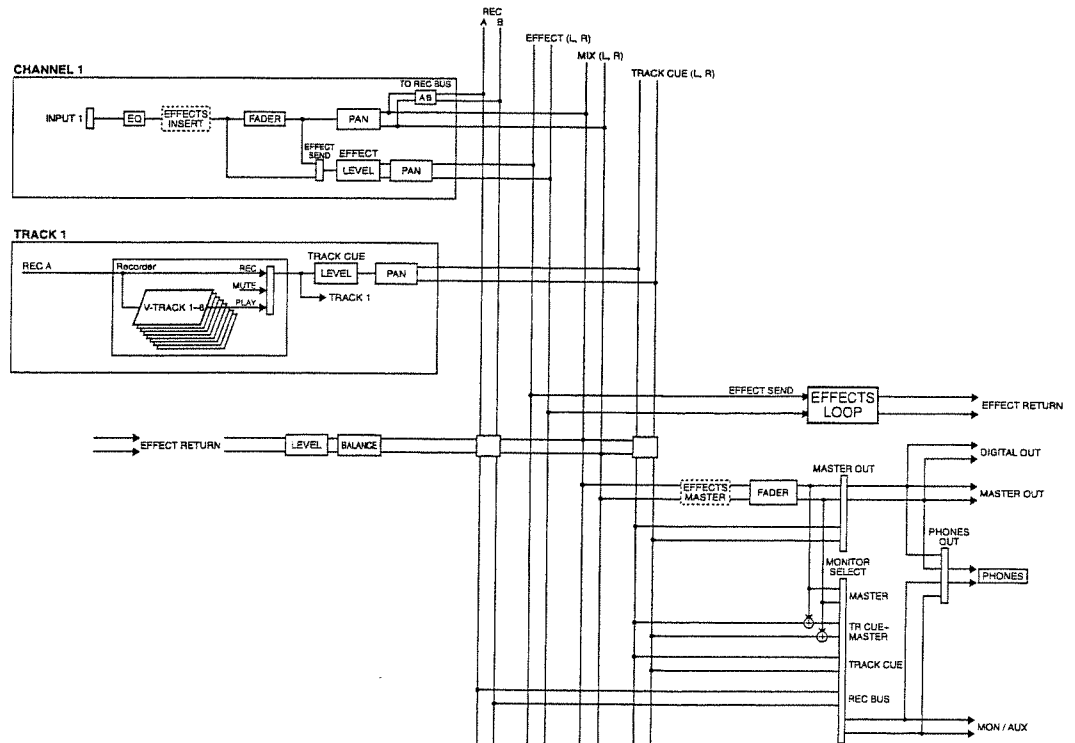

1. Make settings so that the signal from the INPUT 1 jack is input to channel 1. (page 32)
2. Use the channel 1 fader to adjust the level of the direct sound that will be recorded. Set the channel 1 pan to full left (L63). (page 32)
3. Use the procedure "Switching effects" (page 78) to select a patch which uses a reverb algorithm.
For this example, select a patch such as A-00:Medium Room.
4. Turn the effect on. Press [EFFECT] to access the effect setting page. Make sure that the cursor is located at "EFFECT," and use the TIME/VALUE dial to turn it "On."
5. Select the effect connection method. For this example, connect the effect to the EFFECT bus (Loop connection), and cut the direct sound. Use [CURSOR] to move the cursor to "POSITION," and use the TIME/VALUE dial to select "LOOP, DIR:Off."
6. Make settings to send the effect output from the MON/AUX jacks.
First, connect the output of the effect to the TRACK CUE bus. Press [MODE] to make the BUS mode indicator light. Press [EFFECT RTN] several times to make the TR CUE (CD) indicator light. Next, select the TRACK CUE bus as the input source for the MON/AUX jacks. Press [MONITOR SEL] several times to select TRACK CUE (the indicator will light green).
7. Make settings so that the output of channel 1 is sent to the REC A/B bus. (page 32)
8. Set the track status of track 1 to REC. Press the track 1 [TRACK STATUS/V.TRACK] to make the button indicator blink red.
9. While actually inputting a signal into the INPUT 1 jack, use the following procedure to adjust the level. Use the TRACK CUE 1 knob to adjust the volume of the direct sound that is output to the MON/AUX jacks.
10. Set the send level to the effect (output level). Press [MODE] to make the CHANNEL mode indicator light. Next, press channel 1 [SELECT] to select channel 1, and press the CHANNEL PARAMETER button [EFFECT LEVEL] to access the Effect Send Level setting page. Use the TIME/VALUE dial to set the channel 1 effect send level.
11. Set the panning. From the effect send level setting page, press [CURSOR ▾] to access the page in which you can set the pan for output to the EFFECT bus. Use the TIME/VALUE dial to set the pan for channel 1.
12. Set the return level from the effect (output level) and the balance. With either the CHANNEL mode indicator or the SELECT mode indicator lit, press [EFFECT RTN] to access the page for setting the return level and balance. Use [CURSOR] and the TIME/VALUE dial to adjust the return level and balance.
13. When you begin recording, only the direct sound will be recorded on track 1. From the MON/AUX jacks you can monitor the direct sound with the reverb sound added.

■ Applying chorus to the Lch, reverb to the Rch, and mixing them (Loop)

Here we will show how you can apply chorus and reverb to the performance on track 1 and track 2, mix the result, and record it in stereo to track 7/8.

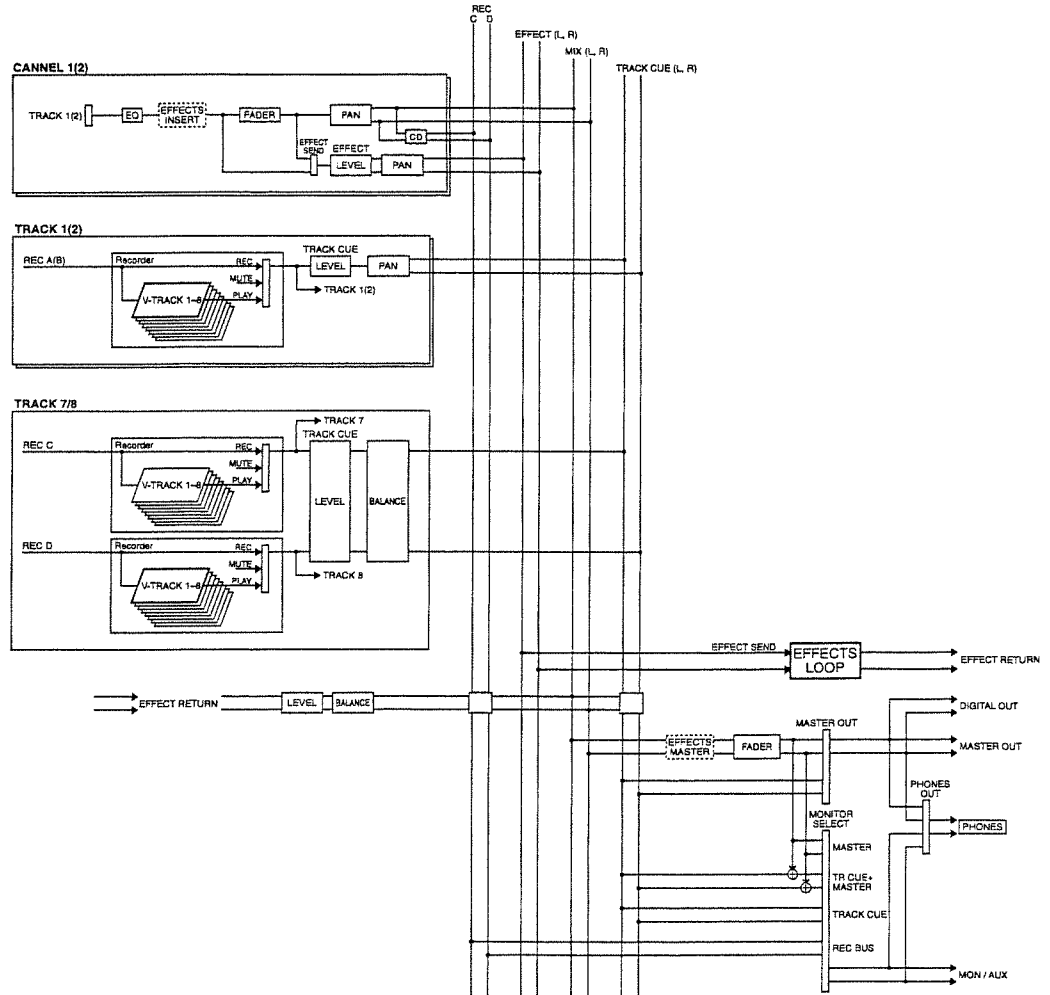

1. Make settings so that the signal from track 1 is input to channel 1, and the signal from track 2 to channel 2. (page 32)
2. Use the channel 1 and 2 faders to adjust the level of the direct sound that will be recorded. Also adjust the panning of channels 1 and 2. (page 32)
3. Use the procedure of "Switching effects" (page 78) to select a patch which uses the Chorus + Reverb algorithm.
4. Turn the effect on. Press [EFFECT] to access the effect setting page. Make sure that the cursor is located at "EFFECT," and use the TIME/VALUE dial to turn it "On."
5. Specify the effect connection method. For this example, connect the effect to the EFFECT bus (Loop connection), and cut the direct sound. Use [CURSOR] to move the cursor to "POSITION," and use the TIME/VALUE dial to select "LOOP, DIR:Off."
6. Connect the output of the effect to REC bus C/D. Press [MODE] to make the BUS mode indicator light. Hold down [SHIFT] and press [EFFECT RTN] several times to make the BUS TR CUE (CD) indicator blink.
7. While playing back a song, use the following procedure to adjust the level.
8. Set the send level to the effect (input level). Press [MODE] to make the CHANNEL mode indicator light. Next, press channel 1 [SELECT] to select channel 1, and press the CHANNEL PARAMETER button [EFFECT LEVEL] to access the Effect Send Level setting page. Use the TIME/VALUE dial to set the effect send level of channel 1. Next, use [CURSOR] to select channel 2, and set the effect send level in the same way.
9. Set the pan. From the effect send level setting page, press [CURSOR \heartsuit] to access the page for setting the panning of the output to the EFFECT bus. Use [CURSOR] and the TIME/VALUE dial to set the pan for channels 1 and 2. By adjusting the panning, you can adjust the ratio (balance) of the signal that is sent to chorus and reverb for each channel.
10. Adjust the return level from the effect (output level) and balance. With either the CHANNEL mode indicator or the SELECT mode indicator lit, press [EFFECT RTN] to access the page for setting the return level and balance. Use [CURSOR] and the TIME/VALUE dial to adjust the return level and the balance.
11. Make settings so that the output of channels 1 and 2 is sent to REC bus C/D. (page 32)
12. Set the track status of tracks 7/8 to REC. Press the track 7/8 [TRACK STATUS/V.TRACK] to make the button indicator light red.
When you begin recording, the direct sound and effect sound will be recorded.

■ Recording with an effect inserted (Insert)

Here we will explain how you can apply an effect to the input source of INPUT 1, and record only the effect sound on track 1. The effect will be inserted between the equalizer and the channel fader. This example will be useful when you wish to apply an effect to a mono source and record it in mono. If you insert an effect in channels 5/6 or 7/8, you can use the effect as a stereo effect (depending on the algorithm of the patch).

In this example, signal flow will be as follows.

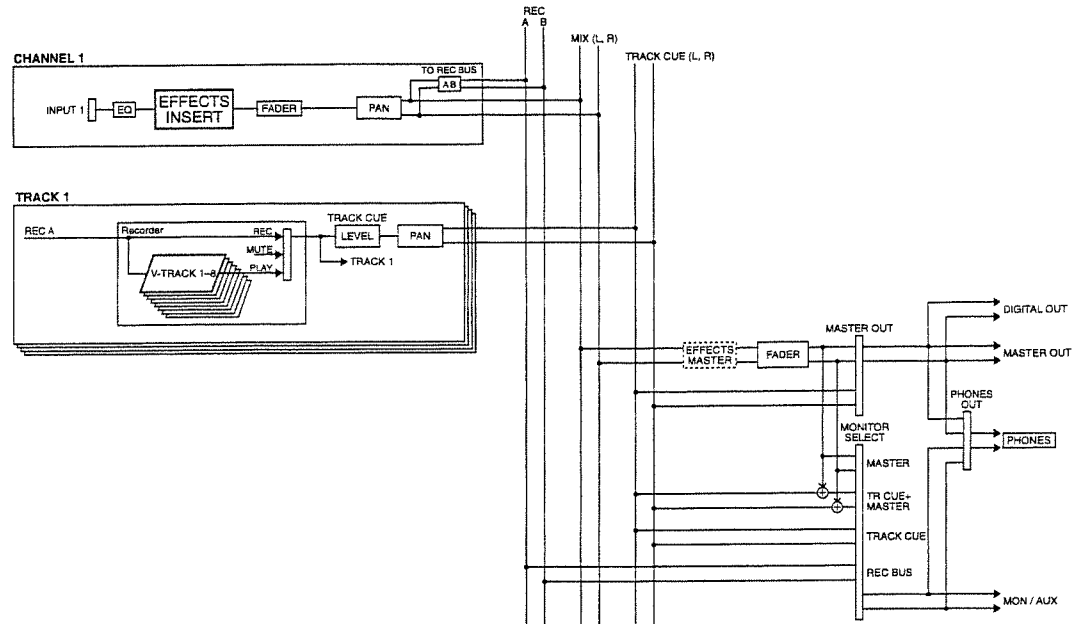

1. Make settings so that the signal from the INPUT 1 jack is sent to channel 1. (page 32)
2. Use the procedure of "Switching effects" (page 78) to select a patch which uses an insert-type algorithm (such as guitar-multi, etc.).
For this example, select an effect such as A-80:Rock Lead.
3. Turn the effect on. Press [EFFECT] to access the effect setting page. Make sure that the cursor is located at "EFFECT," and use the TIME/VALUE dial to select "On."
4. Select the effect connection method. For this example, connect the effect between the equalizer and fader of channel 1 (Insert connection). Use [CURSOR] to move the cursor to "POSITION," and use the TIME/VALUE dial to select "CH1 INSERT."
5. While actually inputting a signal to the INPUT 1 jack, use the channel 1 fader to adjust the volume level that will be recorded. Also set the pan of channel 1 to full left (L63). (page 33)
6. Send the output of channel 1 from REC bus A/B. (page 32)
7. Set the track status of track 1 to REC. Press the track 1 [TRACK STATUS/V.TRACK] to make the button indicator light red.
When you begin recording, the effect sound will be recorded on track 1.

■ Recording while you apply Vocoder (Insert)

In this example we will explain how you can connect a keyboard to INPUT 1 and a mic to INPUT 2, and record a vocoder-processed sound in stereo to tracks 5/6. The signal flow will be as follows.

* When using a vocoder algorithm, insert the effect into channels 5/6 or 7/8.

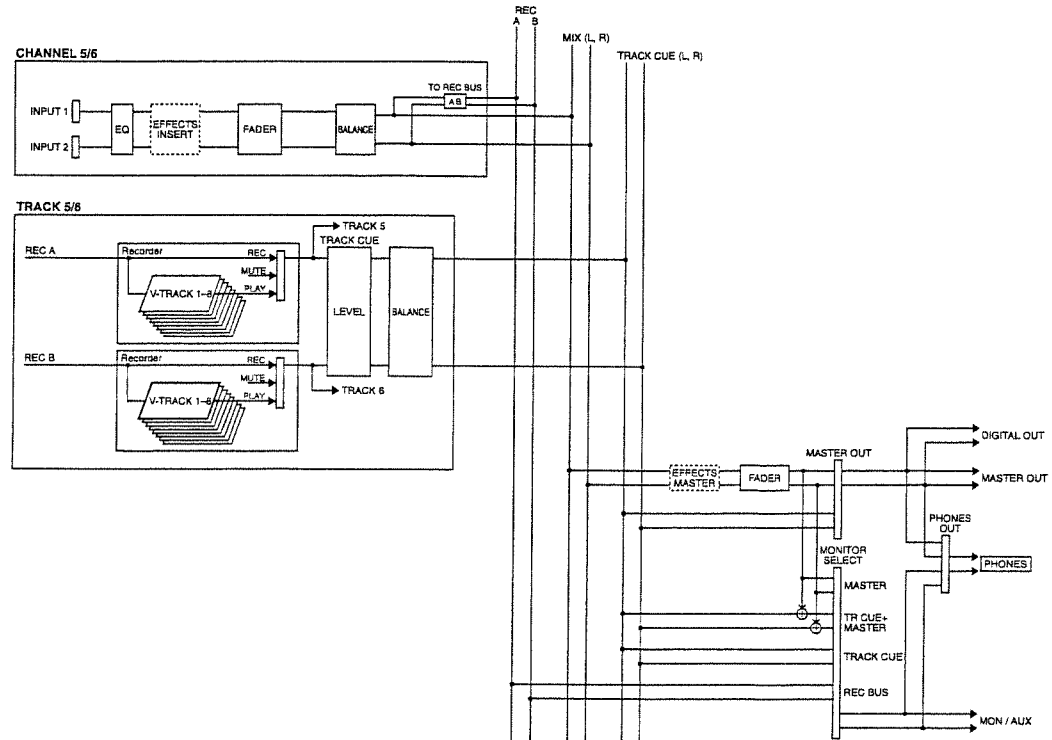

1. Make settings so that the signals of INPUT 1 and 2 are sent to channels 5/6 respectively. (page 32)
2. Use the procedure of "Switching effects" (page 78) to select a patch which uses the vocoder algorithm.
3. Turn the effect on. Press [EFFECT] to access the effect setting display. Make sure that the cursor is located at "EFFECT," and use the TIME/VALUE dial to turn it "On."
4. Select the effect connection method. For this example, insert the effect between the equalizer and fader of channels 5/6 (Insert connection). Use [CURSOR] to move the cursor to "POSITION," and use the TIME/VALUE dial to select "CH5/6 INSERT."
5. While actually inputting a signal into the INPUT 1 and 2 jacks, use the channel 5/6 faders to determine the approximate volume level, and adjust the vocoder parameters (Sens and Vocoder Level). As necessary, you can also adjust the left/right volume balance of channels 5/6. (page 33)
6. Make settings to send the output of channels 5/6 to REC bus A/B. (page 32)
7. Set the track status of tracks 5/6 to REC. Press the track 5/6 [TRACK STATUS/V.TRACK] to make the button indicator light red.

When you begin recording, the effect sound will be recorded on tracks 5/6.

If the effect does not function as you expect

When using Insert connection

- Is the effect level raised?
- Is the direct level raised?
- Is the effect inserted at the correct location?
- Is Monitor Select set correctly?

When using Loop connection

- Is a signal being sent to the EFFECT bus?
- Is the send level to the effect raised for each channel?
- Is the return level from the effect raised?
- Is the return from the effect set correctly?
- Is the effect level raised?
- Is the direct level raised?
- Is Monitor Select set correctly?

Chapter 9. Other convenient functions

Sounding the metronome

No matter how accurately one tries to play, listening to the recording play back sometimes reveals inaccuracies in rhythm or tempo. The VS-840EX provides a metronome that can be sounded at a specified tempo. By listening to the metronome as you play your instrument, you will be able to record a more accurate performance.

When using the metronome, you will need to set the tempo and time signature. For a newly created song, the time signature is 4/4 and the tempo is 120 quarter notes per minute. By making the appropriate settings, you can change this tempo/time signature or make the tempo change mid-way through the song.

This tempo setting will also be the basis for the measure number and beat number that appears in the display. If you first set the tempo for a song before you start recording, and then use the metronome as you record, you will be able to view and move the current time location as measures and beats. Also, you will be able to use measure numbers to specify the area for song editing, so that you can edit the song in a more musical way.

< Using the metronome during recording >

The metronome will begin sounding when recording or playback begins. However you may sometimes wish to hear a count-in on the metronome to help you catch the tempo before recording begins. In such cases, you can set aside the first few measures of the recording to be only for the count-in, and not record on those measures.

The metronome sound is only for the purpose of helping you keep your playing in time, and will not be recorded with the sound of your instrument.

Sounding the metronome

1. Press [UTILITY].
2. Use [CURSOR] to select the Metronome Parameter icon, and press [ENTER/TAP].



3. The page for setting metronome-related parameters will appear. Use [CURSOR] to select the following parameters, and use the TIME/VALUE dial to set the value of each.

OUTPUT

When you wish to use a metronome to keep time as you record, the metronome sound can be output from the VS-840EX. The timing of the metronome sound will depend on the tempo map settings (page 113).

Off:

The metronome sound will not be output.

MASTER:

Output the metronome sound from the MASTER.

TRACK CUE:

Output the metronome sound from the TRACK CUE.

TR CUE+MST:

Output the metronome sound from the MASTER and the TRACK CUE.

MIDI:

A Note message will be transmitted from MIDI OUT connector as the metronome. Select this when you wish to play the metronome using a sound of an external MIDI sound source.

MODE

Specify how the metronome will sound.

Rec Only:

The metronome will sound only during recording.

Rec&Play:

The metronome will sound during both recording and playback.

LEVEL

Adjust the volume level (0 to 127) of the metronome sound.

* This is the volume level of the metronome built into the VS-840EX. If you are using an external MIDI sound source to sound the metronome, adjust the metronome volume on the external MIDI sound source.

4. This completes the metronome settings. Press [DISPLAY] to return to Play mode.

■ Using an external MIDI sound source to play the metronome

A MIDI sound source can be used to play the metronome with a sound of your choosing.

1. Use a MIDI cable to connect the VS-840EX and your MIDI sound source as follows.

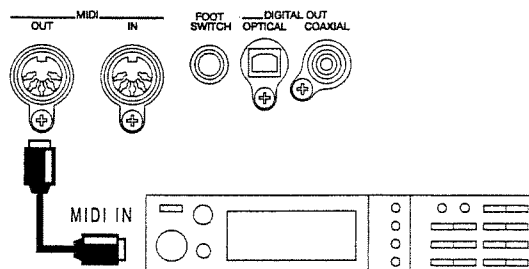

2. Press [UTILITY].

- Use [CURSOR] to select the Metronome Parameter icon, and press [ENTER/TAP].



- The page for setting metronome-related parameters will appear. Use [CURSOR] to select the following parameters, and use the TIME/VALUE dial to set the value of each.

OUTPUT:

Set this to "MIDI."

MODE:

If you want the metronome to sound only during recording, select "Rec Only." If you want it to sound during both recording and playback, select "Rec&Play."

* If you are using an external MIDI sound source to sound the metronome, adjust the metronome volume on the external MIDI sound source.

MIDI CH (MIDI channel):

Select the MIDI channel on which the metronome note messages will be transmitted. Set this to match the MIDI receive channel of your MIDI sound source.

Acc.Note:

Select the note number (C_0 to G_9) for the downbeat of the metronome. If you are playing a drum set, this will select the percussion instrument.

Acc.Velo:

Specify the velocity (1 to 127) of the metronome downbeat.

Nrm.Note:

Select the note number (C_0 to G_9) for the upbeats of the metronome. If you are playing a drum set, this will select the percussion instrument.

Nrm.Velo:

Specify the velocity (1 to 127) of the upbeats of the metronome.

- This completes metronome settings. Press [DISPLAY] to return to Play mode.

Using a foot switch to play-back/stop

A foot switch connected to the FOOT SWITCH jack can be used instead of [PLAY][STOP]. This is convenient when your hands are already occupied, such as when you are playing a guitar on stage.

- Press [UTILITY].
- Use [CURSOR] to select the System Utility icon, and press [ENTER/TAP].



- Use [CURSOR] to select the Global Parameter icon, and press [ENTER/TAP].



- Use [CURSOR] to move the cursor to "Foot Switch," and use the TIME/VALUE dial to select "Play/Stop."
- Press [DISPLAY] to return to Play mode.

Foot Switch

This sets the function of the foot switch connected to the FOOT SWITCH jack.

Play/Stop: The song will alternately playback and stop each time the foot switch is pressed.

Record: The foot switch will have the same function as the [REC]. Use this to switch between recording and playback during manual punch-in recording.

Tap Marker: The foot switch will have the same function as the [TAP]. A Mark point will be placed at the time location where you press the foot switch.

Previous: Each time you press the foot switch, you will move to the previous Mark point.

Next: Each time you press the foot switch, you will move to the next Mark point.

Effect: One parameter specified by each algorithm is assigned to the foot switch.

TUNER: Pressing on the foot switch will alternately switch the On/Off status of the tuner.

Efx Prev: Each time you press the foot switch, you will move to the previous effect patch.

Efx Next: Each time you press the foot switch, you will move to the next effect patch.

Stopping automatically (Marker stop)

You can cause song playback to stop automatically at a mark point.

1. Press [UTILITY].
2. Use [CURSOR] to select the System Utility icon, and press [ENTER/TAP].



3. Use [CURSOR] to select the Play/Rec Parameter icon, and press [ENTER/TAP].



4. Use [CURSOR] to move the cursor to "MARKER Stop," and use the TIME/VALUE dial to select "On."

MARKER Stop

Turn this "On" when you want song playback to automatically halt at time locations where a Mark point exists.

5. Press [DISPLAY] to return to Play mode.

Changing the pitch during playback (Vari-pitch)

When recording an ensemble, all the instruments normally tune to an instrument such as an acoustic piano whose tuning cannot easily be changed. However it is sometimes necessary to record (overdub) an acoustic piano onto an existing recording. In this case if the pitch of the recording is different than the pitch of the acoustic piano, something must be done about it.

In such cases, use the Vari-pitch function. Vari-pitch changes the playback speed of the recorder. When the playback speed changes, the pitch of the playback will also change. In this way, by changing the playback speed, you can make the pitch of the recording match the pitch of the instrument to be newly recorded. Vari-pitch can be used not only to compensate for pitch differences, but also creatively to produce special effects.

If you wish to use the Vari-pitch function, use the following procedure to set the pitch.

- * *The audible result of Vari-pitch is a change in playback speed, but in actuality the sample rate is being modified. This means that when recording the digital output of the VS-840EX into another device, you must return Vari-pitch to the normal pitch. Recording will not be possible with settings other than normal pitch.*

1. Press [VARI PITCH] to make the button indicator light.

When the button indicator is lit, the playback pitch will change in accordance with the Vari-pitch setting. Since Vari-pitch is initially set to normal pitch, the playback pitch will not change yet.

2. To modify the Vari-pitch setting, hold down [SHIFT] and press [VARI PITCH].

The "Vari Pitch" parameter will appear, and you can modify the current vari-pitch setting (sample rate).

While playing back the song to check the actual pitch, use the TIME/VALUE dial to modify the setting.

- * *This page is the Play/Rec Parameter page in System Utility.*



3. When you finish making settings, press [DISPLAY] to return to Play mode.

You can also return to Play mode by holding down [SHIFT] and pressing [VARI PITCH] once again.

4. Now when you press [VARI PITCH] to make the indicator light, playback will occur at the specified pitch.

Vari Pitch

This sets the playback pitch when the Vari-pitch function is used. The value is displayed as a sample rate. Make vari-pitch settings while actually listening to the song playback.

- * *Although it sounds like vari-pitch is changing the playback speed, it is actually changing the sampling rate. For this reason, do not use vari-pitch when you wish to record digital signals from the VS-840EX onto another digital audio device. Digital recording is not possible with a setting other than standard pitch.*

Listening only to a specific channel (Solo)

When making equalizer adjustments or during mix-down, it is often convenient to be able to monitor just the sound of a specific channel. Although it would be possible to individually mute each of the channels that you didn't want to hear, this is inconvenient. In such cases, you can use the Solo function to monitor only a specific channel and mute all the other channels.

To use the Solo function, use the following procedure.

1. For the channel that you wish to monitor, make settings so that either the input source or the track can be monitored. (page 33)
2. Press [SOLO] to make the SOLO indicator light. Now the Solo function is available.
3. Press [SELECT] for the channel that you wish to monitor, and only that channel will be monitored.

The SELECT indicator will blink green when you are monitoring the recorder, and will blink orange when you are monitoring the input source. In this condition, you can adjust the channel fader, pan, and equalizer.

Since monitor and mute will alternate each time you press [SELECT], you can monitor multiple channels. However, channels which were muted before using the Solo function cannot be monitored even if you press [SELECT]. Also, when you are monitoring only one channel, pressing [SELECT] for that channel will allow you to monitor all channels.
4. To switch the Solo function off, press [SOLO] once again.

The SOLO indicator will go dark, and the Solo function will go off.

 - * If [REC] is pressed while the Solo function is on, the Solo function will automatically be turned off.

Making front-panel fader and TRACK CUE knob operation active immediately

When you select a different Scene, the locations of the faders and the TRACK CUE knobs may differ from the actual volume levels. In such cases, you can select one of two ways to specify how the level will change when you operate the faders and TRACK CUE knobs. Here we will explain how to make settings so that moving the faders or TRACK CUE knobs will cause the value to change immediately.

1. Press [UTILITY].
2. Use [CURSOR] to select the System Utility icon, and press [ENTER/TAP].



3. Use [CURSOR] to select the Global Parameter icon, and press [ENTER/TAP].



4. Use [CURSOR] to move the cursor to "FADER Match," and use the TIME/VALUE dial to select "Jump."
5. Press [DISPLAY] to return to Play mode.

FADER Match

Select how the faders will act when the fader or TRACK CUE knob locations do not match the actual volume level.

Null:

Changes will not occur until the channel fader or pan knob is moved to the actual value.

Jump:

The actual value will change at the instant that the fader or TRACK CUE knob is moved.

If you wish to check the actual volume levels, press [DISPLAY] several times to access the Play mode FADER/PAN page. In this page, the current locations of the faders and TRACK CUE knobs will also be displayed simultaneously.

Mixer fader/pan screen

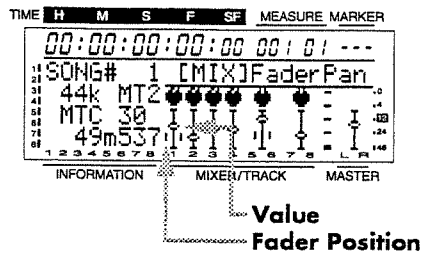

Track fader/pan screen

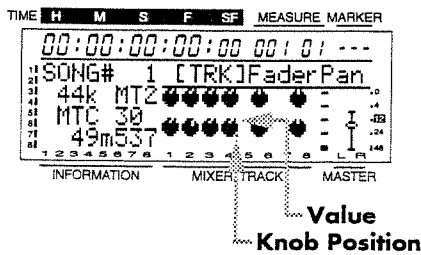

Switching the source for output to the PHONES jack

When using an external effects device, setting the monitor select button to AUX will allow you to use the MON/AUX jacks as effect send jacks. However with the factory settings, the PHONES jack and the MON/AUX jacks will output the same signal, meaning that it will not be possible to use headphones to monitor the TRACK CUE bus or the master out. In such cases, use following procedure to switch the source that is output to the PHONES jack.

Here we will explain the procedure that lets you use the headphones to monitor the TRACK CUE bus even when you have used the monitor select button to select AUX.

1. Press [UTILITY].
2. Use [CURSOR] to select the System Utility icon, and press [ENTER/TAP].

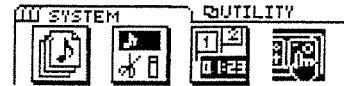

3. Use [CURSOR] to select the Global Parameter icon, and press [ENTER/TAP].



4. Use [CURSOR] to move the cursor to "PHONES OUT," and use the TIME/VALUE dial to select "MASTER."

PHONES OUT (phones out select)

Select the source that will be output from the PHONES jack.

MON/AUX:

The PHONES jack will output the same signal as the MON/AUX jacks.

MASTER:

The PHONES jack will output the same signal as the MASTER OUT jack.

* With the factory settings, MON/AUX is selected.

5. Use [CURSOR] to move the cursor to "MASTER OUT," and use the TIME/VALUE dial to select "TR CUE."

MASTER OUT (master out select)

Select the source that is output from the MASTER OUT jacks.

MASTER:

The master out (MIX bus) will be output from the MASTER OUT jacks.

TR CUE:

The TRACK CUE bus will be output from the MASTER OUT jacks.

* *With the factory settings, MASTER is selected.*

- 6. Now you will be able to use headphones to monitor the TRACK CUE bus. Press [DISPLAY] to return to Play mode.**

Undoing a recording or / editing operation

While using the VS-840EX, there may be times when a recording does not proceed as you wish, or when you would like to re-do an operation. In such cases, use the Undo function. The Undo function cancels the operation that you have performed, and returns the data to its previous condition. To cancel the last-performed Undo operation, you can use the Redo function.

When using the Undo function, you will specify the number of previous steps that will be undone. For example, suppose that you use punch-in recording to perform five consecutive re-recordings of the same location. If you later decide to return to the condition of the second recording (step 2), you would set the Undo function to return to the condition of three steps earlier (Undo Level 3).

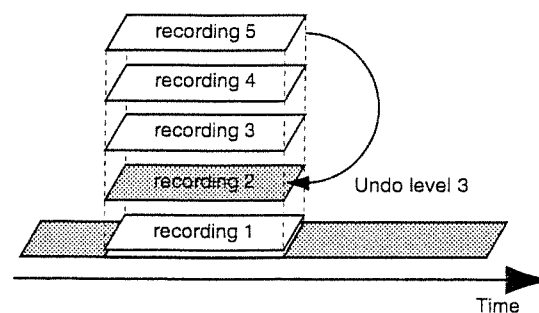

If, after executing the Undo operation, you decide to return to the condition of step 5, execute the Redo operation.

However if you once again record (step 3') after returning to the condition of recording number 2, the recordings 3 to 5 that were canceled by the Undo operation will be lost. This means that if after step 3' you use the Undo operation to return to the previous step, you will return to the condition of step 2.

■ Recording/editing operations which can be undone (Undo)

Recording or editing operations performed after creating a song are recorded together with the song data as its operation history, and the data itself is also preserved without being erased. For example, suppose that you perform 10 recording operations on song 1 and then create song 2. The operation history of song 2 is newly recorded from the time when song 2 was created. If you subsequently select song 1 again, the history of the 10 previous recording operations will still be there.

The Undo function refers to the operation history of the currently selected song, and restores the song to the condition in which it was the specified number of operations ago. In the case of song 1 in this example, you will be able to cancel the 10 recording operations that were performed. A maximum of 999 levels of operation history is recorded for each song.

1. Press [UNDO/REDO].
2. The display will indicate "UNDO Level." Use the TIME/VALUE dial to specify the number of previous steps that you wish to undo.
3. To execute the Undo operation, press [ENTER/TAP]. To cancel the Undo operation, press [EXIT].

■ Canceling the last-performed Undo (Redo)

If you wish to cancel the previously-executed Undo, execute Redo. If the song data has been saved following an Undo (for example due to recording, or selecting another song), it will no longer be possible to execute Redo. When redoable, Redo icon () will be displayed on the Play mode.

1. Hold down [SHIFT] and press [UNDO/REDO], and the display will ask "REDO Last UNDO ?". Press [YES].

If you decide not to execute Redo, press [NO].

■ Canceling only the last-performed operation

If you most frequently use the Undo function to undo just the most frequently performed recording/editing operation (i.e., undo level 1), you may prefer not to be bothered with the messages that appear when the [UNDO/REDO] button is pressed. In this case, make the following settings so that just the previous operation will be undone immediately when the [UNDO/REDO] button is pressed.

1. Press [UTILITY].
2. Use [CURSOR] to select the System Utility icon, and press [ENTER/TAP].



3. Use [CURSOR] to select the Global Parameter icon, and press [ENTER/TAP].



4. Use [CURSOR] to move the cursor to "UNDO Message," and use the TIME/VALUE dial to select "Off."
5. Press [DISPLAY] to return to Play mode.

UNDO Message

If, when [UNDO/REDO] is pressed, you want the previous operation to be undone immediately without a confirmation message appearing, set this "Off." Normally you should set this "On."

When the disk has little remaining space

■ Deleting only unneeded performance data (Song Optimize)

After operations such as overdubbing and punch-in recording have been performed repeatedly, old data will remain on the disk. In some cases, this unwanted data may occupy a significant amount of memory, and disk usage may become inefficient. If this occurs, the time available for recording will decrease.

The "Optimize" operation erases this unneeded data from disk, and increases the disk space that is available for use.

1. Press [UTILITY].
2. Use [CURSOR] to select the Song Edit icon, and press [ENTER/TAP].



3. Use [CURSOR] to select the Song Optimize icon, and press [ENTER/TAP].



4. The display will ask "SONG Optimize ?" so press [YES].
5. The display will ask "Optimize Further ?" If you wish to delete the unwanted data by segmenting the recorded data into small increments, press [YES]. If not, press [NO].

* To maximize the remaining disk space, press [YES].

6. The display will ask "Optimize Sure ?" so press [YES] to execute the operation.

* Depending on the situation, an appreciable length of time will be required for the Optimize operation to be completed. This is not a malfunction. Do not turn the power off until the Optimize operation is completed.

* If you execute Optimize, it will not be possible to use the Undo function to return to the state before optimization.

< Caution when Executing Song Optimize >

By selecting [YES] for "Optimize Further ?," you might encounter the "Drive Busy" display during the playback of the optimized song and possibility of abnormal playback. Since it will not be possible to use the undo function to return to the state before optimization, copying the song to a different disk before optimizing is recommended.

■ Deleting one song of performance data (Song Erase)

This operation deletes song data from disk.

1. Press [UTILITY].
2. Use [CURSOR] to select the Song Edit icon, and press [ENTER/TAP].



3. Use [CURSOR] to select the Song Erase icon, and press [ENTER/TAP].



4. The song names that are saved on disk will be displayed. Select the song that you wish to erase, and press [ENTER/TAP].
An asterisk "*" will be shown at the beginning of the current song (the currently selected song). If you delete the current song, the lowest-numbered song on disk will be selected.
5. The display will ask "SONG Erase Sure ?" so press [YES] to execute the operation.

Copying performance data (Song Copy)

This operation copies a song that was saved on disk to the current disk (the disk currently being used) or to another disk.

1. Press [UTILITY].
2. Use [CURSOR] to select the Song Edit icon, and press [ENTER/TAP].



3. Use [CURSOR] to select the Song Copy icon, and press [ENTER/TAP].



4. The display will indicate "STORE Current ?" If you wish to store the current song before copying, press [YES]. If you wish to execute the copy operation without storing, press [NO].
* If you execute Copy without storing, any changes in the current song will be lost.
5. A list of the songs that are saved in the current disk will be displayed. Use [CURSOR] to select the copy source song, and press [ENTER/TAP].
6. The display will indicate "Select Dest.DISK" so select the copy destination disk. If you wish to save the data on the current disk (the disk currently being used), select "Current." If you wish to save the data on another disk, select "Other." For this example, select "Other" and press [ENTER/TAP].
* If you select "Current" and press [ENTER/TAP], it will not be necessary to exchange disks. When the copy is completed, the display will indicate "Complete !" and you will return to step 5 (selecting the copy source song).
* If you make the song copy, it will be copied to the lowest number for which there is no song on disk.
7. If you select "Other," the current disk will be ejected. The display will prompt "Insert Other DISK !" Insert an initialized disk, and copying will begin.
* If you insert a disk which has not been initialized, you will be asked whether or not you wish to initialize the disk. Refer to "Inserting the disk" (page 27) and follow the procedure.

8. The copy destination disk will be ejected, and the display will ask you to "Insert Current DISK !" Insert the current disk from which the data will be copied.

* If the amount of data to be copied is large, the copy cannot be completed in a single pass, and you will need to exchange disks two or more times. The amount of disk exchange operations that remain are indicated by the "%" in the display.

9. Until the copy operation is completed, exchange disks as the display requests.

* During the procedure, you can cancel the copy operation by pressing [EXIT]. In this case too, exchange disks as requested by the display.

10. When the copy is completed, the display will indicate "Complete !" and you will return to step 5 (the copy source song select page). If you wish to copy another song, repeat steps 5 to 10. If you are finished copying, press [DISPLAY] to return to Play mode.

<If the display indicates "DISK Memory Full">
If this message appears during the copy procedure, either there is no more disk space or the number of songs on the copy destination disk has reached 200 (the maximum number of songs). Either delete unwanted songs from the copy destination disk, or copy the data to a different disk.

Duplicating a disk (Disk Copy)

This operation copies all of the data on the current disk (the disk currently being used) to another disk.

* If the current disk is 100 MB, use 100 MB disk for copying. If the disk is 250 MB, use 250 MB for copying.

1. Press [UTILITY].
2. Use [CURSOR] to select the Disk Utility icon, and press [ENTER/TAP].



3. Use [CURSOR] to select the Disk Copy icon, and [ENTER/TAP].



4. A message will ask "Are you Sure?" If you wish to execute the Disk Copy operation, press [YES]. If you decide not to execute the Disk Copy operation, press [NO].

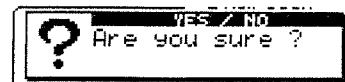

5. The display will indicate "STORE Current ?" If you wish to store the current song before executing the Disk Copy operation, press [YES]. If you wish to execute the disk copy operation without saving, press [NO].

* If you execute the disk copy operation without saving, any changes to the current song will be lost.

6. The current disk will be ejected, and the display will ask you to "Insert New DISK !" Insert a new disk as the copy destination.

7. When you insert a new disk, the display will ask "Initialize OK ?," verifying that it is all right to initialize the copy destination disk. If you press [YES], the disk will be initialized, and the Disk Copy operation will be executed.

If you press [NO], the disk will be ejected without being initialized, and the Disk Copy operation will be halted.

* The copy destination disk must be initialized before beginning the copy operation. When a disk is initialized, all data which was previously on that disk will be lost. Be sure that the disk you insert contains no data that you wish to keep.

8. The copy destination disk will be ejected, and you will be prompted to "Insert Current DISK !" Insert the copy source current disk.

* On the 100 MB disk, disk exchange will take place 64 times, this will require approximately 30 minutes. On the 250 MB disk, exchange will take place 160 times, this will require approximately 90 minutes.

* The remaining number of times for disk exchange will be shown in the display.

9. Until the copy operation is completed, exchange disks as the display requests.

* During the procedure, you can cancel the copy operation by pressing [EXIT]. In this case too, exchange disks as requested by the display.

10. When copying ends, the display will indicate "Complete !" and you will return to Play mode.

Exchanging data between the VS-840EX and VS-880 (Song Convert)

Song data can be converted so that it can be exchanged between the VS-840EX and VS-880. Here we will explain how song data created on the VS-880 can be converted for use by the VS-840EX.

* The only data which can be exchanged between the VS-840EX and VS-880 is song data which was recorded with a Recording Mode and Sample Rate that are supported by both devices. (The VS-840EX's recording mode "LV1" corresponds to the VS-880's "LIV.") Only two types of information are converted: the audio data itself, and information which indicates the V-track of that audio data. Other data (system-related settings, mixer-related settings, locate points in the song, etc.) is not compatible.

* Data cannot be converted directly between the VS-880EX and the VS-1680. You must first convert to VS-880 data, and then use the VS-840 to perform the further conversion.

1. Press [UTILITY].
2. Use [CURSOR] to select the Disk Utility icon, and press [ENTER/TAP].



3. Use [CURSOR] to select the Song Convert icon, and press [ENTER/TAP].



4. The display will indicate "Select Convert Type," so use [CURSOR] to select the conversion type. For this example, select the 880 → 840 icon, and press [ENTER/TAP].
5. The display will indicate "STORE Current ?" If you wish to save the current song before executing Convert, press [YES]. If you wish to execute Convert without saving the current song, press [NO].
 - * If you execute Convert without saving, any changes to the current song will be lost.
6. The disk will be ejected, and the display will indicate "Insert 880 DISK !" Insert a disk which contains a song that was created on the VS-880 (the 880 disk).
7. A list of the songs that were created on the VS-880 will be displayed. Move the cursor to the song in the list that you wish to convert, and press [ENTER/TAP].

8. The 880 disk will be ejected. You will be prompted to "Insert 840 DISK !" Insert an initialized disk as the convert destination, and conversion will begin.
 - * If you insert an uninitialized disk, you will be asked whether you wish to initialize it. Refer to "Inserting the disk" (page 27) and follow the procedure.
9. The copy destination disk will be ejected, and you will be prompted to "Insert 880 DISK !." Insert the convert source 880 disk.
 - * If the amount of data to be copied is large, the copy cannot be completed in a single pass, and you will need to exchange disks two or more times. The amount of disk exchange operations that remain are indicated by the "%" in the display.
10. Until the convert operation is completed, exchange disks as the display requests.
 - * During the procedure, you can cancel the convert operation by pressing [EXIT]. In this case too, exchange disks as requested by the display.
11. When the operation ends, the display will indicate "Complete !" and you will return to the display of step 7 (convert source song select). If you wish to convert other songs, repeat steps 7. to 11. If you are finished, press [DISPLAY] to return to Play mode.
 - * In order to convert song data created on the VS-840EX into a form that can be used by the VS-880, you will need a disk that has been initialized on the VS-880.

If you do not have a disk that has been initialized on the VS-880, you can use the following procedure to initialize a disk. If you insert an un-initialized disk in response to the "Insert 880 Disk" prompt, the following display will appear.

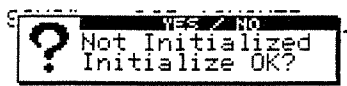

You will be asked whether or not you wish to initialize the disk for use on the VS-880, so execute the following procedure.

1. If you wish to initialize the disk, press [YES]. If you do not wish to initialize the disk, press [NO]. If you press [NO], the inserted disk will be ejected.
2. If you press [YES] in step 1, you will be asked again "Are you sure ?" If you wish to initialize, press [YES]. If you press [NO], the Initialize operation will be halted, and the inserted disk will be ejected.
 - * When a disk is initialized, all data on that disk will be lost. Before initializing a disk, make sure that it does not contain any data you wish to keep.
 - * The VS-840EX and the VS-880 use different disk formats.

Creating a master tape which disables digital copying

When digitally mixing down from the VS-840EX to a DAT recorder etc., you can prohibit digital copying of the data from tape.

For example, a single-generation of digital recording from a CD player to a DAT recorder is permitted. It will not be possible to make a digital copy from the digitally-recorded DAT to another digital device. This function causes a tape which is digitally recorded from the VS-840EX to behave in the same way as a tape digitally recorded from a CD.

1. Press [UTILITY].
2. Use [CURSOR] to select the System Utility icon, and press [ENTER/TAP].



3. Use [CURSOR] to select the Global Parameter icon, and press [ENTER/TAP].



4. Use [CURSOR] to move the cursor to "D.Cpy Protect," and use the TIME/VALUE dial to turn it "On."

D.CpyProtect (Digital Copy Protect)

Specify whether or not digital copying of a digitally-mixed down tape will be permitted or not.

Off:

Digital copying will be permitted.

On:

Digital copying will be prohibited.

5. Press [DISPLAY] to return to Play mode.
6. Digitally mixdown from the VS-840EX to a DAT recorder etc. (page 64). It will not be possible to digitally copy this master tape to another DAT recorder etc.
 - * Some DAT recorders do not support SCMS, or can not be digitally connected to a CD player. If you are using such a DAT recorder, it will not be possible to record the digital output of the VS-840EX to the DAT recorder with D.CpyProtect turned "On." In such cases, turn D.CpyProtect "Off."

■ About SCMS

“SCMS” stands for “Serial Copy Management System.” This is a function that protects the rights of copyright holders by prohibiting recording via a digital connection for more than two generations. When digital connections are made between digital recorders that implement this function, SCMS data will be recorded along with the audio data. Digital audio data which contains this SCMS data cannot again be recorded via a digital connection.

How to use the tuner

VS-840EX has the Chromatic Tuner function built-in. Without changing the connections, speedy tuning can be accomplished. Internal tuner has the standard pitch and output level adjustment functions.

■ Switching to the tuner

Tuning with the internal tuner. Built-in tuner operates with a guitar or a bass guitar plugged into INPUT 1 (Guitar IN). During tuning, sound will mute and input signal will not output.

- * It is possible to output the direct signal during tuning. To find out, refer to “Volume setting during the direct sound bypass” (page 107).

Switching with panel operation

1. press [UTILITY].
2. Use [CURSOR] to select Tuner icon, then press [ENTER/TAP].



3. When finished tuning, press [EXIT] or [DISPLAY].

Switching with the foot switch

Connect foot switch FS-5U (sold separately) and you can control tuner On/Off from the foot switch.

- * To use this function, refer to “Using a foot switch to playback/stop” section (page 96).

■ About the display content during tuning

The display

Internal tuner of the VS-840EX displays a standard pitch on the upper left and a note name on the upper right. Tuning guide is displayed on the bottom which shows the deviation between the input signal and the note pitch.

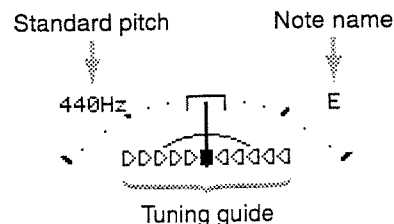

The display for the tuning guide

If the pitch deviation is within +/-50 cents, the tuning guide will indicate the amount of deviation. While watching the tuning guide, adjust the tuning until only the middle indicator (tuned) is lit.

VS-840EX simultaneously displays the tuning guide and the sweep meter type tuner simulator.

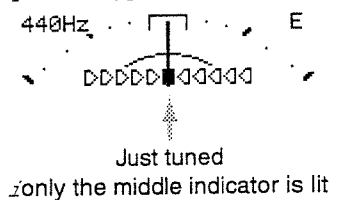

■ Tuning procedure

1. Play a single unfretted note on the string you wish to tune.

The note name closest to the string you played will appear in the display.

- * Cleanly play a single note only on the string that you wish to tune.

2. Adjust the tuning until the note name of the string you played appears in the display.

	6th string	5th string	4th string	3rd string	2nd string	1st string
Guitar	E	A	D	G	B	E
Bass			E	A	D	G

Standard tuning

3. While watching the tuning guide, adjust the tuning until only the middle indicator (tuned) is lit.

4. Repeat steps 1 – 3 to tune all the strings.

- * When tuning a guitar that has a tremolo arm, tuning one string may cause the other strings to go out of tune. In such cases, first tune the strings to the approximate pitch (so that the note name is displayed), and then keep tuning each string until they are all in tune.

■ Tuner settings

Here you can make tuner settings. Make settings as appropriate for the way that you wish to use this function.

The following items can be set.

- Setting the standard pitch
- Bypass on/off of the direct sound
- Volume setting during the direct sound bypass

Setting the standard pitch

“Standard pitch” is the frequency of the A4 note (middle A on a piano) that is used as a standard to which all other notes are tuned. The GT-3 allows you to set the standard pitch over the range of 435 – 455 Hz.

At the factory settings, this is set to 440 Hz.

1. Use the **TIME/VALUE** dial to change the standard pitch.
Setting will be stored when the “Store Current” is executed.

Bypass on/off of the direct sound

Normally, the output sound is muted while the tuner is being used. If you like to output the direct sound during tuning, turn it ON. When it is ON, the display will show “BYPASS” icon.

1. Press **[ENTER/TAP]** on the Tuner page.
Pressing **[ENTER/TAP]** will alternately change the status of the Bypass On/Off.
Setting will be stored when the “Store Current” is executed.

Volume setting during the direct sound bypass

Set the volume level of the direct sound output when the Bypass is On.

1. Use **[MASTER]** to set the desirable volume level.
Volume level will not be stored.

Copy between Channel Pan and Track Cue Pan

Useful when you want the same setting for the Channel Pan and the Track Cue Pan.

■ Copying the Channel Pan

Copying all of the Channel Pan Parameter to the Track Cue Pan parameter.

1. Press **[PAN]** and display the Pan parameter setting page.



2. While holding down **[SHIFT]**, press **[ENTER/TAP]**.
3. Display will indicate “PanCopy to Track.” Press **[ENTER/TAP]** to execute.
4. Press **[DISPLAY]** to return to Play mode.

■ Copying the Track Cue Pan

Copying all of the Track Cue Pan parameter to the Channel Pan parameter.

1. While holding down **[SHIFT]**, press **[TR STATUS]**, and V-track setting page will be displayed.



2. Press **[CURSOR ▽]**, and Track Cue Pan setting page will be displayed.



3. While holding down **[SHIFT]**, press **[ENTER/TAP]**.
4. “PanCopy to Ch” will be displayed. Press **[ENTER/TAP]** to execute.
5. Press **[DISPLAY]** to return to Play mode.

Switching the INFORMATION display content

You can select the INFORMATION display content.

Switching Sync information and External In function information

1. Press [UTILITY].
2. Use [CURSOR] and select System Utility icon, then press [ENTER/TAP].

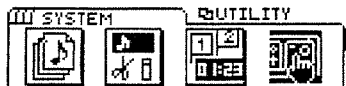

3. Use [CURSOR] and select Play/Rec Parameter icon, then press [ENTER/TAP].



4. Use [CURSOR] to move the cursor to "INFO ExtIn," use the TIME/VALUE dial to change.

SYNC/MIDI:

Sync Information is displayed.

ExtIn:

On/Off status of the External In function is displayed.

5. Press [DISPLAY] to return to Play mode.

Selecting the display method of remaining memory

1. Press [UTILITY].
2. Use [CURSOR] to select the System Utility icon, then press [ENTER/TAP].



3. Use [CURSOR] to select the Play/Rec Parameter icon, then press [ENTER/TAP].



4. Use [CURSOR] to move the cursor to "INFO Type," use the TIME/VALUE dial to change.

Time:

Remaining recordable time is displayed.

CapaMB:

Remaining recordable disk capacity is displayed in MB.

Capa%:

Remaining recordable disk capacity is displayed in %.

Event:

Usable number of Events is displayed.

5. Press [DISPLAY] to return to Play mode.

External In functions

There are times when all of 8 channels are in the playback status on the VS-840EX. You would still like to mix and record the output signals of the devices such as a sequencer, which is running in sync with the VS-840EX, onto a cassette tape etc.. In that situation, set the TRACK CUE knobs 1-4 as the external input level knob ("1-4 EXT INPUT" on the panel). Now you can mix the signal input at INPUT jacks 1-4 as a stereo two-channel signal, even when all 8 channels on the VS-840EX are in the playback status. This function is called External In function.

This function can be set on the Mix Down mode or the External In mode of the EZ Routing, or you can use the following procedure to make settings.

1. Press [UTILITY].
2. Use [CURSOR] to select the System Utility icon, then press [ENTER/TAP].



3. Use [CURSOR] to select the Play/Rec Parameter icon, then press [ENTER/TAP].



4. Use [CURSOR] to move cursor to "Ext Input," and use the TIME/VALUE dial to change.

On:

External In function is used. A TRACK CUE knob acts as an external input level knob.

Off:

External In function is not used. A TRACK CUE knob acts as a normal track level knob.

5. Press [DISPLAY] to return to Play mode.

SCSI ID Scan

Switches the method of checking SCSI device connections. When no SCSI devices are connected, or optional Zip drive is being connected, set to "5/6."

1. Press [UTILITY].
2. Use [CURSOR] to select the System Utility icon, then press [ENTER/TAP].



3. Use [CURSOR] to select the Global parameter icon, then press [ENTER/TAP].



4. Use [CURSOR] to move cursor to "SCSI ID Scan," and use the TIME/VALUE dial to change.

5/6:

Only SCSI ID 5/6 will be used. The time required for startup, restart, shut down, SCSI restart, and SCSI shut down on the VS-840EX will be quicker.

All:

checks all SCSI ID.

5. Press [DISPLAY] to return to Play mode.

Quick search

Search the approximate time location where the sound begins on a pre-selected track.

- * When searching for the location where sound begins, a few seconds of no-sound section is necessary.
- * When sound level and noise interrupts the no-sound section, search may not be accomplished. If the search can not be accomplished, current location comes to Song Top(End).

1. Press [DISPLAY] to return to Play mode.
2. While holding down [SHIFT], press [TR STATUS], and select the track with a sound you want to search.
3. While holding down [SHIFT], hold down [CLEAR] and press [FF] (REW), and search begins.

Holding down [SHIFT], holding down [CLEAR] and press [FF]:

The location A (sound beginning point) at the following chart is searched.

Holding down [SHIFT], holding down [CLEAR] and press [REW]:

The location B (sound ending point) at the following chart is searched.

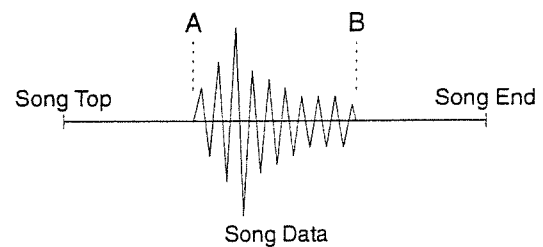

- * To interrupt and terminate the search, press [STOP].

4. "Now working..." will be displayed during the search. When the search is accomplished or if the search reaches the end of a song, the search will terminate automatically and the display returns to Play mode.

- * It takes 1/4 of the actual time to search.

Chapter 10. Use with MIDI devices

This chapter explains how MIDI messages are handled on the VS-840EX, and how it can operate in synchronization with a MIDI sequencer.

About MIDI

This section explains the basic concepts of MIDI, and how the VS-840EX handles MIDI messages.

■ What is MIDI

MIDI stands for "Musical Instrument Digital Interface." It is a worldwide standard that allows electronic musical instruments and personal computer to exchange musical performance data and messages such as sound selections. Any MIDI-compatible device can transmit musical data (as appropriate for the type of device) to any other MIDI-compatible device, regardless of its manufacturer or model type.

■ MIDI connectors

MIDI messages (the data handled by MIDI) are transmitted and received using the following three types of connectors.

MIDI IN:

This receives MIDI messages from external MIDI devices.

MIDI OUT:

This transmits MIDI messages from the VS-840EX.

MIDI THRU:

This re-transmits all MIDI messages that were received at MIDI IN, without modifying them.

* *The VS-840EX does not have a MIDI THRU connector.*

■ MIDI channels

MIDI is able to send information over a single MIDI cable independently to two or more MIDI devices. This is made possible by the concept of MIDI channels. You can think of MIDI channels as being somewhat similar in function to the channels on a television. By changing the channel of a TV set, you can view a variety of programs being transmitted by different broadcast stations. This is because data is received only from the transmitter whose channel is selected on the receiver.

In the same way, a MIDI device whose receive channel is set to "1" will receive only the data being transmitted by another MIDI device whose transmit channel is also set to "1."

■ MIDI messages

The VS-840EX uses the following types of MIDI message.

Note messages

These messages are used to play notes. On a keyboard, these message transmit the key (note number) that was pressed, and how strongly it was pressed (velocity). On the VS-840EX, these messages are used when you use a MIDI sound source to play the metronome sound.

■ MIDI implementation chart

MIDI allows a variety of electronic musical instruments to communicate with each other. However it is not necessarily the case that all devices will be able to communicate using all types of MIDI message. They can only communicate using those types of MIDI message that they have in common.

Each owner's manual for a MIDI device includes a MIDI Implementation Chart. This chart shows you at a glance the types of MIDI message that can be transmitted and received. By comparing the implementation charts of two devices, you will be able to see the types of message with which they will be able to communicate.

* *Detailed MIDI specifications of the VS-840EX are listed in "MIDI implementation" (page 180).*

Synchronizing with a MIDI sequencer

The VS-840EX can be operated in synchronization with a MIDI sequencer. Synchronization can be accomplished in one of the following three ways. Use the method that is appropriate for your situation.

However when operating in synchronization with a MIDI sequencer, it is possible to synchronize the MIDI sequencer from the VS-840EX (as master), but it is not possible to synchronize the VS-840EX (slave) from the MIDI sequencer.

- Using MTC (MIDI time code)
- Using the tempo map
- Using the sync track

* Please use a MIDI sequencer which can receive MTC and MIDI clock data.

* For details on MIDI sequencer operation, refer to the owner's manual for your sequencer.

* For details on MMC, refer to page 126.

■ Using MTC

This section explains how the VS-840EX can be synchronized with a MIDI sequencer that implements MTC (MIDI Time Code).

< Types of MTC >

The VS-840EX allows you to select the following types of MTC. Check the specifications of the MIDI devices that you are using, and select the appropriate type of MTC on the VS-840EX.

30:

30 frames per second non-drop format. This is used by audio devices such as analog tape recorders, and for NTSC format black and white video (used in the US and Japan, etc.).

29N:

29.97 frames per second non-drop format. This is used for NTSC format color video (used in the US and Japan, etc.).

29D:

29.97 frames per second drop format. This is used for NTSC format broadcast color video (used in the US and Japan, etc.).

25:

25 frames per second frame rate. This is used in SECAM format / PAL format video (used in Europe, etc.), and for audio equipment and film.

24:

24 frames per second frame rate. This is used for film in the US.

Synchronizing to the VS-840EX (Master)

When you want to synchronize the MIDI sequencer to the VS-840EX, use the following procedure.

1. Use a MIDI cable to connect the VS-840EX and the MIDI sequencer as follows.

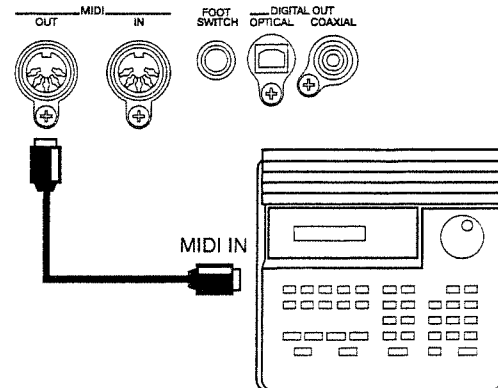

2. Press [UTILITY].

3. Use [CURSOR] to select the Sync/Tempo icon, and press [ENTER/TAP].



4. Make settings so that MTC will be used for synchronization.

Make settings for the following parameters.

Gen.:

Set this to "MTC."

MTC Type:

Select the desired type of MTC.

5. This completes synchronization settings for the VS-840EX. Press [DISPLAY] to return to Play mode.

6. Make settings on your MIDI sequencer so that it will synchronize to incoming MTC, and prepare it to begin playback of MIDI song data. When you start playback on the VS-840EX, the MIDI sequencer will begin playback in synchronization.

Gen. (Sync generator)

This selects the type of synchronization signal that will be transmitted from the MIDI OUT connector. When using a synchronization signal from the VS-840EX to synchronize external MIDI devices, set this to the desired type of synchronization signal.

Off:

Synchronization signals will not be transmitted.

MTC:

MIDI Time Code will be transmitted.

MIDI Clock:

MIDI Clock messages will be transmitted according to the tempo map.

Sync TRACK:

MIDI Clock data recorded on the sync track will be transmitted.

MTC Type

This sets the type of MTC. Check the specifications of the MIDI devices that you are using, and select the appropriate type of MTC on the VS-840EX.

30:

30 frames per second non-drop format. This is used by audio devices such as analog tape recorders, and for NTSC format black and white video (used in the US and Japan, etc.).

29N:

29.97 frames per second non-drop format. This is used for NTSC format color video (used in the US and Japan, etc.).

29D:

29.97 frames per second drop format. This is used for NTSC format broadcast color video (used in the US and Japan, etc.)

25:

25 frames per second frame rate. This is used in SECAM format / PAL format video (used in Europe, etc.), and for audio equipment and film.

24:

24 frames per second frame rate. This is used for film in the US.

< Non-drop format and drop format >

NTSC format VCRs use two formats; non-drop and drop. In non-drop format, the frames are continuous. However in drop format, two frames are skipped at the beginning of each minute except for the minutes which fall at ten-minute intervals.

In most video production and music production, continuous frames are easier to handle, so non-drop format is widely used. However in broadcast studios, where time code must match actual clock time, drop format is widely used.

<Switching the display of the TIME field>

When transmitting MTC from the VS-840EX to synchronize an external MIDI device, you can specify that the time displayed in the TIME field.

1. Press [UTILITY].

2. Use [CURSOR] to select the System Utility icon, and press [ENTER/TAP].



3. Use [CURSOR] to select the Play/Rec Parameters icon, and press [ENTER/TAP].



4. Use [CURSOR] to move the cursor to "TimeDisp," and use the TIME/VALUE dial to select how the time will be displayed.

TimeDisp (Time display format)

Specify the base time for the TIME field display. Normally you will leave this at "ABS." When using MTC to synchronize an external MIDI device from the VS-840EX, you may wish to select "REL."

ABS:

The specified offset time will be added to the display.

REL:

The beginning of the song will be displayed as "00:00:00:00:00".

5. Use [CURSOR] to move the cursor to "Offset," and use the TIME/VALUE dial to specify the time offset.

Offset

When using MTC to synchronize an external MIDI device from the VS-840EX, the Offset setting specifies how song playback will match with the MTC timing.

Specify an Offset value that is the desired "MTC time" minus the desired "song time." For example if you want to synchronize external devices using an MTC time of "00h10m00s00" to correspond to a song time of "01h00m00s00," you would set the offset as follows.

$$(00:10:00:00:00)-(01:00:00:00:00)=(23:10:00:00:00)$$

■ Using the tempo map

Even if your MIDI sequencer does not support MTC or MMC, you can use MIDI Clock for synchronization if the sequencer supports Song Position Pointer messages. There are two methods of synchronization using MIDI Clock; using the tempo map and using the sync track. In this section, the method of using the tempo map is explained.

< Notice when using the tempo map for synchronization >

When using the tempo map, use a song that was recorded using the metronome. The tempo and time signature of the metronome are determined by the tempo map, so if you have been recording in time with the metronome, the recorded performance will match the timing of the tempo map. However if you created the tempo map after recording the song, the timing of the song will not match the tempo map, and correct synchronization will not be possible.

For details on using the metronome, refer to "Sounding the metronome" (page 95).

What is the tempo map?

The tempo of a song is determined by the "Tempo Map." The tempo map lets you specify changes in tempo for each measure. Starting at the specified measure, it changes to a given tempo at the given beat. Tempo maps are numbered sequentially from the beginning of the song as tempo map 1, tempo map 2, and tempo map 3, etc.

Tempo map 1 is already specified at the beginning of the song, and determines the initial tempo of the song. To change the tempo at a subsequent measure, create a new tempo map at each location where you want the tempo to change. Up to 50 tempo maps can be created.

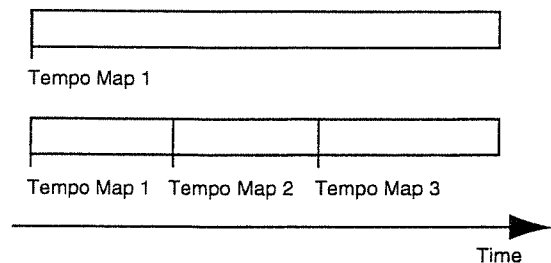

Creating a tempo map

To change the initial tempo of the song, use the following procedure to change the setting of tempo map 1.

1. Press [UTILITY].
2. Use [CURSOR] to select the Sync/Tempo icon, and press [ENTER/TAP].



3. Move the cursor to the "TEMPO" icon, and press [ENTER/TAP] to access the Tempo Map setting page.

The display below means that tempo map 1 starts at measure 1, and specifies a time signature of 4/4 and a tempo of 120 quarter notes per minute.

TEMPO MAP		OUTY: SYNC	
NO	MEASURE	BEAT	TEMPO
1	1	4/4	120
2	---	---	<NEW>
3	---	---	<NEW>

4. Set the tempo and time signature.
Use [CURSOR] to select the value that you wish to change, and use the TIME/VALUE dial to modify the value. (It is not possible to modify the first measure of tempo map 1.)
5. Press [DISPLAY] to return to Play mode.

TEMPO

This sets the tempo (25.0 to 250.0) of the tempo map. The measure and beat shown in the display, the metronome sound, and the MIDI Clock signals sent from the VS-840EX will be according to this tempo setting.

MEASURE

This sets the starting measure (1 to 999) of the tempo map. The measure and beat shown in the display, the metronome sound, and the MIDI Clock signals sent from the VS-840EX will be according to this tempo setting.

BEAT

This sets the time signature (1/1 to 8/1, 1/2 to 8/2, 1/4 to 8/4, 1/8 to 8/8) of the tempo map. The beats shown in the display, the metronome sound, and the MIDI Clock signals sent from the VS-840EX will be according to this time signature setting.

Synchronized operation

1. Use a MIDI cable to connect the VS-840EX and the MIDI sequencer as follows.

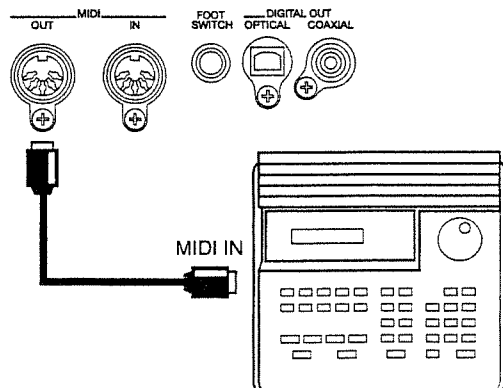

2. Press [UTILITY].
3. Use [CURSOR] to select the Sync/Tempo icon, and press [ENTER/TAP].



4. Make settings so that MIDI Clock will be used for synchronization. Move the cursor to "Gen." and set it to "MIDI Clock."
5. This completes synchronization settings for the VS-840EX. Press [DISPLAY] to return to Play mode.
6. Make settings on your MIDI sequencer so that it will synchronize to incoming MIDI clock messages, and prepare it to begin playback of MIDI song data. When you start playback on the VS-840EX, the MIDI sequencer will begin playback in synchronization.

Gen. (Sync generator)

This selects the type of synchronization signal that will be transmitted from the MIDI OUT connector. When using a synchronization signal from the VS-840EX to synchronize external MIDI devices, set this to the desired type of synchronization signal.

Off:

Synchronization signals will not be transmitted.

MTC:

MIDI Time Code will be transmitted.

MIDI Clock:

MIDI Clock messages will be transmitted according to the tempo map.

Sync TRACK:

MIDI Clock data recorded on the sync track will be transmitted.

Changing the tempo during the performance

To modify tempo map settings, use the following procedure.

< Limitations on changing the starting measure >

Tempo maps are numbered from the beginning of the song as tempo map 1, tempo map 2, tempo map 3, etc. This means that it is not possible to modify the starting measure of a tempo map to make it earlier than the starting measure of the previous tempo map, or later than the starting measure of the following tempo map. For example if tempo map 2 has a starting measure of "8" and tempo map 4 has a starting measure of "16," the starting measure of tempo map 3 can be modified only in the range of "9 to 15."

1. Press [UTILITY].
2. Use [CURSOR] to select the Sync/Tempo icon, and press [ENTER/TAP].



3. Move the cursor to the "TEMPO" icon, and press [ENTER/TAP] to access the Tempo Map setting page.

Use [CURSOR] to select the item that you wish to modify (tempo, starting measure, time signature), and use the TIME/VALUE dial to modify it. When you are read to set the next tempo map, press [CURSOR ▽].

* Since tempo map 1 is the initial tempo of the song, it is not possible to modify the starting measure setting of "1."

4. When you are finished making settings, press [DISPLAY] to return to Play mode.

■ Using the sync track

In this section, the method of using the sync track is explained.

In addition to the tracks for recording audio signals, the VS-840EX has a separate sync track for recording MIDI Clock signals. This means that unlike conventional analog multitrack recorders, it is not necessary to reserve one of the audio tracks for recording the sync signal.

To use the sync track, the MIDI clock of the MIDI song data to which you want to synchronize must first be recorded onto the sync track. Then, transmit the recorded MIDI clock data to the MIDI sequencer to synchronize the MIDI song data. In this way, while the method of using the tempo map explained in the previous section synchronizes the performance to the VS-840EX song, this method of using the sync track synchronizes the performance to the MIDI song data. Thus, this is a convenient method to use when the MIDI song data has been created earlier than the VS-840EX song.

In particular, when synchronizing to MIDI song data in which the tempo gradually becomes faster or slower, using the tempo map allows more precise following of tempo changes, compared to the tempo map in which tempo is set for each measure.

< Notice for synchronization >

The MIDI clock data recorded in the sync track is transmitted after song playback or recording begins. This means that if the music begins at the moment that playback begins, the MIDI sequencer will have to start playing back the MIDI song data at the same time that it receives the first MIDI clock data. In some cases, this can cause synchronization to be initially unstable.

If this problem occurs, insert several measures of blank space at the beginning of the VS-840EX song and the MIDI sequencer song.

Recording MIDI clock messages

1. Use a MIDI cable to connect the VS-840EX and the MIDI sequencer as follows.

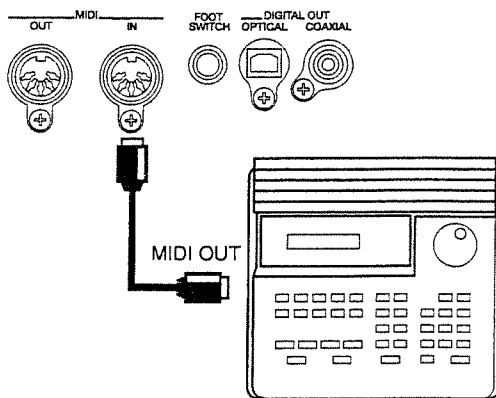

2. Press [UTILITY].
3. Use [CURSOR] to select the Sync/Tempo icon, and press [ENTER/TAP].



4. Use [CURSOR] to select the "SYNC REC" icon. Press [ENTER/TAP], and the display will indicate "Wait for Start," and the sync track will be ready to record MIDI clock data.
5. Start playback of the MIDI song data, and the MIDI clock data will be recorded on the sync track.

* While MIDI clock data is being recorded onto the sync track, the input sources can be monitored, but audio tracks cannot be recorded or played back.

6. When the MIDI song data finishes playing back, the VS-840EX will automatically stop recording MIDI clock data, and will return to Play mode.

Synchronized operation

1. Use a MIDI cable to connect the VS-840EX and the MIDI sequencer as follows.

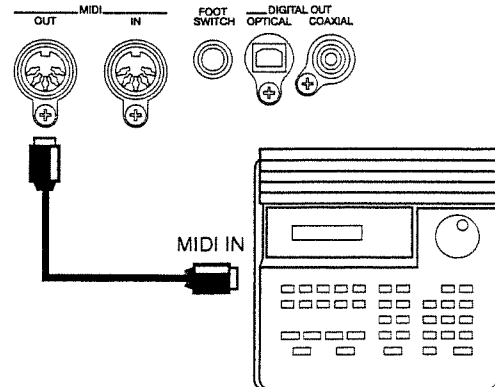

2. Press [UTILITY].
3. Use [CURSOR] to select the Sync/Tempo icon, and press [ENTER/TAP].



4. Make settings so that the MIDI clock data recorded on the sync track will be used for synchronization. Move the cursor to "Gen." and select "Sync TRACK."
5. This completes synchronization settings for the VS-840EX. Press [DISPLAY] to return to Play mode.
6. Make settings on your MIDI sequencer so that it will synchronize to incoming MIDI clock messages, and prepare it to begin playback of MIDI song data. When you start playback on the VS-840EX, the MIDI sequencer will begin playback in synchronization.

Gen. (Sync generator)

This selects the type of synchronization signal that will be transmitted from the MIDI OUT connector. When using a synchronization signal from the VS-840EX to synchronize external MIDI devices, set this to the desired type of synchronization signal.

Off:

Synchronization signals will not be transmitted.

MTC:

MIDI Time Code will be transmitted.

MIDI Clock:

MIDI Clock messages will be transmitted according to the tempo map.

Sync TRACK:

MIDI Clock data recorded on the sync track will be transmitted.

■ Assigning an offset to the sync track / tempo map

You can create a sync track / tempo map which begins at the location where you begin recording.

The sync track / tempo map will be created starting at "00:00:00:00:00." However in most cases, it will be rare for recording to actually begin at "00:00:00:00:00." For example if you have begun recording at "00:00:10:00:00," you can move the beginning of the sync track / tempo map to "00:00:10:00:00."

* During recording or playback, when the beginning of the sync track / tempo map is reached, a Start message will be transmitted from the MIDI OUT connector. This is convenient when you want an external MIDI sequencer to playback in synchronization with the VS-840EX.

1. Press [UTILITY].
2. Use [CURSOR] to select the Sync/Tempo icon, and press [ENTER/TAP].



3. Use [CURSOR \updownarrow] to move the cursor to "Offset."
4. Specify the time at which you want the sync track / tempo map to begin. Use [CURSOR $\leftarrow \rightarrow$] and the TIME/VALUE dial to specify the time.
5. Press [DISPLAY] to return to Play mode.

Sync Edit

■ Creating a Sync Track from Mark Points

A sync track can be created from mark points that were assigned to the previously recorded performance. This is useful when recording acoustic instruments such as guitar or vocal took place first, and later you decide to synchronize a MIDI sequencer etc. to the recording.

1. Press [UTILITY].
2. Use [CURSOR] to select "SYNC EDIT," then press [ENTER/TAP].



3. Use [CURSOR] to select "MARK TO SYNC," then press [ENTER/TAP].



4. Use [CURSOR] to select "Beat/Measure," and use the TIME/VALUE dial to specify the number of beat in one measure.
5. Use [CURSOR] to select "Mark/Measure," and use the TIME/VALUE dial to specify the number of mark point in one measure.
6. Use [CURSOR] to select "GO," then press [ENTER/TAP].
7. A confirmation message will ask "Are you sure?" on the display. Press [ENTER/TAP] to execute.
8. When sync track exists, a confirmation message asking to re-construct will be displayed. Press [ENTER/TAP] to execute.
9. A confirmation message asking to re-construct tempo map will be displayed. Press [ENTER/TAP] to execute.
10. A conversion operation begins. During this operation, "Now working..." appears in the display.
11. When the operation has been completed, "Complete" appears in the display, and you are returned to the original page.
12. Press [DISPLAY], and return to Play mode.

■ Creating a Tempo Map from a Sync Track

You can create a tempo map from the previously stored sync track. This is useful when you want to change the sync signal generated by a sync track with the VS-840EX.

1. Press [UTILITY].
2. Use [CURSOR] to select "SYNC EDIT," then press [ENTER/TAP].



3. Use [CURSOR] to select "SYNC TO TEMPO," then press [ENTER/TAP].



4. Use [CURSOR] to select "Beat/Measure," and use the TIME/VALUE dial to specify the number of sync signal stored in the sync track in one measure.
5. Use [CURSOR] to select "GO," then press [ENTER/TAP].
6. A confirmation message will ask "Are you sure?" on the display. Press [ENTER/TAP] to execute.
7. A confirmation message asking to re-construct tempo map will be displayed. Press [ENTER/TAP] to execute.
8. A conversion operation begins. During this operation, "Now working..." appears in the display.
9. When the operation has been completed, "Complete" appears in the display, and you are returned to the original page.
10. Press [DISPLAY], and return to Play mode.

■ Creating a Sync Track automatically

You can automatically create a sync track by specifying the start and end times of the song, and the number of measures which it contains. This is useful when the length of the song is already known.

1. Press [UTILITY].
2. Use [CURSOR] to select "SYNC EDIT," then press [ENTER/TAP].



3. Use [CURSOR] to select "AUTO CREATE," then press [ENTER/TAP].



4. Use [CURSOR] and the TIME/VALUE dial to set the song start time.
 - * Use [CURSOR] to select "Measure," rotate the TIME/VALUE dial to specify the time in terms of measures.
5. Press [CURSOR ▾] few times, and select End parameter.
6. Use [CURSOR] and the TIME/VALUE dial to set the song end time.
 - * Use [CURSOR] to select "Measure," rotate the TIME/VALUE dial to specify the time in terms of measures.
7. Press [CURSOR ▾] few times to select Total Measure parameter, and use the TIME/VALUE dial to specify the number of measures within a specified time.
8. Press [CURSOR] to select Beat/Measure parameter, and use the TIME/VALUE dial to specify the number of beat in one measure.
9. Use [CURSOR] to select "GO," then press [ENTER/TAP].
10. A confirmation message will ask "Are you sure?" on the display. Press [ENTER/TAP] to execute.
11. When sync track exists, a confirmation message asking to re-construct will be displayed. Press [ENTER/TAP] to execute.
12. A confirmation message asking to re-construct tempo map will be displayed. Press [ENTER] to execute.
13. A conversion operation begins. During this operation, "Now working..." appears in the display.
14. When the operation has been completed, "Complete" appears in the display, and you are returned to the original page.
15. Press [DISPLAY], and return to Play mode.

■ Creating a Tempo Map from Mark Points.

A tempo map can be created from mark points that were assigned to the previously recorded performance. This is useful when recording acoustic instruments such as guitar or vocal took place first, and later you decide to synchronize a MIDI sequencer etc. to the recording.

1. Press [UTILITY].
2. Use [CURSOR] to select "SYNC EDIT," then press [ENTER/TAP].



3. Use [CURSOR] to select "MARK TO TEMPO," then press [ENTER/TAP].



4. Use [CURSOR] to select "Beat/Measure," and use the TIME/VALUE dial to specify the number of beat in one measure.
5. Use [CURSOR] to select "Mark/Measure," and use the TIME/VALUE dial to specify the number of mark point in one measure.
6. Use [CURSOR] to select "GO," then press [ENTER/TAP].
7. A confirmation message will ask "Are you sure?" on the display. Press [ENTER/TAP] to execute.
8. A confirmation message asking to re-construct tempo map will be displayed. Press [ENTER/TAP] to execute.
9. A conversion operation begins. During this operation, "Now working..." appears in the display.
10. When the operation has been completed, "Complete" appears in the display, and you are returned to the original page.
11. Press [DISPLAY], and return to Play mode.

■ When you experience problems with synchronization

- Is the sync generator set correctly?
- If you are using MTC, are both devices set to the same type of MTC?
- If you are using the sync track, are MIDI clock messages recorded in the sync track?

Chapter 11. Overall settings and status checking

If the display area is difficult to read (Contrast)

Depending on the location where the VS-840EX is placed, the display may sometimes be difficult to read. In such cases, use the following procedure to adjust the display contrast (0 to 15).

1. Press [UTILITY].
2. Use [CURSOR] to select the System Utility icon, and press [ENTER/TAP].



3. Use [CURSOR] to select the Global Parameter icon, and press [ENTER/TAP].



4. Use [CURSOR] to move the cursor to "LCD Contrast," and use the TIME/VALUE dial to adjust the contrast.
5. When you finish making the setting, press [DISPLAY] to return to Play mode.

Switching the contents of the display (Display)

In Play mode, you can press [DISPLAY] to switch the contents of the display. To switch the display between settings shown in square brackets such as "[Pre]MIXER" or "[Pst]MIXER," press [CURSOR ▾] several times to move the cursor to [], and use the TIME/VALUE dial to switch the display between Pre/Pst.

Also, you can hold down [SHIFT] and press [DISPLAY] to switch the left side of the display between the V-track screen and the song information screen as shown below.

When the V-track screen is displayed

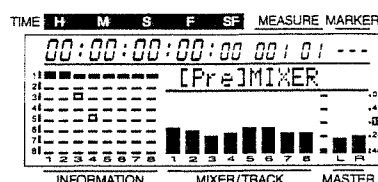

- (■): Currently selected V-track (performance data exists)
- (▬): Currently selected V-track (no performance data)
- (□): V-track which contains performance data
- (-): V-track which contains no performance data

When the song information screen is displayed

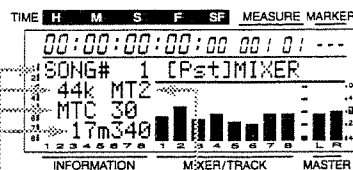

Song number Recording mode

Sample rate

Depending on the INFO ExtIn parameter value of the Play/Rec parameter, display content will change.
SYNC/MIDI

(information relating to synchronization)

When MTC is used for synchronization

MTC: 30, 29N, 29D, 25, 24

When MIDI Clock based on the Tempo Map is used to synchronize

MID: TMP, SYC

When MIDI Clock recorded in the Sync Track is used to synchronize

ExIN (external in)

ExIN: OFF, ON

Depending on the INFO type parameter value of the Play/Rec parameter, display content will change.

Time (remaining time for recording)

(Example shown)

17m340 -> 17 minutes 34.0 seconds

Capa MB (remaining recordable capacity (MB))

Capa % (remaining recordable capacity (%))

Event (remaining number of Events)

● MIXER LEVEL

[Pre] MIXER

The volume of each channel before passing through the channel faders will be displayed.

MASTER shows the volume level after the master faders.

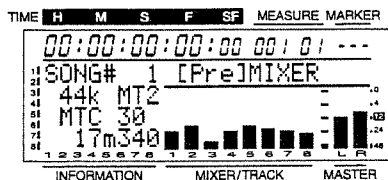

[Pst] MIXER

The volume of each channel after passing through the channel faders will be displayed.

MASTER shows the volume level after the master faders.

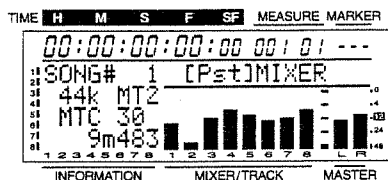

● TRACK LEVEL

[---] TRACK

The volume level before the TRACK CUE knob of each track is displayed.

MASTER shows the volume level after the master fader.

* It is not possible to change the contents of [---].

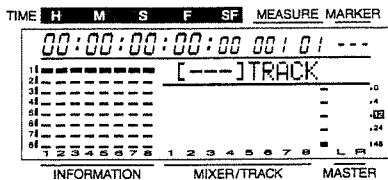

● PLAY LIST

[---] PlayList

The way in which sound is recorded in the various tracks before and after the current time will be displayed.

* It is not possible to change the contents of [---].

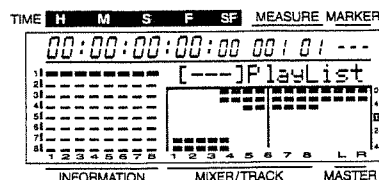

● FADER/PAN

[MIX] FaderPan

The master fader, and the pan and channel fader settings of each channel are shown. If the fader locations are different than the actual volume levels (because you have changed scenes etc.), both the fader locations and the actual settings will be shown.

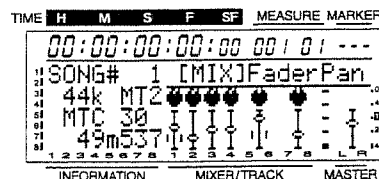

[TRK] FaderPan

The PAN and TRACK CUE knob settings of each track are shown. If the TRACK CUE knob locations are different than the actual volume levels (because you have changed scenes, etc.), both the TRACK CUE knob locations and the actual settings will be shown.

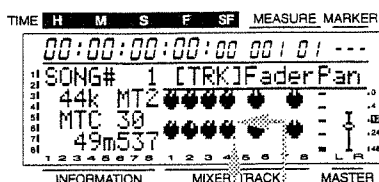

Value Knob Position

Displaying song-related information

The following information is displayed for the currently-selected song (the current song).

- Song number
- Song name
- Song protect on/off
When song protect is on, the song protect symbol will be displayed.
- Recording mode
- Sample rate
- Synchronization-related information
- Amount of disk memory used by the current song
The amount of disk capacity occupied by the current song is displayed both as a bar graph and as a percentage.

Procedure for displaying Song Information

1. Press [UTILITY].
2. Use [CURSOR] to select the Song Edit icon, and press [ENTER/TAP].



3. Use [CURSOR] to select the Song Information icon, and press [ENTER/TAP].

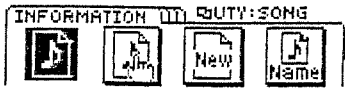

4. The song information page will appear.

```

INFORMATION  UTILITY: SONG
SONG# 1:InitSONG 001
SAMPLE/MODE:44K MT2
SYNC:MTC 30      SIZE:  0.5M

```

SONG#:

Song number/Song name

(If song protect is on, the song protect symbol will also be displayed)

SAMPLE/MODE:

Sample rate/Recording mode

SYNC:

Synchronization-related information

When MTC is used for synchronization

MTC 30, 29N, 29D, 25, 24

When MIDI Clock based on the Tempo Map is used to synchronize

MIDI CLOCK

When MIDI Clock recorded in the Sync Track is used to synchronize

SYNC TRACK

When no synchronization signal is being output

OFF

SIZE:

Amount of disk memory (MByte) used by the current song

Restoring the VS-840EX settings to the initial state

For example after you have been mixing repeatedly, you can use this operation to restore the mixer and system parameter settings to their initial state. However the volume level of each channel and the volume level of the master section will be according to the front panel fader settings.

* System parameters refer to the parameters which are in the System Utility icon. The System Parameter icon contains Global parameters which affect the entire system, and Play/Rec parameters which affect the song.

* Even if the settings of the mixer parameters, the Play/Rec parameters and the Global parameters are initialized, the song, scene, tempo map and sync track data will not be lost.

Here we will explain how to initialize the Global parameters.

1. Press [UTILITY].
2. Use [CURSOR] to select the Init Mixer/System Parameters icon, and press [ENTER/TAP].



3. Use [CURSOR] to select the Init Global Parameters icon, and press [ENTER/TAP].

Init Global Parameters icon

When this icon is selected, the Global parameters in the System Utility icon will be initialized to their factory settings. Global parameters are the parameters which affect the entire system.



Init Mixer / Play/Rec Parameters icon

When this icon is selected, the mixer parameters and the Play/Rec Parameters in the System Utility icon will be initialized to the settings they had when the Song New operation is used to create a song. Play/Rec parameters are song-related parameters.



4. The display will ask "Init GLOBAL PRM Sure ?" If you wish to initialize the Global parameters, press [YES].
5. The display will ask "Are you sure ?" Press [YES] to execute the operation. To cancel, press [NO].
6. When initialization is complete, you will return to Play mode.

Chapter 12. Taking advantage of the VS-840EX (ideas and examples)

Along with the functions explained in earlier chapters, this chapter explains some actual ways in which the VS-840EX can be used effectively.

Recording multiple sources to one track

Here we will explain how the sources input to INPUT 1 to 3 can be recorded on track 1. This is convenient, for example, when you wish to put up a separate mic for hi-hat, snare and cymbal and record the sound of the entire drum set onto a single track. In this case, the signal flow will be as follows.

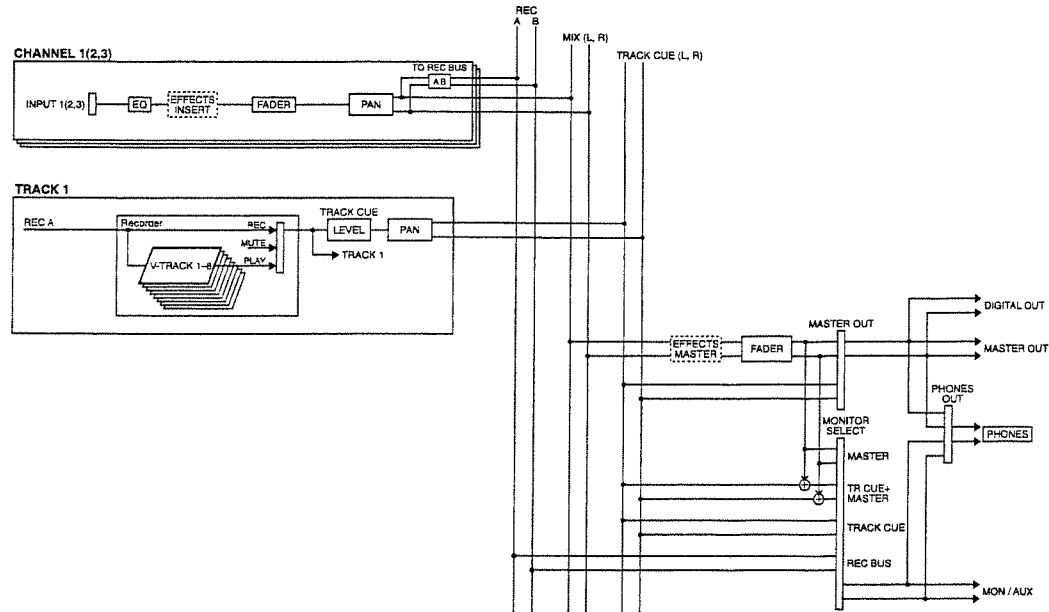

1. Specify the INPUT jack as the input for channels 1 to 3.
Make sure that the SELECT indicator for channels 1 to 3 is lit orange.
2. Select the input source for channels 1 to 3. Press [MODE] to make the CHANNEL mode indicator light. Next, press channel 1 [SELECT] to select channel 1, and press the CHANNEL PARAMETER button [INPUT] to access the input source select page. Here you want to select the INPUT 1 jack, so use the TIME/VALUE dial to select "IN1."
In the same way, use [CURSOR] and the TIME/VALUE dial to set the input source of channels 2 to 3 to INPUT jacks 2 to 3 respectively.
3. Set the pan for channels 1 to 3. With the CHANNEL mode indicator lit, press the CHANNEL PARAMETER button [PAN] to access the pan setting page. Here you want to record only to track 1, so first press [CURSOR] to move the cursor to channel 1, and then use the TIME/VALUE dial to set the parameter to full left (L63).
Do the same for channels 2 to 3.
4. Use the INPUT SENS knobs 1 to 3 to adjust the input sensitivity.
Raise the instrument volume as far as possible so that a high level is input. Then adjust the input sensitivity as high as possible without causing the PEAK indicator to light.
5. Send the output of channels 1 to 3 to the recording bus A/B. Make sure that the BUS AB indicator for channels 1 to 3 is lit.
If the indicator is not lit, press [MODE] to select BUS mode, and then press channel 1 to 3 [SELECT] to make the BUS AB indicator light.
6. Set the track status of track 1 to REC. Press the track 1 [TRACK STATUS/V.TRACK] to make the button indicator light red.
7. Press [REC] to make the button indicator blink red, and then press [PLAY] to begin recording.
When you begin recording, the sources being input to INPUT 1 to 3 will be recorded together onto track 1.

When you finish making settings, press [DISPLAY] to return to Play mode.

Bringing together the desired sections

After listening to the recordings on each V-track, suppose that you wanted to use the intro from V-track 1 and the break from V-track 2, etc. In such cases, copy the desired sections to a different V-track to assemble the sections into a single V-track.

The following procedure shows an example in which sections recorded on V-tracks 1, 2, and 3 of track 1 are assembled by copying them onto V-track 4.

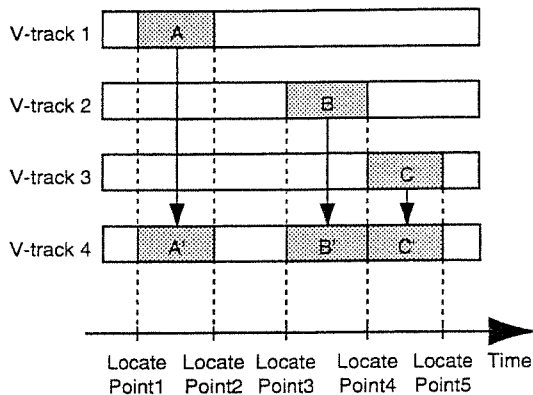

1. Switch V-tracks in INPUT TRACK mode or in TRACK MIX mode, and register Locate points for the times at which you wish to copy data from them. In this example we will use locate points 1 to 5 to specify the desired data. (page 35)

2. Press [UTILITY].

3. Use [CURSOR] to select the Track Edit icon, and press [ENTER/TAP].

4. Use [CURSOR] to select the Track Copy icon, and press [ENTER/TAP].

5. The Track Copy page will appear, allowing you to select the copy source and copy destination tracks/V-tracks. Use [CURSOR] and the TIME/VALUE dial to select the copy source and copy destination tracks/V-tracks.

As the copy source, select track 1 V-track 1 ("1-1"), and as the copy destination select track 1 V-track 4 ("1-4").

6. Specify the copy area and the time location of the copy destination. Move the cursor to the "TIME" icon, and press [ENTER/TAP] to access the Track Copy (TIME) page. Make settings for the following items.

Here we will use locate points to specify the times. Move the cursor to the line that you wish to modify, and press a LOCATOR button to specify the time.

START (start point):

Specify the beginning time location of the copy source performance data. For V-track 1, specify locate point 1.

END (end point):

Specify the end time location of the copy source performance data. For V-track 1, specify locate point 2.

FROM (from point):

Specify the time location of the copy source playback data at the "TO" point. Normally you will set this to the same time as the "START" point. For V-track 1, specify the same locate point 1 as for the Start point.

TO (to point):

Specify the base time location for the copy destination. For V-track 1, specify the same locate point 1 as the Start point.

COPY (copy time):

Specify the number of copies (1 to 99). In this example, specify "1."

7. When you finish making settings, move the cursor to the "GO" icon, and press [ENTER/TAP] to execute the Copy operation.

8. Using the same procedure as steps 5 to 7, copy the desired areas of V-tracks 2 and 3 to V-track 4. When you have finished copying, select V-track 4 and check the playback of the assembled data.

< If noise between segments is obtrusive >

In the seams or breaks that occur when recording is begun or ended or when a phrase is copied, obtrusive noise may occur. The VS-840EX fades-in and fades-out these breaks so that this noise will not be heard. If objectionable noise occurs, you can adjust the length of the fade-in and fade-out.

* It is not possible to set the fade-in/fade-out time to 0. Thus in some cases, such as if you copy a sustained sound such as strings and use it elsewhere, the break may be even more noticeable than if there had been no fade.

1. Press [UTILITY].

2. Use [CURSOR] to select the System Utility icon, and press [ENTER/TAP].



3. Use [CURSOR] to select the Play/Rec Parameters icon, and press [ENTER/TAP].



4. Use [CURSOR] to move the cursor to "Fade Length," and use the TIME/VALUE dial to specify the fade-in/fade-out time.

Fade Length

When recording is begun or ended, unpleasant noise may occur. So that this noise is not heard when the song is played back, the VS-840 fades the start and end of the recording in and out. This parameter sets the fade in/out time (2, 10, 20, 30, 40, 50 ms).

5. Press [DISPLAY].
You will return to Play mode.

Using Mark points to rearrange song data (Song Arrange)

You can use Mark points that have been specified in a song to rearrange the order of song data, in units indicated by the Mark points.

1. While playing back the song, use the procedure of "Marking a time location" (page 35) to set Mark points at the locations that you wish to rearrange.
2. Press [UTILITY].
3. Use [CURSOR] to select the Song Edit icon, and press [ENTER/TAP].



4. Use [CURSOR] to select the Song Arrange icon, and press [ENTER/TAP].

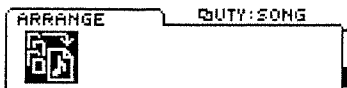

5. A page will appear in which you can specify how the song data will be rearranged. First specify the section that will be moved to the beginning. Use [CURSOR] and the TIME/VALUE dial to specify the Mark point numbers for the START location and END location of the section that will be moved to the beginning. When you have made the settings, press [ENTER/TAP].

* You can rearrange up to 99 sections to create a new song.

6. Now you can specify the next section. As in step 5, specify the location that you wish to add. When you have made the settings, press [ENTER/TAP].

7. Repeat step 6 to specify how the song data will be rearranged.

* If you wish to delete a previously-specified line, use [CURSOR] to select the line that you wish to delete, use the TIME/VALUE dial to set the START location or END location display to "???", and press [ENTER/TAP]. If you use [CURSOR] to move the cursor to another line without pressing [ENTER/TAP], the line for which "???" is displayed will remain as it is, but that line will be ignored.

* If you wish to insert a new line, use [CURSOR] to move the cursor to the location where you wish to insert the new line, and press [ENTER/TAP]. A new line will be inserted, and you can specify the Mark point number for the START and END locations of the section to be inserted.

8. When you have finished specifying the new arrangement of the song data, move the cursor to the "GO" icon, and press [ENTER/TAP].

9. A screen page will appear in which you can specify the time location at which the newly created song data will begin. By default, this will be SONG END. If you wish to change this, use [CURSOR] and the TIME/VALUE dial to set the time. If you move the cursor to "MARKER" and rotate the TIME/VALUE dial, you can use Mark points to specify the time.

* Be aware that if you specify a location earlier than SONG END, existing song data will be overwritten. Also, if you specify a time location later than the last Mark point which existed in the original song, the beginning of the newly created song will be given a new Mark point. If you specify a time location earlier than the last Mark point which existed in the original song, a Mark point will not be added to the beginning of the newly created song.

10. When you finish making time settings, use [CURSOR] to move the cursor to the "GO" icon, and press [ENTER/TAP].

The newly arranged song will be created starting at the time you specified in step 9.

Operating the VS-840EX from another device (MMC)

The VS-840EX supports MMC. This means that when a VS-840EX is used in conjunction with an MMC-supporting MIDI sequencer etc., operations such as song playback, stop and fast-forward can be performed by operating only the master device.

* Depending on the MIDI device that you are using, some devices may not support the MMC functionality of the VS-840EX. In this case, the VS-840EX cannot be operated as explained in this owner's manual.

MMC functions supported by the VS-840EX are listed in detail in "MIDI implementation" (page 180).

< About MMC >

MMC is an acronym for "MIDI Machine Control." This is a rule that defines how MIDI system exclusive messages can be used to control multiple recording devices from a single device. The VS-840EX supports MMC.

You can perform operations such as song playback, stop and fast-forward.

■ Operating the VS-840EX from an MMC-compatible device

Here we will explain the settings for operating the VS-840EX in synchronization with a computer-based sequencer program that supports MMC and MTC. Make connections as follows.

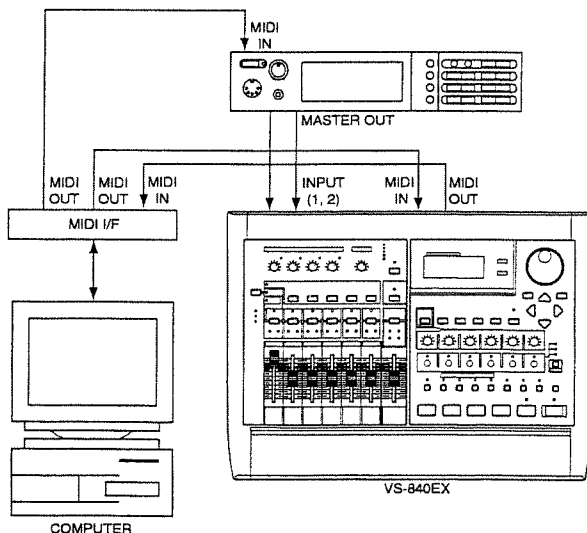

With these settings, the sequencer program will be the master for MMC, and the VS-840EX will be the master for MTC.

Sequencer software can control the VS-840EX, making it playback, stop and fast-forward etc.

Settings for the master VS-840EX

1. Press [UTILITY].
2. Use [CURSOR] to select the MIDI icon, and press [ENTER/TAP].



3. Specify the device ID number of the VS-840EX. Use [CURSOR] to move the cursor to "Device ID," and use the TIME/VALUE dial to select "17."

* The default setting is "17."

4. Use [CURSOR] to move the cursor to "MMC," and select "SLAVE" so that MMC commands can be received.

MMC (MMC mode)

This setting determines how the VS-840EX will implement MMC.

Off:

MMC will neither be transmitted nor received.

MASTER:

MMC will be transmitted. The VS-840EX will be the master device for external MIDI equipment.

SLAVE:

MMC will be received. The VS-840EX will be a slave device for external MIDI equipment.

* For details on MMC commands that are supported, refer to "MIDI implementation" (page 180).

5. Press [EXIT], and then select the Sync/Tempo icon and press [ENTER/TAP].



6. Move the cursor to "Gen." and select "MTC" so that MTC can be transmitted.

Gen. (Sync generator)

This selects the type of synchronization signal that will be transmitted from the MIDI OUT connector. When using a synchronization signal from the VS-840EX to synchronize external MIDI devices, set this to the desired type of synchronization signal.

Off:

Synchronization signals will not be transmitted.

MTC:

MIDI Time Code will be transmitted.

MIDI Clock:

MIDI Clock messages will be transmitted according to the tempo map.

Sync TRACK:

MIDI Clock data recorded on the sync track will be transmitted.

7. Move the cursor to "MTC Type," and select the appropriate MTC type for your sequencer software. For this example, select "30."

MTC Type

This sets the type of MTC. Check the specifications of the MIDI devices that you are using, and select the appropriate type of MTC on the VS-840EX.

30:

30 frames per second non-drop format. This is used by audio devices such as analog tape recorders, and for NTSC format black and white video (used in the US and Japan, etc.).

29N:

29.97 frames per second non-drop format. This is used for NTSC format color video (used in the US and Japan, etc.).

29D:

29.97 frames per second drop format. This is used for NTSC format broadcast color video (used in the US and Japan, etc.).

25:

25 frames per second frame rate. This is used in SECAM format / PAL format video (used in Europe, etc.), and for audio equipment and film.

24:

24 frames per second frame rate. This is used for film in the US.

< Non-drop format and drop format >

NTSC format VCRs use two formats; non-drop and drop. In non-drop format, the frames are continuous. On the other hand, drop format skips the first two frames at the beginning of each minute (except for 10, 20, 30, 40 and 50 minutes), in order to be compatible with NTSC format color video.

In most video production and music production, continuous frames are easier to handle, so non-drop format is widely used. However in broadcast studios, where time code must match actual clock time, drop format is widely used.

8. Press [DISPLAY].

You will return to Play mode.

Make settings for the sequencer program

Make the following settings for the sequencer program that you are using. For details on making the settings, refer to the owner's manual for your sequencer program.

Device ID number	17
MTC	Receive
MTC Type	30 fps
MMC	Transmit (Master)

■ If you have problems with synchronization

- Does the device you are using support the VS-840EX's MMC?
- Do the device ID numbers match?
- Is the Sync Generator set correctly?
- Is the same type of MTC selected for both devices?

Using external effect units

This section gives two examples of using external effect devices. Refer to these explanations when you wish to use your own effect devices.

- * If when Monitor Select is set to AUX, you attempt to change it to a setting other than AUX, the following warning message will appear.



If this message is displayed and you are using the MON/AUX jacks as effect send jacks and are using any of the INPUT jacks 1 to 4 as effect return jacks, you must immediately disconnect the effect return cables which are connected to the INPUT jacks. If you continue operation, feedback may occur. After disconnecting the cables, press [ENTER/TAP] and continue operation.

This is because when the MON/AUX jacks are used as effect send jacks and any of the INPUT jacks 1 to 4 are used as effect return jacks, changing Monitor Select to a setting other than AUX will cause the output from the MON/AUX jacks to be input to the INPUT jacks, which could cause feedback depending on the mixer settings. Also, even if Monitor Select is set to AUX, raising the AUX Send Level of the channel which is inputting the effect return signal may cause feedback. Be sure to set the AUX Send Level to minimum (0) for all channels which are inputting the effect return signal.

- * In order to output the same signal to the PHONES jack as the MASTER OUT jack, use the procedure from "Switching the source for output to the PHONES jack" (page 99) section, and select the PHONES OUT setting to the MASTER.

■ Applying an effect during playback

When using external effects, use the MON/AUX jacks as effect send jacks. Here, we will use the example of applying effects to a stereo performance recorded on tracks 1/2. We will use the INPUT 3 and 4 jacks as effect return jacks. Connect your effect device as shown below.

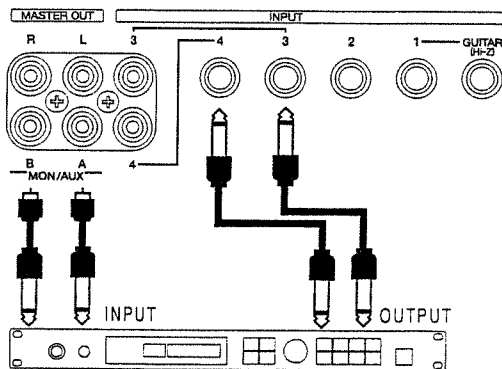

1. Make settings so that the playback from track 1 is input to channel 1, and the playback from track 2 is input to channel 2. Make settings so that the signal from the INPUT 3 jack is input to channel 3, and the signal from the INPUT 4 jack is input to channel 4. (page 32)
2. Select the way in which the signal will be sent to the AUX bus. Press [MODE] to make the CHANNEL mode indicator light. Next press channel 1 [SELECT], and press the CHANNEL PARAMETER button [AUX LEVEL] to access the AUX Level setting page. In the AUX Level setting page, press [CURSOR ▽] twice to access the "AUX SEND SW" display, so that you can specify how the channel 1 signal will be sent. For this example, use the TIME/VALUE dial to select "Pre" (Pre FADER). Next, press [CURSOR ▷] to select channel 2, and set it to "Pre" (Pre FADER) in the same way.

AUX SEND Switch

Select how the signal will be sent to the AUX bus. If "Off" is selected, the AUX level of that channel will be displayed as "___."

Off:

A signal will not be sent.

Pre EQ:

Send the pre-EQ signal to the AUX bus.

Pre (Pre FADER):

Send the pre-fader signal to the AUX bus.

Pst (Post FADER):

Send the post-fader signal to the AUX bus.

3. Adjust the level at which channels 1 and 2 are sent to the AUX bus. From the "AUX SEND SW" display, press [CURSOR △] once to access the setting for AUX level B, and press [CURSOR △] once more to access the setting for AUX level A. Use [CURSOR] to select the channel, and set the AUX level of each channel as follows.

Channel 1

AUX level A=100

AUX level B=0

Channel 2

AUX level A=0

AUX level B=100

* Channels 1 to 4 have AUX levels A and B, but since channels 5/6 and 7/8 are stereo tracks, they have only one AUX level. Left and right will be set to the same level.

4. Switch the monitor output to AUX. Hold down [SHIFT] and press [MONITOR SEL] to select AUX (the indicator will blink green). Now the signal of the AUX bus will be output from the MON/AUX jacks.
5. Set the pan for channels 3 and 4. Make sure that the CHANNEL mode indicator is lit. Next, press channel 3 [SELECT], and then press the CHANNEL PARAMETER button [PAN] to access the pan setting page. Here you will set the channel 3 pan to (L63), and the channel 4 pan to (R63).
6. Now the sound processed by the effect will be output from the MASTER OUT jacks. Press [DISPLAY] to return to Play mode.
7. Playback the song, and adjust the way in which effects are applied.

The signal level that is sent to the external effect device can be adjusted by the AUX level of channel 1 and 2. The signal level from the external effect device can be adjusted by channel faders 3 and 4.

However this balance will depend on the effect that you use, so you should adjust the volume level on the external effect unit, and leave the VS-840EX fixed at an appropriate volume level.

By operating channel faders 1 and 2 you can adjust the volume level of the direct sound. Use this as necessary.

■ Applying an effect while bouncing tracks

Track bouncing is the procedure by which the data recorded on two or more tracks is merged. At this time, you may apply effects to specific tracks.

Here, we will give the example of bouncing two stereo recordings made on tracks 1/2 and tracks 5/6 onto tracks 7/8 as you apply effects only to tracks 1/2.

Use INPUT 3 and 4 as the effect return jacks.

Connect your effect device as explained in the previous section.

1. Make settings so that the playback of track 1 is input to channel 1, and the playback of track 2 is input to channel 2. Make settings so that the signal from the INPUT 3 jack is input to channel 3, and the signal from the INPUT 4 jack is input to channel 4. Make settings so that the playback of tracks 5/6 is input to channels 5/6. (page 32)
2. Select how the signal will be sent to the AUX bus. Press [MODE] to make the CHANNEL mode indicator light. Next, press channel 1 [SELECT], and press the CHANNEL PARAMETER button [AUX LEVEL] to access the AUX level setting page. In this page, press [CURSOR ▽] twice to access "AUX SEND SW," and you can specify how the channel 1 signal will be sent. In this example, use the TIME/VALUE dial to select "Pre" (Pre FADER). Next, press [CURSOR ▾] to select channel 2, and set this to "Pre" (Pre FADER) in the same way.

AUX SEND Switch

Select how the signal will be sent to the AUX bus. If "Off" is selected, the AUX level of that channel will be displayed as "—."

Off:

A signal will not be sent.

Pre EQ:

Send the pre-EQ signal to the AUX bus.

Pre (Pre FADER):

Send the pre-fader signal to the AUX bus.

Pst (Post FADER):

Send the post-fader signal to the AUX bus.

3. Adjust the level at which channels 1 and 2 are sent to the AUX bus. From the "AUX SEND SW" display, press [CURSOR △] once to access the setting for AUX level B, and press [CURSOR △] once more to access the setting for AUX level A. Use [CURSOR] to select the channel, and set the AUX level of each channel as follows.

Channel 1

AUX level A=100

AUX level B=0

Channel 2

AUX level A=0

AUX level B=100

* Channels 1 to 4 have AUX levels A and B, but since channels 5/6 and 7/8 are stereo tracks, they have only one AUX level. Left and right will be set to the same level.

4. Switch the monitor output to AUX. Hold down [SHIFT] and press [MONITOR SEL] to select AUX (the indicator will blink green). Now the signal of the AUX bus will be output from the MON/AUX jacks.
5. Set the pan for channels 3 and 4. Make sure that the CHANNEL mode indicator is lit. Next, press channel 3 [SELECT], and then press the CHANNEL PARAMETER button [PAN] to access the pan setting page. Here you will set the channel 3 pan to (L63), and the channel 4 pan to (R63).
6. Now effects can be applied. Press [DISPLAY] to return to Play mode.
7. Make settings so that channels 3 and 4, and channels 5/6 are output to REC bus CD. (page 32)
8. Set the track status of tracks 7/8 to REC, playback the song, and adjust the effects. When you finish making adjustments, you can record. (page 56)
The signal level that is sent to the external effect device can be adjusted by the AUX level of channel 1 and 2. The signal level from the external effect device can be adjusted by channel faders 3 and 4.
However this balance will depend on the effect that you use, so you should adjust the volume level on the external effect unit, and leave the VS-840EX fixed at an appropriate volume level.

Algorithm list

This section contains explanations of each algorithm. In the “Preset Patch list sheet,” check the algorithm used by the Patch that you are starting with, and refer to this section for an explanation of the algorithm. For details on the function of each parameter, refer to the section “Functions of each parameter” (page 157).

* If the Foot Switch parameter is set to “Effect,” parameters marked by “(*)” can be controlled by operating a foot switch.

1. Reverb 1

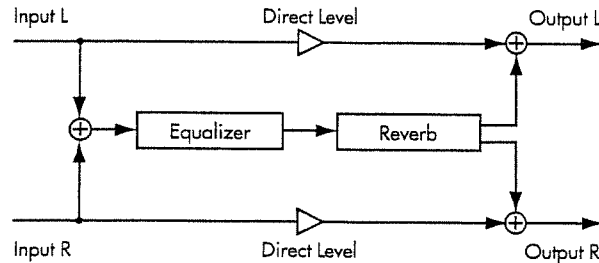

Reverb with a gating function. In addition to producing conventional reverb, this can also be used as a gated reverb.

EQ

Effect On/Off	Off	On	
Low Gain	-12	+12	[dB]
Low Freq	40	1.5k	[Hz]
Mid Gain	-12	+12	[dB]
Mid Freq	200	8.0k	[Hz]
Mid Q	0.5	16	
High Gain	-12	+12	[dB]
High Freq	500	18k	[Hz]
Level	-12	+12	[dB]

Reverb

Effect On/Off (*)	Off	On	
Room Size	5.6	32.6	[m]
Reverb Time	0.1	32.0	[s]
D:E Balance	100:0	0:100	
Level	0	100	
Pre Delay	0	200	[ms]
Density	0	100	
ER Level	0	100	
Release Dnsty	0	100	
Low Damp Gain	-36	0	[dB]
Low Damp Freq	55	4.0k	[Hz]
Hi Damp Gain	-36	0	[dB]
Hi Damp Freq	4.0k	20k	[Hz]
Hi Cut Filter	200	20.0k	[Hz]

--- Gate ---

Gate On/Off	Off	On	
Threshold	0	100	
Hold Time	1	100	
Release Time	1	100	

2. Reverb 2

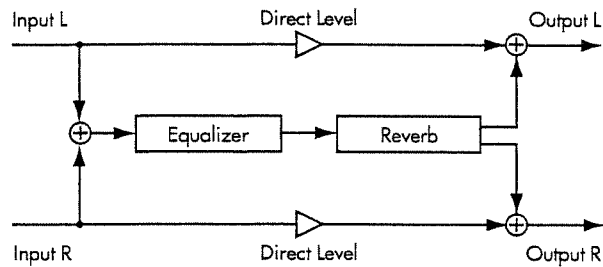

A simulation of the reverberation of a room or hall.

EQ

Effect On/Off	Off	On	
Low Gain	-12	+12	[dB]
Low Freq	40	1.5k	[Hz]
Mid Gain	-12	+12	[dB]
Mid Freq	200	8.0k	[Hz]
Mid Q	0.5	16	
High Gain	-12	+12	[dB]
High Freq	500	18k	[Hz]
Level	-12	+12	[dB]

Reverb

Effect On/Off (*)	Off	On	
Reverb Type	Room, Hall		
Room Size	1	10	
Reverb Time	0.1	32.0	[S]
D:E Balance	100:0	0:100	
Level	0	100	
Pre Delay	0	200	[mS]
Density	0	100	
ER Level	0	100	
Low Damp Gain	-36	0	[dB]
Low Damp Freq	55	4.0k	[Hz]
Hi Damp Gain	-36	0	[dB]
Hi Damp Freq	4.0k	20k	[Hz]
Hi Cut Filter	200	20.0k	[Hz]

3. Tap Delay

[Single]

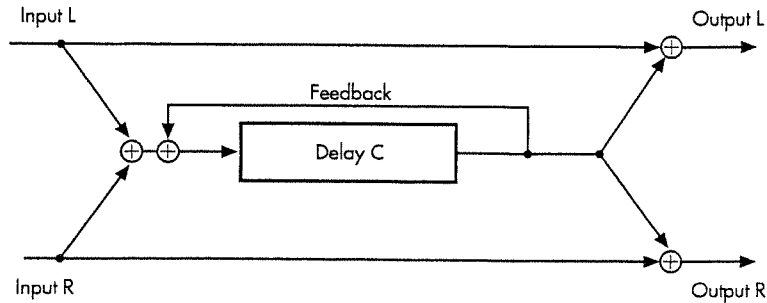

[3 Tap]

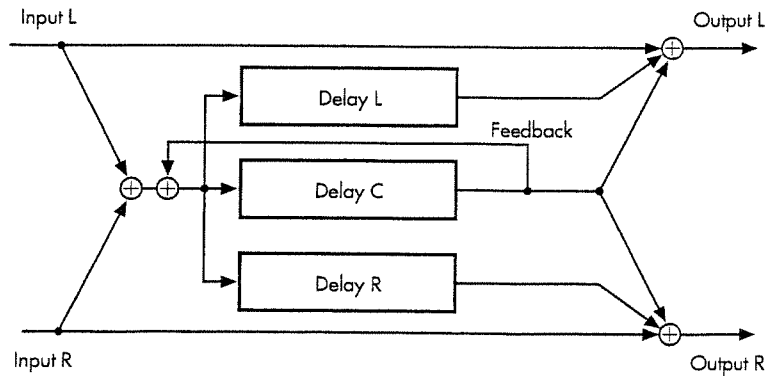

You can select one of two types of delay (single, or 3 taps). The delay time setting can be specified to match the tempo of the song being played.

Delay

Effect On/Off (*)	Off	On			
Mode	Normal, Tempo				
Type	Single, 3Tap				
[Single]			[3Tap]		
Delay Time	1	2800 [ms];(Normal)	Delay Time C	1	2800 [ms];(Normal)
Tempo	50	300 :(Tempo)	Tempo	50	300 :(Tempo)
Interval	1/4	4.0 :(Tempo)	DlyInterval C	1/4	4.0 :(Tempo)
Feedback	0	100	Delay Time L	1	400 [%]
Effect Level	0	120	Delay Time R	1	400 [%]
Direct Level	0	100	Feedback	0	100
High Damp	-50	0	Level C	0	100
Hi Cut Filter	500	12.5k, Flat [Hz]	Level L	0	100
Smooth	Off	On	Level R	0	100
			Effect Level	0	120
			Direct Level	0	100
			High Damp	-50	0
			Hi Cut Filter	500	12.5k, Flat [Hz]
			Smooth	Off	On

4. Stereo Delay Chorus

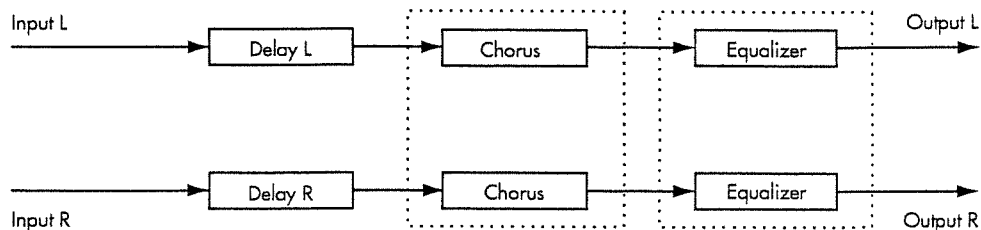

This algorithm connects a stereo delay and a stereo chorus in series, allowing you to add depth and spaciousness to the sound while preserving the positioning of the stereo input signal.

Stereo Delay

Effect On/Off (*)	Off	On	
Delay Time Lch	1	1400	[ms]
Delay Time Rch	1	1400	[ms]
Feedback Lch	0	100	
Feedback Rch	0	100	
Effect Level	0	120	
Direct Level	0	100	
High Damp	-50	0	[dB]
Hi Cut Filter	500	12.5k, Flat	[Hz]
Smooth	Off	On	

EQ

Effect On/Off	Off	On	
Low Gain	-12	+12	[dB]
Low Freq	40	1.5k	[Hz]
Mid Gain	-12	+12	[dB]
Mid Freq	200	8.0k	[Hz]
Mid Q	0.5	16	
High Gain	-12	+12	[dB]
High Freq	500	18k	[Hz]
Level	-12	+12	[dB]

Stereo Chorus

Effect On/Off	Off	On	
Polarity	Sync, Inv		
Rate	0	100	
Depth	0	100	
Effect Level	0	100	
Direct On/Off	Off	On	
Pre Delay	0.0	50.0	[ms]
Lo Cut Filter	Flat, 55	800	[Hz]
Hi Cut Filter	500	12.5k, Flat	[Hz]

5. Stereo Pitch Shifter Delay

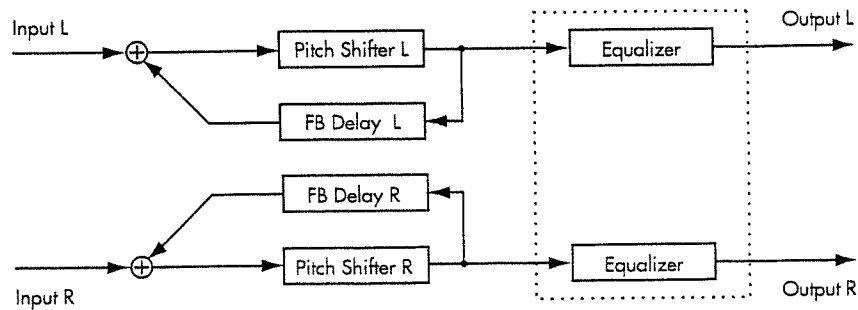

This applies a delay to a pitch-shifted sound, and lets you add feedback. This can be used to produce a special pitch shift effect in which the pitch continues to change. Of course it can also be used as a conventional stereo pitch shifter.

Pitch Shifter

Effect On/Off (*)	Off	On	
Mode	Fast, Medium, Slow		
Lch Pitch	-24	+24	
Rch Pitch	-24	+24	
Lch Fine	-50	+50	
Rch Fine	-50	+50	
Lch Pre Delay	0.0	50.0	[ms]
Rch Pre Delay	0.0	50.0	[ms]
Lch FB Delay	1	1200	[ms]
Rch FB Delay	1	1200	[ms]
Lch FB Level	0	100	
Rch FB Level	0	100	
D:E Balance	100:0	0:100	
Level	0	100	
Smooth	Off	On	

EQ

Effect On/Off	On	Off	
Low Gain	-12	+12	[dB]
Low Freq	40	1.5k	[Hz]
Mid Gain	-12	+12	[dB]
Mid Freq	200	8.0k	[Hz]
Mid Q	0.5	16	
High Gain	-12	+12	[dB]
High Freq	500	18k	[Hz]
Level	-12	+12	[dB]

6. 2 ch RSS

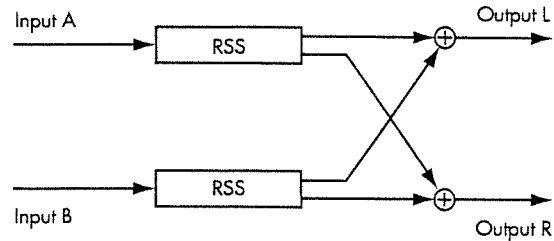

This algorithm lets you specify the spatial placement of each of the input channels. When using this algorithm, do not allow the direct sound to be output. If using the Effect Buss: Effect Pan for the channel should be set to "L63" to have the input be for INPUT A; set it to "R63" to use INPUT B for input.

RSS(2ch)

Effect On/Off (*)	Off	On
Azimuth A	L180	R180
Elevation A	-54	54
Azimuth B	L180	R180
Elevation B	-54	54

7. Panner

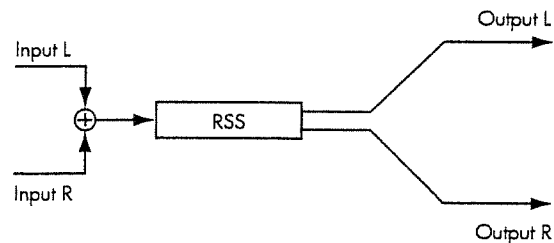

RSS (Panner) can make the sound seem to revolve around the listener.

RSS(Panner)

Effect On/Off	Off	On
Speed	0	100
Direction (*)	CW	CCW

8. Delay RSS

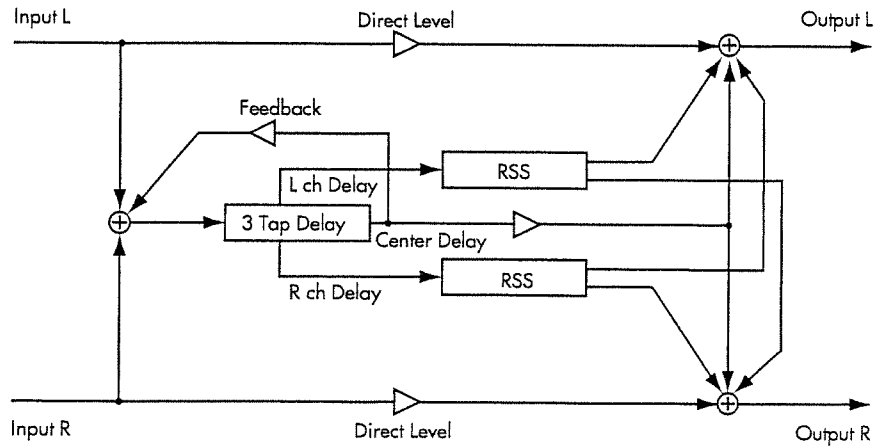

This algorithm is a delay with three independent delay sounds. RSS is connected to each output, left and right, and the sound of the left channel is placed 90 degrees left, and the sound of the right channel is placed 90 degrees right. Feedback can be applied to the output of the center delay.

Delay

Effect On/Off (*)	Off	On	
Delay Time C	1	2800	[ms]
Delay Time L	1	400	[%]
Delay Time R	1	400	[%]
Feedback	0	100	
Level C	0	100	
Level L	0	100	
Level R	0	100	
Effect Level	0	120	
Direct Level	0	100	
High Damp	-50	0	
Hi Cut Filter	500	12.5k, Flat	[Hz]
Smooth	Off	On	

9. Chorus RSS

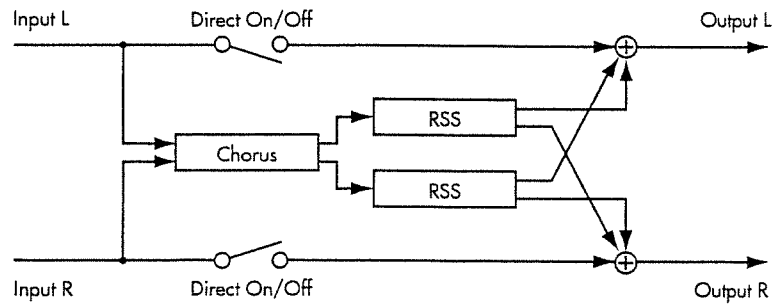

This algorithm is a chorus with RSS connected to the output. The sound of the left channel is placed 90 degrees left, and the sound of the right channel is placed 90 degrees right.

Chorus

Effect On/Off (*)	Off	On	
Polarity	Sync, Inv		
Rate	0	100	
Depth	0	100	
Effect Level	0	100	
Direct On/Off	Off	On	
Pre Delay	0.0	50.0	[ms]
Lo Cut Filter	Flat, 55	800	[Hz]
Hi Cut Filter	500	12.5k, Flat	[Hz]

10. Guitar Multi 1

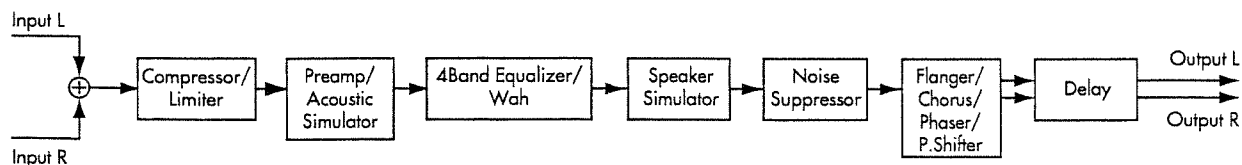

This is a multi-effect designed for guitar. It allows a wide variety of sounds to be produced, including simulations of the distortion created by a preamp, and even an acoustic simulation. The pitch shifter can be used to simulate twelve-string guitar sounds.

* In case of ("Phaser" and "P. Shifter"), output will become monaural.

Compressor

Effect On/Off	Off	On
Effect Type	Comp, Limiter	
Sustain	0	100
Attack	0	100
Tone	-50	+50
Level	0	100

Limiter

Effect On/Off	Off	On
Effect Type	Comp, Limiter	
Threshold	0	100
Release	0	100
Tone	-50	+50
Level	0	100

PreAmp

Effect On/Off	Off	On
Effect Type	Preamp, AC Sim	
Amp Type	JC-120, Clean, Crunch, Match, Voxy, Blues, BG Lead, MS(1), MS(2), MS(1+2), Sldn, Metal, Metal D	
Volume	0	100
Bass	0	100
Middle	0	100
Treble	0	100
Presence	0	100
Master	0	100
Bright	Off	On
Gain	Low, Middle, High	

Acoustic Simulator

Effect On/Off	Off	On
Effect Type	Preamp, AC Sim	
Top	0	100
Body	0	100
Level	0	100

4Band Equalizer

Effect On/Off	Off	On	
Effect Type	Eq, Wah		
Low Gain	-20	+20	[dB]
Low-Mid Gain	-20	+20	[dB]
Low-Mid Freq	100	10k	[Hz]
Low-Mid Q	0.5	16	
High-Mid Gain	-20	+20	[dB]
High-Mid Freq	100	10k	[Hz]
High-Mid Q	0.5	16	
High Gain	-20	+20	[dB]
Level	-20	+20	[dB]

Wah(T-Wah/A-Wah)

Effect On/Off	Off	On
Effect Type	Eq, Wah	
WAH Type	T[UP], I[DOWN], A[UP], A[DOWN]	

[T-WAH]

Sens	0	100
Frequency	0	100
Peak	0	100 (default 50)
Level	0	100

[A-WAH]

Frequency	0	100
Rate	0	100
Depth	0	100
Peak	0	100 (default 50)
Level	0	100

Speaker Simulator

Effect On/Off	Off	On
Sp Type	Small, Middle, JC-120, TWIN, twin, MATCH, match, VOXY, voxy, BG STK, bg stk, MS STK, ms stk, METAL	
Mic Setting	Center, 1	10 [cm]
Mic Level	0	100
Direct Level	0	100

Noise Suppressor

Effect On/Off	Off	On
Threshold	0	100
Release	0	100

Flanger

Effect On/Off	Off	On
Effect Type	Flanger, Chorus, Phaser, PS	
Rate	0	100
Depth	0	100
Manual	0	100
Resonance	0	100
Separation	0	100

Chorus

Effect On/Off	Off	On	
Effect Type	Flanger, Chorus, Phaser, PS		
Mode	Mono, Stereo		
Rate	0	100	
Depth	0	100	
Effect Level	0	100	
Pre Delay	0.0	50.0	[ms]
Lo Cut Filter	Flat, 55	800	[Hz]
Hi Cut Filter	500	12.5k, Flat	[Hz]

Phaser

Effect On/Off	Off	On
Effect Type	Flanger, Chorus, Phaser, PS	
Rate	0	100
Depth	0	100
Manual	0	100
Resonance	-100	+100

Delay

Effect On/Off (*)	Off	On	
Delay Time	1	1400	[ms]
Feedback	0	100	
Effect Level	0	120	
Direct Level	0	100	

Pitch Shifter

Effect On/Off	Off	On
Effect Type	Flanger, Chorus, Phaser, PS	
Mode	Fast, Medium, Slow, Inv1, Inv2	
Pitch	-24	+24
Fine	-50	+50
D:E Balance	100:0	0:100
Level	0	100

11. Guitar Multi 2

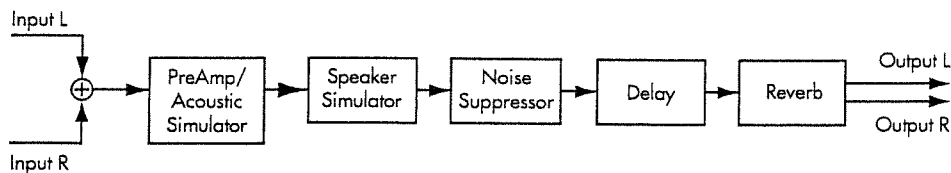

This is a multi-effect designed for guitar. It is suitable for creating basic guitar sounds.

PreAmp

Effect On/Off	Off	On
Effect Type	Preamp, AC Sim	
Type	JC-120, Clean, Crunch, Match, Voxy, Blues, BG Lead, MS(1), MS(2), MS(1+2), Sldn, Metal, Metal D	
Volume	0	100
Bass	0	100
Middle	0	100
Treble	0	100
Presence	0	100
Master	0	100
Bright	Off	On
Gain	Low, Middle, High	

Noise Suppressor

Effect On/Off	Off	On
Threshold	0	100
Release	0	100

Delay

Effect On/Off (*)	Off	On	
Delay Time	1	2000	[ms]
Feedback	0	100	
Effect Level	0	120	
Direct Level	0	100	

Reverb

Effect On/Off	Off	On	
Type	Room1, Room2, Hall1, Hall2, Plate		
Reverb Time	0.1	10	[s]
D:E Balance	100:0	0:100	
Level	0	100	
Pre Delay	0	200	[ms]
Density	0	10	
Lo Cut Filter	Flat, 55	800	[Hz]
Hi Cut Filter	500	12.5k, Flat	[Hz]

Acoustic Simulator

Effect On/Off	Off	On
Effect Type	Preamp, AC Sim	
Top	0	100
Body	0	100
Level	0	100

Speaker Simulator

Effect On/Off	Off	On
Type	Small, Middle, JC-120, TWIN, twin, MATCH, match, VOXY, voxy, BG STK, bg stk, MS STK, ms stk, METAL	
Mic Setting	Center, 1	10 [cm]
Mic Level	0	100
Direct Level	0	100

12. Vocal Multi 1

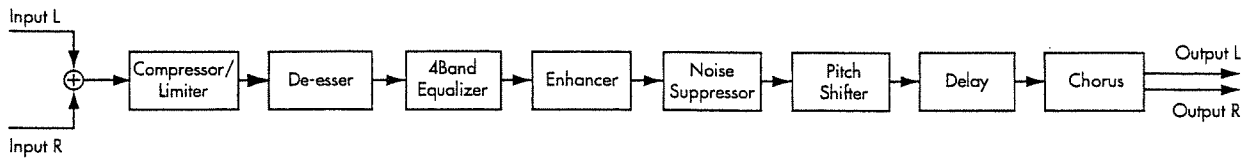

This is a multi-effect designed for vocals. Special effects can also be created using the pitch shifter.

Compressor

Effect On/Off	Off	On
Type	Comp, Limiter	
Threshold	0	100
Ratio	1.5:1	100:1
Attack	0	100
Release	0	100
Tone	-50	+50
Level	0	100

Limiter

Effect On/Off	Off	On
Type	Comp, Limiter	
Threshold	0	100
Release	0	100
Tone	-50	+50
Level	0	100

De-esser

Effect On/Off	Off	On	
Sens	0	100	
Frequency	1k	10k	[Hz]

4Band Equalizer

Effect On/Off	Off	On	
Low Gain	-20	+20	[dB]
Low-Mid Gain	-20	+20	[dB]
Low-Mid Freq	100	10k	[Hz]
Low-Mid Q	0.5	16	
High-Mid Gain	-20	+20	[dB]
High-Mid Freq	100	10k	[Hz]
High-Mid Q	0.5	16	
High Gain	-20	+20	[dB]
Level	-20	+20	[dB]

Enhancer

Effect On/Off	Off	On
Sens	0	100
Frequency	1k	10k
Mix Level	0	100
Low Mix Level	0	100
Level	0	100

Noise Suppressor

Effect On/Off	Off	On
Threshold	0	100
Release	0	100

Pitch Shifter

Effect On/Off	Off	On
Mode	Fast, Medium, Slow, Inv1, Inv2	
Pitch	-24	+24
Fine	-50	+50
D:E Balance	100:0	0:100
Level	0	100

Delay

Effect On/Off (*)	Off	On	
Delay Time	1	1400	[ms]
Feedback	0	100	
Effect Level	0	120	
Direct Level	0	100	

Chorus

Effect On/Off	Off	On	
Mode	Mono, Stereo		
Rate	0	100	
Depth	0	100	
Effect Level	0	100	
Pre Delay	0.0	50.0	[ms]
Lo Cut Filter	Flat, 55	800	[Hz]
Hi Cut Filter	500	12.5k, Flat	[Hz]

13. Vocal Multi 2

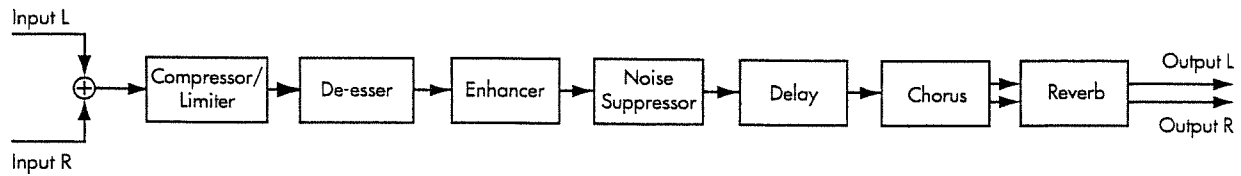

This is a multi-effect designed for vocals. It provides the basic effects needed for vocals.

Compressor

Effect On/Off	Off	On
Type	Comp, Limiter	
Threshold	0	100
Ratio	1.5:1	100:1
Attack	0	100
Release	0	100
Tone	-50	+50
Level	0	100

Limiter

Effect On/Off	Off	On
Type	Comp, Limiter	
Threshold	0	100
Release	0	100
Tone	-50	+50
Level	0	100

De-esser

Effect On/Off	Off	On	
Sens	0	100	
Frequency	1k	10k	[Hz]

Enhancer

Effect On/Off	Off	On	
Sens	0	100	
Frequency	1k	10k	[Hz]
Mix Level	0	100	
Low Mix Level	0	100	
Level	0	100	

Noise Suppressor

Effect On/Off	Off	On
Threshold	0	100
Release	0	100

Delay

Effect On/Off (*)	Off	On	
Delay Time	1	2000	[ms]
Feedback	0	100	
Effect Level	0	120	
Direct Level	0	100	

Chorus

Effect On/Off	Off	On	
Mode	Mono, Stereo		
Rate	0	100	
Depth	0	100	
Effect Level	0	100	
Pre Delay	0.0	50.0	[ms]
Lo Cut Filter	Flat, 55	800	[Hz]
Hi Cut Filter	500	12.5k, Flat	[Hz]

Reverb

Effect On/Off	Off	On	
Type	Room1, Room2, Hall1, Hall2, Plate		
Reverb Time	0.1	10	[s]
D:E Balance	100:0	0:100	
Level	0	100	
Pre Delay	0	200	[ms]
Density	0	10	
Lo Cut Filter	Flat, 55	800	[Hz]
Hi Cut Filter	500	12.5k, Flat	[Hz]

14. Keyboard Multi

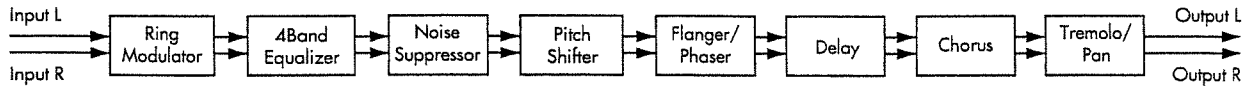

This is a multi-effect designed for keyboard.

* Sound which has been pitch-shifted will be output in monaural.

Ring Modulator

Effect On/Off	Off	On
Frequency	0	100
Effect Level	0	100
Direct Level	0	100

4Band Equalizer

Effect On/Off	Off	On	
Low Gain	-20	+20	[dB]
Low-Mid Gain	-20	+20	[dB]
Low-Mid Freq	100	10k	[Hz]
Low-Mid Q	0.5	16	
High-Mid Gain	-20	+20	[dB]
High-Mid Freq	100	10k	[Hz]
High-Mid Q	0.5	16	
High Gain	-20	+20	[dB]
Level	-20	+20	[dB]

Noise Suppressor

Effect On/Off	Off	On
Threshold	0	100
Release	0	100

Pitch Shifter

Effect On/Off	Off	On
Mode	Fast, Medium, Slow	
Pitch	-24	+24
Fine	-50	+50
D:E Balance	100:0	0:100
Level	0	100

Flanger

Effect On/Off	Off	On
Effect Type	Flanger, Phaser	
Rate	0	100
Depth	0	100
Manual	0	100
Resonance	0	100
Separation	0	100

Phaser

Effect On/Off	Off	On
Effect Type	Flanger, Phaser	
Rate	0	100
Depth	0	100
Manual	0	100
Resonance	-100	+100
Separation	0	100

Delay

Effect On/Off (*)	Off	On	
Delay Time	1	1200	[ms]
Feedback	0	100	
Effect Level	0	120	
Direct Level	0	100	

Chorus

Effect On/Off	Off	On	
Polarity	Sync, Inv		
Rate	0	100	
Depth	0	100	
Effect Level	0	100	
Pre Delay	0.0	50.0	[ms]
Lo Cut Filter	Flat, 55	800	[Hz]
Hi Cut Filter	500	12.5k, Flat	[Hz]

Tremolo/Pan

Effect On/Off	Off	On
Mode	Tre <input checked="" type="checkbox"/> , Tre <input type="checkbox"/> , Pan <input checked="" type="checkbox"/> , Pan <input type="checkbox"/>	
Rate	0	100
Depth	0	100
Balance	L100:R0	L0:R100

15. Rotary

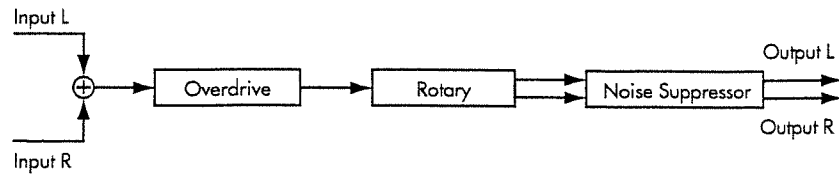

A simulation of a rotary speaker which rotates the speaker to produce a characteristic modulation. The distortion (Overdrive) produced by the vacuum tube amp of the rotary speaker is also simulated.

* *Overdrive cannot be used by itself.*

Overdrive

Effect On/Off	Off	On
Gain	0	100
Drive	1	100
Level	0	100

Noise Suppressor

Effect On/Off	Off	On
Threshold	0	100
Release	0	100

Rotary

Effect On/Off	On	Off	
Speed Select (*)	Slow, Fast		
Horn(fast)	5.00	10.00	[Hz]
Rotor(fast)	5.00	10.00	[Hz]
Horn(slow)	0.05	5.00	[Hz]
Rotor(slow)	0.05	5.00	[Hz]
Rise T;Horn	1	100	
Rise T;Rotor	1	100	
Fall T;Horn	1	100	
Fall T;Rotor	1	100	
R:F Balance	90:10	10:90	
Mic Setting	OfMic, OnMic		
Horn Depth	0	100	
Rotor Depth	0	100	
Horn Tremolo	0	100	
Rotor Tremolo	0	100	
Diffusion	0	100	
Effect Level	0	100	

16. Stereo Phaser

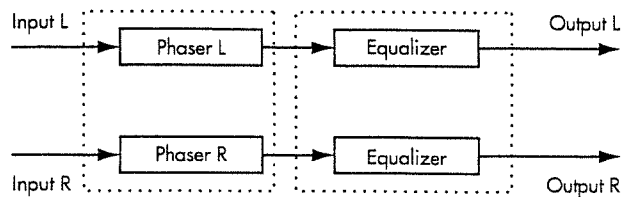

A stereo input/output phaser.

Stereo Phaser

Effect On/Off (*)	Off	On	
Type	4	12	[stage]
Rate	0	100	
Depth	0	100	
Manual	0	100	
Resonance	-100	+100	
Separation	0	100	
Step	Off, 1	100	

EQ

Effect On/Off	Off	On	
Low Gain	-12	+12	[dB]
Low Freq	40	1.5k	[Hz]
Mid Gain	-12	+12	[dB]
Mid Freq	200	8.0k	[Hz]
Mid Q	0.5	16	
High Gain	-12	+12	[dB]
High Freq	500	18k	[Hz]
Level	-12	+12	[dB]

17. Stereo Flanger

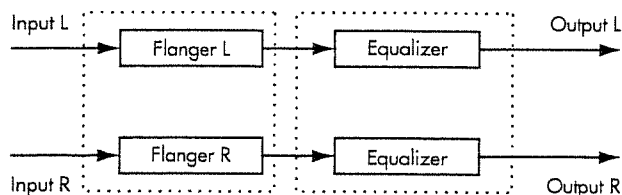

A stereo input/output flanger.

Stereo Flanger

Effect On/Off (*)	Off	On	
Rate	0	100	
Depth	0	100	
Manual	0	100	
Resonance	0	100	
Separation	0	100	
Gate	Off, 1	100	
Direct Switch	Off	On	

EQ

Effect On/Off	Off	On	
Low Gain	-12	+12	[dB]
Low Freq	40	1.5k	[Hz]
Mid Gain	-12	+12	[dB]
Mid Freq	200	8.0k	[Hz]
Mid Q	0.5	16	
High Gain	-12	+12	[dB]
High Freq	500	18k	[Hz]
Level	-12	+12	[dB]

18. Tremolo Pan

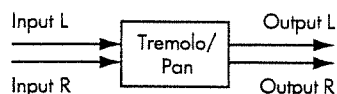

Tremolo/Pan

Effect On/Off (*)	Off	On
Mode	Tre <input checked="" type="checkbox"/> , Tre <input type="checkbox"/> , Pan <input checked="" type="checkbox"/> , Pan <input type="checkbox"/>	
Rate	0	100
Depth	0	100
Balance	L100:R0	L0:R100

This adds a tremolo or auto-pan effect.

19. Stereo Multi

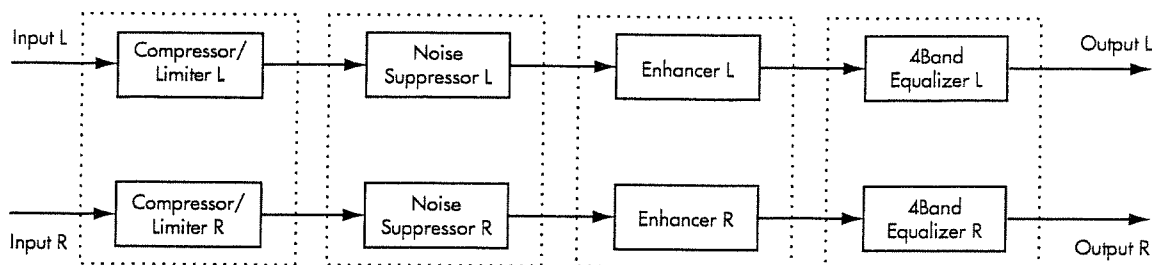

This algorithm connects four basic types of effect, all in full stereo.

Compressor

Effect On/Off	Off	On
Detector in	L, R, Link	
Type	Comp, Limiter	
Threshold	0	100
Ratio	1.5:1	100:1
Attack	0	100
Release	0	100
Tone	-50	+50
Level	0	100

Limiter

Effect On/Off	Off	On
Detector in	L, R, Link	
Type	Comp, Limiter	
Threshold	0	100
Release	0	100
Tone	-50	+50
Level	0	100

Noise Suppressor

Effect On/Off	Off	On
Detector in	L, R, Link	
Threshold	0	100
Release	0	100

Enhancer

Effect On/Off	Off	On	
Detector in	L, R, Link		
Sens	0	100	
Frequency	1k	10k	[Hz]
Mix Level	0	100	
Low Mix Level	0	100	
Level	0	100	

4Band Equalizer

Effect On/Off (*)	Off	On	
Low Gain	-20	+20	[dB]
Low-Mid Gain	-20	+20	[dB]
Low-Mid Freq	100	10k	[Hz]
Low-Mid Q	0.5	16	
High-Mid Gain	-20	+20	[dB]
High-Mid Freq	100	10k	[Hz]
High-Mid Q	0.5	16	
High Gain	-20	+20	[dB]
Level	-20	+20	[dB]

20. Lo-Fi Box

[Radio, Player]

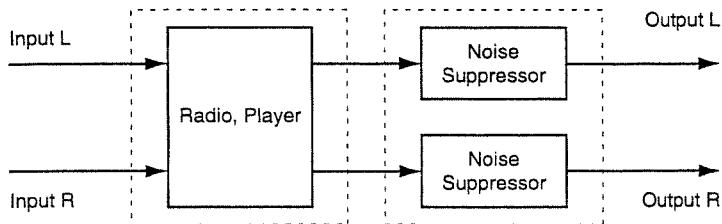

[Lo-Fi Processor]

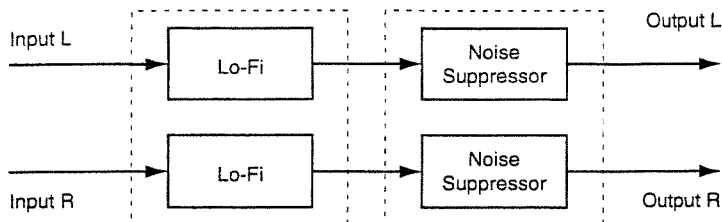

This allows you to simulate sounds that appear to be playing on an AM radio, the sounds of old records played on an old-fashioned gramophone, and even extreme deformations of the sound produced by a lo-fi processor.

Radio, Player

Effect On/Off (*)	Off	On	
Mode	Radio, Player, LO-FI		
Tuning	0	100	:Radio
Wow Flutter	0	100	:Player
Noise	0	100	
Filter	0	100	
Sound	0	100	

Noise Suppressor

Effect On/Off	Off	On
Threshold	0	100
Release	0	100

Lo-Fi Processor

Effect On/Off (*)	Off	On	
Mode	Radio, Player, LO-FI		
Pre Filter	Off	On	
Sample Rate	Off, 1/2	1/32	
Bit	Off, 15	1	[bit]
Post Filter	Off	On	
Effect Level	0	100	
Direct Level	0	100	
R M F	Off, LPF, BPF, HPF		
Cut Off	0	100	
Resonance	0	100	
Gain	0	24	[dB]

21. Vocoder

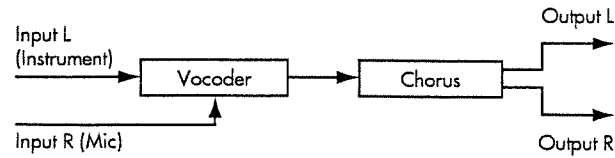

The vocoder creates “talking instrument” effects. When using the vocoder, input an instrumental sound into the L channel, and a vocal sound into the R channel. The instrumental sound is divided into ten frequency bands, and processed according to the frequency characteristics of the vocal sound.

Vocoder

Effect On/Off (*)	Off	On	
Sens	0	100	
Character 1	0	100	
Character 2	0	100	
Character 3	0	100	
Character 4	0	100	
Character 5	0	100	
Character 6	0	100	
Character 7	0	100	
Character 8	0	100	
Character 9	0	100	
Character 10	0	100	
Mic HPF	THRU, 90	12k	[Hz]
Mic Mix	0	100	
NS Threshold	0	100	
Vocoder Level	0	100	

Chorus

Effect On/Off	Off	On	
Mode	Mono, Stereo		
Rate	0	100	
Depth	0	100	
Effect Level	0	100	
Direct On/Off	Off	On	
Pre Delay	0.0	50.0	[ms]
Lo Cut Filter	Flat, 55	800	[Hz]
Hi Cut Filter	500	12.5k, Flat	[Hz]

22. Space Chorus

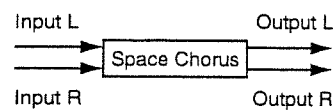

This chorus effect simulates the sound from Roland’s well-known SDD-320 Dimension D.

Space Chorus

Effect On/Off (*)	Off	On
Input	Mono, Stereo	
MODE	1, 2, 3, 4, 1+4, 2+4, 3+4	
Effect Level	0	100
Direct On/Off	Off	On

23. Reverb + Reverb

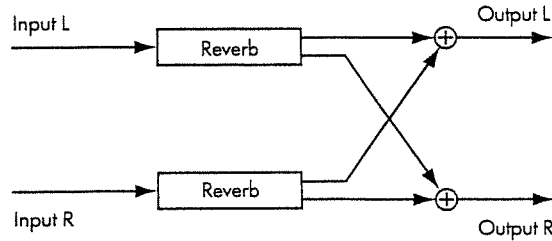

This allows you to simultaneously use two different types of reverb in the L/R channels.

Lch Reverb: Room, Hall

Rch Reverb: Room1, Room2, Hall1, Hall2, Plate

Lch: Room, Hall

Effect On/Off (*)	Off	On	
Reverb Type	Room, Hall		
Room Size	1	10	
Reverb Time	0.1	32.0	[S]
D:E Balance	100:0	0:100	
Level	0	100	
Pre Delay	0	200	[mS]
Density	0	100	
ER Level	0	100	
Low Damp Gain	-36	0	[dB]
Low Damp Freq	55	4.0k	[Hz]
Hi Damp Gain	-36	0	[dB]
Hi Damp Freq	4.0k	20k	[Hz]
Hi Cut Filter	200	20.0k	[Hz]

Rch: Reverb

Effect On/Off	Off	On	
Type	Room1, Room2, Hall1, Hall2, Plate		
Reverb Time	0.1	10	[s]
D:E Balance	100:0	0:100	
Level	0	100	
Pre Delay	0	200	[ms]
Density	0	10	
Lo Cut Filter	Flat, 55	800	[Hz]
Hi Cut Filter	500	12.5k, Flat	[Hz]

24. Delay + Reverb

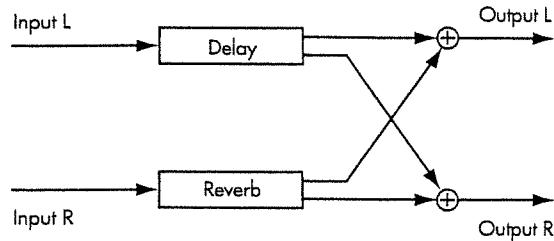

This allows you to simultaneously use independent delay and reverb on the L/R channels.

Lch Delay: Single, 3Tap
Rch Reverb: Room1, Room2, Hall1, Hall2, Plate

Lch: Delay

Effect On/Off (*)	Off	On
Mode	Normal, Tempo	
Type	Single, 3Tap	

<Single>

Delay Time	1	2000 [ms]	:(Normal)
Tempo	50	300	:(Tempo)
Interval	1/4	4.0	:(Tempo)
Feedback	0	100	
Effect Level	0	120	
Direct Level	0	100	
High Damp	-50	0	
Hi Cut Filter	500	12.5k, Flat	[Hz]
Smooth	Off	On	

<3TAP>

Delay Time C	1	2000 [ms]	:(Normal)
Tempo	50	300	:(Tempo)
Dly Interval C	1/4	4.0	:(Tempo)
Delay Time L	1	400 [%]	
Delay Time R	1	400 [%]	
Feedback	0	100	
Level C	0	100	
Level L	0	100	
Level R	0	100	
Effect Level	0	120	
Direct Level	0	100	
High Damp	-50	0	
High Cut Filter	500	12.5k, Flat	[Hz]
Smooth	Off	On	

Rch: Reverb

Effect On/Off	Off	On
Type	Room1, Room2, Hall1, Hall2, Plate	
Reverb Time	0.1	10 [s]
D:E Balance	100:0	0:100
Level	0	100
Pre Delay	0	200 [ms]
Density	0	10
Lo Cut Filter	Flat, 55	800 [Hz]
Hi Cut Filter	500	12.5k, Flat [Hz]

25. Chorus + Reverb

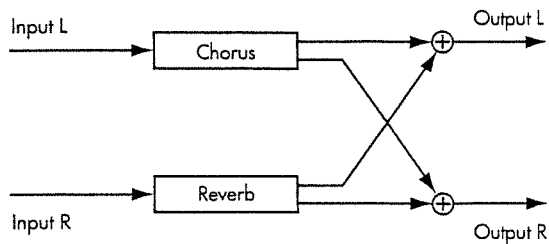

This allows you to simultaneously use independent chorus and reverb on the L/R channels.

Lch Chorus

Rch Reverb: Room 1, Room2, Hall1, Hall2, Plate

Lch: Chorus

Effect On/Off (*)	Off	On	
Mode	Mono, Stereo		
Rate	0	100	
Depth	0	100	
Effect Level	0	100	
Direct On/Off	Off	On	
Pre Delay	0.0	50.0	[ms]
Lo Cut Filter	Flat, 55	800	[Hz]
Hi Cut Filter	500	12.5k, Flat	[Hz]

Rch: Reverb

Effect On/Off	Off	On	
Type	Room1, Room2, Hall1, Hall2, Plate		
Reverb Time	0.1	10	[s]
D:E Balance	100:0	0:100	
Level	0	100	
Pre Delay	0	200	[ms]
Density	0	10	
Lo Cut Filter	Flat, 55	800	[Hz]
Hi Cut Filter	500	12.5k, Flat	[Hz]

26. Delay + Chorus

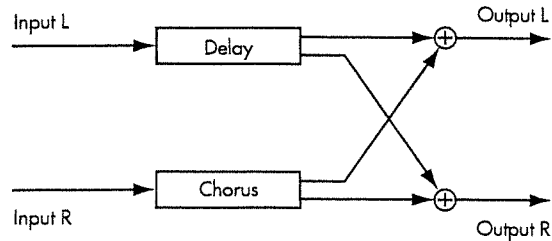

This allows you to simultaneously use independent delay and chorus on the L/R channels.

Lch Delay: Single, 3Tap

Rch Chorus:

Lch: Delay

Effect On/Off (*)	Off	On	
Mode	Normal, Tempo		
Type	Single, 3Tap		
<Single>			
Delay Time	1	2000 [ms];(Normal)	
Tempo	50	300 :(Tempo)	
Interval	1/4	4.0 :(Tempo)	
Feedback	0	100	
Effect Level	0	120	
Direct Level	0	100	
High Damp	-50	0	
Hi Cut Filter	500	12.5k, Flat [Hz]	
Smooth	Off	On	

<3TAP>

Delay Time C	1	2000 [ms];(Normal)	
Tempo	50	300 :(Tempo)	
Dly Interval C	1/4	4.0 :(Tempo)	
Delay Time L	1	400 [%]	
Delay Time R	1	400 [%]	
Feedback	0	100	
Level C	0	100	
Level L	0	100	
Level R	0	100	
Effect Level	0	120	
Direct Level	0	100	
High Damp	-50	0	
Hi Cut Filter	500	12.5k, Flat [Hz]	
Smooth	Off	On	

Rch: Chorus

Effect On/Off	Off	On	
Mode	Mono, Stereo		
Rate	0	100	
Depth	0	100	
Effect Level	0	100	
Direct On/Off	Off	On	
Pre Delay	0.0	50.0	[ms]
Lo Cut Filter	Flat, 55	800	[Hz]
Hi Cut Filter	500	12.5k, Flat	[Hz]

27. Bass Multi 1

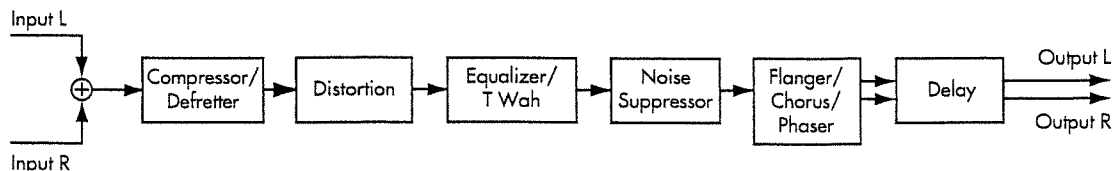

Multi-effect for bass guitar.

Using overdrive/distortion or the “Defretter” effect simulating the sound unique to the fretless bass. Allowing different tone to suit different purposes.

* Phaser effect sound will be monaural.

Compressor

Effect On/Off	Off	On
Effect Type	Comp/Defretter	
Sustain	0	100
Attack	0	100
Enhance Freq	0	3
Enhance Level	0	100
LEVEL		

Defretter

Effect On/Off	Off	On
Effect Type	Comp/Defretter	
Sensitivity	0	100
Attack	0	100
Depth	0	100
Level	0	100

Distortion

Effect On/Off	Off	On
Type	TURBO OD, BASS OD, Hard DS, FUZZ 1, FUZZ 2	
Drive	0	100
Treble	-50	+50
Bass	-50	+50
AMP SIM	OFF	On
Effect Level	0	100
Direct Level	0	100

4Band Equalizer

Effect On/Off	Off	On	
Effect Type	4Band Eq, T Wah		
Low Gain	-20	+20	[dB]
Low-Mid Gain	-20	+20	[dB]
Low-Mid Freq	100	10k	[Hz]
Low-Mid Q	0.5	16	
High-Mid Gain	-20	+20	[dB]
High-Mid Freq	100	10k	[Hz]
High-Mid Q	0.5	16	
High Gain	-20	+20	[dB]
Level	-20	+20	[dB]

T-Wah

Effect On/Off	Off	On
Effect Type	4Band Eq, T-Wah	
Sens	0	100
Start	Down	Up
Stop	0	100
Resonance	0	100
Effect Level	0	100
Direct Level	0	100

Noise Suppressor

Effect On/Off	Off	On
Threshold	0	100
Release	0	100

Flanger

Effect On/Off	Off	On
Effect Type	Flanger, Chorus, Phaser	
Rate	0	100
Depth	0	100
Manual	0	100
Resonance	0	100
Separation	0	100

Chorus

Effect On/Off	Off	On	
Effect Type	Flanger, Chorus, Phaser		
Mode	Mono, Stereo		
Rate	0	100	
Depth	0	100	
Effect Level	0	100	
Pre Delay	0.0	50.0	[ms]
Lo Cut Filter	Flat, 55	800	[Hz]
Hi Cut Filter	500	12.5k, Flat	[Hz]

Phaser

Effect On/Off	Off	On
Effect Type	Flanger, Chorus, Phaser	
Rate	0	100
Depth	0	100
Manual	0	100
Resonance	-100	+100

Delay

Effect On/Off (*)	Off	On	
Delay Time	1	1400	[ms]
Feedback	0	100	
Effect Level	0	120	
Direct Level	0	100	

28. Bass Multi 2

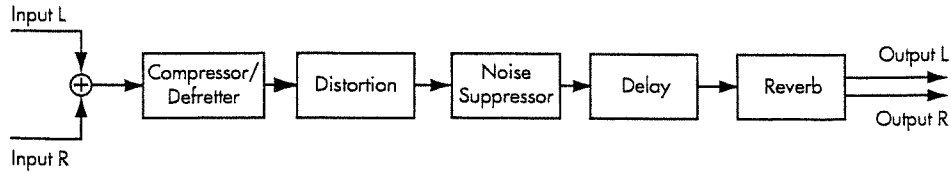

Multi-effect for bass guitar. Appropriate for creating standard bass sound.

Compressor

Effect On/Off	Off	On
Effect Type	Comp/Defretter	
Sustain	0	100
Attack	0	100
Enhance Freq	0	3
Enhance Level	0	100
LEVEL		

Defretter

Effect On/Off	Off	On
Effect Type	Comp/Defretter	
Sensitivity	0	100
Attack	0	100
Depth	0	100
Level	0	100

Distortion

Effect On/Off	Off	On
Type	TURBO OD, BASS OD, Hard DS, FUZZ 1, FUZZ 2	
Drive	0	100
Treble	-50	+50
Bass	-50	+50
AMP SIM	OFF	On
Effect Level	0	100
Direct Level	0	100

Noise Suppressor

Effect On/Off	Off	On
Threshold	0	100
Release	0	100

Delay

Effect On/Off	Off	On	
Delay Time	1	2000	[ms]
Feedback	0	100	
Effect Level	0	120	
Direct Level	0	100	

Reverb

Effect On/Off (*)	Off	On	
Type	Room1, Room2, Hall1, Hall2, Plate		
Reverb Time	0.1	10	[s]
D:E Balance	100:0	0:100	
Level	0	100	
Pre Delay	0	200	[ms]
Density	0	10	
Lo Cut Filter	Flat, 55	800	[Hz]
Hi Cut Filter	500	12.5k, Flat	[Hz]

29. Mic Simulator

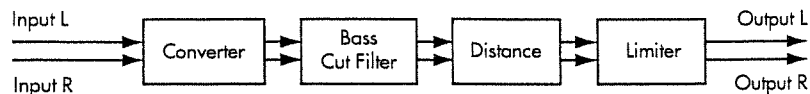

This modifies sound that was recorded by a conventional dynamic mic, lapel mic or direct line, causing it to sound as though it had been recorded by an expensive condenser mic or a special studio mic. The mic simulator can add effects of proximity or distance.

Mic Converter

Effect On/Off (*)	Off	On
Input	DR-20, Sml.Dy, Hed.Dy, Min.Cn, Flat	
Output	Sml.Dy, Voc.Dy, Lrg.Dy, Sml.Cn, Lrg.Cn, Vnt.Cn, Flat	
Phase	Nor, Inv	

Bass Cut Filter

Effect On/Off	Off, On
Frequency	Thru, 20 2000 [Hz]

Distance

Effect On/Off	Off, On
Prox.Fx	-12 +12
Time	0 3000 [cm]

Limiter

Effect On/Off	Off	On
Thres	-60	0 [dB]
Attack	0	100
Release	0	100
Detect HPF	Thru, 20	2000 [Hz]
Level	-60	24 [dB]

30. Acoustic Simulator

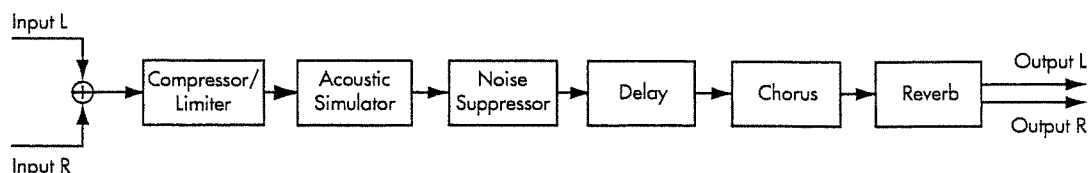

This simulates the sound of an acoustic guitar. It allows you to use an electric guitar to produce sounds similar to those of an acoustic guitar.

Compressor

Effect On/Off	Off	On
Effect Type	Comp, Limiter	
Sustain	0	100
Attack	0	100
Tone	-50	+50
Level	0	100

Limiter

Effect On/Off	Off	On
Effect Type	Comp, Limiter	
Threshold	0	100
Release	0	100
Tone	-50	+50
Level	0	100

Acoustic Simulator

Effect On/Off	Off	On
Top	0	100
Body	0	100
Level	0	100

Noise Suppressor

Effect On/Off	Off	On
Threshold	0	100
Release	0	100

Delay

Effect On/Off (*)	Off	On	
Delay Time	1	2000	[ms]
Feedback	0	100	
Effect Level	0	120	
Direct Level	0	100	

Chorus

Effect On/Off	Off	On	
Mode	Mono, Stereo		
Rate	0	100	
Depth	0	100	
Effect Level	0	100	
Pre Delay	0.0	50.0	[ms]
Lo Cut Filter	Flat, 55	800	[Hz]
Hi Cut Filter	500	12.5k, Flat	[Hz]

Reverb

Effect On/Off	Off	On	
Type	Room1, Room2, Hall1, Hall2, Plate		
Reverb Time	0.1	10	[s]
D:E Balance	100:0	0:100	
Level	0	100	
Pre Delay	0	200	[ms]
Density	0	10	
Lo Cut Filter	Flat, 55	800	[Hz]
Hi Cut Filter	500	12.5k, Flat	[Hz]

31. Bass Simulator

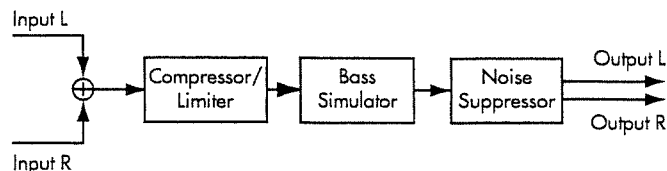

Simulates the sound of a bass guitar. Obtain the sound of a bass guitar while playing an electric guitar. You should avoid playing chords when using the Bass Simulator.

Compressor

Effect On/Off	Off	On
Effect Type	Comp, Limiter	
Sustain	0	100
Attack	0	100
Tone	-50	+50
Level	0	100

Limiter

Effect On/Off	Off	On
Effect Type	Comp, Limiter	
Threshold	0	100
Release	0	100
Tone	-50	+50
Level	0	100

Bass Simulator

Effect On/Off (*)	Off	On
Character	Loose, Tight	
Effect Level	0	120
Direct Level	0	100

Noise Suppressor

Effect On/Off	Off	On
Threshold	0	100
Release	0	100

32. 10 Band Graphic Equalizer

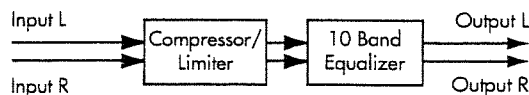

Fully stereo 10-band graphic equalizer.

Compressor

Effect On/Off	Off	On
Detector in	L, R, Link	
Effect Type	Comp, Limiter	
Threshold	0	100
Ratio	1.5:1	100:1
Attack	0	100
Release	0	100
Tone	-50	+50
Level	0	100

Limiter

Effect On/Off	Off	On
Detector in	L, R, Link	
Effect Type	Comp, Limiter	
Threshold	0	100
Release	0	100
Tone	-50	+50
Level	0	100

Graphic EQ

Effect On/Off (*)	Off	On	
Input Gain	-12	+12	[dB]
Level	-12	+12	[dB]
	31.2	+12	[dB]
	62.5	+12	[dB]
	125	+12	[dB]
	250	+12	[dB]
	500	+12	[dB]
	1.0K	+12	[dB]
	2.0K	+12	[dB]
	4.0K	+12	[dB]
	8.0K	+12	[dB]
	16K	+12	[dB]

Functions of each parameter

This section explains the function of each effect parameter included in the algorithms.

Acoustic Guitar Simulator

This simulates the sound of an acoustic guitar. You can obtain an acoustic guitar sound by playing an electric guitar.

Effect On/Off

This parameter turns the acoustic guitar simulator effect on/off.

Effect Type

Select either Preamp or Acoustic Guitar Simulator.

PREAMP:

The effect will function as a preamp.

AC SIM:

The effect will function as an acoustic guitar simulator.

Top

This adjusts the interference to the strings made by the top plate. That is, it adjusts the attack sense or harmonic contents.

Body

This adjusts the resonance of the sound caused by the body. That is, it adjusts the softness and fatness of the sound which is the typical characteristics of acoustic guitars.

Level

This adjusts the volume of the acoustic guitar simulator.

Chorus

A sound with a subtly shifted pitch is added to the direct sound, making the final output sound thicker and broader.

Effect On/Off

This parameter turns the chorus effect on/off.

Polarity

This parameter is for the Stereo Chorus. It lets you choose the difference in LFO phase for the left and right channels.

Synchro:

The left and right phase will be the same.

Inverse:

The left and right phase will be opposite.

Effect Type

This selects the effect to be used from the following ones.

Flanger:

The effect will function as a flanger.

Chorus:

The effect will function as a chorus.

Phaser:

The effect will function as a phaser.

PS:

The effect will function as a pitch shifter.

Mode

Selection for the chorus mode.

Mono:

This chorus effect outputs the same sound from both L and R.

Stereo:

This is a stereo chorus effect that adds different chorus sounds to L and R.

Rate

Adjusts the rate of the Chorus effect.

Depth

Adjusts the depth of the Chorus effect. To use it for doubling, set the value to "0."

Effect Level

Adjusts the volume of the effect sound.

Pre Delay

Adjusts the time needed for the effect sound to be output after the direct sound has been output. By setting a longer Pre Delay time, you can obtain an effect that sounds like more than one sound is being played at the same time (doubling effect).

Low Cut Filter

The low cut filter cuts the frequencies below the specified frequency. This setting adjusts the frequency at which the low cut filter will begin to take effect. When "Flat" is selected, the low cut filter will have no effect.

High Cut Filter

The high cut filter cuts the frequencies above the specified frequency. This setting adjusts the frequency at which the high cut filter will begin to take effect. When "Flat" is selected, the high cut filter will have no effect.

Compressor/Limiter

The compressor is an effect that attenuates loud input levels and boosts soft input levels, thus evening out the volume to create sustain without distortion.

The limiter attenuates loud input levels to prevent distortion.

Effect On/Off

This parameter turns the compressor/limiter effect on/off.

Detector in

This parameter is for "19. Stereo Multi." Select the input source which will control the compressor/limiter.

L: The input source of channel L will control the compressor/limiter.

R: The input source of channel R will control the compressor/limiter.

Link: The input source whose level is higher will control the compressor/limiter.

Effect Type

Select either Compressor or Limiter.

COMP:

The effect will function as a compressor.

LIMIT:

The effect will function as a limiter.

Enhance Freq (Enhance Frequency)

These are the parameters for "27. Bass Multi 1" and "28. Bass Multi 2." This sets the frequency band where you wish to apply the Enhancer effect. Increasing the value will target a higher frequency band.

Enhance Level

These are the parameters for "27. Bass Multi 1" and "28. Bass Multi 2." This adjusts the intensity of the Enhance effect. Increasing the value will emphasize the Enhance effect.

<When "Compressor" is selected>

Sustain

Adjusts the range (time) over which low-level signals are boosted. Larger values will result in longer sustain.

Threshold

This adjusts the level at which the effect will be made apparent.

Ratio

Selects the extent to which the signal will be compressed (compression ratio) while the Limiter is working.

Attack

Adjusts the strength of the attack. Larger values will result in a sharper attack, creating a more clearly defined sound.

Tone

Adjusts the tone.

Level

Adjusts the volume.

<When "Limiter" is selected>

Attack (Attack Time)

This is the parameter for "29. Mic Simulator." Adjust the time from when the input level exceeds the threshold level to when the effect begins to apply.

Detect HPF Freq (Frequency)

This is the parameter for "29. Mic Simulator." Adjust the cutoff frequency of the level detection section. With a setting of Thru, this will operate as a conventional limiter.

Threshold

Adjusts this as appropriate for the inputs signal. When the input signal level exceeds this threshold level, limiting will be applied.

Release

This adjusts the time from when the signal level drops below the threshold until when limiting is removed.

Tone

Adjusts the tone.

Level

Adjusts the volume.

De-esser

Useful for reducing 'sibilant' or 'S' sounds produced by a vocalist.

Effect On/Off

This parameter turns the de-esser effect on/off.

Sens

Adjusts the sensitivity relative to the input volume, which controls how the effect is applied.

Frequency

Set the frequency at which the de-esser effect will be applied. The effect will be made apparent in the frequencies above the frequency set here.

Delay

This parameter creates a distinctive effect (such as a thicker sound) by applying a delayed sound to the direct sound.

By using Tempo Delay, you can easily set the delay time to match the tempo of the song.

Effect On/Off

This parameter turns the delay effect on/off.

Mode

Specify the delay mode.

Normal: This is a delay with adjustable delay time.

Tempo: You can make the delay time change in synchronization with the tempo of the song.

Type

This Parameter selects the type of delay.

Single: This is a simple delay.

3Tap: A delay in which delay time L and delay time R are specified as a ratio relative to delay time C.

Delay Time

This parameter adjusts the delay time (i.e., the interval for which sound is delayed).

With "3Tap Delay," the delay time for the "Delay Time C" is taken to be 100%, and the delay times of "Delay Time L" and "Delay Time R" are adjusted accordingly.

Tempo

This parameter is for the tempo function. It sets the tempo for the song.

Interval

This parameter is for the tempo function. Specify the delay time as a note value, with each beat of the song for which the tempo is specified counting as a quarter note.

Feedback

This parameter adjusts the amount of feedback. Changing the amount of feedback causes the number of times the delayed sound is repeated to change as well.

Level

This parameter is for "3Tap Delay." Adjusts the volume of the output from each tap.

Effect Level

This adjusts the volume of the delay sound.

Direct Level

Adjusts the volume of the direct sound.

High Damp

This parameter adjusts the amount of damping for High Damp. No high-frequency damping occurs when set to "0."

High Cut Filter

The High Cut Filter cuts the frequency contents that are higher than the set frequency. This parameter adjusts the frequency where the high cut filter starts working. When it is set to "Flat," the high cut filter does not work at all.

Smooth

When this is turned on, the change of the delay time will be smooth.

Enhancer

By adding sounds which are out-of-phase with the direct sound, this effect enhances the definition of the sound, and pushes it to the forefront.

Effect On/Off

This parameter turns the enhancer effect on/off.

Detector in

Select the input source which will control the enhancer.

L: The input source of channel L will control the enhancer.

R: The input source of channel R will control the enhancer.

Link: The input source whose level is higher will control the enhancer.

Sens

Adjusts the manner in which the enhancer will be applied relative to the input signals.

Frequency

Sets the frequency at which the enhancer effect will begin to be applied. The effect will be made apparent in the frequencies above the frequency set here.

Mix Level

Adjusts the amount of phase-shifted sound of the range set by "Frequency" that is to be mixed with the input.

Low Mix Level

Adjusts the amount of phase-shifted sound of the lower range that is to be mixed with the input.

Level

Adjusts the volume of the enhanced sound.

Equalizer

A 3-band or 4-band equalizer.

Effect On/Off

This parameter turns the equalizer effect on/off.

Effect Type

Select either Equalizer or Wah.

EQ:

The effect will function as an equalizer.

WAH:

The effect will function as a wah.

Low Gain

This parameter sets the gain (amount of boost or cut) for the bass equalizer.

Low Frequency

This parameter sets the central frequency for the bass equalizer.

Low-Mid Gain

This parameter sets the gain (amount of boost or cut) for the low-midrange equalizer.

Low-Mid Frequency

This parameter sets the central frequency for the low-midrange equalizer.

Low-Mid Q

This parameter sets the range of change in gain for the frequency set by the Low-Mid Frequency parameter. A larger value results in a narrower range of change.

Middle Gain

This parameter sets the gain (amount of boost or cut) for the midrange equalizer.

Middle Frequency

This parameter sets the central frequency for the midrange equalizer.

Middle Q

This parameter sets the range of change in gain for the frequency set by the Middle Frequency parameter. A larger value results in a narrower range of change.

High-Mid Gain

This parameter sets the gain (amount of boost or cut) for the high-midrange equalizer.

High-Mid Frequency

This parameter sets the central frequency for the high-midrange equalizer.

High-Mid Q

This parameter sets the range of change in gain for the frequency set by the High-Mid Frequency parameter. A larger value results in a narrower range of change.

High Gain

This parameter sets the gain (amount of boost or cut) for the treble equalizer.

High Frequency

This parameter sets the central frequency for the treble equalizer.

Level

This parameter adjusts the volume after the equalizer stage.

Flanger

The flanger effect gives a twisting, jet-airplane-like character to the sound.

Effect On/Off

This parameter turns the flanger effect on/off.

Effect Type

This selects the effect to be used from the following ones.

Flanger: The effect will function as a flanger.

Chorus: The effect will function as a chorus.

Phaser: The effect will function as a phaser.

PS: The effect will function as a pitch shifter.

Rate

Determines the depth of the flanging effect.

Depth

Determines the depth of the flanging effect.

Manual

Adjusts the center frequency at which to apply the effect.

Resonance

Determines the amount of resonance (feedback). Increasing the value will emphasize the effect, creating a more unusual sound.

Separation

Adjusts the diffusion. The diffusion increases as the value increases.

Gate

This can be effectively used to cyclically cut the output from the flanger. Increasing the value will shorten the interval. If this is "Off," gate will have no effect.

Direct On/Off

Switch the direct sound on/off (output/no output).

Lo-Fi Box

This adjusts the volume of the effect sound.

Effect On/Off

This parameter turns the lo-fi box effect on/off.

Mode

Select the mode of the lo-fi box.

Radio:

The sound will appear to be heard from an AM radio. By adjusting "Tuning," you can simulate the sounds that occur when you adjust the tuning frequency of the radio.

Player:

The sound will appear to be heard from a gramophone. The noise caused by scratches and dust on the record are is simulated.

LO-FI:

This allows you to create a "lo-fi" sound by lowering the sample rate and/or decreasing the number of bits. Realtime modify filters connected in series allow you to reshape the sound freely.

<When "Radio" or "Player" is selected>**Tuning**

This is a parameter for "Radio." It simulates the sounds that occur when you adjust the tuning frequency of an AM radio.

Wow Flutter

This is a parameter for "Player." It simulates the wow and flutter which occur when the speed of the turntable is not constant.

Noise

This simulates noise.

Filter

Adjusts the filter.

Sound

Adjusts the tone.

<When "Lo-Fi Processor" is selected>**Pre Filter**

This filter decreases digital distortion. By turning this off, you can create an extremely lo-fi sound that includes aliasing.

Sample Rate

Modify the sample rate. If this is turned off, the sample rate will be the same as the sample rate of the currently selected song.

Bit

Modify the number of data bits. If this is turned off, the number of data bits will be unchanged. If an extremely low number of bits is selected, loud noise may appear even when there is no sound, depending on the input source. In such cases, raise the threshold of the noise suppressor.

Post Filter

This filter decreases the digital distortion produced by lo-fi. By turning this off, you can create an extremely lo-fi sound.

Effect Level

Adjust the volume of the lo-fi sound.

Direct Level

Adjust the volume of the direct sound.

Realtime Modify Filter

Select the filter type.

Off:

The realtime modify filter will not be used.

LPF:

The low pass filter will operate.

BPF:

The band pass filter will operate.

HPF:

The high pass filter will operate.

Cut Off

Adjust the cutoff frequency.

Resonance

Adjust the resonance.

Gain

Adjust the volume level of the sound that has passed through the realtime modify filter.

Noise Suppressor

This effect reduces the noise and hum. Since it suppresses the noise in synchronization with the envelope of the sound (the way in which the sound decays over time), it has very little effect on the guitar sound, and does not harm the natural character of the sound.

Effect On/Off

This parameter turns the noise suppressor effect on/off.

Detector in

This parameter is for "19.Stereo Multi." It selects the input source which will control the noise suppressor.

L: It will be controlled by the input source of channel L.

R: It will be controlled by the input source of channel R.

Link: It will be controlled by the input source whose level is greater.

Threshold

Adjust this parameter as appropriate for the volume of the noise. If the noise level is high, a higher setting is appropriate. If the noise level is low, a lower setting is appropriate. Adjust this value until the decay of the sound is as natural as possible.

* *High settings for the Threshold parameter may result in there being no sound when you play with your instruments volume turned down.*

Release

Adjusts the time from when the noise suppressor begins to function until volume reaches "0."

Overdrive

It's possible to simulate the distortion produced by a rotary speaker's vacuum-tube amp (Overdrive).

Effect On/Off

This parameter turns the overdrive effect on/off.

Gain

This parameter adjusts the input level for Overdrive. Larger values result in greater distortion.

* *When set to "0," no sound is output.*

Drive

This parameter adjusts the amount of distortion.

Level

This parameter adjusts the output level for Overdrive.

Phaser

By adding varied-phase portions to the direct sound, the phaser effect gives a whooshing, swirling character to the sound.

Effect On/Off

This parameter turns the phaser effect on/off.

Effect Type

This selects the effect to be used from the following ones.

Flanger:

The effect will function as a flanger.

Chorus:

The effect will function as a chorus.

Phaser:

The effect will function as a phaser.

PS:

The effect will function as a pitch shifter.

Type

This parameter is for "16.Stereo Phaser." Selects the number of stages that the phaser effect will use.

4stage:

This is a four-phase effect. A light phaser effect is obtained.

6state:

This is a six-phase effect.

8stege:

This is an eight-phase effect. It is the most popular phaser effect.

10state:

This is a ten-phase effect.

12stage:

This is a twelve-phase effect. A deep phase effect is obtained.

Rate

This sets the rate of the Phaser effect.

Depth

Determines the depth of the Phaser effect.

Manual

Adjusts the center frequency of the phaser effect.

Resonance

Determines the amount of resonance (feedback). Increasing the value will emphasize the effect, creating a more unusual sound. Setting it to a minus value will create resonance having a reversed phase.

Separation

Adjusts the diffusion. The diffusion increases as the value increases.

Step

This can be used to cause the sound to change in a stepped manner. Increasing the value will make the change finer. If this is "Off," step will have no effect.

Pitch Shifter

This effector changes the pitch of the original sound (up or down) within a range of two octaves.

Effect On/Off

This parameter turns the pitch shifter effect on/off.

Effect Type

This selects the effect to be used from the following ones.

Flanger:

The effect will function as a flanger.

Chorus:

The effect will function as a chorus.

Phaser:

The effect will function as a phaser.

PS:

The effect will function as a pitch shifter.

Mode

This parameter selects the mode of the Pitch Shifter.

Fast, Medium, Slow:

A chord can be input with a normal pitch shifter. The response is slower in the order of Fast, Medium and Slow, but the modulation is lessened in the same order.

INV1:

Provides reverse sound. Response is fast; reverse time is short.

INV2:

Provides reverse sound. Response is slow; reverse time is long.

Pitch

Adjusts the amount of pitch shift (the amount of pitch change) in semitone steps.

Fine

Make fine adjustments to the pitch shift.

* *The amount of the change in the Fine "100" is equivalent to that of the Pitch "1."*

Pre Delay

Adjusts the time from when the direct sound is heard until the pitch shifted sounds are heard. Normally you can leave this set at "0 ms."

Feedback Delay

This parameter is for "5.Stereo Pitch Shifter Delay." It lets you adjust the delay time for the feedback sound.

Feedback Level

This is the parameter for "5. Stereo Pitch Shifter Delay." This adjusts the amount of feedback for the pitch shifted sound. Changing the feedback amount will affect the number of repeats of the pitch shifted sound.

D:E Balance

This adjusts the volume balance of the direct and effect sounds.

Level

This parameter adjusts the volume level.

Smooth

When this is turned on, the change of the delay time will be smooth.

Preamp

Use the preamp to adjust the distortion and tone color of the guitar.

* *When all Bass, Middle and Treble are set to "0," no sound may be produced depending on the Type settings.*

Effect On/Off

This parameter turns the preamp effect on/off.

Effect Type

Select either Preamp or Acoustic Guitar Simulator.

PREAMP:

The effect will function as a preamp.

AC SIM:

The effect will function as an acoustic guitar simulator.

Amp Type

This sets the type of the guitar preamp. The distortion and tone characteristics of each amp are as shown below:

JC-120:

The sound of the Roland "JC-120" (Jazz Chorus 120), a favorite of pro musicians around the world.

Clean:

The sound of a conventional built-in tube amp.

Crunch:

Allows you to obtain a crunch effect that creates a natural distortion.

Match:

A simulation of the latest tube amp widely used in styles from blues and rock.

Voxy:

Allows you to obtain the Liverpool sound of the 60's.

Blues:

A lead sound with a rich middle ideal for Blues.

BG Lead:

The sound of a tube amp typical of the late '70s to '80s, characterized by a distinctive mid-range.

MS(1, 2, 1+2):

The sound of a large tube amp stack that was indispensable to the British hard rock of the '70s, and is used to this day by many hard rock guitarists.

- 1: A trebly sound created by using input I of the guitar amp.
- 2: A mild sound created by using input II of the guitar amp.
- 1+2: The sound of connecting inputs I and II of the guitar amp in parallel, creating a sound with a stronger low end than I.

Sldn:

A tube amp sound with versatile distortion, usable in a wide range of styles.

Metal:

The sound of a large tube amp, suitable for heavy metal.

Metal D:

A high gain and powerful metal sound.

Volume

Adjusts the volume and distortion of the amp.

Bass

Adjusts the tone for the low frequency range.

Middle

Adjusts the tone for the middle frequency range.

* If you have selected "Match" or "Voxy" as the type, the middle control will have no effect.

Treble

Adjusts the tone for the high frequency range.

Presence

Adjusts the tone for the ultra high frequency range.

* If you have selected "Match" or "Voxy" as the type, raising presence will cut the high range (the value will change from "0" to "-100").

Master

Adjusts the volume of the entire preamp.

Bright

Turns the bright setting on/off.

Off:

Bright is not used.

On:

Bright is switched on to create a lighter and crisper tone.

* Depending on the "Amp Type" setting, this may not be displayed.

Gain

Adjusts the distortion of the amp. Distortion will successively increase for settings of "Low," "Middle" and "High."

* The sound of each Type is created on the basis that the Gain is set to "Middle." So, normally set it to "Middle."

Reverb

Reverberation (or reverb) is the effect caused by sound waves decaying in an acoustic space, or a digital simulation thereof. This decay occurs because sound waves bounce off many walls, ceilings, objects, etc. in a very complex way. These reflections, coupled with absorption by various objects, dissipate the acoustic energy over a certain period of time (called the decay time). The ear perceives this phenomenon as a continuous wash of sound.

Effect On/Off

This parameter turns the reverb effect on/off.

Reverb Type

This selects the Reverb Type. Various different simulations of space are offered.

* The available types will depend on the algorithm which is used.

Room:

Simulates the reverberation in a small room.

Hall:

Simulates the reverberation in a concert hall.

Room1:

Simulates the reverberation in a small room.

Provides the bright reverberations.

Room2:

Simulates the reverberation in a small room.

Provides warm reverberations.

Hall1:

Simulates the reverberating in a concert hall.

Provides clear and spacious reverberations.

Hall2:

Simulates the reverberation in a concert hall.

Provides warm reverberations.

Plate:

Simulates plate reverberation (a reverb unit that uses the vibration of a metallic plate). Provides a metallic sound with a distinct upper range.

Room Size

This parameter adjusts the size of the room which is simulated.

Reverb Time

This parameter adjusts the duration (time) of the reverb.

D:E Balance

This adjusts the volume balance of the direct and effect sounds.

Level

This parameter adjusts the volume level.

Pre Delay

This parameter adjusts the time interval between the direct sound and the beginning of the reverb sound.

Density

Adjust the density of the sound (Early Reflections) that arrives at the listener after bouncing off the walls once or a few times.

ER (Early Reflection) Level

This parameter adjusts the volume level of the initial reflected sound.

Release Density

This parameter adjusts the density of the sound that reaches the listener after many repeated reflections.

Low Damp Gain

This parameter adjusts the amount of damping for Low Damp. No low-frequency damping occurs when set to "0."

Low Damp Freq

This parameter adjusts the frequency at which the low-frequencies are damped. The reverb sound in the band below this frequency is damped.

High Damp Gain

This parameter adjusts the amount of damping for High Damp. No high-frequency damping occurs when set to "0."

High Damp Freq

This parameter adjusts the standard frequency at which the high-frequencies are damped. The reverb sound in the band above the standard frequency is damped.

Low Cut Filter

This parameter adjusts the frequency at which a high-pass filter starts to be applied. The effect is applied to the reverb sound.

High Cut Filter

This parameter adjusts the frequency at which a low-pass filter starts to be applied. The effect is applied to the reverb sound.

Gate**GATE On/Off**

This parameter turns the gate effect on/off.

Threshold

This parameter adjusts the standard level for controlling opening and closing of the gate.

Attack Time

This parameter adjusts the time between the direct sound exceeding the threshold level and the opening (closing) of the gate.

Hold Time

This parameter adjusts the time interval between the gate opening and closing completely.

Release Time

This parameter adjusts the time from when the hold time ends to when the sound is completely muted.

Ring Modulator

This creates a bell-like sound by ring-modulating the guitar sound with the signal from the internal oscillator. The sound will be unmusical and lack distinctive pitches.

Effect On/Off

This parameter turns the ring modulator effect on/off.

Frequency

This adjusts the frequency of the internal oscillator.

Effect Level

This adjusts the volume of the effect sound.

Direct Level

This adjusts the volume of the direct sound.

Rotary

This parameter simulates an old-fashioned rotary speaker, which added undulations to the sound by rotating the speaker as it played.

A real rotary speaker has a switch to select slow or fast rotation. Its horn (treble-range speaker) and rotor (bass-range speaker) can also be rotated independently. The ROTARY Effector has parameters that can be used to re-create these subtle effects.

Effect On/Off

This parameter turns the rotary effect on/off.

Speed Select

This parameter changes the simulated speaker's rotating speed (Slow or Fast).

Horn (Fast)

This parameter adjusts the speed of rotation for the horn when set to "Fast."

Rotor (Fast)

This parameter adjusts the speed of rotation for the rotor when set to "Fast."

Horn (Slow)

This parameter adjusts the speed of rotation for the horn when set to "Slow."

Rotor (Slow)

This parameter adjusts the speed of rotation for the rotor when set to "Slow."

Rise Time ; Horn

This parameter adjusts the time it takes for the rotation speed of the horn to change when switched from "Slow" to "Fast."

Rise Time ; Rotor

This parameter adjusts the time it takes for the rotation speed of the rotor to change when switched from "Slow" to "Fast."

Fall Time ; Horn

This parameter adjusts the time it takes for the rotation speed of the horn to change when switched from "Fast" to "Slow."

Fall Time ; Rotor

This parameter adjusts the time it takes for the rotation speed of the rotor to change when switched from "Fast" to "Slow."

R:H Mix Balance

This parameter adjusts the volume balance between the horn and rotor.

Mic Setting Mode

This parameter switches the position of the microphone used to record the sound of the rotary speaker.

OfMic(Off Mic):

This simulates the sound recorded by a microphone positioned at a distance from the rotary speaker. There are few undulations in the sound. This setting is good for instruments such as a jazz organ.

OnMic(On Mic):

This simulates the sound recorded by a microphone positioned close to the rotary speaker. The sound has many undulations. This setting is good for instruments such as a rock organ.

Horn Depth

This parameter adjusts the amount of depth in the Doppler effect for the horn.

Rotor Depth

This parameter adjusts the amount of depth in the Doppler effect for the rotor.

Horn Tremolo

This parameter adjusts the amount of change in volume for the horn.

Rotor Tremolo

This parameter adjusts the amount of change in volume for the rotor.

Diffusion

This parameter adjusts the "fatness" of the sound.

Effect Level

This adjusts the volume of the effect sound.

RSS (2ch)

RSS (Roland Sound Space) is an effector that creates a three-dimensional sonic field. RSS can let you orient the sonic image at a position above, below, before, behind, or to one side or the other of the listener.

* *To get the most out of the effects that RSS can provide, be sure to read "Before using RSS" (page 172).*

Effect On/Off

This parameter turns the RSS(2ch) effect on/off.

Azimuth

This parameter moves the sound horizontally along the perimeter of an imaginary sphere. The setting can be made within a range of about 180 degrees to the left or right, with the standard setting ("0") indicating a position directly in front of the listener.

Elevation

This parameter moves the sound vertically along the perimeter of an imaginary sphere. The setting is made as the number of degrees from the front of the listener (0).

RSS (Panner)

RSS (Panner) can make the sound seem to revolve around the listener.

Effect On/Off

This parameter turns the RSS(Panner) effect on/off.

Speed

This parameter adjusts the speed with which the position of the sound moves.

Direction

This parameter selects the sound's direction of rotation.

CW (Clockwise):

Rotates the sound clockwise.

CCW (Counterclockwise):

Rotates the sound counterclockwise.

Space Chorus

This chorus effect simulates the sound from Roland's well-known SDD-320 Dimension D.

Effect On/Off

This parameter turns the space chorus effect on/off.

Input

This parameter toggles between stereo and monaural input signals.

Mono:

This produces a space chorus for mono input with the left and right channels mixed.

Stereo (Stereo):

This produces a space chorus for stereo input with Space Chorus applied separately to the left and right channels.

Mode

This parameter lets you choose how the chorus changes.

Effect Level

This adjusts the volume of the effect sound.

Direct On/Off

Switch the direct sound on/off (output/no output).

Speaker Simulator

This simulates the characteristics of various types of speakers. When the output of the VS-840 is connected directly to a mixer, etc., this can be used to create the sound of your favorite speaker system.

Effect On/Off

This parameter turns the speaker simulator effect on/off.

Sp Type (Speaker Type)

Selects the type of speaker that will be simulated.

SP Simulator Type	Cabinet	Speaker Unit	Microphone Setting	Comments
Small	Small open-back enclosure	10 inch	On Mic	
Middle	Open-back enclosure	12 inch	On Mic	
JC-120	Open-back enclosure	12 inch (two units)	On Mic	JC-120 Simulation
TWIN	Open-back enclosure	12 inch (two units)	On Mic	A setting suitable for Clean
twin	Open-back enclosure	12 inch (two units)	Off Mic	A setting suitable for Clean
MATCH	Open-back enclosure	12 inch (two units)	On Mic	A setting suitable for Match
match	Open-back enclosure	12 inch (two units)	Off Mic	A setting suitable for Match
VOXY	Open-back enclosure	12 inch (two units)	On Mic	A setting suitable for Voxy
voxy	Open-back enclosure	12 inch (two units)	Off Mic	A setting suitable for Voxy
BG STK	Large Sealed enclosure	12 inch (two units)	OnMic	A setting suitable for BG Lead
bg stk	Large sealed enclosure	12 inch (two units)	Off Mic	A setting suitable for BG Lead
MS STK	Large sealed enclosure	12 inch (four units)	On Mic	A setting suitable for MS
ms stk	Large sealed enclosure	12 inch (four units)	Off Mic	A setting suitable for MS
METAL	Large dual stack	12 inch (four units)	Off Mic	

* "On Mic" simulates the sound when a dynamic microphone is used, and "Off Mic" simulates the sound when a condenser microphone is used.

The following are appropriate matches between pre-amp and speaker simulator settings.

[PREAMP] Type	[SP Simulator] Type
JC-120	JC-120
Clean	TWIN, twin, Middle
Crunch	TWIN, twin, Middle
Match	MATCH, match
Voxy	VOXY, voxy
Blues	Middle, MATCH, match
BG Lead	BG STK, bg stk, Middle
MS(1)	MS STK, ms stk, METAL
MS(2)	MS STK, ms stk, METAL
MS(1+2)	MS STK, ms stk, METAL
Sldn	MS STK, ms stk, METAL
Metal	MS STK, ms stk, METAL
Metal D	MS STK, ms stk, METAL

Mic Setting

This simulates the microphone position. "Center" simulates the condition that the microphone is set in the middle of the speaker cone. "1 to 10 cm" means that the microphone is moved away from the center of the speaker cone.

Mic Level

Adjusts the volume of the microphone.

Direct Level

Adjusts the volume of the direct sound.

Tremolo / Pan

Tremolo is an effect that creates a cyclic change in volume. Pan cyclically moves the stereo position between left and right (when stereo output is used).

Effect On/Off

This parameter turns the tremolo/pan effect on/off.

Mode

Selection for tremolo or pan. And selection for the waveform that the effect will use.

Tremolo :

The volume will change cyclically. Smooth change will be produced.

Tremolo :

The volume will change cyclically. Abrupt change will be produced.

Pan :

The sound will be moved cyclically between left and right. Smooth change will be produced.

Pan :

The sound will be moved cyclically between left and right. Abrupt change will be produced.

Rate

Adjusts the frequency (speed) of the change.

Depth

Adjusts the depth of the effect.

Balance

Adjusts the stereo position of the sound.

Vocoder

The vocoder creates "talking instrument" effects. When using the vocoder, input an instrumental sound into the A channel, and a vocal sound into the B channel. The instrumental sound is divided into ten frequency bands, and processed according to the frequency characteristics of the vocal sound.

Effect On/Off

This parameter turns the vocoder effect on/off.

Sens

Adjust the input sensitivity of the mic.

Voice Character 1 to 10

Adjust the volume of each frequency band. This setting adjusts the tone of the vocoder.

Mic HPF

When mic mix is used, this adjusts the frequency at which the high pass filter (HPF) will begin to affect the mic audio. Higher values for this setting will allow you to mix only the consonants. With a setting of Thru, the HPF will not be applied.

Mic Mix

Adjust the amount of the mic audio (B channel input) which has passed through the mic HPF that will be added to the output of the vocoder.

NS Threshold

Adjust the level at which the noise suppressor applied to the instrumental input (A channel input) will begin to function.

Vocoder Level

Adjusts the volume of the vocoder sound.

Wah

Wah is an effect which changes the frequency response of a filter to produce a characteristic tonal change. T-wah uses the volume of the input sound to control the filter. Auto-wah cyclically modulates the filter.

Effect On/Off

This parameter turns the wah effect on/off.

Effect Type

Selects either Equalizer or Wah.

EQ:

The effect will function as a equalizer.

WAH:

The effect will function as a wah.

WAH Type**T[UP]:**

A wah in which the input will cause the filter to move toward a higher frequency.

T[DOWN]:

A wah in which the input will cause the filter to move toward a lower frequency.

A[UP], A[DOWN]:

A wah in which the filter will change cyclically.

<When "T[UP]" or "T[DOWN]" are selected>**Sens**

Adjust the sensitivity with which the filter will be affected. Higher settings will produce a greater response, and if this is set to a value of "0," a fixed wah will result.

Frequency

This adjusts the center frequency of the Wah effect.

Peak

Adjusts the way in which the wah effect applies to the area around the center frequency. Lower values will produce a wah effect over a wide area around the center frequency. Higher values will produce a wah effect in a narrow area around the center frequency.

* With a value of "50" a standard wah sound will be produced.

Level

Adjusts the volume.

<When "A[UP]" or "A[DOWN]" are selected>**Frequency**

This adjusts the center frequency of the Wah effect.

Rate

Adjusts the frequency of the auto wah.

Depth

Adjusts the depth of the auto wah effect.

Peak

Adjusts the way in which the wah effect applies to the area around the center frequency. Lower values will produce a wah effect over a wide area around the center frequency. Higher values will produce a wah effect in a narrow area around the center frequency.

* With a value of "50" a standard wah sound will be produced.

Level

Adjusts the volume.

Defretter**Sensitivity**

This controls the input sensitivity of the Defretter. It should be adjusted for the bass guitar you have until you get the harmonic changes to sound natural.

Attack

This controls the attack of the Defretter. Increasing the value will cause the harmonics to change more slowly, thus producing a relatively attack-less sound, similar to a fretless bass.

Depth

This controls the rate of the harmonics. Increasing the value will increase the harmonic content and therefore will create a more unusual sound.

Level

Adjusts the volume of the defretter sound.

Distortion

This effect distorts the sound. By changing the TYPE, you can create many different sounds.

Type

This allows you to select the distortion type you like. When the effect is turned on, the indicator of the selected TYPE will be lit.

TURBO OD:

Allows you to obtain a rich effect just like distortion, without losing the subtle nuance of the overdrive.

BASS OD:

Rich and firm overdrive sound can be created.

Hard DS:

This produces a rich and powerful heavy metal sound.

FUZZ 1:

This produces a full-bodied, traditional fuzz sound that has the lower and middle range emphasized.

FUZZ 2:

This produces an exciting fuzz sound that has its overtones emphasized.

Drive

Adjusts the depth of distortion. A higher value will emphasize the distortion.

Treble

This controls the treble sounds. You can set an appropriate frequency band for each TYPE.

Bass

This controls the bass sounds. You can set an appropriate frequency band for each TYPE.

B.AMP SIM (Bass Amp Simulator)

This simulates the characteristics of a bass amplifier. By using this, you can obtain a firm and rich distortion sound that does not get thin when connecting the bass guitar to a mixer or using headphones.

Level

This adjusts the volume of the distorted sound.

Direct Level

This adjusts the volume of the direct sound when the effect is turned on.

Mic Converter

This converts the characteristics of an inexpensive general purpose mic into the characteristics of an expensive studio mic (Microphone → Microphone conversion). For an already-recorded sound, it can create the same tonal change as if the type or distance of the mic had been changed.

This adds a feeling of "air" to an instrumental sound that was recorded by direct line input, causing it to sound as though it had been recorded with a microphone (Line → Microphone conversion).

Input

Select the type of mic that was actually used to record.

DR-20:

Roland DR-20

Sml.Dy:

Small Dynamic Microphone

Hed.Dy:

Head-worn Dynamic Microphone

Min.Cn:

Miniature Condenser Microphone

Flat:

Line Input

Output

Specify the mic that will be simulated.

Sml.Dy:

General purpose dynamic mic for instruments or vocals. Ideal for guitar amp or snare drum.

Voc.Dy:

A popular dynamic mic for vocals. Characterized by a tight mid-range. Use for vocals.

Lrg.Dy:

Dynamic mic with extended low end. Use for bass drum or tom, etc.

Sml.Cn:

Small condenser mic for instruments. Characterized by a sparkling high range. Use for metallic percussion or acoustic guitar.

Lrg.Cn:

Condenser mic with flat response. Use for vocals, narration, or acoustic instruments etc.

Vnt.Cn:

Vintage condenser mic. Use for vocals or acoustic instruments etc.

Flat:

Mic with flat frequency response. For cancelling the characteristics of the mic used for recording.

* *When you select a condenser-type mic simulator, the low range response is strengthened. This may cause noise transmitted from the mic stand to be emphasized. In this case, either use a bass cut filter to cut the unwanted low range, or equip the mic stand that you use at the time of recording with an isolation mount (a mic holder that uses rubber etc. to absorb vibration).*

Phase

Normally you will set this to Normal.

In cases such as when mics are placed both in front of and behind the instrument for recording, setting one of them to Invert will produce a solid sound with a unified phase.

Nor: Same phase as the input

Inv: Opposite phase as the input

Bass Cut Filter

This is a filter that cuts unwanted low range noise, such as pops. It simulates the bass cut switch that is found on some mics.

Freq (Frequency)

Normally you will select Thru, and you can adjust the frequency if the attack contains a section of low volume.

Distance

Microphones have a characteristic which causes the low frequency range to be boosted when the sound source is nearby. This setting simulates this phenomenon.

Prox.Fx (Proximity effects)

Adjust the low frequency response that is affected by the mic distance from the sound source. Adjustment in the [+] direction will move the mic closer to the sound source, and in the [-] direction will move it away from the sound source.

Time

This simulates the time difference due to distance from the sound source.

Bass Guitar Simulator

Simulates the sound of a bass guitar. Obtain the sound of a bass guitar while playing an electric guitar.

Character

Bass tone characteristic is set. When "LOOSE" is selected, as if the string gauge was getting thicker.

Effect Level

Adjusts the volume of the bass guitar simulator sound.

Direct Level

This adjusts the volume of the direct sound when the effect is turned on.

Graphic EQ (Graphic Equalizer)

This simulates a 10-band graphic equalizer. It can be used either as two monaural units or as one stereo unit.

Input Gain

Adjust the overall volume level of the sound before it passes through the equalizer.

Level

Adjust the volume level of the sound which has passed through the equalizer.

31.2-16K (Gain)

Adjust the gain (amount of boost/cut) of the equalizer for each frequency.

Before using RSS

* In the Delay RSS and Chorus RSS algorithms, the spatial placement is fixed, and it is not possible to adjust Azimuth and Elevation.

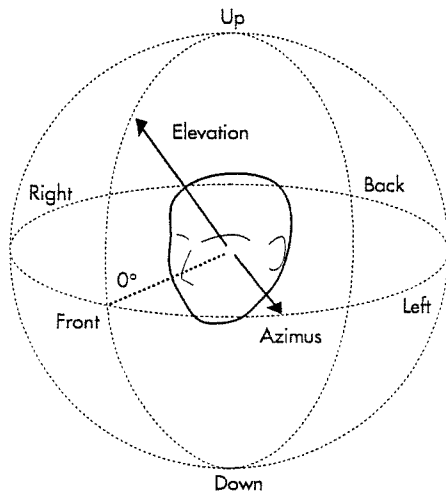

< Cautions when using RSS >

RSS (Roland Sound Space) is an effect that controls three-dimensional placement of the sound. In order for RSS to be as effective as possible, note the following points.

- Acoustically "dead" rooms are most suitable.
- Single-way speakers are most suitable. However, coaxial or virtual coaxial multi-way speakers are also OK.
- The speakers should be distanced from the side walls as far as possible.
- Do not excessively separate the speakers to left and right.
- Monitor in the sweet spot shown below.

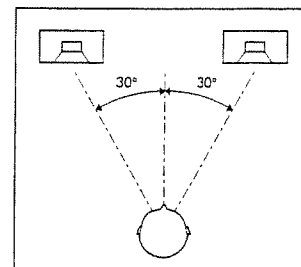

Product package notice for when RSS is used

Some of the Patches use RSS. RSS is an effect that places a sound source in a three-dimensional space when played back on a conventional stereo system. In order for the full RSS effect to be obtained, it is important to specify details of the listening environment. If a song using an RSS Patch is commercially released, we suggest placing the following notice on the package.



For Stereo Speakers

This sound is made to be played specifically through speakers.
The proper effect cannot be obtained if listened to through headphones.

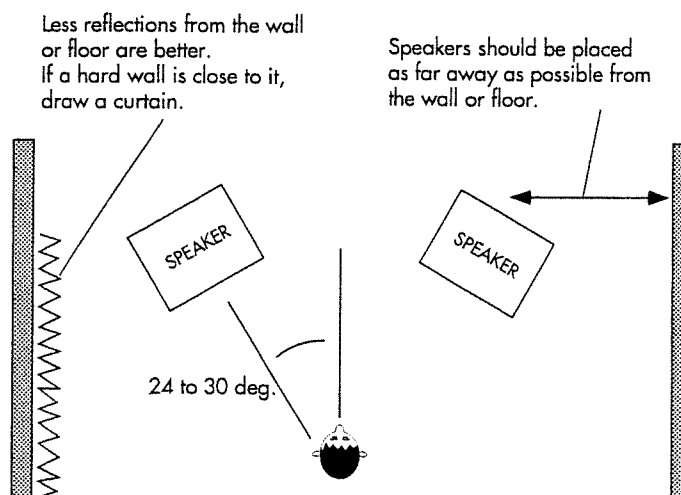

Troubleshooting

When the VS-840EX does not perform the way you expect, check the following points before you suspect a malfunction. If this does not resolve the problem, contact servicing by your dealer or qualified Roland service personnel.

■ Problems with sound

No sound

- The power is not turned on for the VS-840EX and the connected devices.
- The audio cables are not connected correctly.
- The audio cables are broken.
- The volume is turned down on the connected mixer or amp.
- The master fader of the VS-840EX is turned down.
- Short phrases less than 1.0 seconds cannot be played back.
- The source for output from the PHONES jack or the source for output from the MASTER OUT jacks has not been specified correctly. Refer to "Switching the source for output to the PHONES jack" (page 99).
- Monitor Select settings are incorrect. Refer to "Switching the monitor output" (page 33).

Specific channel does not sound

- The volume level of the channel is turned down.
When the scene is switched etc., the actual volume levels may not match the position of the faders. In this case, move the faders up and down to match the settings.
- The track status is set to MUTE (the TRACK STATUS indicator is dark).
- The Solo function (page 98) is being used.
Channels which were muted before the Solo function was used cannot be monitored even if [SELECT] is pressed.
- The channel input is set to MUTE (the SELECT indicator is dark).

Cannot record

- The track status of the recording destination is not set to REC (TRACK STATUS indicator blinks red).
- The disk has insufficient capacity.
- The recording bus is not selected correctly.

Cannot record digitally

- The sampling rate of the VS-840EX's song is different than the sampling rate of the digital audio device.
Match the sample rate setting of the digital audio device to the setting of the song. If it is not possible to change the sample rate of the digital audio device, you must create a new song with that sample rate.
- The Vari-pitch function is on (the VARI PITCH indicator is lit).
Press [VARI PITCH] to turn off the button indicator.
- Digital signal format is different.
Some digital audio devices may use a special digital signal format. Please use a digital audio device that is compatible with S/P DIF.

Noise and distortion appear in the recorded sound

- Input sensitivity settings are inappropriate.
If input sensitivity settings are too high, the recorded sound will be distorted. If they are too low, the recorded sound will be buried by noise. Adjust the INPUT SENS knob so that the level meters move as high as possible without causing the PEAK indicator to light.
- The equalizer is being used.
Some equalizer settings may cause the sound to distort even if the PEAK indicator does not light. Re-adjust the equalizer.
- If noise or distortion occurred as a result of track bouncing, the track output levels were too high.
- A mic is connected directly to the VS-840EX.
The VS-840EX is designed with a large headroom margin. Also, since INPUT-1 to 4 jacks are 10 k-ohm low impedance, the recording level may be low, depending on the characteristics of your mic. Pass the mic signal through a mic preamp before connecting it to the VS-840EX, to convert the signal to line level for recording.

Playback pitch is wrong

- The Vari-pitch function is on (the VARI PITCH indicator is lit).
Press [VARI PITCH] to turn off the button indicator.

■ Problems with the disk drive

Cannot remove disk

- The power has been turned off.
The disk cannot be removed unless the power is turned on.

■ Synchronization problems (does not synchronize)

If you are using MTC to synchronize the VS-840EX and a MIDI sequencer, the VS-840EX must be the master.

- The MIDI cable is not connected correctly.
- The MIDI cable is broken.
- The sync generator is not set to the appropriate synchronization method (MTC, MIDI Clock, Sync Track) (page 111).
- If you are using MTC, the two devices are not set to the same type of MTC (page 111).
- If you are using the sync track, MIDI clock data has not been recorded on the sync track.
- The settings of the MIDI sequencer are not correct.
- The MIDI sequencer is not ready to playback.

■ Other problems

When the power is turned on, the previous data was not saved correctly

It is likely that the VS-840EX power was turned off without performing the shut-down process. The lost data cannot be recovered.

Data on the disk was damaged

The following situations can result in damage to the data on a disk. Re-initialize the disk (execute physical formatting) (page 27).

- The power was turned off while the disk drive was operating.
- A strong shock was applied to the disk drive.

Error messages

If an error occurs in operation, or if an operation could not be processed correctly, and error message will appear. Refer to the displayed error message and take the appropriate action.

Disk Memory Full

Situation: There is insufficient free area on the disk.

Action: Erase unneeded data.

Situation: The maximum number of songs that can be recorded on a disk (200) has been exceeded.

Action: Delete unneeded songs.

Disk Write Error

Situation: An error occurred while writing data to the disk.

Action: The disk must be initialized. Also, the song data you had been attempting to save will be lost.

Drive Busy

Situation: If this message appears after you have been using the disk with the VS-840EX, the data on the disk has become fragmented, causing delays in reading and writing data.

Action 1: Reduce the number of tracks that are played back simultaneously. Use track bouncing etc. to combine tracks, or erase or cut data from tracks which you do not need to playback, and then try the playback again.

Action 2: Reduce the number of tracks that are being recorded simultaneously.

Action 3: Newly create the song again, staying within the limitations of simultaneous recording and playback tracks. Alternatively, newly create the song again with a lower sample rate or recording mode.

	Tracks for simultaneous recording	Tracks for simultaneous playback
Multitrack 1 (MT1)	2 [4]	6
Multitrack 2 (MT2)	2 [6]	8
Live 1 (LV1)	3 [5]	8

The number in square brackets [] indicates the number of playback tracks during recording.

* In cases of unfavorable disk access conditions, such as when track editing or punch-in recording etc. is used to connect phrases (musical data) of several seconds, the "Drive Busy" display may appear even within the above limits on recording and playback.

Event Mem Full

Situation: The VS-840EX has used up all the events that can be handled by one song.

Action: Delete unneeded auto mix data. Alternatively, perform the Song Optimize operation.

MarkerMemory Full

Situation: The VS-840EX has used up all Marker Memory (1000 Markers) that can be handled by one song.

Action: Delete unneeded Marker.

Medium Error

Situation: There is a problem with the disk.

Action: Use the following procedure to initialize the disk.

- Using the procedure described on "Initializing a disk" (p.28), access the Disk Initialize screen and then insert the disk.

- Set "Physical Format" to "On," and then execute initialization.

If an error occurs during initialization, this disk cannot be used by the VS-840EX.

Routing Memory Full

Situation: In the Easy Routing function "User Routing," all available memories have been used.

Action: Delete unneeded User Routing memories.

SONG Protected

Reason: Since Song Protect is ON, the operation cannot be executed.

Action: Turn the Song Protect OFF (page 29).

If you wish to execute the operation without saving the currently selected song, repeat the procedure, and press [NO] in reply to the "STORE Current?" message.

Write Protected

Situation: The disk is protected.

Action: Remove the disk, and use the device which had been using that disk to turn off the protect setting. Alternatively, use the VS-840EX to physically format the disk.

Can't Write Now

Situation: A patch was written to internal memory while playback was taking place.

Action: Stop the playback, then carry out the write procedure again.

Can't Recording

Reason: When recording using vari-pitch, you attempted to record more tracks than can be recorded simultaneously.

Action: Reduce the number of tracks that will be recorded simultaneously.

* For details on the number of tracks that can be recorded simultaneously, refer to page 55.

Aborted Command Illegal Request

Situation: This disk drive cannot be used by the VS-840EX.

Already Selected

Situation: The currently selected disk drive was selected.

Action: If you wish to switch to another disk drive, re-select the disk drive.

Arbitration Fail Busy Status Check Condition Status Error Wait For BUSS Free

Situation: Normal communication with the disk drive could not be accomplished.

Action: Make sure that the disk drive is connected correctly.

Can't Communicate Message Error Drive Time Out Undefined Sense Phase Mismatch ? Unknown Error Unit Attention

Situation: There is a problem with the connections to the disk drive.

Action: Make sure that the disk drive is connected correctly.

Disk Memory Full

Situation: There is insufficient free area on the disk.

Action: Erase unneeded data. Or, select a different disk drive.

Situation: The maximum number of songs that can be saved on a disk (200) has been exceeded.

Action: Delete unneeded songs. Or, select a different disk drive.

Hardware Error

Situation: There is a problem with the disk drive.

Action: Contact the manufacturer or dealer of the disk drive.

Medium Error

Situation: There is a problem with the disk.

Action: This disk cannot be used by the VS-840EX.

Not 512byte/sector

Situation: The disk that you are using is not 512 bytes/sector.

Action: This disk cannot be used by the VS-840EX.

Not Formatted

Situation: The disk has not been initialized by the VS-840EX.

Action: Initialize the disk.

Situation: If this appears for a disk that has been initialized by the VS-840EX, there is a problem with the connections to the disk drive.

Action: Make sure that the disk drive is connected correctly.

Not Ready

Situation: The disk drive is not ready.

Action: Wait a short time.

No Drive Ready

Situation: No disk drive is connected.

Action: Make sure that the disk drive is connected correctly.

Situation: The disk drive has been shut down.

Action: Execute the SCSI Restart icon.

Situation: No disk is inserted.

Action: Insert a disk, and execute the SCSI Restart icon.

SCSI ID Error

Situation: The SCSI ID numbers of two or more disk drives are conflicting.

Action: Make settings so that the SCSI ID numbers do not conflict (page 201).

SPC Not Available

Situation: The SCSI components of the VS-840EX have malfunctioned.

Action: Contact servicing by your dealer or qualified Roland service personnel.

Special key operations

Here is a list of the functions that can be performed by pressing multiple buttons, or by using the TIME/VALUE dial in conjunction with a button.

■ Transport control buttons

[SHIFT]+[STORE(ZERO)]	Store song data to the disk
[SHIFT]+[SONG TOP(REW)]	Move to the time where the first sound of the song is recorded
[SHIFT]+[SONG END(FF)]	Move to the time where the last sound of the song is recorded
[SHIFT]+[SHUT/EJECT(STOP)]	Shut-down / Eject
[SHIFT]+[RESTART(PLAY)]	Re-start (after shut-down)

■ LOCATOR buttons

[SHIFT]+LOCATOR button	Register a locate point 5 to 8
[CLEAR]+LOCATOR button	Clear the setting of a locate point 1 to 4
[SHIFT]+[CLEAR]+LOCATOR button	Clear the setting of a locate point 5 to 8
[CLEAR]+[TAP(ENTER)]	Erase a mark point
[SHIFT]+[CLEAR]+[TAP]→[YES]	Erase all mark points

■ Assigning a function to [SHIFT]+ TRACK CUE knobs

If a parameter has been assigned to the TRACK CUE knobs, the assigned parameter will be shown in a window in the display. To use the assigned function, hold down [SHIFT] and rotate the TRACK CUE knobs. The assigned function will remain in effect until the power is turned off.

[SHIFT]+ [PAN]	Each time the button is pressed, the assigned function will change as follows. Channel PAN/BALANCE Track PAN/BALANCE
[SHIFT]+ [EFFECT LEVEL]	Each time the button is pressed, the assigned function will change as follows. EFFECT SEND LEVEL EFFECT SEND PAN
[SHIFT]+ [AUX LEVEL]	Each time the button is pressed, the assigned function will change as follows. AUX SEND LEVEL A AUX SEND LEVEL B * Channels 1 to 4 have two AUX levels A and B. However channels 5/6 and 7/8 are stereo tracks, and therefore have only one AUX level. Left and right will be set to the same level.
[SHIFT]+ [EQ]	Each time the button is pressed, the assigned function will change as follows. Low Gain/Low Freq/Mid Gain/Mid Freq/Mid Q/Hi Gain/Hi Freq
[SHIFT]+ [EXIT]	Cancels the function that had been assigned to the [SHIFT]+ TRACK CUE knobs

■ Assigning a Utility page to [SHIFT]+ [UTILITY]

In any Utility page, pressing and holding [SHIFT]+ [UTILITY] for 3 seconds or more will create a shortcut to that screen page. Thereafter, you can press [SHIFT]+ [UTILITY] to jump directly to that Utility page. This shortcut will remain valid until the power is turned off.

■ Other

[SHIFT]+[VARI PITCH]	To the vari pitch setting page
[DISPLAY] and TIME/VALUE dial	To the Display Contrast setting page
[SHIFT] and TIME/VALUE dial	Modify the value at 10 times the usual speed
[SHIFT]+[PREVIEW(SCRUB)]	Enable the Preview function (SCRUB indicator will blink)
[TO]+[FROM]	Execute Preview Thru
[SHIFT]+[MONITOR SEL]	Switch the source that is output to the MON/AUX jacks (REC BUS/AUX)
[SHIFT]+[EFFECT RTN]	Switch the bus (REC bus AB/CD) that is connected to effect return
[SHIFT]+[INFORMATION(DISPLAY)]	Switch the display in the left side of the Play mode screen (Song data, V-track data)
[SHIFT]+[V.TRACK(TRACK STATUS)]	To the V-track setting page

Parameter List

■ Mixer Parameter

Parameter name	Display	Initial value	Value
Channel Fader Level	-	current panel settings	0 to 127
Master Fader Level	-	current panel settings	0 to 127
Channel Select	-	INPUT	INPUT, TRACK, MUTE
Channel Bus	-	AB/CD	Off, AB, CD, AB/CD
Effect Return Bus	EFFECT RTN BUS	Off	Off, AB, CD, AB/CD, AUX, TRACK CUE, AUX/TR CUE
Channel Input	INPUT	CH1:IN1, CH2:IN2, CH3:IN3, CH4:IN4, CH5/6:1/2, CH7/8:3/4	IN1-4, 1/2, 3/4
Equalizer Switch	EQ Switch	Off	Off, On
Equalizer Low Gain	EQ Low Gain	0 dB	-12 to +12 dB
Equalizer Low Frequency	EQ Low Freq	300 Hz	40 Hz to 1.5 kHz
Equalizer Middle gain	EQ Mid Gain	0 dB	-12 to +12 dB
Equalizer Middle Frequency	EQ Mid Freq	1.4 kHz	200 Hz to 8 kHz
Equalizer Middle Q	EQ Mid Q	0.5	0.5 to 16
Equalizer High Gain	EQ Hi Gain	0 dB	-12 to +12 dB
Equalizer High Frequency	EQ Hi Freq	4 kHz	500 Hz to 18 kHz
Channel Pan / Balance	PAN	0	L63 to 0 to R63
Effect Send Level	EFX SEND LV	0	0 to 127
Effect Send Pan / Balance	EFX SEND PAN	0	L63 to 0 to R63
Effect Send Switch	EFX SEND SW	Pst	Off, Pre, PstAUX
Send Level A	AUX SEND L A	0	0 to 127AUX
Send Level B	AUX SEND L B	0	0 to 127AUX
Send Switch	AUX SEND SW	Off	Off, Pre, Pst, Pre EQ
Effect Return Level	EFX RETURN LEVEL	100	0 to 127
Effect Return Balance	EFX RETURN BALANCE	0	L63 to 0 to R63
Track Cue Level	-	current panel settings	0 to 127
Track Cue Pan / Balance	TRACK CUE PAN	0	L63 to 0 to R63
Monitor Select	-	TR CUE+MASTER	TR CUE+MASTER, TRACK CUE, MASTER, REC BUS, AUX

■ Recorder Parameter

Parameter name	Display	Initial value	Value
Track Status	-	MUTE	MUTE, PLAY, REC
V-Track	V.TRACK	1	1 to 8

■ Song Parameter

Parameter name	Display	Initial value	Value
Sample Rate	Sample Rate	44.1 kHz	44.1 kHz, 32.0 kHz
Recording Mode	Record Mode	MT2	MT1, MT2, LV1, LV2

■ System Parameter

Global

Parameter name	Display	Initial value	Value
Foot Switch Assign	Foot Switch	Play/Stop	Play/Stop, Record, Tap Marker, Next, Previous, Effect
Fader Match	FADER Match	Jump	Null, Jump
Undo Message	UNDO Message	On	Off, On
Contrast	LCD Contrast	7	0 to 15
Digital Copy Protect	D.CpyProtect	Off	Off, On
Phones Out	PHONES OUT	MON/AUX	MON/AUX, MASTER
Master Out	MASTER OUT	MASTER	MASTER, TR CUE
SCSI ID Scan	SCSI ID SCAN	5/6	5/6, All

Play / Rec

Parameter name	Display	Initial value	Value
Marker Stop	MARKER Stop	Off	Off, On
Preview Length	PREVIEW Length	1.0 s	1.0 to 10.0 s
Scrub Length	SCRUB Length	45 ms	25 to 100 ms
Fade Length	Fade Length	10 ms	2, 10, 20, 30, 40, 50 ms
Vari Pitch	Vari Pitch	Same as Sample Rate	24.06 to 47.00 kHz (MT1, MT2), 24.06 to 50.48 kHz (LV1, LV2)
Time Display Format	TimeDisp	ABS	ABS, REL
Offset	Offset	00:00:00:00	00:00:00:00:00 to 23:59:59:29:99
External Input	Ext Input	off	off, on
Info Type	INFO type	Time	Time, Capa MB, Capa %, Event
Info External In	INFO Ext In	SYNC/MIDI	SYNC/MIDI, Ext In

* The settable range for Offset will change slightly depending on the MTC type (sync parameter).

Metronome Parameter

Parameter name	Display	Initial value	Value
Metronome Output	OUTPUT	Off	Off, MIX BUS, TR CUE BUS, MIX & TR CUE, MIDI
Metronome Mode	MODE	Rec Only	Rec Only, Rec&Play
Metronome Level	LEVEL	50	0 to 127
MIDI Channel	MIDI CH	10	1 to 16(*)
Accent Note	Acc.Note	C#2	C_0 to G_9(*)
Accent Velocity	Acc.Velo	100	1 to 127(*)
Normal Note	Nrm.Note	C#2	C_0 to G_9(*)
Normal Velocity	Nrm.Velo	60	1 to 127(*)

* Valid when Metronome Output "MIDI."

MIDI Parameter

Parameter name	Display	Initial value	Value
Device ID	Device ID	17	1 to 32
MMC Mode	MMC	MASTER	Off, MASTER, SLAVE

Scene Parameter

Parameter name	Display	Initial value	Value
Scene Mode	Scene Mode	All	All, Keep Fader

Sync / Tempo Parameter

Parameter name	Display	Initial value	Value
Sync Generator	Gen.	Off	Off, MTC, MIDI Clock, Sync TRACK
MTC Type	MTC Type	30	30, 29N, 29D, 25, 24
Offset	Offset	00:00:00:00:00	00:00:00:00:00 to 23:59:59:29:99
Tempo Map Number	-	1	1 to 50
Measure	-	1	1 to 999
Beat	-	4/4	1/1 to 8/1, 1/2 to 8/2, 1/4 to 8/4, 1/8 to 8/8
Tempo	-	120.0	25.0 to 250.0

Disk Initialize Parameter

Parameter name	Display	Initial value	Value
Physical Format	Physical Format	Off	Off, On

MIDI Implementation

Model : VS-840EX
DIGITAL STUDIO WORKSTATION

Date : Dec. 10, 1998
Version : 1.00

1. TRANSMITTED DATA AND RECOGNIZED RECEIVE DATA

■ Channel Voice Message

● Note On/Off

Transmit the the message which specified MIDI channel as a Metronome when "OUTPUT" in the METRONOME parameter is "MIDI".

The VS-840EX does not recognize the message.

Status	Second	Third
9nH	mmH	llH

n = MIDI Channel No. : 0H - FH (ch.1 - ch.16)

mm = Note No. : 00H - 7FH (0 - 127)

ll = Velocity : 01H - 7FH (1 - 127) / 00H = NOTE OFF

■ System Common Messages

● MIDI Time Code Quarter Frame Messages

MIDI Time Code Quarter Frame Messages can be transmitted while the VS-840EX is running (Playing or Recording) if the SYNC/TEMPO parameter "Gen." is "MTC" in the SYNC/TEMPO parameter. The transmitted time counts are summed to "SMPTE(MTC) Offset Time" as the song top is "00:00:00:00".

Status	Second
F1H	mmH (= 0nnndddd)

nnn = Message type :
 0 = Frame count LS nibble
 1 = Frame count MS nibble
 2 = Seconds count LS nibble
 3 = Seconds count MS nibble
 4 = Minutes count LS nibble
 5 = Minutes count MS nibble
 6 = Hours count LS nibble
 7 = Hours count MS nibble

ddd = 4 bit nibble data : 0h - FH (0 - 15)

Bit Field is assigned as follows.

Frame Count	xxxxxyyy	
	xxx	Reserved (000)
	yyyyy	Frame No.(0-29)
Seconds Count	xxxxxyyy	
	xx	Reserved (00)
	yyyyy	Seconds (0-59)
Minutes Count	xxxxxyyy	
	xx	Reserved (00)
	yyyyy	Minutes (0-59)
Hours Count	xyzzzzz	
	x	Reserved (0)
	yy	Time Code type
	0	= 24 Frames / Sec
	1	= 25 Frames / Sec
	2	= 30 Frames / Sec (Drop Frame)
	3	= 30 Frames / Sec (Non Drop Frame)
	zzzzz	Hours (0-23)

● Song Position Pointer

The current position is transmitted by the Song Position Pointer Message before the VS-840EX starts to run and after the locate operation if the SYNC/TEMPO parameter "Gen." is "MIDIclk" or "SyncTr".

Status	Second	Third
F2H	mmH	nnH

mm,nn = Song Position Point : 00H 00H - 7FH 7FH

■ System Realtime Message

Transmitted when "Gen." is "MIDIclk" or "SyncTr" in the SYNC/TEMPO parameter.

● Timing Clock

Status
F8H

● Start

Status
FAH

● Continue

Status
FBH

● Stop

Status
FCH

■ System Exclusive Message

Status	Data Bytes	Status
F0H	iiH,ddH, ..., eeH	F7H

Byte	Description
F0H	Status of Exclusive Message
iiH	ID Number
7EH	Universal Non Realtime Message
7FH	Universal Realtime Message
ddH	Data : 00H - 7FH (0-127)
:	:
eeH	Data
F7H	EOX (End of Exclusive Message)

The VS-840EX can transmit and receive Universal System Exclusive messages.

○ About Device ID

Exclusive messages are not assigned to any particular MIDI channel. Instead, they have their own special control parameter called device ID. The Roland exclusive messages use device IDs to specify various devices. The VS-840EX sends exclusive messages using the device ID 00H - 1FH, and receives the exclusive messages which device ID is same as its device ID or 7FH. The value of the device ID is the value set on the MIDI parameter "DeviceID" minus one.

● Universal System Exclusive Message

● MIDI Machine Control Commands

Status	Data Bytes	Status
F0H	7FH,Dev,06H,aaH, ..., bbH	F7H

Byte	Description
F0H	Status of Exclusive Message
7FH	Universal System Exclusive Message Realtime Header
Dev	Device ID (or 7FH)
06H	MMC Command Message
aaH	Command
:	:
bbH	Command
F7H	EOX (End of Exclusive Message)

(*) see '2. MIDI Machine Control' section

● MIDI Machine Control Responses

Status	Data Bytes	Status
F0H	7FH,Dev,07H,aaH, ..., bbH	F7H

Byte	Description
F0H	Status of Exclusive Message
7FH	Universal System Exclusive Message Realtime Header
Dev	Device ID
07H	MMC Response Message
aaH	Response
:	:
bbH	Response
F7H	EOX (End of Exclusive Message)

(*) see '2. MIDI Machine Control' section

2. MIDI Machine Control

■ MIDI Machine Control Command Reference

● STOP (MCS)

Status	Data Bytes	Status
F0H	7FH,Dev,06H,01H	F7H

Byte	Description
F0H	Status of Exclusive Message
7FH	Universal System Exclusive Message Realtime Header
Dev	Device ID (or 7FH)
06H	MMC Command Message
01H	STOP (MCS)
F7H	EOX (End of Exclusive Message)

If the device ID on the message was as same as that of the receiving device or 7FH, the VS-840EX stops immediately.

If the transport switch [STOP] was pressed, the VS-840EX transmits as the device ID 7FH.

● PLAY (MCS)

Status	Data Bytes	Status
F0H	7FH,Dev,06H,02H	F7H

Byte	Description
F0H	Status of Exclusive Message
7FH	Universal System Exclusive Message Realtime Header
Dev	Device ID (or 7FH)
06H	MMC Command Message
02H	PLAY (MCS)
F7H	EOX (End of Exclusive Message)

If the device ID on the message was as same as that of the receiving device or 7FH, the VS-840EX goes into the playback condition.

The VS-840EX does not transmit the message.

● DEFERRED PLAY (MCS)

Status	Data Bytes	Status
F0H	7FH,Dev,06H,03H	F7H

Byte	Description
F0H	Status of Exclusive Message
7FH	Universal System Exclusive Message Realtime Header
Dev	Device ID (or 7FH)
06H	MMC Command Message
03H	DEFERRED PLAY (MCS)
F7H	EOX (End of Exclusive Message)

If the device ID on the message was as same as that of the receiving device or 7FH, the VS-840EX goes into the playback condition after the locate operation.

If the transport switch [PLAY] was pressed, the VS-840EX transmits as the device ID 7FH.

● FAST FORWARD (MCS)

Status	Data Bytes	Status
F0H	7FH,Dev,06H,04H	F7H

Byte	Description
F0H	Status of Exclusive Message
7FH	Universal System Exclusive Message Realtime Header
Dev	Device ID (or 7FH)
06H	MMC Command Message
04H	FAST FORWARD (MCS)
F7H	EOX (End of Exclusive Message)

If the device ID on the message was as same as that of the receiving device or 7FH, the VS-840EX goes into the Fast Forward condition.

The VS-840EX does not transmit the message.

● REWIND (MCS)

Status	Data Bytes	Status
F0H	7FH,Dev,06H,05H	F7H

Byte	Description
F0H	Status of Exclusive Message
7FH	Universal System Exclusive Message Realtime Header
Dev	Device ID (or 7FH)
06H	MMC Command Message
05H	REWIND (MCS)
F7H	EOX (End of Exclusive Message)

If the device ID on the message was as same as that of the receiving device or 7FH, the VS-840EX goes into the rewind condition.

The VS-840EX does not transmit the message.

● RECORD STROBE

Status	Data Bytes	Status
F0H	7FH,Dev,06H,06H	F7H

Byte	Description
F0H	Status of Exclusive Message
7FH	Universal System Exclusive Message Realtime Header
Dev	Device ID (or 7FH)
06H	MMC Command Message
06H	RECORD STROBE
F7H	EOX (End of Exclusive Message)

If the device ID on the message was as same as that of the receiving device or 7FH, the VS-840EX goes into the following condition.

1. The VS-840EX is in the playback condition.
Start Recording the tracks that status are the record standby mode.

2. The VS-840EX is in the stop condition.
Start Playing back, and Start Recording the track that status are the record standby mode.

If the transport switch [REC] was pressed out of the recording condition, the VS-840EX transmits as the device ID 7FH.

● RECORD EXIT

Status	Data Bytes	Status
F0H	7FH,Dev,06H,07H	F7H

Byte	Description
F0H	Status of Exclusive Message
7FH	Universal System Exclusive Message Realtime Header
Dev	Device ID (or 7FH)
06H	MMC Command Message
07H	RECORD EXIT
F7H	EOX (End of Exclusive Message)

If the device ID on the message was as same as that of the receiving device or 7FH, the VS-840EX exits from the record condition.

If the transport switch [REC] was pressed while recording, the VS-840EX transmits as the device ID 7FH.

● MMC RESET

Status	Data Bytes	Status
F0H	7FH,Dev,06H,0DH	F7H

Byte	Description
F0H	Status of Exclusive Message
7FH	Universal System Exclusive Message Realtime Header
Dev	Device ID (or 7FH)
06H	MMC Command Message
0DH	MMC RESET
F7H	EOX (End of Exclusive Message)

If the device ID on the message was as same as that of the receiving device or 7FH, the VS-840EX resets all communication channels related with MMC.

When powered on the VS-840EX transmits as the device ID 7FH.

● WRITE

Status	Data Bytes	Status
F0H	7FH,Dev,06H,40H,ccH,ddH,eeH,,,ffH,,,	F7H

Byte	Description
F0H	Status of Exclusive Message
7FH	Universal System Exclusive Message Realtime Header
Dev	Device ID (or 7FH)
06H	MMC Command Message
40H	WRITE
ccH	Information Bytes follows the command
ddH	The name of the writable Information Field
eeH	Information Field Format
:	:
ffH	Field names and data
:	:
F7H	EOX (End of Exclusive Message)

If the device ID on the message was as same as that of the receiving device or 7FH, the VS-840EX writes the data to the specified information field.

The VS-840EX does not transmit the message.

● MASKED WRITE

Status	Data Bytes	Status
F0H	7FH,Dev,06H,41H,04H,ddH,eeH,ffH,ggH	F7H

Byte	Description
F0H	Status of Exclusive Message
7FH	Universal System Exclusive Message Realtime Header
Dev	Device ID (or 7FH)
06H	MMC Command Message
41H	MASKED WRITE
04H	Number of Bytes follows the command
ddH	The name of the masked type writable Information Field
eeH	Byte number to write in the Bit Map
ffH	Bit location of the bit map byte to change
ggH	New data to write to the specified bit map byte
F7H	EOX (End of Exclusive Message)

If the device ID on the message was as same as that of the receiving device or 7FH, the VS-840EX writes the data to the specified bit map byte.

The VS-840EX does not transmit the message.

● LOCATE (MCP)

○ Format 1 - LOCATE[I/F]

Status	Data Bytes	Status
F0H	7FH,Dev,06H,44H,02H,00H,nnH	F7H

Byte	Description
F0H	Status of Exclusive Message
7FH	Universal System Exclusive Message Realtime Header
Dev	Device ID (or 7FH)
06H	MMC Command Message
44H	LOCATE(MCP)
02H	Number of Bytes
00H	"I/F" sub command
nnH	Information Field
	08H, 09H, 0AH, 0BH, 0CH, 0DH, 0EH, 0FH)
F7H	EOX (End of Exclusive Message)

If the device ID on the message was as same as that of the receiving device or 7FH, the VS-840EX locates the selected time location stored to the specified information field.

The VS-840EX does not transmit the message.

○ Format 2 - LOCATE[TARGET]

Status	Data Bytes	Status
F0H	7FH,Dev,06H,44H,06H,01H,hrH,mnH,scH,frH,ffH	F7H

Byte	Description
F0H	Status of Exclusive Message
7FH	Universal System Exclusive Message Realtime Header
Dev	Device ID (or 7FH)
06H	MMC Command Message
44H	LOCATE(MCP)
06H	Number of Bytes
01H	"TARGET" sub command
	hrH, mnH, scH, frH, ffH
	Standard Time with Sub Frame
F7H	EOX (End of Exclusive Message)

If the device ID on the message was as same as that of the receiving device or 7FH, the VS-840EX locates the specified time location received from the command.

If the efficient Maker of the locate switch is pressed or when moved, the VS-840EX transmits as the device ID 7FH.

● MOVE

Status	Data Bytes	Status
FOH	7FH,Dev,06H,4CH,02H,ddH,ssH	F7H

Byte	Description
FOH	Status of Exclusive Message
7FH	Universal System Exclusive Message Realtime Header
Dev	Device ID (or 7FH)
06H	MMC Command Message
4CH	MOVE
02H	Number of Bytes
ddH	Name of the Efficient Destination Information Field (08H,09H,0AH,0BH,0CH,0DH,0EH,0FH)
ssH	Name of the Efficient Source Information Field (01H)
F7H	EOX (End of Exclusive Message)

If the device ID on the message was as same as that of the receiving device or 7FH, the VS-840EX transfers the data on the selected source information field to the destination Information Field, if the name of both information fields is efficient. The VS-840EX does not transmit the message.

● The efficient Information Field

The followings are the efficient Information Field on the VS-840EX.

The name of the efficient destination Information Field :

01H SELECTED TIME CODE
 08H GP0 / LOCATE POINT
 09H GP1
 0AH GP2
 0BH GP3
 0CH GP4
 0DH GP5
 0EH GP6
 0FH GP7
 4FH TRACK RECORD READY

MIDI Machine Control (MMC) Command, Information Field / Response Reference

* Commands Recognized

Command	Action
01H STOP	STOP
02H PLAY	PLAY
03H DEFERRED PLAY	PLAY
04H FAST FORWARD	FF
05H REWIND	REW
06H RECORD STROBE	REC / PUNCH IN
07H RECORD EXIT	PUNCH OUT
0DH MMC RESET	RESET
40H WRITE	Write to Information Fields
41H MASKED WRITE	Set Track Status Information Fields
44H 00H LOCATE I/F	LOCATE (Read Locater)
44H 01H LOCATE TARGET	LOCATE (Designated Time)
4CH MOVE	Move between Information fields

* Commands Transmitted

Command	Action
01H STOP	STOP
03H DEFERRED PLAY	PLAY
06H RECORD STROBE	REC / PUNCH IN
07H RECORD EXIT	PUNCH OUT
0DH MMC RESET	RESET
44H 01H LOCATE TARGET	LOCATE

* Valid Information Fields / Response

Information Field	Interpret	Valid Commands
01H SELECTED TIME CODE	Current Time	MOVE(FROM)
08H GP0 / LOCATE POINT	Locater 1	MOVE(FROM), MOVE(To), WRITE
09H GP1	Locater 2	MOVE(FROM), MOVE(To), WRITE
0AH GP2	Locater 3	MOVE(FROM), MOVE(To), WRITE
0BH GP3	Locater 4	MOVE(FROM), MOVE(To), WRITE
0CH GP4	Locater 5	MOVE(FROM), MOVE(To), WRITE
0DH GP5	Locater 6	MOVE(FROM), MOVE(To), WRITE
0EH GP6	Locater 7	MOVE(FROM), MOVE(To), WRITE
0FH GP7	Locater 8	MOVE(FROM), MOVE(To), WRITE
4FH TRACK RECORD READY	Track Status	MASKEDWRITE, WRITE

ROLAND EXCLUSIVE MESSAGES

1. Data Format for Exclusive Messages

Roland's MIDI implementation uses the following data format for all Exclusive messages (type IV):

Byte	Description
F0H	Exclusive Status
41H	Manufacturer ID (Roland)
DEV	Device ID
MDL	Model ID
CMD	Command ID
[BODY]	Main data
F7H	End of exclusive

■ MIDI status: F0H, F7H

An Exclusive message must be flanked by a pair of status codes, starting with a Manufacturer ID immediately after F0H (MIDI version 1.0).

■ Manufacturer ID: 41H

The Manufacturer ID identifies the manufacturer of a MIDI instrument that sends an Exclusive message. Value 41H represents Roland's Manufacturer ID.

■ Device ID: DEV

The Device ID contains a unique value that identifies individual devices in the implementation of several MIDI instruments. It is usually set to 00H-0FH, a value smaller by one than that of a basic channel, but value 00H-1FH may be used for a device with several basic channels.

■ Model ID: MDL

The Model ID contains a value that identifies one model from another. Different models, however, may share an identical Model ID if they handle similar data.

The Model ID format may contain 00H in one or more places to provide an extended data field. The following are examples of valid Model IDs, each representing a unique model:

01H
02H
03H
00H, 01H
00H, 02H
00H, 00H, 01H

■ Command ID: CMD

The Command ID indicates the function of an Exclusive message. The Command ID format may contain 00H in one or more places to provide an extended data field. The following are examples of valid Command IDs, each representing a unique function:

01H
02H
03H
00H, 01H
00H, 02H
00H, 00H, 01H

■ Main data: BODY

This field contains a message to be exchanged across an interface. The exact data size and content will vary with the Model ID and Command ID.

2. Address-mapped Data Transfer

Address mapping is a technique for transferring messages conforming to the data format given in Section 1. It assigns a series of memory-resident records--waveform and tone data, switch status, and parameters, for example, to specific locations in a machine-dependent address space, thereby allowing access to data residing at the address a message specifies.

Address-mapped data transfer is therefore independent of models and data categories. This technique allows use of two different transfer procedures: one-way transfer and handshake transfer.

■ One-way transfer procedure

(See Section 3 for details.)

This procedure is suited to the transfer of a small amount of data. It sends out an Exclusive message completely independent of the receiving device's status.

Connection Diagram

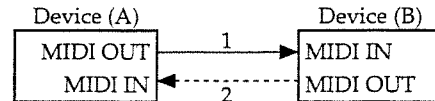

Connection at point 2 is essential for "Request data" procedures. (See Section 3.)

■ Handshake-transfer procedure

(This device does not use this procedure)

This procedure initiates a predetermined transfer sequence (handshaking) across the interface before data transfer takes place. Handshaking ensures that reliability and transfer speed are high enough to handle a large amount of data.

Connection Diagram

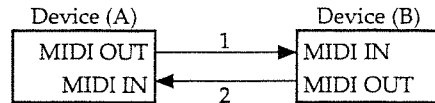

Connection at points 1 and 2 is essential.

Notes on the above procedures

- * There are separate Command IDs for different transfer procedures.
- * Devices A and B cannot exchange data unless they use the same transfer procedure, share identical Device ID and Model ID, and are ready for communication.

3. One-way Transfer Procedure

This procedure sends out data until it has all been sent and is used when the messages are so short that answerbacks need not be checked. For longer messages, however, the receiving device must acquire each message in time with the transfer sequence, which inserts 20 milliseconds intervals.

Types of Messages

Message	Command ID
Request data 1	RQ1 (11H)
Data set 1	DT1 (12H)

■ Request data 1: RQ1 (11H)

This message is sent out when there is a need to acquire data from a device at the other end of the interface. It contains data for the address and size that specify designation and length, respectively, of data required.

On receiving an RQ1 message, the remote device checks its memory for the data address and size that satisfy the request.

If it finds them and is ready for communication, the device will transmit a "Data set 1 (DT1)" message, which contains the requested data. Otherwise, the device won't send out anything.

Byte	Description
F0H	Exclusive Status
41H	Manufacturer ID (Roland)
DEV	Device ID
MDL	Model ID
11H	Command ID
aaH	Address MSB
:	:
:	:
	LSB
ssH	Size MSB
:	:
:	:
	LSB
sum	Check sum
F7H	End of exclusive

- * The size of the requested data does not indicate the number of bytes that will make up a DT1 message, but represents the address fields where the requested data resides.
- * Some models are subject to limitations in data format used for a single transaction. Requested data, for example, may have a limit in length or must be divided into predetermined address fields before it is exchanged across the interface.
- * The same number of bytes comprises address and size data, which, however, vary with the Model ID.
- * The error-checking process uses a checksum that provides a bit pattern where the last 7 bits are zero when values for an address, size, and that checksum are summed.

■ Data set 1: DT1 (12H)

This message corresponds to the actual data transfer process.

Because every byte in the data is assigned a unique address, a DT1 message can convey the starting address of one or more bits of data as well as a series of data formatted in an address-dependent order.

The MIDI standards inhibit non real-time messages from interrupting an Exclusive one. This fact is inconvenient for devices that support a "soft-thru" function. To maintain compatibility with such devices, Roland has limited the DT1 to 256 bytes so that an excessively long message is sent out in separate 'segments'.

Byte	Description
F0H	Exclusive Status
41H	Manufacturer ID (Roland)
DEV	Device ID
MDL	Model ID
12H	Command ID
aaH	Address MSB
:	:
:	:
	LSB
ddH	Data MSB
:	:
:	:
	LSB
sum	Check sum
F7H	End of exclusive

- * A DT1 message is capable of providing only the valid data among those specified by an RQ1 message.
- * Some models are subject to limitations in data format used for a single transaction. Requested data, for example, may have a limit in length or must be divided into predetermined address fields before it is exchanged across the interface.
- * The number of bytes comprising address data varies from one Model ID to another.
- * The error-checking process uses a checksum that provides a bit pattern where the last 7 bits are zero when values for an address, data, and that checksum are summed.

■ Example of Message Transactions

• Device A sending data to Device B

Transfer of a DT1 message is all that takes place.

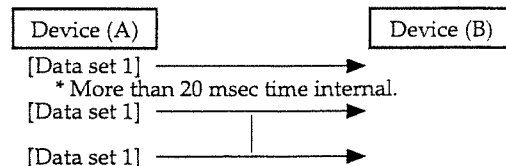

• Device B requesting data from Device A

Device B sends an RQ1 message to Device A. Checking the message, Device A sends a DT1 message back to Device B.

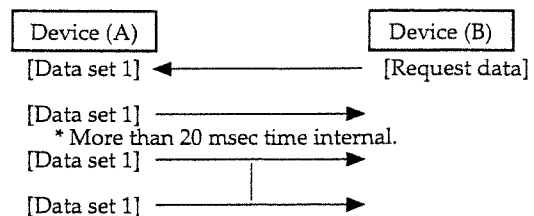

MIDI Implementation Chart

Function...		Transmitted		Recognized		Remarks
Basic Channel	Default Changed	1-16 1-16	*1	X *****		
Mode	Default Messages Altered	mode 3 X *****		mode 3 X X		
Note Number :	True Voice	1-127 *****	*1	X		
Velocity	Note ON Note OFF	1-127 X 9n, v=0	*1	X X		
After Touch	Key's Ch's	X X		X X		
Pitch Bend		X		X		
Control Change		X		X		
Program Change	: True #	X *****		X *****		
System Exclusive		O		O		
System Common	: Quarter Frame: : Song Pos : Song Sel : Tune	O O X X	*2 *3	X X X X		
System Real Time	: Clock : Commands	O O	*3	O O	*4	
Aux Message	: All sound off : Reset all controllers : Local ON/OFF : All Notes OFF : Active Sense : System Reset	X X X X X X		X X X X X X		
Notes		* 1 MIDI Metronome only * 2 SYNC/TEMPO:Gen.=MTC only * 3 SYNC/TEMPO:Gen.=MIDI Clock or Sync TRACK * 4 Sync TRACK of Recording only				

Mode 1 : OMNI ON, POLY
Mode 3 : OMNI OFF, POLY

Mode 2 : OMNI ON, MONO
Mode 4 : OMNI OFF, MONO

O : Yes
X : No

Block Diagram

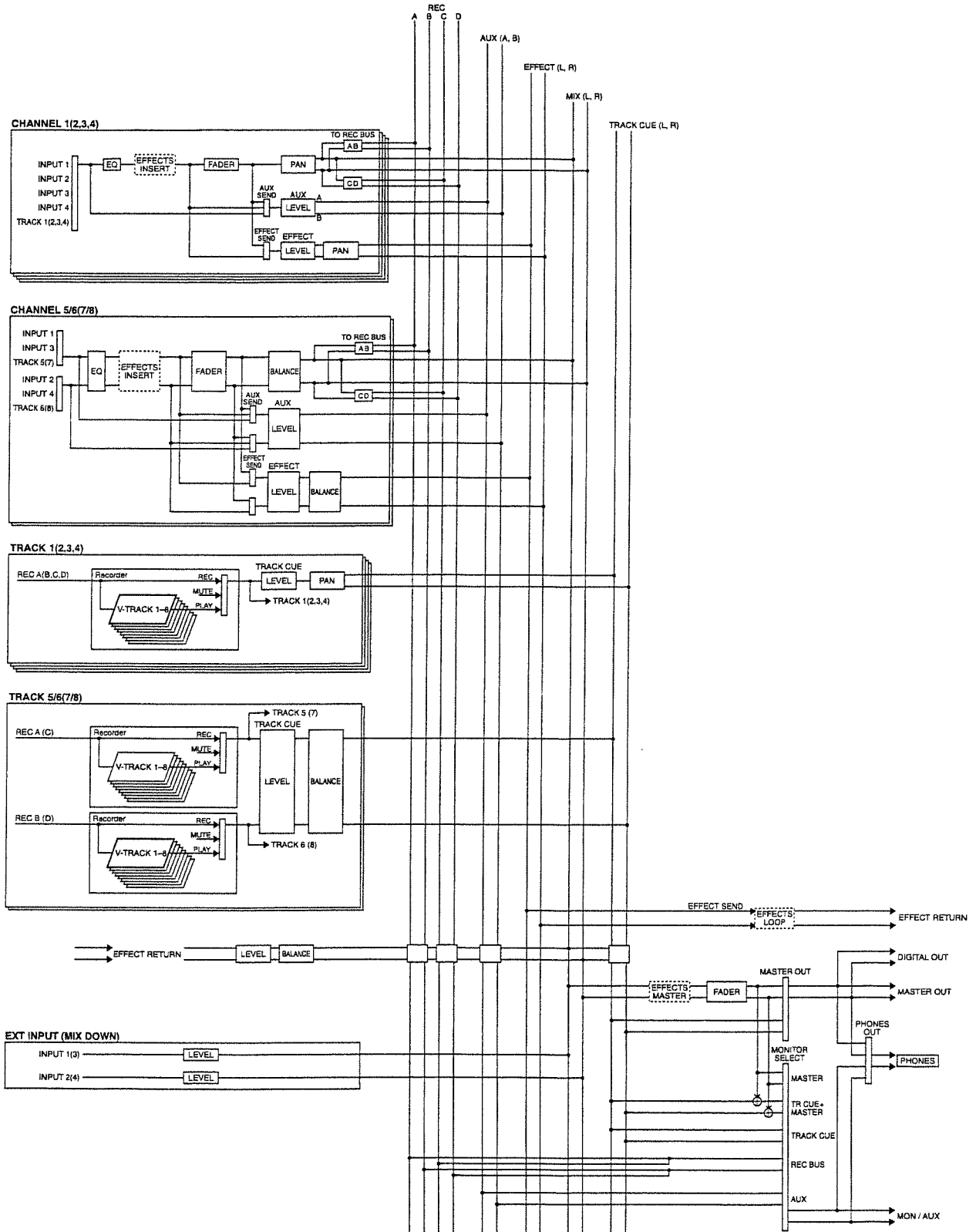

COSM

COSM stands for Composite Object Sound Modeling. This is "a technology which combines multiple sound models to create new sounds," which was first used on the Roland's VG-8 V-Guitar System. For example, sounds created on the VG-8 are the result of a variety of sound models (elements) such as the pickup, the body of the guitar, the guitar amp, mic, and speaker etc.

MTC

MTC stands for MIDI Time Code. This is a group of messages which are transmitted and received between MIDI devices to synchronize their operation. Unlike MIDI Clock messages, MTC specifies an absolute time. If you wish to use MTC to synchronize the operation of two devices, both devices must be set to the same frame rate. (page 111)

RSS

RSS stands for Roland Sound System. This is an effect which allows a sound source to be placed in three-dimensional space when played back on a conventional stereo system. The sound can be placed not only in front of the listener, but also directly to the side, above, below, and behind the listener. (page 172)

S/P DIF

S/P DIF stands for Sony/Philips Digital Interface Format. This is a specifications for transmitting and receiving stereo digital audio signals between digital audio devices. The VS-840EX provides coaxial connectors which support S/P DIF. (page 64)

Scene

Settings for the mixer section and effect section that were stored at a specific time. Even after mixing operations have been performed repeatedly, a Scene can be recalled to instantly restore the settings for fader, pan and effect algorithm etc. that were in use when the Scene was stored. (page 34)

Sync track

This is a track provided separately from the audio recording track, for the purpose of recording MIDI Clock data. The Sync track records the MIDI Clock messages that are transmitted from a MIDI sequencer etc. By transmitting these MIDI Clock messages back to the MIDI sequencer, it will be possible to synchronize even to a song that contains complex tempo changes. In this case, the VS-840EX will be the master and the MIDI sequencer will be the slave. (page 114)

Scrub

This is an editing technique in which a very short section of audio is played back repeatedly while you move the current time location, similar to the result of manually moving a reel of analog tape while it remains in contact with the playback head. This is a convenient way to "cue" a desired location in the recording. Since the playback pitch and formats will not change, cueing is possible with substantial accuracy. (page 66)

Tempo map

Data describing the song's measures, beats and tempo. By transmitting this data to a MIDI sequencer etc., synchronized operation with an external MIDI device is possible. (page 113)

Vari-pitch

When a song is played back on the VS-840EX, this function allows the playback speed of the song can be adjusted in order to match the pitch with instruments whose tuning is not easily changed.

Specifications

VS-840EX: Digital Studio Workstation

● Tracks

Track: 8 V-Track: 64 (8 V-Tracks per each Track)

* Up to 4 tracks can be recorded simultaneously, and up to 8 tracks can be played back simultaneously.

● Maximum Useful Capacity

Zip Disk: 250 M bytes

● Internal Memory

Songs: 200 (each disk)

● Equalizer

HI, MID, LOW

● Recording Mode

Multitrack 1 (MT1)

Multitrack 2 (MT2)

Live 1 (LV1)

Live 2 (LV2)

● Signal Processing

AD Conversion: 20 bit, 64 times oversampling

DA Conversion: 20 bit, 128 times oversampling

Internal Processing: 24 bit (mixer section)

● Sample Rate

44.1 kHz, 32.0 kHz

● Frequency Response

Sample Rate

44.1 kHz: 20 Hz to 21.0 kHz (+1/-1.5 dB)

32.0 kHz: 20 Hz to 15.5 kHz (+1/-1.5 dB)

● Total Harmonic Distortion

0.08 % or less

(INPUT SENS = -10 dBm, 1 kHz at nominal output level, recording mode: MT1)

● Recording Time (at 250 M bytes, 1 track)

Recording mode	Sample rate	
	44.1 kHz	32.0 kHz
MT1	94 minutes	129 minutes
MT2	125 minutes	172 minutes
LV1	150 minutes	207 minutes
LV2	188 minutes	259 minutes

* The above-listed recording times are approximate. Times may be slightly shorter depending on the number of songs that were created.

● Nominal Input Level (Variable)

INPUT Jack 1(Guitar(Hi-Z)type): -50 to +4 dBm

INPUT Jack 1 to 4 (1/4 inch phone type): -50 to +4 dBm

INPUT Jack 3 to 4 (RCA phono type): -50 to +4 dBm

● Input Impedance

INPUT Jack 1(Guitar(Hi-Z)type): 1 M Ω

INPUT Jack 1 to 4 (1/4 inch phone type): 20 k Ω

INPUT Jack 3 to 4 (RCA phono type): 20 k Ω

● Nominal Output Level

MON/AUX Jack: -10 dBm

MASTER OUT Jack: -10 dBm

● Output Impedance

MON/AUX Jack: 1.6 k Ω

MASTER OUT Jack: 1.6 k Ω

PHONES Jack: 100 Ω

● Recommended Load Impedance

MON/AUX Jack: 20 k Ω or greater

MASTER OUT Jack: 20 k Ω or greater

PHONES Jack: 8~50 Ω

● Residual Noise Level

MON/AUX Jack: -91 dBm or less

MASTER OUT Jack: -91 dBm or less

(input terminated with 1 k Ω , INPUT SENS: +4 dBm, IHF-A, typ.)

● Interface

DIGITAL OUT: Coaxial type (conforms to S/P DIF)

Optical type

● Display

69.0 x 25.0 mm (Backlit LCD)

● Connectors

MIDI Connectors (IN, OUT)

DIGITAL OUT Connectors (Coaxial type, Optical type)

FOOT SWITCH Jack (1/4 inch phone type)

PHONES Jack (Stereo 1/4 inch phone type)

INPUT Jack 1 (Guitar (Hi-Z) 1/4 inch phone type)

INPUT Jack 1 to 4 (1/4 inch phone type)

INPUT Jack 3 to 4 (RCA Phono type)

MON/AUX Jack A, B (RCA Phono type)

MASTER OUT Jack L, R (RCA Phono type)

● Power Supply

AC 117 V, AC 230 V, AC 240 V

● Power Consumption

20 W

● Dimensions

410 (W) x 307 (D) x 88 (H) mm

16-3/16 (W) x 12-1/8 (D) x 3-1/2 (H) inches

● Weight

4.5 kg/9 lbs 15 oz

● Accessories

Power cable

Owner's Manual

Quick Start

Preset Patch List

Demo Disk

● Options

SCSI Board VS4S-1

0dBm=0.775V rms

* In the interest of product improvement, the specifications and/or appearance of this unit are subject to change without prior notice.

Index

10 Band Graphic Equalizer	156
2-channel stereo	64
2 ch RSS	135

A

AC IN	19
AC inlet	19
Acoustic Guitar Simulator	157
Acoustic Simulator	155
Algorithm list	130
10 Band Graphic Equalizer	156
2 ch RSS	135
Acoustic Simulator	155
Bass Multi 1	152
Bass Multi 2	153
Bass Simulator	156
Chorus + Reverb	150
Chorus RSS	137
Delay + Chorus	151
Delay + Reverb	149
Delay RSS	136
Guitar Multi 1	138
Guitar Multi 2	139
Keyboard Multi	142
Lo-Fi Box	146
Mic Simulator	154
Panner	135
Reverb 1	130
Reverb 2	131
Reverb + Reverb	148
Rotary	143
Space Chorus	147
Stereo Delay Chorus	133
Stereo Flanger	144
Stereo Multi	145
Stereo Phaser	144
Stereo Pitch Shifter Delay	134
Tap Delay	132
Tremolo Pan	145
Vocal Multi 1	140
Vocal Multi 2	141
Vocoder	147
AUTO PUNCH button	17
auto punch-in	60
AUX bus	22
AUX jack	19
AUX LEVEL button	15
AUX Routing icon	45

B

Bass Cut Filter	170
Bass Guitar Simulator	171
Bass Multi	152, 153
Bass Simulator	156
Block Diagram	187
bus	22

C

Channel	21
Channel fader	15
Channel Pan	107
CHANNEL PARAMETER button	15
Chorus	150, 151, 157
Chorus RSS	137
CLEAR button	17
Compressor	158
contrast	119
copy	68
CURSOR button	17
cut	73

D

De-esser	158
Defretter	169
Delay	149, 151, 159
Delay RSS	136
demo song	28
DIGITAL OUT connector	19
disk copy	103
Disk Drive	20
DISK indicator	18
disk initialize	28
DISK Memory Full	103
display	18, 119
DISPLAY button	16
Distance	170
Distortion	169

E

Easy Routing	37, 52
Easy Routing button	16
effect	26, 75–94
connection	75
creating	80
Examples of how the effects can be used	82
saving	81
switching	78
using	79
Effect bus	22
EFFECT button	16
EFFECT LEVEL button	15
EFFECT RTN button	16
effect return button	16
Eject button	20
Enhancer	159
ENTER/TAP button	17
EQ button	15
equalizer	24, 62, 160
erase	74
Error messages	175, 176
even	26
exchange	71
exclusive messages	184, 185
EXIT button	17

- External In108
 External In icon46
 EZ Routing37
 EZ ROUTING button16
- F**
 Flanger160
 foot switch59, 96
 FOOT SWITCH jack19
- G**
 Glossary188
 Graphic EQ171
 Guitar Multi138, 139
- I**
 INFORMATION18, 108
 initializing the disk28
 Input24
 INPUT button15
 INPUT jack19
 input sensitivity knob15
 INPUT SENS knob15
 insert26, 72, 92, 93
 insert connection77, 78
 inserting the disk27
- K**
 Keyboard Multi142
- L**
 Lack of EVENT!!26
 level/pan63
 Limiter158
 locate point35
 LOCATOR button17
 Lo-Fi Box146, 161
 loop26, 50, 82–91
 LOOP button17
 loop connection77
 loop recording61
- M**
 MARKER18
 marker stop97
 mark point35, 116, 118
 Mark point number35
 MASTER18
 MASTER fader16
 MASTER OUT jack19
 master tape62
 MEASURE18
 metronome95
- Mic Converter170
 Mic Simulator154
 MIDI110–118
 MIDI channel110
 MIDI clock115
 MIDI connector19, 110
 MIDI Implementation180–183
 MIDI Implementation Chart186
 MIDI indicator18
 MIDI message110
 MIDI sequencer111
 MIX bus22
 mix down64
 Mixdown icon42
 Mixer15, 16, 18, 24
 MODE button15
 MON/AUX jack19
 monitor jack19
 MONITOR SEL button16
 monitor select33
 monitor select button16
 move69
 MMC126
 MTC111
- N**
 NO button17
 Noise Suppressor162
- O**
 Output25
 Overdrive162
 overdubbing49, 57
- P**
 Pan63, 168
 PAN button15
 Panner135
 Parameter
 Acoustic Guitar Simulator157
 Bass Cut Filter170
 Bass Guitar Simulator171
 Chorus157
 Compressor/Limiter158
 De-esser158
 Defretter169
 Delay159
 Distance170
 Distortion169
 Enhancer159
 Equalizer160
 Flanger160
 Graphic EQ171
 Lo-Fi Box161
 Mic Converter170
 Noise Suppressor162

- Overdrive.....162
 Phaser.....162
 Pitch Shifter.....163
 PreAmp.....163
 Reverb.....164
 Ring Modulator.....165
 Rotary.....166
 RSS (2ch).....166
 RSS (Panner).....167
 Space Chorus.....167
 Speaker Simulator.....167
 Tremolo / Pan.....168
 Vocoder.....168
 Wah.....168
 Parameter List.....178, 179
 patch change.....78
 PEAK indicator.....15
 Phaser.....162
 PHONES jack.....19, 99
 PHONES knob.....16
 Pitch Shifter.....163
 POWER switch.....19
 PreAmp.....163
 preview.....65
 preview length.....66
 punch-in/out.....58
- Q**
- Quick Recording icon.....37
 Quick search.....109
- R**
- random access.....25
 Rear panel.....19
 Recorder.....16, 17, 25
 Recording bus.....22
 Recording icon.....38
 Recording mode.....54
 Recording time.....54
 redo.....101
 REDO button.....16
 restoring.....122
 Reverb.....130, 131, 148, 149, 150, 165
 Ring Modulator.....165
 Rotary.....143,166
 RSS.....136, 137, 166, 167, 172
- S**
- scene.....25, 34
 SCENE button.....17
 SCMS.....11, 106
 SCRUB button.....17
 scrub length.....67
 SCSI.....200
 SCSI board.....196
 SCSI ID Scan.....109
- SELECT button.....15
 select (song).....31
 sequential access.....25
 SHIFT button.....17
 shut down.....29
 solo.....98
 SOLO button.....16
 song.....23
 song arrange.....125
 song convert.....104
 song copy.....102
 song end.....31
 song erase.....102
 song information screen.....119
 song name.....55
 song new.....54
 song number.....55
 song optimize.....101
 song protect.....29
 song select.....31
 song store.....29
 song top.....31
 source.....21
 Space Chorus.....147, 167
 Speaker Simulator.....167
 Specifications.....189
 standard pitch.....106, 107
 Stereo Delay Chorus.....133
 Stereo Flanger.....144
 Stereo Multi.....145
 Stereo Phaser.....144
 Stereo Pitch Shifter Delay.....134
 STORE Current ?.....30
 store (song).....29
 sync edit.....116
 sync track.....114–117
- T**
- TAP button.....17
 Tap Delay.....132
 tempo map.....113, 116–118
 TIME.....18
 TIME/VALUE dial.....17
 track.....18, 21, 25
 track bouncing.....62
 Track Bouncing icon.....40
 Track cue bus.....23
 Track Cue Pan.....107
 TRACK CUE knob.....17
 track editing.....65
 track sheet.....194, 195
 track status.....33
 TRACK STATUS/V.TRACK button.....17
 Transport control button.....17
 Tremolo.....168
 Tremolo Pan.....145
 Troubleshooting.....173, 174
 tuner.....106, 107

tuning guide.....106

U

undo100

UNDO/REDO button.....16

User Routing icon.....44

UTILITY button16

V

VALUE dial17

vari-pitch97

VARI PITCH button.....16

Vocal Multi140, 141

Vocoder.....147, 168

VS-840-UP1.....4, 196

V-track.....25, 57

V.TRACK button17

V-track screen19

W

Wah168

Y

YES button.....17

Z

Zip disk.....11,14

Zip disk drive.....20

Zip disk drive access indicator LED20

Zip drive200

Roland® VS-840EX

Project _____

Artist _____

Client _____

TRACK SHEET

Song Name _____

Date _____

V. Track ↓	TRACK1	TRACK2	TRACK3	TRACK4	TRACK 5 / 6	TRACK 7 / 8
1						
2						
3						
4						
5						
6						
7						
8						
	EQ Low	EQ Low	EQ Low	EQ Low	EQ Low	EQ Low
	EQ MID	EQ MID	EQ MID	EQ MID	EQ MID	EQ MID
	EQ HI	EQ HI	EQ HI	EQ HI	EQ HI	EQ HI
	AUX Lvl	AUX Lvl	AUX Lvl	AUX Lvl	AUX Lvl	AUX Lvl
	EFFECT Lvl	EFFECT Lvl	EFFECT Lvl	EFFECT Lvl	EFFECT Lvl	EFFECT Lvl

LOCATOR

1	
2	
3	
4	
5	
6	
7	
8	

SCENE

1	
2	
3	
4	
5	
6	
7	
8	

EFFECT

1	
2	
3	
4	
5	
6	
7	
8	

COMMENTS

1	
2	
3	
4	
5	
6	
7	
8	

Position:
Patch:

Installation of the VS4S-1 (optional SCSI board)

* On the VS-840, the bottom cover does not have an accessible opening. For this reason, users should not attempt removal or servicing of the VS4S-1. Consult your nearest Roland Service Center for removal or servicing of the VS4S-1.

The following instructions are for the model VS-840EX only!

⚠ CAUTION

- Do not install anything other than the VS4S-1.
- To avoid the risk of damage to internal components that can be caused by static electricity, please carefully observe the following whenever you handle the VS4S-1.
 - Before you touch the VS4S-1, always first grasp a metal object (such as a water pipe), so you are sure that any static electricity you might have been carrying has been discharged.
 - When handling the VS4S-1, grasp it only by the panel or the board's edges. Avoid touching any of the electronic components or connectors.
 - Before you connect any cables, make sure they do not carry a static electricity charge. Such charges can be transmitted, for example, if the other end of the cable has been in contact with a carpet (or other object) where there is a static electricity buildup.

⚠ WARNING

1. Unplug the VS-840EX from the electrical outlet, and disconnect everything that you have connected at the rear panel.
2. Have the VS4S-1 ready. The supplied cable has a blue line on one edge. With this edge facing up, securely insert the cable into the connector.

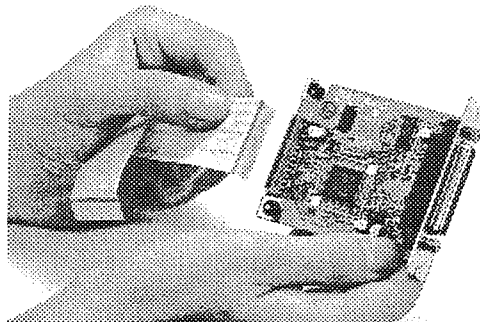

3. Turn the VS-840EX upside-down.
 - * To prevent damage, place the unit on a cushion or the like while performing the installation.
4. Remove the two "A" screws and detach the EXP cover from the rear panel of the VS-840EX.

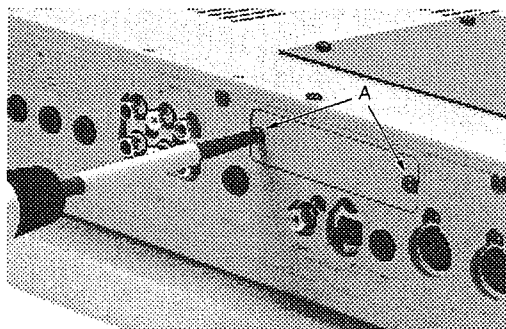

⚠ CAUTION

Do not remove any screws other than the ones shown in the figure.

- 5.** Remove the four "B" screws, then remove the cover from the unit's undersurface.

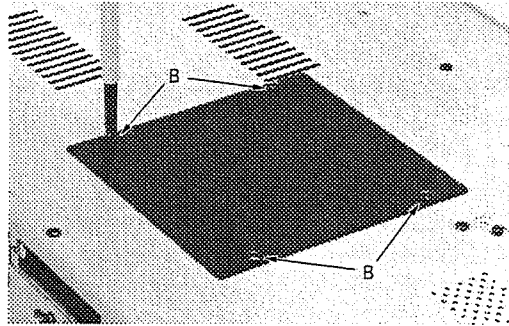

CAUTION

Do not remove any screws other than the ones shown in the figure.



- 6.** Insert the VS4S-1 at the opening on the rear panel, making sure that the side with the connector is facing up. Then, use screws "A" to fasten it in place.

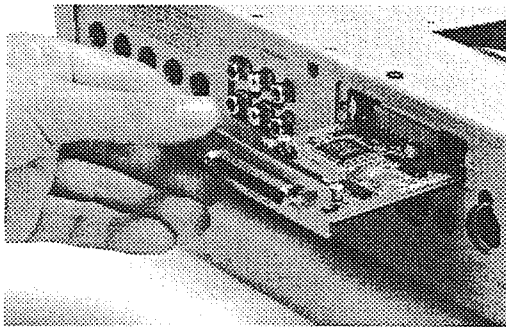

** Never use excessive force when installing a circuit board. If it doesn't fit properly on the first attempt, remove the board and try again.*

- 7.** Hold the cable installed on the VS4S-1 so that the edge of the cable with the blue line is facing up. Bend the cable as shown in the figure, and insert the free end securely into the connector on the main board.

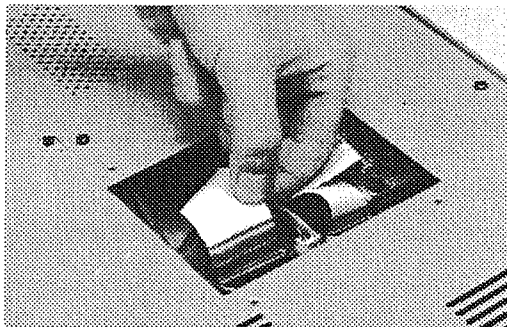

** When circuit board installation is complete, double-check your work.*

- 8.** Make sure the VS4S-1 and cable connections are secure, then use screws "B" to reattach the cover to the unit's undersurface.
- 9.** Turn the VS-840EX right-side up again.
- 10.** Check that the board operates normally. Connect a Zip drive or other suitable device to the SCSI connector, then follow the procedure on p. 201 to check the operation.
- 11.** If operation is without problem, the installation is complete. If a problem is found, repeat the installation procedure.

Installation du VS4S-1 (carte SCSI optionnelle)

* Le panneau du bas du VS-840 n'ayant pas de plaque détachable, ne pas essayer d'enlever ou de réparer soi-même le VS4S-1. Si vous désirez le faire, consulter votre centre de service Roland le plus près de chez vous.

Les instructions suivantes ne s'appliquent qu'au modèle VS-840EX.

PRECAUTION

- Ne rien installer d'autre que le VS4S-1.
- Pour éviter d'endommager les composants internes par de l'électricité statique, suivez attentivement les règles ci-dessous lorsque vous maniez la carte.
 - Avant de toucher la carte, saisissez toujours un objet métallique (tel qu'un tuyau d'arrivée d'eau) pour être sûr de vous décharger de toute électricité statique.
 - Lorsque vous manipulez la carte, la tenir par les côtés de la plaque ou par les côtés du circuit imprimé. Ne pas toucher directement aux composants et connecteur avec les mains.
 - Lorsque vous connectez le câble et la carte, veiller à ce que l'extrémité libre du câble ne touche à aucun objet pouvant facilement produire de l'électricité statique (comme un tapis par exemple).

AVERTISSEMENT

- 1.** Débrancher le VS-840EX et déconnecter tous les câbles reliés à l'arrière de l'appareil. 
- 2.** Prendre le câble fourni avec la carte et bien l'enfoncer dans le connecteur du VS4S-1 de façon à ce que la ligne bleue soit dirigée vers le haut.

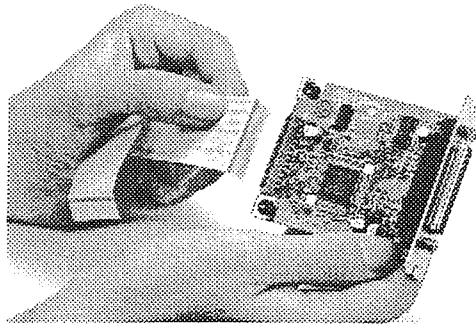

- 3.** Tourner le VS-840EX à l'envers.
 - * Installer l'appareil sur un coussin ou autre protection du même genre pour éviter tout endommagement durant la manipulation.

- 4.** Enlever les 2 vis A et détacher la plaque EXP du panneau arrière du VS-840EX.

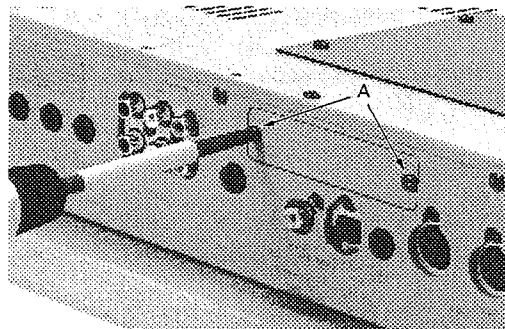

PRECAUTION

N'enlever que les vis indiquées sur le schéma.



- 5.** Enlever les 4 vis B et détacher la plaque protectrice du panneau du bas.

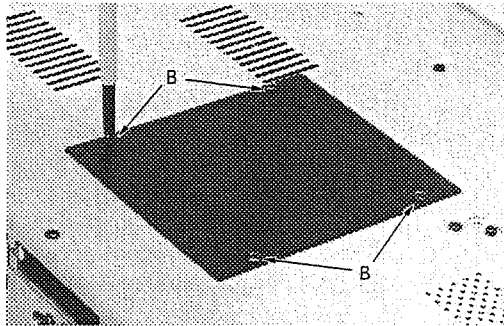

PRECAUTION

N'enlever que les vis indiquées sur le schéma.



- 6.** Orienter le VS4S-1 de façon à ce que le connecteur soit dirigé vers le haut et l'insérer dans l'ouverture du panneau arrière. Utiliser les vis A pour fixer la carte sur le panneau arrière.

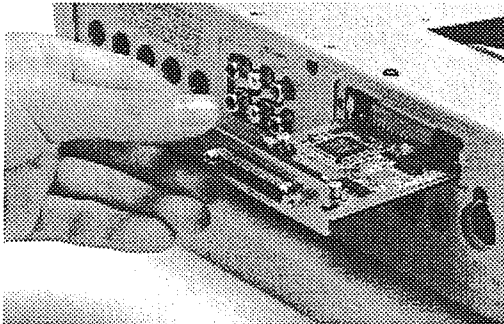

* Ne forcez jamais excessivement lors de l'installation d'une carte d'extension. Si elle ne s'ajuste pas correctement au premier essai, enlevez-la et recommencez.

- 7.** Prendre l'extrémité libre du câble connecté au VS4S-1 et orienter la ligne bleue vers le haut. Plier le câble comme indiqué sur le schéma et bien l'insérer dans la carte mère.

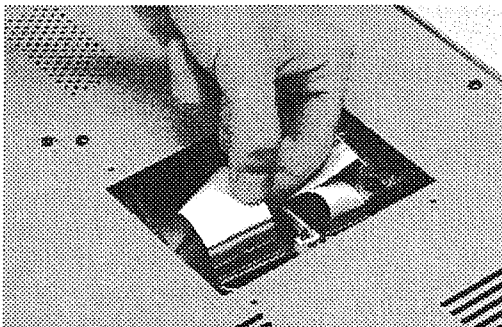

* Lorsque votre installation de la carte d'extension est terminée, revérifiez-la.

- 8.** Après s'être assuré de la mise en place correcte de l'installation du VS4S-1 et des connexions, remettre la plaque protectrice sur le panneau du bas avec les vis B.
- 9.** Remettre le VS-840EX à l'endroit.
- 10.** Vérifier le fonctionnement de l'appareil. Connecter par exemple un lecteur Zip au connecteur SCSI et suivre les instructions de la p.201 pour vérifier le bon fonctionnement de l'appareil.
- 11.** Si l'appareil fonctionne bien, l'installation est terminée. S'il ne fonctionne pas bien, recommencer l'installation.

Using an external Zip drive (About SCSI)

When the VS4S-1 (sold separately) is installed in the VS-840EX, songs created on the VS-840EX can be saved on an external Zip drive.

This section explains the functions which are added when a SCSI connector is installed. Please read it carefully before using an external Zip drive.

* *It is not possible to use an external Zip drive to record.*

<Added functions>

The following icons are added to Utility.

SCSI icon

SCSI Restart icon

SCSI Shut Down icon

SCSI Initialize icon

840 to SCSI Copy icon

SCSI to 840 Copy icon

SCSI Song Erase icon

SCSI Disk Copy icon

SCSI Song Convert icon

SCSI Drive Select icon

SCSI Archive Copy icon

SCSI Track Import icon

SCSI Track Export icon

About SCSI

“SCSI” stands for “Small Computer System Interface.” This is a data transmission method that can transmit large amounts of data. A Zip drive can be connected to the SCSI connector of the VS-840EX.

Before You Use a Zip Drive

Handling the Zip Drive

- A Zip drive is precision devices. If they are connected or used incorrectly, not only may they fail to operate correctly, but the data on the disk can be lost or even the disk drive itself may be damaged. In addition to the explanation in this section, please be sure to read and observe the explanations in the manual for your Zip drive.
- The VS-840EX can use Zip drives which are compatible with the SCSI-2 specification. As a Zip drive for use with the VS-840EX, we recommend the Roland ZIP-EXT-2S Zip drive (sold separately).
- Install the unit on a solid, level surface in an area free from vibration. If the unit is tilted excessively, the Zip drive may malfunction or require service.
- Avoid using the unit immediately after it has been moved to a location with a level of humidity that is greatly different than its former location. Rapid changes in the environment can cause condensation to form inside the Zip drive, which will adversely affect the operation of the Zip drive and/or damage Zip disks. When the unit has been moved, allow it to become accustomed to the new environment (allow a few hours) before operating it.
- To insert a Zip disk, push it gently but firmly into the Zip drive—it will click into place. To remove a Zip disk, press the EJECT button firmly. Do not use excessive force to remove a Zip disk which is lodged in the Zip drive.
- Never attempt to remove a Zip disk from the Zip drive while the Zip drive is operating (the indicator is lit); damage could result to both the Zip disk and the Zip drive.
- Remove any Zip disk from the Zip drive before powering up or down.
- To prevent damage to the Zip disk drive's heads, always try to hold the Zip disk in a level position (not tilted in any direction) while inserting it into the Zip drive. Push it in firmly, but gently. Never use excessive force.
- Do not insert disks other than the specified Zip disks.
- A Zip disk being used for the first time with the VS-840EX must be initialized by the VS-840EX. When a Zip disk is initialized, all data on that disk will be lost. Before using a disk that has been used by another device, make sure that it is OK to erase the data.
- Disks used by the VS-840EX cannot be used by any other device.
- Zip disks contain a plastic disk with a thin coating of magnetic storage medium. Microscopic precision is required to enable storage of large amounts of data on such a small surface area. To preserve their integrity, please observe the following when handling Zip disks:
 - Never touch the magnetic medium inside the Zip disk.
 - Do not use or store Zip disks in dirty or dusty areas.
 - Do not subject Zip disks to temperature extremes (e.g., direct sunlight in an enclosed vehicle). (Storage temperature: -22–51° C, storage humidity: 10–90%)
 - Do not expose Zip disks to strong magnetic fields, such as those generated by loudspeakers.
- The identification label should be firmly affixed to the Zip disk. Should the label come loose while the Zip disk is in the Zip drive, it may be difficult to remove the Zip disk.
- Put the Zip disk back into its case for storage.
- Zip disks do not have a protect tab to prevent data from being erased accidentally. If necessary, use Song Protect to protect your data (page 29).

Handling Zip Disks

Connecting all external Zip drive

Up to 2 Zip drives can be connected to the SCSI connector of the VS-840EX. This section will explain how to make the external Zip drive connections, and how to make the necessary settings. Whenever you connect an external Zip drive, be sure to check the following points.

■ Connectors and cables

SCSI cables are used to connect the external Zip drive as shown below. Since there is no difference between a SCSI input and output, it does not matter which connector you use. This type of connections is referred to as a "SCSI chain" or a "daisy chain."

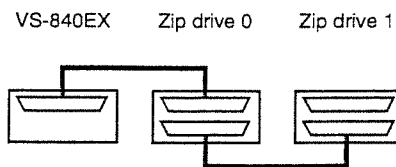

To connect a Zip drive, use the SCSI cable included with the ZIP-EXT-2S Zip drive (sold separately).

When making connections, observe the following points.

- The SCSI connector of the VS-840EX is a 25 pin D-sub type connector.
- Keep SCSI cables as short as possible, and use only cables which have an impedance (110 Ω +/-10%) that is compatible with the SCSI standard, and are completely shield.
- Do not allow the total length of all SCSI cables connecting the chain of disk drives to exceed 6.5 meters.
- Do not connect or disconnect SCSI cables when the power of any device is turned on.

■ Terminators

The device at each end of a SCSI chain must have a terminator (a terminating resistance). Since the VS-840EX is one end of the SCSI chain, it contains an internal terminator. This means that you will need to use a terminator only for the external Zip drive which will be the other end of the chain. For details on terminator settings, refer to the owner's manual for your Zip drive.

■ SCSI ID numbers

Each Zip drive is distinguished by its SCSI ID number (0-7). This means that when two drives are connected, you must make settings so that the SCSI ID numbers of the drives do not conflict (coincide). If the SCSI ID numbers conflict, the VS-840EX will not be able to correctly recognize the drives.

The VS-840EX is set to SCSI ID number 7 (fixed). Set the drives you are connected to ID numbers other than 7.

- * Set the SCSI ID number of the external Zip drive to either 5 or 6.

Restarting the external Zip drive

Check the disk that was inserted in the disk drive, and make the disk ready for use.

When turning on the power, be sure to first turn on the power of the external Zip drive, and then turn on the power of the VS-840EX.

1. If there is a drive that you wish to use, insert a disk into that drive.
If a disk is not inserted, that drive will not be recognized by the VS-840EX.
2. Press [UTILITY].
3. Use [CURSOR] to select the SCSI icon, and press [ENTER/TAP].

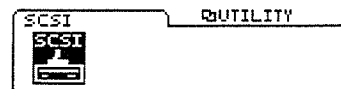

4. Use [CURSOR] to select the SCSI Restart icon, and press [ENTER/TAP].



5. A confirmation message of "Are you sure?" will appear, so press [YES] to execute the operation.

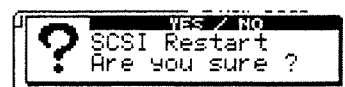

- * The drive (disk) will be prepared for use, and this will require a certain length of time.

Shutting down the external Zip drive

When you wish to eject the disk of a Zip drive connected to the SCSI connector or to change disks, you must Shut Down the external drive.

* Unless you perform the Shut Down, it will not be possible to eject the disk from the Zip drive.

1. Press [UTILITY].
2. Use [CURSOR] to select the SCSI icon, and press [ENTER/TAP].

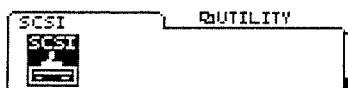

3. Use [CURSOR] to select the SCSI Shut Down icon, and press [ENTER/TAP].



4. A confirmation message of "Are you sure?" will appear, so press [YES] to execute the operation.

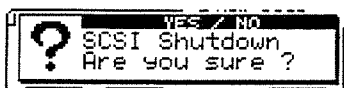

The external drive will be shut down, and the disk will be ejected from the Zip drive. If you wish to change disks, insert the desired disk and then execute the "Restarting the external Zip drive" operation described in the before section.

Initializing the Zip disk

A Zip drive that is being used for the first time by the VS-840EX must be initialized before it can be used. When a disk is initialized, all data that was on that disk will be lost. If you are using a disk which had been used by another device, make sure that it does not contain important data that you wish to keep.

1. Press [UTILITY].
2. Use [CURSOR] to select the SCSI icon, and press [ENTER/TAP].

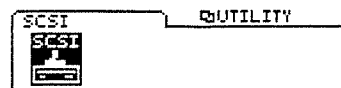

3. Use [CURSOR] to select the SCSI Initialize icon, and press [ENTER/TAP].



4. This display will indicate "STORE Current ?" If you wish to save the currently selected song (the Current Song), press [YES]. If you do not wish to save it, press [NO].

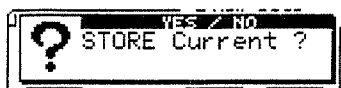

5. Use [CURSOR] to move the cursor to "Physical Format," and use the TIME/ VALUE dial to specify whether or not you wish to physically format the disk.

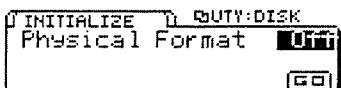

6. Use [CURSOR] to move the cursor to the "GO" icon, and press [ENTER/TAP].

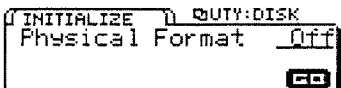

7. A confirmation message will ask "Are you sure?," so press [YES] to execute the operation. When initialization ends successfully, you will return to Play mode. If you press [NO], the initialize operation will be halted.

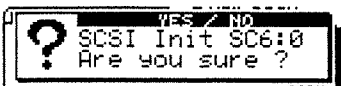

* If you initialize the disk with "Physical Format" turned "On," a certain length of time will be required for initialization to be completed. This is not a malfunction. The progress of the initialization operation will be shown in the display. Do not turn off the power before initialization has ended.

Copying songs from the VS-840EX to the external Zip disk

Here's how songs that were created and saved on the VS-840EX can be copied to the external Zip disk.

1. Press [UTILITY].
2. Use [CURSOR] to select the SCSI icon, and press [ENTER/TAP].

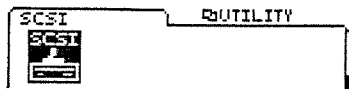

3. Use [CURSOR] to select the 840 to SCSI Copy icon, and press [ENTER/TAP].



4. This display will indicate "STORE Current ?" If you wish to save the currently selected song (the Current Song), press [YES]. If you do not wish to save it, press [NO].

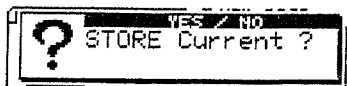

5. Use [CURSOR] to select the song(s) that you wish to copy, and press [ENTER/TAP], and a symbol will be added at the left of the song. Mark each song that you wish to copy.



To remove a mark, use [CURSOR] to select the song from which you wish to remove the mark, and press [ENTER/TAP].

6. Use [CURSOR] to select the "GO" icon, and press [ENTER/TAP] to begin the Copy operation.

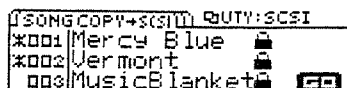

Copying songs from the external Zip disk to the VS-840EX

Here's how a song that was saved on an external Zip disk can be copied to the Zip disk of the VS-840EX.

1. Press [UTILITY].
2. Use [CURSOR] to select the SCSI icon, and press [ENTER/TAP].

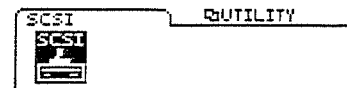

3. Use [CURSOR] to select the SCSI to 840 Copy icon, and press [ENTER/TAP].



4. This display will indicate "STORE Current ?" If you wish to save the currently selected song (the Current Song), press [YES]. If you do not wish to save it, press [NO].

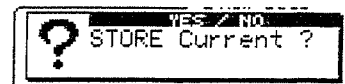

5. Use [CURSOR] to select the song that you wish to copy, and press [ENTER/TAP] to add a mark to the left of the song. Mark each song that you wish to copy.



To remove a mark, use [CURSOR] to select the song from which you wish to remove a mark, and press [ENTER/TAP].

6. Use [CURSOR] to move the cursor to the "GO" icon, and press [ENTER/TAP] to begin the Copy operation.

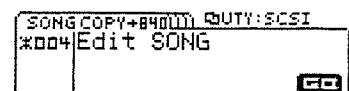

Deleting a song that was saved on an external Zip disk

1. Press [UTILITY].
2. Use [CURSOR] to select the SCSI icon, and press [ENTER/TAP].

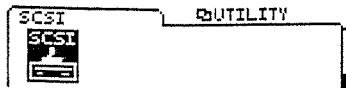

3. Use [CURSOR] to select the SCSI Song Erase icon, and press [ENTER/TAP].



4. This display will indicate "STORE Current ?" If you wish to save the currently selected song (the Current Song), press [YES]. If you do not wish to save it, press [NO].

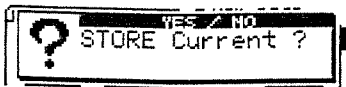

5. Use [CURSOR] to select the song(s) that you wish to delete, and press [ENTER/TAP] to add a mark at the left of the song. Add a mark to each song that you wish to delete.

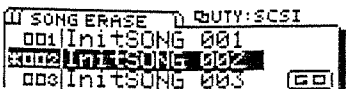

To remove a mark from a song, use [CURSOR] to select the song from which the mark will be removed, and press [ENTER/TAP].

6. Use [CURSOR] to move the cursor to the "GO" icon, and press [ENTER/TAP].

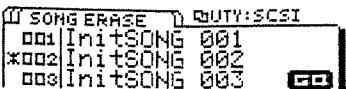

7. The display will ask "SONG Erase Sure?," so press [YES] to execute the delete operation.

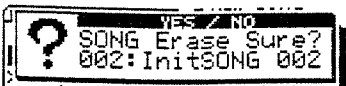

All marked songs will be deleted.

Using an external Zip drive to perform a disk copy

All data on the internal disk of the VS-840EX will be copied to the external Zip disk.

1. Press [UTILITY].
2. Use [CURSOR] to select the SCSI icon, and press [ENTER/TAP].

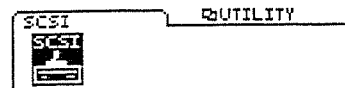

3. Use [CURSOR] to select the SCSI Disk Copy icon, and press [ENTER/TAP].

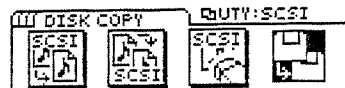

4. This display will indicate "STORE Current ?" If you wish to save the currently selected song (the Current Song), press [YES]. If you do not wish to save it, press [NO].

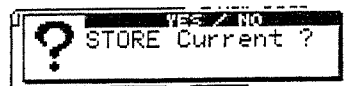

5. A message of "Are you Sure?" will ask you to confirm the operation. Press [YES] to execute the disk copy.

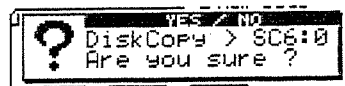

If you press [NO], the disk copy will be halted.

6. When the data has been copied, the display will indicate "Complete!," and you will return to Play mode.

Using an external Zip drive to convert data between VS-840EX/VS-880 formats (Song Convert)

This operation converts data so that it can be exchanged between the VS-840EX and VS-880. Here we will give an example procedure showing how song data created on the VS-880 can be converted for use by the VS-840EX.

- * If you select the SCSI->840 icon, VS-880 song data on the external Zip disk will be converted, and saved on the disk of the VS-840EX. If you select the 840->SCSI icon, VS-840EX data on the VS-840EX disk will be converted, and saved on the external Zip disk.
- * The only data which can be exchanged between the VS-840EX and VS-880 is song data which was recorded with a Recording Mode and Sample Rate that are supported by both devices. (The VS-840EX's recording mode "LV1" corresponds to the VS-880's "LIV.") Only two types of information are converted: the audio data itself, and information which indicates the V-track of that audio data. Other data (system-related settings, mixer-related settings, locate points in the song, etc.) is not compatible.

1. Press [UTILITY].
2. Use [CURSOR] to select the SCSI icon, and press [ENTER/TAP].

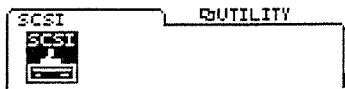

3. Use [CURSOR] to select the SCSI Song Convert icon, and press [ENTER/TAP].



4. The display will indicate "Select Convert Type," so use [CURSOR] to select the Convert Type. For this example, select the SCSI->840 icon, and press [ENTER/TAP].



5. This display will indicate "STORE Current ?" If you wish to save the currently selected song (the Current Song), press [YES]. If you do not wish to save it, press [NO].

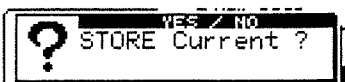

6. A list of songs created on the VS-880 will be displayed. Use [CURSOR] to select a song that you wish to convert and press [ENTER/TAP] to add a mark at the left of the song. In this way, mark each song that you wish to convert.

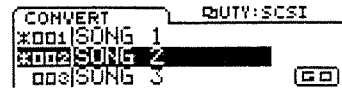

To erase a mark, use [CURSOR] to select the song from which you wish to erase the mark, and press [ENTER/TAP].

7. Use [CURSOR] to move the cursor to the "GO" icon, and press [ENTER/TAP] to begin the convert operation.

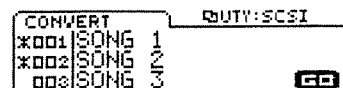

- * In order to convert song data created on the VS-840EX into a form that can be used by the VS-880, you will need a disk that has been initialized on the VS-880.

If you do not have a disk that has been initialized on the VS-880, you can use the following procedure to initialize a disk. If an uninitialized disk is inserted, the following display will appear.

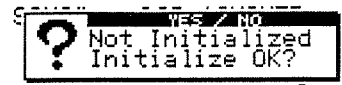

You will be asked whether or not you wish to initialize the disk for use on the VS-880, so execute the following procedure.

1. If you wish to initialize the disk, press [YES]. If you do not wish to initialize the disk, press [NO].
2. If you press [YES] in step 1, you will be asked again "Are you sure ?" If you wish to initialize, press [YES].

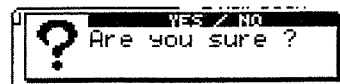

- * If initialization is halted, you will return to the condition of step 3. Execute the Shut-down operation to remove the disk, insert the desired disk, and execute the Restart operation.
- * When a disk is initialized, all data on that disk will be lost. Before initializing a disk, make sure that it does not contain any data you wish to keep.
- * The VS-840EX and the VS-880 use different disk formats.

Select the SCSI drive

Select the SCSI drive (SCSI ID number) with which the VS-840EX will exchange data.

* Only one SCSI drive can be selected on the VS-840EX.

1. Press [UTILITY].
2. Use [CURSOR] to select the SCSI icon, and press [ENTER/TAP].

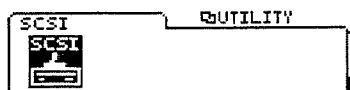

3. Use [CURSOR] to select the SCSI Drive Select icon, and press [ENTER/TAP].



4. Select the SCSI Drive (SCSI ID number). Use [CURSOR] to move the cursor to "Select Drive," and use the TIME/VALUE dial to select the SCSI Drive (SCSI ID number).

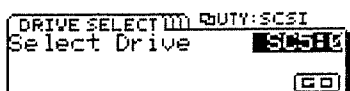

5. Use [CURSOR] to move the cursor to the "GO" icon, and press [ENTER/TAP].

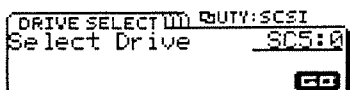

6. A message of "Drive Change to" will ask you to confirm the operation. Press [YES] to execute the drive change. If you decide not to change the drive, press [NO].

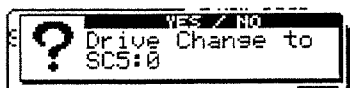

When the Data Cannot be Saved on a Single Disk (Archives)

Use this method when you are using a removable disk drive and several disks will be required to copy the specified song data.

When song data is copied using this method, the song data will be converted into a data format specifically for saving (archive format). This means that it will not be possible to directly playback the archive type song data copied on the disk. You will need to save the song data into the playable format using the appropriate procedure.

Archived files on VS-880/VS-880EX/VS-1680 are not compatible.

Disk Handling

When using this operation to copy song data, the disk will be initialized to hold archive-type song data. This means that this operation can be executed using a disk which has not been initialized by the VS-840EX. However, caution must be used, as this operation of copying data to a disk that already contains song data will result in the loss of the previously saved song data.

Also, a disk containing archive-type song data will be recognized as an uninitialized disk outside of the extract selection of the Archive Copy display.

■ Procedure for Saving on Multiple Disks (Store)

Use this method when using a removable disk drive and two or more disks are required in order to copy the specified song data. SCSI Drive (SCSI ID number) of the target device will be selected from form the "DRIVE SELECT."

1. Press [UTILITY].
2. Use [CURSOR] to select the SCSI icon, and press [ENTER/TAP].

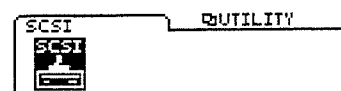

3. Use [CURSOR] to select the SCSI Archive Copy icon, then press [ENTER/TAP].



4. Use [CURSOR] to select the Store icon, then press [ENTER/TAP].



5. Use [CURSOR] to select copy type. Move the cursor to "GO" then press [ENTER/TAP].

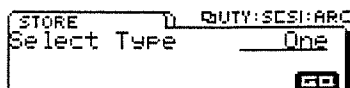

If you wish to copy the currently selected song, select "One." To copy all songs from the current drive, select "All."

6. The display will ask "Archive Store ?" If you wish to store the current song, press [YES], If you decide not to store it, press [NO].

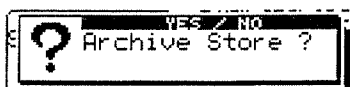

7. The display will ask "STORE Current ?" If you wish to store the current song, press [YES], If you decide not to store it, press [NO].

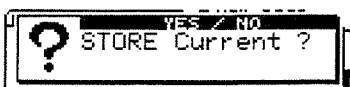

8. The display will request "Insert Disk...", insert a Zip disk into the Zip drive.

9. The display will ask "You'll lose Data?" If you wish to store it, press [YES], If you decide not to store it, press [NO].

* All data stored on the Zip disk will be lost. Do not use a Zip disk that contains song data you wish to keep.

10. If the amount of song data is greater than one Zip disk copy capacity, the disk will be ejected, and the display will request "Insert Disk..." Insert the next disk.

At this time, write the disk numbers on the disk labels so that you will remember the sequence in which they were inserted.

11. If the copy operation involved two or more disks, the display will say "Insert Disk #" (# indicating the disk insertion sequence) at the end. Insert each disk in the correct order.

12. When copying is completed, display will indicate "Complete!" Press [DISPLAY] to return to Play mode.

■ Procedure for Loading from Multiple Disks (Extract)

Use this method to use archive-type song data that was saved to a removable disk drive. Use the following procedure to load the song data into the current drive.

SCSI Drive (SCSI ID number) of the target device will be selected from the "DRIVE SELECT."

1. Press [UTILITY].
2. Use [CURSOR] to select the SCSI icon, and press [ENTER/TAP].

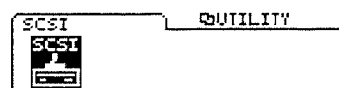

3. Use [CURSOR] to select the SCSI Archive Copy icon, then press [ENTER/TAP].



4. Use [CURSOR] to select the Extract icon, then press [ENTER/TAP].



5. Use [CURSOR] to select the song. Move the cursor to "GO" then press [ENTER/TAP].
If you wish to copy the currently selected song, select "One." To copy all songs from the current drive, select "All."

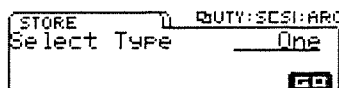

6. The display will ask "STORE Current ?" If you wish to store the current song, press [YES], If you decide not to store it, press [NO].

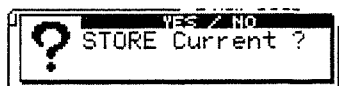

7. If you chose "All" on 5., the display will ask "initialize Internal Zip?" This message is asking you to confirm that you wish to initialize the loading destination drive (the internal Zip disk). If you wish to initialize the drive and then load, press [YES]. If you decide not to initialize, press [NO].
If you press [YES] here, all songs saved on the internal Zip disk will be lost. Normally, you should press [NO]. If the loading destination Zip disk does not have sufficient blank space, you should first make a backup copy of the internal Zip disk or replace with another Zip disk, and then press [YES].

8. When a copy operation involves two or more disks, the disk will be ejected, and the display will request "Insert Disk #" (# is the disk number) Insert the next disk.
9. When the copying is completed, display will indicate "Complete!" Press [DISPLAY] to return to Play mode.

Copying a Performance Data from a Song Saved on a SCSI Device (Track Import)

Copying a performance data from a song saved on a SCSI device to the current song.

1. First select the desired copy destination song as the current song.
2. Press [UTILITY].
3. Use [CURSOR] to select the SCSI icon, and press [ENTER/TAP].

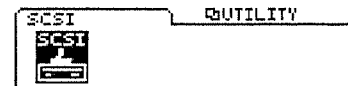

4. Use [CURSOR] to select the SCSI Track Import icon, then press [ENTER/TAP].



5. The display will ask "STORE Current ?" If you wish to store the current song before the Track Import, press [YES]. If you decide not to store it, and to execute the Track Import, press [NO].

* If you execute Track Import without storing, exchanged portion of the current song will be lost.

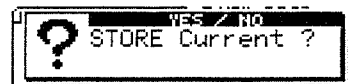

6. Move the cursor to the song containing the source track, then press [ENTER/TAP].



7. Select the source track and the destination track

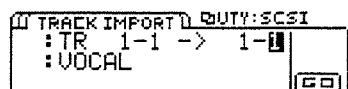

8. Use [CURSOR] to select "GO" then press [ENTER/TAP]. Track Import will be executed.

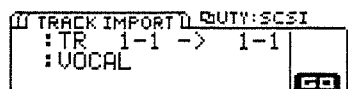

9. When the Track Import is completed successfully, display will indicate "Complete!" Press [DISPLAY] to return to Play mode.

Copying a specified track of a Current Song to a Song Saved (or a New Song) on a SCSI Device (Track Export)

Copying a specified track of a current song to a song saved (or a New Song) on a SCSI device (Track Export).

1. First select the desired copy destination song as the current song.
2. Press [UTILITY].
3. Use [CURSOR] to select the SCSI icon, and press [ENTER/TAP].

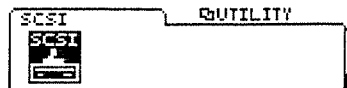

4. Use [CURSOR] to select the SCSI Track Import icon, then press [ENTER/TAP].



5. The display will ask "STORE Current ?" If you wish to store the current song before the Track Import, press [YES]. If you decide not to store it, and to execute the Track Import, press [NO].

* If you execute Track Import without storing, exchanged portion of the current song will be lost.

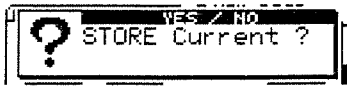

6. Move the cursor to the destination song or the "NEW" icon, then press [ENTER/TAP].



7. Select the source track and the destination track

* Use [CURSOR(▽)] to move the cursor, and you can use the TIME/VALUE dial to select the track name.



8. Use [CURSOR] to select "GO" then press [ENTER/TAP]. Track Import will be executed.

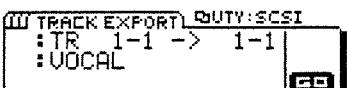

9. When the Track Import is completed successfully, display will indicate "Complete!" Press [DISPLAY] to return to Play mode.

Limitations

You can Import/Export a track from a song which has the same sample rate and the recording mode. If the copy-destination drive with the song does not have sufficient blank space, Track Import/Export can not be executed.

VS4S-1 Specifications

VS4S-1: SCSI Board

Power Supply

Supplied from the VS-840EX

Connector

SCSI Connector (25-pin D-sub type connector)

Dimensions

74.0 (W) x 85.0 (D) x 19.0 (H) mm

2-15/16 (W) x 3-3/8 (H) x 3/4 (D) inches

Weight

200g / 8 oz

* In the interest of product improvement, the specifications and/or appearance of this unit are subject to change without prior notice.

Important Notes Concerning the SCSI Connector

If a VS4S-1 is installed in the VS-840EX, only these SCSI devices that are listed in the owner's manual can be connected to the SCSI connector.

Be careful not to connect any other devices (such as RS-232C-type devices, parallel-type devices, etc.) even though that have similar-looking connectors.

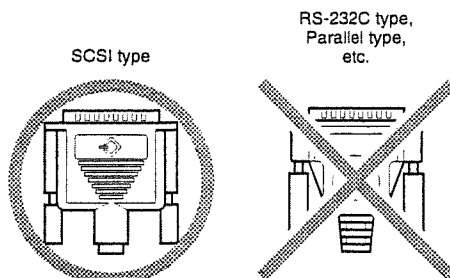



This product complies with the requirements of European Directives EMC 89/336/EEC and LVD 73/23/EEC.

For EU Countries

FEDERAL COMMUNICATIONS COMMISSION RADIO FREQUENCY INTERFERENCE STATEMENT

This equipment has been tested and found to comply with the limits for a Class B digital device, pursuant to Part 15 of the FCC Rules. These limits are designed to provide reasonable protection against harmful interference in a residential installation. This equipment generates, uses, and can radiate radio frequency energy and, if not installed and used in accordance with the instructions, may cause harmful interference to radio communications. However, there is no guarantee that interference will not occur in a particular installation. If this equipment does cause harmful interference to radio or television reception, which can be determined by turning the equipment off and on, the user is encouraged to try to correct the interference by one or more of the following measures:

- Reorient or relocate the receiving antenna.
- Increase the separation between the equipment and receiver.
- Connect the equipment into an outlet on a circuit different from that to which the receiver is connected.
- Consult the dealer or an experienced radio/TV technician for help.

Unauthorized changes or modification to this system can void the users authority to operate this equipment.
This equipment requires shielded interface cables in order to meet FCC class B Limit.

For the USA

NOTICE

This Class B digital apparatus meets all requirements of the Canadian Interference-Causing Equipment Regulations.

For Canada

AVIS

Cet appareil numérique de la classe B respecte toutes les exigences du Règlement sur le matériel brouilleur du Canada.

Information

When you need repair service, call your nearest Roland Service Center or authorized Roland distributor in your country as shown below.

ARGENTINA

Instrumentos Musicales S.A.
Florida 656 2nd Floor
Office Number 206A
Buenos Aires
ARGENTINA, CP1005
TEL: (54-1) 394-6057

BRAZIL

Roland Brasil Ltda.
R. Coronel Octaviano da Silveira
203 05522-010
Sao Paulo BRAZIL
TEL: (011) 843 9377

CANADA

Roland Canada Music Ltd.
(Head Office)
5480 Parkwood Way Richmond
B. C., V6V 2M4 CANADA
TEL: (604) 270 6626

Roland Canada Music Ltd.
(Toronto Office)
Unit 2, 109 Woodbine Downs
Blvd, Etobicoke, ON
M9W 6Y1 CANADA
TEL: (0416) 213 9707

MEXICO

Casa Veerikamp, s.a. de c.v.
Av. Toluca No. 323 Col. Olivar de
los Palcos 01780 Mexico D.F.
MEXICO
TEL: (525) 668 04 80

La Casa Wagner de
Guadalajara s.a. de c.v.
Av. Corona No. 202 S.J.
Guadalajara, Jalisco Mexico
C.P.44100 MEXICO
TEL: (03) 613 1414

PANAMA

Productos Superiores, S.A.
Apartado 655 - Panama 1
REP. DE PANAMA
TEL: (507) 270-2200

U. S. A.

Roland Corporation U.S.
5100 S. Eastern
Los Angeles, CA. 90040-2938,
U. S. A.
TEL: (323) 890 3700

VENEZUELA

Musicland Digital C.A.
Av. Francisco de Miranda,
Centro Parque de Cristal, Nivel
C2 Local 20 Caracas
VENEZUELA
TEL: (02) 285 9218

AUSTRALIA

Roland Corporation
Australia Pty. Ltd.
38 Campbell Avenue
Dee Why West. NSW 2099
AUSTRALIA
TEL: (02) 9982 8266

NEW ZEALAND

Roland Corporation (NZ) Ltd.
97 Mt. Eden Road, Mt. Eden,
Auckland 3, NEW ZEALAND
TEL: (09) 3098 715

CHINA

Beijing Xinghai Musical
Instruments Co., Ltd.
6 Huangmuchiang Chao Yang
District, Beijing, CHINA
TEL: (010) 6774 7491

HONG KONG

Tom Lee Music Co., Ltd.
Service Division
22-32 Pun Shan Street, Tsuen
Wan, New Territories,
HONG KONG
TEL: 2415 0911

INDIA

Rivera Digitech (India) Pvt. Ltd.
409, Nirman Kendra,
off Dr. Edwin Moses Road,
Mumbai 400011, INDIA
TEL: (022) 498 3079

INDONESIA

FT Galestra Inti
Kompleks Perkantoran
Duta Merlin Blok E No.6 7
Jl. Gajah Mada No.3 5,
Jakarta 10130,
INDONESIA
TEL: (021) 6335416

KOREA

Cosmos Corporation
Service Station
261 2nd Floor Nak-Won Arcade
Jong-Ro ku, Seoul, KOREA
TEL: (02) 742 8844

MALAYSIA

Bentley Music SDN BHD
140 & 142, Jalan Bukit Bintang
55100 Kuala Lumpur, MALAYSIA
TEL: (03) 2443333

PHILIPPINES

G.A. Yupangco & Co. Inc.
339 Gil J. Fuyat Avenue
Makati, Metro Manila 1200,
PHILIPPINES
TEL: (02) 899 9801

SINGAPORE

Swee Lee Company
150 Sims Drive,
Singapore 387381
TEL: 784-1669

CRISTOFORI MUSIC PTE LTD

Blk 3014, Bedok Industrial Park E,
#02-2148, SINGAPORE 489980
TEL: 243 9555

TAIWAN

ROLAND TAIWAN
ENTERPRISE CO., LTD.
Room 5, 9th. No. 112 Chung Shun
N.Road Sec.2, Taipei, TAIWAN,
R.O.C.
TEL: (02) 2561 3339

THAILAND

Theera Music Co., Ltd.
330 Verng Nakorn Kasem, Soi 2,
Bangkok 10100, THAILAND
TEL: (02) 2248821

VIETNAM

Saigon Music Distributor
(Tan Dinh Music)
306 Hai Ba Trung, District 1
Ho chi minh City
VIETNAM
TEL: (8) 829-9372

BAHRAIN

Moon Stores
Bab Al Bahrain Road,
P.O.Box 20077
State of BAHRAIN
TEL: 211 005

ISRAEL

Halilit P. Greenspoon &
Sons Ltd.
8 Retzif Fa'aliya Hashnya St.
Tel-Aviv-Yaho ISRAEL
TEL: (03) 682366

JORDAN

AMMAN Trading Agency
Prince Mohammed St. P. O. Box
825 Amman 11118 JORDAN
TEL: (06) 4641200

KUWAIT

Easa Husain Al-Yousifi
P.O. Box 126 Safat 13002
KUWAIT
TEL: 5719499

LEBANON

A. Chahine & Fils
P.O. Box 16-5857 Gergi Zeidan St.
Chahine Building, Achrafieh
Beirut, LEBANON
TEL: (01) 335799

OMAN

OHI Electronics & Trading
Co. LLC
P. O. Box 889 Muscat
Sultanate of OMAN
TEL: 959085

QATAR

Badie Studio & Stores
P.O.Box 62,
DOHA QATAR
TEL: 423554

SAUDI ARABIA

Abdul Latif S. Al-Ghamdi
Trading Establishment
Middle East Commercial Center
Al-Khobar Dharan Highway
P.O. Box 3631 Al-Khobar
31952 SAUDI ARABIA
TEL: (03) 898 2332

aDawliah Universal
Electronics APL
P.O.Box 2154 ALKHOBAR 31952,
SAUDI ARABIA
TEL: (03) 898 2081

SYRIA

Technical Light & Sound
Center
Khaled Ibn Al Walid St.
P.O.Box 13520
Damascus - SYRIA
TEL: (011) 2235 384

TURKEY

Barkat Muzik aletleri ithalat
ve ihracat limited irekefi
Siraselvier Cad. Guney Ishani No.
86/6 Taksim, Istanbul TURKEY
TEL: (0212) 2499324

U.A.E

Zak Electronics & Musical
Instruments Co.
Zabeel Road, Al Sherooq Bldg.,
No. 14, Grand Floor DUBAI
U.A.E.
P.O. Box 8050 DUBAI, U.A.E
TEL: (04) 360715

EGYPT

Al Fanny Trading Office
P.O.Box 2904,
El Horrieh Heliopolis, Cairo,
EGYPT
TEL: (02) 4171828
(02) 4185531

KENYA

Musik Land Limited
P.O. Box 12183 Moi Avenue
Nairobi Republic of KENYA
TEL: (2) 338 346

REUNION

Maison FO - YAM Marcel
25 Rue Jules MermanZL
Chaudron - BP79 97491
Ste Clotilde REUNION
TEL: 28 29 16

SOUTH AFRICA

That Other Music Shop
(PTY) Ltd.
11 Melle Street (Cnr Melle and
Juta Street)
Braamfontein 2001
Republic of SOUTH AFRICA
TEL: (011) 403 4105

Paul Bothner (PTY) Ltd.
17 Werdmuller Centre Claremont
7700
Republic of SOUTH AFRICA
TEL: (021) 64 4030

AUSTRIA

E. Dematte & Co.
Neu-Rum Siemens-Strasse 4
6063 Innsbruck AUSTRIA
TEL: (0512) 26 44 260

BELGIUM/HOLLAND/ LUXEMBOURG

Roland Benelux N. V.
Houtstraat 3 B-2260 Oevel
(Westerlo) BELGIUM
TEL: (014) 575811

BELORUSSIA

TUSHE
UL. Rabkrovskaya 17
220001 MINSK
TEL: (0172) 764-911

CYPRUS

Radex Sound Equipment Ltd.
17 Diagorou St., P.O.Box 2046,
Nicosia CYPRUS
TEL: (02) 453 426

DENMARK

Roland Scandinavia A/S
Langebrogade 6 Post Box 1937
DK-1023 Copenhagen K.
DENMARK
TEL: 32 95 3111

FRANCE

Roland France SA
4, Rue Paul Henri SPAAK
Parc de l'Esplanade F 77 462 St.
Thibault Lagry Cedex FRANCE
TEL: 01 600 73 500

FINLAND

Roland Scandinavia As,
Filial Finland
Lautasaarentie 54 B
Fin-00201 Helsinki, FINLAND
TEL: (9) 682 4020

GERMANY

Roland Elektronische
Musikinstrumente
Handelsgesellschaft mbH.
Oststrasse 96, 22844 Norderstedt,
GERMANY
TEL: (040) 52 60090

GREECE

V. Dimitriadis & Co. Ltd.
20, Alexandras St. & Bouboulinas
54 St. 106 82 Athens, GREECE
TEL: (01) 8232415

HUNGARY

Intermusica Ltd.
Warehouse Area DEPO Pf.83
H-2046 Torokbalint, HUNGARY
TEL: (23) 511011

IRELAND

The Dublin Service Centre
Audio Maintenance Limited
11 Brunswick Place Dublin 2
Republic of IRELAND
TEL: (01) 677322

ITALY

Roland Italy S. p. A.
Viale delle Industrie, 8
20020 Arese Milano, ITALY
TEL: (02) 937-78300

NORWAY

Roland Scandinavia Avd.
Kontor Norge
Lilleakerveien 2 Postboks 95
Lilleaker N-0216 Oslo
NORWAY
TEL: 273 0074

POLAND

P. P. H. Brzostowicz Marian
UL. Blokowa 32, 03624 Warszawa
POLAND
TEL: (022) 679 44 19

PORTUGAL

Tecnologias Musica e Audio,
Roland Portugal, S.A.
RUA SANTA CATARINA
131 - 4000 Porto -PORTUGAL
TEL: (02) 208 44 56

RUSSIA

Slami Music Company
Sadzjava-Triumfalnaja st., 16
103006 Moscow, RUSSIA
TEL: 095 209 2193

SPAIN

Roland Electronics
de España, S. A.
Calle Bolivia 239 08020 Barcelona,
SPAIN
TEL: (93) 308 1000

SWEDEN

Roland Scandinavia A/S
SWEDISH SALES OFFICE
Danvik Center 28, 2 tr.
S-131 30 Nacka SWEDEN
TEL: (08) 702 0020

SWITZERLAND

Roland (Switzerland) AG
Musitronic AG
Gerberstrasse 5, CH-4410 Liestal,
SWITZERLAND
TEL: (061) 921 1615

UKRAINE

TIC-TAC
Mira Str. 19/108
P.O.Box 180
295400 Munkachevo, UKRAINE
TEL: (03131) 414-40

UNITED KINGDOM

Roland (U.K.) Ltd.
Atlantic Close, Swansea
Enterprise Park SWANSEA
West Giamorgan SA7 9FJ,
UNITED KINGDOM
TEL: (01792) 700139

Preset Patch List

Roland®

No.	Patch Name	Algorithm	No.	Patch Name	Algorithm
A 00	MEDIUM ROOM	Reverb 1 w/Gate	A 50	VERY LONG	Tap Delay
A 01	SMALL ROOM	Reverb 1 w/Gate	A 51	St.SHORT Dly	Tap Delay
A 02	LARGE ROOM	Reverb 1 w/Gate	A 52	St.Mid DELAY	Tap Delay
A 03	WOOD ROOM	Reverb 1 w/Gate	A 53	St.LONG Dly	Tap Delay
A 04	DRUM ROOM	Reverb 1 w/Gate	A 54	TEMPO DELAY	Tap Delay
A 05	VOCAL REV 1	Reverb 1 w/Gate	A 55	TEMPO TapDly	Tap Delay
A 06	VOCAL REV 2	Reverb 1 w/Gate	A 56	SLOW CHORUS	St.Delay Chorus
A 07	A.Gtr REVERB	Reverb 1 w/Gate	A 57	FAST CHORUS	St.Delay Chorus
A 08	PIANO REV	Reverb 1 w/Gate	A 58	DEEP CHORUS	St.Delay Chorus
A 09	STRINGS REV	Reverb 1 w/Gate	A 59	DELAY CHORUS	St.Delay Chorus
A 10	TOP AMBIENCE	Reverb 1 w/Gate	A 60	DETUNE	StPitch Shifter Delay
A 11	SoftAmbience	Reverb 1 w/Gate	A 61	-4th	StPitch Shifter Delay
A 12	RoomAmbience	Reverb 1 w/Gate	A 62	OCTAVE	StPitch Shifter Delay
A 13	BRIGHT PLATE	Reverb 1 w/Gate	A 63	ROBOT	StPitch Shifter Delay
A 14	VOCAL ROOM	Reverb 1 w/Gate	A 64	DIMINISH	StPitch Shifter Delay
A 15	MUSIC CLUB	Reverb 1 w/Gate	A 65	RSS L<<>>R	2ch RSS
A 16	POWER'S GATE	Reverb 1 w/Gate	A 66	HIGH_EQ RSS	2ch RSS
A 17	FAT GATE	Reverb 1 w/Gate	A 67	AROUND HEAD	Panner
A 18	BRIGHT GATE	Reverb 1 w/Gate	A 68	HI SPEED PAN	Panner
A 19	LoShort GATE	Reverb 1 w/Gate	A 69	3D DELAY 1	Delay RSS
A 20	HiShort GATE	Reverb 1 w/Gate	A 70	3D DELAY 2	Delay RSS
A 21	LO LONG GATE	Reverb 1 w/Gate	A 71	3D DELAY 3	Delay RSS
A 22	HI LONG GATE	Reverb 1 w/Gate	A 72	3D DELAY 4	Delay RSS
A 23	DELAY GATE	Reverb 1 w/Gate	A 73	3D DELAY 5	Delay RSS
A 24	LARGE HALL	Reverb 2	A 74	3D CHORUS 1	Chorus RSS
A 25	SMALL HALL	Reverb 2	A 75	3D CHORUS 2	Chorus RSS
A 26	KICK REV 1	Reverb 2	A 76	3D CHORUS 3	Chorus RSS
A 27	KICK REV 2	Reverb 2	A 77	3D CHORUS 4	Chorus RSS
A 28	SNARE REV 1	Reverb 2	A 78	3D CHORUS 5	Chorus RSS
A 29	SNARE REV 2	Reverb 2	A 79	MATCH DRIVE	Guitar Multi 1
A 30	70's REVERB	Reverb 2	A 80	ROCK LEAD	Guitar Multi 1
A 31	80's REVERB	Reverb 2	A 81	Smokin' GTR	Guitar Multi 1
A 32	SHORT PLATE	Reverb 2	A 82	CLEAN Cmp	Guitar Multi 1
A 33	LONG PLATE	Reverb 2	A 83	Cmp LEAD	Guitar Multi 1
A 34	COOL PLATE	Reverb 2	A 84	BG LEAD	Guitar Multi 1
A 35	TUNNEL	Reverb 2	A 85	STUDIO LEAD	Guitar Multi 1
A 36	CATHEDRAL	Reverb 2	A 86	LP->A.Gtr	Guitar Multi 1
A 37	ARENA	Reverb 2	A 87	AMERICAN Cln	Guitar Multi 1
A 38	ARENA BACK	Reverb 2	A 88	CHORUS GTR	Guitar Multi 1
A 39	DEEP WATER	Reverb 2	A 89	EARLY 60's	Guitar Multi 1
A 40	FARAWAY	Reverb 2	A 90	WAH LEAD	Guitar Multi 1
A 41	CHURCH	Reverb 2	A 91	T WAH RHYTHM	Guitar Multi 1
A 42	URBAN HALL	Reverb 2	A 92	WAH RHYTHM	Guitar Multi 1
A 43	WARM HALL	Reverb 2	A 93	Dist PHASE	Guitar Multi 1
A 44	LIVE HOUSE	Reverb 2	A 94	CLEAN PHASER	Guitar Multi 1
A 45	BLUES ROOM	Reverb 2	A 95	JET FLANGER	Guitar Multi 1
A 46	VERY SHORT	Tap Delay	A 96	Lmtd CRUNCH	Guitar Multi 1
A 47	SHORT DELAY	Tap Delay	A 97	5th LEAD	Guitar Multi 1
A 48	MIDDLE DELAY	Tap Delay	A 98	OCTAVE LEAD	Guitar Multi 1
A 49	LONG DELAY	Tap Delay	A 99	12st GUITAR	Guitar Multi 1

Preset Patch List

Roland®

No.	Patch Name	Algorithm
B 00	El-Ac GUITAR	Guitar Multi 1
B 01	DIRTY 60's	Guitar Multi 1
B 02	12st RHYTHM	Guitar Multi 1
B 03	METAL 1	Guitar Multi 1
B 04	METAL 2	Guitar Multi 2
B 05	JC CLEAN	Guitar Multi 2
B 06	BLUESY	Guitar Multi 2
B 07	GRUNGE	Guitar Multi 2
B 08	AMBIENT MS	Guitar Multi 2
B 09	VENTURE	Guitar Multi 2
B 10	SPACY LEAD	Guitar Multi 2
B 11	A.Gtr LEAD	Guitar Multi 2
B 12	A.Gtr REVERB	Guitar Multi 2
B 13	Std. BASS	Guitar Multi 1
B 14	FUNKY BASS	Guitar Multi 1
B 15	OD BASS	Guitar Multi 1
B 16	DELAY VOCAL	Vocal Multi 1
B 17	RADIO VOICE	Vocal Multi 1
B 18	St.CHORUS Vo	Vocal Multi 1
B 19	DRY VOCAL	Vocal Multi 1
B 20	KARAOKE	Vocal Multi 2
B 21	S.Dly VOCAL	Vocal Multi 2
B 22	SPACY VOICE	Vocal Multi 2
B 23	AMBIENT Vo	Vocal Multi 2
B 24	Std.VOCAL	Vocal Multi 2
B 25	BALLADE HALL	Vocal Multi 2
B 26	BALLADE Plt	Vocal Multi 2
B 27	ROCK MALE Vo	Vocal Multi 2
B 28	ROCK FEMALE	Vocal Multi 2
B 29	COOL VOCAL	Vocal Multi 2
B 30	ACOUSTIC Gtr	Vocal Multi 1
B 31	REVERSE	Vocal Multi 1
B 32	ET!!	Vocal Multi 1
B 33	RETRO RADIO	Vocal Multi 1
B 34	WHISPER	Vocal Multi 1
B 35	SPACE PHASE	Keyboard Multi
B 36	PITCHSHIFT-1	Keyboard Multi
B 37	PITCHSHIFT+1	Keyboard Multi
B 38	RING NOISE	Keyboard Multi
B 39	DEEP RING	Keyboard Multi
B 40	St.Pan/Trm	Keyboard Multi
B 41	ECHO BACK	Keyboard Multi
B 42	ERASE NOISE	Keyboard Multi
B 43	KB:DETUNE	Keyboard Multi
B 44	LIGHT TOUCH	Keyboard Multi
B 45	OVER EFFECT	Keyboard Multi
B 46	NO PITCH	Keyboard Multi
B 47	ODRotaryFast	Rotary
B 48	ODRotarySlow	Rotary
B 49	ROTARY FAST	Rotary

No.	Patch Name	Algorithm
B 50	ROTARY SLOW	Rotary
B 51	TremoloRotar	Rotary
B 52	NORMAL PHASE	St. Phaser
B 53	STEP PHASE	St. Phaser
B 54	RESO PHASE	St. Phaser
B 55	FAST PHASER	St. Phaser
B 56	NORMAL FLG	St. Flanger
B 57	HiBAND FLG	St. Flanger
B 58	GATE FLANGER	St. Flanger
B 59	BYON BYON	St. Flanger
B 60	FAST TREMOLO	Tremolo/Pan
B 61	RANDOM Trmlo	Tremolo/Pan
B 62	Rhodes PAN	Tremolo/Pan
B 63	SLOW PAN	Tremolo/Pan
B 64	CarStereoMix	Stereo Multi
B 65	NoAttack Cmp	Stereo Multi
B 66	DUAL LoCUT	Stereo Multi
B 67	DUAL HiCUT	Stereo Multi
B 68	DANCE MIX	Stereo Multi
B 69	FULL POWER	Stereo Multi
B 70	DRY MIX	Stereo Multi
B 71	AMBIENT MIX	Stereo Multi
B 72	SP Mix	Lo-Fi Box
B 73	ANALOG Mix	Lo-Fi Box
B 74	RADIO Mix	Lo-Fi Box
B 75	MidNight Mix	Lo-Fi Box
B 76	TECHNO BOX 1	Lo-Fi Box
B 77	TECHNO BOX 2	Lo-Fi Box
B 78	LowBit Sampl	Lo-Fi Box
B 79	ROBOT Lo-Fi	Lo-Fi Box
B 80	Lo-Fi & GATE	Lo-Fi Box
B 81	RetroTurnTbl	Lo-Fi Box
B 82	VOCODER St	Vocoder
B 83	VOCODER MONO	Vocoder
B 84	DIMENSION 1	Space Chorus
B 85	DIMENSION 2	Space Chorus
B 86	WAVE CHORUS	Space Chorus
B 87	NATURAL Cho	Space Chorus
B 88	HALL / ROOM	Reverb+Reverb
B 89	HALL / PLATE	Reverb+Reverb
B 90	Dub REVERB	Delay+Reverb
B 91	Flam REVERB	Delay+Reverb
B 92	CHORUS/Rev 1	Chorus+Reverb
B 93	CHORUS/Rev 2	Chorus+Reverb
B 94	CHORUS/Rev 3	Chorus+Reverb
B 95	CHORUS/Rev 4	Chorus+Reverb
B 96	Dly/CHORUS 1	Delay+Chorus
B 97	Dly/CHORUS 2	Delay+Chorus
B 98	Dly/CHORUS 3	Delay+Chorus
B 99	Dly/CHORUS 4	Delay+Chorus

Preset Patch List

Roland®

No.	Patch Name	Algorithm
C 00	StandardBass	Bass Multi 1
C 01	Pick Bass 1	Bass Multi 1
C 02	Pick Bass 2	Bass Multi 1
C 03	Bass Chorus	Bass Multi 1
C 04	Super Bass	Bass Multi 1
C 05	Funky Bass 1	Bass Multi 1
C 06	Funky Bass 2	Bass Multi 1
C 07	For Slap Bs1	Bass Multi 1
C 08	For Slap Bs2	Bass Multi 1
C 09	OD Fleatless	Bass Multi 1
C 10	Syn Bass Sim	Bass Multi 1
C 11	Phase Bass	Bass Multi 1
C 12	Flange Bass	Bass Multi 1
C 13	Fretless Gt	Bass Multi 1
C 14	Retro Bass	Bass Multi 2
C 15	Rock Room Bs	Bass Multi 2
C 16	Fretless Bs	Bass Multi 2
C 17	FretlessSolo	Bass Multi 2
C 18	DistortionBs	Bass Multi 2
C 19	Fuzz Bass	Bass Multi 2
C 20	MS:57->421	Mic Simulator
C 21	MS:57->451	Mic Simulator
C 22	MS:57->87	Mic Simulator
C 23	MS:57->47	Mic Simulator
C 24	MS:57->Line	Mic Simulator
C 25	MS:DR20->421	Mic Simulator
C 26	MS:DR20->451	Mic Simulator
C 27	MS:DR20->87	Mic Simulator
C 28	MS:10->58	Mic Simulator
C 29	MS:10->87	Mic Simulator
C 30	MS:Mini->57	Mic Simulator
C 31	MS:Mini->87	Mic Simulator
C 32	MS:Kick	Mic Simulator
C 33	MS:Snare	Mic Simulator
C 34	MS:H.Hat	Mic Simulator
C 35	MS:Tom	Mic Simulator
C 36	MS:Ac.Guitar	Mic Simulator
C 37	AC:ForStroke	Acoustic Simulator
C 38	AC:Arpeggio	Acoustic Simulator
C 39	AC:Lead	Acoustic Simulator
C 40	AC:12st Sim	Acoustic Simulator
C 41	AC:DryCuttin	Acoustic Simulator
C 42	AC:HardLimit	Acoustic Simulator
C 43	AC:Stereo Ch	Acoustic Simulator
C 44	BassSimLoose	Bass Simulator
C 45	BassSimTight	Bass Simulator
C 46	BassSimMix	Bass Simulator
C 47	Comp + GEQ	10 Band Graphic Equalizer
C 48	Limit + GEQ	10 Band Graphic Equalizer
C 49	Total GEQ	10 Band Graphic Equalizer

Algorithm

1. Reverb 1 w/Gate
2. Reverb 2
3. Tap Delay
4. Stereo Delay Chorus
5. Stereo Pitch Shifter Delay
6. 2 ch RSS
7. Panner
8. Delay RSS
9. Chorus RSS
10. Guitar Multi 1
11. Guitar Multi 2
12. Vocal Multi 1
13. Vocal Multi 2
14. Keyboard Multi
15. Rotary
16. Stereo Phaser
17. Stereo Flanger
18. Tremolo Pan
19. Stereo Multi
20. Lo-Fi Box
21. Vocoder
22. Space Chorus
23. Reverb + Reverb
24. Delay + Reverb
25. Chorus + Reverb
26. Delay + Chorus
27. Bass Multi 1
28. Bass Multi 2
29. Mic Simulator
30. Acoustic Simulator
31. Bass Simulator
32. 10 Band Graphic Equalizer

Preset Patch List

Roland®

No.	Patch Name	Algorithm	No.	Patch Name	Algorithm
M 00	MEDIUM ROOM	Reverb 1	M 50	GRUNGE	Guitar Multi 2
M 01	SMALL ROOM	Reverb 1	M 51	AMBIENT MS	Guitar Multi 2
M 02	LARGE ROOM	Reverb 1	M 52	VENTURE	Guitar Multi 2
M 03	WOOD ROOM	Reverb 1	M 53	A.Gtr LEAD	Guitar Multi 2
M 04	TOP AMBIENCE	Reverb 1	M 54	A.Gtr REVERB	Guitar Multi 2
M 05	SoftAmbience	Reverb 1	M 55	Std. BASS	Guitar Multi 1
M 06	BRIGHT PLATE	Reverb 1	M 56	FUNKY BASS	Guitar Multi 1
M 07	MUSIC CLUB	Reverb 1	M 57	OD BASS	Guitar Multi 1
M 08	LARGE HALL	Reverb 2	M 58	DELAY VOCAL	Vocal Multi 1
M 09	SMALL HALL	Reverb 2	M 59	RADIO VOICE	Vocal Multi 1
M 10	SNARE REV 1	Reverb 2	M 60	St.CHORUS Vo	Vocal Multi 1
M 11	70's REVERB	Reverb 2	M 61	AMBIENT Vo	Vocal Multi 2
M 12	80's REVERB	Reverb 2	M 62	Std.VOCAL	Vocal Multi 2
M 13	COOL PLATE	Reverb 2	M 63	BALLADE HALL	Vocal Multi 2
M 14	CHURCH	Reverb 2	M 64	ROCK MALE Vo	Vocal Multi 2
M 15	URBAN HALL	Reverb 2	M 65	ROCK FEMALE	Vocal Multi 2
M 16	WARM HALL	Reverb 2	M 66	ACOUSTIC Gtr	Vocal Multi 1
M 17	LIVE HOUSE	Reverb 2	M 67	RETRO RADIO	Vocal Multi 1
M 18	BLUES ROOM	Reverb 2	M 68	WHISPER	Vocal Multi 1
M 19	VERY SHORT	Tap Delay	M 69	SPACE PHASE	Keyboard Multi
M 20	MIDDLE DELAY	Tap Delay	M 70	St.Pan/Trm	Keyboard Multi
M 21	St.Mid DELAY	Tap Delay	M 71	KB:DETUNE	Keyboard Multi
M 22	TEMPO DELAY	Tap Delay	M 72	LIGHT TOUCH	Keyboard Multi
M 23	FAST CHORUS	St.Delay Chorus	M 73	ODRotarySlow	Rotary
M 24	DEEP CHORUS	St.Delay Chorus	M 74	ROTARY SLOW	Rotary
M 25	DETUNE	StPitch Shifter Delay	M 75	TremoloRotar	Rotary
M 26	HI SPEED PAN	Panner	M 76	NORMAL PHASE	St. Phaser
M 27	3D DELAY 1	Delay RSS	M 77	STEP PHASE	St. Phaser
M 28	3D CHORUS 1	Chorus RSS	M 78	RESO PHASE	St. Phaser
M 29	MATCH DRIVE	Guitar Multi 1	M 79	NORMAL FLG	St. Flanger
M 30	ROCK LEAD	Guitar Multi 1	M 80	HiBAND FLG	St. Flanger
M 31	Smokin' GTR	Guitar Multi 1	M 81	FAST TREMOLO	Tremolo/Pan
M 32	CLEAN Cmp	Guitar Multi 1	M 82	Rhodes PAN	Tremolo/Pan
M 33	Cmp LEAD	Guitar Multi 1	M 83	NoAttack Cmp	Stereo Multi
M 34	BG LEAD	Guitar Multi 1	M 84	DANCE MIX	Stereo Multi
M 35	STUDIO LEAD	Guitar Multi 1	M 85	AMBIENT MIX	Stereo Multi
M 36	LP->A.Gtr	Guitar Multi 1	M 86	SP Mix	Lo-Fi Box
M 37	AMERICAN Cln	Guitar Multi 1	M 87	MidNight Mix	Lo-Fi Box
M 38	CHORUS GTR	Guitar Multi 1	M 88	TECHNO BOX 1	Lo-Fi Box
M 39	EARLY 60's	Guitar Multi 1	M 89	TECHNO BOX 2	Lo-Fi Box
M 40	WAH LEAD	Guitar Multi 1	M 90	RetroTurnTbl	Lo-Fi Box
M 41	T WAH RHYTHM	Guitar Multi 1	M 91	DIMENSION 1	Space Chorus
M 42	CLEAN PHASER	Guitar Multi 1	M 92	NATURAL Cho	Space Chorus
M 43	Lmtd CRUNCH	Guitar Multi 1	M 93	HALL / ROOM	Reverb+Reverb
M 44	OCTAVE LEAD	Guitar Multi 1	M 94	HALL / PLATE	Reverb+Reverb
M 45	12st GUITAR	Guitar Multi 1	M 95	Flam REVERB	Delay+Reverb
M 46	El-Ac GUITAR	Guitar Multi 1	M 96	CHORUS/Rev 3	Chorus+Reverb
M 47	12st RHYTHM	Guitar Multi 1	M 97	CHORUS/Rev 4	Chorus+Reverb
M 48	METAL 1	Guitar Multi 1	M 98	Dly/CHORUS 3	Delay+Chorus
M 49	JC CLEAN	Guitar Multi 2	M 99	Dly/CHORUS 4	Delay+Chorus

* When you create a new song, the same contents as user patches (M00–M99) will be copied to user patches (U00–U99).

Roland®

10915

UPC

10915

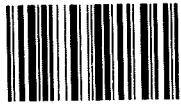

10915

Roland®