

Roland®

24-bit DIGITAL STUDIO WORKSTATION

VS-1824

Owner's Manual





Before using this unit, carefully read the sections entitled: "IMPORTANT SAFETY INSTRUCTIONS" (Owner's Manual p. 2), "USING THE UNIT SAFELY" (Owner's Manual p. 3), and "IMPORTANT NOTES" (Owner's Manual p. 5). These sections provide important information concerning the proper operation of the unit. Additionally, in order to feel assured that you have gained a good grasp of every feature provided by your new unit, User Guide, Owner's Manual, and Appendices should be read in its entirety. These manuals should be saved and kept on hand as a convenient reference.

Copyright © 2001 ROLAND CORPORATION

All rights reserved. No part of this publication may be reproduced in any form without the written permission of ROLAND CORPORATION.

Roland Web Site: <http://www.roland.co.jp/>

	CAUTION RISK OF ELECTRIC SHOCK DO NOT OPEN	
ATTENTION: RISQUE DE CHOC ELECTRIQUE NE PAS OUVRIR		
CAUTION: TO REDUCE THE RISK OF ELECTRIC SHOCK, DO NOT REMOVE COVER (OR BACK). NO USER-SERVICEABLE PARTS INSIDE. REFER SERVICING TO QUALIFIED SERVICE PERSONNEL.		



The lightning flash with arrowhead symbol, within an equilateral triangle, is intended to alert the user to the presence of uninsulated "dangerous voltage" within the product's enclosure that may be of sufficient magnitude to constitute a risk of electric shock to persons.



The exclamation point within an equilateral triangle is intended to alert the user to the presence of important operating and maintenance (servicing) instructions in the literature accompanying the product.

INSTRUCTIONS PERTAINING TO A RISK OF FIRE, ELECTRIC SHOCK, OR INJURY TO PERSONS.

IMPORTANT SAFETY INSTRUCTIONS SAVE THESE INSTRUCTIONS

WARNING - When using electric products, basic precautions should always be followed, including the following:

1. Read these instructions.
2. Keep these instructions.
3. Heed all warnings.
4. Follow all instructions.
5. Do not use this apparatus near water.
6. Clean only with a dry cloth.
7. Do not block any of the ventilation openings. Install in accordance with the manufacturers instructions.
8. Do not install near any heat sources such as radiators, heat registers, stoves, or other apparatus (including amplifiers) that produce heat.
9. Do not defeat the safety purpose of the polarized or grounding-type plug. A polarized plug has two blades with one wider than the other. A grounding type plug has two blades and a third grounding prong. The wide blade or the third prong are provided for your safety. When the provided plug does not fit into your outlet, consult an electrician for replacement of the obsolete outlet.
10. Protect the power cord from being walked on or pinched particularly at plugs, convenience receptacles, and the point where they exit from the apparatus.
11. Only use attachments/accessories specified by the manufacturer.
12. Never use with a cart, stand, tripod, bracket, or table except as specified by the manufacturer, or sold with the apparatus. When a cart is used, use caution when moving the cart/apparatus combination to avoid injury from tip-over. 
13. Unplug this apparatus during lightning storms or when unused for long periods of time.
14. Refer all servicing to qualified service personnel. Servicing is required when the apparatus has been damaged in any way, such as power-supply cord or plug is damaged, liquid has been spilled or objects have fallen into the apparatus, the apparatus has been exposed to rain or moisture, does not operate normally, or has been dropped.

For the U.K.

WARNING: THIS APPARATUS MUST BE EARTHED

IMPORTANT: THE WIRES IN THIS MAINS LEAD ARE COLOURED IN ACCORDANCE WITH THE FOLLOWING CODE.
 GREEN-AND-YELLOW: EARTH, BLUE: NEUTRAL, BROWN: LIVE

As the colours of the wires in the mains lead of this apparatus may not correspond with the coloured markings identifying the terminals in your plug, proceed as follows:



The wire which is coloured GREEN-AND-YELLOW must be connected to the terminal in the plug which is marked by the letter E or by the safety earth symbol  or coloured GREEN or GREEN-AND-YELLOW.



The wire which is coloured BLUE must be connected to the terminal which is marked with the letter N or coloured BLACK.

The wire which is coloured BROWN must be connected to the terminal which is marked with the letter L or coloured RED.







USING THE UNIT SAFELY

INSTRUCTIONS FOR THE PREVENTION OF FIRE, ELECTRIC SHOCK, OR INJURY TO PERSONS

About  WARNING and  CAUTION Notices







 WARNING	Used for instructions intended to alert the user to the risk of death or severe injury should the unit be used improperly.
 CAUTION	Used for instructions intended to alert the user to the risk of injury or material damage should the unit be used improperly. * Material damage refers to damage or other adverse effects caused with respect to the home and all its furnishings, as well to domestic animals or pets.

About the Symbols







	The  symbol alerts the user to important instructions or warnings. The specific meaning of the symbol is determined by the design contained within the triangle. In the case of the symbol at left, it is used for general cautions, warnings, or alerts to danger.
	The  symbol alerts the user to items that must never be carried out (are forbidden). The specific thing that must not be done is indicated by the design contained within the circle. In the case of the symbol at left, it means that the unit must never be disassembled.
	The  symbol alerts the user to things that must be carried out. The specific thing that must be done is indicated by the design contained within the circle. In the case of the symbol at left, it means that the power-cord plug must be unplugged from the outlet.

ALWAYS OBSERVE THE FOLLOWING





WARNING

- Before using this unit, make sure to read the instructions below, and the Owner's Manual. 
- Do not open or perform any internal modifications on the unit. (The only exception would be where this manual provides specific instructions which should be followed in order to put in place user-installable options; see User Guide p. 6, 9.) 
- Do not attempt to repair the unit, or replace parts within it (except when this manual provides specific instructions directing you to do so). Refer all servicing to your retailer, the nearest Roland Service Center, or an authorized Roland distributor, as listed on the "Information" page. 
- Never use or store the unit in places that are:
 - Subject to temperature extremes (e.g., direct sunlight in an enclosed vehicle, near a heating duct, on top of heat-generating equipment); or are 
 - Damp (e.g., baths, washrooms, on wet floors); or are 
 - Humid; or are
 - Exposed to rain; or are
 - Dusty; or are
 - Subject to high levels of vibration.
- Make sure you always have the unit placed so it is level and sure to remain stable. Never place it on stands that could wobble, or on inclined surfaces. 
- The unit should be connected to a power supply only of the type described in the operating instructions, or as marked on the unit. 











WARNING

- Use only the attached power-supply cord. 
- Do not excessively twist or bend the power cord, nor place heavy objects on it. Doing so can damage the cord, producing severed elements and short circuits. Damaged cords are fire and shock hazards! 
- This unit, either alone or in combination with an amplifier and headphones or speakers, may be capable of producing sound levels that could cause permanent hearing loss. Do not operate for a long period of time at a high volume level, or at a level that is uncomfortable. If you experience any hearing loss or ringing in the ears, you should immediately stop using the unit, and consult an audiologist. 
- Do not allow any objects (e.g., flammable material, coins, pins); or liquids of any kind (water, soft drinks, etc.) to penetrate the unit. 

- In households with small children, an adult should provide supervision until the child is capable of following all the rules essential for the safe operation of the unit. 
- Protect the unit from strong impact. (Do not drop it!) 

⚠ WARNING

- Do not force the unit's power-supply cord to share an outlet with an unreasonable number of other devices. Be especially careful when using extension cords—the total power used by all devices you have connected to the extension cord's outlet must never exceed the power rating (watts/amperes) for the extension cord. Excessive loads can cause the insulation on the cord to heat up and eventually melt through. 
- Before using the unit in a foreign country, consult with your retailer, the nearest Roland Service Center, or an authorized Roland distributor, as listed on the "Information" page. 
- Always turn the unit off and unplug the power cord before attempting installation of the circuit board (model no. VS8F-2; User Guide p. 6, 9). 
- DO NOT play a CD-ROM disc on a conventional audio CD player. The resulting sound may be of a level that could cause permanent hearing loss. Damage to speakers or other system components may result. 

⚠ CAUTION

- The unit should be located so that its location or position does not interfere with its proper ventilation. 
- Always grasp only the plug on the power-supply cord when plugging into, or unplugging from, an outlet or this unit. 
- Try to prevent cords and cables from becoming entangled. Also, all cords and cables should be placed so they are out of the reach of children. 
- Never climb on top of, nor place heavy objects on the unit. 
- Never handle the power cord or its plugs with wet hands when plugging into, or unplugging from, an outlet or this unit. 
- Before moving the unit, disconnect the power plug from the outlet, and pull out all cords from external devices. 
- Before cleaning the unit, turn off the power and unplug the power cord from the outlet (p. 32). 
- Whenever you suspect the possibility of lightning in your area, pull the plug on the power cord out of the outlet. 
- Install only the specified circuit board(s) (model no. VS8F-2). Remove only the specified screws (User Guide p. 6, 9). 
- Should you remove the optical connector caps and screws fastening the effect expansion board cover, make sure to put them in a safe place out of children's reach, so there is no chance of them being swallowed accidentally. 

IMPORTANT NOTES

In addition to the items listed under “IMPORTANT SAFETY INSTRUCTIONS” and “USING THE UNIT SAFELY” on pages 2 and 4, please read and observe the following:

Power Supply

- Do not use this unit on the same power circuit with any device that will generate line noise (such as an electric motor or variable lighting system).
- Before connecting this unit to other devices, turn off the power to all units. This will help prevent malfunctions and/or damage to speakers or other devices.

Placement

- Using the unit near power amplifiers (or other equipment containing large power transformers) may induce hum. To alleviate the problem, change the orientation of this unit; or move it farther away from the source of interference.
- This device may interfere with radio and television reception. Do not use this device in the vicinity of such receivers.
- Noise may be produced if wireless communications devices, such as cell phones, are operated in the vicinity of this unit. Such noise could occur when receiving or initiating a call, or while conversing. Should you experience such problems, you should relocate such wireless devices so they are at a greater distance from this unit, or switch them off.
- Do not expose the unit to direct sunlight, place it near devices that radiate heat, leave it inside an enclosed vehicle, or otherwise subject it to temperature extremes. Excessive heat can deform or discolor the unit.
- To avoid possible breakdown, do not use the unit in a wet area, such as an area exposed to rain or other moisture.

VS-1824CD

- Observe the following when using the unit's CD-RW drive. For further details, refer to “Before Using CD-RW drive” (p. 184, 233).
 - Do not place the unit near devices that produce a strong magnetic field (e.g., loudspeakers).
 - Install the unit on a solid, level surface.
 - Do not move the unit or subject it to vibration while the drive is operating.

Maintenance

- For everyday cleaning wipe the unit with a soft, dry cloth or one that has been slightly dampened with water. To remove stubborn dirt, use a cloth impregnated with a mild, non-abrasive detergent. Afterwards, be sure to wipe the unit thoroughly with a soft, dry cloth.
- Never use benzine, thinners, alcohol or solvents of any kind, to avoid the possibility of discoloration and/or deformation.

Repairs and Data

- Please be aware that all data contained in the unit's memory may be lost when the unit is sent for repairs. Important data should always be backed up on a storage device (e.g., CD-R/RW disc or Zip disk) or DAT recorder, or written down on paper (when possible). During repairs, due care is taken to avoid the loss of data. However, in certain cases (such as when circuitry related to memory itself is out of order), we regret that it may not be possible to restore the data, and Roland assumes no liability concerning such loss of data.

Memory Backup

- This unit contains a battery which powers the unit's memory circuits while the main power is off. When this battery becomes weak, the message shown below will appear in the display. Once you see this message, have the battery replaced with a fresh one as soon as possible to avoid the loss of all data in memory. To have the battery replaced, consult with your retailer, the nearest Roland Service Center, or an authorized Roland distributor, as listed on the “Information” page.

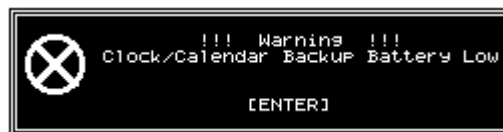

Additional Precautions

- Please be aware that the contents of memory can be irretrievably lost as a result of a malfunction, or the improper operation of the unit. To protect yourself against the risk of losing important data, we recommend that you periodically save a backup copy of important data you have stored in the unit's memory on a storage device (e.g., CD-R/RW disc or Zip disk), or DAT recorder.
- Unfortunately, it may be impossible to restore the contents of data that was stored on a storage device (e.g., CD-R/RW disc or Zip disk), or DAT recorder once it has been lost. Roland Corporation assumes no liability concerning such loss of data.
- Use a reasonable amount of care when using the unit's buttons, sliders, or other controls; and when using its jacks and connectors. Rough handling can lead to malfunctions.
- Never strike or apply strong pressure to the display.
- When connecting / disconnecting all cables, grasp the connector itself—never pull on the cable. This way you will avoid causing shorts, or damage to the cable's internal elements.
- A small amount of heat will radiate from the unit during normal operation.

- To avoid disturbing your neighbors, try to keep the unit's volume at reasonable levels. You may prefer to use headphones, so you do not need to be concerned about those around you (especially when it is late at night).
- When you need to transport the unit, package it in the box (including padding) that it came in, if possible. Otherwise, you will need to use equivalent packaging materials.
- Use a cable from Roland to make the connection. If using some other make of connection cable, please note the following precautions.
 - Some connection cables contain resistors. Do not use cables that incorporate resistors for connecting to this unit. The use of such cables can cause the sound level to be extremely low, or impossible to hear. For information on cable specifications, contact the manufacturer of the cable.

Handling the Internal Hard Disk Drive

- Please note that the hard disk is a consuming product. To protect yourself against risk of losing important data by accidental disk damage, we recommend that you periodically save a backup copy on the storage device (e.g., Zip disk or CD-R/RW recorder which is designated by Roland.)
- Before performing any of the following actions, be sure to perform the shutdown procedure. Failure to do so may result in the loss of song data or damage to the hard disk.
 - Turning off the power of the VS-1824
 - Turning off the power of the disk drive connected with SCSI connector
 - Removing a disk from a removable disk drive connected with SCSI connector

Shutdown (See Appendices p. 13)

Removable Disk Drive (See Appendices p. 13)

- Do not turn off the power while the hard disk is operating.
- While using the VS-1824, be careful not to subject the unit to vibration or shock, and avoid moving the unit while the power is turned on.
- Install the unit on a solid, level surface in an area free from vibration. If the unit must be installed at an angle, be sure the installation does not exceed the permissible range.
- Avoid using the unit immediately after it has been moved to a location with a level of humidity that is greatly different than its former location. Rapid changes in the environment can cause condensation to form inside the drive, which will adversely affect the operation of the drive. When the unit has been moved, allow it to become accustomed to the new environment (allow a few hours) before operating it.

Copyright

- Unauthorized recording, distribution, sale, lending, public performance, broadcasting, or the like, in whole or in part, of a work (musical composition, video, broadcast, public performance, or the like) whose copyright is held by a third party is prohibited by law.
- When exchanging audio signals through a digital connection with an external instrument, this unit can perform recording without being subject to the restrictions of the Serial Copy Management System (SCMS). This is because the unit is intended solely for musical production, and is designed not to be subject to restrictions as long as it is used to record works (such as your own compositions) that do not infringe on the copyrights of others. (SCMS is a feature that prohibits second-generation and later copying through a digital connection. It is built into MD recorders and other consumer digital-audio equipment as a copyright-protection feature.)
- Do not use this unit for purposes that could infringe on a copyright held by a third party. We assume no responsibility whatsoever with regard to any infringements of third-party copyrights arising through your use of this unit.

About the License Agreement

- The VS-1824 and its CD-R/RW capability are designed to allow you to reproduce material to which you have copyright, or material which the copyright owner has granted you permission to copy. Accordingly, reproduction of Music CD or other copyrighted material without permission of the copyright owner avoiding technical prohibiting features of second-generation and later copying like SCMS or others constitutes copyright infringement and may incur penalties even in case such reproduction is for your own personal use and enjoyment (private use). Consult a copyright specialist or special publications for more detailed information on obtaining such permission from copyright holders.

Disclaimer of liability

- Roland will take no responsibility for any "direct damages," "consequential damages," or "any other damages" which may result from your use of the VS-1824. These damages may include but are not limited to the following events which can occur when using the VS-1824.
 - Any loss of profit that may occur to you
 - Permanent loss of your music or data
 - Inability to continue using the VS-1824 itself or a connected device

Table of Contents

USING THE UNIT SAFELY	3
IMPORTANT NOTES	5
Preparations	16
About the Package Contents	16
Main Features.....	16
The Latest in Compact Home Studio Environments	16
Simple Operation	17
Connectivity.....	17
Major Options.....	17
Top and Rear Panels	18
Mixer Section	18
Recorder Section	20
Rear Panel	22
Front Panel.....	23
Chapter 1 Before You Start (VS-1824 Terminology).....	24
Saving and Managing Data	24
Managing Disk Contents (Partitioning).....	24
The Location Where a Performance is Recorded (Song).....	25
Sources, Tracks, and Channels.....	25
Takes and Phrases.....	25
About Events	26
About Button Names.....	26
Mixer Section	27
Signal Flow (Busses)	27
Input Mixer	28
Track Mixer.....	28
Switching the Fader Functions.....	28
Master Block.....	29
Recorder Section	29
Differences from a Tape-Type MTR.....	29
Track Minutes and Recording Time.....	30
Auxiliary Tracks for Each Track	30
Effects Section.....	31
About the Effect Expansion Board	31
Connecting Effects	31
Chapter 2 Basic Operation.....	32
Turning the Power On and Off.....	32
Turning On the Power.....	32
Turning Off the Power	32
Restarting	33
If “STORE Current ?” is Displayed	33
Saving Your Song (Song Store)	33
Setting the Internal Clock	34
Operating the VS-1824	35
Basic Navigation.....	35
Adjusting the display Contrast.....	35
If You Have Trouble Understanding Displays or Operations	35
Function Buttons	36
Mixer and System Initialize	37

Chapter 3 Playback Operations.....38

- The Display..... 38**
 - Display Regions..... 38
 - Selecting a Playlist Display..... 39
 - Function Buttons (While on the Playlist Display) 40
- Mixer Channel Display 41**
- Changing Track Status..... 42**
- Muting and Soloing 42**
 - Muting Tracks..... 42
 - Muting Inputs and Effect Returns 42
 - Quick Soloing..... 43
 - Solo Mode..... 43
- Using Locators..... 43**
 - Storing Locators..... 43
 - Recalling a Stored Locator 43
 - Changing the Locator Bank 44
 - Editing Stored Locators..... 44
 - Clearing Locator 44
- Using Markers 45**
 - Storing a Marker..... 45
 - Locate to a Marker Using PREVIOUS and NEXT 45
 - Editing Marker Values 46
 - Clearing Markers..... 46
- Other Ways to Move In a Song 47**
 - Changing Playback Position Using JUMP..... 47
 - Change Playback Position Using TIME/VALUE Dial 47
 - Move to the Beginning or End of a Song Using [FF] and [REW]..... 47
- Protecting Songs (Song Protect) 48**
 - Protecting Performances 48
 - To Remove Song Protect 49
- Selecting and Loading Songs (Song Select) 49**

Chapter 4 Recording Operations.....50

- Preparing for a New Recording 50**
 - Create a New Song (Song New)..... 50
- The Recording and Mixing Process..... 53**
- Connecting Instruments 53**
- Recording to the Tracks..... 54**
- Recording on Other Tracks (Overdubbing)..... 56**
- Recording Using Different Virtual Tracks (V-Tracks)..... 56**
- Manual Punch-In/Punch-Out..... 57**
 - Manual Punch-In Using the RECORD Button..... 57
 - Manual Punch-In Using the Foot Switch..... 57
- Auto Punch-In and Punch-Out 58**
- Loop Recording 60**
- Undo and Redo 62**
 - Recording and Editing Operation Which Can Be Undone (Undo) 62
 - To use the Undo Function:..... 63
 - To cancel an Undo (Redo):..... 63
 - Cancel Only the Very Last-Performed Operation..... 63
- Track Bouncing..... 64**
 - Track Bouncing With Effects 65
- Recording a Digital Source..... 66**
 - Preparations for Recording a Digital Source..... 66
 - Recording From a CD..... 67



Using the Metronome	67
Turn On the Metronome	67
Program the Tempo Map	68
Using an External MIDI Sound Source to Play the Metronome	68
Chapter 5 Using the Digital Mixer	70
Fader/Mute Button	71
Method One: Switching the Fader Functions (FADER/MUTE Button)	71
Method Two: Input Mixer Screen	71
Determining Output	72
MONITOR Output Connectors	72
AUX Connectors	73
Digital Out Connectors	73
Direct Out Connectors	74
Changing settings of the Track Mixer Buttons and Faders (Fader Mode)	75
Mixer Routing	75
Sources Assigned to Tracks	75
Input Mixer Default Assignment	76
Channel Link	77
Link Adjacent Mixer Channels	77
Adjust the Levels of Linked Channels	77
Adjusting the Panning of Channel Linked Channels	78
Linking the Faders of Two or More Channels (Fader Group)	79
Selecting V-Tracks	80
Using the Equalizer (EQ)	80
Attenuation	82
Phase	82
Copying Mixer Settings	83
Mixer Scenes	84
Storing a Mixer Scene	84
Recalling a Mixer Scene	85
Recalling a Scene Without Affecting the Current Fader Values	85
Deleting a Mixer Scene	85
Updating a Mixer Scene	85
Chapter 6 Mixer Channel Strip Detail	86
Input Mixer	86
[F1 (MIX)] MIX Bus Enable/Pan	86
[F2 (Low)], [F3 (Mid)], and [F4 (High)] Equalizer	86
[F6 (PRM.V)] Parameter View/ [F6 (CH.V)] Channel View	86
[F1 (FX1)] Effect 1 Send	86
[F2 (FX2)] Effect 2 Send	87
[F3 (FX3)] Effect 3 Send	87
[F4 (FX4)] Effect 4 Send	87
[F5 (AUX)] AUX Send	87
[F1 (FX1In)] Effect 1 Insert	88
[F2 (FX2In)] Effect 2 Insert	88
[F3 (FX3In)] Effect 3 Insert	89
[F4 (FX4In)] Effect 4 Insert	89
[F1 (Link)] Channel Link	89
[F2 (ATT)] Attenuation	89
[F3 (Phase)] PHASE	90
[F4 (Group)] FADER GROUP	90
[F1 (Meter)] METER	90
[F3 (Solo)] SOLO	90
[F4 (Mute)] MUTE	90
[F5 (Fader)] FADER	90

Track Mixer	90
[F1 (MIX)] MIX Bus Enable/Pan.....	90
[F2 (Low)], [F3 (Mid)], and [F4 (High)] Equalizer.....	90
[F5 (V.Trk)] V-Track Select.....	91
[F6 (PRM.V)] Parameter View/ [F6 (CH.V)] Channel View.....	91
[F1(FX1)] Effect 1 Send	91
[F2 (FX2)] Effect 2 Send	91
[F3 (FX3)] Effect 3 Send	91
[F4 (FX4)] Effect 4 Send	92
[F5 (AUX)] AUX Send	92
[F1 (FX1In)] Effect 1 Insert	92
[F2 (FX2In)] Effect 2 Insert	93
[F3 (FX3In)] Effect 3 Insert	93
[F4(FX4In)] Effect 4 Insert	94
[F1 (Link)] Channel Link.....	94
[F2 (ATT)] Attenuation.....	94
[F3 (Phase)] PHASE	94
[F4 (Group)] FADER GROUP	94
[F1 (Meter)] METER.....	94
[F2 (Stats)] STATUS	94
[F3 (Solo)] SOLO.....	95
[F4 (Mute)] MUTE.....	95
[F5 (Fader)] FADER	95
Master Block	95
[F1 (MST)] MASTER	95
[F2 (MON)] MONITOR.....	95
[F3 (AUX.A)] AUX A	95
[F4 (AUX.B)] AUX B	96
[F5 (DOUT1)] DIGITAL OUT 1.....	96
[F6 (DOUT2)] DIGITAL OUT 2.....	96
[F1 (FX1In)] Effect 1 Insert	96
[F2 (FX2In)] Effect 2 Insert	97
[F3 (FX3In)] Effect 3 Insert	97
[F4 (FX4In)] Effect 4 Insert	97
[F5 (DIR)] DIRECT OUT	98
[F1 (FX1)] Effect 1 Master Send.....	98
[F2 (FX2)] Effect 2 Master Send.....	98
[F3 (FX3)] Effect 3 Master Send.....	98
[F4 (FX4)] Effect 4 Master Send.....	98
[F5 (AUX)] AUX Master Send	98
Chapter 7 Using Internal Effects (VS8F-2)	99
Location of Effects	99
Effect Types	99
Insert Effects.....	99
Loop Effects.....	100
Making the Effect Connection.....	100
Procedure for Using Effects	100
Selecting Effect Patches	101
Selecting a Preset Patch	101
Creating and Saving User Effect Patches	102
Create a User Effect Patch.....	102
Save an Effect as a User Patch	102
Save an Effect Patch as Part of a Mixer Scene	103
Connecting Insert Effects	103
Connecting Insert Effects to Inputs and Tracks.....	103
Connecting Insert Effects in the Master Block	105
Three Insert Effect Examples.....	105

Connecting Loop Effects	107
Effects Return Section	107
Two Examples of Using Loop Effects	108
Using Effects While Recording	109
Listening to an Insert Effect While Recording	109
Listening to a Loop Effect While Recording	110
Recording Insert Effects	110
Recording a loop effect	111
Recording Stereo Effects	112
Three Important Reminders About Using Effects	112
Chapter 8 EZ Routing	113
Using EZ Routing Step Editing	114
Setting Up for Recording Using Step Editing	114
Setting Up for Mixing Using Step Editing	116
Setting Up for Bouncing Using Step Editing	117
Setting Up for Mastering Using Step Editing	119
Using EZ Routing Quick Editing	121
Using EZ Routing Templates	123
Saving an EZ Routing Template	123
Recalling an EZ Routing Template	123
Deleting an EZ Routing Template	123
Chapter 9 Automix	124
Mixer Automation	124
Using Automix	125
Adjust the Display for Automix	125
Realtime Automix	125
Realtime Automix of Track Faders	125
Realtime Automix of Input Faders	126
Automating the Master Stereo Mix and Monitor Output	126
Automating Effect Returns	126
Snapshot Automation	127
Snap Mode	128
Automating Effect Changes	128
Gradation	129
Updating Automix	131
Editing Automix Data	132
Editing Automix Data (Micro Edit)	132
Erasing Data from a Specific Area (Erase)	132
Copying Data to Another Location (Copy)	133
Smooth Data Transitions (Gradation)	135
Increasing or Decreasing All Data Values (Shift/Expand)	136
Erasing Automix Data	138
Erasing Automix Data on Specified Channels	138
Erasing Automix Data on All Channels	138
Chapter 10 Track and Phrase Editing	139
Track Editing	139
Track Erase	139
Track Cut	140
Track Move	142
Track Copy	144
Track Insert	146
Track Exchange	147
Track Time Compression/Expansion	148
Track Name	150
Track Import	151

Phrase Editing	152
Phrase Delete	152
Dividing a Phrase (Phrase Divide/Split).....	153
Phrase Move.....	155
Phrase Copy.....	157
Phrase Trim In	159
Phrase Trim Out.....	160
Phrase New	161
Phrase Name.....	162
Naming Takes.....	162
Deleting a Take.....	163
Chapter 11 Editing Tips & Tools	164
Editing Operations	164
Steps for Track Editing	164
Step 1: Set the Edit Points.....	165
Step 2: Perform the Button-Pushes to Complete the Edit	169
Track Editing vs. Phrase Editing	170
An Editing Note of Caution	171
Practical Editing Application	171
Chapter 12 Song Editing	173
Song Arrange	173
Song Split	174
Song Combine	175
Chapter 13 CD-RW and Mastering	177
Create Master Data (Mastering)	177
Mastering Room.....	177
Mixing Down to the Mastering Tracks	177
Mastering Tracks Status Shortcut	179
Playing Back the Mastering Tracks	180
To Prohibit Digital Copying	181
Mixing Down While Inserting Effects.....	181
Creating an Audio CD	183
Before Using the CD-RW drive.....	184
Items Necessary for Creating an Audio CD.....	184
Creating a Master Stereo Mix.....	185
Finalizing.....	185
Assembling Multiple Songs for CD Recording	186
Copyright Protection	186
CD Track Numbers.....	186
Writing Songs to CD-R Discs	188
Adding a Song to a Partially Recorded Disc.....	190
Arranging and Recording Multiple Songs to a CD-R Disc	190
CD Player Function	191
Capture Audio data from Audio CD (Capture function)	192
Connecting an external CD-R/CD-RW Drive	194
Chapter 14 Other Useful Functions	195
Vari Pitch	195
Numerics/ASCII	195
Entering Numbers.....	195
Entering Letters	195
Stereo Input	196
Using the MONITOR Knob to Adjust Channel Panning	196

Chapter 15 Using External MIDI Devices	197
Synchronizing with MIDI Sequencers.....	197
Items Necessary for Synchronization.....	197
Master and Slave	197
Using MTC	197
Synchronization Using the VS-1824 as the Master.....	198
Synchronization Using the VS-1824 as the Slave.....	199
Using MTC Offset	200
Using the Sync Track (Master)	200
Recording MIDI Clock Messages.....	201
Synchronized Operation	201
Using the Tempo Map.....	202
Synchronized Operation	203
Other Methods to Generate A Sync Track or Tempo Map	204
Using MIDI Controller Messages.....	206
Switching Track Status	206
Switching Scenes	207
Switching Effects.....	207
Adjusting Effects	208
MIDI Machine Control.....	208
Chapter 16 Using Software Sequencers.....	209
Common Terms	209
MIDI Clock.....	209
MIDI Time Code (MTC).....	209
MIDI Machine Control (MMC)	209
Song Position Pointer (SPP)	209
Synchronization.....	209
Sequencer Tracks.....	209
MIDI Interface.....	209
Specific Software Applications	210
Cakewalk Pro Audio	210
Cubase VST	211
Logic Audio.....	212
Digital Performer	213
Vision DSP.....	214
Chapter 17 Using Hard Drives	216
General Information Regarding Hard Drives.....	216
Drive Partitioning	216
Recording Times vs. Sample Rate/Recording Modes.....	217
Checking Remaining Space	217
Recovering Drive Space.....	218
Song Optimize	218
Song Erase	219
Using External Hard Drives	220
Selecting an External Hard Drive	220
Connecting a Fixed External Hard Drive	220
Connecting a Removable External Hard Drive	221
Before Using the Zip Disk Drive.....	221
Initializing (Formatting) the Drive	222
Saving a Song to an External Drive (Song Copy).....	223
Song Copy Playable	224
Song Copy Archives	225
Loading a Song from an External Drive	226
Loading a Song from an External Drive Using Song Copy Playable	226
Loading a Song from External Disks using Song Archive Extract	227

Drive Select	228
Hard Drive Maintenance	229
Drive Initialize	229
Drive Check.....	230
Check Drive Reliability using Surface Scan	231
Backup Options	232
DAT Backup.....	232
External Removable Drive.....	232
CD-R Backup	232
Chapter 18 CD-R Backup	233
CD-R Backup and Recover	233
Before Using the CD-RW drive.....	233
Items Necessary for CD-R Backup	234
Inserting a CD 	234
If a disc tray does not open 	234
CD-R Backup	235
CD-R Recover	236
Chapter 19 Using a DAT Recorder (DAT Backup)	238
Before Backing Up to DAT	238
Items Necessary for DAT Backup.....	238
About the Devices Used in DAT Backup	238
Saving Song Data to DAT (DAT Backup).....	239
Recovering Data from a DAT	241
DAT Recover.....	241
Canceling the Recover Operation.....	242
Checking DAT Tape Contents	242
DAT Backup Verification.....	243
Chapter 20 Compatibility with Other VS Recorders	245
Drive Compatibility	245
VS-1680, VS-880/880EX, VS-890 or VSR-880 → VS-1824	245
VS-1824 → VS-1680, VS-880/880EX, VS-890 or VSR-880	245
VS-840/840EX ↔ VS-1824	245
Song Import.....	246
Song Export	247
Chapter 21 System and Global Settings.....	249
System Settings for Each Song	249
Fader Match	249
Peak Hold.....	250
Remaining Recording Time.....	250
Foot Switch Settings.....	251
Global Settings	251
Shift Lock.....	251
Numerics Type	252
Measure Display.....	253
SCSI ID Number.....	254
IDE Drive Switch.....	254
Input Peak Level.....	255
Previous/Next Switch.....	255
Adjusting the Button Sensitivity	256
Fan Control	256
Removing a Direct Current Offset from the MIX Bus	257
MIDI Model ID	257

Play and Record Settings	258
Record Monitor.....	258
Marker Stop.....	258
Fade Length	259
Scrolling the Waveform Display.....	259
Alarm Clock.....	260
 Chapter 22 Specific Applications	 261
Syncing Two VS-1824s or a VS-1824 and a VS-1680 with MTC and MMC.....	262
Settings for the Master VS.....	262
Settings for the Slave VS.....	263
Syncing a VS-1824 and VS-880/880EX or VSR-880	263
Syncing the VS-880 to the VS-1824 Using MTC and MMC	263
Using an External MIDI Device to Control the Mixer (Compu Mix)	265
Correspondence Between MIDI Channels and Controller Numbers.....	265
Preparations for Compu Mix.....	266
Recording with Compu Mix.....	267
Synchronizing with Video Equipment	267
Using External Effects Units.....	268
 Chapter 23 Frequently Asked Questions.....	 269
How Do I Control the Stereo Tracks Independently?	269
Why Do I Hear the Inputs All of the Time?	269
What is the FADER/MUTE Button Used For?.....	270
How Do I Burn Audio CDs?.....	270
How Do I Create a Tempo Map?	272
How Do I Use Automix?	272
How Do I Create a User Template in EZ Routing?.....	273
How Do I Bounce Tracks?.....	274
How Do I Bounce Tracks with Effects?.....	275
Why Can't I Hear My Effects?.....	275
How Do I Use the Scrub and Waveform Display Features?.....	276
How Do I Record a Stereo Signal?.....	277
How Do I Restore the Mixer Parameters to the Factory Settings?.....	277
How Do I Know How Much Time I Have Left On My Hard Drive, and How Big Is My Song?	277
How Do I Import VS-1680, VS-880/880EX, VS-890/VSR-880 and VS-840/840EX Songs?.....	278
 Index.....	 279

Preparations

About the Package Contents

The following items are included with the VS-1824. Please check to make sure you have all the items.

- VS-1824
- AC cord
- Demo disc
- Blanc CD-R disc (VS-1824CD only)
- User Guide
- Owner's Manual (this manual)
- Appendices
- Shortcut Seal
 - * *This shows the list of shortcut commands.*
- Overlay Sheet
 - * *If you change setting of buttons and faders of track mixer to "1880 mode." It will be convenient to confirm function assignment with the overlay sheet. As the back side of this is adhesive, you can stick it to the top panel. See "Change settings of the Track Mixer Buttons and Faders (Fader Mode)" (p. 75) for detailed explanation of change setting.*

Main Features

The Latest in Compact Home Studio Environments

The VS-1824 retains all of the features of Roland's VS-1880 Digital studio workstation, a revolution in the world of the home studio, with the disk recorder, digital mixer, and multi effects systematically integrated into a great sounding digital recorder. From when you start picking mics to when you actually record; from mixdown, to adding effects, and on to creating the master data for playing through a PA or mastering on a CD; you can easily control every aspect of the recording process with the VS-1824 in your home studio.

Disk Recorder Section

- The digital disk recorder section provides 18 playback tracks, and allows eight tracks to be recorded simultaneously. Each track features 16 virtual tracks (V-Tracks), providing a total of 288 tracks altogether. This means that you can record multiple takes, make temporary mixes when editing and create songs that require numerous tracks, all with room to spare.
- The VS-1824's recording functions were designed for use with professional digital equipment—DAT recorders, digital mixers, digital effects, etc. You can record and edit with top-quality sound, losing none of that quality in the playback.
- You can instantly find the location of sections in a song you want to hear repeatedly (locator), or places that you wish to record over by placing marks at these points (marker). These markers are recalled by a simple procedure, and you will never have to wait for any rewinding or fast-forwarding.
- Sounds are organized in phrases. Copying, moving, and inserting these phrase units (using Phrase Edit), as well as many other editing processes, are possible with the VS-1824. For example, you can create "break beats" by copying a four-measure drum pattern any number of times, or have the same chorus both at the beginning and end of a song.
- You can cancel and recover up to 999 previous recording and editing operations (Undo/Redo).
- The internal clock runs on battery power, so it continues to function even after the VS-1824's power is turned off. This allows you to manage your songs by "time stamp," the time and date of recording that is registered in the song data.

Digital Mixer Section

- You can store all mixer settings, including fader levels, pan, and effects. Stored settings can be recalled very simply, a convenient feature when adjusting balances during mixdown and comparing mixes with effects.
- Changes in settings over time, such as fader levels and pan, can also be stored (Automix), allowing you to perfect fade-ins and fade-outs in your mixes.
- You can easily set up the VS-1824 for different situations such as recording, track bouncing, and mixdown using its handy EZ Routing feature.

Effects Section

- One effect expansion board, VS8F-2 is pre-installed in the VS-1824. Up to two of these effect expansion boards can be installed in the VS-1824. With the VS8F-2 effect installed in the VS-1824, up to four high-quality stereo effects will be available for your use.
- The VS8F-2 provides not only basic effects such as reverb and delay, but also effects ideal for vocals and guitar (such as guitar amp simulator) and even special effects such as RSS and Roland's exclusive COSM™ speaker modeling that you can use when the VS-1824 is connected to digital speakers such as Roland's DS-90A Powered Monitors. These effects are organized as 34 "algorithms" from which you can easily create new sounds.
- The VS8F-2 provides 240 read-only effects, or "preset patches," that are designed for various uses. In addition, the VS8F-2 provides 200 read-and-write effects, "user patches," that can be customized and re-saved. As a result, you can instantly switch between a wide variety of effects simply by selecting a preset or user patch.

Simple Operation

- The VS-1824 can be operated as easily as a conventional multitrack recorder. You will be able to enjoy all of the advantages of a home studio from the day of purchase.
- The VS-1824 uses the well-known graphics ("icons") made famous by Roland's VG-8 and V-Drums. The large, full-dot graphic display is backlit and inclined, so it is easy to read when used on stage, or wherever high visibility is required.

Connectivity

- A wide variety of connectors and jacks are provided, including two balanced XLR connectors. The VS-1824 features a wide input sensitivity range—from mic level (-50 dBu) to line level (+4 dBu)—and phantom power, allowing you to plug in condenser mics that require external power.

- There are six sets of balanced input jacks, handling a wide input sensitivity range, from line level (+4 dBu) to mic level (-50 dBu). Furthermore, you can choose either the high-input (GUITAR (Hi-Z)) jack for directly plugging in an electric guitar, or the INPUT 8 jack.
- Besides the RCA phono type (stereo) MASTER jacks, (stereo) AUX A and AUX B jacks, and (stereo) MONITOR jacks are also provided. You can monitor an effect send and other outputs without affecting the MASTER Out in any way.
- The VS-1824 provides both coaxial and optical digital I/O connectors. With these, you can digitally connect the VS-1824 to popular consumer electronic devices such as CD players, DAT recorders, MD recorders, and so on.
- A SCSI connector (DB-25 type) is also provided, allowing you to connect the VS-1824 to external SCSI devices such as a Zip drive or CD-R drive.
- MIDI IN and MIDI OUT/THRU connectors are also provided. You can synchronize the VS-1824 with an external MIDI sequencer, use the MIDI sequencer to control the VS-1824's mixer, sound an external MIDI sound generator with the metronome, and more.
- Besides tracks for recording audio signals, the VS-1824 has a sync track for storing MIDI clock messages. You can even synchronize MIDI sequencers that are not compatible with MTC (MIDI Time Code) or MMC (MIDI Machine Control).

Major Options

CD-R Drive (approved by Roland):

A CD-R or CD-RW drive connected with a SCSI connector. Such a device allows you to create songs on the VS-1824 and burn them onto your own original audio CDs. Additionally, you can use a CD-R for backing up song data to inexpensive CD-R discs.

VS8F-2:

One VS8F-2 effect expansion board is pre-installed in the VS-1824. Up to two of these effect expansion boards can be installed in the VS-1824 by adding a second, optional VS8F-2 board. With two VS8F-2 effect boards installed in the VS-1824, up to four high-quality stereo effects will be available for your use.

You can add one more VS8F-2 which can supply two stereo effects, so you can use up to a total of four stereo effects.

- * *The VS8F-1 effect expansion board is for use with the VS-880. It cannot be used in the VS-1824.*

Top and Rear Panels

Mixer Section

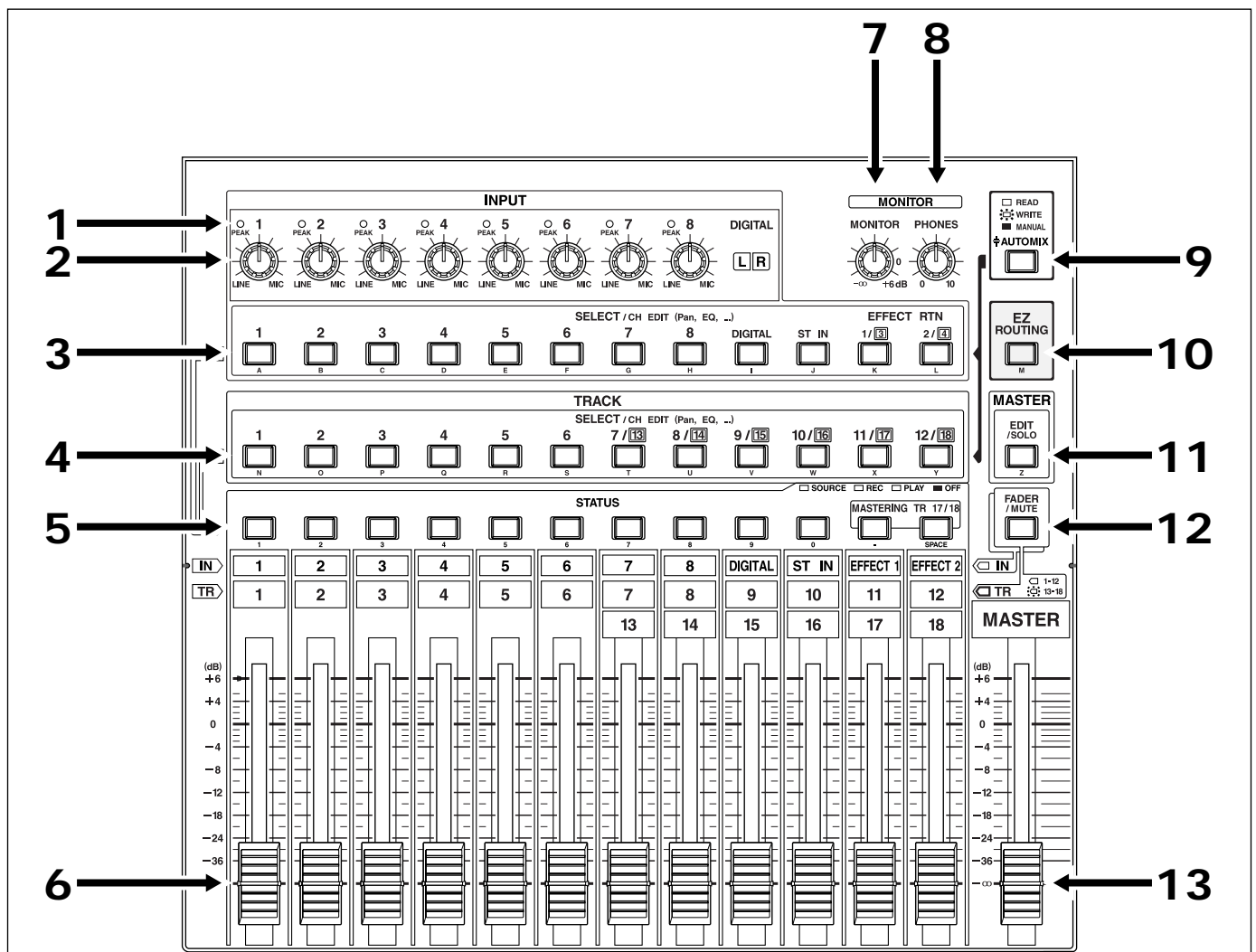

1. PEAK Indicators

Use these indicators to confirm the correct recording level as set with the INPUT knobs. The indicators are set at the factory to illuminate when the input audio reaches 0 dB. You can change the peak level indicator setting so the indicators illuminate when audio reaches -3 or -6 dB. (p. 255)

2. INPUT Knobs

These knobs adjust the sensitivity of the INPUT jacks 1 through 8. Turn the knob fully clockwise for mic level (-50 dBu), or fully counter-clockwise for line level (+4 dBu).

3. SELECT/CH EDIT (Select/Channel Edit) buttons

Use these buttons to change Input Mixer settings for the analog inputs, digital inputs, stereo inputs, and effect returns. The currently selected channel's indicators will light.

1-8: Each input channel (1-8)

DIGITAL: Digital input

ST IN: Stereo in

EFFECT 1/3 RTN: Effect 1/3 Return

EFFECT 2/4 RTN: Effect 2/4 Return

You can assign an input to be recorded to a track by holding down the track's STATUS button, then pressing the desired SELECT button for the input or source you wish to record.

Use these buttons to input alphabetical characters for Song Names, etc., when the [NUMERIC/ASCII] is lit.

4. SELECT/CH EDIT (Select/Channel Edit) buttons

Use these buttons when you wish to change Track Mixer settings and to change track channels. The currently selected channel's indicators are lit.

1–18: Each track channel (1–18)

* *If you want to display track channel 13-18, hold [SHIFT] down and press the SELECT buttons for track channels (13-18).*



You can alter the correspondence between the panel's buttons/faders and the Track Mixer channels. For detailed information, refer to "Change settings of the Track Mixer Buttons and Faders (Fader Mode)" (p. 75).

When you press these buttons while holding down the STATUS button, you can select any desired bouncing destination track.

Use these buttons to input alphabetical characters for Song Names, etc., when the [NUMERIC/ASCII] is lit.

5. STATUS Buttons

These buttons switch the status of each track (p. 42). The current status is shown by the button indicator.

SOURCE (orange):

The input source or track assigned to the channel is being output.

REC (blinking red):

The track is ready to be recorded. When blinking red, previously recorded material on the track will be heard.

REC (blinking red and orange):

The track is ready to be recorded and the source will be heard. This occurs when the VS-1824 is in Record Ready and you press [PLAY], then press the blinking red status button.

PLAY (green):

The track assigned to the channel will play back.

OFF (off):

The channel is muted (silent).

When pressed in combination with the SELECT/CH EDIT button, this selects the source or track to be assigned to a track for recording.

6. Channel Faders

Use these faders to adjust the volume level of each channel or track.

7. MONITOR Knob

This adjusts the volume level output from the MONITOR jacks.

8. PHONES Knob

This knob adjusts the volume of the headphones.

9. AUTOMIX Button

This button switches the Automix function on and off. The button indicator lights when Automix is on.

10. EZ ROUTING Button

This button invokes the EZ Routing screen.

11. EDIT/SOLO Button

Press this button to make block settings for the master section of the mixer.

To use the Solo function to monitor only a specific channel, press this button while holding down the SELECT/CH EDIT button.

12. FADER/MUTE Button

Each press of this button alternately assigns use of the channel faders to the Input Mixer or to the Track Mixer. The button indicator shows the faders' current status. (p. 75)

To mute the channel, press this button while holding down the SELECT/CH EDIT button.

13. Master Fader

Use this fader to adjust the overall output level.

Recorder Section

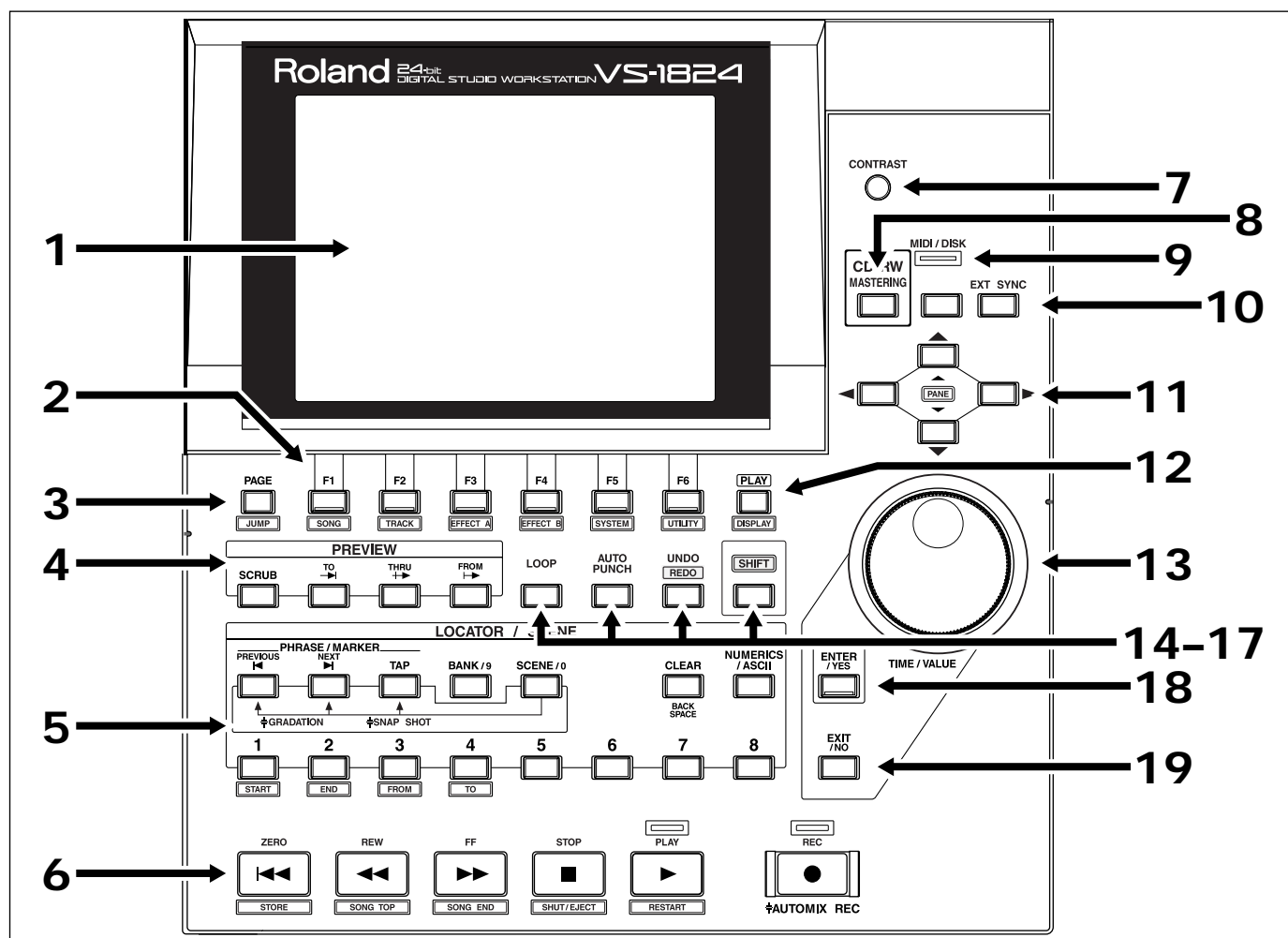

1. Graphic Display

This display shows various data related to the current status of the VS-1824 during recording, playback, editing, changing its settings, and so on.

2. FUNCTION Button

These buttons switch the display screen and execute operations.

The function currently assigned to each button appears at the bottom of the display.

3. PAGE (JUMP) Button

This button switches pages for screens that consist of several pages.

When [SHIFT] is held down together with this button, the Locator Jump screen is displayed.

4. PREVIEW Button

Press this button to use the Preview function that plays back a specific amount of time before and after the current location.

5. LOCATOR/SCENE Button

Pressing this button allows you to store or recall locators and markers or to store or recall Scenes (mixer settings).

PREVIOUS:

Recalls the most recent start or end point of a phrase. Pressed with [SHIFT], this button recalls the previous marker.

NEXT:

Recalls the next start or end point of a phrase. Pressed with [SHIFT], this button recalls the next marker.

TAP:

Press this button to set markers.

BANK/9:

Pressing this with the LOCATOR buttons (1–8) selects the locator bank.

SCENE/0:

This is pressed when storing, recalling, and deleting Scenes.

CLEAR (Back Space):

This button deletes locators, markers, and Scenes.

NUMERICS/ASCII:

Press this when you want to use the STATUS and LOCATOR buttons for entry of alphabetical characters or numbers.

1–8:

These select a locator or Scene.

6. Transport Control Buttons

These buttons operate the recorder.

ZERO: This returns the current time to “00h00m00s00” (zero return).

REW: The current time is moved back only while this button is held down. This corresponds to the rewind button on a tape recorder.

FF: While the button is held down, the current time is moved forward. This corresponds to the fast-forward button on a tape recorder.

STOP: Stops recording or playback of the song.

PLAY: Starts recording or playback from the current time.

REC: Press this button to record a song.

7. CONTRAST Knob

Use this to adjust the brightness of the display screen.

8. CD-RW/MASTERING Button

Press this button to master a song, or to write it on a CD. It also accesses CD backup and restore functions.

9. MIDI/DISK Indicator

This indicator lights green when MIDI messages are being received, and red when data is being written or read on the disk drive. If both occur, the indicator lights orange.

10. EXT SYNC (External Sync) Button

Press this button to designate the VS-1824 or an external MIDI device as the master, or main, controlling synchronization device. With the VS-1824 selected as the master, the external MIDI device functions as the slave unit; with the external MIDI device is selected as the master, the VS-1824 functions as the slave unit.

11. CURSOR Buttons

Normally (i.e. in Play mode), these buttons are used to select the time resolution for changing location using the TIME/VALUE dial. When making settings (i.e. in Edit mode), use these buttons to select parameters.

12. PLAY (DISPLAY) Button

Press this button to return to the screen that appears when the VS-1824 is first turned on (normal playback status).

13. TIME/VALUE Dial

In normal (playback) mode, this dial adjusts the current time for playback. When making settings (i.e. when editing), use this dial to change parameter values.

14. LOOP Button

This button turns Loop Recording on and off. Pressed together with first 1 and then another Locator button, it specifies the range to be recorded in Loop Recording.

15. AUTO PUNCH Button

This button turns Auto Punch-In Recording on and off. Pressed together with first 1 and then another Locator button, it specifies the range to be recorded in Auto Punch-In Recording.

16. UNDO (REDO) Button

Press this button to cancel a recording or editing step that you have made (Undo function). Pressed with [SHIFT], this button cancels the last Undo operation (Redo function).

17. SHIFT Button

This button is pressed in conjunction with other buttons to access additional functions of those buttons.

18. ENTER/YES Button

This is pressed to execute the current operation or select the current screen.

19. EXIT/NO Button

This is pressed to cancel the current operation or exit the current screen.

Rear Panel

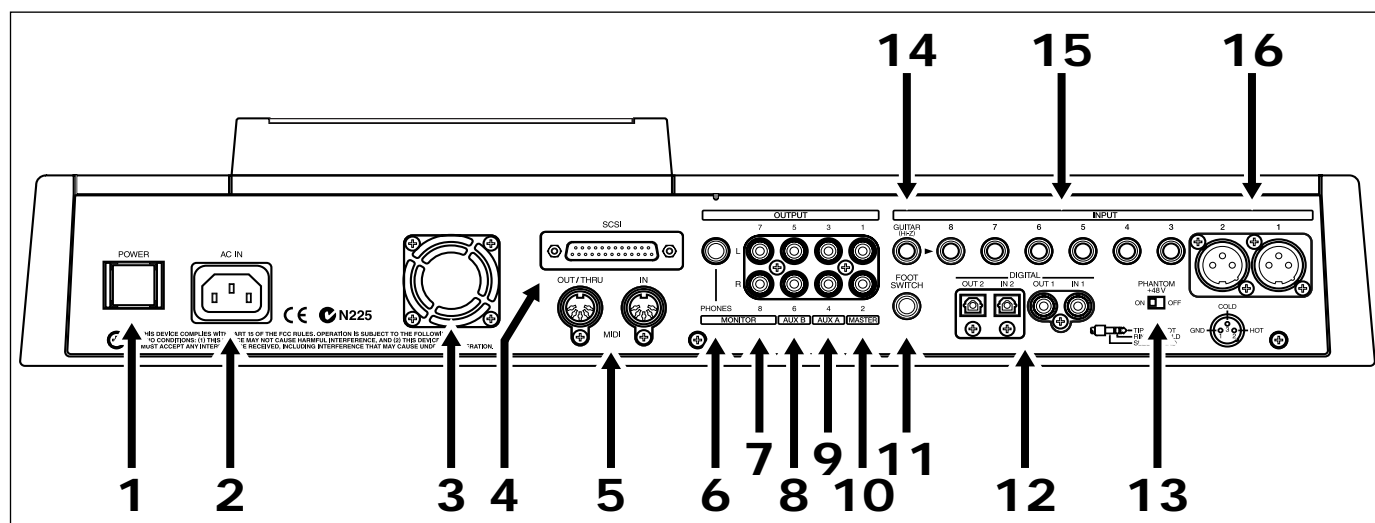

1. POWER Switch

This switch turns the VS-1824's power on and off. See *Chapter 2*.

2. AC IN (AC Inlet)

Connect the included power cable here.

3. Cooling Fan Exhaust

The VS-1824 is equipped with a cooling fan, which prevents overheating of the VS-1824's electronics. Heat from inside is expelled here.

NOTE

Do not place any object in a position where it would block the cooling fan's exhaust or hinder the movement of air. This will defeat the normal cooling action of the fan.

4. SCSI Connector

This is a DB-25 type SCSI connector for connecting SCSI devices, such as an external hard disk, removable media, or a CD-R.

5. MIDI Connectors (IN, OUT/THRU)

Connect external MIDI devices (MIDI sequencers, MIDI controllers, etc.) here.

IN: This connector receives MIDI messages. Connect it to the MIDI OUT connector of an external MIDI device.

OUT/THRU: This connector can be used either as a MIDI OUT or as a MIDI THRU jack. With the factory settings, it will function as a MIDI OUT connector, which means it is set to transmit MIDI messages generated by the VS-1824.

6. PHONES Jack

Connect your headphones (not supplied) here. The PHONES jack outputs the same signal as the MONITOR jack, and is affected by the monitor level and both the MONITOR level and the PHONES level knobs.

7. MONITOR Jacks (L, R)

RCA-phono-type analog audio output jacks. With the factory settings, all signals output from the MASTER OUT jacks also output from the MONITOR jacks. This is determined by the block settings of the mixer's master section and the settings of each channel.

8. AUX B Jacks (L, R)

9. AUX A Jacks (L, R)

RCA-phono-type analog audio output jacks. With the factory settings, there is no output from either the AUX A or the AUX B jacks. The output is determined by the block settings of the mixer's master section and the settings of each channel.

10. MASTER OUT Jacks (L, R)

RCA-phono-type analog audio output jacks. With the factory settings, all signals are output from the MASTER OUT jacks. The output is determined by the block settings of the mixer's master section and the settings of each channel.

11. FOOT SWITCH Jack

An optional foot switch (such as the DP-2 or the BOSS FS-5U) can be connected here when you want to control recorder operations, mark point settings, and punch in/out operations, etc. with a foot switch. With the factory settings, a foot switch is set to start and stop the recorder.

12. DIGITAL Connectors (IN, OUT)

The VS-1824 accepts both coaxial and optical digital I/O connectors (conforming to S/P DIF).

- IN:** This accepts a stereo digital audio signal. You can select either the coaxial input connection or the optical connection.
- OUT:** This outputs a stereo digital audio signal. You can use both the coaxial connector and the optical connector simultaneously, and each can carry a different signal.



S/P DIF (Appendices p. 13)

- * Before recording a digital audio signal, certain system settings must be made. To input a digital signal, refer to “Recording a Digital Source,” p. 66
- * The digital connectors cannot input or output analog audio signals.

13. PHANTOM Switch

This turns phantom power (+48 V) on and off. With the factory settings, this is set to “Off.”



Phantom Power (Appendices p. 13)

- * Supplying phantom power to dynamic microphones or audio playback devices may result in damage to your equipment. Thoroughly read the owner’s manual of your microphone, and make sure that the phantom power switch is set to “Off” unless you are using a condenser mic that requires phantom power.
- * Switching the phantom power on or off while the VS-1824 is turned on produces a loud noise that can damage amps and speakers. Turn the phantom power on or off only when the VS-1824 is turned off.
- * When nothing is plugged into the INPUT 1–2 jacks, make sure that the phantom power switch is set to “Off.” Also, we recommend that the INPUT knob be turned fully to “LINE” to capture as high a sound quality as possible.

14. GUITAR (Hi-Z) Jack (Guitar)

This 1/4” phone-type high-impedance jack is designed to work best with a guitar, for less interference and a louder, cleaner signal. It can be used instead of—but not at the same time as—the regular INPUT 8 jack. If cables are connected to both the GUITAR input and the regular INPUT 8 jack, the GUITAR jack will take priority. Use the INPUT 8 knob to adjust the input sensitivity of this input.

15. 1/4” INPUT Jacks (3-8)

Inputs 3 through 8 may be used as 1/4” phone-type TRS (Tip Ring Sleeve) balanced connections, or as 1/4” phone-type unbalanced connections, depending on the jack and cable used. Use INPUT knobs 3-8 to adjust the input sensitivity of these inputs.

16. XLR Balanced Inputs

Inputs 1 and 2 are XLR balanced connections. Use INPUT knobs 1 and 2 to adjust the input sensitivity of these inputs.

Front Panel VS-1824CD

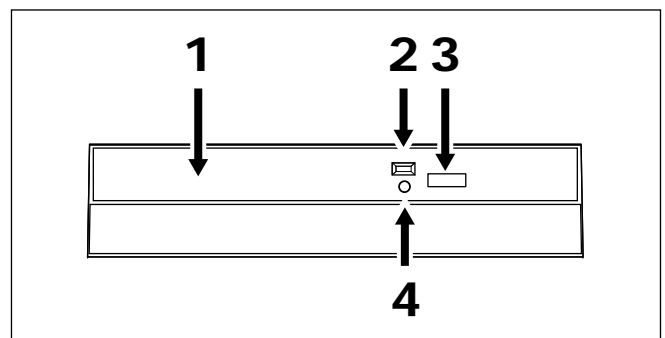

1. Disc Tray

Place the CD to be loaded on this tray.

2. Access Indicator

This indicator will light when the inserted CD is being read or when data is being written to the CD.

3. Eject Button

This button opens or closes the CD disc tray.

4. Emergency eject hole

This hole allows the disc tray to be opened in case of an emergency. See “If a disc tray does not open,” p. 234.



NOTE
It is strictly restricted to eject tray using emergency eject hole during VS-1824 is operating. This is cause error of software.

Chapter 1 Before You Start (VS-1824 Terminology)

This chapter explains the basic concepts, internal structure, and basic procedures that you will need to know in order to operate the VS-1824. Please read this chapter thoroughly to gain a better understanding of the VS-1824.

Saving and Managing Data

The VS-1824 saves all of the data, such as performance data, mixing data, system data, etc., on a hard disk drive.



The internal hard disk is not removable.

Managing Disk Contents (Partitioning)

The internal hard drive has 5 partitions. The size of each partition is 2000 MB. If you would like to change partition size, please refer to drive initializing on p. 229.

The VS-1824 is able to manage 500 MB, 1000 MB or 2000 MB of disk space at once. If you use a disk drive with a capacity that is greater than this, you will need to divide it into two or more areas.

Each of these area is referred as a “partition.” Up to eight partitions can be created in a single disk drive.

Ex. 1: When the disk drive is 10 GB, and the partition size is 2000 MB.

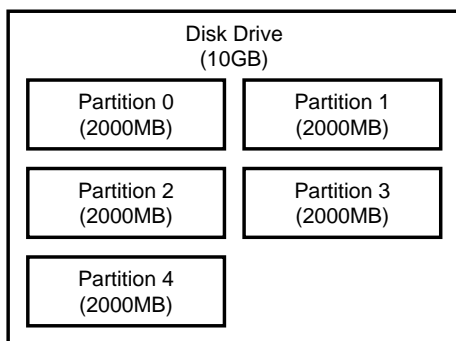

Ex. 2: When the disk drive is 10 GB, and the partition size is 1000 MB.

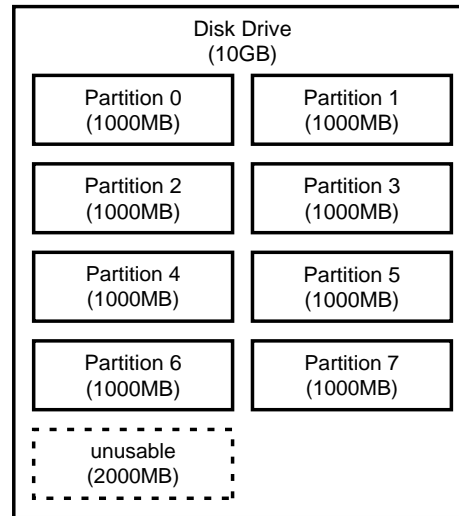

Each partition on the VS-1824’s disk drive is treated as an independent drive, and automatically given a partition number (0–7). When a single hard disk has multiple partitions, you can specify which partition drive will be used (“Drive Select,” p. 228). This selected disk drive partition used is referred to as the “current drive.”

* *If you wish to use hard disks or song data with both the VS-1824 and the VS-880/1680/880EX/890/VSR-880, there will be limitations as to what you can do due to factors such as differing partition sizes and numbers of tracks. For more detailed information, please see “Drive Compatibility,” p. 245.*

VS-1880’s song data is identical to that of the VS-1824.

The Location Where a Performance is Recorded (Song)

The location where performance data is recorded is referred to as a “song.” For example, on a cassette MTR, this would correspond to a cassette tape. Up to 200 songs can be created in each partition. Normally, you should set the partition size at 2000 MB. When dealing with large numbers of songs at the same time, or when you want to use the data on the VS-880 as well, setting the partition size to 1000 MB is recommended. The song currently being recorded, played back, or edited is referred to as the “current song.” The following types of data are included in a song.

- All data recorded on V-Tracks
- MIDI clocks of the sync track
- Points specified within songs—locator, marker, punch-in/out points, loop-in/out points
- Scenes (mixer settings)
- Vari Pitch settings (p. 195)
- System settings—system, MIDI, disk, sync, Scene
- Effect settings
- Automix data

Sources, Tracks, and Channels

On the VS-1824, the recorder section and mixer section use the term “sources,” “tracks” and “channels.” These terms may appear similar to each other, and can be confusing unless their differences are clearly understood.

Source: A signal which is input to the mixer section or recorded in the recorder section. On the VS-1824, this term refers in particular to the signals of the analog INPUT jacks (1-8) and the DIGITAL IN connector.

Track: A signal that is being input to or output from the recorder section. It also refers to the location to which a signal is being recorded or played back from the hard disk.

Channel: A signal that is being input to or output from the mixer section. This term refers in particular to the faders and buttons of the mixer section on the top panel.

Takes and Phrases

On the VS-1824, data is managed in groups called “takes,” and “phrases.” Please take a moment to make sure you understand the differences between these terms.

Takes: The data recorded to the disk is simply called a “take”—a take is actually your audio data recorded on the hard disk, along with time stamp (time and date imprint) information. Each recording is a take. Note that when you record material onto a track that already contains a take, the VS-1824 does not discard the earlier take.

Phrases: A “phrase” is a set of pointers that tells the VS-1824 what portion of a take is to be played by a track. The length of a phrase may just be the entire length of a take, or may consist of only part of a take. Also, you can use any number of phrases from the same take, and have a phrase played back repeatedly as a sort of “break beat.” This is displayed as one box in the playlist.

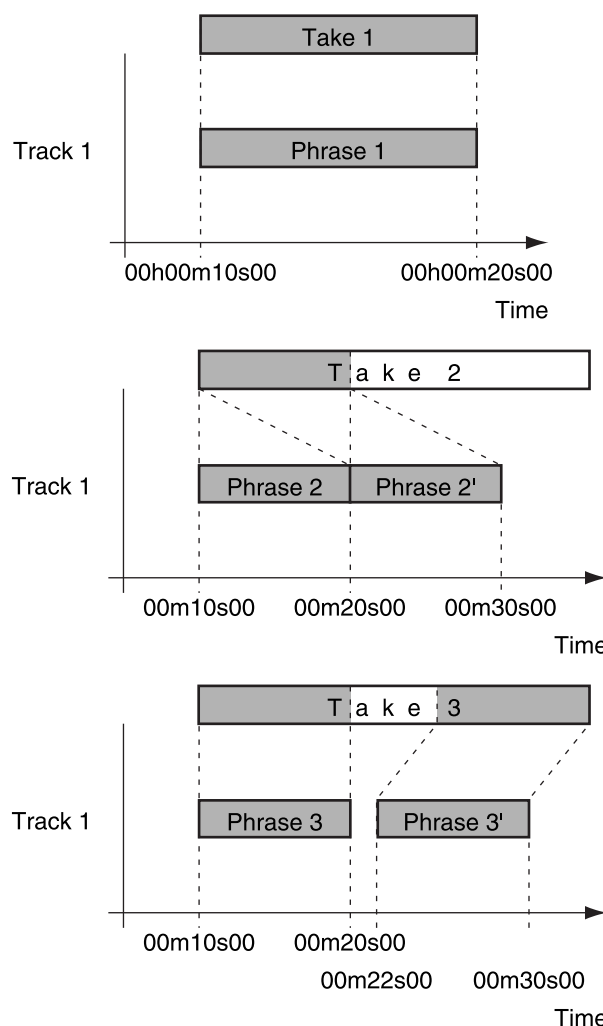

About Events

The smallest unit of memory used by the VS-1824 to store recorded information on disk is called an “event.” A newly created song is provided approximately 18,000 events.

For each track, one recording pass uses two events.

Operations such as punch-in/out or track copy also use up events. The number of events that are used up will change depending on what you are doing. For example, Automix (p. 124) uses up six events for each marker.

Even when your disk has ample free space, one song can use up all the available events, in which case no more data can be recorded to the song.

The remaining number of Events can be saved with the following procedures. Please use the most appropriate procedure for your situation.

Execute Song Store (p. 33)

Use Execute Song Store if the UNDO indicator is lit. Events served for Redo will be released. But please note that you cannot cancel, or redo, the last Undo you once execute this operation.

Execute Song Optimize (p. 218)

Execute Song Optimize if you have done a lot of punch-in recording. Events used for now-unnecessary audio data will be released. But please note that you lose all but one level of Undo after you Optimize.

Erase AutoMix data (p. 138)

If you have recorded AutoMix data, erase unnecessary data. Events used for unnecessary AutoMix data will be released.

About Button Names

There are two groups of buttons referred to as SELECT/CH EDIT (Select/Channel Edit) buttons.

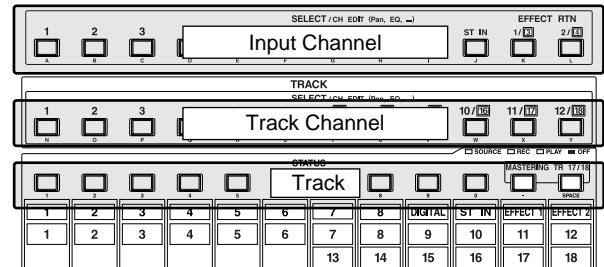

Mixer Section

The digital mixer specifies input or output status of the recorder section.

The VS-1824's mixers include the Input Mixer—which, in the signal path, is situated before the recording section—the Track Mixer, placed after the recording section, and the Master Block, which is used for determining which jacks and connectors output the signals from each of the other mixers.

* For more detailed information about the mixer section, please refer to the "Mixer Section Block Diagram" (Appendices p. 128).

Signal Flow (Busses)

On the VS-1824, signals flow through busses. Busses are shared pathways through which multiple signals can be sent to various tracks or channels. It may be easier to understand this if we use the analogy of water pipes.

For example, the water that is supplied by the water company to your house is branched to a variety of locations within the house (kitchen, bathroom, etc.). The water that is used at each of these locations is then collected and carried away.

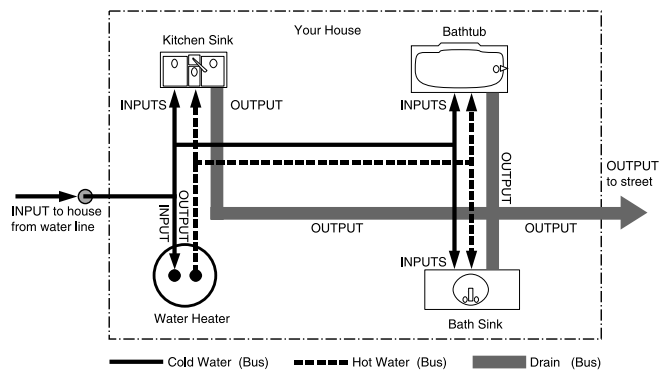

If we think of the VS-1824 as the house, the water being supplied from the water company corresponds to inputs such as mic or guitar. Some of these inputs are sent to recording tracks and are recorded. Other portions are sent to the effects, and reverb or chorus are applied before they are output.

The basic principle of the VS-1824 is that by specifying from where—and to where—the common lines run, you can determine which signals will be recorded on which track or sent to which effects, and to where they will be output.

RECORDING Bus:

Signals assigned to the RECORDING bus are routed to the recorder section to be recorded. The RECORDING bus has eight channels to which you can assign any output of the Input Mixer, Track Mixer, and effects (effect return). Signals assigned to the RECORDING bus cannot be routed to the MIX bus.

MIX Bus:

Signals assigned to the MIX bus are sent to the MASTER jacks for monitoring. It has two channels (L and R), and can take output signals from the Input Mixer, Track Mixer, and effects (effect return). Signals assigned to the MIX bus cannot be routed to the RECORDING bus.

EFFECT Bus:

Signals assigned to the EFFECT bus are sent to the VS8F-2 in order to add effects to them. The EFFECT bus has four channels—FX1 L/R, FX2 L/R—and can process signals from the Input Mixer and the Track Mixer. Signals assigned to the RECORDING bus, as well as the MIX bus, can also be routed to the EFFECT bus.

AUX Bus:

Signals assigned to the AUX bus are routed to the AUX jacks to provide addition mixes for monitoring. This bus features six channels (AUX1 L/R, AUX2 L/R, AUX3 L/R), and can take signals from the Input Mixer and the Track Mixer. Signals assigned to the RECORDING bus as well as the MIX bus can also be routed to the AUX bus. This is convenient if, for example, you want to connect an external effects device, or when you want an additional output separate from that of the MASTER Out jacks (an individual out).

EFFECT bus and AUX bus

If the VS-1824 contains two VS8F-2s, AUX bus (AUX1 L/R, AUX2 L/R) serves as EFFECT bus (FX3 L/R, FX4 L/R).

Input Mixer

The Input Mixer is placed before the recorder section, and corresponds to the input jacks: INPUT 1–8, DIGITAL IN L/R.

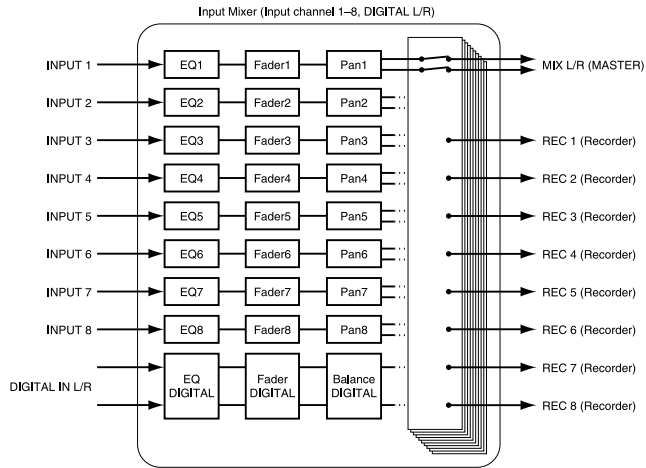

The output of each input channel is assigned to the track on which it is to be recorded. Channels not assigned to tracks are output directly from the MASTER jacks. Also, signals assigned to tracks when the tracks are not in Record Standby (STATUS indicator blinking red) are also output from the MASTER jacks. At this time, the following signals are assigned to the channel faders.

- Channels 1–8:** INPUT jacks 1–8
- DIGITAL:** DIGITAL IN connector L/R
- ST IN:** Sources assigned to STEREO IN (p. 196)
- EFFECT 1/3 RTN:** FX1 return level or FX3 return level
- EFFECT 2/4 RTN:** FX2 return level or FX4 return level

Track Mixer

The Track Mixer is placed after the recorder section, and corresponds to Tracks (1–18).

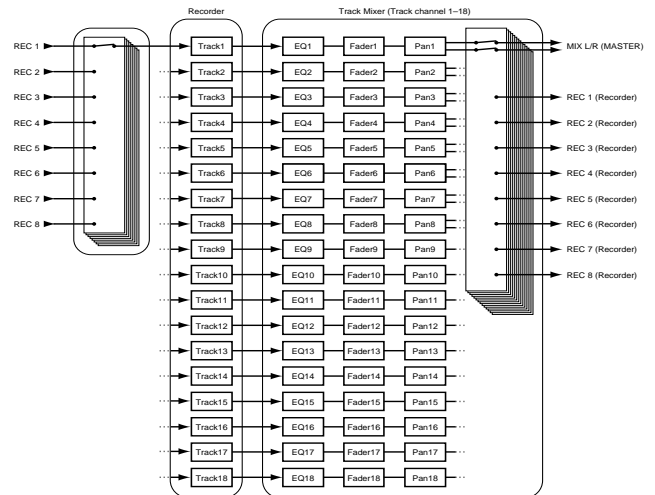

All of the tracks are output from the MASTER jacks. Additionally, tracks can also be routed back to the RECORDING bus for overdubbing, or re-recording. The channel faders 1–18 correspond respectively to Tracks 1–18.

Switching the Fader Functions

On the VS-1824, it is possible to adjust Input Mixer or Track Mixer settings by switching the function of the channel faders on the top panel.

Pressing [FADER/MUTE] on the top panel toggles the function of the channel faders between controlling the Input Mixer and the Track Mixer.

For more detailed information, please see “FADER/MUTE Button,” p. 71.

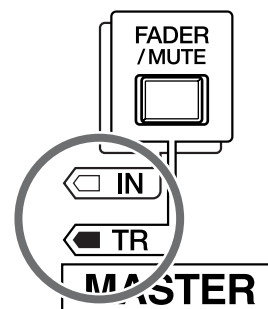

Master Block

This selects the jacks or connectors—which are connected to external equipment—to which the output of each mixer is sent.

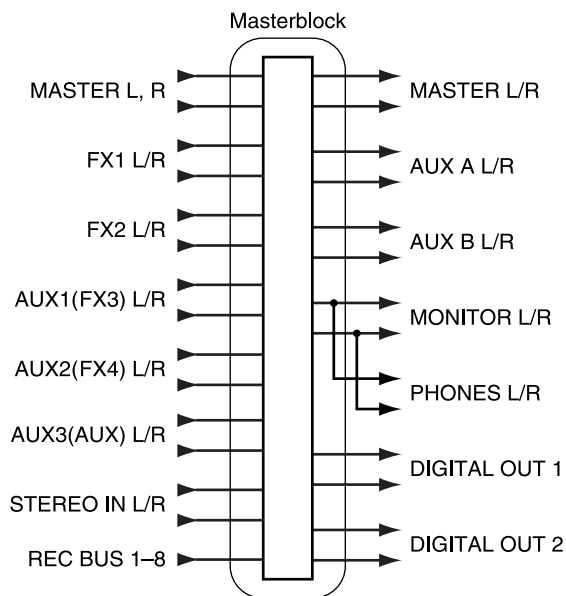

Recorder Section

Differences from a Tape-Type MTR

Unlike DAT recorders, which use tape, digital disk recorders record performances (that is, sounds) on a disk, as do MD recorders. Music that is recorded on disk can be recalled and played back immediately, no matter where it is located on the disk. This is obvious from the difference in speed with which you can move to the beginning of a song on the VS-1824 as opposed to a DAT recorder.

The ability to freely move to data regardless of the time or sequence at which it was recorded is known as “random access.” By contrast, having to move to data in the order of the time or sequence at which it was recorded is known as “sequential access.”

● random access

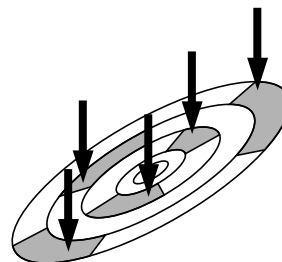

● sequential access

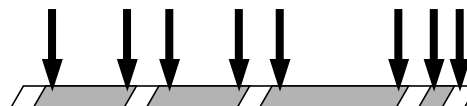

Track Minutes and Recording Time

With cassette tape recorders, the amount of time you can record on a tape is predetermined by the length of that tape. Moreover, any unused portion of the tape is wasted.

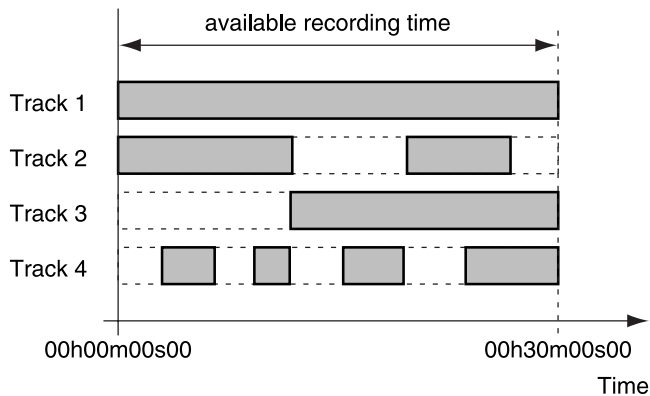

In Case of Tape Recording (using 30-minute tape)
By contrast, with disk recording, although the available recording time is determined by the amount of disk space, only the disk space used for recording is spent. Thus, depending on the number of concurrent tracks and phrases you record, the amount of available recording time will vary. Therefore, it is a good idea to have a standard unit of measurement that corresponds to the time of one continuous monaural signal being recorded on one track. This unit is referred to as a “track minute.”

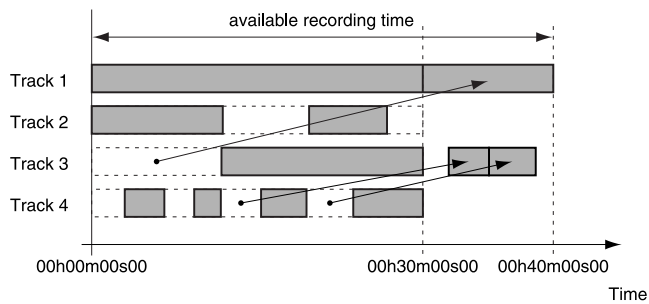

In Case of Disk Recording

For example, 10 track minutes can be used for 10 minutes of monaural recording—this corresponds to the term’s basic definition— or for five minutes of stereo recording since it uses two tracks, or two minutes and 30 seconds of recording on four tracks, and so on.

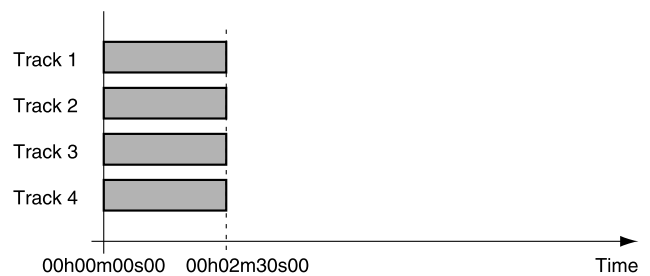
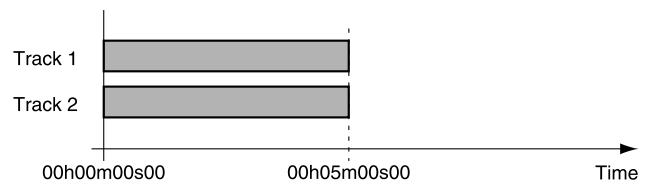
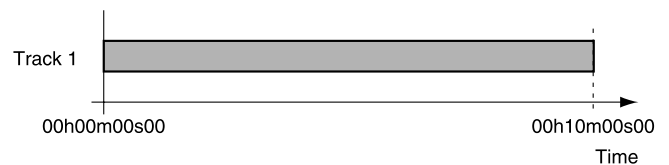

Auxiliary Tracks for Each Track

The VS-1824 provides 18 playback tracks. Each track contains 16 of its own supplementary tracks that can be used for recording or playback. In other words, you can record performances containing up to 288 (18 tracks x 16 tracks). On each of the 18 tracks, any one—and only one—of its supplemental tracks can be playing back at any given moment. These auxiliary tracks are called “V-Tracks.”

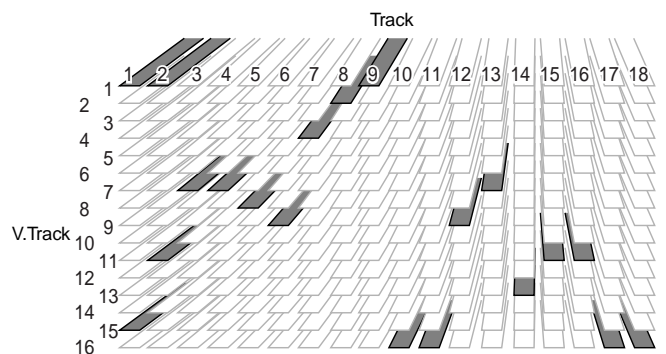

* *The Appendices (p. 130) provides a blank virtual track sheet to help you keep track of your virtual track recordings. Feel free to copy the sheet to use when you record.*

Effects Section

About the Effect Expansion Board

One VS8F-2 effect expansion board is pre-installed in the VS-1824. Up to two of these effect expansion boards can be installed in the VS-1824. With an additional VS8F-2 effect installed in the VS-1824, up to four high-quality stereo effects will be available for your use.

With just a single VS8F-2 installed, you will be able to use EFFECT A (FX1/2). With two VS8F-2s installed, you will be able to use both EFFECT A (FX1/2) and EFFECT B (FX3/4).

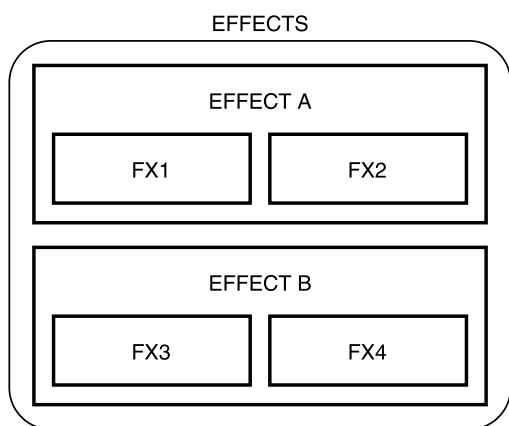

* To install a VS8F-2, please refer to "Installing the Effect Expansion Board" (User Guide p. 6, 9).

Connecting Effects

On the VS-1824, there are two ways to connect the effects devices. Please read and understand these differences described below.

Insert:

The channel's signal is re-directed into and out of the effect between the channel's equalizer and fader, or before the Master fader. Connect an effect in this manner if you want it to change the characteristics of the sound itself, such as when using distortion or overdrive effects or dynamics processing such as compression or vocal multi-effects.

When inserting an effect into one of the channels or into the Master Block, the effect cannot be used in another channel. For example, if you insert FX1 into Channel 1, then no other channel can access FX1.

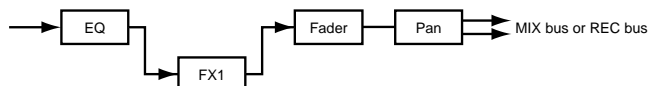

Loop:

Besides the RECORDING bus and the MIX bus, the output of each channel can also be sent to the EFFECT bus. Use this routing with effects such as reverb and delay, when you want to mix the original un-effected, or "dry," sound with the sound after effects have been applied.

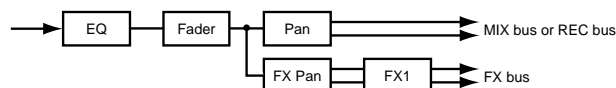

* The VS8F-1 effect expansion board is for use with the VS-880. It cannot be used in the VS-1824.

Chapter 2 Basic Operation

The explanations in this manual include illustrations that depict what the display typically shows. Note, however, that your unit may incorporate a newer, enhanced version of the system software, so what you actually see in the display may not always match what appears in the manual.

Turning the Power On and Off

Turning On the Power

* Once the connections have been completed (User Guide p. 12), turn on the power to your various devices in the order specified. By turning on devices in the wrong order, you risk causing malfunction and/or damage to speakers and other devices.

* Always make sure to have the volume level turned down before switching on the power. Even with the volume all the way down, you may still hear some sound when the power is switched on, but this is normal and does not indicate a malfunction.

1. Turn on the power with the POWER switch on the rear panel of the VS-1824.

* When you turn on the power of the VS-1824, the drive must be recognized and certain required data must be loaded. Thus, it takes a moment for the unit to finish booting up.

When the VS-1824 starts up properly, the following display will appear.

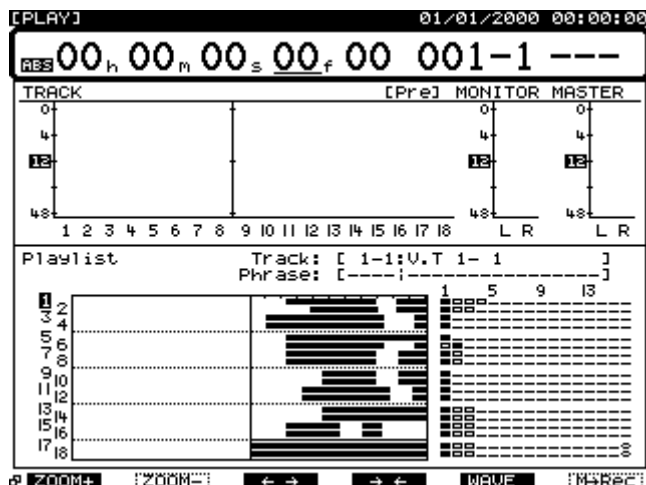

2. Turn on the power of connected audio equipment.
3. Raise the volume of the audio devices to appropriate levels.

Turning Off the Power

The contents of any recorded song will be lost if you simply turn the power off. This may also result in damage to the hard drive. To safely turn off the power and be sure your recorded performances are saved, always follow the shutdown procedure when you finish working with the VS-1824.



Shutdown (See Appendices p. 13)

1. Hold [SHIFT] and press [STOP (SHUT/EJECT)].
“SHUTDOWN/EJECT?” appears in the display.
2. Press [ENTER/YES].
“STORE Current?” appears in the display.
3. If you wish to save the current song, press [ENTER/YES]. If you do not want to save it, or if you do not want to save any changes to the song since the last time you turned on the VS-1824 or executed a Save procedure, press [EXIT/NO].
4. When shutdown has been completed properly, “PowerOFF/RESTART” appears in the display.
5. Turn down the volume of your audio equipment.
6. Turn off the power of the audio equipment.
7. Turn off the power of the VS-1824 with the POWER switch on the rear panel.

* After the power is turned off, the momentum of the hard drive may cause it to continue spinning for a short while. Any physical shock to the unit during this time may damage the hard drive. Avoid moving the VS-1824 with a hard drive installed for at least 30 seconds after turning off the power.

Restarting

You can restart the VS-1824 without turning off the rear panel POWER switch. This is convenient for switching disks when working off of a removable drive (such as a Zip drive) connected to the VS-1824's SCSI port.

1. Perform the Shutdown procedure as described in "Turning Off the Power," p. 32.
2. Make sure "PowerOFF/RESTART" appears in the display.
3. Hold [SHIFT] and press [PLAY (RESTART)].
This restarts the VS-1824.

If "STORE Current ?" is Displayed

When you begin various operations, such as selecting a different song or shutting down, the message "STORE Current ?" may be displayed. This message asks whether you wish to save the currently selected song, or any edits or changes recently made to the current song, to the drive.

If you wish to save the song, press [ENTER/YES].

If you want to proceed with the shutdown without saving the song, press [EXIT/NO].

MEMO

If you press [ENTER/YES] in response to the "STORE Current?" message when Song Protect is on, the message "Song Protected" is displayed, and you will be unable to save any changes or edits you made to the song. Before editing a song, turn Song Protect off (p. 48). Otherwise, press [EXIT/NO].

Saving Your Song (Song Store)

Use the Shutdown procedure before turning the power off. If you just turn the power off without using Shutdown, song data could be lost and you could possibly damage your hard drive. When you switch songs or change drives, a message will ask to confirm whether the currently selected song should be saved. Also, the contents of a recorded song can be lost due to unforeseen accidents such as a power failure or power outage. Once lost, the contents of a recorded song cannot be restored to its previous condition. To prevent this from happening, use the following procedure to save your songs on the drive.



Current Song (See Appendices p. 12)

- * *When handling important song data, or when using the VS-1824 for extended periods, we strongly recommend you use the Song Store procedure frequently.*

1. Hold [SHIFT] and press [ZERO/(STORE)].
"STORE OK?" appears in the display.
2. Press [ENTER/YES].

If the song is saved properly, the Playlist display reappears.

If you wish to cancel the STORE command, press [EXIT/NO].

Setting the Internal Clock

The VS-1824 features an internal clock. When you record a performance, a time stamp consisting of the time, day, and month of recording is entered automatically. This allows you to organize recordings by day, time, and order. Use the following procedure to set the time and date in your VS-1824.

* *The internal clock is battery-powered. Once you set this, the values are remembered each time you turn the VS-1824 off. However, if for any reason the time setting is in error, use the same steps to reset the clock.*

1. Hold [SHIFT] and press [F5 (SYSTEM)].

The System menu icon appears.

If the System menu icon does not appear, press [F6 (EXIT)].

2. Press [F2 (DATE)].

If "DATE" does not appear above [F2], first press [PAGE] until "DATE" appears above [F2], then press [F2 (DATE)].

The System Date/Time screen appears.

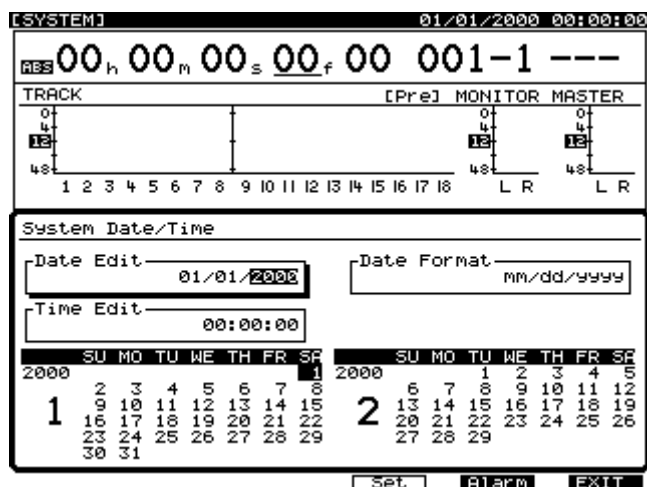

3. Press [▲], [▼], [◀], and [▶] to move the cursor and use the TIME / VALUE dial to change the values for each setting.

Date Edit

This sets the date—year, month, and day—in the Western time format.

Date Format

This selects the way the date is displayed.

mm/dd/yyyy: Month/Day/Year

dd/mm/yyyy: Day/Month/Year

yyyy/mm/dd: Year/Month/Day

MMM.dd'YY: Month/Day/Year

dd MMM 'YY: Day/Month/Year

Time Edit

This sets the current time, displayed in a 24-hour format.

[F4 (Set)]: Sets the date and time.

[F5 (Alarm)]: Sets the alarm function (p. 260).

(F6 (EXIT)): Exits the screen without setting the date and time.

4. After changing the date and time values, press [F4 (Set)] to confirm.

The set time becomes effective immediately.

5. Press [PLAY(DISPLAY)] to return to the Playlist display.

Operating the VS-1824

The VS-1824 features a wide variety of features and settings. They are organized by type, function, operation, etc. Similar functions and operations are grouped together and are referred to as a “mode.” A list of the different modes is described as follows:

Play mode:

The default mode for recording and playback. The VS-1824 defaults to the Play mode whenever the power is turned on.

Input Mixer mode:

Used to make all Input Mixer settings and adjustments.

Track Mixer mode:

Used to make all Track Mixer settings and adjustments.

Master Block mode:

Used to make settings for the mixer’s Master section.

Song mode:

Used to make settings related to song maintenance and organization.

Track mode:

Used to make all track and phrase edits such as Cut, Erase, Copy, etc.

Effect mode:

Used to make changes and edits to the optional internal Effects.

CD-RW mode:

Used for mastering songs and for writing data to CD. In addition, use this mode to perform backups to CD, and to restore data.

System mode:

Used to make overall system settings. These settings will affect the entire operational environment.

Utility mode:

Used for other miscellaneous operations, including those relating to the internal hard drive, as well as external SCSI devices.

Here is a general explanation of some of the buttons used while operating and changing settings in the VS-1824.

Basic Navigation

Adjusting the display Contrast

The text or icon display in the VS-1824’s operation display (LCD) may be difficult to read immediately after the unit is turned on or after it has been used for long periods, or depending on the environment in which the unit is used. If this occurs, rotate the CONTRAST knob to adjust the display contrast.

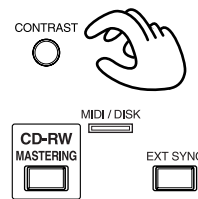

If You Have Trouble Understanding Displays or Operations

If you are unfamiliar with what is displayed on a screen, or you find you are having difficulty understanding a certain procedure, press [PLAY (DISPLAY)]. This allows you to return immediately to the screen that appears when the power is turned on. Then you can try whatever procedure you were working on from the beginning once more.



- If you perform an operation incorrectly or it cannot be executed correctly, an error message may appear in the display. When this occurs, refer to “Error Messages” (Appendices p. 9), and perform the required action.
- If, even after you perform an operation using the prescribed procedure, the result differs from that stated in the User Guide or Owner’s Manual, refer to “Troubleshooting” (Appendices p. 5).

If the above steps do not resolve your problem, contact a nearby Roland Service Center or authorized Roland distributor.

Function Buttons

The function buttons are used for switching the display screen, executing an operation, changing settings, etc. For example, [F4 (Exec)] is used to proceed with (or execute) an edit or command. The function assigned to a function button is displayed directly above it in the LCD. White characters on a black background denote screen-switching functions, and black characters on a white background are used for changing settings and executing operations.

The PAGE (Jump) button

Some screens have more than six functions, and these multiple functions are presented on a number of pages. These screens will show page boxes and page marks. The number of  /  indicates the total number of pages, with the currently selected page indicated by . To switch the display screen to the next group of functions, press [PAGE].

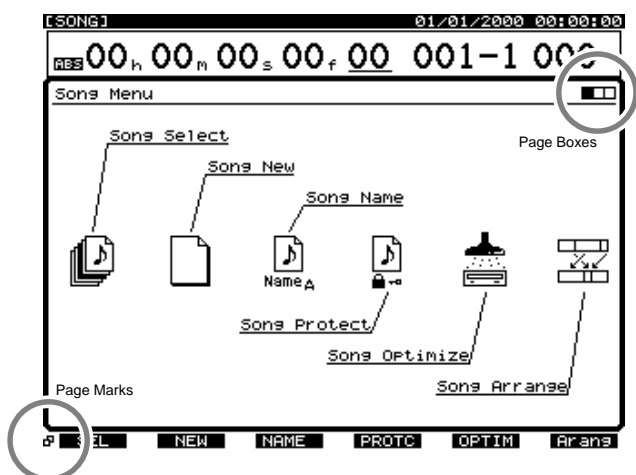

The SHIFT button

Press and hold [SHIFT] whenever you want to use a command indicated on the VS-1824 by a white outlined box with white lettering. For example, to locate to the end of your song using SONG END hold [SHIFT] and press [SONG END] simultaneously.

You can immediately enter some of the VS-1824's operating modes by holding SHIFT and pressing the desired function button, such as [SHIFT] and [F2] to enter the Track mode.

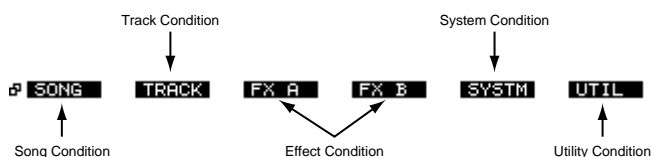

Most [SHIFT] commands are labeled on the VS-1824 front panel.

The SELECT buttons

Press the SELECT buttons for either an input, a track, or an effect return to view its mixer settings. For example, press Track 3 SELECT to see all mixer settings for Track 3. Once in this screen, use one of two methods to move around: you can use the CURSOR buttons located above the TIME/VALUE dial or you can use the FUNCTION buttons.

The CURSOR buttons

The cursor is used to select a parameter on the screen. On the VS-1824, the cursor is indicated by a highlighted parameter. Use [▲], [▼], [◀], and [▶] to move the cursor to the setting you want to change. For example, press Track 8 SELECT. Press [▶] to move the cursor to the MIX setting. Use [◀] and [▲] to move the cursor to the Effects One switch. You may also use the FUNCTION buttons to instantly jump to a setting. The label for each of the FUNCTION buttons appears along the bottom of the display. Press [F1 (PAN)] to move the cursor instantly to the MIX setting. Press [F5 (V.Trk)] to move the cursor directly to the V-Track section.

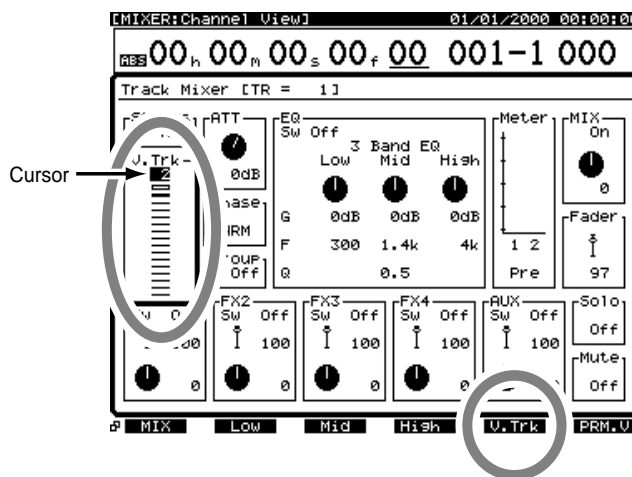

The TIME / VALUE dial

Use the TIME/VALUE dial to change a value on the display. Turning the TIME/VALUE dial counterclockwise decreases a value; turning it clockwise increases it. Value changes are usually in single increment steps. If you hold SHIFT and turn the dial, values will increase or decrease by ten times (or one tenth) the normal rate, depending on the parameter.

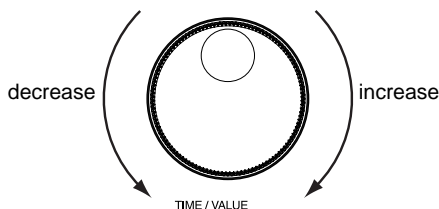

Most value changes can be made while the VS-1824 is playing. However, you must first press [STOP] before changing V-Tracks and before changing mixer Scenes.

[ENTER/YES]

The [ENTER/YES] button is used to respond to an onscreen prompt. For example, if “Store Current?” is displayed, you can press [ENTER/YES] to save your song in its current state. On some screens, [ENTER/YES] will be blinking. In that case, pressing [ENTER/YES] will allow you to view more information than is presently shown on the display. For example, when making changes to the EQ of a track, press the blinking [ENTER/YES] button to see the pop-up EQ curve. To cancel the operation, press [EXIT/NO].

[PLAY (DISPLAY)]

Press [PLAY (DISPLAY)] to return to the startup playlist display. Anytime you are in the middle of making a setting, and you want to get back to the startup screen, just press [PLAY (DISPLAY)]. It also helps to think of [PLAY (DISPLAY)] as an “escape” button.



Mixer and System Initialize

You can restore the default parameter settings of a song. This is convenient when you have made many changes to the Input Mixer, the Track Mixer, the Master Block, as well as changes in the System Menu screens, and you want to quickly restore the VS-1824 to its default settings. This function is called **Initialize System/Mixer parameter**.

NOTE

Even if you restore the settings to their initial state, the song, scene (p. 84), tempo map (p. 202), and sync track (p. 200) data will not be lost. Furthermore, the IDE drive (p. 254), SCSI self ID (p. 254), Scene Mode (p. 84), Shift Lock (p. 251), and Numerics Type (p. 252) settings will not return to their default state.

MEMO

If an operation has been performed incorrectly or cannot be executed correctly, an error message appears in the display. When this occurs, please refer to “Error Messages” (Appendices p. 9) or “Troubleshooting” (Appendices p.5), and perform the specified measure.

1. Hold [SHIFT] and press [F5 (SYSTEM)].
The System menu icon appears.
If the System menu icon does not appear, press [F6 (EXIT)].
2. Press [F1 (INIT)].
If “INIT” does not appear above [F1], first press [PAGE] until “INIT” appears above [F1], then press [F2 (INIT)].
“Init Mixer/System PRM Sure?” appears in the display.
3. Press [ENTER/YES].
If you wish to cancel the initializing, press [EXIT/NO].
4. Press [PLAY (DISPLAY)] to return to the Playlist display.

MEMO

If the above steps do not resolve your problem, contact to a nearby Roland Service Center, or authorized Roland distributor.

Chapter 3 Playback Operations

The Display

Display Regions

When you first turn on the VS-1824, the following display will appear.

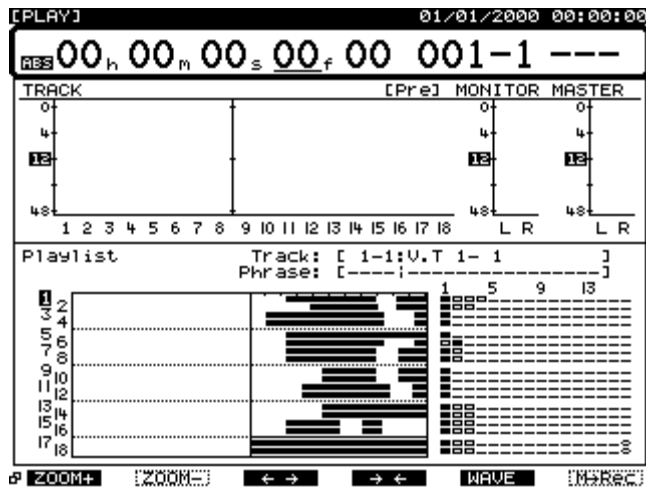

This display is separated into three different areas. You can use [▲], [▼], [◀], and [▶] as well as the Time / Value dial to change settings in each area. The currently active area is outlined with a bold line.

Press [SHIFT] and [▲] or [▼] to change the currently active area.

Upper Part of the Display

The current time of the song is displayed here in hours, minutes, seconds, frames, and subframes. To move the timeline, press [◀] and [▶] to select the desired time increment, then turn the TIME / VALUE dial to change the value. You can also move the timeline in measure or beat increments, or by Marker number.

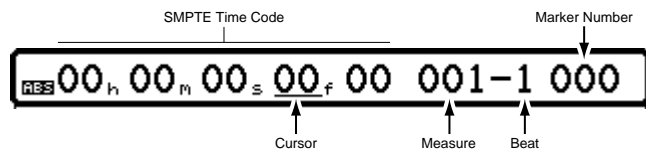

Center Part of the Display

The level meter is displayed here.

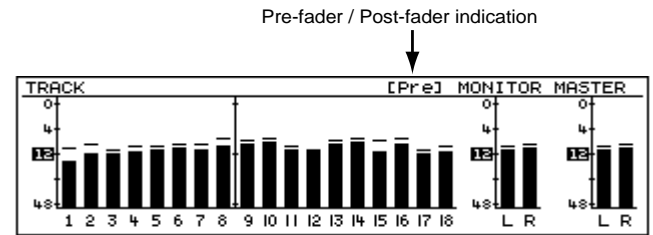

You can switch between Pre-fader and Post-fader by turning the TIME/VALUE dial or pressing [PAGE] until "PRE" or "POST" appears above [F4], and by then pressing [F4].

Song Information display

If you hold [SHIFT] and press [PLAY (DISPLAY)] twice, the level meter will be replaced by the Song Information display.

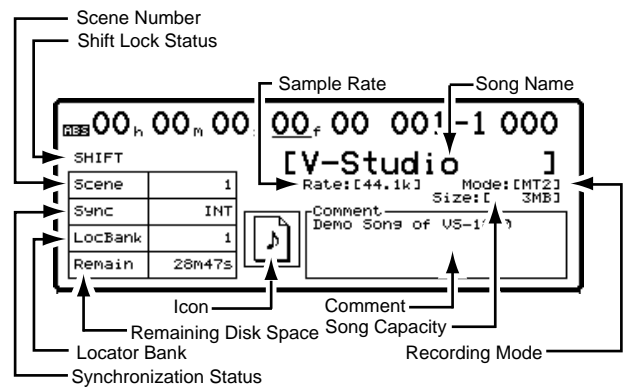

Hold [SHIFT] and press [PLAY (DISPLAY)] twice more to return to the level meter.

Lower Part of the Display

This area displays the Playlist.

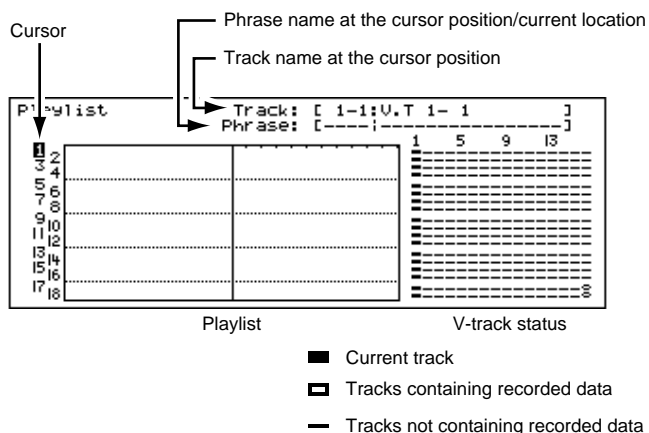

You can use the CURSOR buttons to select the track you wish to view.

The grid at the lower right corner shows the V-Track Status. If you don't wish to view the V-Track Status portion of the display, hold [SHIFT] and press [PLAY (DISPLAY)].

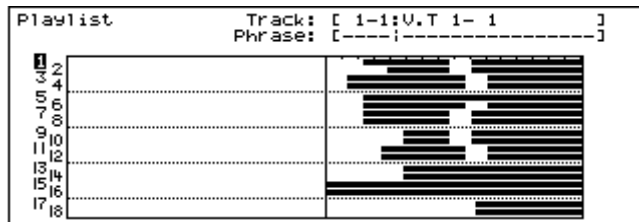

Selecting a Playlist Display

You can select one of four Playlist displays by holding [SHIFT] and pressing [PLAY (DISPLAY)] to toggle between the displays:

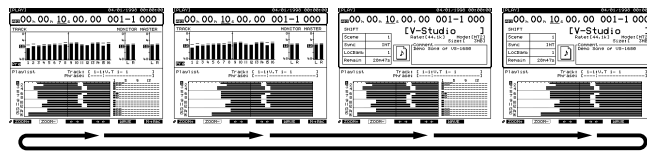

1. The initial screen shows level meters, the Playlist, and the V-Track Status grid. Hold [SHIFT] and press [PLAY (DISPLAY)] to switch to the next Playlist display.
2. The next screen shows level meters, an expanded Playlist, and hides the V-Track Status grid. Hold [SHIFT] and press [PLAY (DISPLAY)] to switch to the next Playlist display.
3. The next screen shows Song Information, the Playlist, and the V-Track Status grid. Hold [SHIFT] and press [PLAY (DISPLAY)] to switch to the next Playlist display.
4. The final screen shows Song Information, an expanded Playlist, and hides the V-Track Status grid. Hold [SHIFT] and press [PLAY (DISPLAY)] to switch back to the first Playlist display.

Function Buttons (While on the Playlist Display)

In the Playlist display, the function buttons perform as follows.

* If "ZOOM+" does not appear above F1, press [PAGE] until it does.

[F1 (ZOOM+)]:

This enlarges, in three stages, the display of the tracks. When a waveform is displayed, this will make it appear taller.

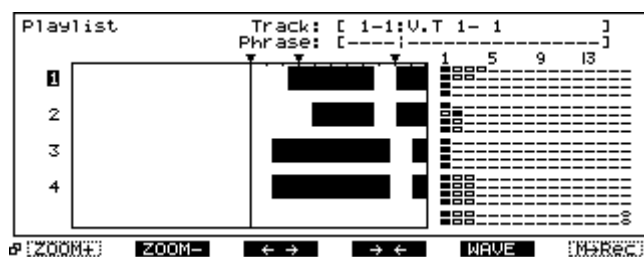

[F2 (ZOOM-)]:

This reduces, in three stages, the display of the tracks. When a waveform is displayed, this will make it appear shorter.

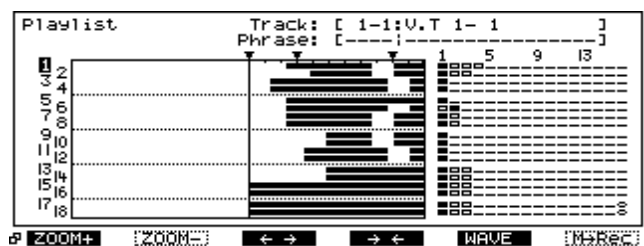

[F3 (← →)]:

This stretches the timeline in four stages. When a waveform is displayed, this laterally stretches out the waveform.

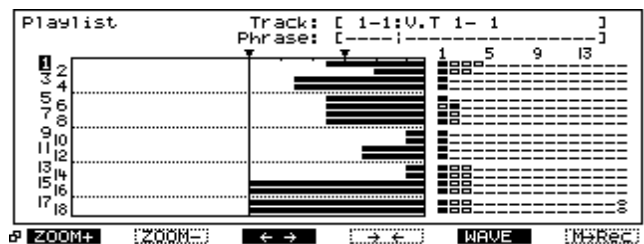

[F4 (→ ←)]:

This shrinks the timeline in four stages. If a waveform is displayed, this will squeeze the waveform.

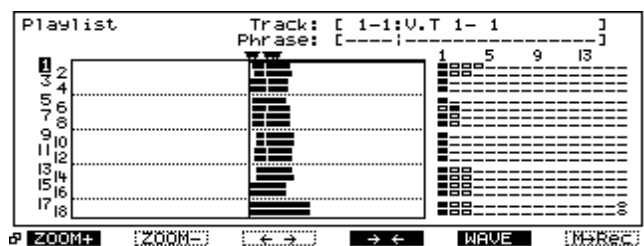

[F5 (WAVE)]: This displays the audio waveform for the corresponding track as selected using the [▲] and [▼] cursors. Press [F5 (WAVE)] once to display the waveform. Press [F5 (WAVE)] again to remove the waveform. (Make sure that the track you have selected contains audio.)

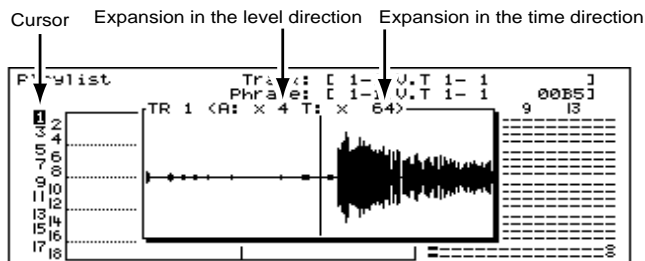

Press [PAGE] to display the second set of functions (when available).

[F1 (LMTrk)]: Displays levels and meters of tracks.

[F2 (LM In)]: Displays levels and meters for inputs.

[F3 (LMAux)]: Displays levels and meters of the AUX and EFFECT Send busses.

[F4 (→PRE)] / [F4 (→POST)]:

This switches the display of the meter from pre-fader to post-fader. Press [F4] to switch back and forth between pre- and post-fader levels. The current Levels setting is labeled either "Pre" or "Post" in the lower left corner of the center portion of the display. If the current setting is pre-fader, you will see the indicator "Pre" in the lower left corner of the level meter display, and the label above [F4] will be "Post". Pressing [F4] at this point will switch the level meter to post-fader.

[F5 (→F/P)] or [F5 (→Metr)]:

This switches the display from Level Meters to Fader/Pan positions for each channel.

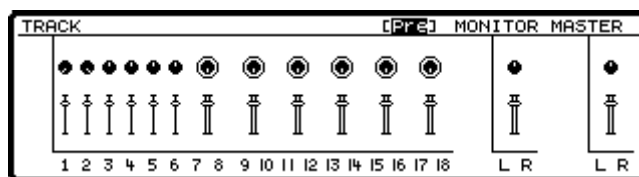

When the middle of the display is showing faders and panning:

- Press [F1 (LMTrk)] to view the fader and pan positions for the Track Mixer.
- Press [F2 (LM In)] to view the fader and pan positions for the Input Mixer.
- Press [F3 (LMAux)] to view the fader and pan positions for the AUX and EFFECT busses.

Mixer Channel Display

To view mixer settings, press any SELECT button for an input or track. The SELECT buttons are divided into two rows. The top row of buttons are referred to as the “Input SELECT buttons” (p. 18). This section also contains the Stereo In and Effects 1-4 Returns. The bottom row of buttons are referred to as the “Track SELECT buttons” (p. 19).

1. Press Track 1 SELECT button.

All mixer settings for Track 6 appear in the display. Here, you can change all the settings for a track, including V-Tracks, EQ, panning, and all effects routing.

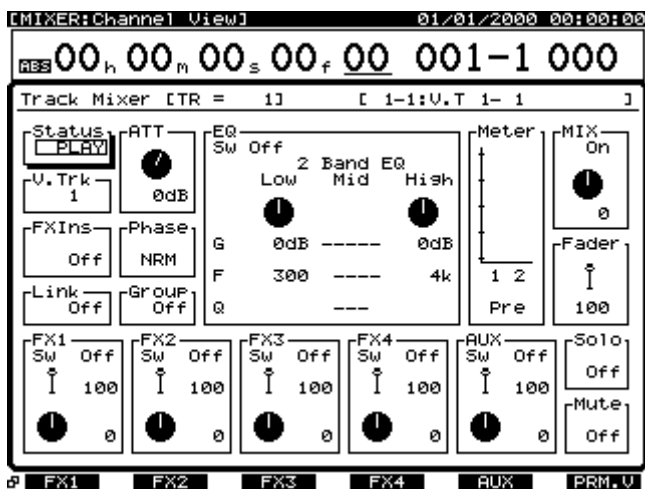

MEMO

If you want to display track channel 13-18, hold [SHIFT] down and press the SELECT buttons for track channels (13-18).

MEMO

When “VS-1880” is selected as the fader mode, the correspondence of the track channel numbers switches to those shown on the overlay sheet provided with the mixer (p. 75).

When Channel Link (p. 77) is set to “Off” and Channel 7/8, 9/10, 11/12, 13/14, 15/16, or 17/18 is pressed with holding [SHIFT] down, the Track Mixer screen for the corresponding even numbered channels is displayed.

2. Press Input 1 SELECT button.

All mixer settings for Input 1 appear in the display. Here, you can change all settings for an input, including phase, EQ, panning, and all effects routing.

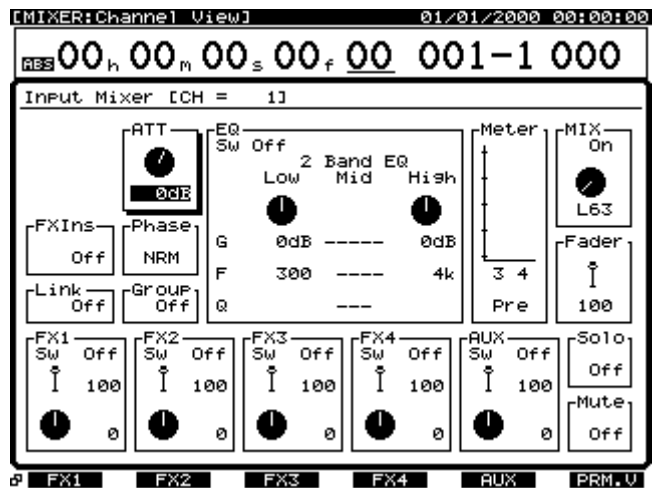

3. Press [PLAY(DISPLAY)] to return to the Playlist display.

Changing Track Status

You can change the status of each track by pressing the STATUS button. The color of the status button determines the current state of the track.

If you want to switch track status, press [FADER/MUTE]. The “TR” indicator lights or blinks. Then, switch to track mixer. For further details, see “Switching the Fader Functions” (p. 71)

Orange: Source

The input source assigned to the channel is heard.

Blinking Red: Record Ready

The track is ready to be recorded. When blinking red, previously recorded material on the track will be heard.

Blinking Red / Orange: Record Ready

The track is ready to be recorded and the source will be heard. This occurs when the VS-1824 is in Record Ready and you press [PLAY], then press the blinking red status button.

Solid Red: Record

Signal is being recorded on that track.

Green: Play

The track will play back.

Off (unlit): Mute

The track is muted.

Blinking Red / Green: Play and Record

This indicates playback from and recording to the same track simultaneously.

- To put a track directly into Record Ready status, press and hold [REC] button and press the track’s STATUS button once.
- To put a track directly into Play mode, press and hold [STOP] and press the track’s STATUS button once.
- During playback, the STATUS button will only change from green to off each time it is pressed. When the STATUS button is off, the track is muted.
- To assign an input to a track for recording, press and hold the track’s STATUS button, and then press the SELECT button for the input (or track) you want to record (see p. 41).

Muting and Soloing

When making EQ adjustments or checking the balance during mixdown, you may want to listen to just one channel or a specific combination of channels. Muting eliminates a track from the monitor mix. Soloing selects a specific channel or channels to monitor, muting other channels.

It is possible to select the channels you wish to monitor using the STATUS buttons, but this involves a lot of button-pushes. Instead, try one of these methods for muting and soloing:

Muting Tracks

To mute tracks while a song is playing:

1. During playback, press the STATUS button once for the track you wish to mute.
The button changes from green to unlit. That track is now muted. You may mute more than one track at a time.
 - * If you want to select TR 1-12, press [FADER/MUTE] several times until the “TR” indicator lights.
If you want to select TR 13-18, press [FADER/MUTE] several times until the “TR” indicator blinks.
→ “Switching the Fader Functions” (p. 71)
2. Press the STATUS button again while the track is playing to make it green.
That track can now be played back.

Muting Inputs and Effect Returns

1. Hold [FADER/MUTE].
2. Press any blinking SELECT button for a track, input or effect return to mute it.
3. The SELECT button will stop blinking.
That channel is now muted.
4. While continuing to hold [FADER/MUTE], press the SELECT button again to monitor that channel.

Quick Soloing

Use this method to quickly solo a track or input with effects in-place:

1. Press and hold [EDIT/SOLO].
The SELECT buttons for all tracks and inputs will begin blinking.
2. While continuing to hold [EDIT/SOLO], press the SELECT button for the track or input you wish to hear.
3. You can select more than one track or input, as long as you continue to hold [EDIT/SOLO].
4. After you're done checking the contents of a track, hold [EDIT/SOLO] and press the SELECT button for the tracks or inputs which have been soloed to un-solo them.

Solo Mode

For situations where you may want to continue to solo several different tracks over and over again, it may be better to use the Solo mode.

1. To turn on Solo mode, hold [SHIFT] and press [EDIT/SOLO].
2. “—SOLO—” will blink in the top of the display and indicate that Solo mode is now turned on. Also, the [EDIT/SOLO] button will begin blinking.
3. Press the SELECT button for the track or input you wish to solo. You may solo more than one track and or input at a time.
4. When you are done, hold [SHIFT] and press [EDIT/SOLO] again to turn off SOLO mode. The [EDIT/SOLO] button will stop blinking.
5. Press [PLAY/DISPLAY] to return to the Playlist display.

Using Locators

One of the fastest ways to move around in your song is to use the *locators*. Time locators are stored for each song using the LOCATOR buttons ([1]-[8]). The VS-1824 provides 64 different locators per song. The locators are organized into eight banks, with eight locators per bank. Each button stores a single time location in the song, and you can move instantly to the stored time by pressing the button. The locators also provide a useful and convenient way to define sections of a song for Loop Recording, to store points for Punch-In recording, and to store track editing values.

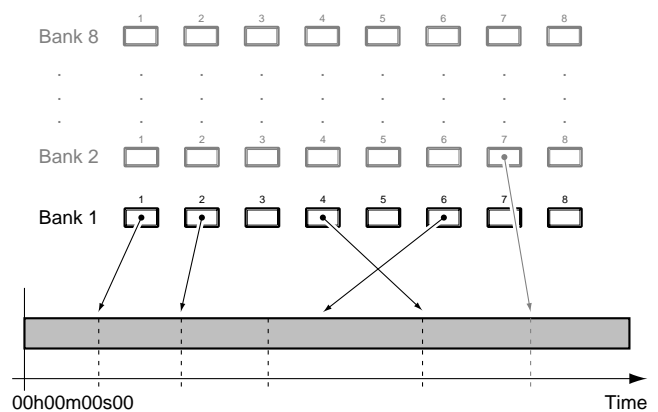

Storing Locators

1. Move to the position in the song where you want to store a locator.
 2. Press any of the eight LOCATOR buttons ([1]-[8]) that are unlit. When a LOCATOR button is lit, it indicates that a locate point is already stored there.
For example, to set Locator 1, press [1].
- * You can store locators while recording, during playback, or when the song is stopped. When a locate point is stored, the corresponding indicator lights.

Recalling a Stored Locator

1. Press the LOCATOR button for the locator you wish to find.
For example, if you wish to move the play position to Locator 3, press [3]. You can do this while the song is playing, or when stopped.

Changing the Locator Bank

1. Press [BANK].
The LOCATE buttons now act as buttons to change locator banks. A blinking locator button will now indicate which bank is active. The currently active bank will be blinking.
2. Press the LOCATOR button ([1]-[8]) corresponding to the bank number you wish to select.
For example, if you wish to use Locator Bank 4, press [4].
3. Once you've selected a locator bank, the [Bank] indicator goes out. To return to the previously selected bank, press [Bank] once more, followed by the locator button corresponding to the bank you want.
For example, if Bank 4 is current, and you wish to get back to Bank 1, press [Bank], and then press [1].

Editing Stored Locators

If you store a locator and later decide to change its value, a simple method is to clear it, move to the new position, and re-store the locator at the new position. Here is another way to change the locator values.

1. Hold [SHIFT] and press [F6 (UTILITY)].
The Utility menu icon appears in the display. If it is not displayed, press [F6 (EXIT)].
2. Press [F2 (Loc)].
If "Loc" does not appear above [F2], press [PAGE] until "Loc" is displayed, and then press [F2 (Loc)].
3. Each of the locators is displayed. Use [▲], [▼], [◀], and [▶] to move the cursor to the locator you want to change. If no value is stored for a locator, "-h-m-s-f- ----" appears in the display.

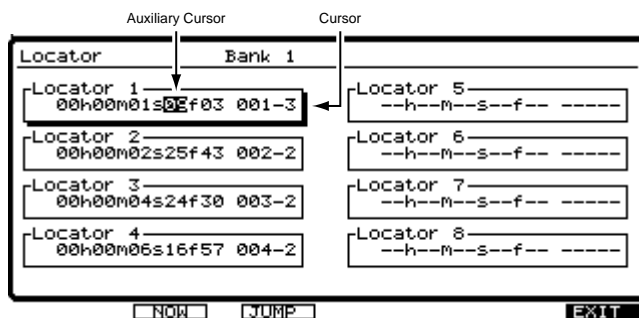

4. Move the cursors to the locator you wish to change. Use the TIME / VALUE dial to modify the value of the locator.
The function buttons work as follows:
[F2 (NOW)]: Enters the value for the current position of the timeline, as indicated in the top of the display.
[F3 (JUMP)]: Moves the current time to the value of the locator.
[F6 (EXIT)]: Exits the screen.
5. When you finish editing your locator values, press [F6 (EXIT)] to return to the Utility menu, or press [PLAY (DISPLAY)] to return to the Playlist display.

Clearing Locator

1. Press and hold [CLEAR], and press the locator buttons ([1]-[8]) that you wish to clear.

Using Markers

In addition to locators, you can store up to 1000 markers per song. Markers also provide a useful and convenient way to define sections of a song for loop recording, or to mark points for punch-in recording. Markers are also used to store Automix data and CD indexes. Markers used for Automix are indicated by the letter “A” after the marker number, while markers used for CD indexes are indicated by the letter “C” after the marker number.

* An interval of at least 0.1 seconds must be left between markers. It will not be possible to add a new marker if a marker already exists at a location less than 0.1 seconds away.

Storing a Marker

Press [TAP] to place a marker at the current location. You can place a marker during recording or playback of a song, as well as when the song is stopped.

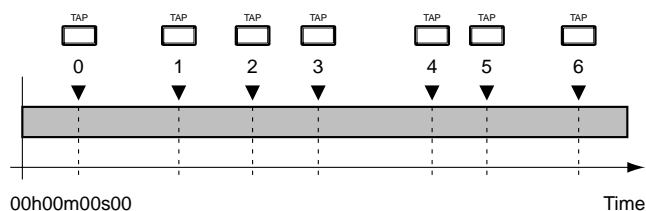

About Marker Numbers

Each marker is assigned a number 000-999 based on the order of its location on the timeline. This means that if you add a new marker at a location earlier than an existing marker, the numbers of the subsequent markers will be increased.

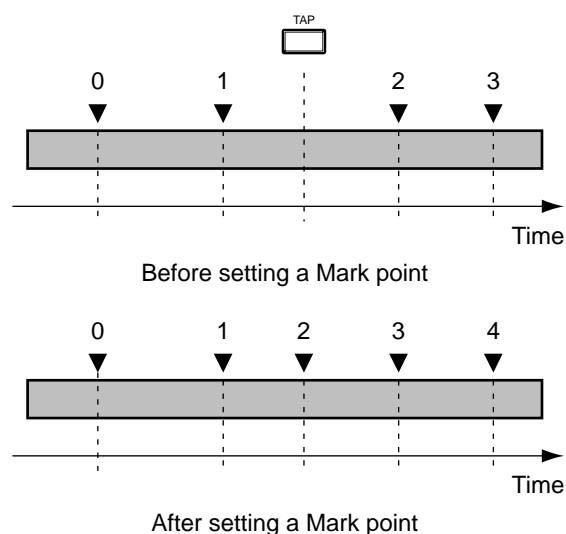

Locate to a Marker Using PREVIOUS and NEXT

To move to the marker immediately following the current time location, hold [SHIFT] and press [NEXT]. You move ahead one marker at a time, in the order they appear on the timeline, each time you hold [SHIFT] and press [NEXT]. To move to the marker immediately preceding the current playback time, hold [SHIFT] and press [PREVIOUS]. Using the default settings, pressing [NEXT] or [PREVIOUS] (without holding SHIFT) will move by phrases instead of markers.

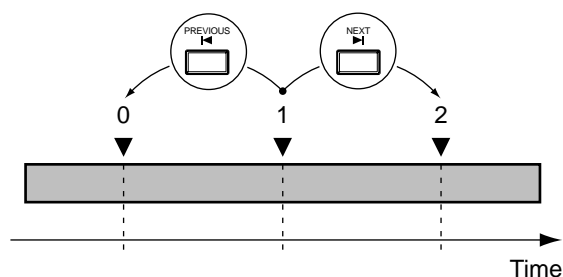

Displaying Markers

The marker number at any playback location is indicated in the display. If there is no marker number at the current location, then the closest preceding marker number is displayed. If there are no markers in the song, “—” is indicated. If “****” is shown in the display, there are markers placed in the song, and the current location of the timeline is earlier in the song than the first marker’s location.

Editing Marker Values

1. Move to the marker you want to change. Hold [SHIFT] and press [PREVIOUS] or [NEXT] to move to the marker.
2. Hold [SHIFT] and press [F6(UTILITY)].
The Utility menu icon appears in the display.
If it is not displayed, press [F6(EXIT)].

Marker Number	Time	Measure	Beat	Status
NUM	Time	M	B	Status
000:	00h00m00s00f00	001	-1	
001:	00h00m05s00f00	004	-1	
002:	00h00m18s00f00	010	-1	
003:	00h00m24s00f00	013	-1	
004:	00h00m28s00f00	015	-1	

↑ AMIX ↑ CD-R
 When saving Auto Mixes When setting track number Markers

3. Press [F1 (Mark)].
If "Mark" does not appear above [F1], press [PAGE] until "Mark" is displayed, and then press [F1 (Mark)].
4. Each marker is shown. Use [▲], [▼], [◀], and [▶] to move the cursor to the marker you want to change. If no value is stored for a marker, "—:—h-m-s-f—" appears in the display.
5. Use the TIME / VALUE dial to modify the value of the marker. The time of a marker can only be modified within the range between the preceding and following markers.

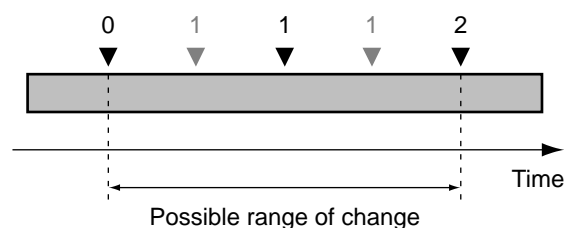

6. When you finish changing settings, press [F6 (EXIT)] to return to the Utility menu. Or, press [PLAY (DISPLAY)] to return to the Playlist display.

Clearing Markers

Setting markers makes it much easier to get to different places within a song, but having too many markers can make it more difficult. Delete unneeded markers whenever you can.

Clearing Specific Markers

1. Move to the marker you wish to delete by holding [SHIFT] and press [PREVIOUS] or [NEXT].
2. Hold [CLEAR] and press [TAP].
The marker is cleared.

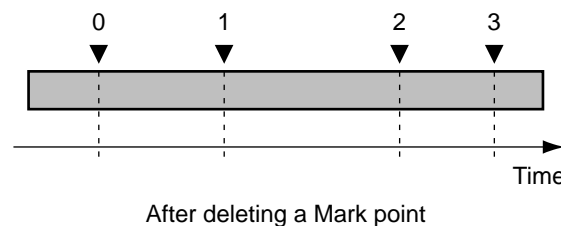
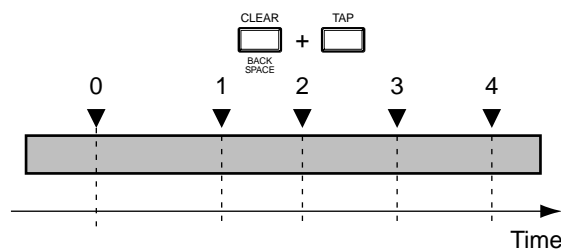

Clearing All Markers

1. Hold down [SHIFT], [CLEAR] and [TAP] at the same time.
"Clear ALL Tap Markers?" appears in the display.

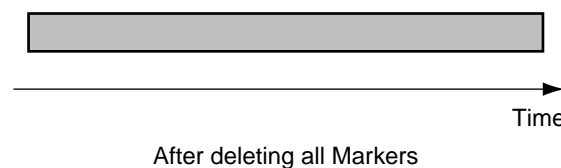
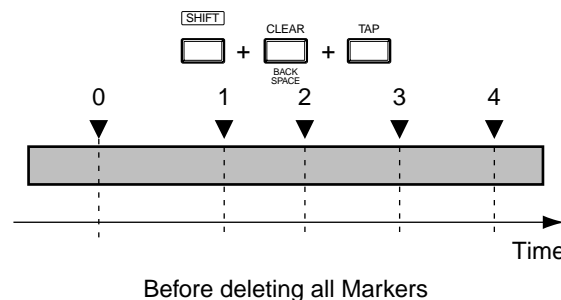

2. Press [ENTER/YES] if you want to clear all markers.
If you want to cancel the procedure, press [EXIT/NO].
* This procedure will erase any existing Automix data and/or CD indexes.

Other Ways to Move In a Song

Changing Playback Position Using JUMP

Besides using markers and locators to move the current time of the song, you can also directly specify a location or measure and beat to move to. This is convenient when designating locations during track and phrase editing.

1. Hold [SHIFT] and press [PAGE (JUMP)].
2. "Jump" appears in the display. Use [◀] and [▶] and the TIME/VALUE dial to enter the time location.
3. Press [F4 (Exec)]. The designated time location is recalled, and you will return to the previous mode.

Change Playback Position Using TIME/VALUE Dial

The current playback time in the display is shown in SMPTE time code. The current measure, beat and marker number are also displayed. Use the following procedure to change the current playback position.



SMPTE Time Code (See Appendices p. 13)

1. Press [PLAY (DISPLAY)].
2. Use the [◀] and [▶] buttons to underline the time value you wish to change.
3. Use the TIME/VALUE dial to change the value.

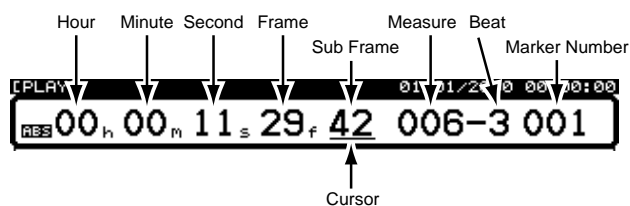

Turn the TIME/VALUE dial to change the playback time according to the position of the cursor. For example, if the cursor is positioned under the Minutes indicator, each click of the TIME/VALUE dial changes the timeline position by one-minute increments. If the cursor is moved to the subframe location, turning the dial moves the timeline position in increments of 1/10th of a frame. To move the timeline in 1/100th frame increments, hold [SHIFT] and turn the TIME/VALUE dial.

Move to the Beginning or End of a Song Using [FF] and [REW]

1. To go to the beginning of actual recorded audio in a song, hold [SHIFT] and press [REW (SONG TOP)].
2. To go to the ending of actual recorded audio in song, hold [SHIFT] and press [FF (SONG END)].



Protecting Songs (Song Protect)

It is possible to mistakenly overwrite or record over an existing song, or to erase a song you meant to keep. You can protect a song from being erased or recorded over by using the Song Protect function.

Song Protect disables the following operations:

- Recording
- Undo/Redo
- Song Name, Song Optimize, Song Arrange, Song Split, and Song Combine
- Track Edit and Phrase Edit
- Recording to Sync Tracks
- Creating Tempo Maps
- Song Store

About Song Protect

Song Protect performs the same function as the protect tab or switch on floppy disks and magnetic optical disks. Even if Song Protect is turned on, you can still place locate points and markers, and carry out operations such as changing Scenes. However, when you try to save your work, “Song Protected” appears in the display, and you are prevented from proceeding with the Save operation. However, when you turn Song Protect off, any edits or changes to the song you made during the time Song Protect was on will be lost. If you are planning to make permanent edits and changes to a song, make sure Song Protect is off before you start.

If you work in an environment where many different people use one VS-1824, you may want to use the following system: When you have finished all work for the day, turn Song Protect on immediately before shutting off the power to the VS-1824. At the beginning of the next day, after turning on the VS-1824, immediately turn Song Protect off.

Protecting Performances

1. Make sure the current song is the one you want to protect using Song Protect (Song Select; p. 49).
2. Press [PLAY (DISPLAY)].
3. Hold down [SHIFT] and press [F1 (SONG)].
The Song menu icon appears in the display.[]
4. Press [F4 (PROTC)].
If “PROTC” does not appear above [F4], press [PAGE] until “PROTC” is displayed, and then press [F4 (PROTC)].
“Song Protect Off → On, Excute ?” appears in the display.



Song Protect Off→On, Excute?

5. Press [F4 (Exec)].
A message will ask you to confirm.
6. Press [ENTER/YES].
“STORE Current?” appears in the display.
7. If you wish to save the current song and then protect it, press [ENTER/YES]. If you wish to protect the state in which Song Store was last executed without saving any recent changes, press [EXIT/NO].
The song will be protected. “---Complete---” appears in the display.
8. Press [PLAY (DISPLAY)] to return to the Playlist display.

To Remove Song Protect

1. Select the song from which you want to remove the protect function (Song Select; p. 49).
2. Press [PLAY (DISPLAY)].
3. Hold down [SHIFT] and press [F1 (SONG)].
The Song menu icon appears in the display. [
4. Press [F4 (PROTC)].
If "PROTC" does not appear above [F4], press [PAGE] until "PROTC" is displayed, and then press [F4 (PROTC)].
"Song Protect On → Off, Excute?" appears in the display.



Song Protect On→Off, Excute?

5. Press [F4 (Exec)].
A message will ask you to confirm.
6. Press [ENTER/YES].
7. Song protect will be disabled. "---Complete---" appears in the display.
8. Press [PLAY (DISPLAY)] to return to the Playlist display.

Selecting and Loading Songs (Song Select)

Before you can play a song you have saved on the hard drive, you must select and load the song into the VS-1824's memory. Use the following procedure to select and load the desired song.

1. Press [PLAY (DISPLAY)].
2. Hold down [SHIFT] and press [F1 (SONG)].
3. Press [F1 (Sel)]—the Song Select screen appears, showing the songs stored in the currently selected hard drive partition.

You can view the songs as icons or in a list. You can also see the size of each song, and the date and time at which it was created.

4. Press [F1] to toggle between the icon display and the list display to select the desired way of viewing the songs.

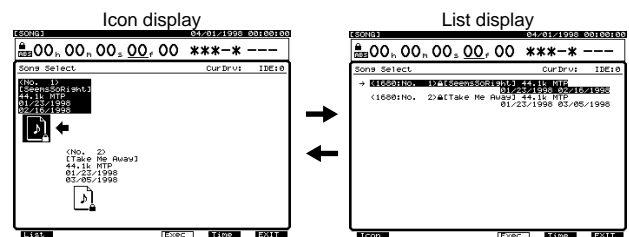

5. Press [F5] to toggle between date of creation → time of creation → size.

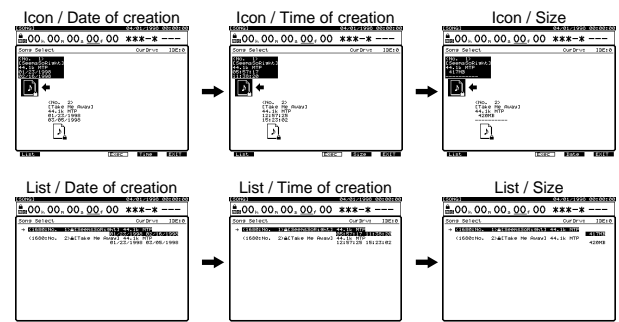

6. Use TIME/VALUE to move the cursor to the song that you wish to select and load.
7. Press [F4 (Exec)].
A message will ask you to confirm.
8. Press [ENTER/YES].
The display will ask "STORE Current?"
9. If you wish to save the current song, press [ENTER/YES]. If not, press [EXIT/NO].
After the current song has been saved—and the selected song has been loaded—you are returned to Play mode.

Chapter 4 Recording Operations

Preparing for a New Recording

Items Necessary for Recording

- VS-1824
- Audio equipment for the Master Out signal, or stereo headphones
- Recording source (microphones, electric guitar, synthesizer, CD player, etc.)

Create a New Song (Song New)

Recording cannot take place when a demo song is selected. This is because the demo songs are protected from being changed or overwritten (p. 48). Use the following procedure to create a new song. This process is analogous to exchanging reels of tape on a multi-track recorder.

1. Press [PLAY (DISPLAY)].
2. Hold [SHIFT] and press [F1 (SONG)].
The Song menu icon is displayed.
3. Press [F2 (NEW)].
If "NEW" does not appear above [F2], press [PAGE] until "NEW" appears above [F2], and then press [F2 (NEW)].
4. Press [F1 (Name)].
The Song Name screen appears in the display.

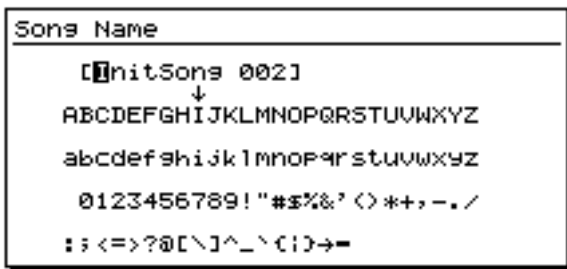

5. Using [▲], [▼], [◀], and [▶], and the TIME/VALUE dial, enter the name of the song.



You can also enter the name of your song by pressing [NUMERICS/ASCII] so it is lit. Then you can enter characters using the SELECT buttons.

The function buttons work as shown below:

- [F1 (Hist)]:** Pressing this button will take you through a list of the last 20 song names, one at a time.
- [F2 (Clr)]:** Clears all the characters in the window.
- [F3 (Del)]:** Deletes the character where the cursor is positioned.
- [F4 (Ins)]:** Inserts a space where the cursor is positioned.
- [F5 (Write)]:** Stores the song name and exits the Song Name screen.
- [F6 (EXIT)]:** Exits the Song Name screen without storing the song name
6. When you are done entering the song name, press [F5 (Write)].

Song Names

It is not necessary to name your song every time you create a new song. When you create a new song, it will automatically be given a name like "InitSong 001." However, this makes it difficult to remember what song it is. We suggest you assign a unique name to your song to help you keep track of it. You can change the name of the song later if desired.

7. Use [▲], [▼], [◀], and [▶], and the TIME/VALUE dial to select the settings for the Sample Rate, Record mode, Icon, Copy System PRM, and Copy Mixer/Scene PRM parameters, as explained below.

Sample Rate

Choose 32 kHz, 44.1 kHz or 48 kHz for the sample rate. If you are planning to use a digital source and want to make a digital connection, you must match the sample rate to that of the digital source. If you are planning to make a CD of your own original music, select 44.1 kHz. You cannot change the sample rate after the song is recorded. In addition, you cannot mix different sample rates within the same song.

Recording Mode

This selects the type of RDAC coding used by the song. For most applications, Roland recommends using the MTP (Multi-Track Pro) mode. Once a song is created, the recording mode cannot be changed.

MTP (Multi-Track Pro):

Appropriate for use with professional quality equipment (digital mixers, effects, processors, etc.). This provides the highest recording quality for recording and editing.

CDR (CD-Writing):

This mode allows you to directly create a CD image file on your hard disk—this file can later be burned onto a CD-R. In CDR mode, Tracks 1-8 are linked in odd/even fader pairs, with their levels controlled by the odd-numbered fader. See “Channel Link,” p. 77.

MAS (Mastering):

Appropriate for use with CD players and DAT recorders. Songs recorded in this recording mode can play back a maximum of eight tracks at a time. If you are recording mastering tracks, you can play Tracks 1-6. If you are not using mastering tracks, you can play Tracks 1-8. Tracks 9-18 cannot be used.

- * *When the Recording mode is set to “CDR” or “MAS,” you can use a total of eight tracks. If you are recording onto the L and R mastering tracks (Track 7/8), you can play back Tracks 1-6. If you are not recording onto the mastering tracks, you can play back Tracks 1-8. **Tracks 9–18 cannot be used.***

MT1 (Multi-Track 1):

This recording mode provides approximately twice the recording time of MAS mode.

MT2 (Multi-Track 2):

This recording mode provides even longer record times than MT1.

LIV (Live 1):

This mode is appropriate when your hard drive lacks free space or when recording live performances where the total recording time is unknown.

LV2 (Live 2):

This mode provides the longest recording time. This mode is appropriate for live recordings of speeches, and recordings made for reference purposes. Use this mode if you have very little drive space left or you aren't sure how long the recording will be.



With the VS-1824, you can select **CDR** as a recording mode (p. 51). If the recording mode of the song is **CDR**, the VS-1824 works as a recorder with four stereo tracks. **Please always keep “Channel Link” (p. 77) of the track channel “On.”** If it accidentally turns “Off,” you cannot record on the tracks of even numbers (tracks 2, 4, 6 and 8).

If “Channel Link” of the track channel turns “Off,” you can recover by initializing the settings of the mixer and the system (Initialize system/mixer parameters: p. 37). If you execute “initialize system/mixer parameters,” mixer settings (routing, EQ, etc.) and system settings (master clock, offset, etc.) are set to their default settings.

Icon

Select from one of seven graphic icons to represent your song.

Copy System PRM (Copy System Parameters)

When set to “on,” you can create a new song that has the current song's system parameters copied to it. This means you don't have to go back to the System menu to recreate your favorite settings. This includes settings such as Preview length (p. 166), metronome settings (p. 67) and so on.



Global System Parameters under [F2 (GLOBL)] are not copied. This is useful, for example, if you are synchronizing multiple 1824s and do not want to redo the synchronization settings each time you create a new song.

Copy Mixer/Scene PRM (Copy Mixer/Scene Parameters)

When set to “On,” you can create a new song that has the current song's mixer settings and stored Scenes.

8. Press [F4 (EXEC)] to accept the settings.
“Create New Song, Sure?” appears in the display.
9. Press [ENTER/YES].
“STORE Current?” appears in the display.
10. If you wish to save any changes or edits made to the current song, press [ENTER/YES]. If the current song is a demo song, press [EXIT/NO]. After the new song is created, the Song menu icon appears in the display.
11. Press [PLAY (DISPLAY)] to return to the Playlist display.
The new song is now the current song selected for recording.

About Recording Times

The available recording time for a hard drive depends on the selected recording mode, the sample rate, and the size of the hard drive. Both the recording mode and the sample rate can be selected on a song-by-song basis. Recording time in track minutes for a 2000 MB partition is shown below:



Track Minutes (See Appendices p. 13)

Mode	Sample Rate		
	48 kHz	44.1 kHz	32 kHz
MTP	742 minutes	808 minutes	1114 minutes
CDR/MAS	370 minutes	404 minutes	556 minutes
MT1	742 minutes	808 minutes	1114 minutes
MT2	990 minutes	1078 minutes	1484 minutes
LIV	1188 minutes	1292 minutes	1782 minutes
LV2	1484 minutes	1616 minutes	2228 minutes

(All times are approximate)

* The above chart is a general yardstick for estimating recording time. Actual times may vary depending on your hard disk's specifications or the number of songs created.

If "Drive Busy!" is Displayed

If this message appears during recording or playback, it means the drive cannot keep up with the data read-write speed. This is usually caused by disk fragmentation and is fairly common with drives used for audio recording on a daily basis. In most cases, it can be fixed by backing up your songs (p. 232), initializing your hard drive (p. 222), and then creating a new song or reloading an existing song.

Song Numbers

On the VS-1824, every song is assigned a number. Newly created songs are given the lowest available number. For example, if there are five songs on the hard drive, the next song created will be assigned Song Number 6. If Song Number Three is deleted, the remaining songs will be numbered 1, 2, 4, 5, and 6. The next new song created will be assigned Song Number 3.

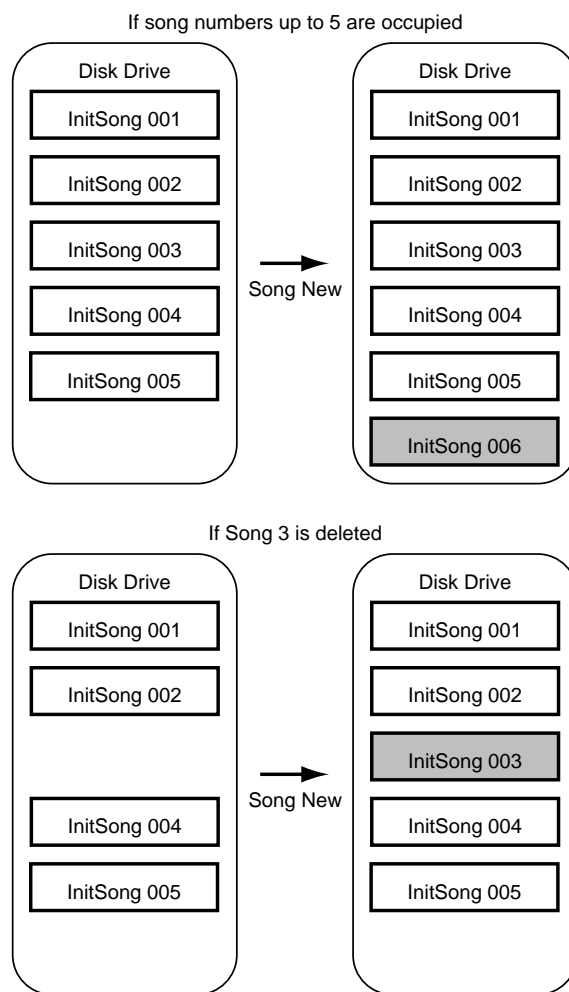

The Recording and Mixing Process

The recording procedure with the VS-1824 is similar to the process of recording with traditional multitrack recorders. The general process of recording a song is outlined below.

1. Connect instruments and microphones to the VS-1824.
2. Record the basic rhythm tracks (i.e. drums, bass, etc.).
3. Record the other parts (electric guitars, synthesizers, vocals, etc.) while playing back the basic rhythm tracks.
4. If there are any mistakes in the process, record over the places where they occurred using punch-in and punch out.
5. Adjust the volume level, panning, equalization, and other settings for each track.
6. If you run out of empty tracks, you can merge the contents of two or more tracks onto a different track using track bouncing (p. 64).
7. Mix down the tracks to your stereo recorder to make a master tape. Or, bounce down the tracks to a stereo track within the VS-1824 to make your own original CD.

VS-1824CD Creates an original audio CD with the internal CD-RW drive.

VS-1824 Creates an original audio CD with the optional Roland VS-CDRII recorder.

Connecting Instruments

1. Pull the Master fader all the way down.
2. Connect instruments and microphones to the desired INPUT jacks.

NOTE

The **INPUT 8 jack** and the **GUITAR (Hi-Z) jack** cannot be used simultaneously. The GUITAR (Hi-Z) jack takes priority when connections are made to both jacks at the same time. If you wish to use the INPUT 8 jack, make sure nothing is plugged into the GUITAR (Hi-Z) jack.



Guitar (Hi-Z) (See Appendices p. 12)

- * This instrument is equipped with balanced (XLR/TRS) type input jacks. Wiring diagrams for these jacks are shown below. Make connections after first checking the wiring diagrams of other equipment you intend to connect.

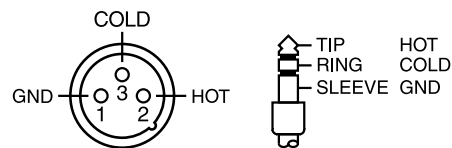

- * To prevent feedback from occurring, pay attention to the position of "live" microphones connected near active speakers. If feedback occurs:
 - Change the position of the microphones.
 - Move the microphones farther from the speakers.
 - Lower the volume levels.

NOTE

To prevent hazard or damage, ensure that only microphone cables and microphones designed to IEC-268-15A are connected.

French language
for Canadian Safety Standard

NOTE

Afin d'éviter tout risque ou dommage, ne brancher que des câbles de microphone et des microphones conformes à la norme IEC-268-15A.

Recording to the Tracks

1. Select a track to record on. While holding down [REC], press the STATUS button for that track. The STATUS button will begin blinking red to indicate that it is "record-ready."
 * If you want to select TR 1-12, press [FADER/MUTE] several times until the "TR" indicator lights.
 If you want to select TR 13-18, press [FADER/MUTE] several times until the "TR" indicator blinks.
 → "Switching the Fader Functions" (p. 71)
2. To select the source to be recorded to the track, press and hold the STATUS button for the track to be recorded. Then, press the Input SELECT button for the input you want assigned to the track. The SELECT button will blink.

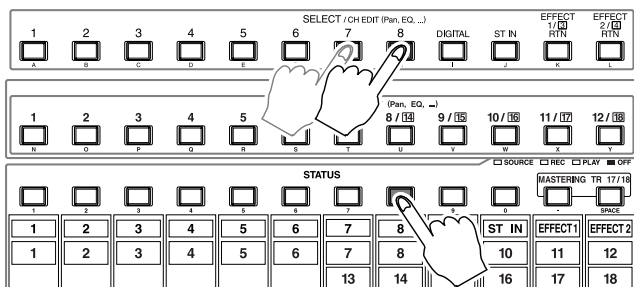

3. Press [FADER/MUTE] several times until the "IN" indicator lights.
4. Set channel fader to the 0 dB position.
5. Adjust the input sensitivity with the INPUT knob for each input. Provide a strong input signal by having instrument volumes as high as possible. Raise the INPUT level as high as possible without having the PEAK indicator light up. The level meters should show signal peaking between -12 dB and 0 dB.
6. Press [REC]. The button indicator blinks red.
7. Press [PLAY]. The button indicator lights green, and recording starts.
8. When the performance, and recording, is finished, press [STOP].
9. To listen to the recorded performance, press [ZERO] to return to the beginning of the song.
10. Press [FADER/MUTE] several times until the "TR" indicator lights (for tracks 1-12) or blinks (for tracks 13-18).
11. Press [PLAY] to begin playback of the song.

12. Use the channel faders and the Master fader to adjust channel volumes to an appropriate volume.
13. If you are satisfied with the results of your recording, save the song using the procedure described in "Saving Your Song (Song Store)," p. 33.

Sources Assigned to Tracks

In a newly created song, the inputs are assigned to tracks as shown below. This is the default mixer routing.

- When "VS-1824" is selected as the fader mode (p. 75)

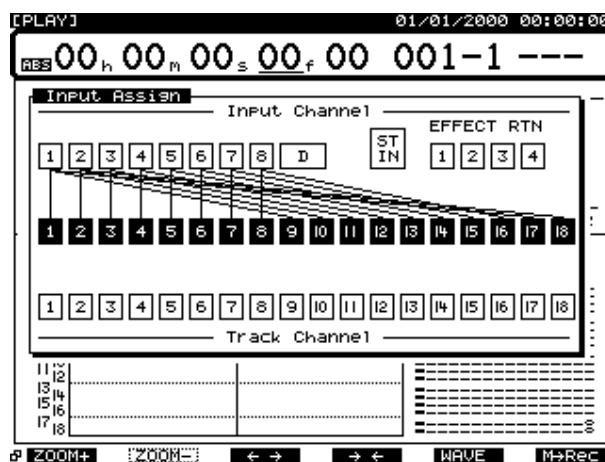

- When "VS-1880" is selected as the fader mode (p. 75)

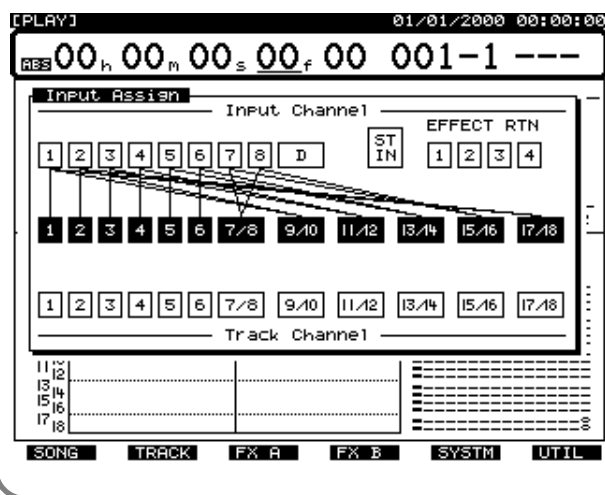

What to do About Low-Level Input Signals

Occasionally, you may have a source which has a very low input level, such as when using a large diaphragm dynamic mic to record a soft-spoken vocalist. Use the steps below to provide extra gain to low-level inputs:

1. Turn the INPUT sensitivity knob all the way clockwise.
2. Press the input SELECT button. There are two settings in the Input Mixer page that can provide additional recording signal gain:

ATT (Attenuation):

In addition to the Input Sensitivity knob used in Step 1, this can provide attenuation—a reduction in volume—or up to 6 dB of additional gain.

Fader:

This is the fader for the Input Mixer. Since all input sources pass through the input fader before going to the recorder, the position of this fader will determine recording levels. The position of this fader defaults to 100, which corresponds to unity gain. This fader can be increased up to 127.

NOTE

If you are using the fader to control the level of the input source, make sure that the [FADER/MUTE] is set to “IN.”

When You Are Recording in Stereo

When recording to tracks with Channel Link (p. 77) on, it is best to turn Channel Link on for the inputs as well. If you are recording independent mono signals to a linked track, you will need to set the pan for each input channel. After Step 3, perform the procedure described below.

1. Press the SELECT button for the input you want assigned to the track.
2. Press [F1 (MIX)]. If “MIX” does not appear in the display, first press [PAGE] until “MIX” is displayed, then press [F1 (MIX)]. Or, you can use [▲], [▼], [◀], and [▶] to move the cursor to “MIX.”
3. Use the TIME/VALUE dial to change the pan setting.

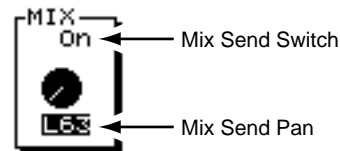

Mix Send Switch

When this is set to “On,” each input is sent to the MIX bus. Keep this setting “On” when you want to simply mix the inputs without recording them.

- * *When you are recording inputs, it is best to turn the MIX bus OFF for all of your input channels. You will then be monitoring your source audio via your recording tracks, and not both from your recording tracks and from the original inputs!*

Mix Send Pan

This adjusts the pan setting (L63-R63) of the signal sent to the MIX bus and the RECORDING bus.

4. Repeat Steps 1 through 3 for all inputs you want to make pan settings on. If you are recording a mono source to a mono track, it is not necessary to change the pan setting.
5. When you’re done, press [PLAY (DISPLAY)] to return to the Playlist display.

Recording on Other Tracks (Overdubbing)

In multitrack recording, the standard procedure is to record new tracks while listening to previously recorded tracks. This is referred to as “overdubbing.”

1. Select the tracks you want to play back.
Hold [STOP] and press the STATUS button for the tracks you want to play back (i.e. that you want to hear while overdubbing).
The STATUS buttons light green.
- * If you want to select TR 1-12, press [FADER/MUTE] several times until the “TR” indicator lights.
If you want to select TR 13-18, press [FADER/MUTE] several times until the “TR” indicator blinks.
→ “Switching the Fader Functions” (p. 71)



Holding [STOP] and pressing a STATUS button will place that channel in Play mode immediately. Hold [REC] and press a STATUS button to place a channel in Record Ready mode.

2. Select the tracks you want to record.
Hold [REC] and press the STATUS button for the tracks you want to record to.
The STATUS buttons light red.
3. Select the inputs to Record for each track.
While holding the STATUS button for the track you will record, press the Input SELECT button for the input you want assigned to the track.
The SELECT button will blink, indicating it is now assigned to the track.
4. Now you are ready for overdubbing. Follow Steps 4-12 of “Recording to the Tracks” (p. 54), to record and then check the track’s recorded content.

Recording Using Different Virtual Tracks (V-Tracks)

The VS-1824 features 16 recordable tracks per channel. These are called Virtual Tracks, or “V-Tracks.” By using V-Tracks, you can record up to 288 tracks per song. You can use Virtual Tracks to record over and over on the same track without erasing or losing the previous recording.

1. Press the SELECT button for the track whose V-Track you wish to change. The button indicator lights. The Track Mixer screen appears in the display.



If you want to display track channel 13-18, hold [SHIFT] down and press the SELECT buttons for track channels (13-18).

2. Press [F5 (V.Trk)].
If “V.Trk” does not appear above [F5], press [PAGE] until it appears, and then press [F5 (V.Trk)]. Or, you may simply use [▲], [▼], [◀], and [▶] to move the cursor to “V. Trk” in the Track Mixer display.
3. Use the TIME/VALUE dial to choose the V-Track you want to use. Note, you cannot change the V-Track while the song is playing. If the song is playing, press [STOP], and then use the TIME/VALUE dial to choose the V-Track.

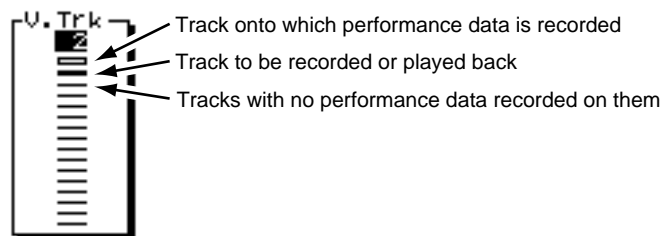

4. Press [PLAY (DISPLAY)] to return to the Playlist display.
Begin recording as explained in “Recording to the Tracks,” p. 54.

Manual Punch-In/Punch-Out

Sometimes when listening to a recording, you may find playing mistakes or lyrics that were sung incorrectly. You may want to correct these sections without re-recording the entire track, or without starting the song over. In such instances, use the following procedure to re-record selected parts. The switching from playback to recording while a song is playing is called a “punch-in,” and the switching from recording back to playback is called a “punch-out.”

Manual Punch-In Using the RECORD Button

Use the transport control buttons to punch in and out.

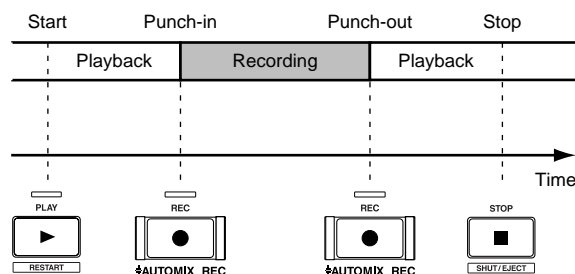

1. Hold down [REC] and press the STATUS button for the track you wish to re-record.

* If you want to select TR 1-12, press [FADER/MUTE] several times until the “TR” indicator lights.

If you want to select TR 13-18, press [FADER/MUTE] several times until the “TR” indicator blinks.

→ “Switching the Fader Functions” (p. 71)

2. Press [ZERO] to return to the beginning of the song.
3. Press [PLAY] to begin song playback.
At this point, you will hear the performance that was already recorded on the track.
4. Press the STATUS button.
The indicator alternately blinks red and orange. Confirm that you can hear the source you want to record in the monitors or headphones.
5. During playback of the song, each time the STATUS button is pressed, you will alternately hear the previously recorded track, and then the source (input). If necessary, use the input sensitivity knob to adjust the input level of the source so it matches the level of the recorded track.
6. Once you have adjusted the input sensitivity, press [STOP].
7. Move to the section of the song where you wish to re-record.
8. Press [PLAY] to begin playback of the song.

9. When you reach the exact point in the song you wish to re-record, press [REC]. The VS-1824 goes into Record mode, and begins recording the new performance.
10. When you have finished recording, press [REC] once more to punch-out.
11. Each time the [REC] button is pressed, the recorder alternately punches in and out. Repeat Steps 9 and 10 for any other tracks you wish to re-record.
12. Press [STOP] to stop the song.
13. To listen to the results of the punch-in and punch-out, press [ZERO] to return to the beginning of the song and press [PLAY].

Manual Punch-In Using the Foot Switch

Performing a manual punch-in punch-out when both playing an instrument and engineering your recording is difficult. In such cases, it is convenient to use a foot switch (such as the DP-2 or BOSS FS-5U) to do your punch-ins and -outs.

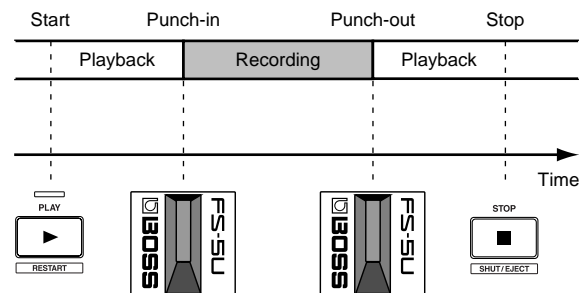

Connect the optional foot switch to the VS-1824’s FOOT SWITCH jack.

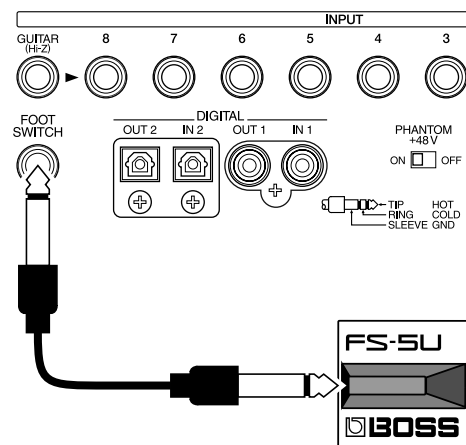

1. Hold [SHIFT] and press [F5 (SYSTEM)].
The System menu icon appears in the display. If the System menu does not appear, press [F6 (EXIT)].
2. Press [F1 (SYSPM)].
If “SYSPM” does not appear above [F1], press [PAGE] until “SYSPM” appears, then press [F1 (SYSPM)].

- Using [▲], [▼], [◀], and [▶], select “Foot Sw.” If “Foot Sw.” does not appear in the display, press [F2 (Prm 2)].

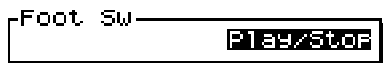

FootSw (Foot Switch)

Set the function of the foot switch connected to the FOOT SWITCH jack. You may select one of the following functions.

Play/Stop:

Alternates between playing back and stopping each time the foot switch is pressed.

Record:

The same function as [REC]. Use this for performing punch-ins and punch-outs with a foot switch.

TapMarker:

The same function as [TAP]. Press the foot switch to place a marker at the current position of the time line.

Next:

Performs the same function as [NEXT]. Moves the time line to the beginning or end of the next phrase each time the foot switch is pressed.

Previous:

Performs the same function as [PREVIOUS]. Moves the time line to the beginning or end of the previous phrase each time the foot switch is pressed.

GPI:

Controls playback and recording depending on the GPI trigger signal received from the FOOT SWITCH jack.



GPI (See Appendices p. 12)

- Select “Record” with the TIME/VALUE dial.
- Press [PLAY (DISPLAY)] to return to the Playlist display. Now you can punch in and punch out of record using the foot switch. Follow the same steps as if you were going to perform a manual punch-in (p. 57), but use the foot switch instead of the [REC] button to perform the operations in Steps 9 to 11.

Auto Punch-In and Punch-Out

You can automatically punch in and punch out at pre-programmed locations. This process is called an auto punch-in. This is convenient when you need to punch in or out at a precise time. Before you begin recording, set the times for punch-in and punch-out. There are three ways to set these times as described below. Use the method appropriate for your situation.

Using Locators

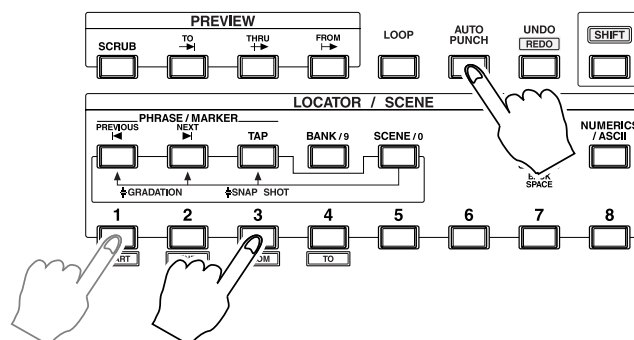

- Find the position in the song where you want to punch in. Place a locator at that point. Find the position in the song where you want to punch out. Place another locator there.
- While holding down [AUTO PUNCH], press the locator corresponding to the punch-in point.
- While continuing to hold [AUTO PUNCH], press the locator corresponding to the punch-out point.

Using Markers

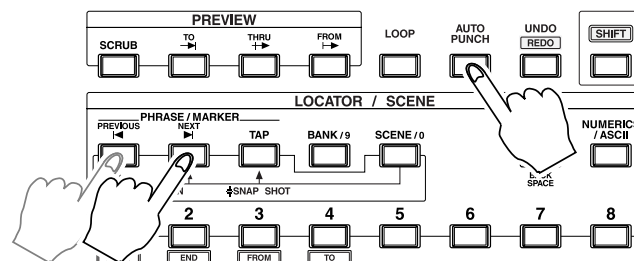

- Place two markers, one at the desired punch-in point, and one at the desired punch-out point.
- Move to the marker which corresponds with the punch-in point.
- Hold [AUTO PUNCH], and press [NEXT].
- Without releasing [AUTO PUNCH], press [PREVIOUS].

Programming Points During Song Playback

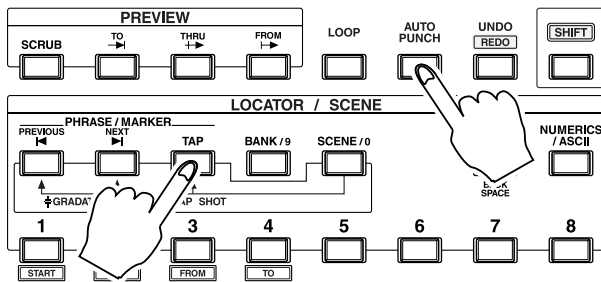

1. Press [PLAY] to begin song playback.
2. Press and hold [AUTO PUNCH] as the song is playing. When you reach the desired punch-in location, press [TAP].
3. Continue to hold [AUTO PUNCH]. When you reach the desired punch-out point, press [TAP] again.
4. Press [STOP].

Editing Punch-In and Punch-Out Points

1. Hold [SHIFT] and press [AUTO PUNCH].

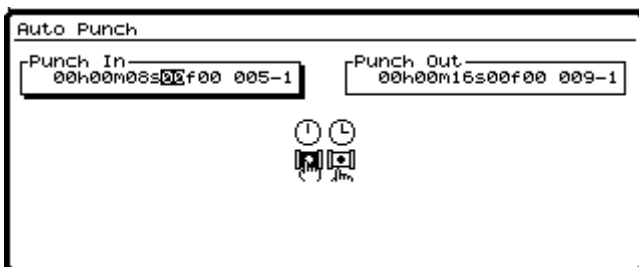

2. The punch-in and punch-out values appear in the display. Use [◀], [▲], [▼], [◀], and [▶] and [▶] to move the cursor to the value you want to adjust. If no value is stored, “-h-m-s-f-” appears in the display.

The function buttons work as listed below.

[F1 (In)]:

Moves the cursor to the punch in location.

[F2 (NOW)]:

Enters the current time as the punch-in or punch-out point, depending on which parameter is highlighted.

[F3 (JUMP)]:

Moves the time line to the currently stored punch-in or punch-out point, depending on which is highlighted.

[F4 (Out)]:

Moves the cursor to the punch-out location.

[F6 (EXIT)]:

Exits the screen. Returns to the Utility menu screen.

3. Enter the new value using the TIME/VALUE dial.
4. When you are done making changes, press [PLAY (DISPLAY)] to return to the Playlist display.

Recording Procedure When Using Auto Punch

1. Hold [REC] and press the STATUS button for the track you wish to re-record. It begins blinking red.
 - * If you want to select TR 1-12, press [FADER/MUTE] several times until the “TR” indicator lights. If you want to select TR 13-18, press [FADER/MUTE] several times until the “TR” indicator blinks. → “Switching the Fader Functions” (p. 71)
2. Press [ZERO] to return to the beginning of the song.
3. Press [PLAY] to begin song playback. At this point, you will hear the performance that has already been recorded on the track.
4. Press the STATUS button. The indicator alternately blinks red and orange. Confirm that you can hear the source you want to record in the monitors or headphones.
5. During playback of the song, each time the STATUS button is pressed, you will alternately hear the previously recorded track, and then the source (input). If necessary, use the input sensitivity knob to adjust the input level of the source so it matches the recorded level of the track.
6. Once you have adjusted the input sensitivity, press [STOP].
7. Press [AUTO PUNCH]. The button indicator will be lit.
8. Locate to a point several seconds or measures before the auto punch-in point.
9. Press [REC]. The button indicator will blink red.
10. Press [PLAY] to begin playback of the song.
11. The VS-1824 will automatically go into Record mode where the punch-in point was set.
12. The VS-1824 will automatically go out of record where the punch-out point was set. Once you’ve passed the punch-out point, press [STOP].
13. To listen to the results of the punch-in and punch-out, press [ZERO] to return to the beginning of the song and press [PLAY].
14. Press [AUTO PUNCH] to disable auto punch when you are finished. The button indicator will be unlit.

Loop Recording

You can play back a specific section of a song over and over again, and use the Auto Punch In feature to record many quick takes. This is called “loop recording.” This can be convenient when you want to rehearse a section of the song, or record a number of takes of a solo, and compare the different takes.

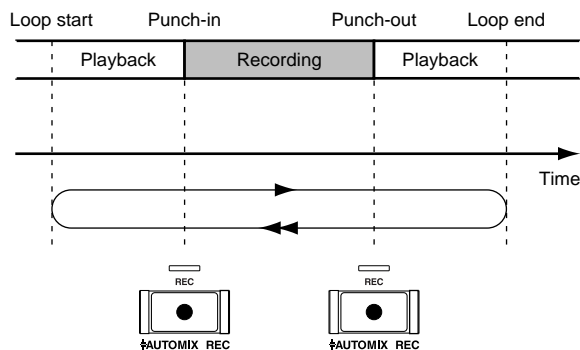

Before you begin recording, specify the begin and end times for the loop. There are three ways to specify the loop times. Use the method appropriate to your situation.

* To specify the punch-in and punch-out points, refer to the previous section “Auto Punch-In and Auto Punch-Out.”

Using Locators

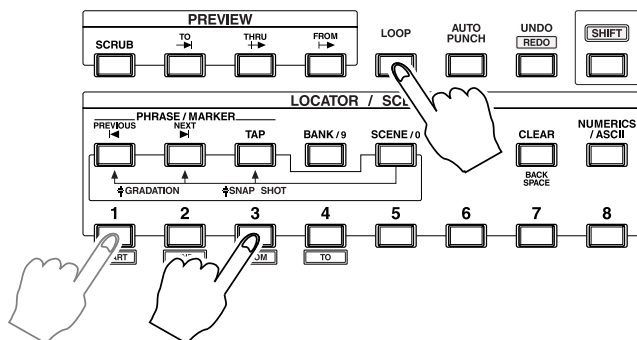

1. Find the position in the song where you want to start the loop. Place a locator at that point. Find the position in the song where you want to end the loop. Place another locator there.
2. While holding down [LOOP], press the locator corresponding to the start point.
3. While continuing to hold [LOOP], press the locator corresponding to the end point.

Using Markers

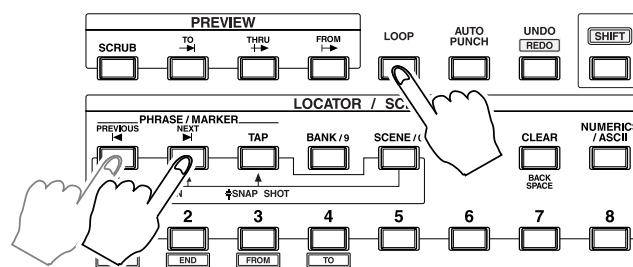

1. Place two markers, one at the desired start point, and one at the desired end point.
2. Move to the marker that corresponds with the loop start point.
3. Hold [LOOP], and press [NEXT].
4. Without releasing [LOOP], press [PREVIOUS].

Programming Points During Song Playback

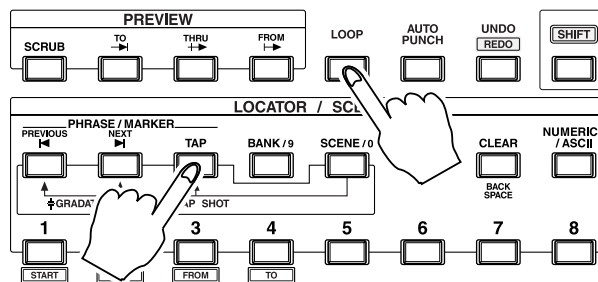

1. Press [PLAY] to begin song playback.
2. Press and hold [LOOP] as the song is playing. When you reach the desired location for the start of the loop, press [TAP].
3. Continue to hold [LOOP]. When you reach the desired ending point, press [TAP] again.
4. Press [STOP].

Editing the Loop Points for Punch-In and Punch-Out

1. Hold [SHIFT] and press [LOOP].

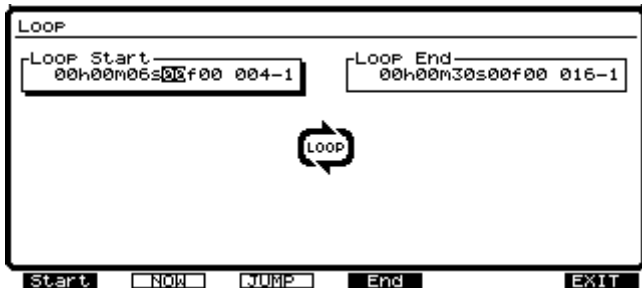

2. The loop start and loop end values appear in the display.

Use [◀] and [▶] to move the cursor to the value you want to adjust. If no value is stored, “—h—m—s—f—” appears in the display.

The function buttons work as described below.

[F1 (Start)]:

Moves the cursor to the start location.

[F2 (NOW)]:

Enters the current time as the loop start or loop end point, depending on which parameter is highlighted in the display.

[F3 (JUMP)]:

Moves the time line to the currently stored loop start or loop end point, depending on which parameter is highlighted in the display.

[F4 (End)]:

Moves the cursor to the loop end location.

[F6 (EXIT)]:

Exits the screen. Returns to the Utility menu screen.

3. Enter the new value using the TIME/VALUE dial.
4. When you are done making changes, press [PLAY] ([DISPLAY]) to return to the Playlist display.

Recording Procedure Using Loop Play

1. Hold [REC] and press the STATUS button for the track you wish to re-record. It begins blinking red.
 - * If you want to select TR 1-12, press [FADER/MUTE] several times until the “TR” indicator lights.
 - If you want to select TR 13-18, press [FADER/MUTE] several times until the “TR” indicator blinks.
 - “Switching the Fader Functions” (p. 71)
2. Press [ZERO] to return to the beginning of the song.

3. Press [PLAY] to begin song playback. At this point, you will hear the performance which has already been recorded on the track.
4. Press the STATUS button.

The indicator alternately blinks red and orange. Confirm that you can hear the source you want to record in the monitors or headphones.
5. During playback of the song, each time the STATUS button is pressed, you will alternately hear the previously recorded track, and then the source (input). If necessary, use the input sensitivity knob to adjust the input level of the source so it matches the recorded level of the track.
6. Once you have adjusted the input sensitivity, press [STOP].
7. Press [LOOP].

The button indicator lights, and Loop Play is enabled.
8. Press [AUTO PUNCH]. The button indicator lights. You are now able to use Auto Punch for recording.
9. Press [PLAY] to begin playback of the song. The song will play until it reaches the end of the loop. It will then locate to the loop start, and play from that point. It will continue to loop between the two specified points until you press [STOP].
10. Press [REC] when you are ready to try recording.

The VS-1824 will automatically go into Record mode where the punch-in point was set.
11. The VS-1824 will automatically go out of Record where the punch-out point was set. Playback continues until the end of the loop is reached, and the loop will begin from the start point again.
12. During the playback of the loop, listen to what you just recorded to check the result. If recording didn't turn out as you intended, repeat Steps 10 and 11.
13. When you are finished recording, press [STOP].
14. Press [LOOP] to disable loop play. The button indicator goes out.
15. Press [AUTO PUNCH] to disable auto punch.

The button indicator goes out.
16. To listen to the results of the recordings, press [ZERO] to return to the beginning of the song and press [PLAY].



You can assign a foot switch to enter and exit Record mode (p. 42).

Undo and Redo

If you decide a recording is unusable just after you've recorded it, you can use Undo to instantly delete the recording. When using Undo, you need to specify the number of levels to be undone.

For example, suppose you use punch-in recording to create five consecutive recordings at the same location. Each of these recordings is given its own Undo level. If you decide you want to revert to the second of the five recordings, you would set the Undo level to three.

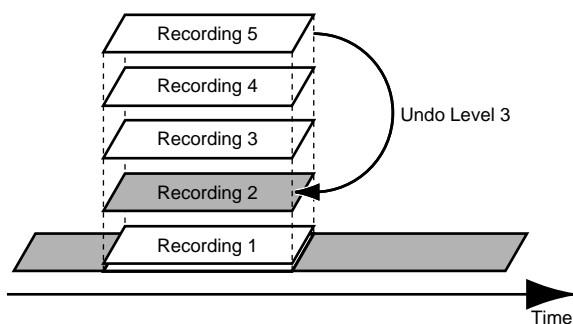

If after executing the Undo function, you decide you want the last (fifth) recording back, you can use Redo to get it back.

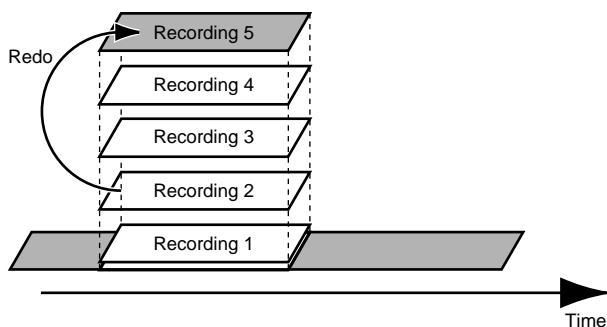

If you use Undo to revert back to the second of five recordings, and then make a new recording, you will not be able to get the old recordings 3-5 back. If after making the new recording, you use Undo, you will be able to get back to the original second recording.

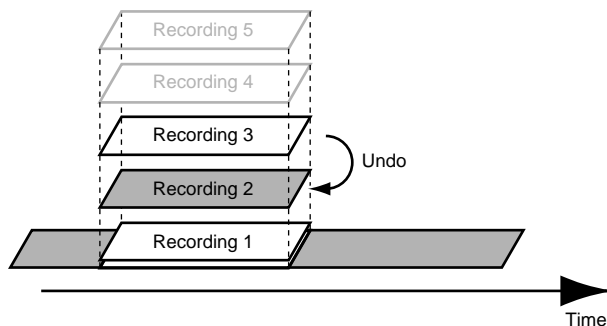

Recording and Editing Operation Which Can Be Undone (Undo)

Recording or editing operations performed after creating a song are recorded together with the song data as its operation history, and the data itself is also preserved without being erased. For example, suppose that you perform 10 recording operations on song 1 and then create song 2. The operation history of song 2 is newly recorded from the time when song 2 was created. If you subsequently select song 1 again, the history of the 10 previous recording operations will still be there.

The Undo function refers to the operation history of the currently selected song, and restores the song to the condition in which it was the specified number of operations ago. In the case of song 1 in this example, you will be able to cancel the 10 recording operations that were performed. A maximum of 999 levels of operation history may be recorded for each song.

Operations that can be undone are **recording operations** and **each of the Track Edit operations**. Check the list below for operations that cannot be undone.

- Song Edit operations (Optimize, Erase, etc.)
- Saves to User Effect Patches
- System operations (mixer initialization, Drive Initialize, Sync Track Recording, etc.)
- Auto Mix operations (Snapshot, Gradation, Real time Recording, etc.)
- Storing in EZ Routing
- Stored Locators, Markers, Scenes

To use the Undo Function:

1. Press [UNDO].
"Level=1" appears in the display.
2. Use the TIME/VALUE dial to select the level of Undo.
As you choose different levels of Undo, the date and time stamp for each recording or edit is displayed.

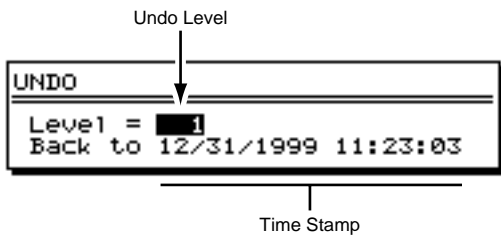

3. Press [ENTER/YES] or [F4 (Exec)] to execute the Undo.
Immediately after performing the Undo function, the Undo button will stay lit. This is a visual reminder that you can Redo your last Undo.

To cancel an Undo (Redo):

1. Hold [SHIFT] and press [UNDO].
"Cancel the last UNDO?" appears in the display.
2. Press [ENTER/YES] or [F4 (Exec)].
The UNDO indicator light goes off. If you wish to cancel, press [EXIT/NO].



You can also use Undo and Redo when editing tracks and phrases.

Cancel Only the Very Last-Performed Operation

If you most frequently use the Undo function to undo just the previously performed recording/editing operation (i.e., undo level 1), you may prefer not to be bothered with the messages that appear when [UNDO] is pressed. In this case, make the following settings so that just the previous operation will be undone immediately when [UNDO] is pressed.

1. Press [PLAY (DISPLAY)].
2. Hold [SHIFT] and press [F5 (SYSTEM)].
The System menu icon appears in the display. If the System menu does not appear, press [F6 (EXIT)].
3. Press [F1 (SYSPM)].
If "SYSPM" does not appear in the display above [F1], press [PAGE] until it appears, then press [F1 (SYSPM)].
4. Use [▲], [▼], [◀] and [▶] to move the cursor to "UNDO message."
If "UNDO message" is not displayed, press [F1 (Prm 1)].



UNDO message

This selects whether or not the Undo confirmation message is displayed.

On: The message is displayed, asking how many levels you want to undo.

Off: The message is not displayed, and only the immediately preceding operation is undone.

5. Use the TIME/VALUE dial to select "Off."
6. Press [PLAY (DISPLAY)] to return to the playlist screen.

Track Bouncing

You can merge the performance of two or more tracks and re-record them onto a different empty track. This operation is known as “track bouncing.” Track bouncing comes in handy when you have run out of free playback tracks. For this example, we’ll mix the audio recorded on Tracks 5-8, and bounce them onto the stereo Track 9/10.

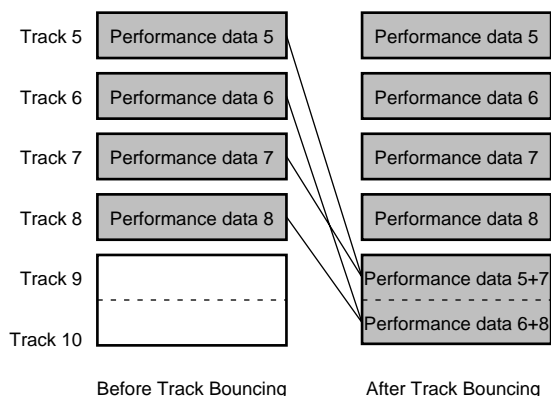

MEMO

For this example, Tracks 5-8 are called the “source tracks.” Tracks 9-10 are called the “destination tracks.”

NOTE

- * Make all panning, level, EQ and effect settings on the source tracks before doing the bounce. Once source tracks have been bounced to the destination tracks, you cannot make individual mixer settings for each source track without bouncing those tracks again. Also, make sure that the EQ and effects are turned off on Channels 9/10. Otherwise, the bounced tracks will sound different than the source tracks.
- * It is not possible to do track bouncing on songs saved with Song Protect On. If you want to do track bouncing, you must turn Song Protect Off first.

Selecting Source Tracks and Destination Tracks

1. Track 9 and 10 are linked as described in “Channel Link” (p. 77).
2. Press [FADER/MUTE] so that “TR” is lit.
3. Hold [STOP], and press the STATUS buttons for source Tracks 5-8.
4. The STATUS buttons light green.
5. Press the STATUS buttons for the destination Track 9 and 10 so it is lit orange.
6. Hold the STATUS button for Track 9 (or Track 10) and press the SELECT buttons for the source Tracks 5-8 so that they blink.
 - * On default settings, Input 1 is assigned to track 9, and Input 2 is assigned to track 10. If this is the case, the SELECT buttons for Input 1 and 2 will be blinking. While continuing to hold the STATUS button for track 9, press the SELECT button for Input 1 and Input 2. The SELECT buttons will stop blinking.
7. The source Tracks 5-8 can now be monitored on Channel 9 and 10.

HINT

If you have done a lot of routing, the Input Assign screen can become a bit cluttered. You can clear all existing routing assignments and start from scratch by holding one of the STATUS buttons and pressing [CLEAR].

Set Meters to Pre-Fader Track

While bouncing tracks, it’s a good idea to set your meters to pre-fader track levels. This will allow you to view the levels so you can create a track bounce that is as loud as possible without distortion.

1. Press [PAGE].
2. Press [F1 (LMTrack)].
3. Look for “Pre” in the lower left area of the Levels display. If it shows “Post,” press [F4 (Pre)] once.
4. While mixing, pay attention to the levels for the destination Tracks 9 and 10.

Adjust the Pan for Each Track and Check the Volume Levels for Each Track

1. Press [PLAY (DISPLAY)] to return to the Playlist display.
2. Press [FADER/MUTE] so that “TR” is lit.
3. Press [PLAY] to begin song playback.
4. Adjust the volume and mix balance using Faders 5-8. The presently monitored sound—track volumes and panning—will be recorded to Track 9 and 10 just as you now hear them.

Record the Track Bounce

1. Press [ZERO] to return to the beginning of the song.
2. While holding [REC], press the STATUS button for Track 9 or 10.
The STATUS button blinks red to indicate Record Ready.
3. Press [REC].
The button blinks red.
4. Press [PLAY].
The button lights green, and recording begins.
5. As the recording occurs, you can make adjustments to the fader levels of the source Tracks 5-8. Any change you make will be reflected in the bounce.
6. Press [STOP] at the end of the song.
7. Press [ZERO] to return to the beginning of the song.
8. Mute Tracks 5-8. Press the STATUS button for each of these tracks once. The button will be unlit, indicating the track is muted.
9. Press [PLAY] to hear the song. Use the track Fader 9 and the Master fader to adjust the volume to a comfortable listening level. You can now select empty Virtual Tracks for Tracks 5-8 and record new material without recording over the original material. It is a good idea to keep your original takes stored on the Virtual Tracks in case you need to re-bounce them later.

Track Bouncing With Effects

The process for bouncing tracks with effects is exactly as explained above in “Track Bouncing,” except follow the steps outlined below in “Select the Source Tracks and the Destination Tracks” to set up effects on each of the source tracks as desired. For specific information on how to apply effects to playback tracks, see *Chapter 7, Using Internal Effects (VS8F-2)*, p. 99.

Bouncing With Effects: Selecting Source Tracks and Destination Tracks

1. Track 9 and 10 are linked as described in “Channel Link” (p. 77).
2. Press [FADER/MUTE] so that “TR” is lit.
3. Hold [STOP], and press the STATUS buttons for source Tracks 5-8.
The STATUS buttons light green.
4. Press the STATUS buttons for the destination Track 9 and 10 so it is lit orange.
5. Hold one of the STATUS buttons and press [CLEAR].
This clears all existing routing assignments.
6. Hold the STATUS button for Track 9 and press the SELECT buttons for the source Tracks 5 and 7 so that they blink.
7. Hold the STATUS button for Track 9, press the SELECT button for EFFECT 1 RTN and EFFECT 2 RTN.
This action will include Effect 1 and Effect 2 Returns in the track bounce.
 - * While continuing to hold the STATUS button for Track 9, hold [SHIFT] and press the SELECT button for EFFECT 1 RTN and EFFECT 2 RTN. This action will include Effect 3 and Effect 4 Returns in the track bounce.
8. Hold the STATUS button for Track 10 and press the SELECT buttons for the source Tracks 6 and 8 so that they blink.
9. Hold the STATUS button for Track 10, press the SELECT button for EFFECT 1 RTN and EFFECT 2 RTN.
This action will include Effect 1 and Effect 2 Returns in the track bounce.
 - * While continuing to hold the STATUS button for Track 10, hold [SHIFT] and press the SELECT button for EFFECT 1 RTN and EFFECT 2 RTN. This action will include Effect 3 and Effect 4 Returns in the track bounce.
10. The source Tracks 5-8 can now be monitored on Channel 9 and 10.
Continue using the steps for bouncing tracks found above in “Track Bouncing.”

Recording a Digital Source

You can record digital signals from CD players, digital mixers such as the Roland VM-3100 or 7000 series, the Roland VS series, DAT machines and other digital sources.

* *The VS-1824's digital interface conforms to S/P DIF. When recording digital signals, be sure to use digital audio devices that utilize the S/P DIF standards.*



S/P DIF (See Appendices p. 13)

Preparations for Recording a Digital Source

1. Items Necessary for a Digital Recording

- VS-1824
- CD player, DAT, VS-880, VM-3100, VM-7000 or other digital audio device
- Digital connector cable (coaxial or optical)

2. Making Connections

Connect the digital output connector of your audio device to the VS-1824's DIGITAL IN connector. DIGITAL IN 1 is a coaxial connector, DIGITAL IN 2 is an optical connector. Use the appropriate connector for your digital device.

* *DIGITAL IN 1 and DIGITAL IN 2 cannot be used simultaneously.*

3. Match Sample Rates

The VS-1824 can record digital signals only when the sample rate of the song is set to the same sample rate of the digital source. When a drive is initialized, the default sample rate of a song is 44.1 kHz. If the sample rate of the source is other than 44.1 kHz, create a new song with that sample rate (p. 50). Many DAT players use a sample rate of 48 kHz. If you wish to create original audio CDs, you must use a sample rate of 44.1 kHz.

4. Set the Master Clock

In order to bring any digital signal into the VS-1824, you must synchronize the VS-1824's internal clock with the digital signal from the your digital source.

a. Hold [SHIFT] and press [F5 (System)].

The System icon appears in the display. If the System menu icon does not appear, press [F6 (EXIT)].

b. Press [F1 (SYSPM)].

If "SYSPM" does not appear above [F1], press [PAGE] until it does, and press [F1].

c. Use [▲], [▼], [◀] and [▶] to move the cursor to "MasterClk."

If "MasterClk" is not displayed, press [F1 (Prm 1)].

d. Use the TIME/VALUE dial to select either DIGIN1 or DIGIN2, depending on whether you are using a coaxial connector or an optical connector.



MasterClk (Master Clock)

This sets the VS-1824's reference clock.

DIGIN1: Receives digital timing information from the DIGITAL IN 1 connector (coaxial).

INT: Uses the VS-1824's own internal clock.

DIGIN2: Receives digital timing information from the DIGITAL IN 2 connector (optical).

e. Press [PLAY (DISPLAY)] to return to the Playlist display.

Record your tracks as usual, following the steps for "Recording to the Tracks," p. 54. Press the SELECT button for the Digital Input in Step 2.

If "Digital In Lock" is Displayed

This indicates the reference clock for the sample rate is set by the digital signal from the DIGITAL IN connector. You can now record using the digital connection.

If "Digital In Unlock" is Displayed

This indicates that no digital signal is being received from the DIGITAL IN connector. Check for good connections, or perhaps try another cable. It may also indicate the sample rate for the selected song does not match the sample rate of the digital source connected to the DIGITAL IN connector. In this state, you cannot record using the digital source.

Recording From a CD

The default setting of the VS-1824 does not permit recording the output of CD players using the DIGITAL IN connector. If you want to record from a CD using the DIGITAL IN connection, use the following procedure. You will only need to perform this procedure one time to enable the VS-1824 to record digital signals from CD players.

1. Hold [SHIFT] and press [F5 (System)].
The System icon appears in the display. If the System menu icon does not appear, press [F6 (EXIT)].
 2. Press [F2 (GLOBL)].
If "GLOBL" does not appear in the display above [F2], press [PAGE] until it appears, then press [F2 (GLOBL)].
 3. Use [▲], [▼], [◀] and [▶] to move the cursor to "CD Digital Record."
 4. Use the TIME/VALUE dial to select "On."
- 
5. A message concerning copyright appears in the display. After reading this message, press [ENTER/YES]. The same message appears in the back cover of this Manual.
 6. A message concerning Licensing Conditions is displayed. After reading this message, press [ENTER/YES]. This message appears in the back cover of this manual. From now on, you can make digital connections and recordings from CD players. If you do not agree to the conditions, press [EXIT/NO]. If you press [EXIT/NO], you will not be able to make any digital connections from CD players.
 7. Press [PLAY (DISPLAY)] to return to the Playlist display. You will now be able to record a CD from the digital input (see p. 66 for details on recording from a digital source).

Using the Metronome

The VS-1824 features a built-in metronome that will provide a click track at any tempo you specify. By listening to the click track as you record your instrument, you'll be able to record your performance with more accuracy. Recording using a click track also allows song editing to be done by measure and beat. The metronome tempo can be controlled by the tempo map or sync track MIDI clock. When using this feature, set up the tempo map (p. 202) or sync track (p. 200) beforehand. When you create a new song, the tempo map defaults to a 4/4 rhythm and a tempo of 120.

Turn On the Metronome

1. The metronome is output from both the MONITOR jacks and the PHONES jack. Connect your playback audio equipment to the MONITOR jacks.
2. Hold [SHIFT] and press [EXT SYNC].
The Sync/Tempo screen appears in the display.

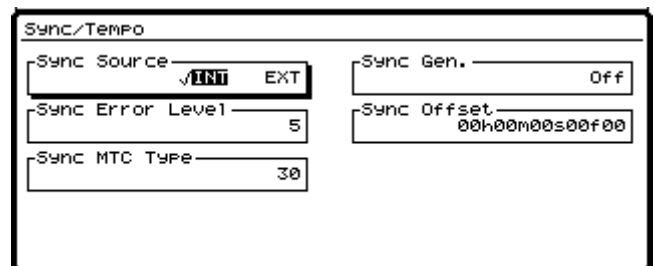

3. Use [▲], [▼], [◀], and [▶] to move the cursor to "Sync Gen.," and use the TIME/VALUE dial to change the setting.

Sync Gen. (Sync Generator)

This determines on which clock the metronome is played.

- Off:** Metronome is played on Tempo map.
- MTC:** Metronome is played on Tempo map.
- MIDIclk:** Metronome is played on Tempo map.
- SyncTr:** Metronome is played on Sync track.

4. Press [F6 (EXIT)].
The System menu icon appears.
5. Press [F5 (METRO)]. If "METRO" does not appear in the display above [F5], press [PAGE] until you see "METRO" above [F5], then press [F5 (METRO)].
The Metronome Parameter screen appears.

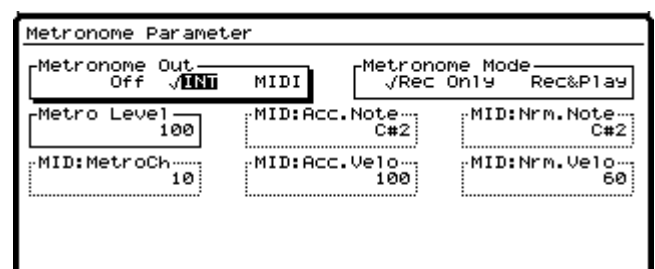

Chapter 4 Recording Operations

- Press [▲], [▼], [◀] and [▶] to move the cursor to and use the TIME/VALUE dial to change the settings.

Metronome Out

This selects where the metronome is output. For now, select "INT." **Selecting "Off" prevents you from making any settings related to the Metronome.**

Off:

The metronome sound is not output.

INT:

The metronome sound is output from the MONITOR and HEADPHONE jacks.

MIDI:

The metronome signal is only transmitted via the MIDI OUT connector so you can trigger an external MIDI sound source such as a drum machine or sound module. If "MIDI" is selected, you will be able to specify the MIDI note numbers and velocities for the beat and downbeat as well.

Metro Level (Metronome Level)

This adjusts the volume level (0-127) of the metronome.

Metronome Mode

This determines when the metronome is played.

Rec Only:

The metronome sounds only during recording.

Rec&Play:

The metronome sounds during playback and recording.

- Press [PLAY (DISPLAY)] to return to the Playlist display.

Program the Tempo Map

- Hold [SHIFT] and press [TAP]. The tempo map appears in the display.

TEMPO MAP								
Tempo Map Number	MAP#	1	2	3	4	5	6	7
Tempo	J =	120.0	130.0	120.0	116.0	123.4	125.2	114.7
Measure	Meas	1	5	9	10	11	15	20
Beat	Beat	4/4	4/4	3/4	5/4	4/4	4/4	4/4

Cursor

- Use [▼] to move the cursor to "120.0" and use the TIME/VALUE dial to change the tempo as desired.

- Use [▼] to move the cursor to "4/4" and use the TIME/VALUE dial to change the time signature, if desired.

NOTE

If your song contains any tempo and/or time signature changes, you can enter them by pressing [F2 (NEW)]. Then, you can use the [CURSOR] buttons and the TIME/VALUE dial to select the new tempo, time signature, and the measure where the change will take place. Up to 50 tempo and/or time signature changes can be entered for each song.

- When you are finished setting the Tempo Map, press [F6 (EXIT)]. The Sync/Tempo screen appears in the display.
- Press [PLAY (DISPLAY)] to return to the Playlist display.

Using an External MIDI Sound Source to Play the Metronome

A MIDI sound source can be used as a metronome in place of the VS-1824's internal metronome. To do this, use the following procedure:

- Connect the VS-1824 and the MIDI sound generator as shown below.

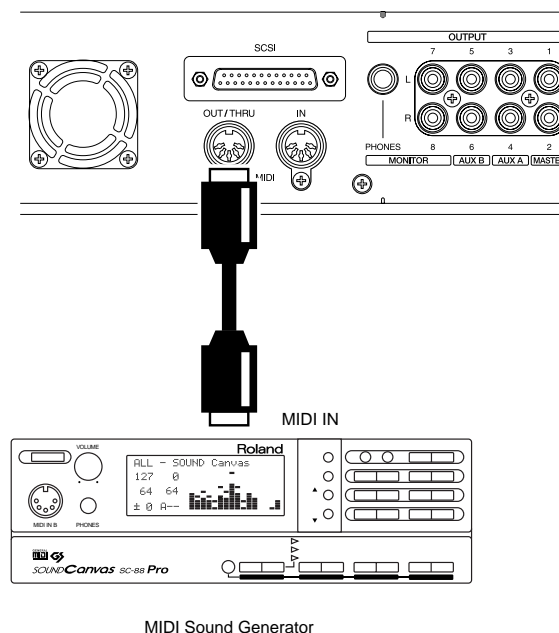

- Hold [SHIFT] and press [F5 (SYSTEM)].
The System menu icon appears in the display. If the System menu icon does not appear, press [F6 (EXIT)].
- Press [F4 (MIDI)].
If "MIDI" does not appear in the display above [F4], press [PAGE] until "MIDI" appears, and then press [F4 (MIDI)].

- Use [▲], [▼], [◀], and [▶] to move the cursor to "MIDI Thru," and use the TIME/VALUE dial to change the setting to "Out."

MIDI Thru (MIDI Thru Switch)

This switches the function of the MIDI OUT/THRU connector. The default setting is "OUT."

Out:

Out put MIDI message of VS-1824 Select this in case you want to send out note message of metronome or settings of mixer parameters (message of control change or exclusive message).

Thru:

Out put the MIDI message coming from MIDI IN connector (through-out).

- Hold [SHIFT] and press [EXT SYNC].
The Sync/Tempo screen appears in the display.

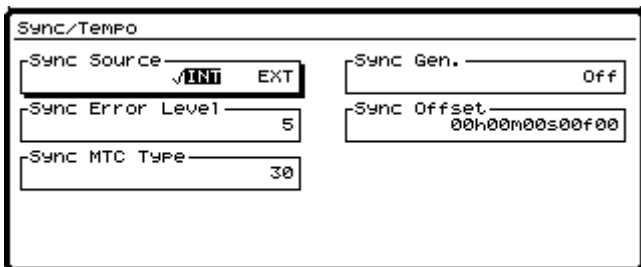

- Use [▲], [▼], [◀], and [▶] to move the cursor to "Sync Gen.," and use the TIME/VALUE dial to change the setting.

Sync Gen. (Sync Generator)

This determines on which clock the metronome is played.

- Off:** Metronome is played on Tempo map.
- MTC:** Metronome is played on Tempo map.
- MIDIclk:** Metronome is played on Tempo map.
- SyncTr:** Metronome is played on Sync track.

- Press [EXIT/NO].
The System menu icon appears in the display.
- Press [F5 (METRO)].
The Metronome Parameter screen appears in the display.

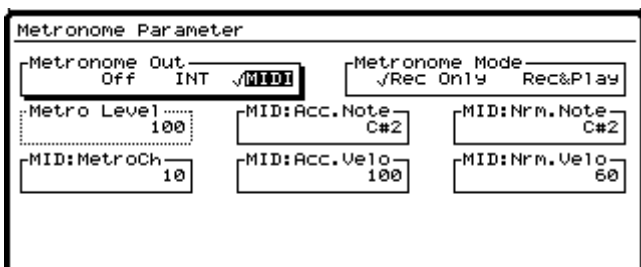

- Use [▲], [▼], [◀], and [▶] to move the cursor and use the TIME/VALUE dial to change each of the settings.

Metronome Out

This selects where the metronome is output. For now, select "MIDI." Selecting "Off" prevents you from making any settings related to the Metronome.

Off:

The metronome sound is not output.

INT:

The metronome sound is output from the MONITOR jacks.

MIDI:

The metronome signal is only transmitted via the MIDI OUT connector.

Metronome Mode

This determines when the metronome is played.

Rec Only:

The metronome sounds only during recording.

Rec&Play:

The metronome sounds during playback and recording.

Metro Level (Metronome Level)

This adjusts the volume level (0-127) of the metronome output.

MID:Acc.Note (Accent Note)

This sets the note number (C0-G9) for the downbeat. When a drum set is playing, this selects specific percussion sounds.

MID:Nrm.Note (Normal Note)

This sets the note number (C0-G9) for the upbeats. When a drum set is playing, this selects specific percussion sounds.

MID:MetroCh (Metronome Channel)

This sets the MIDI channel (1-16) for transmitting Metronome sound MIDI Note Messages.

MID:Acc.Velo (Accent Velocity)

This sets the velocity (1-127) for the downbeats.

MID:Nrm.Velo (Normal Velocity)

This sets the velocity (1-127) for the upbeats.

- Press [PLAY (DISPLAY)] to return to the Playlist display.

Chapter 5 Using the Digital Mixer

This chapter explains general information and applications of the digital mixer in the VS-1824. For detailed information about the individual settings in each mixer channel, see *Chapter 6, "Mixer Channel Settings."*

The built-in digital mixer in the VS-1824 provides many advantages.

- It keeps everything in the digital domain. There is no loss of fidelity when bouncing or mixing tracks.
- Digital mixers with automation, Snapshots, and Scenes give you more control over your mix.
- Dedicated digital faders and knobs make mixing faster and easier.
- A built-in digital mixer increases portability. There's no need for an external mixer.
- You can compare different mixer settings instantly
- You can restore all effect and mixer settings when you re-load a song
- You can easily craft intricate mixes
- You can recall the levels and effects for bounced tracks to re-mix them
- You can automate your mix

The VS-1824 features a 28-channel digital mixer. The mixer is divided into three main sections, the 10-channel Input Mixer, which in the signal path, is situated before the recorder, the 18-channel Track Mixer, which is placed after the recorder, and the Master Block, which is used for determining which signal appears at each of the output jacks and connectors.

When recording new tracks, all sources go through the Input Mixer before arriving at the RECORDING bus. Thus, settings and fader levels of the Input Mixer determine actual recording levels.

During a mixdown session, the Input Mixer and the Track Mixer can work side-by-side, for a total of 28 channels of automated digital mixing. You can use the Input Mixer to bring additional sources into the master mix, such as tracks from a MIDI sound module or another multitrack recorder. The 10-channel Input Mixer and the 18-Channel Track Mixer used together provide 28 channels of mixing.

To view the settings for any channel of the mixer, press the SELECT button for the channel you want to view or adjust. The top row of SELECT buttons allow you to view any of the Input Mixer Channels 1-8, the DIGITAL inputs, or any of the effect returns. The second row of SELECT buttons allow you to view any of the settings for the Track Mixer.

* *For detailed information about the mixer signal flow, refer to the "Mixer Section Block Diagram" (Appendices p. 128).*

Fader/Mute Button

There are two different ways to control the fader levels of the Input and Track Mixers.

Method One: Switching the Fader Functions (FADER/MUTE Button)

The physical faders on the VS-1824 can be used to control either the 10-channel Input Mixer, or the 18-channel Track Mixer. Press [FADER/MUTE] to assign the physical faders to the mixer you want to control. When using this method, always check the FADER/MUTE setting before you begin!

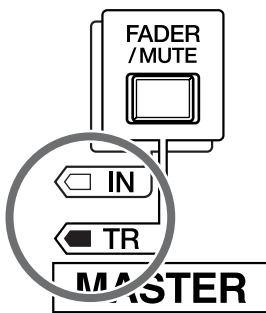

The display varies according to the “Fader Mode” (p. 75).

When “VS-1824” is selected as the fader mode (p. 75)

When “TR” is lit:

You can adjust the volumes and STATUS buttons for Track Channels 1–12.

When “TR” is blinking:

You can adjust the volumes and STATUS buttons for Track Channels 13–18.

When “IN” is lit:

The faders are used to control the Input Mixer (8 analog inputs, 2 digital inputs), the Stereo Input, plus the Effects 1/3 Return and Effects 2/4 Return.

MEMO

Faders 16 and 18 will control the Effect 3 and 4 Returns respectively. They are accessed by holding [SHIFT] while adjusting the fader.

When “VS-1880” is selected as the fader mode (p. 75)

When “TR” is lit:

You can adjust the volumes and STATUS buttons for Track Channels 1–18.

When “IN” is lit:

The faders are used to control the Input Mixer (8 analog inputs, 2 digital inputs), the Stereo Input, plus the Effects 1/3 Return and Effects 2/4 Return.

MEMO

Faders 16 and 18 will control the Effect 3 and 4 Returns respectively. They are accessed by holding [SHIFT] while adjusting the fader.

Method Two: Input Mixer Screen

Another way to use the mixer while recording is to leave the FADER/MUTE button on TR. (It defaults to this setting when you create a new song.) If you need to change the fader level for an input, press SELECT button for the input you wish to adjust, and then move the cursor to the FADER setting. Move the cursor onto the fader value number (the default level is 100) and use the TIME/VALUE dial to adjust the level. With this method, the physical faders are only controlling track playback levels, and have no effect on record levels as long as “TR” remains lit.

When you create a new song, the fader positions of the Input Mixer default to 100, which is equivalent to 0 dB. After creating a new song, press any Input SELECT and you’ll see this in the display. Simply use the INPUT Sensitivity knob to adjust input recording levels. If you have a very low-level signal, the Input Sensitivity knob is turned all the way up, and you still can’t seem to get a loud enough signal, you can move the cursor over to the “ATT” (attenuation) control in the Input Mixer screen and use the TIME/VALUE dial to boost the level of the incoming signal. You can also boost the incoming signal level using an external preamp.

- * *Suggestion: The most common reason to switch the FADER/MUTE button between TR and IN is if you need to mix more than 18 tracks of audio. During mixdown of 18 tracks plus additional sources (i.e. outputs from MIDI sound modules) toggling [FADER/MUTE] between TR and IN allows you to quickly assign the faders to Tracks and then to Inputs as necessary for realtime mixing. During recording, you can leave [FADER/MUTE] on TR.*

Determining Output

The VS-1824 has eight analog output jacks and two stereo digital outputs. Each of these outputs can have various signals assigned to them. Use the following procedure to determine the signal for each output jack or connector.

MONITOR Output Connectors

1. Press [EDIT/SOLO]. The Master Block is displayed.
2. Use [▲], [▼], [◀], and [▶] to move the cursor to "OUTPUT (MON)." Use the TIME/VALUE dial to adjust the setting.

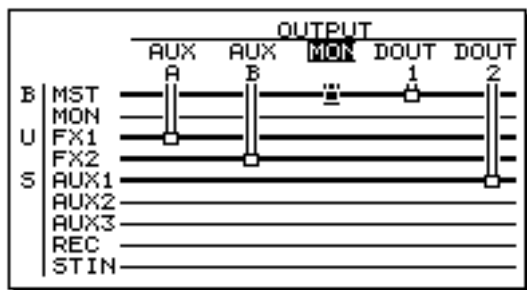

Mon (Monitor)

This selects what signal is to be assigned to the MONITOR jacks.

MST:

The signal at the MASTER jacks (MIX bus).

FX1:

The signal at the EFFECT 1 bus.

FX2:

The signal at the EFFECT 2 bus.

AUX1/FX3:

The signal at the AUX1 bus, or EFFECT 3—the EFFECT 3 bus—when a second VS8F-2 effect card is installed in the VS-1824.

AUX2/FX4:

The signal at the AUX2 bus, or EFFECT 4—the EFFECT 4 bus—when a second VS8F-2 effect card is installed in the VS-1824.

AUX3/AUX:

The signal at the AUX3 bus, or AUX—the AUX bus—when a second VS8F-2 Effect card is installed in the VS-1824.

REC:

The signal at the RECORDING bus.

ST IN:

The signal assigned to the STEREO IN.

3. Press [F2(Mon)]. If "Mon" does not appear above [F2], press [PAGE] until "Mon" appears above [F2], and then press [F2(Mon)].

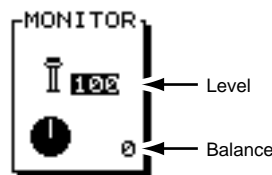

Level

This adjusts the volume level (0-127) for the MONITOR jack. This is normally adjusted using the MONITOR knob on the top panel.

Balance

This adjusts the left-right balance (L63-R63) for the MONITOR jacks.

4. Press [PLAY (DISPLAY)] to return to the Playlist display.

AUX Connectors

1. Press [EDIT/SOLO]. The Master Block is displayed.
2. Press [F3 (AUX.A)].
If "AUX.A" does not appear above [F3], press [PAGE] until "AUX.A" appears above [F3], and then press [F3 (AUX.A)].
3. Determine what signal is assigned to the AUX jacks by turning the TIME/VALUE dial.

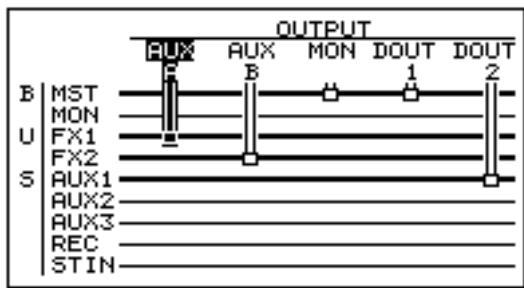

AUX A

This selects which signal is assigned to the AUX A jacks.

FX1:

The signal at the EFFECT 1 bus.

FX2:

The signal at the EFFECT 2 bus.

AUX1/FX3:

The signal at the AUX1 bus, or EFFECT 3 when a second VS8F-2 effect card is installed in the VS-1824.

AUX2/FX4:

The signal at the AUX2 bus, or EFFECT 4 when a second VS8F-2 effect card is installed in the VS-1824.

AUX3/AUX:

The signal at the AUX3 bus, or AUX when a second VS8F-2 effect card is installed in the VS-1824.

4. Press [PLAY (DISPLAY)] to return to the Playlist display.

MEMO

The AUX B jacks are set using the same method. Press [F4 (AUX.B)] at Step 2.

Digital Out Connectors

1. Press [EDIT/SOLO]. The Master Block is displayed.
2. Press [F5 (DOUT1)].
If "DOUT1" does not appear above [F5], press [PAGE] until "DOUT1" appears above [F5], and then press [F5 (DOUT1)].
3. Determine what signal is assigned to the DIGITAL OUT 1 connector by turning the TIME/VALUE dial.

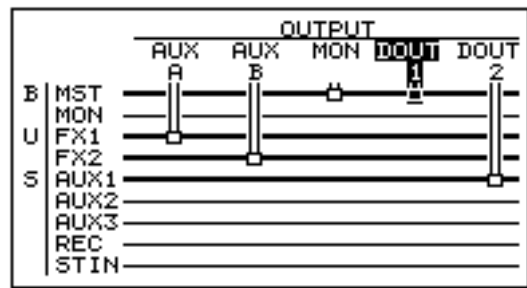

DOUT1 (DIGITAL OUT 1)

This selects what signal is assigned to the DIGITAL OUT 1 (coaxial) connector.

MST:

The signal at the MASTER jacks (MIX bus).

MON:

The signal at the MONITOR jacks.

FX1:

The signal at the EFFECT 1 bus.

FX2:

The signal at the EFFECT 2 bus.

AUX1/FX3:

The signal at the AUX1 bus, or EFFECT 3 when a second VS8F-2 effect card is installed in the VS-1824.

AUX2/FX4:

The signal at the AUX2 bus, or EFFECT 4 when a second VS8F-2 effect card is installed in the VS-1824.

AUX3/AUX:

The signal at the AUX3 bus, or AUX when a second VS8F-2 effect card is installed in the VS-1824.

4. Press [PLAY (DISPLAY)] to return to the Playlist display.

MEMO

The DIGITAL OUT 2 (optical) jacks are set the same way. Press [F6 (DOUT2)] at Step 2.

Direct Out Connectors

The signal from each track of the recorder can be assigned directly to each of the eight analog output jacks. This is convenient for transferring tracks from the VS-1824 to another multi-track recorder.

1. Press [EDIT/SOLO]. The Master Block is displayed.
2. Press [F5 (DIR)].
If "DIR" does not appear above [F5], press [PAGE] until "DIR" appears above [F5], and then press [F5 (DIR)].
3. Use the TIME/VALUE dial to make settings for DIRECT OUT.

DIR OUT (DIRECT OUT)

Select Tracks to be assigned as Direct Out.

Off:

Direct out is not used.

1-8:

Tracks 1-8 are output from the analog output jacks 1-8. When DIRECT OUT is used, the MASTER, MONITOR and AUX jacks are used for the direct track outputs. The signals at each of the DIGITAL OUT connectors can be set as usual.

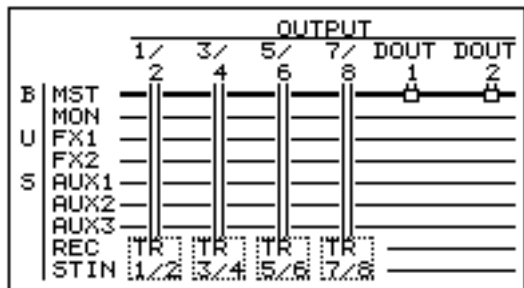

- Track 1: MASTER jack (L)
- Track 2: MASTER jack (R)
- Track 3: AUX A jack (L)
- Track 4: AUX A jack (R)
- Track 5: AUX B jack (L)
- Track 6: AUX B jack (R)
- Track 7: MONITOR jack (L)
- Track 8: MONITOR jack (R)

9-16:

Tracks 9-16 are output from the analog OUTPUT jacks 1-8. When DIRECT OUT is used, the MASTER, MONITOR and AUX jacks are used for the direct track outputs. The signals at each of the DIGITAL OUT connectors can be set as usual.

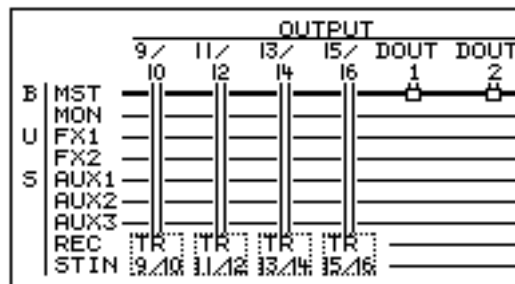

- Track 9: MASTER jack (L)
- Track 10: MASTER jack (R)
- Track 11: AUX A jack (L)
- Track 12: AUX A jack (R)
- Track 13: AUX B jack (L)
- Track 14: AUX B jack (R)
- Track 15: MONITOR jack (L)
- Track 16: MONITOR jack (R)

4. Press [PLAY (DISPLAY)] to return to the Playlist display.



Tracks 17 and 18 cannot be output directly from the VS-1824.



Remember to turn the DIRECT OUT function off when you are finished transferring your tracks.

Changing settings of the Track Mixer Buttons and Faders (Fader Mode)

You can switch the panel buttons and faders that are used to affect each Track Mixer channel.

1. Press [PLAY (DISPLAY)].
2. Hold [SHIFT] and press [F5 (SYSTEM)].
The System menu icon appears in the display.
If the System menu does not appear, press [F6 (EXIT)].
3. Press [F1 (SYSPM)].
If "SYSPM" does not appear above [F1], press [PAGE] until "SYSPM" appears, then press [F1 (SYSPM)].
4. Using [▲], [▼], [◀], and [▶], select "Fader Mode." If "Fader Mode" does not appear in the display, press [F1 (Prm 1)].



Fader Mode

Used for specifying the correspondence or assignment of panel buttons and faders to each of the Track Mixer channels.

VS-1824: Assignments are as indicated on the panel.

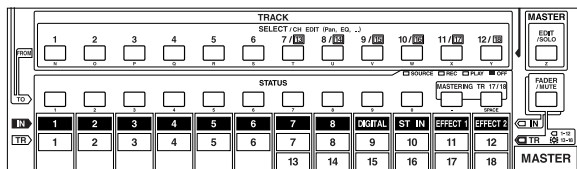

VS-1880: Assignments are according to the overlay sheet provided with the workstation.

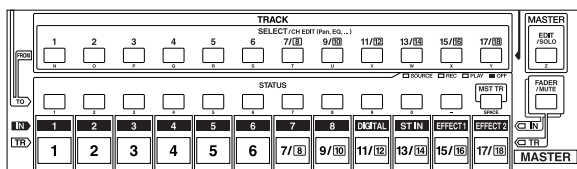

5. Press [PLAY (DISPLAY)] to return to the Playlist display.

Mixer Routing

Sources Assigned to Tracks

In a newly created song, inputs are assigned to tracks as shown below. This is the default mixer routing.

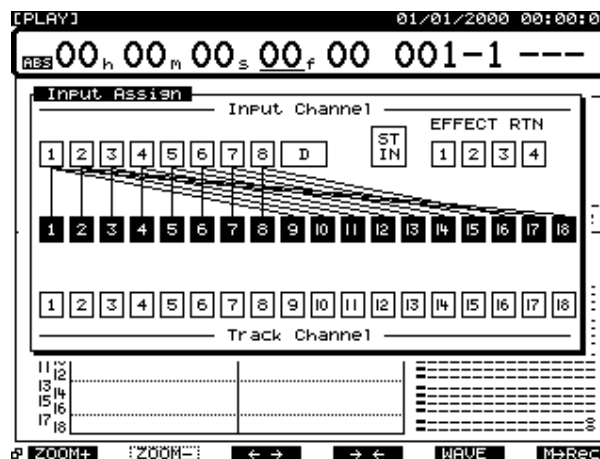

Using the STATUS and SELECT buttons, it is possible to set up almost any type of routing. To determine the source(s) assigned to a track for recording, use the following procedure.

MEMO

When "VS-1880" is selected as the fader mode (p. 75), inputs are assigned to tracks as shown below.

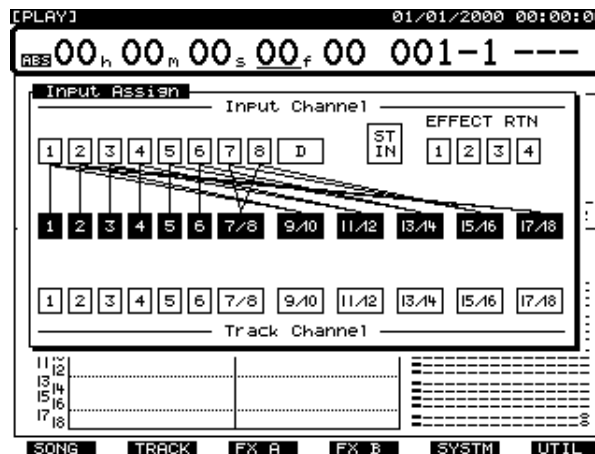

1. Press [FADER MUTE] several times until the “TR” indicator lights.
→ “Switching the Fader Function” (p. 71)
2. Press and hold the STATUS button for the track to be recorded. The SELECT button for the default input routed to that track blinks. The Input Assign screen appears in the display for as long as the STATUS button is held.
3. Press the Input SELECT button for the input you want assigned to the track.

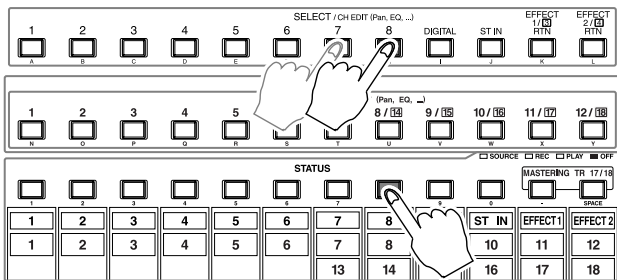

- You can assign more than one input to a track.
- You can assign a track to a track.
- You can assign more than one track to a track.
- You can assign the effect returns to a track.
- You can assign any combination of inputs, effect returns and tracks to a track.

When you are done, the SELECT button for each source routed to the track will be blinking.

MEMO

To clear the mixer routing for all channels, press and hold any STATUS button, and press [CLEAR].

- * In this case, press [FADER MUTE] several times until the “TR” indicator lights.

Input Mixer Default Assignment

You may have noticed that, after making a new recording, you can still hear your live microphones or other sources that are still plugged in. Or, you may hear sources that are connected to inputs, even though you haven’t recorded a track. The reason for this is that each channel of the Input Mixer is automatically routed to the stereo master mix. This is the default setting when a new song is created. Any source connected to an INPUT jack in the VS-1824 is routed to the main stereo output. To change this setting, follow the procedure below.

1. Press the Input SELECT button for each input being used.
2. Use [▲], [▼], [◀], and [▶] to move the cursor to the MIX section in the screen. Or, press [F1 (MIX)]. If “MIX” does not appear above [F1], press [PAGE] until you see “MIX” above [F1], and then press [F1 (MIX)].
3. Use the TIME/VALUE dial to change the Mix Assign Switch—located above the pan knob in the display—to “Off.”

Mix Assign Switch

When this is set to “On”, the source at each Input channel is assigned directly to the MIX bus. Set this to “On” when you simply want to mix an input without actually recording it.

4. Press [PLAY(DISPLAY)] to return to the Playlist display.

Channel Link

When recording or playing back a stereo source, traditional mixers require you to control the left and right channels separately, which can make it inconvenient to adjust EQ, effects and other settings. With the VS-1824, it is possible to link adjacent pairs of mixer channels so you can make adjustments to both channels simultaneously. This feature is called “Channel Link.” When Channel Link is on, adjacent odd- and even-numbered channels are paired as shown below. The settings of each odd-numbered channel will be the same as the settings of the corresponding even-numbered channel. When the settings of one channel are modified, the settings of its paired channel will also change.

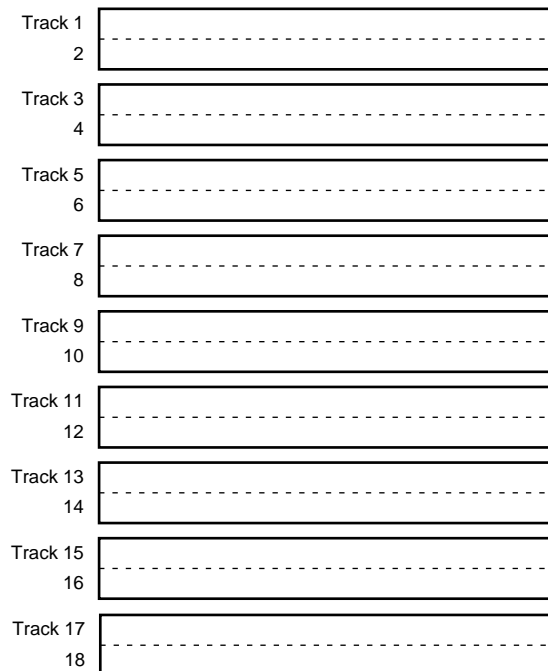

Link Adjacent Mixer Channels

It is possible to link adjacent channels on either the Input Mixer or the Track Mixer. Use this when recording a stereo input to a stereo track.

1. Press the SELECT button for the Input or Track channel you want to have linked.
2. Press [F1 (Link)].
If “Link” does not appear above [F1], press [PAGE] until you see “Link” above [F1], and then press [F1 (Link)].
3. Use the TIME/VALUE dial to select “On.”

Link (Channel Link)

This turns the Channel Link function on and off.

4. Press [PLAY(DISPLAY)] to return to the Playlist display.

Adjust the Levels of Linked Channels

When Channel Link is on, the balance of both channels is preserved, and their overall volume level is controlled with the odd-numbered fader. Even-numbered faders do nothing to stereo-linked channels. If you want to independently adjust the fader levels of each channel, use the following procedure.

1. Press the SELECT button for the input or track channel that is linked.
2. Press [F5 (Fader)].
If “Fader” does not appear above [F5], press [PAGE] until you see “Fader” above [F5], and then press [F5 (Fader)].
3. Press [F6 (PRM.V)]. The values of each fader appear in the display.
4. Use [▲], [▼], [◀], and [▶] to move the cursor. Then use the TIME/VALUE dial to adjust each setting.

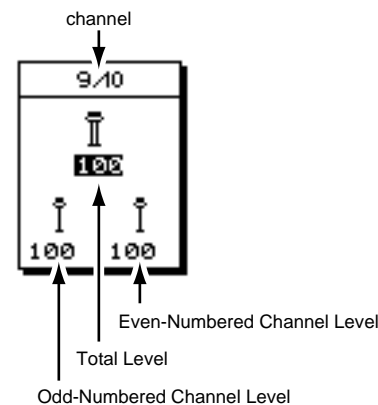

Total Level

This adjusts the total volume level (0-127). Use the fader for the odd-numbered channel to change this setting.

Odd-Numbered Channel Level

This adjusts the total volume level (0-127) of the odd-numbered (left) channel.

Even-Numbered Channel Level

This adjusts the total volume level (0-127) of the even-numbered (right) channel.

5. Press [PLAY (DISPLAY)] to return to the Playlist display.

Adjusting the Panning of Channel Linked Channels

When Channel Link is on, it is possible to adjust the channels' overall stereo position while preserving their pan positions relative to each other. If you want to adjust the pan for each channel independently, use the following procedure.

NOTE

If you adjust the pan while sound is playing, you may notice "blips" in the sound. This is not a malfunction. If you find it annoying, adjust the pan when the sound is not playing.

1. Press the SELECT button for the input or track channel that is linked.
2. Press [F1 (MIX)]. If "MIX" does not appear above [F1], press [PAGE] until you see "MIX" above [F1], and then press [F1 (MIX)].
3. Press [F6 (PRM.V)]. Each of the pan positions appears in the display.
4. Use [▲], [▼], [◀], and [▶] to move the cursor. Then use the TIME/VALUE dial to adjust each setting.

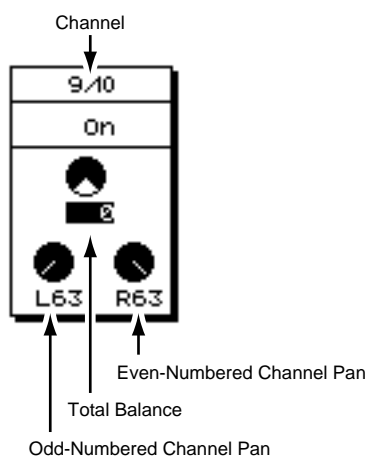

Mix Assign Switch

When this is set to "On", the source at each Input channel is assigned directly to the MIX bus. Set this to "on" when you simply want to mix an input without actually recording it.

Total Balance

With the balance between both channels preserved, this adjusts the total left-right balance (L63-R63).

Odd-Numbered Channel Pan

This adjusts the balance (L63-R63) of the odd-numbered (left) channel.

Even Numbered Channel Pan

This adjusts the balance (L63-R63) of the even-numbered (right) channel.

5. Press [PLAY (DISPLAY)] to return to the Playlist display.

When "VS-1824" is selected on fader mode (p. 75)

When a new song is created, CHANNEL LINK for the DIGITAL input is ON. You can adjust parameters of each individual channel if you turn OFF the CHANNEL LINK. Once the CHANNEL LINK is turned OFF, you can select the channel edit screen of the L channel on the LCD by pressing the [DIGITAL].

To select the channel edit screen for the R channel, hold down [SHIFT] and press [DIGITAL].

The volume of the L channel will be adjusted by moving the [DIGITAL] channel fader.

If you want to adjust the volume of the R channel, move the DIGITAL fader while holding the [SHIFT] down.

When "VS-1880" is selected on fader mode (p. 75)

When a new song is created, the CHANNEL LINKs for DIGITAL input and 7/8, 9/10, 11/12, 13/14 15/16 and 17/18 are ON. You can adjust parameters of individual channels if you turn OFF their CHANNEL LINK. You can select the edit screen for odd numbered channels by pressing the [DIGITAL] button or SELECT button for the target channel.

To select the channel edit screen for even numbered channels, hold down the [SHIFT] and press the [DIGITAL] button or press the SELECT button for the target channel.

The volume of the L channel will be adjusted by moving the [DIGITAL] channel fader.

If you want to adjust the volume of the R channel, move the fader for DIGITAL while holding the [SHIFT] down.

Linking the Faders of Two or More Channels (Fader Group)

The faders of two or more channels (inputs/tracks) can be assigned to groups, so that when the fader of any channel is operated, the fader levels (volume levels) of all channels in that group will be adjusted as well.

When fader group settings have been made, you can adjust the overall volume of a group while preserving the volume balance of the channels included in that group.

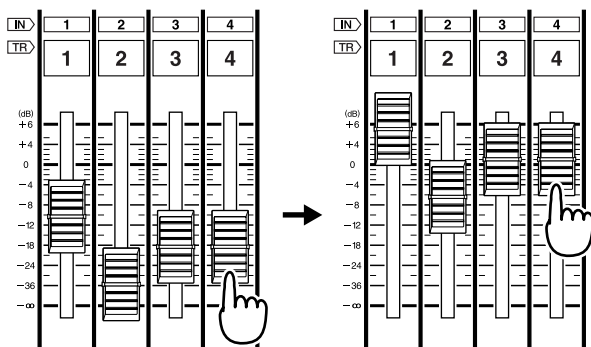

An image of fader group
(Faders cannot be moved.)

1. Press [SELECT (CH EDIT)] for the channel (input or track) you wish to assign to a fader group.
2. Press [PAGE] so that [F4] indicates “Group,” and then press [F4 (Group)].

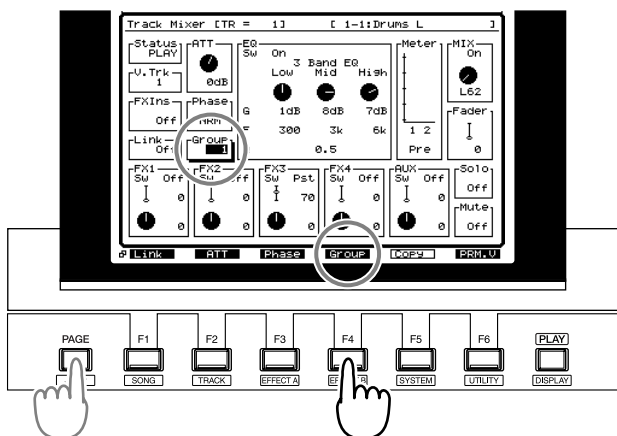

3. Press [F6 (PRM.V)].

4. Use [▲], [▼], [◀], and [▶] to move the cursor, and use the TIME/VALUE dial to set the parameters.

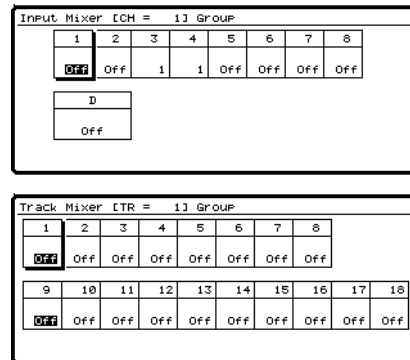

Group

Select the group (1–8) to which you wish to assign the fader. Channels for which the same number is selected will be assigned to the same group. Moving any fader within the group will adjust all faders assigned to that group.

If you select “Off,” the fader will not be assigned to any group, and will function normally.

5. Press [PLAY (DISPLAY)] to return to Play mode.

Selecting V-Tracks

The VS-1824 provides 16 recordable tracks per channel. These are called “V-Tracks,” short for “Virtual Tracks.” By using the V-Tracks, you can record up to 288 tracks per song. To change V-Tracks, use the procedure below.

1. Press the SELECT button for the track whose V-Track you wish to change. The button indicator lights. The Track Mixer screen appears in the display.
2. Use [▲], [▼], [◀], and [▶] to move the cursor to “V. Trk” in the Track Mixer display. Or, press [F5 (V.Trk)]. If “V.Trk” does not appear above [F5], press [PAGE] until it appears, and then press [F5 (V.Trk)].
3. Use the TIME/VALUE dial to choose the V-Track you want to use. Note, you cannot change the V-Track while the song is playing. If the song is playing, press [STOP], and then use the TIME/VALUE dial to choose the V-Track.

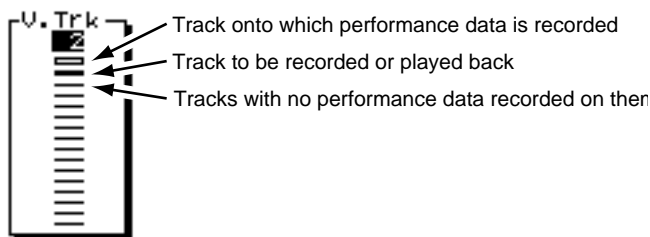

4. Press [PLAY (DISPLAY)] to return to the Playlist display.

Using the Equalizer (EQ)

Each channel of both the Input Mixer and the Track Mixer has a user-definable EQ. You can choose either a two-band (Low, High), or three-band (Low, Mid, High) parametric EQ on a channel-by-channel basis. To use the EQ, first set up EQ settings separately for each channel. Then, while listening to the entire mix, make final adjustments to the EQ, panning, and level for each channel.

* While adjusting the EQ when a track is playing, you may hear short clicks, especially if you change the EQ value very rapidly. This is not a malfunction. To avoid any such noise, change EQ settings slowly.

1. Press the SELECT button for the track to which you want to make EQ settings.

The Track SELECT button lights, and the Track Mixer screen appears in the display.

2. Use [▲], [▼], [◀], and [▶] to move the cursor to the EQ section of the display. Or, press [F2 (Low)]. If “Low” does not appear in the display above [F2], press [PAGE] until “Low” appears above [F2], then press [F2 (Low)].
3. Press [YES]. The EQ curve display appears.
4. Use [▲], [▼], [◀], and [▶] to highlight “SW” and use the TIME/VALUE dial to select “On.”
5. Use [▲], [▼], [◀], and [▶] to move the cursor to the desired EQ parameter. Use the TIME/VALUE dial to select the desired value.

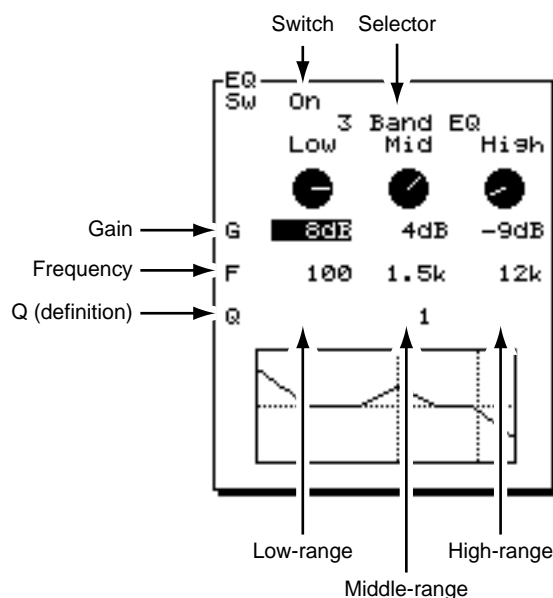

Sw (Equalizer Switch)

Turns the EQ on and off.

(Equalizer Select)

This setting selects how many bands of EQ are available.

2 Band EQ:

Low and High bands are available for 28 inputs and/or tracks at once.

3 Band EQ:

Low, Mid, and High bands are available for 16 Inputs and/or Tracks at once.



You can use three-band EQ on as many as 16 tracks and/or inputs at the same time. Three-band EQ cannot be used on Tracks 17 and 18. Two-band EQ can be used on all 28 tracks and inputs at the same time.

Low

This adjusts the gain (-12 dB to +12 dB) and the shelving frequency (40 Hz-1.5 kHz) of the low-band EQ.

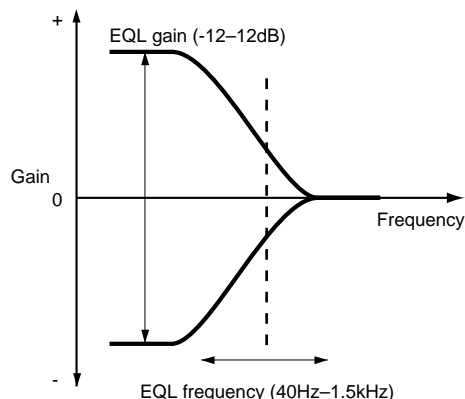

Mid

This adjusts the gain (-12 dB to +12 dB), the center frequency (200 Hz-8 kHz), and the Q (0.5-16) of the mid-band EQ. The Mid band is not available when the 2 Band EQ is selected.

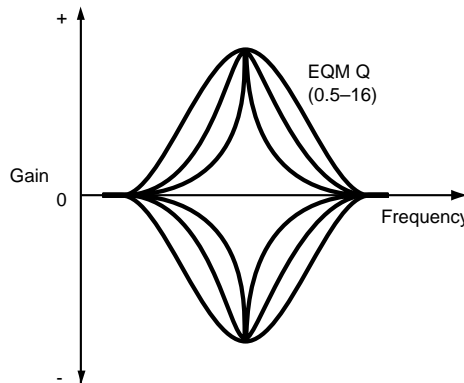
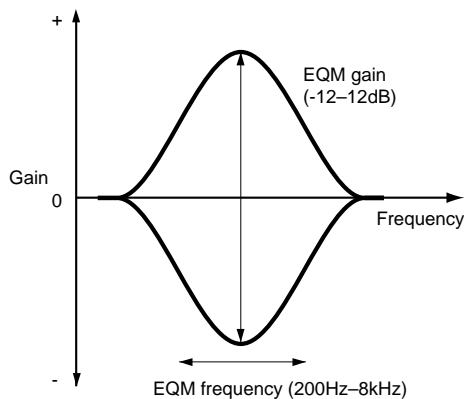

HIGH

This adjusts the gain (-12 dB to +12 dB) and the shelving frequency (500 Hz-18 kHz) of the high-band EQ.

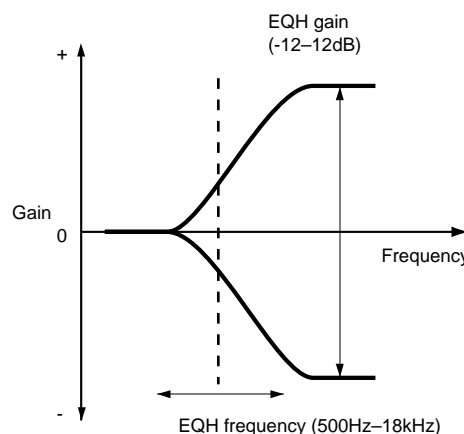

6. Repeat Steps 1-4 to make EQ adjustments to other channels.
7. Press [PLAY (DISPLAY)] to return to the Playlist display.

Attenuation

You can adjust the overall volume of each channel of the Input Mixer and the Track Mixer without using the channel faders. You can lower (attenuate) the volume of a track that is much louder than the others or increase the overall volume of tracks that were recorded at too low a level. This makes adjusting mix levels easier.

1. Press the SELECT button for the track (or input) you want to attenuate or boost. The Track SELECT button lights, and the Track Mixer screen appears in the display.
2. Use [▲], [▼], [◀], and [▶] to move the cursor to "ATT." Or, press [F2 (ATT)]. If "ATT" does not appear in the display above [F2], press [PAGE] until "ATT" appears above [F2], then press [F2 (ATT)].
3. Use the TIME/VALUE dial to change the setting.



ATT (Attenuation)

Lowers or boosts the volume level (-42 dB to +6 dB) of the channel.

4. Press [PLAY (DISPLAY)] to return to the Playlist display.

Phase

The VS-1824 features balanced (TRS) INPUT jacks. The pin assignment of each input is configured as follows:

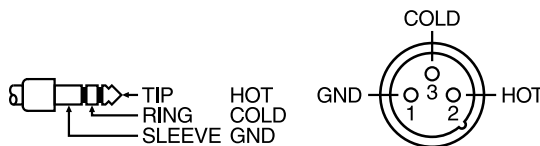

Some audio devices employ the opposite HOT (TIP) and COLD (RING) wiring. Using such equipment as is may result in poor sound placement, loss of correct left-right balance, and loss of separation between left and right channels when using stereo inputs. In such cases, you need to switch the phase of each channel.

1. Press the SELECT button for the track whose phase you want to switch.

The Track SELECT button lights, and the Track Mixer screen appears in the display.

2. Use [▲], [▼], [◀], and [▶] to move the cursor to "Phase." Or, press [F3 (Phase)]. If "Phase" does not appear in the display above [F3], press [PAGE] until "Phase" appears above [F3], then press [F3 (Phase)].
3. Use the TIME/VALUE dial to change the Phase setting.

Phase

This selects the Phase (NRM, INV) for the channel. Usually "NRM" is selected.

NRM:

Normal phase (same phase as input). Default setting.

INV:

Inverted (opposite) phase.

4. Press [PLAY (DISPLAY)] to return to the Playlist display.

When Phase Mismatch is a Problem

Audio equipment connected as shown below will result in audio being out of phase. In such cases, select “INV” for any of the channels that use the third lead as “hot.” It is recommended that you check the HOT and COLD leads for all of your audio equipment.

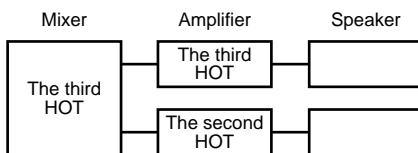

When Phase Mismatch is Not a Problem

Audio equipment connected as shown below will not result in audio being out of phase. In such cases, select “NRM.”

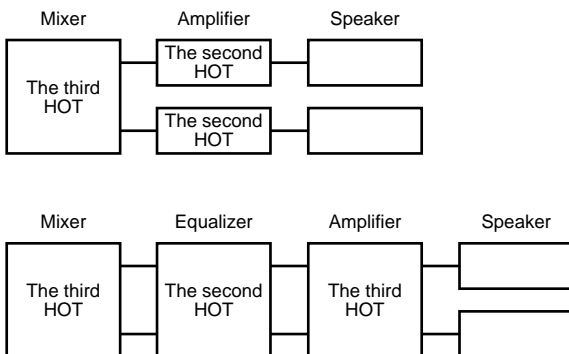

Copying Mixer Settings

You can copy mixer settings—equalizer settings and levels—from another channel to the channel currently shown in the Channel Edit page.

The following settings can be copied.

Equalizer

- EQ low freq
- EQ low gain
- EQ mid freq
- EQ mid gain
- EQ mid Q
- EQ high freq
- EQ high gain

Level

- ATT
- Phase
- FX1 insert send level
- FX1 insert return level
- FX2 insert send level
- FX2 insert return level
- FX3 insert send level
- FX3 insert return level
- FX4 insert send level
- FX4 insert return level
- Fader
- Mix Send pan
- FX1 send level
- FX1 send pan
- FX2 send level
- FX2 send pan
- FX3/AUX1 send level
- FX3/AUX1 send pan
- FX4/AUX2 send level
- FX4/AUX2 send pan
- AUX/AUX3 send level
- AUX/AUX3 send pan

1. Press [SELECT (CH EDIT)] for the copy-destination channel.
2. Press [PAGE] so that [F5] indicates “Copy,” and then press [F5 (Copy)].

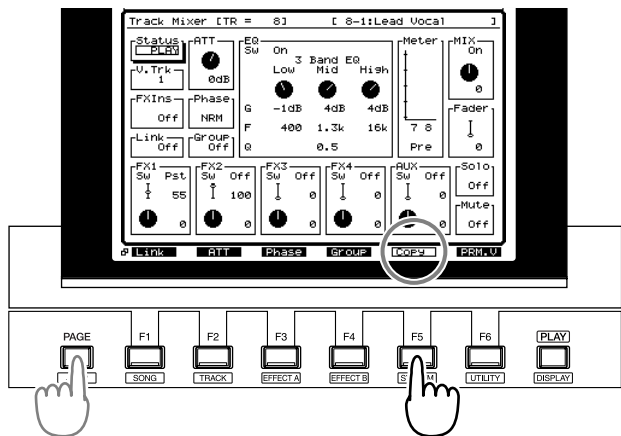

3. Turn the TIME/VALUE dial to select the copy-source channel.

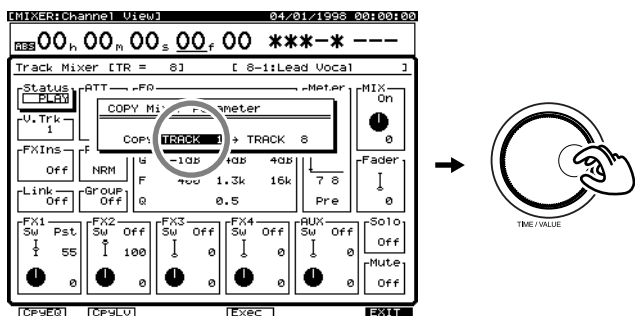

NOTE

If the channel-linking is off for the copy-destination channel, the channel-linking of the copy-source channel will also be considered to be off even though it may actually be on, and only the settings of individual channels will be copied. Similarly, when channel-linking is on for the copy-destination channel, channel-linking of the copy-source channel will also be considered to be on, even though it may actually be off, and the settings of both channels will be copied.

4. Use the function buttons to select the settings to will be copied.
 - [F1 (CpyEQ)]: Copy only the equalizer settings.
 - [F2 (CpyLv)]: Copy only the level settings.
 - [F4 (Exec)] or [ENTER (YES)]: Copy both the equalizer and level settings.
 - [F6 (EXIT)] or [EXIT (NO)]: Exit without copying.
5. When the data has been copied, the display will indicate “Complete.” Press [PLAY (DISPLAY)].

Mixer Scenes

There are two functions to quickly store and recall mixer settings. One is referred to as “Scenes,” and the other is referred to as “EZ Routing.” Use the method appropriate to your situation.

Scene

A Scene stores all EQ, routing, fader-position, pan-position, effects, V-Track selection, and master-level settings. You can store eight different mixer Scenes per song, and each Scene can be recalled using one of the eight dedicated Scene buttons. Scenes are retained as part of the song data when the song is saved. Scenes are useful for trying several different mixes of a song using different combinations of V-Tracks, effects and levels. When you copy a song to a removable drive, such as a Zip drive, and then copy it into a different VS-1824, the Scene settings are restored.

- * *The monitoring level—the position of the MONITOR knob—is not stored in a Scene. When you recall a stored Scene, the monitor level will be determined by the current position of the MONITOR knob.*

EZ Routing

Similar to Scenes, EZ Routing also stores all settings related to mixer routing, V-Track selection, effects, etc. However, unlike Scenes, EZ Routing settings are global—that is, they stay the same regardless of the song. EZ Routing templates are not saved as part of a song. They can be saved within the VS-1824. EZ Routing is useful for storing settings for frequent activities, such as “Recording a Drum Kit,” or “Bouncing Rhythm Section Tracks.” Use EZ Routing to store mixer settings you might want to use on several different songs. For detailed information on using EZ Routing, see Chapter 8 “EZ Routing.”

Storing a Mixer Scene

1. Before storing a Scene, adjust and check all mixer settings, including levels, panning, EQ, effects, V-Tracks, etc.
2. Press [SCENE].
The button indicator lights.
3. Whenever [SCENE] is blinking, the LOCATOR buttons are used to store or recall a Scene. Any LOCATOR which already has a Scene stored will be blinking. LOCATOR buttons that are available to store a Scene will be unlit.
4. Press any LOCATOR which is not lit. For example, if you want to store the current mixer settings as Scene 7, then press [7].

Recalling a Mixer Scene

1. If the song is playing, press [STOP].
2. Press [SCENE]. The button indicator lights.
3. Whenever [SCENE] is blinking, the LOCATOR buttons are used to recall a Scene. Any LOCATOR which already has a Scene stored will be blinking.
4. Press any lit LOCATOR. For example, if you want to recall Scene 3, then press [3].

Recalling a Scene Without Affecting the Current Fader Values

When a Scene is recalled, the fader values will change to the recalled settings. However, the positions of the top panel's faders themselves do not change. This means that the locations of the faders will not match their actual values.

If you want just the fader values to remain unchanged when you recall a Scene, make the following settings.

1. Press [PLAY (DISPLAY)].
2. Hold [SHIFT] and press [F5 (SYSTM)].
The System menu icon appears in the display. If the System menu does not appear, press [F6 (EXIT)].
3. Press [F1 (SYSPM)].
If "SYSPM" does not appear in the display above [F1], press [PAGE] until it appears, then press [F1 (SYSPM)].
4. Use [▲], [▼], [◀] and [▶] to move the cursor to "Scene Mode."
If "Scene Mode" is not displayed, press [F1 (Prm 1)].

Scene Mode:

This setting determines the fader settings when a Scene is recalled.

All:

This changes the mixer settings to those of the Scene being recalled. In this case, when a Scene is recalled, the location of the faders on the top panel may no longer match the actual fader settings.

KeepF:

This changes the mixer settings to those of the Scene being recalled, with the exception of the fader settings. This means that even when a Scene is recalled, fader settings will still match the fader positions on the top panel.

5. Use the TIME/VALUE dial to select "KeepF."
6. Press [PLAY (DISPLAY)] to return to the playlist screen.

Deleting a Mixer Scene

1. If the song is playing, press [STOP].
2. Press [SCENE]. The button indicator lights.
3. Whenever [SCENE] is blinking, the LOCATOR buttons are used to recall a Scene. Any LOCATOR which already has a Scene stored will be blinking.
4. Hold [CLEAR], and press the LOCATOR for the Scene you want to delete. For example, if you want to delete Scene 3, hold [CLEAR] and then press [3].

Updating a Mixer Scene

To make subtle changes in a Scene, you must recall the Scene, then delete it, make the desired mixer setting changes, and then re-store the scene. Follow the procedure described below.

1. If the song is playing, press [STOP].
2. Press [SCENE]. The button indicator lights.
3. Press the LOCATOR for the Scene you want to update. For example, if you want to update Scene 3, then press [3].
4. After a Scene is recalled, the screen returns to the Playlist display. The [SCENE] indicator goes off.
5. Press [SCENE]. The button indicator lights.
6. Hold [CLEAR], and press the LOCATOR for the Scene you want to update. For example, if you want to clear Scene 3, hold [CLEAR] and then press [3].
7. Make the desired changes to the mixer. It is not necessary to re-configure the entire mixer. You only need to adjust the value that you want updated from the previous Scene setting. For example, just adjust the V-Track setting for one playback track.
8. Once you've made the necessary mixer updates, press [SCENE] and then press the LOCATOR button to store the Scene again.

Chapter 6 Mixer Channel Strip Detail

This chapter explains in detail each of the settings available in the Mixer display for the Input Mixer, Track Mixer, and the Master Block. For general information about signal flow, busses, etc., see *Chapter 5, "Using The Digital Mixer."*

Input Mixer

The following functions are found in the Input Mixer. Press the SELECT button for any Input to view and adjust its settings. Press the function button located under the display corresponding to the setting you wish to change. Or, press the [▲], [▼], [◀], and [▶] buttons to move the cursor to the setting you wish to change. Use the TIME/VALUE dial to select the desired value.



If you adjust the equalizer and the pan while sound is playing, you may notice "blips" in the sound. This is not a malfunction. If you find it annoying, adjust the equalizer and the pan when the sound is not playing.

[F1 (MIX)] MIX Bus Enable/Pan

Sets the panning of the signal (L63-R63) sent to the MIX bus.
(Mix Assign Switch)

On:

The channel is assigned directly to the MIX bus. Set this to "on" when you simply want to mix an input without actually recording it.

Off:

The channel is not assigned to the MIX bus.

(Pan Knob)

Sets the left-right balance (L63-R63) of the channel in the MIX bus.

[F2 (Low)], [F3 (Mid)], and [F4 (High)] Equalizer

Sw (Equalizer Switch)

Turns the EQ on and off. The EQ switch must be ON to make settings in the EQ section.

(Equalizer Select)

This setting selects how many bands of EQ are available in the channel.

2 Band EQ:

Low and High bands are available.

3 Band EQ:

Low, Mid, and High bands are available.



You can use three-band EQ on as many as 16 tracks and/or inputs at the same time. Three-band EQ cannot be used on Tracks 17 and 18. Two-band EQ can be used on all 28 tracks and inputs at the same time.

Low

This adjusts the gain (-12 dB to +12 dB) and the shelving frequency (40 Hz-1.5 kHz) of the low-band EQ.

Mid

This adjusts the gain (-12 dB to +12 dB) and the center frequency (200 Hz-8 kHz), and the Q (filter sharpness) (0.5-16) of the mid-band EQ. The Mid band is not available when "2 Band EQ" is selected.

High

This adjusts the gain (-12 dB to +12 dB) and the shelving frequency (500 Hz-18 kHz) of the high-band EQ.

ENTER Button

When the cursor is positioned inside the EQ section, the ENTER button will be blinking. Press [ENTER] to view a graphic display of the EQ settings.

[F6 (PRM.V)] Parameter View/ [F6 (CH.V)] Channel View

This changes the display from Channel View to Parameter View. Press [F6 (PRM.V)] to view the parameter settings (such as Pan or Effect Send) for all channels. Press [F6 (CH.V)] to view all of the mixer settings for just one channel.

[F1 (FX1)] Effect 1 Send

Channel settings for the EFFECT 1 Bus. Sets the Effect Send Switch, the Send Level (0-127) and panning.

Sw (Effect Send Switch)

Switches the channel to the EFFECT bus.

Off:

The channel is not sent to the EFFECT bus.

Pre:

The signal is sent to the EFFECT bus before it passes through the mixer fader.

Post:

The signal is sent to the EFFECT bus after it passes through the mixer fader.

Level

Sets the send level (0-127) of the signal sent to the EFFECT 1 Bus.

Panning

Sets the panning (L63-R63) of the signal sent to the EFFECT 1 Bus.

[F2 (FX2)] Effect 2 Send

Channel settings for the EFFECT 2 Bus. Sets the Effect Send Switch, the Send Level (0-127) and panning.

Sw (Effect Send Switch)

Switches the channel to the EFFECT bus.

Off:

The channel is not sent to the EFFECT bus.

Pre:

The signal is sent to the EFFECT bus before it passes through the mixer fader.

Post:

The signal is sent to the EFFECT bus after it passes through the mixer fader.

Level

Sets the send level (0-127) of the signal sent to the EFFECT 2 Bus.

Panning

Sets the panning (L63-R63) of the signal sent to the EFFECT 2 Bus.

[F3 (FX3)] Effect 3 Send

Channel settings for the EFFECT 3 Bus. Sets the Effect Send Switch, the Send Level (0-127) and panning.

Sw (Effect Send Switch)

Switches the channel to the EFFECT bus.

Off:

The channel is not sent to the EFFECT bus.

Pre:

The signal is sent to the EFFECT bus before it passes through the mixer fader.

Post:

The signal is sent to the EFFECT bus after it passes through the mixer fader.

Level

Sets the send level (0-127) of the signal sent to the EFFECT 3 Bus.

Panning

Sets the panning (L63-R63) of the signal sent to the EFFECT 3 Bus.

[F4 (FX4)] Effect 4 Send

Channel settings for the EFFECT 4 Bus. Sets the Effect Send Switch, the Send Level (0-127) and panning.

Sw (Effect Send Switch)

Switches the channel to the EFFECT bus.

Off:

The channel is not sent to the EFFECT bus.

Pre:

The signal is sent to the EFFECT bus before it passes through the mixer fader.

Post:

The signal is sent to the EFFECT bus after it passes through the mixer fader.

Level

Sets the send level (0-127) of the signal sent to the EFFECT 4 Bus.

Panning

Sets the panning (L63-R63) of the signal sent to the EFFECT 4 Bus.

[F5 (AUX)] AUX Send

Channel settings for the AUX Bus. Sets the AUX Send Switch, the Send Level (0-127) and panning.

Sw (Effect Send Switch)

Switches the channel to the AUX bus.

Off:

The channel is not sent to the AUX bus.

Pre:

The signal is sent to the AUX bus before it passes through the mixer fader.

Post:

The signal is sent to the AUX bus after it passes through the mixer fader.

Level

Sets the send level (0-127) of the signal sent to the AUX Bus.

Panning

Sets the panning (L63-R63) of the signal sent to the AUX Bus.

NOTE

If you are not using VS8F-2 Effect Expansion Boards, the Effect Send parameters will be replaced with additional AUX send busses.

[F1 (FX1In)] Effect 1 Insert

After pressing [F1 (FX1In)], or moving the cursor to the FXIns area, press [ENTER] (see “Effect Types,” p. 99).

FX1 (Effect Insert Switch)

This sets how the effect is connected in the mixer.

Off:

The effect is not inserted in the channel.

Ins:

Both channels of the stereo effect are inserted into the channel.

InsL:

The left channel of the effect is inserted into the mixer channel.

InsR:

The right channel of the effect is inserted into the mixer channel.

InsS:

Each channel of the effect is inserted in series into the mixer channel. In other words, it is sent through one side of a stereo effect before it passes through the other side of the effect.

- * *When Ins or InsS is selected, that effect cannot be inserted on any other channel. When InsL or InsR is selected, that effect can be inserted only on one other mixer channel. If the name of an input or track appears as the Insert Switch setting, the effect is already being inserted in the displayed input or track. You will need to select the input or track that is using that effect and turn its Effect Insert Switch off. Remember that effects can be inserted in the MIX bus as well (p. 105)*

Snd (Insert Send Level)

This adjusts the level of signal (-42 dB to +6 dB) sent to the effect. The default setting is 0 dB.

Rtn (Insert Return Level)

This adjusts the level of signal (-42 dB to +6 dB) returned from the effect. The default setting is 0 dB.

[F2 (FX2In)] Effect 2 Insert

After pressing [F2 (FX2In)], or moving the cursor to the FXIns area, press [ENTER].

FX2 (Effect Insert Switch)

This sets how the effect is connected in the mixer.

Off:

The effect is not inserted in the channel.

Ins:

Both channels of the stereo effect are inserted into the channel.

InsL:

The left channel of the effect is inserted into the mixer channel.

InsR:

The right channel of the effect is inserted into the mixer channel.

InsS:

Each channel of the effect is inserted in series into the mixer channel. In other words, it is sent through one side of a stereo effect before it passes through the other side of the effect.

- * *When Ins or InsS is selected, that effect cannot be inserted on any other channel. When InsL or InsR is selected, that effect can be inserted only on one other mixer channel. If the name of an input or track appears as the Insert Switch setting, the effect is already being inserted in the displayed input or track. You will need to select the input or track that is using that effect and turn its Effect Insert Switch off. Remember that effects can be inserted in the MIX bus as well (p. 105).*

Snd (Insert Send Level)

This adjusts the level of signal (-42 dB to +6 dB) sent to the effect. The default setting is 0 dB.

Rtn (Insert Return Level)

This adjusts the level of signal (-42 dB to +6 dB) returned from the effect. The default setting is 0 dB.

[F3 (FX3In)] Effect 3 Insert

After pressing [F3 (FX3In)], or moving the cursor to the FXIns area, press [ENTER].

FX3 (Effect Insert Switch)

This sets how the effect is connected in the mixer.

Off:

The effect is not inserted in the channel.

Ins:

Both channels of the stereo effect are inserted into the channel.

InsL:

The left channel of the effect is inserted into the mixer channel.

InsR:

The right channel of the effect is inserted into the mixer channel.

InsS:

Each channel of the effect is inserted in series into the mixer channel. In other words, it is sent through one side of a stereo effect before it passes through the other side of the effect.

- * *When Ins or InsS is selected, that effect cannot be inserted on any other channel. When InsL or InsR is selected, that effect can be inserted only on one other mixer channel. If the name of an input or track appears as the Insert Switch setting, the effect is already being inserted in the displayed input or track. You will need to select the input or track that is using that effect and turn its Effect Insert Switch off. Remember that effects can be inserted in the MIX bus as well (p. 105).*

Snd (Insert Send Level)

This adjusts the level of signal (-42 dB to +6 dB) sent to the effect. The default setting is 0 dB.

Rtn (Insert Return Level)

This adjusts the level of signal (-42 dB to +6 dB) returned from the effect. The default setting is 0 dB.

[F4 (FX4In)] Effect 4 Insert

After pressing [F4 (FX4In)], or moving the cursor to the FXIns area, press [ENTER].

FX4 (Effect Insert Switch)

This sets how the effect is connected in the mixer.

Off:

The effect is not inserted in the channel.

Ins:

Both channels of the stereo effect are inserted into the channel.

InsL:

The left channel of the effect is inserted into the mixer channel.

InsR:

The right channel of the effect is inserted into the mixer channel.

InsS:

Each channel of the effect is inserted in series into the mixer channel. In other words, it is sent through one side of a stereo effect before it passes through the other side of the effect.

- * *When Ins or InsS is selected, that effect cannot be inserted on any other channel. When InsL or InsR is selected, that effect can be inserted only on one other mixer channel. If the name of an input or track appears as the Insert Switch setting, the effect is already being inserted in the displayed input or track. You will need to select the input or track that is using that effect and turn its Effect Insert Switch off. Remember that effects can be inserted in the MIX bus as well (p. 105).*

Snd (Insert Send Level)

This adjusts the level of signal (-42 dB to +6 dB) sent to the effect. The default setting is 0 dB.

Rtn (Insert Return Level)

This adjusts the level of signal (-42 dB to +6 dB) returned from the effect. The default setting is 0 dB.

[F1 (Link)] Channel Link

Use this setting to link or unlink adjacent mixer channels. Linking adjacent channels allows you to control both sides of a stereo pair with a single set of parameters.

On:

Adjacent channels are linked.

Off:

Adjacent channels are not linked.

[F2 (ATT)] Attenuation

Lowers or boosts the volume level (-42 dB to +6 dB) of the channel.

[F3 (Phase)] PHASE

This selects the Phase (NRM, INV) for each channel. If you are using two microphones to record one source, it is possible that you will experience “phase cancellation.” This is usually caused by a microphone that is wired in an inverted fashion and results in the lowering or muting of your signal when both channels are played. If you are experiencing this, try setting this parameter to “INV” for one of the microphones. Usually, “NRM” is selected.

NRM:

Normal phase (track has same phase as the input). This is the default setting.

INV:

Inverted (opposite) phase.

[F4 (Group)] FADER GROUP

Turn the TIME/VALUE knob to assign the selected channel to one of the eight Fader Groups.

[F1 (Meter)] METER

Switches the Meter Display in the Mixer screen between pre-fader and post-fader signal levels. Pre-fader indicates the level of the signal before it passes through the channel fader and post-fader indicates the level of the signal after it passes through the channel fader.

[F3 (Solo)] SOLO

Use this to turn the SOLO function on and off for a mixer channel (p. 43).

[F4 (Mute)] MUTE

Use this to turn the MUTE function on and off for a mixer channel (p. 42).

[F5 (Fader)] FADER

Controls the level (0-127) of the signal.

Track Mixer

The following functions are found in the Track Mixer. Press the SELECT button for any Track to view and adjust the settings. Press the function button located under the display corresponding to the setting you wish to change. Or, press [▲], [▼], [◀], and [▶] to move the cursor to settings you wish to change. Use the TIME/VALUE dial to change the value.

NOTE

If you adjust the equalizer and the pan while sound is playing, you may notice “blips” in the sound. This is not a malfunction. If you find it annoying, adjust the equalizer and the pan when the sound is not playing.

[F1 (MIX)] MIX Bus Enable/Pan

Assigns the channel to the MIX bus and determines the balance of the signal in the Master Stereo Mix.

(Mix Assign Switch)

On:

The channel is assigned directly to the MIX bus. Set this to “on” when you simply want to mix an input without actually recording it.

Off:

The channel is not assigned to the MIX bus.

(Pan Knob)

Sets the left-right balance (L63-R63) of the channel in the MIX bus.

[F2 (Low)], [F3 (Mid)], and [F4 (High)] Equalizer

Sw (Equalizer Switch)

Turns the EQ on and off. The EQ switch must be on to make settings in the EQ section.

(Equalizer Select)

This setting selects how many bands of EQ are available in the channel.

2 Band EQ:

Low and High bands are available.

3 Band EQ:

Low, Mid, and High bands are available.

NOTE

You can use three-band EQ on as many as 16 tracks and/or inputs at the same time. Three-band EQ cannot be used on Tracks 17 and 18. Two-band EQ can be used on all 28 tracks and inputs at the same time.

Low

This adjusts the gain (-12 dB to +12 dB) and the shelving frequency (40 Hz-1.5 kHz) of the low-band EQ.

Mid

This adjusts the gain (-12 dB to +12 dB) and the center frequency (200 Hz-8 kHz), and the Q (filter sharpness) (0.5-16) of the mid-band EQ. The Mid band is not available when "2 Band EQ" is selected.

High

This adjusts the gain (-12 dB to +12 dB) and the shelving frequency (500 Hz-18 kHz) of the high-band EQ.

ENTER Button

When the cursor is positioned inside the EQ section, the ENTER button will be blinking. Press [ENTER] to view a graphic display of the EQ settings.

[F5 (V.Trk)] V-Track Select

Selects the V-Track (1-16) for playback or recording. The V-Track setting is only available in the Track Mixer. The VS-1824 must be stopped before this value can be changed. A small box indicates that a recording has been made on the V-Track. A flat line indicates the V-Track has not yet been recorded.

**[F6 (PRM.V)] Parameter View/
[F6 (CH.V)] Channel View**

Changes the display from Channel View to Parameter View. Press [F6 (PRM.V)] to view the Parameter settings (such as Pan or Effect Send) for all channels. Press [F6 (CH.V)] to view the entire mixer settings for just one channel.

[F1(FX1)] Effect 1 Send

Channel settings for the EFFECT 1 Bus. Sets the Effect Send Switch, the Send Level (0-127) and panning.

Sw (Effect Send Switch)

Switches the channel to the EFFECT bus.

Off:

The channel is not sent to the EFFECT bus.

Pre:

The signal is sent to the EFFECT bus before it passes through the mixer fader.

Post:

The signal is sent to the EFFECT bus after it passes through the mixer fader.

Level

Sets the channel's send level (0-127) to the EFFECT 1 Bus.

Panning

Sets the channel's panning (L63-R63) in the EFFECT 1 Bus.

[F2 (FX2)] Effect 2 Send

Channel settings for the EFFECT 2 Bus. Sets the Effect Send Switch, the Send Level (0-127) and panning.

Sw (Effect Send Switch)

Switches the channel to the EFFECT bus.

Off:

The channel is not sent to the EFFECT bus.

Pre:

The signal is sent to the EFFECT bus before it passes through the mixer fader.

Post:

The signal is sent to the EFFECT bus after it passes through the mixer fader.

Level

Sets the channel's send level (0-127) to the EFFECT 2 Bus.

Panning

Sets the channel's panning (L63-R63) in the EFFECT 2 Bus.

[F3 (FX3)] Effect 3 Send

Channel settings for the EFFECT 3 Bus. Sets the Effect Send Switch, the Send Level (0-127) and panning.

Sw (Effect Send Switch)

Switches the channel to the EFFECT bus.

Off:

The channel is not sent to the EFFECT bus.

Pre:

The signal is sent to the EFFECT bus before it passes through the mixer fader.

Post:

The signal is sent to the EFFECT bus after it passes through the mixer fader.

Level

Sets the channel's send level (0-127) to the EFFECT 3 Bus.

Panning

Sets the panning (L63-R63) of the channel to the EFFECT 3 Bus.

[F4 (FX4)] Effect 4 Send

Channel settings for the EFFECT 4 Bus. Sets the Effect Send Switch, the Send Level (0-127) and panning.

Sw (Effect Send Switch)

Switches the channel to the EFFECT bus.

Off:

The channel is not sent to the EFFECT bus.

Pre:

The signal is sent to the EFFECT bus before it passes through the mixer fader.

Post:

The signal is sent to the EFFECT bus after it passes through the mixer fader.

Level

Sets the channel's send level (0-127) to the EFFECT 4 Bus.

Panning

Sets the channel's panning (L63-R63) in the EFFECT 4 Bus.

[F5 (AUX)] AUX Send

Channel settings for the AUX Bus. Sets the AUX Send Switch, the Send Level (0-127) and panning.

Sw (Effect Send Switch)

Switches the channel to the AUX bus.

Off:

The channel is not sent to the AUX bus.

Pre:

The signal is sent to the AUX bus before it passes through the mixer fader.

Post:

The signal is sent to the AUX bus after it passes through the mixer fader.

Level

Sets the send level (0-127) of the channel to the AUX Bus.

Panning

Sets the panning (L63-R63) of the channel to the AUX Send Bus.



If you are not using the VS8F-2 Effect Expansion Boards, the effect send parameters will be replaced with additional AUX send buses.

[F1 (FX1In)] Effect 1 Insert

After pressing [F1 (FX1In)], or moving the cursor to the FXIns area, press [ENTER].

FX1 (Effect Insert Switch)

This sets how the effect is connected in the mixer.

Off:

The effect is not inserted in the channel.

Ins:

Both channels of the stereo effect are inserted into the channel.

InsL:

The left channel of the effect is inserted into the mixer channel.

InsR:

The right channel of the effect is inserted into the mixer channel.

InsS:

Each channel of the effect is inserted in series into the mixer channel.

- * *When Ins or InsS is selected, that effect cannot be inserted on any other channel. When InsL or InsR is selected, that effect can be inserted only on one other mixer channel. If the name of an input or track appears as the Insert Switch setting, the effect is already being inserted in the displayed input or track. You will need to select the input or track that is using that effect and turn its Effect Insert Switch off. Remember that effects can be inserted in the MIX bus as well.*

Snd (Insert Send Level)

This adjusts the level of signal (-42 dB to +6 dB) sent to the effect. The default setting is 0 dB.

Rtn (Insert Return Level)

This adjusts the level of signal (-42 dB to +6 dB) returned from the effect. The default setting is 0 dB.

[F2 (FX2In)] Effect 2 Insert

After pressing [F2 (FX2In)], or moving the cursor to the FXIns area, press [ENTER].

FX2 (Effect Insert Switch)

This sets how the effect is connected in the mixer.

Off:

The effect is not inserted in the channel.

Ins:

Both channels of the stereo effect are inserted into the channel.

InsL:

The left channel of the effect is inserted into the mixer channel.

InsR:

The right channel of the effect is inserted into the mixer channel.

InsS:

Each channel of the effect is inserted in series into the mixer channel.

- * *When Ins or InsS is selected, that effect cannot be inserted on any other channel. When InsL or InsR is selected, that effect can be inserted only on one other mixer channel. If the name of an input or track appears as the Insert Switch setting, the effect is already being inserted in the displayed input or track. You will need to select the input or track that is using that effect and turn its Effect Insert Switch off. Remember that effects can be inserted in the MIX bus as well.*

Snd (Insert Send Level)

This adjusts the level of signal (-42 dB to +6 dB) sent to the effect. The default setting is 0 dB.

Rtn (Insert Return Level)

This adjusts the level of signal (-42 dB to +6 dB) returned from the effect. The default setting is 0 dB.

[F3 (FX3In)] Effect 3 Insert

After pressing [F3 (FX3In)], or moving the cursor to the FXIns area, press [ENTER].

FX3 (Effect Insert Switch)

This sets how the effect is connected in the mixer.

Off:

The effect is not inserted in the channel.

Ins:

Both channels of the stereo effect are inserted into the channel.

InsL:

The left channel of the effect is inserted into the mixer channel.

InsR:

The right channel of the effect is inserted into the mixer channel.

InsS:

Each channel of the effect is inserted in series into the mixer channel.

- * *When Ins or InsS is selected, that effect cannot be inserted on any other channel. When InsL or InsR is selected, that effect can be inserted only on one other mixer channel. If the name of an input or track appears as the Insert Switch setting, the effect is already being inserted in the displayed input or track. You will need to select the track or input that is using that effect and turn its Effect Insert Switch off. Remember that effects can be inserted in the MIX bus as well.*

Snd (Insert Send Level)

This adjusts the level of signal (-42 dB to +6 dB) sent to the effect. The default setting is 0 dB.

Rtn (Insert Return Level)

This adjusts the level of signal (-42 dB to +6 dB) returned from the effect. The default setting is 0 dB.

[F4(FX4In)] Effect 4 Insert

After pressing [F4 (FX4In)], or moving the cursor to the FXIns area, press [ENTER].

FX4 (Effect Insert Switch)

This sets how the effect is connected in the mixer.

Off:

The effect is not inserted in the channel.

Ins:

Both channels of the stereo effect are inserted into the channel.

InsL:

The left channel of the effect is inserted into the mixer channel.

InsR:

The right channel of the effect is inserted into the mixer channel.

InsS:

Each channel of the effect is inserted in series into the mixer channel.

- * *When Ins or InsS is selected, that effect cannot be inserted on any other channel. When InsL or InsR is selected, that effect can be inserted only on one other mixer channel. If the name of an input or track appears as the Insert Switch setting, the effect is already being inserted in the displayed input or track. You will need to select the input or track that is using that effect and turn its Effect Insert Switch off. Remember that effects can be inserted in the MIX bus as well.*

Snd (Insert Send Level)

This adjusts the level of signal (-42 dB to +6 dB) sent to the effect. The default setting is 0 dB.

Rtn (Insert Return Level)

This adjusts the level of signal (-42 dB to +6 dB) returned from the effect. The default setting is 0 dB.

[F1 (Link)] Channel Link

Use this setting to link or unlink adjacent mixer channels.

On:

Adjacent channels are linked.

Off:

Adjacent channels are not linked.

[F2 (ATT)] Attenuation

Lowers or boosts the volume level (-42 dB to +6 dB) of the channel.

[F3 (Phase)] PHASE

This selects the Phase (NRM, INV) for each channel. If you are using two microphones to record one source, it is possible that you will experience “phase cancellation.” This is usually caused by a microphone that is wired in an inverted fashion and results in the lowering or muting of your signal when both channels are played. If you are experiencing this, try setting this parameter to “INV” for one of the microphones. Usually “NRM” is selected.

NRM:

Normal phase (same phase as input). (Default setting).

INV:

Inverted (opposite) phase.

[F4 (Group)] FADER GROUP

Turn the TIME/VALUE knob to assign the selected channel to one of the eight Fader Groups.

[F1 (Meter)] METER

Switches the Meter Display in the Mixer screen between pre-fader and post-fader signal levels. Pre-fader indicates the level of the signal before it passes through the channel fader and post-fader indicates the level of the signal after it passes through the channel fader.

[F2 (Stats)] STATUS

After pressing [F2 (Stats)] or moving the cursor to the “Status” area, press [ENTER]. The display shows the Track Status. (The Track Status is changed by pressing the STATUS button above the channel fader.)

PLAY

The track is set for playback.

MUTE

The track is muted.

SOURCE

The input source or track assigned to the channel is heard.

REC

The track is ready to be recorded, or is being recorded.

Use this area as another way to assign inputs, tracks, and effect returns to a track to be recorded. Move the cursor to the source, and use the TIME/VALUE dial to place a mark for all sources to be assigned to the track.

[F3 (Solo)] SOLO

Use this to turn the SOLO function on and off for a mixer channel.

[F4 (Mute)] MUTE

Use this to turn the MUTE function on and off for a mixer channel.

[F5 (Fader)] FADER

Controls the level (0-127) of the signal.

Master Block

The following functions are found in the Master Block section of the mixer. Press [EDIT/SOLO] to view and adjust the settings of the Master Block. Press the function button located under the display corresponding to the setting you wish to change. Or, press [▲], [▼], [◀], and [▶] to move the cursor to the setting you wish to change. Use the TIME/VALUE dial to select the desired value.

NOTE

If you adjust the pan while sound is playing, you may notice “blips” in the sound. This is not a malfunction. If you find it annoying, adjust the pan when the sound is not playing.

[F1 (MST)] MASTER

Adjusts the level and balance of the master mix.

Level

This adjusts the volume level (0-127) for the MASTER OUT jacks. This is normally adjusted using the Master fader.

Balance

This adjusts the left-right balance (L63-R63) for the MASTER OUT jacks.

[F2 (MON)] MONITOR

Adjusts the level and balance of the Monitor mix.

Level

This adjusts the volume level (0-127) for the MONITOR jack. This is normally adjusted using the MONITOR knob on the top panel.

Balance

This adjusts the left-right balance (L63-R63) for the MONITOR jacks.

[F3 (AUX.A)] AUX A

This selects the signal to be assigned to the AUX A jacks.

FX1:

The signal at the EFFECT 1 bus.

FX2:

The signal at the EFFECT 2 bus.

AUX1/FX3:

The signal at the AUX1 bus, or, when a second VS8F-2 Effect card is installed in the VS-1824, the EFFECT 3 bus.

AUX2/FX4:

The signal at the AUX2 bus, or, when a second VS8F-2 Effect card is installed in the VS-1824, the EFFECT 4 bus.

AUX3/AUX:

The signal at the AUX3 bus, or, when a second VS8F-2 Effect card is installed in the VS-1824, the AUX bus.

[F4 (AUX.B)] AUX B

This selects the signal to be assigned to the AUX B jacks.

FX1:

The signal at the EFFECT 1 bus.

FX2:

The signal at the EFFECT 2 bus.

AUX1/FX3:

The signal at the AUX1 bus, or, when a second VS8F-2 Effect card is installed in the VS-1824, the EFFECT 3 bus.

AUX2/FX4:

The signal at the AUX2 bus, or, when a second VS8F-2 Effect card is installed in the VS-1824, the EFFECT 4 bus.

AUX3/AUX:

The signal at the AUX3 bus, or, when a second VS8F-2 Effect card is installed in the VS-1824, the AUX bus.

[F5 (DOUT1)] DIGITAL OUT 1

This selects the signal to be assigned to the DIGITAL OUT 1 (coaxial) connector.

MST:

The signal at the MASTER jacks (MIX bus).

MON:

The signal at the MONITOR jacks.

FX1:

The signal at the EFFECT 1 bus.

FX2:

The signal at the EFFECT 2 bus.

AUX1/FX3:

The signal at the AUX1 bus, or, when a second VS8F-2 Effect card is installed in the VS-1824, the EFFECT 3 bus.

AUX2/FX4:

The signal at the AUX2 bus, or, when a second VS8F-2 Effect card is installed in the VS-1824, the EFFECT 4 bus.

AUX3/AUX:

The signal at the AUX3 bus, or, when a second VS8F-2 Effect card is installed in the VS-1824, the AUX bus.

[F6 (DOUT2)] DIGITAL OUT 2

This selects the signal to be assigned to the DIGITAL OUT 2 (optical) connector.

MST:

The signal at the MASTER jacks (MIX bus).

MON:

The signal at the MONITOR jacks.

FX1:

The signal at the EFFECT 1 bus.

FX2:

The signal at the EFFECT 2 bus.

AUX1/FX3:

The signal at the AUX1 bus, or, when a second VS8F-2 Effect card is installed in the VS-1824, the EFFECT 3 bus.

AUX2/FX4:

The signal at the AUX2 bus, or, when a second VS8F-2 Effect card is installed in the VS-1824, the EFFECT 4 bus.

AUX3/AUX:

The signal at the AUX3 bus, or, when a second VS8F-2 Effect card is installed in the VS-1824, the AUX bus.

[F1 (FX1In)] Effect 1 Insert

After pressing [F1 (FX1In)], or moving the cursor to the FXIns area, press [ENTER].

FX1 (Effect Insert Switch)

This connects the effect in the Master Block section of the mixer.

Off:

The effect is not inserted.

Ins:

The stereo effect is inserted into the Master Block.

- * *When Ins is selected, that effect cannot be used on any mixer channel. If the name of an input or track appears as the Insert Switch setting, the effect is already inserted in the displayed input or track. You will need to select the input or track that is using that effect and turn its Effect Insert Switch off.*

Snd (Insert Send Level)

This adjusts the level of signal (-42 dB to +6 dB) sent to the effect. The default setting is 0 dB.

Rtn (Insert Return Level)

This adjusts the level of signal (-42 dB to +6 dB) returned from the effect. The default setting is 0 dB.

[F2 (FX2In)] Effect 2 Insert

After pressing [F2 (FX2In)], or moving the cursor to the FXIns area, press [ENTER].

FX2 (Effect Insert Switch)

This connects the effect in the Master Block section of the mixer.

Off:

The effect is not inserted.

Ins:

The stereo effect is inserted into the Master Block.

- * *When Ins is selected, that effect cannot be used on any mixer channel. If the name of an input or track appears as the Insert Switch setting, the effect is already inserted in the displayed input or track. You will need to select the input or track that is using that effect and turn its Effect Insert Switch off.*

Snd (Insert Send Level)

This adjusts the level of signal (-42 dB to +6 dB) sent to the effect. The default setting is 0 dB.

Rtn (Insert Return Level)

This adjusts the level of signal (-42 dB to +6 dB) returned from the effect. The default setting is 0 dB.

[F3 (FX3In)] Effect 3 Insert

After pressing [F3 (FX3In)], or moving the cursor to the FXIns area, press [ENTER].

FX3 (Effect Insert Switch)

This connects the effect in the Master Block section of the mixer.

Off:

The effect is not inserted.

Ins:

The stereo effect is inserted into the Master Block.

- * *When Ins is selected, that effect cannot be used on any mixer channel. If the name of an input or track appears as the Insert Switch setting, the effect is already inserted in the displayed input or track. You will need to select the input or track that is using that effect and turn its Effect Insert Switch off.*

Snd (Insert Send Level)

This adjusts the level of signal (-42 dB to +6 dB) sent to the effect. The default setting is 0 dB.

Rtn (Insert Return Level)

This adjusts the level of signal (-42 dB to +6 dB) returned from the effect. The default setting is 0 dB.

[F4 (FX4In)] Effect 4 Insert

After pressing [F4 (FX4In)], or moving the cursor to the FXIns area, press [ENTER].

FX4 (Effect Insert Switch)

This connects the effect in the Master Block mixer section.

Off:

The effect is not inserted.

Ins:

The stereo effect is inserted into the Master Block.

- * *When Ins is selected, that effect cannot be used on any mixer channel. If the name of an input or track appears as the Insert Switch setting, the effect is already inserted in the displayed input or track. You will need to select the input or track that is using that effect and turn its Effect Insert Switch off.*

Snd (Insert Send Level)

This adjusts the level of signal (-42 dB to +6 dB) sent to the effect. The default setting is 0 dB.

Rtn (Insert Return Level)

This adjusts the level of signal (-42 dB to +6 dB) returned from the effect. The default setting is 0 dB.

[F5 (DIR)] DIRECT OUT

This selects tracks to be assigned as Direct Outputs.

Off:

Direct out is not used.

1-8:

Tracks 1-8 are output from the analog output jacks 1-8. When DIRECT OUT is used, the MASTER, MONITOR and AUX jacks are used for the direct track outputs. The signals at each of the DIGITAL OUT connectors can be set as usual.

Track 1: MASTER jack (L)

Track 2: MASTER jack (R)

Track 3: AUX A jack (L)

Track 4: AUX A jack (R)

Track 5: AUX B jack (L)

Track 6: AUX B jack (R)

Track 7: MONITOR jack (L)

Track 8: MONITOR jack (R)

9-16:

Tracks 9-16 are output from the analog output jacks 1-8. When DIRECT OUT is used, the MASTER, MONITOR and AUX jacks are used for the direct track outputs. The signals at each of the DIGITAL OUT connectors can be set as usual.

Track 9: MASTER jack (L)

Track 10: MASTER jack (R)

Track 11: AUX A jack (L)

Track 12: AUX A jack (R)

Track 13: AUX B jack (L)

Track 14: AUX B jack (R)

Track 15: MONITOR jack (L)

Track 16: MONITOR jack (R)



Tracks 17 and 18—since they are typically used for mastering—are not routed to direct outputs.

[F1 (FX1)] Effect 1 Master Send

Master Block settings for the EFFECT 1 Bus.

Level

Sets the master send level (0-127) of the EFFECT 1 Bus.

Panning

Sets the overall panning (L63-R63) of the EFFECT 1 Send.

[F2 (FX2)] Effect 2 Master Send

Master Block settings for the EFFECT 2 Bus.

Level

Sets the master send level (0-127) of the EFFECT 2 Bus.

Panning

Sets the overall panning (L63-R63) of the EFFECT 2 Send.

[F3 (FX3)] Effect 3 Master Send

Master Block settings for the EFFECT 3 Bus.

Level

Sets the master send level (0-127) of the EFFECT 3 Bus.

Panning

Sets the overall panning (L63-R63) of the EFFECT 3 Send.

[F4 (FX4)] Effect 4 Master Send

Master Block settings for the EFFECT 4 Bus.

Level

Sets the master send level (0-127) of the EFFECT 4 Bus.

Panning

Sets the overall panning (L63-R63) of the EFFECT 4 Send.

[F5 (AUX)] AUX Master Send

Master Block settings for the AUX Bus.

Level

Sets the master send level (0-127) of the AUX Bus.

Panning

Sets the panning (L63-R63) of the master AUX Send.

Chapter 7 Using Internal Effects (VS8F-2)

One effect expansion board, VS8F-2 is pre-installed in the VS-1824. Up to two of these effect expansion boards can be installed in the VS-1824. With two VS8F-2s installed, four high-quality stereo effects are available for use during recording, bouncing and mixing.



Some of the procedures described in this chapter require the installation of the second (optional) VS8F-2 Effect Expansion Board.

Location of Effects

Each VS8F-2 effect expansion board installed in the VS-1824 is given its own control area. These areas are called EFFECT A and EFFECT B. With two VS8F-2s installed, each of the effects in EFFECT A—FX1 and FX2—and the effects in EFFECT B—FX3 and FX4—may be used. You can apply up to four effects at a time to each channel of the VS-1824's mixer.

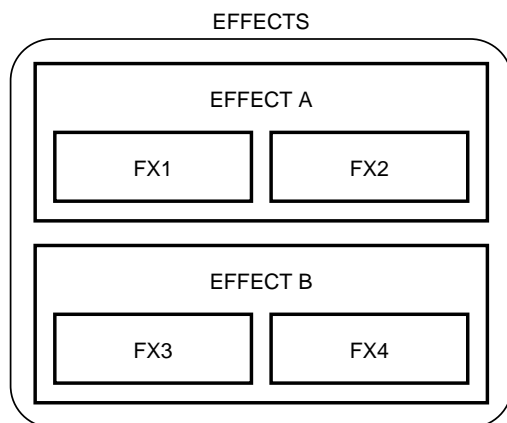

Effect Types

There are two types of effects patches in the VS8F-2 Effects Expansion Board: insert effects, and loop effects. The effect type determines how the effect should be connected in the mixer. The two ways to connect an effect within the mixer are referred to as “insert effects,” and “loop effects.” The differences in these methods are explained in the following sections.

Insert Effects

With insert effects, the effect is added directly, either between the mixer channel's equalizer and fader, or before the Master fader. Effects such as compressors, EQs, guitar amp simulators and mic simulators are normally patched as inserts. If you set up an effect as an insert on either a track or an input, it cannot be used on any other tracks or inputs. When an effect is inserted on a mixer channel, that effect cannot be used in a loop on another channel. For example, if you select Preset Patch P067 Limiter as Effect 1 and insert it on Track 8, no other inputs or tracks can be routed to Effect 1.

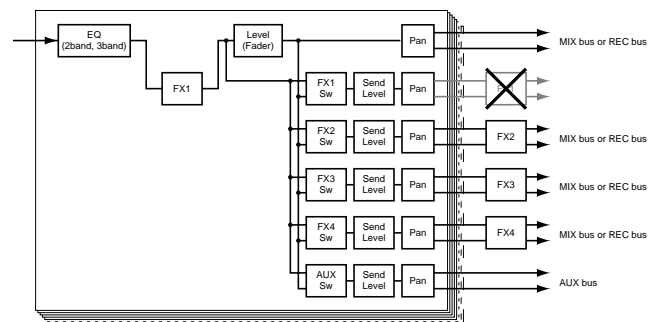

* Depending on the effects used, when mixing with different effects inserted into each channel, or mixing some channels having effects inserted while other channels have no effects, slight timing shifts between tracks may occur.

Loop Effects

With loop effects, the original sound and the effected sound are mixed together. Effects such as reverbs and delays are typically connected using a loop.

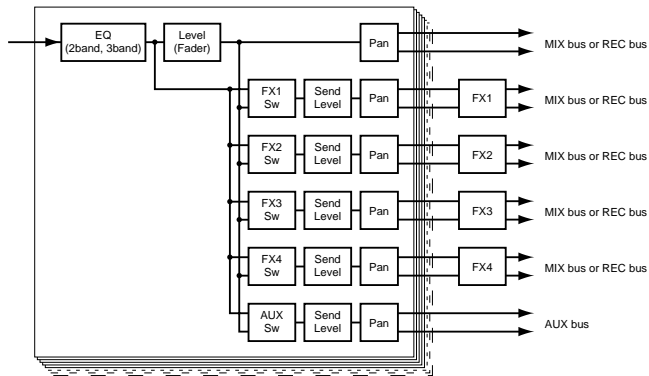

In a loop effect, the original signal is copied and sent to the effect. Later in the signal flow, the output of the effect processor is mixed back in with the original signal. A loop effect provides independent control of the original signal (using the channel fader) and the Effect Return Level. All 28 channels of the VS-1824s mixer can be routed to a single effect using a loop effect. For example, you can have up to 28 different mixer channels routed to the same reverb, with different send levels on each channel.

A mixer channel can be connected to a loop effect using either of two different switch positions. These are referred to as “pre-fader” and “post-fader.”

Pre Fader

With the effect switch set to Pre Fader, the signal is sent to the effect before it passes through its channel fader. The position of the channel fader has no affect on the amount of signal going to the effect. The signal is sent to the effect at the level set with the Effect Send Level value.

Post Fader

With the effect switch set to Post Fader, the signal is sent to the effect after it passes through the channel fader. The position of the channel fader has a direct bearing on the amount of signal going to the effect. As the channel fader is lowered, the amount of signal going to the effect is lowered. As the channel fader is raised, the amount of signal going to the effect is raised. As a result, the direct signal and the effected signal always stay in proportion.

Making the Effect Connection

The VS-1824 Channel Mixer display provides two different areas for connecting effects. One area is used for connecting insert effects only, and is labeled “FXIns.” The other area is used for connecting loop effects. This area appears at the bottom of the Mixer screen, and is labeled “FX1”, “FX2”, “FX3”, and “FX4.” To find out if an effect should be connected as an insert or as a loop, see “Preset Patch List” (Appendices p. 20). Look under “Type.” The Type of effect determines which area of the Mixer display should be used to connect it.

Procedure for Using Effects

To use an effect in the VS-1824, follow these three general steps:

1. Select the Effect Patch to use.
2. Determine whether the effect should be used as an insert effect or in a loop effect.
3. Connect the effect within the mixer. The exact methods for each of these three steps are explained below.

Selecting Effect Patches

An effect setting is referred to as a “patch.” The VS8F-2 provides over 240 preset patches and 200 user patches. Use the following procedure to select a preset patch.

Selecting a Preset Patch

1. Press [PLAY (DISPLAY)].
2. To use EFFECT A (FX1 and FX2), hold [SHIFT] and press [F3 (EFFECT A)]. To use EFFECT B (FX3 and FX4), hold [SHIFT] and press [F4 (EFFECT B)].
3. Press [F1 (FX1)]. The Effect 1 screen appears in the display. If “FX1” does not appear above [F1], press [F6 (EXIT)] until it does. Then, press [F1 (FX1)].
4. Press [F2 (Sel)]. The effects list appears in the display.
5. Use the TIME/VALUE dial or [▲], [▼], [◀], and [▶] to move the cursor to the effect you wish to use. The function buttons work as shown below.

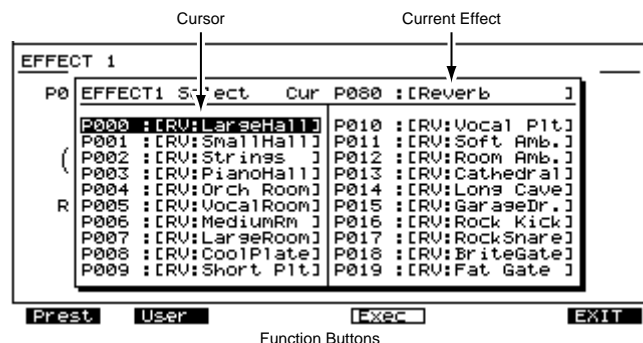

- [F1 (Preset)]: Displays the Preset patch list.
- [F2 (User)]: Displays the User patch list.
- [F4 (Exec)]: Selects the effect and exits the screen.
- [F6 (EXIT)]: Exits the screen without selecting the effect.

6. Press [F4 (Exec)] or press [ENTER/YES] to select the effect. The EFFECT 1 screen appears in the display.
7. Press [PLAY (DISPLAY)] to return to the Playlist display.

If “No Effect Board” Appears in the Display

This indicates there is no VS8F-2 installed. In this case, you cannot use the internal effects. If the message appears even when a VS8F-2 is installed, it indicates that the effect board is not installed properly. Perform the shutdown procedure and turn the power off as described in “Turning Off the Power” (p. 32), and then reinstall the VS8F-2 correctly.

* Patches using the Reverb, Gated Reverb, Vocoder 2, Voice Transformer or Mastering Tool Kit algorithms cannot be selected for FX2 and FX4. A horizontal line is drawn through the effect name in such cases. If you want to use these algorithms, select them from FX1 or FX 3:

EFFECT2 Select		Cur	P022 : [DL:Short Dly]
P020	[RV:ReverseGt]		P030 : [DL:Ping Pong]
P021	[RV:PanningGt]		P031 : [VO:Vocal FX]
P022	[DL:Short Dly]		P032 : [VO:JazzVocal]
P023	[DL:MediumDly]		P033 : [VO:RockVocal]
P024	[DL:LongDelay]		P034 : [VO:Narration]
P025	[DL:AnalogDly]		P035 : [VO:BigChorus]
P026	[DL:Tape Echo]		P036 : [VO:Club DJ]
P027	[DL:Karaoke]		P037 : [VO:AM-Radio]
P028	[DL:Multi-Tap]		P038 : [VO:PlusTwo]
P029	[DL:MixTapAMB]		P039 : [VO:Robot FX]

* With some effects, you may not want the direct sound output, or other special settings may be required. Please refer to “Algorithm List” (Appendices p. 25) when making these settings.

Creating and Saving User Effect Patches

A VS-1824 with one or two of the optional VS8F-2 effect boards installed will have 200 user patches, which are the same as the first 200 preset patches. It is possible to overwrite the user patches to store your own custom effects. To create your own user patch, first select the preset patch whose sound is closest to what you wish to create. Then alter the settings of that patch. If you do not save the changes as a user patch, your edits are lost once you select another patch or recall a different Scene.

Create a User Effect Patch

- Using the first six steps described in “Selecting Effect Patches” (p. 101), select the patch containing the effect algorithms you will base your new effect on. The following screen is displayed:

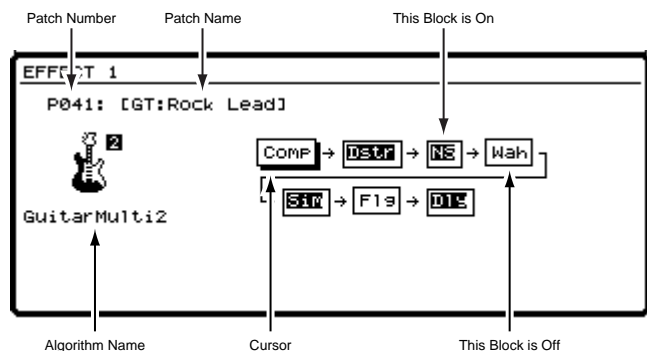

- Press [◀] and [▶] to move the cursor in the screen. When you select a multi-effect patch (e.g., Guitar Multi 2), use the TIME/VALUE dial to turn each effect within that patch on or off. In the display, effect blocks that are currently activated and on are highlighted. Move the cursor to the highlighted effect block whose settings you wish to change.
- Press [F3 (Edit)] or press [ENTER/YES]. A list of settings available in the effect block is displayed.
- Press [▲], [▼], [◀], and [▶] to move the cursor in the screen. Use the TIME/VALUE dial to adjust settings. For more detailed information about the settings included in each effect algorithm, refer to the “Algorithm List” (Appendices p. 25).

The function buttons work as shown below:

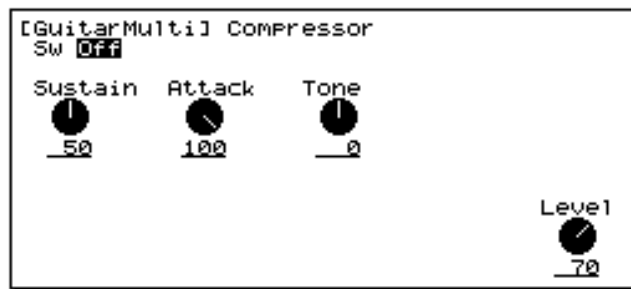

[F1 (← Blk)]:

Displays the settings of the previous effect block.

[F2 (Blk →)]:

Displays the settings of the next effect block.

[F4 (SAVE)]:

Displays the Effect Save screen.

[F6 (EXIT)]:

Exits the screen.

- When saving an effect settings, it is necessary to either save it as a user patch, or save the mixer settings as a Scene. If you want to use a custom effect in a different song, save it as a user patch. If you are only going to use it in the currently selected song, you can save it as part of a mixer Scene. At this point, save the effect using one of the two methods described below.

Save an Effect as a User Patch

- Press [F4 (SAVE)]. The Effect Name screen appears in the display.
- Turn the TIME/VALUE dial to select the destination patch number (U000-U199).

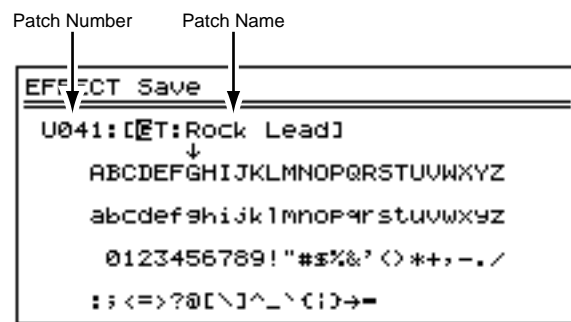

- Use [◀] and [▶], and the TIME/VALUE dial to create the name of the user patch. The function buttons work as shown:

[F1 (Hist)]:

Press this button to take you through a list of the last 20 user patch names entered, one at a time.

[F2 (Clr)]:

Clears all the characters in the window.

[F3 (Del)]:

Deletes the character where the cursor is positioned.

[F4 (Ins)]:

Inserts a space where the cursor is positioned.

[F5 (Write)]:

Stores the user patch and exits the screen.

[F6 (EXIT)]:

Exits the screen without storing the user patch.



If you press [NUMERICS/ASCII] so it is lit, you can use the SELECT buttons to enter characters in a manner similar to a computer keyboard.

4. After entering the name, press [F5 (Write)]. The user patch is saved.
5. Press [PLAY (DISPLAY)] to return to the Playlist display.

Save an Effect Patch as Part of a Mixer Scene

For more detailed information, refer to “Storing a Mixer Scene,” p. 84.

1. Press [PLAY (DISPLAY)].
2. Press [SCENE]. The button indicator lights.
3. Press a SCENE button (1-8) that is not blinking. For example, if you wanted to store the settings to Scene 6, then press [6].
4. After the Scene is stored, the [SCENE] indicator goes off.
5. If you wish to clear the scene, press [SCENE] once. Then hold [CLEAR] and press the blinking SCENE button which you wish to clear.

About Algorithms

An algorithm determines the composition or structure of an effect. The VS8F-2 provides 36 different algorithms. Each effect patch uses at least one, and in many cases more than one of these algorithms. Check the algorithms used in each patch in “Preset Patch List” (Appendices p. 20). For details on each algorithm, refer to “Algorithm List” (Appendices p. 25).

Connecting Insert Effects

Connecting Insert Effects to Inputs and Tracks

The following section explains in detail the steps to connect insert effects, and provides examples for each method.

1. Select the channel on which the effect is to be inserted. Press the SELECT button for either an input channel or a track channel. The button indicator lights, and the Mixer Screen appears in the display.
2. Use [▲], [▼], [◀], and [▶] to move the cursor to “FXIns.” Or, press [F1 (FX1In)]. If “FX1In” does not appear above [F1], press [PAGE] a few times until you see “FX1In”, and then press [F1 (FX1In)]. This will move the cursor directly to “FXIns.”
3. Press [ENTER/YES].
4. Use [◀] and [▶] to move the cursor to the effect you want to insert.

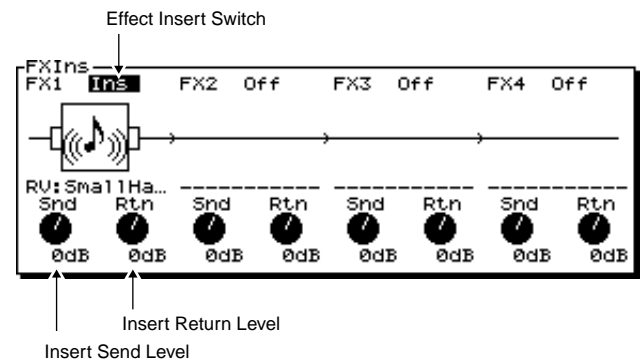

5. Use the TIME/VALUE dial to set the selected effect's Effect Insert Switch.

FX1 (Effect Insert Switch)

This sets how the effect is connected.

- Off:** The channel is not routed into the effect.
- Ins:** The channel is routed into both channels of the stereo effect.
- InsL:** The channel is routed into the left channel of the stereo effect.
- InsR:** The channel is routed into the right channel of the stereo effect.
- InsS:** The channel is routed into both channels of the stereo effect, in series.

Chapter 7 Using Internal Effects (VS8F-2)

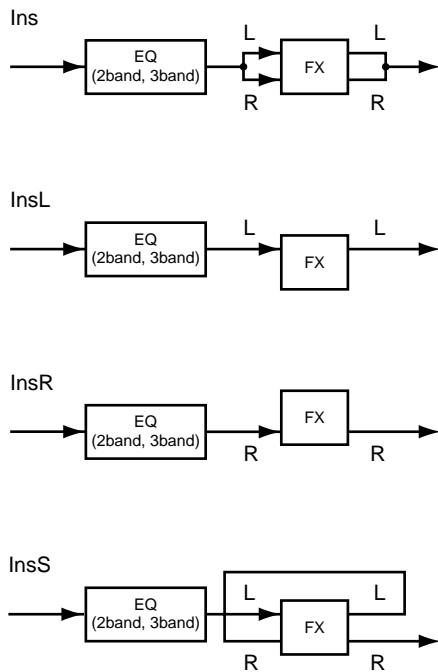

* When *Ins* or *InsS* is selected, that effect cannot be used on any other channel. When *InsL* or *InsR* is selected, that effect can be inserted only on one other mixer channel. If the effect is already being used as an insert effect, the display shows you the channel on which the effect is inserted, as shown in the following illustration.

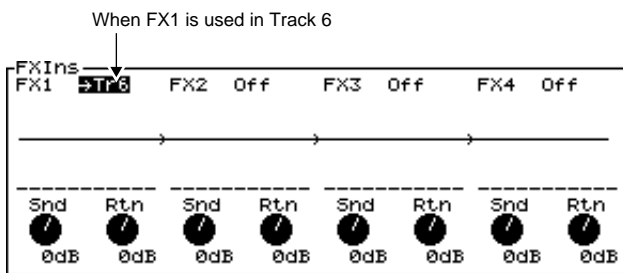

HINT

The way you insert an effect can help you utilize the VS8F-2 effect processors to their fullest potential. For example, the *InsL* and *InsR* options allow you to insert separate compressors (using the Stereo Compressor patch) into two channels using only one effects processor. Using all four effects processors will allow you to insert eight separate compressors into eight individual channels at the same time. The *InsS* option will allow you to turn the stereo four-band parametric EQ patch into a mono eight-band parametric EQ by inserting a single channel into one side of the stereo EQ and then routing the signal through the other side of the stereo EQ patch.

Snd (Insert Send Level)

This adjusts the level of signal (-42 dB to +6 dB) sent to the effect. The default setting is 0 dB.

Rtn (Insert Return Level)

This adjusts the level of signal (-42 dB to +6 dB) returned from the effect. The default setting is 0 dB.

6. Press [PLAY(DISPLAY)] to return to the Playlist display. Use the above steps to insert FX2-FX 4.

Connecting Insert Effects in the Master Block

It is possible to insert an effect into the MIX bus. For example, you might want to send the entire song mix through a compressor or limiter. Use the following steps to do so.

1. Press [EDIT/SOLO]. The button indicator lights, and the Master screen appears in the display.
2. Use [▲], [▼], [◀], and [▶] to move the cursor to “FXIns.” Or, press [F1 (FX1In)]. If “FX1In” does not appear above [F1], press [PAGE] a few times until you see “FX1In”, and then press [F1 (FX1In)].
3. Press [ENTER/YES].
4. Use [◀] and [▶] to move the cursor to the Effect you want to insert. Use the TIME/VALUE dial to select the desired setting for Effect Insert Switch.

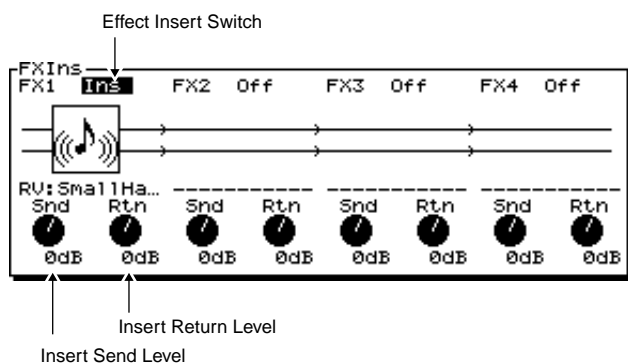

FX1(Effect Insert Switch)

This sets how the effect is connected.

Off:

The channel is not routed into the effect.

Ins:

The channel is routed into both channels of the stereo effect.

Snd (Insert Send Level)

This adjusts the level of signal (-42 dB to +6 dB) sent to the effect. The default setting is 0 dB.

Rtn (Insert Return Level)

This adjusts the level of signal (-42 dB to +6 dB) returned from the effect. The default setting is 0 dB.

5. Press [PLAY (DISPLAY)] to return to the Playlist display. Insert FX2-FX 4 into the MIX bus using the same steps.

Three Insert Effect Examples

Example 1: Process a Recorded Guitar Solo Through a Guitar Amp Simulator.

General Strategy: Insert the effect in the Track Mixer.

Details for this Example: Select Patch P088 as FX1, Insert on Track 3.

Begin by Selecting the Effect

1. Press [PLAY (DISPLAY)].
2. Hold [SHIFT] and press [F3 (EFFECT A)].
3. Press [F1 (FX1)]. The Effect 1 screen appears in the display. If “FX1” does not appear above [F1], press [F6 (EXIT)] until it does. Then, press [F1 (FX1)].
4. Press [F2 (Sel)]. The effects list appears in the display.
5. Use the TIME/VALUE dial or [▲], [▼], [◀], and [▶] to move the cursor to Effect Preset Patch P088 “GuitarMulti1.”
6. Press [F4 (Exec)] or press [ENTER/YES] to select the effect. The EFFECT 1 screen appears in the display.

Next, Set up the Mixer

1. Press the SELECT button for Track 3. The button indicator lights, and the Track Mixer Screen appears in the display.
2. Use [▲], [▼], [◀], and [▶] to move the cursor to “FXIns,” or, press [F1 (FX1In)]. If “FX1In” does not appear above [F1], press [PAGE] a few times until you see “FX1In”, and then press [F1 (FX1In)]. This will move the cursor directly to “FXIns.”
3. Press [ENTER/YES].
4. Use [◀] and [▶] to move the cursor to FX1. Use the TIME/VALUE dial to change the Effect Insert Switch to “Ins.”
5. Press [PLAY (DISPLAY)] to return to the Playlist display.

Example 2: Use a Microphone Simulator on a Vocal Track to be Recorded.

General Strategy: Insert the effect in the Input Mixer.

Details for this Example: Select Patch P128 as FX3, insert on Input 2.

Begin by Selecting The Effect:

1. Press [PLAY (DISPLAY)].
2. Hold [SHIFT] and press [F4 (EFFECT B)].
3. Press [F1 (FX3)]. The Effect 3 screen appears in the display. If “FX3” does not appear above [F1], press [F6 (EXIT)] until it does. Then, press [F1 (FX3)].
4. Press [F2 (Sel)]. The effects list appears in the display.
5. Use the Time/VALUE dial or [▲], [▼], [◀], and [▶] to move the cursor to Effect Preset Patch P128 “DR20 → 87.”
6. Press [F4 (Exec)] or press [ENTER/YES] to select the effect. The EFFECT 3 screen appears in the display.

Next, Set Up the Mixer

1. Press the SELECT button for Input 2. The button indicator lights, and the Input Mixer Screen appears in the display.
2. Use [▲], [▼], [◀], and [▶] to move the cursor to “FXIns.” Or, press [F3 (FX3In)]. If “FX3In” does not appear above [F3], press [PAGE] a few times until you see “FX3In”, and then press [F3 (FX3In)]. This will move the cursor directly to “FXIns.”
3. Press [ENTER/YES].
4. Use [◀] and [▶] to move the cursor to FX3. Use the TIME/VALUE dial to change the Effect Insert Switch to “Ins.”
5. Press [PLAY (DISPLAY)] to return to the Playlist display.

Example 3: Place a Limiter on the Stereo Mix Master Output

General Strategy: Insert the effect on the MIX bus.

Details for this Example: Select Patch P067 as FX2, insert on Master Block.

Begin by Selecting the Effect

1. Press [PLAY (DISPLAY)].
2. Hold [SHIFT] and press [F3 (EFFECT A)].
3. Press [F4 (FX2)]. The Effect 2 screen appears in the display. If “FX2” does not appear above [F4], press [F6 (EXIT)] until it does. Then, press [F4 (FX2)].
4. Press [F2 (Sel)]. The effects list appears in the display.
5. Use the TIME/VALUE dial or [▲], [▼], [◀], and [▶] to move the cursor to Effect Preset Patch P067 “Limiter.”
6. Press [F4 (Exec)] or press [ENTER/YES] to select the effect. The EFFECT 2 screen appears in the display.

Next, Set Up the Mixer

1. Press [EDIT/SOLO]. The button indicator lights, and the Master screen appears in the display.
2. Use [▲], [▼], [◀], and [▶] to move the cursor to “FXIns.” Or, press [F2 (FX2In)]. If “FX2In” does not appear above [F2], press [PAGE] a few times until you see “FX2In”, and then press [F2 (FX2In)]. This will move the cursor directly to “FXIns.”
3. Press [ENTER/YES].
4. Use [◀], and [▶] to move the cursor to FX2. Use the TIME/VALUE dial to change the Effect Insert Switch to “Ins.”
5. Press [PLAY (DISPLAY)] to return to the Playlist display.

Connecting Loop Effects

The following section explains in detail the steps to connect loop effects, and provides examples for each method.

1. Select the channel to which the effect is to be added.
Press the SELECT button for either an input channel or a track channel. The button indicator lights, and the Mixer Screen appears in the display.
2. Use [▲], [▼], [◀], and [▶] to move the cursor to “FX1,” or press [F1 (FX1)]. If “FX1” does not appear above [F1], press [PAGE] a few times until you see “FX1”, and then press [F1 (FX1)].

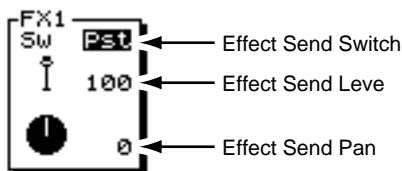

3. Use [▲] and [▼] to move the cursor. Use the TIME/VALUE dial to change the values.

Sw (Effect Send Switch)

This selects how the signal is sent to the EFFECT bus.

Off:

Signal is not sent to the EFFECT bus.

Pre:

(Pre-fader). The signal is sent based on its level before the mixer fader.

Pst:

(Post-fader). The signal is sent based on its level after the mixer fader.

Send Level

This adjusts the volume level of the signal (0-127) sent to the EFFECT bus. The default setting is 100.

Send Pan

This adjusts the stereo placement of the signal (L63-R63) sent to the EFFECT bus. “L63” is hard left and R63 is hard right. The default value is “0” (center). This is useful for isolating channels to the left or right side of a stereo effect so they can be processed independently.

4. Press [PLAY (DISPLAY)] to return to the Playlist display.
5. Connect FX2-FX4 using the same method.

Effects Return Section

When used in a loop effect, each of the four effects has its own return level. You can adjust the return level for each effect using the following procedure.

* *The effect return settings for an individual effect will not function if that effect is being used as an insert effect.*

1. Press the EFFECT 1/3 RTN SELECT button. The Effect Return screen appears in the display.
2. Press [F3 (FX1)], or use [▲], [▼], [◀], and [▶] to move the cursor to “FX1Rtn.”
3. Use [▲] and [▼] to move the cursor. Use the TIME/VALUE dial to change the value.

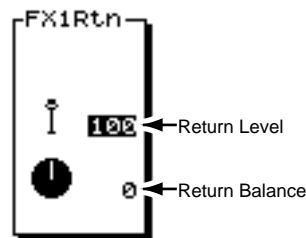

Return Level

This sets the volume level (0-127) of the effect. The default setting is 100.

Return Balance

This adjusts the stereo placement of the effect (L63-R63) in the Master Mix. “L63” designates hard left and R63 designates hard right. The default value is 0 (center).

Adjust the Effect Return Level using the Channel Faders

1. Press [FADER/MUTE] so “IN” is lit.
2. Use the EFFECT 1 fader to adjust the FX1 return level.
3. Use the EFFECT 2 fader to adjust the FX2 return level.
4. Hold [SHIFT] and use the EFFECT 1 fader to adjust the FX3 return level.
5. Hold [SHIFT] and use the EFFECT 2 fader to adjust the FX4 return level.
6. After you are finished adjusting the Effect Return levels, press [FADER/MUTE] so “TR” is lit.

Two Examples of Using Loop Effects

Example 1: Add a Delay to a Recorded Vocal Track.

General Strategy: Connect the effect in the Track Mixer, post-fader.

Details for this Example: Select Patch P024 as FX2, connect to Track 6.

Begin by Selecting the Effect:

1. Press [PLAY (DISPLAY)].
2. Hold [SHIFT] and press [F3 (EFFECT A)].
3. Press [F4 (FX2)]. The Effect 2 screen appears in the display. If “FX2” does not appear above [F4], press [F6 (EXIT)] until it does. Then, press [F4 (FX2)].
4. Press [F2 (Sel)]. The effects list appears in the display.
5. Use the TIME/VALUE dial or [▲], [▼], [◀], and [▶] to move the cursor to Effect Preset Patch P024 “Long Delay.”
6. Press [F4 (Exec)] or press [ENTER/YES] to select the effect. The EFFECT 2 screen appears in the display.

Next, Set up the Mixer

1. Press the SELECT button for Track 6. The button indicator lights, and the Track Mixer Screen appears in the display.
2. Use [▲], [▼], [◀], and [▶] to move the cursor to “FX2.” Or, press [F2 (FX2)]. If “FX2” does not appear above [F2], press [PAGE] a few times until you see “FX2”, and then press [F2 (FX2)].
3. Use the TIME/VALUE dial to change the FX Switch to “Pst” (“post-fader”).
4. Press [▲] and [▼] to move the cursor to the Effect Send Level, and use the TIME/VALUE dial to change the level to “70.”
5. Press [PLAY (DISPLAY)] to return to the Playlist display.

Example 2: Add Reverb to Drum Tracks

General Strategy: Connect the effect on multiple Track Mixer channels, post-fader.

Details for this Example: Select Patch P006 as FX3, and connect on Tracks 7-12.

Begin by Selecting the Effect:

1. Press [PLAY (DISPLAY)].
2. Hold [SHIFT] and press [F4 (EFFECT B)].
3. Press [F1 (FX3)]. The Effect 3 screen appears in the display. If “FX3” does not appear above [F1], press [F6 (EXIT)] until it does. Then, press [F1 (FX3)].
4. Press [F2 (Sel)]. The effects list appears in the display.
5. Use the TIME/VALUE dial or [▲], [▼], [◀], and [▶] to move the cursor to Effect Preset Patch P006 “Medium Room.”
6. Press [F4 (Exec)] or press [ENTER/YES] to select the effect. The EFFECT 3 screen appears in the display.

Next, Set up the Mixer

1. Press Track 7 SELECT. The button indicator lights, and the Track Mixer Screen appears in the display.
2. Use [▲], [▼], [◀], and [▶] to move the cursor to “FX3.” Or, press [F3 (FX3)]. If “FX3” does not appear above [F3], press [PAGE] a few times until you see “FX3”, and then press [F3 (FX3)].
3. Use the TIME/VALUE dial to change FX Switch to “Pst.”
4. Press [▲] and [▼] to move the cursor to the Effect Send Level, and use the TIME/VALUE dial to change the level to “70.”
5. Repeat Steps 1-4 for Track 8-12. Press the Track SELECT button for each of these tracks to make the effect settings.
6. When you are finished setting up effect loops on Tracks 7-12, press [PLAY (DISPLAY)] to return to the Playlist display.

Using Effects While Recording

It is possible to apply effects while recording so that the effect becomes a permanent part of the recorded track, or so that the effect is only used during recording for monitoring purposes. The method for applying effects while recording depends on whether you want the track recorded with the effect or not.

Here are a few recording terms you should be familiar with:

“Print”

This verb means the same as “record.”

“Wet”

Processed using an effect. A wet track has an effect on it.

“Dry”

The track has no effects on it.

“Clean”

Same as “dry.”

“Print Wet”

Record with an effect. Use an effect while recording so that the effect becomes a permanent part of the recording. If you print a vocal track “wet” using a reverb, it is impossible to remove the reverb from the vocal track later to hear just the “dry” vocal.

Four Methods of Using Effects While Recording:

1. **Listening to an Insert Effect While Recording**
Using an insert effect while recording a track, without the effect becoming a permanent part of the track.
2. **Listening to a Loop Effect While Recording**
Using a loop effect while recording a track, without the effect becoming a permanent part of the track.
3. **Recording Insert Effects**
Using an insert effect while recording a track so the effect becomes a permanent part of the track.
4. **Recording Loop Effects**
Using an Effect Loop while recording a track so the effect becomes a permanent part of the track.

The most important thing to keep in mind while using effects during the recording process is deciding whether you want the effect to “print” or not. That decision will determine where the effect should be connected. In some cases, the effect will need to be connected in the Input Mixer. In other cases, the effect will need to be connected in the Track Mixer.

Listening to an Insert Effect While Recording

Use the following procedure when you want to record a guitar track dry, without any effects or processing, while allowing the guitar player to hear the guitar processed by one of the guitar amp simulators in the VS-1824.

General Strategy: Insert the effect in the Track Mixer.

Details for this Example: Select Patch P088 as FX1, insert on Track Mixer Channel 8.

Begin by Selecting the Effect:

1. Press [PLAY (DISPLAY)].
2. Hold [SHIFT] and press [F3 (EFFECT A)].
3. Press [F1 (FX1)]. The Effect 1 screen appears in the display. If “FX1” does not appear above [F1], press [F6 (EXIT)] until it does. Then, press [F1 (FX1)].
4. Press [F2 (Sel)]. The effects list appears in the display.
5. Use the TIME/VALUE dial or [▲], [▼], [◀], and [▶] to move the cursor to Effect Preset Patch P088 “Guitar Multi 1.”
6. Press [F4 (Exec)] or press [ENTER/YES] to select the effect. The EFFECT 1 screen appears in the display.

Next, Set up the Track Mixer

1. Press the SELECT button for Track 8. The button indicator lights, and the Track Mixer Screen appears in the display.
2. Use [▲], [▼], [◀], and [▶] to move the cursor to “FXIns.” Or, press [F1 (FX1In)]. If “FX1In” does not appear above [F1], press [PAGE] a few times until you see “FX1In,” and then press [F1 (FX1In)]. This will move the cursor directly to “FXIns.”
3. Press [ENTER/YES].
4. Use [◀] and [▶] to move the cursor to FX1. Use the TIME/VALUE dial to change the Effect Insert Switch to “Ins.”
5. Press [PLAY (DISPLAY)] to return to the Playlist display. Now you’re ready to record as usual.

Later, when you play the track with the effect still inserted, you will hear the effect. This doesn’t mean you’ve recorded the track with the effect. As soon as you turn the effect off, you’ll hear the dry guitar. This is a great way to record, as it provides you the flexibility to decide which effect to use after the recording has been made.

Listening to a Loop Effect While Recording

Example: A lead singer wants to hear reverb in the headphones while recording, but you want to record the track “dry.”

General Strategy: Connect the effect loop in Track Mixer

Details for this Example: Select Patch P024 as Effect 3, connect post-fader to Track Mixer on Channel 2, record from Input 2.

Begin by Selecting the Effect:

1. Hold [SHIFT] and press [F4 (EFFECT B)].
2. Press [F1 (FX3)]. The Effect 3 screen appears in the display. If “FX3” does not appear above [F1], press [F6 (EXIT)] until it does. Then, press [F1 (FX3)].
3. Press [F2 (Sel)]. The effects list appears in the display.
4. Use the TIME/VALUE dial or [▲], [▼], [◀], and [▶] to move the cursor to Effect Preset Patch P024 “Long Delay.”
5. Press [F4 (Exec)] or press [ENTER/YES] to select the effect. The EFFECT 3 screen appears in the display.

Next, Set up the Mixer

1. Press the SELECT button for Track 2. The button indicator lights, and the Track Mixer Screen appears in the display.
2. Use [▲], [▼], [◀], and [▶] to move the cursor to “FX3.” Or, press [F3 (FX3)]. If “FX3” does not appear above [F3], press [PAGE] a few times until you see “FX3,” and then press [F3 (FX3)].
3. Use the TIME/VALUE dial to set FX Switch to “Pst.”
4. Press [▲] and [▼] to move the cursor to the Effect Send Level, and use the TIME/VALUE dial to change the level to “70.”
5. Press [PLAY (DISPLAY)] to return to the Playlist display. Even though you will hear the effect while recording, the track will actually be printed dry.

Recording Insert Effects

Sometimes you may want an effect to become a permanent part of the track so that, after recording, the effect processor can be used on a different track. This is called recording “wet,” which means recording with an effect. To do this, simply insert the effect in the Input Mixer instead of in the Track Mixer.

Example: Record a Vocalist through a compressor

General Strategy: Insert effect in input Mixer

Details for this Example: Select Patch P096 as Effect 2, insert on Input 1.

Begin by Selecting the effect:

1. Press [PLAY (DISPLAY)].
2. Hold [SHIFT] and press [F3 (EFFECT A)].
3. Press [F4 (FX2)]. The Effect 2 screen appears in the display. If “FX2” does not appear above [F4], press [F6 (EXIT)] until it does. Then, press [F4 (FX2)].
4. Press [F2 (Sel)]. The effects list appears in the display.
5. Use the TIME/VALUE dial or [▲], [▼], [◀], and [▶] to move the cursor to Effect Preset Patch P096 “Dual Comp/Lim.”
6. Press [F4 (Exec)] or press [ENTER/YES] to select the effect. The EFFECT 2 screen appears in the display.

Next, Set up the Mixer

1. Press the SELECT button for Input 2. The button indicator lights, and the Input Mixer Screen appears in the display.
2. Use [▲], [▼], [◀], and [▶] to move the cursor to “FXIns.” Or, press [F2 (FX2In)]. If “FX2In” does not appear above [F2], press [PAGE] a few times until you see “FX2In,” and then press [F2 (FX2In)]. This will move the cursor directly to “FXIns.”
3. Press [ENTER/YES].
4. Use [◀] and [▶] to move the cursor to FX2. Use the TIME/VALUE dial to change the Effect Insert Switch to “Ins.”
5. Press [PLAY (DISPLAY)] to return to the Playlist display. Now you’re ready to record.

* *Important Reminder:* After recording with the effect inserted on Input 2, don’t forget to turn it off. Repeat the steps above for “Next, Set up the Mixer, but use the TIME/VALUE dial to turn the Effect Insert Switch to “off.”

Summary: Using Insert Effects While Recording

To print an insert effect, insert it on the input.

To hear an insert effect while recording, but not have it print, insert it on the track.

Recording a loop effect

This example explains how to use an effect loop while recording so the effect is recorded as a permanent part of the track.

General Strategy: Connect an effect loop in the Input Mixer, assign the input to a stereo track and assign the effect return to the same stereo track.

Details for this Example: Select Patch P024 “Long Delay” as Effect 2, record Input 1 and Effect Return 2 onto stereo Track 9/10.

Begin by Selecting the Effect:

1. Press [PLAY (DISPLAY)].
2. Hold [SHIFT] and press [F3 (EFFECT A)].
3. Press [F4 (FX2)]. The Effect 2 screen appears in the display. If “FX2” does not appear above [F4], press [F6 (EXIT)] until it does. Then, press [F4 (FX2)].
4. Press [F2 (Sel)]. The effects list appears in the display.
5. Use the TIME/VALUE dial or [▲], [▼], [◀], and [▶] to move the cursor to Effect Preset Patch P024 “Long Delay.”
6. Press [F4 (Exec)] or press [ENTER/YES] to select the effect. The EFFECT 2 screen appears in the display.

Next, Set up the Mixer

1. Press the SELECT button for Input 1. The button indicator lights, and the Input Mixer Screen appears in the display.
2. Use [▲], [▼], [◀], and [▶] to move the cursor to “FX1.” Or, press [F2 (FX2)]. If “FX2” does not appear above [F2], press [PAGE] a few times until you see “FX2,” and then press [F2 (FX2)].
3. Use the TIME/VALUE dial to change FX Switch to “Pst.”
4. Press [▲] and [▼] to move the cursor to the Effect Send Level, and use the TIME/VALUE dial to change the level to “75.”

Then Pan the Input to Center

Since Input 1 is a mono source and is being recorded to a stereo track, set the panning for Input 1 to “Center.”

1. Use [▲], [▼], [◀], and [▶] to move the cursor to the “Pan” section.
2. Use the TIME/VALUE dial to change the panning to “0” (center).
3. Press [PLAY (DISPLAY)] to return to the Playlist display.

Finally, Assign both Input 1 and Effects Return 2 to Stereo Track 9/10

1. Press [FADER/MUTE] so “TR” is lit.
2. Press and hold STATUS for Track 9 or Track10.
3. Press Input 1 SELECT so it is blinking.
4. Press Input 2 SELECT so it does not blink.
5. Press Effect 2 SELECT once. Both Input 1 and Effect Return 2 are now routed to stereo Track 9/10.

Begin recording on Track 9/10 as usual. As soon as you are done recording, re-route the effect return off the track. If an effect return is assigned to a track, you won’t hear the output of the effect (unless the track happens to be in Source or Record status). To re-route the effect return back to the main stereo mix—the MIX bus—hold the STATUS button for Track 9 (or Track10) and the SELECT button for each effect assigned to the track.

Recording Stereo Effects

Most of the effects in the Effects Expansion Board are stereo. To record the output of a stereo effect so that it sounds the same as it does in the MIX bus, it must be recorded onto two tracks. To do so, turn Link to “On” for both the input and the track. For example, use the following procedure to set up the VS-1824 to record a stereo effect on Input 8 to Tracks 7/8:

1. Press the SELECT button for Input 8.
2. Use [▲], [▼], [◀], and [▶] to move the cursor to “Link.”
3. Use the TIME/VALUE dial to turn Link “On.”
4. Use [▲], [▼], [◀], and [▶] to move the cursor to FX INS and press [ENTER/YES].
5. Use [▲], [▼], [◀], and [▶] to select the desired effects processor and use the TIME/VALUE dial to select “INSERT.”

NOTE

It is important that you insert the effect after the inputs are linked.

6. Press the SELECT button for Track 8.
7. Use [▲], [▼], [◀], and [▶] to move the cursor to “Link.”
8. Use the TIME/VALUE dial to turn Link “On.”
9. Press [PLAY/DISPLAY] to return to the main Play screen.
10. Hold the Channel 8 STATUS button and press the Input 8 SELECT button so that it is flashing (the Input 7 SELECT button will also flash). This routes Input 8 to Tracks 7 and 8 for recording.

Now, with Tracks 7 and 8 grouped as a stereo pair, any stereo effect inserted on Input 8 will be recorded in stereo on Tracks 7/8.

Three Important Reminders About Using Effects

1. If you insert an effect anywhere in the Track Mixer, Input Mixer, or Master Block, that effect cannot be used on any other tracks or inputs. The exception is when you use a two-channel effect, and insert it on one channel of the mixer using “InsL,” and on another channel using “InsR.” When an effect has already been inserted on another channel—or on the Master Block—the display will tell you so.
2. If you’ve assigned an effect return to a track in order to print the effect, you must un-assign the effect return from the track in order to have it return to the main stereo mix.
3. To print an insert effect applied to an input, make sure that it is inserted on the input and not the track. To listen to an insert effect while recording, without printing it, make sure that the effect is inserted on the track and not the input.

Chapter 8 EZ Routing

As you work with the VS-1824, you will often make settings related to mixer connections—including settings that route inputs to tracks for recording—settings that determine how signals are output, and settings that determine which effects are used. The VS-1824's "EZ Routing" features can make this process easier and faster. EZ Routing allows the VS-1824 to guide you step-by-step through the making of these connections, or helps you get quickly to the parameters you need to change. In addition, your favorite and most-frequently used setups can be stored as EZ Routing templates in the VS-1824's memory—when you recall an EZ Routing template, the VS-1824 is immediately re-configured for the task at hand.

There are three ways that EZ Routing makes working with the VS-1824 simpler:

Step Editing

EZ Routing Step Editing walks you through the required setup steps when recording, mixing, bouncing and mastering. Step Editing is especially handy if you are not sure what needs to be done, and would like some guidance.

Quick Editing

Quick Editing allows you to quickly jump to the parameters that must be set when preparing to record, mix, bounce or master. If you know what you want to change, and want to do it quickly, use Quick Editing.

Templates

When you have set up the VS-1824 for a particular task—and would like the VS-1824 to remember your settings for re-use some time in the future—you can save the setup as an EZ Routing template. When you recall the template, the VS-1824's parameters are instantly reset, and your setup is once more in place. You can save up to 29 EZ Routing templates. In addition, the VS-1824 provides four of its own: one each for recording, mixing, bouncing and mastering.

At the time of purchase, the VS-1824 comes with four read-only EZ Routing templates. The VS-1824 also offers 29 reusable user EZ Routings. You can choose one of the four templates, make changes to it, and then save those settings as one of the user EZ Routings.

EZ Routing templates may seem similar to Scenes; however, there is one important difference: while Scenes are associated—and saved—with particular songs, EZ Routing templates are always available for use in any song.

Using EZ Routing Step Editing

EZ Routing Step Editing walks you through the necessary setup procedure for recording, mixing, bouncing and mastering. As you begin your setup, the VS-1824 presents the first screenful of parameters that must be set. When you are ready, press [F2 (STEP)] to proceed to the next set of parameters until the entire setup is complete. Step Editing can help you learn how the VS-1824 works and is therefore a great tool for beginners.

HINT

When you have finished your setup, you can save it as an EZ Routing template. The following pages describe how to use EZ Routing Step Editing.

Setting Up for Recording Using Step Editing

Select this when you want to make a new recording from a source connected to one of the INPUT jacks. If you wish to cancel the settings procedure, press [F6 (EXIT)].

1. Press [EZ ROUTING].
The EZ Routing icon appears in the display.
2. Press [F5 (Exec)].
If "Exec" does not appear in the display above [F5], press [PAGE] until you see "Exec," and then press [F5 (Exec)].

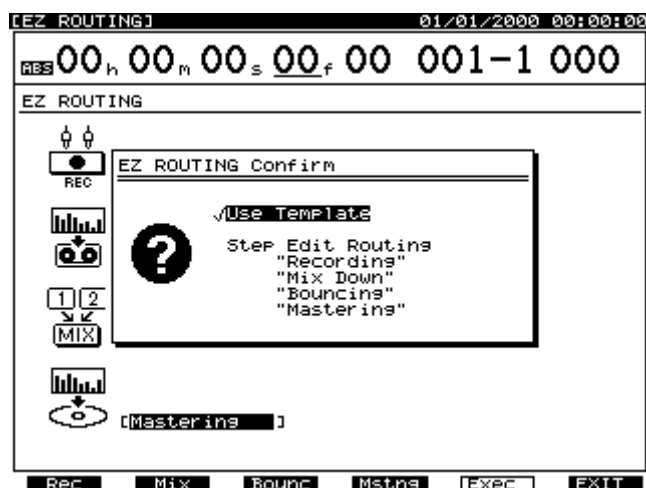

3. Press [F1 (Rec)].
4. Specify which input source is to be recorded to each track. To do this, first press the Input SELECT for the input you want to use, then press the Track STATUS button for the track you want to record on. Using this method, you can assign a single Input to two different tracks for recording. Use [◀] and [▶] to move the cursor and the TIME/VALUE dial to select the V-Track on which you want to record.

- * You cannot assign a DIGITAL input to more than one stereo-linked pair of tracks.
- * Using EZ Routing, it is not possible to assign a stereo-linked input to tracks that are not linked. For example, to record the DIGITAL input on Tracks 3 and 4, you must first turn Channel Link on for Track 3.

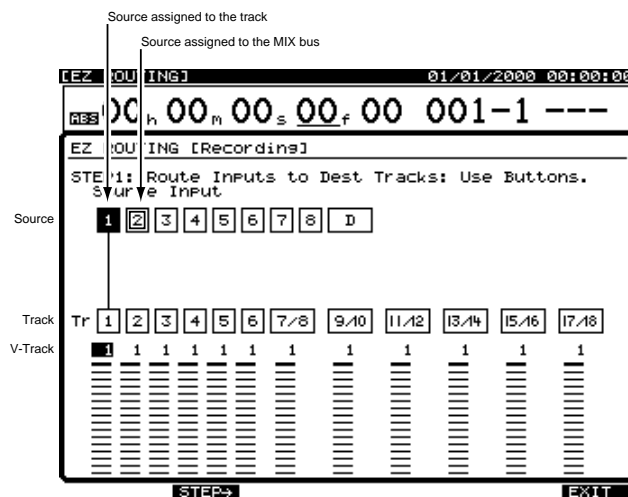

5. Press [F2 (STEP →)].
6. Only the source and destination channels you specified during Step 4 will be shown. Use [▲], [▼], [◀], and [▶] to move the cursor and the TIME/VALUE dial to adjust each of the values.

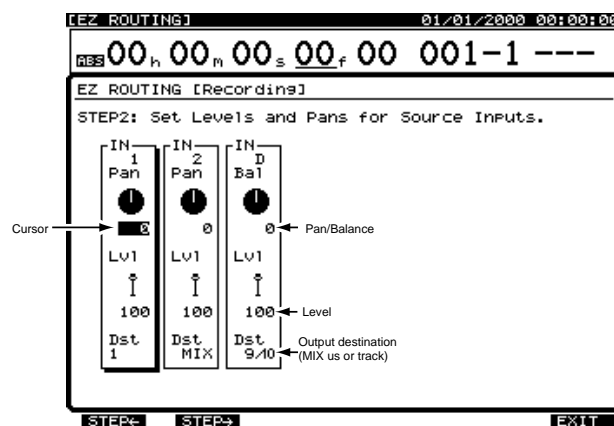

7. Press [F2 (STEP →)]. You can return to the previous screen by pressing [[F1 (STEP←)].

8. Make the settings for the effects.

Use [▲], [▼], [◀], and [▶] to move the cursor and the TIME/VALUE dial to adjust each of the values. Press [F3 (FX A)] to make settings to EFFECT A (FX1/2); press [F4 (FX B)] to make settings to EFFECT B (FX3/4).

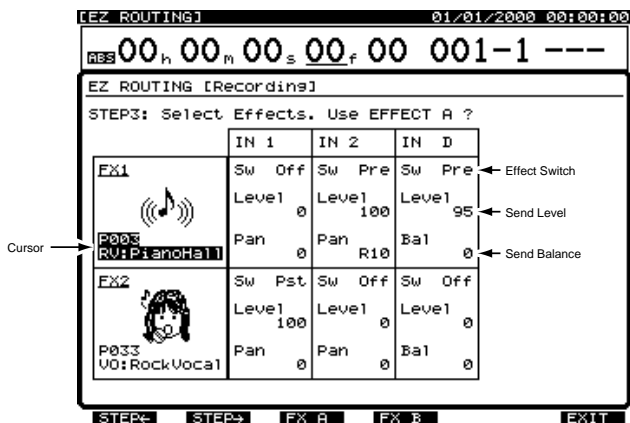

9. Press F2 (STEP →). You can return to the previous screen by pressing [F1 (STEP←)].

10. Decide whether or not to record the output of each effect to a track. First, press the Effect SELECT button for Effect 1 or Effect 2, then press the STATUS button for the track you want the effect recorded on. To select FX 3 or FX 4, hold [SHIFT] and press the Effect SELECT button.

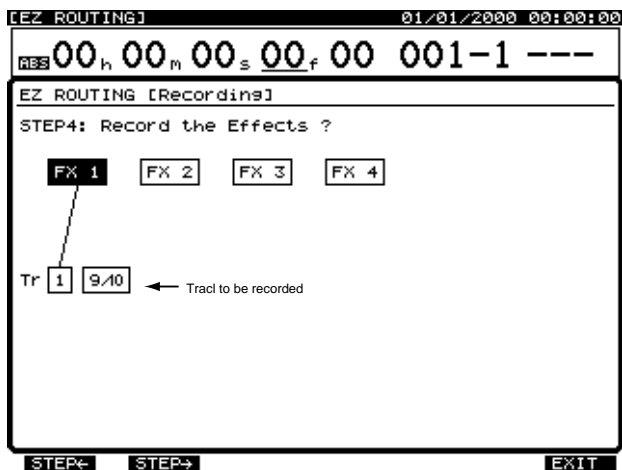

11. Press [F2 (STEP →)]. You can return to the previous screen by pressing [F1 (STEP←)].

12. Select mixer channels to be output to the AUX bus.

The AUX bus is useful for creating a separate headphone mix for the performer you are recording. Use [▲], [▼], [◀], and [▶] to move the cursor and the TIME/VALUE dial to adjust each of the values.

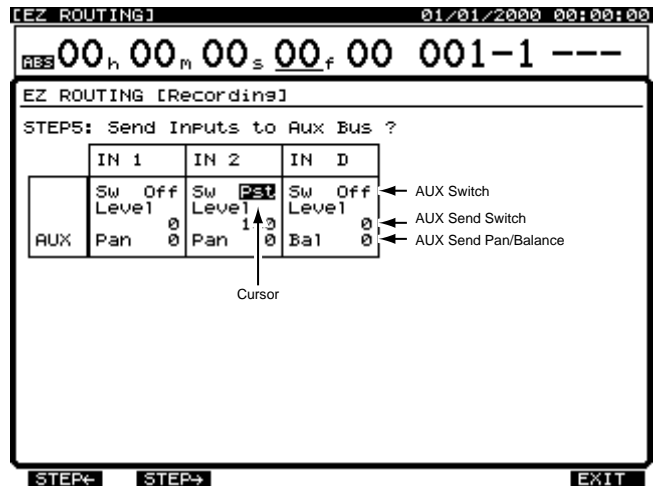

13. Press [F2 (STEP →)]. You can return to the previous screen by pressing [F1 (STEP←)].

14. Select the Master Section settings.

Use [▲], [▼], [◀], and [▶] to move the cursor and the TIME/VALUE dial to adjust each of the values.

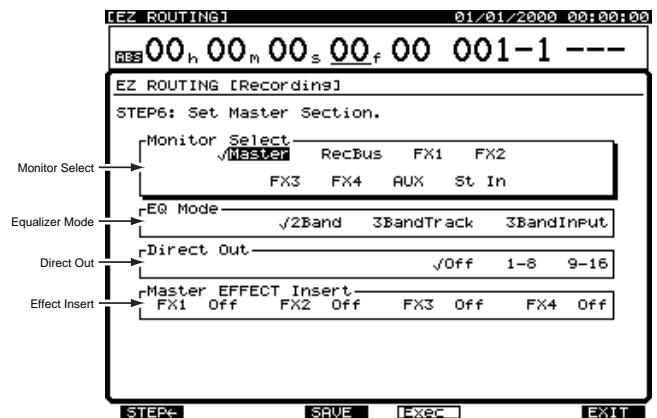

15. Press [F4 (Exec)]. "EZ ROUTING Step Edit is finished!!" appears in the display.

NOTE

WARNING: EZ Routing settings will override any existing mixer settings you have already made.

16. You can save your setup as an EZ Routing template, or Exit [F6 (EXIT)] to leave this display without saving. To save the setup, press [F3 (SAVE)]. The Routing Save screen appears in the display. Save the setup using the procedure described in "Saving an EZ Routing Template," p. 123.

Setting Up for Mixing Using Step Editing

Select this when you want to adjust the balance of each track, or to mix your song to an external two-track recorder. Select this to use the Input Mixer during mixdown to mix external sources along with your 18 tracks to the VS-1824's stereo MASTER mix outputs. If you want to cancel the settings procedure before completing it, press [F6 (EXIT)] at any time.

1. Press [EZ ROUTING].

The EZ Routing icon appears in the display.

2. Press [F5 (Exec)].

If "Exec" does not appear in the display above [F5], press [PAGE] until you see "Exec," and then press [F5 (Exec)].

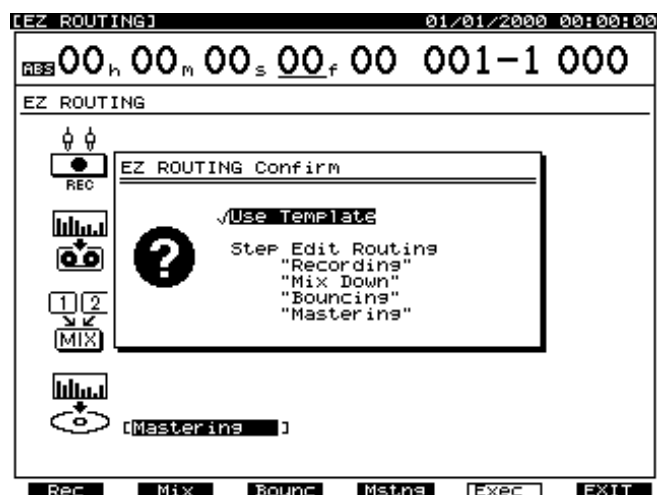

3. Press [F2 (Mix)].

4. Specify which sources are to be output to the MIX bus. Press the Input SELECT buttons and the Track SELECT buttons for all mixer channels you want to include. Use [◀] and [▶] to move the cursor and the TIME/VALUE dial to select the V-Track you want to play back.

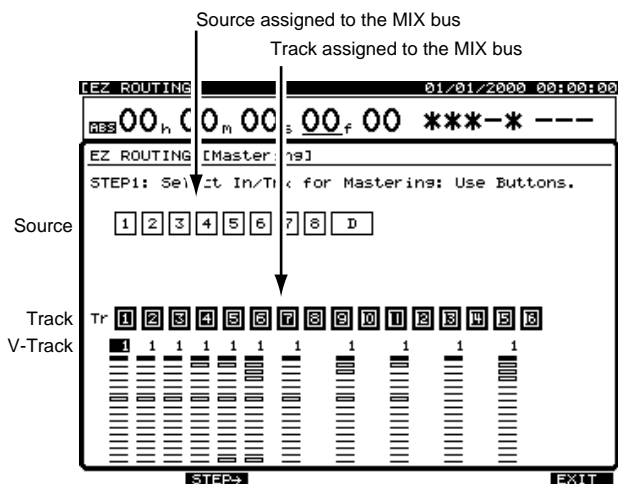

5. Press [F2 (STEP →)].
6. Only the sources—Input Mixer Channels and Track Mixer Channels—you specified during Step 4 will be shown. Use [▲], [▼], [◀], and [▶] to move the cursor and the TIME/VALUE dial to adjust each of the values.

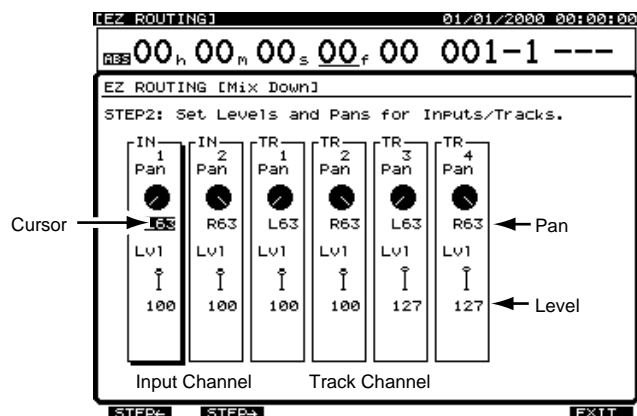

7. Press [F2 (STEP →)]. You can return to the previous screen by pressing [F1 (STEP ←)].
8. Make the settings for the effects. Use [▲], [▼], [◀], and [▶] to move the cursor and the TIME/VALUE dial to adjust each of the values. Press [F3 (FX A)] to make settings to EFFECT A (FX1/2); press [F4 (FX B)] to make settings to EFFECT B (FX3/4).

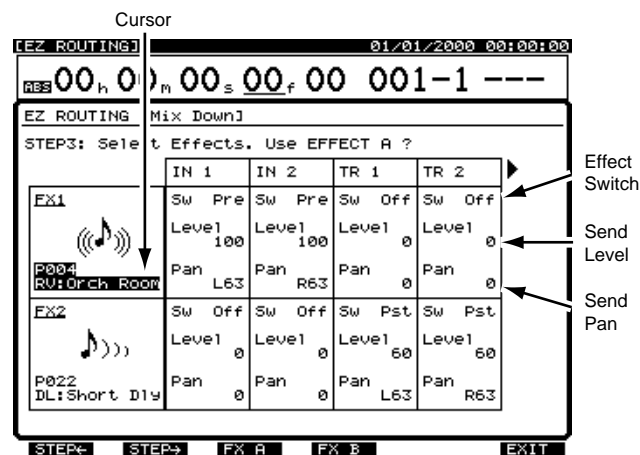

9. Press [F2 (STEP →)]. You can return to the previous screen by pressing [F1 (STEP ←)].

10. Select mixer channels to be output to the AUX bus.

The AUX bus is useful for creating a separate headphone mix for the performer you are recording, or for sending tracks to an external effects processor. Use [▲], [▼], [◀], and [▶] to move the cursor and the TIME/VALUE dial to adjust each of the values.

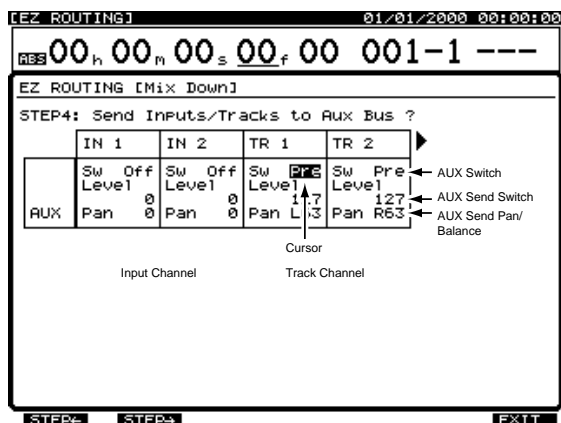

11. Press [F2 (STEP →)]. You can return to the previous screen by pressing [F1 (STEP ←)].

12. Select the Master Section settings. Use [▲], [▼], [◀], and [▶] to move the cursor and the TIME/VALUE dial to adjust each of the values.

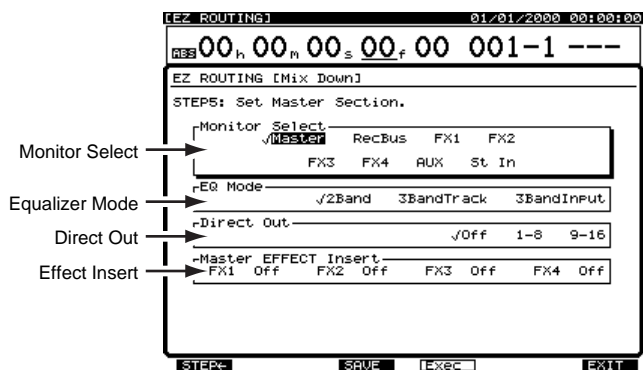

13. Press [F4 (Exec)]. “EZ ROUTING Step Edit is finished!!” appears in the display.



WARNING: EZ Routing settings will override any existing mixer settings you have already made.

14. You can save your setup as an EZ Routing template, or Exit [F6 (EXIT)] to leave this display without saving. To save the setup, press [F3 (SAVE)]. The Routing Save screen appears in the display. Save the setup using the procedure described in “Saving an EZ Routing Template,” p. 123.

Setting Up for Bouncing Using Step Editing

Select this when bouncing audio recordings from a group of tracks onto another track or tracks. To cancel the settings procedure, press [F6 (EXIT)].

1. Press [EZ ROUTING].

The EZ Routing icon appears in the display.

2. Press [F5 (Exec)]. If “Exec” does not appear in the display above [F5], press [PAGE] until you see “Exec,” and then press [F5 (Exec)].

3. Press [F3 (Bounc)].



4. Specify the source tracks for the bounce and the destination track(s). First press the Track SELECT for the source track, then press the Track STATUS button for the destination track. Using this method, you can assign a single source track to two different destination tracks for recording. Use [◀] and [▶] to move the cursor and the TIME/VALUE dial to select the V-Track for both the source tracks as well as for the track you want to record on.

- * You can only assign the bounce to one track-linked destination.
- * You cannot assign a stereo-linked track to tracks that are not linked. For example, it is not possible to assign source Tracks 9/10 to record on Tracks 3 and 4 unless you first turn Channel Link to “On” for Track 3.

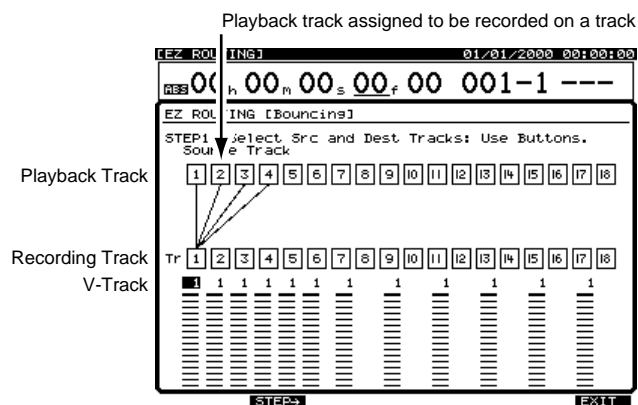

Chapter 8 EZ Routing

- Press [F2 (STEP →)].
- Only the source tracks you specified during Step 4 will be shown. Use [▲], [▼], [◀], and [▶] to move the cursor and the TIME/VALUE dial to adjust each of the values.

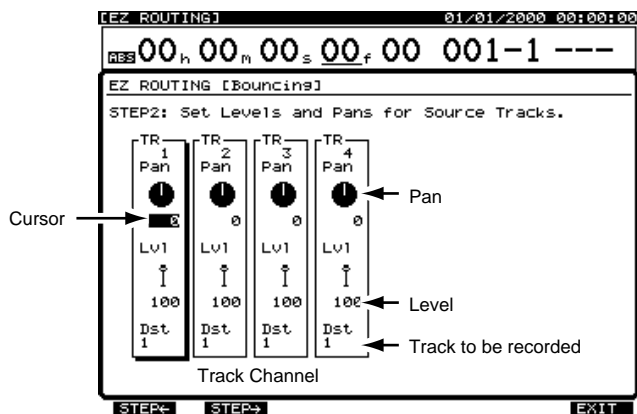

- Press [F2 (STEP →)]. You can return to the previous screen by pressing [F1 (STEP ←)].
- Make the settings for the effects. Use [▲], [▼], [◀], and [▶] to move the cursor and the TIME/VALUE dial to adjust each of the values. Press [F3 (FX A)] to make settings to EFFECT A (FX1/2); press [F4 (FX B)] to make settings to EFFECT B (FX3/4).

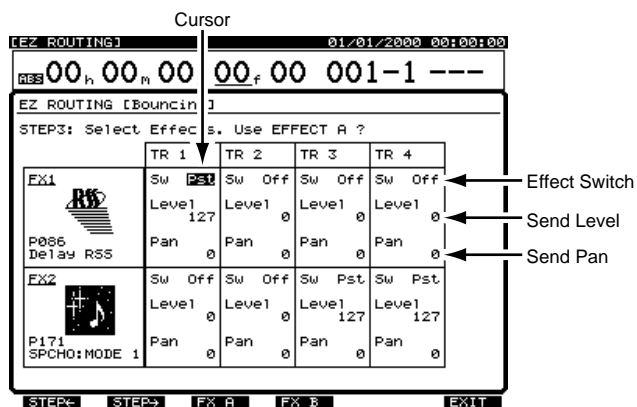

- Press [F2 (STEP →)]. You can return to the previous screen by pressing [F1 (STEP ←)].

- Decide whether or not to record the output of each effect to a track. First, press the Effect SELECT button for Effect 1 or Effect 2, then press the STATUS button for the track you want the effect recorded on. To select FX 3 or FX 4, hold [SHIFT] and press the Effect SELECT button.

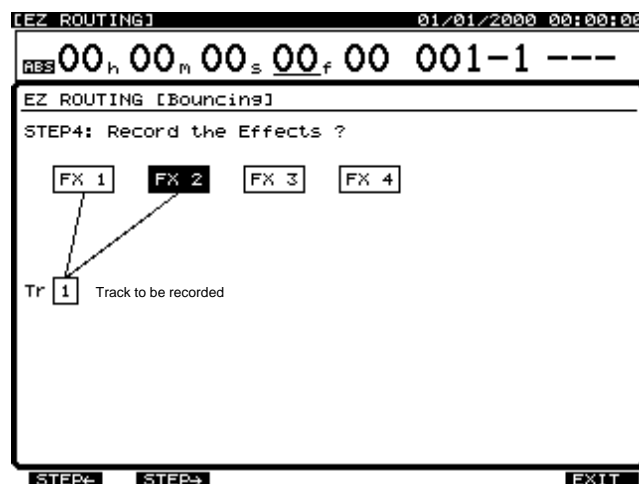

- Press [F2 (STEP →)]. You can return to the previous screen by pressing [F1 (STEP ←)].
- Select mixer channels to be output to the AUX bus. The AUX bus is useful for sending tracks to an external effects processor. Use [▲], [▼], [◀], and [▶] to move the cursor and the TIME/VALUE dial to adjust each of the values.

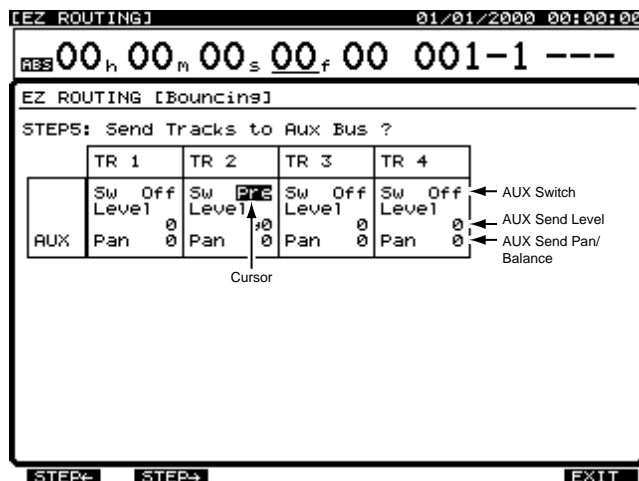

- Press [F2 (STEP →)]. You can return to the previous screen by pressing [F1 (STEP ←)].

14. Select the Master Section settings.

Use [▲], [▼], [◀], and [▶] to move the cursor and the TIME/VALUE dial to adjust each of the values.

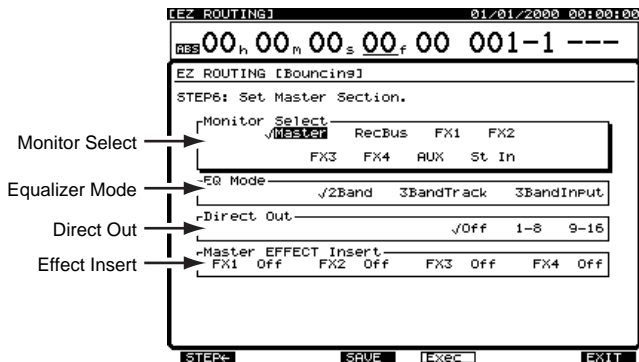

15. Press [F4 (Exec)]. “EZ ROUTING Step Edit is finished!!” appears in the display.

NOTE

WARNING: EZ Routing settings will override any existing mixer settings you have already made.

16. You can save your setup as an EZ Routing template, or Exit [F6 (EXIT)] to leave this display without saving. To save the setup, press [F3 (SAVE)]. The Routing Save screen appears in the display. Save the setup using the procedure described in “Saving an EZ Routing Template,” p. 123.

Setting Up for Mastering Using Step Editing

Select this when creating mixing down to create a final two-track stereo master tracks for burning onto a CD-R. To cancel the settings procedure, press [F6 (EXIT)].

1. Press [EZ ROUTING].
The EZ Routing icon appears in the display.
2. Press [F5 (Exec)]. If “Exec” does not appear in the display above [F5], press [PAGE] until you see “Exec,” and then press [F5 (Exec)].

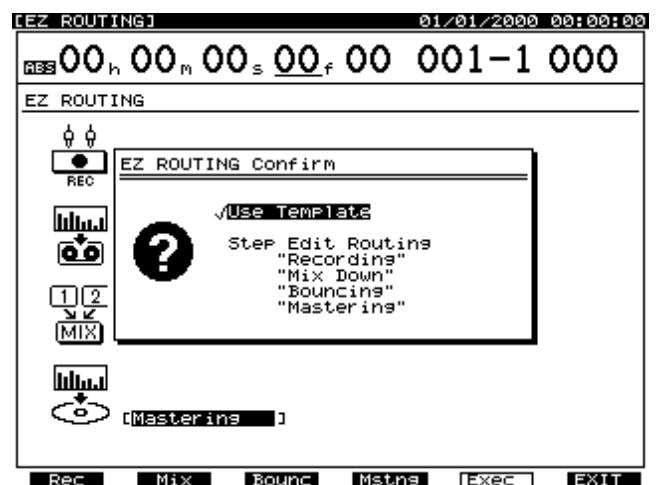

3. Press [F4 (Mstng)].
4. Specify which sources are to be output to the MIX bus. Press the Input SELECT buttons and the Track SELECT buttons for all mixer channels you want to include. Use [◀] and [▶] to move the cursor and the TIME/VALUE dial to select the V-Track you want to play back.

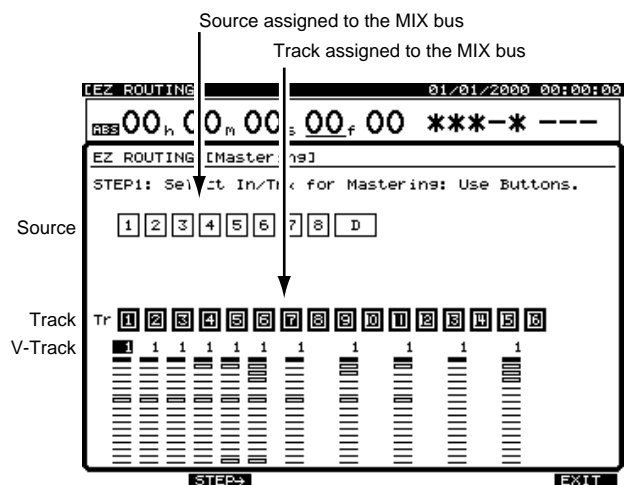

5. Press [F2 (STEP →)].

Chapter 8 EZ Routing

6. Only the sources—Input Mixer Channels and Track Mixer Channels—you specified during Step 5 will be shown. Use [▲], [▼], [◀], and [▶] to move the cursor and the TIME/VALUE dial to adjust each of the values.

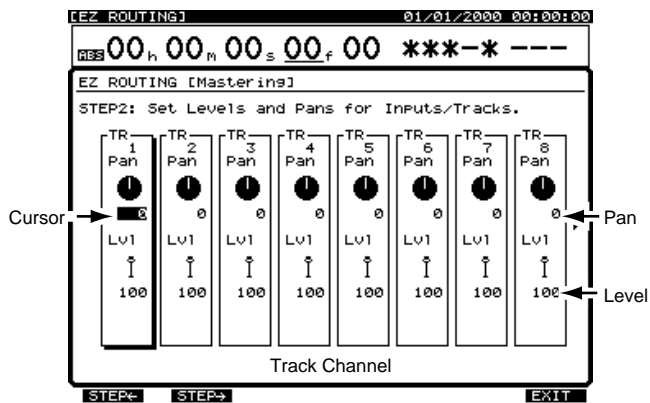

7. Press [F2 (STEP →)]. You can return to the previous screen by pressing [F1 (STEP ←)].
8. Make the settings for the effects. Use [▲], [▼], [◀], and [▶] to move the cursor and the TIME/VALUE dial to adjust each of the values. Press [F3 (FX A)] to make settings to EFFECT A (FX1/2); press [F4 (FX B)] to make settings to EFFECT B (FX3/4).

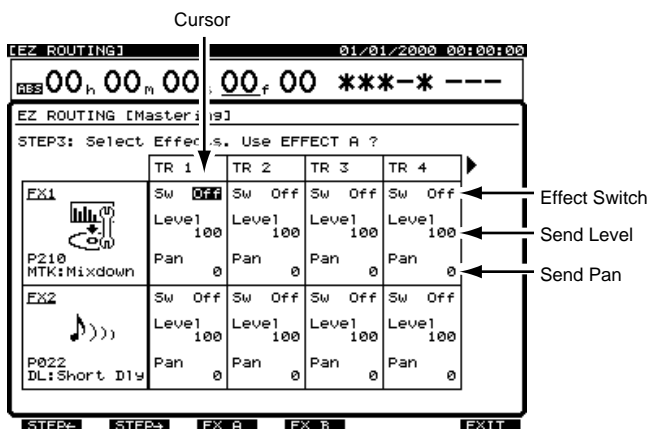

9. Press [F2 (STEP →)]. You can return to the previous screen by pressing [F1 (STEP ←)].

10. Select mixer channels to be output to the AUX bus. The AUX bus is useful for sending tracks to an external effects processor. Use [▲], [▼], [◀], and [▶] to move the cursor and the TIME/VALUE dial to adjust each of the values.

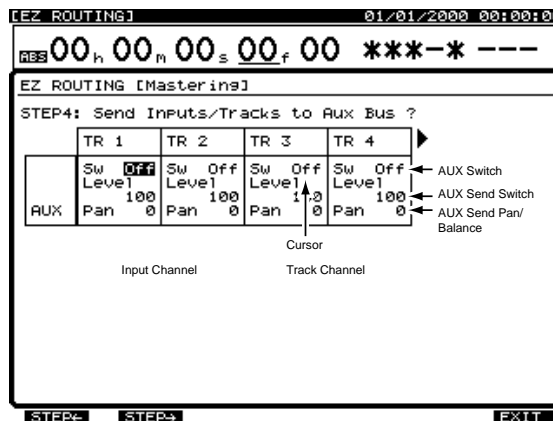

11. Press [F2 (STEP →)]. You can return to the previous screen by pressing [F1 (STEP ←)].
12. Select the Master Section settings. Use [▲], [▼], [◀], and [▶] to move the cursor and the TIME/VALUE dial to adjust each of the values.

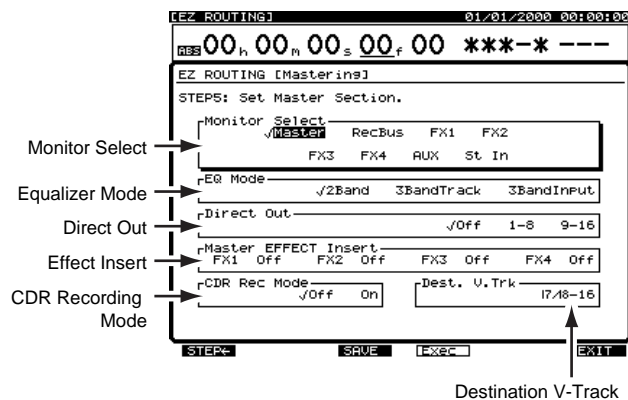

13. Press [F4 (Exec)]. "EZ ROUTING Step Edit is finished!!" appears in the display.

NOTE

WARNING: EZ Routing settings will override any existing mixer settings you have already made.

14. You can save your setup as an EZ Routing template, or Exit [F6 (EXIT)] to leave this display without saving. To save the setup, press [F3 (SAVE)]. The Routing Save screen appears in the display. Save the setup using the procedure described in "Saving an EZ Routing Template," p. 123.

Using EZ Routing Quick Editing

Quick Editing lets you quickly get to VS-1824's Input Mixer, Track Mixer, effect and mastering parameters so that you can change their values in a hurry. Once you become familiar with the many things you can do on the VS-1824, you may find Quick Editing to be the fastest way to create a new setup.

1. Press [EZ ROUTING]. The EZ Routing icon appears in the display.
2. Press [PAGE] so "COMON" appears in the display above [F1]. The function buttons perform as described here:

[F1 (COMON)]:

This status indicator—when highlighted—shows that you are viewing the EZ Routing Common Menu. This menu shows you the EZ Routing templates in the VS-1824's memory. The currently selected template provides a starting point for your editing.

[F2 (INPUT)]:

Press this to display and edit Input Mixer parameters.

[F3 (TRACK)]:

Press this to display and edit Track Mixer parameters.

[F4 (FX)]:

Press this to display and edit effect parameters.

[F5 (MST)]:

Press this to display and edit Master Block parameters.

[F6 (SAVE)]:

Press this button if you wish to save your current settings as an EZ Routing template.

3. Press the F1-F5 button for the section in which you want to make changes.
4. Use [▲], [▼], [◀], and [▶] to move the cursor to a parameter you wish to edit, and turn the TIME/VALUE dial to select the desired value. If, while making settings, the ENTER indicator blinks, press [ENTER] to adjust level and pan settings. After the level and pan settings have been made, press [F6 (EXIT)], or you can press [EXIT/NO].

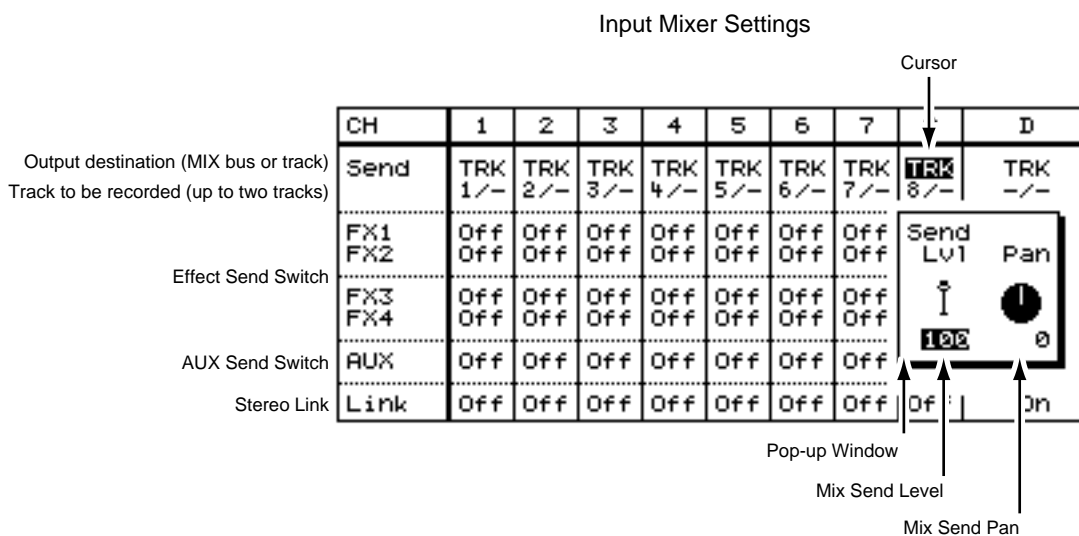

Chapter 8 EZ Routing

Track Mixer Settings

	TR	1	2	3	4	5	6	7	8
Output destination (MIX bus or track)	Send	MIX	MIX	MIX	MIX	MIX	MIX	MIX	MIX
Track to be recorded (up to two tracks)	Stat	REC	REC	REC	REC	REC	REC	REC	REC
Effect Send Switch	FX1	Off	Off	Off	Off	Off	Off	Off	Off
	FX2	Off	Off	Off	Off	Off	Off	Off	Off
	FX3	Off	Off	Off	Off	Off	Off	Off	Off
	FX4	Off	Off	Off	Off	Off	Off	Off	Off
AUX Send Switch	AUX	Off	Off	Off	Off	Off	Off	Off	Off
Stereo Link	Link	Off	Off	Off	Off	Off	Off	Off	On
V-track	VTrk	1	1	1	1	1	1	1	1

Cursor

Pop-up Window

Mix Send Level

Mix Send Pan

Effect Settings

	EFFECT1	EFFECT2
Selecting Effects	Se1 ((())) P000 RV:LargeHall	Se2))) P022 DL:Short Dly
Output Destination (MIX bus or track)	Send	TRK
Track to be recorded (up to two tracks)	---	√MIX

Cursor

Master Block Settings

Monitor Select	Monitor Select	√Master	RecBus	FX1	FX2
			FX3	FX4	AUX St In
Equalizer Mode	EQ Mode	√2Band	3BandTrack	3BandInput	
Direct Out	Direct Out		√Off	1-8	9-16
Effect Insert	Master EFFECT Insert	FX1	---	FX2	---
				FX3	---
					FX4

If you wish to save your current setup as an EZ Routing template, press [F6 (SAVE)] and follow the instructions in “Saving an EZ Routing Template,” p. 123.

Using EZ Routing Templates

Saving an EZ Routing Template

- When you have pressed the SAVE button after creating a new setup, the Routing Save screen appears in the display. Turn the TIME/VALUE dial to select the number of the desired memory location for your EZ Routing template.

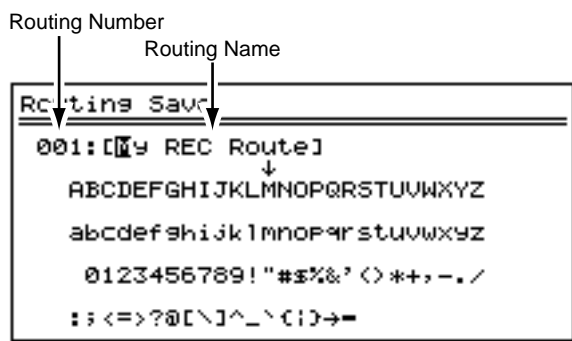

- Press [▶] to move the cursor. Use [▲], [▼], [◀], and [▶] to move the cursor and the TIME/VALUE dial to enter the user EZ Routing's name.

The function buttons work as shown below:

[F1 (Hist)]:

Pressing this button will take you through a list of the last 20 names entered, one at a time.

[F2 (Clr)]:

Clears all the characters in the window.

[F3 (Del)]:

Deletes the character where the cursor is positioned.

[F4 (Ins)]:

Inserts a space where the cursor is positioned.

[F5 (Write)]:

Stores the routing and exits the Routing Save screen.

[F6 (EXIT)]:

Exits the Routing Save screen without storing the routing.



If you press [NUMERIC/ASCII] so it is lit, you can use the SELECT buttons to enter characters in a manner similar to using a computer keyboard.

- After entering the name, press [F5 (WRITE)]. The routing is saved.
- Press [PLAY (DISPLAY)] to return to the Playlist display.

Recalling an EZ Routing Template

- Press [EZ ROUTING].
The EZ Routing icon appears in the display.
- Use [▲], [▼], [◀], and [▶] or use the TIME/VALUE dial to move the cursor to the routing you want to use.
- Press [F5 (Exec)]. If “Exec” does not appear above [F5], press [PAGE] until you see “Exec” above [F5], then press [F5 (Exec)].

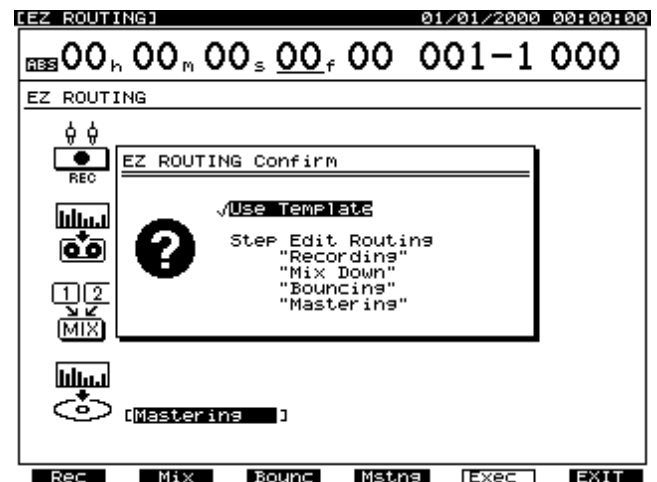

- Press [◀] and [▶] to move the cursor to “Use Template” and press [F5 (Exec)] once more. “Apply this ROUTING ?” appears in the display.
- Press [YES] to recall the EZ Routing settings. (Or, if you wish to cancel the operation, press [NO].)
- Press [PLAY (DISPLAY)] to return to the Playlist display.

Deleting an EZ Routing Template

- Press [EZ ROUTING]. The EZ Routing icon appears in the display.
- Use [▲], [▼], [◀], and [▶] or use the TIME/VALUE dial to move the cursor to the routing you want to delete.
- Press [F6 (Del)]. If “Del” does not appear above [F6], press [PAGE] until you see “Del” above [F6], then press [F6 (Del)]. “EZ ROUTING Delete OK ?” appears in the display.
- Press [YES]. (Or, if you wish to cancel the operation, press [NO].) The EZ Routing is deleted. The four factory templates—“Recording,” “Mix Down,” “Bouncing” and “Mastering”—cannot be deleted.
- Press [PLAY (DISPLAY)] to return to the Playlist display.

Chapter 9 Automix

Mixer Automation

With the VS-1824, you can record the present status or condition of the mixer as a Scene. However, you cannot change a Scene while the song is playing. If you want to store mixer settings that change as the song plays, use Automix. Automix allows both static (Snapshot) and dynamic (realtime) changes in mixer settings during song playback. Automix information includes mixer settings, fader movements, and other settings. This is convenient when

mixing a song with elaborate fader movements that are difficult to reproduce manually or for automating effect changes during a song.

All of the following mixer settings can be recorded as Snapshots in Automix.

* *You can also record realtime automation for the functions marked below in bold.*

INPUT Channel/TRACK Channel:

Faders

Panning

FX 1 Lev (Effect 1 Send Level)

FX 1 Pan (Effect 1 Send Pan)

FX 2 Lev (Effect 2 Send Level)

FX 2 Pan (Effect 2 Send Pan)

FX 3 Lev (Effect 3 Send Level)

FX 3 Pan (Effect 3 Send Pan)

FX 4 Lev (Effect 4 Send Level)

FX 4 Pan (Effect 4 Send Pan)

AUX Lev (AUX Send Level)

AUX Pan

STEREO IN:

Fader

Balance

EFFECT RETURN:

Effect 1 Return Level

Effect 1 Return Balance

Effect 2 Return Level

Effect 2 Return Balance

Effect 3 Return Level

Effect 3 Return Balance

Effect 4 Return Level

Effect 4 Return Balance

MASTER BLOCK:

Master Level

Master Balance

Monitor Level

Monitor Balance

Master Effect 1 Send Level

Master Effect 1 Send Balance

Master Effect 2 Send Level

Master Effect 2 Send Balance

Master Effect 3 Send Level

Master Effect 3 Send Balance

Master Effect 4 Send Level

Master Effect 4 Send Balance

Master AUX Send Level

Master AUX Send Balance

EFFECT:

FX 1 (Effect 1 Program Number)

FX 2 (Effect 2 Program Number)

FX 3 (Effect 3 Program Number)

FX 4 (Effect 4 Program Number)

Using Automix

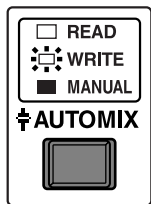

lit

To begin using Automix, press [AUTOMIX]. The button indicator lights, indicating that Automix mode is on.

After turning on Automix, all the SELECT buttons and the EDIT/SOLO button begin blinking. In a new song, Automix record is enabled for all inputs, tracks, effect returns, and for the Master fader.

To disable Automix on individual channels, press and hold [AUTOMIX], and press the Input SELECT, Track SELECT or [EDIT/SOLO] buttons. While holding down [AUTOMIX], each time you press a SELECT button, the status changes as follows:

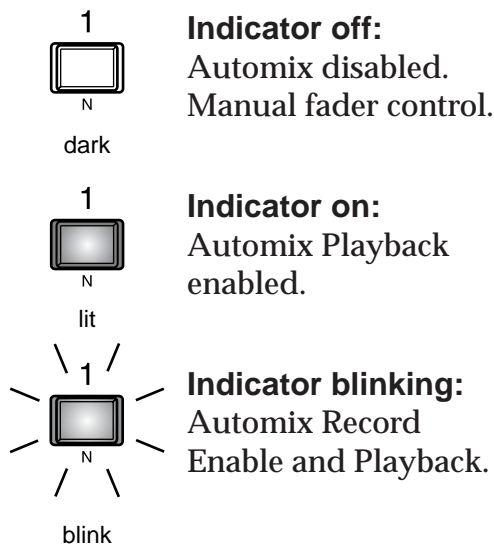

You may, for example, find it convenient to leave the Master fader on manual control while recording Automix on the Track mixer. To do so, hold [AUTOMIX] and press [EDIT/SOLO] so the indicator is off.

Adjust the Display for Automix

While recording Automix, it is helpful to change the display to view fader and panning positions.

1. Press [PLAY (DISPLAY)].
2. Press [PAGE] so you see “F/P” above [F5].
3. Press [F5 (F/P)]. The Fader/Pan display appears.
4. Press [F (LMTrk)] to view fader and panning positions for the Track Mixer.
5. Press [F2 (LM In)] to view fader and panning positions for the Input Mixer.
6. Press [F3 (LMAux)] to view fader and panning positions for the Effect Sends and Aux Send.

Realtime Automix

With realtime Automix, actual physical fader movements you make during song playback are recorded and stored as marker data. This type of automation is also known as dynamic automation, as dynamic fader movements are recorded and stored.

- * If you want to create dynamic panning changes, you can do so by using a combination of snapshot and gradation Automix. See “Snapshot Automation” (p. 127).

Realtime Automix of Track Faders

1. Locate to the point in the song where you wish to record realtime Automix.
2. Press [AUTOMIX].
The AUTOMIX indicator lights, indicating that the VS-1824 is in Automix mode.
3. Decide which track fader’s movement you want to record using Automix. While pressing [AUTOMIX], press the Track SELECT button for the tracks you want to automate so that their indicators are blinking.
4. Hold [SCENE] and press [REC]. The AUTOMIX indicator blinks, showing Automix recording is enabled.
5. Make sure the FADER/MUTE indicator is set to “TR” for tracks.
6. Adjust the track faders for the beginning fader levels as desired.
 - * If you want to adjust TR 13-18 fader levels, press [FADER/MUTE] several times until “TR” indicator blinks (p. 71).
 - * If Fader Match (p. 249) in System Parameters is set to “Null,” and the current physical fader positions do not match the actual volume levels, you must first move the physical faders to match the position of the recorded fader. This is referred to as “crossing the null point.” When the display is set to view faders and panning, the position of each physical fader is represented by a black dot, and the actual level that is recorded using Automix is represented by a white circle. Before beginning Automix, slide each physical fader all the way up and then all the way down so the black dot disappears. Make sure that the [FADER/MUTE] is set appropriately (IN or TR) depending on whether you are trying to control the inputs or the tracks.
7. Press [PLAY] to begin recording Automix data.
8. While the song is playing, move the track faders to adjust the mix of your song as you like. New Automix data will only be recorded for those faders that are moved during song playback.
9. When the song is finished, press [STOP]. Automix markers (markers with an “A” after the marker number) will appear in the Playlist display where Automix data was created.

If “!!! Lack of EVENT!!!” Appears in the Display

If you do a lot of recording or make numerous edits using functions such as Track Copy, the remaining number of events may fall below 1000. When this happens, you will not be able to continue recording Automix data in realtime. Please refer to “About Events,” p. 26. In addition, when planning to record for an extended period with Automix, check the remaining number of events frequently, as described in “Checking Remaining Space,” p. 217.

Realtime Automix of Input Faders

For a song that incorporates both recorded tracks as well as additional sources, such as outputs from MIDI sound modules, you may decide to automate both the input mix as well as track mix. It doesn't matter which mixer you automate first, and it is possible to simultaneously automate both the Input Mixer and the Track Mixer. If you wish to automate the Input Mixer, use the following steps:

1. Move to the location in the song where you wish to record realtime Automix.
2. Press [AUTOMIX].
The AUTOMIX indicator lights, indicating that the VS-1824 is in Automix mode.
3. Decide which input fader's movement you want to record using Automix. While pressing [AUTOMIX], press the Input SELECT button for the inputs you want to automate so that they begin blinking.
4. Hold [SCENE] and press [REC].
The AUTOMIX indicator blinks, showing Automix recording is enabled.
5. Make sure the FADER/MUTE indicator is set to “IN” for Inputs. This assigns the physical faders to the Input Mixer.
6. Adjust the faders for the beginning fader levels as desired.
7. Press [PLAY] to begin recording Automix data.
8. While the song is playing, move the faders to adjust the mix of your song as you like. New Automix data will only be recorded for those faders that are moved during song playback.
9. When the song is finished, press [STOP]. Automix markers will appear in the Playlist display where Automix data was created.

Automating the Master Stereo Mix and Monitor Output

Just as it is possible to automate the Input Mixer and the Track Mixer, you can also automate the master stereo mix as well as the monitoring output level.

1. Move to the location in the song where you wish to record realtime Automix.
2. Press [AUTOMIX].
The AUTOMIX indicator lights, indicating that the VS-1824 is in Automix mode.
3. While pressing [AUTOMIX], press [EDIT/SOLO] so it blinks, indicating Automix record is enabled for the Master fader.
4. Hold [SCENE] and press [REC]. The AUTOMIX indicator blinks, showing Automix recording is enabled.
5. Adjust the Master fader and the MONITOR knob for the beginning level as desired.
6. Press [PLAY] to begin recording Automix data.
7. While the song is playing, move the Master fader to adjust the level of your song. Use the MONITOR knob to make changes to the monitoring output level.
8. When the song is finished, press [STOP]. Automix markers will appear in the Playlist display where Automix data was created.

Automating Effect Returns

Just as it is possible to automate both the Input Mixer and the Track Mixer, you can also automate the effect returns.

1. Move to the location in the song where you wish to record realtime Automix.
2. Press [AUTOMIX].
The AUTOMIX indicator lights, indicating that the VS-1824 is in Automix mode.
3. Confirm the SELECT button for EFFECT 1/3 RTN is blinking. If it is not, hold [AUTOMIX] and press the SELECT button for EFFECT 1/3 RTN so it blinks, indicating Automix Record Ready for the Effect 1 Return.
4. Confirm the SELECT button for EFFECT 2/4 RTN is blinking. If it is not blinking, hold [AUTOMIX] and press the SELECT button for EFFECT 2/4 RTN so it blinks, indicating Automix Record Ready for the Effect 2 Return.

5. To automate Effect 3 Return, press [SHIFT]. Confirm the SELECT button for EFFECT 1/3 RTN is blinking. If it is not blinking, continue to hold [SHIFT], then hold [AUTOMIX] and press the SELECT button for EFFECT 1/3 RTN so it blinks, indicating Automix Record Ready for the Effect 3 Return.
6. To automate Effect 4 Return, press [SHIFT]. Confirm the SELECT button for EFFECT 2/4 RTN is blinking. If it is not blinking, continue to hold [SHIFT], then hold [AUTOMIX] and press the SELECT button for EFFECT 2/4 RTN so it blinks, indicating Automix Record Ready for the Effect 4 Return.
7. Hold [SCENE] and press [REC]. The AUTOMIX indicator blinks, showing Automix recording is enabled.
8. Press [FADER/MUTE] so “IN” is lit.
9. Press [PLAY] to begin recording Automix data.
10. Use Fader 11 to control Effect 1 Return levels when “IN” is lit.
11. Use Fader 12 to control Effect 2 Return levels when “IN” is lit.
12. Hold [SHIFT] and use Fader 11 to control Effect 3 Return levels when “IN” is lit.
13. Hold [SHIFT] and use Fader 12 to control Effect 4 Return levels when “IN” is lit.
14. As the song is playing, continue to move the faders to adjust the effect return levels as you like.
15. When the song is finished, press [STOP].
16. Press [ZERO] to rewind to the beginning of the song, and then press [PLAY].
17. To watch the effect return fader levels change as a result of Automix, press the EFFECT 1/3 SELECT button to see the “Stereo In/Effect Return” display.

HINT

If you are adjusting Effect Returns 3 and/or 4, you can turn on the Shift Lock function (p. 251) so that you can adjust levels with the faders without holding the SHIFT button.

Snapshot Automation

Static mixer settings can be recorded with Automix. This type of Automix involves taking a mixer “Snapshot.” When you play to the point in the song where the Snapshot was recorded, all mixer settings stored with the Snapshot are instantly re-called. This is convenient for making instantaneous level changes in the middle of a song, or for changing effects on a guitar solo, for example. To record a mixer Snapshot, follow the procedure below.

1. Press [AUTOMIX].
The AUTOMIX indicator lights, indicating that the VS-1824 is in Automix mode.
2. Play or locate to the point in the song where you want the Snapshot to occur.
3. Press [STOP].
4. Select the mixer channels whose settings you want recorded in the Snapshot. Any blinking SELECT button will be recorded. If the SELECT button is not blinking for a channel you wish to record, hold [AUTOMIX] and press the SELECT button so it blinks.
5. Make all mixer settings, including panning, fader positions, effect send levels, etc., for each channel.
6. Hold [SCENE] and press [TAP]. A marker is placed at the current time location. A Snapshot of all mixer settings is recorded and stored with the marker. Any marker that stores Automix data will appear in the display followed by an “A.”

004^A

- * If a marker already exists within 0.1 seconds before or after the location of the new Snapshot, the Snapshot information will be stored at the previously existing marker location. A new Snapshot marker will not be created.

Snap Mode

You can specify whether or not the fader levels will be recorded when you create an Automix Snapshot. This is useful, for example, if you want to automate effect changes without affecting the levels of your tracks. Use the following procedure to set the “Snap mode:”

1. Hold [SHIFT] and press [F6 (UTILITY)] to display the Utility menu.
If the Utility menu does not appear, press [F6 (EXIT)].
2. Press [F5 (A.mix)]. If “A.mix” does not appear above [F5], press [PAGE] until it does; then, press [F5 (A.mix)].
3. Use the TIME/VALUE dial to select the desired Snap mode.

Snap Mode Settings

ALL:

All settings are recorded as part of the Snapshot.

MaskFader:

Fader settings are ignored.

4. Press [PLAY (DISPLAY)] to return to the main Play screen.
5. Record an Automix Snapshot (as described in “Snapshot Automation,” p. 127).

Automating Effect Changes

Use Snapshot automation to program effect patch changes “on the fly.” Use the following steps to create effect-change Snapshots.

1. Press [AUTOMIX].
The AUTOMIX indicator lights, indicating that the VS-1824 is in Automix mode.
2. To automate the effect changes for Effect 1 and Effect 2, make sure the Effect 1/3 and Effect 2/4 SELECT buttons are blinking. If the Effect SELECT button is not blinking, hold [AUTOMIX] and press the SELECT button so it begins blinking.
3. To automate the effect changes for Effect 3 and Effect 4, hold [SHIFT] and make sure the Effect 1/3 and Effect 2/4 SELECT buttons are blinking. If a SELECT button is not blinking, continue to hold [SHIFT], hold [AUTOMIX] and press the SELECT button so it begins blinking.
4. Locate to the point in the song where you want the effect to change.
5. To change the effect preset, hold [SHIFT] and press [F3 (FX A)]. Here you can change the settings for Effect 1 and Effect 2.
6. Press [F1 (FX1)] to select Effect 1. If “FX1” does not appear above [F1], press [F6 (EXIT)] until it does. Then, press [F1 (FX1)].
7. Press [F2 (Sel)] to select a different preset.
8. Use the TIME/VALUE dial to choose the Effect.
9. Press [F4 (Exec)].
10. Hold [SCENE] and press [TAP].
11. Repeat Steps 3-10 for each effect change you want to store.
12. When you’re done, press [ZERO] followed by [PLAY] to hear the effect Snapshots.



This procedure automates effect patch changes only. You can automate effect parameter changes by creating multiple versions of your effect with different settings as user effect patches. Then you can use Snapshot automation to recall the desired version at any point in your song. For example, let’s say you are using the GuitarMulti1 effect with the delay turned off and you want the delay portion of GuitarMulti1 turned on for the solo section of the guitar track. You can create two versions of the GuitarMulti1 effect, one with delay and one without, and save them as separate patches in the user bank. Then, using Automix, you can create a Snapshot at the beginning of your song with the “no delay” version of the effect selected. Next, advance the VS-1824 to the beginning of the guitar solo. Select the “delay” version of your effect and create a second Snapshot. Finally, move to the end of the guitar solo. Select the “no delay” version of the effect again and create a third Snapshot. When you play back your song with Automix turned on, your guitar part will only have delay during the solo section.

Gradation

After creating two Snapshots, you can have the VS-1824 automatically create a smooth crossfade between these Snapshots using “gradation.” Gradation can be used to create fade-ins and fade-outs, as well as dynamic panning sweeps. The following is a quick overview of the gradation procedure:

1. Follow the operation as described in “Snapshot Automation” to record two Snapshots.
2. Adjust the mixer settings as desired.
3. Place one Snapshot at the point you want the crossfade to begin.
4. Change the mixer settings as desired.
5. Place a second Snapshot at the point you want the crossfade to end.
6. From the position of the second of the two Snapshots, hold [SCENE] and press [PREVIOUS]. “Gradation *** - *** Sure ?” appears in the display. “***” indicates the Automix marker number.
7. Press [ENTER/YES].

When the timeline is positioned between two Snapshot markers.

Press either [SCENE] and [NEXT] or [SCENE] and [PREVIOUS]. The gradation will take place between the two adjacent Snapshot markers.

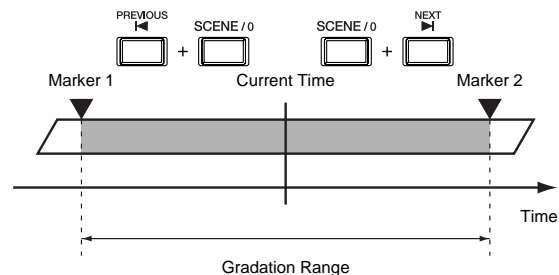

When the timeline is positioned at a Snapshot marker:

If you press [SCENE] and [NEXT], the gradation will occur between the present Snapshot marker and the next one.

If you press [SCENE] and [PREVIOUS], the gradation will occur between the present Snapshot marker and the previous one.

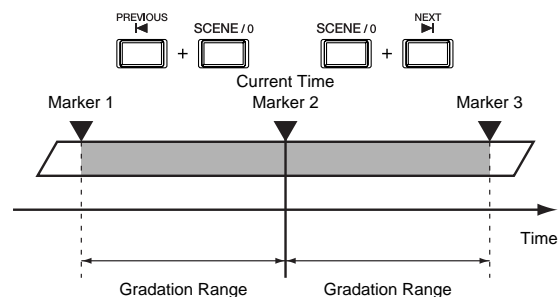

Two Gradation Examples

Example 1: Crossfade Between Stereo Tracks

When creating your own original CD, you may decide you want one song to fade out and the next to fade in simultaneously. You can dictate the length of the crossfade by determining the time between two Snapshots. Here are the steps to creating a seven-second crossfade from Tracks 9/10 to Tracks 11/12 using Snapshot gradation.

1. Make sure Automix is on. The AUTOMIX button should be lit.
2. Make sure the Track 9/10 SELECT and Track 11/12 SELECT buttons are blinking. If either SELECT button is not blinking, hold [AUTOMIX] and press the SELECT button so it begins blinking.
3. Locate to the point in the song where you want the crossfade to begin.
4. Bring the fader for Track 9/10 to the 0 dB position. Bring the fader for Track 11/12 all the way down.
5. Hold [SCENE] and press [TAP].
6. Press [FF] slowly seven times to advance exactly seven seconds on the timeline to the position where you want the crossfade to end.
7. Bring the fader for Track 9/10 all the way down. Bring the fader for Track 11/12 to the 0 dB position.
8. Hold [SCENE] and press [TAP].
9. Hold [SCENE] and press [PREVIOUS]. "Gradation *** - *** Sure ?" appears in the display. "****" indicates the Automix marker number.
10. Press [ENTER/YES].
11. Rewind to a point before the start of the crossfade. Press [PLAY] to hear the crossfade.

Example 2: Fade Out at End of Song

Another way to use a gradation is to create a smooth fade out at the end of a song. Here are the steps for programming a 10-second fadeout at the end of a song.

1. Make sure Automix is on.
2. Make sure the [EDIT/SOLO] button is blinking. This indicates Automix Record Ready for the Master fader. If it is not blinking, hold [AUTOMIX] and press [EDIT/SOLO].
3. Locate to the end of your song by holding [SHIFT] and pressing [FF (Song End)].
4. Pull the Master fader all the way down.
5. Hold [SCENE] and press [TAP]. The current position of the Master fader is stored as a Snapshot.
6. Press [REW] ten times. Each time you press [REW], the play line backs up by exactly one second.
7. Put the Master fader up to 0 dB.
8. Hold [SCENE] and press [TAP].
9. Hold [SCENE] and press [NEXT].
10. "Gradation *** - *** Sure ?" appears in the display. "****" indicates the Automix marker number.
11. Press [ENTER/YES].
12. Rewind back to before the beginning of the fadeout, and press [PLAY] to hear the results.

Updating Automix

When using Automix, it is not necessary to mix all track faders simultaneously. You can mix just the first eight tracks, for example, and then go back and mix the next eight tracks. Or, select a combination of faders that is most comfortable for you. After the first Automix pass, you can go back and update the mix, either on a channel-by-channel basis, or based on a particular section of your song.

Updating Automix for a Selected Group of Faders

You can revise your Automix data at any time, easily updating any track or combination of tracks. All you need to do is disable Automix Record for the channels you are satisfied with.

1. Press [ZERO] to rewind to the beginning of the song.
2. Press [AUTOMIX].
The AUTOMIX indicator lights, indicating that the VS-1824 is in Automix mode.
3. Hold [AUTOMIX], and press the Track SELECT button for the Tracks whose Automix data you are satisfied with, so they are lit, but not blinking. The SELECT buttons for the track or tracks you want to update should be blinking, indicating Automix recording is enabled.
4. Hold [SCENE] and press [REC]. The AUTOMIX indicator blinks, showing Automix recording is enabled.
5. Make sure the FADER/MUTE indicator is set to "TR" for tracks.
6. Adjust the track faders for the track you wish to update. Since the other track faders are now set to Automix playback, you don't need to touch them at all.
** If you want to adjust TR 13-18 fader levels, press [FADER/MUTE] several times until "TR" indicator blinks (p. 71).*
7. Press [PLAY] to begin recording Automix data.
8. While the song is playing, move the track faders to adjust the mix of your song as you like. New Automix data will only be recorded for those faders that are moved during song playback.
9. When the song is finished, press [STOP]. Automix markers will appear in the Playlist display where Automix data was created.

Updating Automix for a Section of a Song

To update Automix data for a section of a song, you must first change the Fader Match setting from "Jump" (the default setting), to "Null." See the following section "Understanding Fader Match."

1. Change the Fader Match setting to "Null." See "Fader Match," p. 249.
2. Move to the location in the song where you wish to re-record realtime Automix.
3. Press [AUTOMIX].
The AUTOMIX indicator lights, indicating that the VS-1824 is in Automix mode.
4. Decide which track fader's movement you want to record using Automix. While pressing [AUTOMIX], press the Track SELECT button for the Tracks you want to mix so they are blinking.
5. Hold [SCENE] and press [REC]. The AUTOMIX indicator blinks, showing Automix recording is enabled.
6. Make sure the FADER/MUTE indicator is set to "TR" for tracks.
7. While watching the Fader/Panning display for track faders, slowly raise the physical faders until they match the stored fader level. The physical fader position is represented on the screen by a black dot, whereas the stored track level is represented by an empty circle.
** If you want to adjust TR 13-18 fader levels, press [FADER/MUTE] several times until "TR" indicator blinks (p. 71).*
8. Press [PLAY] to begin recording Automix data.
9. While the song is playing, move the track faders to adjust the mix of your song as you like. New Automix data will only be recorded for those faders that are moved during song playback.
10. When the song is finished, press [STOP]. Automix markers will appear in the Playlist display where Automix data was created.

Editing Automix Data

Editing Automix Data (Micro Edit)

You can check and change the values for settings pertaining to all Automix data. The general method is as follows.

1. Hold [SHIFT] and press [F6 (UTIL)].
The Utility menu icon appears.
2. Press [F5 (A.Mix)].
If “A.Mix” does not appear above [F5], press [PAGE] and then press [F5 (A.Mix)].
3. Press [F2 (Micro)].
The Micro Edit screen appears in the display.

Step	Time	Meas	Beat	Value
0	00h00m00s00f00	001-1		103
1	00h00m00s17f17	001-2		---
2	00h00m00s20f94	001-2		---
3	00h00m00s24f55	001-2		---
4	00h00m00s27f60	001-2		---
5	00h00m01s00f65	001-3		---
6	00h00m01s03f90	001-3		105
7	00h00m01s07f18	001-3		---
8	00h00m01s10f75	001-3		---
9	00h00m01s14f46	001-3		---

4. Press [◀]. The cursor moves to “Edit Target.” Use the TIME/VALUE dial to select the Automix parameter you want to edit.
5. Press [▲] and [▼] to move the cursor. Use the TIME/VALUE dial to make changes to each of the settings.
* *The only thing that can be edited here is Automix data. If you want to change markers, refer to “Editing Marker Values” (p. 46).*
6. Repeat Steps 4 and 5 for any other Automix data you wish to edit.
7. When you have finished editing, press [PLAY (DISPLAY)] to return to the Playlist display.

Erasing Data from a Specific Area (Erase)

This operation erases the Automix data from a specific area. Markers will not be erased.

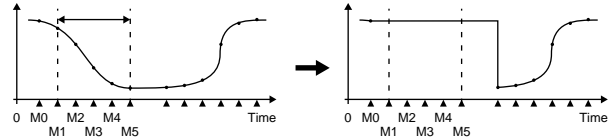

NOTE

Editing of the Automix data cannot be cancelled by the Undo function.

1. Press [PLAY (DISPLAY)].
2. Hold down [SHIFT] and press [F6 (UTIL)].
3. Press [PAGE] so that [F5] indicates “A.Mix,” and then press [F5 (A.Mix)].
4. Press [F2 (Micro)].
5. Press [PAGE] so that [F1] indicates “In.”

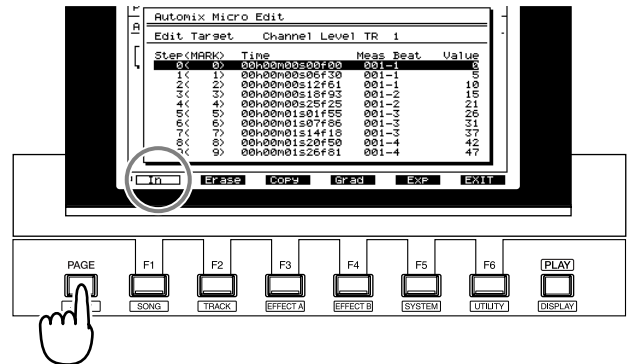

6. Make sure that the cursor is located at “Edit Target,” and use the TIME/VALUE dial to select the Automix data that you wish to erase.
7. Use [▲] and [▼] to move to the first marker of the area from which you wish to erase Automix data, and press [F1 (In)].

- Use [▲] and [▼] to move to the last marker of the area from which you wish to erase Automix value, and press [F1 (Out)].

Checkmarks will be added to the area specified for erasure.

Automix Micro Edit				
Edit Target		Channel	Level	TR 1
Step<MARK>	Time	Meas	Beat	Value
✓ 0< 0>	00h00m00s00f00	001-1		0
✓ 1< 1>	00h00m00s05f30	001-1		5
✓ 2< 2>	00h00m00s12f51	001-1		10
✓ 3< 3>	00h00m00s18f93	001-2		15
4< 4>	00h00m00s25f25	001-2		21
5< 5>	00h00m01s01f55	001-3		26
6< 6>	00h00m01s07f86	001-3		31
7< 7>	00h00m01s14f18	001-3		37
8< 8>	00h00m01s20f50	001-4		42
9< 9>	00h00m01s26f81	001-4		47

Check marks



Even if you wish to erase the Automix data for only one marker, press [F1 (In)] and then [F1 (Out)] for the desired marker.



You can turn the TIME/VALUE dial to modify the Automix setting value at the cursor location. If you wish to re-select the Automix value that will be erased, press [◀].

- Press [F2 (Erase)].

Automix Micro Edit [Erase]				
Target: Channel Level TR 1				
In:	Step<MARK>	Time	M/B	Value
	0< 0>	00h00m00s00f00	001-1	0
Out:	4< 4>	00h00m00s25f25	001-2	21

Target

This will indicate the type of Automix data that you selected to be erased in Step 6. If you wish to erase all Automix data, use the TIME/VALUE dial to select “All Level and Pan.”

- If you wish to erase the data, press [F4 (Exec)].

If you press [F6 (EXIT)], you will return to Step 7 without erasing any data.

- A message will ask you to confirm the operation. Press [ENTER/YES]. If you press [EXIT/NO], the erasure will be halted, and you will return to Step 10.



- When the data has been erased, the display will indicate “Complete.” Press [PLAY (DISPLAY)].

Copying Data to Another Location (Copy)

This operation copies Automix data from a specific area, and overwrites it onto another location (specified data/time).

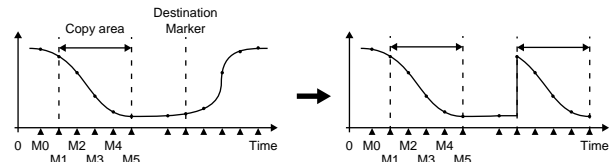

Editing of the Automix data cannot be cancelled by the Undo function.

- Press [PLAY (DISPLAY)].
- Hold down [SHIFT] and press [F6 (UTIL)].
- Press [PAGE] so that [F5] indicates “A.Mix,” and then press [F5 (A.Mix)].
- Press [F2 (Micro)].
- Press [PAGE] so that [F1] indicates “In.”

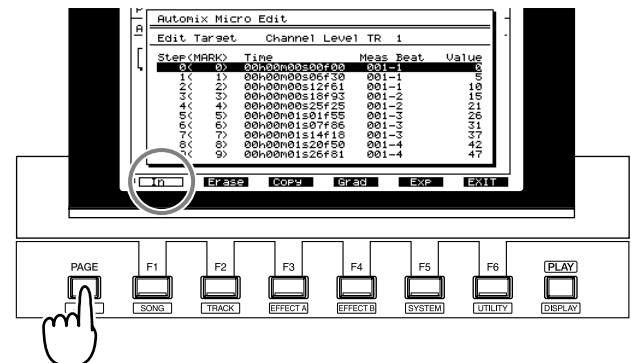

- Make sure that the cursor is located at “Edit Target,” and use the TIME/VALUE dial to select the type of Automix data that you wish to edit.
- Use [▲] and [▼] to move the cursor to the first marker of the area from which you wish to copy Automix data, and press [F1 (In)].

8. Use [▲] and [▼] to move the cursor to the last marker of the area from which you wish to copy Automix data, and press [F1 (Out)]. A checkmark will be added to the copy area.

Automix Micro Edit				
Edit	Target	Channel	Level	TR
Step(MARK)	Time	Meas	Beat	Value
✓ 0< 0>	00h00m00s00f00	001-1		0
✓ 1< 1>	00h00m00s05f30	001-1		5
✓ 2< 2>	00h00m00s12f61	001-1		10
✓ 3< 3>	00h00m00s18f93	001-2		15
✓ 4< 4>	00h00m00s25f25	001-2		21
5< 5>	00h00m01s01f55	001-3		26
6< 6>	00h00m01s07f86	001-3		31
7< 7>	00h00m01s14f18	001-3		37
8< 8>	00h00m01s20f50	001-4		42
9< 9>	00h00m01s26f81	001-4		47

Check marks

NOTE

Even if there is only one marker for the Automix data that you wish to copy, press [F1 (In)] and then [F1 (Out)] for the desired marker.

MEMO

You can turn the TIME/VALUE dial to modify the Automix setting value at the cursor location. If you wish to re-select the Automix data that will be copied, press [◀].

9. Press [F3 (Copy)].
10. Use [▲], [▼], [◀], and [▶] to move the cursor. Turn the TIME/VALUE dial.

Automix Micro Edit [Copy]				
Target	Channel	Level	TR	
In:	Step(MARK)	Time	M/B	Value
	0< 0>	00h00m00s00f00	001-1	0
Out:	4< 4>	00h00m00s25f25	001-2	21
Destination Target	Channel	Level	TR	2
Destination Mark				000

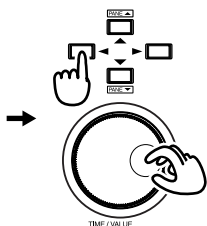

Target

This will indicate the type of Automix data that you selected to be copied in Step 6. If you wish to copy all Automix data, use the TIME/VALUE dial to select "All Level and Pan."

Destination Target

Select the copy destination for the Automix data.

MEMO

There is no limitation on the copy-source and copy-destination data. For example, you can copy the volume level data (0-127) from a track and overwrite it onto the pan data (L63-0-R63). However, if you do so, the results may not be what you expect.

Destination Mark

Select the first marker of the copy destination.

The markers that had originally been assigned to the copy destination will remain, but the data will be rewritten. Also, the markers from the copy source will be added.

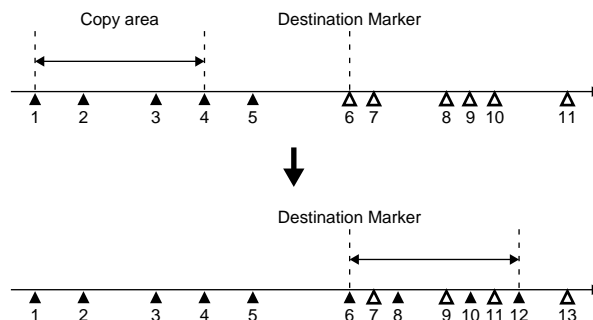

6, 10: The Automix data of the copy-destination markers will be rewritten.

7, 9, 11: Since copy-source markers corresponding to the copy-destination markers do not exist, the Automix data will be erased.

8, 12: Markers with Automix data will be created.

11. To copy the data, press [F4 (Exec)]. If you press [F6 (EXIT)], you will return to Step 7 without copying the data.
12. A message will ask for confirmation. Press [ENTER/YES]. If you press [EXIT/NO], the data copy operation will be halted, and you will return to Step 11.



13. When the data has been copied, the display will indicate "Complete."
14. Press [PLAY (DISPLAY)] to return to the Playlist display.

Smooth Data Transitions (Gradation)

This operation creates Automix data that smoothly connects the first Automix marker in the specified area with the last marker.

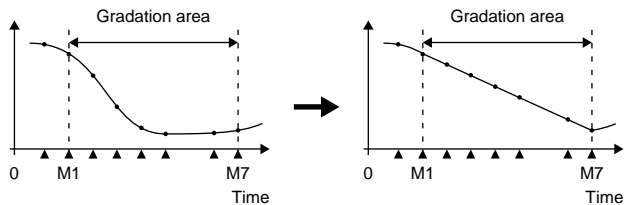

Editing of the Automix data cannot be cancelled by the Undo function.

1. Press [PLAY (DISPLAY)].
2. Hold down [SHIFT] and press [F6 (UTIL)].
3. Press [PAGE] so that [F5] indicates "A.Mix," and then press [F5 (A.Mix)].
4. Press [F2 (Micro)].
5. Press [PAGE] so that [F1] indicates "In."

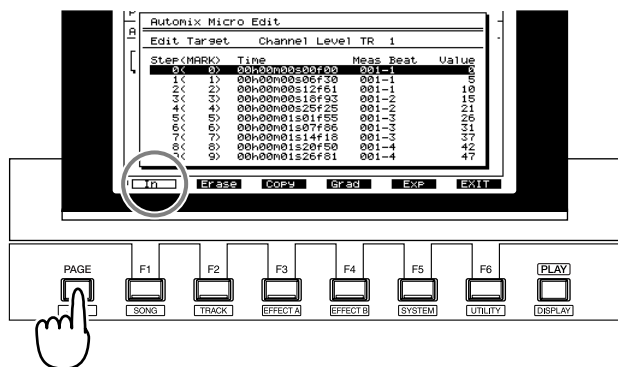

6. Make sure that the cursor is located at "Edit Target," and use the TIME/VALUE dial to select the type of Automix data to which you wish to apply the Gradation operation.
7. Use [▲] and [▼] to move the cursor to the first marker of the Automix data to which you wish to apply the Gradation operation, and press [F1 (In)].
8. Use [▲] and [▼] to move the cursor to the last marker of the Automix data to which you wish to apply the Gradation operation, and press [F1 (Out)].
checkmarks will be added to the range selected for Gradation.

Automix Micro Edit				
Edit Target	Channel	Level	TR	1
Step(MARK)	Time	Meas Beat	Value	
✓ 0< 0>	00h00m00s00f00	001-1	0	
✓ 1< 1>	00h00m00s06f30	001-1	5	
✓ 2< 2>	00h00m00s12f61	001-1	10	
✓ 3< 3>	00h00m00s18f93	001-2	15	
✓ 4< 4>	00h00m00s25f25	001-2	21	
5< 5>	00h00m01s01f55	001-3	26	
6< 6>	00h00m01s07f86	001-3	31	
7< 7>	00h00m01s14f18	001-3	37	
8< 8>	00h00m01s20f50	001-4	42	
9< 9>	00h00m01s26f81	001-4	47	

Check marks



You can turn the TIME/VALUE dial to modify the Automix setting value at the cursor location. If you wish to re-select the type of Automix data that will be edited, press [◀].

9. Press [F4 (Grad)].
10. Use [▲], [▼], [◀], and [▶] to move the cursor. Turn the TIME/VALUE dial to set each parameter.

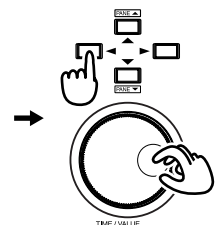
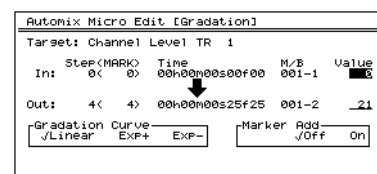

Value

Adjust the beginning (In:) and end (Out:) of the Gradation area.

Gradation Curve

Select the curve by which the gradation will be created.

Linear: Linear.

Exp+: Convex above (exponential curve).

Exp-: Convex below (exponential curve).

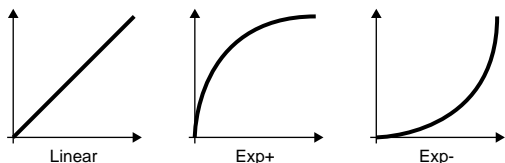

Marker Add

If this is turned on, markers will automatically be added to the area specified for gradation in the optimal locations for the curve that you selected in "Gradation Curve." If this is turned off, markers will not be added.

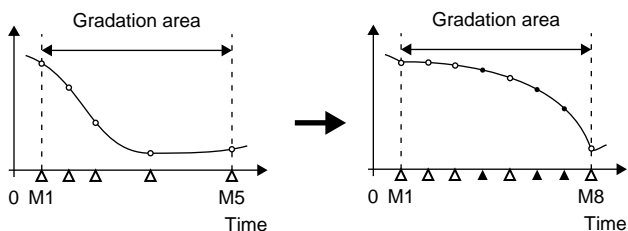

11. To execute the Gradation operation, press [F4 (Exec)]. If you press [F6 (EXIT)], you will return to Step 7 without executing the Gradation operation.

12. A message will ask you to confirm the operation. Press [ENTER/YES]. If you press [EXIT/NO], the Gradation operation will be halted, and you will return to Step 11.



13. When the Gradation operation has been executed, the display will indicate "Complete." Press [PLAY (DISPLAY)].

Increasing or Decreasing All Data Values (Shift/Expand)

This operation increases or decreases the values of the Automix data in a specific area. This can be done in two ways:

Shift adds (or subtracts) the same amount to each Automix data value.

Expand increases or decreases all Automix data values by the same proportion relative to a specified standard value.

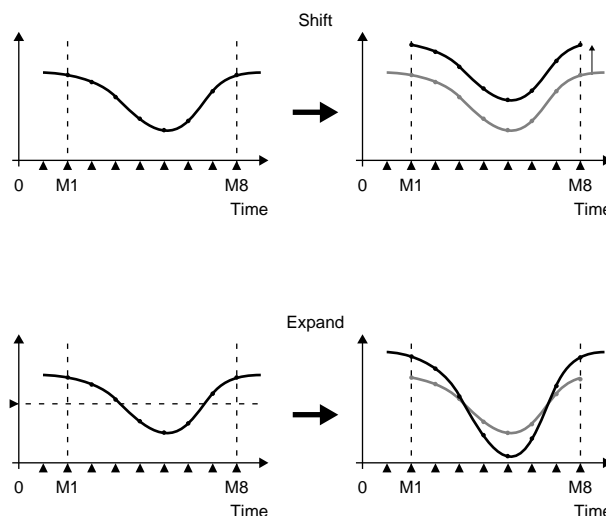

NOTE

Editing of the Automix data cannot be cancelled by the Undo function.

1. Press [PLAY (DISPLAY)].
2. Hold down [SHIFT] and press [F6 (UTIL)].
3. Press [PAGE] so that [F5] indicates "A.Mix," and then press [F5 (A.Mix)].
4. Press [F2 (Micro)].
5. Press [PAGE] so that [F1] indicates "In."

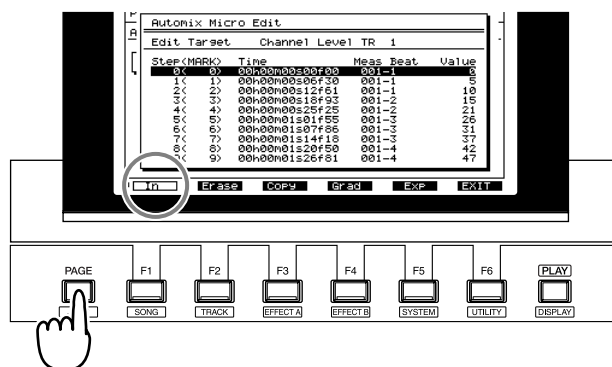

6. Make sure that the cursor is located at “Edit Target,” and use the TIME/VALUE dial to select the Automix data that will be increased or decreased.
7. Use [▲] and [▼] to move the cursor to the first marker of the Automix data you wish to increase or decrease, and press [F1 (In)].
8. Use [▲] and [▼] to move the cursor to the last marker of the Automix value that you wish to increase or decrease, and press [F1 (Out)]. Checkmarks will be added to the selected area.

Automix Micro Edit			
Edit Target	Channel	Level	TR 1
Step(MARK)	Time	Meas Beat	Value
✓ 0< 0>	00h00m00s00f00	001-1	0
✓ 1< 1>	00h00m00s05f30	001-1	5
✓ 2< 2>	00h00m00s12f61	001-1	10
✓ 3< 3>	00h00m00s18f93	001-2	15
✓ 4< 4>	00h00m00s25f25	001-2	21
5< 5>	00h00m01s01f55	001-3	26
6< 6>	00h00m01s07f86	001-3	31
7< 7>	00h00m01s14f18	001-3	37
8< 8>	00h00m01s20f50	001-4	42
9< 9>	00h00m01s26f81	001-4	47

Check marks



Even if there is only one marker for the Automix data that you wish to increase or decrease, press [F1 (In)] and then [F1 (Out)] for the desired marker.



You can turn the TIME/VALUE dial to modify the Automix setting value at the cursor location. If you wish to re-select the Automix data that will be edited, press [◀].

9. Press [F5 (Exp)].
10. Use [▲], [▼], [◀], and [▶] to move the cursor. Use the TIME/VALUE dial to set the parameters.

Automix Micro Edit [Shift/Expand]			
Target:	Channel	Level	TR 1
In:	Step(MARK)	Time	M/B
	0< 0>	00h00m00s00f00	001-1
Out:	4< 4>	00h00m00s25f25	001-2
	Shift	Expand	Threshold
	0	1.0	0

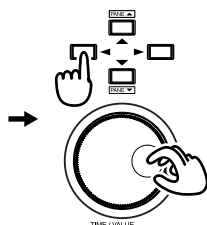

Target

This will indicate the type of Automix data whose data will be increased or decreased, as you selected in Step 6. If you wish to shift or expand the values of all Automix data, use the TIME/VALUE dial to select “All Level and Pan.”

Shift

Specify the actual amount (-50-50) by which the Automix data values will be increased or decreased.

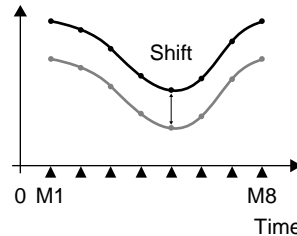

Expand

Specify the ratio (0.5-2.0) by which the Automix data values will be increased or decreased relative to the “Threshold.”

Threshold

When using Expand to increase or decrease the Automix data values by a specified proportion, this specifies the center value.

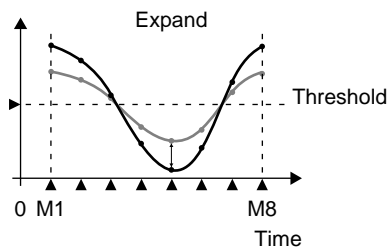

11. To execute the Shift/Expand operation, press [F4 (Exec)]. If you press [F6 (EXIT)], you will return to Step 7 without executing the Shift/Expand operation.
12. A message will ask you to confirm. Press [ENTER/YES]. If you press [EXIT/NO], you will return to Step 11 without executing the Shift/Expand operation.



13. When the Shift/Expand operation has been completed, the display will indicate “Complete.” Press [PLAY (DISPLAY)].

Erasing Automix Data

Erasing Automix Data on Specified Channels

1. Locate to the point where you want to erase the Automix data.
2. Confirm that Automix is on.
3. Select the channels for which you want Automix erased. Hold [AUTOMIX] and press the desired Input SELECT, Track SELECT, or SOLO/EDIT buttons so they are flashing.
4. Hold [SCENE] and press [CLEAR].
Automix is erased on the selected channels.

Erasing Automix Data on All Channels

You may end up recording Automix data only to immediately decide you want to try it again. Do not try to use the UNDO button to erase Automix. Erase Automix data using one of the following two methods.

To Quickly Erase all Automix Data, Including Snapshots



This procedure will erase ALL markers in the VS-1824!

1. Hold [SHIFT] and [CLEAR], and press [TAP].
“Clear All Tap Markers?” appears in the display.
2. Press [ENTER/YES]. Or, if you wish to cancel the operation, press [EXIT/NO].

To Erase Selected Automix Data

1. Hold [SHIFT] and press [F6 (UTIL)].
The Utility menu icon appears.
2. Press [F5 (A.Mix)].
If “A.Mix” does not appear above [F5], press [PAGE] and then press [F5 (A.Mix)].
3. Press [F4 (Erase)]. The Automix Erase screen appears in the display.
4. Press [▲], [▼], [◀], and [▶] to move the cursor, and use the TIME/VALUE dial to change settings.

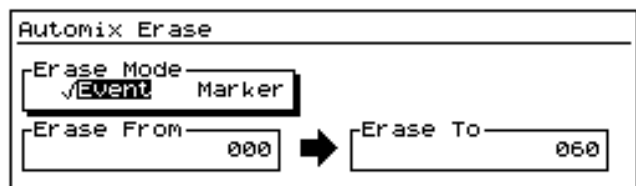

Erase Mode:

Selects the Automix data to be erased

Event:

Only automation events are erased. Markers will remain in place.

Marker:

Both regular markers as well as Automix markers are erased.

Erase From:

Specify the beginning marker number of the range that you want erased.

Erase To:

Specify the ending marker number of the range you want erased.

5. Press [F4 (Exec)].
6. “Erase *** - *** Sure?” appears in the display. “***” indicates the Automix marker number. Press [ENTER/YES]. Or, press [EXIT/NO] if you wish to cancel the operation.

Saving and Exiting Automix

In some cases, you may want to temporarily switch back to manual mixing after you’ve recorded Automix data. The easiest way to do this is to simply press [AUTOMIX] to turn Automix off. Later, you can press [AUTOMIX] again to turn Automix back on, and your previously recorded Automix data will play back. Since all recorded Automix data is stored when you use Song Store, you can be confident your automated mix is only a button touch away.

If you perform Song Store when Automix is on (i.e. [AUTOMIX] is lit), the next time you select the song, it will load and Automix will be turned on.

If you record Automix data, then turn Automix off (i.e. [AUTOMIX] is not lit), and then use Song Store, the next time you select the song, Automix will be off. However, you can press [AUTOMIX] to turn it on, and your previously recorded Automix data will be in place.

Chapter 10 Track and Phrase Editing

Track Editing

The VS-1824 offers some powerful editing functions for manipulating the audio you record. Track edit functions such as Erase, Cut, Move, Copy, Insert, Import, and Time Compression/Expansion allow you to edit your audio quickly and easily within the digital domain. Phrase edit functions such as Delete, Split, Move, Copy, Trim In, and Trim Out allow you to define and edit entire sections of your song at once. Best of all, because the VS-1824's Undo function (p. 62) works during editing in the same way that it does when recording, you can experiment without fear of losing your original version. This chapter explains, in detail, the editing functions available in the VS-1824.

- * *Make sure that track editing does not end up leaving any sections of audio that are 0.5 seconds or shorter. Any sound left over as a result of track editing which is 0.5 seconds or shorter will not be played.*
- * *Track editing may make it seem that a portion of the audio has disappeared, however, the data itself has not been deleted from the hard disk. Thus, even when you carry out a track editing procedure, the available disk space shown in the display does not change.*

Track Erase

This operation erases audio from the specified area, leaving empty space in its place. Compared to a tape recorder, this is like recording silence over an unwanted section of tape.

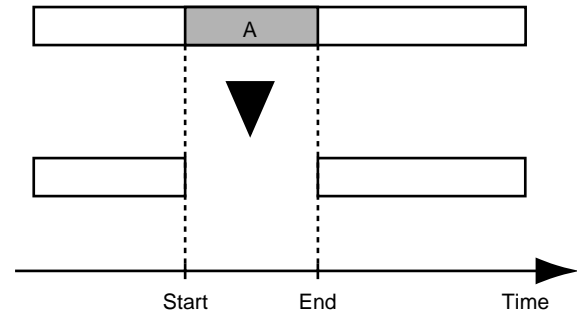

- * *Make sure the Track Erase function does not end up leaving a remaining section of audio that is 0.5 seconds or shorter. Any sound left over as a result of Track Erase that is 0.5 seconds or shorter will not be played.*
- * *While it may seem that the audio has disappeared, the data itself has not been deleted from the hard disk. Even when you carry out the Track Erase procedure, the available disk space shown in the display does not change.*

1. Hold [SHIFT] and press [F2 (TRACK)].
 2. Make sure "Track Edit Menu" appears in the display. If it does not, press [F1 (Tr/Ph)] once.
 3. Press [F2 (Erase)] for Track Erase. If you don't see "Erase" above [F2], press [PAGE] until "Erase" appears, and then press [F2 (Erase)].
 4. Press the Track STATUS button to specify the track to be erased. The STATUS button turns red, indicating it is the track to be edited. You can press more than one STATUS button if you wish to erase more than one track. If you press a STATUS button and then change your mind, press it again to change it back to green.
- * If you want to select TR 1-12, press [FADER/MUTE] several times until the "TR" indicator lights. If you want to select TR 13-18, press [FADER/MUTE] several times until the "TR" indicator blinks.
→ "Switching the Fader Functions" (p. 71)

Alternate method:

- a. Press [F1 (SelTr)].
- b. Press [▲], [▼], [◀], and [▶] to move the cursor to the track you want to erase.
- c. Press [F3 (MARK)].
- d. If [F2 (All)] is pressed, all tracks will be selected to be erased.
- e. Press [F1 (Back)].

- Press [▲], [▼], [◀], and [▶] to move the cursor. Set the START and END values. You can enter the START and END times in a number of different ways such as using LOCATOR buttons, markers, the TIME/VALUE dial, Transport controls, or by Measure/Beat.

HINT

A quick way to enter edit points (START, END, FROM, and TO) is to create a locator for each edit point (43) before entering the edit screen. Then go to the desired edit screen (such as Erase, Copy, Cut). You can enter your edit points by pressing a LOCATOR button and then holding [SHIFT] and pressing [LOC 1] to enter that point as the START time, [SHIFT] + [LOC 2] to enter that point as the END time, [SHIFT] + [LOC 3] to enter that point as the FROM time, or SHIFT+ [LOC 4] to enter that point as the TO time.

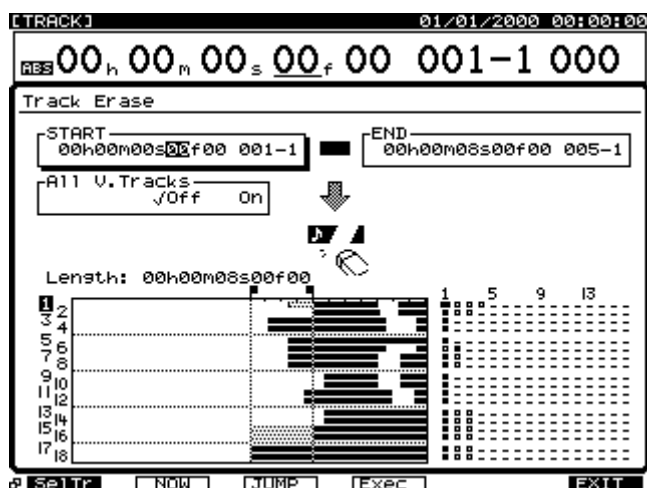

START (Start Point)

Specifies the start time of the segment to be erased.

END (End Point)

Specifies the end time of the segment to be erased.

All V.Tracks

Normally, audio is erased only from the currently selected V-Track. If you want the same segment of audio to be erased on all V-Tracks, set this to "On."

- Press [F4 (Exec)]. This executes the Track Erase.
- When Track Erase is completed correctly, "Complete" appears in the display.
- Press [PLAY (DISPLAY)] to return to the Playlist display.

MEMO

If you are unhappy with the edit you made, press [UNDO]. "UNDO Level 1" will be displayed. Press [ENTER/YES] to restore your track(s) to their condition prior to the edit.

Track Cut

This operation cuts audio from the specified area. The area of audio between the Start point and the End point is removed completely, and the remaining section of audio is spliced on. When a section of audio is cut, audio following the section is moved earlier on the timeline to fill in the gap. Compared to a tape recorder, this is like using a razor blade to slice out a region of tape, and then splicing the two remaining ends together.

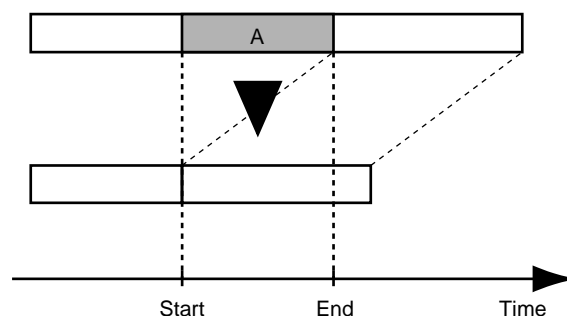

- * Make sure the Track Cut function does not end up leaving a remaining section of audio that is 0.5 seconds or shorter. Any sound left over as a result of Track Cut that is 0.5 seconds or shorter will not be played.
- * While it may seem that the audio has disappeared, the data itself has not been deleted from the hard disk. Even when you carry out the Track Cut procedure, the available disk space shown in the display does not change.

- Hold [SHIFT] and press [F2 (TRACK)].
 - Make sure "Track Edit Menu" appears in the display. If it does not, press [F1 (Tr/Ph)] once.
 - Press [F6 (Cut)] for Track Cut. If you don't see "Cut" above [F6], press [PAGE] until "Cut" appears, and then press [F6 (Cut)].
 - Press the Track STATUS button to specify the track to be cut. The STATUS button turns red, indicating it is the track to be edited. You can press more than one STATUS button if you wish to cut more than one track. If you press a STATUS button and then change your mind, press it again to change it back to green.
- * If you want to select TR 1-12, press [FADER/MUTE] several times until the "TR" indicator lights. If you want to select TR 13-18, press [FADER/MUTE] several times until the "TR" indicator blinks.
→ "Switching the Fader Functions" (p. 71)

Alternate method:

- a. Press [F1 (SelTr)].
- b. Press [▲], [▼], [◀], and [▶] to move the cursor to the track you want to cut.
- c. Press [F3 (MARK)].
- d. If [F2 (All)] is pressed, all tracks are selected to be cut.

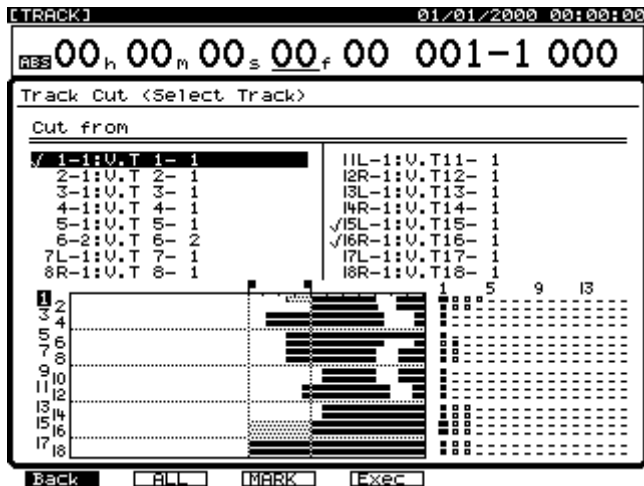

e. Press [F1 (Back)].

5. Press [▲], [▼], [◀], and [▶] to move the cursor. Set the START and END values.

HINT

A quick way to enter edit points (START, END, FROM, and TO) is to create a locator for each edit point (p. 43) before entering the edit screen. Then go to the desired edit screen (such as Erase, Copy, Cut). You can enter your edit points by pressing a LOCATOR button and then holding [SHIFT] and pressing [LOC 1] to enter that point as the START time, [SHIFT] + [LOC 2] to enter that point as the END time, [SHIFT] + [LOC 3] to enter that point as the FROM time, or SHIFT+ [LOC 4] to enter that point as the TO time.

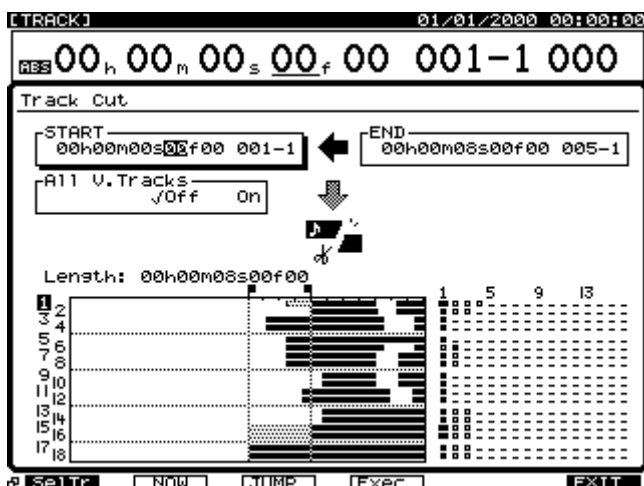

START (Start Point)

Specifies the start time of the segment to be cut.

END (End Point)

Specifies the end time of the segment to be cut.

All V.Tracks

Normally, audio is cut from only the currently selected V-Track. If you want the same segment of audio to be cut on all V-Tracks, set this to "On."

6. Press [F4 (Exec)]. This executes the Track Cut.
7. When Track Cut is completed correctly, "Complete" appears in the display.
8. Press [PLAY (DISPLAY)] to return to the Playlist display.

MEMO

If you are unhappy with the edit you made, press [UNDO]. "UNDO Level 1" will be displayed. Press [ENTER/YES] to restore your track(s) to their condition prior to the edit.

Track Move

This operation moves audio to a new location on the timeline, and simultaneously, to another playback track, if desired. This is useful for correcting timing mistakes that can occur during recording.

Example 1: Moving within the same track

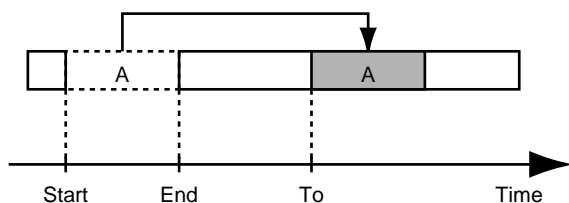

Example 2: Moving to a different track

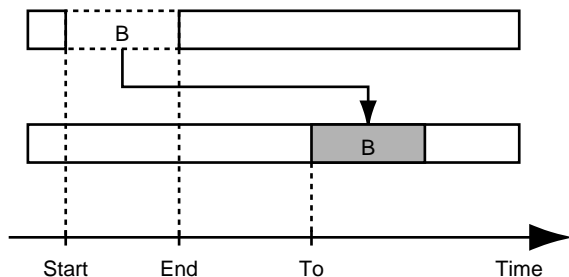

* Make sure the Track Move function does not end up leaving a remaining section of audio that is 0.5 seconds or shorter. Any sound left over as a result of Track Move that is 0.5 seconds or shorter will not be played.

1. Hold [SHIFT] and press [F2 (TRACK)].
 2. Make sure "Track Edit Menu" appears in the display. If it does not, press [F1 (Tr/Ph)] once.
 3. Press [F3 (Move)] for Track Move.
If you don't see "Move" above [F3], press [PAGE] until "Move" appears, and then press [F3 (Move)].
 4. The track SELECT buttons are used to select the source track(s) and the STATUS buttons are used to select the destination track(s). Press the Track SELECT button to specify the track to be moved. The SELECT button stops blinking, indicating it is the track to be moved.
Press the Track STATUS button for the desired destination track. The STATUS button turns red.
- * If you want to select TR 1-12, press [FADER/MUTE] several times until the "TR" indicator lights.
If you want to select TR 13-18, press [FADER/MUTE] several times until the "TR" indicator blinks.
→ "Switching the Fader Functions" (p. 71)
For example, if you wanted to move the section of audio from Track 3 to Track 7, you would first press the Track 3 SELECT button, the press Track 7 STATUS.

Alternate method:

- a. Press [F1 (SelTr)].
- b. Press [▲], [▼], [◀], and [▶] to move the cursor to the track you want to move.
- c. Press [F3 (MARK)].
- e. If [F2 (All)] is pressed, all tracks are selected to be moved.

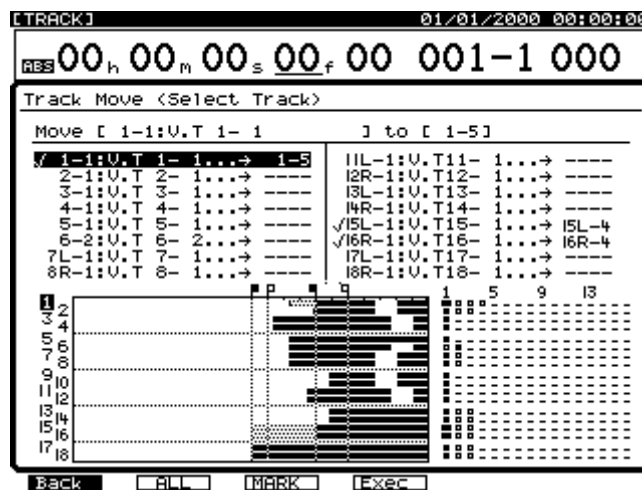

- f. Use the TIME/VALUE dial to select the desired V-Track for the destination track. The V-Track is indicated by the number to the right of the dash. For example, "1-1" indicates "Track 1, V-Track 1," and "9L-1" indicates "Track 9, V-Track 1."
 - * Do not designate V-Tracks that have already been specified as move destinations for other tracks.
 - g. Press [F1 (Back)].
5. Press [▲], [▼], [◀], and [▶] to move the cursor. Set the START, END, FROM, and TO values.

HINT

A quick way to enter edit points (START, END, FROM, and TO) is to create a locator for each edit point (43) before entering the edit screen. Then go to the desired edit screen (such as Erase, Copy, Cut). You can enter your edit points by pressing a LOCATOR button and then holding [SHIFT] and pressing [LOC 1] to enter that point as the START time, [SHIFT] + [LOC 2] to enter that point as the END time, [SHIFT] + [LOC 3] to enter that point as the FROM time, or [SHIFT] + [LOC 4] to enter that point as the TO time.

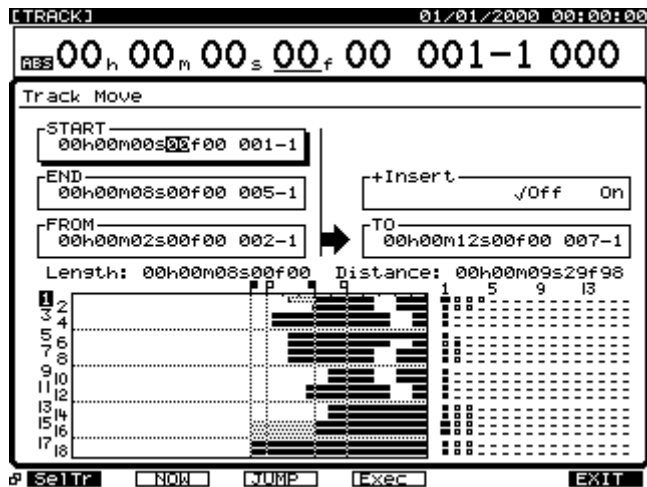

START (Start Point)

Specifies the start time of the segment to be moved.

END (End Point)

Specifies the end time of the segment to be moved.

FROM (From Point)

Specifies the reference position of the segment to be moved, in relation to the TO point. Normally, this is set as the same as the START point.

TO (To Point)

Specifies the time point the segment will be moved to. Specifies the destination point.

+Insert

When this is set to "On," a blank space is inserted at the destination location (the To Point) that is equal in length to the section of audio being moved. Then the Track Move is carried out. This is useful for moving a section of audio within your song without altering any audio that is currently there.

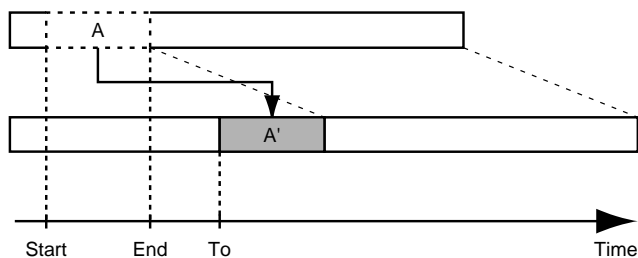

6. Press [F4 (Exec)]. This executes the Track Move.

NOTE

You cannot mix on one V track regularly recorded audio with audio that has been recorded with the CDR Recording Mode ON.

In Songs that use a Recording Mode other than "CDR" follow these rules:

- Even on the mastering tracks, "CDR" V-tracks can only be moved to V-tracks which already have been recorded with "CDR" data, or to new V-tracks which have no data recorded on them.
- V-tracks recorded within a song with a recording mode other than "CDR" cannot be moved to mastering tracks which are already recorded with the "CDR" recording mode ON.

If the above rules are not followed, and the MOVE command would mix CDR audio with regular audio, then "Found Illegal Track Pair!" appears in the display and track move cannot be executed. Please press [ENTER/YES] and select the copy destination again.

7. When Track Move is completed correctly, "Complete" appears in the display.
8. Press [PLAY (DISPLAY)] to return to the Playlist display.

MEMO

If you are unhappy with the edit you made, press [UNDO]. "UNDO Level 1" will be displayed. Press [ENTER/YES] to restore your track(s) to their condition prior to the edit.

Track Copy

This operation copies audio to another location on the timeline, and simultaneously, to another playback track, if desired. This is convenient when you want the same chorus to occur at several different points of the song, but you don't want to re-record it each time.

* Set the track copy so it is longer than 0.5 seconds. If this is less than 0.5 seconds or shorter, the performance data will be copied but may not be played.

Example 1: Copying twice to the same track

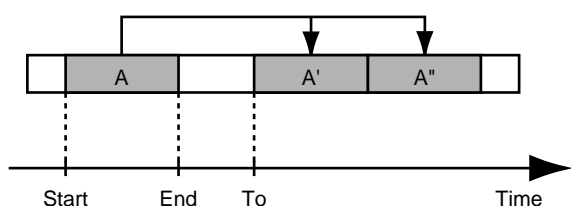

Example 2: Copying twice to a different track

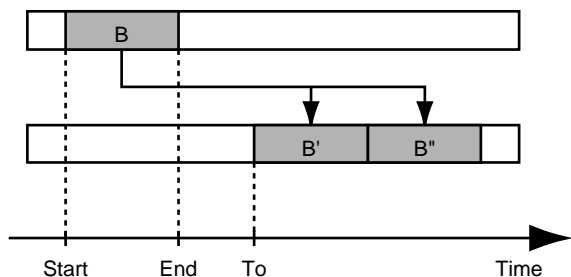

1. Hold [SHIFT] and press [F2 (TRACK)].
2. Make sure "Track Edit Menu" appears in the display. If it does not, press [F1 (Tr/Ph)] once.
3. Press [F2 (Copy)] for Track Copy. If you don't see "Copy" above [F2], press [PAGE] until "Copy" appears, and then press [F2 (Copy)].
4. The track SELECT buttons are used to select the source track(s) and the STATUS buttons are used to select the destination track(s). Press the Track SELECT button to specify the track to be copied. The SELECT button stops blinking, indicating it is the track to be copied. Press the Track STATUS button for the desired destination track. The STATUS button turns red.

* If you want to select TR 1-12, press [FADER/MUTE] several times until the "TR" indicator lights. If you want to select TR 13-18, press [FADER/MUTE] several times until the "TR" indicator blinks. → "Switching the Fader Functions" (p. 71)

For example, if you wanted to copy the section of audio from Track 3 to Track 7, you would first press the Track 3 SELECT button, then press Track 7 STATUS.

Alternate method:

- a. Press [F1 (SelTr)].
- b. Press [▲], [▼], [◀], and [▶] to move the cursor to the track you want to copy.
- c. Press [F3 (MARK)].



If you would like to copy entire sections of your song, you can press [F2 (All)] to select all tracks for copying.

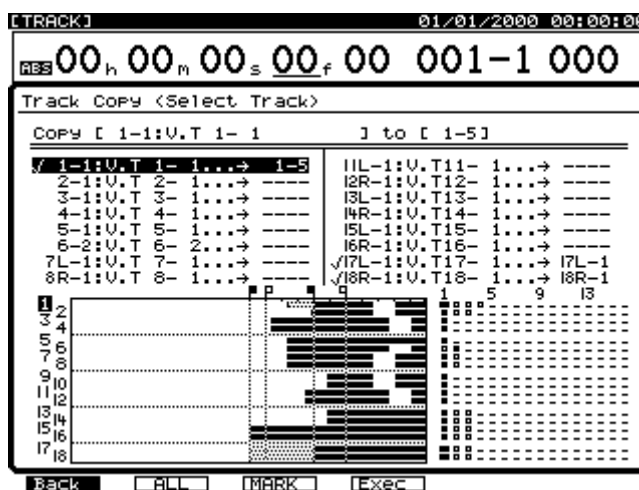

- e. Use the TIME/VALUE dial to specify the V-Track for the destination. For example, "1-1" indicates "Track 1, V-Track 1," and "9L-1" indicates "Track 9, V-Track 1."

* Do not designate V-Tracks that have already been specified as copy destinations for other tracks. Press [F1 (Back)].

5. Press [▲], [▼], [◀], and [▶] to move the cursor. Set the START, END, FROM, and TO values.



A quick way to enter edit points (START, END, FROM, and TO) is to create a locator for each edit point (p. 43) before entering the edit screen. Then go to the desired edit screen (such as Erase, Copy, Cut). You can enter your edit points by pressing a LOCATOR button and then holding [SHIFT] and pressing [LOC 1] to enter that point as the START time, [SHIFT] + [LOC 2] to enter that point as the END time, [SHIFT] + [LOC 3] to enter that point as the FROM time, or [SHIFT] + [LOC 4] to enter that point as the TO time.

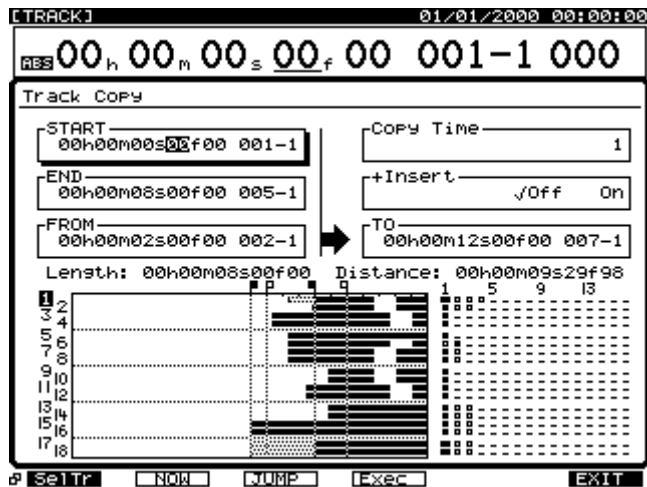

START (Start Point)

Specifies the start time of the segment to be copied.

END (End Point)

Specifies the end time of the segment to be copied.

FROM (From Point)

Specifies the reference position of the segment to be copied, in relation to the TO point. Normally, this is set as the same as the START point.

Copy Time (Copy Time)

Specifies the times (1-99) of copying.

TO (To Point)

Specifies the time point the segment will be copied to. Specifies the destination point.

+Insert

When this is set to "On," first a blank space is inserted at the destination location (the To Point) that is equal in length to the section of audio being copied. Then the Track Copy is carried out.

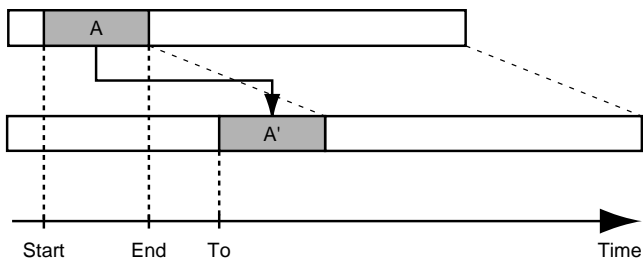

6. Press [F4 (Exec)]. This executes the Track Copy.

NOTE

You cannot mix on one V track regularly recorded audio with audio that has been recorded with the CDR Recording Mode ON.

In Songs that use a Recording Mode other than "CDR" follow these rules:

- Even on the mastering tracks, "CDR" V-tracks can only be copied to V-tracks which already have been recorded with "CDR" data, or to new V-tracks which have no data recorded on them.
- V-tracks recorded within a song with a recording mode other than "CDR" cannot be copied to mastering tracks which are already recorded with the "CDR" recording mode ON.

If the above rules are not followed, and the Copy command would mix CDR audio with regular audio, then "Found Illegal Track Pair!" appears in the display and track move cannot be executed. Please press [ENTER/YES] and select the copy destination again.

7. When Track Copy is completed correctly, "Complete" appears in the display.
8. Press [PLAY (DISPLAY)] to return to the Playlist display.

MEMO

If you are unhappy with the edit you made, press [UNDO]. "UNDO Level 1" will be displayed. Press [ENTER/YES] to restore your track(s) to their condition prior to the edit.

HINT

If you plan on using Track Copy to arrange sections of your song, it is a good idea to use the metronome when you record. Then you will be able to select sections of your song for copying by using the measure and beat indicators.

Track Insert

This operation inserts blank space at the specified location.

* Do not leave sound shorter than 0.5 seconds before or after there area to be inserted. Any sound within 0.5 seconds will be copied but may not be played.

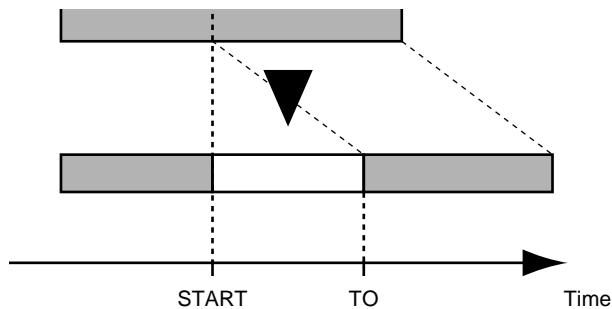

1. Hold [SHIFT] and press [F2 (TRACK)].
2. Make sure "Track Edit Menu" appears in the display. If it does not, press [F1 (Tr/Ph)] once.
3. Press [F5 (Ins)] for Track Insert. If you don't see "Ins" above [F5], press [PAGE] until "Insert" appears, and then press [F5 (Ins)].
4. Press the Track SELECT button to select the tracks on which you want to insert blank space. The SELECT button stops blinking, indicating it is the track to be edited.

Alternate method:

- a. Press [F1 (SelTr)].
- b. Press [▲], [▼], [◀], and [▶] to move the cursor to the track you want to insert on.
- c. Press [F3 (MARK)].
- e. If [F2 (All)] is pressed, all tracks are selected to be inserted on.
- f. Press [F1 (Back)].

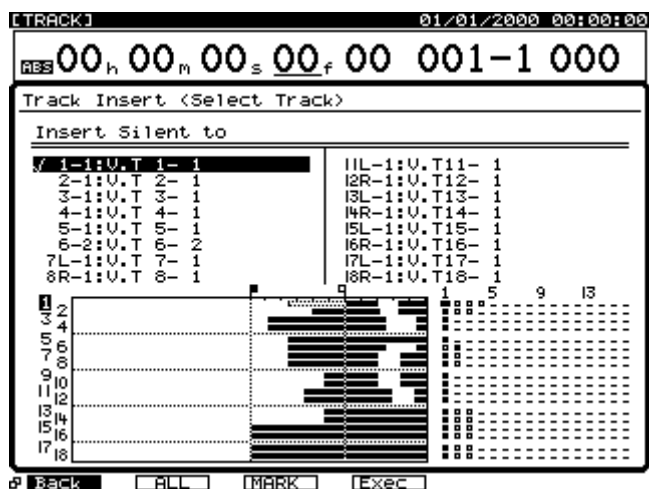

5. Press [▲], [▼], [◀], and [▶] to move the cursor. Set the START and TO values.



A quick way to enter edit points (START, END, FROM, and TO) is to create a locator for each edit point (p. 43) before entering the edit screen. Then go to the desired edit screen (such as Erase, Copy, Cut). You can enter your edit points by pressing a LOCATOR button and then holding [SHIFT] and pressing [LOC 1] to enter that point as the START time, [SHIFT] + [LOC 2] to enter that point as the END time, [SHIFT] + [LOC 3] to enter that point as the FROM time, or [SHIFT] + [LOC 4] to enter that point as the TO time.

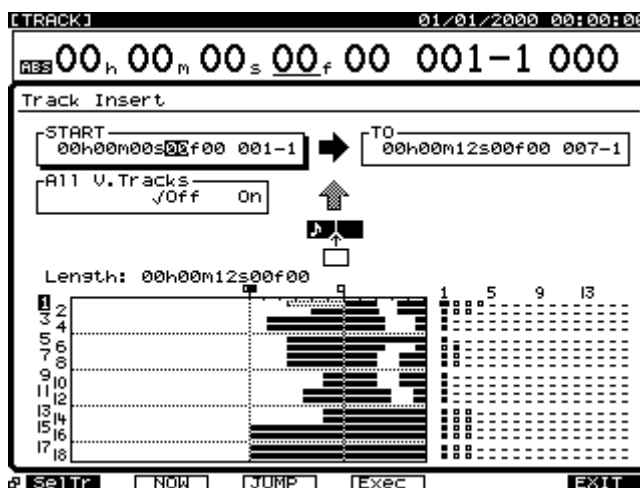

START (Start Point)

Specifies the start time insert.

TO (To Point)

Specifies the time point the segment will be copied to. Specifies the destination point.

All V.Tracks

Normally, silence is inserted only on the currently selected V-Track. If you want silence to be inserted on all V-Tracks, set this to "On."

6. Press [F4 (Exec)]. This executes the Track Insert.
7. When Track Insert is completed correctly, "Complete" appears in the display.
8. Press [PLAY (DISPLAY)] to return to the Playlist display.



If you are unhappy with the edit you made, press [UNDO]. "UNDO Level 1" will be displayed. Press [ENTER/YES] to restore your track(s) to their condition prior to the edit.

Track Exchange

This operation swaps the audio data on two tracks.

Example: Exchanging tracks 1 and 2

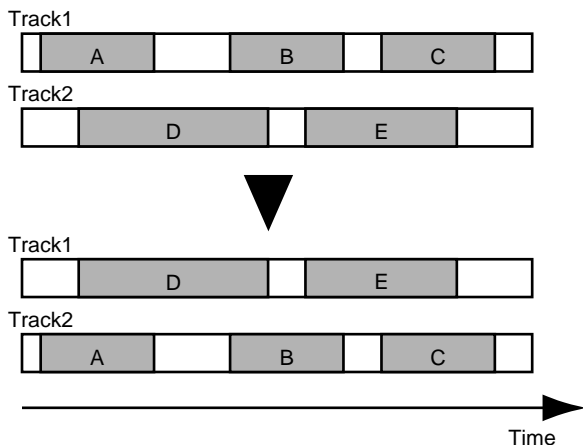

1. Select the V-Track containing the source playback audio to be exchanged.
2. Hold [SHIFT] and press [F2 (TRACK)].
3. Make sure “Track Edit Menu” appears in the display. If it does not, press [F1 (Tr/Ph)] once.
4. Press [F4 (Xchg)] for Track Exchange. If you don’t see “Xchg” above [F4], press [PAGE] until “Xchg” appears, and then press [F4 (Xchg)].
5. The track SELECT buttons are used to select the source track(s) and the STATUS buttons are used to select the destination track(s). Press the Track SELECT button to specify the track to be exchanged. The SELECT button stops blinking, indicating it is the track to be exchanged. Press the Track STATUS button for the desired destination track. The STATUS button turns red.

- * If you want to select TR 1-12, press [FADER/MUTE] several times until the “TR” indicator lights. If you want to select TR 13-18, press [FADER/MUTE] several times until the “TR” indicator blinks. → “Switching the Fader Functions” (p. 71)
- For example, if you wanted to exchange the audio from Track 3 to Track 7, you would first press the Track 3 SELECT button, then press Track 7 STATUS.

Alternate method:

- a. Press [▲], [▼], [◀], and [▶] to move the cursor to the track you want to exchange.
- b. Press [F3 (MARK)].
- c. If [F2 (All)] is pressed, all tracks are selected to be exchanged.

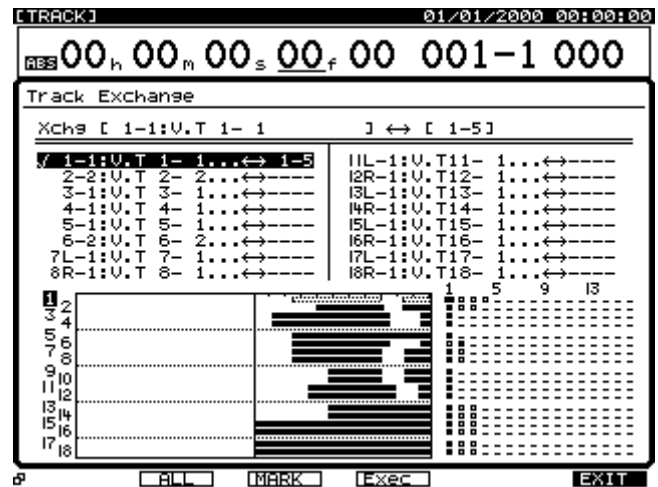

- d. Use the TIME/VALUE dial to specify the V-Track for the destination. For example, “1-1” indicates “Track 1, V-Track 1,” and “9L-1” indicates “Track 9, V-Track 1.”

* Do not designate V-Tracks that have already been specified as exchange destinations for other tracks.

6. Repeat Step 5 if you want to exchange more than one pair of tracks.
7. Press [F4 (Exec)]. This executes Track Exchange.

NOTE

You cannot mix on one V track regularly recorded audio with audio that has been recorded with the CDR Recording Mode ON.

In Songs that use a Recording Mode other than “CDR” follow these rules:

- “On” cannot be exchanged to other V-tracks which are not on the mastering tracks.
- Even on the mastering tracks, “CDR” V-tracks can only be exchanged with V-tracks which already have been recorded with “CDR” data, or with new V-tracks which have no data recorded on them.

If the above rules are not followed, then “Found Illegal Track Pair!” appears in the display and track move cannot be executed. Please press [ENTER/YES] and select the copy destination again.

8. When the exchange is completed correctly, “Complete” appears in the display.
9. Press [PLAY (DISPLAY)] to return to the Playlist display.

MEMO

If you are unhappy with the edit you made, press [UNDO]. “UNDO Level 1” will be displayed. Press [ENTER/YES] to restore your track(s) to their condition prior to the edit.

Track Time Compression/Expansion

This operation allows you to expand or compress the playback time of a track or a group of tracks by a specified time. You can specify the amount of time compression or time expansion in a range of 75-125%, but the more extreme the setting, the more the sound quality may be affected. We recommend you try to keep the compression and expansion within a range of 93-107%.

Example 1: Compression

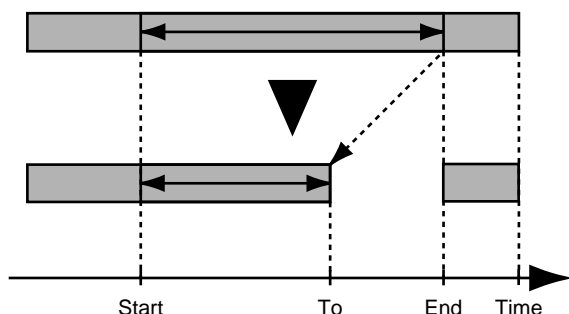

Example 2: Expansion

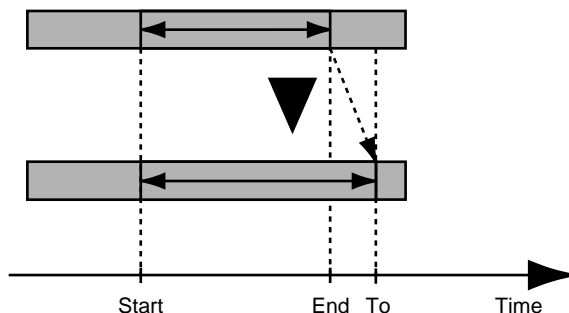

- * Track Compression/Expansion creates new performance data with a different playback time. For this reason, it cannot be executed if there is not sufficient space on the current drive.
- * It is not possible to use Time Compression/Expansion when the elapsed time from the Start Point to the End Point or from the Start Point to the To Point is less than 0.5 seconds.
- * Do not time compress audio to a period of 0.5 seconds or shorter. Any sound 0.5 seconds or shorter will not be played.

1. Hold [SHIFT] and press [F2 (TRACK)].
2. Make sure "Track Edit Menu" appears in the display. If it does not, press [F1 (Tr/Ph)] once.
3. Press [F3 (CmpEx)].
If you don't see "CmpEx" above [F3], press [PAGE] until "CmpEx" appears, and then press [F3 (CmpEx)].

4. Press the Track STATUS button to specify the track to be time-compressed or -expanded. The STATUS button turns red, indicating it is the track to be edited. You can press more than just one STATUS button if you wish to edit more than just one track. If you press a STATUS button and then change your mind, press it again to change it back to green.

* If you want to select TR 1-12, press [FADER/MUTE] several times until the "TR" indicator lights.

If you want to select TR 13-18, press [FADER/MUTE] several times until the "TR" indicator blinks.

→ "Switching the Fader Functions" (p. 71)

Alternate method:

- a. Press [F1 (SelTr)].
- b. Press [▲], [▼], [◀], and [▶] to move the cursor to the track you want to time compress.
- c. Press [F3 (MARK)].
- d. If [F2 (All)] is pressed, all tracks are selected to be cut.
- e. Press [F1 (Back)].

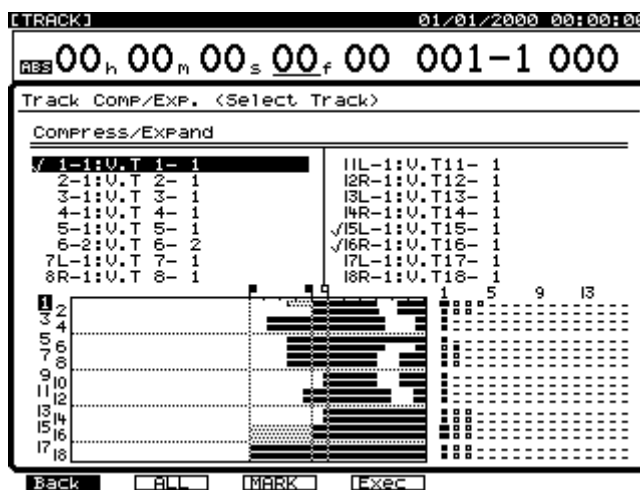

5. [▲], [▼], [◀], and [▶] to move the cursor. Set the START and END values.



A quick way to enter edit points (START, END, FROM, and TO) is to create a locator for each edit point (p. 43) before entering the edit screen. Then go to the desired edit screen (such as Erase, Copy, Cut). You can enter your edit points by pressing a LOCATOR button and then holding [SHIFT] and pressing [LOC 1] to enter that point as the START time, [SHIFT] + [LOC 2] to enter that point as the END time, [SHIFT] + [LOC 3] to enter that point as the FROM time, or [SHIFT] + [LOC 4] to enter that point as the TO time.

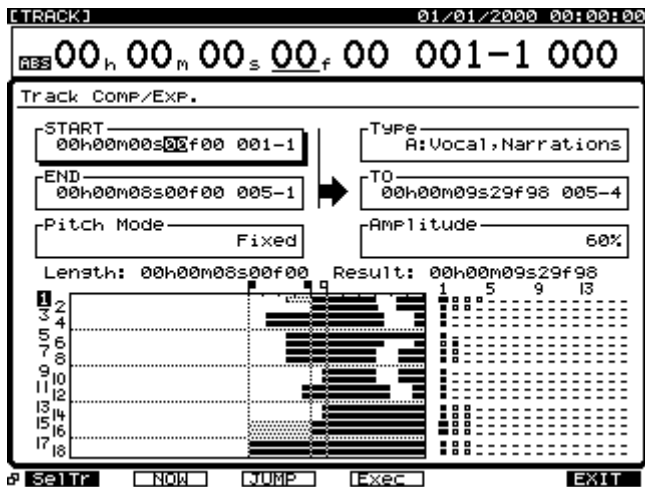

START (Start Point)

Specifies where the time compression or expansion will start.

END (End Point)

Specifies where the time compression or expansion will end.

Pitch Mode

Variable: The pitch of the audio will change

Fixed: The pitch will remain at the original level.

Type

This selects which algorithm is used to complete the Time Compression/Expansion. The type will also affect how long the process takes. Select the setting that matches the type of song or material you are working with.

A: Vocal, Narration

B: Slow-tempo Songs

C: Fast-tempo Songs

To Point

This specifies the ending time location that will result from the compression or expansion.

Amplitude

This specifies the volume level that will result from the compression as a percentage of the original source (50, 60, 70, 80, 90, 100%). The default value of 60% is recommended. If the volume level after conversion is too low, use the Undo function to return to its original state, increase the Amplitude setting, and try the operation again. Excessively high Amplitude settings can introduce distortion in the audio.

6. Press [F4 (Exec)]. This executes the compression or expansion.
 - * Be aware that depending on conditions, it may take some time for compression or expansion to be completed. This is not a malfunction. Progress of the operation is shown in the display. Do not turn off the power until the compression or expansion is completed! You can cancel compression or expansion by pressing [EXIT/NO].
7. When Track Compression/Expansion is completed correctly, "Complete" appears in the display.
8. Press [PLAY (DISPLAY)] to return to the Playlist display.

NOTE

If you are unhappy with the edit you made, press [UNDO]. "UNDO Level 1" will be displayed. Press [ENTER/YES] to restore your track(s) to their condition prior to the edit.

HINT

If you have used the metronome while recording, here is a quick way to change the tempo of your song using Time Compression/Expansion:

1. Hold [SHIFT] and press [SONG END].
2. Make a note of the current measure and beat settings.
3. From the Tempo Map screen, use the [CURSOR] buttons and the [TIME/VALUE] dial to select the new tempo.
4. Advance your song to the measure and beat location noted in Step 2. Don't worry that the measure and beat indicator doesn't match your song.
5. Make a note of the current time location (e.g., 00h07m32s00f).
6. Proceed with the Time Compression/Expansion procedure and use the following edit points:
 - START:** 00h00m00s00f
 - END:** [SHIFT] + [SONG END]
 - TO:** The time location from Step 5

Track Name

Normally, each track is given a name as shown below.

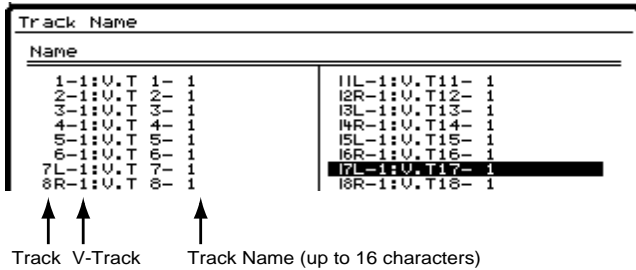

You can change the name for each track. This helps you to remember what performance is recorded on each track. Give your tracks names such as “Lead Vocal” or “Rhythm Guitar” to help keep your work organized.

1. You can change the names of all V-Tracks that are presently selected. If you wish to change the name of a recorded track, first make sure it is the currently selected V-Track.
2. Hold [SHIFT] and press [F2 (TRACK)].
3. Make sure “Track Edit Menu” appears in the display. If it does not, press [F1 (Tr/Ph)] once.
4. Press [F4 (Name)].
If you don’t see “Name” above [F4], press [PAGE] until “Name” appears, and then press [F4 (Name)].
5. Press [▲], [▼], [◀], and [▶] to move the cursor to the track you want to rename, and then press [F1 (Name)] or [ENTER/YES].

The Track Name screen appears in the display.

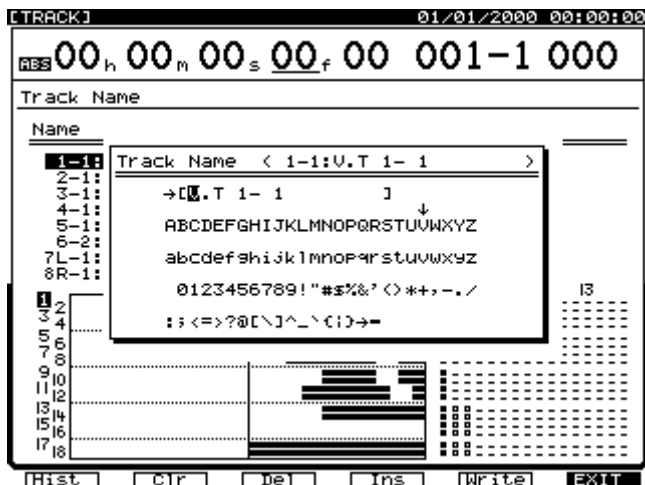

6. Using [▲], [▼], [◀], and [▶], and the TIME/VALUE dial, enter the name of the Track.



If you press [NUMERIC/ASCII] so it is lit, you can use the SELECT and STATUS buttons to enter characters in a fashion similar to a computer keyboard.

The function buttons work as shown below:

[F1 (Hist)]:

Pressing this button will take you through a list of the last 20 track names, one at a time.

[F2 (Clr)]:

Clears all the characters in the window.

[F3 (Del)]:

Deletes the character where the cursor is positioned.

[F4 (Ins)]:

Inserts a space where the cursor is positioned.

[F5 (Write)]:

Stores the track name and exits the Track Name screen.

[F6 (EXIT)]:

Exits the Track Name screen without storing the track name

7. When you are done entering the track name, press [F5 (Write)].
8. Repeat Steps 5-7 to rename additional tracks as desired.
9. Hold [SHIFT] and press [ZERO (STORE)].
“STORE OK ?” appears in the display.
10. Press [ENTER/YES]. This saves the song including the new track names.
11. Press [PLAY (DISPLAY)] to return to the Playlist display.

Track Import

This allows you to copy recordings from other songs into the current song.

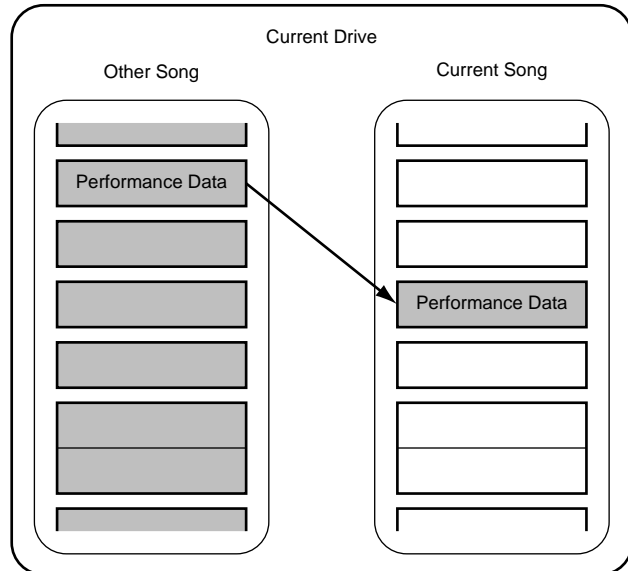

* You can only import a standard track from a song that has the same sample rate and recording mode as the current song.

* You can import a pair of tracks containing a stereo CD image file (p. 183) from any song, regardless of the song's recording mode. If the current song uses the CDR recording mode, you can import the image file to any pair of V-Tracks. If the current song uses MTP, MAS, MT1, MT2, LIV or LV2, you can import image file only to V-Tracks on Tracks 17 and 18—in addition, the destination V-Tracks must not already contain any standard recorded data.

* If there is insufficient disk space on the current drive, the Track Import procedure cannot be successfully performed.

1. First select the song into which you want to import the track.
2. Hold [SHIFT] and press [F2 (TRACK)].
3. Make sure "Track Edit Menu" appears in the display. If it does not, press [F1 (Tr/Ph)] once.
4. Press [F5 (Imprt)] for Track Import. If you don't see "Imprt" above [F5], press [PAGE] until "Imprt" appears, and then press [F5 (Imprt)].
5. Use the TIME/VALUE dial to select the source song—the song containing the track—and press [F3 (Mark)]. The source song you select must have the same recording mode and sample rate as the current song.

6. Press [F4 (Step →)].

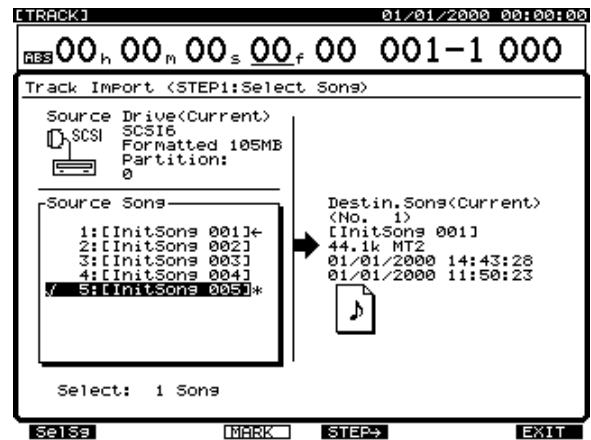

7. Press [◀]. The cursor moves to "Source Track."
8. Use the TIME/VALUE dial to select the source track to be copied.
9. Press [▶]. The cursor moves to "Destination Track."
10. Use the TIME/VALUE dial to select the destination track in the current song.

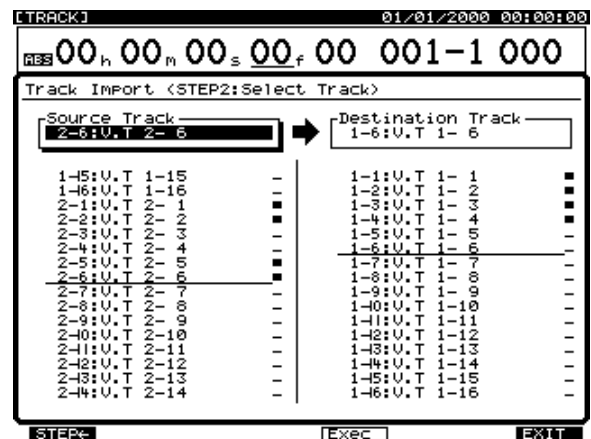

11. Press [F4 (Exec)]. This executes Track Import.

NOTE

Recording mode of the current song: "CDR"

→ Source track to import should be "CDR."

Recording mode of the current song: other than "CDR"

→ If the source track to import is "CDR," the destination track should be one of the mastering track (tracks 17/18 or 7/8), and include "CDR" tracks or tracks with no data recorded.

- If the source track you are importing is not "CDR," the destination track should be the same recording mode as the source track, and include no "CDR" tracks or no data recorded. If the above rules are not followed, "Found Illegal Track Pair!" appears in the display and track import cannot be executed. Please press [ENTER/YES] and select the import destination again.

12. When the Track Import is completed correctly, "Complete" appears in the display.

13. Press [PLAY (DISPLAY)] to return to the Playlist display.

Phrase Editing

In Play mode, you can select the phrase that you wish to edit, and quickly jump to the desired editing window using the following shortcut method.

1. Press [PLAY (DISPLAY)].
2. Move the current time so that it falls within the phrase that you wish to edit.
3. Use [▲], [▼] to highlight the phrase that you wish to edit.

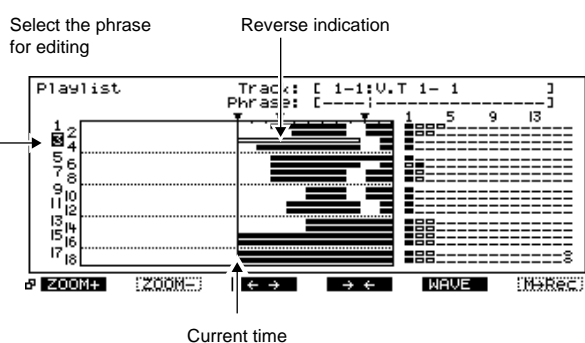

MEMO

If the bottom line of the display is enclosed in a heavy line, you can also turn the TIME/VALUE dial to highlight the phrase that you wish to edit.

4. Press [PAGE] so that the function buttons display the Phrase Edit Menu.

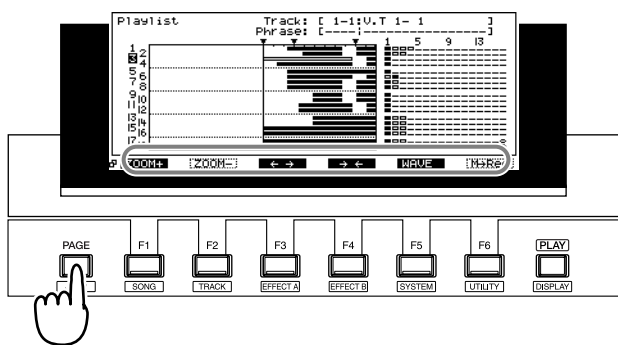

At this time, the function buttons take you to the desired editing operation's window.

- [F1 (Copy)]: Opens the Phrase Copy window, 157.
- [F2 (Move)]: Opens the Phrase Move window, 155.
- [F3 (TrimI)]: Opens the Trim In window, 159.
- [F4 (TrimO)]: Opens the Trim Out window, 160.
- [F5 (Del)]: Opens the Phrase Delete window, below.
- [F6 (Split)]: Opens the Phrase Divide/Split window, 153.

Phrase Delete

This operation deletes the specified phrase. This operation does not change the position of other phrases or tracks on the timeline.

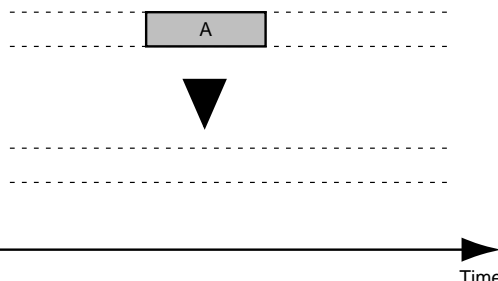

* While it may seem that the audio has disappeared, the data itself has not been deleted from the hard disk. Even when you carry out the Phrase Delete procedure, the available disk space shown in the display does not change.

1. Press [PLAY (DISPLAY)].
 2. Hold down [SHIFT] and press [F2 (TRACK)].
 3. Press [F1 (Tr/Ph)] so that the Phrase Edit Menu appears.
 4. Press [PAGE] so that [F6] indicates "Del," and then press [F6 (Del)].
 5. Press the STATUS button for the phrase that you wish to delete. The STATUS indicator will light in red.
- * If you want to select TR 1-12, press [FADER/MUTE] several times until the "TR" indicator lights.
If you want to select TR 13-18, press [FADER/MUTE] several times until the "TR" indicator blinks.
→ "Switching the Fader Functions" (p. 71)

Alternatively, you can use [▲], [▼], [◀], and [▶] to move the cursor to the phrase that you wish to divide, and press [F3 (MARK)] or [ENTER/YES].

HINT

By pressing [F2 (ALL)], you can mark or unmark all phrases simultaneously.

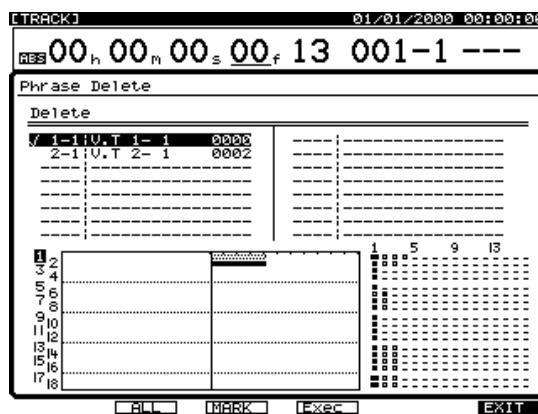

6. Press [F4 (Exec)].
7. When the display indicates "Complete," press [PLAY (DISPLAY)]. You will return to Play mode.

Dividing a Phrase (Phrase Divide/Split)

The Phrase Split function allows you to divide the selected phrase (or phrases) at the Now Time location on the time axis using **Phrase Divide** and **Phrase Split**. This can be useful for isolating a section of audio that you want to loop.

Automatically Dividing a Phrase (Phrase Divide)

This function automatically detects silent portions of a phrase according to the volume level that you specify—the **Threshold Level**—and divides the phrase into two or more phrases at these points.

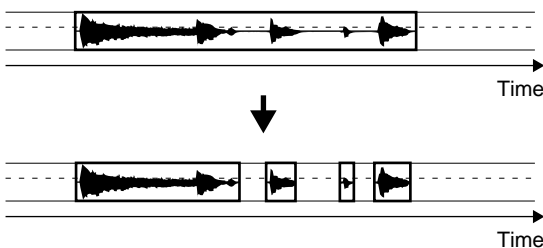

1. Press [PLAY (DISPLAY)].
2. Hold down [SHIFT] and press [F2 (TRACK)].
3. Press [F1 (Tr/Ph)] so that the Phrase Edit Menu appears.
4. Press [PAGE] so that [F2] indicates “Split,” and then press [F2 (Split)].
5. Press [F1 (SelPh)].
6. Press the STATUS button for the phrase that you wish to divide. The STATUS indicator will light in red.

* If you want to select TR 1-12, press [FADER/MUTE] several times until the “TR” indicator lights.

If you want to select TR 13-18, press [FADER/MUTE] several times until the “TR” indicator blinks.

→ “Switching the Fader Functions” (p. 71)

Alternatively, you can use [▲], [▼], [◀], and [▶] to move the cursor to the phrase that you wish to divide, and press [F3 (MARK)] or [ENTER/YES].



By pressing [F2 (ALL)], you can mark or unmark all phrases simultaneously.

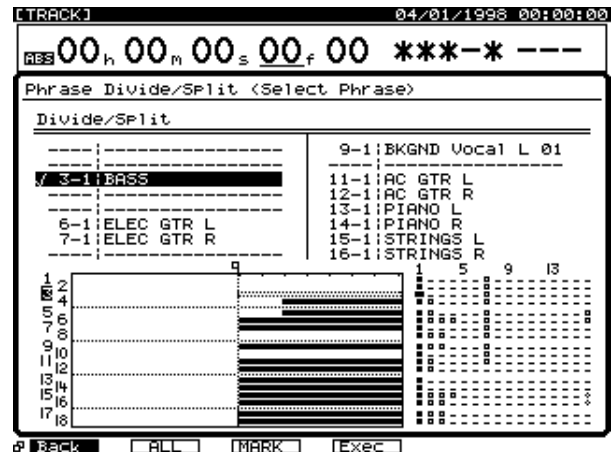

7. Press [F1 (Back)].
8. Use [▲], [▼], [◀], and [▶] to move the cursor, and use the TIME/VALUE dial to set the parameters.

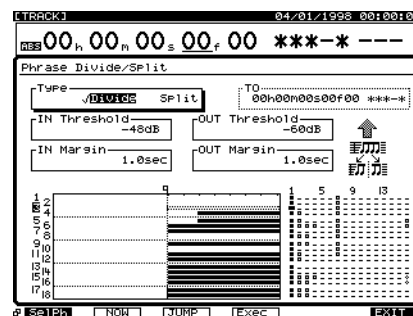

Type

Select how the phrase will be divided. In this case, select “Divide.”

Divide: Automatically divide the phrase into two or more phrases.

Split: Manually divide the phrase into two separate phrases.

IN Threshold

Specify the volume (-84 - 6 dB) that will be used when searching for the point at which the phrase begins to sound. The VS-1824 will search for a point that exceeds this level.

IN Margin

Specify the length of time (0.1–9.9 sec.) that will be preserved before reaching the “IN Threshold.”

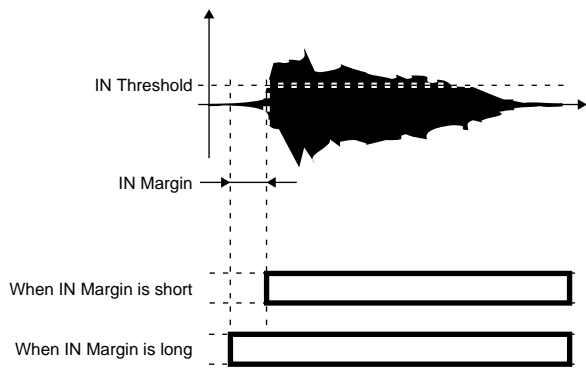

OUT Threshold

Specify the volume (-84-6 dB) that will be used when searching for the point at which the phrase stops sounding. The VS-1824 will search for a point that falls below this level.

OUT Margin

Specify the length of time (0.1–9.9 sec.) that will be preserved after reaching the “OUT Threshold.”

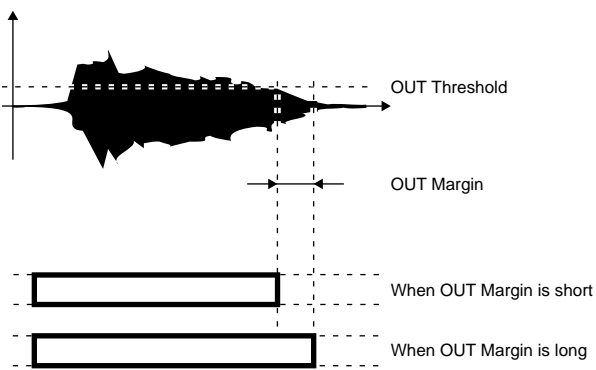

9. Press [F4 (Exec)].
10. When the display indicates “Complete,” press [PLAY (DISPLAY)]. You will return to Play mode.

Splitting a Phrase into Two Parts (Phrase Split)

This operation divides a phrase into two parts at the specified location (time) in the time axis.

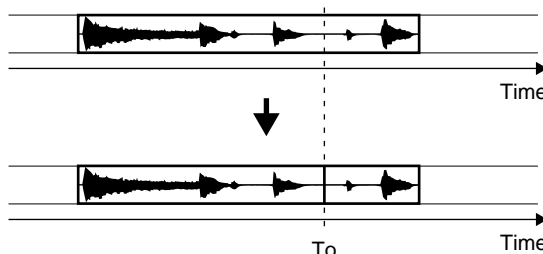

1. Press [PLAY (DISPLAY)].
2. Hold down [SHIFT] and press [F2 (TRACK)].
3. Press [F1 (Tr/Ph)] so that the Phrase Edit Menu appears.
4. Press [PAGE] so that [F2] indicates “Split,” and then press [F2 (Split)].
5. Press [F1 (SelPh)].
6. Press the STATUS button of the phrase that you wish to split. The STATUS indicator will light in red.

* If you want to select TR 1-12, press [FADER/MUTE] several times until the “TR” indicator lights.

If you want to select TR 13-18, press [FADER/MUTE] several times until the “TR” indicator blinks.

→ “Switching the Fader Functions” (p. 71)

Alternatively, you can use [▲], [▼], [◀], and [▶] to move the cursor to the phrase that you wish to split, and press [F3 (MARK)] or [ENTER/YES].



By pressing [F2 (ALL)] you can mark or unmark all phrases simultaneously.

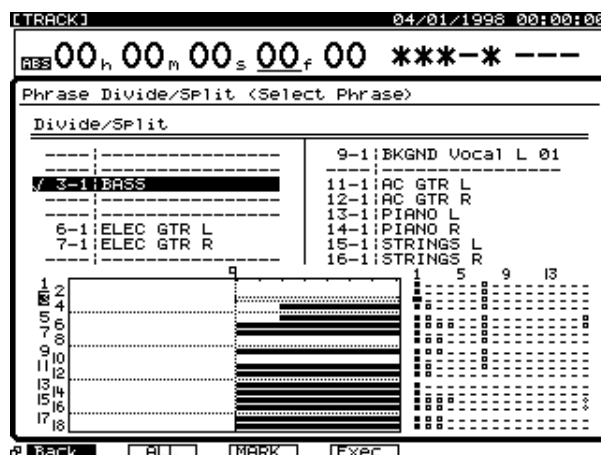

7. Press [F1 (Back)].
8. Use [▲], [▼], [◀], and [▶] to move the cursor, and use the TIME/VALUE dial to set the parameters.

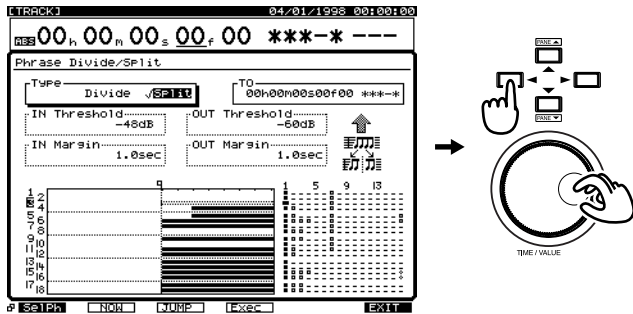

Type

Select how the phrase will be divided. In this case, select "Split."

- Divide:** Automatically divide the phrase into two or more phrases.
- Split:** Manually divide the phrase into two separate phrases.

To (to point)

Specify the time location at which the phrase will be split.

9. Press [F4 (Exec)].
10. When the display indicates "Complete," press [PLAY (DISPLAY)]. You will return to Play mode.

Phrase Move

This operation moves the specified phrase to another location on the timeline, or to a different track. This is convenient for correcting timing mistakes that can occur when recording.

* Each phrase needs to be longer than 0.5 seconds. Otherwise, short phrases will not be played.

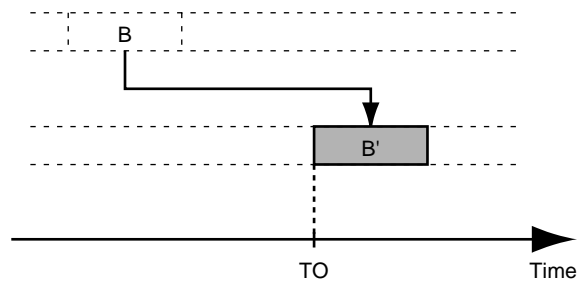
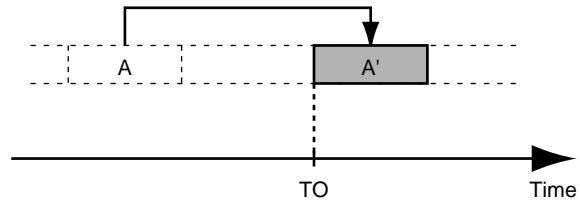

1. Press [PLAY (DISPLAY)].
2. Hold down [SHIFT] and press [F2 (TRACK)].
3. Press [F1 (Tr/Ph)] so that the Phrase Edit Menu appears.
4. Press [PAGE] so that [F3] indicates "Move," and then press [F6 (Move)].
5. Press [F1 (Selph)].
6. The track SELECT buttons are used to select the source track(s). Press the Track SELECT button to specify the phrase to be moved.
Alternatively, you can use [▲], [▼], [◀], and [▶] to move the cursor to the phrase that you wish to move, and press [F3 (MARK)] or [ENTER/YES].
The SELECT button stops blinking, indicating it is the track to be moved.



If [F2 (All)] is pressed, all tracks are selected to be moved.

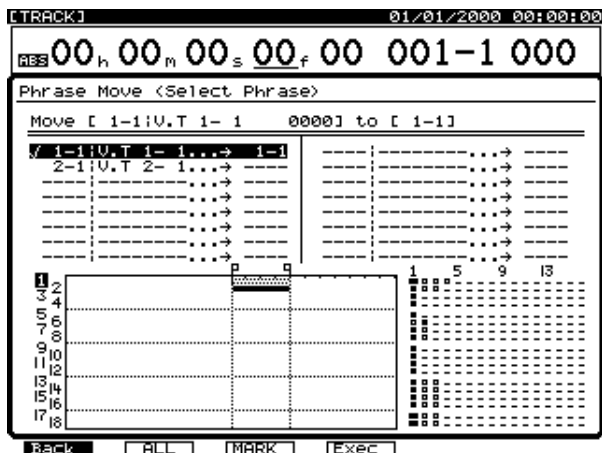

7. Press the Track STATUS button for the desired destination track. The STATUS button turns red.
 - * If you want to select TR 1-12, press [FADER/MUTE] several times until the “TR” indicator lights.
 - If you want to select TR 13-18, press [FADER/MUTE] several times until the “TR” indicator blinks.
 - “Switching the Fader Functions” (p. 71)
8. Press [F1 (Back)].
9. Use [▲], [▼], [◀], and [▶] to move the cursor, and use the TIME/VALUE dial to set the parameters.

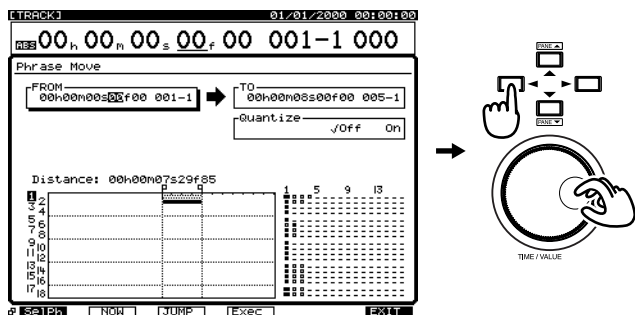

FROM (From Point)

You can specify the exact sync point of the phrase to be moved as the FROM time. The FROM time will be moved to the position designated as the TO time. You can specify a FROM time that is not necessarily located within the phrase. The destination of the Move is the TO time.

TO (To Point)

You can specify the destination time of move as TO time.

Quantize

If you set this to “ON”, the TO time (destination time of the Move) will be set at the beginning of the measure set by the tempo map or sync track. For example, it's easy to Move a phrase one measure when the phrase length is 2.0 seconds as when the tempo map setting is 120. However, you will need a complicated calculation if the tempo is 119.1. If you set Quantize ON, you can avoid this.

Further, if this is set to ON, Overlap will be automatically set to ON also.

10. Press [F4 (Exec)].

NOTE

You cannot mix on one V track regularly recorded audio with audio that has been recorded with the CDR Recording Mode ON.

In Songs that use a Recording Mode other than “CDR” follow these rules:

- Even on the mastering tracks, “CDR” V-tracks can only be moved to V-tracks which already have been recorded with “CDR” data, or to new V-tracks which have no data recorded on them.
- V-tracks recorded within a song with a recording mode other than “CDR” cannot be moved to mastering tracks which are already recorded with the “CDR” recording mode ON.

If the above rules are not followed, and the MOVE command would mix CDR audio with regular audio, then “Found Illegal Track Pair!” appears in the display and phrase move cannot be executed. Please press [ENTER/YES] and select the move destination again.

11. When the display indicates “Complete,” press [PLAY (DISPLAY)]. You will return to Play mode.

Phrase Copy

This operation copies the audio of a specified phrase to another location. This is convenient when you want, for example, a four-measure rhythm pattern to loop seamlessly.

* Each phrases needs to be longer than 0.5 seconds. Otherwise, short phrases will not be played.

1. Press [PLAY (DISPLAY)].
2. Hold down [SHIFT] and press [F2 (TRACK)].
3. Press [F1 (Tr/Ph)] so that the Phrase Edit Menu appears.
4. Press [PAGE] so that [F2] indicates “Copy,” and then press [F2 (Copy)].
5. Press [F1 (Selph)].
6. The track SELECT buttons are used to select the source track(s). Press the Track SELECT button to specify the track to be copied.

Alternatively, you can use [▲], [▼], [◀], and [▶] to move the cursor to the phrase that you wish to move, and press [F3 (MARK)] or [ENTER/YES].

The SELECT button stops blinking, indicating it is the phrase to be copied.



If [F2 (All)] is pressed, all tracks are selected to be moved.

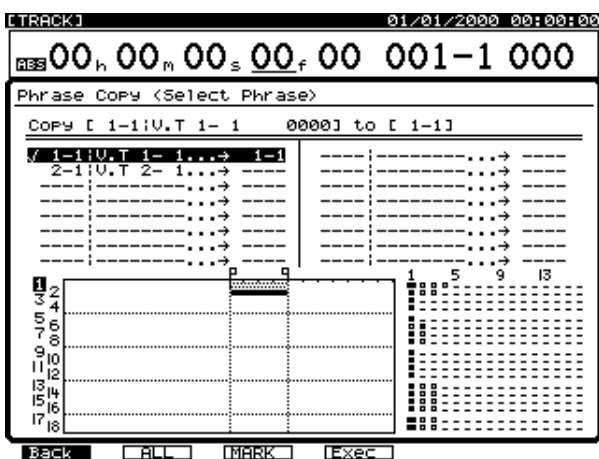

7. Press the Track STATUS button for the desired destination track. The STATUS button turns red.

* If you want to select TR 1-12, press [FADER/MUTE] several times until the “TR” indicator lights.
 If you want to select TR 13-18, press [FADER/MUTE] several times until the “TR” indicator blinks.
 → “Switching the Fader Functions” (p. 71)

8. Press [F1 (Back)].

9. Use [▲], [▼], [◀], and [▶] to move the cursor, and use the TIME/VALUE dial to set the parameters.

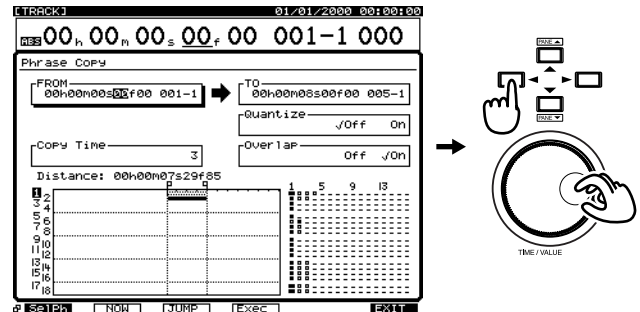

FROM (From Point)

You can specify the exact sync point of the phrase to be copied as the FROM time. The FROM time will be copied to the position designated as the TO time. You can specify a FROM time that is not necessarily located within the phrase.

TO (To Point)

The destination of the Copy is the TO time.

Quantize

If you set this to “ON”, the TO time (destination time of the Copy) will be set at the beginning of the measure set by the tempo map or sync track. For example, it's easy to Copy a phrase one measure when the phrase length is 2.0 seconds as when the tempo map setting is 120.

However, you will need a complicated calculation if the tempo is 119.1. If you set Quantize ON, you can avoid this.

Further, if this is set to ON, Overlap will be automatically set to ON also.

Overlap

If you set this to “OFF”, the phrase will copy so that the first copy begins exactly at the end of the original and the copying procedure will be the same as if the beginning/ending time of the phrase is same as the START/END time of the Copy. If you carry out a copy twice or more under this condition, there will be no blank spaces between the copied phrases. If you set this to “ON”, the interval between FROM and TO will be kept. Therefore, if the phrase length is shorter than the interval, there will be blank spaces between the copied phrases. If phrase length is longer than the interval, the phrases will be overlapped.

(see illustrations below)

EX1 : Phrase is shorter than interval of FROM and TO

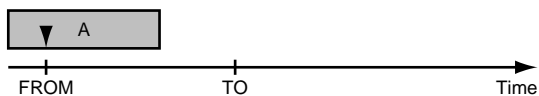

Copy Times="2," Overlap="Off"



Copy Times="2," Overlap="On"



EX2 : Phrase is longer than interval of FROM and TO

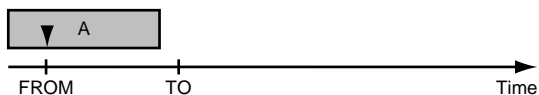

Copy Times="2," Overlap="Off"

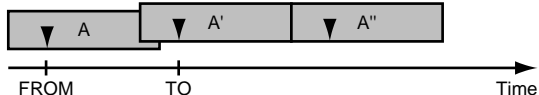

Copy Times="2," Overlap="On"



About phrase copying

Please be careful if you copy 2 or more phrases at the same time when Overlap is OFF. If the lengths of the selected phrases are not exactly the same, you will find that the beginning points of each phrase will be different. If you want to carry out such a copying procedure, be very sure the length of the selected phrases are the same. Phrases captured simultaneously with punch in recording or trimmed phrases using the Trim In/Trim Out functions (see p. 159-160), for example, could be used.

EX : In case phrase length differs

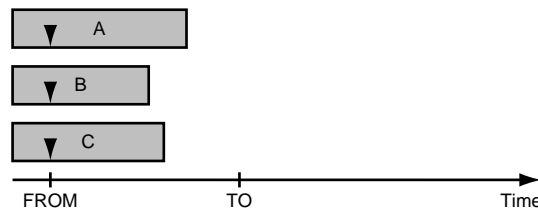

Copy Times="2," Overlap="Off"

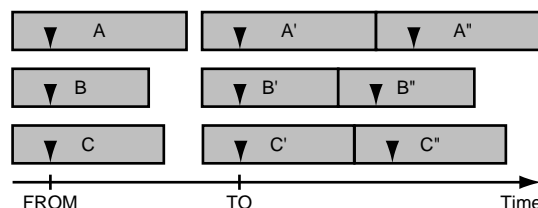

If you are setting Overlap to ON, you do not need to select phrases with the same length. However, it is possible that the ending part of the phrase could be missed if the interval between FROM and TO do not match the phrase length.

Copy Time

Specifies the times (1-99) of copying.

NOTE

You cannot mix on one V track regularly recorded audio with audio that has been recorded with the CDR Recording Mode ON.

In Songs that use a Recording Mode other than "CDR" follow these rules:

- Even on the mastering tracks, "CDR" V-tracks can only be copied to V-tracks which already have been recorded with "CDR" data, or to new V-tracks which have no data recorded on them.
- V-tracks recorded within a song with a recording mode other than "CDR" cannot be copied to mastering tracks which are already recorded with the "CDR" recording mode ON.

If the above rules are not followed, and the Copy command would mix CDR audio with regular audio, then "Found Illegal Track Pair!" appears in the display and phrase move cannot be executed. Please press [ENTER/YES] and select the move destination again.

10. Press [F4 (Exec)].

11. When the display indicates "Complete," press [PLAY (DISPLAY)]. You will return to Play mode.

Phrase Trim In

This adjusts the point at which the phrase begins without changing the phrase's position on the timeline. This is convenient for trimming the edges of a phrase to be looped.

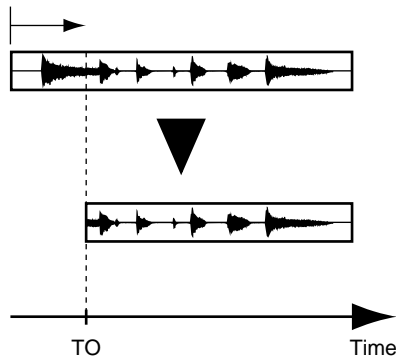

1. Press [PLAY (DISPLAY)].
2. Hold down [SHIFT] and press [F2 (TRACK)].
3. Press [F1 (Tr/Ph)] so that the Phrase Edit Menu appears.
4. Press [PAGE] so that [F4] indicates "TrimI," and then press [F4 (TrimI)].
5. Press [F1 (Selph)].

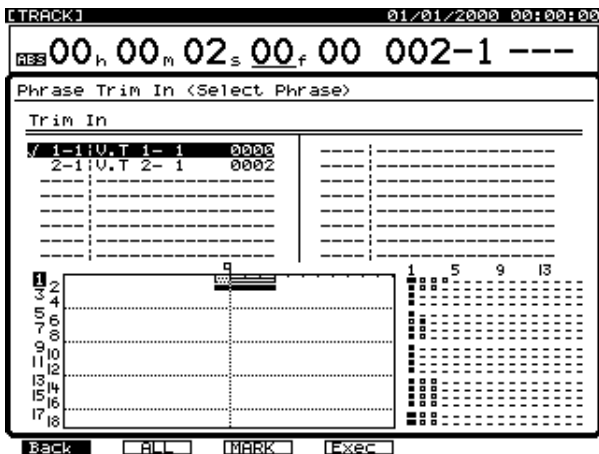

6. Press the STATUS button for the track that you wish to trim.

* If you want to select TR 1-12, press [FADER/MUTE] several times until the "TR" indicator lights.

If you want to select TR 13-18, press [FADER/MUTE] several times until the "TR" indicator blinks.

→ "Switching the Fader Functions" (p. 71)

Alternatively, you can use [▲], [▼], [◀], and [▶] to move the cursor to the phrase that you wish to trim, and press [F3 (MARK)] or [ENTER/YES].

The STATUS button turns red.



If [F2 (All)] is pressed, all tracks are selected to be moved.

7. Press [F1 (Back)].
8. Use [▲], [▼], [◀], and [▶] to move the cursor, and use the TIME/VALUE dial to set the parameters.

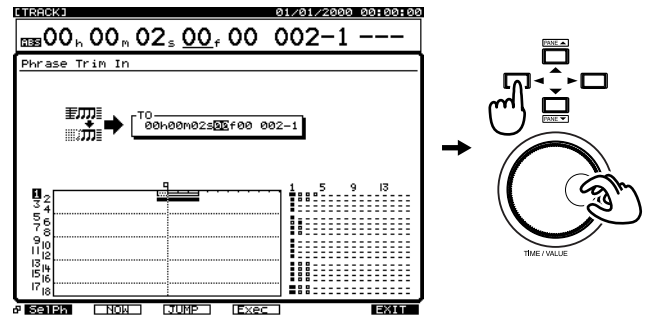

TO (To Point)

You can specify time of trim in.

9. Press [F4 (Exec)].
10. When the display indicates "Complete," press [PLAY (DISPLAY)]. You will return to Play mode.

Phrase Trim Out

This adjusts the point at which the phrase ends without changing the phrase's position on the timeline. This is convenient for trimming the edges of a phrase to be looped.

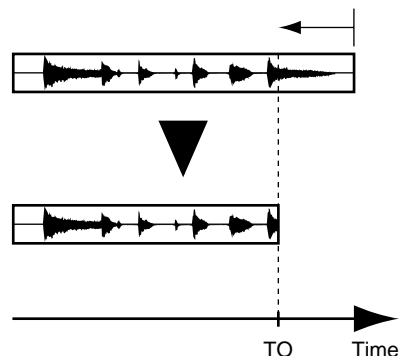

1. Press [PLAY (DISPLAY)].
2. Hold down [SHIFT] and press [F2 (TRACK)].
3. Press [F1 (Tr/Ph)] so that the Phrase Edit Menu appears.
4. Press [PAGE] so that [F5] indicates "TrimO," and then press [F5 (TrimO)].
5. Press [F1 (Selph)].

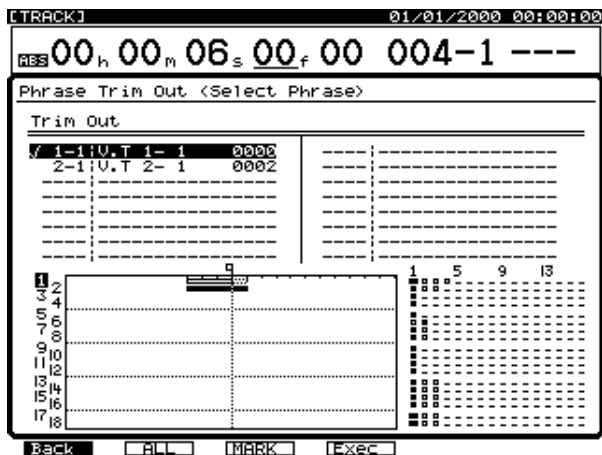

6. Press the STATUS button for the track that you wish to trim.

* If you want to select TR 1-12, press [FADER/MUTE] several times until the "TR" indicator lights.

If you want to select TR 13-18, press [FADER/MUTE] several times until the "TR" indicator blinks.

→ "Switching the Fader Functions" (p. 71)

Alternatively, you can use [▲], [▼], [◀], and [▶] to move the cursor to the phrase that you wish to trim, and press [F3 (MARK)] or [ENTER/YES].

The STATUS button turns red.



If [F2 (All)] is pressed, all tracks are selected to be moved.

7. Press [F1 (Back)].
8. Use [▲], [▼], [◀], and [▶] to move the cursor, and use the TIME/VALUE dial to set the parameters.

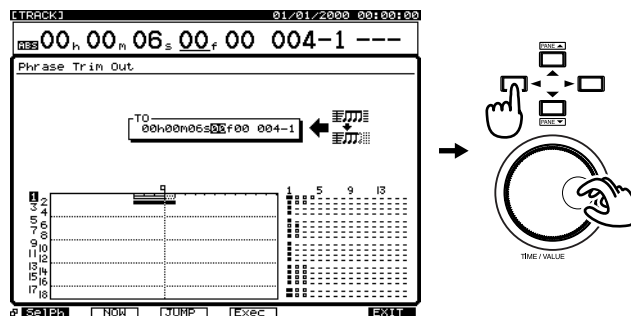

TO (To Point)

You can specify time of trim out.

9. Press [F4 (Exec)].
10. When the display indicates "Complete," press [PLAY (DISPLAY)]. You will return to Play mode.

Phrase New

You can create a new phrase any time you wish from any recorded take in the song.

Creating a New Phrase

1. Press [PLAY (DISPLAY)].
2. Hold down [SHIFT] and press [F2 (TRACK)].
3. Press [F1 (Tr/Ph)] so that the Phrase Edit Menu appears.
4. Press [PAGE] so that [F3] indicates “New,” and then press [F3 (New)].
5. Press [F1 (Take)].
6. At this time, pressing [F3 (Sort)] will switch the order in which the takes are sorted, cycling through the following choices.

- HIST:** The order in which the takes were recorded
- V.Tr:** The order of the V-Tracks on which the takes are recorded
- NAME:** The alphabetical order of the take names

The alphabetical order of the take names

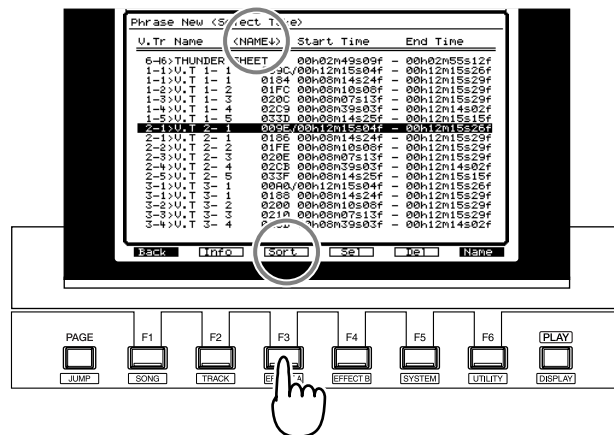

7. Use the TIME/VALUE dial to select the take that will be the basis of the newly created phrase.
8. Press [F4 (Sel)] or [ENTER (YES)].
9. Use [▲], [▼], [◀], and [▶] to move the cursor, and use the TIME/VALUE dial to set the parameters.

The order in which the takes were recorded

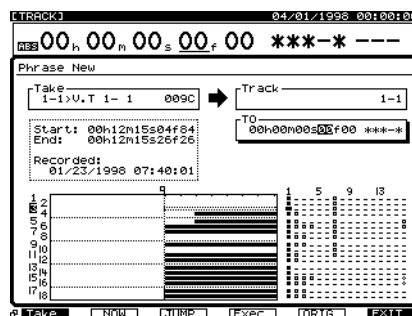
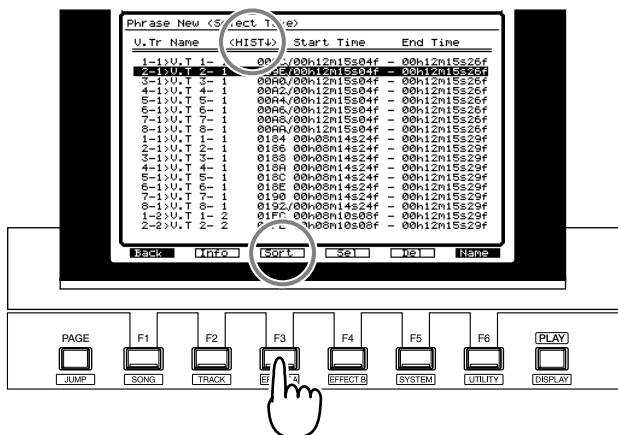

Take

This will show the take that you selected in Step 8. You may re-select the take if desired.

Track

Select the track on which you wish to create the new phrase.

To

Specify the time at which you wish to create the new phrase.

10. Press [F4 (Exec)]. The Phrase New command will be executed.

The order of the V-tracks on which the takes are recorded

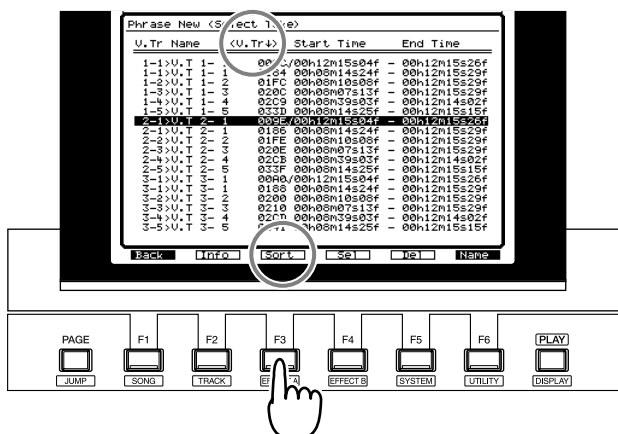

NOTE

You cannot mix on one V track regularly recorded audio with audio that has been recorded with the CDR Recording Mode ON.

In Songs that use a Recording Mode other than “CDR” follow these rules:

- Even on the mastering tracks, new phrases from takes recorded in CDR Mode can only be created on V-tracks which already have been recorded with “CDR” data, or to new V-tracks which have no data recorded on them.
- V-tracks recorded within a song with a recording mode other than “CDR” cannot be used as takes for new phrases on mastering tracks which are already recorded with the “CDR” recording mode ON.

If the above rules are not followed, and the New Phrase command would mix CDR audio with regular audio, then “Illegal Track!” appears in the display and phrase new cannot be executed. Please press [ENTER/YES] and select the destination track to create a new phrase again.

11. When the display indicates “Complete,” press [PLAY (DISPLAY)]. You will return to Play mode.

Phrase Name

With each recording, the following phrase names are assigned automatically.

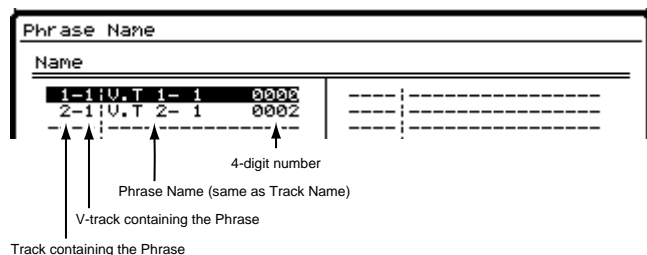

You can change phrase names. Identifying a phrase by its use can make editing simpler, since it leaves you less to remember. For example, on a guitar track, one phrase might be labeled “Riff,” and another phrase labeled “Solo.”

MEMO

If you press [NUMERICS/ASCII] so it is lit, you can use the SELECT buttons and STATUS buttons to enter characters in a fashion similar to a computer keyboard.

Naming Takes

You can assign a name to a take in the Phrase New window. When you do so, you also have the option of automatically re-naming any phrases that play a part of the take.

1. Press [PLAY (DISPLAY)].
2. Hold down [SHIFT] and press [F2 (TRACK)].
3. Press [F1 (Tr/Ph)] to make the Phrase Edit Menu appear.
4. Press [PAGE] so that [F3] indicates “New,” and then press [F2 (New)].
5. Press [F1 (Take)].
6. Use the TIME/VALUE dial to move the cursor to the take whose name you wish to change.
7. Press [F6 (Name)].
8. The Take Name window will appear. Use [▲], [▼], [◀], and [▶] and the TIME/VALUE knob to assign a name to the take.

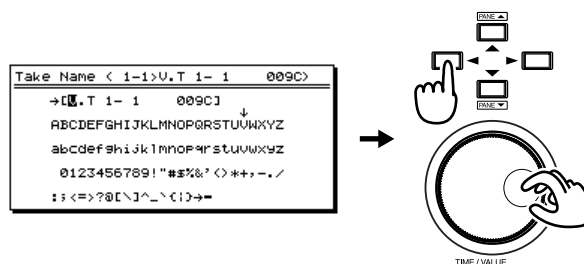

At this time, the function buttons perform the following operations.

- [F1 (Hist)]:** Each time you press the button, you will cycle backward through the last twenty names that were assigned.
- [F2 (Clr)]:** Delete all characters.
- [F3 (Del)]:** Delete the character at the cursor location.
- [F4 (Ins)]:** Insert a space at the cursor location.
- [F5 (Write)]:** Finalize the take name and exit the window.
- [F6 (EXIT)]:** Exit the window without finalizing the take name.

- After assigning the name, press [F5 (Write)].
A message will ask whether you also want to change the names of the phrases used by that take.



- If you also want to change the name of any phrase that plays the take, press [ENTER/YES]. If you press [EXIT/NO], the phrase names will remain the same, and only the take name will change.

MEMO

Phrase names will have an incrementing number added to the end of the take name. For example, if the take is named "AcousticGuitarLR," the phrase names will be "AcousticGuitar-1," "AcousticGuitar-2," etc.

- When the display indicates "Complete," hold down [SHIFT] and press [STORE (ZERO)].
- Press [ENTER/YES]. The song will be saved.
- Press [PLAY (DISPLAY)]. You will return to Play mode.

Deleting a Take

NOTE

A deleted take cannot be recovered using the Undo function.

- Press [PLAY (DISPLAY)].
- Hold down [SHIFT] and press [F2 (TRACK)].
- Press [F1 (Tr/Ph)] so that the Phrase Edit Menu appears.
- Press [PAGE] so that [F3] indicates "New," and then press [F3 (New)].
- Press [F1 (Take)].
- Use the TIME/VALUE dial to move the cursor to the take you wish to delete.

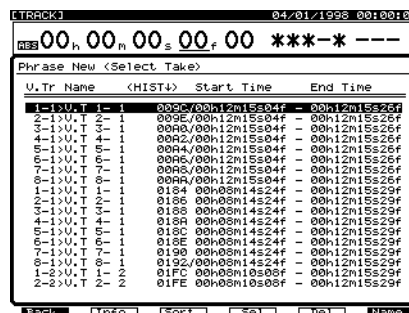

- Press [F5 (Del)]. A message will ask you to confirm.

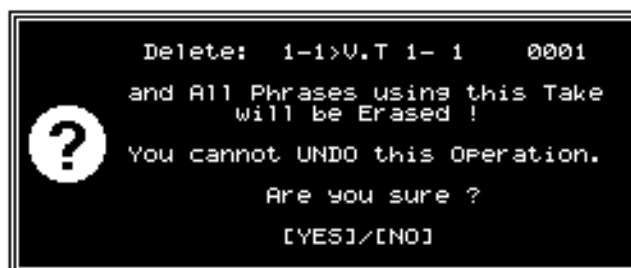

- If you wish to delete the take, press [ENTER/YES].
If you press [EXIT/NO], you will return to Step 6 without deleting the take.
- When the take has been deleted, the display will indicate "Complete." Press [PLAY (DISPLAY)]. You will return to Play mode.

NOTE

When a take is deleted, all phrases it uses are also deleted.

MEMO

When you delete a take, the song will be stored automatically.

Chapter 11 Editing Tips & Tools

Editing Operations

On a tape recorder, in order to modify a performance, you would have to erase the performance you recorded previously. Also, if you wanted to change the composition of a song, you would have to record it from the beginning, or use a razor blade and splicing tape to splice sections of the recording together. In either case, with the tape itself being physically altered, the recording could never be restored back to its original condition. This type of editing is known as destructive editing.

With digital disk recorders, you can make copies of your audio without affecting the original material. Copying data has no effect on the sound quality. It is easy to copy parts of the recording to different locations, or to erase specified portions of the track. Even if you make a mistake during punch-in recording or track bouncing, you can restore the data back to its original condition. Editing that allows the original audio to be recovered is known as non-destructive editing.

Non-destructive track and phrase editing are some of the most powerful tools available in the VS-1824. Since the VS-1824 also has 999 levels of UNDO, you can edit your audio without risk.

Steps for Track Editing

There are two basic editing steps on the VS-1824:

Step 1: Set the edit points.

Step 2: Complete the button presses to perform the edit.

As you approach the editing process, certain information is necessary to perform the edit. You should determine:

- What kind of edit you want to do (Erase, Copy, Insert, etc.—see *Chapter 10*)
- Which track or tracks you want to edit (one, several, or all)
- Where the edit points are (Start, End, From, To)

Simple edits such as Track Erase and Track Cut only have two edit values: START and END. Edits such as Track Move and Track Copy have two additional values: FROM and TO. These terms are explained here:

START (Start point)

Specifies the starting time of the audio to be edited.

END (End Point)

Specifies the ending time of the audio to be edited.

FROM (From point)

Specifies a reference point within the section of audio to be edited that will be placed at the “TO” point to align the edit. In most cases, the FROM point will be the same as the START point. It could also be the downbeat of a measure or a sound effect—anything that can be used for precise alignment.

TO (To point)

Specifies the alignment point (or destination) for the section of audio to be edited, as in a Move or Copy edit.

Using the FROM Point Effectively

Normally, audio is moved starting at the specified START time, and moved to the TO point. However, if you want to move audio based on a point between the START and END points, you can define this using the FROM point.

For example, suppose you want to move a sound effect that consists of a time bomb ticking and then exploding, but you want the beginning of the explosion to land at a specific point in time. In this case, the START point would be the very beginning of the “ticking” sound effect, and the END point would be the very end of the sound effect, after the explosion. The FROM point would be the point in the sound where the explosion begins. The TO point would be the position on the timeline where you want the explosion to occur. This type of edit is called a back-time edit. You don’t have to figure out where the ticking should begin in order to have the FROM and the TO points line up.

Example3: Copying using the “FROM” setting

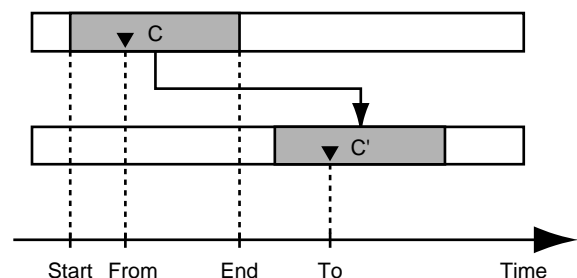

Step 1: Set the Edit Points

The first step to editing audio on the VS-1824 is finding the START and END edit points. These edit points indicate where on the track you want to start the edit, and where on the track you want to end the edit. There are many different ways to do this, and many different tools available to help you, including locators, Preview and Scrub.

Here are some common ways to set edit points:

- Create locators while the song is playing
- Use [FF] and [REW] to locate to point you want to edit
- Preview To and Preview From
- Scrub

Typically, you will use a combination of the above methods to define edit points.

For example, as you're listening to your song, you may press a LOCATOR button to establish a point close to where an edit needs to occur. Now that you're in the ballpark, you might use Preview and Scrub to define a precise edit point.

Quick Editing

Setting Edit Points Using LOCATORS

One of the fastest ways to set edit points is to set locators “on the fly,” that is, while your song is playing. Start by clearing the first two locators (if necessary).

1. Hold [CLEAR] and press [LOCATOR 1]. Hold [CLEAR] and press [LOCATOR 2].
2. Press [PLAY].
3. Press [LOCATOR 1] at the spot where you would like to start an edit.
4. Press [LOCATOR 2] at the end of the section you wish to edit.

LOCATOR Editing Example: Track Erase

Below is a specific example of how to perform one of the most basic edits on the VS-1824, Track Erase. In Track Erase, the area of audio between the Start and End points is replaced with silence. Study the basic steps involved in track editing using this example: editing Track 5.

Before entering Track Edit mode, set your locators.

1. Hold [CLEAR] and press [LOCATOR 1]. Hold [CLEAR] and press [LOCATOR 2].
2. Locate the point in the song where you want to start erasing. Press [LOCATOR 1].

3. Locate the point in the song where you want to end your erasing. Press [LOCATOR 2].

Now try the edit:

1. Hold [SHIFT] and press [F2 (TRACK)].
2. Press [F2 (Erase)] for Track Erase. If you don't see “Erase” above [F2], press [PAGE] until “Erase” appears, and then press [F2 (Erase)].
3. Press the Track 5 STATUS button to select Track 5 for erasure. The STATUS button turns red, indicating it is the track to be edited. You can press more than one STATUS button if you wish to erase more than one track. To deselect a track, press the STATUS button again to change it back to flashing green.



SPECIAL SHORTCUT: The first four LOCATOR buttons can be used to enter the current time location into the START, END, FROM and TO fields by holding [SHIFT] and the respective LOCATOR button. See Steps 4 through 7 below:

4. Press [LOCATOR 1]. This moves the timeline to the point where you want to begin erasing.
5. Hold [SHIFT] and press [LOCATOR 1]. This enters the current time value (recalled by LOCATOR 1) as the “START” point for the edit.
6. Press [LOCATOR 2]. This moves the timeline to the point where you want to stop erasing.
7. Hold [SHIFT] and press [LOCATOR 2]. This enters the current time value (recalled by LOCATOR 2) as the “END” point for the edit.
8. Press [F4 (Exec)] to execute the edit based on the parameters you've defined. If it didn't work, press [UNDO] and then [ENTER] to “undo” the edit.

Precision Editing

In the previous example, we used locators to set edit points. This is a fast and easy way to perform most edits. For some edits, you may need to define edit points with more precision. To precisely position your edit points, you will need to become familiar with the following tools: The PREVIEW section, Scrub function, and the Waveform display.

Setting Edit Points Using Preview

The Preview function allows you to search for specific edit points on a track.

For locating precise points in a song, Preview offers a way to hear a short portion of audio leading up to the current time location, just after the current time location, or just before and after the current time location.

Preview [TO], [THRU], and [FROM]

Preview provides a fast and convenient method to audition a short portion of a track. You can specify the length of the audition from 1 to 10 seconds. Press the appropriate Preview button [TO], [THRU], or [FROM] when the song is stopped.

[TO]:

A preview of the song is played back one time for the specified duration. If the Preview To value is set at two seconds, you will hear two seconds of the song leading up to the point of the current play position. You will hear two seconds of audio playing up to the current timeline. Use [TO] when you are trying to determine the exact location of the beginning of a sound, for example the beginning of a snare hit, or the start of a vocal track.

[THRU]:

A preview of the song is played back one time for the specified duration. Based on the Preview Lengths for both the Preview To and Preview From, you will hear a portion of the song playing through the current position of the timeline. Use [THRU] when you are trying to determine the transition between two tracks, and you want to hear how one ends and the other begins.

[FROM]:

A preview of the song is played back one time for the specified duration. If the Preview From value is set at two seconds, all tracks will play for two seconds, beginning at the current play position. You will hear two seconds of audio playing from the current timeline. Use [FROM] when you are trying to determine the exact location of the end of a sound, for example the ending of a bass guitar note.

Adjusting the Preview Length

1. To adjust the Preview To length, hold [SHIFT] and press [TO].
2. To adjust the Preview From length, hold [SHIFT] and press [FROM].
3. The Preview Length is displayed. Use the TIME/VALUE dial to adjust the time. When you are first getting familiar with the Preview functions, you may want to try a longer Preview length, such as three seconds.

4. Press [TO] or [FROM] to check the actual playback time.

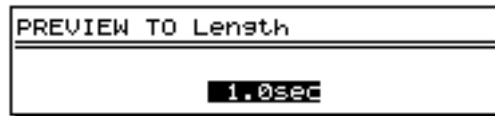

5. After you have finished adjusting the Preview Length, press [PLAY (DISPLAY)] or [EXIT] to return to the Playlist display.

Setting Edit Points Using Scrub

Another part of the Preview section of the VS-1824 is the Scrub function. Scrub provides an exact method to find edit points. With analog tape recorders, edit points were determined by slowly rocking the tape back and forth across the playback head of the tape machine. The Scrub function on the VS-1824 emulates this process. During Scrub, you use the TIME/VALUE dial to slowly rock a portion of your recording past the VS-1824's virtual "playback head."

The following buttons are used during Scrub.

[▲], [▼]:

Selects the track to be heard during Scrub.

[TO]:

The track is played repeatedly up to the position of the timeline.

[FROM]:

The track is played repeatedly from the position of the timeline.

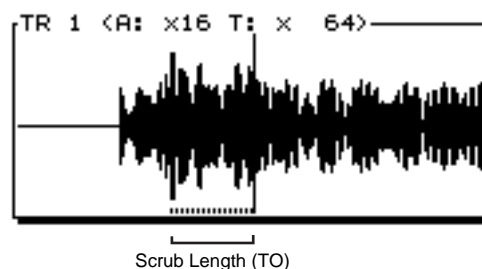
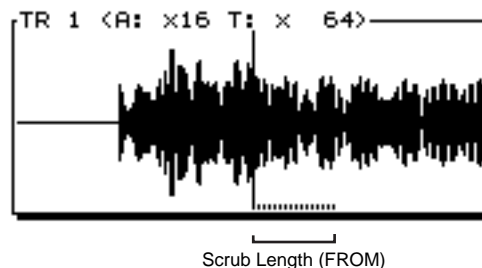

Setting Scrub Length

Before you try using Scrub for the first time, you may want to adjust the Scrub Length, as this setting affects how Scrub sounds.

1. To adjust the Scrub length, hold [SHIFT] and press [SCRUB].
2. The Scrub length is displayed. Use the TIME/VALUE dial to adjust the time. When you are first getting familiar with the Scrub function, you may want to try a longer length, such as 70 or 80ms.

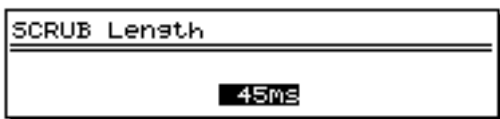

Scrub Length

This sets the length (25ms to 100msec) of audio that is looped when the SCRUB button is pressed.

3. After you have finished adjusting the Scrub Length, press [PLAY (DISPLAY)] or [EXIT] to return to the Playlist display.

General Guidelines for Using Scrub

Before using Scrub, you should do two things:

- Set the TIME/VALUE dial to adjust frame increments.
- Set the Scrub Direction using Preview To and Preview From.

Set the TIME/VALUE Dial to Adjust Frame Increments

1. Cursor up [▲] to access the top section of the VS-1824 display screen.
2. Press [▶] to move the cursor to the last pair of numbers just after the small "f" in the time display. These are Sub Frames.

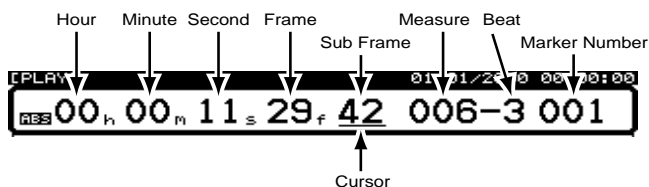

There are 100 Sub Frames in each frame. With the cursor at this position, each click of the TIME/VALUE dial advances the play position by 11 hundredths (11/100th) of a frame. Hold [SHIFT] and slowly turn the TIME/VALUE dial. Now each click moves the edit line by exactly one hundredth of a frame. One hundredth (1/100th) of a frame is equivalent to one three thousandths (1/3,000th) of a second.

For scrubbing, start with the cursor under the Frame value. Then later, as you need a finer editing resolution, press [▶] to move the cursor over to Sub Frames. As you try scrubbing, turn the TIME/VALUE slowly and smoothly for the best results.

Setting Scrub Direction

When using the Scrub function in the VS-1824, it is possible to scrub both forward and backward. That is, you can turn the TIME/VALUE dial either clockwise or counter-clockwise to find an edit point. If you are trying to find the beginning of a note or a kick drum, you will most likely start by turning the TIME/VALUE dial clockwise.

If you are editing dialog and need to find the end of a spoken word, you would likely locate just past the word and scrub backwards by turning the TIME/VALUE dial counter-clockwise until you begin to hear the sound that signifies the end of the word. When editing dialog, radio or TV spots, you will probably use the counter-clockwise method of scrubbing more frequently than when editing music tracks.

Whenever you use Scrub, program the scrub direction for either clockwise scrubbing or counter-clockwise scrubbing.

Clockwise Scrubbing:

Press [PREVIEW TO] once before pressing [SCRUB]

Counter-clockwise Scrubbing:

Press [PREVIEW FROM] once before pressing [SCRUB]

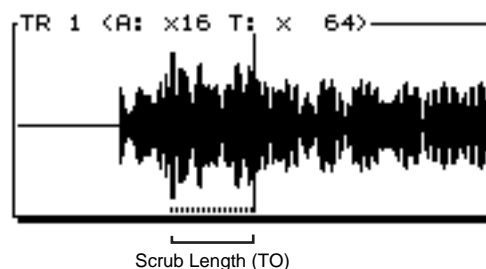
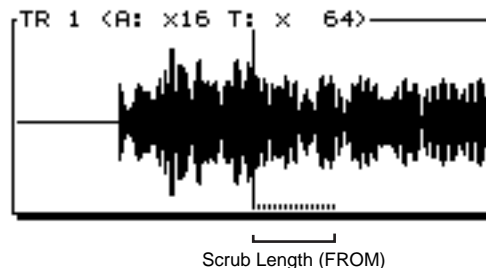

Summary of Using Scrub

Before using Scrub, remember to do these five things:

1. Cursor up [▲] to access the top section of the VS-1824 display screen.
2. Press [►] so the cursor (underline) is positioned under either Frames or Sub Frames in the Time Display.
3. Press [TO] once to set the Scrub direction to Clockwise or [FROM] for Counter-clockwise.
4. Use [▲] and [▼] to select the track which is heard during Scrub.
5. Press [SCRUB].

Waveform Display

The pop-up waveform display in the VS-1824 is very useful for precision editing. The waveform shows audio amplitudes of the recorded track. You can use the function buttons to manipulate the resolution of this waveform for very precise location of edit points.

1. Press [PLAY (DISPLAY)] to view the Playlist Display.
2. Cursor down [▼] to access the lower section of the VS-1824 display screen.
3. Press [F5 (WAVE)]. If "WAVE" does not appear above [F5], press [PAGE] until it appears, and then press [F5 (WAVE)].

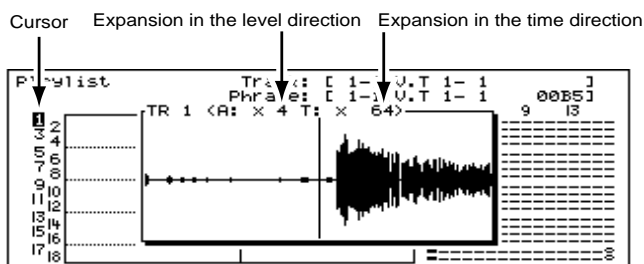

4. Use [▲] and [▼] to select the track to view.
5. If after you press [F5 (WAVE)], a flat line appears in the waveform window, try the following:
 Make sure you have selected a location on a track that has audio on it.
 Press [F1 (ZOOM+)] three times to increase the amplitude of the waveform.
 Press [F3 (←→)] four times to decrease the time zoom of the waveform.

6. When the waveform is displayed, the function buttons operate as follows:

[F1 (ZOOM+)]:

Increases the amplitude of the waveform display, in three steps. This makes the waveform taller in the display.

[F2 (ZOOM-)]:

Decreases the amplitude of the waveform display, in three steps. This makes the waveform shorter in the display.

[F3 (←→)]:

Decreases the time-zoom of the waveform display, in four stages. This zooms back on the timeline.

[F4 (→←)]:

Increases the time-zoom of the waveform display, in four stages. This zooms in on the timeline.

[F5 (WAVE)]:

Removes the waveform display from the screen.

7. When you are done viewing the waveform for a track, press [F5 (WAVE)] to turn the waveform display off.

Step 2: Perform the Button-Pushes to Complete the Edit

Entering Editing Time Values

Once you've entered a track editing screen, you must then place the time locations you've established for the edit points (START, END, etc.) into the appropriate fields in the display. There are several ways to do this. The examples below will explain how to get your time locations for the START, END, etc. into the corresponding fields in an edit screen. We'll use Track Erase in these examples. See p. 171 for an example using Track Copy.

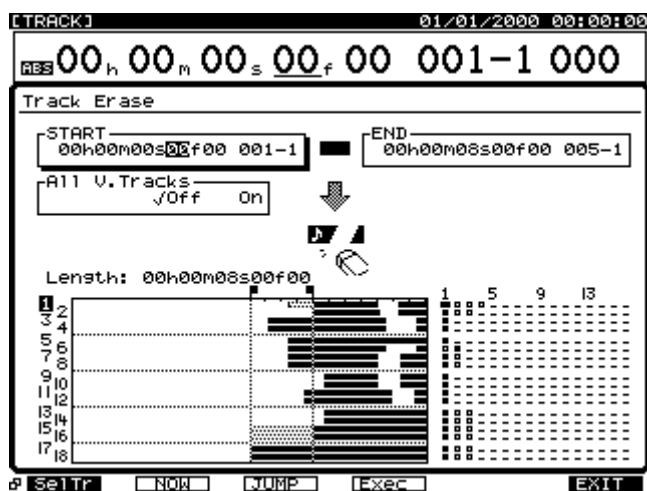

Using the TIME/VALUE Dial:

1. Hold [SHIFT] and press [F2 (TRACK)].
2. Make sure "Track Edit Menu" appears in the display. If it does not, press [F1 (Tr/Ph)] once.
3. Press [F2 (Erase)] for Track Erase. If you don't see "Erase" above [F2], press [PAGE] so "Erase" appears, and then press [F2 (Erase)].
4. Press [▲], [▼], [◀], and [▶] to move the cursor to the START field. Use the TIME/VALUE dial to change the value of hours, minutes, seconds, frames and sub frames. If your song was recorded using a tempo map, you can use the TIME/VALUE dial to choose Measures and Beats as well.
5. Press [▶] to move the cursor to the END field. Use the TIME/VALUE dial to change the value of hours, minutes, seconds, frames and sub frames, or use the TIME/VALUE dial to choose Measures and Beats.

* Continue this method for FROM and TO fields in applicable edit functions (e.g., Track Copy). See p. 171 for a practical example.

Using [F2 (Now)]:

1. Press [FF] or [REW] or turn the TIME/VALUE dial to locate to the time at which you want to START the edit.
2. Hold [SHIFT] and press [F2 (TRACK)].
3. Make sure "Track Edit Menu" appears in the display. If it does not, press [F1 (Tr/Ph)] once.
4. Press [F2 (Erase)] for Track Erase. If you don't see "Erase" above [F2], press [PAGE] until "Erase" appears, and then press [F2 (Erase)].
5. Press [▲], [▼], [◀], and [▶] to move the cursor to the START field.
6. Press [F2 (Now)]. This captures the current time value and places it in the START field.
7. Press [FF] or turn the TIME/VALUE dial to locate to the time at which you want to end the edit.
8. Press [▶] to move the cursor to the END field.
9. Press [F2 (Now)]. This captures the current time and places it in the END field.

* Continue this method for FROM and TO fields in applicable edit functions (e.g., Track Copy). See page p. 171 for a practical example.

Using the LOCATOR buttons:

Before using this method, hold [CLEAR] and press [LOCATOR 1] and then press [LOCATOR 2]. This will clear these two locators, making them available for new assignments. For edit functions that make use of the From and To fields, clear Locators 3 and 4 as well.

1. Go to the time location at which you want to START the edit and press [LOCATOR 1].
 2. Go to the time location at which you want to END the edit and press [LOCATOR 2].
- * In applicable edit functions, continue this process for the FROM and TO points using Locators 3 and 4 respectively. See p. 171 for a practical example.
3. Hold [SHIFT] and press [F2 (TRACK)].
 4. Make sure "Track Edit Menu" appears in the display. If it does not, press [F1 (Tr/Ph)] once.

5. Press [F2 (Erase)] for Track Erase. If you don't see "Erase" above [F2], press [PAGE] until "Erase" appears, and then press [F2 (Erase)].



SPECIAL SHORTCUT: The first four LOCATOR buttons can be used to enter the current time location into the START, END, FROM and TO fields by holding [SHIFT] and the respective LOCATOR button. See Steps 6 through 9 below:

6. Press [LOCATOR 1] to go to the time location you've designated as the START point.
 7. Hold [SHIFT] and press [LOCATOR 1]. This places the current time value into the START field.
 8. Press [LOCATOR 2] to go to the time location you've designated as the END point.
 9. Hold [SHIFT] and press [LOCATOR 2]. This places the current time value into the END field.
- * *Continue this method for FROM and TO fields using Locators 3 and 4 respectively. See p. 171 for a practical example.*

Track Editing vs. Phrase Editing

The VS-1824 offers two different types of editing. These are called "track editing" and "phrase editing." Every time you start and stop recording, the VS-1824 creates a block of audio in the display. These blocks are called "phrases," and they include the instructions that tell the VS-1824 which portion of your recordings should be played. If you put a track into Record at the very beginning of a song, press [PLAY] and record all the way to the end, you will have one phrase that plays the entire newly recorded disk file. On the other hand, if you punch in and out several times over the length of a track, you will end up with many different phrases—one for each punch-in and punch-out—that tell the VS-1824 to play a bit of this recorded disk file, a bit of that one, and so on.

In a track edit, you must specify the START and END points in a section of audio you wish to edit. For track edits such as Cut and Erase, you only need to specify the start and end points. Most editing functions other than Cut and Erase have four parameters: START, END, FROM and TO. (see Section II in this chapter for definitions of these parameters).

In track editing, you must select all four points. In phrase editing however, the START and END points are already defined as the edges of the phrase.

When to Use Phrase Editing

Phrase Editing can work well when you punch in and out frequently while recording, since it allows you to work with the individual pieces of audio that make up the final track. The START and END points for each piece are defined during each punch-in and -out. The VS-1824 calculates the START and END point as defined by the edges of the phrase. In many cases, phrase editing can be a time-saver. For more information on phrase editing, see p. 152.

An Editing Note of Caution

The VS-1824 is not able to play individual pieces of audio that are 0.5 seconds in length or smaller. If you have a phrase that is five seconds long, and you erase from the beginning up to 4.5 seconds, you will be left with a phrase 0.5 seconds long. Phrases 0.5 seconds or shorter will not be played. While editing, try to avoid leaving an isolated piece of audio that is shorter than 0.5 seconds. This applies to Track Erase, Track Cut, Track Insert and Track Move. For Track Copy, Track Move, and Track Expansion/Compression, you must choose a section of audio to be edited greater than 0.5 seconds.

Don't confuse this with editing resolution. It is possible to choose edit points in increments of 1/3000th of a second. It is also possible to erase or cut a portion of audio shorter than 0.5 seconds within a longer section.

Practical Editing Application

Seamless Looping using Track Copy

It is possible to isolate a portion of a rhythm track and use Track Copy to create a drum loop. Since the Track Copy function does not actually re-write audio to the hard drive, creating rhythm loops (or any other edit function) will not decrease available disk space.

Very carefully determine the START point. The START point for the loop should be on a downbeat, or on a beat of a measure that has a clearly audible "edge," such as a snare hit or a solid kick drum beat. Then carefully determine the END point. The END point for the loop should also be on a downbeat, or on a beat of a measure that has an edge, such as a snare hit or a solid kick drum beat. If the START point is on the second beat of a measure, then the END point must also be on the second beat of a measure, to assure a smooth-sounding loop of the correct length.

- Make sure you have complete measures of music between the START point and the END point.
- For looping, the START and FROM points must be the same, and the END and TO points must be the same.

The smoothness of the loop will depend on the accuracy with which you find the START and END points. If your music was recorded using a Tempo Map and Metronome, finding the START and END points may be as simple as using the TIME/VALUE dial to select the measure numbers you want. If the song was recorded without using the metronome, you may need to use [SCRUB], [PREVIEW TO], [PREVIEW FROM] and the Waveform display to find the edit points.

1. Determine the START and END points of the loop, using one of the previously discussed methods. Place LOCATOR 1 at the START point. Place LOCATOR 3 at the same position. Place LOCATOR 2 at the END point. Place LOCATOR 4 at the same position.
2. Hold [SHIFT] and press [F2 (TRACK)].
3. Make sure "Track Edit Menu" appears in the display. If it does not, press [F1 (Tr/Ph)] once.
4. Press [F2 (Copy)] for Track Copy. If you don't see "Copy" above [F2], press [PAGE] until "Copy" appears, and then press [F2 (Copy)].
5. Press the Track SELECT button to specify the track to be copied. The SELECT button stops blinking, indicating it is the track to be copied.

SPECIAL SHORTCUT:

If you do not wish to use locators to define your edit points or if you want to use locators other than Locators 1 through 4 to define your edit points, you can still use the [SHIFT] functions of Locators 1 through 4 to assign the current time location to an edit position (START, END, etc.)

1. From the normal Playlist Display, simply hold [SHIFT] and press [LOCATOR 1] (START). The current time location will now be the START time of any edit you perform.
2. Continue this procedure for END, FROM and TO by holding [SHIFT] and the respective Locators 2 thru 4. Whatever the current time is, when you hold [SHIFT] and the first four LOCATOR buttons, will be entered into their corresponding edit positions. You do not have to be in an edit screen to do this!

6. Enter the START, END, FROM, and TO values:

Method #1: Using LOCATORS

- a. Press [LOCATOR 1]. Hold [SHIFT] and press [LOCATOR 1].
- b. Press [LOCATOR 2]. Hold [SHIFT] and press [LOCATOR 2].
- c. Press [LOCATOR 3]. Hold [SHIFT] and press [LOCATOR 3].
- d. Press [LOCATOR 4]. Hold [SHIFT] and press [LOCATOR 4].

Method #2: Using [▲], [▼], [◀], and [▶] and [F2 (Now)]

- a. Press [LOCATOR 1]. Use [▲], [▼], [◀], and [▶] to move the cursor to "START." Press [F2 (Now)].
- b. Press [LOCATOR 2]. Use [▼] to move the cursor to "END." Press [F2 (Now)].
- c. Press [LOCATOR 3]. Use [▼] to move the cursor to "FROM." Press [F2 (Now)].
- d. Press [LOCATOR 4]. Use [▶] to move the cursor to "TO." Press [F2 (Now)].

Method #3: Using a Tempo Map

- a. Use [▲], [▼], [◀], and [▶] to move the cursor to the three-digit Measure Number in "START." Use the TIME/VALUE dial to select the measure number where you want the loop to start.
 - b. Use [▼] to move the cursor to the three-digit Measure Number in "END." Use the TIME/VALUE dial to select the measure number where you want the loop to end.
 - c. Use [▼] to move the cursor to the three-digit Measure Number in "FROM." Use the TIME/VALUE dial to select the same measure number you did for START.
 - d. Use [▶] to move the cursor to the Measure Number in "TO." Use the TIME/VALUE dial to select the same measure number you did for "END."
7. Use [▲], [▼], [◀], and [▶] to move the cursor to "Copy Time." Use the TIME/VALUE dial to select the number of loops you want.
 8. Use [▼] to move the cursor to "+Insert." Use the TIME/VALUE dial to select "On." The VS-1824 will now automatically insert the amount of blank space necessary for the copy. This ensures that any existing audio on the selected track(s) will not be copied over. Instead, it will be pushed back in time to the point immediately after the copied data.
 9. Press [F4 (Exec)]. This executes the Track Copy.
 10. When Track Copy is completed correctly, "Complete" appears in the display.
 11. Press [LOCATOR 1] to locate to the beginning of your Track Loop. Press [PLAY]. Listen to the loop. If it does not sound as you expected, use the Undo function. You may need to adjust the values of the START and END points. If you change the START or END points, make sure you also change the FROM and TO values accordingly. Then press [F4 (Exec)] to try the loop again.
 12. When you are finished with Track Copy, press [PLAY (DISPLAY)] to return to the Playlist display.

Chapter 12 Song Editing

This chapter explains editing that can be done across an entire song, rather than on a track-by-track basis.

Song Arrange

Song Arrange allows you to easily rearrange song structure. To use Song Arrange, place markers at the beginning of major sections of your song. Next, set the order in which the markers are to be played back. This operation can be undone using the UNDO function.

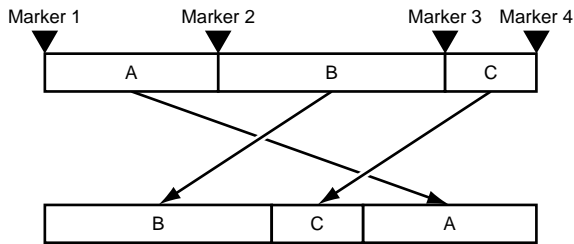

1. Follow the procedure as described in “Using Markers” (p. 45), place markers at the beginning of each section of your song (e.g. Intro, Verse 1, Verse 2, Chorus, etc.).
2. Hold [SHIFT] and press [F1 (Song)].
The Song menu icon appears.
3. Press [F6 (Arang)].
If “Arang” does not appear in the display above [F6], press [PAGE] until you see “Arang,” and then press [F6 (Arang)].

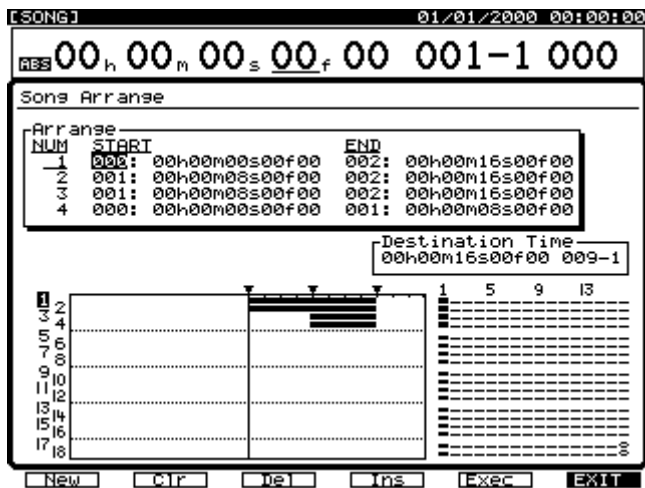

4. Use [▲], [▼], [◀], and [▶] to move the cursor to “START.” Use the TIME/VALUE dial to enter the marker number which defines the start of the first section of your song.
5. Use [▲], [▼], [◀], and [▶] to move the cursor to “END.” Use the TIME/VALUE dial to enter the marker number that defines the end of the first section of your song.

6. Press [ENTER]. This will move the cursor to the second section. Repeat Steps 4 and 5 to define the second section of your song, as defined by the audio which plays between the two markers you specify.

You can arrange up to a maximum of 99 separate segments. The function buttons work as follows:

[F1 (NEW)]:

Specifies the next segment.

[F2 (Clr)]:

Clears all segments.

[F3 (Del)]:

Clears just the segment where the cursor is positioned.

[F4 (Ins)]:

Inserts a segment in front of where the cursor is positioned.

[F5 (Exec)]:

Executes Song Arrange.

[F6 (EXIT)]:

Exits the Song Arrange screen.

7. When all the segments have been set, press [▶] to move the cursor to “Destination Time.”

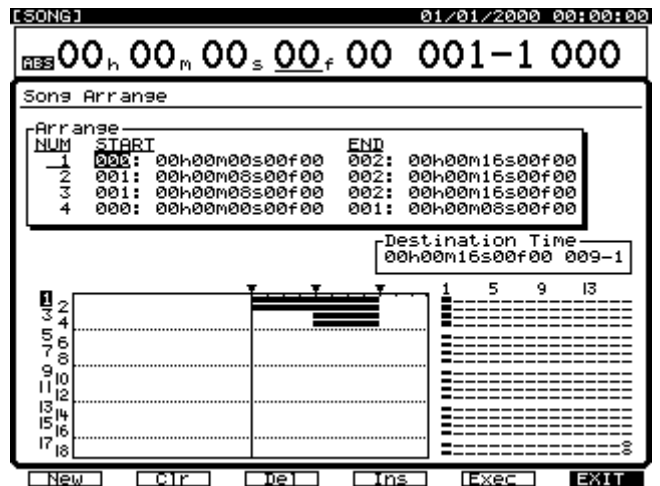

8. Press [◀] and [▶] to move the cursor. Use the TIME/VALUE dial to set the time location where the newly created song is to begin. The function buttons work as follows.

[F2 (NOW)]:

Enters the time where the timeline is currently positioned.

[F3 (JUMP)]:

Moves the timeline to the current value of “Destination Time.”

[F4 (Arng)]:

Moves the cursor back to “Arrange.”

[F5 (Exec)]:

Executes Song Arrange.

[F6 (EXIT)]:

Exits the Song Arrange screen.

* *If the time for the new playlist to begin is set at a point earlier than the previous song end, the original playlist is overwritten. If the time for the new playlist to begin is set after the last mark point of the original song, a mark point is set at the beginning of the new playlist.*

9. Press [F5 (Exec)]. “Song Arrange Sure ?” appears in the display.
10. Press [ENTER/YES]. Or, if you wish to cancel the procedure, press [EXIT/NO].
11. When Song Arrange is completed, the screen returns to the Playlist display.

Song Split

Song Split allows you to make a copy of a song, and to specify which tracks (and V-Tracks) are to be included in the copy. The new song created as a result of Song Split will include all markers, locators, Automix data, tempo maps, sync tracks, and system settings from the original song. The newly created song will have the same song name as the original song, except with the last character replaced by the letter A.

Song Split cannot be carried out if there is not enough hard drive space. Song Split cannot be undone using the Undo procedure. However, it is possible to delete the newly created song.

1. Hold [SHIFT] and press [F1 (Song)].
The Song menu icon appears.
2. Press [F1 (Split)].
If “Split” does not appear in the display above [F1], press [PAGE] until you see “Split,” and then press [F1 (Split)].
3. Use [[▲], [▼], [◀], and [▶], or turn the TIME/VALUE dial to move the cursor to the track you want to include in the new song. Press [F3 (MARK)] or press [ENTER/YES]. The track with the mark next to it will be copied.

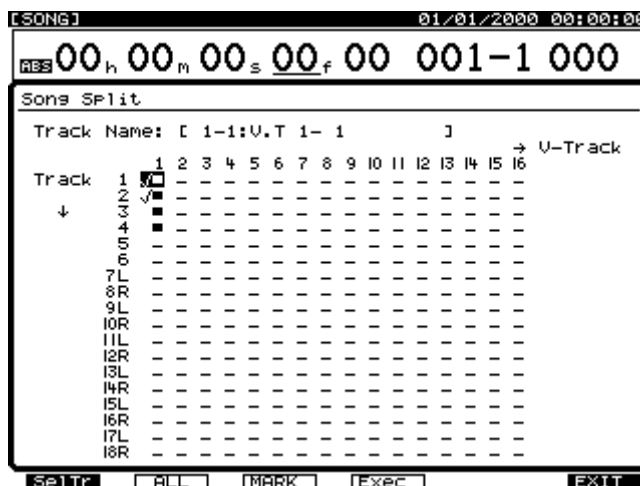

Shortcuts for Selecting Tracks During Song Split

When the cursor is moved to “Track,” you can have marks simultaneously set or deleted from all selected tracks. For example, if you move the cursor to the actual track number column, and press [F3 (Mark)], marks will be set for all V-Tracks on the selected track. Similarly, if you move the cursor to the row for the V-Track number and press [F3 (Mark)], all V-Tracks will be selected. For example, if you move the cursor to “V-Track 3” and press [F3 (Mark)], the third V-Track in all tracks will be marked. Press [F2 (ALL)] to place or remove marks from all tracks and V-Tracks simultaneously.

4. Check the track name by pressing [F1 (SelTr)].
The Song Split Select Track screen appears. You can also choose tracks to be copied in this screen by pressing [F3 (MARK)]. When you are done choosing tracks, press [F1 (Back)].

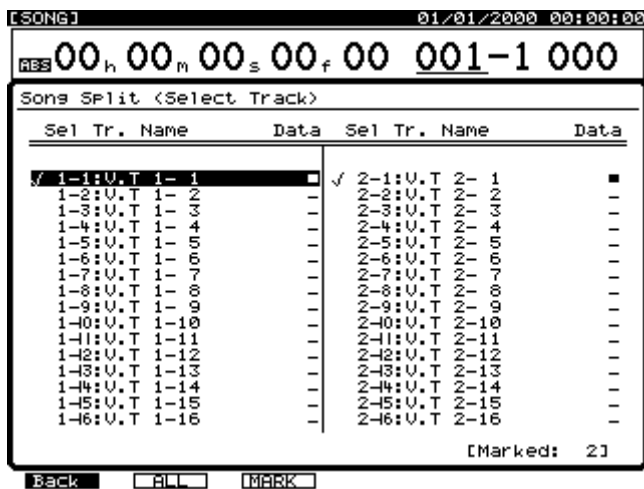

5. Press [F5 (Exec)]. The Song Split confirmation message appears in the display.
6. Press [ENTER/YES]. Or, if you wish to cancel the operation, press [EXIT/NO].
7. “STORE Current?” appears in the display. If you want to save changes made to the current song, press [ENTER/YES]. Otherwise, press [EXIT/NO].
8. When Song Split is finished, the screen will return to the Playlist display.

Song Combine

Song Combine allows you to combine the V-Tracks of two different songs. When Song Combine is executed, all tracks from a second song (source song) are moved to the current song (destination song), and the second song is deleted.

It is not possible to cancel Song Combine using the Undo function, so it is recommended that before you perform Song Combine, make a backup of both the source and destination songs using a CD-R, CD-RW or DAT recorder.

You can perform Song Combine with any two VS-1824 songs that have the same sample rate and Record mode. The information copied to the current song includes performance data (audio) and the information that designates the track numbers the performance data is recorded on. Other settings such as markers, locators, Automix, tempo maps, sync tracks and system settings are not copied, and will be lost when the source song is erased.

As a result of Song Combine, it is possible for the tracks of the source song to overwrite the tracks of the destination song. To prevent this from happening, use Track Exchange to move all the V-Tracks in the source song to odd-numbered positions, and all the V-Tracks in the destination song to even-numbered positions. Later, after Song Combine is finished, you can use Track Exchange to re-position all the V-Tracks as desired.

1. First, select the desired song to be used as the destination and current song.
2. Hold [SHIFT] and press [F1 (Song)].
The Song menu icon appears.
3. Press [F2 (Combn)].

If “Combn” does not appear in the display above [F2], press [PAGE] until you see “Combn,” and then press [F2 (Combn)].

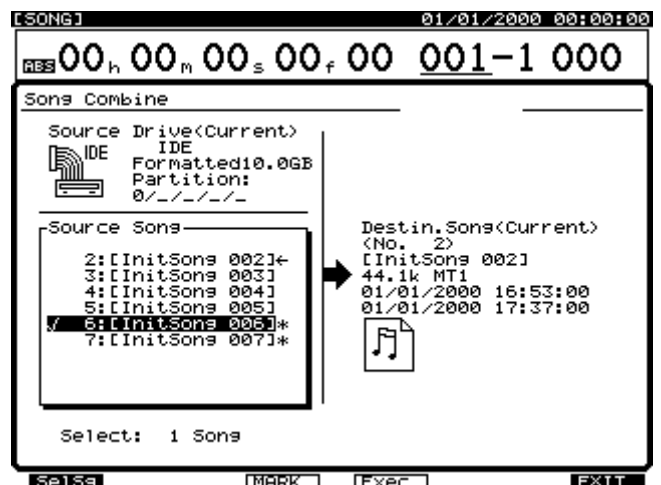

Chapter 12 Song Editing

- Use the TIME/VALUE dial to move the cursor to the source song and press [F3 (MARK)]. The song with the mark will be combined with the current song.
- Press [F1 (SelSg)], and a directory of song names will appear. From this screen, you can use the TIME/VALUE dial to choose the source song. Then press [F3 (MARK)]. When you are done choosing a song, press [F1 (Back)].

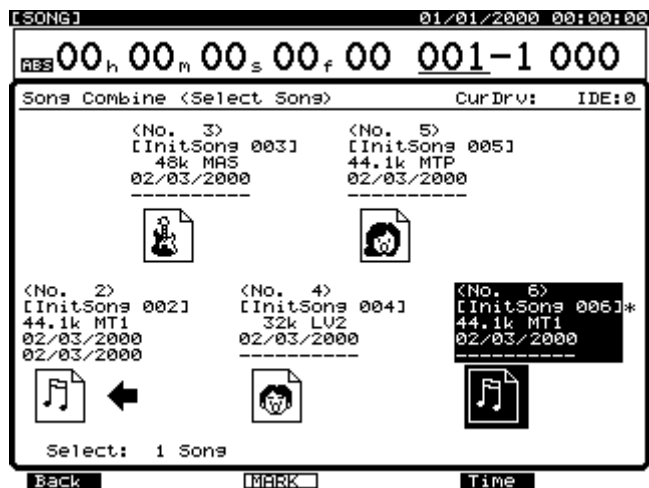

- Press [F4 (Exec)].
The Song Combine confirmation message appears in the display.
- Press [ENTER/YES]. (Or, if you would like to cancel the operation, press [EXIT/NO].) "STORE Current?" appears in the display.
- If you want to save changes made to the current song, press [ENTER/YES]. Otherwise, press [EXIT/NO].

When Song Combine is finished, the screen will return to the Playlist display.

Chapter 13 CD-RW and Mastering

VS-1824CD Now try making an original audio CD using the internal CD-RW drive.

VS-1824 You can connect an optional CD-R/RW drive to the VS-1824's SCSI connector. Adding the CD-R/RW drive allows you to create original audio CDs. Please refer to the CD-R/RW drive Owner's Manual for more information.



For more detailed information about SCSI, refer to "About SCSI" (Appendices p. 4).

Create Master Data (Mastering)

Mastering Room

The VS-1824's Mastering Room contains everything you need to turn your song into a final master that can be burned onto your own original audio CD.

The process involves mixing up to 16 of your tracks down to the L and R "mastering tracks" (Tracks 17 and 18). You can select the V-Track you want to use—with the factory settings, V-Track 16 of Tracks 17 and 18 (i.e., 17-16 and 18-16) are selected. For example, you can play back V-Tracks 1-1, 2-1, 3-1...15-1, and 16-1 (a total of 16 tracks), and record the result onto the L and R mastering tracks.

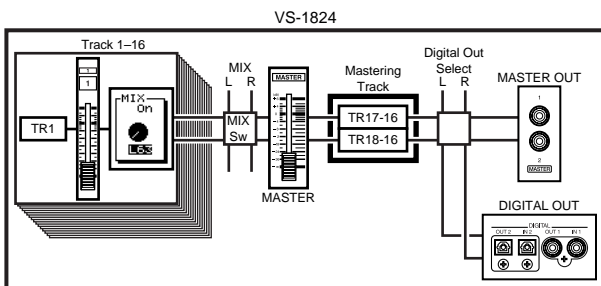

When the Recording mode (p. 51) is set to "MAS" or "CDR," you can use a total of eight tracks. If you are recording onto the L and R mastering tracks (Tracks 7 and 8), you can play back Tracks 1-6. If you are not recording onto the mastering tracks, you can play back Tracks 1-8. **Tracks 9–18 cannot be used.**



When playing back mastering tracks, playback of all other tracks is silenced.

Mixing Down to the Mastering Tracks

Here's how to select the mastering tracks and perform a mixdown.



In some countries—such as the United States—the VS-1824 is shipped with a hard drive already installed. If you need to purchase an internal hard drive for your VS-1824, be sure to purchase an appropriate drive. The successful playing back of 16 tracks while you mix down to the mastering tracks is significantly affected by the speed of the hard disk. For this reason, depending on the structure of the song data—sampling rate and recording mode, or if punch-in/out is used frequently, etc.—or depending on the drive that you use, the display may show "Drive Busy," and the operation may not take place correctly.

** In order to take full advantage of the VS-1824's potential—the number of tracks that can be recorded/played simultaneously and recording capacity—we recommend that you use a hard disk that is 2.1 GB in size or greater.*

1. Press [CD-RW/MASTERING].
2. Press [F1 (MastRm)].

The Mastering Room screen will appear.

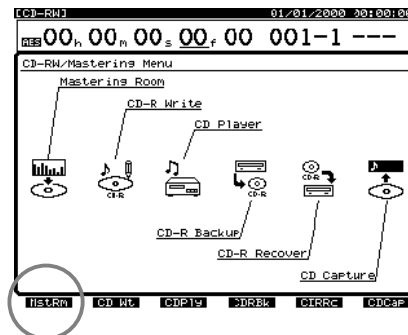

3. Press [▲], [▼], [◀], and [▶] to move the cursor. Use the TIME/VALUE dial to specify the value for each parameter.

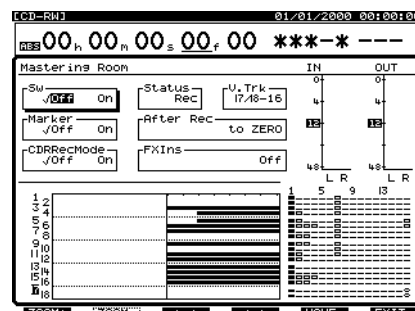

Chapter 13 CD-RW and Mastering

Sw

This parameter turns the Mastering Room feature on and off. Since you'll first want to rehearse your mix before actually recording the mastering tracks, set this to "Off."

On: When Sw is turned on, Tracks 17 and 18 are designated as the mastering tracks—and will be shown as "L" and "R" on the Playlist display.

Off: When Sw is turned off, Tracks 17 and 18 function normally.

* Remember that audio on Tracks 17 and 18 will not be included in the final mixdown once Sw is set to "On," since Tracks 17 and 18 will be used as mastering tracks. If you wish to include audio from Tracks 17 and 18 in your final mix, you must bounce it to any track from 1-16.

Status

Specify the status of the mastering tracks. For this example, select "Rec."

Rec: Play back Tracks 1-16 while recording them to the mastering tracks.

Play: Play back the mastering tracks. The sound of Tracks 1-16 will not be output from the MASTER jacks.

MEMO

For details on signal flow—routing—refer to p. 27.

V. Trk

While Tracks 17 and 18 are automatically selected as mastering tracks, you can select which of their V-Tracks will be used for mastering. When a new song is created, V-Track 16 of tracks 17/18—17-16, 18-16—are selected by default.

After Rec (after recording)

Specify the time location of the mastering track to which the mixdown will be recorded. When creating an original audio CD, it is usually best to select "to ZERO."

to ZERO:

Place the data starting at 00h00m00s00f.

to last Phrs:0S:

Place the data after the end of the last phrase in the mastering tracks.

to last Phrs:2S:

Place the data two seconds after the end of the last phrase in the mastering tracks.

to last Phrs:4S:

Place the data four seconds after the end of the last phrase in the mastering tracks.

Stay HERE:

Place the data at the time location at which it was actually recorded.

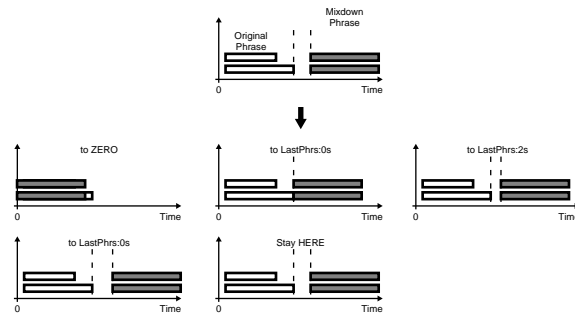

CDRRecMode

This parameter determines whether or not a CD disk image is to be created as your master.

On: When CDRRecMode is on, a CD disk image is created during the recording of the mastering tracks using the VS-1824's CDR recording mode.

Off: When CDRRecMode is off, no CD disk image is created during the recording of the mastering tracks. The mastering tracks are created using the currently selected recording mode.

Marker

If this is turned "On," a track number marker will automatically be assigned to the beginning of the data that is mixed down. Normally, you will set this "On."

If "Can't Set Marker" Appears in the Display

CD markers must be set at least 4 seconds apart. If you see this message, your markers are set too closely together. To fix this, try a longer After Rec setting. You can also reset the markers manually—see "CD Track Numbers," p. 186.

4. Press [FADER] so that the TR (track) indicator lights.



5. Hold down [STOP], and press the STATUS button for all tracks (1-12) that you wish to mix down.

The STATUS indicators will light green.

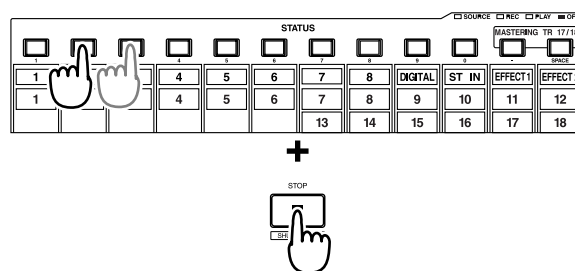

- Press [FADER] so that the TR (track) indicator blinks.

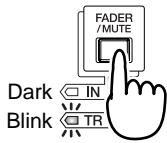

- Hold down [STOP], and press the STATUS button for all tracks (13–16) that you wish to mix down.

The STATUS indicators will light green.

- Press [PLAY]. The song will play back.
- Raise and lower the Master fader to set the overall mixing volume.

MEMO

The sound that passes through the Master fader will be recorded on the mastering tracks. In order to record at the optimal audio quality, you should normally set this to the 0 dB position.

- Use the channel faders (1–15/16) to adjust the volume balance of each track. At this time the sound that is being output from the MASTER jacks—including volume levels and panning—will be recorded to the mastering tracks. It is best to set the volume as high as possible without causing it to distort.
- When you have finished adjusting the volume, press [STOP].
- Move to the location at which you wish to begin the mixdown (such as 00h00m00s00f).
- Use the cursor buttons and the TIME/VALUE dial to change the Sw setting to “On.”
- Press [REC]. The REC indicator will light in red.
- Press [PLAY]. The PLAY indicator will light in green, and recording will begin.
- When you finish recording, press [STOP].

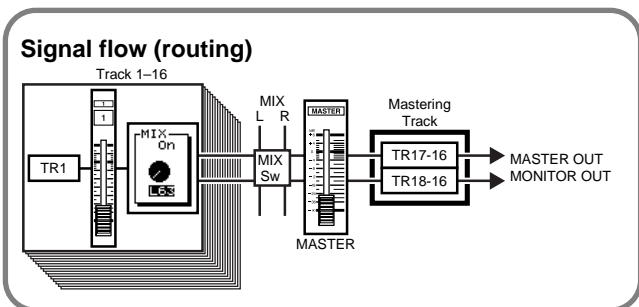

Mastering Tracks Status Shortcut

The “Status” of the mastering tracks can also be set as follows.

- Press [PLAY (DISPLAY)].
- Press [PAGE] so that [F6] indicates “M→***” (***) is either Rec, Ply, or Off).

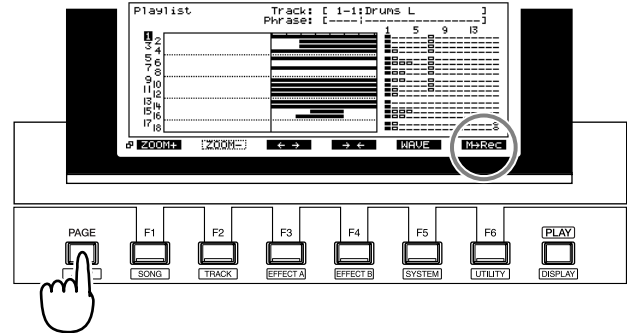

- The mastering tracks can be turned off, or set to record or play back. [F6] toggles between these settings. The indicator above [F6] shows the setting that will be selected when you next press [F6], as indicated by an arrow. The current status of the mastering tracks can be viewed in the level meter in the display. For this example, press [F6] until “M→Off” appears above [F6]. Press [F6] once more to select this setting.

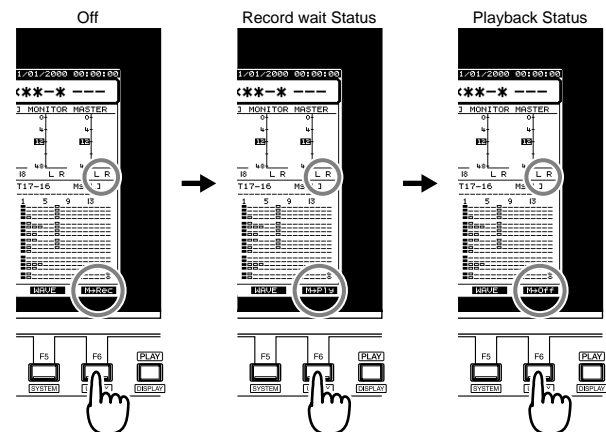

Playing Back the Mastering Tracks

Here's how you can verify the audio that was mixed down to the mastering tracks. You will listen to the mastering tracks. Tracks 1-16 themselves will not be played.

1. Press [PLAY (DISPLAY)].
2. Press [PAGE] so that [F6] indicates "M→***" (***) is either Rec, Ply, or Off).

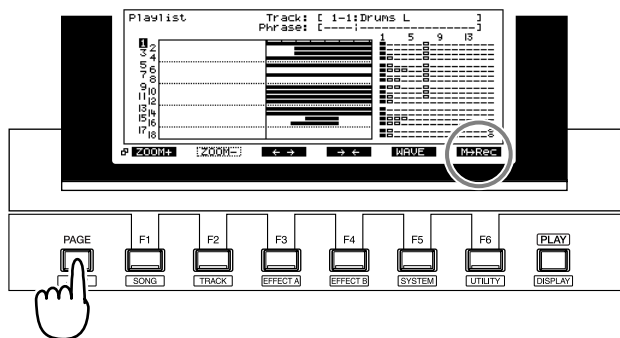

3. Press [F6] until "M→Ply" appears above [F6]. Press [F6] once more to select this setting. The current status of the mastering tracks is shown in the display.

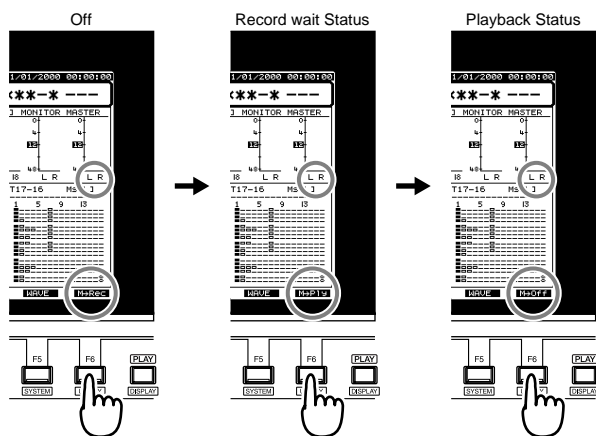

MEMO

For details on the signal flow, see p. 27.

4. Move to the location at which you started the mixdown.

5. Press [PLAY]. The mastering tracks will play back. Use the master fader to adjust the volume to a comfortable listening level.

At this time, the function buttons will perform the following actions.

[F1 (ZOOM+)]:

Enlarges the playlist display in the track direction (three levels).

[F2 (ZOOM-)]:

Reduces the playlist display in the track direction (three levels).

[F3 (←→)]:

Enlarges the playlist display in the time direction (five levels).

[F4 (→←)]:

Reduces the playlist display in the time direction (five levels).

[F5 (WAVE)]:

Displays the sound level (waveform) that is recorded in the tracks.

6. When playback ends, press [STOP].

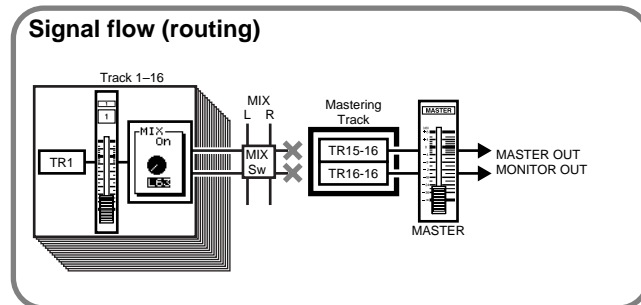

To Prohibit Digital Copying

When mixing down from the VS-1824 to a DAT recorder or similar recorder via a digital connection, you can prevent digital copying of the tape on which the mixdown has been recorded. Many DAT recorders implement “SCMS”—the Serial Copy Management System. With a DAT recorder which uses SCMS, you are allowed to make only one digital copy of a regular audio CD onto a DAT tape. Once the digital copy exists on the DAT tape, you cannot make additional digital copies using the DAT tape as the source. This function makes DAT tapes recorded digitally from the VS-1824 function as those recorded digitally from a CD. With the following procedure, you can prevent your digitally mixed master tapes from being later copied digitally onto DAT tapes or other similar digital media.



SCMS (See Appendices p. 13)

- Hold [SHIFT] and press [F5 (SYSTEM)].
The System menu icon appears in the display. If the System menu icon does not appear, press [F6 (EXIT)].
- Press [F1 (SYSPM)].
If “SYSPM” does not appear in the display above [F1], press [PAGE] until “SYSPM” appears, and then press [F1 (SYSPM)].
- Use [▲], [▼], [◀], and [▶] to move the cursor to “Digital Copy Protect.”
Digital Copy Protect
This setting determines whether or not a DAT master created from the Digital Output jacks of the VS-1824 can be later copied digitally.
 - Off:**
Digital copying of the DAT tape is allowed.
 - On:**
Digital copying of the DAT tape is prohibited.
- If you want to prohibit the digital copying of a master DAT created from the VS-1824, use the TIME/VALUE dial set Digital Copy Protect to “On.”
- Press [PLAY (DISPLAY)] to return to the Playlist display.

Mixing Down While Inserting Effects

You can insert effects as you mix down.



While performing a mixdown, it is common to insert an effect such as a parametric equalizer or a compressor. For this example, we will insert the Mastering Tool Kit (FX1; p. 99) to adjust the overall volume balance as we mix down.

- Press [CD-RW/MASTERING].
- Press [F1 (MstRm)].
The Mastering Room screen will appear.
- Press [▲], [▼], [◀], and [▶] to move the cursor. Use the TIME/VALUE dial to specify the value for each parameter.

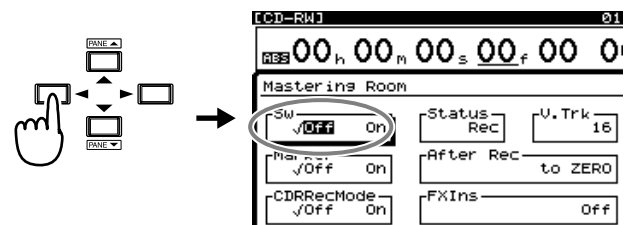

Sw

This parameter turns the Mastering Room feature on and off. To rehearse your mix before actually recording your mastering tracks, select “Off.”

- On:** When Sw is turned on, Tracks 17 and 18 are designated as the mastering tracks—and will be shown as “L” and “R” on the Playlist display.
- Off:** When Sw is turned off, Tracks 17 and 18 function normally.

* Remember that audio on Tracks 17 and 18 will not be included in the final mixdown once Sw is set to “On,” since Tracks 17 and 18 will be used as mastering tracks. If you wish to include audio from Tracks 17 and 18 in your final mix, you must bounce it to any track from 1-16.

Status

This specifies the status of the mastering tracks. For this example, select “Rec.”

- Rec:** Play back Tracks 1-16 while recording them to the mastering tracks.
- Play:** Play back the mastering tracks. The sound of Tracks 1-16 will not be output from the MASTER jacks.



For details on the signal flow, see p. 27.

Chapter 13 CD-RW and Mastering

4. Use [▲], [▼], [◀], and [▶] to move the cursor to “FXIns.”

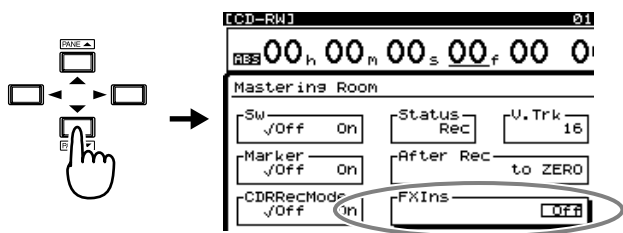

5. Press [ENTER (YES)].
6. Use [▲], [▼], [◀], and [▶] to move the cursor. Use the TIME/VALUE dial to make your settings.

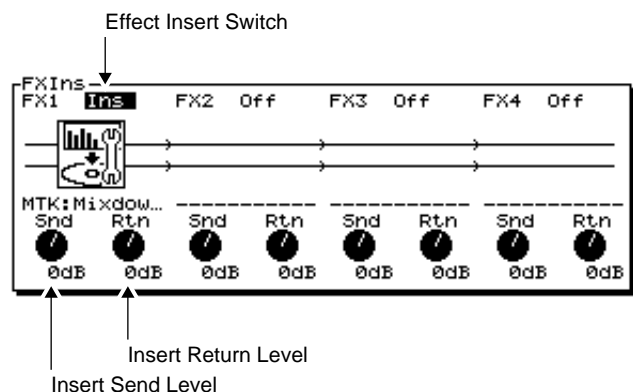

FX1 (effect insert switch 1)

Select how the effect will be connected.

- Off:** The effect will not be inserted.
- Ins:** The stereo effect will be inserted into both channels. The inserted effects are shown as icons and as patch names of up to ten characters.

Snd (effect send level)

Adjust the volume level of the signal that is sent to the insert effect (-42-6 dB). The default is “0 dB.”

Rtn (effect return level)

Adjust the volume level of the signal that is output from the insertion effect (-42-6 dB). The default is “0 dB.”

7. Press [F1 (FX1)].
8. Press [F2 (Sel)].

9. Use the TIME/VALUE dial to move the cursor to the effect that you wish to use. For this example, select an effect such as “P210 MTK:Mixdown.”

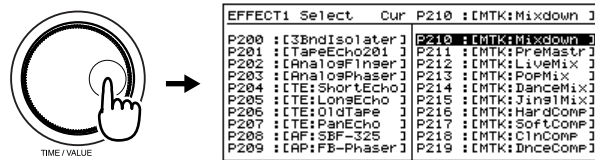

10. After selecting an effect, press [F4 (Exec)].
11. Press [F6 (EXIT)].
12. Press [FADER] so that the TR (track) indicator lights.



13. Hold down [STOP], and press the STATUS button for all tracks (1-12) that you wish to mix down. The STATUS indicators will light green.

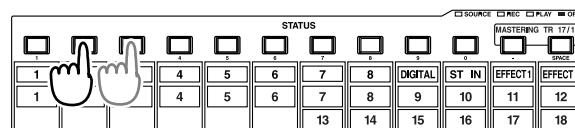

14. Press [FADER] so that the TR (track) indicator blinks.

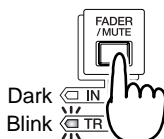

15. Hold down [STOP], and press the STATUS button for all tracks (13-16) that you wish to mix down. Press [PLAY]. The song will play back.

16. Raise and lower the master fader, and verify that the volume of each track changes.

MEMO

The sound that has passed through the master fader will be recorded on the mastering tracks. In order to record at the optimal audio quality, you will normally set the master fader to 0 dB.

17. Use the channel faders (1–16) to adjust the volume balance of the tracks. At this time, the sound—the volume level and panning—that is output from the MASTER jacks will be recorded “as is” to the mastering tracks. Adjust the volume to as high a level as possible without causing distortion.
18. When you are finished adjusting the volume, press [STOP].
19. Move to the time location at which you wish to begin the mixdown (e.g., 00h00m00s00f).
20. Use the cursor buttons and the TIME/VALUE dial to change the Sw setting to “On.”
21. Press [REC]. The REC indicator will light in red.
22. Press [PLAY]. The PLAY indicator will light in green, and recording will begin.
23. When you finish recording, press [STOP].

Creating an Audio CD

You can create your own audio CD by choosing audio from two individual tracks in the VS-1824 and writing those to a CD-R disc. A CD can contain as many as 99 tracks—typically, each song on a CD is a track—up to a total length of 74 minutes.

To conform to CD audio standards (Red Book), the VS-1824 turns your song into an “image file,” or “disk image,” that is written, or “burned,” to the CD. This image file can be created as you burn a CD, during the recording process—using the CDR recording mode—or during mastering, which can also use the CDR recording mode (see p. 178).

In both cases, the image file is created on the VS-1824’s internal IDE drive. The image file must also be located on the internal IDE drive during the actual CD burning.

An internal IDE hard drive is therefore required for burning an audio CD. Some countries, such as the United States, ship the VS-1824 with an internal IDE drive installed.

NOTE

When a disk image is created using the CDR recording mode or during mastering, it is saved when you save the song.

NOTE

You can store a song containing an image file on an external drive or removable disk, such as a Zip disk. However, when you wish to make an audio CD of the song, you must first copy the song back to your internal IDE drive.

NOTE

When an image file is created during the actual CD-burning procedure, it is temporarily stored on the VS-1824’s internal IDE drive before being written to the CD-R disc. The song itself can be stored on the internal drive, or on an external drive or removable disk. The internal drive must have enough free space to hold the image file—all available free space on the drive can be used for this purpose, regardless of the partition in which the space is located. After the image file is written to the CD-R disc, it is automatically deleted from the internal IDE drive.

Before Using the CD-RW drive

Handling the CD-RW Drive

- Install the unit on a solid, level surface in an area free from vibration.
- Remove any disc from the drive before powering up or down.
- Avoid using the unit immediately after it has been moved to a location with a level of humidity that is greatly different than its former location. Rapid changes in the environment can cause condensation to form inside the drive, which will adversely affect the operation of the drive and/or damage discs. When the unit has been moved, allow it to become accustomed to the new environment (allow a few hours) before operating it.
- To avoid the risk of malfunction and/or damage, insert only discs with  into the CD-RW drive. Never insert any other type of disc. Avoid getting paper clips, coins, or any other foreign objects inside the drive.
- Do not attempt to remove the disc from the CD-RW drive while the drive is functioning (while the MIDI/DISK indicator of VS-1824 or busy indicator of external CD-RW drive is lit).
- Do not attempt to carry a VS-1824 equipped with a CD-RW drive (VS-1824 CD) while a disc is loaded in the CD-RW drive.

VS-1824CD

- Do not touch the lens.
- When the lens is dirty, clean the lens with a commercial lens blower.

Handling CD-R/CD-RW Discs

- When handling the discs, please observe the following.
 - Do not touch the recorded surface of the disc.
 - Do not use in dusty areas.
 - Do not leave the disc in direct sunlight or an enclosed vehicle.
- Avoid touching or scratching the shiny underside (encoded surface) of the disc. Damaged or dirty discs may not read/write properly. Keep your discs clean using a commercially available CD cleaner.
- Keep the disc in the case.
- Do not keep the disc in the CD-RW drive for a long time.
- Do not put a sticker on the label of the disc.
- Wipe the disc with a soft and dry cloth radially from inside to outside. Do not wipe along circumference.
- Do not use benzine, record cleaner spray or solvents of any kind.
- Do not bend the disc.

Items Necessary for Creating an Audio CD

- VS-1824
- Blank CD-R (Compact Disc-Recordable) or CD-RW (Compact Disc-Rewritable) disc
 - * *The audio recorded on CD-RW discs cannot be played on conventional CD players. If you want to play CD-RW discs, it is recommended to use the "CD Player Function" (p. 191) on the VS-1824.*
 - * *You cannot use high-speed compatible CD-RW discs. This mark is printed on high-speed compatible CD-RW discs.*



VS-1824CD

It is recommended to use CD-R discs from the following manufacturers.

Taiyo Yuden Co., TDK Co., Mitsui Chemicals Co.,
Mitsubishi Chemicals Inc., Ricoh Co.,Ltd,
Hitachi Maxell Ltd.

It is recommended to use CD-RW discs from the following manufacturers.

Ricoh Co., Ltd, Mitsubishi Chemicals Inc.

VS-1824

Recommended CD-R/CD-RW discs (approved by Roland) are shown in the owner's manual of the CD-R/RW drive.

- Audio equipment to be connected to the MASTER output jacks, or stereo headphones

NOTE

VS-1824

If you are using a VS-1824 that is not equipped with an internal CD-RW drive, you will need to purchase a separately available CD-RW drive (approved by Roland). For instructions on connecting the drive, refer to "Connecting an External CD-R/CD-RW Drive" (p. 194).

Creating a Master Stereo Mix

CD standards only allow two tracks (left and right) to be written to a CD-R. Before recording an audio CD, it is necessary to create a stereo recording of your song within the VS-1824. You can do this easily by bouncing your existing tracks to two available tracks on the VS-1824 (see “Mastering Room,” p. 177). Or, if you mix your songs to an external stereo recorder such as a DAT recorder, you can transfer the stereo mixes back into the VS-1824 for CD recording.



It is a good idea to prepare the final stereo recording of your song using the tools found in the VS-1824’s Mastering Room—see p. 177. In particular, we recommend turning on the Mastering Room’s CDRecMode parameter to create a CD image file of your song as you record your final mix. This image file will then be saved when you save your song.

Song data that can be written to CD-R discs must satisfy the following conditions:

1. Sample Rate and Recording Mode:

Only tracks recorded with a sample rate of 44.1 kHz can be written to CD-R discs. Make sure you select the 44.1 kHz sample rate when you create a new song. You may use any of the recording modes; however, it is recommended you use either MTP, CDR, MAS, or MT1 for best results.

2. Levels

Audio transferred to the CD will only be the actual audio data as stored on the hard drive. Mixer, EQ, effects settings, and Automix data on these tracks will not be transferred. Thus, any desired level settings, panning, EQ and effects must be recorded as a part of the tracks’ audio. Make all EQ, level, pan and other settings on the source tracks during track bouncing—you can use Automix during the track bouncing process (p. 64).

3. Effects

Audio transferred to the CD will only be the actual audio data as stored on the hard drive. Effects settings made with the Track Mixer on these tracks will not transfer to the CD. Even if reverb or delay is applied to a track, the reverb or delay will not be written to the CD-R disc. All desired effects must be recorded as a part of these tracks. Make all effect settings during track bouncing.

4. Track Bouncing

You can select any two tracks (including any V-Tracks) to be written to the CD-R disc. One track will become the left channel of the CD-R, the other the right channel. If your song exists in a multitrack format, it must be mixed and bounced down to two tracks before being written to a CD-R. Designate the resulting stereo tracks as the tracks to be written to the CD-R disc.

5. Track Editing

The two tracks designated for writing to the CD-R disc are written from the beginning of the tracks (normally “00h00m00s00”) to the end of the tracks. Any blank

space or silence on the tracks before and after the actual performance will be written as silence on the CD-R disc. To avoid this, use Track Cut to remove any unwanted silence at the beginning of the tracks and at the end of the tracks, or Track Insert to create space between tracks.

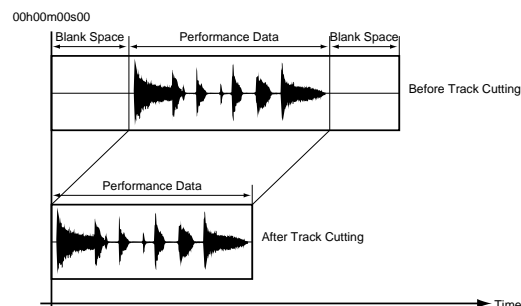

Finalizing

Before a CD can be played on a standard audio CD player—or can be duplicated—it must be “finalized.” Finalizing writes certain important information onto the CD, including the track numbers and Table of Contents (TOC). It is the final step in the creation of a CD—once a CD has been finalized, no more songs can be added to the CD.

You can add songs to a CD one-by-one without finalizing the CD until you are done adding songs, though an un-finalized CD can only be played using the CD Player feature (p. 191). This lets you create the CD in stages as you finish each of its songs. When you are ready to, you can finalize the CD.

If all of the songs are finished, you can burn and finalize the entire CD at once.



If you plan on having a CD duplicated, burn and finalize the entire CD at the same time (this is often referred to as the “disk at once,” or “DAO” method). Some professional duplicators will not accept a CD created a track at a time. Two CD-Writer parameters—Finalize and Write Method—work together to determine how and when a CD is finalized.

When you are adding songs to a CD one-by-one:

- If you may be adding more songs later on, set Write Method to “Track at Once” and set Finalize to “Off.”
- If you are writing the final song, set Write Method to “Track at Once” and set Finalize to “On.”
- If you have already written all of the songs you wish to have on the CD, but have not yet finalized it, you can do so by setting Write Method to “Track at Once” and Finalize to “OnlyFin.”

When you are writing the entire contents of a CD at once:

- set Write Method to “Disk at Once.” The VS-1824 will automatically finalize the CD regardless of the Finalize setting.

Assembling Multiple Songs for CD Recording

It is not necessary to use a DAT machine or some other digital stereo recorder in order to create professional quality CD masters. Here's an example of how you would use the VS-1824 for creating Disc At Once CD-Rs:

1. Record each of your multitrack songs, using 44.1 kHz sample rate, and MTP recording mode.
2. Adjust EQ, adjust levels, and add effects on each track as desired.
3. Use the Mastering Room to bounce the tracks to a stereo mix.
4. Create a New Song, using 44.1 kHz sample rate, MTP recording mode. For example, you might name it "My CD Project."
5. Use Track Import (p. 151) to assemble the stereo bounces of each of your songs into the song "My CD Project." The sample rate and recording mode of the song "My CD Project" must match the sample rate and recording mode of each of the songs.
6. Use Track Move, Track Cut, and Track Insert to determine the sequence of each of the songs.
7. Place CD track markers.
8. Continue with CD Recording as described in "Writing Songs to CD-R Discs," p. 188.

Copyright Protection

Duplication of a copyrighted CD is a violation of the rights of manufacturers and of the owners of the recorded work. If you use a part or an entire CD in your compositions with the VS-1824 and write the song onto a CD-R, obey the copyright notice on the original CD. The VS-1824 and its CD recording function is designed to assist you in reproducing material for which you own the copyright or have obtained permission to copy material from the copyright owner. Unless you own the copyright or have permission to copy it from the copyright owner, you may be violating copyright law and may be subject to payment of damages and other remedies. If you are uncertain about your rights, you should contact your legal advisor.

CD Track Numbers

When creating a CD-R with Finalize on, it is recommended that you designate the position of CD track numbers on the CD-R by first placing CD track markers in the VS-1824 song.

The location of a track number on a finished CD-R is determined by the position of CD track markers in the VS-1824 song. A CD track marker is placed by holding down [PLAY (DISPLAY)] and pressing [TAP]. A new marker number appears in the VS-1824 display. This marker will have a small "c" following it, to designate it as a CD track number.

Before placing CD track markers, use Track Cut to remove any unwanted silence from the beginning and end of your song. Cut the silence so that the beginning of actual audio is placed at 00h00m00s15f. Do not place a CD track marker at this point (the VS-1824 automatically places a CD track marker at 00h00m00s00f). The first CD track marker should be at the beginning of your second song. Place this CD track marker by holding [PLAY (DISPLAY)] and pressing [TAP]. If no other markers are placed in the song, the display will show 000c for this marker. If you hold [PLAY (DISPLAY)] and press [TAP] at the beginning of the third song, the display will show Marker 001c. The following page shows what you'll end up with.

Beginning of Song #1	No CD marker is needed	Becomes CD Track 1
Beginning of Song #2	CD Track Marker # 000c	Becomes CD Track 2
Beginning of Song #3	CD Track Marker # 001c	Becomes CD Track 3
Beginning of Song #4	CD Track Marker # 002c	Becomes CD Track 4
<i>and so on...</i>		

* *Due to audio CD standards, songs on a CD must be at least four seconds long. Thus, you cannot set two CD track markers within four seconds of each other. If you attempt to do this, "Can't Set Marker" appears in the display, and the process cannot be carried out. Make sure your CD markers are at least four seconds apart.*

The placement of a CD track marker in a VS-1824 song sends a command to the CD-R to increment the track number on the CD-R disc by one. It is not possible to create a CD-R with non-sequential track numbers, or to skip track numbers.

Do all your editing first. Use Track Cut and Track Insert to create exactly the desired transitions between songs. If you

place all your CD track markers and then use Track Cut or Track Insert, you will need to go back and re-do all your markers.

Once you are completely satisfied with the timing and transitions between songs, place your CD track markers. Check them by pressing [NEXT] then [PLAY]. If you need to erase a marker, press [CLEAR]+[SONG]+[TAP].

If you are only recording one song to the CD-R, it is not necessary to place any CD track markers, whether or not Finalize is on or off.

CD Track Number Tip

When setting up CD track markers for a full length CD-R, it's easy to get confused by the discontinuity between the CD track marker number and the actual CD track number created. During the CD-R writing process, regular markers—placed by pressing [TAP]—are ignored by the CD-R. By placing two regular markers during the first song, the subsequent CD track markers match the actual CD track numbers which they will create.

Before using the CD Write function, place two "dummy" markers somewhere during the first song. It doesn't matter where the two dummy markers are placed, as they will be ignored by the CD-R. The first two marker numbers are 000 and 001. Place the next marker using [PLAY (DISPLAY)]+[TAP] (to indicate a CD track number) where you want the second track of the CD to begin. This will be marker 002c.

Beginning of Song #1	No CD marker is needed	Becomes CD Track 1
Middle of Song #1	Normal Marker #000	(ignored by CD-R)
Middle of Song #1	Normal Marker #001	(ignored by CD-R)
Beginning of Song #2	CD Track Marker # 002c	Becomes CD Track 2
Beginning of Song #3 (etc.)	CD Track Marker # 003c	Becomes CD Track 3

Writing Songs to CD-R Discs

NOTE

You can create a CD using a CD-RW disc, but it is impossible to play back audio data recorded on a CD-RW disc using most CD players, even if the disc is finalized. Audio data recorded on a CD-RW disc can be played back using the “CD Player Function” (p. 191) on the VS-1824. Consider using a CD-R disc instead of a CD-RW disc—CD-R discs can be played back on a wider variety of CD players.

1. **VS-1824**
Make sure that the CD-R/CD-RW drive is properly connected (see p. 194).
2. Place a blank CD-R disc in the CD-R/CD-RW drive.
VS-1824CD For details refer to the column “Inserting a CD” (see p. 234).
3. Press [CD-RW/MASTERING].
4. Press [F2 (CD Wt)].

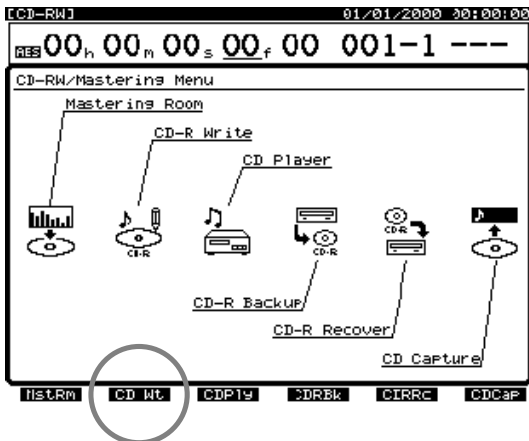

5. “CD-R Write Ready ?” appears in the display. Press [ENTER/YES].
6. “Store Current ?” appears in the display. Press [ENTER/YES]. If you don’t want to save any changes made to the current song, press [EXIT/NO].

If the CD-RW disc you are using contains data, “Erase?” appears in the display. To erase the existing data, press [ENTER/YES]. “Erase Disc” appears and all the contents of the CD-RW disc are erased. If you do not wish to erase the data, press [EXIT/NO], and insert a new disc.

When erase is finished, “Can’t be played back with Audio CD player” appears in the display. This is to confirm that regular audio CD players cannot play back an audio CD made with a CD-RW disc. Press [ENTER/YES]. Or press [EXIT/NO] to cancel the procedure.

7. Wait a moment for the CD-R Writer display to appear. Press [F1 (SelTr)].

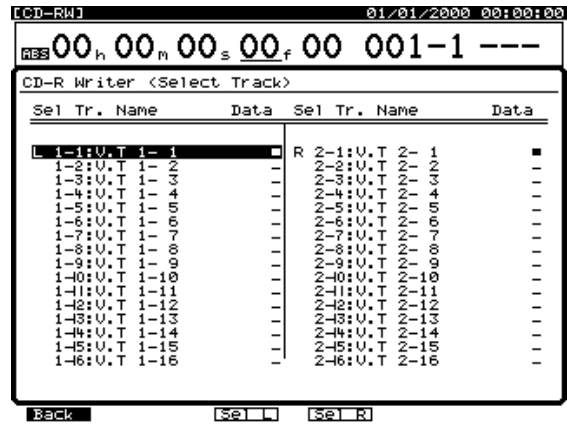

8. Select the left and right tracks from the VS-1824 that you want written to the CD-R. Use [▲], [▼], [◀], and [▶] and the TIME/VALUE dial to move the cursor to the V-Track you want written as the left channel of the CD-R, and press [F3 (Sel L)]. Move the cursor to the V-Track you want written as the right channel of the CD-R and press [F4 (Sel R)].

HINT

You can use [◀], and [▶] to jump from track to track, and then use the TIME/VALUE dial to select the desired V-Track.

9. Press [F1 (Back)].

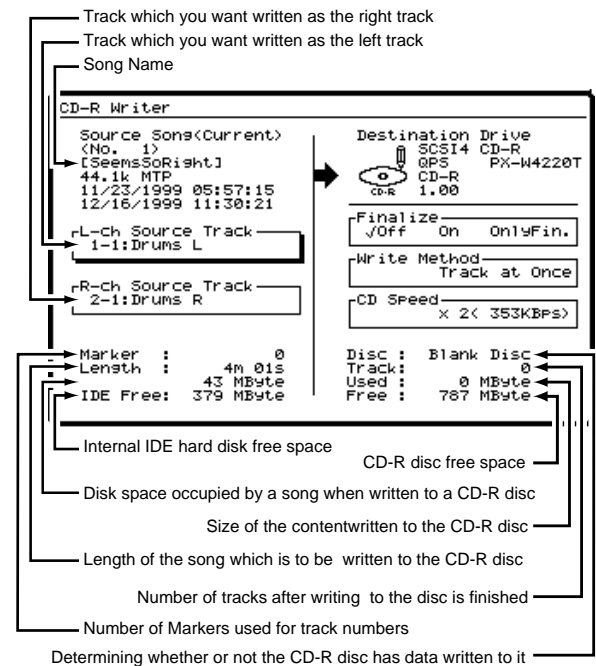

10. Verify that the Length M (Megabyte) value is less than the value for IDE Free. (This step does not apply if your image file has already been created.)
11. Verify that the Length M value is less than the value for Free (the amount of free space on the CD).

Source Track Length (in Mbyte) compared to Free Disc Space on CD-R/CD-RW

The amount of drive space source tracks occupy on the VS-1824 may not be the same amount of disc space it occupies on a CD-R/CD-RW disc. The track size on the VS-1824 varies depending on the number of tracks and recording mode used. You can make a rough estimate of the space required on a CD-R/CD-RW disc for a track to be written by using the following calculation:

Source track length (in seconds) x 2 (bytes) x 2 (stereo tracks) x 44,100 = SIZE (bytes)

For example, a source track that is 60 minutes long (3,600 seconds) occupies:

$$3,600 \times 2 \times 2 \times 44,100 = 635,040,000 \text{ bytes} = 635 \text{ MB}$$

12. Press [▲], [▼], [◀], and [▶] to move the cursor. Then use the TIME/VALUE dial to adjust each setting.

Finalize

A TOC (Table Of Contents) will be written so that the audio CD created by the VS-1824 can be played back on a standard CD player. It is possible to write additional data to an audio CD that has been finalize.

- Off:** Write only the song, and do not finalize.
- On:** Write the song, and then finalize.
- OnlyFin:** Only finalize without writing the song. Select this if you have inserted a CD-R disc to which you have already written songs, but which has not yet been finalized.

Write Method

Track at Once:

Two seconds of silence is automatically added to the CD-R disc before the markers placed in the song to designate the track number (the same condition as when writing additional songs).

You can write additional songs to a CD-R disc written using Track at Once, as much as the available space on the disc allows.

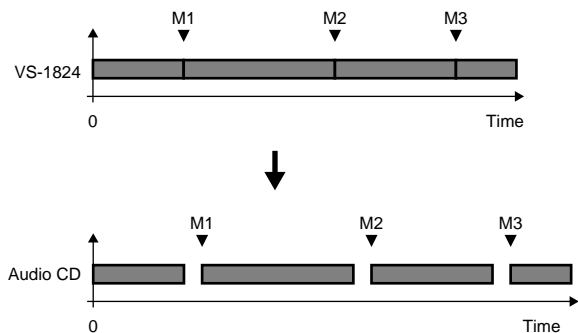

Disc at Once:

The song and the track number markers added to the song are written as is to the CD-R disc. However, additional songs cannot be written to CD-R discs that have been written using Disc at Once (the same state as when finalize has been executed).

Even if “Finalize” has been set to “Off,” once you write a song yo a CD-R disc with “Disc at Once” selected, additional material can no longer be written to that disc.

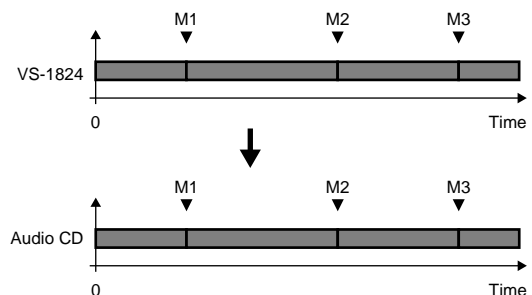

CD Speed

VS-1824CD

- x4:** The song will be written at quadruple speed (706 kilobytes per second).
- x2:** The song will be written at double speed (353 kilobytes per second).

VS-1824

The available speeds will depend on the Roland-approved CD drive connected to the VS-1824.

13. Press [F5 (Exec)].

A message will ask you to confirm.

NOTE

When you are using CD-RW discs:

“Track at Once” cannot be selected as the writing mode for “Writing Method.” The following message appears on the LCD and it will be unable to carry out the operation if you try to write CD-RW discs using the Track at Once method. In this case, press [ENTER/YES].

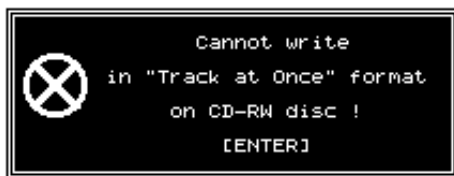

14. “Audio CD-R Write Sure ?” and “CD Track No. OK?” appears in the display. This message confirms the Finalize setting, and makes sure CD track markers are set. Press [ENTER/YES], or to cancel the operation, press [EXIT/NO].
15. A message regarding copyright appears in the display. After reading this message carefully, if you agree to the conditions, press [ENTER/YES]. To cancel, press [EXIT/NO].
16. A message regarding licensing conditions appears in the display. After reading this message carefully, if you agree to the conditions, press [ENTER/YES]. To cancel the operation, press [EXIT/NO].

If “Not 44.1kHz Song !” Appears in the Display

The sample rate is not 44.1 kHz, so the song cannot be written to the CD-R disc. Press [YES/ENTER] to cancel the procedure. Please refer to “Create a New Song (Song New),” p. 50. Make sure to use 44.1 kHz sample rate for songs, to be recorded to the CD-R/CD-RW drive.

If “Please Insert Disc!” Appears in the Display

This indicates the CD-R/CD-RW drive loading tray is open, that there is no disc loaded, or the CD-R/CD-RW drive is not ready for use. Insert a CD-R disc, wait a few moments for the CD-R drive to read the disc, and then press [ENTER/YES].

17. After the CD-R writing is finished, “Write Another ?” appears in the display. If you want to write the same track data to another CD-R disc, place a new disc in the CD-R/CD-RW drive and press [ENTER/YES]. Press [EXIT/NO] to return to Step 2.

Adding a Song to a Partially Recorded Disc

You can add new songs to a CD-R disc that has not been finalized. Repeat the procedure described in “Writing Songs to CD-R Discs,” p. 188. Approximately two seconds of silence is inserted between the new song and the song before it. The track number is recorded automatically.

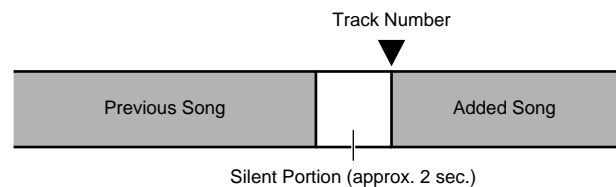

Arranging and Recording Multiple Songs to a CD-R Disc

By sequencing a number of different songs on stereo tracks, you can arrange these songs and write them to a CD-R disc. You can program CD track numbers by placing CD track markers at song boundaries.

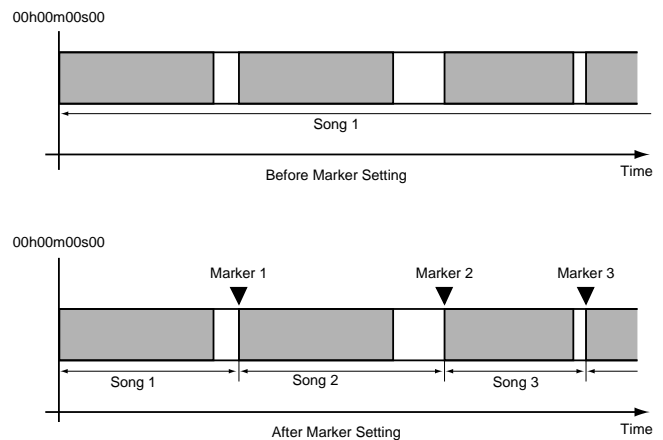

CD Player Function

You can use the CD-R/CD-RW drive to play a partially recorded CD-R disc—a disc which has not been finalized (see p. 185)—or to listen to commercially recorded CDs. To listen to partially recorded CD-R discs, use the CD Player function.

* You can listen to the contents of the disc only through the VS-1824's MASTER output, MONITOR output, or from the PHONES jack. You cannot output the audio from the CD-R/CD-RW headphone jack or AUDIO OUT jacks.

1. Insert the partially recorded CD-R disc or a pre-recorded commercial CD into the CD-R/CD-RW drive.
- VS-1824CD** For details refer to the column "Inserting a CD" (see p. 234).
2. Press [PLAY (DISPLAY)].
 3. Press [CD-RW/MASTERING].
 4. Press [F3 (CDPl)].

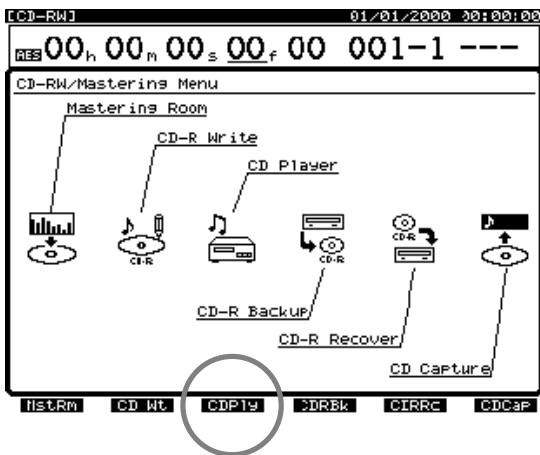

The CD Player screen appears in the display. Information is displayed as shown in the following:

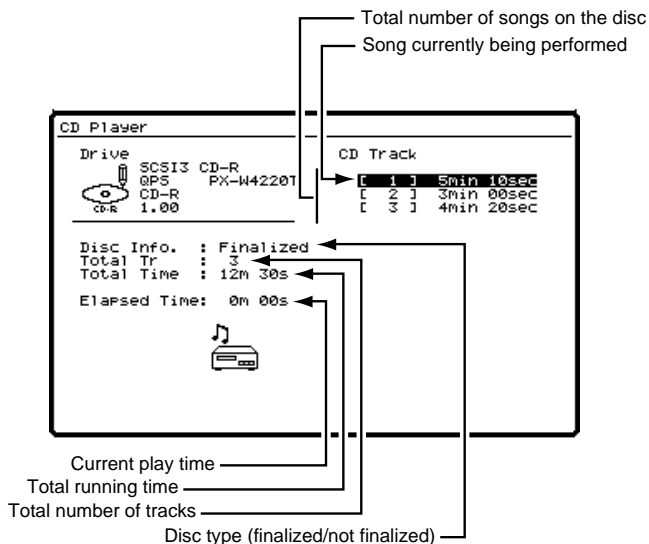

Only the following buttons, knobs, and faders can be used in the CD Player function.

[ZERO]:

Goes to the start of the first song.

[REW]:

Rewinds as long as the button is held down.

* [REW] activates when be stooping.

[FF]:

Rapidly advances as long as the button is held down.

* [FF] activates when be stooping.

[STOP]:

Stops the CD.

[PLAY]:

Begins playback from the present location.

[PREVIOUS] or [▲]:

Returns to the beginning of the previous song.

[NEXT] or [▼]:

Advances to the beginning of the next song.

MASTER Fader:

Adjusts the overall volume.

MONITOR Knob:

Adjusts the volume output from the MONITOR jacks.

PHONES Knob:

Adjusts the headphone volume.

* When using the CD Player function, the transport control buttons do not control standard VS-1824 transport functions.

* The audio playing from the CD-R/CD-RW drive cannot be recorded back into the VS-1824.

* When listening to a partially recorded CD-R, the last 0.5 second (approximate) of the song cannot be played back until the disc is finalized.

5. In the CD Player screen, the function buttons perform as described below.

[F3 (Eject)]:

Ejects the CD-R/CD-RW tray.

[F5 (SelDr)]:

If more than one CD-R/CD-RW drive is connected to the VS-1824, you can choose another drive to use.

[F6 (EXIT)]:

Exits the CD Player screen and returns to the Song Menu icon.

6. Use [▲] and [▼] to move the cursor to the CD track you want to hear.

7. Press [PLAY] to begin CD playback.

8. Press [STOP] when you are finished with the CD Player function.
9. Press [PLAY (DISPLAY)] to return to the Playlist display.

If "Please Insert Disc!" Appears in the Display

This indicates the CD-R/CD-RW drive loading tray is open, that there is no disc loaded, or the CD-R/CD-RW drive is not ready for use. Insert a CD-R disc, wait a few moments for the CD-R/CD-RW drive to read the disc, and then press [ENTER/YES].

If "Blank Disc" Appears in the Display

You are attempting to use the CD Player function with a CD-R disc that has no audio recorded on it. Insert a commercially recorded CD or a CD-R disc on which a recording has been made, and try the operation once more.

Capture Audio data from Audio CD (Capture function)

VS-1824 have function to capture Audio data from Audio CDs.

This can capture audio from CD **only in case the sampling rate setting of current song is 44.1kHz.**

NOTE

VS-1824

If you are using a VS-1824 that is not equipped with an internal CD-RW drive, you will need to purchase a separately available CD-RW drive.

For instructions on connecting the drive, refer to "Connecting an External CD-R/CD-RW Drive" (see p. 194).

PX-4220Te, PX-8220Te, PX-W124TSe, and PX-W1210TSE manufactured by PLEXTOR is supported. In case you are using other drives approved by Roland, consult with your retailer, the nearest Roland Service Center, or an authorized Roland distributor.

1. Load an Audio CD or CD-R/RW disc that contains audio you like to capture on CD-R/CD-RW drive.

VS-1824CD For details refer to the column "Inserting a CD" (see p. 234).

2. Press [CD-RW/MASTERING].
CD-RW/Mastering Menu will appear.

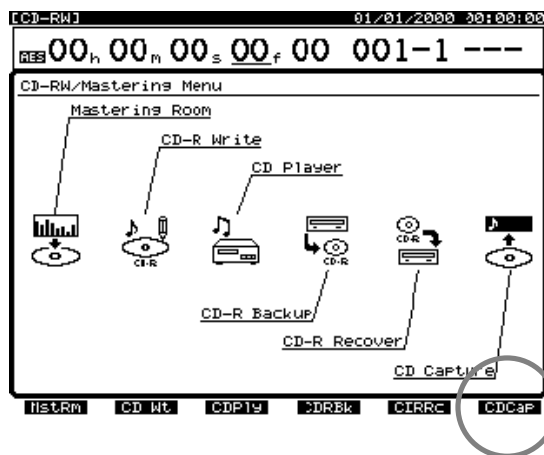

- Press [F6 (CDCap)].
CD Capture screen will appear.

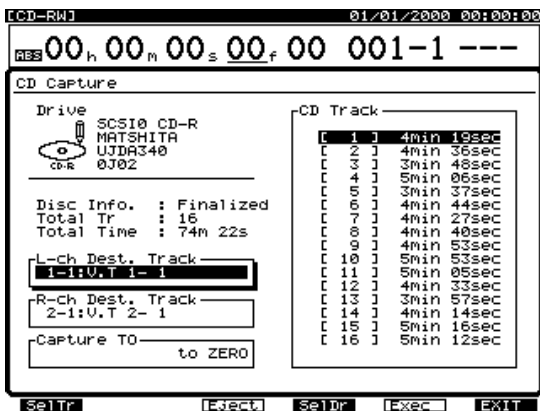

- Press [▲] [▼] [◀] [▶] to move cursor and set each of following parameters using TIME/VALUE dial.

NOTE

If following cases, the tracks to capture audio must be set as Stereo Pair. In case it is not set as Stereo Pair, a message of “Illegal Track Pair!” appears and unable to capture audio.

- “CDR” is selected as recording mode of the current song.
- Any phrases in CD-R mode is recorded in destination tracks.

● **L-Ch Dest Track (L channel destination track)**

Select the destination track of audio to capture. Select the destination track of left channel audio here.

● **R-Ch Dest Track (R channel destination track)**

Select the destination track of audio to capture. Select the destination track of right channel audio here.

* In case the track which contain any phrases in CD-R mode is selected as destination of “L-Ch Dest Track,” it is impossible to change “R-Ch Dest Track” with TIME/VALUE dial.

● **Capture TO**

You can adjust the time of placement.

to ZERO:

Place the audio data starting at 00h00m00s00f.

to Last Phrs:0S:

Place the audio data after the end of the last phrase in the destination tracks.

to Last Phrs:2S:

Place the audio data two seconds after the end of the last phrase in the destination tracks.

to Last Phrs:4S:

Place the audio data four seconds after the end of the last phrase in the destination tracks.

- Once the above parameters are set, select the track of CD shown under “CD Track” pressing [PREVIOUS] or [NEXT]. The highlighted track is the target to capture.

● **CD Track**

Select the track of CD shown under “CD Track.”

MEMO

Press [PLAY] to play the highlighted track.

MEMO

When the cursor is in list of “CD Track,” you can select track of CD pressing [▲] [▼].

- Press [F5 (Exec)] after completion all the settings.

A message concerning copyright appears in the display. After reading this message, press [ENTER/YES].

The same message appears in the back cover of Owner’s Manual.

MEMO

A message of “Capture to Mastering Tr. In CDR mode?” appears in case of followings.

- 17 and 18 tracks * are selected as destination tracks and
 - those tracks are selected as stereo pair and
 - no song data exists on 17 and 18 tracks *.
- * This is applicable to 7 and 8 tracks instead of 17 and 18 in case the Recording mode is “MAS.”

Press [ENTER/YES] when you want to capture in CDR mode. If you press [EXIT/NO], the recording mode of current song will be applied.

If you find message “Illegal Track Pair!”

In the following cases, the tracks to capture audio must be set as Stereo Pair. Unless, unable to capture.

- “CDR” is selected as recording mode of the current song.
- Any phrases in CD-R mode is recorded in destination tracks.

In this case, press [ENTER/YES] and re-set destination track. (See process 4. above)

- A message concerning Licensing Conditions is displayed. After reading this message, press [ENTER/YES]. This message appears in the back cover of Owner’s manual. A message “CD Capture..” appears on display and starts capture.
- If you want to capture other audio data from same CD, go back to process 4. above.
- Press [PLAY (DISPLAY)] to return to the Playlist display.

Canceling the capture

If you want to cancel capture in the middle, operate as follows.

1. Press [EXIT/NO]
A message "Abort?" appears.
2. Press [ENTER/YES] to cease capture.
Press [EXIT/NO] to re-start capture.

Capturing Time

Capturing time differs according to recording mode as follows.

Recording Mode

CDR (CD writing)	Approx 40% of actual time
MAS (Mastering)	Approx 80% of actual time
Others	Approx 150% of actual time

Connecting an external CD-R/CD-RW Drive

* To prevent malfunction and or damage to speakers or other devices, always turn down the volume and turn off the power on all devices before making any connections.

1. Make sure both the VS-1824 and the CD-R/CD-RW drive are off. Connect the CD-R/CD-RW drive to the VS-1824 as shown below. If the CD-R is the only SCSI device connected to the VS-1824, or if it is the last device in the chain, make sure that the terminator plug is connected to the remaining SCSI port on the CD-R.
2. Turn on the power of the CD-R/CD-RW drive.

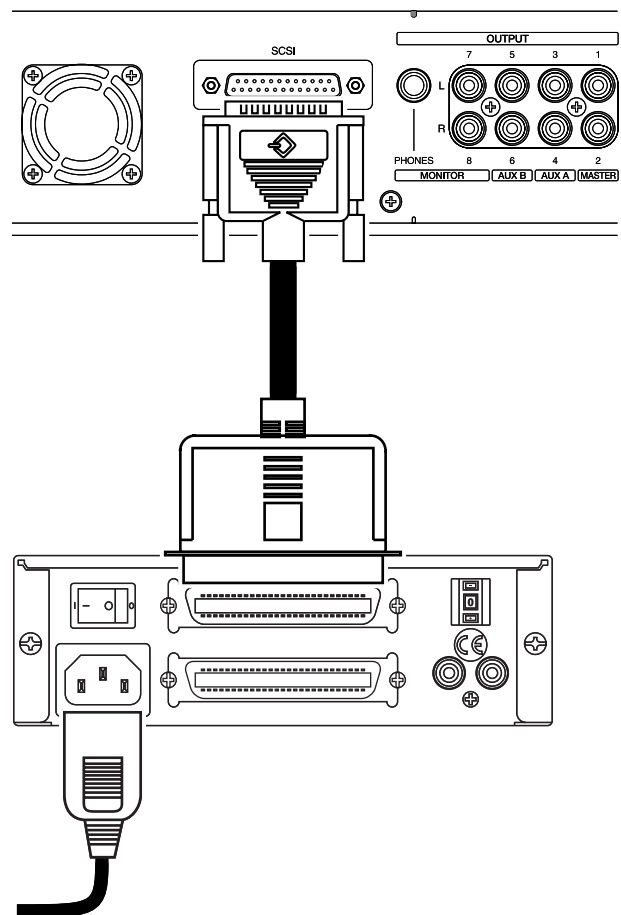

3. Turn on the power of the VS-1824.
* In order for the VS-1824 to properly recognize the CD-R/CD-RW drive upon boot-up, it is very important to turn the CD-R/CD-RW drive on first, and then turn on the VS-1824.
4. Turn on the power of connected audio equipment.
5. Raise the volume of the audio devices as desired.

Chapter 14 Other Useful Functions

Vari Pitch

Vari Pitch allows the VS-1824 to match the pitch of previously recorded tracks to the instrument currently being recorded, or to produce certain special effects.

When recording an ensemble performance, all the instruments normally tune to an instrument such as an acoustic piano whose tuning cannot easily be changed. However, it is sometimes necessary to record (overdub) an acoustic piano onto an existing recording. If, in this case, and the pitch of the recording is different than the pitch of the acoustic piano, the new recording will be out of tune relative to the previously recorded tracks.

In such cases, you can change the pitch of the recorded performance being played to match the pitch of the instrument you want to record. This is done by changing the playback speed of the VS-1824.

To use Vari Pitch, use the following procedure.

1. Hold [SHIFT] and press [SYSTEM].
The System Menu appears in the display.
2. Press [F3 (PLAY)].
If you don't see "PLAY" above [F3], press [PAGE] until "PLAY" appears, and then press [F3 (PLAY)]. The Play/Rec Parameter screen appears.
3. Use [▲], [▼], [◀], or [▶] to cursor to "VariPitchSw."
4. Turn the TIME/VALUE dial to select "On."
5. Use [▲], [▼], [◀], or [▶] to cursor to "Vari Pitch."
6. Use the TIME/VALUE dial to change the value for sample rate, which will change playback speed. Listen during playback to see how the pitch changes.
7. When you have finished adjusting the Vari Pitch, press [F6 (EXIT)] to return to the Playlist display.

NOTE

When Vari Pitch is active, a small "V" appears next to the current time in the upper part of the display.

8. To return to normal playback speed, repeat Steps 1-3 and turn VariPitchSw to "Off."

Numerics/ASCII

It is possible to enter text using the buttons on the top panel as an ASCII keyboard. This is useful for entering song, track, and phrase names, naming user effect patches and EZ Routings.

Entering Numbers

1. Press [NUMERICS/ASCII]. The button indicator lights.
2. Use the [LOCATOR], [BANK(9)], and [SCENE(0)] buttons to enter numerals as indicated below.

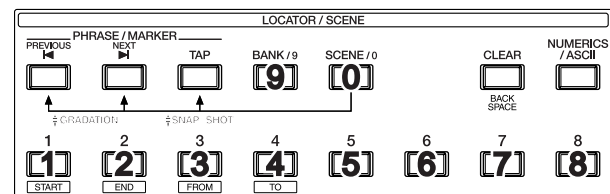

* For some settings, you can enter "-" (a minus sign) by pressing [0] twice.

3. After you have finished entering the numbers, press [ENTER/YES]. This sets the numbers.

Entering Letters

1. Press [NUMERICS/ASCII]. The button indicator lights.
2. Use all the SELECT and STATUS buttons to enter letters and numerals as indicated below.

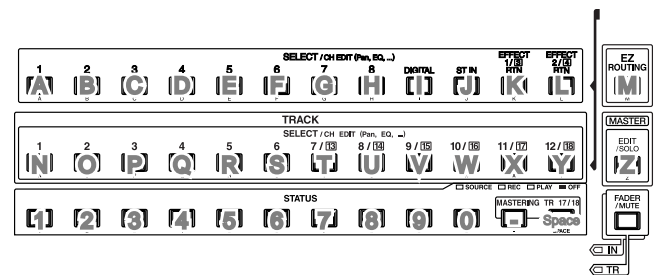

3. After you have finished entering the letters, press [ENTER/YES]. This sets the text and exits the Numerics/ASCII mode.

Stereo Input

You can assign input signals from the INPUT jacks or DIGITAL IN connector directly to the MIX or RECORDING bus without having them pass through the Input Mixer. You can also monitor these signals without having them pass through the Input Mixer or Track Mixer. This is referred to as the STEREO IN bus. This can be used to bring an additional stereo input source into the VS-1824. Use the following procedure to route a signal to the STEREO IN bus.

1. Press the [ST IN] SELECT button. The Stereo In/Effect Return screen appears in the display.
2. Press [F1(St In)].
3. Press [◀], and [▶] to move the cursor. Use the TIME/VALUE dial to adjust each of the settings as desired.

Stereo In Select

This setting determines which external input is assigned to the STEREO IN bus.

Off:

The STEREO IN bus is not used.

Input 1/2:

Assigns INPUT jacks 1 and 2 to the STEREO IN bus.

Input 3/4:

Assigns INPUT jacks 3 and 4 to the STEREO IN bus.

Input 5/6:

Assigns INPUT jacks 5 and 6 to the STEREO IN bus.

Input 7/8:

Assigns INPUT jacks 7 and 8 to the STEREO IN bus.

Digital:

Assigns the DIGITAL IN connector (coaxial or optical) to the STEREO IN bus.

Level:

Adjusts the volume level (0-127) of the STEREO IN bus.

Balance:

Adjusts the balance (L63—R63) for the STEREO IN bus.

4. Press [PLAY (DISPLAY)] to return to the Playlist display.
5. Adjust the STEREO IN bus level using the channel fader.
6. Press [FADER/MUTE] so the “IN” indicator is lit.
7. Use the ST IN fader to adjust the STEREO IN bus level.
8. After you’re finished adjusting the STEREO IN bus level, press [FADER/MUTE] so “TR” is lit or blinking (p. 71).

* You can quickly assign an INPUT jack to the STEREO IN bus by holding [ST IN] and pressing the SELECT button for the input you want. The inputs are assigned in pairs (Inputs 1 and 2, Inputs 3 and 4, Inputs 5 and 6, etc.).

Using the MONITOR Knob to Adjust Channel Panning

You can use the MONITOR knob to directly adjust the pan (or balance) of the specified channel.

1. Press [PLAY (DISPLAY)].
2. Hold down the SELECT button for the channel whose pan you wish to adjust, and do so by turning the MONITOR knob.

Be Careful!

If you turn the MONITOR knob without pressing SELECT buttons, you will adjust the volume level. If you are attempting to adjust panning and inadvertently turn the MONITOR knob toward the right without pressing SELECT buttons—or if you let go of SELECT buttons while turning the knob, a high-volume noise capable of damaging your amp or speakers may occur.

* When you release SELECT button after adjusting the pan, the edit screen of that channel may appear, but the MONITOR knob will adjust the pan only for the channel whose SELECT button is being pressed. For example, even when the edit screen for Track 1 is displayed, turning the MONITOR knob while holding down the Track 2 SELECT button will adjust the Track 2 pan.



If you adjust the pan while sound is playing, you may notice “blips” in the sound. This is not a malfunction. If you find it annoying, adjust the pan when the sound is not playing.

Synchronization Using the VS-1824 as the Master

When you want the VS-1824 to control the MIDI sequencer, use the following procedure:

1. Connect the VS-1824 and the MIDI sequencer as shown in the following illustration.

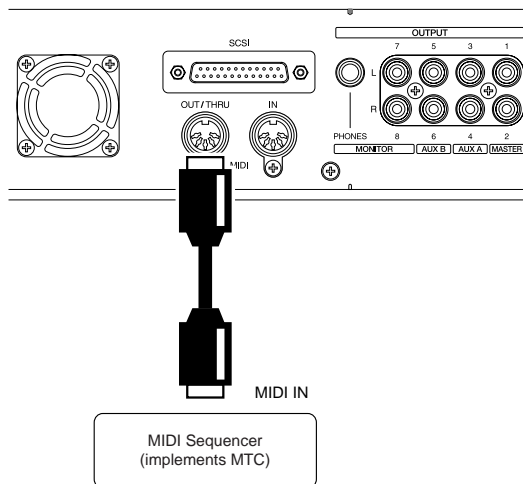

2. Press [PLAY(DISPLAY)].
3. Hold [SHIFT] and press [F5 (SYSTEM)]. The System menu icon appears in the display. If the System menu icon does not appear, press [F6 (EXIT)].
4. Press [F4 (MIDI)]. If “MIDI” does not appear in the display above [F4], press [PAGE] until “MIDI” appears, and then press [F4 (MIDI)].
5. Use [▲], [▼], [◀], and [▶] to move the cursor to “MIDI Thru,” and use the TIME/VALUE dial to change the setting.

MIDI Thru

This switches the function of the MIDI OUT/THRU connector. For this application, use “OUT.”

Out:

MIDI messages are sent from the VS-1824. Select this when sending MIDI messages such as metronome note messages, mixer parameter settings (Control Change or Exclusive messages), and/or synchronization messages.

Thru:

This echoes MIDI messages received via the MIDI IN connector without changing them.

6. Hold [SHIFT] and press [EXT SYNC].

The Sync/Tempo screen appears in the display.

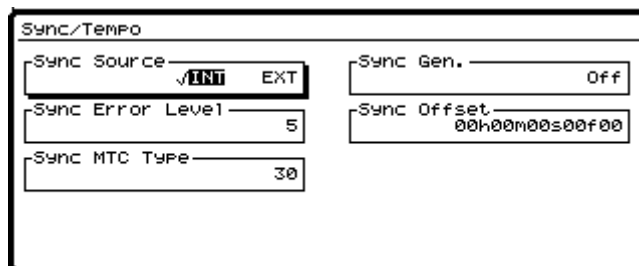

7. Use [▲], [▼], [◀], and [▶] to move the cursor to “Sync Gen.,” and use the TIME/VALUE dial to change the setting.

Sync Gen. (Sync Generator)

This setting determines what type of MIDI signal is generated at the MIDI OUT connector on the VS-1824. For this application, choose “MTC.”

Off:

No MIDI signals are transmitted.

MTC:

MIDI Time Code is transmitted.

MIDIclk:

The tempo map MIDI Clock is transmitted.

SyncTr:

The sync track MIDI Clock is transmitted.

Sync MTC Type

This selects the MTC frame rate (30, 29N, 29D, 25,24).

Select the MTC rate that matches the rate used in your MIDI sequencer.

8. Press [PLAY (DISPLAY)] to return to the Playlist display.
9. Set your MIDI sequencer to slave to the MIDI Time Code messages received from the VS-1824, and set it to play back MIDI song data. When playback begins on the VS-1824, the MIDI sequencer begins playback as well.

Synchronization Using the VS-1824 as the Slave

When you want to use the MIDI sequencer as the master to control the VS-1824, use the following procedure:

1. Connect the VS-1824 and the MIDI sequencer as shown in the following illustration.

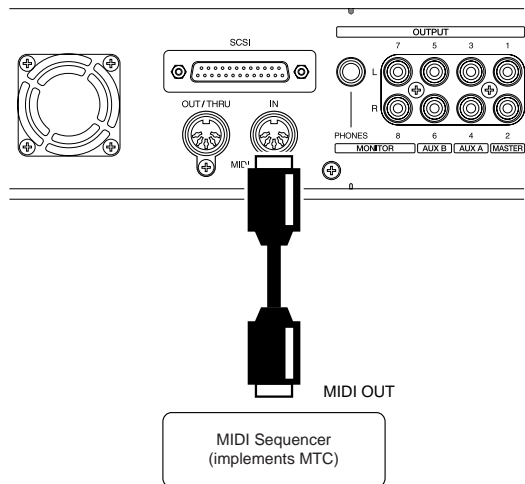

2. Hold [SHIFT] and press [EXT SYNC]. The Sync/Tempo screen appears in the display.

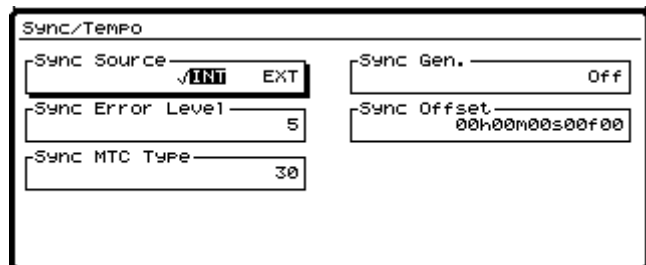

3. Use [▲], [▼], [◀], and [▶] to move the cursor and use the TIME/VALUE dial to change the settings.

Sync Error Level

This sets the interval (0-10) for checking MTC reception when synchronizing the VS-1824 to MTC transmitted by an external MIDI device. When MTC is not sent continuously, the VS-1824 checks the MTC and cancels synchronization if there is an error. By setting a longer interval under such circumstances, synchronization can continue, even if there are errors in the source MTC.

Sync MTC Type

This selects the MTC frame rate (30, 29N, 29D, 25,24). Select the MTC rate that matches the rate used in your MIDI sequencer.

4. Press [PLAY (DISPLAY)] to return to the Playlist display.
5. Set your MIDI sequencer to transmit MTC.

6. Press [EXT SYNC]. The button will begin blinking, indicating the VS-1824 is set to synchronize using MTC from the external MIDI sequencer.
7. Press [PLAY]. The button blinks green, indicating the VS-1824 is in MTC receive-standby mode. When the MIDI sequencer begins playback and begins transmitting MTC, playback will begin on the VS-1824. During synchronization, the EXT SYNC indicator and PLAY indicator remain lit.

If MIDI Time Code is Unstable

When using MIDI sequencer software for personal computers, depending on the hardware specifications and the playing conditions, the MTC signal sent to the VS-1824 may be unstable. If the synchronization is erratic, try using the VS-1824 as the master device, or try raising the VS-1824 Sync Error Level as described above.

Using MTC Offset

When the VS-1824 is running under the control of MTC from an external MIDI device, you can synchronize the song's playback time and the MTC time. The difference in these two times is called the "offset." For example, if the MTC time is 01h00m00s00f00, and the song's time is 00h10m00s00f00, the offset is as follows:

$$\begin{aligned} \text{Offset} &= (\text{MTC Time}) - (\text{song time}) \\ \text{Offset} &= 01\text{h}00\text{m}00\text{s}00\text{f}00 - 00\text{h}10\text{m}00\text{s}00\text{f}00 \\ \text{Offset} &= 00\text{h}50\text{m}00\text{s}00\text{f}00 \end{aligned}$$

If the offset value turns out to be a negative number, add 24h00m00s00f00 to the MTC time before subtracting the song time. For example if the MTC time transmitted is 00h00m50s00f00, and you want the song to playback at 00h01m00s00f00, then the offset works out as shown below:

$$\begin{aligned} \text{Offset} &= (\text{MTC Time}) - (\text{song time}) \\ &= 00\text{h}00\text{m}50\text{s}00\text{f}00 - 00\text{h}01\text{m}00\text{s}00\text{f}00 \\ &= (24\text{h}00\text{m}00\text{s}00\text{f}00 + 00\text{h}00\text{m}50\text{s}00\text{f}00) \\ &\quad - 00\text{h}01\text{m}00\text{s}00\text{f}00 \\ &= 23\text{h}59\text{m}50\text{s}00\text{f}00 \end{aligned}$$

NOTE

If the VS-1824 is slaved to a MIDI device using a negative offset, song playback across 00h00m00s00f00 will momentarily stop at 23h59m59s29f99 before resuming playback. Be careful not to record any audio until after this point in time.

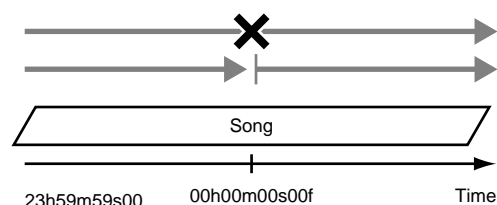

1. Hold [SHIFT] and press [F5 (SYSTEM)]. The System menu icon appears in the display. If the System menu icon does not appear, press [F6 (EXIT)].
2. Press [F1 (SYSPM)]. If "SYSPM" does not appear in the display above [F1], press [PAGE] until "SYSPM" appears, and then press [F1 (SYSPM)].

3. Use [▲], [▼], [◀], and [▶] to move the cursor to "Offset," and use the TIME/VALUE dial to change the setting.

Offset

When the VS-1824 is used as a slave to an external MIDI device, you can synchronize the song's playback time and the MTC time. The offset settings range varies depending on the MTC frame rate selected for the current song.

Time Display Format

The time display can be set to either Relative (REL) or Absolute (ABS). For this application, choose "ABS."

REL:

The starting time of the song is displayed as 00h00m00s00f00.

ABS:

The starting time of the song is based on the offset time.

4. Press [PLAY (DISPLAY)] to return to the Playlist display.

Using the Sync Track (Master)

If your MIDI sequencer supports Song Position Pointer messages, you can use MIDI Clock for synchronization. There are two methods of synchronizing using MIDI Clock. One is to use the sync track, and the other is to use the tempo map. The following material explains how to control the MIDI sequencer from the VS-1824 using the sync track. Tempo mapping is described in the next section.

What is the Sync Track?

In addition to the tracks for recording audio signals, the VS-1824 has a separate track for recording MIDI Clock signals. This is called the "sync track." Unlike conventional multitrack tape recorders, it is not necessary to reserve one of the audio tracks for recording the sync track.

To use the sync track, simply record the MIDI Clock messages from your sequencer onto the sync track. Then put your sequencer in external sync mode and transmit the sync track data from the VS-1824 back to your sequencer.

The sync track can be very convenient if you have already created a tempo map in your sequencer and you want the measure/beat display on the VS-1824 to match that of your sequencer. Many sequencers also provide more precise control over things such as tempo and meter changes than is possible from the tempo map editing parameters within the VS-1824.

Recording MIDI Clock Messages

1. Connect the VS-1824 and the MIDI sequencer as shown below:

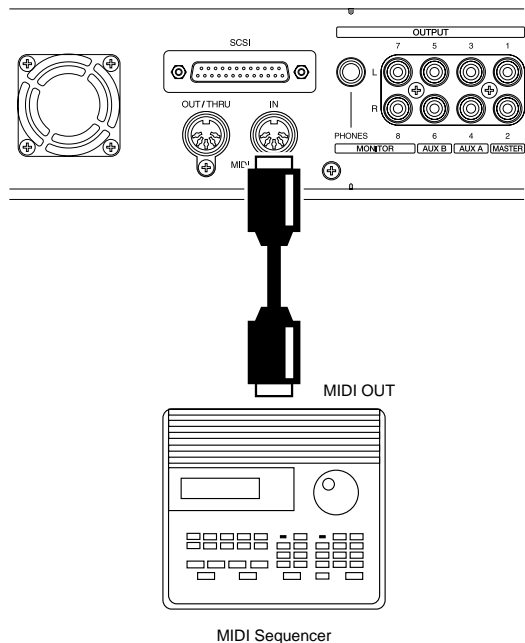

2. Hold [SHIFT] and press [EXT SYNC]. The Sync/Tempo screen appears in the display.
3. Press [F1 (STRec)].
4. If you wish to cancel the MIDI clock data recording, press [EXIT]. "Wait for Start Command" appears in the display, and the sync track is ready to record MIDI clock data.
5. Start playback of the MIDI song. The MIDI clock data is recorded on the sync track. While MIDI clock data is being recorded, the input sources can be monitored, but audio tracks cannot be recorded or played back. When the MIDI song data is finished playing back, the VS-1824 automatically stops recording MIDI clock data.
6. Press [PLAY (DISPLAY)] to return to the Playlist display.

Synchronized Operation

1. Connect the VS-1824 and the MIDI sequencer as shown below:

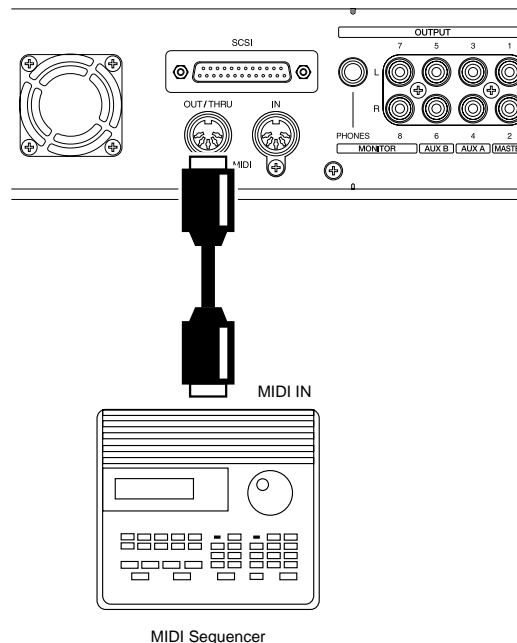

2. Press [PLAY (DISPLAY)].
3. Hold [SHIFT] and press [F5 (SYSTEM)]. The System menu icon appears in the display. If the System menu icon does not appear, press [F6 (EXIT)].
4. Press [F4 (MIDI)]. If "MIDI" does not appear in the display above [F4], press [PAGE] until "MIDI" appears, and then press [F4 (MIDI)].
5. Use [▲], [▼], [◀], and [▶] to move the cursor to "MIDI Thru," and use the TIME/VALUE dial to change the setting.

MIDI Thru

This switches the function of the MIDI OUT/THRU connector. For this application, use "OUT."

6. Hold [SHIFT] and press [EXT SYNC]. The Sync/Tempo screen appears in the display.

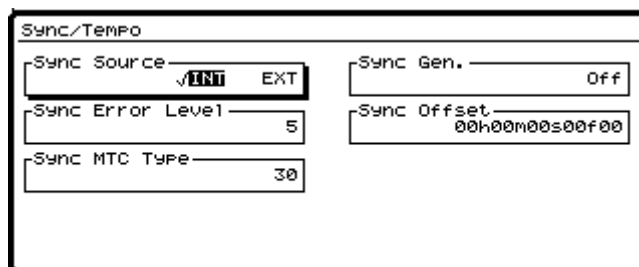

- Use [▲], [▼], [◀], and [▶] to move the cursor to “Sync Gen.,” and use the TIME/VALUE dial to change the setting.

Sync Gen. (Sync Generator)

This setting determines what type of MIDI signal is generated at the MIDI OUT connector on the VS-1824.

For this application, choose “SyncTr.”

Off:

No MIDI signals are transmitted.

MTC:

MIDI Time Code is transmitted.

MIDIclk:

The tempo map MIDI Clock is transmitted.

SyncTr:

The sync track MIDI Clock is transmitted.

- Press [PLAY (DISPLAY)] to return to the Playlist display.
- Set your MIDI sequencer to follow the MIDI Clock messages received from external devices, and to play back MIDI song data. When playback begins on the VS-1824, the MIDI sequencer will begin playback as well.

Using the Tempo Map

If your MIDI sequencer supports Song Position Pointer messages, you can use the MIDI Clock to synchronize operations. There are two methods of synchronization using the MIDI Clock: one is to use the sync track, and the other is to use the tempo map. This section provides an explanation of how to control the MIDI sequencer from the VS-1824 using a tempo map.

What is a Tempo Map?

A tempo map is a song’s measure, beat, and tempo information. By transmitting this information to MIDI sequencers and other devices, it can be used to synchronize operation with external MIDI devices. The tempo map sets tempo changes for each measure, so you can record information that specifies changes in rhythm and tempo to be played from any designated measure. With the VS-1824, tempo maps are numbered sequentially from the beginning of the song, with Tempo Map 1 first, followed by Tempo Map 2, Tempo Map 3, and so on. Tempo Map 1 is already specified at the beginning of the song, and determines the initial tempo of the song. To change the tempo at a subsequent measure, create a new tempo map at each location where you want the tempo to change. You can create up to 50 tempo maps per song.

Example 1: Song with no tempo changes

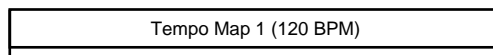

Example 2: Song with tempo changes occurring during the song

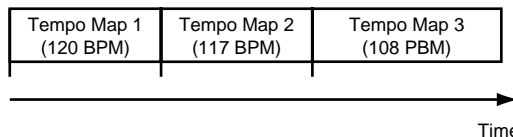

Creating A Tempo Map

1. Hold [SHIFT] and press [TAP]. The Tempo Map screen appears in the display. Tempo Map 1 (the starting tempo) is displayed.
2. Press [▲], [▼], [◀], and [▶] to move the cursor and use the TIME/VALUE dial to change the settings as desired.

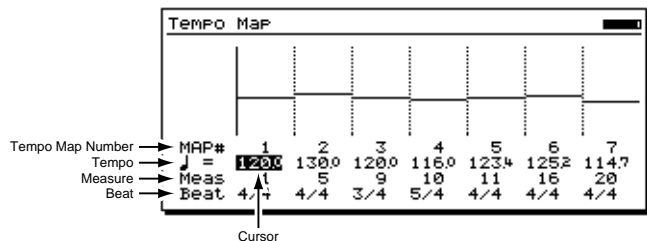

(Tempo)

Sets the tempo (25.0-250.0) of each tempo map

Meas (Measure)

Selects the measure number of the song (1-999) where the next tempo map starts.

Beat

This sets the tempo map time signature (1/1 to 8/1, 1/2 to 8/2, 1/4 to 8/4, 1/8 to 8/8). The function buttons work as shown below.

[F2 (New)]:

Adds a new tempo map to the current ending location.

[F3 (Ins)]:

Inserts a new tempo map at the current position of the cursor.

[F4 (Del)]:

Deletes a tempo map at the position of the cursor.

[F6 (EXIT)]:

Exits the Tempo Map screen.

* *Tempo Map 1 is the song's initial tempo. You cannot delete Tempo Map 1.*

3. When you are finished setting the tempo map, press [F6 (EXIT)]. The Sync/Tempo screen appears in the display.
4. Press [PLAY (DISPLAY)] to return to the Playlist display.

Synchronized Operation

1. Connect the VS-1824 and the MIDI sequencer as shown below:

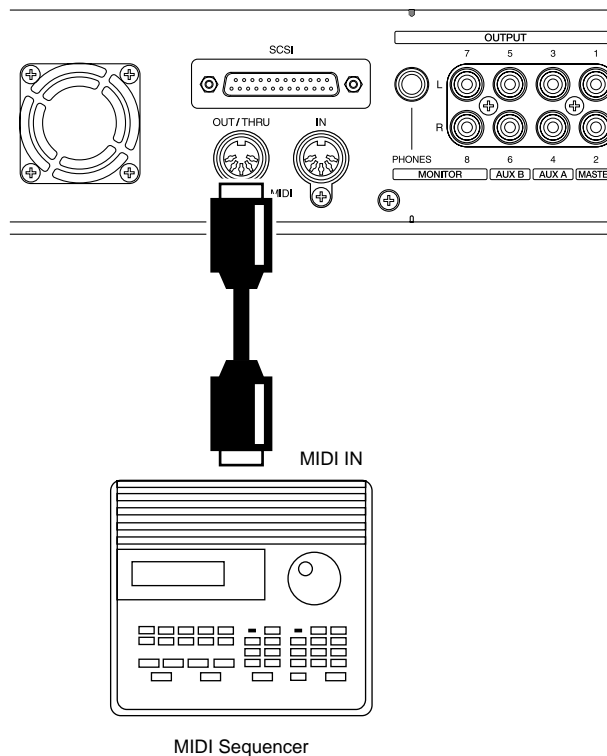

2. Press [PLAY (DISPLAY)].
3. Hold [SHIFT] and press [F5 (SYSTEM)]. The System menu icon appears in the display. If the System menu icon does not appear, press [F6 (EXIT)].
4. Press [F4 (MIDI)]. If "MIDI" does not appear in the display above [F4], press [PAGE] until "MIDI" appears, and then press [F4 (MIDI)].
5. Use [▲], [▼], [◀], and [▶] to move the cursor to "MIDI Thru," and use the TIME/VALUE dial to change the setting.

MIDI Thru

This switches the function of the MIDI OUT/THRU connector. For this application, use "OUT."

6. Hold [SHIFT] and press [EXT SYNC]. The Sync/Tempo screen appears in the display.

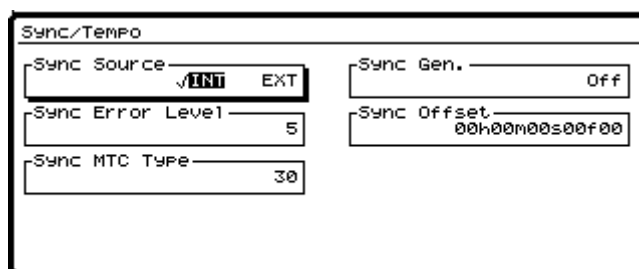

- Use [▲], [▼], [◀], and [▶] to move the cursor to “Sync Gen.,” and use the TIME/VALUE dial to change the setting.

Sync Gen. (Sync Generator)

This setting determines what type of MIDI signal is generated at the MIDI OUT connector on the VS-1824. For this application, choose “MIDIclk.”

Off:

No MIDI signals are transmitted.

MTC:

MIDI Time Code is transmitted.

MIDIclk:

MIDI Clock messages, as determined by the tempo map, are transmitted.

SyncTr:

MIDI Clock messages, as determined by the sync track, are transmitted.

- Press [PLAY (DISPLAY)] to return to the Playlist display.
- Set your MIDI sequencer to follow the MIDI Clock messages received from external devices, and to play back MIDI song data. When playback begins on the VS-1824, the MIDI sequencer begins playback as well.

Other Methods to Generate A Sync Track or Tempo Map

There may be instances when audio is recorded into the VS-1824 before a sync track is recorded, or before a tempo map is generated. It is possible to create a sync track or tempo map to match previously recorded audio. This is helpful when you want to record a new MIDI sequence on an external sequencer based upon the previously recorded tracks in the VS-1824. For example, you might want to program a drum machine to add percussion parts to a previously recorded live drum track in the VS-1824. If you create a sync track or tempo map which matches the live drum track, the MIDI sequence will be in sync.

Place Markers Along with the Tempo

- Press [ZERO].
- Press [PLAY] to begin song playback.
- While listening to the song, press [TAP] on each beat of each measure, for the entire song.
- When the song is finished, press [STOP].

Create a Sync Track from Markers

After placing markers at each beat of a song, it is possible to convert the marker data into a sync track. This is useful when you have already recorded a guitar or vocal performance in the VS-1824, and now you want to synchronize a MIDI sequencer to the recording.

- Hold [SHIFT] and press [EXT SYNC].
- Press [F2 (STCnv)].
- Press [F1 (TP→ST)].
- Press [◀] and [▶] to move the cursor. Turn the TIME/VALUE dial to change each value.

The screenshot shows a screen titled "Sync Track Convert: Tap → Sync Trk". Below the title are two input fields. The first field is labeled "Beat" and contains the value "4/4". The second field is labeled "Tap Beat" and contains the value "4".

Beat

Specify the time signature (number of beats per measure).

Tap Beat

Specify the number of markers in each measure.

- Press [F5 (Exec)].
- “Overwrite Tempo Map” appears in the display. Press [YES], or to cancel the operation, press [NO].
- When the operation is finished, press [PLAY (DISPLAY)] to return to the Playlist display.

Create a Tempo Map from Markers

After placing markers for each beat of a song, it is possible to convert the marker data into a tempo map. This is useful when you have already recorded a guitar or vocal performance in the VS-1824, and now you want to synchronize a MIDI sequencer to the recording.

1. Hold [SHIFT] and press [EXT SYNC].
2. Press [F2 (STCnv)].
3. Press [F2 (TP→TM)].
4. Press [◀] and [▶] to move the cursor. Turn the TIME/VALUE dial to change each value.



Beat

Specify the time signature (number of beats per measure).

Tap Beat

Specify the number of markers in each measure.

5. Press [F5 (Exec)].
6. “Overwrite Tempo Map” appears in the display. Press [YES]. Or, to cancel the operation, press [NO].
7. When the operation is finished, press [PLAY (DISPLAY)] to return to the Playlist display.

Create a Tempo Map from a Sync Track

If you have already recorded a VS-1824 sync track from an external MIDI source, you can convert it into a tempo map.

1. Hold [SHIFT] and press [EXT SYNC].
2. Press [F2 (STCnv)].
3. Press [F3 (ST→TM)].
4. Press [◀] and [▶] to move the cursor. Turn the TIME/VALUE dial to change each value.



Sync Track Beat

Specify the time signature (number of beats per measure) for the MIDI clock data recorded in the sync track.

5. Press [F5 (Exec)].
6. “Overwrite Tempo Map” appears in the display. Press [YES], or to cancel the operation, press [NO].
7. When the operation is finished, press [PLAY (DISPLAY)] to return to the Playlist display.

Creating a Sync Track Automatically

In cases where live audio was recorded into the VS-1824 before a tempo map was set, you can automatically create a sync track based on two points in the song, and then convert the sync track to a tempo map using the method explained above (“Creating a Tempo Map from a Sync Track”). For this procedure to work you must know the exact number of measures in the song, and there cannot be any tempo or time signature changes in the song.

To automatically create a sync track, you must specify a start time, an end time, and the exact number of measures between the start time and the end time.

1. Hold [SHIFT] and press [EXT SYNC].
2. Press [F2 (STCnv)].
3. Press [F4 (TI→TM)].
4. Press [◀] and [▶] to move the cursor. Turn the TIME/VALUE dial to change each value.

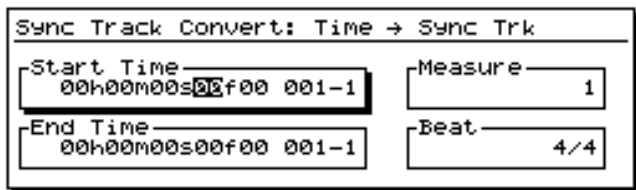

Start Time

Specify the actual start time.

End Time

Specify the actual end time.

Measure

Specify the exact number of measures between the Start Time and the End Time.

Beat

Specify the time signature (number of beats per measure).

5. Press [F5 (Exec)].
6. “Overwrite Tempo Map” appears in the display. Press [YES]. Or, to cancel the operation, press [NO].
7. When the Time to SyncTrack Conversion is finished, press [PLAY (DISPLAY)] to return to the Playlist display.

Delaying Sync Track and Tempo Map Start Times

Usually, a sync track or tempo map is created with 00h00m00s00f00 as the beginning of the song. However, actual audio recording doesn't typically start at 00h00m00s00f00. If this is the case, you can determine how much later recording begins after the start of the song. This time is referred to as the “offset.” If you want the first measure of the song to begin ten seconds from the beginning of the song, set the offset time to 00h00m10s00f00.

* *During recording or playback, when the beginning of a sync track or tempo map is reached, the start message is sent from the MIDI OUT connector. This is convenient when you want to synchronize the VS-1824 with an external MIDI sequencer.*

1. Hold [SHIFT] and press [EXT SYNC]. The Sync/Tempo screen appears in the display.
2. Use [▲], [▼], [◀], and [▶] to move the cursor to “Sync Offset”
3. Use the TIME/VALUE dial to specify the offset.
4. Press [PLAY (DISPLAY)] to return to the Playlist display.

Using MIDI Controller Messages

The VS-1824 can transmit its mixer settings and functions as MIDI messages, and MIDI messages from an external MIDI controller can be used to control the VS-1824's track status and mixer settings.

Switching Track Status

You can use MIDI Control Change messages to switch the status of each track. MIDI channels 1-16 carry MIDI data to and from Tracks 1-16 respectively. MIDI channels 1 and 2 also receive and transmit data for Tracks 17 and 18 (see p. 265). Use Controller # 3 to switch a track's status. Depending on the value of Controller # 3, the track status changes as shown below:

When stopped:

VALUE	0-31	32-63	64-95	96-127
STATUS	Mute	Mute	Mute	Mute
	→Mute	→Play	→Rec	→Source
	Play	Play	Play	Play
	→Mute	→Play	→Rec	→Source
	Rec	Rec	Rec	Rec
	→Mute	→Play	→Rec	→Source
	Source	Source	Source	Source
	→Mute	→Play	→Rec	→Source

During playback or recording:

VALUE	0-31	32-63	64-95	96-127
STATUS	(*1)	Mute	(*1)	(*1)
		→Play		
	Play	Play	(*1)	(*1)
	→Mute	→Play		
	(*1)	(*1)	Rec	Rec
			→Rec	→Source (*2)
	Source	(*1)	Source	Source
	→Mute		→Rec (*2)	→Source

(*1) Ignored

(*2) Cannot be switched while recording. “Source” here means “the status in which the track indicator blinks alternately red and orange” and is only valid when Record Monitor is set to “Auto Punch” (p. 58)

Switching Scenes

You can switch mixer Scenes with MIDI Program Change messages sent by an external MIDI controller.

During Playback of a Song

Scenes cannot be switched during song playback without pausing playback as the settings are changed. The VS-1824 will stop momentarily if it receives a Program Change message during playback instructing it to change Scenes. While it is stopped, the Scene is switched, and then playback resumes. During recording, only effect Program Change messages can be responded to. Scenes cannot be switched during recording.

1. Hold [SHIFT] and press [F5 (SYSTEM)]. The System menu icon appears in the display. If the System menu icon does not appear, press [F6 (EXIT)].
2. Press [F4 (MIDI)]. If “MIDI” does not appear in the display above [F4], press [PAGE] until “MIDI” appears, and then press [F4 (MIDI)].
3. Use [▲], [▼], [◀], and [▶] to move the cursor to “P.C.Scene,” and use the TIME/VALUE dial to change the setting.

P.C.Scene (Program Change Scene)

With this set to “ON,” the scene is changed when Program Change messages are received. For this application, select “on.”

4. Press [PLAY (DISPLAY)] to return to the Playlist display.

Use MIDI Channel 16 for switching Scenes. The relationship between the Program Change number received by the VS-1824 and the Scene Number it switches to is shown here:

Program Number	Scene Number
1-8	1-8

* For more detailed information, refer to the “MIDI Implementation” (Appendices p. 82).

Switching Effects

You can use MIDI Bank Select and Program Change messages transmitted from an external MIDI controller to switch effects.

1. Press [PLAY (DISPLAY)].
2. Hold [SHIFT] and press [F5 (SYSTEM)]. The System menu icon appears in the display. If the System menu icon does not appear, press [F6 (EXIT)].
3. Press [F4 (MIDI)]. If “MIDI” does not appear in the display above [F4], press [PAGE] until “MIDI” appears, and then press [F4 (MIDI)].
4. Use [▲], [▼], [◀], and [▶] to move the cursor to “P.C.Eff,” and use the TIME/VALUE dial to change the setting.

P.C.Eff (Program Change Effect)

With this set to “On,” the effect is changed when Program Change messages are received. For this application, select “On.”

5. Press [PLAY (DISPLAY)] to return to the Playlist display.

MIDI Channels 1-4 correspond to FX1-FX4 respectively. The relationship between the bank number received by the VS-1824 and the effect patch number it selects is shown here:

CC # 0	CC # 32		
Bank # MSB	Bank # LSB	Program #	Patch #
0	0	1-100	P000-P099
0	1	1-100	P100-P199
0	2	1-40	P200-P239
0	3	1-100	U000-U099
0	4	1-100	U100-U199

Adjusting Effects

You can use MIDI Control Change messages transmitted from an external MIDI controller to control effects.

1. Press [PLAY (DISPLAY)].
2. Hold [SHIFT] and press [F5 (SYSTEM)]. The System menu icon appears in the display. If the System menu icon does not appear, press [F6 (EXIT)].
3. Press [F4 (MIDI)]. If “MIDI” does not appear in the display above [F4], press [PAGE] until “MIDI” appears, and then press [F4 (MIDI)].
4. Use [▲], [▼], [◀], and [▶] to move the cursor to “Control Type” and use the TIME/VALUE dial to select “C.C.”

Control Type

This selects the type of MIDI messages that will be used when transmitting mixer settings to an external MIDI device, or when MIDI messages from an external MIDI device are used to control the mixer.

- Off:** MIDI messages related to mixer operation are not transmitted or received.
- C.C.:** The mixer is controlled using Control Change message.
- Excl:** The mixer is controlled using Exclusive messages.

5. Use [▲], [▼], [◀], and [▶] to move the cursor to “C.C.Eff,” and use the TIME/VALUE dial to select “On.”

C.C.Eff (Control Change Effect)

With this set to “On,” the effect is adjusted when control change messages are received.

6. Press [PLAY (DISPLAY)] to return to the Playlist display.

* *If you wish to use Control Change messages to edit effects, use NRPN (Non Registered Parameter Numbers). For more information, refer to the “MIDI Implementation” (Appendices p. 82; NRPN references begin on Appendices p. 83).*

MIDI Machine Control

The VS-1824 supports MIDI Machine Control (MMC). This means that when two VS-1824s are synchronized, or when a VS-1824 is synchronized with a MIDI sequencer that also implements MMC, operations such as Play, Stop, Fast Forward, etc., can be accomplished by operating only the Master device.

MMC messages include transport control functions and location information, but not actual synchronization signals. Synchronizing with MMC is done in a loop configuration, with an MMC master device sending the command to start the MMC slave device which, in turn, sends sync signal (usually MTC or MIDI Clock) back to the MMC master device. An MMC setup requires two-way MIDI communication and the proper setting of the following parameters on the VS-1824: Device ID, MIDI Out/Thru, SysEx RX, SysEx Tx, MMC Mode (Master, Slave, or Off), Sync Gen, and Internal Clock. For more information on these settings, take a look at the synchronization example using Cakewalk and the VS-1824 (p. 210).



MMC (See Appendices p. 12)

Chapter 16 Using Software Sequencers

Synchronizing the VS-1824 with a MIDI sequencer allows you to add MIDI instruments without actually recording them to tracks on the VS-1824. Because the VS-1824 includes a 28-channel digital mixer, you can mix and process up to 10 live signals from a MIDI-based sequencing system along with the recorded tracks in the VS-1824. This can reserve the VS-1824's tracks for recording vocals, guitar, etc.

This chapter explains how to synchronize the VS-1824 with some common software sequencing programs. If you are using a version of one of the following programs other than the one described in this chapter, it is likely the steps here will still apply—see the sequencer's manual if the menus and settings you find are different from those in this chapter.

Common Terms

MIDI Clock

Used for synchronizing two or more MIDI devices. MIDI Clock (sometimes called MIDI Beat Clock) sends timing information based on the number of beats per minute (e.g. 120bpm). MIDI Clock is available on almost all sequencers and drum machines and is usually used in conjunction with Song Position Pointer (see below).

MIDI Time Code (MTC)

Another method of synchronizing two or more MIDI devices. Unlike MIDI Clock, MTC uses time-based information (Hours, Minutes, Seconds, Frames) to synchronize devices and does not reference a specific tempo or time signature. Because MTC uses a more complicated signal, it is not implemented on some devices. When available, MTC is usually more desirable for synchronizing audio recorders and tape decks. MTC is sometimes used in conjunction with MIDI Machine Control (see below).

MIDI Machine Control (MMC)

Transport and locate commands (Play, Stop, Record, etc.) that are transmitted through MIDI. MMC is used to control a device (e.g. the VS-1824) remotely. Another protocol (usually MTC) is used to provide the sync signal.

Song Position Pointer (SPP)

This MIDI message allows you to locate to any point within a song (e.g., bar 33, beat 4). SPP is normally used with MIDI Clock. It does not work with MTC.

Synchronization

When using a sequencer or a drum machine with the VS-1824, it is often desirable for the two devices to start and stop at the same time. This is referred to as “synchronization.” Typically, you have a “master” device and a “slave” device. When the master device is started, the slave device will start at the same time. MIDI devices primarily use either of two methods for synchronization: MIDI Clock (often used with Song Position Pointer) or MIDI Time Code (sometimes used with MIDI Machine Control).

Sequencer Tracks

Tracks on the VS-1824 are similar to tracks on a sequencer. Just as you can record an instrument (or multiple instruments) on a track of the VS-1824, you can record MIDI information on a sequencer track.

MIDI Interface

A MIDI Interface is used to connect MIDI devices to your computer. There are various types of MIDI interfaces available to choose from. The setup procedure for your MIDI interface will vary depending on the type of interface and computer you are using. On the Macintosh, MIDI interfaces are usually connected to the printer, modem, or USB port(s). The interface is then controlled by the sequencing software itself or by one of three programs: Apple MIDI Manager, OMS (Opcode), or FreeMIDI (Mark of the Unicorn). On Windows-based computers, MIDI interfaces are usually connected to the serial port, parallel port, USB port, or directly to a sound card. Each interface will likely have its own software drivers that must be installed and configured for the interface to operate correctly.

MIDI Interface Troubleshooting Tips

If you are having trouble getting your MIDI interface to work properly, there are a number of troubleshooting techniques you can use to determine where the problem lies. On the Macintosh, most setup problems are the result of conflicting extensions in the System Folder. Try disabling any extensions that are not absolutely necessary for the program to run, and restart your computer. On Windows-based computers, most setup problems are the result of conflicting IRQ and/or Port Address settings. Make sure that each of the devices connected to your computer is set to its own IRQ and Port Address and that the corresponding software driver(s) reflects those settings. Defective or incorrectly connected MIDI cables are another common problem encountered when configuring a MIDI sequencing setup.

Specific Software Applications

Cakewalk Pro Audio

Cakewalk Pro Audio™ is available for IBM-compatible computers. Version 8.0 is used in the following example.

Cakewalk as Master Device

There are two methods for synchronizing the VS-1824 with Cakewalk: Using MTC/MMC with Cakewalk as the master, or using MIDI Clock with the VS-1824 as the master. Using the first method, the Play, Stop, etc. buttons in Cakewalk will control the VS-1824.

Connections

1. Connect the MIDI OUT port of your MIDI interface to the MIDI IN port of the VS-1824.
2. Connect the MIDI OUT port of the VS-1824 to the MIDI IN port of your MIDI interface.

Cakewalk Settings

1. Click on “Project Options...” in the Tools menu.
2. Click on the “Clock” tab.
3. Click on “SMPTE/MTC” under Source.
4. Click on “30 Frame Non-Drop” under SMPTE/MTC Format.
5. Click on the “MIDI Out” tab.
6. Click on “Transmit MMC” under MIDI Machine Control.
7. Use your mouse to select “17” under Timecode Master’s Unit ID.
8. Click on “OK.”

VS-1824 Settings

1. Hold [SHIFT] and press [EXT SYNC].
2. Move the cursor to Sync Source and use the TIME/VALUE dial to select “INT.”
3. Move the cursor to Sync Gen and use the TIME/VALUE dial to select “MTC.”
4. Move the cursor to Sync MTC Type and use the TIME/VALUE dial to select “30.”
5. Press [F6 (Exit)], then press [F4 (MIDI)].
6. Move the cursor to Device ID and use the TIME/VALUE dial to select “17.”

7. Move the cursor to MIDI Thru and use the TIME/VALUE dial to select “Out.”
8. Move the cursor to SysEx Rx and use the TIME/VALUE dial to select “On.”
9. Move the cursor to MMC and use the TIME/VALUE dial to select “Slave.”
10. Press [PLAY (DISPLAY)] to return to the Playlist display.

Click on the Play icon in Cakewalk. The VS-1824 should begin playback in sync with Cakewalk. If not, check the MIDI connections and driver settings in your computer.

VS-1824 as Master Device

The second method for synchronizing the VS-1824 with Cakewalk uses MIDI Clock messages. Using this method the VS-1824 will control the playback of Cakewalk.

Connections

1. Connect the MIDI OUT port of the VS-1824 to the MIDI IN port of your MIDI interface.

Cakewalk Settings

1. Click on “Project Options...” in the Tools menu.
2. Click on the “CLOCK” tab.
3. Click on “MIDI Sync” under Source.
4. Click on “OK.”

VS-1824 Settings

1. Hold [SHIFT] and press [EXT SYNC].
2. Move the cursor to Sync Source and use the TIME/VALUE dial to select “INT.”
3. Move the cursor to Sync Gen and use the TIME/VALUE dial to select “MIDIclk.”
4. Press [F6 (Exit)], then press [F4 (MIDI)].
5. Move the cursor to MIDI Thru and use the TIME/VALUE dial to select “Out.”
6. Press [PLAY (DISPLAY)] to return to the Playlist display.

Click on the Play icon in Cakewalk and “Waiting for MIDI Sync” will be displayed. Press [PLAY] on the VS-1824 and Cakewalk will begin playback in sync with the VS-1824.

Cubase VST

Cubase VST™ is available for Mac or IBM-compatible computers. Version 4.0 on a Macintosh is used in the following example.

Cubase as Master Device

There are various methods that can be used to synchronize Cubase with the VS-1824. This example will use MTC with Cubase controlling the playback of the VS-1824.

Connections

1. Connect the MIDI OUT port of your MIDI interface to the MIDI IN port of the VS-1824.

Cubase Settings

1. Click on “Synchronization” in the Options menu.
2. Click on the pop-up menu by MIDI Timecode and click on the Interface that is connected to the VS-1824.
3. Click on the pop-up menu by Frame Rate, and click on “30FPS.” Click on “OK.”

VS-1824 Settings

1. Hold [SHIFT] and press [EXT SYNC].
2. Move the cursor to Sync Source and use the TIME/VALUE dial to select “EXT.”
3. Move the cursor to Sync MTC Type and use the TIME/VALUE dial to select “30.”
4. Press [F6 (Exit)], then press [F4 (MIDI)].
5. Move the cursor to Device ID and use the TIME/VALUE dial to select “17.”
6. Move the cursor to MIDI Thru and use the TIME/VALUE dial to select “Out.”
7. Press [PLAY (DISPLAY)] to return to the Playlist display.

Press [PLAY] on the VS-1824 (it will start flashing). Start playback in Cubase, the VS-1824 should start playing in sync with Cubase. If not, check your MIDI connections and driver settings in your computer.

VS-1824 as Master Device

The next example also uses MTC, with the VS-1824 controlling the playback of Cubase.

Connections

1. Connect the MIDI OUT port of the VS-1824 to the MIDI IN port of your MIDI interface.

Cubase Settings

1. Click on “Synchronization” in the Options menu.
2. Click on the pop-up menu by From Input and click on the interface that is connected to the VS-1824.
3. Click on the pop-up menu by SMPTE Sync and click on “MTC.”
4. Click on the pop-up menu by Frame Rate and click on “30FPS.”
5. Click on “OK,” then click on the SYNC box in the Transport control bar so that it darkens.

VS-1824 Settings

1. Hold [SHIFT] and press [EXT SYNC].
2. Move the cursor to Sync Source and use the TIME/VALUE dial to select “INT.”
3. Move the cursor to Sync Gen. and use the TIME/VALUE dial to select “MTC.”
4. Move the cursor to Sync MTC Type and use the TIME/VALUE dial to select “30.”
5. Press [F6 (Exit)], then press [F4 (MIDI)].
6. Move the cursor to MIDI Thru and use the TIME/VALUE dial to select “Out.”
7. Press [PLAY (DISPLAY)] to return to the Playlist display.

Press [PLAY] on the VS-1824 and Cubase should start playback in sync with the VS-1824. If it does not, check your MIDI connections and the driver settings in your computer.

Logic Audio

Logic Audio™ is available for Mac or IBM-compatible computers. Version 3.5 for Macintosh is used in this example.

Logic as Master Device

There are several methods that can be used to synchronize Logic with the VS-1824. This example uses MTC and MMC, with Logic controlling the playback of the VS-1824.

Connections

1. Connect the MIDI OUT port of your MIDI interface to the MIDI IN port of the VS-1824.

Logic Settings

1. Click on “Open Arrange” in the Windows menu.
2. Click on “MIDI Options” in the Options sub menu.
3. Click on “Transmit MTC (MIDI Time Code)” so it has an “X” in its box.
4. Click on “MIDI Machine Control (MMC)” so there is not an “X” in its box.
5. Click on “OK.”
6. Click on “Synchronization” in the Options menu.
7. Click on “General” and click on “Intern” from the Sync Mode pop-up menu.
8. Click on “30” in the Frame Rate (fps) pop-up menu, click on the 30 button. Click on OK.

VS-1824 Settings

1. Hold [SHIFT] and press [EXT SYNC].
2. Move the cursor to Sync Source and use the TIME/VALUE dial to select “EXT.”
3. Move the cursor to Sync MTC Type and use the TIME/VALUE dial to select “30.”
4. Press [PLAY (DISPLAY)] to return to the Playlist display.

Press [PLAY] on the VS-1824 and it will start to blink. Now you can click on Play in Logic and the VS-1824 will begin playing back as well.

VS-1824 as Master Device

The next example uses MTC, with the VS-1824 controlling the playback of Logic.

Connections

1. Connect the MIDI OUT port of the VS-1824 to the MIDI IN port of your MIDI interface.

Logic Settings

1. Click on “Open Arrange” in the Windows menu.
2. Click on “MIDI Options” in the Options sub menu.
3. Click on “Auto Sync In” so it has an “X” in its box.
4. Click on “OK.”

VS-1824 Settings

1. Hold [SHIFT] and press [EXT SYNC].
2. Move the cursor to Sync Source and use the TIME/VALUE dial to select “INT.”
3. Move the cursor to Sync Gen and use the TIME/VALUE dial to select “MTC.”
4. Press [F6 (Exit)], then press [F4 (MIDI)].
5. Move the cursor to MIDI Thru and use the TIME/VALUE dial to select “Out.”
6. Press [PLAY (DISPLAY)] to return to the Playlist display.

Press [PLAY] on the VS-1824 and Logic will play in sync with the VS-1824. Logic will automatically recognize the frame rate that the VS-1824 is using. If it is different than the frame rate set in Logic, a pop-up window will appear allowing you to adjust Logic’s frame rate accordingly.

Digital Performer

Digital Performer™ is available for Macintosh computers. Version 2.41 was used for this explanation.

FreeMIDI

FreeMIDI is a software program used by Performer to coordinate the various devices in your MIDI studio. When connecting a VS-1824 to Performer, the first thing you need to do is create a VS-1824 device in your FreeMIDI setup. You should only have to do this once.

FreeMIDI Configuration

1. From Performer, click on “Edit FreeMIDI Configuration” in the Basics Menu.
2. Click on “Create Device” from the Configuration menu. The FreeMIDI Device Specification window will appear.
3. Click on “Roland” in the Manufacturer pop-up menu and click on “Other” in the Model pop-up menu.
4. Click in the Name box and type “VS-1824.”
5. Click in the Device ID box and select “17.”
6. Click on “Receives MTC,” “Transmits MTC,” and “MIDI Machine” under the Properties menu.
7. Click on “Icons...” and select an icon for the VS-1824. Click on “OK.”
8. Click and drag from the MIDI IN and OUT on the VS-1824 icon to the MIDI IN and OUT on the MIDI Interface icon. You should now see them connected on the screen.
9. Click on “Return” in the MIDI menu to return to Performer.

Performer as Master Device

There are several methods that can be used to synchronize Performer with the VS-1824. This example uses MTC and MMC, with Performer controlling playback on the VS-1824.

Connections

1. Connect the MIDI OUT port of your MIDI interface to the MIDI IN port of the VS-1824.
2. Connect the MIDI OUT port of the VS-1824 to the MIDI IN port of your MIDI interface.

Performer Settings

1. Click on “Receive Sync” in the Basics menu.
2. Click on the MIDI interface port that is connected to the VS-1824 in the Sync to Port pop-up menu.
3. Click on “MTC, DTL, or DTLe” under Type of Sync.
4. Click on “30 fps” under SMPTE Frame Format.
5. Click on “OK.”
6. Click on “Transmit Sync...” in the Basics menu.
7. Click on “None” under Transmit beat clocks via port(s).
8. Click on “OK.”
9. Click on “Slave to External Sync” in the Basics menu. A check mark will appear next to it.

VS-1824 Settings

1. Hold [SHIFT] and press [EXT SYNC].
2. Move the cursor to Sync Source and use the TIME/VALUE dial to select “INT.”
3. Move the cursor to Sync Gen and use the TIME/VALUE dial to select “MTC.”
4. Move the cursor to Sync MTC Type and use the TIME/VALUE dial to select “30.”
5. Press [F6 (Exit)], then press [F4 (MIDI)].
6. Move the cursor to Device ID and use the TIME/VALUE dial to select “17.”
7. Move the cursor to MIDI Thru and use the TIME/VALUE dial to select “Out.”
8. Move the cursor to SysEx.Rx and use the TIME/VALUE dial to select “On.”
9. Move the cursor to MMC and use the TIME/VALUE dial to select “Slave.”
10. Press [PLAY (DISPLAY)] to return to the Playlist display.

Click on the Play icon in Performer. The VS-1824 should begin playback in sync with Performer. If not, check your FreeMIDI settings and the MIDI connections to your computer.

VS-1824 as Master Device

The next example uses MTC with the VS-1824 controlling the playback of Performer.

Connections

1. Connect the MIDI OUT port of the VS-1824 to the MIDI IN port of your MIDI interface.

Performer Settings

1. Click on “Receive Sync...” in the Basics menu.
2. Click on “MTC, DTL, or DTLe” under Type of Sync.
3. Click on “30 fps” under SMPTE Frame Format.
4. Click on “OK.”
5. Click on “Slave to External Sync” in the Basics menu so that there is a check mark next to it.

VS-1824 Settings

1. Hold [SHIFT] and press [EXT SYNC].
2. Move the cursor to Sync Source and use the TIME/VALUE dial to select “INT.”
3. Move the cursor to Sync Gen. and use the TIME/VALUE dial to select “MTC.”
4. Move the cursor to Sync MTC Type and use the TIME/VALUE dial to select “30.”
5. Press [F6 (Exit)], then press [F4 (MIDI)].
6. Move the cursor to MIDI Thru and use the TIME/VALUE dial to select “Out.”
7. Press [PLAY (DISPLAY)] to return to the Playlist display.

Click on the Play icon in Performer (it will start flashing). Press [PLAY] on the VS-1824 and Performer should begin playback in sync with the VS-1824. If not, check your FreeMIDI settings and the MIDI connections to your computer.

Vision DSP

Vision DSP™ (referred to hereafter as “Vision”) is available for Macintosh and IBM compatible computers. Version 4.1 on a Macintosh is used in this example.

Open MIDI System (OMS)

OMS is a software program used by Vision to coordinate the various devices in your MIDI studio. When using a VS-1824 with Vision, the first thing you need to do is create a VS-1824 device in your OMS setup. You should only have to do this once.

OMS Configuration

1. Click on “OMS Studio Setup...” in the Setups menu in Vision.
2. Click on “New Device” in the Studio menu.
3. Click on “Roland” in the pop up menu next to Manuf.
4. Click on “Other” in the pop-up menu next to Model.
5. Click in the “Name” box and type “VS-1824.”
6. Click in the “is controller” and “is multitimbral” boxes so that a checkmark appears.
7. Click in the “Receive Channels” boxes for all 16 MIDI channels so that a checkmark appears.
8. Click in the “Receives” and “Sends” boxes for MTC and MMC, and click in the “Sends” box for MIDI Beat Clock so that a checkmark appears.
9. Click on “Device ID” and select “16.”
10. Click “OK.”
11. Click on the VS-1824 icon in the open window. Click on “Device Icon” in the Studio menu and choose the desired icon for the VS-1824.
12. Click on “Save,” followed by “Quit” in the File menu.

Vision as Master Device

There are several methods that can be used to synchronize Vision with the VS-1824. This example uses MTC and MMC with Vision controlling playback in the VS-1824.

Connections

1. Connect the MIDI OUT port of your MIDI interface to the MIDI IN port of the VS-1824.
2. Connect the MIDI OUT port of the VS-1824 to the MIDI IN port of your MIDI interface.

Vision Settings

1. Click on “Sync Options...” in the Options menu.
2. Click on “MIDI Time Code” in the pop-up menu next to Receive Sync.
3. Click on “30 fps, non drop” in the pop-up menu next to SMPTE Format.
4. Click on “OK.”

VS-1824 Settings

1. Hold [SHIFT] and press [EXT SYNC].
2. Move the cursor to Sync Source and use the TIME/VALUE dial to select “INT.”
3. Move the cursor to Sync Gen and use the TIME/VALUE dial to select “MTC.”
4. Move the cursor to Sync MTC Type and use the TIME/VALUE dial to select “30.”
5. Press [F6 (Exit)], then press [F4 (MIDI)].
6. Move the cursor to Device ID and use the TIME/VALUE dial to select “17.”
7. Move the cursor to MIDI Thru and use the TIME/VALUE dial to select “Out.”
8. Move the cursor to SysEx Rx and use the TIME/VALUE dial to select “On.”
9. Move the cursor to MMC and use the TIME/VALUE dial to select “Slave.”
10. Press [PLAY (DISPLAY)] to return to the Playlist display.

Click on the Play icon in Vision. The VS-1824 should begin playback in sync with Vision. If not, check the MIDI connections and OMS settings in your computer.

VS-1824 as Master Device

The next example uses MTC, with the VS-1824 controlling the playback of Vision.

Connections

1. Connect the MIDI OUT port of the VS-1824 to the MIDI IN port of your MIDI interface.

Vision Settings

1. Click on “Sync Options...” in the Options menu.
2. Click on “MIDI Time Code” in the pop-up menu next to Receive Sync.
3. Click on “30 fps, non drop” in the pop-up menu next to SMPTE Format.
4. Click on “Remote Start,” so it is checked.
5. Click on “OK.”

VS-1824 Settings

1. Hold [SHIFT] and press [EXT SYNC].
2. Move the cursor to Sync Source and use the TIME/VALUE dial to select “INT.”
3. Move the cursor to Sync Gen and use the TIME/VALUE dial to select “MTC.”
4. Move the cursor to Sync MTC Type and use the TIME/VALUE dial to select “30.”
5. Press [F6 (Exit)], then press [F4 (MIDI)].
6. Move the cursor to Device ID and use the TIME/VALUE dial to select “17.”
7. Move the cursor to MIDI Thru and use the TIME/VALUE dial to select “Out.”
8. Press [PLAY (DISPLAY)] to return to the Playlist display.

Click on the Play icon in Vision, it will start to flash. Press [PLAY] on the VS-1824 and Vision should start playback in sync with the VS-1824. If not, check the MIDI connections and OMS settings in your computer.

Chapter 17 Using Hard Drives

This chapter explains basic concepts, internal structure, and basic operation regarding the use of hard drives with the VS-1824. Read this chapter thoroughly to gain a better understanding of how the VS-1824 operates.

General Information Regarding Hard Drives



The internal hard disk is not removable.

Drive Partitioning

The internal hard drive has 5 partitions. The size of each partition is 2000 MB. If you would like to change partition size, please refer to drive initializing on p. 229.

The VS-1824 is able to manage 500 MB, 1000 MB or 2000 MB of disk space at once. If you use a disk drive with a capacity that is greater than this, you will need to divide it into two or more areas.

Each of these area is referred as a “partition.” Up to eight partitions can be created in a single disk drive.

Ex. 1: When the disk drive is 10 GB, and the partition size is 2000 MB.

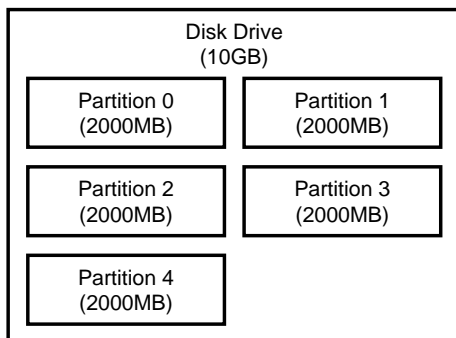

Ex. 2: When the disk drive is 10 GB, and the partition size is 1000 MB.

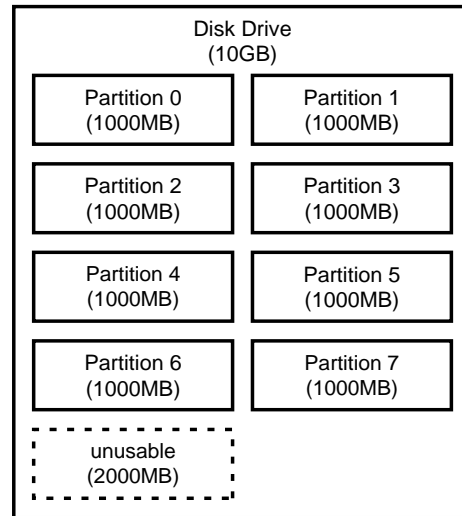

Each partition on the VS-1824’s disk drive is treated as an independent drive, and automatically given a partition number (0–7). When a single hard disk has multiple partitions, you can specify which partition drive will be used (“Drive Select,” p. 228). This selected disk drive partition used is referred to as the “current drive.”

- * *If you wish to use hard disks or song data with both the VS-1824 and the VS-880/1680/880EX/890/VSR-880, there will be limitations as to what you can do due to factors such as differing partition sizes and numbers of tracks. For more detailed information, please see “Drive Compatibility,” p. 245. VS-1880's song data is identical to that of the VS-1824.*

Recording Times vs. Sample Rate/Recording Modes

The available recording time for a hard drive depends on a number of factors, including the size of the drive, the sample rate, the recording mode and the total number of tracks recorded. Both the recording mode and sample rate can be selected on a song-by-song basis. Recording time in track minutes for a 2000 MB partition is shown below:



Track Minutes (see Appendices p. 13).

Recording Mode	Sample Rate		
	48 kHz	44.1 kHz	32 kHz
MTP	742 mins.	808 mins.	1114 mins.
CDR/MAS	370 mins.	404 mins.	556 mins.
MT1	742 mins.	808 mins.	1114 mins.
MT2	990 mins.	1078 mins.	1484 mins.
LIV1	1188 mins.	1292 mins.	1782 mins.
LIV2	1484 mins.	1616 mins.	2228 mins.

(All times are approximate)

* *The above chart is a general yardstick for estimating record times. Actual times may vary slightly depending on your hard drive's specifications or the number of songs created.*

Checking Remaining Space

The amount of free drive space available for recording is displayed under "Remain" in the upper part of the Playlist display when Song Information is shown. Hold [SHIFT] and press [PLAY (DISPLAY)] to switch Playlist display screens.

* "Remain" does not appear while the level meters or fader/pans are displayed (p. 39).

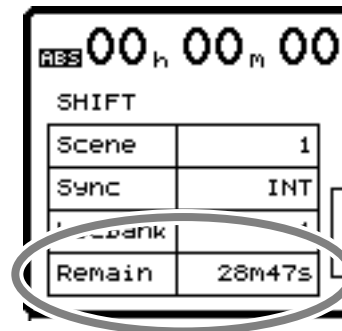

1. Hold [SHIFT] and press [F5 (SYSTEM)].
The System menu icon is displayed. If the System menu icon does not appear, press [F6 (EXIT)].
2. Press [F1 (SYSPM)].
If "SYSPM" does not appear above [F1], first press [PAGE] until "SYSPM" appears, and then press [F1 (SYSPM)].
3. Use [▲], [▼], [◀], and [▶] to move the cursor to "Remain Display." If "Remain Display" is not displayed, press [F2 (Prm2)].
4. Use the TIME/VALUE dial to change the setting for Remain Display.

Remain Display (Remaining Display)

This selects the units of measurements for the remaining drive space.

Time:

The remaining time for recording is shown in minutes and seconds.

CapaMB:

The remaining space on the hard drive is shown in megabytes.

Capa %:

The remaining space on the hard drive is shown as a percentage of the space originally available.

Event:

This shows the remaining number of events available during for recording and mixing.

5. Press [PLAY (DISPLAY)] to return to the Playlist display.

Recovering Drive Space

There may be times when the remaining space becomes low. You may want to recover drive space without initializing (formatting) the hard drive.

Song Optimize

When operations such as overdubbing and punch-in recording are repeated, the older data remains on the drive. This storage of this material can be a great advantage because it enables the VS-1824 to have an Undo function (p. 62) that can, for example, recover data that was recorded-over by accident.

In some cases, significant amounts of memory can be used by this older data, decreasing the available space on the current drive, and shortening the length of time available for recording. You can free up drive space by erasing this old data from the drive. The deletion of unnecessary data and the freeing of available space on the drive is referred to as “Song Optimize.” This operation cannot be undone with the Undo function, and will erase all previous Undo levels.

For example, if you record on a track, then rewind and record over again on the same track without selecting a different V-Track, the first recording will reside on the hard drive even though it cannot be heard during playback. Song Optimize permanently removes these recordings that are “covered up” by other recordings. V-Tracks that are not currently selected will not be erased.

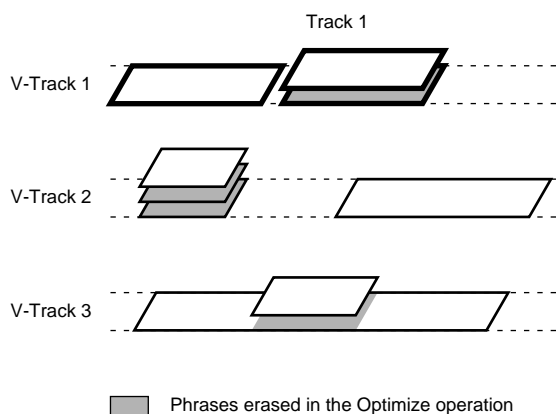

1. Select the song you want to optimize as the current song (p. 49).
2. Hold [SHIFT] and press [F1 (SONG)].
The Song Menu icon appears in the display.
3. Press [F5 (OPTIM)].
If “OPTIM” does not appear in the display above [F5], press [PAGE] until “OPTIM” appears, and then press [F5 (OPTIM)].
4. “Song Optimize, Execute ?” appears in the display. Press [F4 (EXEC)]. Or, if you wish to cancel Song Optimize, press [F6 (EXIT)].
5. “Optimize Sure ?” appears in the display. Press [ENTER/YES]. Or, if you wish to cancel the procedure, press [EXIT/NO].
6. “Optimize Really Sure?” appears in the display. Press [ENTER/YES]. Or, if you wish to cancel the procedure, press [EXIT/NO].

When Song Optimize is finished, the screen returns to the Playlist display.

- * It may take some time for the Song Optimize operation to complete. This is not a malfunction. Do not turn the power off until the Optimize operation is completed.
- * Do not use the Undo function immediately after performing the Song Optimize function. Undo information is deleted during the Song Optimize procedure, and using Undo immediately after Song Optimize may result in lost data.

Song Erase

Eventually you will probably need to remove songs from the hard drive. This may be done to increase the amount of recording time available on the drive or because you no longer need to keep a particular song. The Song Erase function is used to delete song data from the current drive. If you would like to use a song at a later time, make sure you back that song up (p. 232) before you erase it, since the Song Erase operation cannot be undone.

1. Select the drive that contains the song you want to erase as the current drive (p. 228).
2. Hold [SHIFT] and press [F1 (SONG)].
The Song Menu icon appears in the display.
3. Press [F6 (Erase)].
If “Erase” does not appear in the display above [F6], press [PAGE] until “Erase” appears, and then press [F6 (Erase)].
4. Use the TIME/VALUE dial to move the cursor to the song you want to erase, then press [F3 (MARK)]. A mark is placed next to the song. Pressing [F3 (MARK)] alternately places or deletes the mark. When [F2 (ALL)] is pressed, you can place or remove marks from all songs simultaneously.

Or, if you want to cancel the Song Erase operation, press [F6 (EXIT)].

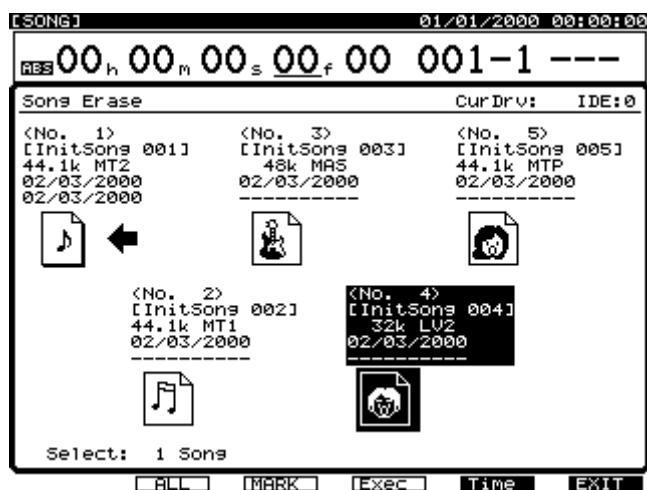

5. Press [F4 (Exec)]. A Song Erase confirmation message appears in the display. Press [ENTER/YES] to continue, or if you wish to cancel Song Erase, press [EXIT/NO].



6. “Song Erase: Are you really sure ?” appears in the display. Press [ENTER/YES] to continue, or if you wish to cancel the procedure, press [EXIT/NO].
7. If the song you are erasing is not the current song, “STORE Current ?” appears in the display. If you wish to save the current song, press [ENTER/YES]. Otherwise, press [EXIT/NO]. If the current song is a demo song, then press [EXIT/NO].

When the Song Erase process is finished, the screen returns to the Playlist display.

Using External Hard Drives

External SCSI drives can be connected to the SCSI connector on the VS-1824. This section will explain using external (both fixed and removable) drives with the VS-1824. For more information about SCSI drives, see “About SCSI” (Appendices p. 4).

Selecting an External Hard Drive

Most SCSI hard drives that adhere to AV specifications will work with the VS-1824. Bear in mind that drives that do not meet AV specs, though not recommended for recording and playback, are often still reliable for data storage. The VS-1824 can format a compatible drive in either 1 GB or 2 GB partitions and can also access up to eight partitions. Therefore, up to 16 gigabyte drives can be fully utilized by the VS-1824.

Suggested specifications for external SCSI hard drives:

- 13 ms access time
- No or intelligent recalibration
- Active termination
- 1:1 interleave
- Slip sectoring
- Macintosh-compatible

Connecting a Fixed External Hard Drive

Use the following procedure to connect an external drive to the VS-1824.

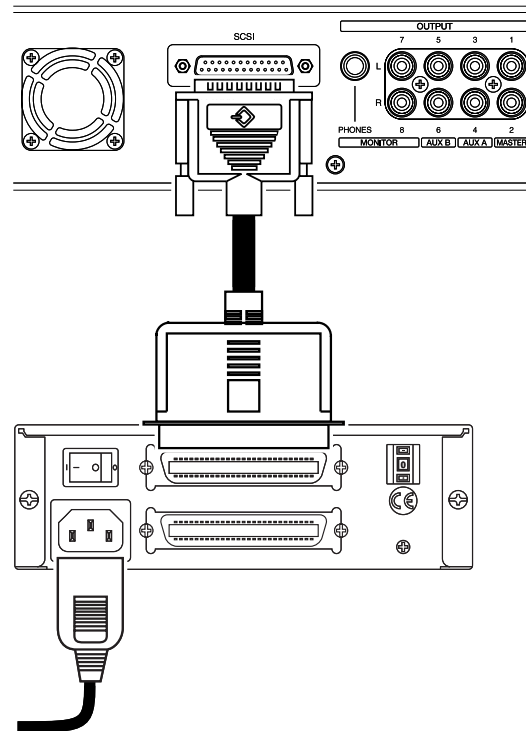

* Once the connections have been completed, turn on the power to your various devices in the order specified. You can cause malfunction and/or damage to your speakers and other devices if you turn on devices in the wrong order.

* Always make sure to have the volume level turned down before switching on power. Even with the volume all the way down, you may still hear some sound when the power is switched on, but this is normal, and does not indicate a malfunction.

1. Make sure that the power for all SCSI and audio devices is turned off, and connect the external SCSI device to the 25-pin SCSI port on the rear panel of the VS-1824.

NOTE

WARNING: Only SCSI devices can be connected to the SCSI port on the VS-1824. Connecting non-SCSI devices (including parallel devices, which have a similar connector) can damage the VS-1824.

2. Turn on the power of the external drive.
3. Turn on the power of the VS-1824 with the POWER switch on the rear panel.
4. Turn on the power of the connected audio equipment.
5. Raise the volume of the audio devices to appropriate levels.

Connecting a Removable External Hard Drive

It is possible to connect a removable external hard drive, such as a Zip® drive, to the SCSI connector on the VS-1824. Use the following procedure to connect an external removable drive to the VS-1824.

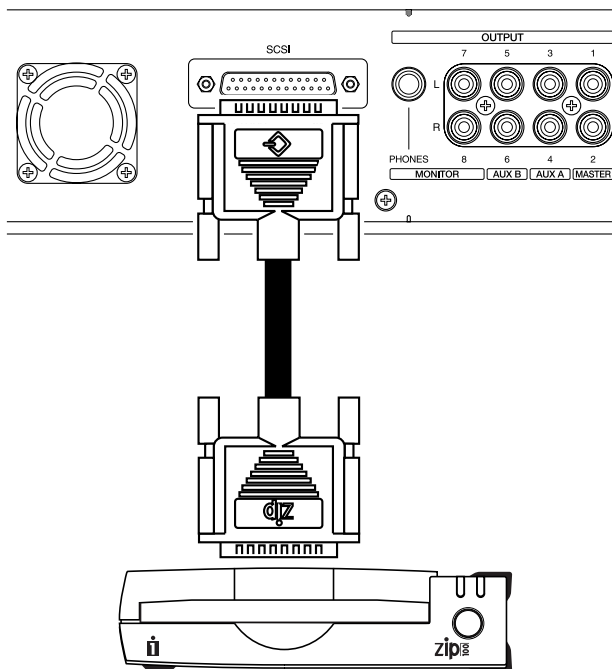

* Once the connections have been completed, turn on the power to your various devices in the order specified. You can cause malfunction and or damage to your speakers and other devices if you turn on devices in the wrong order.

* Always make sure to have the volume level turned down before switching on power. Even with the volume all the way down, you may still hear some sound when the power is switched on, but this is normal, and does not indicate a malfunction.

1. Make sure that the power for all SCSI and audio devices is turned off and connect the external SCSI device to the 25-pin SCSI port on the rear panel of the VS-1824.

NOTE

WARNING: Only SCSI devices can be connected to the SCSI port on the VS-1824. Connecting non-SCSI devices (including parallel devices, which have a similar connector) can damage the VS-1824.

2. Turn on the power of the external drive.
3. Turn on the power of the VS-1824 with the POWER switch on the rear panel.
4. Turn on the power of connected audio equipment.
5. Raise the volume of the audio devices to appropriate levels.

Before Using the Zip Disk Drive

Handling the Zip Disk Drive

- Install the unit on a solid, level surface in an area free from vibration. If the unit must be installed at an angle, be sure the installation does not exceed the permissible range.
- Avoid using the unit immediately after it has been moved to a location with a level of humidity that is greatly different than its former location. Rapid changes in the environment can cause condensation to form inside the drive, which will adversely affect the operation of the drive and/or damage ZIP disks. When the unit has been moved, allow it to become accustomed to the new environment (allow a few hours) before operating it.
- Remove any disk from the drive before powering up or down.
- To prevent damage to the disk drive's heads, always try to hold the ZIP disk in a level position (not tilted in any direction) while inserting it into the drive. Push it in firmly, but gently. Never use excessive force.
- To avoid the risk of malfunction and/or damage, insert only ZIP disks into the disk drive. Never insert any other type of disk. Avoid getting paper clips, coins, or any other foreign objects inside the drive.

Handling Zip Disks

- ZIP disks contain a plastic disk with a thin coating of magnetic storage medium. Microscopic precision is required to enable storage of large amounts of data on such a small surface area. To preserve their integrity, please observe the following when handling ZIP disks:
 - Never touch the magnetic medium inside the disk.
 - Do not use or store ZIP disks in dirty or dusty areas.
 - Do not subject ZIP disks to temperature extremes (e.g., direct sunlight in an enclosed vehicle). Recommended temperature range: -22 to 51° C (-7.6 to 123.8° F).
 - Do not expose ZIP disks to strong magnetic fields, such as those generated by loudspeakers.
- The identification label should be firmly affixed to the disk. Should the label come loose while the disk is in the drive, it may be difficult to remove the disk.
- Store all disks in a safe place to avoid damaging them, and to protect them from dust, dirt, and other hazards. By using a dirty or dust-ridden disk, you risk damaging the disk, as well as causing the disk drive to malfunction.

Initializing (Formatting) the Drive

A new drive, or a drive that was used by another device, cannot be used on the VS-1824 as is. You must initialize the drive so it can be used by the VS-1824. When a drive is initialized, all existing data on that drive is erased—all of its contents are irretrievably lost. Check any such drive you plan to initialize to make sure it does not contain anything you don't want deleted. Drives used with the VS-1824 cannot be used on other devices, such as personal computers.

* *If you accidentally delete data, that data cannot be restored to its previous state. Roland Corporation assumes no liability concerning such loss of data.*

NOTE

CAUTION: If you are using a drive or disk that has been partitioned, you will not be able to choose a particular partition to initialize. When you initialize a drive, the whole drive and all of its partitions will be initialized at the same time.

To initialize a new drive:

1. Confirm that power to the drive and the VS-1824 are turned on.
2. If you are using a removable type drive insert a disk into the drive.
3. Press [PLAY (DISPLAY)].
4. Hold [SHIFT] and press [F6 (UTILITY)].
The Utility menu icon appears in the display.
5. Press [F6 (DrIni)].
If "DrIni" does not appear in the display above [F6], first press [PAGE] until "DrIni" is displayed, and then press [F6 (DrIni)].
6. Use [▲], [▼], [◀], and [▶] to move the cursor, and use the TIME/VALUE dial to set each value.

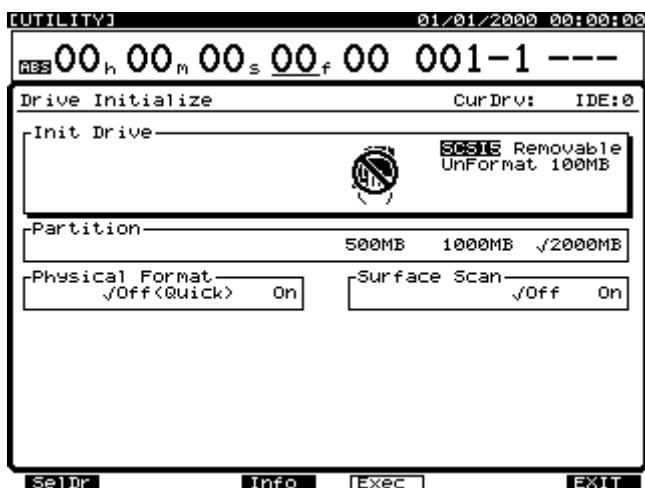

Init Drive (Initialize Drive)

Select the drive (IDE, SCSI0-SCSI7). "IDE" indicates the internal hard drive, and "SCSI" indicates external SCSI drives. For example, use "SCSI5" or "SCSI6" to select a Zip drive, depending on the Zip drive's settings.

Partition

Select the partition size (500 MB, 1000 MB, 2000 MB). In most cases, select "2000 MB."

Physical Format

Select whether or not to use physical formatting. For new drives, or drives that have been used by another device, this should be set to "On."

* *If you are initializing a Zip 250 MB cartridge, set Physical Format to "Off."*

Surface Scan

This confirms that the read and write functions in all of the drive's partitions are operating correctly when the drive is initialized. In normal circumstances, set this to "Off." When you specifically want to conduct a test of the read/write functions, set this to "On".

The function buttons work as shown:

[F1 (DrSel)]:

Displays a directory of the currently connected drives. Use [▲], [▼], [◀], and [▶] to move the cursor to the drive you want to initialize.

[F3 (Info)]:

Displays the drive information.

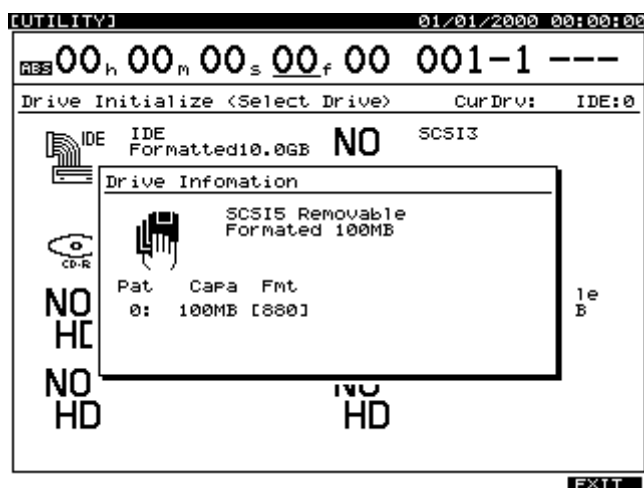

[F4 (Exec)]:

Executes initialization of the selected drive.

[F6 (EXIT)]:

Exits the screen.

7. When the settings are made, press [F4 (Exec)].
“Initialize *** OK ?” appears in the display. “***” refers to the selected drive’s SCSI number. For example, “SCSI5” indicates an external drive that is set to SCSI ID #5.
8. Press [ENTER/YES] to confirm that you wish to Initialize (“Initialize ****, Sure?” appears in the display), or [EXIT/NO] to cancel the operation.
9. Press [ENTER/YES]. “STORE Current ?” appears in the display. Press [ENTER/YES] to store the current song; otherwise press [EXIT/NO].

After the initialization is completed, the VS-1824 restarts automatically, and returns to the Playlist display.

NOTE

Be aware that initializing a drive requires some time. This is not a malfunction. For example, when physical format is turned “On,” the time required to format a 100MB Zip disk™ is approximately 10 minutes. The progress of initialization will be shown in the display. Be sure not to turn the power off until initialization is complete.

Saving a Song to an External Drive (Song Copy)

You can save a song created on the VS-1824 to an external drive, such as a Zip drive. This is a good way to have the song backed up in the event of possible drive problems, or to get back drive space when little space on the internal IDE remains. We recommend keeping multiple backup copies of important songs.

** Incorrectly using the Song Copy procedure may result in loss of data. Roland Corporation assumes no liability concerning such loss of data. Furthermore, Roland does not warrant any copied data, regardless of the performance or condition of the external drive.*

There are two ways to use Song Copy: Song Copy Playable and Song Copy Archives. The method you choose depends on the amount of free space on the destination disk (for example, 100 MB for Zip disks). The size of the current song is shown in the display.

Song Copy Playable (p. 224)

Use Song Copy Playable when the total size of the song is less than the total size of available space on the removable disk drive. For example, use Song Copy Playable to copy a 93MB song onto a 100MB disk.

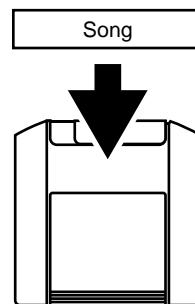

Song Copy Archives (p. 225)

Use Song Copy Archives for removable drives when the total size of the song is more than the total size of available space on the disk. For example, use Song Copy Archives to copy a 247MB song onto three 100MB disks. The song data is converted into a data format specifically for saving it across multiple disks (archives format). The song is copied across multiple disks according to the available space on each disk. This means it is not possible to directly play back song data from one disk. To play back song data copied using the Song Copy Archives format, it must first be copied back onto the VS-1824's hard drive using the Song Copy Extract procedure. If song data is copied onto disks that already have data on them, the older data will be erased.

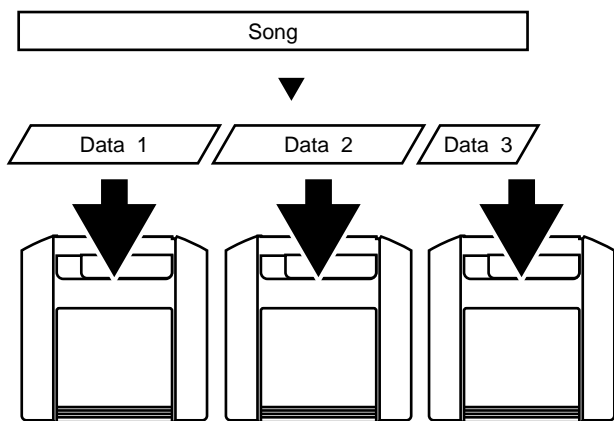

Before copying a song to an external removable drive, you may want to use Optimize (See "Song Optimize," p. 218) to reduce the memory required to store the song.

Song Copy Playable

Use the following procedure to copy a song from the VS-1824's internal hard drive to a removable disk drive (such as a Zip drive) that is set to SCSI ID 5:

1. Select the drive containing the source song you want to copy as the current drive (p. 228).
2. Press [PLAY (DISPLAY)].
3. Hold [SHIFT] and press [F1 (SONG)].
The Song Menu icon is displayed.
4. Press [F1 (CP PL)]. If "CP PL" does not appear above [F1], press [PAGE] until "CP PL" appears above [F1], and then press [F1 (CP PL)].

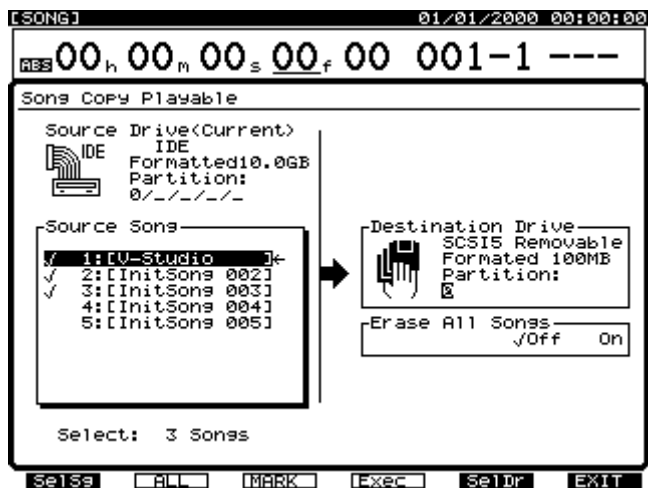

5. Use [◀] and [▶] to move the cursor to "Source Song."
6. Use the TIME/VALUE dial to move the cursor to the song you want to copy and press [F3 (MARK)].
By pressing [F2 (ALL)], you can place and remove Marks from all songs. Press [F1 (SelSg)] to view a directory of songs. From here, after you have placed a Mark at the song(s) you want to copy, press [F1 (Back)].

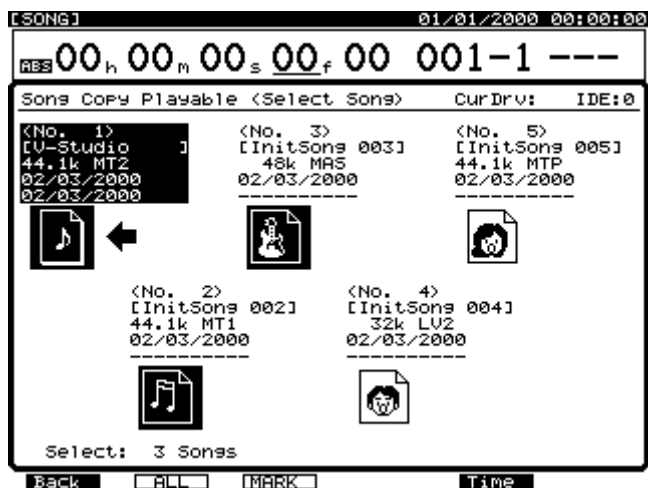

7. Press [▶] to move the cursor to “Destination Drive.”
8. Use the TIME/VALUE dial to select the destination drive and partition. Press [F5 (SelDr)] to view a directory of drives. Then use [▲], [▼], [◀], and [▶] to select the destination drive, and use the TIME/VALUE dial to select the partition. Once you have selected the destination drive, press [F1 (Back)].

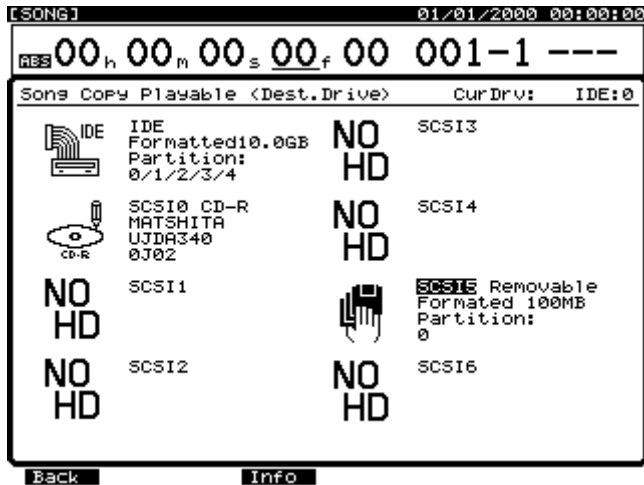

9. If the source and the destination drives are different, press [▼]. Move the cursor to “Erase All Songs” and use the TIME/VALUE dial to set the value.

Erase All Songs

When this is set to “On,” the destination drive is initialized before the copy procedure is performed. If you want to perform the Song Copy procedure without erasing any songs currently on the destination drive, leave this setting “Off.”

10. Press [F4 (Exec)]. A confirmation message appears in the display.
11. Press [ENTER/YES]. “STORE Current ?” appears in the display. Press [ENTER/YES] if you want to save changes made to the current song, otherwise press [EXIT/NO].
12. When the Song Copy Playable procedure is finished, the screen returns to the Playlist display.

If “Disk Memory Full” Appears in the Display

This indicates the destination drive does not have enough free space, or the number of songs on the destination drive exceeds the maximum number (200 songs) that can be stored on the drive. If this message appears, the Song Copy procedure is canceled.

Song Copy Archives

Use the following procedure to copy a song that cannot fit on a single disk:

1. Select the drive containing the source song you want to copy as the current drive (p. 228).
2. Press [PLAY (DISPLAY)].
3. Hold [SHIFT] and press [F1 (SONG)].
The Song menu icon is displayed.
4. Press [F2 (AcStr)].
If “AcStr” does not appear above [F2], press [PAGE] until “AcStr” appears above [F2], and then press [F2 (AcStr)].

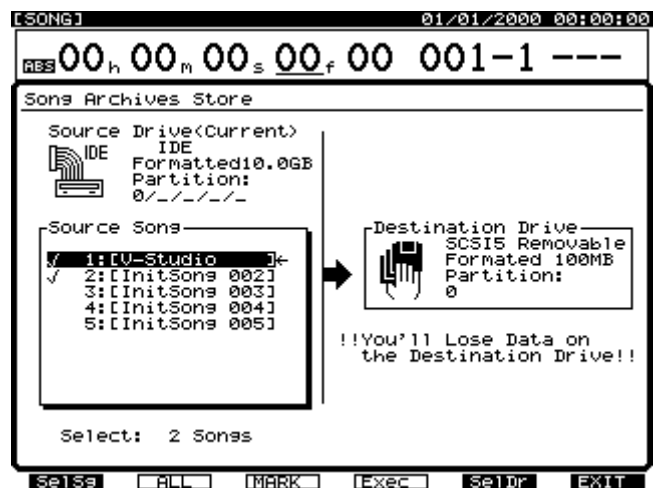

5. Press [◀] to move the cursor to “Source Song.”
6. Use the TIME/VALUE dial to move the cursor to the song you want to copy and press [F3 (MARK)]. By pressing [F2 (ALL)], you can place and remove Marks from all songs. Press [F1 (SelSg)] to view a directory of songs. From here, after you have Marked the song(s) you want to copy, press [F1 (Back)].

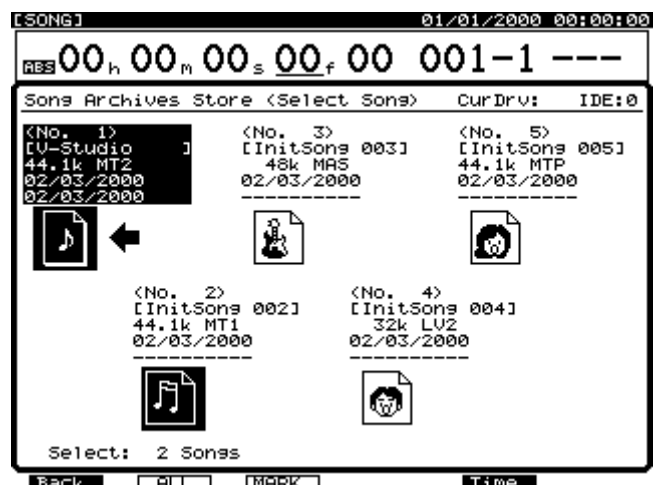

7. Press [▶] to move the cursor to “Destination Drive.”

- Use the TIME/VALUE dial to select the destination drive and partition. Press [F5 (SelDr)] to view a directory of drives. Then use [▲], [▼], [◀], and [▶] to select the destination drive, and use the TIME/VALUE dial to select the partition. Once you have selected the destination drive, press [F1 (Back)].

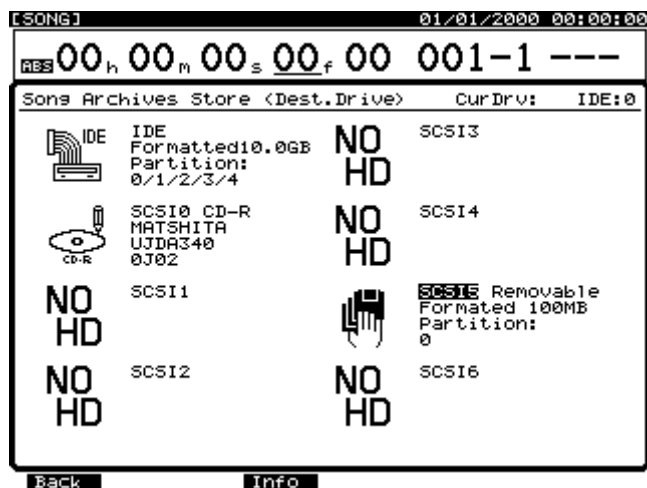

- Press [F4 (Exec)]. A confirmation message appears in the display.
- Press [ENTER/YES]. "STORE Current?" appears in the display. Press [ENTER/YES] if you want to save changes made to the current song, otherwise press [EXIT/NO].

* All data currently on the removable disk will be deleted. Do not use any disks for Song Copy Archives that contain data you want to save.

- When the first disk in the external drive (destination drive) is full, the disk is ejected and the message "Please Insert Disk" appears in the display. Insert the next disk and press [ENTER/YES]. It is a good idea to write the disk numbers on the labels to remember the order in which the disks were used.
- The message "Insert Disk # " will appear in the display. (# indicates the number in the order the disks were written). Insert each disk as requested and press [ENTER/YES]. When the Song Copy Archives procedure is finished, the screen returns to the Playlist display.

Handling Song Copy Archives Disks

When you save songs using the Song Copy Archives method, the destination disks are initialized automatically. This initialization differs from the usual Drive Initialize formatting (p. 222). Since disks are initialized automatically, you can use the Song Copy Archives procedure with newly purchased disks, disks that were used with another device, or other unformatted disks. However, any older data residing on the disks is lost once the Archives procedure is performed. Do not designate a disk that contains archive song data as the current drive. If you try to do this, the disk will be identified as an uninitialized disk.

Loading a Song from an External Drive

Loading a Song from an External Drive Using Song Copy Playable

To copy songs from an external drive into the internal drive, first switch the current drive (the drive or partition in active use) to the external drive's SCSI ID using Drive Select, as described below. Then use Song Copy Playable to copy the song from the external drive to the internal drive.

* If you copy a song from the external drive back to the internal drive without first erasing the original song from the internal drive, the original song is not overwritten. A new song is created with the same name as the original and is written to the lowest available song number.

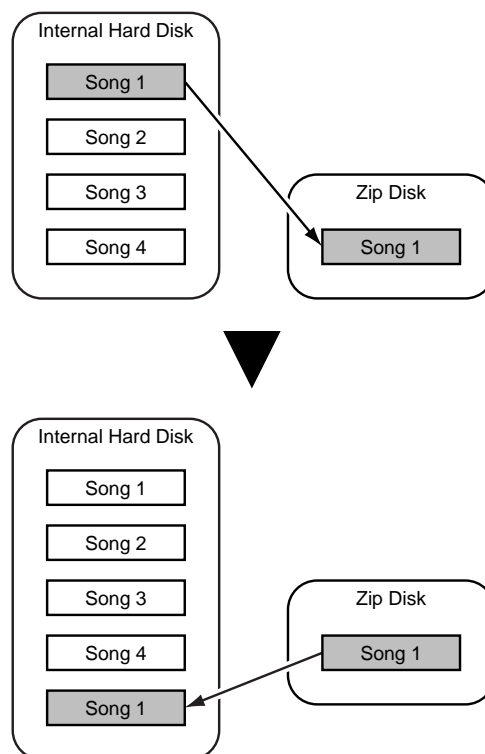

- Confirm that the power on both the VS-1824 and the external drive are turned on.
- If you are using a removable-type drive, insert a disk into the drive.
- Press [PLAY (DISPLAY)].
- Hold [SHIFT] and press [F6 (UTILITY)]. The Utility menu icon appears in the display.

- Press [F4 (DrSel)].
If “DrSel” does not appear in the display above [F4], first press [PAGE] until “DrSel” is displayed, and then press [F4 (DrSel)]. A list of currently connected drives appears in the display.
- Use [▲], [▼], [◀], and [▶] to move the cursor. Select the drive that contains the song you wish to recover. Use the TIME/VALUE dial to select the correct partition (if necessary).

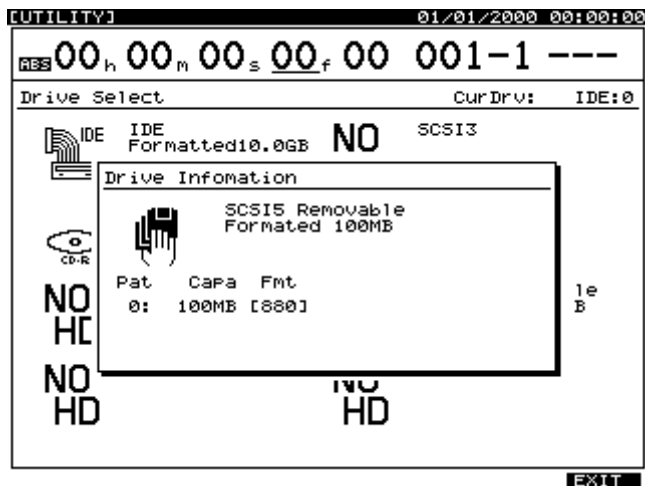

- After you have selected the drive and partition, press [F4 (Exec)].
- A confirmation message appears in the display. Press [ENTER/YES].
- “STORE Current ?” appears in the display.
Press [ENTER/YES] if you want to save changes made to the current song, otherwise press [EXIT/NO]. After the current drive changes to the one you selected, the screen returns to the Playlist display.
- Follow the procedure described in “Song Copy Playable” (p. 224), to make a copy of the song from the external drive to the internal (IDE) drive. Make sure you select the IDE drive as the destination drive so that the song is copied to the internal drive.
- After the Song Copy procedure is complete, repeat Steps 3-10 to select the internal IDE drive as the current drive (select the IDE drive in Step #6).

Loading a Song from External Disks using Song Archive Extract

Use the following procedure to restore a song saved using Song Copy Archives.

- Select the internal drive as the current drive.
- Insert Disk #1 created from a Song Copy Archives into the external drive.
- Press [PLAY (DISPLAY)].
- Hold [SHIFT] and press [F1 (SONG)].
The Song Menu icon appears in the display.
- Press [F3 (AcExt)].
If “AcExt” does not appear in the display above [F3], press [PAGE] until “AcExt” appears, and then press [F3 (AcExt)].

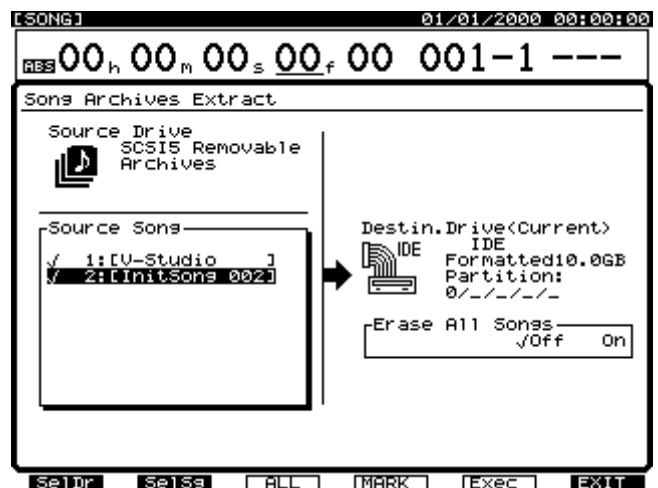

- If several external drives are connected to the VS-1824, press [F5 (SelDr)] to view a list of drives. Use CURSORS to select the drive that contains the Song Archive disk, and press [F1 (Back)].

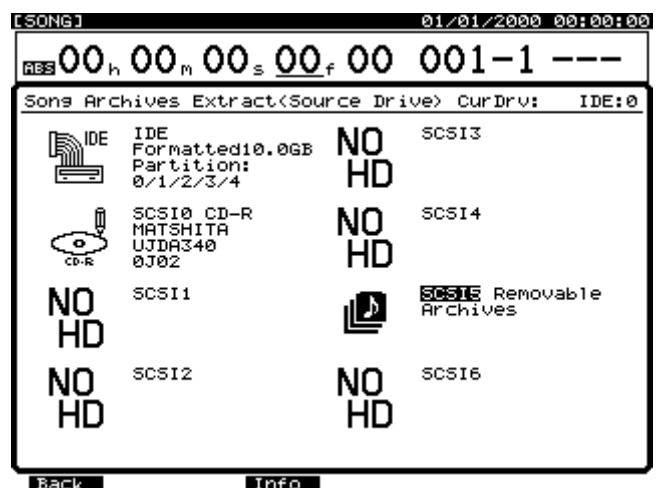

7. Use [◀] and [▶] to move the cursor to “Source Song.”

8. Use the TIME/VALUE dial to move the cursor to the song you want to extract and press [F3 (MARK)].

By pressing [F2 (ALL)], you can place and remove Marks from all songs. Press [F1 (SelSg)] to view a directory of songs. From here, after you have Marked the song(s) you want to extract, press [F1 (Back)].

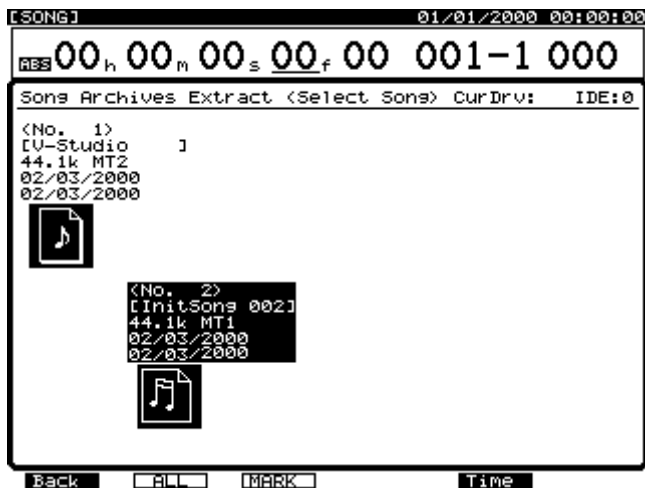

9. Press [▶] to move the cursor to “Erase All Songs” and use the TIME/VALUE dial to set the value.

Erase All Songs

When this is set to “On,” the destination drive is initialized before the Song Archive Extract procedure is performed. If you want to perform the extract procedure without erasing any songs on the destination drive, leave this “Off.”

10. Press [F4 (Exec)]. A confirmation message appears in the display.

11. Press [ENTER/YES]. “STORE Current ?” appears in the display. Press [ENTER/YES] if you want to save changes made to the current song; otherwise press [EXIT/NO].

12. Execute the Song Archives Extract. “Insert Disk #” appears in the display. Insert the correct disk number and press [ENTER/YES].

13. When the Song Archive Extract procedure is finished, the screen returns to the Playlist display.

Drive Select

To select either another partition of your internal (IDE) drive, or select another connected SCSI hard drive, use the following procedure:

1. Press [Play (Display)].

2. Hold [Shift] and press [F6 (Utility)].

The Utility menu appears in the display.

3. Press [F4 (DrSel)]. If “DrSel” does not appear in the display above [F4], first press [PAGE] until “DrSel” is displayed, and then press [F4 (DrSel)].

A list of partitions on the currently selected drive as well as other external SCSI drives connected is displayed.

4. Use [▲], [▼], [◀], and [▶] to move the cursor. Select the drive that you wish to make current. Use the TIME/Value dial to select the current partition.

[F3 (Info)]:

Displays the drive information.

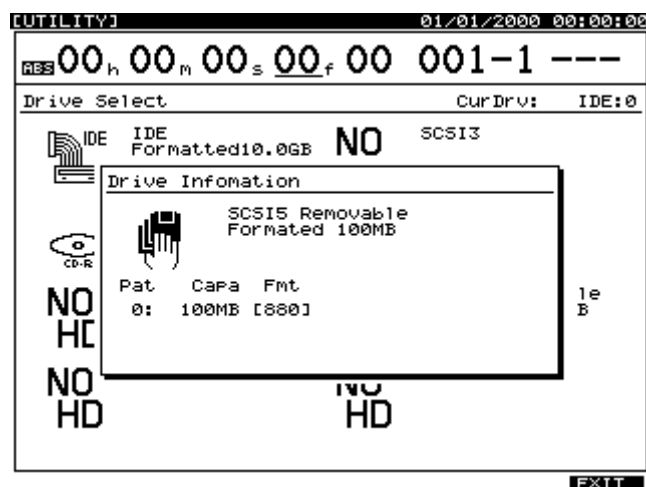

[F4 (Exec)]:

Executes selecting drive.

[F6 (EXIT)]:

Exits the screen.

5. Press [F4 (Exec)]. A confirmation message appears in the display.

6. Press [ENTER/YES]. “STORE Current ?” appears in the display. Press [ENTER/YES] to store the current song; otherwise press [EXIT/NO].

7. If you switch the current drive, the screen returns to the Playlist display.

Hard Drive Maintenance

When a drive is initialized, its entire contents are irretrievably lost. Make sure you make backups of any songs on the drive that you want to keep before you use drive initialize.

* *If you accidentally delete data, that data cannot be restored to its previous state. Roland Corporation assumes no liability concerning such loss of data.*



CAUTION: If you are using a drive or disk that has been partitioned, you will not be able to choose a particular partition that you wish to initialize. When you carry out drive initialization, the whole drive and all its partitions will be initialized at once.

Be aware that initializing a drive may take some time. This is not a malfunction. For example, when physical format is turned “On,” the time required to format a 100MB Zip disk is approximately 10 minutes. The progress of initialization will be shown in the display. Be sure not to turn the power off until initialization is complete.

Drive Initialize

As you use a hard drive, the data on the drive is recorded and erased repeatedly in whatever space is currently available, and the data may become fragmented on the hard drive. When this happens, the message “Error Drive Too Slow” may appear in the display during certain operations. In order to achieve maximum performance from the drive, perform the Initializing (Formatting) procedure described on this page.

Drive Initialize with Physical Formatting

Physical formatting is useful for new removable media and for circumstances where you are experiencing problems with your hard drive that cannot be corrected by normal initialization.

To initialize a drive using Physical Format:

1. Confirm that the power of the drive and the VS-1824 is turned on.
2. Insert a disk into the drive if you are using a removable type drive.
3. Press [PLAY (DISPLAY)].
4. Hold [SHIFT] and press [F6 (UTILITY)].
The Utility menu icon appears in the display.
5. Press [F6 (DrIni)].
If “DrIni” does not appear in the display above [F6], first press [PAGE] until “DrIni” is displayed, and then press [F6 (DrIni)].
6. Use [▲], [▼], [◀], and [▶] to move the cursor, and use the TIME/VALUE dial to set each value described below.

Init Drive (Initialize Drive)

Select the drive (IDE, SCSI0-SCSI7). “IDE” indicates the internal hard drive, and “SCSI” indicates external SCSI drives. For example, use “SCSI5” to select a Zip Drive.



VS-1824CD The SCSI ID number of the internal CD-RW drive is fixed at “0.”

Partition

Select the partition size (500 MB, 1000 MB, 2000 MB). In most cases, select “2000 MB.”

Physical Format

Select whether or not to use physical formatting. For new drives, new removable media, or drives that have been used by another device, this must be set to “On.” Also set this to “On” if you are experiencing problems with your hard drive that cannot be corrected by normal initialization.

Surface Scan

This confirms that the read and write functions in all of the drive's partitions are operating correctly when the drive is initialized. In normal circumstances, set this to "Off." When you want to conduct a test of the read/write functions, such as when you are experiencing problems with your hard drive that cannot be corrected by normal initialization, set this to "On".

The function buttons operate as shown.

[F1 (SelDr)]:

This displays a directory of the currently connected drives. Use [▲], [▼], [◀], and [▶] to move the cursor to the drive you want to initialize.

[F3 (Info)]:

Displays the drive information.

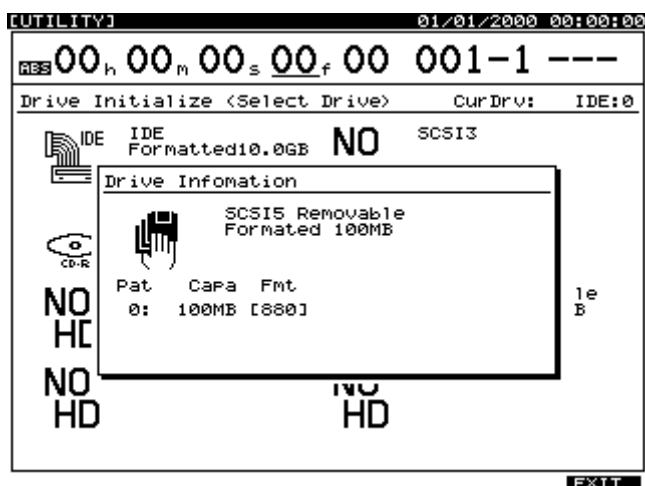

[F4 (Exec)]:

Executes initialization of the selected drive.

[F6 (EXIT)]:

Exits the screen.

- When the settings are made, press [F4 (Exec)]. "Initialize *** OK?" appears in the display. "***" refers to the selected drive's SCSI number. For example, "SCSI5" indicates an external drive which is set to SCSI ID #5.
- Press [ENTER/YES]. (Or, to cancel the operation, press [EXIT/NO].) "Initialize ****, Sure?" appears in the display.
- Press [ENTER/YES]. "STORE Current?" appears in the display. Press [ENTER/YES] to store the current song; otherwise press [EXIT/NO].
- After the initialization is completed, the VS-1824 restarts automatically, and returns to the Playlist display.

Drive Check

You can check the drive you are using to make sure it can be read correctly. This is referred to as a "Drive Check." A Drive Check can determine whether a failure during Song Copy (p. 224) or DAT Backup (p. 232) is due to a problem in the song itself, whether the problem is with the connections, or if there is a problem of some other kind. If data cannot be read correctly, the display will indicate the song in which the error occurred.

- Hold [SHIFT] and press [F6 (UTILITY)].

The Utility menu icon appears in the display.

- Press [F5 (DrChk)]. If "DrChk" does not appear in the display above [F5], first press [PAGE] until "DrChk" is displayed, and then press [F5 (DrChk)].

A list of currently connected drives appears in the display.

- Use [▲], [▼], [◀], and [▶] to move the cursor. Select the drive you wish to check.

The function buttons work as shown.

[F3 (Info)]:

Displays the drive information.

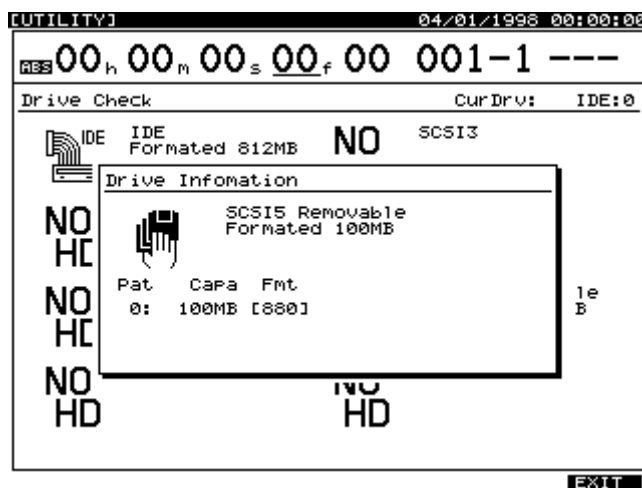

[F4 (Exec)]:

Executes a Drive Check.

[F6 (EXIT)]:

Exits the screen.

- When you have selected the drive you wish to check, press [F4 (Exec)]. "Drive Check ***?" appears in the display. "***" refers to the selected drive's ID number.
- Press [ENTER/YES] to continue, or if you wish to cancel Drive Check, press [EXIT/NO].

6. "STORE Current ?" appears in the display. Press [ENTER/YES] to store the current song; otherwise press [EXIT/NO].

During the Drive Check process, the progress of the operation is shown in the display. When the procedure is finished, the "Result List" will be displayed. If any errors are found, they will be reported here. Songs that do not contain any errors are indicated by "OK," songs containing errors are indicated by "ERR." If all of your songs are not displayed, use the TIME/VALUE dial to view the remaining songs. Do not turn off the power until the operation is completed. When you are finished viewing the result list, press [ENTER/YES] to return to the main Play screen.

To Cancel Drive Check

You can use the following procedure to cancel the Drive Check.

1. Press [EXIT/NO]. "Cancel ?" appears in the display.
2. Press [ENTER/YES]. Drive Check is canceled.

If Errors are Found

If the Drive Check function indicates that there are errors within the data on the drive, it is possible to erase the portion of the data that contains the error while keeping the remaining data as intact as possible. This can be very useful if you cannot access all of the songs on a drive because of an error in one of the songs.



This procedure does not correct the disk error. All error locations will be erased. This means that, depending on the location in which the error occurred, a take that was recorded may no longer be playable, Automix data may be lost, or the entire song itself may even be erased. If the error has occurred in the system or song list, the probability of this happening is especially high.

1. After the Drive Check procedure is finished, press [ENTER/YES].
"You'll Lose Data" will be displayed.
2. Press [ENTER/YES] to proceed with the recover function, or press [EXIT/NO] to cancel the operation. After the recover operation is finished, the results will be displayed. Songs that were partially altered are indicated by "Adj" and songs that have been deleted are indicated by "Del."
3. Press [ENTER/YES] to return to the main Play screen.

Check Drive Reliability using Surface Scan

When initializing a hard drive, you can confirm that the read and write functions in all the drive partitions are operating correctly. This is referred to as a "Surface Scan." If there are any places on the drive where the reading or writing of data cannot be performed, the VS-1824 registers this as unusable memory. The VS-1824 subsequently avoids that area during recording or playback.

Performing this procedure deletes all contents saved on the drive. Conduct this check when initializing a newly purchased drive or a drive that had previously been used with a personal computer or other device. Be sure to make a backup copy of any songs on the drive that you want to keep before carrying out a Surface Scan.

1. Follow the procedure described in "Initializing (Formatting) the Drive" (p. 222), and set "Surface Scan" to "On." After the drive has been initialized, Surface Scan begins immediately.
 - * *The Surface Scan procedure takes time. This is not a malfunction. For example, the time required to conduct Surface Scan on a 100 MB Zip disk is approximately 10 minutes. The time it will take to conduct Surface Scan on your drive is based on the size (capacity) of the disk. The progress of the Surface Scan procedure is shown in the display.*

- * *Once the drive is initialized and Surface Scan has begun, you may cancel Surface Scan by performing the following procedure.*
 1. Press [EXIT/NO]. "Cancel ?" appears in the display.
 2. Press [ENTER/YES]. Surface Scan is now canceled. Note that any unusable memory found up to that point is not registered by the VS-1824.
 3. The VS-1824 restarts automatically.

2. When Surface Scan is completed, one of the following messages appears in the display.
 - "- Complete -":
This drive is good to use. All memory areas were found to be usable.
 - "_____ Defect":
The underlined portion will indicate the number of unusable memory locations in this drive. The larger this number, the lower the reliability of this drive.
 - "File System Err":
A read or write failure has occurred in a location that stores basic data used by the VS-1824 for recording and playback. This drive cannot be used by the VS-1824.

Backup Options

There are several methods you can use to backup song data from the VS-1824. It is important to remember that simply backing up a song does not automatically remove it from the current drive. If you wish to free up drive space, backup the song using one of the methods described below, and then use Song Erase to remove it from the current drive.

DAT Backup

Data backup to DAT tape is very economical, since DAT tapes are rather inexpensive. However, the process can take a long time. One 60-minute DAT tape can hold approximately 330 MB of song data. Large amounts of song data will automatically be copied across multiple DAT tapes as necessary. DAT tapes are also reusable. For more detailed information regarding using a DAT recorder for data backup, see *Chapter 19*, starting on p. 238.

External Removable Drive

You can copy songs from the current drive to an external removable hard disk such as a Zip disk using the Song Copy function. This is a great way to quickly backup a song before temporarily removing it from the current drive. This method is fast; however, the cost per MB of storage is higher than it would be with DAT tape or CD-R/CD-RW disks. One Zip disk can hold approximately 100 MB of song data. Using the Song Copy Archives, large amounts of song data will automatically be copied across multiple Zip disks as necessary. Zip disks and other types of removable disks are also reusable. For more detailed information regarding using an external removable hard drive for data backup, see "Saving a Song to an External Drive (Song Copy)," p. 223.

CD-R Backup

Using an optional VS-CDR or VS-CDRII drive, or the internal drive in a VS-1824CD, you can back up song data to recordable CDs. This method is fast, reliable, and economical. One blank CD-R disc can hold approximately 650 MB of song data. Large amounts of song data will automatically be copied across multiple CD-R discs as necessary. CD-RW disks are reusable, but regular CD-R discs are not reusable. For more detailed information regarding using a CD-R drive for data backup, see *Chapter 18*, starting on p. 233.

Chapter 18 CD-R Backup

This chapter explains how to create your own original audio CD and backup song data to CD-R/CD-RW discs.



This chapter describes various general CD-R or CD-RW operations. See *Chapter 13* to learn about mastering a song to a CD-R or CD-RW.

CD-R Backup and Recover

You can save song data stored on the VS-1824's hard drive to CD-R/CD-RW discs. This procedure is called "CD-R backup." The process of loading backed-up song data from a CD-R/CD-RW disc onto the VS-1824 hard drive is referred to as "CD-R recover." Besides all V-Track recordings, backed-up data also includes locators, markers, mixer Scenes, Automix data, and Undo levels.

In CD-R backup, song data is converted into a data format specifically for saving. This means it is not possible to play back song data directly from the CD-R/CD-RW drive. If you wish to play the backup data, it must be recovered onto a VS-1824 hard drive first. A song that will not fit on a single disc will be copied across multiple discs based on the available free space on the discs.

- * *Only song data on the internal drive can be backed up onto CD-R/CD-RW discs.*
- * *Song data cannot be backed up to discs that already have songs (audio tracks) recorded on them.*
- * *You may lose song data by incorrectly performing the CD-R backup procedure. Roland Corporation assumes no liability concerning such loss of data. Furthermore, Roland does not warrant any copied data, regardless of the performance or condition of the CD-R/CD-RW drive.*
- * *It is impossible to backup songs created by other VS models or in other VS model formats. For these types of songs, Execute Song Import first, then perform the Backup.*

Before Using the CD-RW drive

Handling the CD-RW Drive

- Install the unit on a solid, level surface in an area free from vibration.
- Remove any disc from the drive before powering up or down.
- Avoid using the unit immediately after it has been moved to a location with a level of humidity that is greatly different than its former location. Rapid changes in the

environment can cause condensation to form inside the drive, which will adversely affect the operation of the drive and/or damage discs. When the unit has been moved, allow it to become accustomed to the new environment (allow a few hours) before operating it.

- To avoid the risk of malfunction and/or damage, insert only discs with  into the CD-RW drive. Never insert any other type of disc. Avoid getting paper clips, coins, or any other foreign objects inside the drive.
- Do not attempt to remove the disc from the CD-RW drive while the drive is functioning (while the MIDI/DISK indicator of VS-1824 or busy indicator of external CD-RW drive is lit).
- Do not attempt to carry a VS-1824 equipped with a CD-RW drive (VS-1824 CD) while a disc is loaded in the CD-RW drive.

VS-1824CD

- Do not touch the lens.
- When the lens is dirty, clean the lens with a commercial lens blower.

Handling CD-R/CD-RW Discs

- DO NOT play a CD-R/RW disc (CD-R/RW disc on which song data has been backed up) on a conventional audio CD player. The resulting sound may be of a level that could cause permanent hearing loss. Damage to speakers or other system components may result.
- Upon handling the discs, please observe the following.
 - Do not touch the recorded surface of the disc.
 - Do not use in dusty areas.
 - Do not leave the disc in direct sunlight or an enclosed vehicle.
- Avoid touching or scratching the shiny underside (encoded surface) of the disc. Damaged or dirty discs may not read/write properly. Keep your discs clean using a commercially available CD cleaner.
- Keep the disc in the case.
- Do not keep the disc in the CD-RW drive for a long time.
- Do not put a sticker on the label of the disc.
- Wipe the disc with a soft and dry cloth radially from inside to outside. Do not wipe along circumference.
- Do not use benzine, record cleaner spray or solvents of any kind.
- Do not bend the disc.

Items Necessary for CD-R Backup

- VS-1824
- Blank CD-R (Compact Disc-Recordable) or CD-RW (Compact Disc-Rewritable) disc

* *You cannot use high-speed compatible CD-RW discs. This mark is printed on high-speed compatible CD-RW discs.*



VS-1824CD

It is recommended to use CD-R discs from the following manufacturers.

Taiyo Yuden Co., TDK Co., Mitsui Chemicals Co.,
Mitsubishi Chemicals Inc., Ricoh Co., Ltd.,
Hitachi Maxell Ltd.

It is recommended to use CD-RW discs from the following manufacturers.

Ricoh Co., Ltd, Mitsubishi Chemicals Inc.

VS-1824

Recommended CD-R/CD-RW discs (approved by Roland) are shown in the owner's manual of the CD-R/RW drive.

NOTE

VS-1824 If you are using a VS-1824 that is not equipped with an internal CD-RW drive, you will need to purchase a separately available CD-RW drive (approved by Roland). For instructions on connecting the drive, refer to "Connecting an External CD-R/CD-RW Drive" (p. 194).

VS-1824CD

Inserting a CD

1. Press the eject button and open a disc tray.
2. Pull out a disc tray.
3. Locate the position of center hole of CD at stopper of CD-RW drive.
4. Press the CD downward. The CD will be locked by 3 clips of the stopper.

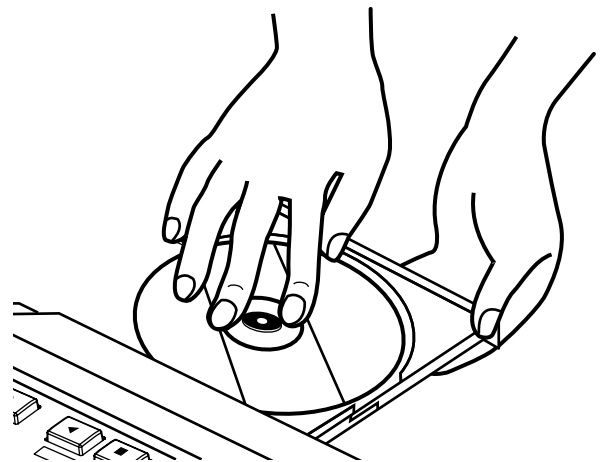

5. Press disc tray until it is locked in the VS-1824.

If a disc tray does not open

If the power is turned off with the disc still in the drive (such as due to a power failure), the disc tray cannot be opened by pressing the eject button. In this case, you can insert a piece of wire to force the tray open.

NOTE

It is strictly restricted to eject tray using emergency eject hall during VS-1824 is operating. This is cause error of software.

1. Turn off the power of the VS-1824.
2. Insert a thin object such as a wire into the emergency eject hole. The disc tray will open.

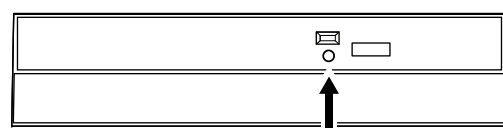

Emergency Eject Hole

CD-R Backup

1. Select the drive (internal IDE hard drive) containing the source song to be backed up as the current drive.
2. Place a blank CD-R/CD-RW disc in the CD-R/CD-RW drive.

VS-1824CD For details refer to the column "Inserting a CD" (see p. 234).
3. Press [CD-RW/MASTERING].
4. Press [F4 (CDRBk)].

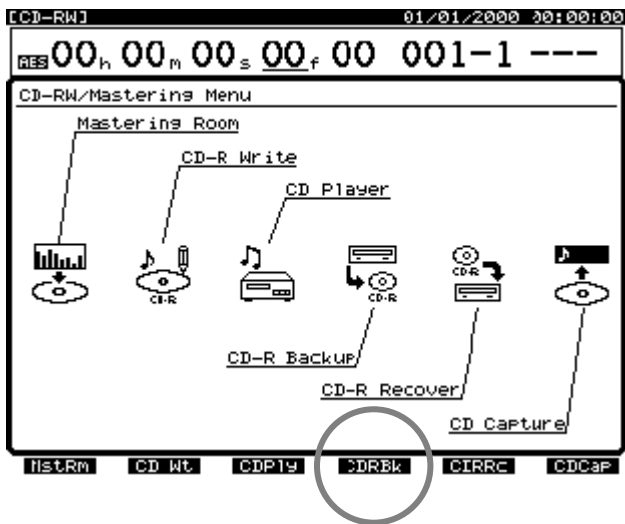

If you are using a finalized CD-RW disc that contains data, "Erase?" appears in the display. To erase the existing data, press [ENTER/YES]. "Erase Disc" appears and the contents of the CD-RW disc are erased. If you do not wish to erase the data, press [EXIT/NO], and insert a new disc.

5. Press [▲], [▼], [◀], and [▶] to move the cursor. Then use the TIME/VALUE dial to adjust each settings.

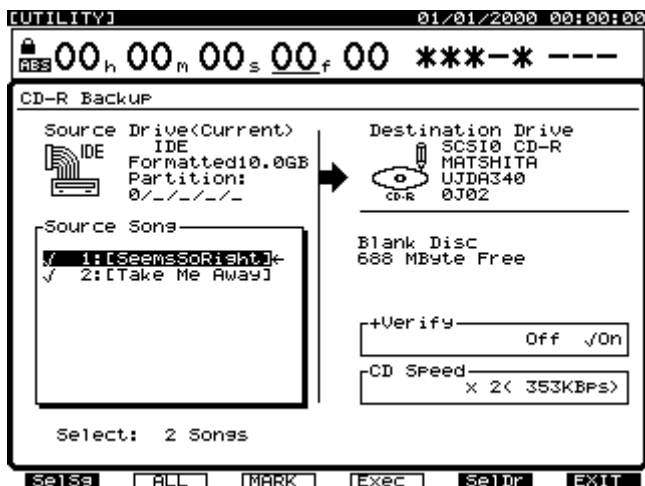

SOURCE SONG

Mark the songs you want to back up.

Use the TIME/VALUE dial to move the cursor to the song you want to back up, and then press [F3 (MARK)].

You can choose more than just one song to backup. By pressing [F2 (ALL)], all songs will be marked for backup.

MEMO

Press [F1 (SelSg)] to display a directory of songs. From the song directory, press [F1 (Back)].

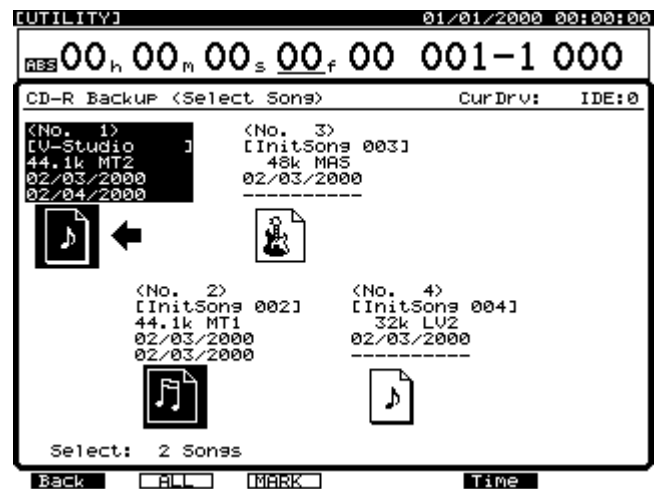

+Verify

If this is turned "On," verification will be performed after the song data has been backed up, to check whether or not the data was saved correctly.

- * When backing up to a CD-R, we recommend that you also execute +Verify to check whether the data was bask up correctly.
- * Since +Verify checks the entire CD-R disc, the operation will take a certain amount of time.
- * If as a result of the "+Verify" operation you receive a warning that was not written correctly, please make a backup on another disc.

CD Speed

VS-1824CD

- x4: The song will be written at quadruple speed (706 kilobytes per second).
- x2: The song will be written at double speed (353 kilobytes per second).

VS-1824

The available speeds will depend on the Roland-approved CD drive connected to the VS-1824.

- If several CD-R/CD-RW drives are connected to the VS-1824, you can press [F5 (SelDr)] to display a directory of drives. From this screen, use [▲], [▼], [◀], and [▶] to select the CD-R/CD-RW backup destination drive, then press [F1 (Back)].

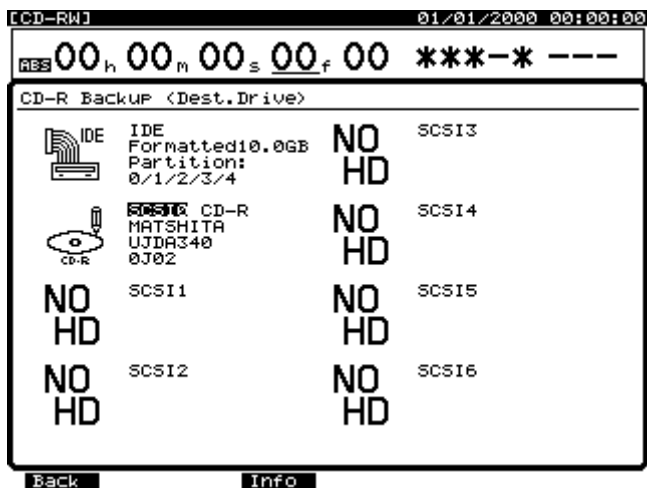

- Press [F4 (Exec)].
A message will ask you to confirm.
- Press [ENTER/YES]. (Or, press [EXIT/NO] to cancel the operation.)
- "Store Current ?" appears in the display. Press [ENTER/YES] to store changes made to the current song, or press [EXIT/NO] if you don't want to save changes made to the current song. If the current song is a demo song, press [EXIT/NO].
- If the song or selected songs data will not fit on a single CD-R/CD-RW disc, the first disc is ejected and the message "Insert Disc #" (# indicating the next disc number in the sequence) appears in the display. Insert another blank CD-R/CD-RW disc and press [ENTER/YES]. Write the disc numbers on the labels using a permanent-ink, soft-tipped pen to keep track of the order in which the discs were inserted into the drive. (When you recover data from this disc set, you will need to insert the discs in the same order.) When copying song data across multiple CD-R/CD-RW discs, the message "Insert Disc #" may appear several times. Continue to insert the discs in the order as instructed and press [ENTER/YES].
- When the CD-R backup procedure is finished, the screen will return to the Playlist display.

CD-R Recover

- Place a CD-R/CD-RW disc containing song data in the CD-R/CD-RW drive.
VS-1824CD For details refer to the column "Inserting a CD" (see p. 234).
- Press [CD-RW/MASTERING].
- Press [F5 (CDRRc)].

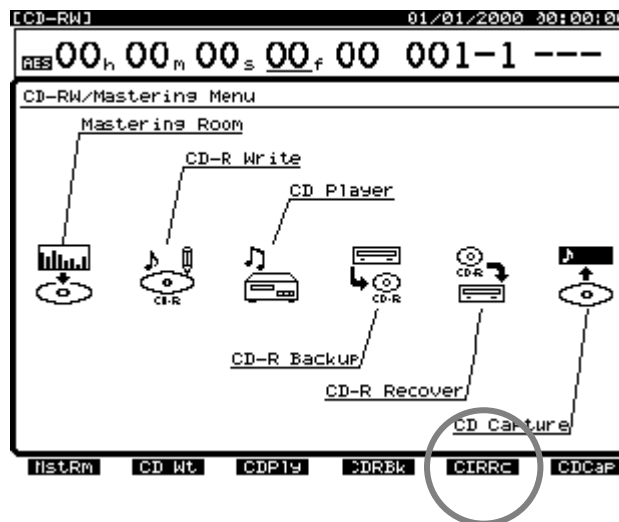

- Press [▲], [▼], [◀], and [▶] to move the cursor. Then use the TIME/VALUE dial to adjust each settings.

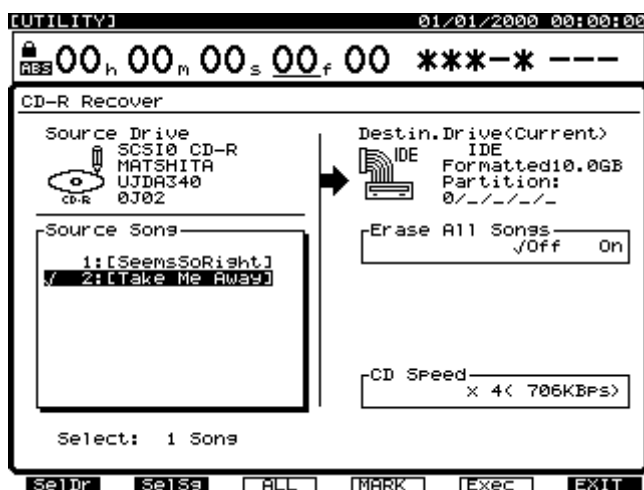

SOURCE SONG

- Mark the songs you want to recover.
- Use the TIME/VALUE dial to move the cursor to the song you want to recover, and then press [F4 (MARK)]. You can choose more than just one song to recover. By pressing [F2 (ALL)], all songs will be marked for recovery.

MEMO

Press [F2 (SelSg)] to display a directory of songs. From the song directory, press [F1 (Back)].

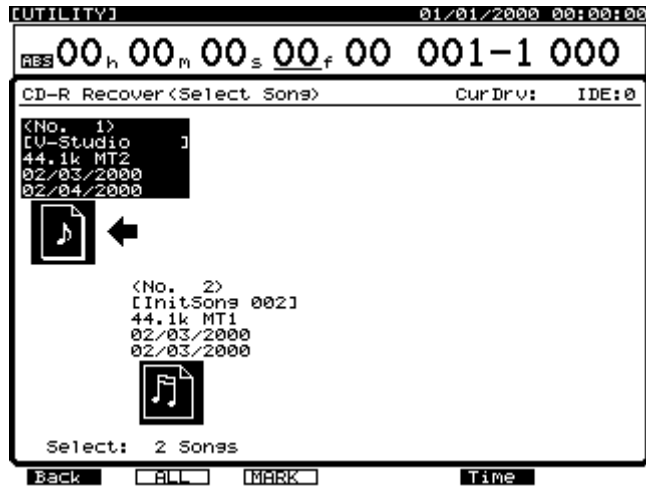
**Erase All Songs**

When this is set to “On,” the destination drive is initialized before the recover procedure is carried out. This will erase all songs from the destination drive. If you want to recover a song from CD-R/CD-RW without erasing any songs on the current drive, make sure this setting is “Off.”

CD Speed**VS-1824CD**

- x24:** The song will be recovered at twenty-fourfold speed (4234 kilobytes per second).
- x14:** The song will be recovered at fourteenfold speed (2470 kilobytes per second).
- x4:** The song will be recovered at fourfold speed (706 kilobytes per second).

VS-1824

The available speeds will depend on the Roland-approved CD drive connected to the VS-1824.

NOTE

Even if the “CD SPEED” is set to “x24” or “x14” the time it takes for recovery is onto always 1/24 or 1/14 of the base. This is because writing to the internal hard disk can take a lot of time, or disc read errors can sometimes occur.

5. Mark the songs you want to recover. Use the TIME/VALUE dial to move the cursor to the song you want to recover, then press [F4 (MARK)]. You can choose more than just one song to recover. By pressing [F3 (ALL)], all songs will be marked for recovery.

6. Press [F5 (Exec)].
A message will ask you to confirm.
7. Press [ENTER/YES] (or press [EXIT/NO] to cancel the operation). “Store Current ?” appears in the display.
8. Press [ENTER/YES] to store changes made to the current song and begin the recovery process. Or, press [EXIT/NO] if you don’t want to save changes made to the current song. If the current song is a demo song, press [EXIT/NO].
9. If song data is spread out across more than one disc, the disc will be ejected and “Insert Disc #” (# indicates the number in the order of insertion) appears in the display. Insert the next disc in the sequence and press [ENTER/YES]. When the CD-R backup procedure is finished, the screen will return to the Playlist display.

Chapter 19 Using a DAT Recorder (DAT Backup)

This chapter explains the procedures for using a DAT recorder in conjunction with the VS-1824. Refer to the owner's manual for your DAT recorder as you read this section.

Before Backing Up to DAT

Song data can be saved using a DAT recorder by connecting the VS-1824's DIGITAL OUT connector (coaxial or optical) to a DAT ("digital audio tape") recorder. This procedure is referred to as "DAT Backup." The procedure of loading previously backed-up song data into the VS-1824 is referred to as "DAT Recover." The backed up song data includes the data of all V-Tracks, and song settings such as locators, markers, mixer Scenes and Automix data. Make backups of your data as a precaution against unexpected problems, or when your drive is full and no more recording is possible. Since DAT tapes are easily transported, they are good for exchanging song data with other VS-1824 users. We recommend important data be backed up to multiple tapes.



DAT (See Appendices p. 12)

- * *You may lose song data if you incorrectly perform the DAT Backup procedure. Roland Corporation assumes no liability concerning the loss of such data. Furthermore, Roland does not warrant any copied data, regardless of the performance or condition of the DAT recorder.*
- * *It is impossible to backup songs created by other VS models or in other VS model formats. For these types of songs, Execute Song Import first, then perform the Backup.*

Items Necessary for DAT Backup

- VS-1824
- DAT recorder
- Blank DAT tapes
- Digital connection cables (coaxial or optical)

About the Devices Used in DAT Backup

DAT recorder:

You can use a conventional DAT recorder. Other digital recording devices such as MD recorders or DCC recorders cannot be used to back up data. You cannot use a DAT recorder that alters recorded data during playback; for example, DAT recorders featuring internal digital signal recorded on the drive.

- * *Portable DAT recorders may require a special adapter when connecting to the VS-1824's DIGITAL IN and OUT. Check the owner's manual for your DAT recorder, or consult your dealer or service center to find out what your model may require.*

Tape:

You can use conventional DAT tapes. However, 180-minute tapes are very thin, and may easily stretch or become tangled in the recorder. Avoid using 180-minute tapes.

When you need more than one tape to do the backup, prepare whatever number of tapes you need. It is recommended that you write down the numbers of the tapes to indicate the order in which they are to be used during the backup, and that you use tapes that are of the same recording length.

Audio equipment:

Turn down the volume of any connected audio devices while song data is being backed up. During DAT backups, no audio is output from the VS-1824's analog output jacks. The song data sent to the DAT recorder from the VS-1824 is a particular signal recorded on the drive. Monitoring this with the DAT recorder's volume raised may result in damage to your speakers, and may adversely affect your hearing.

Saving Song Data to DAT (DAT Backup)

Use the following procedure to back up song data on the current drive.

1. Connect the VS-1824 and the DAT recorder as shown below.

Optical

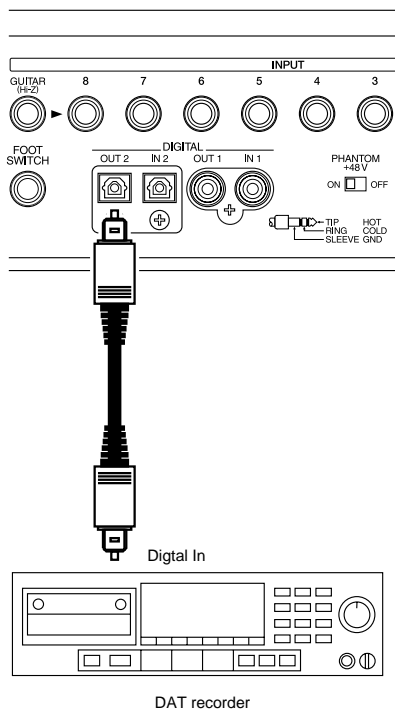

Coaxial

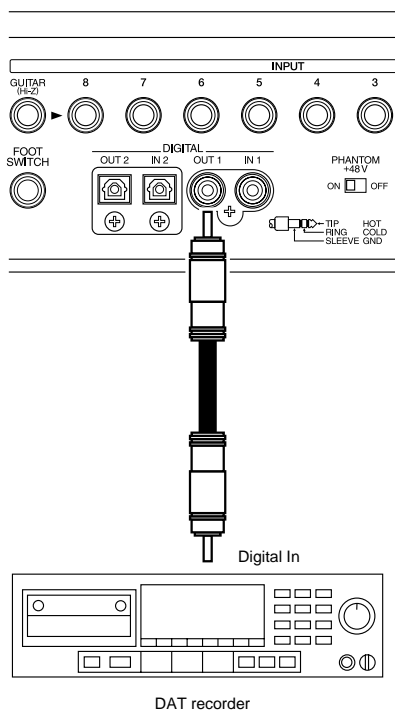

2. Set the DAT recorder so it is able to record digital signals.
 - * Normally the sample rate at which song data is transmitted is set to 48kHz. This sample rate has no relation to the sample rate of the song data. If your DAT recorder requires you to set the sample rate, set it to 48 kHz.
3. Hold [SHIFT] and press [F6 (UTILITY)].
The Utility Menu icon appears in the display.
4. Press [PAGE] so "DATBk" appears in the display above [F6]. Press [F6 (DATBk)].
"DAT Backup Ready?" appears in the display.
5. Press [ENTER/YES] and "Store Current?" will be displayed.
If you wish to save changes made to the current song, press [ENTER/YES]; if not, press [EXIT/NO]

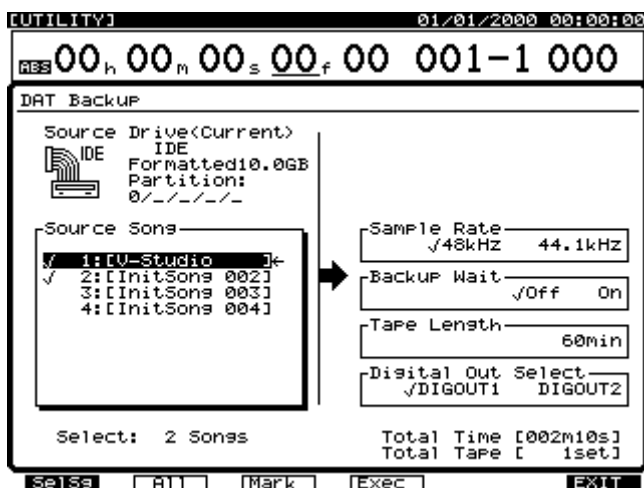

6. Press [▲], [▼], [◀], and [▶] to move the cursor to "Source Song."
7. Use the TIME/VALUE dial to move the cursor to the song you want to copy and press [F3 (MARK)].
By pressing [F2 (ALL)], you can place and remove marks from all songs.
Press [F1 (SelSg)] to view a directory of songs. After marking songs, press [F1 (Back)].

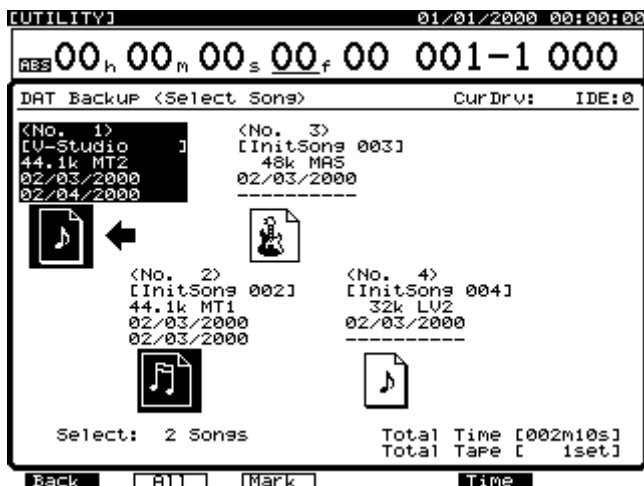

Chapter 19 Using a DAT Recorder (DAT Backup)

8. Press [▲], [▼], [◀], and [▶] to move the cursor. Set each of the values described below.

Digital Out Select

Select either "DIGOUT1" (coaxial) or "DIGOUT2" (optical).

Sample Rate

This sets the sample rate (48 kHz or 44.1 kHz) used during DAT backup. This sample rate has no relation to the sample rate of the song data. This defaults to 48 kHz.

Backup Wait

When this is set to "On," the data transmission speed will be slower. Turn this on when using an external drive (such as a Zip drive) whose data read/write speed is slower. When this is set to "On," although it takes longer for the backup to finish, problems resulting from the data transfer, such as data loss, are minimized. The default setting is "Off."

Tape Length

Specify the interval at which the backup will be paused in order to change tapes. Set this so the interval is no less than five minutes shorter than the length of tape on which you are recording. When using tapes with different recording lengths, set this to the recording time of the shortest tape.

9. The approximate time it will take and the number of tapes needed to back up the data are indicated in the display. Make sure you have the correct number of tapes.
10. Press [F4 (Exec)]. A confirmation message appears in the display.
11. Press [ENTER/YES]. "Please Rec DAT" appears in the display.
12. Put the DAT recorder in Record Standby, press [ENTER/YES] on the VS-1824 once more, then start recording on your DAT machine.
13. If you cannot back everything up on one tape, the operation is carried out for the length of time designated in "Tape Length." When "Insert Tape" is displayed, insert the next tape into the DAT recorder and again put it in Record Standby, press [ENTER/YES] on the VS-1824, then start recording on your DAT machine. The backup procedure continues in this fashion. Write the tape numbers on the labels in the order they are backed up.
14. When the backup procedure is finished, "Please Stop DAT" appears in the display. Stop the DAT recorder and press [ENTER/YES].
15. Press [PLAY (DISPLAY)] to return to the Playlist display.

* If you wish to cancel the backup, press [EXIT/NO]. This stops backup at any time during the procedure. Song data recorded to a DAT up to that point cannot be loaded into the VS-1824.

* To check whether or not a backup has been performed correctly, we recommend you carry out the Verify procedure (p. 243).

Tape Quantity Needed for DAT Backup

One 60-minute tape can back up approximately 330 MB of song data. For example, you would need four 60-minute (or two 120-minute) tapes to back up 1000MB of song data. Check the display to see the number of tapes required for the backup.

Time Needed to Backup

It takes about 60 minutes to back up 330 MB of song data. Backing up 1000 MB of song data takes about 190 minutes. However, if the number of songs being backed up is high compared to the total MB size of the data, it may take longer.

Recovering Data from a DAT

DAT Recover

Use the following procedure to load song data that was backed up to a DAT recorder. If two or more songs were saved together during the backup, the data of all songs will be loaded.

* You can recover VS-880/880EX/1680 song data backed up using DAT backup. However you cannot edit or resave the recovered data on the VS-1824 while it is still in a VS-880/880EX/1680 format. If you wish to edit VS-880/880EX/1680 song data with the VS-1824, you will need to convert it to VS-1824 format using the Song Import procedure (p. 246).

1. Connect the VS-1824 and the DAT recorder as shown below.

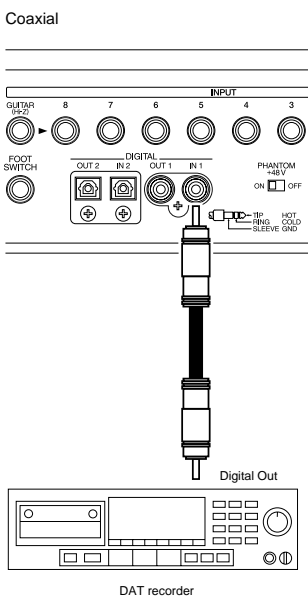
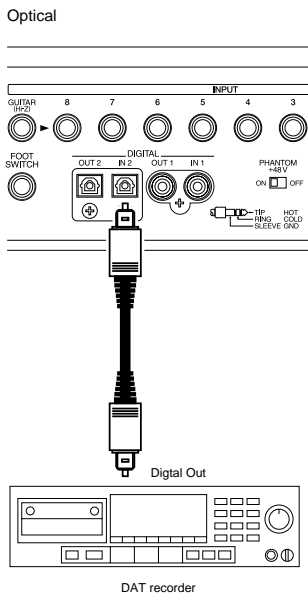

2. Insert the tape that contains the song data into the DAT recorder.
If the song data is backed up on two or more tapes, insert the first tape.
3. Rewind the tape to begin playback from the beginning of song data.
4. Hold [SHIFT] and press [F6 (UTILITY)].
The Utility Menu icon appears in the display.
5. Press [PAGE] so "DATRc" appears in the display above [F1]. Press [F1 (DATRc)].

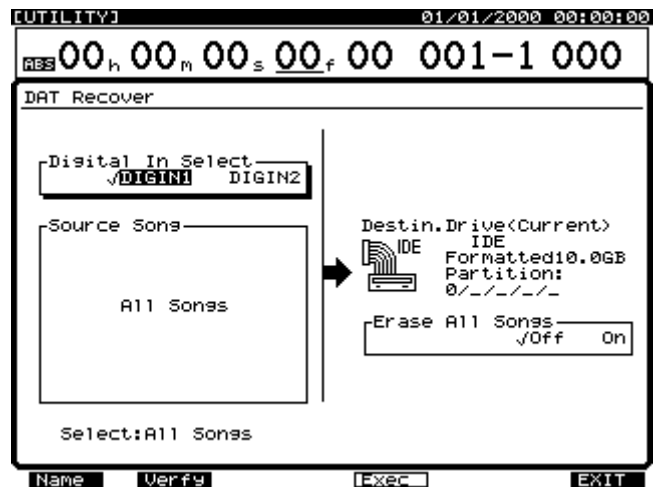

6. Press [▲], [▼], [◀], and [▶] to move the cursor. Set each of the values described below.
 - Digital In Select**
Select either "DIGIN1" (coaxial) or "DIGIN2" (optical).
 - Erase All Songs**
When this is set to "On," the destination drive is initialized before the DAT Recover procedure is carried out. This will erase all songs from the destination drive. If you want to recover a song from DAT without erasing any songs on the current drive, make sure this is set to "Off."
7. Press [F4 (Exec)].
"STORE Current?" appears in the display.
8. Press [ENTER/YES] to save changes to the current song.
"Please Play DAT" appears in the display, or press [EXIT/NO] to exit the procedure.
9. Put the DAT recorder in play. The data begins to load.
10. If you have backed up data to multiple tapes, the operation will pause when the end of each tape is reached. Insert the next-numbered tape as indicated in the display, press [ENTER/YES], and start the DAT recorder playing again.

11. When the backup procedure is finished, "Please Stop DAT" appears in the display. Stop the DAT recorder and press [ENTER/YES].
12. Press [PLAY (DISPLAY)] to return to the Playlist display.

Canceling the Recover Operation

You can cancel the recover operation by pressing [EXIT/NO] during the recover. Also, when there is an error in song data backed up on a tape, the recover operation is temporarily halted. In such instances, you can choose whether to leave or delete the unfinished song data recovered up to that point.

- * *This procedure does not correct the drive error, but tries to restore the song and save as much of the data as possible. Depending on the location where the error occurred, some noises may be generated, or settings for the mixer, tempo map, and/or sync track may be lost.*
- * *Loud noises may damage your amplifier and speakers. Turn down the headphones and master volume of the VS-1824 when you check for errors in the song data.*

Canceling a DAT Recovery Operation in Progress

1. Press [EXIT/NO] during the DAT recovery. Recovery is stopped, and "Delete Err Song?" (Delete the song containing the error?) appears in the display.
2. If you would like to delete the problem song data that stopped the recovery operation from the hard drive, press [ENTER/YES]. If you would like to leave it unchanged, even though recovery is not complete, press [EXIT/NO].

When an Error is Found in the Song Data

1. If an error is found in song data that was recovered with the DAT Recover operation, "Recover Err Retry?"—"An error was found, retry the recovery?"—appears in the display.
2. If you want to recover the data, press [ENTER/YES]. If you want to cancel the recovery, press [EXIT/NO].
3. If you press [EXIT/NO] in Step 2, "Delete Err Song?" appears in the display.
4. If you would like to delete the song data from the hard drive, press [ENTER/YES]. If you would like to keep it as is even though the error is included, press [EXIT/NO].

Checking DAT Tape Contents

This operation lets you view the names of songs saved to a DAT tape. Even if you have saved the data of two or more songs in a single backup operation, you can check the name of each song.

1. Connect the VS-1824 and the DAT recorder as shown below.

Optical

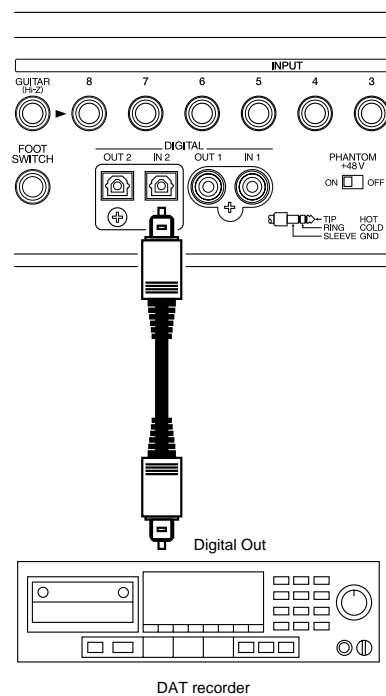

Coaxial

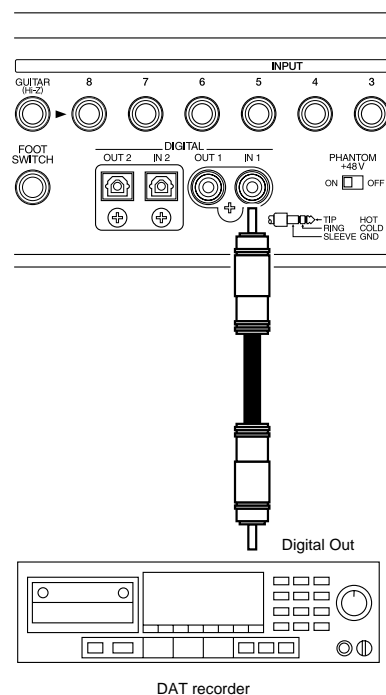

2. Insert the tape that contains the song data into the DAT recorder. If the song data is backed up on two or more tapes, insert the first tape.
3. Rewind the tape to begin playback from the beginning of song data.
4. Hold [SHIFT] and press [F6 (UTILITY)].
The Utility Menu icon appears in the display.
5. Press [PAGE] so "DATRc" appears in the display above [F1]. Press [F1 (DATRc)].
6. Press [◀] to move the cursor to "Digital In Select" and turn the TIME/VALUE dial.

Digital In Select

Select either "DIGIN1" (coaxial) or "DIGIN2" (optical).

7. Press [F1 (Name)].
"Please Play DAT" appears in the display.
8. Put the DAT recorder in play. The song name will load.
9. When the procedure is finished, "Please Stop DAT" appears in the display. Stop the DAT recorder and press [ENTER/YES]. The DAT Name screen appears in the display.

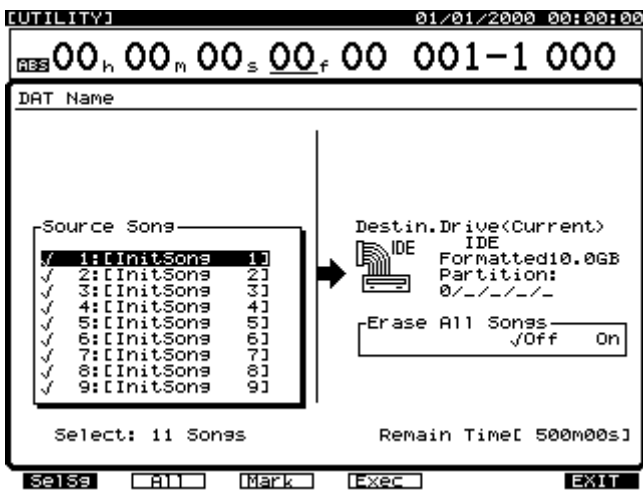

10. If you wish to end the operation after checking the song names, press [PLAY (DISPLAY)] to return to the Playlist display.
If you wish to recover the song data, please refer to "Recovering Data from a DAT," p. 241.

DAT Backup Verification

This operation checks the condition of song data that was recorded to a DAT tape. It does not perform a comparison of the song data on the hard drive and the song data on the tape. If the DAT verify operation results in a warning that data is not recorded properly, it is possible the tape has been scratched or stretched. If the original song data still exists on the drive, perform the DAT backup procedure once again using a different DAT tape.

** After performing DAT backups, in order to confirm the data has indeed been properly backed up, we strongly recommend you carry out the Verify procedure.*

1. Connect the VS-1824 and the DAT recorder as shown below.

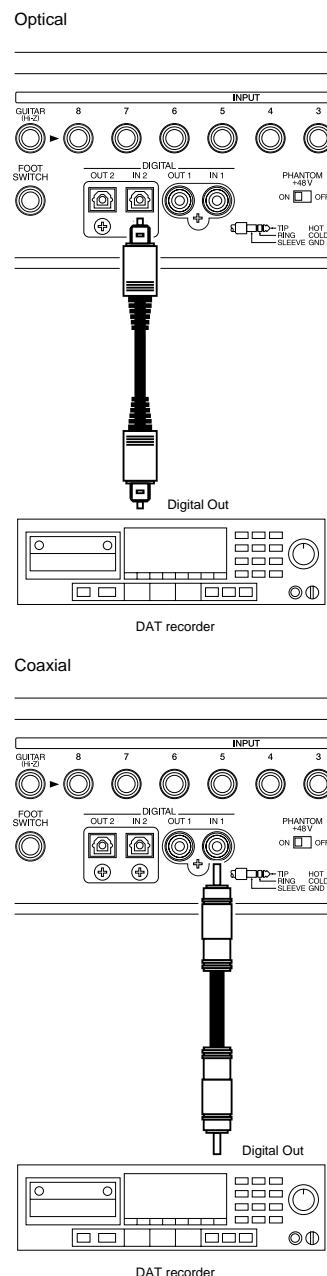

Chapter 19 Using a DAT Recorder (DAT Backup)

2. Insert the tape that contains the song data into the DAT recorder. If the song data is backed up on two or more tapes, insert the first tape.
3. Rewind the tape to begin playback from the beginning of song data.
4. Hold [SHIFT] and press [F6 (UTILITY)].
The Utility Menu icon appears in the display.
5. Press [PAGE] so "DATRc" appears in the display above [F1]. Press [F1 (DATRc)].
6. Press [◀] to move the cursor to "Digital In Select."
Use the TIME/VALUE dial to make the choice for "Digital In Select."
Digital In Select
Select either "DIGIN1" (coaxial) or "DIGIN2" (optical).
7. Press [F2 (Verify)].
"Please Play DAT" appears in the display.
8. Put the DAT recorder in play.
The Verify process begins. If you have backed up data to multiple tapes, the operation will suspend when the end of each tape is reached. Insert the next-numbered tape as indicated in the display, press [ENTER/YES], and start the DAT recorder playing again.
9. When the verify procedure is finished, "Please Stop DAT" appears in the display. Stop the DAT recorder and press [ENTER/YES].
10. If there is no problem with the condition of the recorded song data, "Complete" appears in the display. If a warning message appears when the song data is loaded, then that song data cannot be loaded correctly. If you wish to check a tape again, insert the tape with the number indicated in the display, press [ENTER/YES] and play the DAT recorder. Press [EXIT/NO] if you want to finish the procedure without checking the tape again.

* To cancel the Verify operation, press [EXIT/NO].

Chapter 20 Compatibility with Other VS Recorders

Drives used with Roland's VS-890, 1680, VS-880/880EX or VSR-880 can also be used by the VS-1824. Song data recorded on such drives can be loaded by the VS-1824. Because of differences in the structure of drive space and song data between the VS-1680, VS-880/880EX, VS-890 and the VSR-880, there are a number of precautions concerning the loading and saving of data that should be observed.

MEMO

VS-1880's song data is identical to that of the VS-1824.
VS-2480's song data cannot be used on VS-1824.

NOTE

The internal hard disk is not removable. Therefore, internal hard disks used on other VS series (VS-1680, VS-880/880EX, VS-890 and the VSR-880) cannot be used on VS-1824.

Drive Compatibility

VS-1680, VS-880/880EX, VS-890 or VSR-880 → VS-1824

When external hard drives that have been used by a VS-1680, VS-880/880EX, VS-890 or VSR-880 are attached to a VS-1824, they are recognized as a formatted disk. The VS-1824 can be used for playing back songs recorded with the VS-1680, VS-880/880EX, VS-890 or VSR-880. However, before you can use the VS-1824 to edit such songs, or save new versions of them, you must first use Song Import to convert the songs to VS-1824 format.

VS-890/VSR-880 Partition numbers:

The VSR-880 supports the use of up to 10 (0-9) partitions, while the VS-1824 supports the use of up to eight. VS-890/VSR-880 Partitions 8 and 9 will not be recognized by the VS-1824.

Song Copy Archive Data

VS-1680, VS-880/880EX, VS-890 or VSR-880 song data that has been saved to a hard drive or CD-R using the Song Copy Archive or CD-R Backup procedure can be restored to the VS-1824. However, you cannot edit or re-save the recovered data on the VS-1824 until you have used Song Import.

* If you wish to edit VS-1680, VS-880/880EX, VS-890 or VSR-880 song data with the VS-1824, use the Song Copy Archives Extract (p. 227) or the CD-R Recover procedure (p. 241) first. Then convert it to a VS-1824 song using Song Import.

DAT Backup Data

Song data that has been saved using the DAT backup procedure on the VS-1680 or VS-880/880EX can be recovered by the VS-1824.

VS-1824 → VS-1680, VS-880/880EX, VS-890 or VSR-880

When external hard drives that have been used by a VS-1824 are attached to a VS-1680, VS-880/880EX, VS-890 or VSR-880, they are recognized as a formatted disk, provided they meet the conditions below. The VS-1680, VS-880/880EX, VS-890 and VSR-880, however, cannot load VS-1824 songs unless they have been converted to the desired VS's format using the VS-1824's Song Export procedure (p. 247).

* Partition space: With the VS-880/880EX, VS-890 and VSR-880, only a partition of one GB or less can be used.

VS-880/880EX Partition numbers:

With the VS-880/880EX, only Partitions 0-3 can be used. Partitions 5-8 cannot be used.

Song Copy Archive Data

Song data that has been saved using the Song Copy Archive or CD-R Backup procedure on the VS-1824 cannot be restored (extracted) by the VS-880/880EX, VS-890 or VSR-880.

DAT Backup Data

Song data that has been saved using the DAT backup procedure on the VS-1824 cannot be recovered by the VS-880/880EX, VS-890 or VSR-880.

VS-840/840EX ↔ VS-1824

Zip disks used on the VS-840/840EX and VS-1824 are not mutually compatible. The disk cannot be accessed directly, but song data can be converted to VS-880 format. This will allow you to transfer song data between the VS-1824 and the VS-840/840EX.

Song Import

You can convert songs created on a VS-1680/880/880EX/840/840EX/890 or VSR-880 for use in the VS-1824 and copy them as new songs to the current drive. This is called “Song Import.”

When VS-1680, VS-880/880EX, VS-890 or VSR-880 song data is converted, all the data such as mixer settings including EQ (where applicable) and Channel Link, system settings such as sync track and tempo map, locators and markers and effect settings will be copied.

VS-840/840EX song data recorded on Zip disks only includes the performance data (audio) and information describing the tracks on which the performance data is recorded. Therefore, mixer settings such as EQ and Channel Link, locators and markers and effect settings are not imported.

- * You can only create a song using Song Import that has the same sample rate and recording mode as the source song.
- * If there is insufficient free space on the current drive, Song Import cannot be carried out.

The procedure for importing a playable copy of a song from a Zip disk is explained below. If you wish to import song data created by using Song Copy Archive or DAT backup, proceed to Step 3.

1. Make connections as shown below.

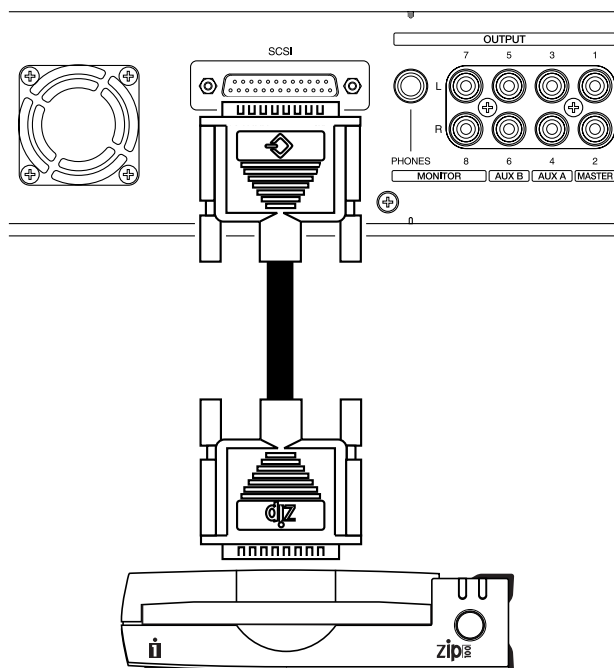

2. Insert the Zip disk on which a VS-1680/880/880EX/840/840EX/890 or VSR-880 song has been recorded.

3. Select the internal drive (IDE hard drive) so that it is the current drive (see “Drive Select,” p. 228).
4. Press [PLAY (DISPLAY)].
5. Hold [SHIFT] and press [F1 (SONG)]. The Song Menu icon is displayed.
6. Press [F4 (Imprt)]. If you do not see “Imprt” in the display above [F4], press [PAGE] until you see “Imprt,” and then press [F4 (Imprt)].

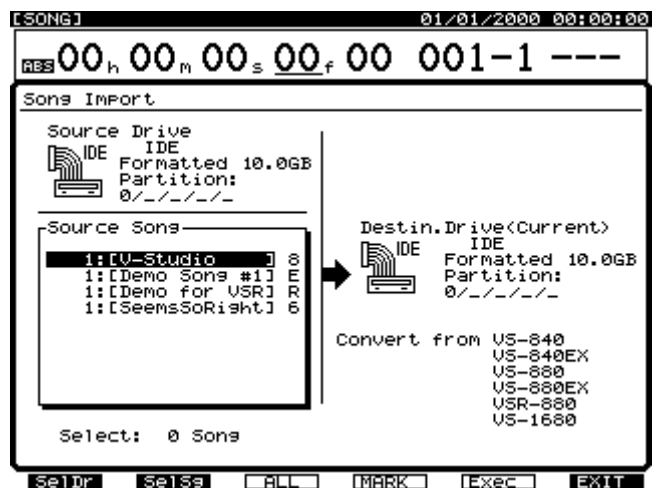

7. Press [F1 (SelDr)]. A list of drives appears in the display.
8. Press [▲], [▼], [◀], and [▶] to select the source drive, and use the TIME/VALUE dial to select the source drive partition. Then press [F1 (Back)].

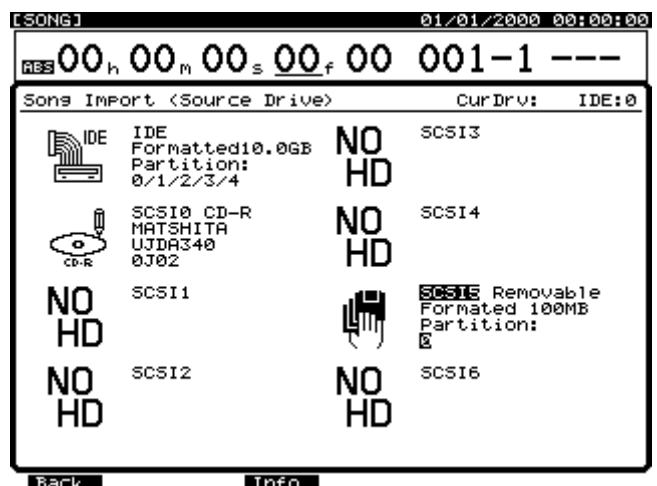

9. Use the TIME/VALUE dial to move the cursor to the song you want to import and press [F4 (Mark)]. When [F3 (All)] is pressed, you can place or remove marks from all songs. By pressing [F2 (SelSg)], you can view a directory of available songs.

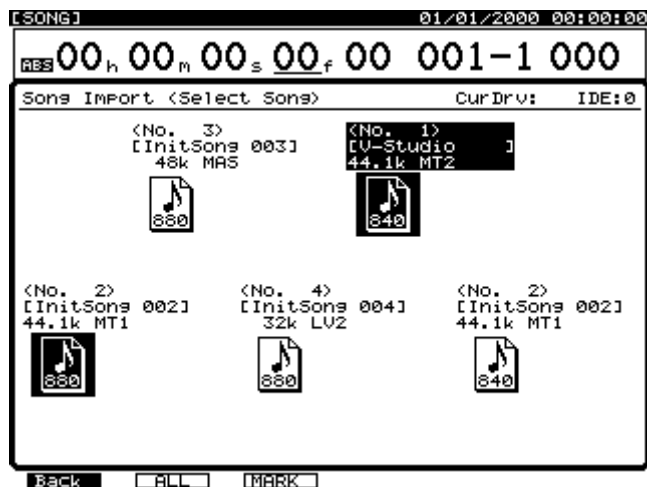

From this screen, select the songs you want to import by pressing [F3 (Mark)]. Then press [F1 (Back)].

10. Press [F5 (Exec)]. A confirmation message appears in the display.
11. Press [ENTER/YES]. “STORE Current ?” appears in the display.
12. Press [ENTER/YES] if you want to save changes made to the current song; otherwise press [EXIT/NO]. (If the current song is a demo song, press [EXIT/NO].) After Song Import is completed, the screen returns to the Playlist display. The song imported for use by the VS-1824 becomes the current song.

Song Export

You can convert the data of the current song for use with a VS-1680/880/880EX/890 or VSR-880 and copy it as a new song to an external drive (such as a Zip drive) connected to the VS-1824’s SCSI port. This is referred to as “Song Export.” All song data, including mixer settings such as EQ (where applicable) and Channel Link, system settings such as sync tracks and tempo maps, locators, markers, effect settings, etc., are copied.

Limits of Song Export to VS-1680

Tracks:	1-16 or 3-18
Song modes:	MTP, MAS, MT1, MT2, LIV, LV2

Limits of Song Export to VS-880EX

Tracks:	1-8, 9-16 or 11-18
V-Tracks:	1-8 to Bank A, 9-18 to Bank B
Locators:	Bank 1-Bank 4
Song modes:	MAS, MT1, MT2, LIV

Limits of Song Export to VS-880

Tracks:	1-8, 9-16 or 11-18
V-Tracks:	1-8
Locators:	Bank 1-Bank 4
Song modes:	MAS, MT1, MT2, LIV

Limits of Song Export to VSR-880

Tracks:	1-8, 9-16 or 11-18
V-Tracks:	1-8 to Bank A, 9-18 to Bank B
Locators:	Bank 1-Bank 4
Song modes:	MTP (automatically converted to VSR), CDR, MAS, MT1, MT2, LIV, LV2

A VS-1680, VS-880/880EX, VS-890 or VSR-880 song created as a result of Song Import will have both the same sample rate and recording mode as the source song.

An audio CD image file cannot be exported to the VS-1680 or VS-880/880EX.

When you export a song containing an image file, only the song data—and not the image file—will be included in the exported file.

If there is insufficient free space on the destination drive, Song Export cannot be carried out.

The procedure on the next page demonstrates the Song Export procedure using an Zip drive (other drives can be used in its place).

Chapter 20 Compatibility with Other VS Recorders

1. Make your connections as shown in the diagram below.

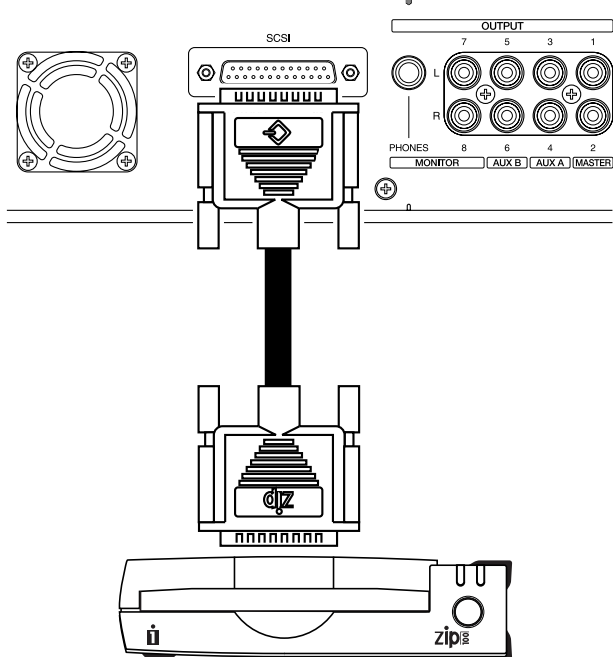

2. Select the song you want to export as the current song.
3. Insert a disk into the Zip drive.
4. Press [PLAY (DISPLAY)].
5. Hold [SHIFT] and press [F1 (SONG)]. The Song Menu icon is displayed.
6. Press [F5 (Exprt)]. If you do not see “Exprt” in the display above [F5], press [PAGE] until you see “Exprt,” and then press [F5 (Exprt)].

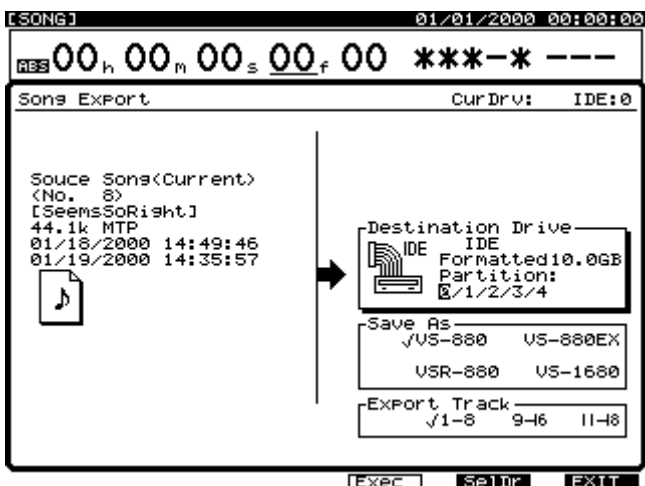

7. Press [F5 (SelDr)]. A list of drives appears in the display.

8. Press [▲], [▼], [◀], and [▶] to select the destination drive (the Zip drive). Then press [F1 (Back)].

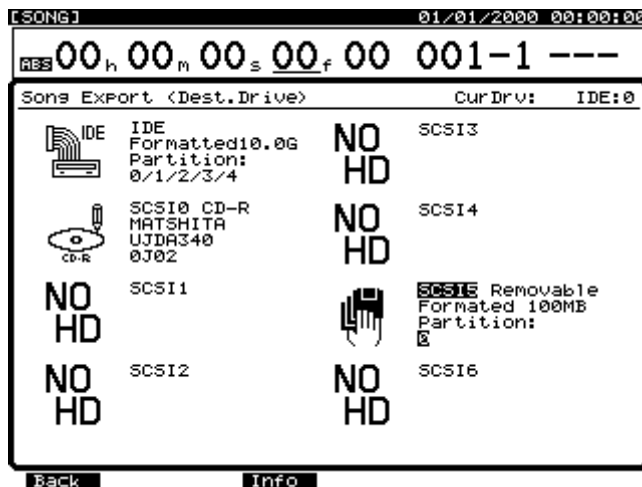

9. Press [▲], [▼], [◀], and [▶] to move the cursor, and use the TIME/VALUE dial to select the desired value for the following parameters.

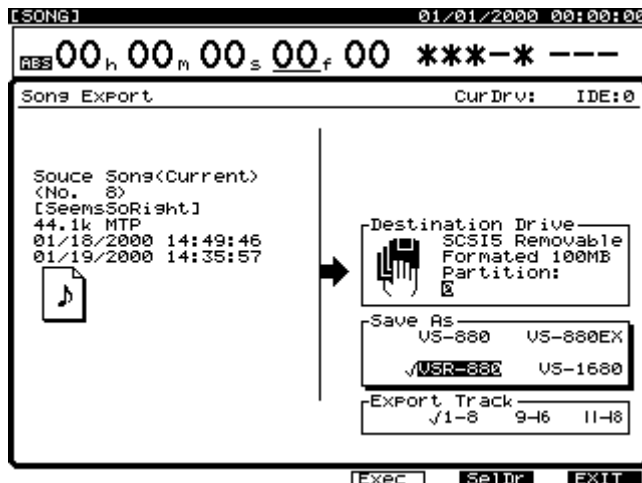

Save As

This selects the format for the exported song: VS-1680/880/880EX or VSR-880.

Export Track

This selects the tracks to be exported.

10. Press [F4 (Exec)].
A confirmation message appears in the display.
11. Press [ENTER/YES].
“STORE Current ?” appears in the display.
12. Press [ENTER/YES] if you want to save changes made to the current song; otherwise, press [EXIT/NO]. (If the current song is a demo song, press [EXIT/NO].)
13. After Song Export is completed, the screen returns to the Playlist display.

Chapter 21 System and Global Settings

System Settings for Each Song

These are overall system settings that can be saved with each song. These settings are lost if the power is turned off without the song being saved, or if the system settings are reset to their original conditions.

Fader Match

During Automix playback, or when you use [FADER/MUTE] to reassign the physical faders from track channels to input channels, there will be times when the physical fader positions may not correspond to their actual stored volume settings. In such instances, the position of each fader is represented by a black dot, and the actual level that is set is represented by a white circle. Use the following procedure to adjust the Fader Match settings:

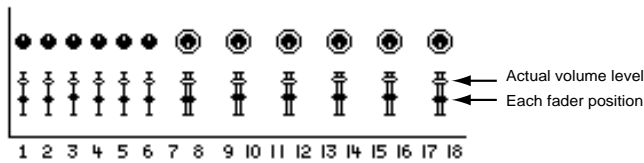

1. Hold [SHIFT] and press [F5 (SYSTEM)].
The System Menu icon is displayed.
If the System Menu icon does not appear, press [F6 (EXIT)].
2. Press [F1 (SYSPM)].
If "SYSPM" does not appear above [F1], first press [PAGE] until "SYSPM" appears, and then press [F1 (SYSPM)].
3. Use [▲], [▼], [◀], and [▶] to move the cursor to "Fader Match."
If "Fader Match" is not displayed, press [F1 (Prm1)].



The left/right [CURSOR] buttons can also be used to access any additional parameters that are not displayed.

4. Use the TIME/VALUE dial to change the setting for Fader Match.

Jump:

The actual stored fader value will change the instant the physical fader is moved. The stored value will instantly update to match the physical fader position. (This is the default setting.)

Null:

The stored fader value will change only after the physical fader matches the position of the stored value. The physical fader must be moved to the stored fader position before the value will change.

5. When you are done setting Fader Match, press [PLAY (DISPLAY)] to return to the Playlist display.

Peak Hold

You can set the display to hold the maximum values (peaks) while the level meter is shown in the graphic display.

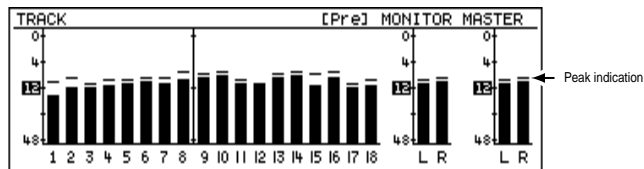

1. Hold [SHIFT] and press [F5 (SYSTEM)].
The System Menu icon is displayed.
If the System Menu icon does not appear, press [F6 (EXIT)].
2. Press [F1 (SYSPM)].
If "SYSPM" does not appear above [F1], first press [PAGE] until "SYSPM" appears, and then press [F1 (SYSPM)].
3. Use [▲], [▼], [◀], and [▶] to move the cursor to "Peak Hold Sw." If "Peak H. Sw" is not displayed, press [F1 (Prm1)].

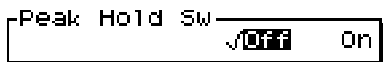

4. Use the TIME/VALUE dial to change the setting for Peak Hold Switch.
Peak Hold Sw (Peak Hold Switch)
With this set to "On," the level meter in the graphic display holds the display of the maximum levels.
5. When you are done setting Peak Hold, press [PLAY (DISPLAY)] to return to the Playlist display.

Each time you press [PLAY (DISPLAY)], the peak display is reset (cleared). Switching to a display that does not show level meters, such as switching to the Track Mixer screen, Song Information or other displays also resets the peak display.

Remaining Recording Time

The amount of free drive space available for recording in the current song is displayed as "Remain" in the upper part of the Playlist display when Song Information is shown. You can select the units of measurement for this value.

* "Remain" does not appear while the level meter or fader/pan screens are displayed (p. 39). Hold [SHIFT] and press [PLAY (DISPLAY)] until the Song Information screen is displayed.

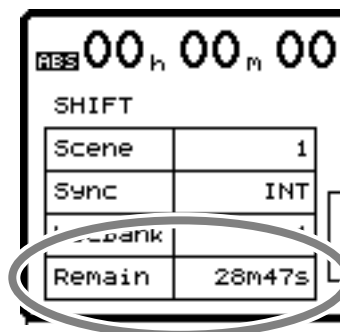

1. Hold [SHIFT] and press [F5 (SYSTEM)].
The System Menu icon is displayed.
If the System Menu icon does not appear, press [F6 (EXIT)].
2. Press [F1 (SYSPM)].
If "SYSPM" does not appear above [F1], first press [PAGE] until "SYSPM" appears, and then press [F1 (SYSPM)].
3. Use [▲], [▼], [◀], and [▶] to move the cursor to "Remain Display."
If "Remain Display" is not displayed, press [F1 (Prm1)].

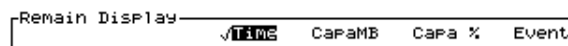

4. Use the TIME/VALUE dial to change the setting for the Remain Display.

Remain Display (Remaining Display)

This selects the units of measurements in which the remaining drive space is shown.

Time:

The remaining time for recording is shown in minutes and seconds.

CapaMB:

The remaining time for recording is shown in available megabytes of drive space.

Capa %:

The remaining time for recording is shown as a percentage of total drive space.

Event:

This shows the remaining number of events available for recording and mixing.

5. Press [PLAY (DISPLAY)] to return to the Playlist display.

Foot Switch Settings

You can choose how the foot switch functions when an optional foot switch—such as the Roland DP-2 or BOSS FS-5U—is connected to the FOOT SWITCH jack.

1. Hold [SHIFT] and press [F5 (SYSTEM)].
The System Menu icon is displayed. If the System Menu icon does not appear, press [F6 (EXIT)].
2. Press [F1 (SYSPM)].
If “SYSPM” does not appear above [F1], first press [PAGE] until “SYSPM” appears, and then press [F1 (SYSPM)].
3. Use [▲], [▼], [◀], and [▶] to move the cursor to “Foot Sw.”
If “Foot Sw” is not displayed, press [F1 (Prm1)].

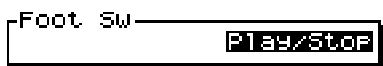

4. Use the TIME/VALUE dial to change the setting for Foot Switch.

Play/Stop:

Repeats playback and stop each time the foot switch is pressed.

Record:

Performs the same function as [REC]. Use this setting for performing punch-ins and -outs using a foot switch.

TapMarker:

Performs the same function as [TAP]. Pressing the foot switch places a marker at the current position of the song.

Next:

Performs the same function as [NEXT]. Moves to the beginning or end of the next phrase each time the foot switch is pressed.

Previous:

Performs the same function as [PREVIOUS]. Moves to the beginning or end of the previous phrase each time the foot switch is pressed.

GPI:

Controls playback and recording of the song depending on the GPI trigger signal received from the FOOT SWITCH jack.



GPI (See Appendices p. 12)

5. Press [PLAY (DISPLAY)] to return to the Playlist display.

Global Settings

These are settings related to the overall operation of the VS-1824. Unlike system settings, these settings are not set on a song-by-song basis.

Shift Lock

Many functions in the VS-1824 are accessed by holding [SHIFT], and then pressing a second button. If you find it inconvenient to use two hands, you can set Shift Lock to temporarily lock in the [SHIFT] button. This allows you to perform most [SHIFT] functions with one hand.

1. Hold [SHIFT] and press [F5 (SYSTEM)].
The System Menu icon is displayed.
If the System Menu icon does not appear, press [F6 (EXIT)].
2. Press [F2 (GLOBL)].
If “GLOBL” does not appear above [F2], first press [PAGE] until “GLOBL” appears, and then press [F2 (GLOBL)].
3. Use [▲], [▼], [◀], and [▶] to move the cursor to “Shift Lock.”



4. Use the TIME/VALUE dial to change the setting for Shift Lock.

Shift Lock

Set this to “On” to enable the Shift Lock function.

5. Press [PLAY (DISPLAY)] to return to the Playlist display.
6. The [SHIFT] button indicator lights on and off each time the button is pressed. [SHIFT] is in effect when the indicator is lit. The [SHIFT] state changes when another button is pressed or the TIME/VALUE dial is turned.

Shift Lock Shortcut

You can quickly toggle the Shift Lock feature on and off by holding down [SHIFT] and pressing [ENTER/YES].

To Display the Song Menu Icon

1. Press [SHIFT] and immediately release the button. The button indicator lights. When the level meter is not displayed, "SHIFT" appears in the upper left part of the display and indicates the Shift Hold function is in effect.
2. Press [F1 (SONG)]. The [SHIFT] button indicator goes off, and the Song Menu icon appears in the display.

When Holding Down [SHIFT]

If [SHIFT] is held down during an operation, the Shift Lock function will be ignored. For example, if you hold down [SHIFT] and press [F1 (SONG)], [SHIFT] will not be rocked when you release [SHIFT]. The function of [SHIFT] itself remains in effect, so the Song Menu icon is displayed.

In some cases, it is possible to quickly change value settings by holding [SHIFT] while turning the TIME/VALUE dial. Depending on what value is being changed, holding [SHIFT] while turning the TIME/VALUE dial will change the values by a factor of 10, or in other cases, by a factor of 1/10.

Numerics Type

When using the Jump function, or typing in the values of a punch-in point, you can use the LOCATOR buttons to enter numbers directly. The setting for Numerics Type determines how the numbers are entered.

1. Hold [SHIFT] and press [F5 (SYSTEM)].
The System Menu icon is displayed.
If the System Menu icon does not appear, press [F6 (EXIT)].
2. Press [F2 (GLOBL)].
3. If "GLOBL" does not appear above [F2], first press [PAGE] until "GLOBL" appears, and then press [F2 (GLOBL)].
4. Use [▲], [▼], [◀], and [▶] to move the cursor to "NUMERICS Type."



NUMERICS Type
√ 10 Down

5. Use the TIME/VALUE dial to change the setting for Numerics Type.

NUMERICS Type

This sets how numerals are entered when you use the LOCATOR buttons as a numbering keypad.

Up:

Numerals are entered from lower-place digits on up (from the right).

Down:

Numerals are entered from higher-place digits on down (from the left).

6. Press [PLAY (DISPLAY)] to return to the Playlist display.

Example of entering numerals with “Up” Setting

This example explains how “01h23m45s00f” is entered when the NUMERICS Type is “Up”.

1. Press [NUMERICS]. The button indicator lights.
2. The cursor appears at the digit furthest to the right (the lowest digit place). Press the LOCATOR buttons [1], [2], [3], [4], [5], and [SCENE/0] (four times), in that order.

The numerals appear in the place furthest to the right and shift to higher places as other numerals are entered. You can also move the cursor to the desired place by pressing [◀] and [▶].

3. When you are finished entering the numerals, press [ENTER/YES]. The numerical value is set, and the button indicator goes off.

Example of entering numerals with “Down” Setting

This example explains how “01h23m45s00f” is entered when the NUMERICS Type is “Down”.

1. Press [NUMERICS]. The button indicator lights.
2. The cursor appears at the digit furthest to the left (the highest digit place). Press the LOCATOR buttons [SCENE/0], [1], [2], [3], [4], [5], [SCENE/0], and [SCENE/0], in that order.

The numerals appear from left to right, just as they are entered. You can also move the cursor to the desired place by pressing [◀] and [▶].

3. When you are finished entering the numerals, press [ENTER/YES]. The numerical value is set, and the button indicator goes off.

Measure Display

VS-1824 can show measure and beat while it is sending MIDI clock. About MIDI clock, see “Sync Gen.” on p. 198. VS-1824 can send MIDI clock in case “Sync Gen.” setting is “MIDIclk” or “SyncTr.”

1. Hold [SHIFT] and press [F5 (SYSTEM)].
The System Menu icon is displayed.
If the System Menu icon does not appear, press [F6 (EXIT)].
2. Press [F2 (GLOBL)].
If “GLOBL” does not appear above [F2], first press [PAGE] until “GLOBL” appears, and then press [F2 (GLOBL)].
3. Use [▲], [▼], [◀], and [▶] to move the cursor to “Measure Display.”



4. Use the TIME/VALUE dial to change the setting to “Auto”.

Measure Display

Use this to select whether or not the measures and beats appear in the graphic display.

Always:

The measure and beat are always displayed.

Auto:

The measure and beat are not displayed when the MIDI clock is not sending.

5. Press [PLAY (DISPLAY)] to return to the Playlist display.

SCSI ID Number

When connecting SCSI devices to the VS-1824, the SCSI ID number of each device connected must be set so none of the devices have the same ID number. The VS-1824's ID number is set to "7" at the factory. When connecting SCSI devices (such as a Zip drive or a CD-R drive) to the VS-1824, be sure to set the SCSI ID number for these devices to a number other than "7." If no other SCSI ID number is available, it is possible to change the SCSI ID number of the VS-1824.

1. Hold [SHIFT] and press [F5 (SYSTEM)].
The System Menu icon is displayed.
If the System Menu icon does not appear, press [F6 (EXIT)].
2. Press [F2 (GLOBL)].
If "GLOBL" does not appear above [F2], first press [PAGE] until "GLOBL" appears, and then press [F2 (GLOBL)].
3. Use [▲], [▼], [◀], and [▶] to move the cursor to "SCSI Self ID."

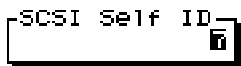

4. Use the TIME/VALUE dial to change the setting for SCSI Self ID.
SCSI Self ID
This sets the VS-1824's own SCSI ID number (1-7).

NOTE

VS-1824CD The SCSI ID number of the internal CD-RW drive is fixed at "0."

5. Hold [SHIFT] and press [ZERO]. "STORE OK ?" appears in the display.
6. Press [ENTER/YES]. The current song is saved.
7. Press [PLAY (DISPLAY)] to return to the Playlist display.
You must Restart the VS-1824 for the new SCSI ID number to become effective.

IDE Drive Switch

It is possible to use a VS-1824 with just an external hard drive connected to the SCSI port, with turning the internal hard drive OFF. You can turn off the internal hard drive with following procedure.

1. Hold [SHIFT] and press [F5 (SYSTEM)].
The System Menu icon is displayed.
If the System Menu icon does not appear, press [F6 (EXIT)].
2. Press [F2 (GLOBL)].
If "GLOBL" does not appear above [F2], first press [PAGE] until "GLOBL" appears, and then press [F2 (GLOBL)].
3. Use [▲], [▼], [◀], and [▶] to move the cursor to "IDE Drive."

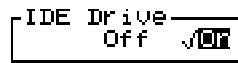

4. Use the TIME/VALUE dial to change the setting for IDE Drive.
IDE Drive
When not using an internal hard drive, set this to "Off."
The default setting is "On."
5. Hold [SHIFT] and press [ZERO].
"STORE OK ?" appears in the display.
6. Press [ENTER/YES].
The current song is saved.
7. Press [PLAY (DISPLAY)] to return to the Playlist display.
The changed setting becomes effective the next time the VS-1824 is turned on.

Input Peak Level

You can designate the level at which the peak indicator lights based on signal input via the INPUT jacks (1-8).

1. Hold [SHIFT] and press [F5 (SYSTEM)]. The System Menu icon is displayed. If the System Menu icon does not appear, press [F6 (EXIT)].
2. Press [F2 (GLOBL)]. If "GLOBL" does not appear above [F2], first press [PAGE] until "GLOBL" appears, and then press [F2 (GLOBL)].

```
Input Peak Level
CLIP -3dB ✓-6dB
```

3. Use [▲], [▼], [◀], and [▶] to move the cursor to "Input Peak Level." Use the TIME/VALUE dial to change the setting.

Input Peak Level

This sets the volume level at which the peak indicators (above the Input Sens knobs) light.

CLIP:

The indicator lights when the input is at maximum level (distortion).

-3 dB:

The indicator lights 3 dB before the input is at maximum level.

-6 dB:

The indicator lights 6 dB before input is at maximum level.

4. Press [PLAY (DISPLAY)] to return to the Playlist display.

Previous/Next Switch

[PREVIOUS] and [NEXT] normally move the position of the timeline to the beginning or end of the previous or next phrase on the selected track.

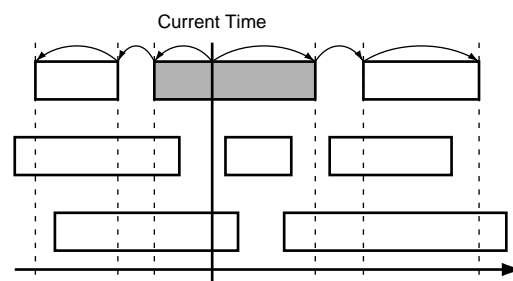

You can change this function so [PREVIOUS] and [NEXT] recall markers, similar to the manner in which the track skip button on a CD player works.

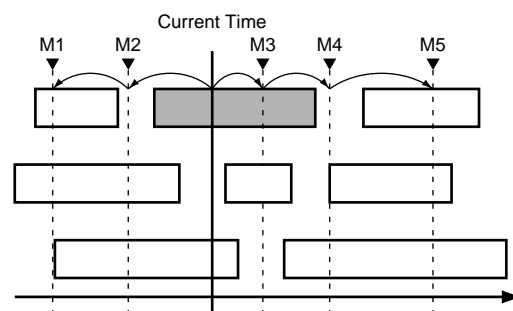

1. Hold [SHIFT] and press [F5 (SYSTEM)]. The System Menu icon is displayed. If the System Menu icon does not appear, press [F6 (EXIT)].
2. Press [F2 (GLOBL)]. If "GLOBL" does not appear above [F2], first press [PAGE] until "GLOBL" appears, and then press [F2 (GLOBL)].
3. Use [▲], [▼], [◀], and [▶] to move the cursor to "PREVIOUS/NEXT Sw." Use the TIME/VALUE dial to change the setting.

```
PREVIOUS/NEXT SW
✓PHRASE MARKER
```

PREVIOUS/NEXT Sw (PREVIOUS NEXT Switch)

This sets how the [PREVIOUS] and [NEXT] buttons function.

PHRASE:

[PREVIOUS] and [NEXT] move the current playback time to the beginning or end of the previous or next phrase.

MARKER:

[PREVIOUS] and [NEXT] move the current playback time to the previous or next marker.

NOTE

Holding [SHIFT] and pressing the [PREVIOUS] or [NEXT] buttons will have the opposite effect of the Previous/Next Sw setting on this screen. For example, if the Previous/Next Sw is set to "PHRASE," holding [SHIFT] and pressing [NEXT] will advance you to the next marker.

4. Press [PLAY (DISPLAY)] to return to the Playlist display.

Adjusting the Button Sensitivity

Several buttons on the VS-1824 change functions depending on whether they are pressed once or held down.

STATUS button

When pressed:	Changes track status.
When Held Down:	Displays the "Input Assign" screen and shows which inputs or tracks are connected/routed to the track.

[EDIT/SOLO]

When pressed:	Displays the Master Block settings.
When Held Down:	Turns on the SOLO function.

[FADER/MUTE]

When pressed:	Toggles the physical fader assignments from TR to IN.
When Held Down:	Turns on the MUTE function.

You can specify the length of time the button must be held down in order to use its secondary function.

1. Hold [SHIFT] and press [F5 (SYSTEM)].
The System Menu icon is displayed.
If the System Menu icon does not appear, press [F6 (EXIT)].
2. Press [F2 (GLOBL)].
If "GLOBL" does not appear above [F2], first press [PAGE] until "GLOBL" appears, and then press [F2 (GLOBL)].
3. Use [▲], [▼], [◀], and [▶] to move the cursor to "Switching Time." Use the TIME/VALUE dial to change the setting.



Switching Time

This sets the time a button must be held down (0.3-2.0 seconds) in order to use its secondary function.

4. Press [PLAY (DISPLAY)] to return to the Playlist display.

Fan Control

You may find the noise from the VS-1824's cooling fan to be a concern when recording with a mic nearby. If this is the case, you can program the VS-1824 to turn off the fan during certain operations.

1. Hold [SHIFT] and press [F5 (SYSTEM)].
The System Menu icon is displayed.
If the System Menu icon does not appear, press [F6 (EXIT)].
2. Press [F2 (GLOBL)].
If "GLOBL" does not appear above [F2], first press [PAGE] until "GLOBL" appears, and then press [F2 (GLOBL)].
3. Use [▲], [▼], [◀], and [▶] to move the cursor to "Fan Control." Use the TIME/VALUE dial to change the setting.



Fan Control

This specifies which operations cause the cooling fan to turn off.

Off:

The Fan Control feature is disabled. The fan operates constantly.

Play:

The fan stops during playback.

Rec&Play:

The fan stops when Record Standby is enabled, and stays off during recording and playback.

NOTE

While the cooling fan is stopped for long periods of time, heat can build up and, as a result, may damage the internal hard drive. To avoid this problem, do not leave this set to "Play" or "Rec&Play" for long periods of time. Keep the fan running as much as possible with the Fan Control set to "Off."

4. Press [PLAY (DISPLAY)] to return to the Playlist display.

Removing a Direct Current Offset from the MIX Bus

When the level meters of a device (mixer etc.) connected to the output of the VS-1824 may move even though no sound is being output from the VS-1824, you may be experiencing a direct current offset on the MIX bus that is being output from the VS-1824's MASTER outputs. This can be removed.

1. Press [PLAY (DISPLAY)].
2. Hold down [SHIFT] and press [F5 (SYSTEM)].
The System Menu icon is displayed.
If the System Menu icon does not appear, press [F6 (EXIT)].
3. Press [F2 (GLOBL)].
If "GLOBL" does not appear above [F2], first press [PAGE] until "GLOBL" appears, and then press [F2 (GLOBL)].
4. Use [▲], [▼], [◀], and [▶] to move the cursor to "DC Cut," and use the TIME/VALUE dial to select the desired setting.
If "DC Cut" is not shown, press [F2 (Prm2)], and turn the TIME/VALUE dial.

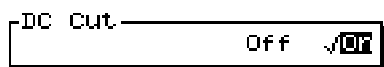

DC Cut

When this is turned on, any direct current offset on the MIX bus will be removed before the VS-1824 MASTER outputs.

5. Press [PLAY (DISPLAY)].

MIDI Model ID

MIDI devices communicating with the VS-1824 using System Exclusive messages identify it by its model ID number. The MIDI Model ID parameter allows you to switch the VS-1824's ID number to the number used by the VS-1680. When MIDI Model ID is set to "VS-1680," you can use VS-1680-based software—such as Logic VS, v. 4.X—with the VS-1824. The MIDI Model ID is not the same thing as a MIDI Device ID—the VS-1824 provides a separate Device ID parameter (p. 261).

1. Hold [SHIFT] and press [F5 (SYSTEM)].
The System Menu icon is displayed.
If the System Menu icon does not appear, press [F6 (EXIT)].
2. Press [F2 (GLOBL)].
If "GLOBL" does not appear above [F2], first press [PAGE] until "GLOBL" appears, and then press [F2 (GLOBL)].
3. Press [F2 (Prm 2)]. If "Prm 2" does not appear above [F2], first press [PAGE] until "Prm 2" appears, and then press [F2 (Prm 2)].
4. Use [▲], [▼], [◀], and [▶] to move the cursor to "MIDI Model ID." Use the TIME/VALUE dial to select the desired setting.



MIDI Model ID

VS-1880:

The VS-1824 uses its factory-designated MIDI Model ID number.

VS-1680:

The VS-1824 uses the MIDI Model ID number used by the VS-1680.

When MIDI Model ID is set to "VS-1680," you cannot control the VS-1824's Tracks 17 and 18 via MIDI.

NOTE

If you are using a VS-1824 and a VS-1680 in the same MIDI system, and you set the VS-1824's MIDI Model ID parameter to "VS-1680," be sure to set the two recorders to different Device ID numbers (see p. 261).

Play and Record Settings

These are settings related to the overall workings of the Play and Record functions.

Record Monitor

When a Track STATUS button is set for recording (blinking red), you can hear the previously recorded material by pressing play, and you can hear the input source during recording. During playback, you can press STATUS to switch between monitoring the recorded track and monitoring the input source. It is also possible to set the VS-1824 so the input source is always monitored.

1. Hold [SHIFT] and press [F5 (SYSTEM)].
The System Menu icon is displayed.
If the System Menu icon does not appear, press [F6 (EXIT)].
2. Press [F3 (PLAY)].
If "PLAY" does not appear above [F3], first press [PAGE] until "PLAY" appears, and then press [F3 (PLAY)].
3. Use [▲], [▼], [◀], and [▶] to move the cursor to "Record Monitor." Use the TIME/VALUE dial to change the setting.



Record Monitor

This switches between track and source monitoring.

AUTO:

Monitoring switches between track and source.

SOURCE:

Source is monitored at all times.

Setting	Stopped	Playback	Recording
AUTO:	SOURCE	TRACK or SOURCE*	SOURCE
SOURCE:	SOURCE	SOURCE	SOURCE

* With Record Monitor set to "AUTO," during recording it is possible to switch monitoring from TRACK to SOURCE by pressing the STATUS button.

4. Press [PLAY (DISPLAY)] to return to the Playlist display.

Marker Stop

You can program the VS-1824 to stop playing when a marker is reached.

1. Hold [SHIFT] and press [F5 (SYSTEM)].
The System Menu icon is displayed.
If the System Menu icon does not appear, press [F6 (EXIT)].
2. Press [F3 (PLAY)].
If "PLAY" does not appear above [F3], first press [PAGE] until "PLAY" appears, and then press [F3 (PLAY)].
3. Use [▲], [▼], [◀], and [▶] to move the cursor to "Marker Stop." Use the TIME/VALUE dial to change the setting.



Marker Stop

When this is set to "On," song playback stops automatically when a marker is reached.

4. Press [PLAY (DISPLAY)] to return to the Playlist display.
5. Press [PLAY] to begin song playback. When the song reaches a marker location, playback stops.

Fade Length

During track editing, or punch-in and punch-out recording, it is possible that a tiny audio click may occur. The VS-1824 can fade in and fade out these edges so no noise is heard.

Adjust the Fade Length if an objectionable noise occurs as a result of editing or recording. A Fade Length setting applies to both the fade-in at the beginning of a phrase, and the fadeout at the end of the phrase.

1. Hold [SHIFT] and press [F5 (SYSTEM)].
The System Menu icon is displayed.
If the System Menu icon does not appear, press [F6 (EXIT)].
2. Press [F3 (PLAY)].
If “PLAY” does not appear above [F3], first press [PAGE] until “PLAY” appears, and then press [F3 (PLAY)].
3. Use [▲], [▼], [◀], and [▶] to move the cursor to “Fade Length.” Use the TIME/VALUE dial to change the setting.
Fade Length
This sets the length—2, 10, 20, 30, 40, or 50 ms—of the fade-in and fadeout.
** It is not possible to set the Fade Length time to 0.*
4. Press [PLAY (DISPLAY)] to return to the Playlist display.

Scrolling the Waveform Display

When a song is played back while waveforms are shown in the playlist (p. 33), the waveform display scrolls in keeping with the playback time.

1. Press [PLAY (DISPLAY)].
2. Hold [SHIFT] and press [F5 (SYSTEM)].
The System Menu icon is displayed.
If the System Menu icon does not appear, press [F6 (EXIT)].
3. Press [F3 (PLAY)].
If “PLAY” does not appear above [F3], first press [PAGE] until “PLAY” appears, and then press [F3 (PLAY)].
4. Use [▲], [▼], [◀], and [▶] to move the cursor to “Waveform.” Use the TIME/VALUE dial to change the setting.



Waveform Scroll

When set to “On,” the waveform scrolls in keeping with the playback time.

NOTE

The “Drive Busy” indication may appear more readily when Waveform Scroll is on, which may result in recording being cancelled. If this occurs, turn the Waveform Scroll function off.

5. Press [PLAY (DISPLAY)] to return to the Playlist display.
6. Press [F5 (WAVE)].
If “WAVE” does not appear above [F5], first press [PAGE] until “WAVE” appears, and then press [F5 (WAVE)].
7. Press [PLAY]
The waveform display is scrolled.

Alarm Clock

The VS-1824 has a built-in clock with an alarm function. With the alarm function, you can have a text message of your choice appear in the display at a certain time of day, day of week, month or year. Use the alarm to program reminders such as “Back Up the Hard Drive” and other things you don’t want to forget.

- Hold [SHIFT] and press [F5 (SYSTEM)].
The System Menu icon is displayed.
If the System Menu icon does not appear, press [F6 (EXIT)].
- Press [F2 (DATE)].
If “DATE” does not appear above [F2], first press [PAGE] until “DATE” appears, and then press [F2 (DATE)].
- Press [F5 (Alarm)].
- Press [▲], [▼], [◀], and [▶] to move the cursor. Specify the date and time you wish the message to appear.

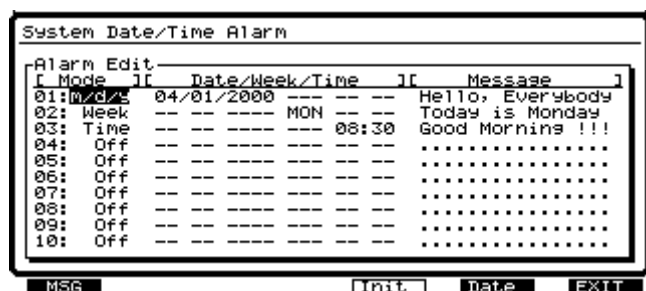

Mode

This specifies how often you want the message to appear.

Off:

No message is displayed.

m/d/y:

Message appears on a specific month, day, and year, such as 2000/June/20 (June 20, 2000).

m/d/-:

Message appears on a specific month and day, of every year, such as December/31 (every year on December 31).

-d/-:

Message appears on a specific day of every month.

Week:

Message appears on a specific day of the week, every week.

Time:

Message appears on a specific time of the day, every day.

Every:

Message appears every day.

- Press [F5 (MSG)].

The Message Edit appears in the display. Use [▲], [▼], [◀], and [▶] to move the cursor and turn the TIME/VALUE dial to enter your message.

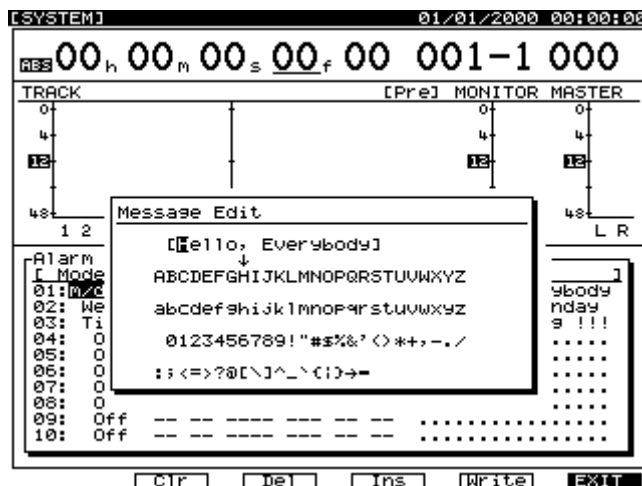

The function buttons work as shown below.

[F2 (Clr)]:

Clears all the characters in the window.

[F3 (Del)]:

Deletes the character where the cursor is positioned.

[F4 (Ins)]:

Inserts a space where the cursor is positioned.

[F5 (Write)]:

Saves the message and exits the screen.

[F6 (EXIT)]:

Exits the screen without saving the message.

- After you have entered your message, press [F5 (Write)]. You can store up to ten messages at a time. Repeat steps 4-6 if you wish to enter additional messages.
- Press [PLAY (DISPLAY)] to return to the Playlist display.

Chapter 22 Specific Applications

This chapter explains some additional ways to use the VS-1824, including synchronizing two VS-1824s, a VS-1824 and VS-1680, as well as synchronizing (“syncing”) a VS-1824 and a VS-880 or a VSR-880. Press [PLAY (DISPLAY)] to begin each operation from the Playlist display.

The following items will be used from the MIDI page of the system section:

Device ID

This sets the Device ID number (1-32) used when exchanging System Exclusive messages (mixer parameters) with an external MIDI device. These messages can be transmitted and received between devices that have the same Device ID number.

MIDI Thru (MIDI Thru Switch)

This switches the function of the MIDI OUT/THRU connector.

OUT:

The connector transmits MIDI messages such as metronome note messages or MTC from the VS-1824.

THRU:

The connector transmits MIDI messages as received at the MIDI IN connector without any changes.

SysEx.Rx (System Exclusive Receive Switch)

System Exclusive messages are received when this is set to “On.” System Exclusive messages can be received when the VS-1824 is in the Play mode.

SysEx.Tx (System Exclusive Transmit Switch)

System Exclusive messages are transmitted when this is set to “On.”

Cntrl Local (Control Local Switch)

When this is set to “Off,” volume levels of mixer channels cannot be changed using the physical faders on the mixer. The physical mixer faders are disabled. Normally, this setting is turned on.

MMC (MIDI Machine Control Mode)

This setting determines how the VS-1824 implements MMC.

Off:

MMC is neither transmitted or received.

MASTER:

MMC is transmitted. The VS-1824 functions as the master device for controlling the machine controls (transport controls) of external MIDI equipment.

SLAVE:

MMC is received. The VS-1824 functions as a slave device to the machine controls (transport controls) of external MIDI equipment.

Control Type (Mixer Control Types)

This selects the type of MIDI messages used when transmitting mixer settings to an external MIDI device, or when MIDI messages from an external MIDI device are used to control the mixer. For now, leave this “Off.”

Off:

MIDI messages related to mixer settings are not transmitted or received.

C.C.:

The mixer is controlled using Control Change messages.

Excl:

The mixer is controlled using System Exclusive messages.

- * *When “C.C.” or “Excl” is selected, mixer adjustments made on the master VS-1824 will result in the same mixer settings occurring on the slave VS-1824. For more detailed information about System Exclusive messages, refer to “MIDI Implementation” (Appendices p. 82)*

The following items will be used from the External Sync page of the system section:

Sync Source

This determines how the VS-1824 is synchronized with other devices.

INT:

The VS-1824 runs according to its own internal clock. Use this setting when you are not synchronizing with other devices or when you want external MIDI devices to be controlled by sync signals from the VS-1824.

EXT:

The VS-1824 is controlled by synchronization signals (MTC) from the external MIDI device. With this setting, the VS-1824 will not go into Play or Record unless it is receiving MTC signals. Use this setting when you want to use the MTC from an external MIDI device to control the VS-1824.

Sync Gen. (Generator)

This setting determines what type of MIDI signal is generated at the MIDI OUT connector on the VS-1824.

Off: No MIDI signals are transmitted.

MTC: MIDI Time Code is transmitted.

MIDIclk: The Tempo Map MIDI Clock is transmitted.

SyncTr: The Sync Track MIDI Clock is transmitted.

Sync Error Level

This sets the interval (0-10) for checking MTC receiving status when synchronizing to MTC from an external MIDI device. If MTC is not being sent continuously, the VS-1824 checks the MTC and if there is an error, temporarily cancels synchronization. Selecting a longer interval under such circumstances will allow synchronization to continue, even if errors are present. Normally, this is set to “5.”

Sync MTC Type (MTC Type)

This selects the type of MTC (30, 29N, 29D, 25, or 24). Set this to conform to the type of MTC on the slave VS-1824.

Syncing Two VS-1824s or a VS-1824 and a VS-1680 with MTC and MMC

The VS-1824 has the ability to generate and slave to MIDI Time Code (MTC). It also has the ability to varispeed its sample rate to account for fluctuations in the source clock signal. This provides a sync that is frame-accurate and allows you to do things such as lock to video and locate on the fly. The following example explains how to synchronize two VS-1824s using MTC and MMC. One VS-1824 or VS-1680 acts as the MMC/MTC master, and the other acts as the MMC/MTC slave. Make connections as described below:



MMC (See Appendices p. 12)

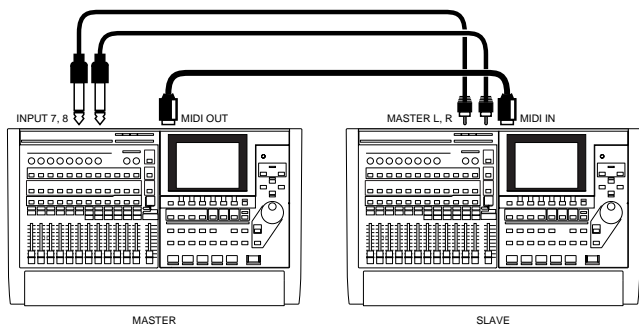

* *In this example, you can use the master's Stereo In function for the mix balance between the master and slave VS recorders (p. 196) First adjust the individual track balances on both machines. Of course, you can also send the output of both recorders to an external mixer.*

Settings for the Master VS

1. Hold [SHIFT] and press [F5 (SYSTEM)]. The System Menu appears in the display.
If the System Menu does not appear, press [F6 (EXIT)].
2. Press [F4 (MIDI)]. If "MIDI" does not appear above [F4], press [PAGE] until "MIDI" appears, then press [F4 (MIDI)].
3. Use [▲], [▼], [◀], and [▶] to move the cursor and use the TIME/VALUE dial to make settings for each parameter as described below.

Device ID

This should be set to "17."

MIDI Thru (MIDI Thru Switch) = OUT

For this application, set this to "OUT."

SysEx.Tx (System Exclusive Transmit Switch)

For this application, set this to "On."

MMC (Midi Machine Control Mode)

For this application, set this to "MASTER."

Control Type (Mixer Control Types)

For this application, set this to "Off."

* *When "C.C." or "Excl" is selected, mixer adjustments made on the master VS will result in the same mixer settings occurring on the slave VS. For more detailed information about System Exclusive messages, refer to "MIDI Implementation" (Appendices p. 82)*

4. Hold [SHIFT] and press [EXT SYNC].
5. Use [▲], [▼], [◀], and [▶] to move the cursor and use the TIME/VALUE dial to make the settings as described below.

Sync Source

For this application, set this to "INT."

Sync Gen. (Generator)

For this application, set this to "MTC."

Sync MTC Type (MTC Type)

For this application, set this to "30."

6. Press [PLAY (DISPLAY)] to return to the Playlist display.

Settings for the Slave VS

1. Hold [SHIFT] and press [F5 (SYSTEM)].
The System Menu appears in the display. If the System Menu does not appear, press [F6 (EXIT)].
2. Press [F4 (MIDI)].
If “MIDI” does not appear above [F4], press [PAGE] until “MIDI” appears, then press [F4 (MIDI)].
3. Use [▲], [▼], [◀], and [▶] to move the cursor and use the TIME/VALUE dial to make settings for each parameter as described below.
 - Device ID**
This should be set to “17.”
 - SysEx.Rx (System Exclusive Receive Switch)**
For this application, set this to “On.”
 - MMC (Midi Machine Control Mode)**
For this application, set this to “SLAVE.”
 - Control Type (Mixer Control Types)**
For this application, leave this “Off.”
4. Hold [SHIFT] and press [EXT SYNC] button, located above the TIME/VALUE dial.
5. Use [▲], [▼], [◀], and [▶] to move the cursor and use the TIME/VALUE dial to make the settings as described below.
 - Sync Error Level**
Normally, this is set to “5.”
 - Sync MTC Type (MTC Type)**
For this application, set this to “30.”
6. Press [PLAY (DISPLAY)] to return to the Playlist display.
7. Press [EXT SYNC]. The button indicator blinks, indicating the VS is ready to receive MTC. In this state, the slave VS operates in sync with the master VS. The EXT SYNC indicator is lit when the slave VS is waiting for MTC.



You can also use this method to transfer digital audio between two VS recorders. Connect the DIGITAL OUT of the master VS to the DIGITAL IN of the slave VS—since the MTC generated by the master VS provides synchronization to both VS recorders, its digital output must also supply digital clock to the slave VS.

Syncing a VS-1824 and VS-880/880EX or VSR-880

This section explains how to synchronize a VS-1824 and a VS-880/880EX or VSR-880. The VS-1824 functions as the MMC/MTC master, and the VS-880/880EX or VSR-880 functions as the MMC/MTC slave. The first example explains the procedure for synchronizing a VS-1824 with a VS-880/880EX using MIDI Time Code—the same steps apply when you’re synchronizing a VS-1824 and VSR-880. Make connections as described below.

Syncing the VS-880 to the VS-1824 Using MTC and MMC

Both the VS-1824 and the VS-880/880EX have the ability to generate and slave to MIDI Time Code (MTC). They also have the ability to varispeed their sample rate to account for fluctuations in the source signal. This provides a sync that is frame-accurate and allows you to do things such as lock to video and locate on the fly. MMC allows you to control the transport of the slave VS from the master. The following example explains how to synchronize the VS-880/880EX as a slave device to the VS-1824 using MTC and MMC.

Setup

The only items needed to synchronize the VS-1824 and VS-880/880EX are a MIDI cable and a pair of audio cables. Use the following procedure to setup a VS-1824 and VS-880/880EX to operate in sync with the VS-1824 as the master device:

1. Connect the MIDI OUT jack of the VS-1824 to the MIDI IN jack of the VS-880/880EX.
2. Connect the left MASTER OUT jack of the VS-880/880EX to INPUT 3 on the VS-1824.
3. Connect the right MASTER OUT jack of the VS-880/880EX to INPUT 4 on the VS-1824.

VS-1824 Settings

1. Hold [SHIFT] and press [F5 (SYSTEM)].
The System Menu appears in the display.
If the System Menu does not appear, press [F6 (EXIT)].
2. Press [F4 (MIDI)].
If “MIDI” does not appear above [F4], press [PAGE] until “MIDI” appears, then press [F4 (MIDI)].

3. Use [▲], [▼], [◀], and [▶] to move the cursor and use the TIME/VALUE dial to make settings for each parameter as described below.

Device ID

For this application, set this to “17.”

MIDI Thru (MIDI Thru Switch)

For this application, set this to “OUT.”

SysEx.Tx (System Exclusive Transmit Switch)

For this application, set this to “On.”

MMC (Midi Machine Control Mode)

For this application, set this to “MASTER.”

Control Type (Mixer Control Types)

For this application, set this to “Off.”

4. Hold [SHIFT] and press [EXT SYNC].
5. Use [▲], [▼], [◀], and [▶] to move the cursor and use the TIME/VALUE dial to make the settings as described below.

Sync Source

For this application, set this to “INT.”

Sync Gen. (Generator)

For this application, set this to “MTC.”

Sync MTC Type (MTC Type)

For this application, set this to “30.”

6. Press [PLAY (DISPLAY)] to return to the Playlist display.

VS-880/880EX Settings

1. Press [SYSTEM] until “SYS MIDI PRM?” is displayed and press [YES/ENTER].
2. Press the PARAMETER RIGHT button until “SYS EX RX” is displayed and use the TIME/VALUE dial to select “ON.”
3. Press the PARAMETER RIGHT button until “MMC =” is displayed and use the TIME/VALUE dial to select “SLAVE.”
4. Press the PARAMETER RIGHT button until “OUT/THRU =” is displayed and use the TIME/VALUE dial to select “OUT.”
5. Press [SYSTEM] until “SYS SYNC/TEMPO” is displayed and press [YES/ENTER].
6. Use the TIME/VALUE dial to select “EXT.”
7. Press the PARAMETER RIGHT button so that “MTC TYPE” is displayed and use the TIME/VALUE dial to select “30.”
8. Press [PLAY (DISPLAY)] to return to the main screen.

When you press PLAY on the VS-1824, both units will start playing. The VS-1824's stereo mix output will now contain audio from both units.



You can also use this method to transfer digital audio between the two VS recorders. Connect the DIGITAL OUT of the master VS to the DIGITAL IN of the slave VS—since the MTC generated by the master VS provides synchronization to both VS recorders, its digital output must also supply digital clock to the slave VS.

Using an External MIDI Device to Control the Mixer (Compu Mix)

The VS-1824 can send and receive mixer settings and fader movements as MIDI messages. You can use an external MIDI controller to control the VS-1824's faders. You can also use an external MIDI sequencer to record mixer settings and movements during playback as MIDI song data, and the mixer can be controlled automatically by the MIDI sequencer when the song is played back later. This is referred to as Compu Mix. Compu Mix uses Control Change messages or System Exclusive messages.

When using System Exclusive Messages

When working in Compu Mix, you should normally use Control Change messages. However, if the Control Change messages affect the settings of other MIDI devices in your setup, you can use System Exclusive messages. For more detailed information about Control Change messages and System Exclusive messages, refer to "MIDI Implementation" (Appendices p.82).

Correspondence Between MIDI Channels and Controller Numbers

MIDI channels correspond to the mixer channels as shown below. For channels paired using the Channel Link function, Control Change messages can be exchanged using the odd-numbered channel's MIDI channel. Control Change messages transmitted via the even-numbered channel's MIDI channel are ignored.

MIDI Channel	Input Mixer	Track Mixer	Master Block
1	1	1/17	-
2	2	2/18	-
3	3	3	-
4	4	4	-
5	5	5	-
6	6	6	-
7	7	7	-
8	8	8	-
9	DIGITAL L	9	-
10	DIGITAL R	10	-
11	ST IN	11	-
12	FX1	12	-
13	FX2	13	-
14	FX3	14	-
15	FX4	15	-
16	-	16	Master Block

Controller numbers correspond to the track channel parameters as follows for Tracks 1-16.

Controller Number	Mixer Parameter
3	TRACK STATUS
7	MIX Send Level
10	MIX Send Pan
12	EQ L Freq.
13	EQ L Gain
14	EQ M Freq.
15	EQ M Gain
16	EQ M Q
17	EQ H Freq.
18	EQ H Gain
19	FX1 SND Level
20	FX1 SND Pan/Balance
21	FX2 SND Level
22	FX2 SND Pan/Balance
23	AUX1 (* FX3) SND Level
24	AUX1 (* FX3) SND Pan/Balance
25	AUX2 (* FX4) SND Level
26	AUX2 (* FX4) SND Pan/Balance
27	AUX3 (* AUX) SND Level
28	AUX3 (* AUX) SND Pan/Balance
29	MIX Offset Level
30	MIX Offset Balance

* When you are installing two effect expansion boards.

Controller numbers correspond to the track channel parameters as follows for Tracks 17 and 18.

Controller Number	Mixer Parameter
35	TRACK STATUS
39	MIX Send Level
42	MIX Send Pan
44	EQ L Freq.
45	EQ L Gain
49	EQ H Freq.
50	EQ H Gain
51	FX1 SND Level
52	FX1 SND Pan/Balance
53	FX2 SND Level
54	FX2 SND Pan/Balance
55	AUX1 (* FX3) SND Level
56	AUX1 (* FX3) SND Pan/Balance
57	AUX2 (* FX4) SND Level
58	AUX2 (* FX4) SND Pan/Balance
59	AUX3 (* AUX) SND Level
60	AUX3 (* AUX) SND Pan/Balance
61	MIX Offset Level
62	MIX Offset Balance

* When you are installing two effect expansion boards.

Chapter 22 Specific Applications

Controller numbers correspond to the input channel parameters as follows.

Controller Number	Mixer Parameter
68	MIX Send Level
70	MIX Send Pan
71	EQ L Freq.
72	EQ L Gain
73	EQ M Freq.
74	EQ M Gain
75	EQ M Q
76	EQ H Freq.
77	EQ H Gain
78	FX1 SND Level
79	FX1 SND Pan/Balance
80	FX2 SND Level
81	FX2 SND Pan/Balance
82	AUX1 (* FX3) SND Level
83	AUX1 (* FX3) SND Pan/Balance
84	AUX2 (* FX4) SND Level
85	AUX2 (* FX4) SND Pan/Balance
86	AUX3 (* AUX) SND Level
87	AUX3 (* AUX) SND Pan/Balance
88	MIX Offset Level
89	MIX Offset Balance

* When you are installing two effect expansion boards.

Controller numbers correspond to the Master Block parameters as follows.

Controller Number	Mixer Parameter
68	Master Level
70	Master Balance
78	FX1 SND Level
79	FX1 SND Balance
80	FX2 SND Level
81	FX2 SND Balance
82	AUX1 (* FX3) SND Level
83	AUX1 (* FX3) SND Balance
84	AUX2 (* FX4) SND Level
85	AUX2 (* FX4) SND Balance
86	AUX3 (* AUX) Level
87	AUX3 (* AUX) Balance
102	Monitor Level
103	Monitor Balance

* When you are installing two effect expansion boards.

Preparations for Compu Mix

1. Make connections as shown below.

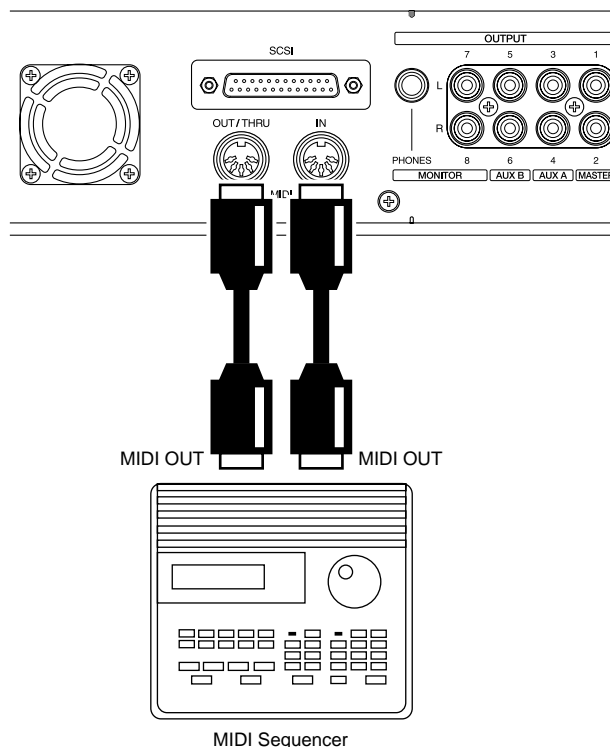

- Hold [SHIFT] and press [F5 (SYSTEM)]. The System Menu appears in the display.
If the System Menu does not appear, press [F6 (EXIT)].
- Press [F4 (MIDI)]. If "MIDI" does not appear above [F4], press [PAGE] until "MIDI" appears, then press [F4 (MIDI)].
- Use [▲], [▼], [◀], and [▶] to move the cursor and use the TIME/VALUE dial to make settings for each parameter as described below.
 - MIDI Thru (MIDI Thru Switch)**
For this application, set this to "OUT."
 - Cntrl Local (Control Local Switch)**
For this application, set this to "On."
 - Control Type (Mixer Control Types)**
For this application, set this to "C.C."
- Follow the procedure described in "Synchronizing with MIDI Sequencers" ("Synchronizing with MIDI Sequencers," p. 197) to make the necessary settings in both the VS-1824 and the MIDI sequencer to synchronize the two machines. Make sure to set the MIDI sequencer so MIDI messages received at the MIDI In connector are not output from the MIDI Out connector.

Recording with Compu Mix

1. Prepare the VS-1824's initial mixer settings (e.g. panning, faders, EQ, etc.) during song playback. Then press [STOP] and rewind to the beginning of the song.
2. Put the MIDI sequencer into Record mode, and press [PLAY] on the VS-1824.
3. As soon as playback of the VS-1824 starts, immediately hold [SHIFT] and press [SCENE]. The mixer's initial settings are transmitted from the MIDI OUT connector.
4. As the song continues to play, make adjustments to the faders and other mixer settings as desired.
5. When the song is finished playing, stop the MIDI sequencer and the VS-1824.

This completes recording with Compu Mix. When you rewind to the beginning of the MIDI sequence and the VS-1824 song and then begin playback, all mixer settings are controlled according to the Compu Mix. Save the MIDI song file to a floppy disk or other storage media.

Synchronizing with Video Equipment

When used in combination with the optional Roland SI-80S LANC to MTC Converter, you can control the Play and Stop functions of the VS-1824 using consumer video equipment. This video equipment must provide a consumer video interface that conforms to RCTC time code. On many video products, this interface is labeled "LANC." Make your connections as shown below, and refer to the SI-80S owner's manual and the owner's manual for your video device.

1. Hold [SHIFT] and press [F5 (SYSTEM)]. The System Menu icon appears in the display. If the System Menu icon does not appear, press [F6 (EXIT)].
2. Press [F4 (MIDI)]. If "MIDI" does not appear in the display above [F4], press [PAGE] until "MIDI" appears, and then press [F4 (MIDI)].
3. Use [▲], [▼], [◀], and [▶] to move the cursor and use the TIME/VALUE dial to change the setting.

SysEx.Rx (System Exclusive Receive Switch)

For this application, set this to "On."

MMC (MIDI Machine Control)

For this application, set this to "SLAVE."

4. Hold [SHIFT] and press [EXT SYNC]. The Sync/Tempo screen appears in the display.
5. Use [▲], [▼], [◀], and [▶] to move the cursor and use the TIME/VALUE dial to change the settings.

Sync Error Level

Normally, this is set to "5." If you are having difficulties, setting a longer interval allows synchronization to continue even if there are errors in the source MTC.

Sync MTC Type

This selects the MTC frame rate (30, 29N, 29D, 25,24). Select the MTC rate so it matches the rate of the SI-80S (30, 29D or 29N).

6. Press [PLAY (DISPLAY)] to return to the Playlist display.
7. Press [EXT SYNC]. The button indicator lights, indicating the VS-1824 is synchronized using MTC received from the SI-80S. In this state, commands such as Play and Stop performed on the video equipment are also performed on the VS-1824.

Using External Effects Units

When using external effects devices, the AUX A/B jacks serve as effects send jacks. The following example describes how effects can be added to a stereo recording on Track 9/10. Follow these steps when you want to use an external effects unit. Use the INPUT 7 and 8 jacks as the effect return jacks.

1. Connect your effects unit as shown here:

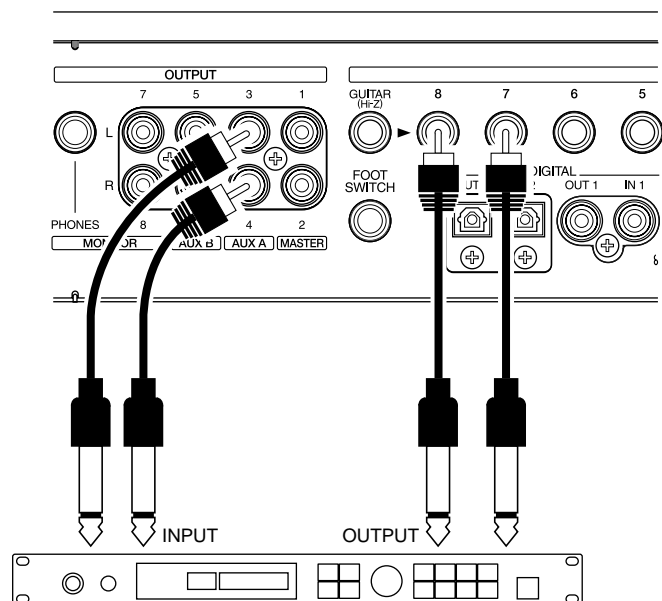

2. Press Track 9/10 SELECT. The Track Mixer appears in the display.
3. Press [F5 (AUX)]. If “AUX” does not appear in the display above [F5], press [PAGE] until you see “AUX,” and then press [F5 (AUX)].
 - * If EFFECT B is not installed in the VS-1824, then [F4] displays “AUX3.”
4. Move the cursor to “AUX Sw.” Use the TIME/VALUE dial to select “Pst.”
5. Press [▲] and [▼] to move the cursor. Adjust the volume level (0-127) and pan (L63-R63) as needed.
6. Press [MASTER]. The Master Block appears in the display.
7. Press [F3 (AUX.A)]. If “AUX.A” does not appear in the display above [F3], press [PAGE] until you see “AUX.A,” and then press [F3 (AUX.A)].
8. Move the cursor to “AUX.A.” Use the TIME/VALUE dial to select “AUX.”
9. Press [ST IN].
10. Use the TIME/VALUE to select “Input 7/8” for StereoIn Select.

11. Press [▲] and [▼] to move the cursor. Adjust the volume level (0-127) and pan (L63-R63) as needed.
12. Press [PLAY (DISPLAY)] to return to the Playlist display. You are now ready to use the external effect unit.
13. While playing back the song, adjust the sound of the effect. To control the external effect return level using the channel fader on the VS-1824, press [FADER/MUTE] so “IN” is lit. Then use the “ST IN” fader (same as Track Fader 11/12) to adjust external effect return level. When you are satisfied with the level, press [FADER/MUTE] so “TR” is lit.

Chapter 23 Frequently Asked Questions

This chapter will answer some of the most frequently asked questions by VS-1824 owners regarding its operation.

How Do I Control the Stereo Tracks Independently?

When a new song is created with “VS-1880” selected as the fader mode (p. 75), Channels 7/8, 9/10, 11/12, 13/14, 15/16, and 17/18 are set with Channel Link ON and act as stereo pairs.

Tracks 7-18 on the VS-1824 are configured as stereo tracks but they can be controlled independently. To do this, the Channel Link function must be turned off. Tracks 7, 9, 11, 13, 15 and 17 can then be controlled from the front panel just as Tracks 1-6 are. Tracks 8, 10, 12, 14, 16 and 18 can be controlled by holding [SHIFT] and adjusting the desired front panel control. For example, holding [SHIFT] and moving the 7/8 fader will adjust the level for Track 8, but not Track 7. The following procedure will guide you through the process of recording a mono signal to Track 16.

1. Press Track 15/16 SELECT so “Track Mixer [TR=15/16]” appears in the display.
2. Use [▲], [▼], [◀], and [▶] to select “Link” and use the TIME/VALUE dial to select “OFF.”
3. Hold [SHIFT] and Track 15/16 STATUS and press the Input SELECT button for the input you wish to record (so that it begins to flash).
4. Hold [SHIFT] and press the Track 15/16 STATUS so it is flashing red.
5. Use the appropriate INPUT SENS knob to set the recording level as desired.
6. Press [REC] followed by [PLAY] to begin recording.
7. Press [STOP] when you are finished.
8. Press [PLAY] to hear the results. Hold [SHIFT] and use the Channel 15/16 fader to adjust the playback volume of Track 16 as desired.

NOTE

Each time you press the Track 15/16 SELECT button when Channel Linking is turned “off,” the display will alternate between the Track Mixer for Tracks 15 and 16.

Why Do I Hear the Inputs All of the Time?

The setting of the “MIX On/Off” switch determines whether or not a track or input is sent to the MIX bus. This parameter should be checked when you are hearing a track or input that you don’t want to hear, or when you are having trouble hearing a track or input that you should be hearing. The default setting for this switch is “On,” even for the inputs. This is why it is possible to hear your inputs when you first plug in a microphone. If you are going to record an input such as a microphone, the normal procedure would be to route the input to the track you are going to record it on, and then turn the MIX switch to OFF for the input. You will then be monitoring your microphone from the track and not also hearing it in the mix bus straight from the input channel itself.

Use the following procedure to set the MIX On/Off switch:

1. Press the desired Input or Track SELECT button.
2. Use [▲], [▼], [◀], and [▶] to highlight the parameter beneath “MIX” (in the upper right corner of the display).
3. Use the TIME/VALUE dial to select “On” or “Off” as desired. For example, if you are trying to prevent an input from being heard at the MASTER outputs, you would set this switch to “Off.”
4. Repeat Steps 1-3 for any additional tracks or inputs as desired.

What is the FADER/MUTE Button Used For?

The position of the [FADER/MUTE] determines whether the faders control track levels or input and effect return levels.

When “VS-1824” is selected as the fader mode (p. 75)

When “TR” is lit:

You can adjust the volumes and change the status of Track Channels 1–12.

When “TR” is blinking:

You can adjust the volumes and change the status of Track Channels 13–18.

When “IN” is lit:

The faders are used to control the Input Mixer (8 analog inputs, 2 digital inputs), the Stereo Input, plus the Effects 1/3 Return and Effects 2/4 Return.

MEMO

Faders 16 and 18 will control the Effect 3 and 4 Returns respectively. They are accessed by holding [SHIFT] while adjusting the fader.

When “VS-1880” is selected as the fader mode (p. 75)

When “TR” is lit:

You can adjust the volumes and change the status of Track Channels 1–18.

When “IN” is lit:

The faders are used to control the Input Mixer (8 analog inputs, 2 digital inputs), the Stereo Input, plus the Effects 1/3 Return and Effects 2/4 Return.

Faders 16 and 18 will control the Effect 3 and 4 Returns respectively. They are accessed by holding [SHIFT] while adjusting the fader.

How Do I Burn Audio CDs?

The VS-1824 allows you to take a project from its beginning stages all the way to a finished CD. What steps need to be taken to produce a finished CD? A general description of the recording process might be as follows:

- Recording basic tracks
- Editing your tracks
- Mixing your tracks
- Mastering your tracks to a final stereo mix
- Preparing your stereo mix for CD

This section covers some of the common questions that arise during the CD-preparation phase of the recording process. If you haven't already, you will need to mix your songs down to a two-track stereo format. You can do this by recording to an external device such as a DAT machine or cassette deck or by “bouncing” your tracks down to a stereo pair within the VS-1824 itself.

How Do I Choose Which Tracks are Burned to the CD?

CDs use a stereo format. This means that you will always use two tracks (left and right) to be burned onto the CD-R.

** We recommend using stereo Track 17/18 for this purpose.*

Use the following procedure to designate a left and right track for creating a CD:

1. Press [CD-RW/MASTERING]. The CD-RW/Mastering Menu will be displayed. If it is not, press F6 [EXIT].
2. Press [F2 (CD Wt)] to display the “CD Write Ready?” prompt.
3. Press [ENTER/YES] and “Store Current?” will be displayed. If you have made any changes to your song that have not been saved, press [ENTER/YES]; otherwise, press [EXIT/NO].
4. Press [F1 (SelTr)] to display the “Select Track” screen.
5. Use the TIME/VALUE dial to select the track (and V-Track) that will become the left side of the CD and press [F3 (Sel L)]. For example, if your stereo mix is recorded to Tracks 17 and 18, you will highlight “17-1: V.T 17-1” and press [F3 (Sel L)] to designate Track 17 (V-Track 1) as the left track of the CD.
6. Use the TIME/VALUE dial to select the track (and V-Track) that will become the right side of the CD and press [F4 (Sel R)].
7. Press [F1 (Back)] and the tracks you selected will be displayed under “L-Ch Source Track” and “R-Ch Source Track.” You can now continue with the CD Write procedure on p. 188 of this manual.

How Do I Set CD Markers?

When writing multiple songs to the CD at once, it is important that CD number markers are created at the beginning of each song. Otherwise, your audio will be combined into one long song on the CD. The VS-1824 automatically creates the first CD marker at 00h00m00s00f. You will need to create CD markers for any additional songs. Use the following procedure to create CD markers:

1. Locate the VS-1824 to the point where the audio for your second song begins.
2. Hold [PLAY (DISPLAY)] and press [TAP].
3. Locate the VS-1824 to the beginning of the third song.
4. Hold [PLAY (DISPLAY)] and press [TAP].
5. Continue this procedure for any additional songs.

* *Note: CD standards require a song to be at least four seconds in length. If you try to set a CD marker within four seconds of another CD marker, the VS-1824 will respond with a “Can’t Set Marker” message.*



The Scrub and Preview functions can be very helpful in locating the exact beginning of your songs. Use the PREVIEW TO command to make sure that the current time is right before the audio begins. Also, some CD players will cut off the beginning of your song if it is too close to the CD marker. If you set your CD markers around 0.5 second (15 frames) before your song actually begins, it should index correctly on most CD players.

Why Does My Music Sound Different on the CD?

If a song on a CD you make sounds drastically different than it does when played on the VS-1824, remember that mixer settings such as fader level, effects, and EQ do not translate to the CD. Use the following procedure to listen to your song as it will be recorded to the CD:

1. Solo the tracks that you have selected as the left and right CD tracks.
2. Press [FADER/MUTE] so “TR” is lit and set the faders for the selected tracks to 0dB (at the bold line approximately two-thirds of the way up).
3. Press the Track SELECT button for the track selected as the “L-Ch Source Track” so that the Track Mixer screen appears in the display.
4. Use [▲], [▼], [◀], and [▶] to highlight the Link parameter and use the TIME/VALUE dial to select “On.”
5. Use [▲], [▼], [◀], and [▶] to highlight the Pan parameter (under the pan knob icon) and use the TIME/VALUE dial to select “0.”
6. Use [▲], [▼], [◀], and [▶] to highlight the EQ Sw parameter and use the TIME/VALUE dial to select “Off.”
7. Use [▲], [▼], [◀], and [▶] to highlight the FX 1 parameter and use the TIME/VALUE dial to select “Off.” Do the same for FX 2, 3, and 4.
8. Use [▲], [▼], [◀], and [▶] to highlight the FX Ins parameter and press [ENTER/YES]. Use the TIME/VALUE dial to select “Off” for FX 1. Do the same for FX 2, 3, and 4.
9. Use [▲], [▼], [◀], and [▶] to highlight the ATT parameter and use the TIME/VALUE dial to select “0dB.”
10. Press [AUTOMIX] so it is not lit.
11. Press the Track STATUS button for the track selected as the “L-Ch Source Track” until it is in Play mode (green) and set its fader to 0dB. Bring the remaining channel faders all the way down.
12. Set the Master fader to 0dB. Reset your song to the beginning and press [PLAY] to hear your song as it will sound on the CD.

How Do I Create a Tempo Map?

The VS-1824 allows you to create a tempo map that controls tempo and meter changes throughout your song. This is very useful when you are integrating the VS-1824 with a MIDI sequencer. Use the following procedure to create a tempo map:

1. Hold [SHIFT] and press [F5 (SYSTEM)]. The “System Menu” page should be displayed. If it is not, press [F6 (EXIT)].
2. Press [F6 (SYNC)]. If “SYNC” does not appear above [F6], press [PAGE] followed by [F6]. The “Sync/Tempo” page will be displayed.
3. Press [F3 (Tmap)] to display the “Tempo Map” screen.
4. Use [▼] to move the cursor to the current tempo setting (e.g. q = 120) and use the TIME/VALUE dial to select the desired starting tempo for your song.



Tempo Map #1 must always start at Measure One.

5. Use [▼] to move the cursor to the beat setting (e.g. 4/4) and use the TIME/VALUE dial to select the desired time signature.
6. Press [F2 (NEW)].
7. Use [▲], [▼], [◀], and [▶] to highlight the tempo setting and the TIME/VALUE dial to select the new tempo.
8. Use [▼] to move the cursor to the measure setting and use the TIME/VALUE dial to select the measure where you want the new tempo to begin.
9. Use [▼] to move the cursor to the beat setting (e.g. 4/4) and use the TIME/VALUE dial to select the desired time signature.
10. Repeat Steps 6-9 for any additional tempo and/or time signature changes as desired.

Why Doesn't it Change the Audio?

The tempo map can alter the tempo and meter of MIDI sequences. It cannot, however, do the same for audio recorded on the VS-1824. For this reason, it is best to create your tempo map before you begin recording any acoustic instruments whenever possible and to record while listening to the metronome. It is only possible to alter the playback speed of recorded audio by using the Vari Pitch and/or Time Compression/Expansion functions.

How Do I Use Automix?

The Automix function of the VS-1824 allows you to perfect your final mix before you commit to a master DAT tape or CD. Instead of manually “riding” the faders while you are recording to your master tape, Automix allows you to record mixer changes such as level, pan, effects type, etc. You can even automate the mixer settings for the inputs. This is helpful when you have synchronized a keyboard or drum machine and you want to mix it in with the audio tracks without actually recording it. There are three main types of Automix available on the VS-1824: realtime, Snapshot, and gradation.

Realtime

Realtime Automix allows you to record fader movements as you make them. This is great for perfecting your track mixes before you record them down to two tracks. Use the following procedure to create a realtime Automix:

1. Press [AUTOMIX] so it is lit.
2. Hold [AUTOMIX] and press the Input and/or Track SELECT buttons— so that they are flashing—for any inputs or tracks that you want to automate.
3. Reset your song to the beginning and adjust the faders as desired for the start of the song.
4. Hold [SCENE] and press [REC] to enable realtime Automix mode.
5. Press [PLAY] and adjust the faders as desired.
6. Press [STOP] when you are finished. Reset your song to the beginning and press [PLAY] to hear the results.

Snapshot

Snapshot automation allows you to recall settings such as fader levels, effect send levels, effect types, and panning at a specific point in time. This is useful, for instance, when you want to change effects during your song. Use the following procedure to create a Snapshot:

1. Press [AUTOMIX] so it is lit.
2. Hold [AUTOMIX] and press the Input and/or Track SELECT buttons— so that they are flashing—for any inputs or tracks that you want to automate.
3. Reset your song to the beginning and adjust the settings as desired for the beginning of your song.
4. Hold [SCENE] and press [TAP] to create a Snapshot of your initial settings.

5. Advance the VS-1824 to the point in time where you want these settings to change and adjust them as desired. Then, hold [SCENE] and press [TAP].
6. Repeat Step 4 to create additional Snapshots as desired.
7. Reset your song to the beginning and press [PLAY] to hear the results.

Gradation

Gradation allows you to designate two Snapshots and have the VS-1824 automatically crossfade the faders and panning between those two points to create a smooth transition. This a very handy tool for creating fades. Use the following procedure to create a fadeout using gradation:

1. Press [AUTOMIX] so it is lit.
2. Hold [AUTOMIX] and press the Input and/or Track SELECT buttons— so that they are flashing—for any inputs or tracks that you want to automate.
3. Advance your song to the point in time where you want the fadeout to begin and adjust the fader levels (including the Master fader) as desired.
4. Hold [SCENE] and press [TAP].
5. Advance your song to the point in time where the fadeout should end, and pull the Master fader all the way down.
6. Hold [SCENE] and press [TAP].
7. Hold [SCENE] and press PREVIOUS. “Gradation Marker #000-#001?” appears in the display.
8. Press [ENTER/YES] and the VS-1824 will create a fadeout between those marker points.
9. Reset your song to a point before the first marker and press [PLAY] to hear the fadeout.

How Do I Create a User Template in EZ Routing?

The the ability to save your own user EZ Routing templates can be a huge timesaver. It can simplify the setup process for frequently used recording or mixing configurations. These user-programmable templates allow you to set up the VS-1824 exactly the way you need, step-by-step, for a particular task. Then, when you need to perform that same task in the future, you simply select that user template and your custom setup will be recalled automatically. The following example will show you how to create a user EZ Routing template for recording Inputs 1-8 to Tracks 1-8 with a compressor effect inserted on each input.

1. Press [EZ ROUTING] so it is lit.
2. Press [PAGE] so that “INPUT” appears in the display above [F2].
3. Press [F2 (INPUT)] to display the Input Mixer settings.
4. Use [▲], [▼], [◀], and [▶] and the TIME/VALUE dial to set the Send for Inputs 1-8 to Tracks 1-8. For example, the Send for Input 1 would appear as “1/-.”
5. Use [▲], [▼], [◀], and [▶] and the TIME/VALUE dial to set FX 1 to “INL” for Input 1 and “INR” for Input 2.
6. Use [▲], [▼], [◀], and [▶] and the TIME/VALUE dial to set FX 2 to “INL” for Input 3 and “INR” for Input 4.
7. Use [▲], [▼], [◀], and [▶] and the TIME/VALUE dial to set FX 3 to “INL” for Input 5 and “INR” for Input 6.
8. Use [▲], [▼], [◀], and [▶] and the TIME/VALUE dial to set FX 4 to “INL” for Input 7 and “INR” for Input 8.
9. Press [F3 (TRACK)] to display the Track Routing screen.
10. Use [▲], [▼], [◀], and [▶] and the TIME/VALUE dial to set Send for Tracks 1-8 to “MIX.”
11. Use [▲], [▼], [◀], and [▶] and the TIME/VALUE dial to set Status for Tracks 1-8 to “REC.”
12. Press [F4 (FX)] to display the Effect Settings screen.
13. Use [▲], [▼], [◀], and [▶] and the TIME/VALUE dial to select “P096 Dual Comp/Lim” for Effects 1-4.

14. Press [F6 (Save)] and the Routing Save screen will appear in the display.
15. Use [▲], [▼], [◀], and [▶] and the TIME/VALUE dial to enter a name for this user EZ Routing template (e.g. "8 Ins w/comp").
16. Press [F5 (Write)] and your template will be saved.
17. Press [PLAY (DISPLAY)] to return to the Playlist display.

Use the following procedure to recall your user template:

1. Press [EZ ROUTING] so it is lit.
2. Use the TIME/VALUE dial to highlight your user template.
3. Press [PAGE] so that "EXEC" appears above F4.
4. Press [F4 (EXEC)] twice. "Apply this Routing?" will appear in the display.
5. Press [ENTER/YES] to apply your user template.

How Do I Bounce Tracks?

Bouncing tracks is a common recording technique used to free up additional recording tracks, or as you prepare a song for CD production by combining ("or bouncing") audio recorded on multiple tracks to a single track or stereo pair of tracks. New material can then be recorded to the original tracks if necessary. On the VS-1824, you can record new tracks without recording over the original material by recording on different V-Tracks. Also, because the bouncing is performed digitally, so you are not adding noise each time you bounce tracks. Use the following procedure to bounce Tracks 1-16 to Tracks 17 and 18:

MEMO

If you want to switch the STATUS of tracks 13-18 and adjust their mixer settings, press [FADER/MUTE] several times until the "TR" indicator blinks.

→ "Switching the Fader Functions" (p. 71)

1. Hold [SHIFT] and press the SELECT button for track 17 or track 18.
2. Press [F1 (Link)].
If "Link" does not appear above [F1], press [PAGE] until you see "Link" above [F1], and then press [F1 (Link)].
3. Use the TIME/VALUE dial to select "ON."
4. Press [FADER/MUTE] several times until the "TR" indicator lights.
5. Hold the track STATUS button (of any track) and press [CLEAR].
6. Hold the track 17 or track 18 STATUS button and press the Track 1-16 SELECT buttons consecutively so that they are flashing.
7. Press the track 17 or track 18 STATUS button until it is set to Source mode (orange). Press the STATUS buttons for Tracks 1-16 until they are set to Play mode (green).
8. Press [PLAY] and adjust the level and pan settings for Tracks 1-16 as desired. Press [STOP] when you are finished.
9. Press the track 17 or track 18 STATUS button until it is set to Record Ready mode (flashing red).
10. Reset your song to the beginning and press [REC] followed by [PLAY].
11. Press [STOP] when your song is finished playing. Now, Tracks 17 and 18 contain a stereo mix of Tracks 1-16.
12. Reset your song to the beginning, turn off Tracks 1-16, and press [PLAY] to hear the results. Make sure that the EQ switch and all effects sends for Tracks 17 and 18 are turned off. This will ensure that the "bounced" version of Tracks 1-16 sounds the same as the original.

How Do I Bounce Tracks with Effects?

If you are using effects, it can be beneficial to include the output of the effects processor when you bounce tracks. This is sometimes referred to as “printing” the effects. By printing the effects, you make them a permanent part of the audio. This also frees up the effect processor to be used on a different track, or to add a different effect on the same track. Use the following procedure to bounce Tracks 1-16 to Tracks 17 and 18 with effects:

MEMO

If you want to switch the STATUS of tracks 13-18 and adjust their mixer settings, press [FADER/MUTE] several times until the “TR” indicator blinks.

→ “Switching the Fader Functions” (p. 71)

1. Assign Tracks 1-16 to any of the available effects processors (1-4) as desired.
2. Hold [SHIFT] and press the SELECT button for the track 17 or track 18.
3. Press [F1 (Link)].
If “Link” does not appear above [F1], press [PAGE] until you see “Link” above [F1], and then press [F1 (Link)].
4. Use the TIME/VALUE dial to select “ON.”
5. Press [FADER/MUTE] several times until the “TR” indicator lights.
6. Hold the track STATUS button (of any track) and press [CLEAR].
7. Hold the track 17 or track 18 STATUS button and press the Track 1-16 SELECT buttons consecutively so they are flashing.
8. Hold the track 17 or track 18 STATUS button and press the EFF RTN button for all of the effects processors being used. For example, to record Effect 1 to Tracks 17 and 18, hold the track 17 or track 18 STATUS button and press EFFECT 1/3 RTN.
** If you are using Effects 3 or 4, you will need to hold Track 17/18 STATUS, [SHIFT], and [EFFECT 1/3 RTN] or [EFFECT 2/4 RTN] to assign Effects 3 and/or 4 to be recorded on Tracks 17 and 18.*
9. Press the track 17 or track 18 STATUS button until it is set to Source mode (orange). Press the STATUS buttons for Tracks 1-16 until they are set to Play mode (green).
10. Press [PLAY] and adjust the level and pan settings for Tracks 1-16 as desired. Press [STOP] when you are finished.
11. Press the track 17 or track 18 STATUS button until it is set to Record Ready mode (flashing red).
12. Reset your song to the beginning and press [REC] followed by [PLAY].
13. Press [STOP] when your song is finished playing. Now, Tracks 17 and 18 will contain a stereo mix of Tracks 1-16 with the effects included.

Why Can't I Hear My Effects?

If you have routed a track or input to one of the internal effects processors (using the optional VS8F-2) and are having difficulty hearing the output of the effects processor, the problem can usually be traced to one of three scenarios: your effects are either inserted on another track or input, the output of the effects processor is routed to a RECORDING bus instead of the MIX bus, or your effect return level for the effect is set to zero.

If you have inserted an effect on a certain track or input, you cannot use that effects processor on any other track or input. Use the following procedure to ensure that Effects 1-4 are not being used as insert effects:

1. Press the Input 1 SELECT button to display the Input Mixer screen.
2. Use [▲], [▼], [◀], and [▶] to highlight the FX Ins icon and press [F6 (PRM.V)].
3. Use [▲], [▼], [◀], and [▶] and TIME/VALUE dial to set the Sw parameter to “Off” for all inputs.
4. Press the Track 1 SELECT button to display the Track Mixer screen.
5. Use [▲], [▼], [◀], and [▶] and the TIME/VALUE dial to set the Sw parameter to “Off” for all tracks.
6. Press the [EDIT/SOLO] button to display the Master Block screen.
7. Use [▲], [▼], [◀], and [▶] to highlight the FX Ins icon and press [ENTER/YES]. Use the TIME/VALUE dial to select “Off” for Effects 1-4.

Routing the outputs of the effects processors to a RECORDING bus is common when bouncing tracks. If you do not return the outputs of the effects processors to the MIX bus, the effects might not be heard the next time you try and use them. Use the following procedure to ensure the outputs of the effects processors are sent to the MIX bus:

MEMO

If you want to select track 1-12 STATUS, press [FADER/MUTE] several times until the “TR” indicator lights.

If you want to select track 13-18 STATUS, press [FADER/MUTE] several times until the “TR” indicator blinks.

→ “Switching the Fader Functions” (p. 71)

1. Hold the Track 1 STATUS button. If the EFFECT 1/3 RTN or EFFECT 2/4 RTN buttons begin to flash, press them so they stop flashing.
2. Repeat this procedure for Tracks 2-18.

Another common reason for being unable to hear an effects processor is that effect return for that effect is set to “0.” Use the following procedure to check the effect return level:

1. Press the [EDIT/SOLO] button to display the Master screen.
2. Use [▲], [▼], [◀], and [▶] and the TIME/VALUE dial to select the desired return level for FX 1-4 (100 is the default value).

How Do I Use the Scrub and Waveform Display Features?

The Scrub and Waveform Display functions of the VS-1824 are extremely useful when performing track edits such as Cut, Copy, and Erase. The Waveform Display helps you find exact edit points in your audio by providing a graphic representation of a particular audio waveform. The Scrub function allows you to hear that edit point by playing back a loop (with a resolution as fine as 25ms) of your audio. You can control the audio that is being looped by selecting the track you want to hear and using the dial to move the audio back and forth across the “Now Line” (the solid line that runs across the middle of the Waveform display). To use the Scrub and Waveform Display functions effectively, it is important that you understand the control parameters used in each function.

Setting the Scrub Length

There are two factors that can affect the precision with which you can scrub audio in the VS-1824: the Scrub Length and the position of the cursor in the time display. Scrub Length controls the size (in milliseconds) of the section of audio that is looped, and can set as low as 25ms or as high as 100ms. The default value is 45ms. Use the following procedure to adjust the Scrub Length:

1. Press [STOP] if the VS-1824 is currently playing.
2. Hold [SHIFT] and press [SCRUB], and the “Scrub Length” screen will appear in the display.
3. Use the TIME/VALUE dial to adjust the scrub length as desired.
4. Press [PLAY (DISPLAY)] to return to the Playlist display.

The position of the cursor in the time display will control the amount of time advanced with each turn of the TIME/VALUE dial. You can set the dial to advance in hour, minute, second, frame, or even subframe increments. You can also set it to advance by measures, beats, or markers. Setting the cursor under the frame portion of the time display will work best for most editing applications. Use the following procedure to adjust the position of the cursor in the time display:

1. Press [PLAY (DISPLAY)] so that the main Play screen appears in the display.
2. Hold [SHIFT] and press [▲] until the time portion of the display is selected.
3. Use [◀] and [▼] to place the cursor under the desired increment for advancing the time display. For example, if you want the VS-1824 to move one frame at a time when the TIME/VALUE dial is turned, the time display would be as follows: 00h00m00s00f00.

NOTE

To advance the time display in subframe increments, set the cursor under the frame portion of the time display and turn the TIME/VALUE dial. The counter will move in increments of 10 subframes. To advance the time display in single subframe increments, hold [SHIFT] while you turn the TIME/VALUE dial.

What do the X and Y Parameters do?

The VS-1824 allows you to zoom in and out on both the amplitude (level) and time values of the Waveform display. The default zoom values for amplitude and time are 1 and 16, respectively. Use the following procedure to adjust the zoom controls on the Waveform display:

1. Press [PLAY (DISPLAY)] so that the main Play screen appears.
2. Use [▲] and [▼] to select the track to be viewed in the Waveform display and advance the song to a point where there is audio present on that track.
3. Press [F5 (WAVE)] to view the Waveform display.
4. Use [F1 (ZOOM+)] and [F2 (ZOOM-)] to zoom in and out on the amplitude (level) portion of the display (vertical).
5. Use [F3 (←→)] and [F4 (→←)] to zoom in and out on the time portion of the display (horizontal).
6. Press [F5 (WAVE)] when you are finished to close the Waveform display.

How Do I Record a Stereo Signal?

Recording a stereo signal is nearly identical to recording a mono signal with the exception that you will need to use two inputs and two tracks. The easiest way to record a stereo signal is to link the source (inputs and/or tracks) and the destination tracks. Use the following procedure to link Tracks 3 and 4:

1. Press the Track 3 SELECT button.
2. Use [▲], [▼], [◀], and [▶] to highlight "Link."
3. Use the TIME/VALUE dial to select "ON."
4. Press [PLAY (DISPLAY)] to return to the Playlist display. You can now use the Track 3 fader to control the volume of Tracks 3 and 4.

How Do I Restore the Mixer Parameters to the Factory Settings?

The VS-1824 gives you the ability to return all of your mixer and system parameters back to their original factory settings. This is convenient if you want to reset the mixer and system settings to their original values without having to adjust each parameter manually. This is also a good beginning for troubleshooting when you are having difficulties that appear to be mixer-related. Use the following procedure to initialize the VS-1824 mixer and system parameters:

1. Hold [SHIFT] and press [F5 (SYSTEM)]. The "System Menu" page should be displayed. If it is not, press [F6 (EXIT)].
2. Press [PAGE] so that INIT appears in the display above [F1].
3. Press [F1] and "Init Mix/Sys Prm Sure?" will be displayed.
4. Press [ENTER/YES] and "Initializing...Please Wait" will be displayed.
5. Press [PLAY (DISPLAY)] to return to the main Play screen.

How Do I Know How Much Time I Have Left On My Hard Drive, and How Big Is My Song?

While you are recording with the VS-1824, it is important to know exactly how much recording time is available to you on the current hard drive, or, more accurately, the current partition of that drive. The VS-1824 allows you to view this information in one of the following forms:

Remaining Time:

The amount of available time shown in minutes and seconds.

Capacity MB:

The amount of available space shown in megabytes.

Capacity %:

The amount of free space shown as a percentage.

Capacity Event:

The number of events available.

Use the following procedure to select the format for showing the amount of available space on the current drive:

1. Hold [SHIFT] and press [F5 (SYSTEM)]. The System Menu appears in the display. If the System Menu does not appear, press [F6 (Exit)].
2. Press [F1 (SYSPM)] followed by [F2 (Prm 2)].
3. Use [▲], [▼], [◀], and [▶] to highlight "Remain Display" and use the TIME/VALUE dial to select the desired format (time, megabytes, percentage, or events).
4. Press [PLAY (DISPLAY)] to return to the Playlist display.
5. Hold [SHIFT] and press [PLAY (DISPLAY)] until the name of the current song appears in the display. The amount of space left on the drive will be indicated next to "REMAIN" in the format selected in Step 3.

How Many Megabytes Does My Song Use?

In addition to viewing the remaining space on your hard drive, it is also important to know how many megabytes a song uses. Use the following procedure to view the size of the current song in megabytes:

1. Press [PLAY (DISPLAY)].
2. Hold [SHIFT] and press [PLAY (DISPLAY)] until the name of the current song appears in the display. The size of the current song will be displayed in megabytes next to "Size:" under the song name.

How Do I Import VS-1680, VS-880/880EX, VS-890/VSR-880 and VS-840/840EX Songs?

If you have songs created on a VS-1680, VS-880/880EX, VS-890/VSR-880 or VS-840/840EX that you would like to edit on the VS-1824, you will need to convert them to the VS-1824's format using the Song Import function. If your VS-1680, VS-880/880EX, VS-890/VSR-880 or VS-840/840EX backup is not in a playable form (e.g. DAT, CD-R, or on a Zip disk in archive format), you will need to recover that material on to a VS-1824-formatted drive first.

* VS-1880's song data is identical to that of the VS-1824.

* VS-2480's song data cannot be used on VS-1824.

Use the following steps to recover a VS-1680, VS-1880 or VS-880/880EX DAT:

1. Connect the digital output of your DAT machine to the VS-1824's digital input (DIGIN1 for coaxial or DIGIN 2 for optical).
2. Load the DAT tape that contains the desired song and set the tape to play back from the beginning of that song backup.
3. Hold [SHIFT] and press [F6 (Utility)] to display the Utility Menu.
4. Press [PAGE] so that "DATRc" appears above F1 (if necessary). Press [F1 (DATRc)] to display the DAT Recover screen.
5. Use [▲], [▼], [◀], and [▶] and the TIME/VALUE dial to select the appropriate "Digital In Source" (DIGIN 1 for coaxial or DIGIN 2 for optical).
6. Use [▲], [▼], [◀], and [▶] and the TIME/VALUE dial to select the song to be recovered under "Source Song."

NOTE

Warning: If you have any songs on the VS-1824's internal drive that you do not want erased, make sure that "Off" is selected under "Erase All Songs."

7. Press [F4 (Exec)]. "Store Current?" appears in the display. If you have any changes in the current song that have not been saved, press [ENTER/YES]. Otherwise, press [EXIT/NO].
8. When "Please Play DAT" appears in the display, start playing your DAT machine.

9. When "Please Stop DAT" appears in the display, stop your DAT machine and press [ENTER/YES] on the VS-1824.

10. Press [PLAY (DISPLAY)] to return to the Playlist display.

In order to edit a VS-1680, VS-880/880EX, VS-840/840EX or VS-890/VSR-880 song on the VS-1824, you must use the Song Import function to convert it to a VS-1824 formatted song. Use the following procedure to import a song into the VS-1824:

1. Hold [SHIFT] and press [F1 (SONG)]. The Song Menu appears in the display. If Song Menu does not appear, press [F6 (Exit)].
2. Press [PAGE] until "IMPORT" appears in the display above [F4].
3. Press [F4 (IMPORT)].
4. Use [▲], [▼], [◀], and [▶] to highlight the song you wish to convert and press [F4 (MARK)].
5. Repeat Step 3 for any additional songs that you wish to convert.
6. Press [F4 (EXECUTE)]. A new copy of the selected song(s) will be created in VS-1824 format.

Index

Numerics

1–8 (Scene) button	21
1–8 button	18
2 Band EQ	81
24 fps	197
25 fps	197
29 fps (drop)	197
29 fps (non-drop)	197
3 Band EQ	81
30 fps (non-drop)	197

A

AC IN jack	22
Access Indicator	23
Alarm clock	260
Algorithms	103
Arrow buttons.	See CURSOR buttons
Attenuation	55, 82
Input Mixer	89
Track Mixer	94
Auto Punch	58
AUTO PUNCH button	21
Automation.	See Automix
Automix	124–138
copying data	133
crossfade	130
decreasing data values	136
displaying	125
editing	
Micro Edit overview	132
erasing	
all	138
from one area	132
from specific channels	138
selected data	138
exiting	138
fadeout	130
Fader Match	249
general procedure	125
how do I use it?	272
increasing data values	136
realtime	
described	125
effect returns	126
input faders	126
master mix	126
monitor output	126
track faders	125
saving data	138
scaling data values	136
Shift/Expand	136

Snapshots

contents	124
determining	128
described	127
erasing	138
gradation	129
examples	130
overview	129
recalling	128
recording	127
Snap mode	128
transitions	129
transitions	
smoothing	135
updating	131
selected faders	131
song section	131
AUTOMIX button	19
AUX A & B jacks	22, 73
routing signals to	95
AUX bus	27
master level and balance	98
routing to	
Input Mixer	87

B

Backup	
options	232
DAT	232
removable drive	232
VS-CDR	232
Balanced inputs	23
BANK/9 button	21
Beat Clock.	See MIDI synchronization
Blank Disc	192
Bouncing tracks	64
with effects	65
Burning a CD.	See CD, 183
Busses	
AUX bus	27
EFFECT	27
introduced	27
MIX	27
RECORDING	27
Button sensitivity	256

C

Cakewalk	210
Can't Set Marker	178
Capture	192

- CD**
 connecting a CD-R/CD-RW drive 194
 creating an audio CD 183
 adding songs 190
 all songs at once 190
 CD-RW 188
 disk at once 185
 necessary items 184, 234
 rules 185
 Table of Contents 185
 track at once 185
 track markers 186
 track numbers 186
 why it sounds different 271
 writing one song 188
 creating and audio CD
 choosing tracks 270
 playing 191
 recording from 67
 Red Book standard 183
CD Player 191
CD-RW
 creating an audio CD 188
Channel faders 19
Channel Link 55, 77
 Input Mixer 89
 Track Mixer 94
 See also Linking channels
Channels
 defined 25
 equalization 80
 grouping 79
 Input Mixer 86
 linking 77
 Input Mixer 89
 Track Mixer 94
 muting 42
 selecting 19
 soloing 42
 Track Mixer 90
CLEAR (Back Space) button 21
Clock
 internal, setting 34
 master
 selection 66
 MIDI 201
Clock alarm 260
Compu Mix
 external control of VS 265
 preparations 266
 recording 267
Connecting
 electric guitar 53
 instruments 53
Contents of package 16
CONTRAST knob 21
Control Changes. See MIDI
Controllers. See MIDI
Cooling Fan Exhaust 22
Copying
 mixer settings 83
Copyright 181, 186
Cubase VST 211
Cursor 36
CURSOR buttons 21, 36

D
DAO 185
DAT Backup 232, 238–240
 about the devices used 238
 before backing up 238
 checking tape contents 242
 necessary items 238
 performing the backup 239
 tape required 240
 time required 240
 verifying data 243
DAT Recover 241–242
 checking tape contents 242
 restoring the data 241
DC offset removal 257
Delete Err Song? 242
Digital
 inputs
 connecting 23
 recording 66
 selecting 66
 outputs
 connecting 23
 routing signals to 73, 96
DIGITAL button 18
DIGITAL IN & OUT jacks 23
Digital In Lock 66
Digital In Unlock 66
Digital Performer 213
Direct current offset removal 257
Direct outputs 74
 assigning tracks to 98
Disc at Once 189
Disc Tray 23
Disk at once 185–186
Disk drive. See Hard drives
Disk Memory Full 225
Disk space remaining 52

- Display** 38
 Automix 125
 regions 38
 understanding 38
DP-2 251
DR20 → 87 106
Drive Busy! 52
Drive Check 230
Drive Initialize 229
Drive Select 228
Drop frames described 197
Drum reverb 108
- E**
- EDIT/SOLO button** 19
Editing
 Undo and Redo 62
Editing phrases. See Phrase editing
Editing tracks. See Track editing
Effect
 return 100
 send 100
EFFECT 1/3 RTN button 18
EFFECT 2/4 RTN button 18
EFFECT bus 27
 master level and balance 98
Effects
 algorithms 103
 and MIDI Control Changes 208
 bus levels and balance 98
 Effect mode 35
 external 268
 important reminders 112
 insert
 connecting 103, 105, 107
 described 99
 examples 105
 Input Mixer 88
 Master Block 96
 Track Mixer 92
 location of controls 99
 loop
 connecting 107
 described 100
 examples 108
 Input Mixer 86
 Track Mixer 91
 overview 31
 patches
 creating 102
 saving 102
 in a Scene 103
 selecting 101
 printing 109
 procedure for using 100
 recording 109
 in stereo 112
 return
 automating 126
 controls 107
 routing
 Input Mixer 86–89
 Master Block 96–97
 Track Mixer 91–94
 two types
 explained 31, 99
 insert 31, 99
 loop 31, 100
 why can't I hear them? 275
Eject Button 23
Emergency eject hole 23
END 164
ENTER/YES button 21, 37
EQ. See Equalization
Equalization
 Input Mixer 86
 Track Mixer 90
 using 80
Error Drive Too Slow 229
Events
 and Automix data 26
 and Song Optimize 26
 and Song Store 26
 explained 26
EXIT/NO button 21
EXT SYNC button 21
External effects 268
EZ Routing 84
 templates
 deleting 123
 storing 121
 bouncing setup 117
 mastering setup 119
 mixing setup 116
 recording setup 114
EZ routing
 templates
 recalling 123
EZ ROUTING button 19
- F**
- F buttons** 36
Factory reset 37
Fade Length 259
Fadeout 130
Fader Group 79

Fader Match 249
 Fader Mode 75
 FADER/MUTE button 19, 71, 270
 Faders 19
 automating 125–126
 independent control of stereo faders 269
 level control 71
 Input Mixer 90
 Track Mixer 95
 switching between input and track 28
 See also Input Mixer, Track Mixer
 Fan noise control 256
 FF button 21, 47
 Finalize 189
 Finalizing 185
 Finishing a CD. See Finalizing
 FOOT SWITCH jack 22
 settings 251
 Formatting. See Hard drives
 FreeMIDI 213
 FROM 164
 FS-5U 251
 Function (F) buttons 36
 FUNCTION button 20

G

Global settings 251–256
 button sensitivity 256
 Fade Length 259
 Fan Control 256
 input peak level 255
 Numerics Type 252
 Shift Lock 251
 global settings
 PREVIOUS/NEXT switch 255
 GPI 58
 Gradation. See Automix
 Graphic display 20
 Grouping channels 79
 GUITAR (Hi-Z) jack 23, 53
 Guitar amp simulator 105
 GuitarMulti1 105, 128

H

Hard drives
 backing up
 options 232
 DAT 232
 removable drive 232
 VS-CDR 232

compatibility with
 VS-1680 245
 VS-840/840EX 245
 VS-880/880EX 245
 VSR-880 245
 external
 connecting
 a fixed drive 220
 a removable drive 221
 purchasing 220
 removable drives 232
 using 220
 initializing/formatting 222, 229
 physical formatting 229
 maintenance 229
 partitions 24
 selecting 228
 recording time 217
 checking 217
 recovering space 218
 testing
 drive check 230
 surface scan 231

Hi-level signals. See Attenuation
 How big is my song? 277
 How can I store my connections? 273
 How do I automate the VS-1824? 272
 How do I bounce tracks? 274
 How do I bounce with effects? 275
 How do I burn audio CDs? 270
 How do I choose tracks to burn on a CD? 270
 How do I control stereo tracks separately? ... 269
 How do I do a factory reset? 277
 How do I import songs from other recorders? . 277
 How do I make a tempo map? 272
 How do I record in stereo? 277
 How do I set CD markers? 271
 How do I use Automix? 272
 How do I use scrubbing? 276
 How do I use the waveform display? 276
 How much time is left? 277
 Hum removal 257

I

Icon display 49
 ID
 MIDI Device ID 261
 MIDI Model ID 257
 SCSI 254
 Image file
 defined 183
 Importing tracks 151

- IN MIDI jack 22
- Initialize**
 System/Mixer 37
- Initializing**
 a hard drive 222
 the VS-1824 277
- INPUT jacks** 23
- INPUT Knobs** 18
- Input Mixer**
 channel parameters 86
 default routing 76
 diagram 28
 faders 71
 mode 35
- Input peak level** 255
- Inputs**
 adjusting level 90
 setting meter peaking 255
 turning off unwanted signals 269
- Insert effects**
 connecting 103, 105, 107
 described 31, 99
 examples 105
 important reminders 112
 Input Mixer 88
 Master Block 96
 Track Mixer 92
- Internal fan control** 256
- J**
- Jump** 47
- L**
- Lack of EVENT!!** 126
- Letters, typing** 195
- Levels**
 setting
 for recording 54
 in linked channels 77
 Undo and Redo 62
- Limiter** 106
- Linking channels** 77
 in a group 79
 setting levels 77
 setting panning 78
 unlinking stereo channels 269
- List display** 49
- Listening to inputs** 258
- LIV** 51
- Live input.** See Stereo Input
- Loading songs** 49
- LOCATOR/SCENE button** 20
- Locators**
 banks, changing 43
 described 43
 editing 43
 recalling 43
 START, END, FROM and TO 165
 storing 43
 using 43
- Locking to picture** 267
- Logic Audio** 212
- Long Delay** 108
- LOOP button** 21
- Loop effects**
 connecting 107
 described 31, 100
 examples 108
 important reminders 112
 Input Mixer 86
 Track Mixer 91
- Loop recording** 60
 and punching 61
 setup during playback 60
 using locators 60
 using markers 60
- Looping**
 using Track Copy 171
- Loud signals.** See Attenuation
- Low-level signals.** See Attenuation
- LV2** 51
- M**
- Main features** 16
- Marker Stop** 258
- Markers**
 and synchronization 204
 CD track markers 186
 clearing 46
 described 45
 displaying 45
 editing 46
 moving between 45
 numbering 45
 stopping playback at 258
 storing 45
 using 45
- MAS** 51
- Master (synchronization)** 197
- Master Block**
 diagram 29
 mode 35
 routing outputs 72, 95
- Master clock** 66

Master fader	19	synchronization	197
MASTER OUT jacks	22	clock	209
level & balance adjustment	95	clocks	201
Mastering Room	177	described	209
creating mastering tracks	177	MTC	197, 209
Mastering Tool Kit	181	sync track	200–202, 204–206
Mastering tracks		tempo map	202, 204–206
defined	177	System Exclusive	
playing back	180	receive switch	261
recording	177	transmit switch	261
with effects	181	when using	265
setting status		thru switch	261
shortcut	179	MIDI Clock	209
Mastering. See Mastering Room		MIDI connectors	22
Meter. See Metering		MIDI Machine Control. See MMC	
Metering		MIDI Model ID	257
Input Mixer	90	MIDI Thru Switch	261
Peak Hold	250	MIDI Time Code. See MTC	
setting peak level	255	MIDI/DISK indicator	21
Track Mixer	94	MIX bus	27
Metronome	67	routing inputs to	86
activating	67	routing tracks to	90
settings	68	Mix limiter	106
tempo map	68	Mixdown	
using an external MIDI source	68	mastering	177
Micro Edit. See Automix		Mixer	
Microphone simulator	106	automation	124
MIDI	 See also Automix	
channels	265	channel display	41
channels vs. controller numbers	265	copying settings	51, 83
Compu Mix		initialization	37
external control	265	Scenes	84
preparations	266	section overview	18, 27
recording	267	understanding	70
Control Changes		Mixing	
and effects	208	process overview	53
controllers	206, 265	MMC	208–209
and track status	206	setting mode	261
FreeMIDI	213	Modes	35
interface	209	MONITOR jacks	22, 72
troubleshooting tips	209	level & balance adjustment	95
machine control	208–209	MONITOR knob	19, 196
metronome	68	Monitoring inputs	258
model ID	257	MT1	51
OMS	214	MT2	51
Program Changes		MTC	197, 209
and Scenes	207	offset	200
sequencers	209	types	197
Cakewalk	210	unstable	199
Cubase VST	211	MTP	51
Digital Performer	213	Multitracking	56
Logic Audio	212		
Vision DSP	214		
Song Position Pointer	200, 209		

- Muting channels 42
 Input Mixer 90
 Track Mixer 95
- N**
- Naming by typing 195
NEXT button 20, 45
No Effect Board 101
Non-drop 197
Not 44.1kHz Song ! 190
NTSC 197
Numbers, typing 195, 252
Numerics Type 252
NUMERICS/ASCII button 21
 using 195
- O**
- OMS 214
Operating modes 35
Options 17
OUT MIDI jack 22
Overdubbing 56
- P**
- PAGE (JUMP) button 20, 36, 47
PAL 197
Panning
 in linked channels 78
 Input Mixer 86
 Track mixer 90
 using MONITOR knob 196
Parameters
 Input Mixer channels 86
 Track Mixer channels 90
Partitioning 24
 selecting partitions 228
Patches. See Effects
Peak Hold 250
PEAK Indicators 18
Performer 213
PHANTOM switch 23
Phase
 Input Mixer 90
 problems 82
 Track Mixer 94
PHONES jack 22
PHONES knob 19
Phrase Copy 157
Phrase Delete 152
Phrase Divide 153
Phrase Move 155
Phrase Name 162
Phrase New 161
Phrase Split 154
Phrase Trim In 159
Phrase Trim Out 160
Phrases
 creating 161
 defined 25, 170
 editing
 copying 157
 deleting 152
 dividing 153
 moving 155
 naming 162
 note of caution 171
 overview 152
 splitting 153–154
 trimming
 back 160
 front 159
 vs. track editing 170
 when to edit phrases 170
Picture, locking to 267
Ping-ponging. See Bouncing tracks
Pitch correction 195
PLAY (DISPLAY) button 21, 37
Play (DISPLAY) button 35
Play and Record settings
 Marker Stop 258
Play and record settings 258
 Record Monitor 258
PLAY button 21
Play mode 35
Playlist display 39
 selecting type of 39
Please Insert Disc! 190, 192
Power
 turning off 32
 turning on 32
POWER switch 22
Presets. See Effects patches
Preview
 TO, THRU and FROM 166
PREVIEW button 20
Preview function
 overview 166
PREVIOUS button 20, 45
PREVIOUS/NEXT switch 255
Printing effects 109

Program Changes. See MIDI
 Program numbers. See Track numbers on a CD
 Protecting songs 48
 Punch-in
 defined 57
 See also Punching
 Punching
 and phrases 170
 Auto Punch 58
 setting during playback 59
 using locators 58
 using markers 58
 described 57
 manual 57
 foot switch 57
 front panel 57
 setting crossfade length 259
 with looping 61
 Punch-out
 defined 57
 See also Punching

Q

Quiet signals. See Attenuation

R

Random access 29
 Realtime automation. See Automix
 Rear panel 22
 REC button 21
 Record Monitor 258
 Recorder section
 overview 20
 Recording 50
 a digital source 66
 effects
 in stereo 112
 from a CD 67
 how it works 29
 in stereo 55, 277
 loop recording 60
 mode, selecting 51
 modes
 times 52, 217
 checking 217
 monitoring inputs 258
 overdubbing 56
 process overview 53
 setting fade length 259
 time available 30, 52
 checking 217, 250
 with effects 109

RECORDING bus 27
 Recording mode 51
 Recover Err Retry ? 242
 Red Book 183
 Redo
 defined 62
 Reinitializing 277
 Remaining recording time 250
 Removable drives. See hard drives
 Return. See Effects return
 REW button 21, 47

S

Sample rate 50
 Scaling. See Automix
 Scene Mode 85
 SCENE/0 button 21
 Scenes
 and MIDI Program Changes 207
 copying 51
 defined 84
 deleting 85
 recalling 85
 storing 84
 updating 85
 SCMS 181
 Scrub 166–168, 276
 SCSI
 connector 22
 ID number 254
 See also Hard drives
 SECAM 197
 SELECT/CH EDIT 36
 1-18 19
 Selecting songs 49
 Send. See Effects send
 Sequencers. See MIDI, 197
 SHIFT button 21, 36
 Shift Lock 251
 Shift Lock 251
 Shrinking time. .. See Time compression/expansion
 Shutdown procedure 33
 Signal flow 27
 Slave (synchronization) 197
 SMPTE. See MTC
 Snap Mode 128
 Snapshots. See Automix Snapshots
 Solo. See Soloing channels

- Soloing channels 42
 - Input Mixer 90
 - quick solo 43
 - Solo mode 43
 - Track Mixer 95
- Song Archive Extract 227
- Song Arrange 173
- Song Combine 175
- Song Copy Archives 225
 - handling 226
- Song Copy Playable 224
- Song Erase 219
- Song Export 247
- Song Import 246
- Song mode 35
- Song Optimize 218
- Song Position Pointer 200, 209
- Song Protect 48
- Song Split 174
- Song Store 33
- Songs
 - archiving 225
 - automation. See Automix
 - backing up
 - to DAT
 - backup steps 239
 - checking tape contents 242
 - recovering data 241
 - verifying data 243
 - CD requirements 185
 - contents of 25
 - copying
 - using Song Copy Archives 225
 - using Song Copy Playable 224
 - using Song Split 174
 - creating new 50
 - defined 25
 - editing
 - structure 173
 - erasing 219
 - exporting to other VS recorders 247
 - icon 51
 - importing from other VS recorders 246
 - importing tracks 175
 - loading 49
 - using Song Archive Extract 227
 - using Song Copy Playable 226
 - naming 50
 - numbers 52
 - optimizing 218
 - protecting 48
 - recording on a CD
 - a song 188
 - adding new songs 190
 - all songs at once 190
 - saving 33
 - to an external drive 223–228
 - selecting 49
 - system settings 249–251
 - Fader Match 249
 - foot switch 251
 - Peak Hold 250
 - remaining time 250
- Sources
 - defined 25
 - routing to tracks 54
- Speed control 195
- SPP. See MIDI Song Position Pointer
- ST IN button 18
- START 164
- Starting over 35
- STATUS buttons 19
 - blinking red 19
 - blinking red & orange 19
 - green 19
 - orange 19
 - unlit 19
- Stereo channels, independent control 269
- Stereo Input 196
- Stereo placement. See Panning
- Stereo recording 277
- STOP button 21
- Stretching time. ... See Time compression/expansion
- Surface scan 231
- Swapping tracks. See Track Exchange
- Sync track 200–202, 204–206
- Synchronization with MIDI devices 197
 - described 209
 - master and slave 197
 - necessary items 197
 - sync track 200–202, 204–206
 - tempo map 202, 204–206
 - unstable 199
- Synchronization with video equipment 267
- Synchronization with VS recorders 261–264
 - another VS-1824 262
 - VS-1680 262
 - VS-880/880EX 263
- System initialization 37
- System mode 35
- System parameters
 - copying 51

T

Table of Contents 185

Takes
 defined 25
 naming 162

TAP button 20

Tempo map 202–206
 and the metronome 68
 creating 272

THRU MIDI jack 22

Time compression/expansion 148

Time remaining 250

Time stamp 34

TIME/VALUE dial 21, 37, 47

TO 164

TOC. See Table of Contents

Track at Once 189

Track Copy 144, 171

Track Cut 140

Track Erase 139

Track Exchange 147

Track Import 151

Track Insert 146

Track minutes 30

Track Mixer
 channel parameters 90
 diagram 28
 faders 71
 mode 35

Track Move 142

Track Name 150

Track numbers on a CD 186

Tracks
 adjusting playback level 95
 assigning sources to 54
 bouncing 64
 how do I bounce
 with effects? 275
 how do I bounce? 274
 changing status 42, 94
 combining from different songs 175
 defined 25
 editing
 a practical application 171
 basic procedure 164
 copying 144
 seamless looping 171
 cutting 140
 entering time values 169
 using [F2 (Now)] 169
 using locator buttons 169
 using the TIME/VALUE dial 169

erasing 139

exchanging 147

inserting blank space 146

moving 142

naming 150

note of caution 171

overview 139

setting edit points 165
 using Preview 166
 using Scrub 166
 with locators 165

swapping 147

time-compression/expansion 148

vs. phrase editing 170

Waveform Display 168

extracting from a song 174

importing 151

muting 42

recording to 54

soloing 42

Track mode 35

Transitions. See Automix Snapshots

Transport controls 21

Turning off the VS-1824 32

Turning on the VS-1824 32

Typing numbers and letters 195, 252

U

Undo
 defined 62
 See also Undo and Redo

UNDO (REDO) button 21

Undo and Redo
 explained 62
 levels 62
 using 62
 when recording 62

UNDO message 63

Utility mode 35

V

Vari Pitch 195

VARI PITCH button 21

Video synchronization 267

Virtual tracks. See V-Tracks

Vision DSP 214

Vocal delay 108

Volume
 setting
 for recording 54
 in linked channels 77

VS-1680	
compatibility	245
syncing with	262
VS-840/840EX	
compatibility	245
VS-880/880EX	
compatibility	245
syncing with	263
VS8F-1	17
VS8F-2	17
VSR-880	
compatibility	245
V-Tracks	
explained	30
recording	56
selecting	56, 80, 91
W	
Wake-up call	260
Waveform Display	168, 276
Why can't I hear effects?	275
Why do I hear all of the inputs?	269
Why does the CD sound different?	271
Write Method	189
X	
X and Y	276
XLR	23
wiring	53
Z	
ZERO button	21

Information

When you need repair service, call your nearest Roland Service Center or authorized Roland distributor in your country as shown below.

AFRICA

EGYPT

Al Fanny Trading Office
9, EBN Hagar A1 Askalany Street,
ARD El Golf, Heliopolis,
Cairo 11341, EGYPT
TEL: 20-2-417-1828

REUNION

Maison FO - YAM Marcel
25 Rue Jules Hermann,
Chaudron - BP79 97 491
Ste Clotilde Cedex,
REUNION ISLAND
TEL: (0262) 218-429

SOUTH AFRICA

**That Other Music Shop
(PTY) Ltd.**
11 Melle St., Braamfontein,
Johannesburg, SOUTH AFRICA

P.O.Box 32918, Braamfontein 2017
Johannesburg, SOUTH AFRICA
TEL: (011) 403 4105

Paul Bothner (PTY) Ltd.

17 Werdmuller Centre,
Main Road, Claremont 7708
SOUTH AFRICA

P.O.Box 23032, Claremont 7735,
SOUTH AFRICA
TEL: (021) 674 4030

ASIA

CHINA

**Beijing Xinghai Musical
Instruments Co., Ltd.**
6 Huangmunchang Chao Yang
District, Beijing, CHINA
TEL: (010) 6774 7491

Shanghai Xingtong Acoustics

Equipment CO., Ltd.
5F. No.1500 Pingliang Road
New East Club Plaza, Shanghai,
CHINA
TEL: (021) 5580-0800

HONG KONG

**Tom Lee Music Co., Ltd.
Service Division**
22-32 Pun Shan Street, Tsuen
Wan, New Territories,
HONG KONG
TEL: 2415 0911

INDIA

Rivera Digitec (India) Pvt. Ltd.
409, Nirman Kendra Mahalaxmi
Flats Compound Off. Dr. Edwin
Moses Road, Mumbai-400011,
INDIA
TEL: (022) 498 3079

INDONESIA

PT Citra IntiRama
Jl. Cideng Timur No. 15J-150
Jakarta Pusat
INDONESIA
TEL: (021) 6324170

KOREA

Cosmos Corporation
1461-9, Seocho-Dong,
Seocho Ku, Seoul, KOREA
TEL: (02) 3486-8855

MALAYSIA

BENTLEY MUSIC SDN BHD
140 & 142, Jalan Bukit Bintang
55100 Kuala Lumpur, MALAYSIA
TEL: (03) 2144-3333

PHILIPPINES

G.A. Yupangco & Co. Inc.
339 Gil J. Puyat Avenue
Makati, Metro Manila 1200,
PHILIPPINES
TEL: (02) 899 9801

SINGAPORE

Swee Lee Company
150 Sims Drive,
SINGAPORE 387381
TEL: 846-3676

CRISTOFORI MUSIC PTE LTD

Blk 3014, Bedok Industrial Park E,
#02-2148, SINGAPORE 489980
TEL: 243 9555

TAIWAN

**ROLAND TAIWAN
ENTERPRISE CO., LTD.**
Room 5, 9fl. No. 112 Chung Shan
N.Road Sec.2, Taipei, TAIWAN,
R.O.C.
TEL: (02) 2561 3339

THAILAND

Theera Music Co., Ltd.
330 Vergng NakornKasem, Soi 2,
Bangkok 10100, THAILAND
TEL: (02) 2248821

VIETNAM

Saigon Music
138 Tran Quang Khai St.,
District 1
Ho Chi Minh City
VIETNAM
TEL: (08) 844-4068

AUSTRALIA/ NEW ZEALAND

AUSTRALIA

**Roland Corporation
Australia Pty., Ltd.**
38 Campbell Avenue
Dee Why West, NSW 2099
AUSTRALIA
TEL: (02) 9982 8266

NEW ZEALAND

Roland Corporation Ltd.
32 Shaddock Street, Mount Eden,
Auckland, NEW ZEALAND
TEL: (09) 3098 715

CENTRAL/LATIN AMERICA

ARGENTINA

Instrumentos Musicales S.A.
Av.Santa Fe 2055
(1123) Buenos Aires
ARGENTINA
TEL: (011) 4508-2700

BRAZIL

Roland Brasil Ltda
Rua San Jose, 780 Sala B
Parque Industrial San Jose
Cotia - Sao Paulo - SP, BRAZIL
TEL: (011) 4615 5666

COSTA RICA

**JUAN Banschach
Instrumentos Musicales**
Ave.1. Calle 11, Apartado 10237,
San Jose, COSTA RICA
TEL: 258-0211

CHILE

Comercial Fancy II S.A.
Rut.: 96.919.420-1
Nataníel Cox #739, 4th Floor
Santiago - Centro, CHILE
TEL: (02) 688-9540

EL SALVADOR

OMNI MUSIC
75 Avenida Norte y Final
Alameda Juan Pablo II,
Edificio No.4010 San Salvador,
EL SALVADOR
TEL: 262-0788

MEXICO

Casa Veerkamp, s.a. de c.v.
Av. Toluca No. 323, Col. Olivar
de los Padres 01780 Mexico D.F.
MEXICO
TEL: 668-0480

PANAMA

SUPRO MUNDIAL, S.A.
Boulevard Andrews, Albrook,
Panama City, REP. DE PANAMA
TEL: 315-0101

PARAGUAY

**Distribuidora De
Instrumentos Musicales**
J.E. Olear y ESQ. Manduvira
Asuncion PARAGUAY
TEL: (021) 492-124

PERU

VIDEO Broadcast S.A.
Portinari 199 (ESQ. HALS),
San Borja, Lima 41,
REP. OF PERU
TEL: (01) 4758226

URUGUAY

Todo Musica S.A.
Francisco Acuna de Figueroa 1771
C.P.: 11.800
Montevideo, URUGUAY
TEL: (02) 924-2335

VENEZUELA

Musicland Digital C.A.
Av. Francisco de Miranda,
Centro Parque de Cristal, Nivel
C2 Local 20 Caracas
VENEZUELA
TEL: (212) 285-8586

EUROPE

AUSTRIA

Roland Austria GES.M.B.H.
Siemensstrasse 4, P.O. Box 74,
A-6063 RUM, AUSTRIA
TEL: (0512) 26 44 260

BELGIUM/HOLLAND/ LUXEMBOURG

Roland Benelux N. V.
Houtstraat 3, B-2260, Oevel
(Westerlo) BELGIUM
TEL: (014) 575811

DENMARK

Roland Scandinavia A/S
Nordhavnsvej 7, Postbox 880,
DK-2100 Copenhagen
DENMARK
TEL: (039)16 6200

FRANCE

Roland France SA
4, Rue Paul Henri SPAAK,
Parc de l'Esplanade, F 77 462 St.
Thibault, Lagny Cedex FRANCE
TEL: 01 600 73 500

FINLAND

**Roland Scandinavia As,
Filial Finland**
Lauttasaarentie 54 B
Fin-00201 Helsinki, FINLAND
TEL: (9) 682 4020

GERMANY

**Roland Elektronische
Musikinstrumente HmbH.**
Oststrasse 96, 22844 Norderstedt,
GERMANY
TEL: (040) 52 60090

GREECE

**STOLLAS S.A.
Music Sound Light**
155, New National Road
Patras 26442, GREECE
TEL: (061) 43-5400

HUNGARY

Intermusica Ltd.
Warehouse Area 'DEPO' Pf.83
H-2046 Torokbalint, HUNGARY
TEL: (23) 511011

IRELAND

Roland Ireland
Audio House, Belmont Court,
Donnybrook, Dublin 4,
Republic of IRELAND
TEL: (01) 2603501

ITALY

Roland Italy S. p. A.
Viale delle Industrie 8,
20020 Arese, Milano, ITALY
TEL: (02) 937-78300

NORWAY

**Roland Scandinavia Avd.
Kontor Norge**
Lilleakerveien 2 Postboks 95
Lilleaker N-0216 Oslo
NORWAY
TEL: 273 0074

POLAND

P. P. H. Brzostowicz
UL. Gibraltarska 4,
PL-03664 Warszawa POLAND
TEL: (022) 679 44 19

PORTUGAL

**Tecnologias Musica e Audio,
Roland Portugal, S.A.**
Cais Das Pedras, 8/9-1 Dto
4050-465 PORTO
PORTUGAL
TEL: (022) 608 00 60

ROMANIA

FBS LINES
Piata Libertatii 1,
RO-4200 Gheorgheni
VENEZUELA
TEL: (095) 169-5043

RUSSIA

MuTek
3-Bogatyrskaya Str. 1.k.1
107 564 Moscow, RUSSIA
TEL: (095) 169 5043

SPAIN

**Roland Electronics
de España, S. A.**
Calle Bolivia 239, 08020
Barcelona, SPAIN
TEL: (03) 308 1000

SWEDEN

**Roland Scandinavia A/S
SWEDISH SALES OFFICE**
Danvik Center 28, 2 tr.
S-131 30 Nacka SWEDEN
TEL: (08) 702 0020

SWITZERLAND

**Roland (Switzerland) AG
Musitronic AG**
Gerberstrasse 5, Postfach,
CH-4410 Liestal, SWITZERLAND
TEL: (061) 927-8383

UKRAINE

TIC-TAC
Mira Str. 19/108
P.O. Box 180
295400 Munkachevo, UKRAINE
TEL: (03131) 414-40

UNITED KINGDOM

Roland (U.K.) Ltd.
Atlantic Close, Swansea
Enterprise Park, SWANSEA
SA7 9FJ,
UNITED KINGDOM
TEL: (01792) 700139

MIDDLE EAST

BAHRAIN

Moon Stores
No.16, Bab Al Bahrain Avenue,
P.O.Box 247, Manama 304,
State of BAHRAIN
TEL: 211 005

CYPRUS

Radex Sound Equipment Ltd.
17, Diagorou Street, Nicosia,
CYPRUS
TEL: (02) 66-9426

IRAN

MOCO, INC.
No.41 Nike St., Dr.Shariyati Ave.,
Toberoye Cerahe Mirdamad
Tehran, IRAN
TEL: (021) 285-4169

ISRAEL

**Hailit P. Greenspoon &
Sons Ltd.**
8 Retzif Ha'aliya Hashnya St.
Tel-Aviv-Yafo ISRAEL
TEL: (03) 6823666

JORDAN

AMMAN Trading Agency
245 Prince Mohammad St.,
Amman 1118, JORDAN
TEL: (06) 464-1200

KUWAIT

Easa Husain Al-Yousifi
Abdullah Salem Street,
Safat, KUWAIT
TEL: 243-6399

LEBANON

A. Chahine & Fils
George Zeidan St., Chahine Bldg.,
Achrafieh, P.O.Box: 16-5857
Beirut, LEBANON
TEL: (01) 20-1441

QATAR

**Al Emadi Co. (Badie Studio
& Stores)**
P.O. Box 62,
Doha, QATAR
TEL: 4423-554

SAUDI ARABIA

**aDawlah Universal
Electronics APL**
Corniche Road, Aldossary Bldg.,
1st Floor, Alkhobar,
SAUDI ARABIA

P.O.Box 2154, Alkhobar 31952

SAUDI ARABIA
TEL: (03) 898 2081

SYRIA

**Technical Light & Sound
Center**
Bldg. No. 47,
Khaled Ebn Al Walid St.
Damascus, SYRIA
TEL: (011) 221-1230

TURKEY

**Barkat muzik aletleri ithalat
ve ihracat Ltd Sti**
Siraselvililer Caddesi Siraselvililer
Pasaji No:74/20
Taksim - Istanbul, TURKEY
TEL: (0212) 2499324

U.A.E.

**Zak Electronics & Musical
Instruments Co. L.L.C.**
Zabeel Road, Al Sherooq Bldg.,
No. 14, Grand Floor, Dubai, U.A.E.
TEL: (04) 3360715

NORTH AMERICA

CANADA

**Roland Canada Music Ltd.
(Head Office)**
5480 Parkwood Way Richmond
B. C., V6V 2M4 CANADA
TEL: (0604) 270 6626

**Roland Canada Music Ltd.
(Toronto Office)**

Unit 2, 109 Woodbine Downs
Blvd, Etobicoke, ON
M9W 6Y1 CANADA
TEL: (0416) 213 9707

U. S. A.

Roland Corporation U.S.
5100 S. Eastern Avenue
Los Angeles, CA 90040-2938,
U. S. A.
TEL: (323) 890 3700

For EU Countries

Apparatus containing Lithium batteries

ADVARSEL!

Lithiumbatteri - Eksplosionsfare ved fejlagtig håndtering.
Udskiftning må kun ske med batteri af samme fabrikat og type.
Levér det brugte batteri tilbage til leverandøren.

ADVARSEL

Ekspløsjonsfare ved feilaktig skifte av batteri.
Benytt samme batteritype eller en tilsvarende type anbefalt av apparatfabrikanten.
Brukte batterier kasseres i henhold til fabrikantens instruksjoner.

CAUTION

Danger of explosion if battery is incorrectly replaced.
Replace only with the same or equivalent type recommended by the manufacturer.
Discard used batteries according to the manufacturer's instructions.

VARNING

Explosionsfara vid felaktigt batteribyte.
Använd samma batterityp eller en ekvivalent typ som rekommenderas av apparattillverkaren.
Kassera använt batteri enligt fabrikantens instruktion.

VAROITUS

Paristo voi räjähtää, jos se on virheellisesti asennettu.
Vaihda paristo ainoastaan laitevalmistajan suosittelemaan tyyppiin. Hävitä käytetty paristo valmistajan ohjeiden mukaisesti.

For EU Countries



This product complies with the requirements of European Directives EMC 89/336/EEC and LVD 73/23/EEC.

For the USA

FEDERAL COMMUNICATIONS COMMISSION RADIO FREQUENCY INTERFERENCE STATEMENT

This equipment has been tested and found to comply with the limits for a Class B digital device, pursuant to Part 15 of the FCC Rules. These limits are designed to provide reasonable protection against harmful interference in a residential installation. This equipment generates, uses, and can radiate radio frequency energy and, if not installed and used in accordance with the instructions, may cause harmful interference to radio communications. However, there is no guarantee that interference will not occur in a particular installation. If this equipment does cause harmful interference to radio or television reception, which can be determined by turning the equipment off and on, the user is encouraged to try to correct the interference by one or more of the following measures:

- Reorient or relocate the receiving antenna.
- Increase the separation between the equipment and receiver.
- Connect the equipment into an outlet on a circuit different from that to which the receiver is connected.
- Consult the dealer or an experienced radio/TV technician for help.

This device complies with Part 15 of the FCC Rules. Operation is subject to the following two conditions:

- (1) This device may not cause harmful interference, and
- (2) This device must accept any interference received, including interference that may cause undesired operation.

Unauthorized changes or modification to this system can void the users authority to operate this equipment.
This equipment requires shielded interface cables in order to meet FCC class B Limit.

For Canada

NOTICE

This Class B digital apparatus meets all requirements of the Canadian Interference-Causing Equipment Regulations.

AVIS

Cet appareil numérique de la classe B respecte toutes les exigences du Règlement sur le matériel brouilleur du Canada.

Copyright

- Unauthorized recording, distribution, sale, lending, public performance, broadcasting, or the like, in whole or in part, of a work (musical composition, video, broadcast, public performance, or the like) whose copyright is held by a third party is prohibited by law.
- When exchanging audio signals through a digital connection with an external instrument, this unit can perform recording without being subject to the restrictions of the Serial Copy Management System (SCMS). This is because the unit is intended solely for musical production, and is designed not to be subject to restrictions as long as it is used to record works (such as your own compositions) that do not infringe on the copyrights of others. (SCMS is a feature that prohibits second-generation and later copying through a digital connection. It is built into MD recorders and other consumer digital-audio equipment as a copyright-protection feature.)
- Do not use this unit for purposes that could infringe on a copyright held by a third party. We assume no responsibility whatsoever with regard to any infringements of third-party copyrights arising through your use of this unit.

About the License Agreement

- The VS-1824 and its CD-R/RW capability are designed to allow you to reproduce material to which you have copyright, or material which the copyright owner has granted you permission to copy. Accordingly, reproduction of Music CD or other copyrighted material without permission of the copyright owner avoiding technical prohibiting features of second-generation and later copying like SCMS or others constitutes copyright infringement and may incur penalties even in case such reproduction is for your own personal use and enjoyment (private use). Consult a copyright specialist or special publications for more detailed information on obtaining such permission from copyright holders.

Disclaimer of liability

Roland will take no responsibility for any “direct damages,” “consequential damages,” or “any other damages” which may result from your use of the VS-1824. These damages may include but are not limited to the following events which can occur when using the VS-1824.

- Any loss of profit that may occur to you
- Permanent loss of your music or data
- Inability to continue using the VS-1824 itself or a connected device

* *Microsoft and Windows are registered trademarks of Microsoft Corporation.*

* *Apple and Macintosh are registered trademark of Apple Computer, Inc.*

* *IBM and IBM PC are registered trademark of International Business Machines Corporation.*

* *Iomega is a registered trademark of Iomega Corporation.*

* *ZIP is a trademark of Iomega Corporation.*

* *Cakewalk is a registered trademark of Twelve Tone systems, Inc.*

* *Cakewalk Pro Audio and Cakewalk Professional are trademarks of Twelve Tone systems, Inc.*

* *OMS is a registered trademark of Opcode Systems, Inc.*

* *FreeMIDI is a trademark of Mark of the Unicorn, Inc.*

* *VST is a trademark of Steinberg Media Technologies AG.*

* *All product names mentioned in this document are trademarks or registered trademarks of their respective owners.*

This owner's manual is printed on recycled paper.

Capture Audio data from Audio CD (Capture function)

VS-1824 have function to capture Audio data from Audio CDs.

This can capture audio from CD **only in case the sampling rate setting of current song is 44.1kHz.**

NOTE

VS-1824 If you are using a VS-1824 that is not equipped with an internal CD-RW drive, you will need to purchase a separately available CD-RW drive. For instructions on connecting the drive, refer to “Connecting an External CD-R/CD-RW Drive” (Owner’s Manual p. 192).

PX-4220Te, PX-8220Te, PX-W124TSe, and PX-W1210TSE manufactured by PLEXTOR is supported. In case you are using other drives approved by Roland, consult with your retailer, the nearest Roland Service Center, or an authorized Roland distributor.

1. Load an Audio CD or CD-R/RW disc that contains audio you like to capture on CD-RW drive.
2. Press [CD-RW/MASTERING].
CD-RW/Mastering Menu will appear.

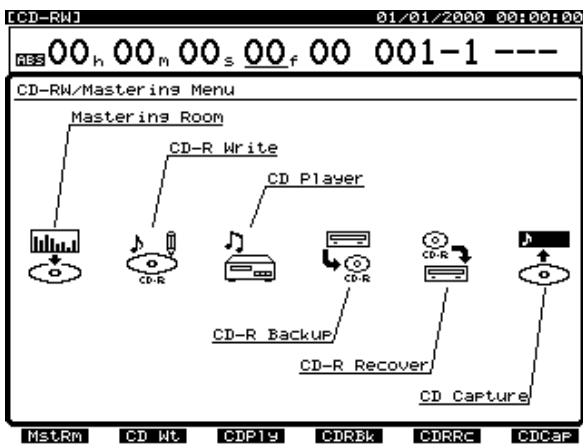

3. Press [F6 (CDCap)].
CD Capture screen will appear.

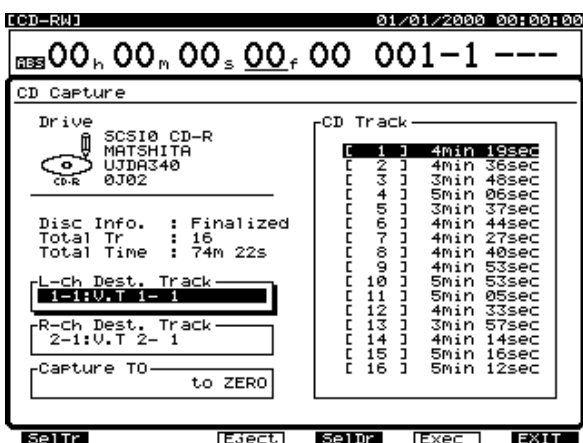

4. Press [▲] || [▼] || [◀] || [▶] to move cursor and set each of following parameters using TIME/VALUE dial.

NOTE

If following cases, the tracks to capture audio must be set as Stereo Pair. In case it is not set as Stereo Pair, a message of “Illegal Track Pair!” appears and unable to capture audio.

- “CD-R” is selected as recording mode of the current song.
- Any phrases in CD-R mode is recorded in destination tracks.

● L-Ch Dest Track (L channel destination track)

Select the destination track of audio to capture. Select the destination track of left channel audio here.

● R-Ch Dest Track (R channel destination track)

Select the destination track of audio to capture. Select the destination track of right channel audio here.

* In case the track which contain any phrases in CD-R mode is selected as destination of “L-Ch Dest Track,” it is impossible to change “R-Ch Dest Track” with TIME/VALUE dial.

● Capture TO

You can adjust the time of placement.

to ZERO:

Place the audio data starting at 00h00m00s00f.

to Last Phrs:0S:

Place the audio data after the end of the last phrase in the destination tracks.

to Last Phrs:2S:

Place the audio data two seconds after the end of the last phrase in the destination tracks.

to Last Phrs:4S:

Place the audio data four seconds after the end of the last phrase in the destination tracks.

5. Once the above parameters are set, select the track of CD shown under “CD Track” pressing [PREVIOUS] or [NEXT]. The highlighted track is the target to capture.

● CD Track

Select the track of CD shown under “CD Track.”

MEMO

Press [PLAY] to play the highlighted track.

MEMO

When the cursor is in list of “CD Track,” you can select track of CD pressing [▲] || [▼].

Capture Audio data from Audio CD (Capture function)

6. Press [F5 (Exec)] after completion all the settings.

A message concerning copyright appears in the display.

After reading this message, press [ENTER/YES].

The same message appears in the back cover of Owner's Manual.

MEMO

A message of "Capture to Mastering Tr. In CDR mode?" appears in case of followings.

- 17 and 18 tracks * are selected as destination tracks and
- those tracks are selected as stereo pair and
- no song data exists on 17 and 18 tracks *.

* *This is applicable to 7 and 8 tracks instead of 17 and 18 in case the Recording mode is "MAS."*

Press [ENTER/YES] when you want to capture in CDR mode.

If you press [EXIT/NO], the recording mode of current song will be applied.

If you find message "Illegal Track Pair!"

In the following cases, the tracks to capture audio must be set as Stereo Pair. Unless, unable to capture.

- "CDR" is selected as recording mode of the current song.
- Any phrases in CD-R mode is recorded in destination tracks.

In this case, press [ENTER/YES] and re-set destination track. (See process 4. above)

7. A message concerning Licensing Conditions is displayed. After reading this message, press [ENTER/YES]. This message appears in the back cover of Owner's manual. A message "CD Capture.." appears on display and starts capture.
8. If you want to capture other audio data from same CD, go back to process 4. above.
9. Press [PLAY (DISPLAY)] to return to the Playlist display.

Canceling the capture

If you want to cancel capture in the middle, operate as follows.

1. Press [EXIT/NO]
A message "Abort?" appears.
2. Press [ENTER/YES] to cease capture.
Press [EXIT/NO] to re-start capture.

Capturing Time

Capturing time differs according to recording mode as follows.

Recording Mode

CDR (CD writing)	Approx 40% of actual time
MAS (Mastering)	Approx 80% of actual time
Others	Approx 150% of actual time

VS-1824

A demo song is pre-installed!

A demo song is pre-installed in internal hard disk of VS-1824.

Therefore, it is not necessary to execute process of “How To Load a Demo Song (CD-R Recover)” (p. 21–23) in the User Guide.

When listening to a demo song, please execute operation after “For Making the Preparations Which Listen to a Demo Song (Song Select)” (p. 24) in the User Guide.

● User Guide p. 19 “About the Demo Songs”

should read	incorrect
The CD-ROM comes with the VS-1824 contains a demo song that is also pre-installed in internal hard disk shown below.	The CD-ROM comes with the VS-1824 contains a demo song shown below. It is necessary to load song data form the CD-ROM to hard disk of VS-1824. See “How to Load a Demo Song (CD-R Recover)” on p. 21.

● User Guide p. 21–23 “How To Load a Demo Song (CD-R Recover)”

Please skip step 1–12 of “How To Load a Demo Song (CD-R Recover).”