



# VGA-7

## Owner's Manual

Thank you, and congratulations on your choice of the Roland VGA-7 V-Guitar Amplifier.

Before using this unit, carefully read the sections entitled:

**"IMPORTANT SAFETY INSTRUCTIONS" (page 2)**

**"USING THE UNIT SAFELY" (page 3-4)**

**"IMPORTANT NOTES" (page 8-9)**

These sections provide important information concerning the proper operation of the unit.

Additionally, in order to feel assured that you have gained a good grasp of every feature provided by your new unit, this manual should be read in its entirety. The manual should be saved and kept on hand as a convenient reference.



### Conversions Used in This Manual

- Words enclosed in square brackets [ ] indicate panel buttons or knobs.  
(Example)  
[SYSTEM]: SYSTEM button  
[BASS]: BASS knob
- (p. \*\*) indicates a reference page.

A separate publication titled "MIDI Implementation" is also available. It provides complete details concerning the way MIDI has been implemented on this unit. If you should require this publication (such as when you intend to carry out byte-level programming), please contact the nearest Roland Service Center or authorized Roland distributor.

Copyright © 2000 ROLAND CORPORATION

All rights reserved. No part of this publication may be reproduced in any form without the written permission of ROLAND CORPORATION.

	<b>CAUTION</b> RISK OF ELECTRIC SHOCK DO NOT OPEN	
<b>ATTENTION:</b> RISQUE DE CHOC ELECTRIQUE NE PAS OUVRIR		
<b>CAUTION:</b> TO REDUCE THE RISK OF ELECTRIC SHOCK, DO NOT REMOVE COVER (OR BACK). NO USER-SERVICEABLE PARTS INSIDE. REFER SERVICING TO QUALIFIED SERVICE PERSONNEL.		



The lightning flash with arrowhead symbol, within an equilateral triangle, is intended to alert the user to the presence of uninsulated "dangerous voltage" within the product's enclosure that may be of sufficient magnitude to constitute a risk of electric shock to persons.



The exclamation point within an equilateral triangle is intended to alert the user to the presence of important operating and maintenance (servicing) instructions in the literature accompanying the product.

INSTRUCTIONS PERTAINING TO A RISK OF FIRE, ELECTRIC SHOCK, OR INJURY TO PERSONS.

## IMPORTANT SAFETY INSTRUCTIONS SAVE THESE INSTRUCTIONS

**WARNING** - When using electric products, basic precautions should always be followed, including the following:

- |  |  |
|--|--|
| <ol style="list-style-type: none"> <li>1. Read these instructions.</li> <li>2. Keep these instructions.</li> <li>3. Heed all warnings.</li> <li>4. Follow all instructions.</li> <li>5. Do not use this apparatus near water.</li> <li>6. Clean only with a damp cloth.</li> <li>7. Do not block any of the ventilation openings. Install in accordance with the manufacturers instructions.</li> <li>8. Do not install near any heat sources such as radiators, heat registers, stoves, or other apparatus (including amplifiers) that produce heat.</li> <li>9. Do not defeat the safety purpose of the polarized or grounding-type plug. A polarized plug has two blades with one wider than the other. A grounding type plug has two blades and a third grounding prong. The wide blade or the third prong are provided for your safety. When the provided plug does not fit into your outlet, consult an electrician for replacement of the obsolete outlet.</li> </ol> | <ol style="list-style-type: none"> <li>10. Protect the power cord from being walked on or pinched particularly at plugs, convenience receptacles, and the point where they exit from the apparatus.</li> <li>11. Only use attachments/accessories specified by the manufacturer.</li> <li>12. Never use with a cart, stand, tripod, bracket, or table except as specified by the manufacturer, or sold with the apparatus. When a cart is used, use caution when moving the cart/apparatus combination to avoid injury from tip-over.</li> <li>13. Unplug this apparatus during lightning storms or when unused for long periods of time.</li> <li>14. Refer all servicing to qualified service personnel. Servicing is required when the apparatus has been damaged in any way, such as power-supply cord or plug is damaged, liquid has been spilled or objects have fallen into the apparatus, the apparatus has been exposed to rain or moisture, does not operate normally, or has been dropped.</li> </ol> |
|--|--|



**For the U.K.**

<p><b>WARNING:</b> THIS APPARATUS MUST BE EARTHED</p> <p><b>IMPORTANT:</b> THE WIRES IN THIS MAINS LEAD ARE COLOURED IN ACCORDANCE WITH THE FOLLOWING CODE. GREEN-AND-YELLOW: EARTH, BLUE: NEUTRAL, BROWN: LIVE</p> <p>As the colours of the wires in the mains lead of this apparatus may not correspond with the coloured markings identifying the terminals in your plug, proceed as follows:</p> <p>The wire which is coloured GREEN-AND-YELLOW must be connected to the terminal in the plug which is marked by the letter E or by the safety earth symbol  or coloured GREEN or GREEN-AND-YELLOW.</p> <p>The wire which is coloured BLUE must be connected to the terminal which is marked with the letter N or coloured BLACK.</p> <p>The wire which is coloured BROWN must be connected to the terminal which is marked with the letter L or coloured RED.</p>
---



# USING THE UNIT SAFELY

## INSTRUCTIONS FOR THE PREVENTION OF FIRE, ELECTRIC SHOCK, OR INJURY TO PERSONS

### About ⚠ WARNING and ⚠ CAUTION Notices







<b>⚠ WARNING</b>	Used for instructions intended to alert the user to the risk of death or severe injury should the unit be used improperly.
<b>⚠ CAUTION</b>	Used for instructions intended to alert the user to the risk of injury or material damage should the unit be used improperly. * Material damage refers to damage or other adverse effects caused with respect to the home and all its furnishings, as well to domestic animals or pets.

### About the Symbols







	The ⚠ symbol alerts the user to important instructions or warnings. The specific meaning of the symbol is determined by the design contained within the triangle. In the case of the symbol at left, it is used for general cautions, warnings, or alerts to danger.
	The ⚡ symbol alerts the user to items that must never be carried out (are forbidden). The specific thing that must not be done is indicated by the design contained within the circle. In the case of the symbol at left, it means that the unit must never be disassembled.
	The ● symbol alerts the user to things that must be carried out. The specific thing that must be done is indicated by the design contained within the circle. In the case of the symbol at left, it means that the power-cord plug must be unplugged from the outlet.

### ALWAYS OBSERVE THE FOLLOWING



#### ⚠ WARNING

- Before using this unit, make sure to read the instructions below, and the Owner's Manual. 
- Do not open or perform any internal modifications on the unit. 
- Do not attempt to repair the unit, or replace parts within it (except when this manual provides specific instructions directing you to do so). Refer all servicing to your retailer, the nearest Roland Service Center, or an authorized Roland distributor, as listed on the "Information" page. 
- Never use or store the unit in places that are:
  - Subject to temperature extremes (e.g., direct sunlight in an enclosed vehicle, near a heating duct, on top of heat-generating equipment); or are 
  - Damp (e.g., baths, washrooms, on wet floors); or are 
  - Humid; or are
  - Exposed to rain; or are
  - Dusty; or are
  - Subject to high levels of vibration.
- Make sure you always have the unit placed so it is level and sure to remain stable. Never place it on stands that could wobble, or on inclined surfaces. 
- The unit should be connected to a power supply only of the type described in the operating instructions, or as marked on the unit. 









#### ⚠ WARNING

- Do not excessively twist or bend the power cord, nor place heavy objects on it. Doing so can damage the cord, producing severed elements and short circuits. Damaged cords are fire and shock hazards! 
- This unit, either alone or in combination with an amplifier and headphones or speakers, may be capable of producing sound levels that could cause permanent hearing loss. Do not operate for a long period of time at a high volume level, or at a level that is uncomfortable. If you experience any hearing loss or ringing in the ears, you should immediately stop using the unit, and consult an audiologist. 
- Do not allow any objects (e.g., flammable material, coins, pins); or liquids of any kind (water, soft drinks, etc.) to penetrate the unit.   

- In households with small children, an adult should provide supervision until the child is capable of following all the rules essential for the safe operation of the unit. 
- Protect the unit from strong impact. (Do not drop it!) 

**⚠ WARNING**

- Do not force the unit's power-supply cord to share an outlet with an unreasonable number of other devices. Be especially careful when using extension cords—the total power used by all devices you have connected to the extension cord's outlet must never exceed the power rating (watts/ampères) for the extension cord. Excessive loads can cause the insulation on the cord to heat up and eventually melt through. 
- Before using the unit in a foreign country, consult with your retailer, the nearest Roland Service Center, or an authorized Roland distributor, as listed on the "Information" page. 

**⚠ CAUTION**

- The unit should be located so that its location or position does not interfere with its proper ventilation. 
- Always grasp only the plug on the power-supply cord when plugging into, or unplugging from an outlet. 
- Try to prevent cords and cables from becoming entangled. Also, all cords and cables should be placed so they are out of the reach of children. 
- If the unit could become a hazard if it moves, all caster wheels should be removed once the unit has been placed at the place of installation, or has been loaded onto a vehicle. 
- Never climb on top of, nor place heavy objects on the unit. 
- Never handle the power cord or its plug with wet hands when plugging into, or unplugging from, an outlet. 
- Before moving the unit, disconnect the power plug from the outlet, and pull out all cords from external devices. 
- Before cleaning the unit, turn off the power and unplug the power cord from the outlet. 
- Whenever you suspect the possibility of lightning in your area, pull the plug on the power cord out of the outlet. 

# Contents

<b>IMPORTANT SAFTY INSTRUCTIONS</b> .....	<b>2</b>	Changing Patch Settings.....	<b>23</b>
<b>USING THE UNIT SAFELY</b> .....	<b>3</b>	Selecting variations .....	23
<b>Main Features</b> .....	<b>6</b>	Checking the settings of a knob.....	23
<b>IMPORTANT NOTES</b> .....	<b>8</b>	Saving your modifications in a patch (Write).....	24
Attaching and Removing the Casters.....	9	Manual Mode.....	24
<b>Basic Opration</b> .....	<b>10</b>	<b>Panel Descriptions</b> .....	<b>25</b>
Preparations for using the VGA-7 .....	12	Front Panel.....	25
Attaching the GK-2A to your guitar.....	12	COSM Guitar Section (COSM GUITAR).....	25
About the GK-2A select switch .....	12	COSM Amplifier Section (COSM AMPLIFIER).....	28
About the SYNTH VOL knob of the GK-2A .....	12	Effects Section (EFFECTS) .....	30
of the GK-2A .....	12	Master Section .....	34
<b>Making Connections</b> .....	<b>13</b>	Rear Panel .....	35
Turning the Power On and Off .....	13	<b>System setting</b> .....	<b>38</b>
<b>Make settings for the divided pickup</b> ....	<b>14</b>	Procedure .....	38
Specify the pickup type (1 GK TYPE) .....	15	TUNER .....	38
Specify the direction in which the pickup is attached (2 DIRECTION).....	15	NOISE SUPRESSOR .....	38
Specify the scale length (3 SCALE).....	16	Foot Switch (FOOT SW) .....	39
Set the length from the pickup to the bridge (4 PICKUP-BRIDGE) .....	16	Expression Pedal (EXP PEDAL).....	39
Adjusting the Pickup Sensitivity for Each String (5 SENS).....	17	MIDI .....	40
Matching the phase of the divided pickup and the guitar pickup (6 PHASE).....	18	Transmitting/receiving VGA-7 settings .....	40
Specify the function of the S1/S2 switch (7 S1/S2) .....	19	MIDI OUT.....	42
Setting the Output Level of the COSM Guitar (8 LEVEL).....	19	<b>Operating the VGA-7 with the FC-200</b> ...	<b>43</b>
<b>TUNER</b> .....	<b>20</b>	Initializing the FC-200 from the VGA-7 .....	43
Setting the Tuner.....	20	Connecting the VGA-7 and the FC-200.....	43
Specify the standard pitch (1 PITCH).....	20	Functions That Can Be Controlled with the FC-200 .....	44
Setting the output level of the tuning sound (2 LEVEL).....	20	In Program Change Mode.....	44
Tuning your guitar.....	21	In Control Change Mode.....	44
<b>About Patch</b> .....	<b>22</b>	<b>Appendices</b> .....	<b>46</b>
Switching the Patches .....	22	If You Think There Might Be a Problem (Troubleshooting) .....	46
Direct Number Button .....	22	Restoring the Factory Settings.....	47
		Changing the MIDI Settings.....	48
		Effect connection order .....	49
		Block diagram .....	49
		MIDI Implementation Chart .....	50
		Specifications .....	51
		<b>Index</b> .....	<b>53</b>

# Main Features

The VGA-7, a V-guitar amplifier with a GK input, affords a new dimension in sound-creation potential, through its combination of COSM guitars, COSM amplifiers, and effects. Additionally, it offers a memory storage feature, and stereo output (65 + 65 W).

The two-way speaker system provides 12-inch speakers and horn tweeters in a bass-reflex cabinet, producing richly expressive sound over a broad range, from powerful lows to sparkling highs.

## COSM Guitar

---

- The pitch and envelope data that the divided pickup extracts from the guitar's vibrations are used to create 26 types of realistic tones, ranging from standard electric guitar to acoustic guitar, and on-to even completely new dimensions in sound.
- You can switch pickups and pickup position as appropriate for the type of guitar. For acoustic guitars, you can select piezo pickup or mic'ed sound.
- The Tuning function (six-string independent) provided by the VGA-7 allows you to play in open tunings or Nashville tuning without changing the actual tuning of your guitar. You can also switch instantly to 12-string guitar tuning. Each individual string can also be tuned freely.
- Digital Capo function lets you use hitherto-impossible "negative" fret settings.

## COSM Amplifier

---

- In addition to classic, solid-state and vacuum tube units, full-range amps ideal for acoustic instruments are also provided, giving you a total of twenty different guitar amp sound simulations.
- Gain/volume/3-band equalizer/presence controls let you fine-tune your sound even more. All of these functions are adjusted according to the unique characteristics of each amp type.
- Speaker Modeling function simulates the characteristics of different cabinets. You can use simulations of classic models of speaker cabinets, or combine speakers and cabinets in new and creative ways.

## Effects

---

- Four kinds of effects are offered onboard: EFX, delay, chorus, and reverb. All four can be used simultaneously. You can also use a foot switch to switch each effect on/off.
- As the EFX, one of the following six can be selected: wah, slow gear, compressor, tremolo, phaser, or flanger.
- The delay supports tap input, making it easy to set the delay time. The Delay Hold function lets you repeatedly play back a recorded phrase.
- Chorus features the richly spacious air-mixed chorus made famous by the Roland JC series.

## Memory Storage Feature

---

A whole string of settings, calling for things such as a change in guitar, in the tuning, in the amp, or a different choice of effects can be stored as "patches" in memory. Then, during performance, simply call up the patch, and you've instantly selected just the settings you need.

In addition to eighty pre-programmed "preset" patches, another eighty "user" patches can be programmed with your own settings, for a total of 160 patches at your fingertips.

## Easy Operation

---

Buttons and knobs are located for easy operation, making everything from patch changes to sound editing quick and intuitive.

## Broad Expandability

- Stereo external input jacks are provided, allowing you to mix the sound of the VGA-7 with an external sound source, such as a guitar synthesizer. Stereo line out jacks convenient for recording are also provided.
- The foot control jack lets you use your feet to select patches or turn effects on/off. You can also connect an expression pedal to control volume or wah.
- MIDI connectors allow VGA-7 patch changes and other operations to be controlled from an external MIDI device. You can also transmit VGA-7 settings to an external MIDI device to be saved.

## ■ Sound Modeling

Roland believes that the final evaluation of an electric guitar's sound should not be based only on sound output from the guitar itself, but should also include the sound that passes through the guitar amps, speakers, and other equipment.

To achieve this, it's necessary to simulate all the steps along the way — from the moment a guitar string is plucked, until the time the sound reaches the ears — thereby re-creating the sound. Roland has made it possible to re-create these steps with this latest sound modeling technology — in other words, other means are used to make a virtual model of the physical structures and materials that actually exist.

## ■ COSM

The new Composite Object Sound Modeling (COSM) advanced by Roland combines a number of sound modeling technologies to create even newer sounds.

COSM is able to combine optimized sound models for various objects to simulate anything from existing musical instruments to sound-producing structures that could not physically exist in the real world.

### COSM GUITAR/COSM AMPLIFIER

COSM guitar/COSM amplifier are modeling technologies that can reproduce the sounds of any existing guitar. This includes the following.

- Electronic Modeling, which simulates all characteristics which can be attributed to the use of vacuum tubes, transistors, and all other electronic circuitry.
- Magnetic Modeling, which simulates all the characteristics which can be produced as a result of using pickups, transformers, speakers, and other electromagnetic parts.
- Physical Modeling, which simulates all the characteristics that are produced as a result of the use of certain types of materials to make a guitar, including the kind of wood, metal parts, or finish that are used.

In addition, COSM guitar is able to produce completely new sounds that never existed before. The numerous harmonics contained in the sound from the vibrating strings (the sound source) can be radically emphasized, added to, or removed, in order to create totally new guitar sounds.

A guitarist conveys musical expression through string vibration. Vibrating strings carry a great deal of information about the dynamics of a performance, including that which expresses the way in which strings have been pressed, the location at which they've been picked, the position of the pick, and the kind of vibrato that's been used. The V-Guitar system uses the string vibration itself (which contains all of this performance information) as the sound source, and can create not only previously existing guitar sounds, but also completely new sounds. One great advantage of this system is that it preserves the playing dynamics of the guitarist, as they are conveyed by the vibration of the string.

# IMPORTANT NOTES

In addition to the items listed under “IMPORTANT SAFETY INSTRUCTIONS” and “USING THE UNIT SAFELY” on pages 2 and 3–4, please read and observe the following:

## Power Supply

- Do not use this unit on the same power circuit with any device that will generate line noise (such as an electric motor or variable lighting system).
- Before connecting this unit to other devices, turn off the power to all units. This will help prevent malfunctions and/or damage to speakers or other devices.

## Placement

- Using the unit near power amplifiers (or other equipment containing large power transformers) may induce hum. To alleviate the problem, change the orientation of this unit; or move it farther away from the source of interference.
- This device may interfere with radio and television reception. Do not use this device in the vicinity of such receivers.
- Do not expose the unit to direct sunlight, place it near devices that radiate heat, leave it inside an enclosed vehicle, or otherwise subject it to temperature extremes. Excessive heat can deform or discolor the unit.
- To avoid possible breakdown, do not use the unit in a wet area, such as an area exposed to rain or other moisture.
- Do not allow rubber, vinyl, or similar materials to remain on the piano for long periods of time. Such objects can discolor or otherwise harmfully affect the finish.
- Do not put anything that contains water (e.g., flower vases) on the piano. Also, avoid the use of insecticides, perfumes, alcohol, nail polish, spray cans, etc., near the unit. Swiftly wipe away any liquid that spills on the unit using a dry, soft cloth.
- During operation, this device must be placed at a distance of no less than 50 cm from any walls.
- Do not allow objects to remain on top of the unit while it is in operation.
  - If you cover the heat-dissipation fins, their function is defeated, and their temperature can rise to overly high levels, which could cause burns if they are accidentally touched.
  - Placing heavy objects on this unit may result in injury if it overturns or falls.

## Maintenance

- For everyday cleaning wipe the unit with a soft, dry cloth or one that has been slightly dampened with water. To remove stubborn dirt, use a cloth impregnated with a mild, non-abrasive detergent. Afterwards, be sure to wipe the unit thoroughly with a soft, dry cloth.
- Never use benzine, thinners, alcohol or solvents of any kind, to avoid the possibility of discoloration and/or deformation.

## Repairs and Data

- Please be aware that all data contained in the unit’s memory may be lost when the unit is sent for repairs. Important data should always be backed up in another MIDI device (e.g., a sequencer), or written down on paper (when possible). During repairs, due care is taken to avoid the loss of data. However, in certain cases (such as when circuitry related to memory itself is out of order), we regret that it may not be possible to restore the data, and Roland assumes no liability concerning such loss of data.

## Memory Backup

- This unit contains a battery which powers the unit’s memory circuits while the main power is off. When this battery becomes weak, the message shown below will appear in the display. Once you see this message, have the battery replaced with a fresh one as soon as possible to avoid the loss of all data in memory. To have the battery replaced, consult with your retailer, the nearest Roland Service Center, or an authorized Roland distributor, as listed on the “Information” page.



## Additional Precautions

- Please be aware that the contents of memory can be irretrievably lost as a result of a malfunction, or the improper operation of the unit. To protect yourself against the risk of losing important data, we recommend that you periodically save a backup copy of important data you have stored in the unit’s memory in another MIDI device (e.g., a sequencer).
- Unfortunately, it may be impossible to restore the contents of data that was stored in the unit’s memory once it has been lost. Roland Corporation assumes no liability concerning such loss of data.



- Use a reasonable amount of care when using the unit's buttons, sliders, or other controls; and when using its jacks and connectors. Rough handling can lead to malfunctions.
- Never strike or apply strong pressure to the display.
- When connecting / disconnecting all cables, grasp the connector itself—never pull on the cable. This way you will avoid causing shorts, or damage to the cable's internal elements.
- A small amount of heat will radiate from the unit during normal operation.
- To avoid disturbing your neighbors, try to keep the unit's volume at reasonable levels. You may prefer to use headphones, so you do not need to be concerned about those around you (especially when it is late at night).
- When you need to transport the unit, package it in the box (including padding) that it came in, if possible. Otherwise, you will need to use equivalent packaging materials.
- This is a heavy device. To prevent injury caused by the unit overturning or being dropped, use two or more people to carry the unit whenever possible.
- Use only the specified expression pedal (EV-5, FV-300L; sold separately). By connecting any other expression pedals, you risk causing malfunction and/or damage to the unit.
- Use a cable from Roland to make the connection. If using some other make of connection cable, please note the following precautions.
  - Some connection cables contain resistors. Do not use cables that incorporate resistors for connecting to this unit. The use of such cables can cause the sound level to be extremely low, or impossible to hear. For information on cable specifications, contact the manufacturer of the cable.
- To avoid injury, avoid placing hands at points indicated by the arrows in the following figure.

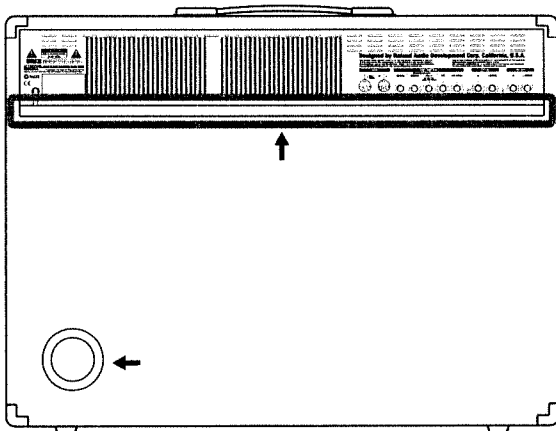

- When this device is in operation, the cooling fins located on the rear panel will become hot. Take care not to touch them with your hands.

## Attaching and Removing the Casters

Attaching all of the casters can make it easier to move the amplifier.

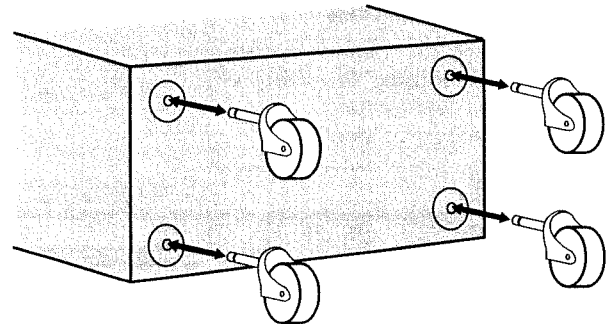

When using casters, take care not to allow fingers or other parts of the hand or body to get pinched or injured.



Be sure to remove all casters when accidental movement may be dangerous such as when setting up the VGA-7 on stage or when transporting it in a vehicle.



If casters have been attached to the amp, make sure it is used only on a stable, level surface.

# Basic Operation

\* For details on each function, refer to p. 14 and following.

## Manual Button

By pressing the Manual button, you can play using the sound of the current knob settings, as on a conventional guitar amplifier.

## Power Switch

Turns the power on/off.

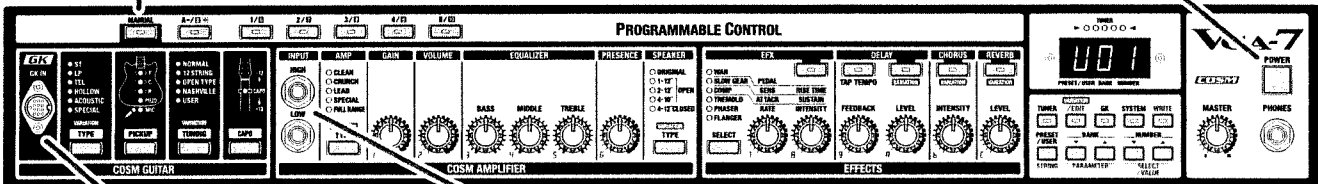

## GK IN

Use the special cable to connect the GK-2A-compatible guitar (or the guitar in which the GK-2A is installed).

When the GK cable is connected or disconnected, the indicators of the COSM guitar section will blink.

You can use all functions of the COSM guitar, COSM amplifier, and EFFECTS.

## INPUT Jacks

Connect a conventional guitar. You can use the functions of the COSM amplifier and EFFECTS.

## Effect On/Off Buttons

Switch the effects on/off. When on, the button indicator will light.

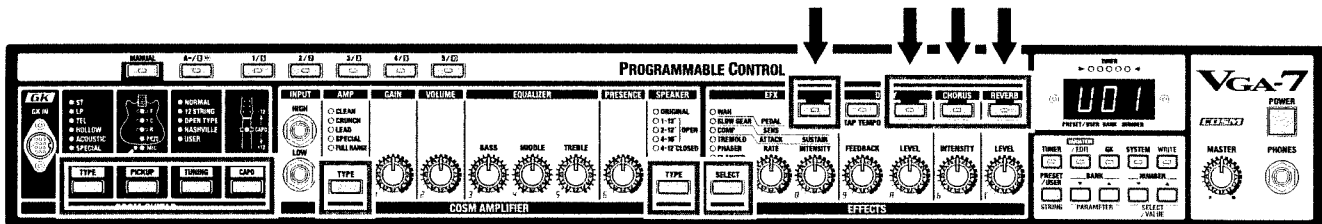

## Function select buttons

Press a button to select the desired function.

## VARIATION Function

In addition to the settings, there are several other choices of COSM guitar type and tuning, COSM amplifier and speaker, and EFFECTS delay, chorus and reverb.

\* **VARIATION** is printed top or under buttons (that the arrow in the picture below should indicate) for which variation settings (types) are provided.

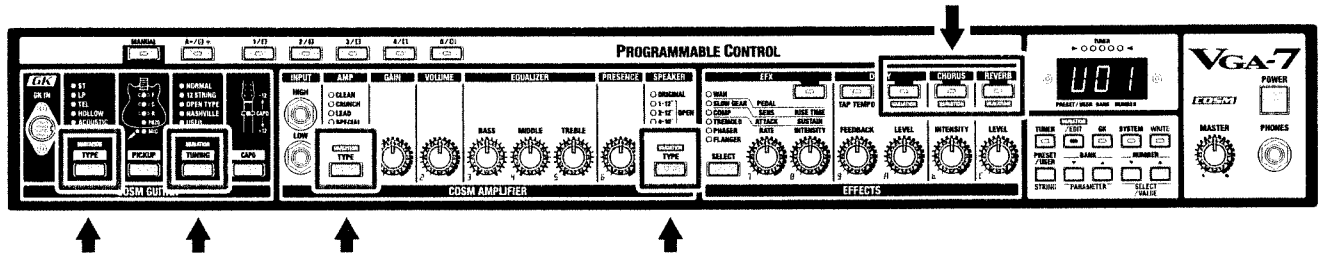

### MEMO

The plate on the upper left of the cabinet provides a list of variations.

#### VARIATION

COSM GUITAR TYPE										TUNING																				
ST		LP		TEL		HOLLOW		ACOUSTIC		SPECIAL		12 STRING	OPEN TYPE	NASHVILLE																
1 CLASSIC	2 MODERN	3 S-S-H	1 CLASSIC	2 MODERN	3 Jr	1 CLASSIC	2 MODERN	3 H-S	1 SEMI	2 FULL	3 RICK	1 STANDARD	4 NYLON STR	1 BOWED	5 SOLO	2 REGULAR	3 OCTAVE	4 DETUNE	1 OPEN D	2 OPEN G	3 DROPPED D	1 TYPE 1	2 TYPE 2							
COSM AMP TYPE					SPEAKER TYPE					EFFECTS																				
CLEAN		CRUNCH		LEAD		SPECIAL		FULL RANGE		OPEN		CLOSED		DELAY		CHORUS		REVERB												
1 JC	2 CLASSIC 1	3 CLASSIC 2	4 MELLOW	1 CLASSIC 1	2 CLASSIC 2	3 CLASSIC 3	4 MODERN	1 CLASSIC I	2 CLASSIC I+II	3 MODERN 1	4 MODERN 2	1 LAYER 1	2 LAYER 2	3 FUZZ	1 FLAT	2 SHAPED	3 FAT	1 CLASSIC	2 MODERN	3 CLASSIC STACK	4 MODERN STACK	1 MONO	2 PANNING	3 HOLD	1 SPACE	2 WARM	3 BRIGHT	1 PLATE	2 ROOM	3 HALL

### Selecting variations

1. Press the button that "**VARIATION**" is printed, then preselect the variation setting to which you want to change.
2. Press [VARIATION/EDIT], getting its indicator to light. The indicator of the currently selected type will blink.

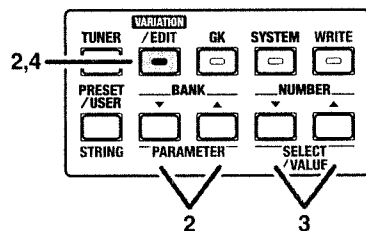

\* You can switch the variation setting to the one you want by pressing [PARAMETER ▼/▲].

3. Press [SELECT/VALUE ▼/▲] to select the variation number.

4. Once you've selected a variation number, press [VARIATION] again, extinguishing its indicator. The indicator of the currently selected type will light, thus finalizing your selection of a variation.

### MEMO

If you want to save the selected variation, carry out the Write operation. (p. 24)

## Basic Operation

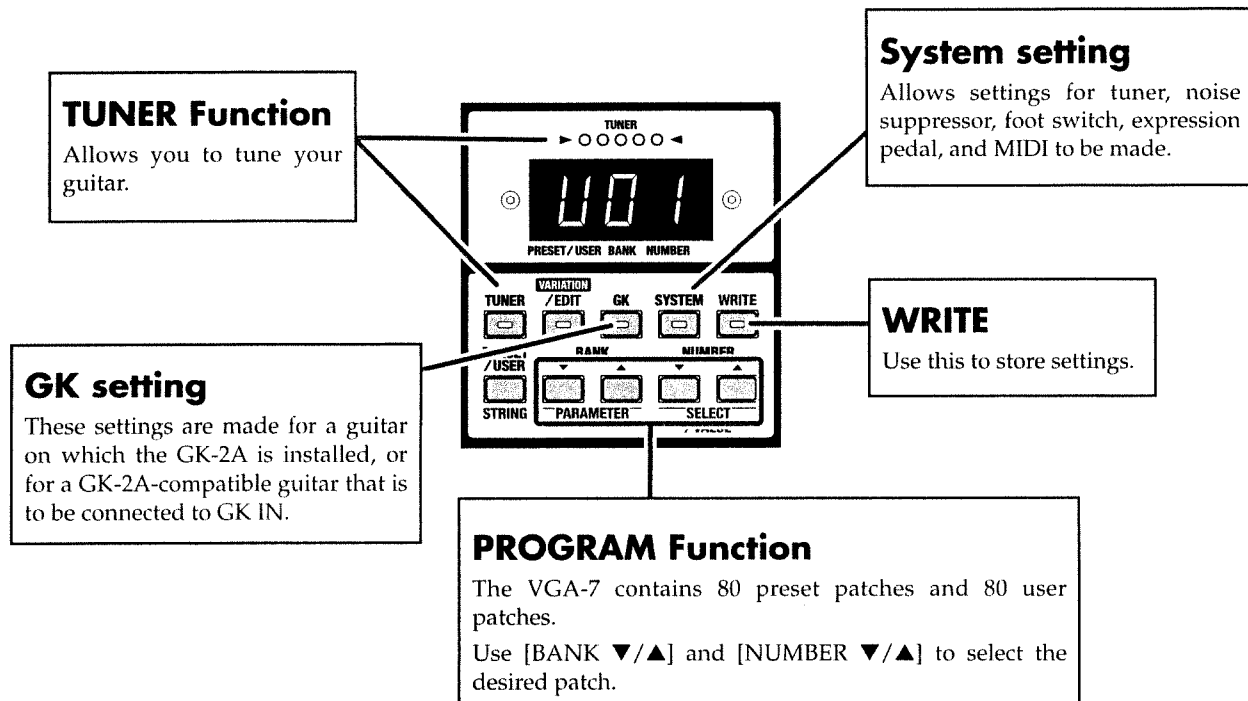

## Preparations for using the VGA-7

### Attaching the GK-2A to your guitar

First, attach the GK-2A divided pickup (sold separately) to your guitar.

To learn how, refer to the owner's manual for the GK-2A.

### The GK-2A cannot be used with the following types of guitar.

**(When attached to one of these guitars, the GK-2A will not function correctly.)**

- Guitars with unconventional string structures, such as twelve-string guitars or pedal steel guitars
- Guitars that use nylon or gut strings
- Bass guitars
- Other guitars that, for structural reasons, have no location where the GK-2A divided pickup can be attached correctly

### About the GK-2A select switch

- SYNTH:** Select this if you are using a GK-2A divided pickup
- MIX:** When combining the GK-2A divided pickup with the normal pickup of the guitar
- GUITAR:** When using the normal pickup of the guitar

#### NOTE

If you won't be connecting the jack of the guitar to the normal guitar input jack of the GK-2A, make sure to set the GK-2A select switch to the SYNTH position.

If this is set to MIX or GUITAR, noise or hum may occur.

### About the SYNTH VOL knob of the GK-2A

This controls the volume of the COSM guitar.

# Making Connections

You will need a guitar on which the GK-2A has been installed, or a GK compatible guitar.

The following equipment will add additional functionality to your VGA-7 system.

- MIDI Foot Controller (sold separately: Roland FC-200)
- Expression Pedal (sold separately: Roland EV-5, BOSS FV-300L)
- Foot Switch (sold separately: BOSS FS-5U/FS-5L)

- \* Use only the specified expression pedal (EV-5 or BOSS FV-300L; sold separately). By connecting any other expression pedals, you risk causing malfunction and/or damage to the unit.
- \* Use an FS-5U (momentary type) foot switch to change program numbers.

After you have prepared your guitar — by installing the GK-2A — connect your equipment as shown in the following diagram.

- \* To prevent malfunction and/or damage to speakers or other devices, always turn down the volume, and turn off the power on all devices before making any connections.

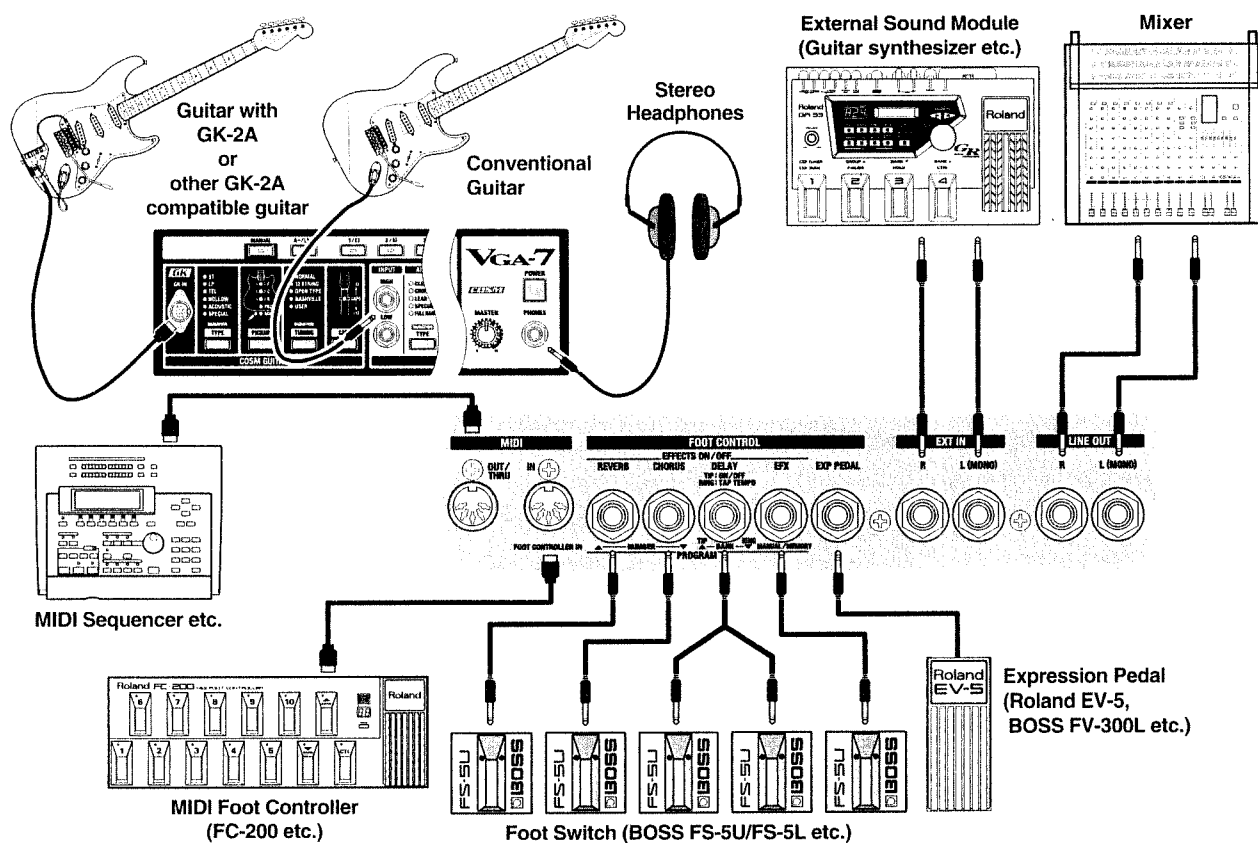

\* When using the FS-5L, only effect on/off can be controlled. (p. 36)

## Turning the Power On and Off

Once the connections have been completed, turn on power to your various devices in the order specified. By turning on devices in the wrong order, you risk causing malfunction and/or damage to speakers and other devices.

External devices (except for output devices) →VGA-7→ output devices

- \* When the power is turned on, the last-selected patch number or Manual mode (p. 24) will be selected.

- \* When this device is in operation, the cooling fins located on the rear panel will become hot. Take care not to touch them with your hands.
- \* This unit is equipped with a protection circuit. A brief interval after power up is required before the unit will operate normally.
- \* Turn the volume down before you turn the power on or off. Even if the volume is turned down, some extraneous sound may be heard when turning the power on/off, but this is not a malfunction.

# Make settings for the divided pickup

The sound quality of the VGA-7 is dramatically affected by how the divided pickup is installed. In order to minimize tonal irregularity due to variations in installation, you must input the manner in which the divided pickup is installed (divided pickup settings).



When playing the VGA-7, divided pickup settings are extremely important to the final sound quality.

You must be sure to set these parameters correctly.

Redo the settings when you change the guitar you are using.

- ◆ To make settings for the divided pickup, press [GK], getting the indicator to light, and then make the necessary settings.

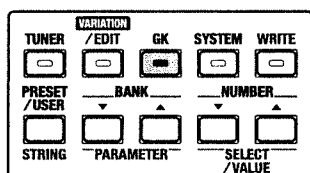

When you are finished, press [GK] once again, extinguishing its indicator.

- \* Once you have made the correct settings, they will be saved even when the power is turned off. You do not need to redo these settings each time you play.

When you press [GK], the VGA-7 will be set as follows, so that the sound will be most appropriate for the divided pickup settings.

- \* Although you will still be able to adjust the volume—using either [VOLUME] on the COSM guitar or [MASTER]—all other buttons and knobs on the panel will be disabled.

## COSM GUITAR

TYPE: ST (Variation 1)  
 PICKUP: C  
 TUNING: NORMAL  
 CAPO: Off

## COSM AMPLIFIER

TYPE: CLEAN (Variation 1)  
 GAIN: 50  
 EQUALIZER (BASS/MIDDLE/TREBLE): 50  
 PRESENCE: 50  
 SPEAKER: ORIGINAL

## EFFECTS

EFX: Off  
 DELAY: Off  
 CHORUS: Off  
 REVERB: Off



A list of divided pickup settings is provided on the plate located on the upper right of the cabinet.

GK	DIVIDED PICKUP SETTING								COSM GUITAR
PARAMETER	1 GK TYPE	2 DIRECTION	3 SCALE	4 PICKUP-BRIDGE	5 SENS	6 PHASE	7 S1/S2	8 LEVEL	
VALUE	1 GK-2A 2 GK-2 3 PIEZO	1 NORMAL 2 REVERSE	5L LP 20-60 (ST LP 620-660mm)	IND STRING 10 - 30 mm	IND STRING 0 - 99	1 NORMAL 2 INVERSE	1 PICKUP SEL 2 NUMBER SEL 3 BANK SEL 4 TUNER	-5 - 5	

## Specify the pickup type (1 GK TYPE)

\* With the factory settings, this is set to "1 GK-2A."

1. Press [PARAMETER ▼/▲] until "1" is shown (blink) at the left side of the display.

This selects "1 GK TYPE."

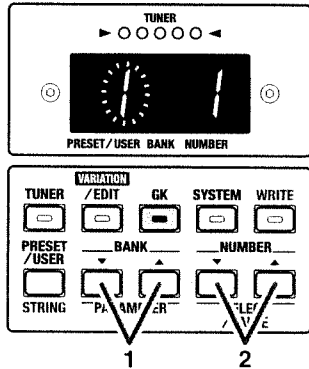

2. Press [SELECT/VALUE ▼/▲] to select the desired pickup type. The corresponding number will appear in the right of the display.

\* The example display shows that "1 GK-2A" has been selected.

Display	Setting
1	<b>GK-2A:</b> Make this setting if you are using a GK-2A.
2	<b>GK-2:</b> Make this setting if you are using a GK-2.
3	<b>PIEZO:</b> Make this setting if you are using a piezo divided pickup.

\* A piezo-type pickup uses a piezo-electric sensor attached to the bridge of the guitar to detect the vibrations of the strings.

## Specify the direction in which the pickup is attached (2 DIRECTION)

\* With the factory settings, this is set to "1 NORMAL."

1. Press [PARAMETER ▼/▲] until "2" is shown (blink) at the left of the display.

This selects "2 DIRECTION."

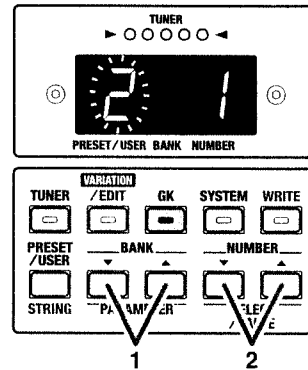

2. Press [SELECT/VALUE ▼/▲] to select the direction in which the divided pickup is installed.

The corresponding number will appear in the right of the display.

\* The example display shows that "1 NORMAL" has been selected.

Display	Setting
1	<b>NORMAL:</b> In this direction, the cable exits on the side of string 6.
2	<b>REVERSE:</b> In this direction, the cable exits on the side of string 1.

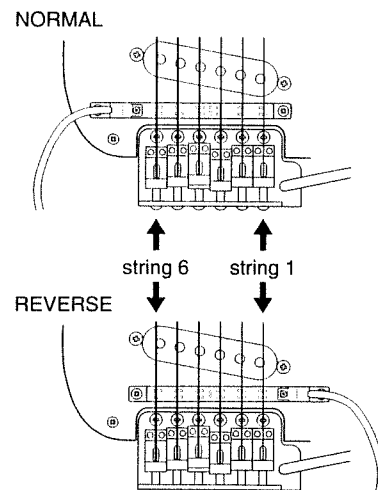

## Make settings for the divided pickup

### Specify the scale length (3 SCALE)

\* With the factory settings, this is set to "5E."



When playing the VGA-7, the scale length setting is extremely important to the final sound quality. You must be sure to set this parameter correctly.

1. Press [PARAMETER ▼/▲] until "3" is shown (blink) at the left of the display.  
This selects "3 SCALE."

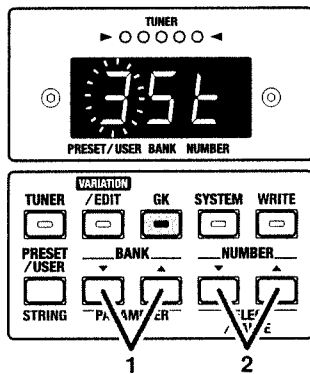

2. Press [SELECT/VALUE ▼/▲] to set the scale length.  
In the display, select the scale length (the length from the bridge to the nut) that is closest to your guitar.

Display	Setting
5E	ST type guitars (648 mm)
LP	LP type guitars (628 mm)
20-60	620 mm-660 mm

### Set the length from the pickup to the bridge (4 PICKUP-BRIDGE)

\* This setting is unnecessary if a piezo pickup has been selected.

Use a ruler or tape measure to actually measure along each string from the center of the divided pickup to the bridge. Specify the result as the length in millimeters for each string.

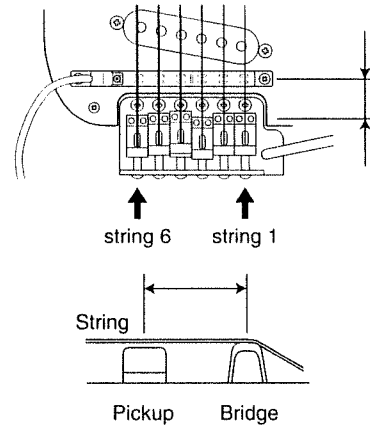

\* The factory settings are shown in the following.

String	1	2	3	4	5	6
Length (mm)	18	19	20	19	20	21

1. Press [PARAMETER ▼/▲] until "4" is shown (blink) at the left of the display.  
This selects "4 PICKUP-BRIDGE."

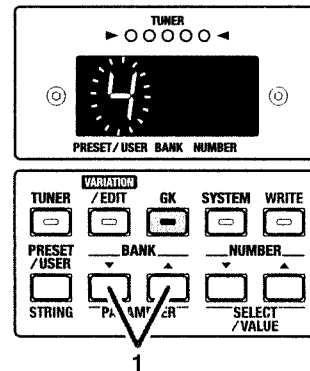

2. Play any string on your guitar.  
The string that you played will be detected automatically, and the string number will be shown in the display.



You can press [STRING] to specify the string number directly.

Each press of the button takes you to the next string number, from string 1 through string 6.

(The string number is indicated by a dot.)

If you play a string other than the one indicated by the dot, the display switches to the number of the string that was played.

- Use [SELECT/VALUE ▼/▲] to specify the distance for the selected string number.

Display	Setting
10-30	10-30 mm

\* The example display shows that the 6th string is at a distance of 10 mm.

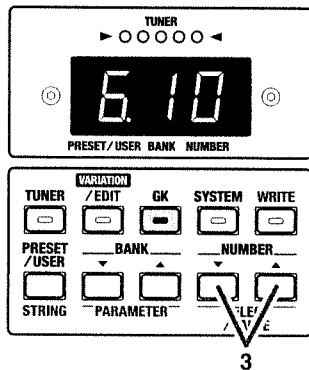

- Repeat steps 2-3 for each of the remaining strings.

## Adjusting the Pickup Sensitivity for Each String (5 SENS)

Adjust the pickup sensitivity for each string according to how the GK-2A divided pickup was installed.

\* With the factory settings, this is set to "65."



Make sure to set the divided pickup select switch to the "SYNTH" position.

- Press [PARAMETER ▼/▲] until "5" is shown (blink) at the left of the display.

This selects "5 SENS."

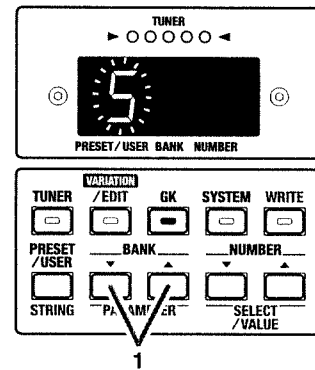

- Play any string on your guitar.

The string you played will be detected automatically, and the string number will appear in the display.

At the same time, the TUNER indicator will show the level. The indicators will light from left to right, corresponding to the strength with which you played the string.

\* If you play the string too weak or the pickup sensitivity is set too low, the string number may not appear in the display.

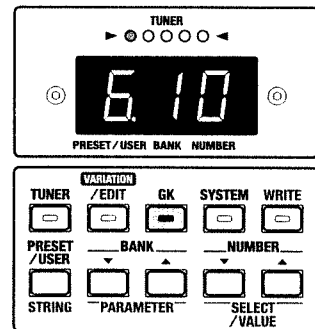

## Make settings for the divided pickup

You can press [STRING] to specify the string number directly. Each press of the button takes you to the next string number, from string 1 through string 6. (The string number is indicated by a dot.)

If you play a string other than the one indicated by the dot, the display switches to the number of the string that was played.

- Press [SELECT/VALUE ▼/▲] to adjust the sensitivity. Play the guitar, using what is likely to be the most forceful playing that you will use in actual performance. At the same time, adjust the value until the green indicator in the center is lighted. Then, adjust further until you get it to the highest value possible without causing the indicator to the right of that to light. Higher values will increase the sensitivity.

\* The example display shows that the sensitivity for the 6th string is set at 10.

Display	Setting
0-99	0-99

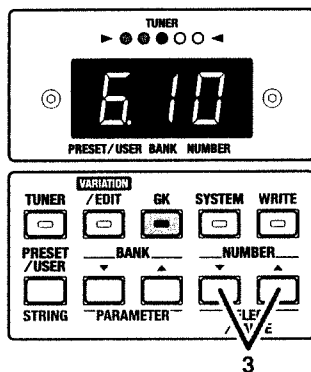

\* Depending on the guitar that you use, the level may reach the maximum even if you set sensitivity to the minimum setting. If this occurs, increase the distance between the divided pickup and the string so that it is greater than specified.

- Repeat steps 2-3 for each of the remaining strings.
- Play Strings 6-1 as softly as possible. If any string produces a particularly loud sound, lower the sensitivity for that string in order to minimize volume differences between strings.

## Matching the phase of the divided pickup and the guitar pickup (6 PHASE)

Unless the phase of the divided pickup and the pickup of the guitar are matched, they will partially cancel each other out when they are mixed, adversely affecting the tone or volume.

\* With the factory settings, this is set to "1 NORMAL."



Make sure to set the divided pickup select switch to the "MIX" position.

- Press [PARAMETER ▼/▲] until "6" is shown (blink) at the left of the display. This selects "6 PHASE."

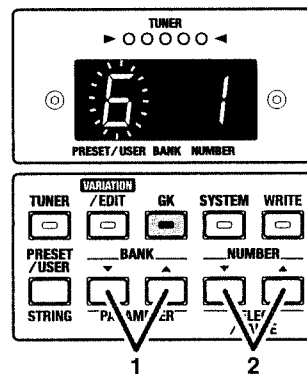

- While playing String 6, press [SELECT/VALUE ▼/▲] and select the position that does not cause the volume of the low-frequency range to diminish significantly. Get the corresponding number to appear at the right of the display.

\* The example display shows that the 6th string is set to "1 NORMAL."

Display	Setting
1	<b>NORMAL:</b> The phase will remain unchanged.
2	<b>INVERSE:</b> The phase will be inverted.

## Specify the function of the S1/S2 switch (7 S1/S2)

\* With the factory settings, this is set to "1 PICKUP SEL."

1. Press [PARAMETER ▼/▲] until "7" is shown (blink) at the left of the display.

This selects "7 S1/S2."

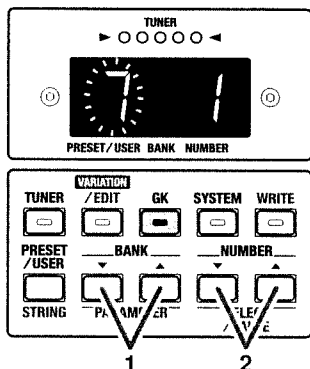

2. Use [SELECT/VALUE ▼/▲] to specify the function of the S1/S2 switches.

Get the corresponding number to appear at the right of the display.

\* The S1/S2 switch is disabled while settings are being made.

\* The example display shows that the S1/S2 switch is set to "1 PICKUP SEL."

Display	Setting
1	<b>PICKUP SEL:</b> Switching the pickup of COSM guitar
2	<b>NUMBER:</b> Number up/down
3	<b>BANK:</b> Bank up/down
4	<b>TUNER:</b> Tuner on/off

## Changing the Switching Direction of S1 and S2 when PICKUP SEL Is Selected

Normally, the COSM GUITAR pickups are switched by pressing the S1 switch for MIC → F, and pressing the S2 switch for F → MIC, but by switching on the POWER switch while holding down [GK] and [NUMBER ▲], you can set this so the directions are reversed. In this case, the COSM GUITAR PICKUP "R" indicator will blink.

To return to the ordinary state, switch on the POWER while holding down [GK] and [NUMBER ▼].

In this case, the COSM GUITAR PICKUP "F" indicator will blink.

## Setting the Output Level of the COSM Guitar (8 LEVEL)

You can adjust the balance between the output level of the divided pickup and the output level of the guitar pickup.

\* With the factory settings, this is set to "0."



Make sure to set the divided pickup select switch to the "SYNTH" position.

1. Press [PARAMETER ▼/▲] until "8" is shown (blink) at the left of the display.

This selects "8 LEVEL."

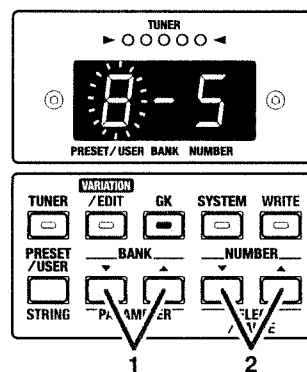

2. Press [SELECT/VALUE ▼/▲] to adjust the balance (- 5-5) between the COSM guitar sound and the normal guitar sound.

Negative (-) settings will decrease the COSM guitar sound, and positive (+) settings will increase it.



Move the select switch of the divided pickup between "SYNTH" and "GUITAR," and adjust the volume balance while playing your instrument in each position.

# TUNER

Here's how to use the VGA-7's tuner function to tune your guitar.  
In order to use the tuner, you must first make tuner settings.

## Setting the Tuner

Press [SYSTEM], getting the indicator to light, and then make the following settings.

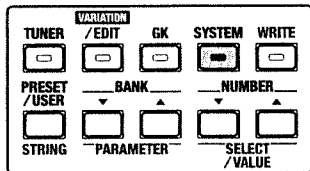

When you have finished making settings, press [SYSTEM] once again, extinguishing its indicator.

## Specify the standard pitch (1 PITCH)

\* With the factory settings, this is set to "440 Hz."

1. Press [PARAMETER ▼/▲] until "1" is shown (blink) at the left of the display.  
This selects "1 PITCH."
2. Press [SELECT/VALUE ▼/▲] to set the standard pitch.

\* The example display shows that the standard pitch is set to 440 Hz.

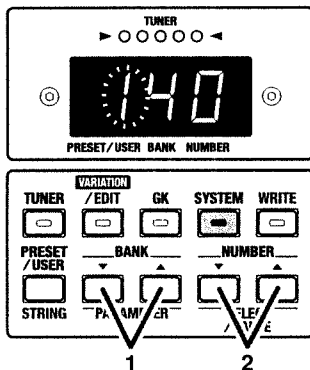

Display	Setting
35-45	435 -445 Hz

## Setting the output level of the tuning sound (2 LEVEL)

\* At the factory settings, this is set to 0 (MUTE: sound will not be output during tuning).

1. Press [PARAMETER ▼/▲] until "2" is shown (blink) at the left of the display.  
This selects "2 LEVEL."
2. Press [SELECT/VALUE ▼/▲] to set the output level.

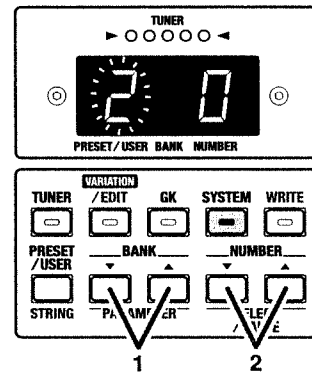

Display	Setting
0-10	0 (MUTE: sound will not be output during tuning)-10

## Tuning your guitar

\* While using the tuner, sound will not be output from the line out jacks.

1. Press [TUNER], getting the indicator to light.

This turns on the Tuner function.

2. Play a single unfretted note on the string you wish to tune.

The note name closest to the string you played will appear in the display.

For a guitar connected to GK IN, the string number will also be displayed.

\* Cleanly play a single note only on the string that you wish to tune.

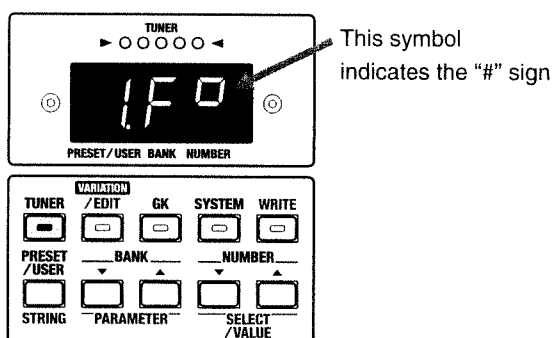

3. Adjust the tuning until the note name of the string you played appears in the display.

4. Tune your guitar so that only the green indicator in the center is lit.

5. Repeat steps 2–4 to tune all the strings.

\* When tuning a guitar that has a tremolo arm, tuning one string may cause the other strings to go out of tune. In such cases, first tune the strings to the approximate pitch (so that the note name is displayed), and then keep tuning each string until they are all in tune.

6. When you have finished tuning, press [TUNER], extinguishing its indicator.

This turns off the Tuner function.

# About Patch

When you are performing on your guitar, you will need a variety of sounds, depending on the situation.

On the VGA-7, the settings of the panel buttons and knobs used to create the sound can be remembered as a set, which is called a **Patch**.

You can create several patches, and switch between patches to use the desired tonal character whenever you need.

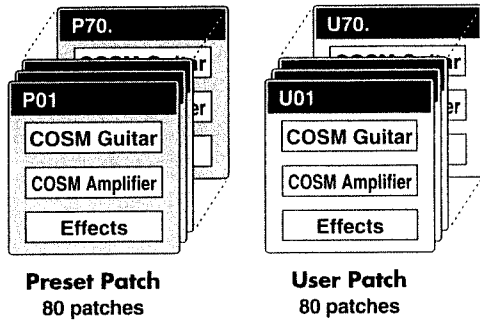

There are two types of patches.

## Preset Patches

These are 80 patches provided by the VGA-7. They contain a wide range of sounds appropriate for various situations.

After selecting one of these patches, you can use the buttons or knobs to temporarily modify the settings, but if you turn off the power or select another patch, your modifications will be lost. If you wish to keep the modified settings as a patch, you must save the patch as a User Patch.

## User Patches

These are original patches that you create. You are free to rewrite and save the contents of the settings. Up to 80 user patches can be created.

## Switching the Patches

Patches (preset/user) are selected by specifying the bank (0–7) and number (1–10).

		NUMBER										
		▼					▲					
		1	2	3	4	5	6	7	8	9	10	
BANK	▼	0	01	02	03	04	05	06	07	08	09	00.
	▲	1	11	12	13	14	15	16	17	18	19	10.
2	▼	2	21	22	23	24	25	26	27	28	29	20.
	▲	3	31	32	33	34	35	36	37	38	39	30.
4	▼	4	41	42	43	44	45	46	47	48	49	40.
	▲	5	51	52	53	54	55	56	57	58	59	50.
6	▼	6	61	62	63	64	65	66	67	68	69	60.
	▲	7	71	72	73	74	75	76	77	78	79	70.

1. Press [PRESET/USER] to select the Preset Patches (P) or the User Patches (U).
2. Press [BANK ▼/▲] to select the Banks (0–7).
3. Press [NUMBER ▼/▲] to select the Number (1–10).
  - When the number is 10, the display will indicate "0."

## MEMO

You can use a foot switch to switch the bank/number. (p. 36)

## Direct Number Button

You can use the Direct Number button to directly access and select numbers in the currently selected bank.



- If you press [A/B], extinguishing the indicator, these buttons will select numbers 1–5.
- If you press [A/B], getting the indicator to light, these buttons will select numbers 6–10.

## Changing Patch Settings

Use the buttons and knobs to modify the settings of the selected patch. This operation is called "Editing."

### MEMO

- Immediately after changing patches, the settings stored in the patch will not match the positions of the knobs. When you turn the knob, the setting value stored in the patch will be shown in the display. Once the position of the knob matches the displayed value, the displayed value will begin to change. When you change the setting of a knob, it is a good idea to rotate the knob all the way to the right or left before you begin adjusting the value.
- When you modify the settings stored in a patch, the direct number button for the current patch will blink. This indicates that the current patch is being edited.

## Selecting variations

For the COSM guitar type and tuning, COSM amplifier type and speaker, and EFFECTS delay, chorus and reverb, there are several variations in addition to the settings (types).

\* **VARIATION** is printed top or under buttons for which variation settings (types) are provided.

### MEMO

A list of variations is provided on the plate located on the top left of the cabinet. (p. 11)

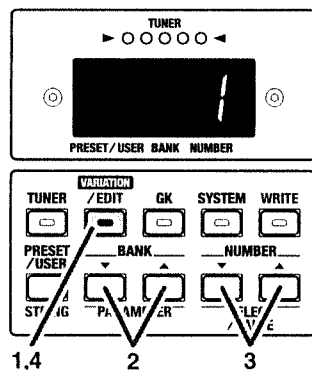

1. Press the button that "**VARIATION**" is printed, then preselect the variation setting to which you want to change.
2. Press [VARIATION/EDIT], getting its indicator to light. The indicator of the currently selected type will blink.
  - \* You can switch the variation setting to the one you want by pressing [PARAMETER ▼/▲].

- \* If the settings are turned off when either CAPO, EFX, DELAY, CHORUS, or REVERB is selected, the display indication flashes. (You can turn this on by pressing the button.)
- \* If a setting with no variation is selected, the display will show as follows.

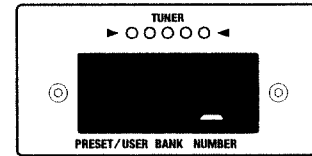

3. Press [SELECT/VALUE ▼/▲] to select the variation number.
4. Press [SELECT/VALUE ▼/▲] to select the variation number.
5. Once you've selected a variation number, press [VARIATION] again, extinguishing its indicator. The indicator of the currently selected type will light, thus finalizing your selection of a variation.

## Checking the settings of a knob

1. Press and hold [VARIATION/EDIT] for two seconds or longer, until the indicator lights.

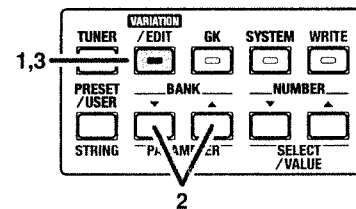

2. Press [PARAMETER ▼/▲] to select the setting and confirm the value. The position number (1-9, A-C) assigned to each knob and its value will be shown.

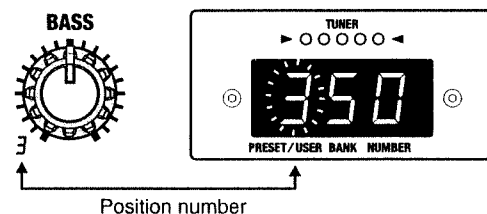

- \* You can modify the value by pressing [SELECT/VALUE ▼/▲] when the setting is shown in the display. However, this is not possible in Manual mode.
3. When you are finished checking the values, press [VARIATION/EDIT] once again, extinguishing its indicator.

## About Patch

### Saving your modifications in a patch (Write)

If you wish to save the modifications you have made, you must store them in a user patch. This operation is called "Write."

All settings except for the MASTER knob can be saved.

\* If you used the foot switch to turn the effect on/off (p. 36), that setting will also be remembered.

1. When you finish modifying (editing) the settings, press [WRITE], getting its indicator to blink.

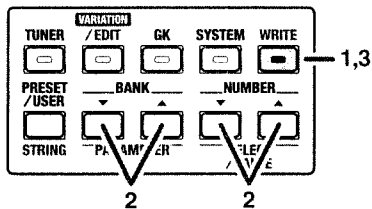

2. Use [BANK ▼/▲] and [NUMBER ▼/▲] to select the user patch in which your settings will be stored.

\* Patch numbers can also be selected using the direct number buttons.

3. To write the settings, press [WRITE].

While Write is being executed, the indicator flashes rapidly.

When the data has been written, the indicator will go out, and the writing destination user patch will be displayed.

### If You Want to Cancel a Write Operation in Progress

Press either [TUNER], [VARIATION/EDIT], [GK], [SYSTEM], or [PRESET/USER].

The values are left as is, and the Write operation is cancelled.

## Manual Mode

If you wish to play the sound specified by the current settings of the knobs (rather than the sound memorized in the patch), switch to Manual mode.

- ◆ To select Manual mode, press [MANUAL], lighting its indicator.

In Manual mode, the display will show the following.

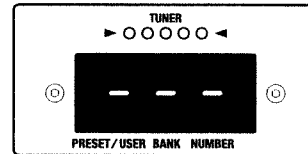

After this, when one of the buttons or knobs is used, the settings for that control appear in the display.

- \* When the settings for CAPO (p. 27) or DELAY TIME (p. 32) are showing in the display, you can change the settings value directly by pressing the [SELECT/VALUE ▼/▲].

Press [A/B] to exit Manual mode and return to the settings of the selected patch.

- \* The [MANUAL] indicator will also go out, and Manual mode will be exited if you press one of the [PRESET/USER], [BANK ▼/▲], [NUMBER ▼/▲] or Direct Number buttons.

- ◆ If you once again enter Manual mode, the previous settings used in Manual mode are called up (except for knob settings).
- ◆ If you hold down the Direct Number button that is lit and press [MANUAL] to select Manual mode, settings from the previous patch settings (other than the knob settings) will remain active.



# Panel Descriptions

## Front Panel

**NOTE** In some cases, odd sounds may occur when operating the button or a knob, but this does not indicate a malfunction.

## COSM Guitar Section (COSM GUITAR)

This analyzes the principal components of an electric guitar, and precisely simulates the function of each of the components.

The number and type of pickups, the number of strings, the tuning of each string, and each element that plays a part in creating the tone of a guitar is digitally added to the vibration produced by the strings of your guitar.

In addition, the VGA-7 detects each string's pitch and enveloping — the “shape” of the sound. These characteristics are then digitally applied to the current patch's waveform, causing it to sound with all of the nuances of your guitar performance.

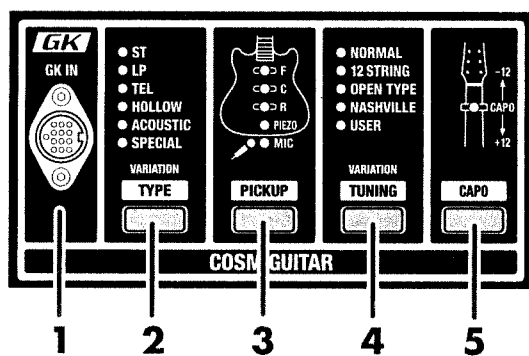

### 1 GK Input Connector (GK IN)

Use the special cable to connect the GK-2A-compatible guitar (or the guitar in which the GK-2A is installed).

When the GK cable is connected or disconnected, the indicators of the COSM guitar section will blink.

### MEMO

Setting the divided pickup switch to “SYNTH” allows you to hear the different effects obtained with different settings.

### 2 Type Button [TYPE]

Selects the type of guitar.

Each press of the button selects the next type in the series, either ST, LP, TEL, HOLLOW, ACOUSTIC, or SPECIAL.

For each type you can select the following variations.



Selecting variations (p. 23)

### ST:

- 1 CLASSIC** A solid-body guitar with three passive single-coil pickups.
- 2 MODERN** A solid-body guitar with three active single-coil pickups.
- 3 S-S-H** A solid-body guitar with three active pickups; from the front, single/single/humbucking.

### LP:

- 1 CLASSIC** A solid-body guitar with two vintage humbucking pickups.
- 2 MODERN** A solid-body guitar with two passive humbucking pickups.
- 3 Jr** A solid-body guitar with two single-coil pickups familiarly called “dog ear” or “soap bar.”

### TEL:

- 1 CLASSIC** A typical solid-body guitar with two single-coil pickups, suitable for country or rock'n'roll.
- 2 MODERN** A solid-body guitar with two single-coil pickups, and a distinctive-sounding high range.
- 3 H-S** A solid-body guitar with a humbucking pickup in front and a single-coil in the rear.

### HOLLOW:

- 1 SEMI** Semi-hollow-body guitar with two humbucking pickups.
- 2 FULL** Full hollow-body guitar with two humbucking pickups.
- 3 RICK** A distinctive guitar beloved by vocal groups in the 60's, with two unique single-coil pickups.

## Panel Descriptions

### ACOUSTIC:

- 1 STANDARD** The acoustic guitar with a flat top and back
- 2 ROUND** The flat top acoustic guitar with a round back made of resin
- 3 METAL** A metal body guitar with one cone resonator, suitable for bottle-neck (slide) playing techniques.
- 4 NYLON STR** Guitars using nylon or gut strings
- 5 BANJO** A plucked string instrument with a skin-covered body.
- 6 UKULELE** A plucked string instrument with a small body and nylon strings.

### SPECIAL:

- 1 BOWED** This sound represents stringed musical instruments played with a bow.
- 2 PIPE** This sound is like a soft woodwind lead instrument.
- 3 ORGAN** Sustained organ-like sound.
- 4 BRASS** Soft brass-like sound.
- 5 SOLO** Soft lead sound.
- 6 SYNTH 1** Synth sound with filter sweep.
- 7 SYNTH 2** Synth sound with modulation.
- 8 FILTER BASS** A sound reminiscent of a bass with filter applied.



When ACOUSTIC or SPECIAL is selected, setting the AMP TYPE (p. 28) in the COSM AMP section to "FULL RANGE" is very effective.

### 3 Pickup Button [PICKUP]

Depending on the type (variation) of COSM guitar, you can select the pickup or mic.

\* If the COSM guitar type is SPECIAL, the pickup selection is ignored.

#### F:

Use the front pickup.

#### C:

Use the center pickup.

#### R:

Use the rear pickup.

#### PIEZO: (type: ACOUSTIC)

Use the piezo pickup.

#### MIC: (type: ACOUSTIC)

Use a hypothetical mike ideal for picking up the sound of an acoustic guitar.

\* If either ST, LP, TEL, or HOLLOW is selected, you can select a setting in which two pickups are used simultaneously.

**F+C:** When ST is selected

**F+R:** When either LP, TEL, or HOLLOW is selected

**C+R:** When ST is selected



You can use the S1/S2 switch to switch pickups. (p. 19)

### 4 Tuning Button [TUNING]

You can perform using various tunings that are set on the VGA-7, without actually retuning the guitar.

Each time you press the button, the tuning type will alternate.

\* If the COSM guitar type is SPECIAL, tunings other than NORMAL cannot be selected.

You can select variations for 12 STRING, OPEN TYPE, and NASHVILLE types.



Selecting variations (p. 23)

#### NORMAL:

This is the conventional tuning in which the strings are pitched starting from the 6th string as E/A/D/G/B/E.

#### 12 STRING:

This tuning simulates the sound of a 12-string guitar.

- 1 REGULAR** A higher octave is added to strings 6–3, and strings 2 and 1 are doubled at the same pitch.
- 2 OCTAVE** A higher octave is added to strings 6–1.
- 3 DETUNE** Adds a slight off-pitch sound to the original sounds of strings 6–1.

#### OPEN TYPE:

A tuning indispensable for blues, effective when played with a slide bar.

- 1 OPEN D** Starting from the 6th string, the strings will be pitched D, A, D, F#, A, D.
- 2 OPEN G** Starting from the 6th string, the strings will be pitched D, G, D, G, B, D.
- 3 DROPPED D** Only string 6 is lowered a whole step. Starting from the 6th string, the strings will be pitched D, A, D, G, B, E.

## NASHVILLE:

- 1 **TYPE 1** Strings 6–3 will be one octave higher.  
Strings 2 and 1 will be the original pitch.
- 2 **TYPE 2** Strings 6–4 will be one octave higher.  
Strings 3–1 will be the original pitch.

## USER:

This is a user-specified tuning.

Relative to the conventional tuning for each string (starting from the 6th string, E/A/D/G/B/E), you can freely specify the pitch in a range of  $\pm 1$  octave.

### ■ Creating user settings

1. Press [TUNING] to select USER.
2. Press [VARIATION/EDIT], getting its indicator to light.  
The USER indicator will blink to indicate that you may begin making user settings.  
The string number and note name will appear in the display, and the octave setting will be shown by the tuner indicator.

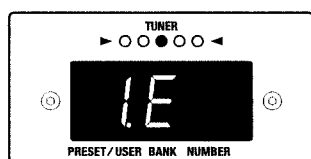

The relationship between the tuner indicator lights and the pitch is shown below.

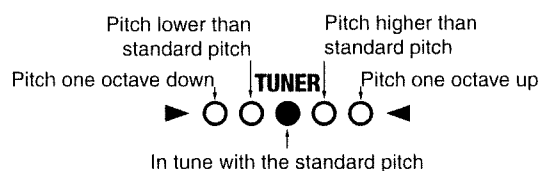

3. Play any string of your guitar.  
The string that you played will be detected automatically, and the string number will appear in the display.

You can press [STRING] to specify the string number directly.

Each press of the button takes you to the next string number, from string 1 through string 6. (The string number is indicated by a dot.)

If you play a string other than the one indicated by the dot, the display switches to the number of the string that was played.

4. Press [SELECT/VALUE ▼/▲] to specify the note name (pitch) for the string number.
5. Repeat steps 3–4 for each of the remaining strings.
6. When you have finished making settings, press [VARIATION/EDIT], extinguishing its indicator.

\* To save the changes, you must perform a write operation. (p. 24)

## 5 Capo Button [CAPO]

This simulates a capo attached to the neck of the guitar.

The pitch specified by the tuning of the COSM guitar can be shifted in semitone steps over a range of  $\pm 1$  octave.

\* You can turn the Capo function on/off by pressing the [CAPO]. When on, the indicator will light.

\* If the type of COSM guitar is SPECIAL, Capo setting is ignored.

### ■ Adjusting the amount of pitch shift

1. Press [CAPO], getting the indicator to light.
2. Press [VARIATION/EDIT], getting its indicator to light.  
The capo indicator will blink, and the display will show the amount of pitch shift.
3. Press [SELECT/VALUE ▼/▲] to specify the amount of pitch shift.  
Range: -12 – -1, 1 – 12

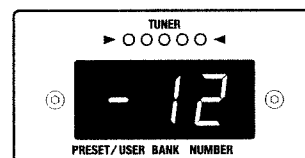

4. After making the setting, press [VARIATION/EDIT] once again, extinguishing its indicator.

### HINT

When you press [CAPO], the current pitch shift amount will be shown in the display for several seconds. When the amount of pitch shift is displayed, you can press [SELECT/VALUE ▼/▲] to change it.

\* To save the changes, you must perform a write operation. (p. 24)

## Panel Descriptions

### COSM Amplifier Section (COSM AMPLIFIER)

By selecting the amp type, using the equalizer to adjust the tone, and specifying the type of cabinet (including the number and type of speakers), you can create the basic sound of the guitar amplifier.

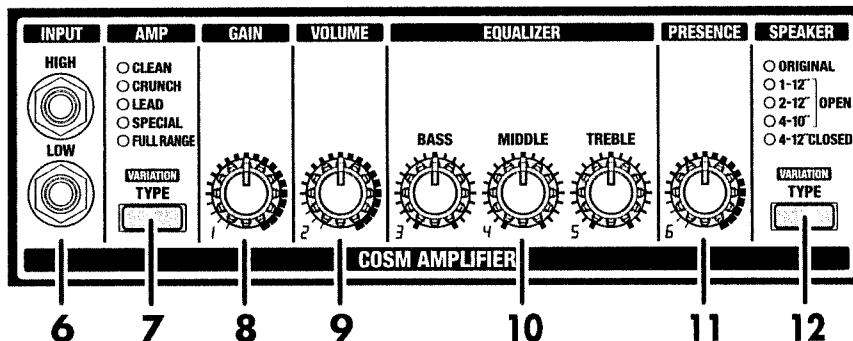

If you wish to play the sound as specified by the current locations of the knobs, you should get into the Manual mode, by pressing [MANUAL] and lighting its indicator. (p. 24)

#### 6 Input Jacks (INPUT HIGH/LOW)

Connect a conventional guitar (a guitar without a GK-2A installed).

As appropriate for the output of your guitar, connect it to HIGH or LOW.

- \* If you are using the GK IN, you can use the functionality of the COSM amplifier section even without connecting to this jack.
- \* When using a conventional guitar, the functionality of the COSM guitar section is not available.
- \* When using INPUT and GK IN simultaneously, the tuner function and EFX (EFFECTS section) SLOW GEAR settings are not applied to sounds input from the INPUT jack.

#### 7 Amp Type Button [TYPE]

You can select various amp sounds.

The amp type will change each time you press the button.

For each type you can select the following variations.



Selecting variations (p. 23)

#### CLEAN:

- 1 **JC** The sound of the Roland "JC-120" (Jazz Chorus 120), a favorite of pro musicians around the world.
- 2 **CLASSIC 1** The sound of a standard, classic American amp noted for its bright high range.
- 3 **CLASSIC 2** The Liverpool sound of the 60's produced by a classic British amp.
- 4 **MELLOW** A small combo amp favored by jazz musicians.

#### CRUNCH:

- 1 **CLASSIC 1** The sound of a classic American amp favored by blues and country guitarists.
- 2 **CLASSIC 2** The sound of a classic British amp ideal for Liverpool-style rock.
- 3 **CLASSIC 3** The sound of a classic American amp noted for its bright sound.
- 4 **MODERN** The sound of a modern vacuum tube amp widely used in styles ranging from blues to rock and fusion.

#### LEAD

- 1 **CLASSIC I** The sound of a classic amp stack indispensable to the British hard rock of the 70's, and still favored by many rock guitarists.  
This is the trebly sound of a guitar connected to input I of the guitar amp.
- 2 **CLASSIC I+II** The sound of connecting inputs I and II of the guitar amp in parallel, so that the low range is added by input II.

- 3 **MODERN 1** The sound of a tube amp typical of the late '70s to 80s, characterized by a distinctive mid-range.
- 4 **MODERN 2** A tube amp sound with versatile distortion, usable in a wide range of styles.
- 5 **METAL 1** The sound of a vacuum tube amp stack for heavy metal.
- 6 **METAL2** A high gain and powerful metal sound.

**SPECIAL:**

- 1 **LAYER 1** The layered sound of two different amps used simultaneously, produced by a combination of a clean tone (line) and a drive tone.  
When the GK input is used, the sound of the COSM guitar section will be the clean tone, and the sound of the normal guitar will be the drive tone. If using the divided pickup, set the select switch to the "MIX" position.
- 2 **LAYER 2** The layered sound of two different amps used simultaneously, produced by a combination of a clean tone (guitar amp) and drive tone.  
When the GK input is used, the sound of the COSM guitar section will be the clean tone, and the sound of the normal guitar will be the drive tone. If using the divided pickup, set the select switch to the "MIX" position.
- 3 **FUZZ** The fuzz sound of a transistor amp, with unique harmonic content quite unlike the distortion of a vacuum tube amp.

\* When LAYER 1 or LAYER 2 is selected, the WAH, SLOW GEAR, and COMPRESSOR effects are not operational with the GK-2A switch set to "SYNTH."



You can use LAYER to get performances with a layered sound, for example, with one guitar using an acoustic guitar (in the COSM GUITAR settings) with a drive tone (normal guitar sound setting in COSM AMPLIFIER).

\* Control the volume balance between the COSM guitar and the normal guitar by adjusting the COSM guitar setting "8 LEVEL." (p. 19)

**FULL RANGE:**

- 1 **FLAT** This amp has a flat response that is ideal for use with COSM guitar types SPECIAL or ACOUSTIC.
- 2 **SHAPED** A transparent sound, ideal for chording on an electric-acoustic guitar.
- 3 **FAT** A sound with a distinctively rich mid- and low-range.

**8 Gain Knob [GAIN]**

Adjusts the input gain of the amp.  
Range: 0-99

**9 Volume Knob [VOLUME]**

Adjusts the volume. It is convenient to use the volume knob when adjusting the volume between patches.  
Range: 0-99

**10 Equalizer (EQUALIZER)**

This is a three-band type equalizer. The tone of each range will be adjusted according to the amp type.

**Bass Knob [BASS]**

Adjusts the low frequency range tone.  
Range: 0-99

**Middle Knob [MIDDLE]**

Adjusts the tone for the middle frequency range.  
Range: 0-99

**Treble Knob [TREBLE]**

Adjusts the high frequency range tone.  
Range: 0-99

\* Depending on the amp type, there may be no sound if you set [BASS], [MIDDLE], and [TREBLE] all to values of 0.

**11 Presence Knob [PRESENCE]**

Adjusts the definition of the sound.  
Range: 0-99

**12 Speaker Type Button [TYPE]**

You can select the speaker size and cabinet shape. The type will change each time you press the button. You can select a variation for each type other than ORIGINAL.



Selecting variations (p. 23)

## Panel Descriptions

### ORIGINAL:

The speaker best matched for the selected amp type (p. 28).

### 1-12" OPEN:

An open-back cabinet with one 12-inch speaker.

### 2-12" OPEN:

An open-back cabinet with two 12-inch speakers.

### 4-10" OPEN:

An open-backed cabinet with four 10-inch speakers.

◆ With 1-12" OPEN, 2-12" OPEN, and 4-10" OPEN, you can select the following variations.

- 1 **CLASSIC** Classic speaker units with relatively low input power capacity, which produce a warm sound with a smooth mid- and high-frequency range.
- 2 **MODERN** Modern speaker units with relatively high input power capacity and a powerful mid- and high-frequency range.

### 4-12" CLOSED:

A large, sealed cabinet with four 12-inch speakers.

- 1 **CLASSIC** Classic speaker units with relatively low input power capacity, which produce a warm sound with a smooth mid- and high-frequency range.
- 2 **MODERN** Modern speaker units with relatively high input power capacity and a powerful mid- and high-frequency range.
- 3 **CLASSIC STACK** Two large, sealed cabinets with "CLASSIC" type speaker units.
- 4 **MODERN STACK** Two large, sealed cabinets with "MODERN" type speaker units.

## Effects Section (EFFECTS)

You can use four effects simultaneously: insert, delay, chorus, and reverb.

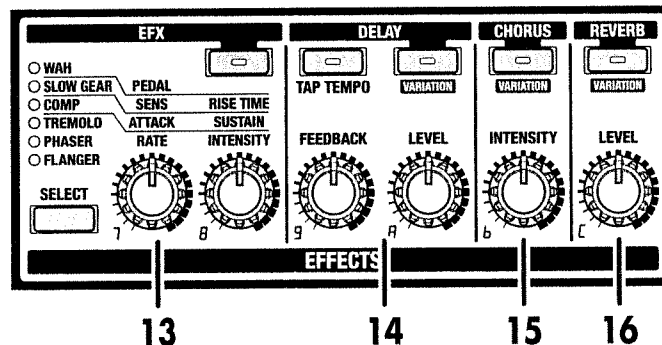

### 13 EFX

You can select and use one of the six effects WAH, SLOW GEAR, COMP (compressor), TREMOLO, PHASER, or FLANGER.

The type will change each time you press [SELECT].

\* The function of the two knobs will change depending on the selected type.

### EFX Button [EFX]

Switch the EFX on/off. When on, the indicator will light.

\* You can use the foot pedal to turn effects on/off. (p. 36)

If you wish to play the sound as specified by the current locations of the knobs, you should get into the Manual mode, by pressing [MANUAL] and lighting its indicator. (p. 24)

● **WAH**

This effect creates a unique tone by changing the frequency response of a filter. By connecting a separately available expression pedal (e.g., Roland EV-5 or BOSS FV-300L) you can control the wah effect in real time.

\* While using WAH, the expression pedal cannot be used to control the volume.

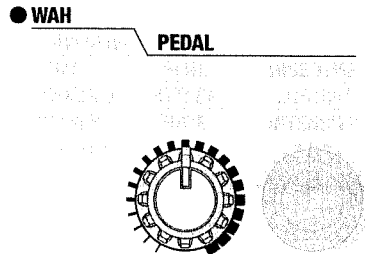

**Pedal Knob [PEDAL]**

This simulates the pedal position when the wah pedal is operated.

Rotating the knob fully clockwise will advance the pedal all the way. Rotating the knob fully counterclockwise will return the pedal all the way.

Range: 0-99

● **SLOW GEAR**

Slow Gear is an effect that fades-in each note (violin-style playing) by detecting the picking of the guitar. It lowers the volume of the attack of the input signal, and gradually raises it.

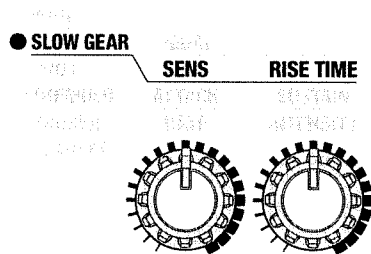

**Sensitivity Knob [SENS]**

This adjusts the sensitivity of the slow gear. When it is set to a lower value, the effect of the slow gear can be obtained only with stronger picking, while no effect is obtained with weaker picking. When the value is set higher, the effect is obtained even with weak picking.

Range: 0-99

**Rise Time Knob [RISE TIME]**

This adjusts the time needed for the volume to reach its maximum from the moment you begin picking.

Range: 0-99

● **COMP (Compressor)**

The compressor is an effect that attenuates loud input levels and boosts soft input levels, thus evening out the volume to create sustain without distortion.

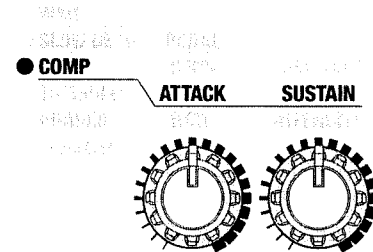

**Attack Knob [ATTACK]**

Adjusts the strength of the picking attack. Larger values will result in a sharper attack, creating a more clearly defined sound.

Range: 0-99

**Sustain Knob [SUSTAIN]**

Adjusts the range (time) over which low-level signals are boosted. Larger values will result in longer sustain.

Range: 0-99

● **TREMOLO**

Tremolo is an effect that cyclically modulates the volume.

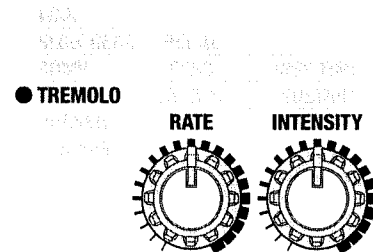

**Rate Knob [RATE]**

Adjust the speed at which the volume will change.

Range: 0-99

**Intensity Knob [INTENSITY]**

Adjust the depth of the effect.

Range: 0-99

## Panel Descriptions

### ● PHASER

By adding varied-phase portions to the direct sound, the phaser effect gives a whooshing, swirling character to the sound.

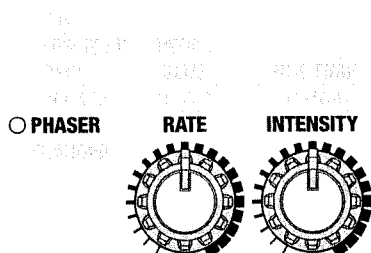

#### Rate Knob [RATE]

This sets the rate of the flanging effect.

Range: 0–99

#### Intensity Knob [INTENSITY]

Adjust the depth of the effect.

Range: 0–99

### ● FLANGER

The flanging effect gives a twisting, jet-airplane-like character to the sound.

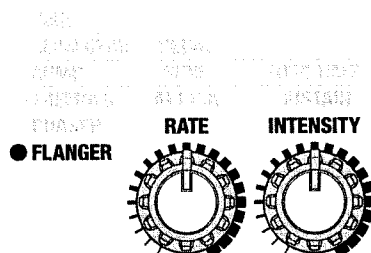

#### Rate Knob [RATE]

This sets the rate of the flanging effect.

Range: 0–99

#### Intensity Knob [INTENSITY]

Adjust the depth of the effect.

Range: 0–99

## 14 DELAY

### Delay Button [DELAY]

Turns the delay on/off. When on, the indicator will light.

\* You can use the foot pedal to turn effects on/off. (p. 36)

### Feedback Knob [FEEDBACK]

Adjusts the amount of delay returned to the signal.

Range: 0–99

### Level Knob [LEVEL]

Adjusts the volume of the delay sound.

Range: 0–99

◆ For delay you can select the following variations.



Selecting variations (p. 23)

- 1 **MONO** A conventional delay effect
- 2 **PANNING** A tapped delay effect that assigns the delay time to L and R channels
- 3 **HOLD** Your performance can be recorded, and played back repeatedly.

### ■ Setting the Delay Time

Specify the delay time when the delay type of MONO or PANNING is selected. There are two ways to input the delay time.

#### ● Tap input

Press [TAP TEMPO] two times at the tempo of the song, and the delay time will be set to the timing you've used while tapping the button, then the current delay time will be shown in the display for several seconds.

Range: 0–999 (msec), 1.00–1.80 (sec)

\* You can also use a foot switch for tap input. However, the foot switch must use the optional PCS-31 connector cord. (p. 36)

#### ● Numerical input

Press [TAP TEMPO], the current delay time will be shown in the display for several seconds. When the delay time is displayed, you can press [SELECT/VALUE ▼/▲] to change it.

\* To save the changes, you must perform a write operation. (p. 24)



## ■ Recording your playing

By selecting HOLD as the delay type, you can record your playing.

### MEMO

With a momentary-type foot switch (BOSS FS-5U: sold separately) connected, you can use your foot to control the recording operations. Connect the foot switch to the DELAY jack on the rear panel.

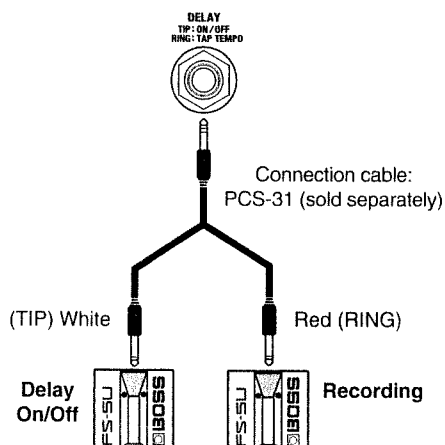

\* If you connect only one foot switch instead of using the PCS-31, you will only be able to turn delay on/off.

- ◆ The performance is recorded while [TAP TEMPO] is pressed, or while the foot switch is depressed.

During recording, the [TAP TEMPO] indicator lights.

When you have finished recording, the recording time is shown in the display, and repeat playback of the recorded performance begins.

The recording time is 0.0–1.8 seconds.

When the recording exceeds 1.8 seconds, it will end automatically, and the recorded sound will be played back repeatedly.

When you press the on/off foot switch or [DELAY], the recorded content will be erased.

- \* If the delay type is HOLD, [FEEDBACK] will not function.
- \* To save the changes, you must perform a write operation. (p. 24)

## 15 CHORUS

### Chorus Button [CHORUS]

Switches the chorus on/off. When on, the indicator will light.

- \* You can use the foot pedal to turn effects on/off. (p. 36)

### Intensity Knob [INTENSITY]

Adjust the depth of the effect.

Range: 0–99

- ◆ For chorus you can select the following variations.



Selecting variations (p. 23)

- 1 **SPACE** Chorus with a natural spread created by synthesized space.
- 2 **WARM** A stereo two-stage chorus with a warm tone.
- 3 **BRIGHT** A stereo two-stage chorus with a bright tone.

### ■ Setting the Chorus Rate

1. While holding down [TAP TEMPO] and press [CHORUS]. The display will indicate the current value.
2. Press [SELECT/VALUE ▼/▲] to set the chorus rate. Range: 0–99  
Shortly after the setting has been made, you will return to the previous condition.

\* To save the changes, you must perform a write operation. (p. 24)

## 16 REVERB

### Reverb Button [REVERB]

Switches reverb on or off. When on, the indicator will light.

- \* You can use the foot pedal to turn effects on/off. (p. 36)

### Level Knob [LEVEL]

Adjusts the volume of the reverb sound.

Range: 0–99

- ◆ For reverb you can select the following variations.



Selecting variations (p. 23)

- 1 **PLATE** Simulates plate reverberation (a reverb unit that uses the vibration of a metallic plate). Provides a metallic sound with a distinct upper range.
- 2 **ROOM** Simulates the reverberation of a small room.
- 3 **HALL** Simulates the reverberation of a concert hall.

\* To save the changes, you must perform a write operation. (p. 24)

### Master Section

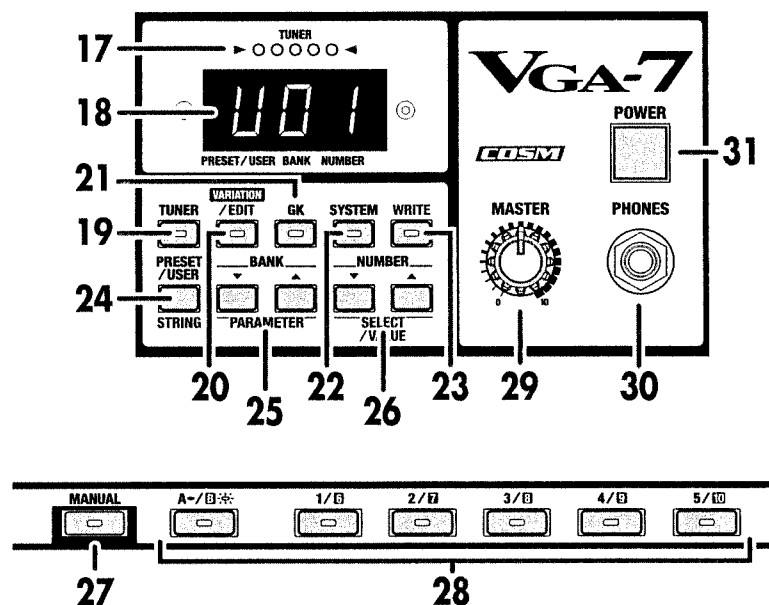

#### 17 Tuner Indicator

This displays the pitch during tuning, and the sensitivity for GK settings.

#### 18 Display

This displays the patch number or variation number.

#### 19 Tuner Button [TUNER]

Press this to use the tuner.

#### 20 Variation/Edit Button [VARIATION/EDIT]

Use this to set or change the Variation setting.

To view or change the value, hold down the button for two seconds or more until the indicator starts blinking.

#### 21 GK Button [GK]

Press this to make settings for the divided pickup.

#### 22 System Button [SYSTEM]

Press this to set the System setting.

#### 23 Write Button [WRITE]

Press this to store settings in a user patch.

#### 24 Preset/User Button [PRESET/USER]

Switch between preset patches and user patches.

#### 25 Bank Button [BANK ▼/▲]

Use these buttons to change the patch bank.

When using [VARIATION/EDIT], these are also used as parameter buttons ([PARAMETER ▼/▲]).

#### 26 Number Button [NUMBER ▼/▲]

Use these to change the patch number.

When using [VARIATION/EDIT], these are also used as select/value buttons ([SELECT/VALUE ▼/▲]).

#### 27 Manual Button [MANUAL]

Press this button when you wish to play using the actual settings of the knobs, rather than the sound stored in the patch.

#### 28 Direct Number Button

Press these to select patch numbers directly.

\* The Direct Number buttons can be used with any bank.

After pressing [A/B], if the indicator is extinguished, these buttons can be used to select numbers 1–5.

If the indicator is lighted as the result of pressing [A/B], these buttons can be used to select numbers 6–10.

### 29 Master Knob [MASTER]

Adjust the speaker volume or headphone volume of the VGA-7.

- \* The setting of the master knob is not memorized.

### 30 Headphones Jack (PHONES)

Headphones are plugged in here.

- \* When headphones are connected, sound will not be output from the speaker of the VGA-7.
- \* Before connecting or disconnecting headphones, you must set [MASTER] to 0.

### 31 Power Switch [POWER]

Turns the power on/off.

- \* Before turning the power switch on/off, you must set [MASTER] to 0.

## Rear Panel

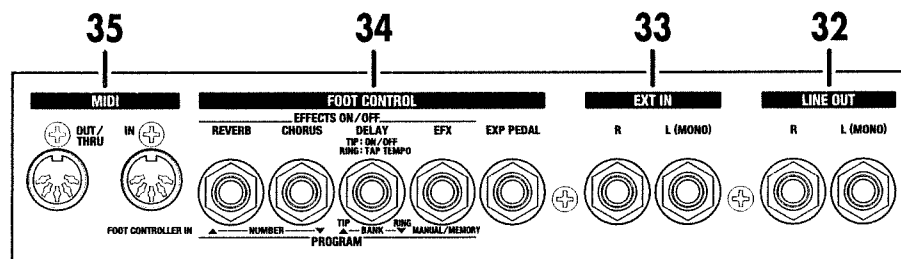

### 32 Line Out Jacks (LINE OUT L (MONO)/R)

These output the sound of the pre-amp, including the effect section.

External devices such as a mixer can be connected here.

When using mono output, make the connection to the L (MONO) jack.

### 33 EXT Input Jacks (EXT IN L (MONO)/R)

These are stereo external input jacks.

External devices such as a guitar synthesizer can be connected here.

The sound that is input will be output from the internal speaker and from the headphones and line out jacks.

You can use the Master knob to adjust the volume.

When using mono input, make the connection to the L (MONO) jack.

### 34 FOOT CONTROL

- \* If the plug is connected or disconnected while the power is on, the effect on/off, patch, or manual/memory settings may change.
- \* When connecting the FS-5U/FS-5L (sold separately) to the FOOT SW jack, set the polarity switch as shown below.

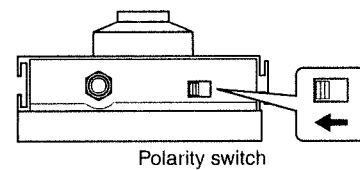

### Expression Pedal Jack (EXP PEDAL)

A separately available expression pedal (e.g., Roland EV-5 or BOSS FV-300L) can be connected here.

The expression pedal can be used as a volume pedal to adjust the volume of the VGA-7. However if the EFFECTS section INSERT type is set to WAH, the pedal will function as a wah pedal.

## Panel Descriptions

### Turning the Effects On and Off

#### MEMO

With the FS-5L connected, you can check the indicator on the FS-5L to see whether the effect is on or off.

The indicator is lit when the effect is on; the light goes out when the effect is turned off.

\* *The VGA-7's panel controls cannot be used to turn the effects on and off while the FS-5L is connected.*

### EFX Jack (EFX)

Separately sold foot switches (e.g., BOSS FS-5U or FS-5L) can be connected here to turn effects on/off.

### Delay Jack (DELAY)

By using a separately available connection cable (Roland PCS-31) to connect two foot switches, you can use the foot switches in the following ways.

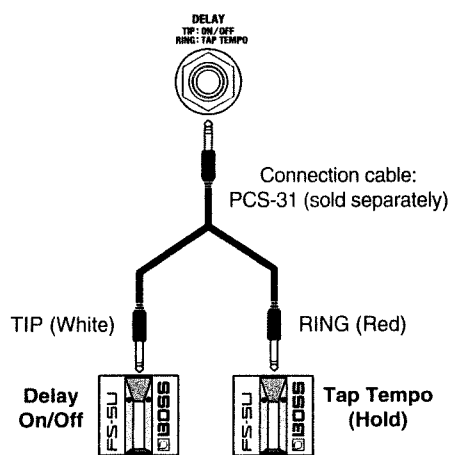

#### TIP (white): DELAY

The delay effect will be turned on/off.

#### RING (red): TAP/HOLD

Use for tap-input of the delay time. If the delay type is set to HOLD, this will function as the switch to start/stop recording.

Connect a momentary-type foot switch (BOSS FS-5U: sold separately).

\* *If only one foot switch is connected, it will turn delay on/off.*

### Chorus Jack (CHORUS)

You can connect a separately available foot switch (BOSS FS-5U or FS-5L) to turn chorus on/off.

### Reverb Jack (REVERB)

You can connect a separately available foot switch (BOSS FS-5U or FS-5L) to turn reverb on/off.

### Switching Manual/Memory and Patches

When the Foot Switch Type (p. 39) in the System settings is set to "3 PROGRAM," Manual and Memory are switched with a foot switch connected to the EFX jack, while you can switch Patches when the foot switch is connected to the DELAY, CHORUS, or REVERB jack.

#### NOTE

Connect a momentary-type foot switch (BOSS FS-5U: sold separately).

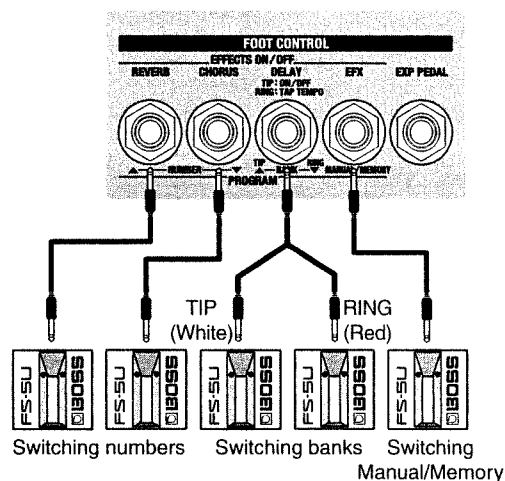

### EFX Jack

Switches between Manual mode and the currently selected Patch (Memory).

### DELAY Jack

\* *Connect two foot switches using the optional connection cord (Roland PCS-31).*

#### TIP (white)

Each time the foot switch is pressed, the Patch bank number rises to the next highest in the series of numbers.

#### RING (red)

Each time the foot switch is pressed, the Patch bank number decreases to the next lowest in the series of numbers.

### CHORUS Jack

The Patch number decreases in sequence each time the foot switch is pressed.

### REVERB Jack

The Patch number increases in sequence each time the foot switch is pressed.

## 35 MIDI

### **MIDI IN Connector**

By connecting a separately available MIDI foot controller (e.g., Roland FC-200) you can use your feet to switch patches. This connector is also used to receive data from an external MIDI device.

### **MIDI OUT Connector**

This connector is used to transmit VGA-7 data to an external MIDI device.

- \* *Depending on the system settings, this connector can also be used as a MIDI THRU connector which re-transmits the data received at MIDI IN without change. (p. 42)*

# System setting

## Procedure

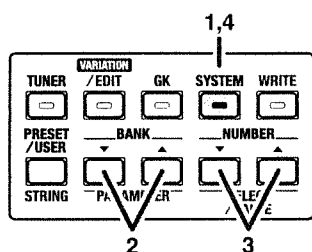

1. Press [SYSTEM], getting the indicator to light.
2. Press [PARAMETER ▼/▲] to select the parameter number.
3. Press [SELECT/VALUE ▼/▲] to input the value.
4. Once you've finished making settings, press [SYSTEM] again, extinguishing its indicator.  
The setting will be saved.



A list of system parameters is given on the plate located on the top right of the cabinet.

SYSTEM	TUNER	NOISE SUPPRESSOR	FOOT SW	EXP PEDAL	BULK LOAD	BULK DUMP	MIDI OUT	
PARAMETER	1 PITCH	2 LEVEL	3 THRESHOLD	4 FUNCTION	5 PEDAL HOLD	6 LOAD	7 DUMP	8 FUNCTION
VALUE	35-45 (435-445 Hz)	0 (MUTE)-10	0 (OFF)-10	1 EFFECTS (MOMENTARY) 2 EFFECTS (LATCH) 3 PROGRAM	1 ON 2 OFF	▲: EXIT	1 ALL 2 PATCH (ALL) 3 PATCH (ONE) WRITE: START	1 OUT 2 THRU

## TUNER

### Parameter Number: 1 PITCH

Specify the standard pitch.

Display	Setting
35-45	435-445 Hz

\* With the factory settings, this is set to "440 Hz."

### Parameter Number: 2 LEVEL

Specify the output level of the tuning sound.

Display	Setting
0-10	0 (MUTE: sound will not be output while tuning) - 10

\* With the factory settings, this is set to "0."

## NOISE SUPPRESSOR

This effect reduces the noise and hum picked up by guitar pickups. Since it suppresses the noise in synchronization with the envelope of the guitar sound (the way in which the guitar sound decays over time), it has very little effect on the guitar sound, and does not harm the natural character of the sound.

### Parameter Number: 3 THRESHOLD

Adjust this parameter as appropriate for the volume of the noise. If the noise level is high, a higher setting is appropriate. If the noise level is low, a lower setting is appropriate. Adjust this value until the decay of the guitar sound is as natural as possible.

This can be turned off by setting the value to 0.

Display	Setting
0-10	0 (OFF)-10

\* With the factory settings, this is set to "4."

\* High settings for the threshold parameter may result in there being no sound when you play with your guitar volume turned down.

## Foot Switch (FOOT SW)

Specify the operation of the foot switches connected to the EFX-REVERB jacks.

\* You cannot change the settings for each individual jack.

### Parameter Number: 4 TYPE

Display	Setting
1	<p><b>EFFECTS (MOMENTARY):</b> The effect on/off state specified by the patch will be reversed. If the effect is on, it will be switched off → on → off → on... when the switch is pressed. If the effect is off, it will be switched on → off → on → off... when the switch is pressed.</p> <p>* Connect a momentary-type foot switch (sold separately: BOSS FS-5U).</p>
2	<p><b>EFFECTS (LATCH):</b> The foot switch's current status is the one used, regardless of the Patch's effects status (on/off).</p> <p>* When this setting is selected, the effects cannot be turned on and off with the buttons on the front panel.</p> <p>* Connect a latch-type foot switch (sold separately: BOSS-FS-5L). Be sure to connect the FS-5U to the DELAY jack's RING.</p>
3	<p><b>PROGRAM:</b> Manual and Memory are switched using a foot switch connected to the EFX jack, while you can switch Patches when the foot switch is connected to the DELAY, CHORUS, or REVERB jack.</p> <p>* Connect a momentary-type foot switch (sold separately: BOSS FS-5U).</p>

\* With the factory settings, this is set to "1 EFFECTS (MOMENTARY)."

## Expression Pedal (EXP PEDAL)

Specify how the expression pedal will behave when the patch is changed.

### Parameter Number: 5 PEDAL HOLD

Display	Setting
1	<p><b>ON:</b> When the patch is changed, the volume will be as specified by the position of the pedal.</p>
2	<p><b>OFF:</b> When the patch is changed, the volume will be as specified by the [VOLUME] setting of the COSM amplifier, regardless of the position of the pedal.</p>

\* With the factory settings, this is set to "1 ON."

## System setting

### MIDI

The VGA-7 uses the following MIDI messages.

- Program Change messages transmit commands for switching Patches.
- “Control Change” messages, which can be used to convey changes in various effects, control the volume, and switch effects on/off.
- “System Exclusive” messages (carrying data specific to a particular device), used to save patch data on an external device, or to reload patch data saved on an external device back into the VGA-7.

### About MIDI Channels

MIDI has sixteen channels 1 – 16, and MIDI messages will be received by the instrument (the receiving device) whose channel matches the channel of the transmitter.

When the Omni mode setting on the receiving device is set to ON, then MIDI messages can be received, regardless of the MIDI channel of the sending device.

- \* *Factory settings have the MIDI channel set to Channel 1 and Omni mode ON.*
- \* *The MIDI channel and Omni Mode settings can be modified. (p. 48)*

### Program Change

“Program Change” is a MIDI message that is generally used to switch Patches.

The VGA-7 uses Program Change messages to select patches. By connecting a MIDI foot controller such as an FC-200 (sold separately), you can use your feet to transmit Program Changes and select patches. (refer to p. 43)

### Transmitting/receiving VGA-7 settings

VGA-7 user patches / divided pickup settings / system settings can be transmitted as MIDI exclusive data to an external MIDI device, and this data can be re-transmitted from the external MIDI device back to the VGA-7.

The action of transmitting MIDI exclusive data is called **bulk dump**, while receiving it is called **bulk load**.

By using a MIDI sequencer that is able to record exclusive data, you can transmit data to the MIDI sequencer and save it on floppy disk or other media. Alternatively, you can directly connect two VGA-7 units via a MIDI cable, and transmit or receive parameters directly.

- \* *Even if the MIDI channel is set to “Omni ON,” Exclusive messages cannot be received if the Device ID differs. Be sure to match the Device ID when sending and receiving data. (refer to p. 48)*  
*The Device ID is set to “1” at the factory.*

### BULK LOAD

Receives the VGA-7’s data from an external device.

#### Connection Examples: Receiving settings that were stored on a sequencer

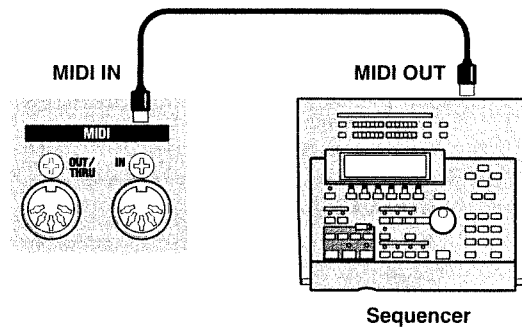

- \* *For details on sequencer operation, refer to the owner’s manual for your sequencer.*

#### Receiving all settings from an external device

To receive data that was transmitted via Bulk Dump (p. 41) with the “1 ALL” or “2 PATCH (ALL)” setting, use the following procedure.

1. Select the **Parameter Number: 6 LOAD**.
2. Send the data from the transmitting device (sequencer).  
While the data is being received, the following display will appear.

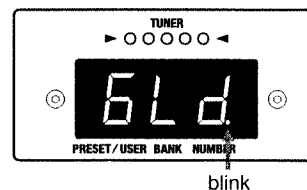

3. When this display disappears, press [SELECT/VALUE ▲] (EXIT) to end the procedure. The display will indicate “U01.”

- \* *If you press [TUNER], [VARIATION/EDIT], [GK], or [SYSTEM] instead of pressing [SELECT/VALUE ▲] (EXIT), you are returned to where you were before [SYSTEM] was pressed, and the data existing before the load will sound until you change patches.*



### Receiving only one patch

\* You cannot operate this procedure in Manual mode.

To receive data that was transmitted via Bulk Dump (p. 41) with the "3 PATCH (ONE)" setting, use the following procedure.

1. Use [BANK ▼/▲], [NUMBER ▼/▲] ([PRESET/USER]) to select the user patch that you wish to receive.

2. Select the **Parameter Number: 6 LOAD**.

\* You can use the direct number buttons to change the number of the patch to be received.

3. Send the data (one patch) from the transmitted device (sequencer).

While the data is being received, the following display will appear.

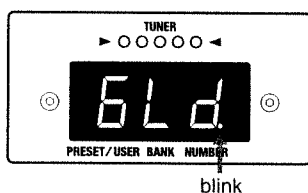

4. When this display disappears, press [SELECT/VALUE ▲] (EXIT) to end the procedure. The user patch you selected in step 1 will be displayed.

\* If you press [TUNER], [VARIATION/EDIT], [GK], or [SYSTEM] instead of pressing [SELECT/VALUE ▲] (EXIT), you are returned to where you were before [SYSTEM] was pressed, and the data existing before the load will sound until you change patches.

If Bulk Load cannot be executed correctly, an error message appears, and the [SYSTEM] indicator flashes. Take the appropriate action according to the message displayed.

\* Press [SYSTEM] to restore the Bulk Load to previous status.



**Reason:** A large amount of MIDI data was received in a short time and could not be processed.

**Action :** Check that the transmitting device is not transmitting excessive amounts of MIDI data.

### BULK DUMP

Sends MIDI messages to an external device.

\* It is not possible to transmit the data being edited. Use the Write operation to save the data before transmitting it.

#### Connection Examples: Saving data on a sequencer

Prepare your sequencer to receive exclusive data.

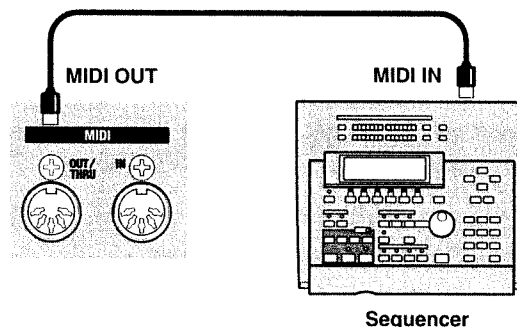

If parameter number 8 FUNCTION is set to "2 THRU," the MIDI OUT connector will function as a MIDI THRU connector. However, when data is being transmitted, it will temporarily function as a MIDI OUT connector, and will then revert to the MIDI THRU function when transmission is finished.

\* For details on sequencer operation, refer to the owner's manual for your sequencer.

#### Transmitting data

1. Select the **Parameter Number: 7 DUMP**.

2. Press [SELECT/VALUE ▼/▲] to select the data that will be transmitted.

Display	Setting
1	<b>ALL:</b> All settings (all user patches / divided pickup settings / system settings) will be transmitted.
2	<b>PATCH (ALL):</b> Data for all user patches will be transmitted.
3	<b>PATCH (ONE):</b> Data for the currently selected user patch will be transmitted. You can use the direct number buttons to select the number of the patch that will be transmitted.

\* You cannot select this setting in Manual mode.

\* With the factory settings, this is set to "1 ALL."

## System setting

3. Press [WRITE] to send the data.

The following display will appear while the data is being transmitted.

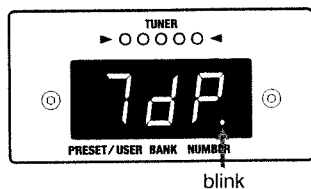

\* When ALL/PATCH (ALL) is selected, it takes approximately 40 seconds to complete transmission of the data.

4. When the transmit data selection display reappears, press [SYSTEM] to end the procedure.

### Sending Only the Divided Pickup Settings and System Settings

1. While holding down [GK] and [SYSTEM], turn on the power switch.  
[WRITE] indicator will blink, the following will appear in the display.

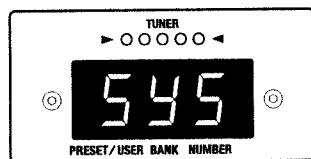

\* To cancel transmission, press either [TUNER], [VARIATION/EDIT], [GK], or [SYSTEM].

2. Press [WRITE] to send the data.  
The following display will appear while the data is being transmitted.

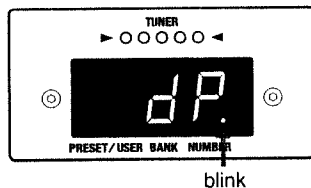

When transmission is finished, the patch or manual mode that was selected at the time the POWER switch was turned off will be selected.

## MIDI OUT

### Parameter Number: 8 FUNCTION

Here's how to change the function of the MIDI OUT connector to MIDI THRU.

\* At the factory settings, this is set to "MIDI OUT."

Display	Setting
1	<b>OUT:</b> The connector will function as MIDI OUT.
2	<b>THRU:</b> The connector will function as MIDI THRU. MIDI messages received at MIDI IN will be re-transmitted without change.

# Operating the VGA-7 with the FC-200

With the optional FC-200 MIDI Foot Controller, you can use pedal operations to control the VGA-7.

## Initializing the FC-200 from the VGA-7

Provide the FC-200 with the VGA-7's settings by sending the data from the VGA-7.

### NOTE

At the same time that the FC-200 is initialized, the VGA-7 will also be set to settings suitable for the FC-200.

For the settings that will be changed, refer to p. 48.

1. Use a MIDI cable to connect the VGA-7's MIDI OUT and the FC-200's MIDI IN connectors.

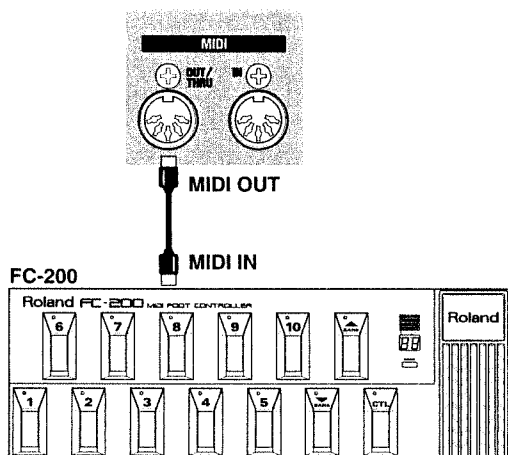

2. While holding down [VARIATION/EDIT] and turn on the VGA-7's POWER switch.

"FC" and "200" appear alternately in the display, and the [WRITE] indicator flashes.

\* To cancel the operation, press either [TUNER], [VARIATION/EDIT], [GK], or [SYSTEM].

3. After confirming that the FC-200's power switch is on, press [WRITE].

During transmission, "-" appears, moving from left to right across the display.

When transmission is finished, the unit returns to the status in effect before the last time the power was turned off.

This completes initialization of the FC-200.

\* Immediately after initialization, the VGA-7 will be in Program Change mode (p. 44).

## Connecting the VGA-7 and the FC-200

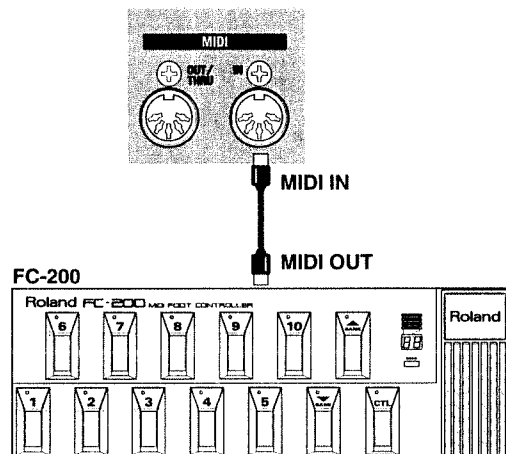

Set the VGA-7's MIDI channel to "OMNI ON" or to the same channel set for the FC-200 (p. 48).

\* This is set at the factory to "OMNI ON."

### MEMO

With an optional FS-5U foot switch connected to the FC-200's Mode jack, you can use the setup to switch between Program Change mode, used for switching Patches, and Control Change mode, in which Control Change messages are sent.

\* When connecting the FS-5U (sold separately) to the FOOT SW jack, set the polarity switch as shown below.

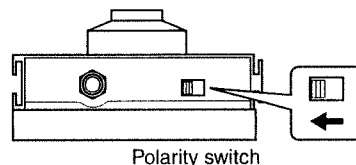

# Functions That Can Be Controlled with the FC-200

## In Program Change Mode

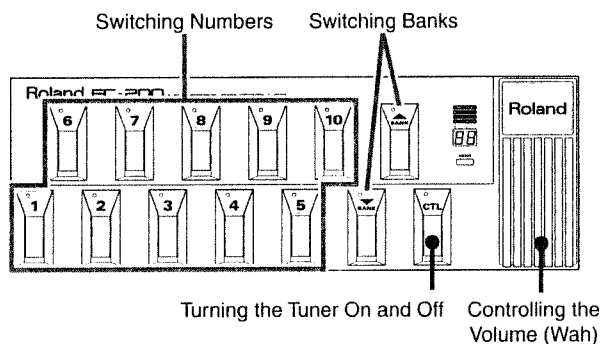

## Switching Between Preset Patches and User Patches

\* Distinctions between Preset and User Patches follow the VGA-7 settings.

### Switching Banks

Each time the Bank (UP/DOWN) pedal is pressed, the bank is switched, and the Bank is indicated on the FC-200's display.

Press "UP" to rise through the bank numbers in sequence; press "DOWN" to descend through the sequence of Bank numbers.

### Switching Numbers

Press the Number pedals (1–10) to select the numbers. The selected number indicator lights, and the program number is switched.

When switching to a Patch of a different number within the same Bank, reselection of the Bank is unnecessary.



When in Control Change mode, you can use the UP bank pedal to switch between Preset and User Patches.

## Turning the Tuner On and Off

Each time the control pedal is pressed, the information controlled with the pedal is sent from the FC-200 as a Control Change message (Controller Number 80).

These messages can be used to turn the VGA-7's tuner on and off.

## Controlling the Volume (Wah)

When the expression pedal is used, the information controlled with the pedal is sent from the FC-200 as a Control Change message (Controller Number 7).

These messages can be used to control the VGA-7's volume level.

When EFX in the EFFECTS section is on, with the TYPE set to "WAH," you can use the expression pedal as a wah pedal.

## In Control Change Mode

In Control Change mode, the various pedals are used to send the Control Change messages shown below.

These messages can be used to control the VGA-7's different functions.

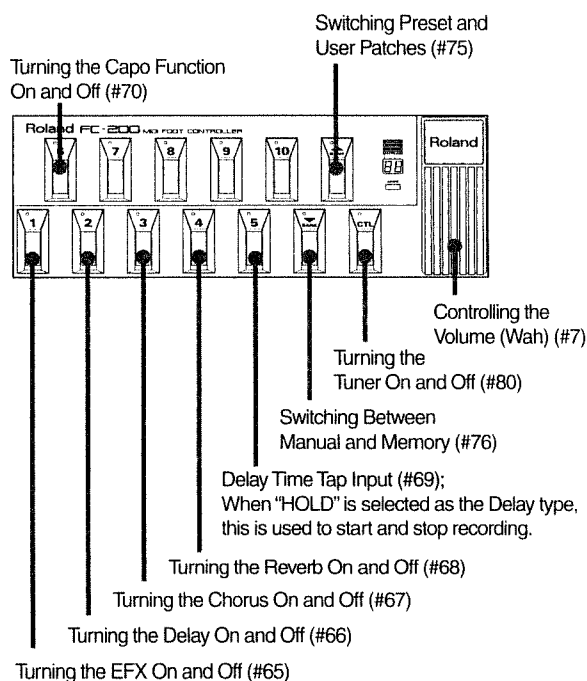

## Switching Preset and User Patches

Each time the UP Bank pedal is pressed, the information controlled with the pedal is sent from the FC-200 as a Control Change message (Controller Number 75).

These messages can be used to switch between Preset and User Patches.

## Turning the Capo Function On and Off

Each time Number pedal 6 is pressed, the information controlled with the pedal is sent from the FC-200 as a Control Change message (Controller Number 70).

These messages can be used to turn the Capo function on and off.

## Turning the Effects On and Off

Each time one of the Number pedals 1–4 is pressed, the information controlled with the pedal is sent from the FC-200 as a Control Change message.

These messages can be used to turn the EFX, DELAY, CHORUS, and REVERB effects on and off.

### Number Pedal 1:

EFX (Controller Number 65)

### Number Pedal 2:

Delay (Controller Number 66)

### Number Pedal 3:

Chorus (Controller Number 67)

### Number Pedal 4:

Reverb (Controller Number 68)

## Delay Time Tap Input

Each time Number pedal 5 is pressed, the information controlled with the pedal is sent from the FC-200 as a Control Change message (Controller Number 69).

These messages can be used for tap input of Delay Time.

When “HOLD” is selected as the Delay type, this is used to start and stop recording.

## Switching Between Manual and Memory

Each time the DOWN Bank pedal is pressed, the information controlled with the pedal is sent from the FC-200 as a Control Change message (Controller Number 76).

These messages can be used to switch between Manual and Memory.

## Turning the Tuner On and Off

Each time the control pedal is pressed, the information controlled with the pedal is sent from the FC-200 as a Control Change message (Controller Number 80).

These messages can be used to turn the VGA-7’s tuner on and off.

## Controlling the Volume (Wah)

When the expression pedal is used, the information controlled with the pedal is sent from the FC-200 as a Control Change message (Controller Number 7).

These messages can be used to control the VGA-7’s volume level.

When EFX in the EFFECTS section is on with the TYPE set to “WAH,” you can use the expression pedal as a wah pedal.



When the FC-200 is supplemented with an additional external expression pedal (sold separately: Roland EV-5, BOSS FV-300L ), and EFX in the EFFECTS section is ON, with the type set to “WAH,” it is then possible to control the wah effect and the volume level independently with separate pedals.

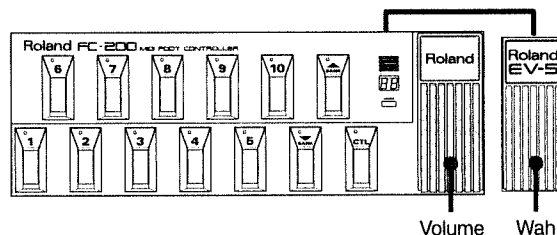

With an expression pedal connected to the FC-200’s FOOT SW or EXP jack (either may be used), set the jack’s Control Number and the Control Number for the VGA-7’s “5 WAH” MIDI parameter to a number not otherwise being used.

With these settings, the FC-200’s expression pedal can then function exclusively as a volume pedal, with the external expression pedal used only as a wah pedal.

You have complete freedom to choose the controller numbers assigned for the VGA-7’s various functions and the FC-200’s pedals and jacks.

For more detailed information and instructions, refer to “Changing the MIDI Settings” in the VGA-7 Owner’s Manual (p. 48) as well as the FC-200 Owner’s Manual.

# Appendices

## If You Think There Might Be a Problem (Troubleshooting)

This section explains some things that might go wrong when using the VGA-7, and what needs to be done to correct the problem. If you think there may be something wrong with your VGA-7, please check through the following first. If these suggestions don't fix the problem, then go ahead and contact the store you bought it from, or your nearest Roland Service Station.

### ■ Trouble with the Sound

#### The sound isn't right.

- Is the divided pickup setting correctly?  
→ Check the divided pickup setting. (p. 15–19)
- Is the selector switch on the GK pickup set to "GUITAR"?  
→ Set the select switch to a setting other than "GUITAR."

#### There is no sound when the guitar is played.

- Is the divided pickup connecting correctly?  
→ Check the connections are correct. (p. 12)
- Is the SYNTH VOL on the GK-2A set to "0"?  
→ Raise the volume to an appropriate level.
- Are [MASTER], [GAIN], or [VOLUME] on the VGA-7 set to "0"?  
→ Raise the volume to an appropriate level.
- Are [BASS], [MIDDLE], and [TREBLE] all set to "0"?  
→ Depending on the amp type (p. 28), there may be no sound if you set the [BASS], [MIDDLE], and [TREBLE] equalizer settings all to 0.
- Are you using the expression pedal?  
→ If the expression pedal is returned (toward yourself), there may be no sound. Advance the pedal (away from yourself).

#### The pitch isn't right.

- Is the guitar in tune?  
→ Tune the guitar. (p. 21)
- Is the VGA-7 out of tune with other instruments?  
→ Adjust the Standard pitch setting. (p. 20)

- Have you set TUNING or CAPO for the COSM GUITAR?  
→ Set the TUNING of the COSM GUITAR to NORMAL, and turn CAPO off.

#### The volume fluctuates from one string to another.

- Are the Sensitivity settings for all strings correct?  
→ Adjust the settings if necessary. (p. 17)

#### Onboard effects are not applied.

- Is the effect turned "OFF"?  
→ If an effect is turned "OFF," that effect will not be applied. Turn the effect "ON."
- Are the effect levels high enough?  
→ An effect is not applied and only the original sound is heard when the effect level is at the lowest setting. Set the effect level to an appropriate value.

#### Depending on the guitar being used, hum may be audible.

- Is the output jack on your guitar connected to the NORMAL GUITAR input jack on the GK-2A?  
→ You should be sure to make this connection even if the guitar sound is not to be output. For more details, see the Owner's Manual for the GK-2A.

### ■ Other Problems

#### " **bLo** " is displayed when the power is switched on.

- The internal battery for saving Patch and system parameters is almost out of power. Replace the battery soon to prevent parameters from being lost. Contact your nearest Roland Service Station or the store where you bought the VGA-7.

### Patches aren't switched when a Program Change is received from an external device.

- Are Program Change messages being transmitted on a channel other than the selected MIDI channel?
- Send the Program Change messages on the same channel as the one set with MIDI Channel (p. 48).

### Data can't be sent or received with Bulk Dump.

- Have you made settings to allow bulk dump transmission?
- In the System settings, select parameter number 7: DUMP, specify the data to be transmitted, and then execute bulk dump.
- Is the MIDI sequencer you are using able to record exclusive data?
- Use a MIDI sequencer that can record SysEx messages. We recommend that you use the Roland MC-80.

### The volume level of the instrument connected to EXT IN is too low.

- Could you be using a connection cable that contains a resistor?
- Use a connection cable that does not contain a resistor.

## Restoring the Factory Settings

You can restore the VGA-7 to its factory settings. This operation is called "Factory Reset."



Once you carry out a Factory Reset, all of the existing data that you've created will be lost. If there is any important data that you wish to keep, use Bulk Dump (p. 41) to save the data on an external MIDI device (such as a sequencer) beforehand.

1. While holding down [WRITE], turn on the POWER switch. The [WRITE] indicator flashes, and the following messages alternate repeatedly in the display.

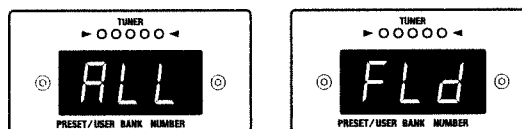

#### ■ Restoring All Settings to the Values Set at the Factory

2. Press [WRITE].  
Factory Reset is executed.  
During the operation, "-" appears, moving from left to right across the display.  
When Factory Reset is finished, "U01" appears in the display.

#### ■ Restoring Only the User Patches to the Factory Settings

2. Press [PRESET/USER].  
The following messages alternate repeatedly in the display.

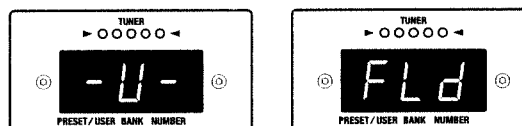

3. Press [WRITE].  
Factory Reset is executed.  
During the operation, "-" appears, moving from left to right across the display.  
When Factory Reset is finished, "U01" appears in the display.

### Changing the MIDI Settings

When using MIDI to control the VGA-7, you can change the settings for the MIDI parameters as needed.

1. While holding down [SYSTEM], turn on the POWER switch.
2. Use [PARAMETER ▼/▲] to select MIDI parameters.
3. Press [SELECT/VALUE ▼/▲] to set the value.
4. Press either [TUNER], [VARIATION/EDIT], [GK], or [SYSTEM] to stop the operation.

Parameter No.	Value	Factory Setting	Setting for FC-200
<b>1</b> MIDI CH (Setting for MIDI channel)	1-16	1	1
<b>2</b> OMNI (Setting for Omni mode)	On, OFF	On	On
<b>3</b> DEVICE ID (Setting for Device ID)	1-32	1	1
<b>4</b> Foot Volume (Controller No.)	1-31, 64-95	7	7
<b>5</b> WAH (Controller No.)	1-31, 64-95	7	7
<b>6</b> TUNER (Controller No.)	1-31, 64-95	80	80
<b>7</b> EFX (Controller No.)	1-31, 64-95	65	65
<b>8</b> DELAY (Controller No.)	1-31, 64-95	66	66
<b>9</b> CHORUS (Controller No.)	1-31, 64-95	67	67
<b>A</b> REVERB (Controller No.)	1-31, 64-95	68	68
<b>b</b> TAP (Controller No.)	1-31, 64-95	69	69
<b>c</b> CAPO (Controller No.)	1-31, 64-95	70	70
<b>d</b> USER/PRESET (Controller No.)	1-31, 64-95	75	75
<b>E</b> MANUAL/MEMORY (Controller No.)	1-31, 64-95	64	76

\* If two or all of "6 TUNER," "d PRESET/USER," and "E MANUAL/MEMORY" are set to the same controller number, control will be given priority in the order of 1: 6 TUNER, 2: E MANUAL/MEMORY, and 3: d PRESET/USER, and control of the remaining parameter(s) will be disabled.



With the foot volume and the WAH controller number both set to the same number, you can use a single expression pedal to control both the volume and the wah effect, the pedal acting as a wah pedal when the WAH effect is on, and as a volume pedal when the wah effect is off.



## Effect connection order

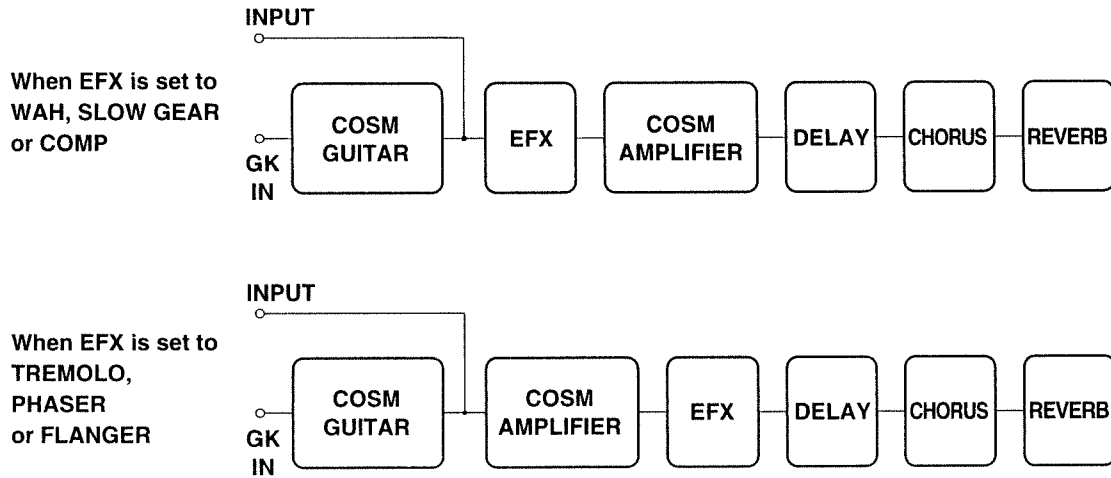

## Block diagram

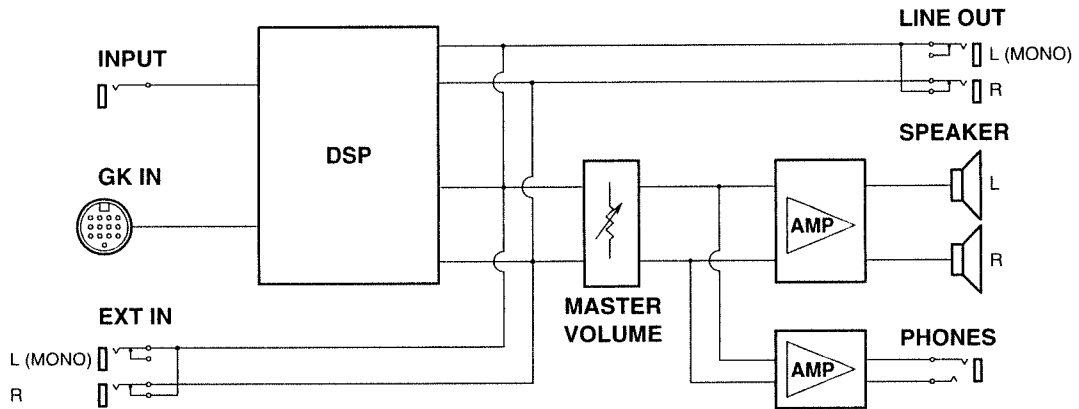

# Appendices

V-GUITAR AMPLIFIER

Date : Aug. 1, 2000

Model VGA-7

## MIDI Implementation Chart

Version : 1.00

Function...		Transmitted	Recognized	Remarks
Basic Channel	Default Changed	1-16 1-16	1-16 1-16	Memorized
Mode	Default Messages Altered	X X *****	OMNI ON/OFF X	Memorized
Note Number :	True Voice	X *****	X	
Velocity	Note ON Note OFF	X X	X X	
After Touch	Key's Ch's	X X	X X	
Pitch Bend		X	X	
Control Change	0, 32	X	O *1	Bank Select
	1-31	X	O *2	
	64-95	X	O *2	
Prog Change	: True #	X X	O 0-79	Program Number
System Exclusive		O *3	O *4	
System Common	: Song Pos : Song Sel : Tune	X X X	X X X	
System Real Time	: Clock : Command	X X	X X	
Aux Message	: All sound off : Local ON/OFF : All Notes OFF : Active Sense : Reset	X X X X X	X X X X X	
Notes	* 1 This ignores the LSB. * 2 This recognize the message set for "Parameters realtime control." * 3 Bulk data can be transmitted only when the MIDI Bulk Dump screen is displayed. * 4 Bulk data can be received only when the MIDI Bulk Load screen is displayed.			

Mode 1 : OMNI ON, POLY

Mode 2 : OMNI ON, MONO

O : Yes

Mode 3 : OMNI OFF, POLY

Mode 4 : OMNI OFF, MONO

X : No

# Specifications

## VGA-7: V-Guitar Amplifier

- **Rated Power Output**

130 W (65 W + 65 W)

- **Patches**

160 (Preset: 80 + User: 80)

- **Nominal Input Level (1 kHz)**

INPUT HIGH: -10 dBu/470 kΩ

INPUT LOW: 0 dBu/330 kΩ

EXT IN: +4 dBu

- **Nominal Output Level**

LINE OUT: +4 dBu

\* 0 dBu = 0.775 V<sub>rms</sub>

- **Speakers**

(30 cm + Horn Tweeter) x 2

- **Display**

8 segments 3 characters LED

- **Controls**

**COSM GUITAR section**

TYPE button

PICKUP button

TUNING button

CAPO button

**COSM AMPLIFIER section**

AMP TYPE button

GAIN knob

VOLUME knob

EQUALIZER: BASS knob

MIDDLE knob

TREBLE knob

PRESENCE knob

SPEAKER TYPE button

**EFFECTS section**

EFX: EFX button

SELECT button

Control knob x 2

DELAY: DELAY button

TAP TEMPO button

FEEDBACK knob

LEVEL knob

CHORUS: CHORUS button

INTENSITY knob

REVERB: REVERB button

LEVEL knob

**Master section**

TUNER button

VARIATION/EDIT button

GK button

SYSTEM button

WRITE button

PRESET/USER button

BANK ▼ button

BANK ▲ button

NUMBER ▼ button

NUMBER ▲ button

MANUAL button

Direct number button (A/B, 1/6–5/10)

TUNER indicator

MASTER knob

POWER switch

- **Connectors**

GK IN connector

INPUT jacks (HIGH, LOW)

PHONES jack

LINE OUT jacks (L(MONO)/R)

EXT IN jacks (L(MONO)/R)

EXP PEDAL jack

EFX jack

DELAY jack (TIP: ON/OFF, RING: TAP TEMPO)

CHORUS jack

REVERB jack

MIDI connectors (IN, OUT/THRU)

## Appendices

---

- **Power Supply**

AC 117 V, 230 V or 240 V

- **Power Consumption**

160 W (117 V, 230 V, 240 V)

- **Dimensions**

770 (W) x 300 (D) x 640 (H) mm

30 - 3/8 (W) x 11-13/16 (D) x 25 - 1/4 (H) inches

(Include casters)

- **Weight**

37.6 kg / 82 lbs 15 oz

- **Accessories**

GK Connecting Cable: C-13A (5 m)

Casters (x4)

Owner's Manual

Preset Patch List

- **Options**

Divided Pickup: GK-2A

Unit Selector: US-20

Expression Pedal: EV-5, FV-300L (BOSS)

Foot Switch: FS-5U (BOSS), FS-5L (BOSS)

MIDI Foot Controller: FC-200



In the interest of product improvement, the specifications and/or appearance of this unit are subject to change without prior notice.

# Index

## Numerics

12 STRING .....	26
1-12" OPEN .....	30
2-12" OPEN .....	30
4-10" OPEN .....	30
4-12" CLOSED .....	30

## A

A/B .....	22
ACOUSTIC .....	26
ATTACK .....	31

## B

BANK .....	22, 34
BASS .....	29
BULK DUMP .....	41
BULK LOAD .....	40

## C

CAPO .....	27
CHORUS .....	33, 36
CLEAN .....	28
COMP .....	31
COSM .....	7
COSM AMPLIFIER .....	28
COSM GUITAR .....	25
CRUNCH .....	28

## D

DELAY .....	32, 36
DIRECTION .....	15

## E

EFFECTS .....	30
EFX .....	30, 36
EQUALIZER .....	29
EXP PEDAL .....	35
EXT IN .....	35

## F

FEEDBACK .....	32
FLANGER .....	32
FOOT CONTROL .....	35
FOOT SW .....	39
FULL RANGE .....	29
FUNCTION .....	42

## G

GAIN .....	29
GK .....	14, 34
GK IN .....	25
GK TYPE .....	15

## H

HOLLOW .....	25
--------------	----

## I

INPUT .....	28
INTENSITY .....	31-33

## L

LEAD .....	28
LEVEL .....	19-20, 32-33, 38
LINE OUT .....	35
LP .....	25

## M

MANUAL .....	24, 34
MASTER .....	35
MIDDLE .....	29
MIDI .....	40, 50
MIDI IN .....	37
MIDI OUT .....	37, 42

## N

NASHVILLE .....	27
NOISE SUPPRESSOR .....	38
NORMAL .....	26
NUMBER .....	22, 34

## O

OPEN TYPE .....	26
ORIGINAL .....	30

## P

PEDAL .....	31
PEDAL HOLD .....	39
PHASE .....	18
PHASER .....	32
PHONES .....	35
PICKUP .....	26
PICKUP-BRIDGE .....	16
PITCH .....	20, 38
POWER .....	35

## Index

---

PRESENCE ..... 29  
PRESET/USER ..... 22, 34

### R

RATE ..... 31–32  
REVERB ..... 33, 36  
RISE TIME ..... 31

### S

S1/S2 ..... 19  
SCALE ..... 16  
SENS ..... 17, 31  
SLOW GEAR ..... 31  
SPECIAL ..... 26, 29  
ST ..... 25  
STRING ..... 17, 27  
SUSTAIN ..... 31  
SYSTEM ..... 20, 34, 38

### T

TAP TEMPO ..... 32–33  
TEL ..... 25  
THRESHOLD ..... 38  
TREBLE ..... 29  
TREMOLO ..... 31  
TUNER ..... 21, 34, 38  
TUNING ..... 26–27  
TYPE ..... 25, 28–29, 39

### U

USER ..... 27

### V

VARIATION ..... 11, 23  
VARIATION/EDIT ..... 23, 27, 34  
VOLUME ..... 29

### W

WAH ..... 31  
WRITE ..... 24, 34

For EU Countries

## Apparatus containing Lithium batteries

### ADVARSEL!

Lithiumbatteri - Eksplosionsfare ved fejlagtig håndtering.  
Udskiftning må kun ske med batteri af samme fabrikat og type.  
Levér det brugte batteri tilbage til leverandøren.

### ADVARSEL

Eksplosjonsfare ved feilaktig skifte av batteri.  
Benytt samme batteritype eller en tilsvarende type anbefalt av apparatfabrikanten.  
Brukte batterier kasseres i henhold til fabrikantens instruksjoner.

### CAUTION

Danger of explosion if battery is incorrectly replaced.  
Replace only with the same or equivalent type recommended by the manufacturer.  
Discard used batteries according to the manufacturer's instructions.

### VARNING

Explosionsfara vid felaktigt batteribyte.  
Använd samma batterityp eller en ekvivalent typ som rekommenderas av apparatillverkaren.  
Kassera använt batteri enligt fabrikantens instruktion.

### VAROITUS

Paristo voi räjähtää, jos se on virheellisesti asennettu.  
Vaihda paristo ainoastaan laitevalmistajan suosittelemaan tyyppiin. Hävitä käytetty paristo valmistajan ohjeiden mukaisesti.

For EU Countries



This product complies with the requirements of European Directives EMC 89/336/EEC and LVD 73/23/EEC.

For the USA

## FEDERAL COMMUNICATIONS COMMISSION RADIO FREQUENCY INTERFERENCE STATEMENT

This equipment has been tested and found to comply with the limits for a Class B digital device, pursuant to Part 15 of the FCC Rules. These limits are designed to provide reasonable protection against harmful interference in a residential installation. This equipment generates, uses, and can radiate radio frequency energy and, if not installed and used in accordance with the instructions, may cause harmful interference to radio communications. However, there is no guarantee that interference will not occur in a particular installation. If this equipment does cause harmful interference to radio or television reception, which can be determined by turning the equipment off and on, the user is encouraged to try to correct the interference by one or more of the following measures:

- Reorient or relocate the receiving antenna.
- Increase the separation between the equipment and receiver.
- Connect the equipment into an outlet on a circuit different from that to which the receiver is connected.
- Consult the dealer or an experienced radio/TV technician for help.

Unauthorized changes or modification to this system can void the users authority to operate this equipment.  
This equipment requires shielded interface cables in order to meet FCC class B Limit.

For Canada

### NOTICE

This Class B digital apparatus meets all requirements of the Canadian Interference-Causing Equipment Regulations.

### AVIS

Cet appareil numérique de la classe B respecte toutes les exigences du Règlement sur le matériel brouilleur du Canada.

## Information

When you need repair service, call your nearest Roland Service Center or authorized Roland distributor in your country as shown below.

### AFRICA

#### EGYPT

**Al Fanny Trading Office**  
P.O. Box 2904,  
El Horrieh Heliopolis, Cairo,  
EGYPT  
TEL: (02) 4185531

#### REUNION

**Maison FO - YAM Marcel**  
25 Rue Jules Hermann,  
Chaudron - BP79 97 491  
Ste Clotilde Cedex,  
REUNION ISLAND  
TEL: 28 29 16

#### SOUTH AFRICA

**That Other Music Shop  
(PTY) Ltd.**  
11 Melle St., Braamfontein,  
Johannesburg  
Republic of SOUTH AFRICA

P.O. Box 32918, Braamfontein 217  
Republic of SOUTH AFRICA  
TEL: (011) 403 4105

**Paul Bothner (PTY) Ltd.**  
17 Werdmuller Centre Claremont  
7700  
Republic of SOUTH AFRICA

P.O. Box 23032  
Claremont, Cape Town  
SOUTH AFRICA, 7735  
TEL: (021) 674 4030

### ASIA

#### CHINA

**Beijing Xinghai Musical  
Instruments Co., Ltd.**  
6 Huangmunchang Chao Yang  
District, Beijing, CHINA  
TEL: (010) 6774 7491

#### HONG KONG

**Tom Lee Music Co., Ltd.  
Service Division**  
22-32 Pun Shan Street, Tsuen  
Wan, New Territories,  
HONG KONG  
TEL: 2415 0911

#### INDIA

**Rivera Digitec (India) Pvt. Ltd.**  
409, Nirman Kendra Mahalaxmi  
Flats Compound Off. Dr. Edwin  
Moses Road, Mumbai-400011,  
INDIA  
TEL: (022) 498 3079

#### INDONESIA

**PT Citra Inti Rama**  
Jl. Cideng Timur No. 151-150  
Jakarta Pusat  
INDONESIA  
TEL: (021) 6324170

#### KOREA

**Cosmos Corporation**  
1461-9, Seocho-Dong,  
Seocho Ku, Seoul, KOREA  
TEL: (02) 3486-8855

#### MALAYSIA

**Bentley Music SDN BHD**  
140 & 142, Jalan Bukit Bintang  
55100 Kuala Lumpur, MALAYSIA  
TEL: (03) 2443333

#### PHILIPPINES

**G.A. Yupangco & Co. Inc.**  
339 Gil J. Puyat Avenue  
Makati, Metro Manila 1200,  
PHILIPPINES  
TEL: (02) 899 9801

#### SINGAPORE

**Swee Lee Company**  
150 Sims Drive,  
SINGAPORE 387381  
TEL: 748-1669

**CRISTOFORI MUSIC PTE  
LTD**  
Blk 3014, Bedok Industrial Park E,  
402-2148, SINGAPORE 489980  
TEL: 243 9555

#### TAIWAN

**ROLAND TAIWAN  
ENTERPRISE CO., LTD.**  
Room 5, 9f, No. 112 Chung Shan  
N.Road Sec.2, Taipei, TAIWAN,  
R.O.C.  
TEL: (02) 2561 3339

#### THAILAND

**Theera Music Co., Ltd.**  
330 Verang NakornKasem, Soi 2,  
Bangkok 10110, THAILAND  
TEL: (02) 2248821

#### VIETNAM

**Saigon Music**  
138 Tran Quang Khai St.,  
District 1  
Ho Chi Minh City  
VIETNAM  
TEL: (08) 844-4068

### AUSTRALIA/ NEW ZEALAND

#### AUSTRALIA

**Roland Corporation  
Australia Pty., Ltd.**  
38 Campbell Avenue  
Doe Why West, NSW 2099  
AUSTRALIA  
TEL: (02) 9982 8266

#### NEW ZEALAND

**Roland Corporation (NZ) Ltd.**  
97 Mt. Eden Road, Mt. Eden,  
Auckland 3, NEW ZEALAND  
TEL: (09) 3098 715

### CENTRAL/LATIN AMERICA

#### ARGENTINA

**Instrumentos Musicales S.A.**  
Florida 656 2nd Floor  
Office Number 206A  
Buenos Aires  
ARGENTINA, CP1005  
TEL: (54-11) 4-393-6057

#### BRAZIL

**Roland Brasil Ltda.**  
R. Coronel Octaviano da Silveira  
203 05522-010  
Sao Paulo BRAZIL  
TEL: (011) 3743 9377

#### COSTA RICA

**JUAN BANSBACH  
Instrumentos Musicales**  
Ave. 1, Calle 11, Apartado 10237,  
San Jose, COSTA RICA  
TEL: (506) 258-0211

#### CHILE

**Comercial Fancy S.A.**  
Avenida Rancagua #0330  
Providencia Santiago, CHILE  
TEL: 56-2-373-9100

#### EL SALVADOR

**OMNI MUSIC**  
75 Avenida Notre YY Alameda,  
Juan Pablo 2, No. 4010  
San Salvador, EL SALVADOR  
TEL: (503) 262-0788

#### MEXICO

**Casa Veerkamp, s.a. de c.v.**  
Av. Toluca No. 323, Col. Olivar  
de los Padres 01780 Mexico D.F.  
MEXICO  
TEL: (525) 668 04 80

**La Casa Wagner de  
Guadalajara s.a. de c.v.**  
Av. Corona No. 202 S.J.  
Guadalajara, Jalisco Mexico  
C.P.44100 MEXICO  
TEL: (3) 613 1414

#### PANAMA

**SUPRO MUNDIAL, S.A.**  
Boulevard Andrews, Albrook,  
Panama City,  
REP. DE PANAMA  
TEL: (507) 315-0101

#### PARAGUAY

**Distribuidora De  
Instrumentos Musicales**  
J.E. Olear y ESQ. Manduvira  
Edificio, El Dorado Planta Baja  
Asuncion PARAGUAY  
TEL: 595-21-492147

#### PERU

**VIDEO Broadcast S.A.**  
Portinari 199 (ESQ. HA15),  
San Borja, Lima 41,  
REP. OF PERU  
TEL: 51-14-758226

#### URUGUAY

**Todo Musica S.A.**  
Cuareim 1844, Montevideo,  
URUGUAY, CP11200  
TEL: 5982-924-2335

#### VENEZUELA

**Musicland Digital C.A.**  
Av. Francisco de Miranda,  
Centro Parque de Cristal, Nivel  
C2 Local 20 Caracas  
VENEZUELA  
TEL: (02) 285 9218

### EUROPE

#### AUSTRIA

**Roland Austria GES.M.B.H.**  
Siemensstrasse 4, P.O. Box 74,  
A-6063 RUM, AUSTRIA  
TEL: (0512) 26 44 260

#### BELGIUM/HOLLAND/ LUXEMBOURG

**Roland Benelux N. V.**  
Houtstraet 3, B-2260, Oevel  
(Westerlo) BELGIUM  
TEL: (014) 575811

#### DENMARK

**Roland Scandinavia A/S**  
Nordhavnsvej 7, Postbox 880,  
DK-2100 Copenhagen  
DENMARK  
TEL: (039)16 6200

#### FRANCE

**Roland France SA**  
4, Rue Paul Henri SPAAK,  
Parc de l'Esplanade, F 77 462 St.  
Thibault, Lagny Cedex FRANCE  
TEL: 01 600 73 500

#### FINLAND

**Roland Scandinavia As,  
Filial Finland**  
Lautasaarentie 54 B  
Fin-00201 Helsinki, FINLAND  
TEL: (9) 682 4020

#### GERMANY

**Roland Elektronische  
Musikinstrumente Hmb.H.**  
Oststrasse 96, 22844 Norderstedt,  
GERMANY  
TEL: (040) 52 60090

#### GREECE

**STOLLAS S.A.**  
**Music Sound Light**  
155, New National Road  
26422 Patras, GREECE  
TEL: 061-435400

#### HUNGARY

**Intermusica Ltd.**  
Warehouse Area 'DEPO' P/63  
H-2046 Torokbalint, HUNGARY  
TEL: (23) 511011

#### IRELAND

**Roland Ireland**  
Audio House, Belmont Court,  
Donnybrook, Dublin 4,  
Republic of IRELAND  
TEL: (01) 2603501

#### ITALY

**Roland Italy S. p. a.**  
Viale delle Industrie 8,  
20020 Arese, Milano, ITALY  
TEL: (02) 937-78300

#### NORWAY

**Roland Scandinavia Avd.  
Kontor Norge**  
Lilleakerveien 2 Postboks 95  
Lilleaker N-0216 Oslo  
NORWAY  
TEL: 273 0074

#### POLAND

**P. P. H. Brzostowicz**  
Ul. Gibraltarska 4,  
PL-03664 Warszawa POLAND  
TEL: (022) 679 44 19

#### PORTUGAL

**Tecnologias Musica e Audio,  
Roland Portugal, S.A.**  
RUA DE SANTA CARARINA  
131/133, 4000-450 PORTO  
PORTUGAL  
TEL: (022) 208 4456

#### ROMANIA

**FBS LINES**  
Plata Libertatii 1,  
RO-4200 Cheorgheni  
TEL: (066) 164-609

#### RUSSIA

**Slami Music Company**  
Sadovaya-Triumfalnaja st., 16  
103006 Moscow, RUSSIA  
TEL: 095 209 2193

#### SPAIN

**Roland Electronics  
de España, S. A.**  
Calle Bolivia 239, 08020  
Barcelona, SPAIN  
TEL: (93) 308 1000

#### SWEDEN

**Roland Scandinavia A/S  
SWEDISH SALES OFFICE**  
Danvik Center 28, 2 tr.  
S-131 30 Nacka SWEDEN  
TEL: (08) 702 0020

#### SWITZERLAND

**Roland (Switzerland) AG  
Musitronic AG**  
Gerberstrasse 5, Postfach,  
CH-4410 Liestal, SWITZERLAND  
TEL: (061) 921 1615

#### UKRAINE

**TIC-TAC**  
Mira Str. 19/108  
P.O. Box 180  
295400 Mukachevo, UKRAINE  
TEL: (03131) 414-40

#### UNITED KINGDOM

**Roland (U.K.) Ltd.**  
Atlantic Close, Swansea  
Enterprise Park, SWANSEA  
SA7 9FJ,  
UNITED KINGDOM  
TEL: (01792) 700139

### MIDDLE EAST

#### BAHRAIN

**Moon Stores**  
Bab Al Bahrain Road,  
P.O. Box 20077  
State of BAHRAIN  
TEL: 211 005

#### CYPRUS

**Radex Sound Equipment Ltd.**  
17 Diagorou St., P.O. Box 2046,  
Nicosia CYPRUS  
TEL: (02) 453 426

#### ISRAEL

**Haliilit P. Greenspoon &  
Sons Ltd.**  
8 Retzif Ha'aliya Hashnya St.  
Tel-Aviv-Yafa ISRAEL  
TEL: (03) 6823666

#### JORDAN

**AMMAN Trading Agency**  
Prince Mohammed St. P.O. Box  
825 Amman 11118 JORDAN  
TEL: (06) 4612100

#### KUWAIT

**Easa Husain Al-Yousifi**  
Abdullah Salem Street,  
Satat KUWAIT  
TEL: 5719499

#### LEBANON

**A. Chahine & Fils**  
P.O. Box 16-5857 Gergi Zeidan St.  
Chahine Building, Achrafieh  
Beirut, LEBANON  
TEL: (01) 335799

#### QATAR

**Al Emadi Co. (Badie Studio  
& Stores)**  
P.O. Box 62,  
DOHA QATAR  
TEL: 4423-554

#### SAUDI ARABIA

**aDawlah Universal  
Electronics APF**  
Corniche Road, Aldossary Bldg.,  
1st Floor  
SAUDI ARABIA

P.O. Box 2154, Alkhobar 31952  
SAUDI ARABIA  
TEL: (03) 898 2081

#### SYRIA

**Technical Light & Sound  
Center**  
Khaled Ibn Al Walid St.  
P.O. Box 13520  
Damascus - SYRIA  
TEL: (011) 2235 384

#### TURKEY

**Barkat muzik aletleri ithalat  
ve ihracat Ltd Sti**  
Siraselviler cad.Guney is hani 84-  
86/6, Taksim, Istanbul, TURKEY  
TEL: (0212) 2499324

#### U.A.E.

**Zak Electronics & Musical  
Instruments Co. L.L.C.**  
Zabeel Road, Al Sherooq Bldg.,  
No. 14, Grand Floor DUBAI  
U.A.E.  
TEL: (04) 3360715

### NORTH AMERICA

#### CANADA

**Roland Canada Music Ltd.  
(Head Office)**  
5480 Parkwood Way Richmond  
B.C., V6V 2M4 CANADA  
TEL: (604) 270 6626

#### Roland Canada Music Ltd. (Toronto Office)

Unit 2, 109 Woodbine Downs  
Blvd, Etobicoke, ON  
M9W 6Y1 CANADA  
TEL: (416) 213 9707

#### U. S. A.

**Roland Corporation U.S.**  
5100 S. Eastern Avenue  
Los Angeles, CA 90040-2938,  
U. S. A.  
TEL: (323) 890 3700

As of November 1, 2000 (Roland)





 Roland®

---

**02452478**

UPC

02452478



14981

**Roland**