



VF-1 24-BIT MULTIPLE EFFECTS PROCESSOR

Owner's Manual

Thank you, and congratulations on your choice of the BOSS VF-1 24-BIT MULTIPLE EFFECTS PROCESSOR.

Before using this unit, carefully read the sections entitled:

- **USING THE UNIT SAFELY** (page 2-3)
- **IMPORTANT NOTES** (page 11)

These sections provide important information concerning the proper operation of the unit.

Additionally, in order to feel assured that you have gained a good grasp of every feature provided by your new unit, Owner's manual should be read in its entirety. The manual should be saved and kept on hand as a convenient reference.

Copyright © 1999 BOSS CORPORATION

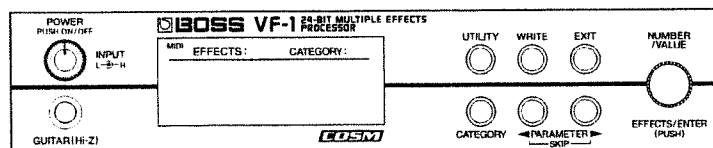

All rights reserved. No part of this publication may be reproduced in any form without the written permission of BOSS CORPORATION.









USING THE UNIT SAFELY

INSTRUCTIONS FOR THE PREVENTION OF FIRE, ELECTRIC SHOCK, OR INJURY TO PERSONS

About WARNING and CAUTION Notices







 WARNING	Used for instructions intended to alert the user to the risk of death or severe injury should the unit be used improperly.
 CAUTION	Used for instructions intended to alert the user to the risk of injury or material damage should the unit be used improperly. * Material damage refers to damage or other adverse effects caused with respect to the home and all its furnishings, as well to domestic animals or pets.

About the Symbols







	The  symbol alerts the user to important instructions or warnings. The specific meaning of the symbol is determined by the design contained within the triangle. In the case of the symbol at left, it is used for general cautions, warnings, or alerts to danger.
	The  symbol alerts the user to items that must never be carried out (are forbidden). The specific thing that must not be done is indicated by the design contained within the circle. In the case of the symbol at left, it means that the unit must never be disassembled.
	The  symbol alerts the user to things that must be carried out. The specific thing that must be done is indicated by the design contained within the circle. In the case of the symbol at left, it means that the power-cord plug must be unplugged from the outlet.

ALWAYS OBSERVE THE FOLLOWING

WARNING

- Before using this unit, make sure to read the instructions below, and the Owner's Manual. 
- Do not open (or modify in any way) the unit or its AC adaptor. 
- Do not attempt to repair the unit, or replace parts within it (except when this manual provides specific instructions directing you to do so). Refer all servicing to your retailer, the nearest Roland Service Center, or an authorized Roland distributor, as listed on the "Information" page. 
- Never use or store the unit in places that are:
 - Subject to temperature extremes (e.g., direct sunlight in an enclosed vehicle, near a heating duct, on top of heat-generating equipment); or are 
 - Damp (e.g., baths, washrooms, on wet floors); or are 
 - Humid; or are
 - Exposed to rain; or are
 - Dusty; or are
 - Subject to high levels of vibration.
- This unit should be used only with a rack or stand that is recommended by Roland. 
- When using the unit with a rack or stand recommended by Roland, the rack or stand must be carefully placed so it is level and sure to remain stable. If not using a rack or stand, you still need to make sure that any location you choose for placing the unit provides a level surface that will properly support the unit, and keep it from wobbling. 

WARNING

- Be sure to use only the AC adaptor supplied with the unit. Also, make sure the line voltage at the installation matches the input voltage specified on the AC adaptor's body. Other AC adaptors may use a different polarity, or be designed for a different voltage, so their use could result in damage, malfunction, or electric shock. 

- Avoid damaging the power cord. Do not bend it excessively, step on it, place heavy objects on it, etc. A damaged cord can easily become a shock or fire hazard. Never use a power cord after it has been damaged. 
- This unit, either alone or in combination with an amplifier and headphones or speakers, may be capable of producing sound levels that could cause permanent hearing loss. Do not operate for a long period of time at a high volume level, or at a level that is uncomfortable. If you experience any hearing loss or ringing in the ears, you should immediately stop using the unit, and consult an audiologist. 
- Do not allow any objects (e.g., flammable material, coins, pins); or liquids of any kind (water, soft drinks, etc.) to penetrate the unit. 

⚠ WARNING

- Immediately turn the power off, remove the AC adaptor from the outlet, and request servicing by your retailer, the nearest Roland Service Center, or an authorized Roland distributor, as listed on the “Information” page when:
 - The AC adaptor, the power-supply cord, or the plug has been damaged; or
 - Objects have fallen into, or liquid has been spilled onto the unit; or
 - The unit has been exposed to rain (or otherwise has become wet); or
 - The unit does not appear to operate normally or exhibits a marked change in performance.
- In households with small children, an adult should provide supervision until the child is capable of following all the rules essential for the safe operation of the unit.
- Protect the unit from strong impact. (Do not drop it!)
- Do not force the unit’s power-supply cord to share an outlet with an unreasonable number of other devices. Be especially careful when using extension cords—the total power used by all devices you have connected to the extension cord’s outlet must never exceed the power rating (watts/ amperes) for the extension cord. Excessive loads can cause the insulation on the cord to heat up and eventually melt through.
- Before using the unit in a foreign country, consult with your retailer, the nearest Roland Service Center, or an authorized Roland distributor, as listed on the “Information” page.

⚠ CAUTION

- The unit and the AC adaptor should be located so their location or position does not interfere with their proper ventilation.
- Always grasp only the plug on the AC adaptor cord when plugging into, or unplugging from, an outlet or this unit.
- Whenever the unit is to remain unused for an extended period of time, disconnect the AC adaptor.
- Try to prevent cords and cables from becoming entangled. Also, all cords and cables should be placed so they are out of the reach of children.
- Never climb on top of, nor place heavy objects on the unit.
- Never handle the AC adaptor or its plugs with wet hands when plugging into, or unplugging from, an outlet or this unit.
- Before moving the unit, disconnect the AC adaptor and all cords coming from external devices.
- Before cleaning the unit, turn off the power and unplug the AC adaptor from the outlet (p. 17).
- Whenever you suspect the possibility of lightning in your area, disconnect the AC adaptor from the outlet.

Contents

Main Features	9
How to use this manual	10
Conventions used in this manual.....	10
IMPORTANT NOTES	11
Front and rear panels	12
Front panel.....	12
Rear panel	13
Section 1. Producing Sound	14
Making connections	14
Connecting a guitar.....	14
Connecting a keyboard	15
Connecting a mic.....	15
Connecting to the send/return of a mixer.....	16
Connecting an expression pedal or foot switch.....	16
Turning on the power, and standby	17
Turning on the power.....	17
Adjusting the Input Level.....	17
Selecting the effect sound	18
About the Screen Indications.....	18
Selecting a patch	18
Quickly finding the desired patch (Category Search)	19
Selecting Patches with a Foot Switch	20
Switching EFFECTS on/off	22
Tuning your instrument	22
Displaying the tuner	22
About the tuner display	23
Tuning Procedure	23
Modifying the tuner settings (Standard pitch/Volume).....	24
Adjusting the display contrast.....	24
Section 2. Creating Sounds	25
Before You Begin Creating Sounds	25
User banks and preset banks.....	25
Algorithms	25
Settings that are stored in a patch.....	25
The display screen.....	25
Rapidly editing a patch (Quick Setting)	26
Editing a patch	27
About display selection.....	27
Procedure	27
Copying a patch	28
Turning an effect on/off	28
Editing the settings of each effect	29
Changing the order of the effects.....	30
Checking the input/output levels of each effect	31
Copying effect settings (Effect Copy).....	32

Setting the output level	32
Controlling parameters in real time (Control Assign).....	33
Assigning the category	37
Editing the patch name	37
Canceling your edits	38
Saving the changes you make (the Write operation)	38
Ways to use control assign.....	39
Using an expression pedal	39
Using two foot switches	40
Using an expression pedal (example)	41
Section 3. Overall Settings (Utility)	42
Utility functions.....	42
How to make settings	42
TUNER.....	42
SYSTEM SETTING	43
GLOBAL SOUND SETTINGS	45
FACTORY RESET	46
MIDI.....	46
Section 4. Effect guide	47
About the algorithm list.....	47
About POSITION	47
About "The function of each parameter"	47
About MOD.....	47
MOD parameters.....	47
About SFX.....	48
SFX parameters.....	48
About FV (foot volume)	48
About DELAY, MultiTAP DELAY and STEREO PS DLY	48
Algorithm list.....	49
PB1 GUITAR MULTI 1	49
PB2 GUITAR MULTI 2	52
PB3 BASS MULTI	54
PB4 ACOUSTIC MULTI.....	56
PB5 KEYBOARD MULTI.....	57
PB6 ROTARY MULTI.....	59
PB7 VOCAL MULTI	60
PB8 VOCODER.....	62
PB9 VoiceTRANSFORM (Voice Transformer).....	63
PB10 ISOLATOR.....	64
PB11 LOFI PROCESSOR	65
PB12 REVERB 1	66
PB13 REVERB 2	67
PB14 GATE REVERB.....	68
PB15 2CH RSS (2 channel RSS)	69
PB16 DELAY RSS	70

PB17 CHORUS RSS	71
PB18 REVERB RSS.....	72
PB19 RSS PANNER.....	73
PB20 DELAY.....	74
PB21 MultiTAP DELAY (20 TAP)	75
PB22 TAPE ECHO201	76
PB23 MIC SIMULATOR.....	77
PB24 SPACE CHORUS.....	78
PB25 StFLANGER DLY (Stereo Flanger Delay)	79
PB26 StPHASER DLY (Stereo Phaser Delay).....	80
PB27 StCHORUS DLY (Stereo Chorus Delay)	81
PB28 STEREO PS DLY (Stereo Pitch Shifter Delay)	82
PB29 STEREO MULTI.....	83
PB30 10GRAPHIC EQ (10-Band Graphic Equalizer).....	84
PB31 HUM CANCELER.....	85
PB32 VOCAL CANCELER.....	86
PB33 REVERB+REVERB.....	87
PB34 CHORUS+REVERB	88
PB35 DELAY+REVERB.....	89
PB36 DELAY+CHORUS	90

The function of each parameter91

2x2 CHORUS.....	91
4BAND EQ (equalizer).....	91
ACOUSTIC.....	92
ACOUSTIC GtSIM (acoustic guitar simulator).....	92
AFB (anti-feedback).....	92
BASS GTR SIM (bass guitar simulator)	92
BCF (bass cut filter).....	92
CHORUS.....	93
COMPRESSOR/LIMITER	93
DE-ESSER.....	94
DEFRETTER.....	95
DELAY.....	95
DISTANCE	96
DISTORTION.....	96
ENHANCER	97
FEEDBACKER	97
FLANGER.....	98
GRAPHIC EQ (graphic equalizer)	98
GUITAR SYNTH (guitar synthesizer)	99
HARMONIST	101
HUM CANCELER (hum canceller).....	102
HUMANIZER.....	103
3BAND ISOLATOR.....	103
LOFI BOX.....	104
MASTER	105

MIC CONV (Mic Converter).....	106
MULTI TAP DELAY.....	107
NS.SUPPRESSOR (Noise Suppressor)	107
OCTAVE	108
OVER DRIVE.....	108
PHASER	108
PICKUP SIM (Pickup Simulator).....	109
PITCH SHIFTER.....	109
PREAMP/SP.SIM (Preamp/Speaker Simulator).....	110
REVERB.....	111
GATE	112
RING MODULATOR.....	112
ROTARY	113
RSS PANNER.....	114
RSS (2ch)	114
SHORT DELAY	114
SLICER	114
SLOW GEAR.....	115
SPACE CHORUS.....	115
STEREO PS DLY (Stereo Pitch Shifter Delay)	115
SUB 4BAND EQ (Sub 4 Band Equalizer)	116
T-WAH (Touch WAH).....	116
TAPE ECHO201	117
TREMOLO/PAN.....	117
VIBRATO.....	118
VOCAL CANCELER.....	118
VOCODER.....	118
VoiceTRANSFORM (Voice Transformer).....	119
WAH.....	120
Before using RSS.....	121

Section 5. Using MIDI to Operate the VF-1 122

What you can do using MIDI.....	122
Making settings	122
Setting the MIDI channel	123
Setting the Omni mode	123
Setting the Device ID	123
Program Change Map Settings	124
Making settings	124
Transmitting VF-1 data (Bulk Dump)	125
Connections.....	125
Transmission Procedure.....	125
Restoring data from a Sequencer to the VF-1 (Bulk Load).....	126
Connections.....	126
Reception procedure.....	126

Section 6. Appendices.....127

About the VF-1's digital output..... 127
 Digital output signal..... 127
 Connecting the VF-1 to a digital audio device..... 127
 Digital OUT specifications..... 127

VF-1 operation using the FC-200 127
 VF-1 and FC-200 connections 127
 Selecting Patches from the FC-200..... 128
 Control Assign operations using the FC-200 129

VF-1 operation using the FC-50 130
 Connecting the VF-1 and FC-50 130
 Controlling the VF-1 from the FC-50..... 130

About MIDI..... 131
 How MIDI messages are transmitted and received..... 131
 Main types of MIDI message used by the VF-1..... 132
 About the MIDI Implementation Chart..... 132

Restoring the factory settings (Factory Reset)..... 133

Troubleshooting 134

Error Messages 135

MIDI Implementation Chart..... 136

Specifications 137

Index.....138

Preset Patch List.....140

Main Features

Versatile algorithms and high-quality sound that rivals dedicated professional equipment

The VF-1 provides 46 effects, and 36 algorithms (effects combinations).

A variety of simulations including preamp / speaker simulators produced by **COSM** as well as a rich array of effects such as reverb and chorus are provided.

It features 24 bit AD/DA conversion, and uses high-speed, custom DPS to ensure quality that rivals expensive professional equipment. It is a perfect match for any instrument, and is ideal for use with any instrument, even for serious recording efforts.

Algorithms and effect settings can be saved as **patches**.

In addition to 200 preset patches, the VF-1 allows you to create 200 user patches.

Rapid searching by category

Each patch is classified by a category such as guitar or vocal, etc. You can use the Category Search function to rapidly find the desired patch. (p.19)

Graphic LCD

The front panel of the VF-1 features a graphic LCD for easy and highly visual editing.

Quick setting

A preset setting is provided for each edit function. You can easily create the desired effect sound simply by selecting the preset setting for the function (effect) you wish to use. (p.26)

Guitar input jack

The front panel provides a high impedance input jack for direct connection of an electric guitar. (p.12)

Built-in tuner function

The VF-1 contains a chromatic tuner function. (p.22)

Realtime parameter control

Parameters can be controlled from a foot switch or expression pedal, or via MIDI messages. (p.33)

2-IN, 2-OUT

The VF-1 supports stereo input and output. You can apply effects without impairing the stereo input image, or apply two independent effects in parallel. (p.13)

Mountable in a 19-inch rack

A separately sold rack mount adapter (RAD-50) allows the VF-1 to be mounted in a standard 19-inch rack.

Digital out connector

A coaxial type digital output is provided, allowing connection to another digital device with no sacrifice in audio quality. (p.127)

COSM (Composite Object Sound Modeling)

Once a musical instrument generates sound vibrations, it reaches the human ear through various mediating objects, each of which significantly affects the sound. The material and configuration of the instrument, the electric/electronic/magnetic amplifying system, the air and the reverberation of the room all affect the final sound. Sound modeling, the latest DSP technology, "Virtually" reconstructs these objects. Roland's breakthrough Composite Object Sound Modeling (COSM) uses the advantages of multiple modeling methods and succeeds in accurately emulating existing sounds, as well as producing sounds that have never before been created.

How to use this manual

This manual is broadly organized into six sections, covering the operations and functions that you will use for normal performance, as well as how to make various settings. Please read the sections consecutively.

An alphabetical index is provided at the end of the manual. Please refer to the index if you come across any unfamiliar term.

Section 1. Producing Sound

This section explains basic operation of the VF-1, including connections with external devices and how to change patches.

Section 2. Creating Sounds

This section explains how to modify the effect settings, and how to use various functions.

Section 3. Overall Settings (Utility)

This section explains settings that affect the overall operation of the VF-1, such as how to use the tuner, and how to make system settings.

Section 4. Effect Guide

This section explains the effects and algorithms of the VF-1, and what they do.

Section 5. Using MIDI to Operate the VF-1

This section explains the settings used when controlling the VF-1 from an external MIDI device, and operations using MIDI to exchange data.

Section 6. Appendices

This section explains operations when using the FC-200 MIDI foot controller (sold separately).

It also provides information that will help you get the most out of the VF-1, how to restore the factory settings, and troubleshooting.

Conventions used in this manual

For clarity in explaining operations, the following conventions are used in this manual.

■ Words or symbols enclosed in square brackets [] indicate buttons or knobs on the front panel.

Example

[UTILITY] Utility button
PARAMETER [◀] [▶] Parameter buttons

■ The following controls and jacks are indicated as follows.

POWER
PUSH ON/OFF



Rotate the knob ->
[INPUT L/R]

INPUT
L → R

Press the knob ->
[POWER]

NUMBER
/VALUE

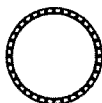

Rotate the knob ->
[NUMBER] or [VALUE]

Press the knob ->
[EFFECTS] or [ENTER]

EFFECTS/ENTER
(PUSH)

EXP PEDAL
/CTL 1,2



Connect the expression pedal ->
EXP PEDAL jack

Connect the foot switch ->
CTL 1,2 jack

IMPORTANT NOTES

In addition to the items listed under “USING THE UNIT SAFELY” on page 2–3, please read and observe the following:

Power Supply

- Do not use this unit on the same power circuit with any device that will generate line noise (such as an electric motor or variable lighting system).
- The AC adaptor will begin to generate heat after long hours of consecutive use. This is normal, and is not a cause for concern.
- Before connecting this unit to other devices, turn off the power to all units. This will help prevent malfunctions and/or damage to speakers or other devices.

Placement

- Using the unit near power amplifiers (or other equipment containing large power transformers) may induce hum. To alleviate the problem, change the orientation of this unit; or move it farther away from the source of interference.
- This device may interfere with radio and television reception. Do not use this device in the vicinity of such receivers.
- To avoid possible breakdown, do not use the unit in a wet area, such as an area exposed to rain or other moisture.

Maintenance

- For everyday cleaning wipe the unit with a soft, dry cloth or one that has been slightly dampened with water. To remove stubborn dirt, use a cloth impregnated with a mild, non-abrasive detergent. Afterwards, be sure to wipe the unit thoroughly with a soft, dry cloth.
- Never use benzine, thinners, alcohol or solvents of any kind, to avoid the possibility of discoloration and/or deformation.

Additional Precautions

- Please be aware that the contents of memory can be irretrievably lost as a result of a malfunction, or the improper operation of the unit. To protect yourself against the risk of losing important data, we recommend that you periodically save a backup copy of important data you have stored in the unit's memory in another MIDI device (e.g., a sequencer).
- Unfortunately, it may be impossible to restore the contents of data that was stored in another MIDI device (e.g., a sequencer) once it has been lost. Roland Corporation assumes no liability concerning such loss of data.
- Use a reasonable amount of care when using the unit's buttons, sliders, or other controls; and when using its jacks and connectors. Rough handling can lead to malfunctions.
- Never strike or apply strong pressure to the display.
- When connecting / disconnecting all cables, grasp the connector itself—never pull on the cable. This way you will avoid causing shorts, or damage to the cable's internal elements.
- To avoid disturbing your neighbors, try to keep the unit's volume at reasonable levels. You may prefer to use headphones, so you do not need to be concerned about those around you (especially when it is late at night).
- When you need to transport the unit, package it in the box (including padding) that it came in, if possible. Otherwise, you will need to use equivalent packaging materials.
- Use only the specified expression pedal (BOSS FV-300L+PCS-33 (Roland) or EV-5 (Roland); sold separately). By connecting any other expression pedals, you risk causing malfunction and/or damage to the unit.
- Use a cable from Roland to make the connection. If using some other make of connection cable, please note the following precautions.
 - Some connection cables contain resistors. Do not use cables that incorporate resistors for connecting to this unit. The use of such cables can cause the sound level to be extremely low, or impossible to hear. For information on cable specifications, contact the manufacturer of the cable.

Front and rear panels

Front panel

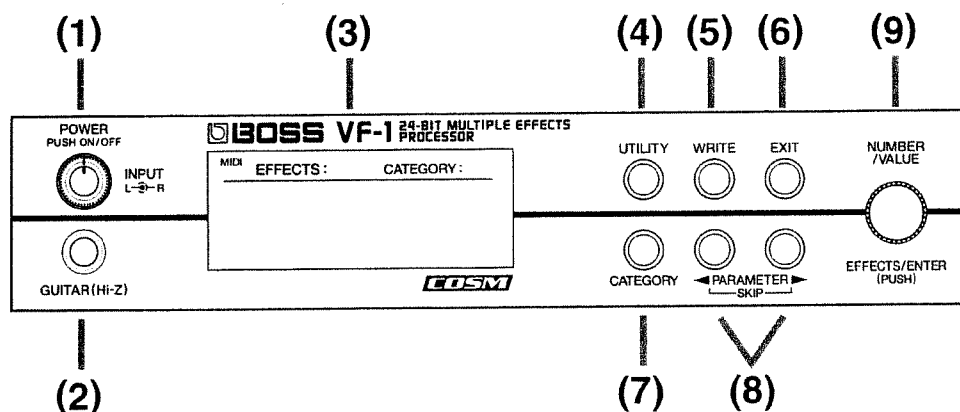

(1) POWER/INPUT (L/R)

Power switch/Input level knob (L/R)

Pressing this knob will turn the power on/off. Rotating the knob will adjust the input level. The input level can be adjusted separately for left and right.

(2) GUITAR (Hi-Z)

Guitar jack

This is an input jack for guitar (high impedance).

(3) Display

This is where the VF-1 displays various information, such as the current state of settings.

(4) UTILITY

Utility button

Press this when you wish to make system settings, use the tuning function, or make MIDI-related settings.

(5) WRITE

Write button

Press this when you wish to save or copy effect settings.

(6) EXIT

Exit button

By pressing this button you can cancel a parameter setting and return to the performance screen.

(7) CATEGORY

Category button

Press this button when you wish to search by category.

(8) PARAMETER (◀ / ▶)

Parameter buttons

Use these buttons to select the parameter whose value you wish to change. When you press these buttons, the cursor will move between parameter or setting locations in the display.

(9) NUMBER/VALUE, EFFECTS/ENTER

Number/Value knob, Effects/Enter button

By rotating the knob, you can select patch numbers or modify parameter values.

By pressing the knob, you can switch effects on/off, or finalize a value.

Rear panel

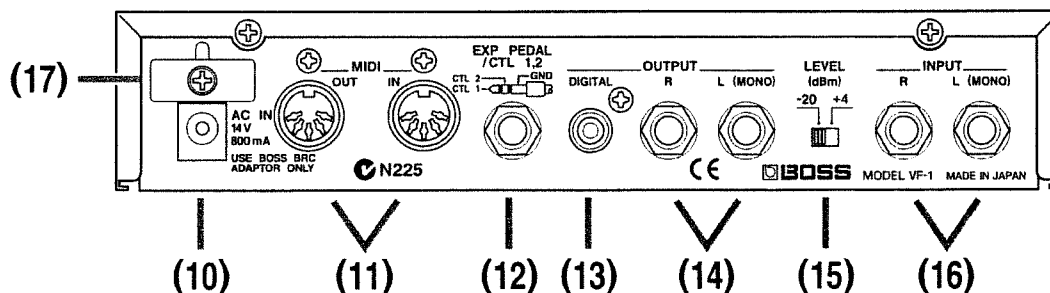

(10) AC Adapter jack

Connect the included AC adapter to this jack.

(11) MIDI IN/OUT

MIDI connectors (in/out)

An external MIDI device can be connected here to transmit/receive MIDI messages to/from the VF-1. Use a MIDI cable (sold separately) to make connections.

(12) EXP PEDAL/CTL 1,2

Expression pedal/Control 1,2 jack

Either an expression pedal or a foot switch can be connected here, and used to step up/down through patch numbers, or for realtime control of parameters. If a Roland PCS-31 (sold separately) is used, you can use its two foot switches to simultaneously control different parameters.

(13) DIGITAL OUTPUT

Digital output connector (coaxial)

A digital audio signal is output from this connector.

Use a video cable (75 Ω unbalanced) to make connections.

(14) OUTPUT L (MONO) /R

Output jacks

These are the output jacks for the audio signal. Connect them to your amp or mixer.

Use audio cables (separately sold) to make connections.

(15) LEVEL

Level switch

Switch simultaneously regular input and output.

(16) INPUT L (MONO) /R

Input jacks

These are the audio input jacks. Connect them to a keyboard or the like.

(17) Cord Hook

To prevent the AC adapter cord from being accidentally disconnected, wrap the cord around this hook.

* If you wish to attach the rack mount adapter (RAD-50; sold separately), refer to the manual of the rack mount adapter (RAD-50).

* If you will be using the VF-1 by itself, without using the rack mount adapter (RAD-50; sold separately), attach the included rubber feet as shown in the diagram.

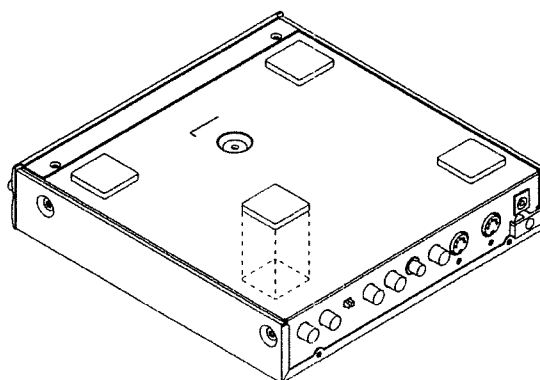

Section 1. Producing Sound

Making connections

Make connections as follows, depending on how you will be using the VF-1.

NOTE

To prevent malfunction and/or damage to speakers or other devices, always turn down the volume, and turn off the power on all devices before making any connections.

- * To output in monaural, connect a cable to only the OUTPUT L (MONO) jack.
- * There are three input jacks: the GUITAR jack, and the INPUT L (MONO) / R jacks. If you make connections both to the GUITAR jack and to the INPUT L (MONO) jack, the input from the GUITAR jack will be given priority.
- * To prevent the inadvertent disruption of power to your unit (should the plug be pulled out accidentally), and to avoid applying undue stress to the AC adaptor jack, anchor the power cord using the cord hook, as shown in the illustration.

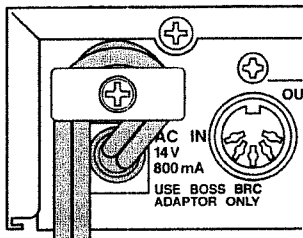

Connecting a guitar

- * When connecting a guitar, you will normally make connections to the front panel GUITAR jack.
- * If you will be outputting in mono, use the OUTPUT L (MONO) jack to make connections.
- * Normally you should set the LEVEL switch to -20 dBm.

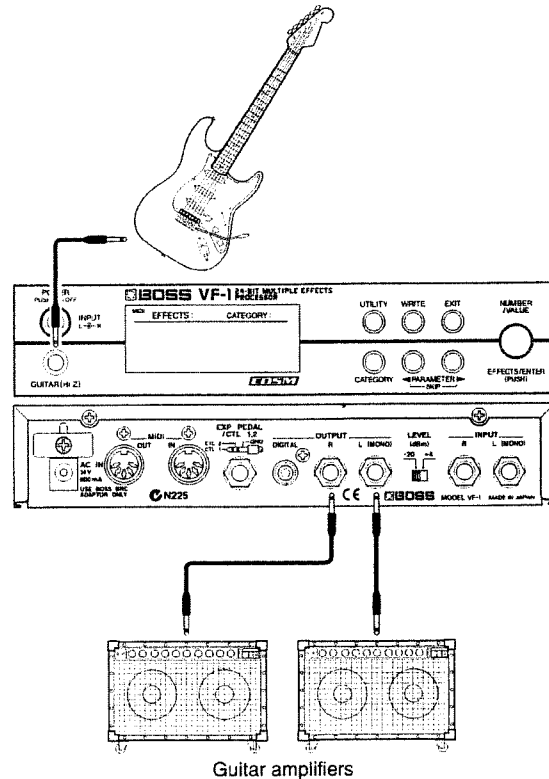

You can set the VF-1 to obtain optimal sound with the amp that you use.
For details refer to "GLOBAL SOUND SETTING" (p.45).

Connecting a keyboard

- * Normally you should set the LEVEL switch to -20 dBm.
- * When inputting in mono, make connections to the INPUT L (MONO) jack.
- * When outputting in mono, make connections to the OUTPUT L (MONO) jack.

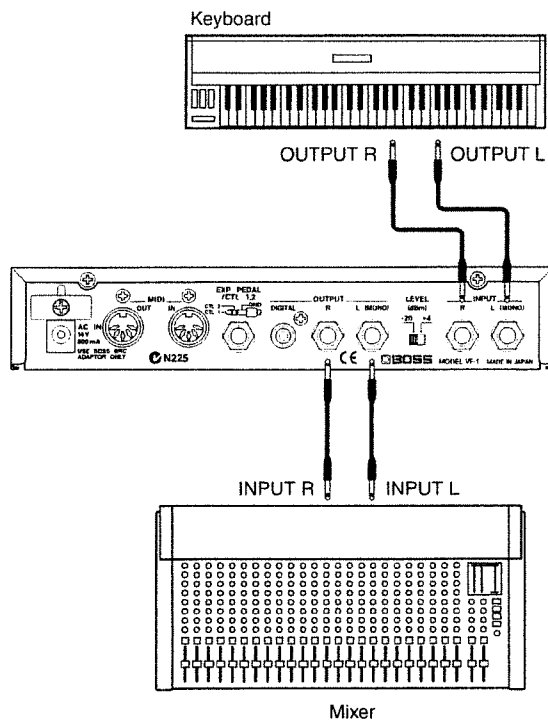

Connecting a mic

- * Set the LEVEL switch to match the level of the mixer to which the VF-1 is connected.

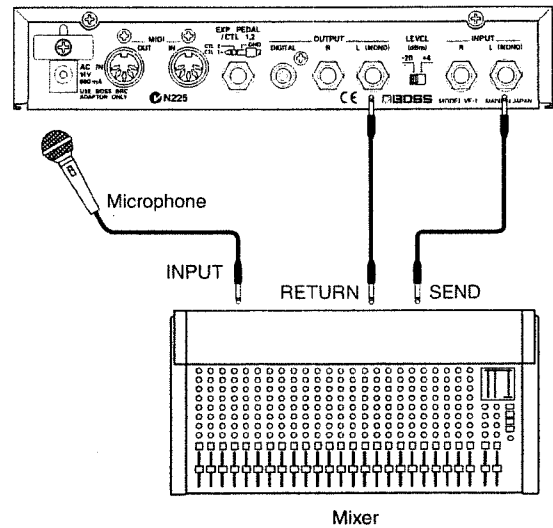

NOTE

Howling could be produced depending on the location of mics relative to speakers. This can be remedied by:

1. Changing the orientation of the mic(s).
2. Relocating mic(s) at a greater distance from speakers.
3. Lowering volume levels.

Connecting to the send/return of a mixer

- * Set the LEVEL switch to match the level of the mixer to which the VF-1 is connected.
- * If the VF-1 is connected to a send/return loop, set EFFECTS OFF MD (Effect Off mode) to "MUTE" (p.43) and DIRECT MIX to "OFF" (p.46).

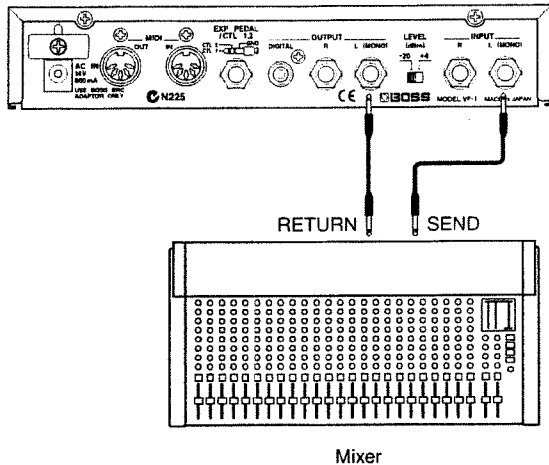

Connecting an expression pedal or foot switch

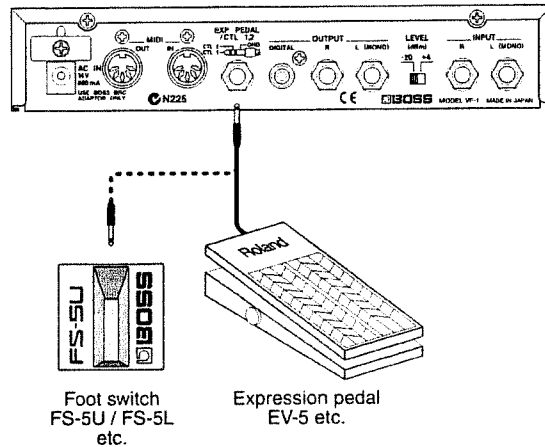

NOTE

Use only the specified expression pedal (BOSS FV-300L + PCS-33 (Roland) or EV-5 (Roland); sold separately). By connecting any other expression pedals, you risk causing malfunction and/or damage to the unit.

- * Set the minimum volume on the expression pedal connected to the EXP PEDAL jack to the "MIN" position. Unless the minimum volume is set to "MIN," the expression pedal will not work correctly.

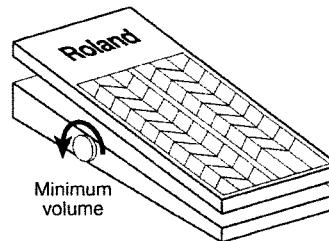

- * If connecting a footswitch to the CTL 1/2 jack, set the polarity switch as shown below. Unless the polarity switch is set correctly, the foot switch will not work properly.

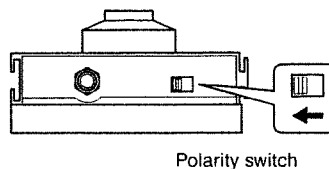

Turning on the power, and standby

In order to take full advantage of the VF-1's potential, be sure to adjust the input/output levels after turning on the power.

Turning on the power

Once the connections have been completed (p. 14–16), turn on power to your various devices in the order specified. By turning on devices in the wrong order, you risk causing malfunction and/or damage to speakers and other devices.

1. Before turning on the power, check the following points.
 - Have connections with external devices been made correctly?
 - Has the volume been turned completely down on the VF-1 and on the connected amp, etc.?
2. Turn on the power on the sound generating device (keyboard or other device).
3. Press the VF-1's [POWER] switch to turn on the power. The following display will appear, and after several seconds, the VF-1 will be ready for normal playing. This display is referred to as the "Play mode."

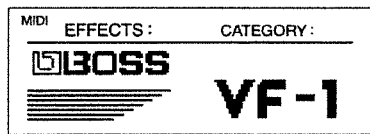

NOTE

This unit is equipped with a protection circuit. A brief interval (a few seconds) after power up is required before the unit will operate normally.

- * When the power is turned on, the last-selected Patch number will be selected.
 - * Depending on the location where the VF-1 is placed, the display may be difficult to read. In this case, adjust the display contrast (P.24).
4. Turn on the power of your other equipment in the order of effect processors → mixer → amp.

NOTE

Turn up the amp volume only after all devices have been powered on.

Turning off the power

1. Before turning off the power, check the following points.
 - Has the volume of the connected amp, etc. been turned completely down?
2. Turn off the power in the order of amp → mixer → other effect processors.
3. Press the [POWER] switch of the VF-1 to turn off the power.
4. Turn off the power on your sound generating devices (keyboard or other device).

Adjusting the Input Level

Adjust the signal from the input device to an appropriate level.

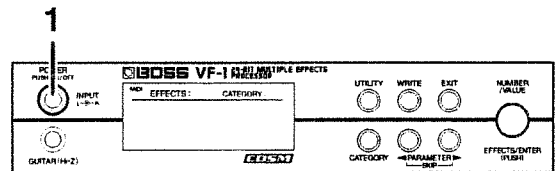

1. Rotate [INPUT L/R] to adjust the input level. Adjust this so that the level meter briefly reaches the peak level when the instrument is played most loudly.

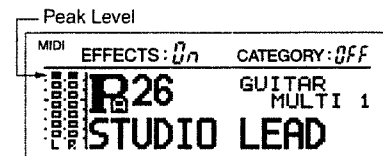

- * If the input level is not set appropriately, the VF-1 will not perform to its full potential.
- * Even though [INPUT L/R] is turned all the way down, the input level may not be "0."
- * If the level switch is set to the "-20 dBm" position and the level meter occasionally reaches the peak level even though [INPUT L/R] has been turned all the way down, change the level switch to the "+4 dBm" position.

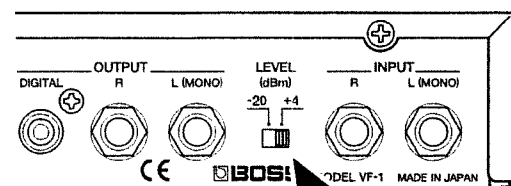

Selecting the effect sound

The VF-1 contains 400 effect settings covering a wide range of sounds. Each of these is called a **Patch**. The 400 patches are organized into four banks, each with 100 patches numbered 1–100.

To select the desired patch, you can operate the front panel or an external MIDI device to switch banks and patch numbers.



A “bank” contains 100 patches. There are four banks: Preset banks A and B, and User banks A and B.

Patches can be selected only when the screen display is in Play mode (showing the patch number). If the display is not in Play mode, press [EXIT] several times to select Play mode.

About the Screen Indications

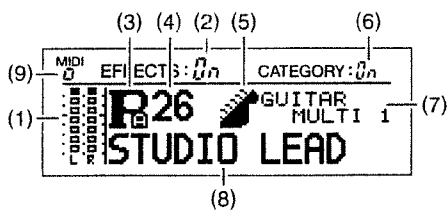

- (1) Level meter:
In Play mode, this shows the level of the input signal. When you are making effect settings, this shows the level of the input signal and the output levels from each effect (p.17, 31).
- (2) EFFECTS On/OFF:
This shows the status (on/off (bypass/mute)) of each effect.
- (3) Bank:
This shows the currently selected bank.
- (4) Patch number:
This shows the number of the currently selected patch.
- (5) Category:
This shows the category of the currently selected patch.
- * When the category switch is off (when the display indicates “CATEGORY OFF”), the categories will not be displayed.
- (6) Category search on/off:
This shows the status (on/off) of Category Search.
- (7) Algorithm name:
This shows the algorithm of the currently selected patch.
- (8) Patch name:
This shows the name of the currently selected patch.

- (9) MIDI indicator:
This indicator will light when the VF-1 is receiving MIDI messages.

Selecting a patch

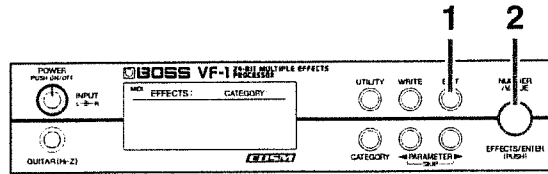

1. Make sure that the display indicates “CATEGORY OFF.” If it indicates “CATEGORY On,” press [EXIT] to make it read “CATEGORY OFF.”

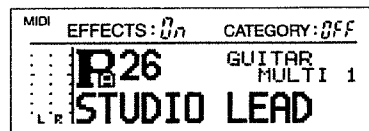

2. Rotate [NUMBER] to select the desired patch. The selected patch will appear in the display. Rotating the knob toward the right will move through the patches in increasing order of patch number, and rotating it toward the left will move in decreasing order. If you hold down [CATEGORY] as you rotate [NUMBER], the setting will change more rapidly.

Banks will change as follows.

Rotate to the right:

Preset A → Preset B → User A → User B → Preset A...

Rotate to the left:

Preset A → User B → User A → Preset B → Preset A...



















- * It is not possible to switch patches if the VF-1 is not in Play mode.
- * If the display indicates “CATEGORY On,” the Category Search function (see following item) is operating, so that not all patch numbers can be accessed in sequence by rotating [NUMBER].

Quickly finding the desired patch (Category Search)

The VF-1 classifies all patches by category (such as performance style or instrument).

The VF-1 provides a Category Search function that lets you select a category so that only the patches in that category are displayed. By using this function, you can view only the patches of the currently selected category, and rapidly find the patch you want.

The following categories are provided.

1. E.GUITAR 	10. MASTER 
2. A.GUITAR 	11. OTHERS1 
3. BASS 	12. OTHERS2 
4. KEYBOARD 	13. OTHERS3 
5. VOCAL 	14. ALL 
6. GROOVE 	15. PRESET-A 
7. REVERB 	16. PRESET-B 
8. RSS 	17. USER-A 
9. STUDIO 	18. USER-B 

* "OTHERS1," "OTHERS2," and "OTHERS3" are user categories. You can use them to categorize your own favorite patches. For details refer to "Assigning the category" (p.37).

* With the factory settings, none of the patches are assigned to "OTHERS1," "OTHERS2," or "OTHERS3" categories.

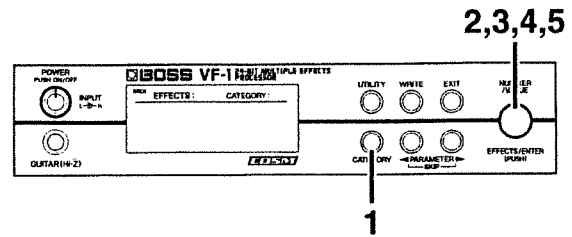

1. Press [CATEGORY] to select Category Search.

2. Rotate [NUMBER] to select the desired category.

If you press [EXIT] at this point, you will return to Play mode.

* Category search can be performed only from the front panel.

* Since the category display is not able to show all categories in a single screen, it is divided into several screens. Rotating [NUMBER] to move through the screens and select from all 18 different categories.

* You can use PARAMETER [◀ || ▶] to switch screens.

The current location is shown by the indicator at the right edge of the screen.

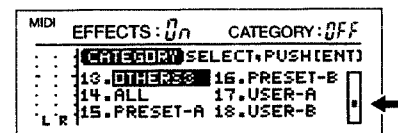
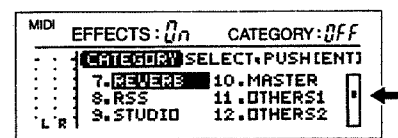
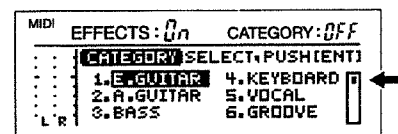

3. Press [ENTER].

This finalizes the category.

4. Rotate [NUMBER] to select the desired patch.

If you press [EXIT] at this point, you will return to step 2.

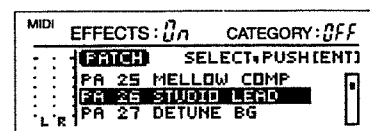

Section 1. Producing Sound

5. Press [ENTER].

The selected patch will be recalled, and you will return to Play mode.

At this time, the display will show the symbol of the selected category, and will indicate "CATEGORY On."

Now you can rotate [NUMBER] to select other patches of the same category.

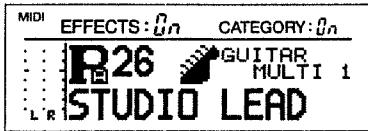

- * If you select "ALL" as the category, no category symbol will appear, and the display will indicate "CATEGORY OFF." In this case, rotating [NUMBER] will select from all patches.
- * After you have finished with Category Search, and wish to select from all patches, press [EXIT] to make the display read "CATEGORY OFF."

Selecting Patches with a Foot Switch

If an FS-5U foot switch (optional) is connected to the CTL 1/2 jack, you can change Patch numbers by operating the foot switch.

When connecting only one foot switch

If you use only one foot switch, you can use it to move either up or down (not both) through the Patch numbers.

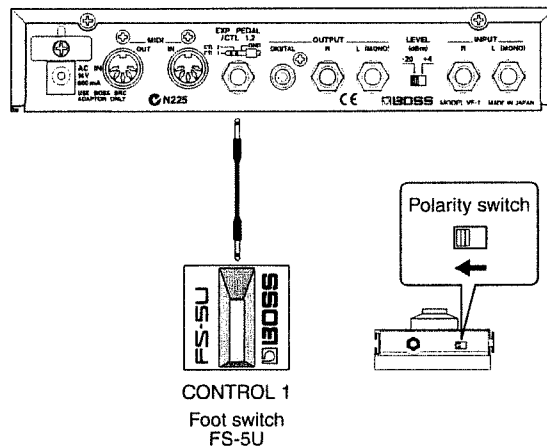

When using two foot switches

If you use a special cable (PCS-31; optional) to connect two foot switches, you can operate the foot switches to select patches in the same way as when rotating the [NUMBER] knob.

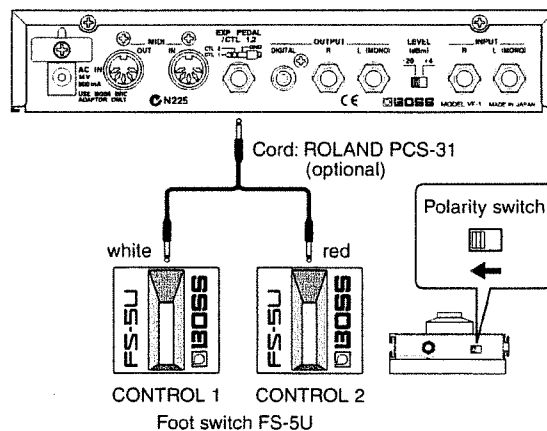

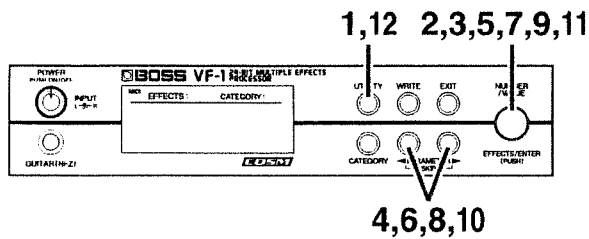

1. Press [UTILITY].
2. Rotate [VALUE] to select "SYSTEM."

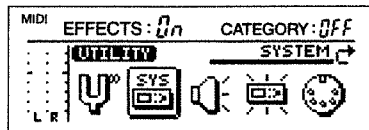

3. Press [ENTER].
4. Use PARAMETER [◀][▶] to access the following screen, and select "NUMBER U/D MIN."

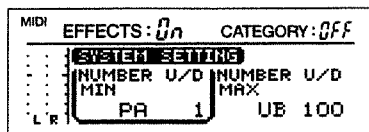

5. Rotate [VALUE] to select "PA 1."
6. Use PARAMETER [◀][▶] to select "NUMBER U/D MAX."
7. Rotate [VALUE] to select "UB100."
8. Use PARAMETER [◀][▶] to access the following screen, and select "CONTROL 1."
9. Rotate [VALUE] to select "NUMBER UP (DOWN)."

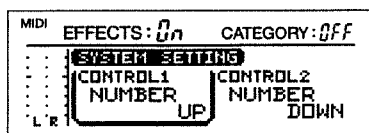

10. Use PARAMETER [◀][▶] to select "CONTROL 2."
11. Rotate [VALUE] to select "NUMBER DOWN (UP)."
12. Press [UTILITY] to return to Play mode.

* If you press [EXIT] in step 12, you will return to step 2. If you press [EXIT] once again, you will return to Play mode.

* In Play mode when the display indicates "CATEGORY On," you can step through patches of the same category. If you press [EXIT] in Play mode, the display will indicate "CATEGORY OFF," and you will be able to step through the range of patches that you specified by the "NUMBER U/D MIN" and "NUMBER U/D MAX" settings.

When using only one foot switch:

Each time you press the foot switch, the patch number will increase.

* If in step 8 you selected "NUMBER DOWN," the patch number will decrease.

* If you have connected only one pedal, the "CONTROL 2" setting will have no effect.

* You can change the range of patch numbers that are selected when you press the foot pedal. For details refer to "SYSTEM SETTING" (p.43).

When using two foot switches:

Each time you press CONTROL 1, the patch number will increase. Each time you press CONTROL 2, the patch number will decrease.

* If in steps 8 and 10 you select "NUMBER UP" and "NUMBER DOWN" in reverse, the result of pressing CONTROL 1 and CONTROL 2 will also be reversed.

• Selecting Effect Sounds with an FC-200 MIDI Foot Controller

If an FC-200 MIDI Foot Controller (optional) is connected, you can switch Patch numbers by pedal operations on the controller. For details refer to "VF-1 operation using the FC-200" (P.127).

• Selecting Effect Sounds by MIDI Messages

VF-1 Patches can be selected by Program Change messages from an external MIDI device.

For details refer to "Using MIDI to Operate the VF-1" (p.122).

Switching EFFECTS on/off

You can switch the effect sound on/off.

When EFFECTS is turned off, the input sound will be output without change, and no effect will be applied. If you wish to output only the direct sound, turn EFFECTS OFF.

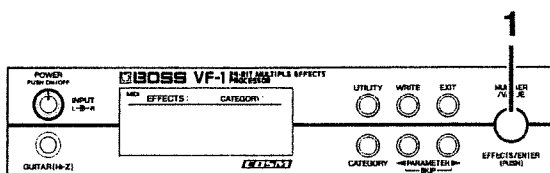

1. In Play mode, press [EFFECTS].

The EFFECTS on/off status will change.

When EFFECTS is turned off, the display will indicate "EFFECTS OFF."



- The EFFECTS on/off function can be changed to a Mute (silence) function. For details refer to "SYSTEM SETTING" (p.43).
- If a separately available BOSS FS-5U foot switch is connected, you can switch EFFECTS on/off in two ways. For details refer to "SYSTEM SETTING" (p.43).
- If an FC-200 MIDI foot controller (optional) is connected, you can use pedal operations to switch EFFECTS on/off. For details refer to "VF-1 operation using the FC-200" (p.127).
- MIDI Control Change messages can be used to switch EFFECTS on/off. For details refer to "Controlling parameters in real time (Control Assign)" (p.33), and "Using MIDI to control the VF-1." (p.122)

Tuning your instrument

The VF-1 has a built-in chromatic tuner. You can tune your instrument quickly without having to change connections. The built-in tuner can display the note names, and also allows you to adjust the standard pitch and the output level during tuning.

Displaying the tuner

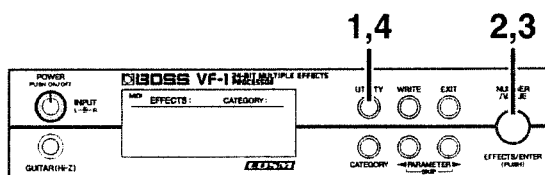

1. Press [UTILITY].

2. Rotate [VALUE] to select "TUNER."

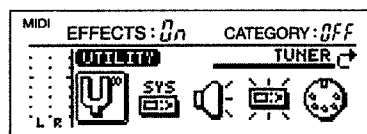

3. Press [ENTER].

The following display will appear.

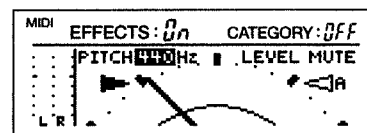

4. Press [UTILITY] to return to Play mode.

With the factory settings, the input sound will be muted (silenced) when the tuner is in use, and the input sound from the input jack (i.e., your guitar or bass) will not be output.

* If you press [EXIT] in step 4, you will return to step 2. If you press [EXIT] once again, you will return to Play mode.

- It is also possible to output the direct sound even while the tuner is being used.
For details refer to "Modifying the tuner settings" (p.24).
- If an FS-5U is connected to the CTL 1/2 jack, you can switch the TUNER on/off with the foot switch.
For details refer to "SYSTEM SETTING" (p.43).
- If an FC-200 MIDI Foot Controller (optional) is connected, you can switch the tuner on/off by pedal operations on the controller. For details refer to "VF-1 operation using the FC-200" (p.127).
- MIDI Control Change messages can be used to switch the Tuner on/off.
For details refer to "Controlling parameters in real time (Control Assign)" (p.33), and "Using MIDI to control the VF-1." (p.122)

About the tuner display

The tuner display includes the following contents.

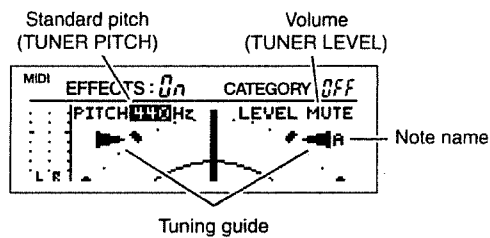

Tuning Procedure

1. Play a single unfretted note on the string you wish to tune. The note name closest to the string you played will appear in the display.

* Cleanly play a single note only on the string that you wish to tune.

2. Adjust the tuning until the note name of the string you played appears in the display.

guitar tuning

	6th string	5th string	4th string	3rd string	2nd string	1st string
guitar	E	A	D	G	B	E

3. Watch the tuning guide, and tune your instrument so that both the left and right guides light.

If the difference between the instrument and the correct tuning is within +/-50 cents, the tuning guide will indicate the amount of difference.

For example if the right-hand indicator is lit, your instrument is tuned above the displayed note (sharp). If the left-hand indicator is lit, your instrument is tuned below the displayed note (flat).

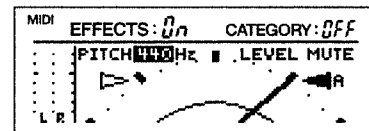

your instrument is tuned above the displayed note (#)

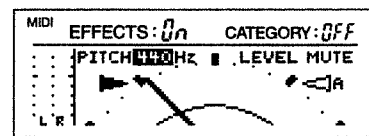

your instrument is tuned below the displayed note (♭)

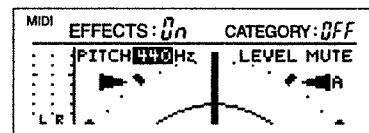

your instrument is tuned the displayed note

4. Repeat steps 1-3 to tune all the strings.

* When tuning a guitar that has a tremolo arm, tuning one string may cause the other strings to go out of tune. In such cases, first tune the strings to the approximate pitch (so that the note name is displayed), and then keep tuning each string until they are all in tune.

Modifying the tuner settings (Standard pitch/Volume)

Here you can make tuner settings. Make settings as appropriate for the way that you wish to use this function. The following items can be set.

- Standard pitch setting
- Volume setting during tuning

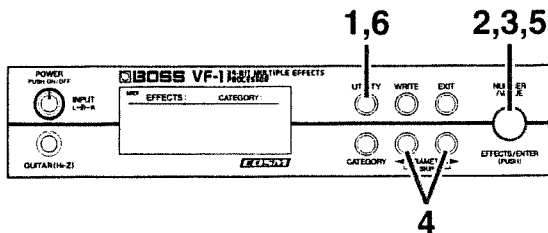

1. Press [UTILITY].
2. Rotate [NUMBER] to select "TUNER."
3. Press [ENTER].
4. Use PARAMETER [◀ || ▶] to move the cursor to "PITCH" if you wish to change the standard pitch, or to "LEVEL" if you wish to change the volume.
5. Rotate [VALUE] to modify the setting. If you hold down [CATEGORY] as you rotate [VALUE], the setting will change more rapidly.

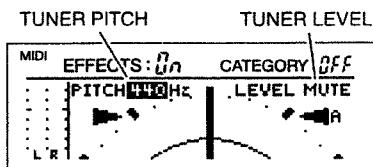

TUNER PITCH: 435–445 (Hz)

"Standard pitch" is the frequency of the A4 note (middle A on a piano) that is used as a standard to which all other notes are tuned. The VF-1 allows you to set the standard pitch over the range of 435–455 Hz.

* At the factory settings, this is set to 440 Hz.

TUNER LEVEL: MUTE, 1–100

Adjust the volume while tuning.

* With the factory settings, "MUTE" is selected.

6. Press [UTILITY] to return to Play mode.

Adjusting the display contrast

Depending on the location where you place the VF-1, the display may be difficult to read. In this case, adjust the display contrast.

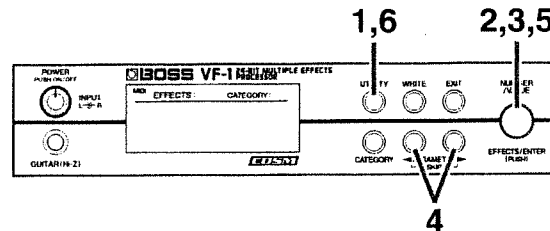

1. Press [UTILITY].
2. Rotate [VALUE] to select "SYSTEM."

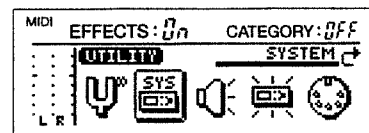

3. Press [ENTER].
4. Use PARAMETER [◀ || ▶] to select "CONTRAST."

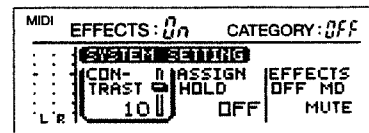

5. Rotate [VALUE] to adjust the contrast (1–16). If you hold down [CATEGORY] while you rotate [VALUE], the setting will change more rapidly.

6. Press [UTILITY] to return to Play mode.

* If you press [EXIT] in step 6, you will return to step 2. If you press [EXIT] once again, you will return to Play mode.

Section 2. Creating Sounds

On the VF-1, each of the different effect sounds are called “patches.” A patch consists of settings that specify the order in which the internal effects are connected, and the settings for each effect. The internal memory of the VF-1 contains 400 patches. This section explains how you can modify (edit) patch settings to create new effect sounds, and save them.

Before You Begin Creating Sounds

Before you begin creating sounds there are several things that you need to understand.

User banks and preset banks

The 400 patches of the VF-1 are organized into user banks and preset banks.

User banks

User banks can store original patches that you create.

There are two user banks, A and B, and each can store 100 patches.

Preset banks

Preset banks contain preset patches that are useful for a wide variety of situations and needs.

There are two preset banks, A and B, and each can store 100 patches.

* *It is not possible to rewrite the contents of a patch in the preset banks. Nor is it possible to save an original patch in a preset bank. However, you can edit a patch from a preset bank to create a new patch, and save it in a user bank.*

Algorithms

The “algorithm” determines how effects are connected internally, and how their parameters are structured. The VF-1 provides 36 different algorithms (PB1–36).

Each algorithm is designed to be useful in an actual situation, and provides an ideal setup for that situation. This makes editing easy and efficient. Individual effects within an algorithm can also be switched on/off, and you can change the order in which they are connected.

Settings that are stored in a patch

Each patch in the user banks contains the following settings.

- On/off of each effects processor
- Settings for each effects processor
- Output level / BPM setting
- Category setting
- Control assign (4 types)
- Name

The display screen

During editing, the following information is shown in the display.

Algorithm display

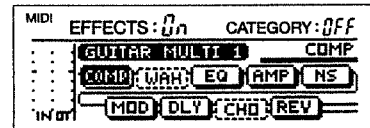

When a parameter value is being edited

Name of the effect being edited

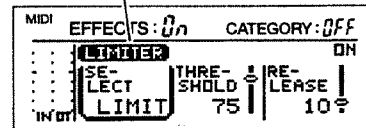

When [EXIT] was pressed to display Play mode

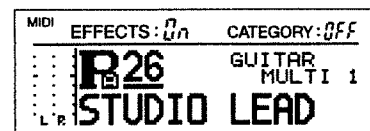

An underline is added to the patch number to indicate that the patch is being edited (modified).

Rapidly editing a patch (Quick Setting)

Each effect of the VF-1 provides various preset settings (effect settings). You can easily create new effect sounds simply by selecting these settings and combining them. This is called the Quick Setting function.

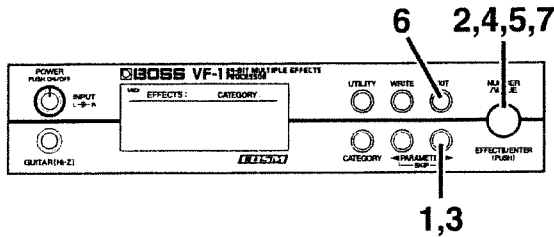

1. In Play mode, press PARAMETER [**▶**].
The following algorithm display screen will appear.

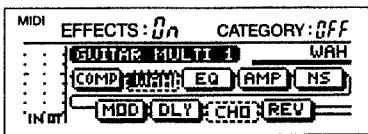

2. Rotate [VALUE] to select the effect for which you wish to use Quick Setting.
To move more rapidly between effects, hold down [CATEGORY] and rotate [VALUE].
3. Use PARAMETER [**▶**] to move the cursor to the effect on/off display.

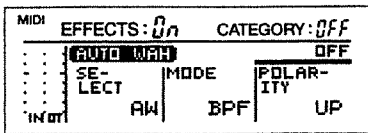

4. Rotate [VALUE] to make the display read "ON."

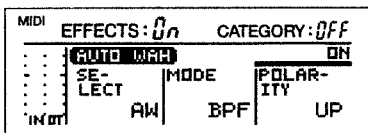

5. In the condition of step 4, continue rotating the [VALUE] knob to select the desired effect setting.
As you rotate [VALUE], the effect setting will change as follows.
Listen to the sound, and select the desired setting.

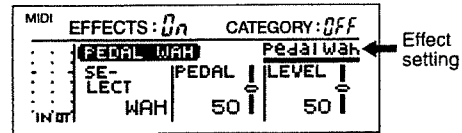

6. When you are finished making settings, press [EXIT].
7. Rotate [VALUE] to move the another effect.
8. Repeat steps 3-7 as necessary to complete the desired effect settings.

NOTE

The patch settings you modify are temporary, and will be lost if you select a different patch without writing the edited patch into memory. If you wish to keep the newly created patch, use the "Write operation (p.38)".

Editing a patch

About display selection

The display will respond as follows in patch creation:

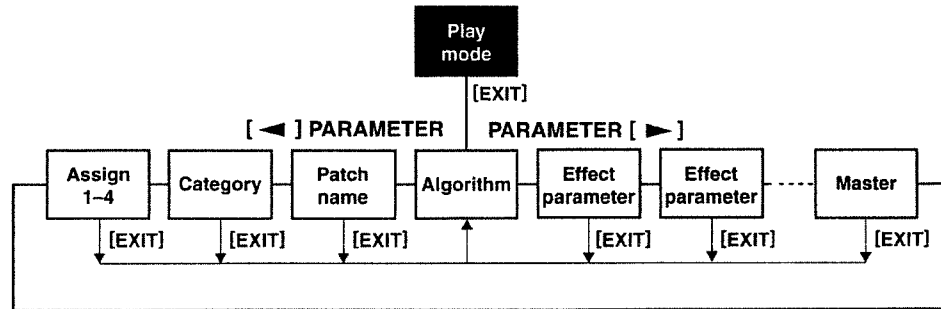

- Pressing **PARAMETER** [◀] and [▶] will change displays.
- Pressing **[EXIT]** in the selected display (except the **Algorithm** display) will retrieve the **Algorithm** display.
- Rotating **[NUMBER]** in the **Algorithm** display will allow you to move between the effects which are being shown in the display.

The Skip function (SKIP)

If you wish to change displays rapidly, press the **PARAMETER** ([◀] or [▶]) which you wish to move to then press the opposite one ([▶] or [◀]) at the same time.

Procedure

Here's the basic procedure for creating a patch.

1. From the user bank or preset bank, select a patch that is similar to the effect sound that you wish to create.
 - * You cannot alter the Algorithm that is used in the patch currently selected.
2. Copy the contents of the selected Patch to an unneeded Patch number. (p. 28)
 - In Play mode, press **[WRITE]** to copy the patch.
3. Edit (modify) the patch that you copied.
 - Turn each effect on/off. (p. 28)
Press **PARAMETER** [▶] to display the algorithm, use **[VALUE]** to select the effect that you wish to turn on/off, and use **[ENTER]** to turn it on/off.
 - Edit the settings of each effect. (p. 29)
 - Change the order of the effects. (p. 30)
 - Use **PARAMETER** [◀] [▶] to select the parameter that you wish to edit, and use **[VALUE]** to modify the value.
4. Assign a name to the new patch. (p. 37)
 - Use **PARAMETER** [◀] [▶] to select "NAME," and use **PARAMETER** [◀] [▶] and **[VALUE]** to assign the name.
5. Save the new patch in a user bank. (p. 38)
 - In the Edit screen, press **[WRITE]**, use **[VALUE]** to select the patch number into which the currently-edited patch will be stored, and press **[WRITE]**.

NOTE

The modified settings of the new effect sound are temporary, and will be lost if you select another Patch. If you want to save your new Patch, use "the Write operation" (P.38) to store it.

- * If you turn off the power while effect settings are being stored, the VF-1 may malfunction.

Copying a patch

Here's how to copy the settings of the currently selected patch into a different patch.

It is not possible to copy to a patch in a preset bank (PA1-PA100, PB1-PB100).

* It is not possible to copy while you are editing.

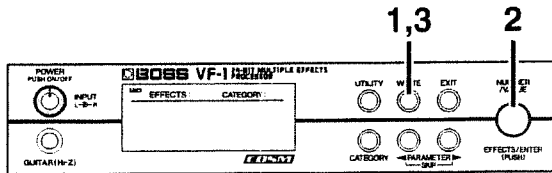

1. In Play mode, press [WRITE].
2. Rotate [NUMBER] to select the copy destination patch number.

The number will change more rapidly if you hold down [CATEGORY] as you rotate [NUMBER].

* It is not possible to select a patch number from a preset bank.



3. Press [WRITE].

After the data has been written, "Complete!" will be shown in the display, then you are returned to Play mode.

NOTE

Never turn off the power while the display shows "KEEP POWER ON!" If the power is turned off while this display is shown, the VF-1 may malfunction or its data may be lost.

* If you press [EXIT] in step 2, the copy operation will be cancelled and you will return to Play mode.

Turning an effect on/off

In the algorithm of the currently selected patch, you can turn on the effect(s) that you wish to use, and turn off any unused effect(s).

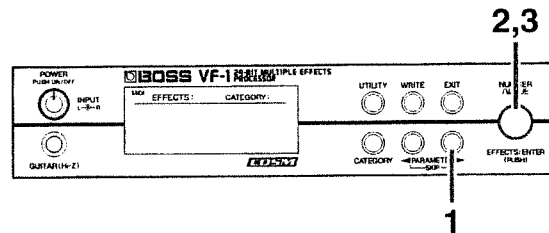

1. In Play mode, press [PARAMETER] [▶]. The following algorithm display screen will appear.

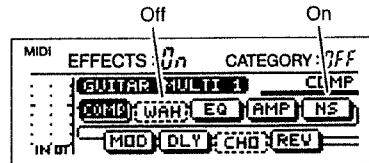

2. Rotate the [VALUE] knob to select the effect that you wish to turn on/off.

To move more rapidly between effects, hold down [CATEGORY] as you rotate [VALUE].

3. Press [EFFECTS] to turn the effect on/off.

MEMO

Depending on the algorithm, some effects cannot be switched on/off. For details refer to "Algorithm list" (p.49-p.90).

* You can also switch an effect on/off while making effect settings (p.29).

NOTE

If you wish to keep your modified settings, you must perform the Write operation (p.38).

Editing the settings of each effect

Each effect consists of several different parameters. You can create new effect sounds by modifying the settings of these parameters.

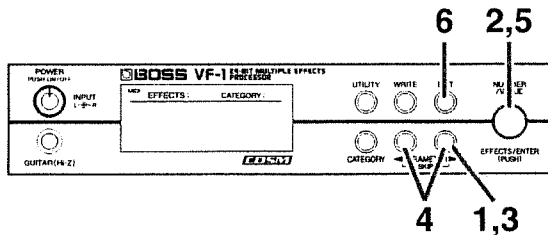

1. In Play mode, press PARAMETER [▶].
The following algorithm display screen will appear.

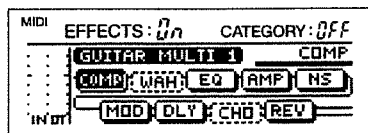

2. Rotate [VALUE] to select the effect whose settings you wish to edit.
3. Press PARAMETER [▶] to display the parameter screen.
4. Use PARAMETER [◀]([▶]) to select the parameter that you wish to edit.

< Display example >

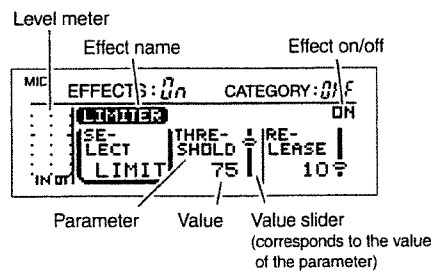

5. Rotate [VALUE] to edit the value.
The value will change more rapidly if you hold down [CATEGORY] while you rotate [VALUE].
6. Press [EXIT].
7. Repeat steps 2–6 to create your effect sound.

MEMO

Even when another parameter is selected, you can press [ENTER] to switch the effect on/off.

NOTE

If you wish to keep your modified settings, you must perform the Write operation (p.38).

FIN

The Skip function (SKIP)

You can skip to the first parameter in each effect by holding down PARAMETER [◀] ([▶]) for the direction in which you wish to go, and pressing the PARAMETER [▶] ([◀]) for the opposite direction. This is particularly useful for algorithms that have a large number of parameters.

Changing the order of the effects

For some algorithms, you can place SFX, MOD (modulation), and PREAMP/SP.SIM (speaker simulator) in different locations within the algorithm.

MEMO

The algorithms that allow SFX, MOD, and PREAMP/SP.SIM to be moved are noted in the "Algorithm list" (p. 49-90).

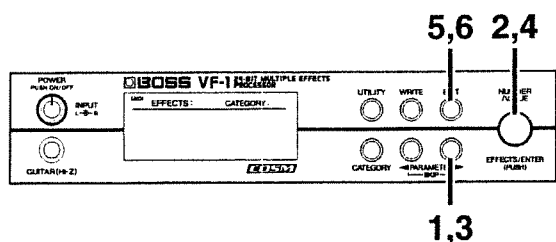

1. In Play mode, press PARAMETER [►].
The following algorithm display screen will appear.

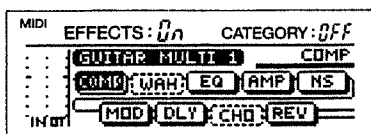

2. Rotate [VALUE] to select the effect (SFX, MOD or PREAMP/SP.SIM) that you wish to move.
3. Press PARAMETER [►] several times to select "POSITION."

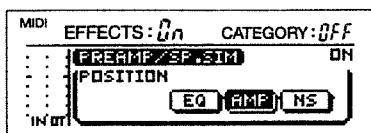

4. Rotate [VALUE] to move the location of the effect.
- * It is not possible to place SFX, MOD, or PREAMP/SP.SIM after "MASTER."
5. Press [EXIT] to access the following screen, and confirm the new location of the effect.

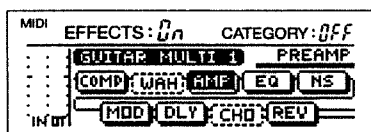

6. If you press [EXIT] once again, you will return to Play mode.

NOTE

If you wish to keep your settings, you must perform the Write operation (p. 38).

Checking the input/output levels of each effect

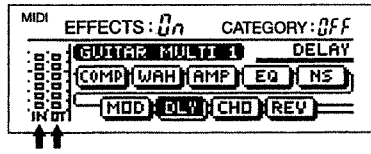

The algorithm screen of each effect and the parameter setting screen provide a meter function. The meter lets you see the input level at the beginning of the algorithm, and the output level of each effect.

e.x.: When you have made the DELAY parameter appear in the display

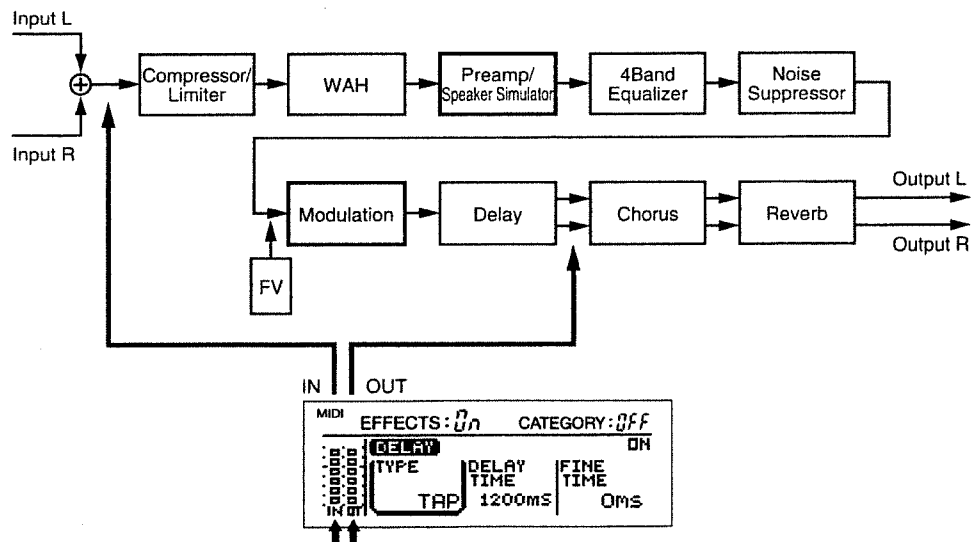

* If the input and/or output levels are excessive, the desired result will not be obtained. Check the input and output levels of each effect, and adjust the output level appropriately. Adjust the input level with [INPUT L/R] and check the output level of each effect with the level meter to adjust it to an appropriate level.

MEMO

The final output of the patch can be checked with the level meter in the "MASTER" parameter setting screen.

Copying effect settings (Effect Copy)

You can copy the settings of an individual effect from another patch to an effect in the currently selected patch. This function is convenient when you wish to use effects with similar settings in two or more patches.

- * **The Effect Copy can be applied to the effects that share the same Algorithm.**

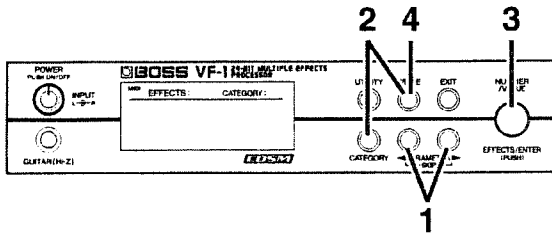

1. Use PARAMETER [◀ || ▶] to access the settings for the copy-destination effect.

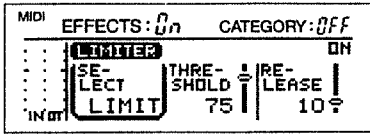

2. With the effect settings displayed, hold down [CATEGORY] and press [WRITE].

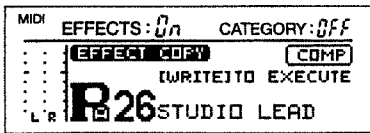

3. Rotate [VALUE] to select the patch number that contains the copy-source effect.

The number will change more rapidly if you hold down [CATEGORY] as you rotate [VALUE].

4. Press [WRITE].

The effect data will be copied, and you will return to the display screen in which you were.



If you wish to keep the modified settings, perform the Write operation (p.38).

Setting the output level

Here's how to adjust the final output level from the patch.

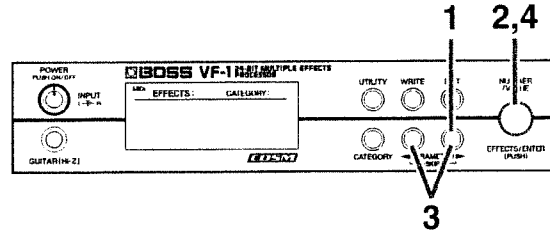

1. In Play mode, press PARAMETER [▶]. The following display will appear.

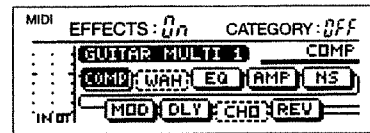

2. Rotate [VALUE] to select "MASTER."

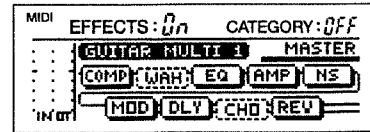

3. Use PARAMETER [◀ || ▶] to select "MASTER LEVEL."

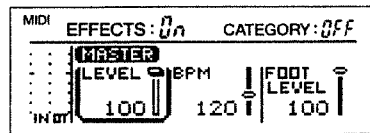

4. Rotate [VALUE] to adjust output level.

The setting will change more rapidly if you hold down [CATEGORY] as you rotate [VALUE].

Range: 0-100

- * *After adjusting "MASTER LEVEL," check the output level in the level meter (p.31).*

Controlling parameters in real time (Control Assign)

Here's how you can make settings so that you can control parameters from a foot switch or pedal connected to the VF-1 or from an external MIDI device. The controller that will affect each parameter can be specified independently for each patch.

Assign on/off

Four types of control assign can be turned on/off. Turn "ON" only the control assign setting that you wish to use. Be sure to turn "OFF" any unused control assign settings.

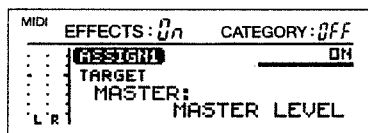

Parameters that can be controlled

Specify the parameter (target) you wish to control. The following parameters can be selected as targets.

- TUNER On/Off
- EFFECTS On/Off
- MASTER LEVEL
- MASTER BPM
- FOOT VOLUME (FOOT LEVEL)
- Effect On/Off for each effect
- Effect unit parameters

* You may assign two or more controllers to control the same target, but in this case, avoid using two of these controllers to simultaneously modify the target parameter. This can produce noise.

Target value range

Operations on the external device will modify the value of the target parameter within the range of the "minimum (TARGET MIN)" and "maximum (TARGET MAX)" values you specify.

For on/off-type controllers such as foot switches, "Off" will produce the "minimum value" and "On" will produce the "maximum value." For continuous controllers such as expression pedals, the value will change within the range of the specified "minimum" and "maximum." If the target is an on/off type parameter, it will be switched on or off by values above or below the central value of the controller.

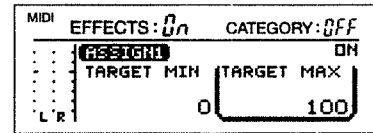
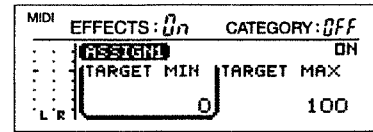

● When using the foot switch

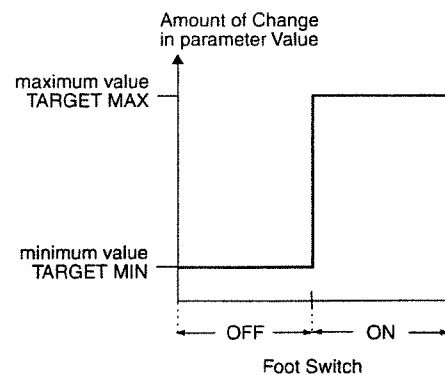

● When using the expression pedal

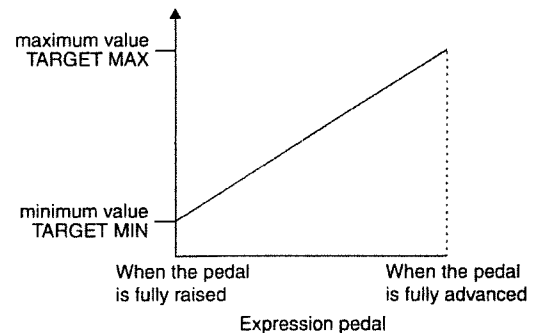

● **When controlling the ON/OFF target with the expression pedal:**

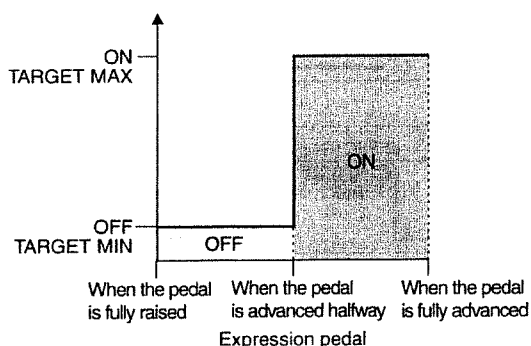

- * The range available for setting will depend on the selected target.
- * If you set the "TARGET MIN" above the "TARGET MAX," the direction of parameter change will be reversed.
- * If after setting the "TARGET MIN" and "TARGET MAX" values you then change the target, the settings may change. After changing the target, check the "TARGET MIN" and "TARGET MAX."

The controller that will control the parameter

Selection for the controller (source) that will control the target parameter.

The following controllers can be selected as sources.

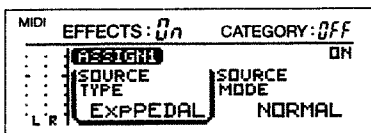

ExpPEDAL:

An expression pedal connected to the expression pedal jack (optional: EV-5 (Roland), FV-300L + PCS-33 (Roland))

CONTROL 1,2:

A foot switch (optional: FS-5U, FS-5L, FS-1 (Roland), DP-2 (Roland) etc.) connected to the CTL 1/2 jack

MIDI-7:

The expression pedal of an FC-200 MIDI Foot Controller (optional)

MIDI-80:

The control pedal of an FC-200 MIDI Foot Controller (optional)

MIDI-1-31, 64-95:

Control Change messages (MIDI-1-31, 64-95) from an external MIDI device

The result of operating a foot switch

This setting determines how the target parameter value will be affected when you operate a momentary-type foot switch (optional: FS-5U, DP-2 (Roland), etc.).

NORMAL:

The parameter will normally be off (minimum value), and will be on (maximum value) only while the foot switch is depressed.

TOGGLE:

The parameter will switch between off (minimum) and on (maximum) value each time you press the foot switch.

- * Set this to "NORMAL" when a latch-type foot switch (sold separately: FS-5L, FS-1 (Roland) etc.) is connected, or when something other than an expression pedal is selected as the controller.

Momentary-type and latch-type foot switches

- If you use a foot switch to switch Effect On/Off

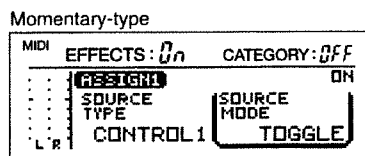
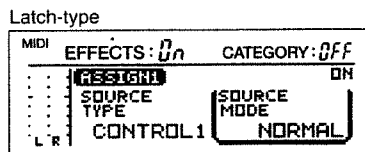

You may use either a momentary-type or a latch-type foot switch. When using a momentary-type, select "TOGGLE." When using a latch-type, select "NORMAL." In either case, Effect On/Off will alternate each time you press the foot switch.

- If you want an effect to become stronger while you depress a foot switch, or for the effect to be on only while the foot switch is depressed

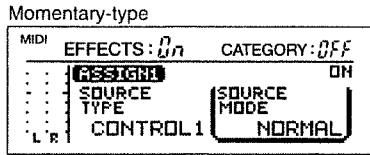

Use a momentary-type foot switch, and select “NORMAL.” In this case, the setting (on/off) will depend on whether the foot switch is depressed or not. This type of operation is not possible with a latch-type foot switch.

Control Value Range

If a continuously variable controller such as an expression pedal or pitch bend lever has been selected as the control source, you can specify the range of values which will affect the target parameter. The value of the target parameter will not be affected by controller movements outside this specified range, but will remain at the “Maximum” or “Minimum” value.

When sets the SOURCE MIN: 40 and SOURCE MAX: 80

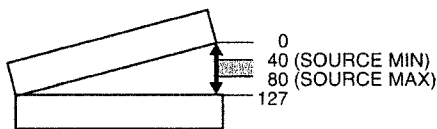
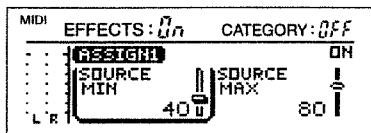

- * The state in which the pedal is fully raised is “SOURCE=0,” and the state in which the pedal is fully advanced is “SOURCE=127.”

The parameter value will change from TARGET MIN to TARGET MAX as the pedal is operated (from SOURCE MIN to SOURCE MAX). If the pedal is advanced further than SOURCE MAX, or raised to less than SOURCE MIN, the parameter value will be maintained at TARGET MAX or TARGET MIN respectively.

Controller: Expression Pedal

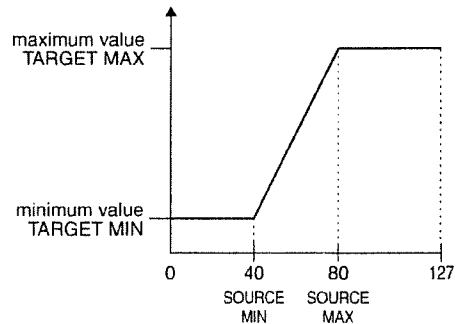

If effect on/off has been specified as the target, on/off will occur at the central value between SOURCE MIN and SOURCE MAX. If the pedal is advanced further than SOURCE MAX or raised to less than SOURCE MIN, the respective on or off setting will be maintained.

Controller: Expression Pedal

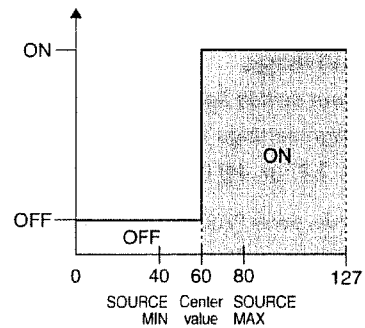

- * When you use an on/off-type controller such as a foot switch, set the SOURCE MIN to “0” and the SOURCE MAX to “127.” If you set them to any other values, the parameter values may remain unchanged.
- * SOURCE MAX cannot be set to a value that is less than Number Min.

MEMO

For details on setting TARGET MIN and TARGET MAX, refer to “Target value range” (p.33).

Section 2. Creating Sounds

Set the Control Assign as shown below according to the connected controller.

	SOURCE TYPE	SOURCE MODE	SOURCE MIN	SOURCE MAX
Expression pedal	Exp PEDAL	NORMAL	0-126	1-127
Foot switch (latch-type)	CONTROL 1,2	NORMAL	0	127
Foot switch (momentary-type)	CONTROL 1,2	TOGGLE, NORMAL	0	127
MIDI	MIDI-1-31 MIDI-64-95	TOGGLE, NORMAL	0-126	1-127

- * When the expression pedal is connected, set the SOURCE MIN and MAX to your taste.
- * When using a footswitch of the Momentary type, you can control the parameters either by setting the SOURCE MODE to "NORMAL" or "TOGGLE." The effect you can attain, however, will differ.

Making settings

- * When the foot switch has been set to source, the control assign settings will be ignored unless the "CONTROL 1,2" (p. 44) is set to "ASSIGNABLE."

1. In Play mode, press PARAMETER [▶].

The following display will appear.

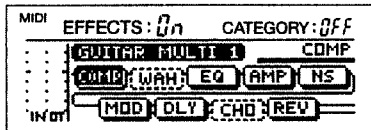

2. In Play mode, press PARAMETER [◀] several time to select "ASSIGN1."

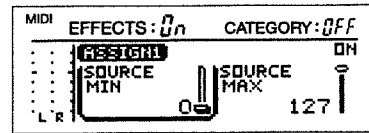
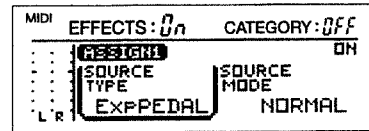
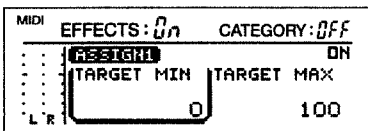
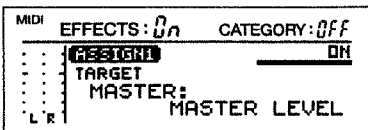

3. Use PARAMETER [◀ || ▶] to select the parameter that you wish to assign.
4. Rotate [VALUE] to change the assignment. The change will occur more rapidly if you hold down [CATEGORY] while you rotate [VALUE].
5. Repeat steps 2-4 to complete the desired control assign (ASSIGN 1-4) settings.

MEMO

Even when another parameter is selected, you can press [ENTER] to switch assign on/off.

- * Unused control assignments should be set to "ASSIGN OFF."

NOTE

If you wish to keep your settings, perform the Write operation (p.38).

Assigning the category

You can assign a category for each patch.

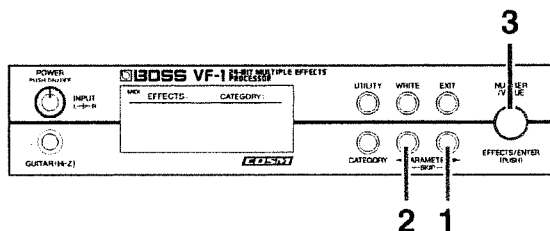

1. In Play mode, press PARAMETER [▶].
The following display will appear.

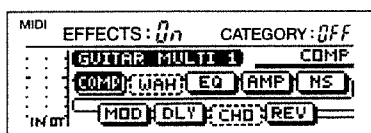

2. Press PARAMETER [◀] to select "CATEGORY."

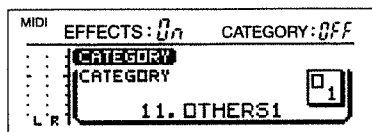

3. Rotate [VALUE] to assign the category.
The change will occur more rapidly if you hold down [CATEGORY] while you rotate [VALUE].

MEMO

For the available categories, refer to p. 19.

* The following categories cannot be selected.

- PRESET-A
- PRESET-B
- USER-A
- USER-B

NOTE

If you wish to keep your settings, perform the Write operation (p. 38).

Editing the patch name

Each patch can be given a name (patch name) of up to 13 characters. You can assign a name that reflects the type of sound you created, or the song in which the patch is used.

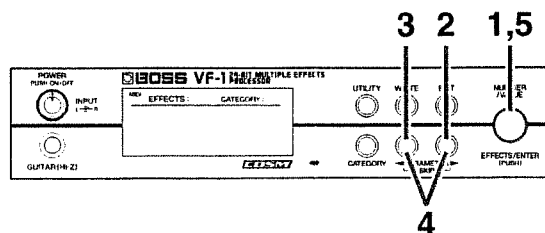

1. In Play mode, rotate [NUMBER] to select the patch whose name you wish to edit. (p.18)
2. Press PARAMETER [▶].
The following display will appear.

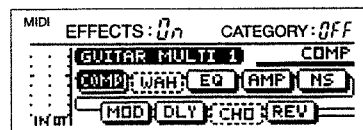

3. Use PARAMETER [◀] to access the "NAME" display.
4. Use PARAMETER [◀||▶] to move the cursor to the character that you wish to change.

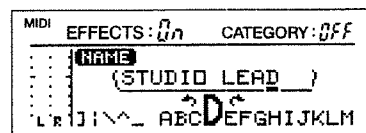

5. Rotate [VALUE] to change the character.
The change will occur more rapidly if you hold down [CATEGORY] as you rotate [VALUE].

The following characters can be used.

- Uppercase alphabet
- Lowercase alphabet
- Numerals
- Symbols
- (Space)

By pressing [ENTER], you can switch the type of the character where the cursor is located.

- Uppercase alphabet -> Lowercase alphabet ->
- Numerals -> Space -> Uppercase alphabet -> ...



If you wish to keep your settings, perform the Write operation (p. 38).

Canceling your edits

Here's how you can cancel the changes you made, and return to the unmodified settings.

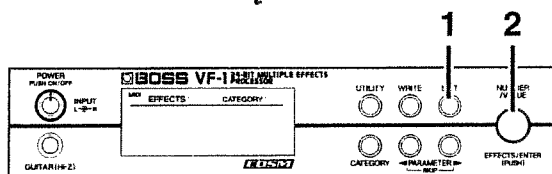

1. While editing, press [EXIT] several times to return to Play mode.
2. Rotate [NUMBER].
A different patch will be selected. Your modifications will be discarded, and the patch will return to its previous condition.

Saving the changes you make (the Write operation)

Changes you make to a patch are temporary. The patch will return to its previous condition if you switch to a different patch. If you wish to keep the changes you make, you must perform the Write operation.

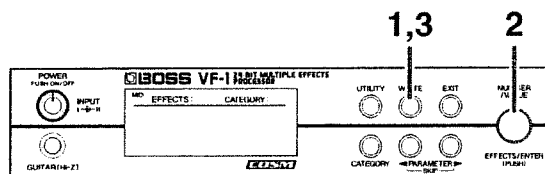

1. When you have finished making the desired settings, press [WRITE].
The following display will appear.

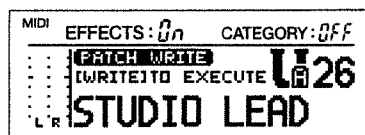

2. Rotate [VALUE] to select the write-destination patch.
 - * If you wish to store the new settings in the original Patch number, this step is not necessary.
 - * It is not possible to select a preset bank patch as the write destination. If you've modified a preset bank patch, select a user bank patch as the write destination.
 - * Press [EXIT] to cancel the Write operation and return to Play mode.
3. Press [WRITE].

The settings you modified will be saved in the patch you selected in step 2.
After the data has been written, "Complete!" will be shown in the display, then you are returned to Play mode.



Never turn off the power while the display shows "Keep Power ON!" If the power is turned off while this display is shown, the VF-1 may malfunction or its data may be lost.



While you are editing a patch, you can press [WRITE] at any time to save your settings.

Ways to use control assign

Using an expression pedal

Using an expression pedal to operate PEDAL WAH in the "GUITAR MULTI 1" algorithm

Here's how you can use an expression pedal to control the PEDAL WAH in realtime.

Connections

Make connections as shown in the diagram.

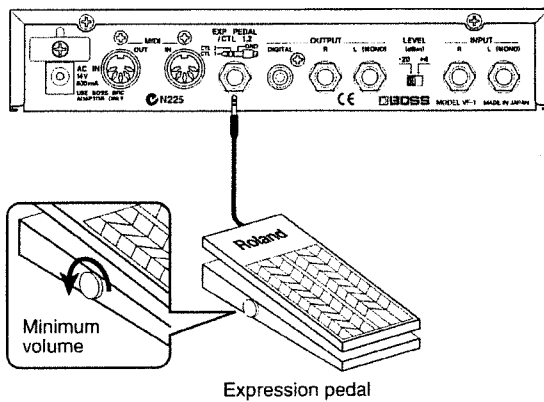

NOTE

Use only the specified expression pedal (BOSS FV-300 + PCS-3 (Roland) or EV-5 (Roland); sold separately). By connecting any other expression pedals, you risk causing malfunction and/or damage to the unit.

* Set the minimum volume on the expression pedal connected to the EXP PEDAL jack to the "MIN" position. Unless the minimum volume is set to "MIN," the expression pedal will not work correctly.

Settings

Use the following procedure to make settings.

1. Set WAH "EFFECT" to "ON." (refer to p.28)
2. Set SELECT to "WAH." (refer to p.29)
3. Set "ASSIGN 1" of the patch. (refer to p.33)

ASSIGN 1:	ON
TARGET:	WAH (PEDAL WAH): PEDAL
TARGET MIN:	0
TARGET MAX:	100
SOURCE TYPE:	ExpPEDAL
SOURCE MODE:	NORMAL
SOURCE MIN:	0
SOURCE MAX:	127

* Adjust "TARGET MIN," "TARGET MAX," and "SOURCE MIN," "SOURCE MAX" as desired.

4. Set "ASSIGN 2," "ASSIGN 3," and "ASSIGN 4" to "OFF." (refer to p.33)

NOTE

If you wish to keep your settings, perform the Write operation (p.38).

Using two foot switches

Using two foot switches with the "GUITAR MULTI 1" algorithm to switch the REVERB effect on/off and change the "DELAY TIME" of the DELAY

Connections

Make connections as shown in the diagram.

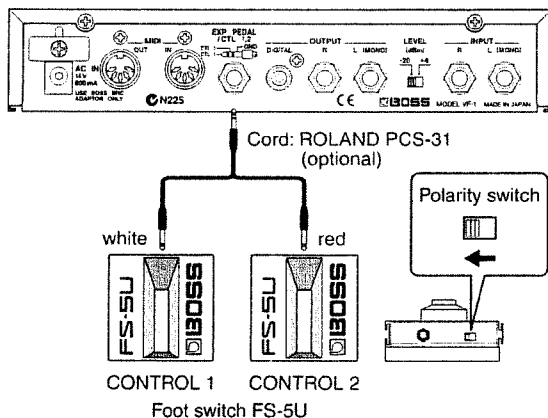

- * Use two FS-5U (optional) foot switches.
- * In order to connect two foot switches to the VF-1, you will need a separately sold PCS-31 (Roland).
- * If connecting a footswitch (FS-5U; optional) to the CONTROL 1/2 jack, set the polarity switch as shown above. Unless the polarity switch is set correctly, the foot switch will not work properly.

Settings

Use the following procedure to make settings.

1. In "SYSTEM SETTING" (Utility), set "CONTROL 1" and "CONTROL 2" to "ASSIGNABLE." (refer to p. 44)
2. Set DELAY and REVERB "EFFECT" to "ON." (refer to p. 28)
3. Set "ASSIGN 1" and "ASSIGN 2" of the patch. (refer to p.33)

ASSIGN 1: ON
 TARGET: DELAY: DELAY TIME
 TARGET MIN: 300 ms
 TARGET MAX: 1300 ms
 SOURCE TYPE: CONTROL 1
 SOURCE MODE: NORMAL
 SOURCE MIN: 0
 SOURCE MAX: 127

ASSIGN 2: ON
 TARGET: REVERB: ON/OFF
 TARGET MIN: OFF
 TARGET MAX: ON
 SOURCE TYPE: CONTROL 2
 SOURCE MODE: TOGGLE
 SOURCE MIN: 0
 SOURCE MAX: 127

- * The Delay Time will change only while the foot switch is pressed.
- * You can adjust the "TARGET MIN" and "TARGET MAX" of "ASSIGN 1" as desired.

4. Turn "ASSIGN 3" and "ASSIGN 4" to "OFF." (refer to p.33)

- * When using a foot switch to control parameters, set "SOURCE MIN" and "SOURCE MAX" to "SOURCE MIN 0" and "SOURCE MAX 127" respectively.
- * Control pedal 2 can also be operated using a latch-type foot switch. When using a latch-type foot pedal, set "SOURCE MODE" to "NORMAL."



If you wish to keep your settings, perform the Write operation (p. 38).

Using an expression pedal (example)

Using a pedal to operate the wah of the "GUITAR MULTI 1" algorithm, and turning the wah on/off without changing the patch (Use as a wah pedal)

Connections

Make connections as shown in the diagram.

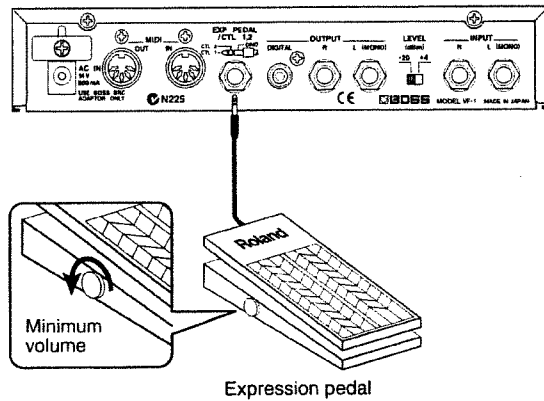

NOTE

Use only the specified expression pedal (BOSS FV-300 + PCS-33 (Roland) or EV-5 (Roland); sold separately). By connecting any other expression pedals, you risk causing malfunction and/or damage to the unit.

Settings

Use the following procedure to make settings.

1. Set the WAH "EFFECT" to "On." (refer to p.28)
2. Set the SELECT to "WAH." (refer to p.29)
3. Make patch settings for "ASSIGN 1" and "ASSIGN 2." (refer to p.33)

ASSIGN 1: **ON**
 TARGET: WAH (PEDAL WAH): PEDAL
 TARGET MIN: 0
 TARGET MAX: 100
 SOURCE TYPE: ExpPEDAL
 SOURCE MODE: NORMAL
 SOURCE MIN: 0
 SOURCE MAX: 50

ASSIGN 2: **ON**
 TARGET: WAH: ON/OFF
 TARGET MIN: ON
 TARGET MAX: OFF
 SOURCE TYPE: ExpPEDAL
 SOURCE MODE: TOGGLE
 SOURCE MIN: 80
 SOURCE MAX: 120

With these settings, moving the expression pedal in the range of 0-99 will turn the wah on, producing a wah effect. Advancing the pedal to 100 or beyond will turn the wah off. In this way, you can use the pedal to turn the effect on/off.

4. Turn the "ASSIGN 3" and "ASSIGN 4" parameters "OFF." (refer to p.33)



The pedal will be easier to operate if you insert a rubber eraser etc. into the expression pedal where it is positioned at a source value of approximately 99.

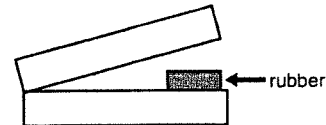

NOTE

If you wish to keep your settings, perform the Write operation (p. 38).

Section 3. Overall Settings (Utility)

Here's how you can access the various Utility screens to make settings that apply to the entire VF-1, such as tuner settings and system settings. Make these settings as appropriate for the situation or setup in which you are using the VF-1.

Utility functions

There are five Utility functions, as follows.

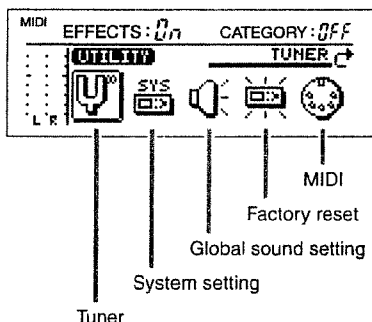

How to make settings

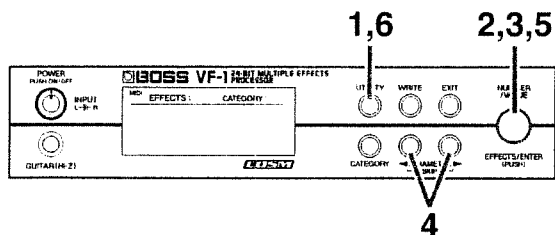

1. Press [UTILITY].
2. Rotate [VALUE] to select the desired Utility function.

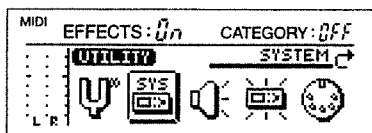

3. Press [ENTER].
4. Use PARAMETER [◀] [▶] to select the parameter that you wish to adjust.



5. Rotate [VALUE] to change the setting. The change will occur more rapidly if you hold down [CATEGORY] as you rotate [VALUE].

6. Press [UTILITY] to return to Play mode.

- * If you wish to save "MIDI PC MAP" settings, you must press [WRITE]. For details refer to "Setting the Program Change Map" (p.124).
- * If you press [EXIT] in step 6, you will return to step 2. If you press [EXIT] once again, you will return to Play mode.

TUNER

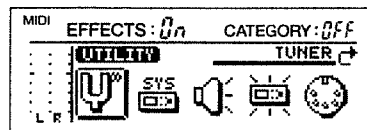

Here you can make tuner-related settings.

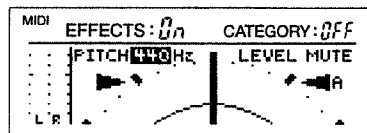

TUNER PITCH: 435-445 (Hz)
TUNER LEVEL: MUTE, 1-100

For details refer to "Modifying the tuner settings" (p. 24).

SYSTEM SETTING

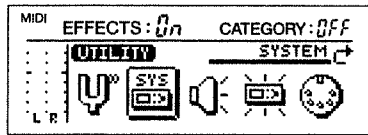

Here you can make basic system settings for the VF-1, such as the display contrast (p.24), output settings for when "EFFECTS OFF" (p. 22) is selected, settings for when foot switches (p.36) are connected to the CTL 1,2 jack, and user scale settings (p.101) for the Harmonist.

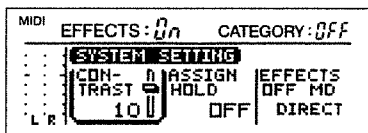

CONTRAST (display contrast): 1–16

For details refer to "Adjusting the display contrast" (p. 24).

ASSIGN HOLD: ON, OFF

If control assign settings have been made so that effect parameters can be controlled in realtime, this setting determines how the VF-1 will act when you switch patches while controlling parameters.

ON:

Controller operations will be reflected by the newly-selected patch even after you switch patches.

OFF:

Controller operations will not be reflected by the newly-selected patch. Each time you switch patches, the target will be set to the value specified by the patch.

EFFECTS OFF MD (Effects off mode)

DIRECT, MUTE

Specifies how output is to be handled when Bypass is switched on.

DIRECT:

Only the direct sound from the input jacks will be output.

MUTE:

All output jacks will be muted (silenced).

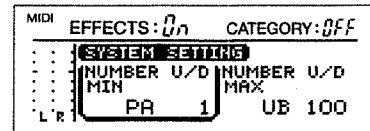

NUMBER U/D MIN (Minimum number)

PA1 (PRESET A1) – PA100 (PRESET A100) –

PB1 (PRESET B1) – PB100 (PRESET B100) –

UA1 (USER A1) – UA100 (USER A100) –

UB1 (USER B1) – UB100 (USER B100) –

Specifies the lowest patch (smallest number) that will be selected by a foot switch connected to the CTL 1,2 jack.

NUMBER U/D MAX (Maximum number)

PA1 (PRESET A1) – PA100 (PRESET A100) –

PB1 (PRESET B1) – PB100 (PRESET B100) –

UA1 (USER A1) – UA100 (USER A100) –

UB1 (USER B1) – UB100 (USER B100) –

Specifies the highest patch (greatest number) that will be selected by a foot switch connected to the CTL 1,2 jack.

- * When you use a foot switch to switch patches up to the upper limit (lower limit), you will then "fold over" to the lower limit (upper limit).
- * In Play mode if "CATEGORY On" is displayed, you can step through patches of the same category. In Play mode if you press [EXIT], the display will change to "CATEGORY OFF," and you will be able to switch patches within the range specified by "NUMBER U/D MIN" and "NUMBER U/D MAX."
- * The "NUMBER U/D MIN" and "NUMBER U/D MAX" settings will have no effect unless you select "NUMBER UP" and/or "NUMBER DOWN" for CONTROL1 and/or CONTROL2.

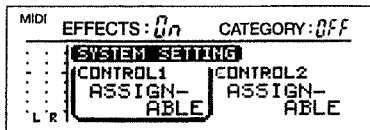

CONTROL 1, 2

EFFECTS ON/OFF, TUNER, NUMBER DOWN, NUMBER UP, ASSIGNABLE

You can specify the foot switch functions when the foot switch is connected to CTL 1,2 jack.

* For foot switch connections and settings, refer to "Connecting an expression pedal or foot switch" (p. 16) and "The result of operating a foot switch" (p. 34).

EFFECTS ON/OFF:

The jack will function as a remote jack for turning EFFECTS on/off. Connect a momentary-type foot switch (optional: FS-5U etc.)

TUNER:

The jack will function as a remote jack for turning the tuner on/off. Connect a momentary-type foot switch (optional: FS-5U etc.)

NUMBER DOWN:

The jack will function as a remote jack for decreasing the Patch number. Connect a momentary-type foot switch (optional: FS-5U etc.) (p. 20)

NUMBER UP:

The jack will function as a remote jack for increasing the Patch number. Connect a momentary-type foot switch (optional: FS-5U etc.) (p. 20)

ASSIGNABLE:

The jack will function as a controller jack for the Control Assign function. Connect the type of foot switch that is appropriate for the control target you select.

Connecting two foot switches (optional) and a PCS-31 connecting cable (optional)

Two control functions (CONTROL 1 and CONTROL 2) can be controlled by foot switch.

Connecting one foot switch

One control function (CONTROL 1) can be controlled by foot switch.

Creating a user scale

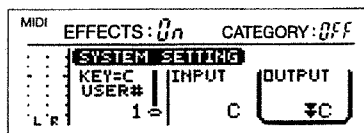

If the Harmonist function (p.101) does not produce the harmony you intend, you can create your own User Scale to produce the desired harmonies.

Up to 5 user scales can be created.

For details refer to "HARMONIST: Creating a user scale" (p. 101).

* The user scale will have no effect if you are using a patch whose algorithm does not include the Harmonist, or if the Harmonist is turned off.

GLOBAL SOUND SETTINGS

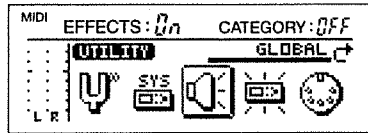

The VF-1 allows you to modify the settings of all patches in common. This is called the Global function. By using the Global function, you can leave the settings of each patch as they are, and quickly make changes in your settings as appropriate for the equipment you are using or the situation in which you are playing.

In particular when a guitar is connected, it is convenient to use the Global function to optimize the VF-1 for the amp that you are using.

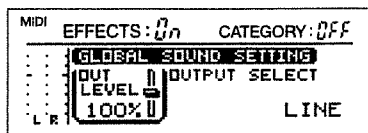

OUT LEVEL (output level): 0%–200%

Adjusts the output level that is specified for each patch.

OUTPUT SELECT

GUITAR AMP (COMBO), GUITAR AMP (STACK),
POWER AMP (COMBO), POWER AMP (STACK), LINE

Set the VF-1 to the optimal settings for the amp to which it is connected.

- * **This setting is effective when a guitar is connected to the VF-1, and you are playing the sound through a guitar amp.**
- * When you are using the Patch that uses the algorithm BASS MULTI, no effect will be obtained if the value other than LINE is selected.
- * The global sound setting function will not operate if the algorithm of the currently selected patch does not contain the "Preamp/Speaker Simulator," or if the "Preamp/Speaker Simulator" has been turned off.

In order to take fullest advantage of the VF-1's potential, we recommend that you set "OUTPUT SELECT" to either "POWER AMP (COMBO)" or "POWER AMP (STACK)," and connect it to the RETURN or MAIN IN jack of your guitar amp. If your guitar amp does not have a RETURN or MAIN IN, connect it to the normal input (if the amp has L and H inputs, use the L input), and set the tone controls of the guitar amp BASS=0, MIDDLE=10, and TREBLE=0 so that the frequency response is flat. If your amp has switchable channels, use the normal (clean) channel.

* *The suggested settings of BASS=0, MIDDLE=10, and TREBLE=0 are general guidelines. The optimal settings may be different for your amp. Adjust the tone controls of your amp so that its frequency response is flat.*

GUITAR AMP (COMBO):

Use this setting when connecting to the guitar input of a combo-type guitar amp (i.e., amp and speaker contained in a single unit).

GUITAR AMP (STACK):

Use this setting when connecting to the guitar input of a stack-type guitar amp (i.e., amp and speaker in separate units).

POWER AMP (COMBO):

Use this setting when connecting to the RETURN or MAIN IN of a combo-type guitar amp.

POWER AMP (STACK):

Select this when connecting to a power amp + speaker, or when connecting to the RETURN or MAIN IN of a stack-type guitar amp.

LINE:

Use this setting when connecting to a mixer or MTR.

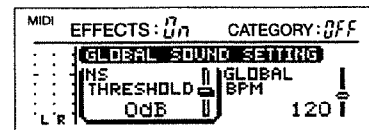

NS THRESHOLD (Noise suppressor threshold)

-20 dB – +20 dB

Adjusts the threshold level of the noise suppressor that is included in each patch. When you connect a different guitar, it is effective to adjust this according to the output level of your guitar.

Section 3. Overall Settings (Utility)

- * If you wish to use the settings of each patch without change, set this to "0 dB."
- * The noise suppressor threshold will have no effect for a patch whose algorithm does not include the noise suppressor, or if the noise suppressor is turned off.

GLOBAL BPM: 40–250, MIDI

By setting the BPM to match the tempo of your performance, you can make the sound change in synchronization with the tempo. For example by setting the "RATE" of a flanger to "BPM ♩ - ♩," you can make the sound modulate in synchronization with the tempo.

The GLOBAL BPM setting is common to all patches.



BPM (Beats Per Minute) indicates the number of quarter notes per minute.



In order to use GLOBAL BPM, you must make the following two settings.

1. Set the parameter of the effect to "BPM ♩ - ♩"
2. Set the master (p.105) "MASTER BPM" to "GLOBAL"



In the following cases, GLOBAL BPM will have no effect.

- If "BPM ♩ - ♩" is not shown in the display when "MASTER" (p.105) is selected.
- If the effect parameter is set to "BPM ♩ - ♩" but that effect is turned off

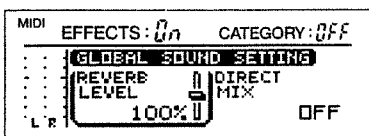

REVERB LEVEL: 0%–200%

Adjusts the reverb level of the reverb that is included in each patch. It is effective to adjust the reverb level as appropriate for the natural reverberation of the location where you are playing.

- * The reverb level will have no effect for a patch whose algorithm does not include reverb, or if reverb is turned off.

DIRECT MIX: OFF, PATCH

For algorithms that include a spatial-type effect, you can specify whether or not the direct sound will be output. This is useful when the VF-1 is connected to the AUX SEND / RETURN of a mixer.

OFF:

The direct sound will not be output.

PATCH:

The direct sound will be turned on/off according to the settings of the selected patch.

- * In some Algorithm settings, there will be no effect obtained even by selecting "DIRECT MIX". Check this in "Algorithm list" (p.49–90), whether it has effect or not.

FACTORY RESET

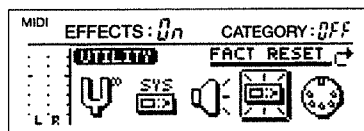

You can return the VF-1 to the factory settings.

For details refer to "Restoring the factory settings (Factory Reset)" (p. 133).

MIDI

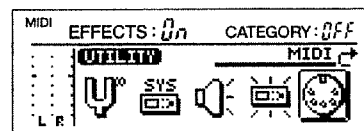

Here you can make MIDI-related settings.

For details refer to "Section 5. Using MIDI to operate the VF-1." (p.122)

Section 4. Effect guide

Section 4 explains the contents of the algorithms on which effect sounds are based, the effects that make up each algorithm, and the parameters of each effect.

About the algorithm list

How an algorithm is organized

The algorithm determines the type of effects and the structure of the parameters that create the effect sound. The algorithm list (p.49–90) shows the effects in each algorithm, and the parameters of each effect.



For details on the parameters of each effect, refer to “The function of each parameter” (p.91–120).

Parameters

Depending on the algorithm, the same effect may have different parameters available for adjustment. Note the available parameters in the “Algorithm list” (p.49–90) as you make effect settings.

About POSITION

Depending on the algorithm, the locations of SFX (special effect), MOD (modulation), and PREAMP/SP.SIM (speaker simulator) can be changed. If this adjustment is available, a “POSITION” setting will appear. For details on setting this, refer to “Changing the order of the effects” (p.30).

MOD (modulation)

position can be changed in

- GUITAR MULTI 1
- BASS MULTI

PREAMP/SP.SIM (speaker simulator)

position can be changed in

- GUITAR MULTI 1
- GUITAR MULTI 2
- BASS MULTI

SFX (special effect)

position can be changed in

- GUITAR MULTI 2

* It is not possible to place SFX, MOD, or PREAMP/SP.SIM after “MASTER.”

About “The function of each parameter”

The section “The function of each parameter” (p.91) explains the function of the parameters for each effect listed in the “Algorithm list.”

The effects are listed in alphabetical order.

About MOD

For **MOD (modulation)** you can select one of the following effects.

- Harmonist
- Flanger
- Phaser
- Sub 4band equalizer
- Chorus
- 2 x 2 chorus
- Short delay
- Humanizer
- Vibrato
- Guitar synth
- Ring modulator
- Slicer
- Pitch Shifter

* The effects that can be selected for MOD will depend on the algorithm. Refer to the “Algorithm list” (p.49–90).

MOD can be used in the following algorithms.

- GUITAR MULTI 1
- BASS MULTI
- KEYBOARD MULTI
- VOCAL MULTI
- ISOLATOR

MOD parameters

MOD provides the following parameters.

For details on the parameters of the selected effect, refer to “The function of each parameter” (p.91–120).

EFFECT

Turns the MOD effect on/off.

SELECT (select effect)

Selects one of the following effects to use.

If you modify the effect by "SELECT," parameter used before modifying is initialized.

- HR (Harmonist) (p.101)**
- FL (Flanger) (p.98)**
- PH (Phaser) (p.108)**
- SEQ (Sub 4band equalizer) (p.116)**
- CE (Chorus) (p.93)**
- 2CE (2x2 chorus) (p.91)**
- SDD (Short delay) (p.114)**
- HU (Humanizer) (p.103)**
- VB (Vibrato) (p.118)**
- SYN (Guitar synth) (p.99)**
- RM (Ring modulator) (p.112)**
- SL (Slicer) (p.114)**
- PS (Pitch Shifter) (p.109)**

About SFX

For **SFX (special effects)**, you can choose one of the following effects.

- Acoustic guitar simulator
- Bass guitar simulator
- Slow gear
- Feedbacker
- Pickup simulator
- Tremolo/pan
- * *SFX can be used in the "GUITAR MULTI 2" algorithm.*

SFX parameters

SFX has the following parameters.

For details on the parameters of the selected effect, refer to "The function of each parameter" (p.91–120).

EFFECT

Turn the SFX effect on/off.

SELECT (select effect)

From the following effects, select the one that you wish to use.

For details on the parameters of the selected effect, refer to "The function of each parameter" (p.91–120).

- * *If you edit an effect with "SELECT," the effect is parameter that you have set before editing will be initialized.*

- AC (Acoustic guitar simulator) (p.92)**
- BS (Bass guitar simulator) (p.92)**
- SG (Slow gear) (p.115)**
- FB (Feedbacker) (p.97)**
- PIC (Pickup simulator) (p.109)**
- TR (Tremolo/pan) (p.117)**

About FV (foot volume)

[FV] shown in the Algorithm represents the position where the volume is controlled with the expression pedal or footswitch when the Target of the Control Assign is set to FOOT VOLUME LEVEL (p.33, 105).

About DELAY, MultiTAP DELAY and STEREO PS DLY

When you have set BPM ♩ - ∞ in DELAY TIME, DELAY TIME [L] and [R], and FB DELAY TIME [L] and [R], the following parameters will not be shown in the display.

DELAY (p.95)

- DELAY TIME = BPM ♩ - ∞**
- FINE TIME

STEREO DELAY (p.95)

- DELAY TIME [L] = BPM ♩ - ∞**
- FINE TIME [L]

- DELAY TIME [R] = BPM ♩ - ∞**
- FINE TIME [R]

MULTI TAP DELAY (p.107)

- TAP [1]–[20] DELAY TIME = BPM ♩ - ∞**
- TAP [1]–[20] FINE TIME

STEREO PS DLY

(stereo pitch shifter delay) (p.115)

- FB DELAY TIME [L] = BPM ♩ - ∞**
- FB FINE TIME [L]

- FB DELAY TIME [R] = BPM ♩ - ∞**
- FB FINE TIME [R]

Algorithm list

P_B1 GUITAR MULTI 1

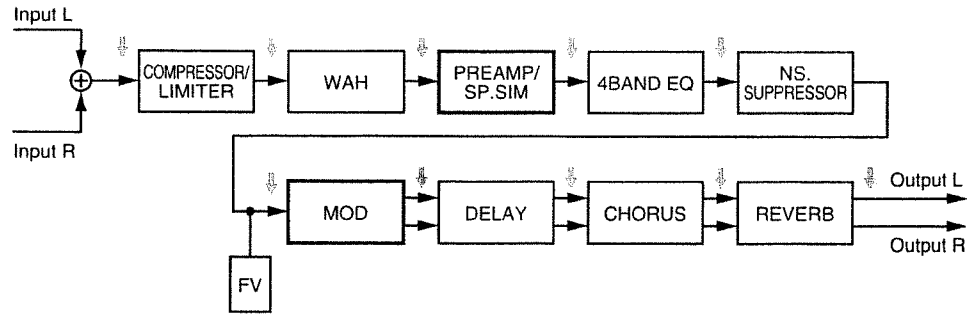

This is a multi-effect for guitar that contains a preamp / speaker simulator.

The MOD (Modulation) settings allow you to use guitar synth, slicer, or harmonist etc.

MEMO

MOD: MODULATION lets you select one of the following effects.

MOD: HR (Harmonist)

FL (Flanger)

PH (Phaser)

SEQ (Sub Equalizer)

2CE (2X2 Chorus)

SDD (Short Delay)

HU (Humanizer)

VB (Vibrato)

SYN (Guitar Synth)

RM (Ring Modulator)

SL (Slicer)

PREAMP/SP.SIM and MOD can be moved to the () locations shown in the diagram.

COMPRESSOR/LIMITER

EFFECT OFF, ON
SELECT COMP, LIMIT

<COMP: COMPRESSOR>

SUSTAIN 0-100
ATTACK 0-100
TONE -50+50
LEVEL 0-100

<LIMIT: LIMITER>

THRESHOLD 0-100
RELEASE 0-100
TONE -50+50
LEVEL 0-100

WAH

EFFECT OFF, ON
SELECT WAH, AW

<WAH: PEDAL WAH>

PEDAL 0-100
LEVEL 0-100

<AW: AUTO WAH>

MODE LPE, BPF
POLARITY DOWN, UP
SENS 0-100
FREQ 0-100
PEAK 0-100
RATE 0-100, BPM: -
DEPTH 0-100
LEVEL 0-100

PREAMP/SP.SIM (Speaker Simulator)

EFFECT OFF, ON
PREAMP TYPE JC-120, CLEAN TWIN, CRUNCH, MATCH DRIVE, VO DRIVE, BLUES, BG LEAD, MS1959 (I), MS1959 (II), MS1959 (I+II), SLDN LEAD, METAL 5150, METAL DRIVE, AC.GUITAR, OD-1, OD-2 TURBO, DISTORTION, FUZZ
VOLUME 0-100
BASS 0-100
MIDDLE 0-100
TREBLE 0-100
PRESENCE 0-100 (MATCH DRIVE, VO DRIVE: 0- -100)
MASTER 0-100
BRIGHT OFF, ON
GAIN LOW, MID, HIGH
MIC SETTING CENT, 1-10 (cm)
MIC LEVEL 0-100
DIRECT LEVEL 0-100
POSITION Can be moved to the () locations shown in the diagram.

Algorithm list

4BAND EQ (Equalizer)

EFFECT	OFF, ON
LOW EQ	-20→+20 (dB)
HIGH EQ	-20→+20 (dB)
LEVEL	-20→+20 (dB)
LO-MD F	100-10.0 k (Hz)
LOW-MID Q	0.5-16.0
LOW-MID EQ	-20→+20 (dB)
HI-MD F	100-10.0 k (Hz)
HI-MID Q	0.5-16.0
HI-MID EQ	-20→+20 (dB)

NS. SUPPRESSOR (Noise Suppressor)

EFFECT	OFF, ON
THRESHOLD	0-100
RELEASE	0-100

MOD (Modulation)

EFFECT	OFF, ON
SELECT	HR, FL, PH, SEQ, 2CE, SDD, HU, VB, SYN, RM, SL

<HR: HARMONIST>

VOICE	1 MONO, 2 MONO, 2 STEREO
MODE [1]	FAST, MEDIUM, SLOW, MONO, HARMONY
MODE [2]	FAST, MEDIUM, SLOW, MONO, HARMONY VOICE = 2 MONO, 2 STEREO
PITCH [1]	-24→+24 MODE=FAST, MEDIUM, SLOW, MONO
FINE [1]	-50→+50 MODE = FAST, MEDIUM, SLOW, MONO
PITCH [2]	-24→+24 VOICE = 2 MONO, 2 STEREO MODE = FAST, MEDIUM, SLOW, MONO
FINE [2]	-50→+50 VOICE = 2 MONO, 2 STEREO MODE = FAST, MEDIUM, SLOW, MONO
HARMONY [1]	-2OCT→+2OCT, SCALE#1-SCALE#5 MODE = HARMONY
HARMONY [2]	-2OCT→+2OCT, SCALE#1-SCALE#5 VOICE = 2 MONO, 2 STEREO MODE = HARMONY
PRE DELAY [1]	0-300 (msec), BPM: ♩ - ○
PRE DELAY [2]	0-300 (msec), BPM: ♩ - ○ VOICE = 2 MONO, 2 STEREO
FEEDBACK	0-100
LEVEL [1]	0-100
LEVEL [2]	0-100 VOICE = 2 MONO, 2 STEREO
KEY	C (Am)-B (G#m) MODE = HARMONY
DIR LEVEL	0-100
POSITION	Can be moved to the (♩) locations shown in the diagram.

<FL: FLANGER>

RATE	0-100, BPM: ○ - ♩
DEPTH	0-100
MANUAL	0-100
RESONANCE	0-100
SEPARATE	0-100
LEVEL	0-100
POSITION	Can be moved to the (♩) locations shown in the diagram.

<PH: PHASER>

TYPE	4STAGE, 8STAGE, 12STAGE, BI-PHASE
RATE	0-100, BPM: ○ - ♩
DEPTH	0-100
MANUAL	0-100
RESONANCE	0-100
STEP	OFF, 1-100
LEVEL	0-100
POSITION	Can be moved to the (♩) locations shown in the diagram.

<SEQ: SUB 4BAND EQ>

LOW EQ	-20→+20 (dB)
HIGH EQ	-20→+20 (dB)
LO-MD F	100-10.0 k (Hz)
LOW-MID Q	0.5-16.0
LOW-MID EQ	-20→+20 (dB)
HI-MD F	100-10.0 k (Hz)
HI-MID Q	0.5-16.0
HI-MID EQ	-20→+20 (dB)
LEVEL	-20→+20 (dB)
POSITION	Can be moved to the (♩) locations shown in the diagram.



<2CE: 2x2 CHORUS>

XOVER	100-4.0 k (Hz)
LOW RATE	0-100, BPM: ○ - ♩
LOW DEPTH	0-100
LOW PRE DELAY	0.0-40.0 (msec)
LOW LEVEL	0-100
HIGH RATE	0-100, BPM: ○ - ♩
HIGH DEPTH	0-100
HIGH PRE DELAY	0.0-40.0 (msec)
HIGH LEVEL	0-100
POSITION	Can be moved to the (♩) locations shown in the diagram.



<SDD: SHORT DELAY>

DELAY TIME	0-400 (msec), BPM: ♩ - ○
FEEDBACK	0-100
FX LEVEL	0-120
POSITION	Can be moved to the (♩) locations shown in the diagram.

<HU: HUMANIZER>

MODE	PICK, AUTO, RANDOM	
VOWEL [1]	a, e, i, o, u	MODE = PICK, AUTO
VOWEL [2]	a, e, i, o, u	MODE = PICK, AUTO
SENS	0-100	MODE = PICK
RATE	0-100, BPM:  - 	
DEPTH	0-100	
MANUAL	0-100	MODE = AUTO
LEVEL	0-100	
POSITION	Can be moved to the () locations shown in the diagram.	

<VB: VIBRATO>

RATE	0-100, BPM:  - 
DEPTH	0-100
TRIGGER	OFF, ON
RISE TIME	0-100
POSITION	Can be moved to the () locations shown in the diagram.



<SYN: GUITAR SYNTH>

SENS	0-100	
WAVE	SQR, SAW, BRASS, BOW	
CHROMATIC	OFF, ON	WAVE = SQR, SAW
OCT SHIFT	0, -1, -2	WAVE = SQR, SAW
PWM RATE	0-100	WAVE=SQR
PWM DEPTH	0-100	WAVE=SQR
CUTOFF F	0-100	
RESONANCE	0-100	
FLT SENS	0-100	
FLT DECAY	0-100	
FLT DEPTH	-100-+100	
ATTACK	DECAY, 0-100	
RELEASE	0-100	
VELOCITY	0-100	
HOLD	OFF, ON	WAVE = SQR, SAW
SYNTH LEVEL	0-100	
DIR LEVEL	0-100	
POSITION	Can be moved to the () locations shown in the diagram.	



<RM: RING MODULATOR>

MODE	NORMAL, INTELLIGENT
FREQ	0-100
FX LEVEL	0-100
DIR LEVEL	0-100
POSITION	Can be moved to the () locations shown in the diagram.



<SL: SLICER>

PATTERN	P01-P20
RATE	0-100, BPM:  - 
TRIGGER SENS	0-100
POSITION	Can be moved to the () locations shown in the diagram.

DELAY

EFFECT	OFF, ON	
TYPE	SINGLE, TAP	
DELAY TIME	0-1800 (msec), BPM:  - 	
FINE TIME	0-20 (msec)	
TAP TIME	0-100 (%)	TYPE = TAP
FEEDBACK	0-100	
HIGH CUT	700-11 k (Hz), FLAT	
FX LEVEL	0-120	

CHORUS

EFFECT	OFF, ON
MODE	MONO, ST.
RATE	0-100, BPM:  - 
DEPTH	0-100
PRE DELAY	0.0-40.0 (msec)
HIGH CUT	700-11 k (Hz), FLAT
FX LEVEL	0-100

REVERB

EFFECT	OFF, ON
TYPE	ROOM 1, ROOM 2, HALL 1, HALL 2, PLATE
REVERB TIME	0.1-10.0 (sec)
PRE DELAY	0-100 (msec)
LOW CUT	55-800 (Hz)
HIGH CUT	700-11 k (Hz), FLAT
DENSITY	0-10
FX LEVEL	0-100

MASTER

<MASTER>	
LEVEL	0-100
BPM	40-250, MIDI, GLOBAL
<FV: FOOT VOLUME>	
FOOT LEVEL	0-100

P_B2 GUITAR MULTI 2

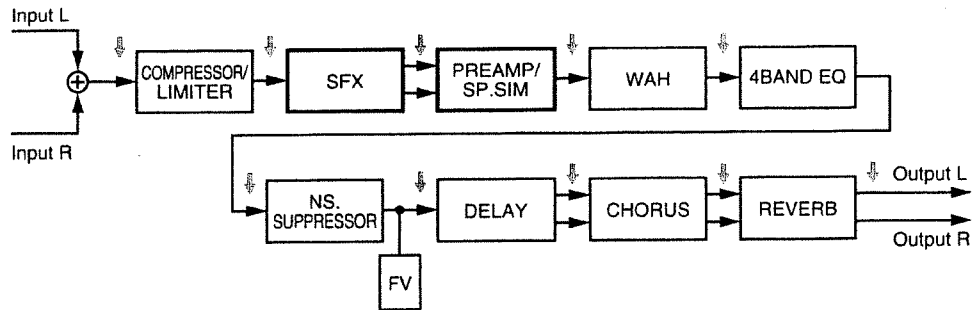

This is a multi-effect for guitar that contains a preamp/speaker simulator.

The SFX (special effects) settings allow you to use an acoustic simulator, bass guitar simulator, or pickup simulator etc.



SFX lets you select one of the following effects.

- SFX: AC (Acoustic Guitar Simulator)
 BS (Bass Guitar Simulator)
 SG (Slow Gear)
 FB (Feedbacker)
 PIC (Pick Up Simulator)
 TR (Tremolo/Pan)

PREAMP/SP.SIM and SFX can be moved to the () locations shown in the diagram.

COMPRESSOR/LIMITER

EFFECT OFF, ON
 SELECT COMP, LIMIT

<COMP: COMPRESSOR>

SUSTAIN 0-100
 ATTACK 0-100
 TONE -50+50
 LEVEL 0-100

<LIMIT: LIMITER>

THRESHOLD 0-100
 RELEASE 0-100
 TONE -50+50
 LEVEL 0-100

SFX (Special Effect)

EFFECT OFF, ON
 SELECT AC, BS, SG, FB, PIC, TR

<AC: ACOUSTIC G_TSIM>

TOP 0-100
 BODY 0-100
 LEVEL 0-100
 POSITION Can be moved to the () locations shown in the diagram.

<BS: BASS GTR SIM>

CHARACTER LOOSE, TIGHT
 FX LEVEL 0-100
 DIR LEVEL 0-100
 POSITION Can be moved to the () locations shown in the diagram.

<SG: SLOW GEAR>

SENS 0-100
 RISE TIME 0-100
 POSITION Can be moved to the () locations shown in the diagram.

<FB: FEEDBACKER>

MODE OSC, BOOST
 RISE TIME 0-100
 RISE TIME ▲ 0-100 MODE = OSC
 F.B LEVEL 0-100 MODE = OSC
 F.B ▲ LEVEL 0-100 MODE = OSC
 VIB RATE 0-100 MODE = OSC
 VIB DEPTH 0-100 MODE = OSC
 F.B DEPTH 0-100 MODE = BOOST
 FEEDBACK TONE NORMAL, +1OCT MODE = BOOST
 POSITION Can be moved to the () locations shown in the diagram.

<PIC: PICKUP SIM>

TYPE 'S' to 'H', 'H' to 'S', 'H' to 'HF'
 TONE -50+50
 LEVEL 0-100
 POSITION Can be moved to the () locations shown in the diagram.

<TR: TREMOLO/PAN>

MODE TREMOLO, PAN
 WAVE SHAPE 0-100
 RATE 0-100, BPM: ♪ - ♪
 DEPTH 0-100
 POSITION Can be moved to the () locations shown in the diagram.

WAH

EFFECT OFF, ON
 SELECT WAH, AW

<WAH: PEDAL WAH>

PEDAL 0-100
 LEVEL 0-100

<AW: AUTO WAH>

MODE LPF, BPF
 POLARITY DOWN, UP
 SENS 0-100
 FREQ 0-100
 PEAK 0-100
 RATE 0-100, BPM: ♩ - ♪
 DEPTH 0-100
 LEVEL 0-100

PREAMP/SP.SIM (Speaker Simulator)

EFFECT OFF, ON
 PREAMP TYPE JC-120, CLEAN TWIN, CRUNCH,
 MATCH DRIVE, VO DRIVE, BLUES,
 BG LEAD, MS1959 (I), MS1959 (II),
 MS1959 (I+II), SLDN LEAD, METAL 5150,
 METAL DRIVE, AC.GUITAR, OD-1,
 OD-2 TURBO, DISTORTION, FUZZ

VOLUME 0-100
 BASS 0-100
 MIDDLE 0-100
 TREBLE 0-100
 PRESENCE 0-100 (MATCH DRIVE, VO DRIVE: 0- -100)
 MASTER 0-100
 BRIGHT OFF, ON
 GAIN LOW, MID, HIGH
 MIC SETTING CENT, 1-10 (cm)
 MIC LEVEL 0-100
 DIRECT LEVEL 0-100
 POSITION Can be moved to the (♪) locations shown
 in the diagram.

4BAND EQ (Equalizer)

EFFECT OFF, ON
 LOW EQ -20→+20 (dB)
 HIGH EQ -20→+20 (dB)
 LEVEL -20→+20 (dB)
 LO-MD F 100-10.0 k (Hz)
 LOW-MID Q 0.5-16.0
 LOW-MID EQ -20→+20 (dB)
 HI-MD F 100-10.0 k (Hz)
 HI-MID Q 0.5-16.0
 HI-MID EQ -20→+20 (dB)

NS. SUPPRESSOR (Noise Suppressor)

EFFECT OFF, ON
 THRESHOLD 0-100
 RELEASE 0-100

DELAY

EFFECT OFF, ON
 TYPE SINGLE, TAP
 DELAY TIME 0-1800 (msec), BPM: ♪ - ♩
 FINE TIME 0-20 (msec)
 TAP TIME 0-100 (%) TYPE = TAP
 FEEDBACK 0-100
 HIGH CUT 700-11 k (Hz), FLAT
 FX LEVEL 0-120

CHORUS

EFFECT OFF, ON
 MODE MONO, ST.
 RATE 0-100, BPM: ♩ - ♪
 DEPTH 0-100
 PRE DELAY 0.0-40.0 (msec)
 HIGH CUT 700-11 k (Hz), FLAT
 FX LEVEL 0-100

REVERB

EFFECT OFF, ON
 TYPE ROOM 1, ROOM 2, HALL 1, HALL 2,
 PLATE
 REVERB TIME 0.1-10.0 (sec)
 PRE DELAY 0-100 (msec)
 LOW CUT 55-800 (Hz)
 HIGH CUT 700-11 k (Hz), FLAT
 DENSITY 0-10
 FX LEVEL 0-100

MASTER

<MASTER>
 LEVEL 0-100
 BPM 40-250, MIDI, GLOBAL

<FV: FOOT VOLUME>

FOOT LEVEL 0-100

P_B3 BASS MULTI

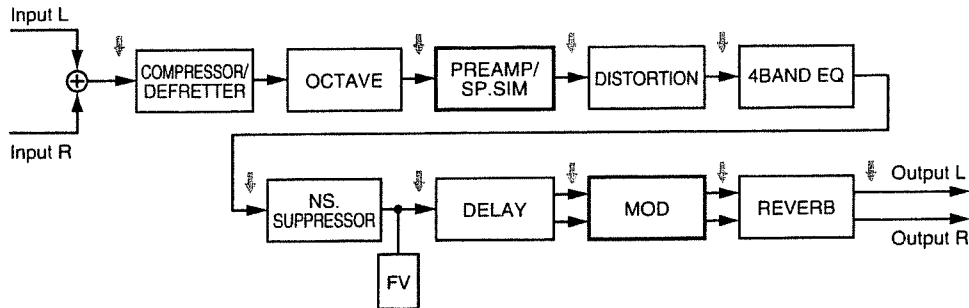

This is a multi-effect for bass guitar.

You can use overdrive/distortion, octave, or defretter etc. to create the sound you want.



MOD: MODULATION lets you select one of the following effects.

- MOD: FL (Flanger)
- PH (Phaser)
- CE (Chorus)

* The phaser effect is mono output.

COMP: COMPRESSOR/DEFRETTTER lets you select one of the following effects.

- COMP: COMP (Compressor)
- DEFRET (Defretter)

EQ: 4BAND EQ/T-WAH lets you select one of the following effects.

- EQ: 4BAND EQ (Equalizer)
- T-WAH (Touch wah)

* To select an effect of the COMP or EQ, use the "SELECT".

* If you edit an effect with "SELECT," the effect is parameter that you have set before editing will be initialized.

PREAMP/SP.SIM and MOD can be moved to the ($\frac{1}{2}$) locations shown in the diagram.

COMPRESSOR/DEFRETTTER

EFFECT OFF, ON
SELECT COMP, DEFRET

<COMP: COMPRESSOR>

SUSTAIN 0-100
ATTACK 0-100
ENH FREQ 0-3
ENH LEVEL 0-100
LEVEL 0-100

<DEFRET: DEFRETTTER>

SENS 0-100
ATTACK 0-100
DEPTH 0-100
LEVEL 0-100

OCTAVE

EFFECT OFF, ON
OCT LEVEL 0-100
DIR LEVEL 0-100

PREAMP/SP.SIM (Speaker Simulator)

EFFECT OFF, ON
PREAMP TYPE AC, AMG
VOLUME 0-100
BASS -100+100
MIDDLE -100+100
TREBLE -100+100
MASTER 0-100
BRIGHT OFF, ON
GAIN LOW, MID, HIGH
MIC SETTING CENT, 1-10 (cm), OFF
MIC LEVEL 0-100
DIR LEVEL 0-100
POSITION Can be moved to the ($\frac{1}{2}$) locations shown in the diagram.

DISTORTION

EFFECT	OFF, ON
TYPE	TURBO OD, BASS OD, HARD DS, FUZZ 1, FUZZ 2
DRIVE	0-100
BASS	-50+50
TREBLE	-50+50
FX LEVEL	0-100
DIR LEVEL	0-100

4BAND EQ (Equalizer)/T-WAH

EFFECT	OFF, ON
SELECT	4BAND EQ, T-WAH

<4BAND EQ>

LOW EQ	-20+20 (dB)
HIGH EQ	-20+20 (dB)
LEVEL	-20+20 (dB)
LO-MD F	100-10.0 k (Hz)
LOW-MID Q	0.5-16.0
LOW-MID EQ	-20+20 (dB)
HI-MD F	100-10.0 k (Hz)
HI-MID Q	0.5-16.0
HI-MID EQ	-20+20 (dB)

<T-WAH>

SENS	0-100
START	DOWN, UP
STOP	0-100
RESONANCE	0-100
FX LEVEL	0-100
DIR LEVEL	0-100

NS. SUPPRESSOR (Noise Suppressor)

EFFECT	OFF, ON
THRESHOLD	0-100
RELEASE	0-100

DELAY

EFFECT	OFF, ON
TYPE	SINGLE, TAP
DELAY TIME	0-1800 (msec), BPM: ♩ - ○
FINE TIME	0-20 (msec)
TAP TIME	0-100 (%)
FEEDBACK	0-100
HIGH CUT	700-11 k (Hz), FLAT
FX LEVEL	0-120

TYPE = TAP

MOD (Modulation)

EFFECT	OFF, ON
SELECT	FL, PH, CE

<FL: FLANGER>

RATE	0-100, BPM: ○ - ♩
DEPTH	0-100
MANUAL	0-100
RESONANCE	0-100
SEPARATE	0-100
LEVEL	0-100
POSITION	Can be moved to the (♯) locations shown in the diagram.

<PH: PHASER>

RATE	0-100, BPM: ○ - ♩
DEPTH	0-100
MANUAL	0-100
RESONANCE	0-100
POSITION	Can be moved to the (♯) locations shown in the diagram.

<CE: CHORUS>

MODE	MONO, ST.
RATE	0-100, BPM: ○ - ♩
DEPTH	0-100
PRE DELAY	0.0-40.0 (msec)
LOW CUT	FLAT, 55-800 (Hz)
FX LEVEL	0-100
POSITION	Can be moved to the (♯) locations shown in the diagram.

REVERB

EFFECT	OFF, ON
TYPE	ROOM1, ROOM2, HALL1, HALL 2, PLATE
REVERB TIME	0.1-10.0 (sec)
PRE DELAY	0-100 (msec)
LOW CUT	55-800 (Hz)
HIGH CUT	700-11 k (Hz), FLAT
DENSITY	0-10
FX LEVEL	0-100

MASTER

<MASTER>	
LEVEL	0-100
BPM	40-250, MIDI, GLOBAL
<FV: FOOT VOLUME>	
FOOT LEVEL	0-100

P_B4 ACOUSTIC MULTI

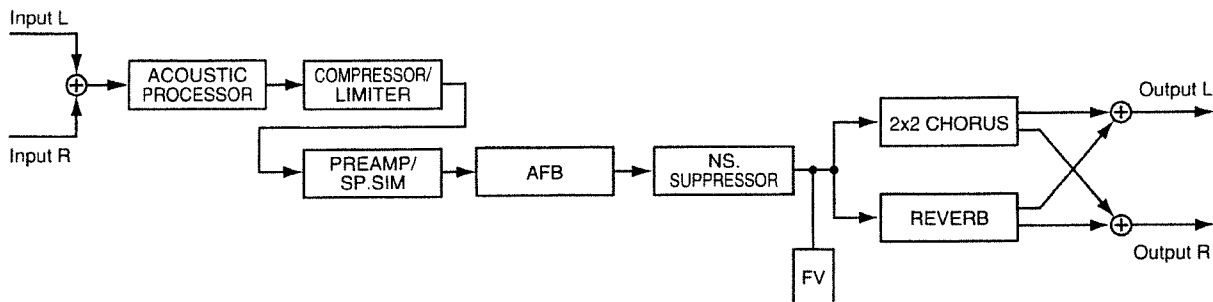

This is a multi-effect for acoustic guitar.

You can use effects such as acoustic and anti-feedback to create a fully-produced acoustic sound.

ACOUSTIC

EFFECT	OFF, ON
BODY	0-100
MIC DISTANCE	0-100

COMPRESSOR/LIMITER

EFFECT	OFF, ON
SELECT	COMP, LIMIT

<COMP: COMPRESSOR>

SUSTAIN	0-100
ATTACK	0-100
TONE	-50-+50
LEVEL	0-100

<LIMIT: LIMITER>

THRESHOLD	0-100
RELEASE	0-100
TONE	-50-+50
LEVEL	0-100

PREAMP/SP.SIM (Speaker Simulator)

EFFECT	OFF, ON
VOLUME	0-100
BASS	0-100
MIDDLE	0-100
TREBLE	0-100
PRESENCE	0-100
MASTER	0-100
GAIN	LOW, MID, HIGH
MIC SETTING	CENT, 1-10 (cm)
MIC LEVEL	0-100
DIR LEVEL	0-100

AFB (Anti-Feedback)

EFFECT	OFF, ON
DEPTH	0-100
FREQUENCY	0-100

NS. SUPPRESSOR (Noise Suppressor)

EFFECT	OFF, ON
THRESHOLD	0-100
RELEASE	0-100

2x2 CHORUS

EFFECT	OFF, ON
XOVER	100-4.0 k (Hz)
LOW RATE	0-100, BPM: ♩ - ♪
LOW DEPTH	0-100
LOW PRE DELAY	0.0-40.0 (msec)
LOW LEVEL	0-100
HIGH RATE	0-100, BPM: ♩ - ♪
HIGH DEPTH	0-100
HIGH PRE DELAY	0.0-40.0 (msec)
HIGH LEVEL	0-100

REVERB

EFFECT	OFF, ON
TYPE	ROOM1, ROOM2, HALL1, HALL 2, PLATE
REVERB TIME	0.1-10.0 (sec)
PRE DELAY	0-100 (msec)
LOW CUT	55-800 (Hz)
HIGH CUT	700-11 k (Hz), FLAT
DENSITY	0-10
FX LEVEL	0-100

MASTER

<MASTER>	
LEVEL	0-100
BPM	40-250, MIDI, GLOBAL

<FV: FOOT VOLUME>

FOOT LEVEL	0-100
------------	-------

P_B5 KEYBOARD MULTI

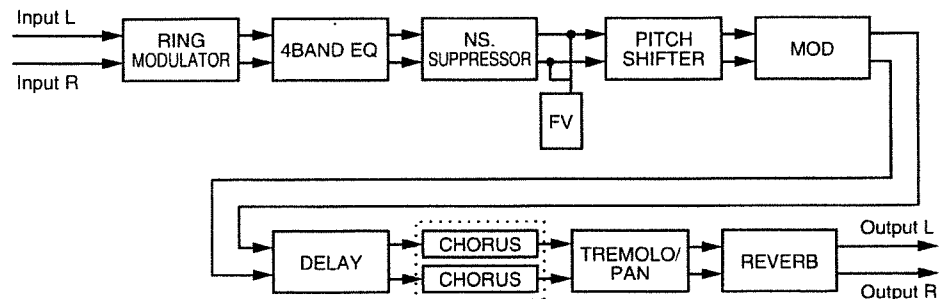

This is a multi-effect suitable for keyboard.

It provides a wide variety of effects ranging from basic sounds, to special effects using a ring modulator or pitch shifter.



MOD: MODULATION lets you select one of the following effects.

MOD: FL (Flanger)

PH (Phaser)

RING MODULATOR

EFFECT	OFF, ON
FREQ	0-100
FX LEVEL	0-100
DIR LEVEL	0-100

4BAND EQ (Equalizer)

EFFECT	OFF, ON
LOW EQ	-20+20 (dB)
HIGH EQ	-20+20 (dB)
LEVEL	-20+20 (dB)
LO-MD F	100-10.0 k (Hz)
LOW-MID Q	0.5-16.0
LOW-MID EQ	-20+20 (dB)
HI-MD F	100-10.0 k (Hz)
HI-MID Q	0.5-16.0
HI-MID EQ	-20+20 (dB)

NS. SUPPRESSOR (Noise Suppressor)

EFFECT	OFF, ON
THRESHOLD	0-100
RELEASE	0-100

PITCH SHIFTER

EFFECT	OFF, ON
MODE	FAST, MEDIUM, SLOW
PITCH	-24+24
FINE	-50+50
BALANCE DIR:FX	100:0-0:100
LEVEL	0-100

MOD (Modulation)

EFFECT	OFF, ON
SELECT	FL, PH

<FL: FLANGER>

RATE	0-100, BPM: ♩ - ♪
DEPTH	0-100
MANUAL	0-100
RESONANCE	0-100
SEPARATE	0-100

<PH: PHASER>

RATE	0-100, BPM: ♩ - ♪
DEPTH	0-100
MANUAL	0-100
RESONANCE	-100+100
SEPARATE	0-100

DELAY

EFFECT	OFF, ON
DELAY TIME	0-800 (msec), BPM: ♩ - ♪
FINE TIME	0-20 (msec)
FEEDBACK	0-100
FX LEVEL	0-120

STEREO CHORUS

EFFECT	OFF, ON
POLARITY	SYNC, INVERT
RATE	0-100, BPM: ♩ - ♪
DEPTH	0-100
PRE DELAY	0.0-40.0 (msec)
HIGH CUT	700-11 k (Hz), FLAT
EFFECT LEVEL	0-100

Algorithm list

TREMOLO/PAN

EFFECT	OFF, ON
MODE	TREMOLO, PAN
WAVE SHAPE	0-100
RATE	0-100, BPM: ♩ - ♪
DEPTH	0-100

REVERB

EFFECT	OFF, ON
TYPE	ROOM1, ROOM2, HALL1, HALL 2, PLATE
REVERB TIME	0.1-10.0 (sec)
PRE DELAY	0-100 (msec)
LOW CUT	55-800 (Hz)
HIGH CUT	700-11 k (Hz), FLAT
DENSITY	0-10
FX LEVEL	0-100

MASTER

<MASTER>

LEVEL	0-100
BPM	40-250, MIDI, GLOBAL

<FV: FOOT VOLUME>

FOOT LEVEL	0-100
------------	-------

P_B6 ROTARY MULTI

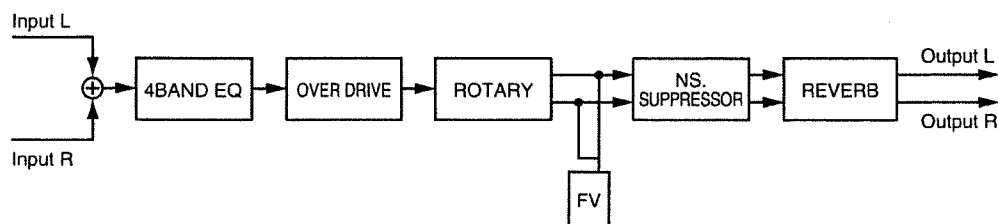

This simulates a rotary speaker that produces a modulating sound by rotating the speaker. It also simulates the distortion (Overdrive) produced by the vacuum tube amp of a rotary speaker

4BAND EQ (Equalizer)

EFFECT	OFF, ON
LOW EQ	-20→+20 (dB)
HIGH EQ	-20→+20 (dB)
LEVEL	-20→+20 (dB)
LO-MID F	100–10.0 k (Hz)
LOW-MID Q	0.5–16.0
LOW-MID EQ	-20–20 (dB)
HI-MID F	100–10.0 k (Hz)
HI-MID Q	0.5–16.0
HI-MID EQ	-20→+20 (dB)

OVER DRIVE

EFFECT	OFF, ON
GAIN	0–100
DRIVE	1–100
LEVEL	0–100

ROTARY

EFFECT	OFF, ON
SPEED SELECT	SLOW, FAST
HORN FAST	5.00–10.00 (Hz)
ROTOR FAST	5.00–10.00 (Hz)
HORN SLOW	0.05–5.00 (Hz)
ROTOR SLOW	0.05–5.00 (Hz)
RISE TIME HORN	1–100
RISE TIME ROTOR	1–100
FALL TIME HORN	1–100
FALL TIME ROTOR	1–100
BALANCE ROTOR:HORN	90:10–10:90
MIC SETTING	OFF MIC, ON MIC
HORN DEPTH	0–100
ROTOR DEPTH	0–100
HORN TRMLO	0–100
ROTOR TRMLO	0–100
DIFFUSION	0–100
FX LEVEL	0–100

NS. SUPPRESSOR (Noise Suppressor)

EFFECT	OFF, ON
THRESHOLD	0–100
RELEASE	0–100

REVERB

EFFECT	OFF, ON
TYPE	ROOM1, ROOM2, HALL1, HALL 2, PLATE
REVERB TIME	0.1–10.0 (sec)
PRE DELAY	0–100 (msec)
LOW CUT	55–800 (Hz)
HIGH CUT	700–11 k (Hz), FLAT
DENSITY	0–10
FX LEVEL	0–100

MASTER

<MASTER>	
LEVEL	0–100
<FV: FOOT VOLUME>	
FOOT LEVEL	0–100

P_B7 VOCAL MULTI

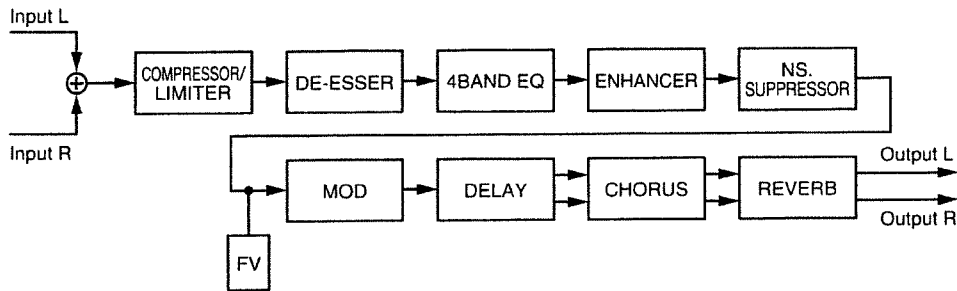

This is a multi-effect for vocals. It allows you to use flanger, phaser, and pitch shifter etc. to produce special effects.



MOD: MODULATION lets you select one of the following effects.

- MOD: FL (Flanger)
- PH (Phaser)
- PS (Pitch Shifter)

COMPRESSOR/LIMITER

EFFECT OFF, ON
SELECT COMP, LIMIT

<COMP: COMPRESSOR>

THRESHOLD 0-100
RATIO 1.5:1-100:1
ATTACK 0-100
RELEASE 0-100
TONE -50+50
LEVEL 0-100

<LIMIT: LIMITER>

THRESHOLD 0-100
RELEASE 0-100
TONE -50+50
LEVEL 0-100

DE-ESSER

EFFECT OFF, ON
SENS 0-100
FREQUENCY 1.0 k-10.0 k (Hz)

4BAND EQ (Equalizer)

EFFECT OFF, ON
LOW EQ -20+20 (dB)
HIGH EQ -20+20 (dB)
LEVEL -20+20 (dB)
LO-MD F 100-10.0 k (Hz)
LOW-MID Q 0.5-16.0
LOW-MID EQ -20+20 (dB)
HI-MD F 100-10.0 k (Hz)
HI-MID Q 0.5-16.0
HI-MID EQ -20+20 (dB)

ENHANCER

EFFECT OFF, ON
SENS 0-100
FREQUENCY 1.0 k-10.0 k (Hz)
MIX LEVEL 0-100
LoMIX LEVEL 0-100
LEVEL 0-100

NS. SUPPRESSOR (Noise Suppressor)

EFFECT OFF, ON
THRESHOLD 0-100
RELEASE 0-100

MOD (Modulation)

EFFECT OFF, ON
SELECT FL, PH, PS

<FL: FLANGER>

RATE 0-100, BPM: ♩ - ♪
DEPTH 0-100
MANUAL 0-100
RESONANCE 0-100
SEPARATE 0-100
LEVEL 0-100

<PH: PHASER>

TYPE 4STAGE, 8STAGE, 12STAGE, BI-PHASE
 RATE 0-100, BPM: ♩ - ♪
 DEPTH 0-100
 MANUAL 0-100
 RESONANCE 0-100
 STEP OFF, 1-100
 LEVEL 0-100

<PS: PITCH SHIFTER>

MODE FAST, MEDIUM, SLOW, INV1, INV2
 PITCH -24+24
 FINE -50+50
 BALANCE DIR:FX 100:0-0:100
 LEVEL 0-100

DELAY

EFFECT OFF, ON
 TYPE SINGLE, TAP
 DELAY TIME 0-1200 (msec), BPM: ♪ - ♩
 FINE TIME 0-20 (msec)
 TAP TIME 0-100% TYPE = TAP
 FEEDBACK 0-100
 HIGH CUT 700-11 k (Hz), FLAT
 FX LEVEL 0-120

CHORUS

EFFECT OFF, ON
 MODE MONO, ST.
 RATE 0-100, BPM: ♩ - ♪
 DEPTH 0-100
 PRE DELAY 0.0-40.0 (msec)
 LOW CUT FLAT, 55-800 (Hz)
 HIGH CUT 700-11 k (Hz), FLAT
 FX LEVEL 0-100

REVERB

EFFECT OFF, ON
 TYPE ROOM 1, ROOM 2, HALL 1, HALL 2,
 PLATE
 REVERB TIME 0.1-10.0 (sec)
 PRE DELAY 0-100 (msec)
 LOW CUT 55-800 (Hz)
 HIGH CUT 700-11 k (Hz), FLAT
 DENSITY 0-10
 FX LEVEL 0-100

MASTER**<MASTER>**

LEVEL 0-100
 BPM 40-250, MIDI, GLOBAL

<FV: FOOT VOLUME>

FOOT LEVEL 0-100

P_B8 VOCODER

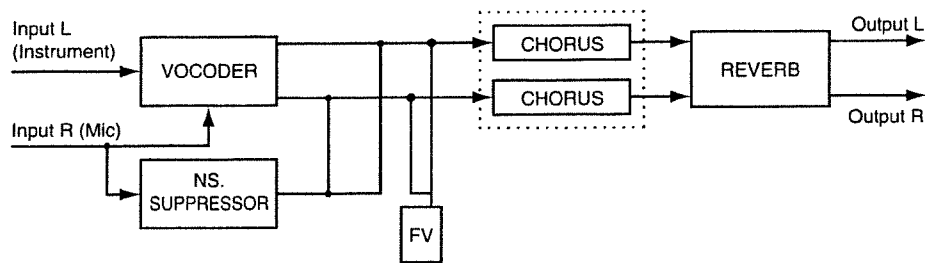

Vocoder is an effect that allows you to produce the impression that an instrument is speaking or singing with a human voice. When using the vocoder, input an instrumental sound to the L channel, and a human voice to the R channel. The instrumental sound will be divided into 10 frequency bands, and will be processed according to the frequency components of the voice.

* We recommend the microphone should be pre-amplified (by a mixer, etc.).

VOCODER

EFFECT	OFF, ON
ENVELOPE	SHARP, SOFT, LONG
PAN MODE	MONO, STEREO, L->R, R->L
HOLD	OFF, ON
MIC SENS	0-100
SYNTH LEVEL	0-100
CHAR [1]- [10]	0-100
MIC MIX	0-100
MIC HPF	THRU, 1.0 k-20.0 k (Hz)
MIC PAN L:R	100:0-0:100
NS THRESHOLD	0-100

STEREO CHORUS

EFFECT	OFF, ON
POLARITY	SYNC, INVERT
RATE	0-100, BPM: ♩ - ♪
DEPTH	0-100
PRE DELAY	0.0-40.0 (msec)
LOW CUT	FLAT, 55-800 (Hz)
HIGH CUT	700-11 k (Hz), FLAT
EFFECT LEVEL	0-100

REVERB

EFFECT	OFF, ON
TYPE	ROOM 1, ROOM 2, HALL 1, HALL 2, PLATE
REVERB TIME	0.1-10.0 (sec)
PRE DELAY	0-100 (msec)
LOW CUT	55-800 (Hz)
HIGH CUT	700-11 k (Hz), FLAT
DENSITY	0-10
FX LEVEL	0-100

MASTER

<MASTER>

LEVEL	0-100
BPM	40-250, MIDI, GLOBAL

<FV: FOOT VOLUME>

FOOT LEVEL	0-100
------------	-------

P_B9 VoiceTRANSFORM (Voice Transformer)

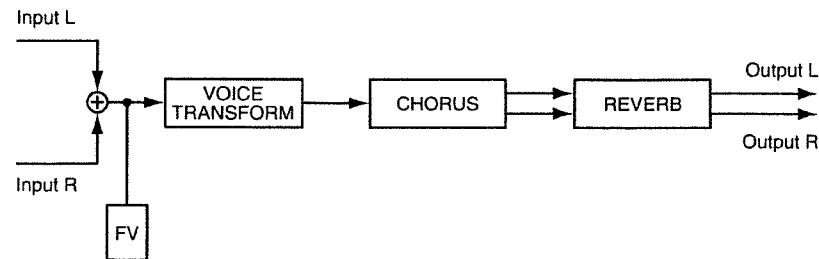

By separately controlling the basic pitch and the formants, this effect lets you create a variety of vocal characters.

VoiceTRANSFORM (Voice Transformer)

EFFECT	OFF, ON
ROBOT	OFF, ON
CRMTC PITCH	-12-+12
FINE PITCH	-100-+100
CRMTC FRMT	-12-+12
FINE FRMT	-100-+100
MIX BAL	0-100

CHORUS

EFFECT	OFF, ON
MODE	MONO, ST.
RATE	0-100, BPM: -
DEPTH	0-100
PRE DELAY	0.0-40.0 (msec)
LOW CUT	FLAT, 55-800 (Hz)
HIGH CUT	700-11 k (Hz), FLAT
FX LEVEL	0-100

REVERB

EFFECT	OFF, ON
TYPE	ROOM 1, ROOM 2, HALL 1, HALL 2, PLATE
REVERB TIME	0.1-10.0 (sec)
PRE DELAY	0-100 (msec)
LOW CUT	55-800 (Hz)
HIGH CUT	700-11 k (Hz), FLAT
DENSITY	0-10
FX LEVEL	0-100

MASTER

<MASTER>

LEVEL	0-100
BPM	40-250, MIDI, GLOBAL

<FV: FOOT VOLUME>

FOOT LEVEL	0-100
------------	-------

P_B10 ISOLATOR

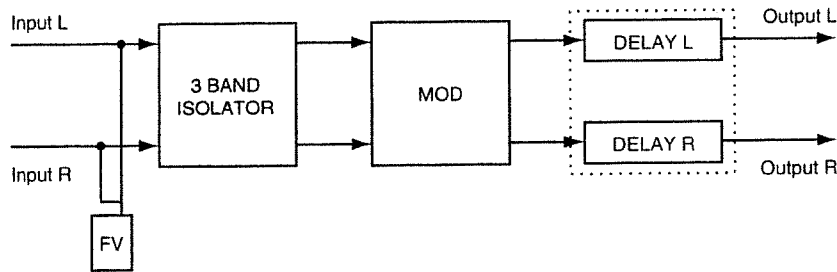

A three-band isolator divides the input signal into three frequency bands (low / middle / high), and allows you to extract or delete each frequency band.

An effect such as chorus or slicer can be applied to the extracted sound.

MEMO

MOD: MODULATION lets you select one of the following effects.

- MOD: PH (Stereo Phaser)
- FL (Stereo Flanger)
- CE (Stereo Chorus)
- SL (Stereo Slicer)

3 BAND ISOLATER

EFFECT	OFF, ON
AntiPHASE LowLEVEL	0-100
AntiPHASE MidLEVEL	0-100
LOW MIX SWITCH	OFF, ON
MID MIX SWITCH	OFF, ON
LOW LEVEL	-60→+4 (dB)
MID LEVEL	-60→+4 (dB)
HIGH LEVEL	-60→+4 (dB)

MOD (Modulation)

EFFECT	OFF, ON
SELECT	PH, FL, CE, SL

<PH: STEREO PHASER>

TYPE	4-12 (STAGE)
RATE	0-100, BPM: ♩ - ♪
DEPTH	0-100
MANUAL	0-100
RESONANCE	-100→+100
SEPARATE	0-100
STEP	OFF, 1-100

<FL: STEREO FLANGER>

RATE	0-100, BPM: ♩ - ♪
DEPTH	0-100
MANUAL	0-100
RESONANCE	0-100
SEPARATE	0-100
GATE	OFF, 1-100

<CE: STEREO CHORUS>

POLARITY	SYNC, INVERT
RATE	0-100, BPM: ♩ - ♪
DEPTH	0-100
PRE DELAY	0.0-40.0 (msec)
LOW CUT	FLAT, 55-800 (Hz)
HIGH CUT	700-11k (Hz), FLAT
EFFECT LEVEL	0-100

<SL: STEREO SLICER>

PATTERN	P01-P20
RATE	0-100, BPM: ♩ - ♪
TRIGGER SENS	0-100

STEREO DELAY

EFFECT	OFF, ON
DELAY TIME [L]	0-1400 (msec), BPM: ♩ - ♩
FINE TIME [L]	0-20 (msec)
DELAY TIME [R]	0-1400 (msec), BPM: ♩ - ♩
FINE TIME [R]	0-20 (msec)
FEEDBK [L]	0-100
FEEDBK [R]	0-100
FX LEVEL	0-120
DIR LEVEL	0-100
HIGH DAMP GAIN	-50-0 (dB)
HIGH CUT FILTER	700-11 k (Hz), FLAT

MASTER

<MASTER>

LEVEL	0-100
BPM	40-250, MIDI, GLOBAL

<FV: FOOT VOLUME>

FOOT LEVEL	0-100
------------	-------

P_B11 LOFI PROCESSOR

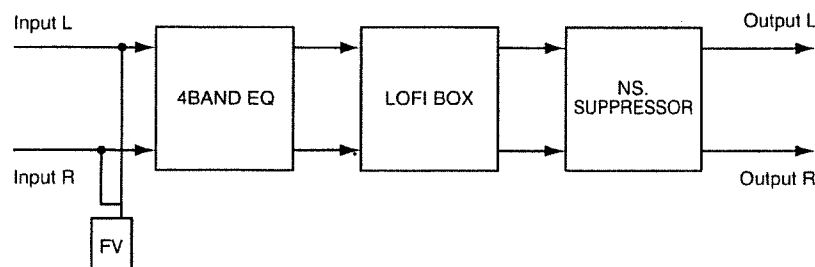

This effect allows you to simulate various levels of audio quality, such as the sound that is heard from an AM radio, the sound of an old record played on a gramophone, and even extreme changes in tonality produced by the lo-fi processor.

4BAND EQ (Equalizer)

EFFECT	OFF, ON
LOW EQ	-20→+20 (dB)
HIGH EQ	-20→+20 (dB)
LEVEL	-20→+20 (dB)
LO-MD F	100-10.0 k (Hz)
LOW-MID Q	0.5-16.0
LOW-MID EQ	-20→+20 (dB)
HI-MD F	100-10.0 k (Hz)
HI-MID Q	0.5-16.0
HI-MID EQ	-20→+20 (dB)

LOFI BOX

EFFECT	OFF, ON
SELECT	RADIO, PLAYER, PROCESSOR

<RADIO: LOFI RADIO>

TUNING	0-100
NOISE	0-100
FILTER	0-100
SOUND	0-100

<PLAYER: LOFI PLAYER>

WOW FLUTTER	0-100
NOISE	0-100
FILTER	0-100
SOUND	0-100

<PROCESSOR: LOFI PROCESSOR>

PRE FILTER	OFF, ON
SAMPLE RATE	OFF, 1/2-1/32
BIT	OFF, 15-1
POST FILTER	OFF, ON
FX LEVEL	0-100
DIR LEVEL	0-100
REALTIME MODIFY FILTER	OFF, LPF, BPF, HPF
CUTOFF	0-100
RESONANCE	0-100
GAIN	0-24 (dB)

NS. SUPPRESSOR (Noise Suppressor)

EFFECT	OFF, ON
THRESHOLD	0-100
RELEASE	0-100

MASTER

<MASTER>

LEVEL	0-100
-------	-------

<FV: FOOT VOLUME>

FOOT LEVEL	0-100
------------	-------

P_B12 REVERB 1

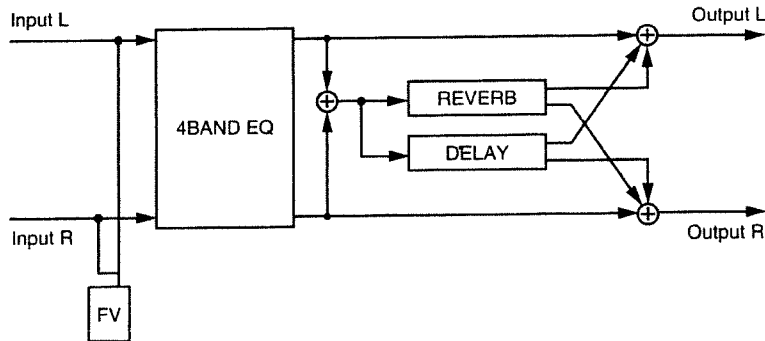

This simulates the reverberation of a room or hall. A delay can also be used simultaneously.



In this Algorithm, what you have set with the DIRECT MIX (p.46) will have effect.

4BAND EQ (Equalizer)

EFFECT	OFF, ON
LOW EQ	-20~+20 (dB)
HIGH EQ	-20~+20 (dB)
LEVEL	-20~+20 (dB)
LO-MD F	100~10.0 k (Hz)
LOW-MID Q	0.5~16.0
LOW-MID EQ	-20~+20 (dB)
HI-MD F	100~10.0 k (Hz)
HI-MID Q	0.5~16.0
HI-MID EQ	-20~+20 (dB)

REVERB

EFFECT	OFF, ON
ROOM SIZE	5.6~32.6 (m)
REVERB TIME	0.1~32.0 (sec)
BALANCE DIR:FX	100:0~0:100
EFFECT LEVEL	0~100
PRE DELAY	0~200 (msec)
DENSITY	0~100
EARLY REF LEVEL	0~100
RELEASE DENSITY	0~100
LOW DAMP GAIN	-36.0~0.0 (dB)
LOW DAMP FREQUENCY	55~4.0 k (Hz)
HIGH DAMP GAIN	-36.0~0.0 (dB)
HIGH DAMP FREQUENCY	4.0 k~20.0 k (Hz)
HIGH CUT FILTER	200~20.0 k (Hz)

DELAY

EFFECT	OFF, ON
TYPE	SINGLE, 3TAP
(SINGLE)	
DELAY TIME	0~1800 (msec), BPM: ♪ - ∞
FINE TIME	0~20 (msec)
FEEDBACK	0~100
FX LEVEL	0~120
HIGH DAMP GAIN	-50~0 (dB)
HIGH CUT FILTER	700~11 k (Hz), FLAT
(3TAP)	
DELAY TIME [C]	0~1800 (msec), BPM: ♪ - ∞
FINE TIME [C]	0~20 (msec)
TIME [L]	1~400 (%)
TIME [R]	1~400 (%)
FEEDBACK	0~100
LEVEL [C]	0~100
LEVEL [L]	0~100
LEVEL [R]	0~100
FX LEVEL	0~120
HIGH DAMP GAIN	-50~0 (dB)
HIGH CUT FILTER	700~11 k (Hz), FLAT

MASTER

<MASTER>	
LEVEL	0~100
BPM	40~250, MIDI, GLOBAL
<FV: FOOT VOLUME>	
FOOT LEVEL	0~100

P_B13 REVERB 2

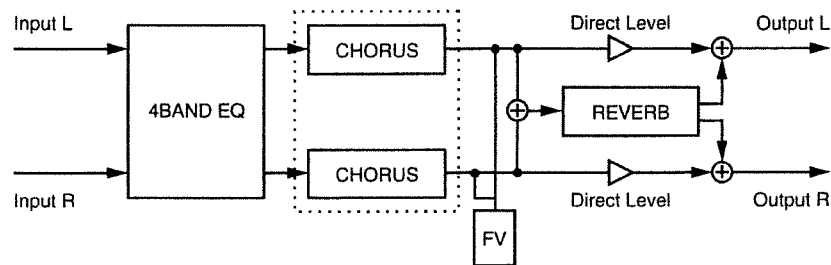

This connects an equalizer, chorus, and reverb in series.

After using the equalizer to adjust the input sound, you can use chorus and reverb to create spacious reverb.



In this Algorithm, what you have set with the **DIRECT MIX (p.46)** will have effect.

4BAND EQ (Equalizer)

EFFECT	OFF, ON
LOW EQ	-20+20 (dB)
HIGH EQ	-20+20 (dB)
LEVEL	-20+20 (dB)
LO-MD F	100-10.0 k (Hz)
LOW-MID Q	0.5-16.0
LOW-MID EQ	-20+20 (dB)
HI-MD F	100-10.0 k (Hz)
HI-MID Q	0.5-16.0
HI-MID EQ	-20+20 (dB)

STEREO CHORUS

EFFECT	OFF, ON
POLARITY	SYNC, INVERT
RATE	0-100, BPM: \circ - ♪
DEPTH	0-100
PRE DELAY	0.0-40.0 (msec)
LOW CUT	FLAT, 55-800 (Hz)
HIGH CUT	700-11 k (Hz), FLAT
EFFECT LEVEL	0-100
DIRECT SWITCH	OFF, ON

REVERB

EFFECT	OFF, ON
TYPE	ROOM, HALL
SIZE	1-10
REVERB TIME	0.1-32.0 (sec)
BALANCE DIR:FX	100:0-0:100
EFFECT LEVEL	0-100
PRE DELAY	0-200 (msec)
DENSITY	0-100
EARLY REF LEVEL	0-100
LOW DAMP GAIN	-36.0-0.0 (dB)
LOW DAMP FREQUENCY	55-4.0 k (Hz)
HIGH DAMP GAIN	-36.0-0.0 (dB)
HIGH DAMP FREQUENCY	4.0 k-20.0 k (Hz)
HIGH CUT FILTER	200-20.0 k (Hz)

MASTER

<MASTER>

LEVEL	0-100
BPM	40-250, MIDI, GLOBAL

<FV: FOOT VOLUME>

FOOT LEVEL	0-100
------------	-------

P_B14 GATE REVERB

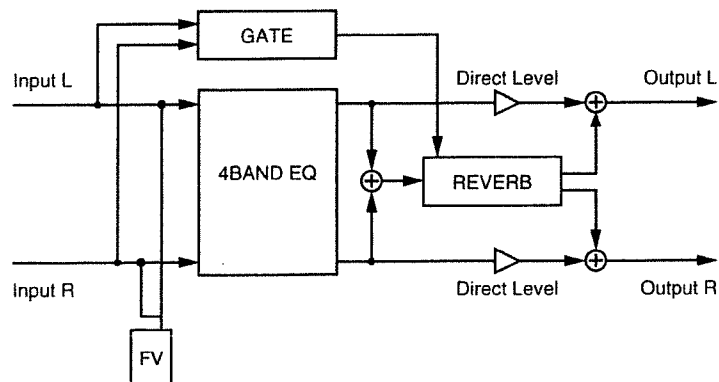

This is a gated reverb. You can specify how the reverb depth will be affected by the input level. It can also be used as a conventional reverb.



In this Algorithm, what you have set with the **DIRECT MIX (p.46)** will have effect.

4BAND EQ (Equalizer)

EFFECT	OFF, ON
LOW EQ	-20→+20 (dB)
HIGH EQ	-20→+20 (dB)
LEVEL	-20→+20 (dB)
LO-MD F	100-10.0 k (Hz)
LOW-MID Q	0.5-16.0
LOW-MID EQ	-20-20 (dB)
HI-MD F	100-10.0 k (Hz)
HI-MID Q	0.5-16.0
HI-MID EQ	-20→+20 (dB)

REVERB

EFFECT	OFF, ON
ROOM SIZE	5.6-32.6 (m)
REVERB TIME	0.1-32.0 (sec)
BALANCE DIR:FX	100:0-0:100
EFFECT LEVEL	0-100
PRE DELAY	0-200 (msec)
DENSITY	0-100
EARLY REF LEVEL	0-100
RELEASE DENSITY	0-100
LOW DAMP GAIN	-36.0-0.0 (dB)
LOW DAMP FREQUENCY	55-4.0 k (Hz)
HIGH DAMP GAIN	-36.0-0.0 (dB)
HIGH DAMP FREQUENCY	4.0 k-20.0 k (Hz)
HIGH CUT FILTER	200-20.0 k (Hz)

GATE

EFFECT	OFF, ON
THRESHOLD	0-100
HOLD TIME	1-100
RLS TIME	1-100

MASTER

<MASTER>	
LEVEL	0-100

<FV: FOOT VOLUME>

FOOT LEVEL	0-100
------------	-------

P_B15 2CH RSS (2 channel RSS)

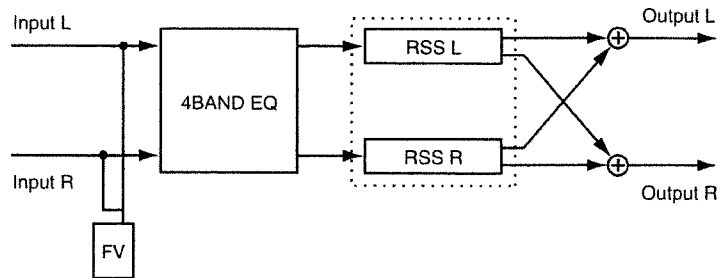

This allows the sounds that are input from each channel to be positioned in three-dimensional space. The position can be specified by the RSS (2CH) Azimuth and Elevation.

4BAND EQ (Equalizer)

EFFECT	OFF, ON
LOW EQ	-20→+20 (dB)
HIGH EQ	-20→+20 (dB)
LEVEL	-20→+20 (dB)
LO-MD F	100–10.0 k (Hz)
LOW-MID Q	0.5–16.0
LOW-MID EQ	-20→+20 (dB)
HI-MD F	100–10.0 k (Hz)
HI-MID Q	0.5–16.0
HI-MID EQ	-20→+20 (dB)

RSS (2ch) PROCESSOR

EFFECT	OFF, ON
AZIMUTH [L]	L:180–R:180
ELEVATION [L]	-54→+54
AZIMUTH [R]	L:180–R:180
ELEVATION [R]	-54→+54

MASTER

<MASTER>

LEVEL 0–100

<FV: FOOT VOLUME>

FOOT LEVEL 0–100

P_B16 DELAY RSS

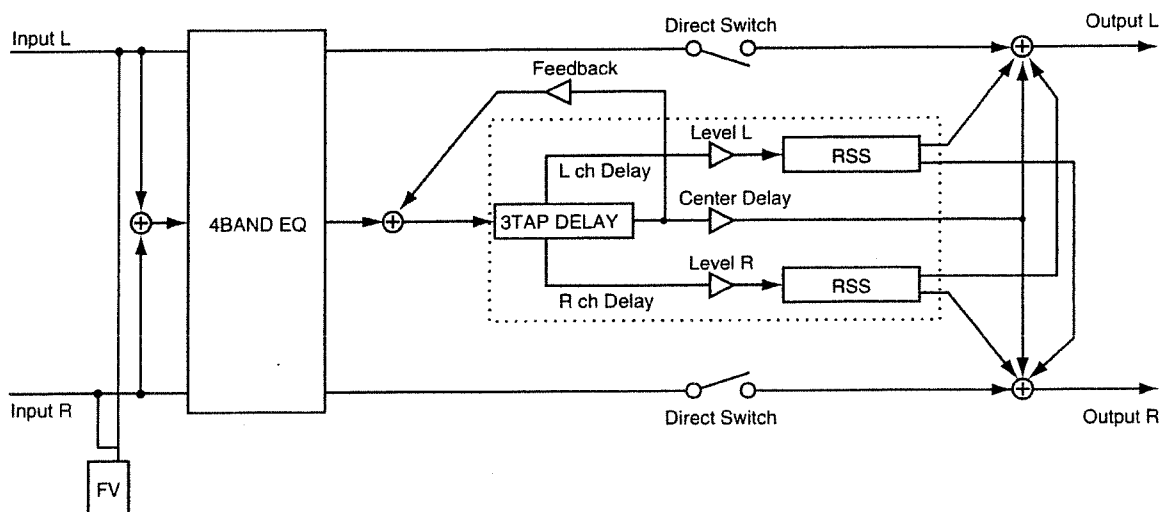

This is a delay that allows three delay sounds to be adjusted independently. The left and right outputs are connected to RSS; the left-channel sound is positioned at 90 degrees left, and the right-channel sound is positioned at 90 degrees right. A four-band equalizer is provided on the input.



In this Algorithm, what you have set with the DIRECT MIX (p.46) will have effect.

4BAND EQ (Equalizer)

EFFECT	OFF, ON
LOW EQ	-20→+20 (dB)
HIGH EQ	-20→+20 (dB)
LEVEL	-20→+20 (dB)
LO-MD F	100-10.0 k (Hz)
LOW-MID Q	0.5-16.0
LOW-MID EQ	-20→+20 (dB)
HI-MD F	100-10.0 k (Hz)
HI-MID Q	0.5-16.0
HI-MID EQ	-20→+20 (dB)

MASTER

<MASTER>	
LEVEL	0-100
BPM	40-250, MIDI, GLOBAL

<FV: FOOT VOLUME>

FOOT LEVEL	0-100
------------	-------

DELAY

EFFECT	OFF, ON
DELAY TIME [C]	0-2800 (msec), BPM: ♪ - ♪
FINE TIME [C]	0-20 (msec)
TIME [L]	1-400 (%)
TIME [R]	1-400 (%)
FEEDBACK	0-100
LEVEL [C]	0-100
LEVEL [L]	0-100
LEVEL [R]	0-100
FX LEVEL	0-120
DIR LEVEL	0-100
HIGH DAMP GAIN	-50-0 (dB)
HIGH CUT FILTER	700-11 k (Hz), FLAT
RSS SWITCH	OFF, ON

P_B17 CHORUS RSS

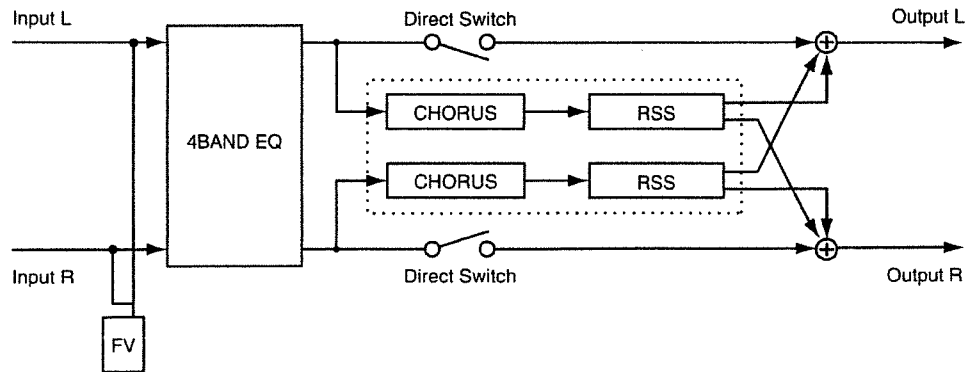

The output of the chorus is connected to RSS. The left-channel sound is positioned at 90 degrees left, and the right-channel sound is positioned at 90 degrees right.

A four-band equalizer is provided on the input.



In this Algorithm, what you have set with the DIRECT MIX (p.46) will have effect.

4BAND EQ (Equalizer)

EFFECT	OFF, ON
LOW EQ	-20→+20 (dB)
HIGH EQ	-20→+20 (dB)
LEVEL	-20→+20 (dB)
LO-MD F	100-10.0 k (Hz)
LOW-MID Q	0.5-16.0
LOW-MID EQ	-20→+20 (dB)
HI-MD F	100-10.0 k (Hz)
HI-MID Q	0.5-16.0
HI-MID EQ	-20→+20 (dB)

MASTER

<MASTER>

LEVEL	0-100
BPM	40-250, MIDI, GLOBAL

<FV: FOOT VOLUME>

FOOT LEVEL	0-100
------------	-------

STEREO CHORUS

EFFECT	OFF, ON
POLARITY	SYNC, INVERT
RATE	0-100, BPM: ♩ - ♪
DEPTH	0-100
PRE DELAY	0.0-40.0 (msec)
LOW CUT	FLAT, 55-800 (Hz)
HIGH CUT	700-11 k (Hz), FLAT
EFFECT LEVEL	0-100
DIRECT SWITCH	OFF, ON
RSS SWITCH	OFF, ON

P_B18 REVERB RSS

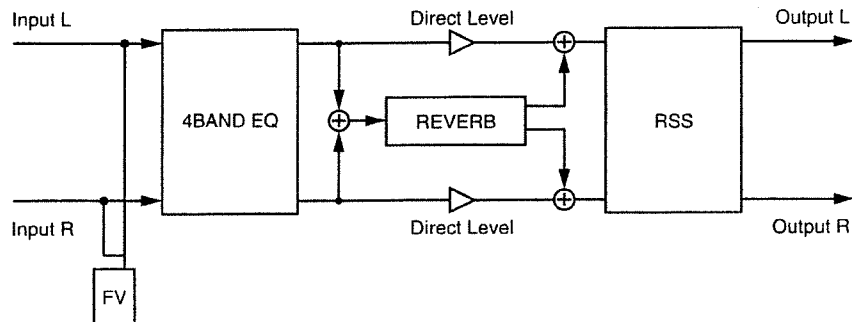

The output of the reverb is connected to RSS. The left-channel sound is positioned at 90 degrees left, and the right-channel sound is positioned at 90 degrees right.

A four-band equalizer is provided on the input.



In this Algorithm, what you have set with the DIRECT MIX (p.46) will have effect.

4BAND EQ (Equalizer)

EFFECT	OFF, ON
LOW EQ	-20~+20 (dB)
HIGH EQ	-20~+20 (dB)
LEVEL	-20~+20 (dB)
LO-MD F	100~10.0 k (Hz)
LOW-MID Q	0.5~16.0
LOW-MID EQ	-20~+20 (dB)
HI-MD F	100~10.0 k (Hz)
HI-MID Q	0.5~16.0
HI-MID EQ	-20~+20 (dB)

MASTER

<MASTER>	
LEVEL	0~100

<FV: FOOT VOLUME>	
FOOT LEVEL	0~100

REVERB

EFFECT	OFF, ON
TYPE	ROOM, HALL
SIZE	1~10
REVERB TIME	0.1~32.0 (sec)
BALANCE DIR:FX	100:0~0:100
EFFECT LEVEL	0~100
PRE DELAY	0~200 (msec)
DENSITY	0~100
EARLY REF LEVEL	0~100
LOW DAMP GAIN	-36.0~0.0 (dB)
LOW DAMP FREQUENCY	55~4.0 k (Hz)
HIGH DAMP GAIN	-36.0~0.0 (dB)
HIGH DAMP FREQUENCY	4.0k~20.0 k (Hz)
HIGH CUT FILTER	200~20.0 k (Hz)
RSS SWITCH	OFF, ON

P_B19 RSS PANNER

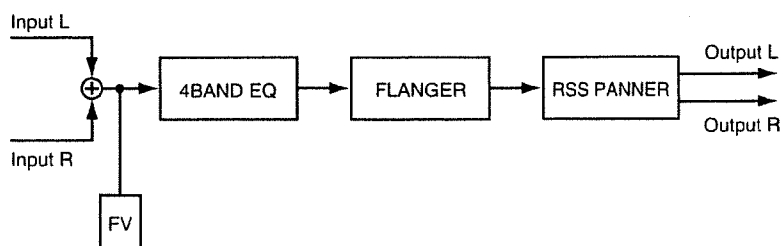

This produces the impression of a sound that rotates around the listener.

You can use a flanger to add an even more distinctive effect.

4BAND EQ (Equalizer)

EFFECT	OFF, ON
LOW EQ	-20-+20 (dB)
HIGH EQ	-20-+20 (dB)
LEVEL	-20-+20 (dB)
LO-MD F	100-10.0 k (Hz)
LOW-MID Q	0.5-16.0
LOW-MID EQ	-20-+20 (dB)
HI-MD F	100-10.0 k (Hz)
HI-MID Q	0.5-16.0
HI-MID EQ	-20-+20 (dB)

FLANGER

EFFECT	OFF, ON
RATE	0-100, BPM: ♩ - ♪
DEPTH	0-100
MANUAL	0-100
RESONANCE	0-100
GATE	OFF, 1-100
DIRECT SWITCH	OFF, ON

RSS PANNER

EFFECT	OFF, ON
SPEED	0-100, BPM: ♩ - ♪
DIRECTION	CW, CCW

MASTER

<MASTER>	
LEVEL	0-100
BPM	40-250, MIDI, GLOBAL

<FV: FOOT VOLUME>

FOOT LEVEL	0-100
------------	-------

P_B20 DELAY

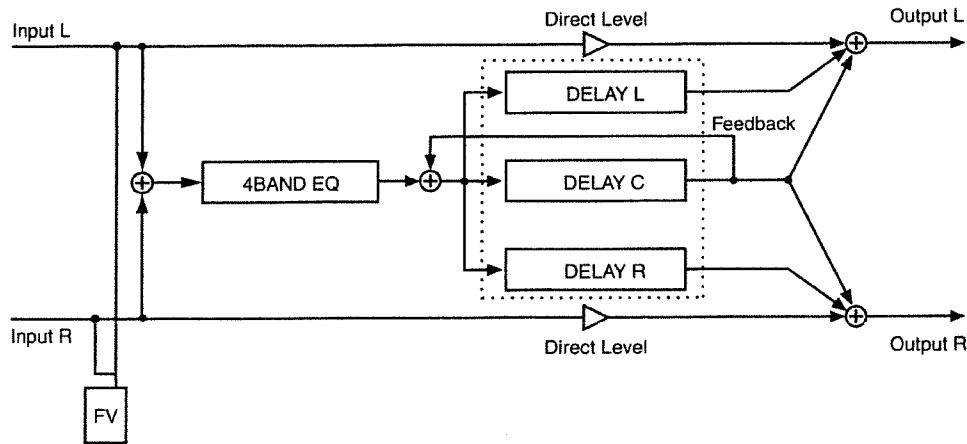

You can choose one of two types of delay; single, or three-tap.

By using the three-tap delay, you can make independent settings for each of the three delay sounds.

A four-band equalizer is provided on the input.

MEMO

In this Algorithm, what you have set with the DIRECT MIX (p.46) will have effect.

4BAND EQ (Equalizer)

EFFECT	OFF, ON
LOW EQ	-20→+20 (dB)
HIGH EQ	-20→+20 (dB)
LEVEL	-20→+20 (dB)
LO-MD F	100-10.0 k (Hz)
LOW-MID Q	0.5-16.0
LOW-MID EQ	-20→+20 (dB)
HI-MD F	100-10.0 k (Hz)
HI-MID Q	0.5-16.0
HI-MID EQ	-20→+20 (dB)

DELAY

EFFECT	OFF, ON
TYPE	SINGLE, 3TAP

(SINGLE)

DELAY TIME	0-2800 (msec), BPM: ♩ - ∞
FINE TIME	0-20 (msec)
FEEDBACK	0-100
FX LEVEL	0-120
DIR LEVEL	0-100
HIGH DAMP GAIN	-50-0 (dB)
HIGH CUT FILTER	700-11 k (Hz), FLAT

(3TAP)

DELAY TIME [C]	0-2800 (msec), BPM: ♩ - ∞
FINE TIME [C]	0-20 (msec)
TIME [L]	1-400 (%)
TIME [R]	1-400 (%)
FEEDBACK	0-100
LEVEL [C]	0-100
LEVEL [L]	0-100
LEVEL [R]	0-100
FX LEVEL	0-120
DIR LEVEL	0-100
HIGH DAMP GAIN	-50-0 (dB)
HIGH CUT FILTER	700-11 k (Hz), FLAT

MASTER

<MASTER>

LEVEL	0-100
BPM	40-250, MIDI, GLOBAL

<FV: FOOT VOLUME>

FOOT LEVEL	0-100
------------	-------

P_B21 MultiTAP DELAY (20 TAP)

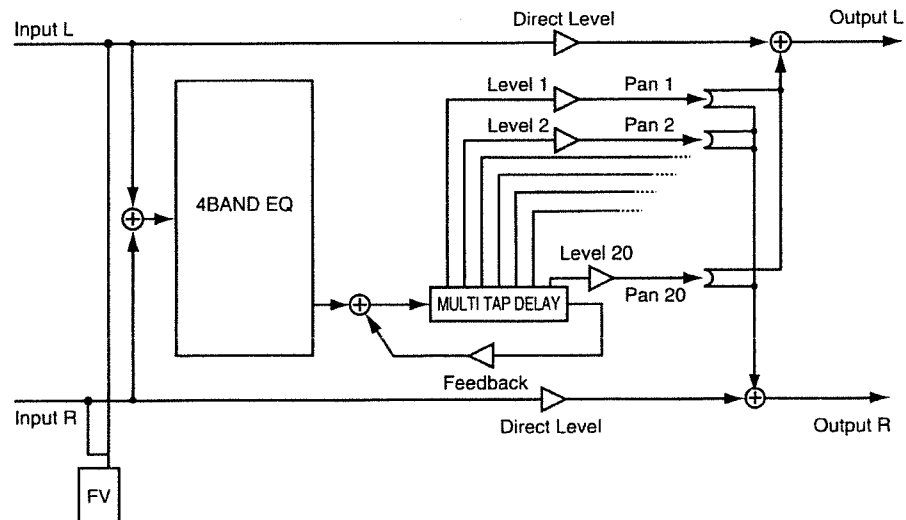

This delay lets you make independent settings for twenty separate delay sounds.
A four-band equalizer is provided on the input.

MEMO

In this Algorithm, what you have set with the **DIRECT MIX (p.46)** will have effect.

4BAND EQ (Equalizer)

EFFECT	OFF, ON
LOW EQ	-20→+20 (dB)
HIGH EQ	-20→+20 (dB)
LEVEL	-20→+20 (dB)
LO-MD F	100–10.0 k (Hz)
LOW-MID Q	0.5–16.0
LOW-MID EQ	-20→+20 (dB)
HI-MD F	100–10.0 k (Hz)
HI-MID Q	0.5–16.0
HI-MID EQ	-20→+20 (dB)

MASTER

<MASTER>	
LEVEL	0–100
BPM	40–250, MIDI, GLOBAL
<FV: FOOT VOLUME>	
FOOT LEVEL	0–100

MULTI TAP DELAY

EFFECT	OFF, ON
RATIO	1–100 (%)
TAP [1]– [20] DELAY TIME	0–2800 (msec), BPM: ♪ - ∞
TAP [1]– [20] FINE TIME	0–20 (msec)
TAP [1]– [20] PAN L:R	100:0–0:100
TAP [1]– [20] LEVEL	0–100
FB DELAY	0–2800 (msec), BPM: ♪ - ∞
FB FINE	0–20 (msec)
FB LEVEL	0–100
LOW CUT	FLAT, 55–800 (Hz)
HIGH CUT	700–11 k (Hz), FLAT
DIR LEVEL	0–100
FX LEVEL	0–120

P_B22 TAPE ECHO201

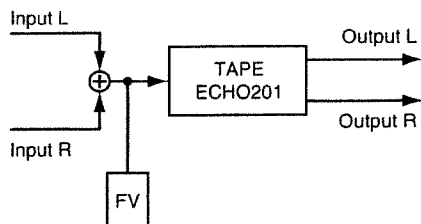

This is a simulation of a Roland RE-201 tape echo.

MEMO

In this Algorithm, what you have set with the **DIRECT MIX** (p.46) will have effect.

TAPE ECHO201

EFFECT	OFF, ON
MODE	1-7
REPEAT RATE	0-100
INTENSITY	0-100
TONE BASS	-100+100
TONE TREBLE	-100+100
PAN HEAD S L:R	100:0-0:100
PAN HEAD M L:R	100:0-0:100
PAN HEAD L L:R	100:0-0:100
TAPE DIST	0-100
WOW RATE	0-100
WOW DEPTH	0-100
FX LEVEL	0-100
DIR LEVEL	0-100

MASTER

<MASTER>	
LEVEL	0-100
<FV: FOOT VOLUME>	
FOOT LEVEL	0-100

P_B23 MIC SIMULATOR

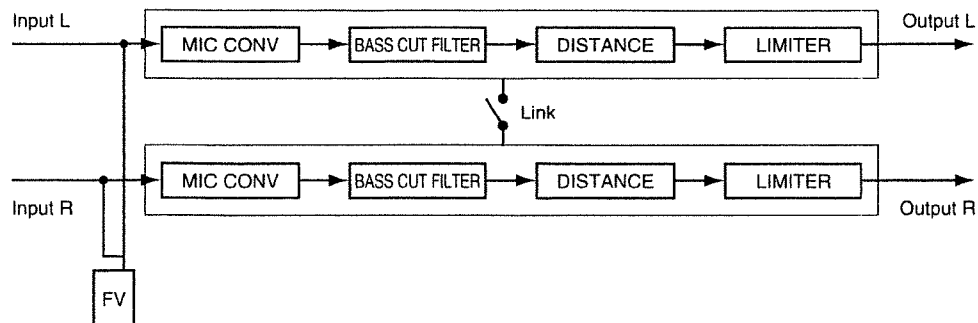

With this effect, sounds that were picked up by a standard dynamic mic, pin mic, or direct line, can be converted to produce the impression that the sounds were recorded on an expensive condenser mic or a special studio mic.

A proximity effect or a sense of distance from the mic can also be added.

* We recommended the microphone should be pre-amplified (by a mixer, etc.).

Lch & Rch: MIC CONV (Mic Converter)

EFFECT	OFF, ON
INPUT	DR-20, SML.DY, HED.DY, MIN.CN, FLAT
OUTPUT	SML.DY, VOC.DY, LRG.DY, SML.CN, LRG.CN, VNT.CN, FLAT
PHASE	NOR, INV

* If "MIC.CN" is selected for Input, it will be possible to select only "SML.DY" or "LRG.CN" for Output.

Lch & Rch: BCF (Bass cut filter)

EFFECT	OFF, ON
FREQUENCY	THRU, 20-2000 (Hz)

Lch & Rch: DISTANCE

EFFECT	OFF, ON
PROX.FX	-12--+12
TIME	0-3000 (cm)

Lch & Rch: LIMITER

EFFECT	OFF, ON
THRESHOLD	-60-0 (dB)
ATTACK	0-100
RELEASE	0-100
DETECT HPF	THRU, 20-2000 (Hz)
LEVEL	-60--+4 (dB)

MASTER

<MASTER>	
LINK	OFF, ON
LEVEL	0-100

<FV: FOOT VOLUME>

FOOT LEVEL	0-100
------------	-------

P_B24 SPACE CHORUS

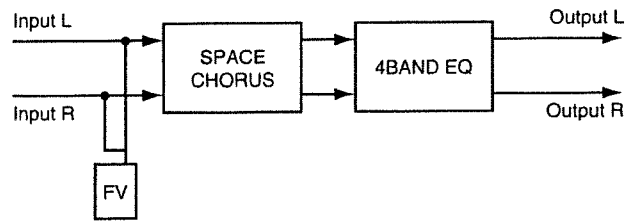

This is a chorus that simulates a Roland SDD-320 (Dimension D).

MEMO

In this Algorithm, what you have set with the DIRECT MIX (p.46) will have effect.

SPACE CHORUS

EFFECT	OFF, ON
INPUT	MONO, ST.
MODE	1, 2, 3, 4, 1+4, 2+4, 3+4
FX LEVEL	0-100
DIRECT SWITCH	OFF, ON

MASTER

<MASTER>	
LEVEL	0-100
<FV: FOOT VOLUME>	
FOOT LEVEL	0-100

4BAND EQ (Equalizer)

EFFECT	OFF, ON
LOW EQ	-20→+20 (dB)
HIGH EQ	-20→+20 (dB)
LEVEL	-20→+20 (dB)
LO-MD F	100-10.0 k (Hz)
LOW-MID Q	0.5-16
LOW-MID EQ	-20→+20 (dB)
HI-MD F	100-10.0 k (Hz)
HI-MID Q	0.5-16
HI-MID EQ	-20→+20 (dB)

P_B25 StFLANGER DLY (Stereo Flanger Delay)

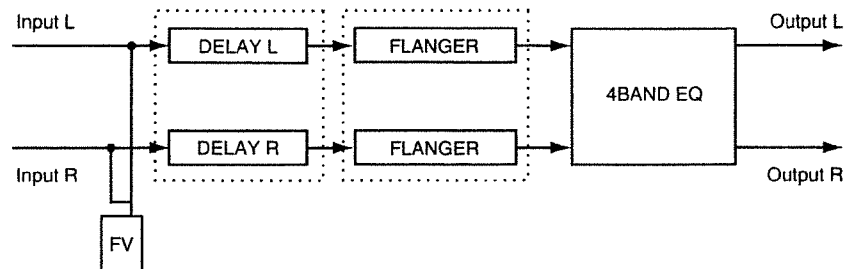

This algorithm combines a stereo flanger, stereo delay, and equalizer in series. It allows you to add modulation to the sound while preserving the positioning of the stereo input.

MEMO

In this Algorithm, what you have set with the DIRECT MIX (p.46) will have effect.

STEREO DELAY

EFFECT	OFF, ON
DELAY TIME [L]	0-1400 (msec), BPM: ♪ - ∞
FINE TIME [L]	0-20 (msec)
DELAY TIME [R]	0-1400 (msec), BPM: ♪ - ∞
FINE TIME [R]	0-20 (msec)
FEEDBK [L]	0-100
FEEDBK [R]	0-100
FX LEVEL	0-120
DIR LEVEL	0-100
HIGH DAMP GAIN	-50-0 (dB)
HIGH CUT FILTER	700-11 k (Hz), FLAT

STEREO FLANGER

EFFECT	OFF, ON
RATE	0-100, BPM: ∞ - ♪
DEPTH	0-100
MANUAL	0-100
RESONANCE	0-100
SEPARATE	0-100
GATE	OFF, 1-100
DIRECT SWITCH	OFF, ON

4BAND EQ (Equalizer)

EFFECT	OFF, ON
LOW EQ	-20-+20 (dB)
HIGH EQ	-20-+20 (dB)
LEVEL	-20-+20 (dB)
LO-MD F	100-10.0 k (Hz)
LOW-MID Q	0.5-16.0
LOW-MID EQ	-20-+20 (dB)
HI-MD F	100-10.0 k (Hz)
HI-MID Q	0.5-16.0
HI-MID EQ	-20-+20 (dB)

MASTER

<MASTER>	
LEVEL	0-100
BPM	40-250, MIDI, GLOBAL

<FV: FOOT VOLUME>

FOOT LEVEL	0-100
------------	-------

P_B26 StPHASER DLY (Stereo Phaser Delay)

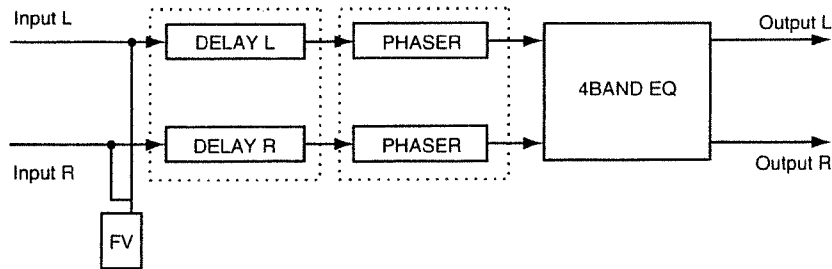

This algorithm combines a stereo phaser, stereo delay, and equalizer in series. It allows you to add modulation to the sound while preserving the positioning of the stereo input.

MEMO

In this Algorithm, what you have set with the DIRECT MIX (p.46) will have effect.

STEREO DELAY

EFFECT	OFF, ON
DELAY TIME [L]	0-1400 (msec), BPM: ♪ - ∞
FINE TIME [L]	0-20 (msec)
DELAY TIME [R]	0-1400 (msec), BPM: ♪ - ∞
FINE TIME [R]	0-20 (msec)
FEEDBK [L]	0-100
FEEDBK [R]	0-100
FX LEVEL	0-120
DIR LEVEL	0-100
HIGH DAMP GAIN	-50-0 (dB)
HIGH CUT FILTER	700-11 k (Hz), FLAT

STEREO PHASER

EFFECT	OFF, ON
TYPE	4-12 (STAGE)
RATE	0-100, BPM: ∞ - ♪
DEPTH	0-100
MANUAL	0-100
RESONANCE	-100-+100
SEPARATE	0-100
STEP	OFF, 1-100

4BAND EQ (Equalizer)

EFFECT	OFF, ON
LOW EQ	-20-+20 (dB)
HIGH EQ	-20-+20 (dB)
LEVEL	-20-+20 (dB)
LO-MD F	100-10.0 k (Hz)
LOW-MID Q	0.5-16.0
LOW-MID EQ	-20-+20 (dB)
HI-MD F	100-10.0 k (Hz)
HI-MID Q	0.5-16.0
HI-MID EQ	-20-+20 (dB)

MASTER

<MASTER>	
LEVEL	0-100
BPM	40-250, MIDI, GLOBAL

<FV: FOOT VOLUME>

FOOT LEVEL	0-100
------------	-------

P_B27 StCHORUS DLY (Stereo Chorus Delay)

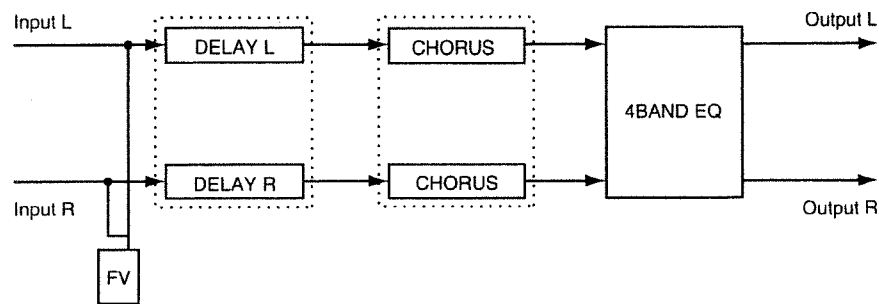

This algorithm combines a stereo chorus, stereo delay, and equalizer in series. It allows you to add depth and spaciousness to the sound while preserving the positioning of the stereo input.



In this Algorithm, what you have set with the DIRECT MIX (p.46) will have effect.

STEREO DELAY

EFFECT	OFF, ON
DELAY TIME [L]	0–1400 (msec), BPM: ♪ – ∞
FINE TIME [L]	0–20 (msec)
DELAY TIME [R]	0–1400 (msec), BPM: ♪ – ∞
FINE TIME [R]	0–20 (msec)
FEEDBK [L]	0–100
FEEDBK [R]	0–100
FX LEVEL	0–120
DIR LEVEL	0–100
HIGH DAMP GAIN	-50–0 (dB)
HIGH CUT FILTER	700–11 k (Hz), FLAT

STEREO CHORUS

EFFECT	OFF, ON
POLARITY	SYNC, INVERT
RATE	0–100, BPM: ∞ – ♪
DEPTH	0–100
PRE DELAY	0.0–40.0 (msec)
LOW CUT	FLAT, 55–800 (Hz)
HIGH CUT	700–11 k (Hz), FLAT
EFFECT LEVEL	0–100
DIRECT SWITCH	OFF, ON

4BAND EQ (Equalizer)

EFFECT	OFF, ON
LOW EQ	-20–+20 (dB)
HIGH EQ	-20–+20 (dB)
LEVEL	-20–+20 (dB)
LO-MID F	100–10.0 k (Hz)
LOW-MID Q	0.5–16.0
LOW-MID EQ	-20–+20 (dB)
HI-MD F	100–10.0 k (Hz)
HI-MID Q	0.5–16.0
HI-MID EQ	-20–+20 (dB)

MASTER

<MASTER>

LEVEL	0–100
BPM	40–250, MIDI, GLOBAL

<FV: FOOT VOLUME>

FOOT LEVEL	0–100
------------	-------

P_B28 STEREO PS DLY (Stereo Pitch Shifter Delay)

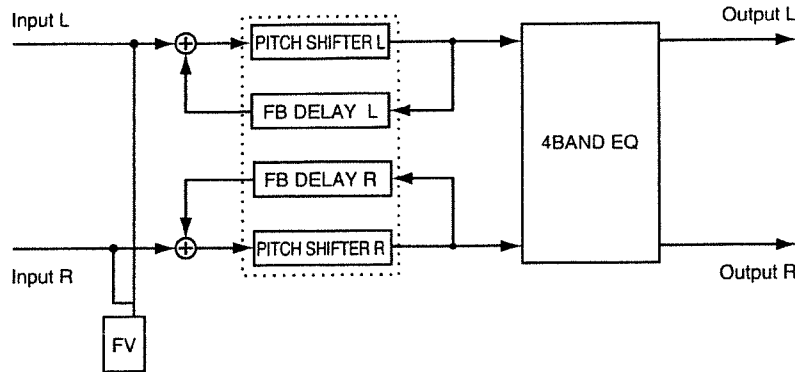

This allows you to apply delay which is fed back to the pitch-shifted sound. You can use this to create special pitch-shift effects in which the pitch continues to change in steps. Of course it can also be used as a conventional stereo pitch shifter.



In this Algorithm, what you have set with the DIRECT MIX (p.46) will have effect.

STEREO PS DLY (Stereo Pitch Shifter Delay)

EFFECT	OFF, ON
MODE	FAST, MEDIUM, SLOW
PITCH [L]	-24+24
FINE [L]	-50+50
PITCH [R]	-24+24
FINE [R]	-50+50
PRE DELAY [L]	0.0-50.0 (msec)
PRE DELAY [R]	0.0-50.0 (msec)
FB DELAY TIME [L]	0-1200 (msec), BPM: ♪ - ∞
FB FINE TIME [L]	0-20 (msec)
FB DELAY TIME [R]	0-1200 (msec), BPM: ♪ - ∞
FB FINE TIME [R]	0-20 (msec)
FB LEVEL [L]	0-100
FB LEVEL [R]	0-100
BALANCE DIR:FX	100:0-0:100
LEVEL	0-100

4BAND EQ (Equalizer)

EFFECT	OFF, ON
LOW EQ	-20+20 (dB)
HIGH EQ	-20+20 (dB)
LEVEL	-20+20 (dB)
LO-MD F	100-10.0 k (Hz)
LOW-MID Q	0.5-16.0
LOW-MID EQ	-20+20 (dB)
HI-MD F	100-10.0 k (Hz)
HI-MID Q	0.5-16.0
HI-MID EQ	-20+20 (dB)

MASTER

<MASTER>	
LEVEL	0-100
BPM	40-250, MIDI, GLOBAL

<FV: FOOT VOLUME

FOOT LEVEL	0-100
------------	-------

P_B29 STEREO MULTI

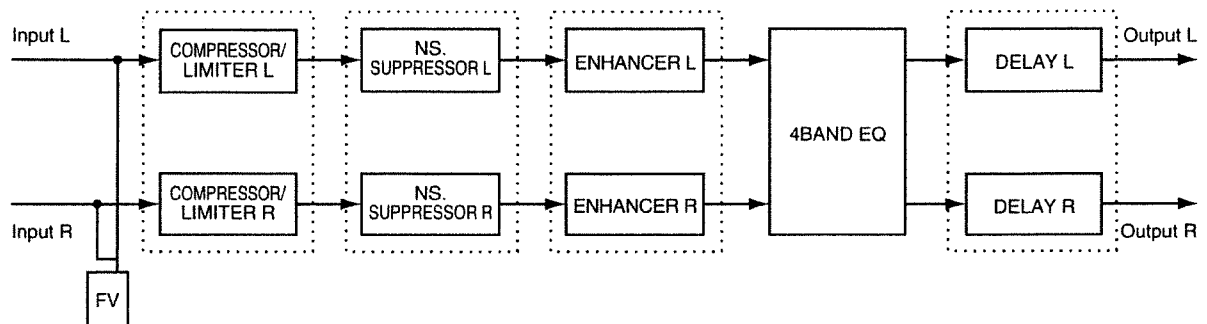

This algorithm is a series connection of five basic effects, each completely in stereo.

It allows you to add depth and spaciousness to the sound while preserving the positioning of the stereo input.

COMPRESSOR/LIMITER

EFFECT OFF, ON
SELECT COMP, LIMIT

<COMPRESSOR>

DETECT L, R, LINK
THRESHOLD 0-100
RATIO 1.5:1-100:1
ATTACK 0-100
RELEASE 0-100
TONE -50+50
LEVEL 0-100

<LIMITER>

DETECT L, R, LINK
THRESHOLD 0-100
RELEASE 0-100
TONE -50+50
LEVEL 0-100

NS. SUPPRESSOR (Noise Suppressor)

EFFECT OFF, ON
DETECT L, R, LINK
THRESHOLD 0-100
RELEASE 0-100

ENHANCER

EFFECT OFF, ON
DETECT L, R, LINK
SENS 0-100
FREQUENCY 1.0 k-10.0 k (Hz)
MIX LEVEL 0-100
LoMIX LEVEL 0-100
LEVEL 0-100

4BAND EQ (Equalizer)

EFFECT OFF, ON
LOW EQ -20+20 (dB)
HIGH EQ -20+20 (dB)
LEVEL -20+20 (dB)
LO-MD F 100-10.0 k (Hz)
LOW-MID Q 0.5-16.0
LOW-MID EQ -20+20 (dB)
HI-MD F 100-10.0 k (Hz)
HI-MID Q 0.5-16.0
HI-MID EQ -20+20 (dB)

STEREO DELAY

EFFECT OFF, ON
DELAY TIME [L] 0-1400 (msec), BPM: ♪ - ∞
FINE TIME [L] 0-20 (msec)
DELAY TIME [R] 0-1400 (msec), BPM: ♪ - ∞
FINE TIME [R] 0-20 (msec)
FEEDBK [L] 0-100
FEEDBK [R] 0-100
FX LEVEL 0-120
DIR LEVEL 0-100
HIGH DAMP GAIN -50-0 (dB)
HIGH CUT FILTER 700-11 k (Hz), FLAT

MASTER

<MASTER>

LEVEL 0-100
BPM 40-250, MIDI, GLOBAL

<FV: FOOT VOLUME>

FOOT LEVEL 0-100

P_B30 10GRAPHIC EQ (10-Band Graphic Equalizer)

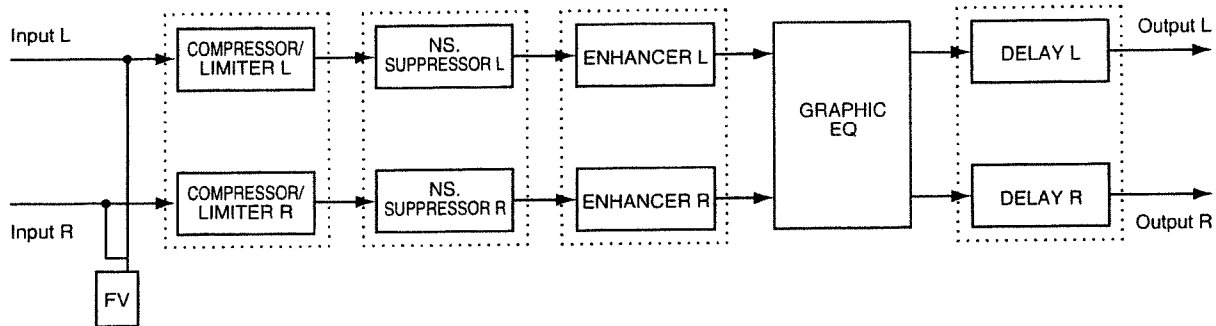

This is a completely stereo ten-band graphic equalizer.
It allows detailed adjustments to be made in the frequency response.

COMPRESSOR/LIMITER

EFFECT OFF, ON
SELECT COMP. LIMIT

<COMP: COMPRESSOR>

DETECT L, R, LINK
THRESHOLD 0-100
RATIO 1.5:1-100:1
ATTACK 0-100
RELEASE 0-100
TONE -50-+50
LEVEL 0-100

<LIMIT: LIMITER>

DETECT L, R, LINK
THRESHOLD 0-100
RELEASE 0-100
TONE -50-+50
LEVEL 0-100

NS. SUPPRESSOR (Noise Suppressor)

EFFECT OFF, ON
DETECT L, R, LINK
THRESHOLD 0-100
RELEASE 0-100

ENHANCER

EFFECT OFF, ON
DETECT L, R, LINK
SENS 0-100
FREQUENCY 1.0 k-10.0 k (Hz)
MIX LEVEL 0-100
LoMIX LEVEL 0-100
LEVEL 0-100

GRAPHIC EQ (Equalizer)

EFFECT OFF, ON
INPUT GAIN -12-+12 (dB)
LEVEL -12-+12 (dB)
31.2 Hz -12-+12 (dB)
62.5 Hz -12-+12 (dB)
125 Hz -12-+12 (dB)
250 Hz -12-+12 (dB)
500 Hz -12-+12 (dB)
1.0 kHz -12-+12 (dB)
2.0 kHz -12-+12 (dB)
4.0 kHz -12-+12 (dB)
8.0 kHz -12-+12 (dB)
16 kHz -12-+12 (dB)

STEREO DELAY

EFFECT OFF, ON
DELAY TIME [L] 0-1400 (msec), BPM: ♪ - ∞
FINE TIME [L] 0-20 (msec)
DELAY TIME [R] 0-1400 (msec), BPM: ♪ - ∞
FINE TIME [R] 0-20 (msec)
FEEDBK [L] 0-100
FEEDBK [R] 0-100
FX LEVEL 0-120
DIR LEVEL 0-100
HIGH DAMP GAIN -50-0 (dB)
HIGH CUT FILTER 700-11 k (Hz), FLAT

MASTER

<MASTER>
LEVEL 0-100
BPM 40-250, MIDI, GLOBAL

<FV: FOOT VOLUME>

FOOT LEVEL 0-100

P_B31 HUM CANCELER

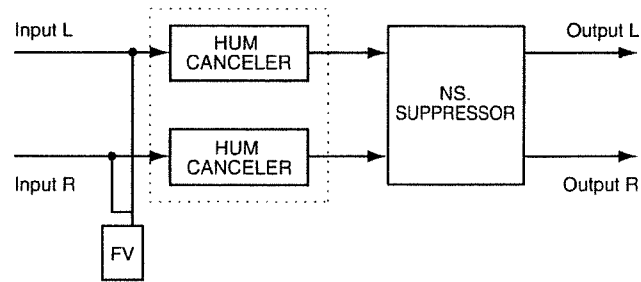

This removes unwanted hum ("buzz" noise). A noise suppressor is provided on the output.

HUM CANCELER

EFFECT	OFF, ON
FREQUENCY	20.0–800.0 (Hz)
WIDTH	10–40 (%)
DEPTH	0–100
THRESHOLD	0–100
RANGE LOW	20–2000 (Hz)
RANGE HIGH	1.0 k–20.0 k (Hz)

MASTER

<MASTER>	
LEVEL	0–100

<FV: FOOT VOLUME>

FOOT LEVEL	0–100
------------	-------

NS. SUPPRESSOR (Noise Suppressor)

EFFECT	OFF, ON
THRESHOLD	0–100
RELEASE	0–100

P_B32 VOCAL CANCELER

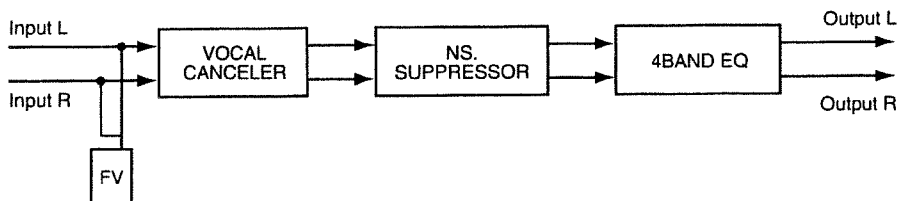

When a stereo source such as CD or DAT is input to this effect, sounds that are located in the center (such as vocals or bass) will be removed. A four-band equalizer is provided on the output.

* Depending on the musical source, desired sounds may be removed, or there may be other ways in which the result is not as you wish. In particular, the desired effect will not be obtained on musical sources with deep reverb, or if the sound you wish to cancel is not located in the center.

VOCAL CANCELER

EFFECT	OFF, ON
BALANCE	0-100
RANGE LOW	20-2000 (Hz)
RANGE HIGH	1.0 k-20.0 k (Hz)

MASTER

<MASTER>	
LEVEL	0-100
<FV: FOOT VOLUME>	
FOOT LEVEL	0-100

NS. SUPPRESSOR (Noise Suppressor)

EFFECT	OFF, ON
THRESHOLD	0-100
RELEASE	0-100

4BAND EQ (Equalizer)

EFFECT	OFF, ON
LOW EQ	-20+20 (dB)
HIGH EQ	-20+20 (dB)
LEVEL	-20+20 (dB)
LO-MD F	100-10.0 k (Hz)
LOW-MID Q	0.5-16.0
LOW-MID EQ	-20+20 (dB)
HI-MD F	100-10.0 k (Hz)
HI-MID Q	0.5-16.0
HI-MID EQ	-20+20 (dB)

P_B33 REVERB+REVERB

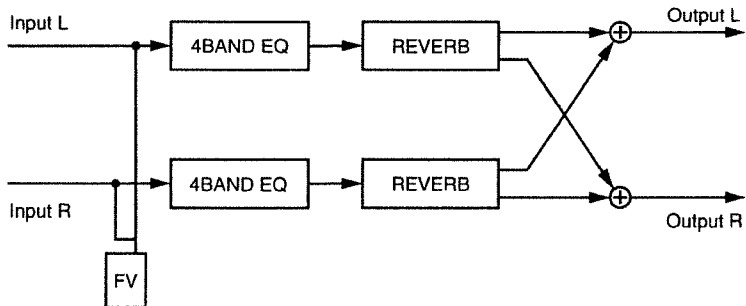

This allows you to simultaneously and independently use two different types of reverb on the L and R channels. A four-band equalizer is provided on the input.



In this Algorithm, what you have set with the DIRECT MIX (p.46) will have effect.

Lch & Rch: 4BAND EQ (Equalizer)

EFFECT	OFF, ON
LOW EQ	-20→+20 (dB)
HIGH EQ	-20→+20 (dB)
LEVEL	-20→+20 (dB)
LO-MD F	100-10.0 k (Hz)
LOW-MID Q	0.5-16.0
LOW-MID EQ	-20→+20 (dB)
HI-MD F	100-10.0 k (Hz)
HI-MID Q	0.5-16.0
HI-MID EQ	-20→+20 (dB)

Rch: REVERB

EFFECT	OFF, ON
TYPE	ROOM1, ROOM2, HALL1, HALL2, PLATE
REVERB TIME	0.1-10.0 (sec)
BALANCE DIR:FX	100:0-0:100
EFFECT LEVEL	0-100
PRE DELAY	0-100 (msec)
DENSITY	0-10
LOW CUT	FLAT, 55-800 (Hz)
HIGH CUT	700-11 k (Hz), FLAT

Lch: REVERB

EFFECT	OFF, ON
TYPE	ROOM, HALL
SIZE	1-10
REVERB TIME	0.1-32.0 (sec)
BALANCE DIR:FX	100:0-0:100
EFFECT LEVEL	0-100
PRE DELAY	0-200 (msec)
DENSITY	0-100
EARLY REF LEVEL	0-100
LOW DAMP GAIN	-36.0-0.0 (dB)
LOW DAMP FREQUENCY	55-4.0 k (Hz)
HIGH DAMP GAIN	-36.0-0.0 (dB)
HIGH DAMP FREQUENCY	4.0 k-20.0 k (Hz)
HIGH CUT FILTER	200-20.0 k (Hz)

MASTER

<MASTER>	
LEVEL	0-100
<FV: FOOT VOLUME>	
FOOT LEVEL	0-100

P_B34 CHORUS+REVERB

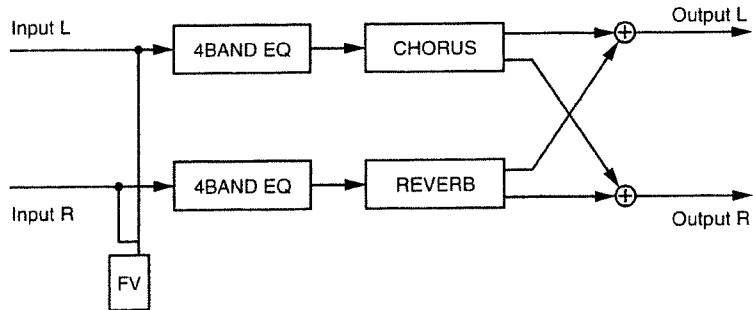

This allows you to simultaneously and independently use chorus and reverb on the L and R channels. A four-band equalizer is provided on the input.



In this Algorithm, what you have set with the DIRECT MIX (p.46) will have effect.

Lch & Rch: 4BAND EQ (Equalizer)

EFFECT	OFF, ON
LOW EQ	-20→+20 (dB)
HIGH EQ	-20→+20 (dB)
LEVEL	-20→+20 (dB)
LO-MD F	100-10.0 k (Hz)
LOW-MID Q	0.5-16.0
LOW-MID EQ	-20→+20 (dB)
HI-MD F	100-10.0 k (Hz)
HI-MID Q	0.5-16.0
HI-MID EQ	-20→+20 (dB)

Lch: CHORUS

EFFECT	OFF, ON
MODE	MONO, ST.
RATE	0-100, BPM: ♩ - ♪
DEPTH	0-100
PRE DELAY	0.0-40.0 (msec)
LOW CUT	FLAT, 55-800 (Hz)
HIGH CUT	700-11 k (Hz), FLAT
FX LEVEL	0-100
DIRECT SWITCH	OFF, ON

Rch: REVERB

EFFECT	OFF, ON
TYPE	ROOM1, ROOM2, HALL1, HALL2, PLATE
REVERB TIME	0.1-10.0 (sec)
BALANCE DIR:FX	100:0-0:100
EFFECT LEVEL	0-100
PRE DELAY	0-100 (msec)
DENSITY	0-10
LOW CUT	FLAT, 55-800 (Hz)
HIGH CUT	700-11 k (Hz), FLAT

MASTER

<MASTER>

LEVEL	0-100
BPM	40-250, MIDI, GLOBAL

<FV: FOOT VOLUME>

FOOT LEVEL	0-100
------------	-------

P_B35 DELAY+REVERB

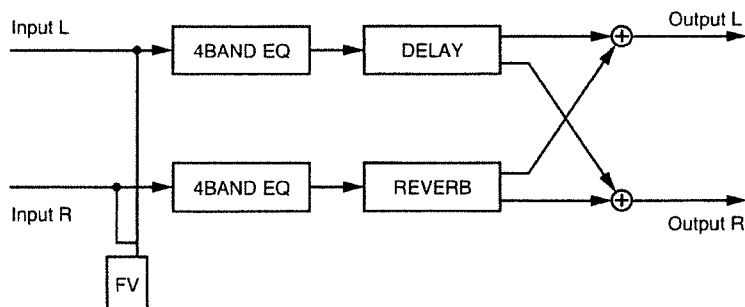

This allows you to simultaneously and independently use delay and reverb on the L and R channels. A four-band equalizer is provided on the input.

MEMO

In this Algorithm, what you have set with the DIRECT MIX (p.46) will have effect.

Lch & Rch: 4BAND EQ (Equalizer)

EFFECT	OFF, ON
LOW EQ	-20→+20 (dB)
HIGH EQ	-20→+20 (dB)
LEVEL	-20→+20 (dB)
LO-MD F	100-10.0 k (Hz)
LOW-MID Q	0.5-16.0
LOW-MID EQ	-20→+20 (dB)
HI-MD F	100-10.0 k (Hz)
HI-MID Q	0.5-16.0
HI-MID EQ	-20→+20 (dB)

Lch: DELAY

EFFECT	OFF, ON
TYPE	SINGLE, 3TAP

(SINGLE)

DELAY TIME	0-1800 (msec), BPM: ♩ - ∞
FINE TIME	0-20 (msec)
FEEDBACK	0-100
FX LEVEL	0-120
DIR LEVEL	0-100
HIGH DAMP GAIN	-50-0 (dB)
HIGH CUT FILTER	700-11 k (Hz), FLAT

(3TAP)

DELAY TIME [C]	0-1800 (msec), BPM: ♩ - ∞
FINE TIME [C]	0-20 (msec)
TIME [L]	1-400 (%)
TIME [R]	1-400 (%)
FEEDBACK	0-100
LEVEL [C]	0-100
LEVEL [L]	0-100
LEVEL [R]	0-100
FX LEVEL	0-120
DIR LEVEL	0-100
HIGH DAMP GAIN	-50-0 (dB)
HIGH CUT FILTER	700-11 k (Hz), FLAT

Rch: REVERB

EFFECT	OFF, ON
TYPE	ROOM1, ROOM2, HALL1, HALL2, PLATE
REVERB TIME	0.1-10 (sec)
BALANCE DIR:FX	100:0-0:100
EFFECT LEVEL	0-100
PRE DELAY	0-100 (msec)
DENSITY	0-10
LOW CUT	FLAT, 55-800 (Hz)
HIGH CUT	700-11 k (Hz), FLAT

MASTER

<MASTER>

LEVEL	0-100
BPM	40-250, MIDI, GLOBAL

<FV: FOOT VOLUME>

FOOT LEVEL	0-100
------------	-------

P_B36 DELAY+CHORUS

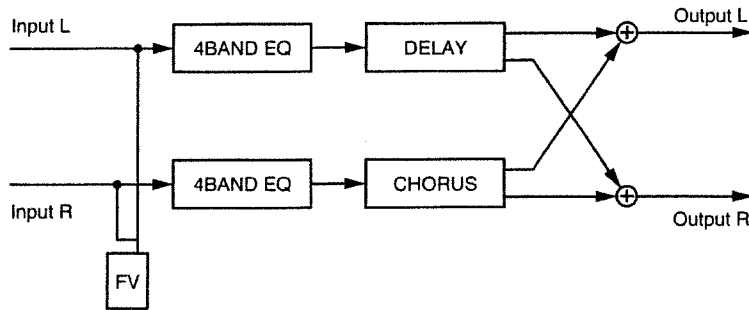

This allows you to simultaneously and independently use delay and chorus on the L and R channels. A four-band equalizer is provided on the input.

MEMO

In this Algorithm, what you have set with the DIRECT MIX (p.46) will have effect.

Lch & Rch: 4BAND EQ (Equalizer)

EFFECT	OFF, ON
LOW EQ	-20→+20 (dB)
HIGH EQ	-20→+20 (dB)
LEVEL	-20→+20 (dB)
LO-MD F	100-10.0 k (Hz)
LOW-MID Q	0.5-16.0
LOW-MID EQ	-20→+20 (dB)
HI-MD F	100-10.0 k (Hz)
HI-MID Q	0.5-16.0
HI-MID EQ	-20→+20 (dB)

Lch: DELAY

EFFECT	OFF, ON
TYPE	SINGLE, 3TAP
(SINGLE)	
DELAY TIME	0-1800 (msec), BPM: ♪ - ∞
FINE TIME	0-20 (msec)
FEEDBACK	0-100
FX LEVEL	0-120
DIR LEVEL	0-100
HIGH DAMP GAIN	-50-0 (dB)
HIGH CUT FILTER	700-11 k (Hz), FLAT

(3TAP)

DELAY TIME [C]	0-1800 (msec), BPM: ♪ - ∞
FINE TIME [C]	0-20 (msec)
TIME [L]	1-400 (%)
TIME [R]	1-400 (%)
FEEDBACK	0-100
LEVEL [C]	0-100
LEVEL [L]	0-100
LEVEL [R]	0-100
FX LEVEL	0-120
DIR LEVEL	0-100
HIGH DAMP GAIN	-50-0 (dB)
HIGH CUT FILTER	700-11.0 k (Hz), FLAT

Rch: CHORUS

EFFECT	OFF, ON
MODE	MONO, ST.
RATE	0-100, BPM: ∞ - ♪
DEPTH	0-100
PRE DELAY	0.0-40.0 (msec)
LOW CUT	FLAT, 55-800 (Hz)
HIGH CUT	700-11 k (Hz), FLAT
FX LEVEL	0-100
DIRECT SWITCH	OFF, ON

MASTER

<MASTER>

LEVEL	0-100
BPM	40-250, MIDI, GLOBAL

<FV: FOOT VOLUME>

FOOT LEVEL	0-100
------------	-------

The function of each parameter

2x2 CHORUS

This adds a pitch-shifted sound to the original sound, producing an effect of greater depth and spaciousness. Two separate stereo chorus units are used for the low-frequency and high-frequency ranges in order to create a more natural chorus sound.

EFFECT

This parameter turns the 2x2 Chorus effect on/off.

XOVER (crossover frequency)

This parameter sets the frequency at which the frequency components of the effect sound are divided into bass and treble bands.

LOW RATE

Adjust the speed of the chorus effect for the low frequency range.

* If this is set to BPM, the MASTER BPM (p.105) value that is set for each patch will determine the speed of the effect, so that the effect will match the tempo of the song. However if the BPM value is large, the effect will synchronize to 1/2 or 1/4 of the BPM.

LOW DEPTH

Adjust the depth of the chorus effect for the low frequency range. If you wish to use this as a doubling effect, use a setting of "0."

LOW PRE DELAY

Adjust the time from when the low frequency range direct sound is output until the effect sound is output. Extending the pre-delay will produce the sensation of multiple sounds (doubling effect).

LOW LEVEL

Adjust the volume of the low frequency range effect sound.

HIGH RATE

Adjust the speed of the chorus effect for the high frequency range.

* If this is set to BPM, the MASTER BPM (p.105) value that is set for each patch will determine the speed of the effect, so that the effect will match the tempo of the song. However if the BPM value is large, the effect will synchronize to 1/2 or 1/4 of the BPM.

HIGH DEPTH

Adjust the depth of the chorus effect for the high frequency range. If you wish to use this as a doubling effect, use a setting of "0."

HIGH PRE DELAY

Adjust the time from when the high frequency range direct sound is output until the effect sound is output. Extending the pre-delay will produce the sensation of multiple sounds (doubling effect).

HIGH LEVEL

Adjust the volume of the high frequency range effect sound.

4BAND EQ (equalizer)

This simulates a 4-band equalizer.

EFFECT

This parameter turns the equalizer effect on/off.

LOW EQ (low equalizer)

Adjusts the low frequency range tone.

HIGH EQ (high equalizer)

Adjusts the high frequency range tone.

LEVEL

This parameter adjusts the volume after the equalizer stage.

LO-MD F (low-middle frequency)

This parameter sets the central frequency for the "LOW-MID EQ."

LOW-MID Q (low-middle Q)

This parameter sets the range of change in gain for the frequency set by the "LO-MD F." A larger value results in a narrower range of change.

LOW-MID EQ (low-middle equalizer)

Adjusts the low-middle frequency range tone.

HI-MD F (high-middle frequency)

This parameter sets the central frequency for the "HI-MID EQ."

HI-MID Q (high-middle Q)

This parameter sets the range of change in gain for the frequency set by the "HI-MD F." A larger value results in a narrower range of change.

HI-MID EQ (high-middle equalizer)

Adjusts the high-middle frequency range tone.

The function of each parameter

ACOUSTIC

With this feature, you can change the sound from a pickup on an electric-acoustic guitar into a richer sound, similar to that obtained by a microphone placed near a guitar.

EFFECT

This parameter turns the acoustic effect on/off.

BODY

This adjusts the resonance of the sound caused by the body. That is, it adjusts the softness and fatness of the sound which is the typical characteristics of acoustic guitars.

MIC DISTANCE

This simulates the distance between the microphone capturing the sound of an acoustic guitar and the guitar itself.

ACOUSTIC G+SIM (acoustic guitar simulator)

This simulates the sound of an acoustic guitar. It allows you to use an electric guitar to produce sounds similar to those of an acoustic guitar.

This effect can be used in the "GUITAR MULTI 2" algorithm when the SFX "SELECT" parameter is set to "AC."

* For details on SFX settings, refer to "About SFX" (p.48).

TOP

This adjusts the interference to the strings made by the top plate. That is, it adjusts the attack sense or harmonic contents.

BODY

This adjusts the resonance of the sound caused by the body. That is, it adjusts the softness and fatness of the sound which is the typical characteristics of acoustic guitars.

LEVEL

This adjusts the volume of the acoustic guitar simulator.

AFB (anti-feedback)

This prevents the acoustic feedback that can be produced by the body resonances of a guitar.

EFFECT

This parameter turns the anti-feedback effect on/off.

DEPTH

Adjust the suppression strength of the fixed frequency point for feedback cancellation.

FREQUENCY

Adjust the fixed frequency point at which feedback will be cancelled.

BASS GTR SIM (bass guitar simulator)

Simulates the sound of a bass guitar. Obtain the sound of a bass guitar while playing an electric guitar.

This effect can be used in the "GUITAR MULTI 2" algorithm when the SFX "SELECT" parameter is set to "BS."

* For details on SFX settings, refer to "About SFX" (p.48).

CHARACTER

Bass tone characteristic is set. When "LOOSE" is selected, as if the string gauge was getting thicker.

FX LEVEL (effect level)

Adjusts the volume of the bass guitar simulator sound.

DIR LEVEL (direct level)

This adjusts the volume of the direct sound when the effect is turned on.

BCF (bass cut filter)

This is a filter that cuts unwanted low range noise, such as pops. It simulates the bass cut switch that is found on some mics.

EFFECT

This parameter turns the bass cut filter effect on/off.

FREQUENCY

This parameter sets the cutoff frequency for the bass cut filter.

CHORUS

A sound with a subtly shifted pitch is added to the direct sound, making the final output sound thicker and broader.

EFFECT

This parameter turns the chorus effect on/off.

POLARITY

This parameter is for the Stereo Chorus. It lets you choose the difference in LFO phase for the left and right channels.

SYNC (synchro):

The left and right phase will be the same.

INVERT:

The left and right phase will be opposite.

MODE

Selection for the chorus mode.

MONO:

This chorus effect outputs the same sound from both L and R.

ST. (stereo):

This is a stereo chorus effect that adds different chorus sounds to L and R.

RATE

Adjusts the rate of the Chorus effect.

* *If this is set to BPM, the MASTER BPM (p.105) setting for each patch will determine the rate, so that the effect sound will match the song tempo. However, if the BPM value is high, the effect will synchronize to 1/2 or 1/4 of the BPM.*

DEPTH

Adjusts the depth of the Chorus effect. To use it for doubling, set the value to "0."

PRE DELAY

Adjusts the time needed for the effect sound to be output after the direct sound has been output. By setting a longer Pre Delay time, you can obtain an effect that sounds like more than one sound is being played at the same time (doubling effect).

LOW CUT (low cut filter)

The low cut filter cuts the frequencies below the specified frequency. This setting adjusts the frequency at which the low cut filter will begin to take effect. When "Flat" is selected, the low cut filter will have no effect.

HIGH CUT (high cut filter)

This setting adjusts the frequency at which the high cut filter will begin to take effect. When "Flat" is selected, the high cut filter will have no effect.

FX (EFFECT) LEVEL

Adjusts the volume of the effect sound.

DIRECT SWITCH

Switch the direct sound ON/OFF (OUTPUT/NO OUTPUT).

COMPRESSOR/LIMITER

The compressor is an effect that attenuates loud input levels and boosts soft input levels, thus evening out the volume to create sustain without distortion.

The limiter attenuates loud input levels to prevent distortion.

EFFECT

This parameter turns the Compressor/Limiter effect on/off.

DETECT (detector in)

This parameter is for both "STEREO MULTI" and "10 GRAPHIC EQ." Select the input source which will control the compressor/limiter.

L:

The input source of channel L will control the compressor/limiter.

R:

The input source of channel R will control the compressor/limiter.

LINK:

The input source whose level is higher will control the compressor/limiter.

* *If you edit an effect with "SELECT," the effect is parameter that you have set before editing will be initialized.*

SELECT

Select either Compressor or Limiter.

COMP (compressor):

The effect will function as a compressor.

LIMIT (limiter):

The effect will function as a limiter.

<When "COMP (compressor)" is selected> EFFECT

This parameter turns the Compressor effect on/off.

The function of each parameter

THRESHOLD

This adjusts the level at which the effect will be made apparent.

RATIO

This parameter is for both "STEREO MULTI," "10 GRAPHIC EQ" and "VOCAL MULTI." Selects the extent to which the signal will be compressed (compression ratio) while the Limiter is working.

SUSTAIN

Adjusts the range (time) over which low-level signals are boosted. Larger values will result in longer sustain.

ATTACK

Adjusts the strength of the attack. Larger values will result in a sharper attack, creating a more clearly defined sound.

RELEASE

This adjusts the time from when the signal level drops below the threshold until when limiting is removed.

ENH FREQ (enhance frequency)

This is the parameters for "BASS MULTI." This sets the frequency band where you wish to apply the Enhancer effect. Increasing the value will target a higher frequency band.

ENH LEVEL (enhance level)

This is the parameters for "BASS MULTI." This adjusts the intensity of the Enhance effect. Increasing the value will emphasize the Enhance effect.

tone

Adjusts the tone.

LEVEL

Adjusts the volume.

<When "LIMIT (limiter)" is selected>

EFFECT

This parameter turns the Limiter effect on/off.

THRESHOLD

Adjusts this as appropriate for the inputs signal. When the input signal level exceeds this threshold level, limiting will be applied.

ATTACK (attack time)

This is the parameter for "MIC SIMULATOR." Adjust the time from when the input level exceeds the threshold level to when the effect begins to apply.

RELEASE

This adjusts the time from when the signal level drops below the threshold until when limiting is removed.

DETECT HPF (detect frequency)

This is the parameter for "MIC SIMULATOR." Adjust the cutoff frequency of the level detection section. With a setting of Thru, this will operate as a conventional limiter.

tone

Adjusts the tone.

LEVEL

Adjusts the volume.

DE-ESSER

Useful for reducing 'sibilant' or 'S' sounds produced by a vocalist.

EFFECT

This parameter turns the de-esser effect on/off.

SENS (sensitivity)

Adjusts the sensitivity relative to the input volume, which controls how the effect is applied.

FREQUENCY

Set the frequency at which the de-esser effect will be applied.

The effect will be made apparent in the frequencies above the frequency set here.

DEFRETTER

This simulates a fretless bass. The defretter can be selected in the "BASS MULTI" algorithm as an alternate for the compressor.

SENS (sensitivity)

This controls the input sensitivity of the Defretter. It should be adjusted for the bass guitar you have until you get the harmonic changes to sound natural.

ATTACK

This controls the attack of the Defretter. Increasing the value will cause the harmonics to change more slowly, thus producing a relatively attack-less sound, similar to a fretless bass.

DEPTH

This controls the rate of the harmonics. Increasing the value will increase the harmonic content and therefore will create a more unusual sound.

LEVEL

Adjusts the volume of the defretter sound.

DELAY

This parameter creates a distinctive effect (such as a thicker sound) by applying a delayed sound to the direct sound.

EFFECT

This parameter turns the delay effect on/off.

TYPE

This Parameter selects the type of delay.

SINGLE:

This is a simple delay.

TAP:

This allows you to obtain the tap delay effect that divides the delay time, then deliver them to left and right channel.

3TAP:

Tap Delay that allows you to adjust the delay time for each channel (L and R channel) by setting the Tap time L and the Tap time R.

DELAY TIME

This parameter adjusts the delay time (i.e., the interval for which sound is delayed).

* If "3TAP" is selected as the Type, this parameter will be displayed as "DELAY TIME [C]."

* If this is set to BPM, the MASTER BPM (p.105) value that is set for each patch will determine the delay time, so that the effect will match the tempo of the song. However if the BPM value is low, the effect will synchronize to twice or four times the BPM.

DELAY TIME [L]

DELAY TIME [R]

These are the stereo input delay parameters, allowing you to adjust the delay time independently for left and right channels.

* If this is set to BPM, the MASTER BPM (p.105) value that is set for each patch will determine the delay time, so that the effect will match the tempo of the song. However if the BPM value is low, the effect will synchronize to twice or four times the BPM.

FINE TIME (delay time fine)

Make fine adjustments to the delay time.

* If "3TAP" is selected as the Type, this parameter will be displayed as "FINE TIME [C]."

FINE TIME [L] (delay time fine L)

FINE TIME [R] (delay time fine R)

These are the stereo input delay parameters, allowing you to fine adjust the delay time independently for left and right channels.

TAP TIME

Adjust the delay time of the right channel. The delay time of the left channel is considered at 100%, and the delay time of the right channel is adjusted relative to this.

TIME [L] (tap time L)

TIME [R] (tap time R)

These parameters are for "3TAP." They adjust the TAP TIME L and TAP TIME R relative to "DELAY TIME C" as 100%.

FEEDBACK

This parameter is for a monaural-input delay, and adjusts the amount of feedback.

Changing the amount of feedback causes the number of time the delayed sound is repeated to change as well.

The function of each parameter

FEEDBK [L] (feedback L)

FEEDBK [R] (feedback R)

These parameters are for a stereo-input delay, and adjust the amount of feedback for left and right channels independently. Adjusting the amount of feedback will change the number of times that the delay sound is repeated.

LEVEL [C]

LEVEL [L]

LEVEL [R]

These parameters are for "3TAP." Adjusts the volume of the output from each tap.

HIGH DAMP GAIN

This parameter adjusts the amount of damping for High Damp. No high-frequency damping occurs when set to "0."

HIGH CUT FILTER (HIGH CUT)

The High Cut Filter cuts the frequency contents that are higher than the set frequency. This parameter adjusts the frequency where the high cut filter starts working. When it is set to "FLAT," the high cut filter does not work at all.

FX LEVEL (effect level)

This adjusts the volume of the delay sound.

DIR LEVEL (direct level)

Adjusts the volume of the direct sound.

DISTANCE

Microphones have a characteristic which causes the low frequency range to be boosted when the sound source is nearby. This setting simulates this phenomenon.

EFFECT

This parameter turns the distance effect on/off.

PROX.FX (proximity effects)

Adjust the low frequency response that is affected by the mic distance from the sound source. Adjustment in the "+" direction will move the mic closer to the sound source, and in the "-" direction will move it away from the sound source.

TIME

This simulates the time difference due to distance from the sound source.

DISTORTION

This effect distorts the sound. By changing the TYPE, you can create many different sounds.

EFFECT

This parameter turns the distortion effect on/off.

TYPE

This allows you to select the distortion type you like.

TURBO OD (turbo overdrive):

Allows you to obtain a rich effect just like distortion, without losing the subtle nuance of the overdrive.

BASS OD (bass overdrive):

Rich and firm overdrive sound can be created.

HARD DS (hard distortion):

This produces a rich and powerful heavy metal sound.

FUZZ 1:

This produces a full-bodied, traditional fuzz sound that has the lower and middle range emphasized.

FUZZ 2:

This produces an exciting fuzz sound that has its overtones emphasized.

DRIVE

Adjusts the depth of distortion. A higher value will emphasize the distortion.

BASS

This controls the bass sounds. You can set an appropriate frequency band for each TYPE.

TREBLE

This controls the treble sounds. You can set an appropriate frequency band for each TYPE.

FX LEVEL (effect level)

This adjusts the volume of the distorted sound.

DIR LEVEL (direct level)

This adjusts the volume of the direct sound when the effect is turned on.

ENHANCER

By adding sounds which are out-of-phase with the direct sound, this effect enhances the definition of the sound, and pushes it to the forefront.

EFFECT

This parameter turns the enhancer effect on/off.

DETECT (detector in)

This is the parameters for both "STEREO MULTI" and "10 GRAPHIC EQ." Select the input source which will control the enhancer.

L:

The input source of channel L will control the enhancer.

R:

The input source of channel R will control the enhancer.

LINK:

The input source whose level is higher will control the enhancer.

SENS (sensitivity)

Adjusts the manner in which the enhancer will be applied relative to the input signals.

FREQUENCY

Adjusts the frequency at which the enhancer effect will begin to be applied. The effect will be made apparent in the frequencies above the frequency set here.

MIX LEVEL

Adjusts the amount of phase-shifted sound of the range set by "Frequency" that is to be mixed with the input.

LoMIX LEVEL (low mix level)

Adjusts the amount of phase-shifted sound of the lower range that is to be mixed with the input.

LEVEL

Adjusts the volume of the enhanced sound.

FEEDBACKER

This allows you to use feedback playing techniques.

This effect can be used in the "GUITAR MULTI 2" algorithm when the SFX "SELECT" parameter is set to "FB."

* For details on SFX settings, refer to "About SFX" (p.48).

When using the feedbacker, play a single note accurately and then switch the effect on to produce a feedback effect. When you turn the effect off, the feedback will disappear. Use the foot switch to switch the effect on/off, so that the effect will be on only while the pedal is being pressed. To make a note feedback, you must cleanly play a single note. Then, when the sound has stabilized, turn on the effect.

MODE

Select either oscillator "OSC" or boost "BOOST."

OSC (oscillator):

An artificial feedback sound will be created internally.

BOOST:

Only the frequency at which you want feedback will be boosted, making it easier to use feedback playing techniques.

* Since boost mode only assists you with feedback playing, the result will not be satisfactory if the volume of your guitar amp is low.

RISE TIME

This determines the time needed for the volume of the feedback sound to reach its maximum from the moment the effect is turned on.

<When "OSC (oscillator)" is selected>

RISE TIME ▲

This determines the time needed for the volume of the one octave higher feedback sound to reach its maximum from the moment the effect is turned on.

F.B LEVEL (feedback level)

Adjusts the volume of the feedback sound.

F.B ▲ LEVEL (feedback level)

This adjusts the volume of the one octave higher feedback sound.

VIB RATE (vibrato rate)

This adjusts the rate of the vibrato when the feedbacker is on.

The function of each parameter

VIB DEPTH (vibrato depth)

This adjusts the depth of the vibrato when the feedbacker is on.

<When "BOOST" is selected>

F.B DEPTH (feedback depth)

Adjust the amount of boost for the feedback frequency.

FEEDBACK TONE

Adjust the frequency range at which you wish to create feedback.

FEEDBACKER ON/OFF

To switch the feedbacker on/off using the Footswitch (FS-5U, DP-2 (Roland), etc.), set "Control Assign" (p. 33) as follows.

< ASSIGN1: ON >

TARGET:	SFX: ON/OFF
TARGET MIN:	OFF
TARGET MAX:	ON
SOURCE TYPE:	CONTROL1
SOURCE MODE:	NORMAL
SOURCE MIN:	0
SOURCE MAX:	127

FLANGER

The flanger effect gives a twisting, jet-airplane-like character to the sound.

EFFECT

This parameter turns the flanger effect on/off.

RATE

Determines the rate of the flanging effect.

* If this is set to BPM, the MASTER BPM (p.105) setting for each patch will determine the rate, so that the effect sound will match the song tempo. However, if the BPM value is high, the effect will synchronize to 1/2 or 1/4 of the BPM.

DEPTH

Determines the depth of the flanging effect.

MANUAL

Adjusts the center frequency at which to apply the effect.

RESONANCE

Determines the amount of resonance (feedback). Increasing the value will emphasize the effect, creating a more unusual sound.

SEPARATE (separation)

Adjusts the diffusion. The diffusion increases as the value increases.

LEVEL

This adjusts the volume of the flanger.

GATE

This can be effectively used to cyclically cut the output from the flanger. Increasing the value will shorten the interval. If this is "Off," gate will have no effect.

DIRECT SWITCH

Switch the direct sound on/off (output/no output).

GRAPHIC EQ (graphic equalizer)

This simulates a 10-band graphic equalizer.

EFFECT

This parameter turns the graphic EQ effect on/off.

INPUT GAIN

Adjust the overall volume level of the sound before it passes through the equalizer.

LEVEL

Adjust the volume level of the sound which has passed through the equalizer.

31.2-16KHz (Gain)

Adjust the gain (amount of boost/cut) of the equalizer for each frequency.

GUITAR SYNTH (guitar synthesizer)

This detects the pitch of an electric guitar and outputs a synthesizer sound.

This effect can be used in the "GUITAR MULTI 1" algorithm when the MOD "SELECT" parameter is set to "SYN."

- * For details on MOD (Modulation) settings, refer to "About MOD" (p.47).
- * When you use a guitar synthesizer, observe the following points.
 - It does not work properly when a chord is played. Be sure to mute all the other strings and play in a single note.
 - When you are to play the next string while a certain sound is still playing, perfectly mute the previous sound then play the next one with a clear attack. If the unit cannot detect the attack, it may not sound correctly.

SENS (sensitivity)

This adjusts the input sensitivity. The response of the internal sound source is better with a higher sensitivity value, but the malfunctions will be increased on the other hand. So, try to set it as high as possible without causing malfunction.

WAVE

This selects a wave type that is the source of the guitar synthesizer.

SQR (square) ():

The unit detects the pitch and attack information from the input guitar sound, then send the square waveform from the internal sound source.

SAW ():

The unit detects the pitch and attack information from the input guitar sound, then send the saw waveform from the internal sound source.

BRASS:

The unit directly processes the input guitar sound and creates a guitar synthesizer sound. It gives a quick sound rise and send the sound with a sharp edge.

BOW:

The unit directly processes the input guitar sound and creates a guitar synthesizer sound. It outputs a soft sound without attack.

CHROMATIC

This switches on or off the chromatic function. When it is on, the pitch change of the synthesizer sound is in semitone steps. This does not respond to pitch changes less than a semitone, such as what might be obtained with bending or vibrato. Thus, this is effectively used for realistically playing musical instruments whose pitch will change in steps greater than a semitone, such as a keyboard.

- * Use this parameter when "Square" or "Saw" is selected for wave.

OCT SHIFT (octave shift)

This allows you to shift the pitch of the internal sound module in an octave step from the guitar sound.

- * This parameter should be set when "SQR" or "SAW" is selected for the wave.

PWM RATE (pulse width modulation rate)

This gives breadth or fatness to the sound by applying modulation to the waveform (only to Square) in the internal sound module. A higher value will quicken the rate of the modulation.

- * This parameter should be set only when "SQR" is selected for the wave.

PWM DEPTH (pulse width modulation depth)

This adjusts the depth of the PWM. When it is set to "0," no PWM effect is obtained.

- * This parameter should be set only when "SQR" is selected for the wave.

CUTOFF F (cutoff frequency)

This adjusts the frequency where the harmonics contents of the sound is cut off.

RESONANCE

This adjusts how much of the harmonics contents around the cutoff frequency should be emphasized.

FLT SENS (filter sensitivity)

This adjusts the sensitivity of the filter. When it is set to a lower value, the filter is affected only with a stronger picking. When it is set higher, the filter changes even with a weaker picking. When it is set to "0," the depth of the filter will be the same no matter how the picking strength may be.

FLT DECAY (filter decay)

This sets the time needed until the filter change will be stable.

The function of each parameter

FLT DEPTH (filter depth)

This adjusts the depth of the filter. When the value is higher, the filter will change more drastically. The polarity of the filter will be opposite with "+" and "-."

ATTACK (attack decay)

This adjusts the time needed for a synthesizer sound to reach its maximum. When it is set to a lower value, the sound will rise quickly. When it is set higher, the sound will rise slowly. When it is set to "Decay," the sound will rise quickly and turn to a Release status regardless of the input of the guitar sound.

* When "BRASS" or "BOW" is selected for the wave, the attack time will not be quicker from a certain level even if the attack is set to "DECAY" or "0."

RELEASE

This determines the time needed for the synthesizer sound to reach zero from the moment the input of the guitar sound is completed.

* When "BRASS" or "BOW" is selected for the wave, the guitar signal itself is processed. That is, the synthesizer sound will go down when the guitar signal goes down no matter how long the release may be set.

VELOCITY

This adjusts the amount of the volume change of the synthesizer sound. When it is set to high, the volume change will be greater depending on the picking strength. When it is set to "0," no volume change is caused even by changing the picking manner.

HOLD

The hold function can sustain the output of the synthesizer sound. If you turn on the hold while a synthesizer sound is being output, the synthesizer sound will be held until you turn it off.

You can control the on/off of the hold using the footswitch. Normally, select "HOLD OFF."

* This parameter is used when "SQR" or "SAW" is selected for the wave.

SYNTH LEVEL

This determines the volume of the synthesizer sound.

DIR LEVEL (direct level)

This determines the volume of the direct sound.

HOLD ON/OFF

To switch hold on/off using the foot switch (FS-5U, DP-2 (Roland), etc.), set "Control Assign" (p. 33) as follows.

< ASSIGN1: ON >

TARGET:	MOD (Guitar SYNTH): HOLD
TARGET MIN:	OFF
TARGET MAX:	ON
SOURCE TYPE:	CONTROL1
SOURCE MODE:	NORMAL
SOURCE MIN:	0
SOURCE MAX:	127

HARMONIST

This effect changes the pitch of the original sound. It is variable up and down 2 octaves.

This effect can be used in the "GUITAR MULTI 1" algorithm when the MOD "SELECT" parameter is set to "HR."

* For details on MOD (Modulation) settings, refer to "About MOD" (p.47).

VOICE

This selects the number of voices for the pitch shift sound (harmony).

1 MONO:

One-voice pitch-shifted sound ([1]) output in monaural.

2 MONO:

Two-voice pitch-shifted sound ([1], [2]) output in monaural.

2 STEREO:

Two-voice pitch-shifted sound ([1], [2]) output through left and right channels.

MODE [1], [2]

Selection for the harmonist mode.

FAST, MEDIUM, SLOW:

A chord can be input with a normal pitch shifter. The response is slower in the order of FAST, MEDIUM and SLOW, but the modulation is lessened in the same order.

MONO:

Compared with the conventional pitch shifter, the modulation is minimized. Play in a single note.

HARMONY:

This creates harmony that matches the key of the song being played. Play in a single note.

PITCH [1], [2]

Adjusts the amount of pitch shift (the amount of pitch change) in semitone steps.

FINE [1], [2]

Make fine adjustments to the pitch shift.

* The amount of the change in the Fine "100" is equivalent to that of the Pitch "1."

HARMONY [1], [2]

This determines the pitch of the sound added to the input sound, when you are making a harmony. It allows you to set it by up to 2 octaves higher or lower than the input sound. When the scale is set to "SCALE#1-5," this parameter sets the user scale number to be used.

* If it is set to "TONIC," the pitch of the original sound will be output without being altered.

PRE DELAY [1], [2]

Adjusts the time from when the direct sound is heard until the pitch shifted sounds are heard. Normally you can leave this set at "0 ms."

* If this is set to BPM, the MASTER BPM (p.105) setting for each patch will determine the time, so that the effect sound will match the song tempo. However, if the BPM value is low, the effect will synchronize to twice or four times the BPM.

FEEDBACK

This adjusts the feedback amount of the pitch shift sound.

LEVEL [1], [2]

This adjusts the volume of the pitch shift sound.

KEY

Specify the key of the song you are playing. By specifying the key, you can create harmonies that fit the key of the song. The key setting corresponds to the key of the song (♯, ♭) as follows.

Major	C	F	B ^b	E ^b	A ^b	D ^b	G ^b
Minor	Am	Dm	Gm	Cm	Fm	B ^b m	E ^b m
Major	G	D	A	E	B	F [#]	
Minor	Em	Bm	F [#] m	C [#] m	G [#] m	D [#] m	

DIR LEVEL (direct level)

Adjusts the volume of the direct sound.

Creating a user scale

If the harmonist does not generate the harmonies that you expect, you can use a User Scale to get the desired harmony. A different user scale can be specified for each patch and each voice. Up to 5 different user scales can be created.

* User Scale settings have no effect when using a patch whose algorithm does not include the Harmonist, or if the Harmonist is turned off.

The function of each parameter

Use the following procedure to create a user scale.

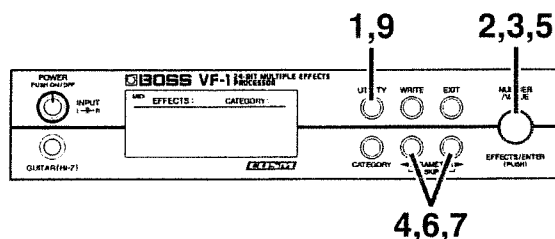

1. Press [UTILITY].
2. Rotate [NUMBER] to select "SYSTEM."

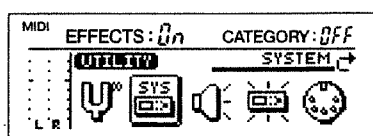

3. Press [ENTER].
4. Use PARAMETER [◀][▶] to select "USER#".
5. Rotate the [NUMBER] knob to select the scale number (SCALE#1-5) for which you wish to make user scale settings.

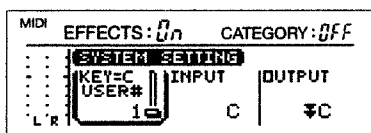

6. Use PARAMETER [◀][▶] to move the cursor to the "INPUT" setting.

When you play a single note on your guitar, the VF-1 will detect the note name and display it as the note name of the input sound.

You can also rotate [VALUE] to specify the note name of the input sound that you wish to change.

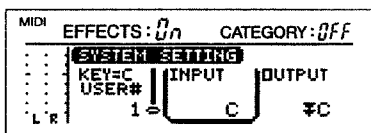

7. Use PARAMETER [◀][▶] to move the cursor to the "OUTPUT" setting.

You can rotate [VALUE] to specify the note name of the output note that corresponds to the input note.

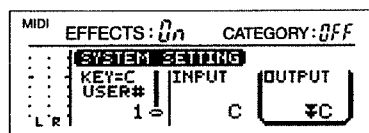

8. Repeat steps 6-7 to specify the output note for each input note.
9. Press [UTILITY] to return to Play mode.

HUM CANCELER (hum canceller)

This removes unwanted hum (electrical "buzz" or "drone").

EFFECT

This parameter turns the hum canceller effect on/off.

FREQUENCY

Hum will be removed at the specified frequency and at multiples of that frequency. Set it to match the frequency of your power supply.

WIDTH

Specify the width of the filter which will remove the hum.

DEPTH

Specify the depth of the filter which will remove the hum.

THRESHOLD

Adjust the level at which the hum canceller will begin to take effect. If the signal falls below the specified level, only the hum will be removed from the signal. With the maximum setting, hum will always be removed regardless of the level of the signal.

RANGE LOW

Specify the lower limit of the frequency range in which the hum canceller will operate.

RANGE HIGH

Specify the upper limit of the frequency range in which the hum canceller will operate.

HUMANIZER

This can create vowel sounds of the human beings using the guitar sound.

This effect can be used in the "GUITAR MULTI 1" algorithm when the MOD "SELECT" parameter is set to "HU."

* For details on MOD (Modulation) settings, refer to "About MOD" (p.47).

MODE

This sets the mode that switches the vowels.

PICK (picking):

It changes from vowel 1 to vowel 2 along with the picking. The time spent for the change is adjusted with the rate.

AUTO:

By adjusting the rate and depth, two vowels (Vowel 1 and Vowel 2) can be switched.

RANDOM:

Five vowels (a, e, i, o, u) are called out at random by adjusting the "RATE" and "DEPTH."

VOWEL [1]

This selects the first vowel.

VOWEL [2]

This selects the second vowel.

SENS (sensitivity)

This adjusts the sensitivity of the humanizer. When it is set to a lower value, no effect of the humanizer is obtained with weaker picking, while stronger picking produces the effect. When it is set to a higher value, the effect of the humanizer can be obtained whether the picking is weak or strong.

RATE

This adjusts the cycle for changing the two vowels.

* If this is set to BPM, the MASTER BPM (p.105) value set for each patch will determine the cycle, so that the effect sound will match the tempo of the song. However if the BPM value is high, the effect will synchronize to 1/2 or 1/4 of the BPM value.

DEPTH

This adjusts the depth of the effect.

MANUAL

This determines the point where the two vowels are switched. When it is set to "50," vowel 1 and vowel 2 are switched in the same length of time. When it is set to lower than "50," the time for vowel 1 is shorter. When it is set to higher than "50," the time for vowel 1 is longer.

LEVEL

This sets the volume of the humanizer.

3BAND ISOLATOR

The input sound is separated into three frequency ranges — high, mid, and low — each of which can be boost or cut. With ordinary equalizers, even when the gain control for any of the frequency ranges turned all the way down, some sound from that range remains, whereas the VF-1's Isolator cuts it completely. You may find turning the Isolator on and off or adjusting the level in real time to be a very effective technique.

EFFECT

This parameter turns the 3-band isolator iso effect on/off.

AntiPHASE LowLEVEL (anti-phase low level)

AntiPHASE MidLEVEL (anti-phase middle level)

These set the level of the Anti-Phase function. Adjusting these levels for certain frequencies allows you to lend emphasis to specific parts.

LOW MIX SWITCH (anti-phase low mix switch)

MID MIX SWITCH (anti-phase middle mix switch)

These turn the low- and mid-range Anti-Phase function on and off. When turned on, the phases of opposite stereo channels are reversed and then added.

LOW LEVEL

MID LEVEL (middle level)

HIGH LEVEL

These boost and cut each of the Low, Mid, and High frequency ranges. Setting any of these to "-60 dB," the sounds in that range become inaudible. When set to "0 dB," the sound remains at the input level.

LOFI BOX

This allows you to create a “lo-fi” sound.

EFFECT

This parameter turns the lo-fi box effect on/off.

SELECT

Select the mode of the lo-fi box.

* *If you edit an effect with “SELECT,” the effect parameter that you have set before editing will be initialized.*

RADIO:

The sound will appear to be heard from an AM radio. By adjusting “Tuning,” you can simulate the sounds that occur when you adjust the tuning frequency of the radio.

PLAYER:

The sound will appear to be heard from a gramophone. The noise caused by scratches and dust on the record is simulated.

PROCESSOR:

This allows you to create a “lo-fi” sound by lowering the sample rate and/or decreasing the number of bits. Realtime modify filters connected in series allow you to reshape the sound freely.

<When “RADIO” or “PLAYER” is selected> TUNING

This is a parameter for “Radio.” It simulates the sounds that occur when you adjust the tuning frequency of an AM radio.

WOW FLUTTER

This is a parameter for “PLAYER.” It simulates the wow and flutter which occur when the speed of the turntable is not constant.

NOISE

This simulates noise.

FILTER

Adjusts the filter.

SOUND

Adjusts the tone.

<When “PROCESSOR” is selected>

PRE FILTER

This filter decreases digital distortion. By turning this off, you can create an extremely lo-fi sound that includes digital distortion.

SAMPLE RATE

Modify the sample rate. If this is turned off, when it is set to “off” the sample rate does not work at all.

BIT

Modify the number of data bits. If this is turned off, the number of data bits will be unchanged.

If an extremely low number of bits is selected, loud noise may appear even when there is no sound, depending on the input source. In such cases, raise the threshold of the noise suppressor.

POST FILTER

This filter decreases the digital distortion produced by lo-fi. By turning this off, you can create an extremely lo-fi sound.

FX LEVEL (effect level)

Adjust the volume of the lo-fi sound.

DIR LEVEL (direct level)

Adjust the volume of the direct sound.

REALTIME MODIFY FILTER

Select the filter type.

OFF:

The realtime modify filter will not be used.

LPF:

The low pass filter will operate.

BPF:

The band pass filter will operate.

HPF:

The high pass filter will operate.

CUTOFF

Adjust the cutoff frequency.

RESONANCE

Adjust the resonance.

GAIN

Adjust the volume level of the sound that has passed through the realtime modify filter.

MASTER

“Master” is located on the last of all each algorithm, allowing you to set the patch’s output level, and foot volume level.

LINK

This parameter is for “MIC SIMULATOR.”

This is a link switch for channels L and R.

If this is turned off, the channels will function independently as two monaural channels. If this is turned on, both channels will be controlled simultaneously by the settings of channel L.

* If “LINK=ON” has been selected, the parameter you have set on the R channel will have no effect, turning it to exactly the same setting as the L channel.

LEVEL (master level)

This adjusts the output volume of the VF-1.



When making Master settings, the level meter (p.18, 31) will show the initial input of the patch (the signal before it passes through any effect) and the final output (the signal after it has passed through all effects of the algorithm).

BPM (master BPM)

By specifying a BPM to match the tempo of your song, you can create an effect that changes the sound in synchronization with the tempo. For example if you use BPM for a flanger, the sound will modulate in synchronization with the tempo.

Here you can make the BPM setting for each effect.

* If there is no parameter that can set the BPM in the effects of the Algorithm, “BPM” will not be shown in the display.



BPM (Beats Per Minute) indicates the number of quarter notes per minute.

The notes for the BPM can be selected from the followings:

BPM ♩ BPM ♪ BPM ♪♩ BPM ♪♩
 BPM ♪ BPM ♪♩ BPM ♪ BPM ♪
 BPM ♪♩ BPM ♪ BPM ♪♩ BPM ♪♩
 BPM ♪

BPM can be set in one of the following three ways.

* In order to make the effect use the BPM setting, you must set the appropriate parameter (e.g., Chorus Rate or Dly Time) to “BPM ♩ - ♪.”

40-250:

Set the BPM in the range of 40-250.

MIDI:

The Timing Clock messages received at MIDI IN will determine the BPM value.

GLOBAL:

The value (speed) specified for the GLOBAL SOUND SETTING parameter “GLOBAL BPM” will control the effect.

* For details on the “GLOBAL” BPM setting, refer to “GLOBAL SYSTEM SETTING: GLOBAL BPM (p.45).”

* In the following cases, the BPM setting will have no effect.

- When “BPM ♩ - ♪” is selected as the effect parameter, but that effect is turned off
- When the effect parameter is set to other than “BPM ♩ - ♪.”

FOOT LEVEL (foot volume level)

This adjusts the volume at the position where “FV (foot volume)” in the Algorithm is connected.

To control the volume of foot level with the Expression pedal, set “Control Assign” (p. 103) as follows.

< ASSIGN1: ON >

TARGET:	MASTER:FOOT VOLUME LEVEL
TARGET MIN:	0
TARGET MAX:	100
SOURCE TYPE:	ExpPEDAL
SOURCE MODE:	NORMAL
SOURCE MIN:	0
SOURCE MAX:	127

* The foot volume is placed in the optimal location for each algorithm. For details refer to “Algorithm list” (p.49-90).

MIC CONV (Mic Converter)

This converts the characteristics of an inexpensive general purpose mic into the characteristics of an expensive studio mic (Microphone → Microphone conversion). For an already-recorded sound, it can create the same tonal change as if the type or distance of the mic had been changed. This adds a feeling of “air” to an instrumental sound that was recorded by direct line input, causing it to sound as though it had been recorded with a microphone (Line → Microphone conversion).

EFFECT

This parameter turns the mic converter effect on/off.

INPUT

Select the type of mic that was actually used to record.

DR-20:

Roland DR-20

SML.DY:

Small Dynamic Microphone

HED.DY:

Head-worn Dynamic Microphone

MIN.CN:

Miniature Condenser Microphone

FLAT:

Line Input

OUTPUT

Specify the mic that will be simulated.

SML.DY:

General purpose dynamic mic for instruments or vocals. Ideal for guitar amp or snare drum.

VOC.DY:

A popular dynamic mic for vocals. Characterized by a tight mid-range. Use for vocals.

LRG.DY:

Dynamic mic with extended low end. Use for bass drum or tom, etc.

SML.CN:

Small condenser mic for instruments. Characterized by a sparkling high range. Use for metallic percussion or acoustic guitar.

LRG.CN:

Condenser mic with flat response. Use for vocals, narration, or acoustic instruments etc.

VNT.CN:

Vintage condenser mic. Use for vocals or acoustic instruments etc.

FLAT:

Mic with flat frequency response. For cancelling the characteristics of the mic used for recording.

* *When you select a condenser-type mic simulator, the low range response is strengthened. This may cause noise transmitted from the mic stand to be emphasized. In this case, either use a bass cut filter (p. 92) to cut the unwanted low range, or equip the mic stand that you use at the time of recording with an isolation mount (a mic holder that uses rubber etc. to absorb vibration).*

* *If INPUT is set to “MIC.CN,” the OUTPUT can be set only to “SML.DY” or “LRG.CN.”*

PHASE

Specify the phase of the mic.

NOR:

Same phase as the input

INV:

Opposite phase as the input

MULTI TAP DELAY

This is an effect in the "Multi tap delay (20 tap)" algorithm. This parameter creates a distinctive effect (such as a thicker sound) by applying a delayed sound to the direct sound. Multi tap delay lets you make independent settings for each of 20 tap delays.

EFFECT

This parameter turns the multi tap delay effect on/off.

RATIO (time ratio)

This setting maintains the time ratio set in the DELAY TIME [1]-[20] settings and extends / shortens this ratio to the overall time.

TAP [1]-[20] DELAY TIME

Adjust the delay time for each delay (TAP [1]-[20]).

- * If this is set to BPM, the MASTER BPM (p.105) value that is set for each patch will determine the delay time, so that the effect will match the tempo of the song. However if the BPM value is low, the effect will synchronize to twice or four times the BPM.

TAP [1]-[20] FINE TIME

Make fine adjustments to the delay time for each delay (TAP [1]-[20]).

TAP [1]-[20] PAN L:R

Adjust the stereo location (pan) of each delay sound (TAP [1]-[20]).

LO-100:

Adjust the output level of the L channel.

RO-100:

Adjust the output level of the R channel.

- * When L100 is set, only the L channel will be used, while only the R channel will be used when R100 is set.

TAP [1]-[20] LEVEL

Adjust the volume of each delay sound (TAP [1]-[20]).

FB DELAY (feedback delay time)

Adjust the delay time for the feedback sound.

- * If this is set to BPM, the MASTER BPM (p.105) value that is set for each patch will determine the delay time, so that the effect will match the tempo of the song. However if the BPM value is low, the effect will synchronize to twice or four times the BPM.

FB FINE (feedback delay time)

Make fine adjustments to the delay time for the feedback sound.

FB LEVEL (feedback level)

Adjust the amount of feedback. Higher settings will result more delay repeats.

LOW CUT (low cut filter)

The Low Cut Filter cuts the frequency contents that are lower than the set frequency. This parameter adjusts the frequency where the low cut filter starts working. When it is set to "FLAT," the high cut filter does not work at all.

HIGH CUT (high cut filter)

This parameter adjusts the frequency where the high cut filter starts working. When it is set to "FLAT," the high cut filter does not work at all.

DIR LEVEL (direct level)

Adjusts the volume of the direct sound.

FX LEVEL (effect level)

This adjusts the volume of the delay sound.

NS.SUPPRESSOR (Noise Suppressor)

This effect reduces the noise and hum. Since it suppresses the noise in synchronization with the envelope of the sound (the way in which the sound decays over time), it has very little effect on the guitar sound, and does not harm the natural character of the sound.

EFFECT

This parameter turns the noise suppressor effect on/off.

DETECT (detector in)

This is the parameters for both "STEREO MULTI" and "10 GRAPHIC EQ." It selects the input source which will control the noise suppressor.

L:

It will be controlled by the input source of channel L.

R:

It will be controlled by the input source of channel R.

LINK:

It will be controlled by the input source whose level is greater.

THRESHOLD

Adjust this parameter as appropriate for the volume of the noise. If the noise level is high, a higher setting is appropriate. If the noise level is low, a lower setting is appropriate. Adjust this value until the decay of the sound is as natural as possible.

* *High settings for the Threshold parameter may result in there being no sound when you play with your instruments volume turned down.*

RELEASE

Adjusts the time from when the noise suppressor begins to function until volume reaches "0."

OCTAVE

This adds a note one octave lower, creating a richer sound.

EFFECT

This parameter turns the octave effect on/off.

OCT LEVEL (octave level)

This adjust the volume of the sound one octave below.

DIR LEVEL (direct level)

This adjust the volume of the direct sound.

OVER DRIVE

It's possible to simulate the distortion produced by a rotary speaker's vacuum-tube amp (Overdrive).

EFFECT

This parameter turns the overdrive effect on/off.

GAIN

This parameter adjusts the input level for Overdrive. Larger values result in greater distortion.

DRIVE

This parameter adjusts the amount of distortion.

LEVEL

This parameter adjusts the output level for Overdrive.

PHASER

By adding varied-phase portions to the direct sound, the phaser effect gives a whooshing, swirling character to the sound.

EFFECT

This parameter turns the phaser effect on/off.

TYPE

Selects the number of stages that the phaser effect will use.

4STAGE:

This is a four-phase effect. A light phaser effect is obtained.

6STAGE:

This is a six-phase effect. A popular phaser effect is obtained.

8STAGE:

This is an eight-phase effect. It is the most popular phaser effect.

10STAGE:

This is a ten-phase effect. A deep phaser effect is obtained.

12STAGE:

This is a twelve-phase effect. The deepest phaser effect is obtained.

BI-PHASE:

This is the phaser with two phase shift circuits connected in series.

RATE

This sets the rate of the Phaser effect.

* *If this is set to BPM, the MASTER BPM (p.105) setting for each patch will determine the rate, and the effect sound will synchronize to the tempo of the song. However if the BPM value is large, the effect will synchronize to 1/2 or 1/4 of the BPM.*

DEPTH

Determines the depth of the Phaser effect.

MANUAL

Adjusts the center frequency of the phaser effect.

RESONANCE

Determines the amount of resonance (feedback). Increasing the value will emphasize the effect, creating a more unusual sound. Setting it to a minus value will create resonance having a reversed phase.

SEPARATE (separation)

Adjusts the diffusion. The diffusion increases as the value increases.

STEP

This can be used to cause the sound to change in a stepped manner. Increasing the value will make the change finer. If this is "OFF," step will have no effect.

LEVEL

This adjusts the volume of the phaser.

PICKUP SIM (Pickup Simulator)

This produces the sound of different types of pickup. You can produce thick humbucking-style sounds even with a single-coil guitar.

This effect can be used in the "GUITAR MULTI 2" algorithm when the SFX "SELECT" parameter is set to "PIC."

* For details on SFX settings, refer to "About SFX" (p.48).

TYPE

Select the type of pickup.

'S' to 'H' (single to hum):

This converts the sound of a single coil pickup to the sound of a humbucking pickup.

'H' to 'S' (hum to single):

This converts the sound of a humbucking pickup to the sound of a single coil pickup.

'H' to 'HF' (hum to half-tone):

This converts the sound of a humbucking pickup to the half-tone sound of a single-coil pickup.

TONE

Adjusts the tone.

LEVEL

Adjusts the volume.

PITCH SHIFTER

This effect changes the pitch of the original sound (up or down) within a range of two octaves.

EFFECT

This parameter turns the pitch shifter effect on/off.

MODE

This parameter selects the mode of the Pitch Shifter.

FAST, MEDIUM, SLOW:

A chord can be input with a normal pitch shifter. The response is slower in the order of Fast, Medium and Slow, but the modulation is lessened in the same order.

INV1:

Provides reverse sound. Response is fast; reverse time is short.

INV2:

Provides reverse sound. Response is slow; reverse time is long.

PITCH

Adjusts the amount of pitch shift (the amount of pitch change) in semitone steps.

FINE

Make fine adjustments to the pitch shift.

* The amount of the change in the Fine "100" is equivalent to that of the Pitch "1."

BALANCE DIR:FX (direct: effect)

This adjusts the volume balance of the direct and effect sounds.

DIR:FX=100:0 Only the direct sound will be output.

DIR:FX=0:100 Only the effect sound will be output.

LEVEL

This parameter adjusts the volume level.

PREAMP/SP.SIM **(Preamp/Speaker Simulator)**

Adjust the distortion and tone of the guitar sound.

- * When all **BASS**, **MIDDLE** and **TREBLE** are set to "0," no sound may be produced depending on the **Type** settings.
- * When using the preamp / speaker simulator, specifying it as a "global sound setting" will produce the most effective preamp / speaker simulator effect. For details refer to "Global sound settings" (p.45).
- * For the "GUITAR MULTI 1," "GUITAR MULTI 2," and "BASS MULTI" algorithms, you can change the location where **PRE/SP.SIM** will be placed. In this case, **PRE/SP.SIM** will indicate "POSITION." For details on the setting, refer to "Changing the order of the effects" (p.30).

EFFECT

Turns the **PREAMP/SP.SIM** effect on/off.

PREAMP TYPE

This sets the type of the guitar preamp. The distortion and tone characteristics of each amp are as shown below:

JC-120:

The sound of the Roland "JC-120" (Jazz Chorus 120), a favorite of pro musicians around the world.

CLEAN TWIN:

The sound of a conventional built-in tube amp.

CRUNCH:

Allows you to obtain a crunch effect that creates a natural distortion.

MATCH DRIVE:

A simulation of the latest tube amp widely used in styles of blues, rock and fusion.

VO DRIVE:

Allows you to obtain the Liverpool sound of the 60's.

BLUES:

A lead sound with a rich middle ideal for Blues.

BG LEAD:

The sound of a tube amp typical of the late '70s to '80s, characterized by a distinctive mid-range.

MS1959 (I, II, I+II):

The sound of a large tube amp stack that was indispensable to the British hard rock of the 70's, and is used to this day by many hard rock guitarists.

I:

A trebly sound created by using input I of the guitar amp.

II:

A mild sound created by using input II of the guitar amp.

I+II:

The sound of connecting inputs I and II of the guitar amp in parallel, creating a sound with a stronger low end than I.

SLDN LEAD:

A tube amp sound with versatile distortion, usable in a wide range of styles.

METAL 5150:

The sound of a large tube amp, suitable for heavy metal.

METAL DRIVE:

A high gain and powerful metal sound.

AC.GUITAR (acoustic guitar):

This is a preamp for electric-acoustic guitars.

- * Choosing "AC.GUITAR" activates the built-in flat-amp simulator, delivering a natural sound with no guitar-amp idiosyncrasies. Note that when "GLOBAL SOUND SETTING" for **OUTPUT SELECT** is set to "LINE," the flat-amp simulator is switched off.

OD-1:

The sound of the renowned OD-1 from the BOSS compact series.

OD-2 TURBO:

The sound of the OD-2 from the BOSS compact series, with Turbo switched on.

DISTORTION:

This produces a standard distortion.

FUZZ:

This produces a basic fuzz sound.

AC:

This can be selected in the "BASS MULTI" algorithm. It produces the vintage sound of an early transistor amp.

AMG:

This can be selected in the "BASS MULTI" algorithm. It produces the sound of a large double-stack vacuum tube amp with ultra-lows and a crisp edge.

VOLUME

Adjusts the volume and distortion of the amp.

BASS

Adjusts the tone for the low frequency range.

MIDDLE

Adjusts the tone for the middle frequency range.

- * If you have selected "MATCH DRIVE" as the type, the middle control will have no effect.

TREBLE

Adjusts the tone for the high frequency range.

PRESENCE

Adjusts the tone for the ultra high frequency range.

* *If you have selected "MATCH DRIVE" or "VO DRIVE" as the type, raising presence will cut the high range (the value will change from "0" to "-100").*

MASTER

Adjusts the volume of the entire preamp.

BRIGHT

Turns the bright setting on/off.

OFF:

Bright is not used.

ON:

Bright is switched on to create a lighter and crisper tone.

* *Depending on the "PREAMP TYPE" setting, this may not be displayed.*

GAIN

Adjusts the distortion of the amp. Distortion will successively increase for settings of "LOW," "MID" and "HIGH."

* *The sound of each Type is created on the basis that the Gain is set to "MID." So, normally set it to "MID."*

MIC SETTING

This simulates the microphone position. "CENT (center)" simulates the condition that the microphone is set in the middle of the speaker cone. "1-10 cm" means that the microphone is moved away from the center of the speaker cone.

MIC LEVEL

Adjusts the volume of the microphone.

DIR (DIRECT) LEVEL

Adjusts the volume of the direct sound.

* *If you've chosen "AC.GUITAR" for "PREAMP TYPE", use with MIC LEVEL=100 and DIRECT LEVEL=0.*

* *MIC SETTING, MIC LEVEL or DIR (DIRECT) LEVEL will not be shown in the display if being set as follows:*

- When the OUTPUT SELECT of the Global Sound Setting (p.45) is set to other than "LINE".
- When the TYPE of the Preamp Speaker Simulator is set to "OD1", "OD-2 TURBO", "DISTORTION" or "FUZZ".

REVERB

Reverberation (or reverb) is the effect caused by sound waves decaying in an acoustic space, or a digital simulation thereof. This decay occurs because sound waves bounce off many walls, ceilings, objects, etc. in a very complex way. These reflections, coupled with absorption by various objects, dissipate the acoustic energy over a certain period of time (called the decay time). The ear perceives this phenomenon as a continuous wash of sound.

EFFECT

This parameter turns the reverb effect on/off.

TYPE

This selects the Reverb Type. Various different simulations of space are offered.

* *The available types will depend on the algorithm which is used.*

ROOM:

Simulates the reverberation in a small room.

HALL:

Simulates the reverberation in a concert hall.

ROOM1:

Simulates the reverberation in a small room. Provides the bright reverberations.

ROOM2:

Simulates the reverberation in a small room. Provides warm reverberations.

HALL1:

Simulates the reverberating in a concert hall. Provides clear and spacious reverberations.

HALL2:

Simulates the reverberation in a concert hall. Provides warm reverberations.

PLATE:

Simulates plate reverberation (a reverb unit that uses the vibration of a metallic plate). Provides a metallic sound with a distinct upper range.

(ROOM) SIZE

This parameter adjusts the size of the room which is simulated.

REVERB TIME

This parameter adjusts the duration (time) of the reverb.

BALANCE DIR:FX (direct: effect)

This adjusts the volume balance of the direct and effect sounds.

DIR:FX 100:0 Only the direct sound will be output.

DIR:FX 0:100 Only the effect sound will be output.

FX (EFFECT) LEVEL

This parameter adjusts the effect level.

PRE DELAY

This parameter adjusts the time interval between the direct sound and the beginning of the reverb sound.

DENSITY

Adjust the density of the sound (Early Reflections) that arrives at the listener after bouncing off the walls once or a few times.

EARLY REF LEVEL (early reflection level)

This parameter adjusts the volume level of the initial reflected sound.

RELEASE DENSITY

This parameter adjusts the density of the sound that reaches the listener after many repeated reflections.

LOW DAMP GAIN

This parameter adjusts the amount of damping for Low Damp. No low-frequency damping occurs when set to "0."

LOW DAMP FREQUENCY

This parameter adjusts the standard frequency at which the low-frequencies are damped. The reverb sound in the band below this frequency is damped.

HIGH DAMP GAIN

This parameter adjusts the amount of damping for High Damp. No high-frequency damping occurs when set to "0."

HIGH DAMP FREQUENCY

This parameter adjusts the standard frequency at which the high-frequencies are damped. The reverb sound in the band above the standard frequency is damped.

LOW CUT (low cut filter)

This parameter adjusts the frequency at which a high-pass filter starts to be applied. The effect is applied to the reverb sound.

HIGH CUT (FILTER)

This parameter adjusts the frequency at which a low-pass filter starts to be applied. The effect is applied to the reverb sound.

GATE

Adjust the input level to control the reverb.

This setting can be used in the "GATE REVERB" algorithm.

EFFECT

This parameter turns the GATE effect on/off.

THRESHOLD (gate threshold)

This parameter adjusts the standard level for controlling opening and closing of the gate.

HOLD TIME (gate hold time)

This parameter adjusts the time interval between the gate opening and closing completely.

RLS TIME (gate release time)

This parameter adjusts the time from when the hold time ends to when the sound is completely muted.

RING MODULATOR

This creates a bell-like sound by ring-modulating the input sound with the signal from the internal oscillator. The sound will be unmusical and lack distinctive pitches.

MODE

This selects the mode for the ring modulator.

NORMAL:

By ring-modulating the signal with the guitar sound and the signal of the internal oscillator, it can create a bell like sound. You can obtain a non-musical sound with the sense of pitch.

INTELLIGENT:

By ring-modulating the input signal, a bell like sound is created. The intelligent ring modulator changes the oscillation frequency according to the pitch of the input sound and therefore produces a sound with the sense of pitch, which is quite different from "Normal." This effect does not give a satisfactory result if the pitch of the guitar sound is not correctly detected. So, you must use a single note.

FREQ (frequency)

This adjusts the frequency of the internal oscillator.

FX LEVEL (effect level)

This adjusts the volume of the effect sound.

DIR LEVEL (direct level)

This adjusts the volume of the direct sound.

ROTARY

This parameter simulates an old-fashioned rotary speaker, which added undulations to the sound by rotating the speaker as it played.

A real rotary speaker has a switch to select slow or fast rotation. Its horn (treble-range speaker) and rotor (bass-range speaker) can also be rotated independently. The ROTARY Effector has parameters that can be used to re-create these subtle effects.

EFFECT

This parameter turns the rotary effect on/off.

SPEED SELECT

This parameter changes the simulated speaker's rotating speed (SLOW or FAST).

HORN FAST

This parameter adjusts the speed of rotation for the horn when set to "FAST."

ROTOR FAST

This parameter adjusts the speed of rotation for the rotor when set to "FAST."

HORN SLOW

This parameter adjusts the speed of rotation for the horn when set to "SLOW."

ROTOR SLOW

This parameter adjusts the speed of rotation for the rotor when set to "SLOW."

RISE TIME HORN

This parameter adjusts the time it takes for the rotation speed of the horn to change when switched from "SLOW" to "FAST."

RISE TIME ROTOR

This parameter adjusts the time it takes for the rotation speed of the rotor to change when switched from "SLOW" to "FAST."

FALL TIME HORN

This parameter adjusts the time it takes for the rotation speed of the horn to change when switched from "FAST" to "SLOW."

FALL TIME ROTOR

This parameter adjusts the time it takes for the rotation speed of the rotor to change when switched from "FAST" to "SLOW."

BALANCE ROTOR:HORN

This parameter adjusts the volume balance between the horn and rotor.

MIC SETTING

This parameter switches the position of the microphone used to record the sound of the rotary speaker.

OFF MIC:

This simulates the sound recorded by a microphone positioned at a distance from the rotary speaker. There are few undulations in the sound. This setting is good for instruments such as a jazz organ.

ON MIC:

This simulates the sound recorded by a microphone positioned close to the rotary speaker. The sound has many undulations. This setting is good for instruments such as a rock organ.

HORN DEPTH

This parameter adjusts the amount of depth in the Doppler effect for the horn.

ROTOR DEPTH

This parameter adjusts the amount of depth in the Doppler effect for the rotor.

HORN TRMLO (horn tremolo)

This parameter adjusts the amount of change in volume for the horn.

ROTOR TRMLO (rotor tremolo)

This parameter adjusts the amount of change in volume for the rotor.

DIFFUSION

This parameter adjusts the "fatness" of the sound.

FX LEVEL (effect level)

This adjusts the volume of the effect sound.

RSS PANNER

RSS PANNER can make the sound seem to revolve around the listener.

EFFECT

This parameter turns the RSS PANNER effect on/off.

SPEED

This parameter adjusts the speed with which the position of the sound moves.

* *If this is set to BPM, the MASTER BPM (p.105) setting for each patch will determine the rate, so that the effect sound will match the song tempo. However, if the BPM value is high, the effect will synchronize to 1/2 or 1/4 of the BPM.*

DIRECTION

This parameter selects the sound's direction of rotation.

CW (clockwise):

Rotates the sound clockwise, looking down from above.

CCW (counterclockwise):

Rotates the sound counterclockwise, looking down from above.

RSS (2ch)

RSS (Roland Sound Space) is an effector that creates a three-dimensional sonic field. RSS can let you orient the sonic image at a position above, below, before, behind, or to one side or the other of the listener.

* *To get the most out of the effects that RSS can provide, be sure to read "Before using RSS" (page 121).*

EFFECT

This parameter turns the RSS (2ch) effect on/off.

AZIMUTH [L]

AZIMUTH [R]

This parameter moves the sound horizontally along the perimeter of an imaginary sphere. The setting can be made within a range of about 180 degrees to the left or right, with the standard setting ("0") indicating a position directly in front of the listener.

ELEVATION [L]

ELEVATION [R]

This parameter moves the sound vertically along the perimeter of an imaginary sphere. The setting is made as the number of degrees from the front of the listener (0).

SHORT DELAY

This is the delay with the maximum delay time of 400 ms.

This effect is efficient for making the sound fatter.

This effect can be used in the "GUITAR MULTI 1" algorithm when the MOD "SELECT" parameter is set to "SDD."

* *For details on MOD (Modulation) settings, refer to "About MOD" (p.47).*

DELAY TIME

Adjusts the delay time.

* *If this is set to BPM, the MASTER BPM (p.105) value that is set for each patch will determine the delay time, so that the effect will match the tempo of the song. However if the BPM value is low, the effect will synchronize to twice or four times the BPM.*

FEEDBACK

Feedback refers to returning the delayed signal back into the input of the delay. This parameter adjusts the volume that is returned to the input. Higher settings will result in more delay repeats.

FX LEVEL (effect level)

Adjusts the volume of delay sound.

SLICER

This consecutively interrupts the sound to create the impression that a rhythm backing phrase is being played.

This effect can be used in the "GUITAR MULTI 1" and "ISOLETER" algorithm when the MOD "SELECT" parameter is set to "SL."

* *For details on MOD (Modulation) settings, refer to "About MOD" (p.47).*

PATTERN

Select the slice pattern that will be used to cut the sound.

RATE

Adjust the rate at which the sound will be cut.

* *When this is set to BPM, the MASTER BPM setting (p.105) made for each patch will determine the rate, producing an effect sound that is synchronized with the tempo of the song. However, if the BPM value is large, the effect will synchronize to 1/2 or 1/4 of the BPM.*

TRIGGER SENS (trigger sensitivity)

Adjust the sensitivity of triggering. With low settings of this parameter, softly picked notes will not retrigger the phrase (i.e., the phrase will continue playing), but strongly picked notes will retrigger the phrase so that it will playback from the beginning. With high settings of this parameter, the phrase will be retriggered even by softly picked notes.

SLOW GEAR

This produces a volume-swell effect ("violin-like" sound). This effect can be used in the "GUITAR MULTI 2" algorithm when the SFX "SELECT" parameter is set to "SG."

* For details on SFX settings, refer to "About SFX" (p.48).

SENS (sensitivity)

This adjusts the sensitivity of the slow gear. When it is set to a lower value, the effect of the slow gear can be obtained only with a stronger picking, while no effect is obtained with a weaker picking. When the value is set higher, the effect is obtained even with a weak picking.

RISE TIME

This adjusts the time needed for the volume to reach its maximum from the moment you begin picking.

SPACE CHORUS

This chorus effect simulates the sound from Roland's well-known SDD-320 Dimension D.

EFFECT

This parameter turns the space chorus effect on/off.

INPUT

This parameter toggles between stereo and monaural input signals.

MONO:

This produces a space chorus for mono input with the left and right channels mixed.

ST. (stereo):

This produces a space chorus for stereo input with Space Chorus applied separately to the left and right channels.

MODE

This parameter lets you choose how the chorus changes.

FX LEVEL (effect level)

This adjusts the volume of the effect sound.

DIRECT SWITCH

Switch the direct sound on/off (output/no output).

**STEREO PS DLY
(Stereo Pitch Shifter Delay)**

This applies a delay effect to the sound of the pitch shifter effect.

EFFECT

This parameter turns the pitch shifter effect on/off.

MODE

This parameter selects the mode of the Pitch Shifter.

FAST, MEDIUM, SLOW:

A chord can be input with a normal pitch shifter. The response is slower in the order of Fast, Medium and Slow, but the modulation is lessened in the same order.

PITCH [L]**PITCH [R]**

Adjusts the amount of pitch shift (the amount of pitch change) in semitone steps separately for each right and left channel.

FINE [L]**FINE [R]**

Make fine Adjustments to the pitch shift separately for each right and left channel.

* The amount of the change in the FINE "100" is equivalent that of the Pitch "1."

PRE DELAY [L]**PRE DELAY [R]**

Adjusts the time from when the direct sound is heard until the pitch shifted sounds are heard separately for each right and left channel. Normally you can leave this set at "0 ms."

**FB DELAY TIME [L]
(feedback delay time L)****FB DELAY TIME [R]
(feedback delay time R)**

They adjust the delay time of the pitch-shifted feedback sound independently for the right and left channels.

The function of each parameter

* If this is set to BPM, the MASTER BPM (p.105) value that is set for each patch will determine the delay time, so that the effect will match the tempo of the song. However if the BPM value is low, the effect will synchronize to twice or four times the BPM.

FB FINE TIME [L] **(feedback delay time fine L)**

FB FINE TIME [R] **(feedback delay time fine R)**

They allow fine adjustment of the delay time of the pitch-shifted feedback sound, independently for the left and right channels.

FB LEVEL [L] (feedback level L)

FB LEVEL [R] (feedback level R)

These parameters adjust the feedback amount of the pitch-shifted sound independently for the right and left channels. Changing the feedback amount will change the number of times that the pitch-shifted sound is repeated.

BALANCE DIR: FX (direct: effect)

This adjusts the volume balance of the direct and effect sounds.

DIR:FX 100:0 Only the direct sound will be output.

DIR:FX 0:100 Only the effect sound will be output.

LEVEL

This parameter adjusts the volume level.

SUB 4BAND EQ **(Sub 4 Band Equalizer)**

This adjusts the tone as a sub equalizer. A parametric type is adopted for the high-middle and low-middle range.

This effect can be used in the "GUITAR MULTI 1" algorithm when the MOD "SELECT" parameter is set to "SEQ."

* For details on MOD (Modulation) settings, refer to "About MOD" (p.47).

LOW EQ (low equalizer)

Adjusts the low frequency range tone.

HIGH EQ (high equalizer)

Adjusts the high frequency range tone.

LO-MD F (low-middle frequency)

Specify the center of the frequency range that will be adjusted by the "LOW-MID EQ."

LOW-MID Q (low-middle Q)

Adjusts the width of the area affected by the EQ centered at the "LO-MD F." Higher values will narrow the area.

LOW-MID EQ (low-middle equalizer)

Adjusts the low-middle frequency range tone.

HI-MD F (high-middle frequency)

Specify the center of the frequency range that will be adjusted by the "HI-MID EQ."

HI-MID Q (high-middle Q)

Adjusts the width of the area affected by the EQ centered at the "HI-MD F." Higher values will narrow the area.

HI-MID EQ (high-middle equalizer)

Adjusts the high-middle frequency range tone.

LEVEL

Adjusts the volume after the equalizer.

T-WAH (Touch WAH)

Touch wah creates an automatic wah by changing the filter in response to the volume of input.

This effect can be used in the "BASS MULTI" algorithm when the EQ/TW "SELECT" parameter is set to "TW."

SENS (Sensitivity)

Adjust the sensitivity with which the filter will be affected.

Higher settings will produce a greater response, and if this is set to a value of "0," a fixed wah will result.

START

This determines the direction to which the filter's cutoff frequency should move.

UP:

A wah in which the input will cause the filter to move toward a higher frequency.

DOWN:

A wah in which the input will cause the filter to move toward a lower frequency.

STOP

This adjust the frequency where the filter's cutoff frequency will ultimately stop as the input level decreases.

RESONANCE

This adjusts the feedback amount of the filter. As it is set to a higher value, the created sound will be more unusual.

FX LEVEL (effect level)

Adjusts the volume of the effect sound.

DIR LEVEL (direct level)

This adjusts the volume of the direct sound when the effect is turned on.

TAPE ECHO201

This echo effect simulates the sound from Roland's well-known RE-201.

EFFECT

This parameter turns tape echo201 effect on/off.

MODE (mode selector)

This is used to select the different delay times (short, middle, and long) combination of three playback heads. When set to "4," you can select short delays.

REPEAT RATE

This adjusts the "tape's" running speed. The higher the value, the shorter the interval of the repeated sound.

INTENSITY

This sets the number of times the sound is repeated.

TONE BASS

This adjusts the volume of the low end of the Tape Echo sound.

TONE TREBLE

This adjusts the volume of the Tape Echo sound's high end.

PAN HEAD S L:R

PAN HEAD M L:R

PAN HEAD L L:R

These adjust the pan settings for each of the short, middle, and long delay playback heads individually. This function is not featured on Roland's RE-201.

TAPE DIST (tape distortion)

This adds the distortion characteristic of a tape. It simulates even the very subtle behavior that can be detected only by an analyzer.

WOW RATE (wow flutter rate)

This adjusts the wavering of the pitch that occurs with deterioration or unevenness in the tape. The higher the value, the more intense the wavering effect.

WOW DEPTH (wow flutter depth)

Adjust the depth of pitch modulation that is produced by wear on the tape and by irregular rotation of the tape mechanism. Increasing this value will produce deeper modulation.

FX LEVEL (effect level)

This adjusts the volume level of the Tape Echo effect.

DIR LEVEL (direct level)

This adjusts the volume level of the direct sound.

TREMOLO/PAN

Tremolo is an effect that creates a cyclic change in volume. Pan cyclically moves the stereo position between left and right (when stereo output is used).

EFFECT

This parameter turns the tremolo/pan effect on/off.

MODE

Selection for tremolo or pan.

TREMOLO:

The volume will change cyclically.

PAN:

The sound will be moved cyclically between left and right.

WAVE SHAPE

This adjusts changes in volume level.

RATE

Adjust the rate at which the effect will operate.

* When this is set to BPM, the MASTER BPM setting (p.105) made for each patch will determine the rate, producing an effect sound that is synchronized with the tempo of the song. However, if the BPM value is large, the effect will synchronize to 1/2 or 1/4 of the BPM.

DEPTH

Adjusts the depth of the effect.

VIBRATO

This effect creates vibrato by slightly modulating the pitch. This effect can be used in the "GUITAR MULTI 1" algorithm when the MOD "SELECT" parameter is set to "VB."

* For details on MOD (Modulation) settings, refer to "About MOD" (p.47).

RATE

This adjusts the rate of the vibrato.

* If this is set to BPM, the MASTER BPM (p.105) setting for each patch will determine the rate, so that the effect sound will match the song tempo. However, if the BPM value is high, the effect will synchronize to 1/2 or 1/4 of the BPM.

DEPTH

This adjusts the depth of the vibrato.

TRIGGER

This parameter works as a switch that turns on the vibrato effect.

When it is set to ON, the vibrato effect will be obtained according to the RISE TIME setting.

* This effect assumes that the trigger will be turned on with a foot switch for attaining the vibrato effect.

RISE TIME

This sets the time passing from the moment the trigger is turned on until the set vibrato is obtained.

TRIGGER ON/OFF

To switch the trigger on/off of the vibrato using the foot switch (FS-5U, DP-2 (Roland), etc.), set "Control Assign" (p. 33) as follows.

< ASSIGN1: ON >

TARGET:	MOD (VIBRATO): TRIGGER
TARGET MIN:	OFF
TARGET MAX:	ON
SOURCE TYPE:	CONTROL1
SOURCE MODE:	NORMAL
SOURCE MIN:	0
SOURCE MAX:	127

VOCAL CANCELER

When a stereo source is being input from CD or DAT etc., this cancels the sound which is located in the stereo center, such as the vocal or bass.

EFFECT

This parameter turns the vocal canceller effect on/off.

BALANCE

If the sound that you wish to cancel is not located in the center, find the point at which it is most effectively cancelled. When the value is set to "50," the sound that is located at the center will be muted.

RANGE LOW

Specify the lower limit of the frequency range from which you wish to cancel a sound. Use this setting when you wish to decrease the volume of the vocal without affecting a low-frequency instrument (such as bass) located in the center.

RANGE HIGH

Specify the upper limit of the frequency range from which you wish to cancel a sound. Use this setting when you wish to decrease the volume of the vocal without affecting a high-frequency instrument located in the center.

VOCODER

This is a 10 band vocoder. A clear sound that was not possible with conventional vocoders can be obtained. Input an instrumental sound into the left channel, and a voice into the right channel.

EFFECT

This parameter turns the vocoder effect on/off.

ENVELOPE

Select how the sound will be produced.

SHARP:

The human voice will be emphasized.

SOFT:

The instrumental sound will be emphasized.

LONG:

A vintage sound with long decay will be produced.

PAN MODE

Select MONO, STEREO, L->R or R->L.

MONO:

The components of each frequency band will be located in the center.

STEREO:

The odd-numbered frequency bands will be located at the left, and the even-numbered components at the right.

L->R:

The low frequency bands will be located increasingly toward the left, and the high frequency bands will be located increasingly toward the right.

R->L:

The low frequency bands will be located increasingly toward the right, and the high frequency bands will be located increasingly toward the left.

HOLD

This turns the Hold function on/off. If you turn Hold on while a voice is being input into the mic, the instrument will sound with the vocal formats that are fixed at that time.

MIC SENS (mic sensitivity)

Adjust the input sensitivity of the mic.

SYNTH LEVEL (synthesizer in level)

Adjust the input level of the instrument.

CHAR [1]-[10] (voice character channel)

Adjust the volume of each frequency band. This setting adjusts the tone of the vocoder. As the value is increased, the frequency will rise.

MIC MIX

Adjust the amount of the mic audio (R channel input) which has passed through the mic HPF that will be added to the output of the vocoder.

MIC HPF

When mic mix is used, this adjusts the frequency at which the high pass filter (HPF) will begin to affect the mic audio. Higher values for this setting will allow you to mix only the consonants. With a setting of Thru, the HPF will not be applied.

MIC PAN L:R

Adjust the panning of the mic audio.

NS THRESHOLD (noise suppressor threshold)

Adjust the level at which the noise suppressor applied to the Mic input (R channel input) will begin to function.

HOLD ON/OFF

To switch hold on/off using the foot switch (FS-5U,DP-2 (Roland),etc.), set "Control Assign" (p. 33) as follows.

< ASSIGN1: ON >

TARGET:	VOCODER: HOLD
TARGET MIN:	OFF
TARGET MAX:	ON
SOURCE TYPE:	CONTROL1
SOURCE MODE:	NORMAL
SOURCE MIN:	0
SOURCE MAX:	127

VoiceTRANSFORM (Voice Transformer)

This independently controls the basic pitch and the formants, allowing a variety of voice characters to be created.

EFFECT

This parameter turns the voice transformer effect on/off.

ROBOT

Turn the robot function on/off. When this is on, the audio will be output at a fixed pitch regardless of the pitch that is input, producing a voice character without inflection.

CRMTC PITCH (chromatic pitch)

Adjust the pitch of the voice character in semitone steps. This can be adjusted over a range of 1 octave down to 1 octaves up.

FINE PITCH

Make fine adjustments to the pitch of the voice character.

CRMTC FRMT (chromatic formant)

Adjust the formant of the voice character in semitone steps. This can be adjusted over a range of 1 octave down to 1 octaves up.

FINE FRMT (fine formant)

Make fine adjustments to the formant of the voice character.

MIX BAL (mix balance)

Adjust the balance between the voice character volume and the normal voice volume. When the value is set to "0," only the normal voice will be output, while only the voice character sound is output when it is set to "100."

WAH

The wah effect creates a unique tone by changing the frequency response characteristics of a filter. Pedal wah lets you use an Expression pedal or the like to obtain real-time control of the wah effect. Auto wah creates an automatic wah by cyclically changing the filter, or by changing the filter in response to the volume of the input.

EFFECT

Turns the pedal wah/auto wah effect on/off.

SELECT (effect select)

Selects either pedal wah "WAH" or auto wah "AW".

* *If you edit an effect with "SELECT," the effect parameter that you have set before editing will be initialized.*

WAH (pedal wah):

The effect will function as a pedal wah.

AW (auto wah):

The effect will function as an auto wah.

< When "WAH (pedal wah)" is selected >

The effect of the wah pedal can be obtained by operating the Expression pedal.

* *For a detailed explanation, see "Ways to use control assign" (page 39).*

PEDAL

This adjusts the position of the wah pedal.

LEVEL

Adjusts the volume.

< When "AW (auto wah)" is selected >

MODE

Selection for the wah mode.

LPF (low pass filter):

This creates a wah effect over a wide frequency range.

BPF (band pass filter):

This creates a wah effect in a narrow frequency range.

POLARITY

Selection for the direction in which the filter will change in response to the input.

UP:

The frequency of the filter will rise.

DOWN:

The frequency of the filter will fall.

SENS (sensitivity)

This adjusts the sensitivity at which the filter will change in the direction determined by the polarity setting. Higher values will result in a stronger response. With a setting of "0," the strength of picking will have no effect.

FREQ (frequency)

This adjusts the center frequency of the Wah effect.

PEAK

Adjusts the way in which the wah effect applies to the area around the center frequency. Lower values will produce a wah effect over a wide area around the center frequency. Higher values will produce a wah effect in a narrow area around the center frequency.

* *With a value of "50" a standard wah sound will be produced.*

RATE

Adjusts the rate of the auto wah.

* *If this is set to BPM, the MASTER BPM (p.105) value set for each patch will determine the rate, so that the effect sound will match the tempo of the song. However if the BPM value is high, the effect will synchronize to 1/2 or 1/4 of the BPM value.*

DEPTH

Adjusts the depth of the auto wah effect.

LEVEL

Adjusts the volume.

Before using RSS

* In the Delay RSS and Chorus RSS algorithms, the spatial placement is fixed, and it is not possible to adjust Azimuth and Elevation.

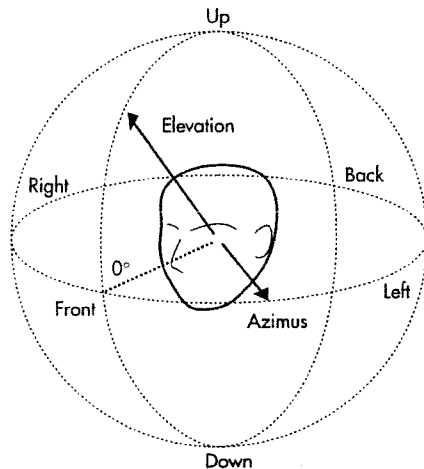

< Cautions when using RSS >

RSS (Roland Sound Space) is an effect that controls three-dimensional placement of the sound. In order for RSS to be as effective as possible, note the following points.

- Acoustically "dead" rooms are most suitable.
- Single-way speakers are most suitable. However, coaxial or virtual coaxial multi-way speakers are also OK.
- The speakers should be distanced from the side walls as far as possible.
- Do not excessively separate the speakers to left and right.
- Monitor in the sweet spot shown below.

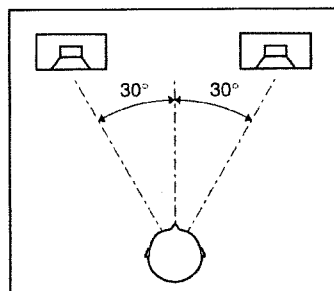

Section 5. Using MIDI to Operate the VF-1

* If you would like to learn more about MIDI, refer to "What is MIDI" (p. 131).

What you can do using MIDI

Select Patches

You can make VF-1 patches switch when you change sounds (Program Change messages) on an external MIDI device.

The settings of the Program Change Map (p. 124) determine the patches that will be selected when a program change message is received.

When connected as illustrated below, switching a program number on the external MIDI device will cause the corresponding program number to be transmitted, and the VF-1 will receive this program change message (program number) and switch patches accordingly.

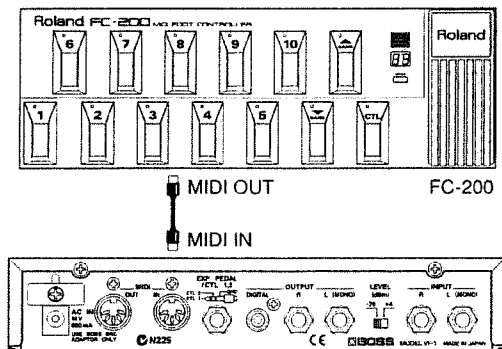

At the factory settings, the program change map is set as follows.

Program number	VF-1 Patch number
1	UA1
2	UA2
3	UA3
...	...
100	UA100
101	UB1
...	...
128	UB28

If you wish to select a patch that is not shown in this table, you will need to modify the settings of the program change map. For the procedure, refer to "Program Change Map Settings" (p. 124).

The VF-1 can accept "Bank Select messages," thus allowing all of its patches to be selected. For details refer to the MIDI implementation (p.132).

Control specified parameters

Control Change can be used to control specified VF-1 parameters during your performance. The Control Assign settings (p.33) determine the VF-1 parameter that is controlled by each MIDI message.

Transmit data

VF-1 settings such as effect sounds etc. can be transmitted as exclusive messages to other MIDI devices. This allows another VF-1 to be given the same settings, or effect sound settings to be stored in a sequencer or other data storage device.

Making settings

* When using the following functions, please refer to the procedure given for each function.

MIDI PC MAP (MIDI program change map) (p. 124)

MIDI BULK DUMP (MIDI bulk dump) (p. 125)

MIDI BULK LOAD (p. 126)

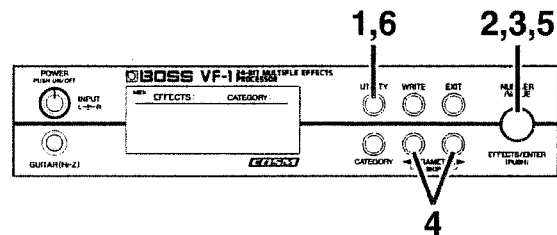

1. Press [UTILITY].
2. Rotate [NUMBER] to select "MIDI."

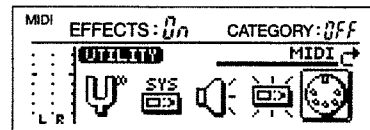

3. Press [ENTER].
4. Use PARAMETER [◀ || ▶] to move the cursor to the value of the parameter that you wish to set.

Setting the Omni mode

OMNI MODE: OFF, ON

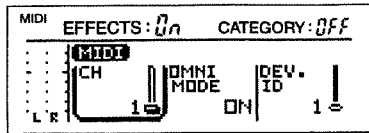

CH (MIDI channel)
 OMNI MODE
 DEV. ID (Device ID)

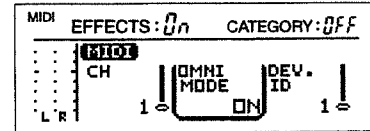

If Omni mode is on, MIDI messages of all channels will be received, regardless of the MIDI channel setting.

- * Even if Omni mode is turned on, system exclusive data is received only if its device ID matches the "Device ID" setting.
- * With the factory settings, the setting is Omni On.

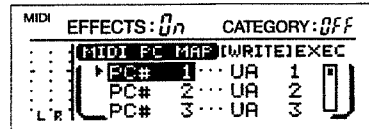

MIDI PC MAP (Program change map)

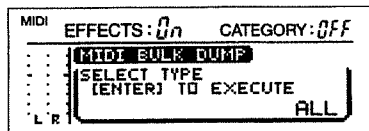

MIDI BULK DUMP (Bulk dump) (p. 125)

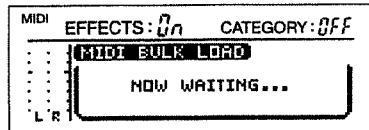

MIDI BULK LOAD (Bulk load) (p. 126)

Setting the Device ID

DEV. ID (Device ID): 1-32

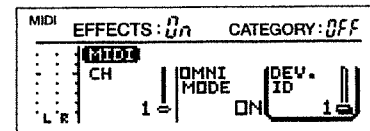

Determines the device ID used for transmitting and receiving exclusive messages.

- * At the factory settings, the device ID is set to "1."

5. Rotate [VALUE] to modify the setting.
 The change will occur more rapidly if you hold down [CATEGORY] as you rotate [VALUE].

6. Press [UTILITY] to return to Play mode.

- * If you press [EXIT] in step 6, you will return to step 2. If you press [EXIT] once again, you will return to Play mode.

Setting the MIDI channel

CH (MIDI channel): 1-16

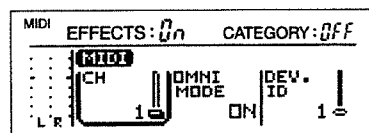

Set the MIDI channel used for transmitting and receiving MIDI messages.

Select the same channel as used by the device connected to the VF-1.

- * At the factory settings, the MIDI channel will be channel 1.

Program Change Map Settings

When using Program Change messages sent from an external MIDI device to select VF-1 Patches, you can freely specify the correspondence between the Program Change number that was received and the VF-1 Patch that will be selected.

Making settings

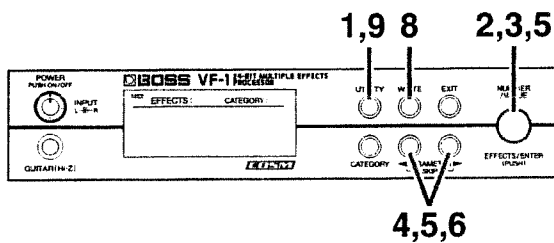

1. Press [UTILITY].
2. Rotate [NUMBER] to select "MIDI."

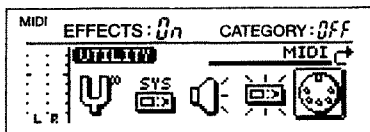

3. Press [ENTER].
4. Use PARAMETER [◀ || ▶] to select "MIDI PC MAP."
5. Use PARAMETER [◀ || ▶] to move the cursor to the program number (PC#), and rotate [VALUE] to select the program number that will be received.

The setting will change more rapidly if you hold down [CATEGORY] while you rotate [VALUE].

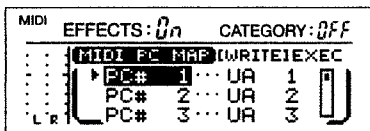

6. Use PARAMETER [◀ || ▶] to move the cursor to the patch number, and rotate [VALUE] to specify the patch number that will be selected when the program number (selected in step 5) is received.

The setting will change more rapidly if you hold down [CATEGORY] while you rotate [VALUE].

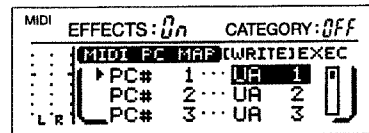

7. Repeat steps 5–6 as necessary to specify the correspondence between incoming program numbers and the patches that will be selected.
8. Press [WRITE] to save the program change map settings. The settings will be discarded unless you press [WRITE].
9. Press [UTILITY] to return to Play mode.

NOTE

Never turn off the power while the display shows "Keep Power ON!" If the power is turned off while this display is shown, the VF-1 may malfunction or its data may be lost.

* If you press [EXIT] in step 7, you will return to step 2. If you press [EXIT] once again you will return to Play mode.

Transmitting VF-1 data (Bulk Dump)

The VF-1 can use exclusive messages to set another VF-1 to the same settings, or to transmit its settings to a device such as a sequencer for storage. The process of transmitting such data is called Bulk Dump.

The following data can be transmitted. You can select from the following four types of transmission.

- ALL: Contents of both UTILITY and PATCH
- UTILITY: Utility parameters
- PATCH: All user bank patches
- TEMP: Patch settings currently being edited

Connections

When saving data on a sequencer

Make connections as shown below, and set the sequencer to a condition ready to receive exclusive messages (p. 132).

* For details on sequencer operation, refer to the manual for the sequencer you are using.

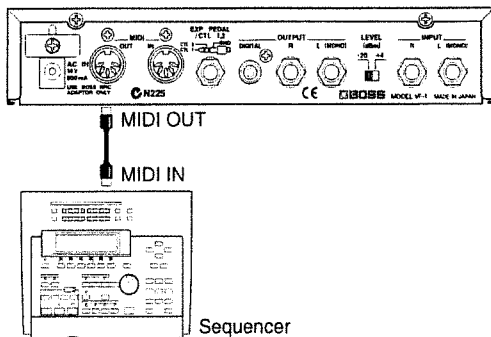

When copying data to another VF-1

Make connections as shown below, and set the Device ID (p.123) of both units to match.

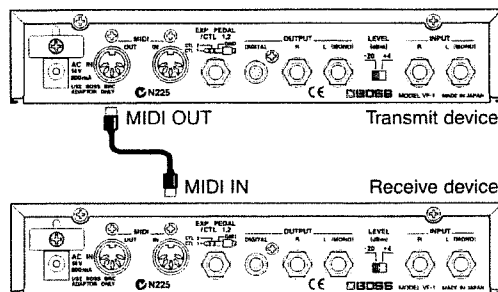

Transmission Procedure

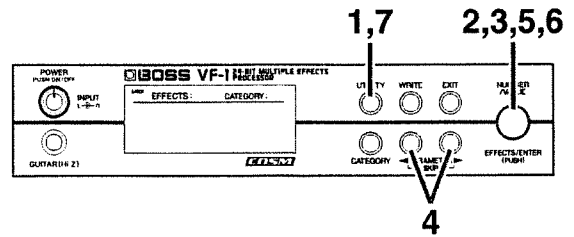

1. Press [UTILITY].
2. Rotate [NUMBER] to select "MIDI."

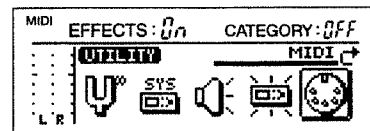

3. Press [ENTER].
4. Use PARAMETER [◀ || ▶] to select "MIDI BULK DUMP."

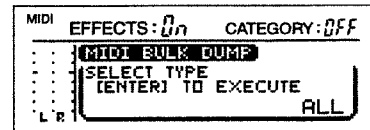

5. Rotate [VALUE] to select the data that you wish to transmit.
6. Press [ENTER] to execute the Bulk Dump.
The message "Bulk Dump..." will appear while the data is being transmitted. When the bulk dump is completed, the message "Complete!" will appear, then the previous screen will reappear.
7. Press [UTILITY] to return to Play mode.

* If you press [EXIT] you will return to step 2. If you press [EXIT] once again, you will return to Play mode.

NOTE

While a bulk dump is being executed, the VF-1 will ignore any operations of its controls.

Restoring data from a Sequencer to the VF-1 (Bulk Load)

Data that was transmitted from the VF-1 to a sequencer can be re-transmitted to the VF-1, or data can be received from another VF-1. This is referred to as Bulk Load.

Connections

Make connections as shown.

- * If you are re-transmitting data from a sequencer back to the VF-1, set the Device ID of the VF-1 to the same number that was used when the data was transmitted to the sequencer.

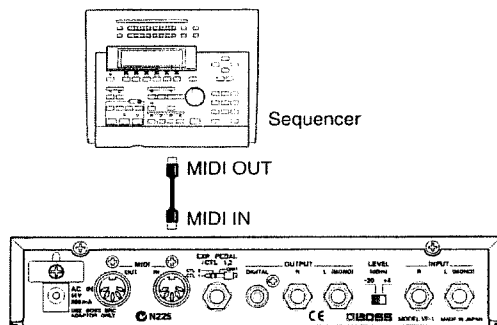

- * For details on sequencer operation, refer to the manual for the device you are using.

Reception procedure

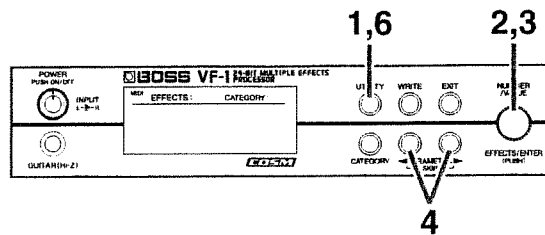

1. Press [UTILITY].
2. Rotate [NUMBER] to select "MIDI."

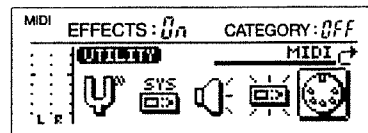

3. Press [ENTER].
4. Use PARAMETER [◀][▶] to select "MIDI BULK LOAD."

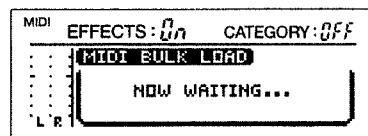

5. Transmit the data from the sequencer or other VF-1 unit.
 - * While data is being received, the display shows "NOW RECEIVING..." When the bulk load is completed, the message "Complete!" will appear, the previous display will reappear.
 - * While a bulk dump is being executed, the MIDI indicator (p.18) of the VF-1 will light.
 - * Only exclusive data of the same Device ID will be received.
6. Press [UTILITY] to return to Play mode.

NOTE

While exclusive data is being received, the VF-1 will ignore any operations of its controls.

- * If you press [EXIT], you will return to step 2. If you then press [EXIT] once again, you will return to Play mode.

Section 6. Appendices

About the VF-1's digital output

The VF-1 provides a coaxial connector (DIGITAL OUTPUT) for digital output.

This section explains how to make connections to other devices when using the VF-1's DIGITAL OUT, and describes the specifications of the digital signal that is output from the VF-1.

Digital output signal

The VF-1 transmits an EIAJ CP-1201, S/P DIF Format digital audio signal.

● About the EIAJ CP-1201 format

This is a format defined by the Electric Industries Association of Japan for connections between consumer and broadcast digital audio devices.

● About S/P DIF Format

S/P DIF, short for Sony/Philips Digital Interface Format, is one standard used for sending and receiving stereo digital signals between digital devices.

Connecting the VF-1 to a digital audio device

Use a video cable (75 Ω unbalanced) to make connections.



Turn off the power of the VF-1 before connecting a digital audio device to it. If the power is on when a digital audio device is connected to the VF-1, malfunctions can occur.

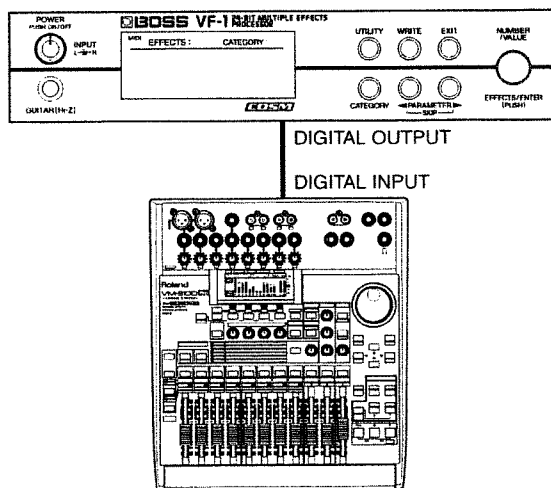

Digital OUT specifications

Format:	EIAJ CP-1201, S/P DIF
Connector:	coaxial connector
Electrical characteristics:	RS-422A
Impedance:	75 Ω unbalanced

VF-1 operation using the FC-200

When an FC-200 MIDI foot controller (optional) is connected, you can control the VF-1 using pedal operations. This section includes all the information you need when using an FC-200 connected to the VF-1.

VF-1 and FC-200 connections

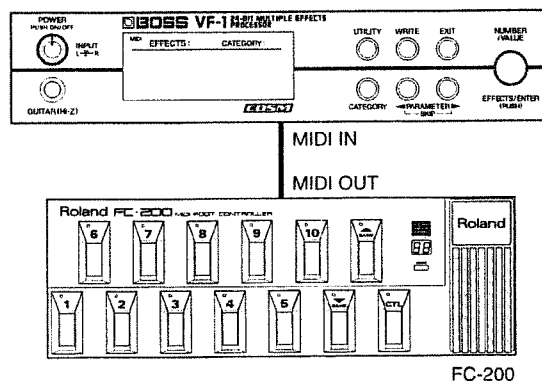

- * If you wish to use a foot switch to switch modes on the FC-200, connect a BOSS FS-5U foot switch (optional) to the Mode jack of the FC-200.
- * If connecting a footswitch (FS-5U; optional) to the CTL 1/2 jack, set the polarity switch as shown below. Unless the polarity switch is set correctly, the foot switch will not work properly.

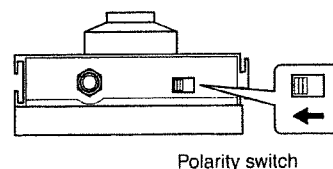

Selecting Patches from the FC-200

Here's how to select VF-1 Patches from the FC-200. Start the procedure from the following state.

VF-1: the Play mode
 FC-200: Program Change mode

- * Set the MIDI channel of the VF-1 and FC-200 to the same setting. At the factory defaults, the MIDI channel are set at "1."
- * If the VF-1 is not in Play mode (p. 17), press [EXIT] several times (once or twice) to return to Play mode.

Correspondence between VF-1 patch numbers and FC-200 program numbers

FC-200 program numbers correspond to the same program numbers that are specified in the VF-1's MIDI program change map (p. 124). In other words, when you switch program numbers on the FC-200, the VF-1 will switch to the patch of the same program number.

- * At the factory settings, the VF-1's program change map is set as follows.

Program number	VF-1 Patch number
1	UA1
2	UA2
3	UA3
⋮	⋮
100	UA100
101	UB1
⋮	⋮
128	UB28

About FC-200 Program Change numbers

FC-200 Program change numbers (1-128) are formed by adding the program change number corresponding to the Number (1-10) to the program change number for the Bank (0-12).

Banks 0-12 correspond to Program change numbers as follows.

Bank	0	1	2....	9	10	11	12
Program number	0	10	20....	90	100	110	120

Numbers 1-10 correspond to Program change numbers as follows.

Number	1	2	3....	9	10
Program number	1	2	3....	9	10

For example, if Bank = 1 and Number = 2, the Program number would be 10+2=12.

If Bank=2 and Number = 10, the Program number would be 20+10=30.

FC-200 operations

Here's how to use the Bank and Number pedals of the FC-200 to select VF-1 Patches.

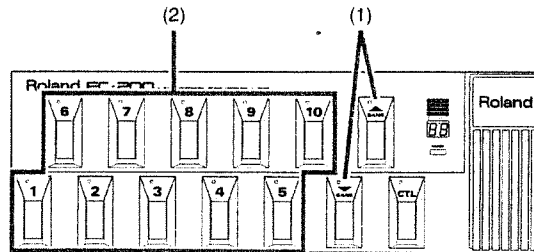

(1) Selecting the bank.

Each time you press a Bank pedal (UP/DOWN) the bank will change, and will be shown in the display. Pressing "UP" takes you to the next higher bank, and pressing "DOWN" takes you to the next lower bank.

- * Simply changing the Bank number will not make FC-200's Program numbers change. The Program number will change when you next select a number.

(2) Selecting the number.

Press a Number pedal (1 – 10). The number pedal indicator will light, and the Program number will change. At the same time, the VF-1 Patch number will change.

- * *If you wish to select a program number which has the same Bank number as the previous selection, it is not necessary to re-select the Bank.*
- * *In addition to this procedure, it is also possible to change program numbers just by selecting a different Bank, or to use the number pedals as numeric keys when selecting a Bank. For details refer to the manual of the FC-200.*

Control Assign operations using the FC-200

Using the control pedal

When the FC-200's CTL pedal is pressed, Control Change messages (controller number 80) will be transmitted from the FC-200.

The VF-1 can receive these Control Change messages as one of the "control assign sources" specified in each Patch, and control the specified target parameters.

- * *The CTL pedal can be used when the FC-200 is in "Program change mode" or "Control change mode."*

For example by making the following control assign settings for a control source, you can use the control pedal to switch the TUNER ON/OFF.

TARGET:	TUNER ON/OFF
TARGET MIN:	OFF
TARGET MAX:	ON
SOURCE TYPE:	MIDI-80
SOURCE MODE:	TOGGLE
SOURCE MIN:	0
SOURCE MAX:	127

For details on control assign, refer to "Controlling parameters in real time (Control Assign)" (p.33).

Using the expression pedal

When the FC-200's expression pedal is moved, Control Change messages (controller number 7) will be transmitted from the FC-200.

The VF-1 can receive these Control Change messages as one of the "control assign sources" specified in each Patch, and control the specified target parameters.

- * *The control pedal can be used when the FC-200 is in "Program Change mode," "Control Change mode," or "Note mode."*

For example by making the following control assign settings for a control source, you can use the expression pedal to control the Output Level.

TARGET:	MASTER: MASTER LEVEL
TARGET MIN:	0
TARGET MAX:	100
SOURCE TYPE:	MIDI-7
SOURCE MODE:	NORMAL
SOURCE MIN:	0
SOURCE MAX:	127

For details on control assign, refer to "Controlling parameters in real time (Control Assign)" (p.33).

Using the FOOT SW/EXP jack

When a separately available foot switch or expression pedal is connected to an FC-200 FOOT SW/EXP jack, pedal or switch movements will transmit Control Change messages of the controller number specified for each jack.

The VF-1 can receive these Control Change messages as one of the "control assign sources" specified in each Patch, and control the specified target parameters.

The controller numbers specified for each FC-200 jack are as follows.

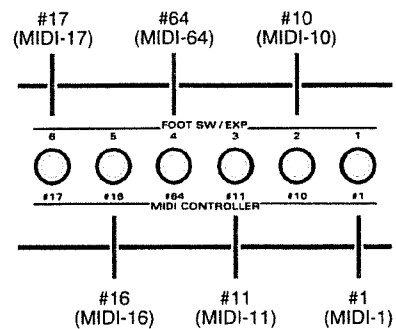

- * *Adjust "SOURCE TYPE" to (MIDI-*).*

* These can be used when the FC-200 is in "Program Change mode," "Control Change mode," or "Note mode."

The type and timing of the messages transmitted by the FOOT SW/EXP Jack will depend on the type of device that is connected. Use the type of foot switch or pedal that is appropriate for your needs.

When an FS-5L foot switch is connected

When you press the switch, an "On" (maximum value) message will be transmitted. When you press the switch once again, an "Off" (minimum value) message will be transmitted. The pedal indicator will light when the pedal is on.

When an FS-5U foot switch is connected

When you press the switch an "On" (maximum value) message will be transmitted, and when you release the switch an "Off" (minimum value) message will be transmitted.

When an EV-5 expression pedal is connected

When you move the expression pedal, messages will be transmitted to continuously indicate the current position of the pedal, from minimum to maximum values.

VF-1 operation using the FC-50

By connecting an FC-50 MIDI foot controller (sold separately), you can control the VF-1 from a foot pedal.

Connecting the VF-1 and FC-50

Make connections as shown in the diagram.

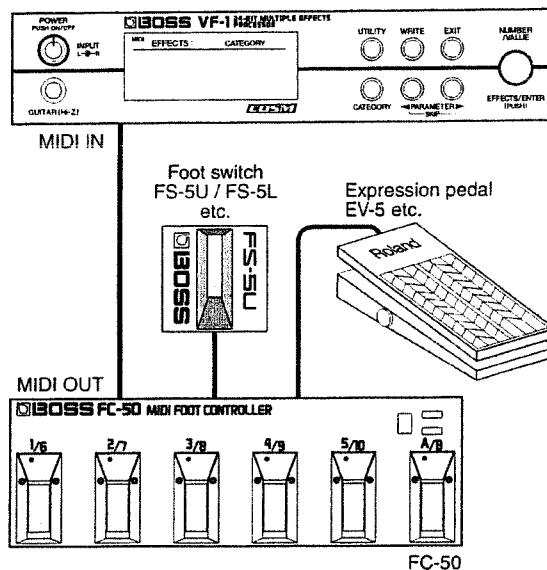

* The VF-1 and FC-50 are connected in the same way as the VF-1 and FC-200 are connected. For details refer to "VF-1 and FC-200 connections" (p.127).

Controlling the VF-1 from the FC-50

When the FC-50 is connected to the VF-1, pedal operations on the FC-50 can control the VF-1 as follows.

Selecting VF-1 patches from the FC-50

The FC-50 can select patches corresponding to the VF-1 program change map. In order to select VF-1 patches from the FC-50, make the following settings.

1. Set the MIDI channel of the FC-50 and VF-1. (p.123)
2. Set the program change map of the VF-1. (p.124)

* When making these settings, refer to the FC-50 owner's manual as well.



If you connect an FS-5U (sold separately) to the bank shift jack (UP/DOWN) of the FC-50, you will be able to select a patch in the program change map of the VF-1. For details refer to the FC-50 owner's manual.

Using a foot pedal or expression connected to the FC-50 to control parameters in realtime

A foot pedal or expression pedal connected to the FC-50 can be used to control parameters in realtime. Make the following settings on the FC-50 and VF-1.

1. Set the MIDI channel of the FC-50 and VF-1. (p.123)
 2. Make control assign settings on the VF-1. (p.33)
- * When making these settings, refer to the FC-50 owner's manual as well.

About MIDI

MIDI is an acronym for Musical Instrument Digital Interface, and is a world-wide standard for allowing electronic musical equipment to communicate by transmitting messages such as performance information and sound selections. Any MIDI equipped device is able to transmit applicable types of data to another MIDI equipped device, even if the two devices are different models or were made by different manufacturers. In MIDI, performance information such as playing a key or pressing a pedal are transmitted as MIDI Messages.

How MIDI messages are transmitted and received

First, we will explain briefly how MIDI messages are transmitted and received.

MIDI connectors

The following two types of connector are used to convey MIDI messages. MIDI cables are connected to these connectors as needed.

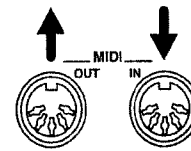

- MIDI IN: This connector receives messages from another MIDI device.
- MIDI OUT: This connector transmits messages from this device.

MIDI channels

MIDI is able to independently control more than one MIDI device over a single MIDI cable. This is possible because of the concept of MIDI channels.

The idea of MIDI channels is somewhat similar to the idea of television channels. By changing channels on a television set, you can view a variety of programs. This is because the information of a particular channel is received when the channels of the transmitter and receiver match.

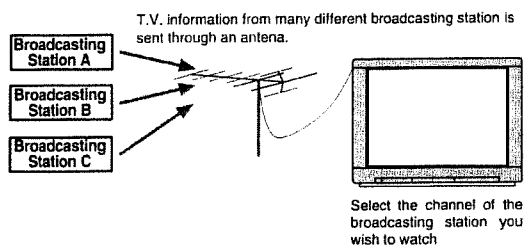

MIDI has sixteen channels 1 – 16, and MIDI messages will be received by the instrument (the receiving device) whose channel matches the channel of the transmitter.

* *If Omni mode is on, data of all MIDI channels will be received regardless of the MIDI channel setting. If you do not need to control a specific MIDI channel, you may set Omni On.*

Main types of MIDI message used by the VF-1

MIDI includes many types of MIDI messages that can convey a variety of information. MIDI messages can be broadly divided into two types; messages that are handled separately by MIDI channel (channel messages), and messages that are handled without reference to a MIDI channel (system messages).

Channel Messages

These messages are used to convey performance information. Normally these messages perform most of the control. The way in which a receiving device will react to each type of MIDI message will be determined by the settings of the receiving device.

Program Change messages

These messages are generally used to select sounds, and include a program change number from 1 to 128 which specifies the desired sound.

Control Change messages

These messages are used to enhance the expressiveness of a performance. Each message includes a controller number, and the settings of the receiving device will determine what aspect of the sound will be affected by Control Change messages of a given control number.

System Messages

System messages include exclusive messages, messages used for synchronization, and messages used to keep a MIDI system running correctly. Exclusive messages are the main type of message in this category used by the VF-1.

Exclusive Messages

Exclusive messages handle information related to a unit's own unique sounds, or other device specific information. Generally, such messages can only be exchanged between devices of the same model by the same manufacturer. Exclusive messages can be employed to save the settings for Effects Programs into a sequencer, or for transferring such data to another VF-1.

About the MIDI Implementation Chart

MIDI allows a variety of messages to be exchanged between instruments, but it is not necessarily the case that all types of message can be exchanged between any two MIDI devices. Two devices can communicate only if they both use the types of messages that they have in common. Thus, every owner's manual for a MIDI device includes a "MIDI Implementation Chart." This chart shows the types of message that the device is able to transmit and receive. By comparing the MIDI implementation charts of two devices, you can tell at a glance which messages they will be able to exchange. Since the charts are always of a uniform size, you can simply place the two charts side by side.

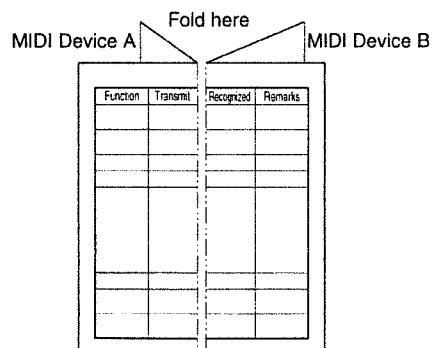

* ***A separate publication titled "MIDI Implementation" is also available. It provides complete details concerning the way MIDI has been implemented on this unit. If you should require this publication (such as when you intend to carry out byte-level programming), please contact the nearest Roland Service Center or authorized Roland distributor.***

Restoring the factory settings (Factory Reset)

You can restore the VF-1 to its factory settings. This operation is called "Factory Reset."



When you perform the Factory Reset operation, all data that was saved will be returned to the factory settings. If you have already saved data that you wish to keep, use Bulk Dump (p. 125) to save the data on an external MIDI device (sequencer or the like) before performing the factory reset.

The following types of factory reset are available.

ALL:

All data of the VF-1 will be restored to the factory settings.

UTILITY:

All of the Utility data will be restored to the factory settings.

PATCH:

All the user bank patches (UA1–100, UB1–100) will be restored to the factory settings.

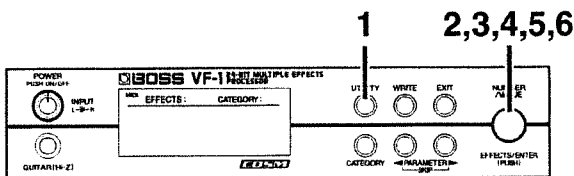

1. Press [UTILITY].

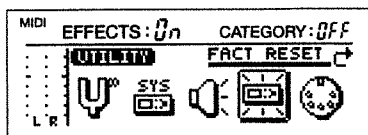

2. Rotate [VALUE] to select "FACT RESET."
3. Press [ENTER].
4. Rotate [NUMBER] to select the data that will be restored to the factory settings.

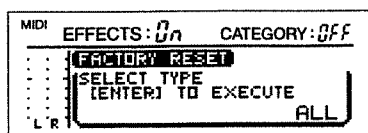

5. Press [ENTER].

A message will ask you to confirm that you really want to execute the Factory Reset operation.

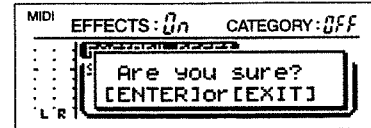

To halt the Factory Reset operation, press [EXIT].

6. When you press [ENTER], the Factory Reset operation will be executed.

When the factory reset has been completed, the display will indicate "Complete !," and you will return to Play mode.



Never turn off the power while the display shows "KEEP POWER ON !". If the power is turned off while this display is shown, the VF-1 may malfunction or its data may be lost.

Troubleshooting

If there is no sound or other operational problem occurs, first check through the following solutions. If this does not resolve the problem, then contact your dealer or a nearby Roland service station.

No Sound/Volume Too Low

- ❑ **Are the connection cables broken?**
Try using a different set of connection cables.
- ❑ **Could you be using a connection cable that contains a resistor?**
Use a connection cable that does not contain a resistor.
- ❑ **Is the VF-1 correctly connected to the other devices?**
Check connections with the other devices. (p.14)
- ❑ **Is the connected amp/mixer turned off, or the volume lowered?**
Check the settings of your amp/mixer system.
- ❑ **Is the INPUT Level knob lowered?**
Adjust [INPUT L/R] to an appropriate position. (p.17)
- ❑ **Is EFFECTS OFF?**
If the EFFECTS operation has been set to "MUTE," setting EFFECTS will mean that the direct sound is not output either. (p.22, 43)
- ❑ **Is each effect set correctly?**
Use the level meter to check the output level of each effect. If there is an effect for which the meter does not move, check the settings for that effect. (p.31)
- ❑ **Is the LEVEL or FOOT LEVEL set to "0"?**
Adjust the MASTER and FOOT LEVEL to appropriate volumes. (p.105)
- ❑ **Are "MASTER LEVEL" and "FOOT VOLUME LEVEL" specified as a control assign Target?**
Move the controller to which it is assigned. (p.33)

Sound Is Distorted

- ❑ **Are the input levels set appropriately?**
Adjust [INPUT L/R] to an appropriate position. (p.17)
- ❑ **Is each effect set correctly?**
Use the Level Meter (p.31) to check the output level of each effect.
If the output level moves beyond the peak, adjust the settings of the effect.
- ❑ **Are the levels of connected devices excessively high?**
Adjust the output levels of connected devices to an appropriate setting.

The direct and effect sounds are not output as you have set.

- ❑ **Is the DIRECT MIX is set to "OFF"?**
If the DIRECT MIX is set to "OFF," no direct sound is output, but only the effect sound is sent.
Set the DIRECT MIX (p. 46) of the Global Sound Settings to "PATCH"

Patch Number Does Not Change

- ❑ **Is something other than the Play mode screen (p.17) shown in the display?**
On the VF-1, patches cannot be selected outside of the Play mode screen. Press [EXIT] once or twice to return to Play mode.

Pedal Connected to CTL 1/2 Jack Doesn't Change Patches

- ❑ **Is something other than the Play mode screen (p.17) shown in the display?**
On the VF-1, patches cannot be selected outside of the Play mode screen. Press [EXIT] once or twice to return to Play mode.
- ❑ **Is the VF-1 set to "CATEGORY On"?**
In Play mode when the display indicates "CATEGORY On," patches of the same category will be selected sequentially. Pressing [EXIT] in Play mode will make the display change to "CATEGORY OFF," and you will be able to select patches as you specified in the "NUMBER U/D MIN" and "NUMBER U/D MAX" settings.
- ❑ **Has the Patch number select range been set appropriately?**
Check the "NUMBER U/D MIN" and "NUMBER U/D MAX" range. (p.43)
- ❑ **Has the function of the CTL 1/2 jack been set correctly?**
Set the function of the CTL 1/2 jack to either "NUMBER UP" or "NUMBER DOWN." (p.44)

Parameters Specified with Control Assign Can't Be Controlled

- ❑ **If you are using a foot switch connected to the CTL 1,2 jack to control the effect, make sure that the function of the jack to which the foot switch is connected is set to "ASSIGNABLE."** (p.44)
- ❑ **Has the source setting been made correctly for the Control Assign?**
Make sure that "SOURCE TYPE" and "SOURCE MODE" are set appropriately for the "source" (foot switch, expression pedal) that is connected to the CTL 1,2 jack. (p.34)
- ❑ **When using MIDI to control parameters**
Make sure that the MIDI channels of both devices match. (p.123)
Make sure that the controller numbers you are using match. (p.34)

MIDI Messages Are Not Received

- ❑ **Are the MIDI cables broken?**
Try another set of MIDI cables.
- ❑ **Is the VF-1 correctly connected to the other MIDI device?**
Check connections with the other MIDI device.
- ❑ **Do the MIDI channel settings of both devices match?**
Make sure that the MIDI channels of both devices match. (p.124)
- ❑ **Did you set the device IDs to match?**
If you wish to transfer data between two VF-1 units, the transmitting VF-1 and receiving VF-1 must be set to the same device ID. (p.123)

Error Messages

MIDI FORMAT ERR!

Reason: The format of the Exclusive message that is being received is incorrect.

Action: Check the data that is being transmitted and try the operation again. Also, make sure the MIDI cable isn't unplugged, broken, or shorted.

CHECK SUM ERROR!

Reason: The Check Sum of the Exclusive message that is being received is incorrect.

Action: Check the data that is being transmitted and try the operation again. Also, make sure the MIDI cable isn't unplugged, broken, or shorted.

MIDI RXBUF ERR!

Reason: A large amount of MIDI data was received in a short time and could not be processed.

Action: Check that the transmitting device is not transmitting excessive amounts of MIDI data.

MIDI RX ERROR!

Reason1: A large amount of MIDI data was received in a short time and could not be processed.

Action 1: Check that the transmitting device is not transmitting excessive amounts of MIDI data.

Reason 2: It is possible that the MIDI cable connected to MIDI IN has been pulled out, or damaged?

Action 2: Check the MIDI cable connections.

24-BIT MULTIPLE EFFECTS PROCESSOR

Date : Aug. 31, 1999

Model VF-1

MIDI Implementation Chart

Version : 1.00

Function...	Transmitted	Recognized	Remarks
Basic Channel Default Changed	X	1-16 1-16	Memorized
Mode Default Messages Altered	X X *****	Mode 1 / Mode 3 X X	* 3
Note Number : True Voice	X *****	X	
Velocity Note ON Note OFF	X X	X X	
After Touch Key's Ch's	X X	X X	
Pitch Bend	X	X	
Control Change 0, 32 1-31 64-95	X X X	O * 1 O * 2 O * 2	Bank Select
Prog Change : True #	X *****	O 0-127	Patch Number 1-128
System Exclusive	O	O	
System Common : Song Pos : Song Sel : Tune	X X X	X X X	
System Real Time : Clock : Command	X X	O * 4 X	
Aux Message : All sound off : Reset all controllers : Local ON/OFF : All Notes OFF : Active Sense : System Reset	X X X X X X	X X X X X X	
Notes	* 1 This ignores the LSB. * 2 This recognize the message set for "Parameters realtime control." * 3 This can be set with the OMNI MODE parameters. Memorized. * 4 This is used for calculating the tempo when you set the parameters that allows BPM setting, such as DELAY TIME/RATE, to MIDI Sync.		

Mode 1 : OMNI ON, POLY

Mode 2 : OMNI ON, MONO

O : Yes

Mode 3 : OMNI OFF, POLY

Mode 4 : OMNI OFF, MONO

X : No

Specifications

VF-1 : 24-Bit Multiple Effects Processor

AD Conversion

24 bit 64 times Oversampling $\Delta\Sigma$ Modulation

DA Conversion

24 bit 128 times Oversampling $\Delta\Sigma$ Modulation

Sampling Frequency

44.1 kHz

Program Memories

400: 200 (User) + 200 (Preset)

Nominal Input Level

GUITAR INPUT Jack: -20 dBm

INPUT Jack L (MONO)/R: -20 dBm,+4dBm

Input Impedance

GUITAR INPUT Jack: 1 M Ω

INPUT Jack L (MONO)/R: 20 k Ω

Nominal Output Level

OUTPUT Jack L (MONO)/R: -20 dBm, +4 dBm

Output Impedance

OUTPUT Jack L (MONO)/R: 1 k Ω

Dynamic Range

97 dB or greater (IHF-A)

Controls

<Front Panel>

POWER switch /INPUT LEVEL knob

UTILITY button

WRITE button

EXIT button

CATEGORY button

PARAMETER button (◀ / ▶)

NUMBER/VALUE knob, EFFECTS/ENTER button

<Rear Panel>

LEVEL switch

Display

Graphic LCD (backlit LCD)

Connectors

<Front>

GUITAR jack

<Rear>

INPUT jack L (MONO)/R

OUTPUT jack L (MONO)/R

DIGITAL OUTPUT connector: Coaxial

* EIAJ CP-1201, S/P DIF

Expression pedal/Control 1/2 jack

MIDI connectors (IN, OUT)

AC ADAPTOR jack

Power Supply

AC 14 V; Supply AC Adaptor (BOSS BRC-120, 230, 240)

Current Draw

800 mA

Dimensions

218 (W) x 248 (D) x 44 (H) mm

8-5/8 (W) x 9-13/16 (D) x 1-3/4 (H) inches

Weight

1.4 kg/3 lbs 2 oz (excluding AC Adaptor)

Accessories

Owner's Manual

AC Adaptor: BOSS BRC-120, 230, 240

Foot Rubber x4

Roland Service (information sheet)

Options

MIDI Foot Controller: FC-200 (Roland), FC-50

Foot Switch: FS-5U, FS-5L

Expression Pedal: EV-5 (Roland), FV-300L+PCS-33 (Roland)

Rack Mount Adaptor: RAD-50 (Roland)

Insert Cable: PCS-31(Roland)

(1/4 inches Phone Plug (stereo)-1/4 inches Phone Plug (mono) x2)

* 0 dBm = 0.775 Vrms



In the interest of product improvement, the specifications and/or appearance of this unit are subject to change without prior notice.

Index

Numerics

10-Band Graphic Equalizer	84
10GRAPHIC EQ	84
2 channel RSS	69
2CH	69

A

AC Adapter jack	13
ACOUSTIC MULTI	56
Algorithm	25
ASSIGN HOLD	43
Assign on/off	33
ASSIGNABLE	44

B

Bank	18
Bank Select message	128
BASS MULTI	54
BPM	105
Bulk Dump	125
Bulk Load	126

C

CATEGORY	12
category	37
Category button	12
Category Search	19
CHORUS RSS	71
CHORUS+REVERB	88
CONTRAST	43
CONTROL 1, 2	44
Control 1,2 jack	13
Control Assign	33
Control Change message	132
controller	34
Copy	28
Cord Hook	13-14
CTL 1,2	13
CTL 1,2 jack	10

D

DELAY	74
DELAY CHORUS	90
DELAY RSS	70
DELAY+REVERB	89
DETECT IN	93
Device ID	123
DIGITAL OUT	127
DIGITAL OUTPUT	13
Digital output connector	13
Digital output signal	127
DIRECT MIX	46
Display	12, 25, 27
display contrast	43

E

Effect Copy	32
Effects button	12
EFFECTS OFF MD	43

EFFECTS on/off	22
EFFECTS/ENTER	12
EIAJ CP-1201 format	127
Enter button	12
EXIT	12
Exit button	12
EXP PEDAL	13
EXP PEDAL jack	10
expression pedal	39
Expression pedal jack	13

F

Factory Reset	133
FC-200	127
FC-50	130
FOOT LEVEL	105
foot switch	34
foot volume	48
foot volume level	105
FV	48

G

GATE REVERB	68
GLOBAL	105
GLOBAL BPM	46
GLOBAL SOUND SETTINGS	45
guitar	14
GUITAR (Hi-Z)	12
GUITAR jack	12, 14
GUITAR MULTI 1	49
GUITAR MULTI 2	52

H

HUM CANCELER	85
--------------------	----

I

INPUT (L/R)	12
Input jacks	13
INPUT L (MONO) /R	13
.....	10
Input Level	17, 31
Input level knob (L/R)	12
ISOLATOR	64

K

KEYBOARD MULTI	57
----------------------	----

L

latch-type	34
LEVEL	13
level meter	17
Level switch	13, 17
LOFI PROCESSOR	65

M

MASTER	105
master BPM	105
master level	105
MIC SIMULATOR	77
MIDI channel	123, 131

-
- MIDI connector 13, 131
 MIDI Implementation Chart 132
 MIDI IN/OUT 13
 MIDI indicator 18
 MOD 47
 momentary-type 34
 MultiTAP DELAY 75
 MUTE 43
 Mute function 22
- N**
- NORMAL 34
 Number knob 12
 NUMBER/VALUE 12
- O**
- Omni mode 123
 Output jacks 13
 OUTPUT L (MONO) /R 13
 output level 31–32
 OUTPUT SELECT 45
- P**
- PARAMETER 12
 Parameter buttons 10, 12
 Patch 18
 Play mode 17
 polarity switch 16, 40
 POSITION 30, 47
 POWER 12
 Power switch 12
 Preset banks 25
 Program Change Map 124
 Program Change message 132
- Q**
- Quick Setting 26
- R**
- Reset 133
 REVERB 111
 REVERB 1 66
 REVERB 2 67
 REVERB RSS 72
 REVERB+REVERB 87
 ROTARY MULTI 59
 RSS 121
 RSS PANNER 73
- S**
- S/P DIF Format 127
 SFX 48
 SKIP 27, 29
 Skip function 27, 29
 SPACE CHORUS 78
 StCHORUS DLY 81
 Stereo Chorus Delay 81
 Stereo Flanger Delay 79
 STEREO MULTI 83
 Stereo Phaser Delay 80
- Stereo Pitch Shifter Delay 82
 STEREO PS DLY 82
 StFLANGER DELAY 79
 StPHASER DLY 80
 SYSTEM SETTING 43
- T**
- TAPE ECHO201 76
 TOGGLE 34
 TUNER 42
 tuner 22–24
- U**
- User bank 25
 UTILITY 12
 Utility 42
 Utility button 10, 12
- V**
- Value knob 12
 VOCAL CANCELER 86
 VOCAL MULTI 60
 VOCODER 62
 Voice Transformer 63
 VoiceTRANSFORM 63
- W**
- WAH 120
 WRITE 12
 Write button 12
 Write operation 38
-

Preset Patch List

Bank / No.	Name	Algorithm	Control Assign	Bank / No.	Name	Algorithm	Control Assign
A 1	MS DRIVE	GUIAR MULTI 1	EXP:Foot Volume Level	A 51	60'S MS	GUIAR MULTI 2	CTL:WAH ON/OFF
A 2	W DLY CLEAN	GUIAR MULTI 1	EXP:Foot Volume Level	A 52	BIG BACKING	GUIAR MULTI 2	EXP:Foot Volume Level
A 3	TWIN BACKING	GUIAR MULTI 1	EXP:Foot Volume Level	A 53	FULL MS	GUIAR MULTI 2	EXP:Foot Volume Level
A 4	HUM4Cuttin'	GUIAR MULTI 1	EXP:Foot Volume Level	A 54	LARRY C	GUIAR MULTI 2	EXP:Foot Volume Level
A 5	TOUCH <oi>	GUIAR MULTI 1	EXP:Foot Volume Level	A 55	SOLO MS	GUIAR MULTI 2	CTL:WAH ON/OFF
A 6	HYPER METAL	GUIAR MULTI 1	EXP:Foot Volume Level	A 56	80'S METAL	GUIAR MULTI 2	EXP:Foot Volume Level
A 7	BRIGHT CLEAN	GUIAR MULTI 1	EXP:Foot Volume Level	A 57	BIG LEAD	GUIAR MULTI 2	EXP:Foot Volume Level
A 8	VO CRUNCH	GUIAR MULTI 1	EXP:Foot Volume Level	A 58	BACK CRUNCH	GUIAR MULTI 2	EXP:Foot Volume Level
A 9	JET FLANGER	GUIAR MULTI 1	EXP:Foot Volume Level	A 59	ULTIMATE	GUIAR MULTI 2	EXP:Foot Volume Level
A 10	CRUNCH WAH	GUIAR MULTI 1	EXP:Foot Volume Level	A 60	AC. W/DLY	GUIAR MULTI 2	EXP:Foot Volume Level
A 11	5150 DRIVE	GUIAR MULTI 1	EXP:Foot Volume Level	A 61	METAL SOLO	GUIAR MULTI 2	EXP:Foot Volume Level
A 12	DETUNE CLEAN	GUIAR MULTI 1	EXP:Foot Volume Level	A 62	SYN LEAD	BASS MULTI	EXP:Foot Volume Level
A 13	VINTAGE TWIN	GUIAR MULTI 1	EXP:Foot Volume Level	A 63	DRIVE'n' ROLL	BASS MULTI	EXP:Foot Volume Level
A 14	FL MATCH	GUIAR MULTI 1	EXP:Foot Volume Level	A 64	Funkenstein	BASS MULTI	EXP:Foot Volume Level
A 15	3-VOICE LEAD	GUIAR MULTI 1	EXP:PEDAL WAH	A 65	DEEP SEA	BASS MULTI	EXP:Foot Volume Level
A 16	E.C. LEAD	GUIAR MULTI 1	EXP:Foot Volume Level	A 66	UPRIGHTER	BASS MULTI	EXP:Foot Volume Level
A 17	PH CRUNCH	GUIAR MULTI 1	EXP:Foot Volume Level	A 67	CLEAN HEADS	BASS MULTI	EXP:Foot Volume Level
A 18	DELAY CRUNCH	GUIAR MULTI 1	EXP:Foot Volume Level	A 68	FlangJackson	BASS MULTI	EXP:Foot Volume Level
A 19	MELLOW ATTACK	GUIAR MULTI 1	EXP:Foot Volume Level	A 69	DINOSAUR	BASS MULTI	EXP:Foot Volume Level
A 20	RING MOD	GUIAR MULTI 1	EXP:RING FREQUENCY	A 70	ROCK CS PICK	BASS MULTI	CTL:DELAY ON/OFF
A 21	90's METAL	GUIAR MULTI 1	EXP:Foot Volume Level	A 71	Std. BASS	BASS MULTI	EXP:Foot Volume Level
A 22	JAZZ GARAGE	GUIAR MULTI 1	EXP:Foot Volume Level	A 72	DEFUSION	BASS MULTI	CTL:MOD ON/OFF
A 23	COMBO DRIVE	GUIAR MULTI 1	EXP:Foot Volume Level	A 73	Fxtorious	BASS MULTI	CTL:FEEDBACK
A 24	STEP PHASER	GUIAR MULTI 1	EXP:Foot Volume Level	A 74	LOW BLOW	BASS MULTI	EXP:Foot Volume Level
A 25	MELLOW COMP	GUIAR MULTI 1	EXP:Foot Volume Level	A 75	FAKE FRETLESS	BASS MULTI	EXP:Foot Volume Level
A 26	STUDIO LEAD	GUIAR MULTI 1	EXP:Foot Volume Level	A 76	FUNKY BASS	BASS MULTI	EXP:Foot Volume Level
A 27	DETUNE BG	GUIAR MULTI 1	EXP:Foot Volume Level	A 77	PHASE BASS	BASS MULTI	EXP:PHASER RATE
A 28	GUIAR+SYN 1	GUIAR MULTI 1	EXP:Foot Volume Level	A 78	PHASE ATTACK	BASS MULTI	EXP:PHASER RATE
A 29	GUIAR+SYN 2	GUIAR MULTI 1	EXP:Foot Volume Level	A 79	CLEAR	ACOUSTIC MULTI	EXP:Foot Volume Level
A 30	SPACY LEAD	GUIAR MULTI 1	EXP:Foot Volume Level	A 80	DARK ROOM	ACOUSTIC MULTI	EXP:Foot Volume Level
A 31	HEY! Jimi	GUIAR MULTI 1	EXP:Foot Volume Level	A 81	JAZZ CHORUS	ACOUSTIC MULTI	EXP:Foot Volume Level
A 32	STEREO OD	GUIAR MULTI 1	EXP:Foot Volume Level	A 82	OV PUNCH	ACOUSTIC MULTI	EXP:Foot Volume Level
A 33	HI GAIN MS	GUIAR MULTI 1	EXP:Foot Volume Level	A 83	ARPEGGATE	ACOUSTIC MULTI	EXP:Foot Volume Level
A 34	5150 LEAD	GUIAR MULTI 1	EXP:Foot Volume Level	A 84	BURN	ACOUSTIC MULTI	EXP:Foot Volume Level
A 35	TUBE STACK	GUIAR MULTI 1	EXP:Foot Volume Level	A 85	SMOOTHY	ACOUSTIC MULTI	EXP:Foot Volume Level
A 36	BALLADE TREM	GUIAR MULTI 2	EXP:TR PAN RATE	A 86	SPACE PHASE	KEYBOARD MULTI	EXP:Foot Volume Level
A 37	BRIAN M	GUIAR MULTI 2	CTL:WAH ON/OFF	A 87	RING NOISE	KEYBOARD MULTI	CTL:CHORUS ON/OFF
A 38	M DELAY	GUIAR MULTI 2	EXP:Foot Volume Level	A 88	DEEP RING	KEYBOARD MULTI	EXP:Foot Volume Level
A 39	MICHAEL S	GUIAR MULTI 2	EXP:Foot Volume Level	A 89	ROTARY SLOW	ROTARY MULTI	CTL:SPEED SELECT
A 40	COOL BLUES	GUIAR MULTI 2	EXP:Foot Volume Level	A 90	ROTARY FAST	ROTARY MULTI	CTL:SPEED SELECT
A 41	COUNTRY TELE	GUIAR MULTI 2	EXP:Foot Volume Level	A 91	OD ROTAR FAST	ROTARY MULTI	CTL:SPEED SELECT
A 42	BIG RIFF	GUIAR MULTI 2	EXP:Foot Volume Level	A 92	OD ROTAR SLOW	ROTARY MULTI	CTL:SPEED SELECT
A 43	FUSION?	GUIAR MULTI 2	EXP:Foot Volume Level	A 93	DELAY VOCAL	VOCAL MULTI	EXP:Foot Volume Level
A 44	JAZZY	GUIAR MULTI 2	EXP:Foot Volume Level	A 94	RADIO VOICE	VOCAL MULTI	CTL:EQ ON/OFF
A 45	AUTO WAH	GUIAR MULTI 2	EXP:Foot Volume Level	A 95	REVERSE	VOCAL MULTI	CTL:MOD ON/OFF
A 46	80'S CLEAN	GUIAR MULTI 2	EXP:Foot Volume Level	A 96	VOCODER MONO	VOCODER	CTL:HOLD
A 47	OLD VH	GUIAR MULTI 2	EXP:Foot Volume Level	A 97	MALE > FEMALE	VoiceTRANSFORM	CTL:VT ON/OFF
A 48	CRUNCH CLEAN	GUIAR MULTI 2	EXP:Foot Volume Level	A 98	FEMALE > MALE	VoiceTRANSFORM	CTL:VT ON/OFF
A 49	BOSTON	GUIAR MULTI 2	EXP:Foot Volume Level	A 99	VOCAL DUO	VoiceTRANSFORM	CTL:VT ON/OFF
A 50	VO DRIVE	GUIAR MULTI 2	EXP:Foot Volume Level	A 100	OldSpaceDisco	ISOLATOR	EXP:Foot Volume Level

EXP: Expression Pedal

CTL: Foot Switch

Bank / No.	Name	Algorithm	Control Assign	Bank / No.	Name	Algorithm	Control Assign
B 1	CHORUS GTR	GIUITAR MULTI 1	EXP:Foot Volume Level	B 51	MUSIC CLUB	REVERB 1	CTL:REVERB ON/OFF
B 2	JUMBO AC	GIUITAR MULTI 2	EXP:Foot Volume Level	B 52	AC.Gtr REVERB	REVERB 1	CTL:REVERB ON/OFF
B 3	OD FRETLESS	BASS MULTI	EXP:Foot Volume Level	B 53	BLUES ROOM	REVERB 2	CTL:REVERB ON/OFF
B 4	REAL ACOUSTIC	ACOUSTIC MULTI	EXP:Foot Volume Level	B 54	LIVE HOUSE	REVERB 2	CTL:REVERB ON/OFF
B 5	ECHO BACK	KEYBOARD MULTI	CTL:DELAY ON/OFF	B 55	WARM HALL	REVERB 2	CTL:REVERB ON/OFF
B 6	TREMOLO ROTAR	ROTARY MULTI	CTL:SPEED SELECT	B 56	SMALL HALL	REVERB 2	CTL:REVERB ON/OFF
B 7	Std. VOCAL	VOCAL MULTI	EXP:Foot Volume Level	B 57	ARENA	REVERB 2	CTL:REVERB ON/OFF
B 8	VOCODER St.	VOCODER	CTL:HOLD	B 58	ARENA BACK	REVERB 2	CTL:REVERB ON/OFF
B 9	ROBOT VOICE	VoiceTRANSFORM	CTL:ROBOT ON/OFF	B 59	KICK REV1	REVERB 2	CTL:REVERB ON/OFF
B 10	DANCE VIOLIN	ISOLATOR	EXP:Foot Volume Level	B 60	KICK REV2	REVERB 2	CTL:REVERB ON/OFF
B 11	HPF BitFilter	LOFI PROCESSOR	MIDI-1:SAMPLE RATE	B 61	FAT GATE	GATE REVERB	CTL:REVERB ON/OFF
B 12	SMALL ROOM	REVERB 1	CTL:REVERB ON/OFF	B 62	BRIGHT GATE	GATE REVERB	CTL:REVERB ON/OFF
B 13	LARGE HALL	REVERB 2	CTL:REVERB ON/OFF	B 63	HI LONG GATE	GATE REVERB	CTL:REVERB ON/OFF
B 14	POWER'S GATE	GATE REVERB	CTL:REVERB ON/OFF	B 64	LO LONG GATE	GATE REVERB	CTL:REVERB ON/OFF
B 15	RSS L << >> R	2CH RSS	EXP:Foot Volume Level	B 65	RSS WIDE-High	2CH RSS	EXP:Foot Volume Level
B 16	3D DELAY 1	DELAY RSS	CTL:DELAY ON/OFF	B 66	3D DELAY 2	DELAY RSS	CTL:DELAY ON/OFF
B 17	3D CHORUS 1	CHORUS RSS	CTL:CHORUS ON/OFF	B 67	3D CHORUS 2	CHORUS RSS	CTL:CHORUS ON/OFF
B 18	3D REVERB 1	REVERB RSS	CTL:REVERB ON/OFF	B 68	3D REVERB 2	REVERB RSS	CTL:REVERB ON/OFF
B 19	GATE PANNER	RSS PANNER	CTL:PANNER ON/OFF	B 69	JET PANNER	RSS PANNER	CTL:PANNER ON/OFF
B 20	SHORT DELAY	DELAY	EXP:Foot Volume Level	B 70	LONG DELAY	DELAY	EXP:Foot Volume Level
B 21	MultiTapDelay	MultiTAP DELAY	EXP:Foot Volume Level	B 71	St.SHORT Dly	DELAY	EXP:Foot Volume Level
B 22	WIDE ECHO	TAPE ECHO201	EXP:Foot Volume Level	B 72	St.LONG DELAY	DELAY	EXP:Foot Volume Level
B 23	MIC DR20->87	MIC SIMULATOR	EXP:Foot Volume Level	B 73	Drifting L->>R	MultiTAP DELAY	EXP:Foot Volume Level
B 24	WAVE CHORUS	SPACE CHORUS	EXP:Foot Volume Level	B 74	RANDOM DELAY	MultiTAP DELAY	EXP:Foot Volume Level
B 25	GATE FLANGER	SiFLANGER DLY	EXP:Foot Volume Level	B 75	SHORT ECHO	TAPE ECHO201	EXP:Foot Volume Level
B 26	FAST PHASER	SiPHASER DLY	EXP:PHASER RATE	B 76	LONG ECHO	TAPE ECHO201	EXP:REPEAT RATE
B 27	DELAY CHORUS	SiCHORUS DLY	CTL:DELAY ON/OFF	B 77	MIC 57->421	MIC SIMULATOR	EXP:Foot Volume Level
B 28	DETUNE CHORUS	STEREO PS DLY	EXP:Foot Volume Level	B 78	MIC DR20->421	MIC SIMULATOR	EXP:Foot Volume Level
B 29	NO ATTACK CMP	STEREO MULTI	EXP:Foot Volume Level	B 79	MIC Mini->57	MIC SIMULATOR	EXP:Foot Volume Level
B 30	COMP + GEQ	10GRAPHIC EQ	EXP:Foot Volume Level	B 80	MIC 10 -> 87	MIC SIMULATOR	EXP:Foot Volume Level
B 31	QUIET 60Hz	HUM CANCELER	EXP:Foot Volume Level	B 81	DIMENSION 1	SPACE CHORUS	EXP:Foot Volume Level
B 32	VOCAL CANCEL	VOCAL CANCELER	EXP:Foot Volume Level	B 82	DIMENSION 2	SPACE CHORUS	EXP:Foot Volume Level
B 33	HALL / ROOM	REVERB + REVERB	CTL:EFFECTS ON/OFF	B 83	DEEP FLANGER	SiFLANGER DLY	EXP:FLANGER RATE
B 34	CHORUS/REV 1	CHORUS + REVERB	CTL:EFFECTS ON/OFF	B 84	SLOW FLANGER	SiFLANGER DLY	EXP:Foot Volume Level
B 35	Dub REVERB	DELAY + REVERB	CTL:EFFECTS ON/OFF	B 85	St.STEP PH	SiPHASER DLY	EXP:Foot Volume Level
B 36	DLY/CHORUS 1	DELAY + CHORUS	CTL:EFFECTS ON/OFF	B 86	NORMAL PHASER	SiPHASER DLY	EXP:Foot Volume Level
B 37	BabbleElectro	ISOLATOR	EXP:Foot Volume Level	B 87	DEEP CHORUS	SiCHORUS DLY	EXP:Foot Volume Level
B 38	SPACE WATER	ISOLATOR	EXP:Foot Volume Level	B 88	SLOW CHORUS	SiCHORUS DLY	EXP:Foot Volume Level
B 39	MOVE FLGATE	ISOLATOR	MIDI-1:FLANGER GATE	B 89	OCTAVE	STEREO PS DLY	CTL:PITCH SHIFTER ON/OFF
B 40	EMERGENCY	ISOLATOR	EXP:Foot Volume Level	B 90	DIMINISH	STEREO PS DLY	EXP:Foot Volume Level
B 41	HeavyBitFiltr	LOFI PROCESSOR	MIDI-1:SAMPLE RATE	B 91	DUAL LOW-CUT	STEREO MULTI	EXP:Foot Volume Level
B 42	BreakBeatSkit	LOFI PROCESSOR	EXP:Foot Volume Level	B 92	DUAL HIGH-CUT	STEREO MULTI	EXP:Foot Volume Level
B 43	TunnelMoveMod	LOFI PROCESSOR	MIDI-1:SOUND	B 93	LIMIT + GEQ	10GRAPHIC EQ	EXP:Foot Volume Level
B 44	AnalogCutting	LOFI PROCESSOR	EXP:Foot Volume Level	B 94	TOTAL GEQ	10GRAPHIC EQ	EXP:Foot Volume Level
B 45	WOOD ROOM	REVERB 1	CTL:REVERB ON/OFF	B 95	QUIET 50Hz	HUM CANCELER	EXP:Foot Volume Level
B 46	MEDIUM ROOM	REVERB 1	CTL:REVERB ON/OFF	B 96	CENTER CANCEL	VOCAL CANCELER	EXP:Foot Volume Level
B 47	LARGE ROOM	REVERB 1	CTL:REVERB ON/OFF	B 97	HALL / PLATE	REVERB + REVERB	CTL:EFFECTS ON/OFF
B 48	PIANO REVERB	REVERB 1	CTL:REVERB ON/OFF	B 98	CHORUS/REV 2	CHORUS + REVERB	CTL:EFFECTS ON/OFF
B 49	STRINGS REV	REVERB 1	CTL:REVERB ON/OFF	B 99	Flam REVERB	DELAY + REVERB	CTL:EFFECTS ON/OFF
B 50	KARAOKE	REVERB 1	CTL:DELAY ON/OFF	B100	DLY/CHORUS 2	DELAY + CHORUS	CTL:EFFECTS ON/OFF

EXP: Expression Pedal

CTL: Foot Switch

MEMO

Information

■ New algorithm

The algorithm "PB101 Speaker Modeling" has been newly added on VF-1.

Regarding each parameter of this speaker modeling, refer to the VF-1 manual, along with the part "New parameters" of this leaflet.

■ New patches

The addition of "Speaker Modeling" algorithm caused the new patches.

Patches: PA101, PB101, UA101, UB101

Therefore, the number of program memory described on the VF-1 manual has been changed as follows.

Program Memories 404: 202 (User) + 202 (Preset)

User Bank A: 101 / B: 101

Preset Bank A: 101 / B: 101

PB101 SPEAKER MODELING

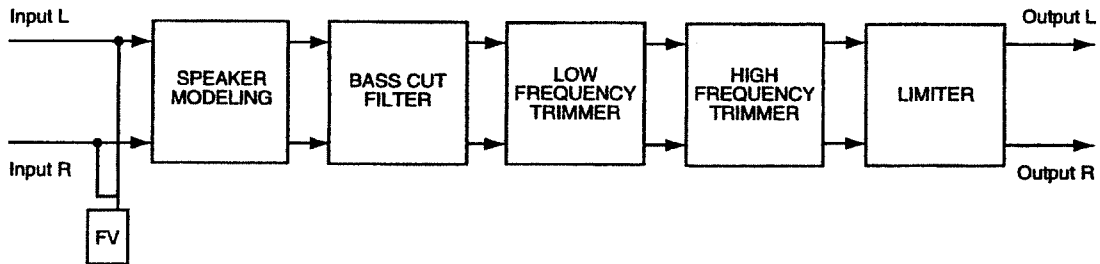

You can model the acoustical characteristics of a variety of speakers, ranging from high-level professional monitor speakers used in studios worldwide, to the speakers of small televisions or portable radios.

* Regarding SP MODELING, LOW TRIM and HIGH TRIM, refer to "New parameters" of this leaflet.

Regarding BCF, LIMITER and MASTER, refer to "The function of each parameter" (page 91-121) of the VF-1 manual.

SP MODELING (Speaker Modeling)

EFFECT	OFF, ON
MODEL	SUPER FLAT, PWD. BLACK, PWD. E-Bas, PWD. MACK, SMALL CUBE, WHITE CONE, WHITE C+TIS, SMALL RADIO, SMALL TV, BOOM BOX, BOOM LO-Bst
PHASE	NOR, INV

BCF (Bass Cut Filter)

EFFECT	OFF, ON
FREQUENCY	THRU, 20-2000 (Hz)

LOW TRIM (Low Frequency Trimmer)

EFFECT	OFF, ON
GAIN	-12+12(dB)
FREQUENCY	20-2000 (Hz)

HIGH TRIM (High Frequency Trimmer)

EFFECT	OFF, ON
GAIN	-12+12(dB)
FREQUENCY	1.0-20.0 (kHz)

LIMITER

EFFECT	OFF, ON
THRESHOLD	-60-0 (dB)
RELEASE	0-100
LEVEL	-60+24 (dB)

MASTER

<MASTER>	
LEVEL	0-100
<FV: FOOT VOLUME>	
FOOT LEVEL	0-100

New parameters

SP MODELING (Speaker Modeling)

You can model the acoustical characteristics of a variety of speakers, ranging from high-level professional monitor speakers used in studios worldwide, to the speakers of small televisions or portable radios.

Speaker modeling has been calibrated so that the optimal effect will be obtained when Roland DS-90/DS-90A (sold separately) powered monitors are connected digitally. If you are using other speakers, you may not be able to obtain the desired effect.

EFFECT

This parameter turns the speaker modeling effect on/off.

MODEL (Modeling Speaker)

Select the speaker whose characteristics will be simulated (modeled).

SUPER FLAT

Modeling is used to compensate the DS-90/DS-90A, to produce an even flatter sound with a wider range.

PWD. BLACK

A widely used model of powered monitors (two-way type, with a woofer diameter of 170 mm (6-1/2 inches)).

PWD. E-Bas

Powered monitors characterized by a bright tone.

PWD. MACK

Powered monitors characterized by an extended low-frequency response.

SMALL CUBE

Small full-range speakers widely used in recording studios.

WHITE CONE

Sealed enclosure two-way speakers known for their white woofers and widely used in recording studios.

WHITE C+TIS

A more mild sound, with tissue paper affixed over the tweeters of the above "White Cone" speakers.

SMALL RADIO

Small pocket-type radio.

SMALL TV

Speakers built into a 14 inch size television.

BOOM BOX

Radio cassette recorder.

BOOM LO-Bst

Radio cassette recorder with the Low Boost switched on.

PHASE

Specifies the phase of the speakers.

NOR

Same phase as the input.

INV

Opposite phase of the input.

LOW TRIM (Low Frequency Trimmer)

Adjusts the low frequency band sounds.

EFFECT

This parameter turns the low frequency trimmer effect on/off.

GAIN

For low frequency trimmer, adjusts the gain (amount of boost/cut).

FREQUENCY

Set the center frequency of low frequency trimmer.

HIGH TRIM (High Frequency Trimmer)

Adjusts the high frequency band sounds.

EFFECT

This parameter turns the high frequency trimmer effect on/off.

GAIN

For high frequency trimmer, adjusts the gain (amount of boost/cut).

FREQUENCY

Set the center frequency of high frequency trimmer.

Copyright © 2000 BOSS CORPORATION

All rights reserved. No part of this publication may be reproduced in any form without the written permission of BOSS CORPORATION.



This product complies with the requirements of European Directive 89/336/EEC.

For EU Countries

FEDERAL COMMUNICATIONS COMMISSION RADIO FREQUENCY INTERFERENCE STATEMENT

This equipment has been tested and found to comply with the limits for a Class B digital device, pursuant to Part 15 of the FCC Rules. These limits are designed to provide reasonable protection against harmful interference in a residential installation. This equipment generates, uses, and can radiate radio frequency energy and, if not installed and used in accordance with the instructions, may cause harmful interference to radio communications. However, there is no guarantee that interference will not occur in a particular installation. If this equipment does cause harmful interference to radio or television reception, which can be determined by turning the equipment off and on, the user is encouraged to try to correct the interference by one or more of the following measures:

- Reorient or relocate the receiving antenna.
- Increase the separation between the equipment and receiver.
- Connect the equipment into an outlet on a circuit different from that to which the receiver is connected.
- Consult the dealer or an experienced radio/TV technician for help.

Unauthorized changes or modification to this system can void the users authority to operate this equipment.
This equipment requires shielded interface cables in order to meet FCC class B Limit.

For the USA

NOTICE

This Class B digital apparatus meets all requirements of the Canadian Interference-Causing Equipment Regulations.

AVIS

Cet appareil numérique de la classe B respecte toutes les exigences du Règlement sur le matériel brouilleur du Canada.

For Canada

 Roland®

71454312

UPC 71454312



10981



 BOSS®

01903667

'02-9-H2-32N