

TU-2 Chromatic Tuner

Owner's Manual

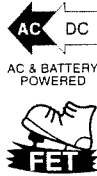
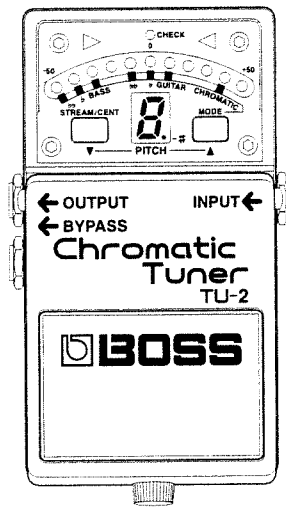

Thank you, and congratulations on your choice of BOSS TU-2 Chromatic Tuner.

Before using this unit, carefully read the sections entitled: "USING THE UNIT SAFELY" and "IMPORTANT NOTES" (p. 28–34; 5–7). These sections provide important information concerning the proper operation of the unit. Additionally, in order to feel assured that you have gained a good grasp of every feature provided by your new unit, Owner's manual should be read in its entirety. The manual should be saved and kept on hand as a convenient reference.

Copyright © 1998 BOSS CORPORATION

All rights reserved. No part of this publication may be reproduced in any form without the written permission of BOSS CORPORATION.

2

Features

- The ideal tuner for use in live concert situations.
- Since the TU-2 uses the same shape and structure as other Boss compact effect units, it features excellent durability and allows neat connection with other effect units.
- The OUTPUT is muted when the tuning function is on, allowing you to tune without being heard.
- High-luminosity LEDs allow visual tuning even in outdoor sunlight.
- You can choose from two types of meter display: CENT (normal needle-style movement), or STREAM (a flow of lights indicates the pitch deviation).
- In addition to chromatic mode which indicates the note name of the input sound, you can also use Guitar/Bass mode which displays the string number. (5-string bass is supported.)

- In Guitar/Bass mode, you can also use Flat tuning (a semitone down) or Double-flat tuning (a whole step down).
- When the tuner is off, a battery conservation function minimizes power consumption.
- By using an AC adapter (sold separately) with the DC 9V in/out jacks, you can supply power to other compact effect units as well.

4

IMPORTANT NOTES

In addition to the items listed under “USING THE UNIT SAFELY” on page 28–34, please read and observe the following:

Power Supply: Use of Batteries

- Do not use this unit on the same power circuit with any device that will generate line noise (such as an electric motor or variable lighting system).
- The AC adaptor will begin to generate heat after long hours of consecutive use. This is normal, and is not a cause for concern.
- Batteries should always be installed or replaced before connecting any other devices. This way, you can prevent malfunction and/or damage to speakers or other devices.
- A battery was installed in the unit before it left the factory. The life of this battery may be limited, however, since its primary purpose was to enable testing.

- Before connecting this unit to other devices, turn off the power to all units. This will help prevent malfunctions and/or damage to speakers or other devices.

Placement

- Using the unit near power amplifiers (or other equipment containing large power transformers) may induce hum. To alleviate the problem, change the orientation of this unit; or move it farther away from the source of interference.
- This device may interfere with radio and television reception. Do not use this device in the vicinity of such receivers.

- Do not expose the unit to direct sunlight, place it near devices that radiate heat, leave it inside an enclosed vehicle, or otherwise subject it to temperature extremes. Excessive heat can deform or discolor the unit.
- To avoid possible breakdown, do not use the unit in a wet area, such as an area exposed to rain or other moisture.
- Do not allow rubber, vinyl, or similar materials to remain on the piano for long periods of time. Such objects can discolor or otherwise harmfully affect the finish.

Maintenance

- For everyday cleaning wipe the unit with a soft, dry cloth or one that has been slightly dampened with water. To remove stubborn dirt, use a cloth impregnated with a mild, non-abrasive detergent. Afterwards, be sure to wipe the unit thoroughly with a soft, dry cloth.
- Never use benzine, thinners, alcohol or solvents of any kind, to avoid the possibility of discoloration and/or deformation.

Additional Precautions

- Use a reasonable amount of care when using the unit's buttons, sliders, or other controls; and when using its jacks and connectors. Rough handling can lead to malfunctions.
- Never strike or apply strong pressure to the display.

6

- When connecting / disconnecting all cables, grasp the connector itself—never pull on the cable. This way you will avoid causing shorts, or damage to the cable's internal elements.
- To avoid disturbing your neighbors, try to keep the unit's volume at reasonable levels. You may prefer to use headphones, so you do not need to be concerned about those around you (especially when it is late at night).

Panel Description

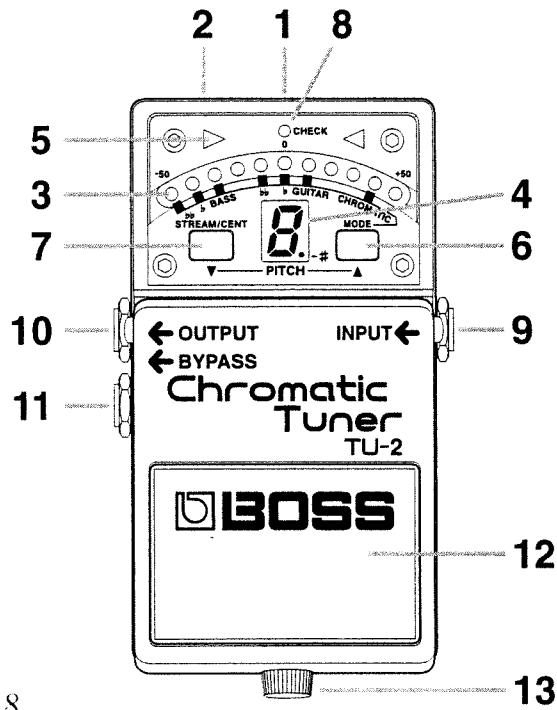

1. DC 9V In jack

An AC adapter (BOSS PSA-Series: sold separately) can be connected to this jack. If an AC adapter is used, you will be able to play for extended periods without worrying about battery life.

* As soon as you connect the AC adapter, the unit is turned ON.

2. DC 9V Out jack

When an AC adapter is used, you can connect a PCS-20A parallel DC cord (sold separately) to supply power to other 9V effect units.

* Power cannot be supplied when the TU-2 is running on batteries.

* When using a DC 9V Out jack, make sure that the total current consumption of the TU-2 and other effects being supplied does not exceed 200 mA.

8

3. Meter

The meter indicates the pitch deviation of the input sound from the note name or string number that is shown in the note name / string number indicator.

CENT display

The LED that is lit will be further toward the left as the input pitch is flat, and further toward the right as the input pitch is sharp. The pitch is correct when the center (green) indicator of the meter is lit.

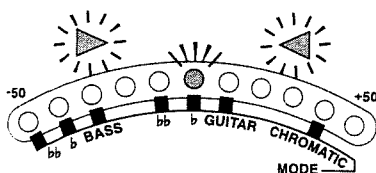

STREAM display

Deviation of the input pitch will be shown by a flow of lights toward left or right. The lights will flow toward the left if the input pitch is flat, and toward the right if the input pitch is sharp.

As the pitch deviation decreases, the flow will become slower, and the flow will stop when the pitch is correct.

4. Note name / String number indicator

In Chromatic mode, this indicates the note name.

In Guitar/Bass mode, this indicates the string number.

5. Tuning guide indicators

These will light to roughly indicate the tuning.

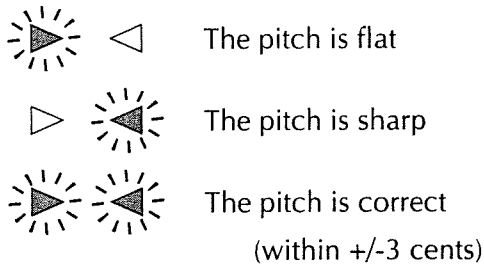

6. MODE select switch

This switch changes the tuning mode. When this switch is first pressed, the meter will blink to indicate the current mode. If you press the switch again, the meter will cycle through the following modes, and the corresponding indicator will light.

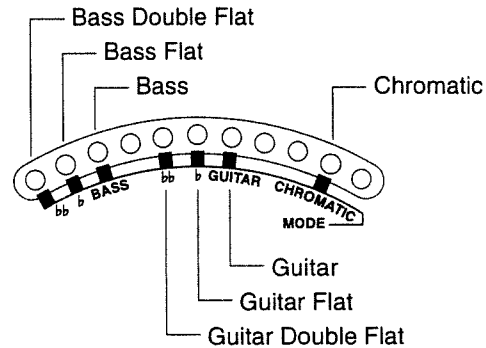

10

7. STREAM/CENT select switch

This switches the meter display method. The meter will indicate the selected display method for approximately two seconds after the method has been switched.

8. CHECK indicator

This shows the Tuner On/Off status and also serves as a battery check indicator. This indicator will light when the tuner is on. If the indicator is dim or fails to light when the tuner is on, the battery has run down, and should be replaced with a new battery as soon as possible. For the procedure, refer to "Changing the battery" (page 23).

9. INPUT jack

Use this jack to connect the electric guitar / electric bass that you wish to tune.

* When a battery is used, the input jack also functions as a power switch. When a plug is inserted into the input jack, the power will be turned on. When the plug is pulled out, the power will be turned off. When you are not using the tuner, pull the plug out of the input jack.

10. OUTPUT jack

Connect your amp or another effect unit to this jack.

When the tuner is off, this will output the signal of the instrument connected to the Input jack.

When the tuner is on, no sound will be output from this jack, so use this jack if you wish to tune silently.

11

11. BYPASS jack

Connect your amp or another effect unit to this jack.

This jack will always output the signal from the instrument connected to the Input jack. Use this jack if you want to be heard while you tune.

12. Pedal switch

Pressing this switch will turn the tuner on/off.

13. Thumbscrew

When this screw is loosened, the pedal will open, allowing you to change the battery. For the procedure, refer to "Changing the battery" (page 23).

12

Connections

- * Before connecting or disconnecting any patch cords, be sure all the volume controls in your system are set to minimum. This will help prevent any damage to system components.
- * To prevent malfunction and/or damage to speakers or other devices, always turn down the volume, and turn off the power on all devices before making any connections.
- * If there are batteries in the unit while an AC adaptor is being used, normal operation will continue should the line voltage be interrupted (power blackout or power cord disconnection).

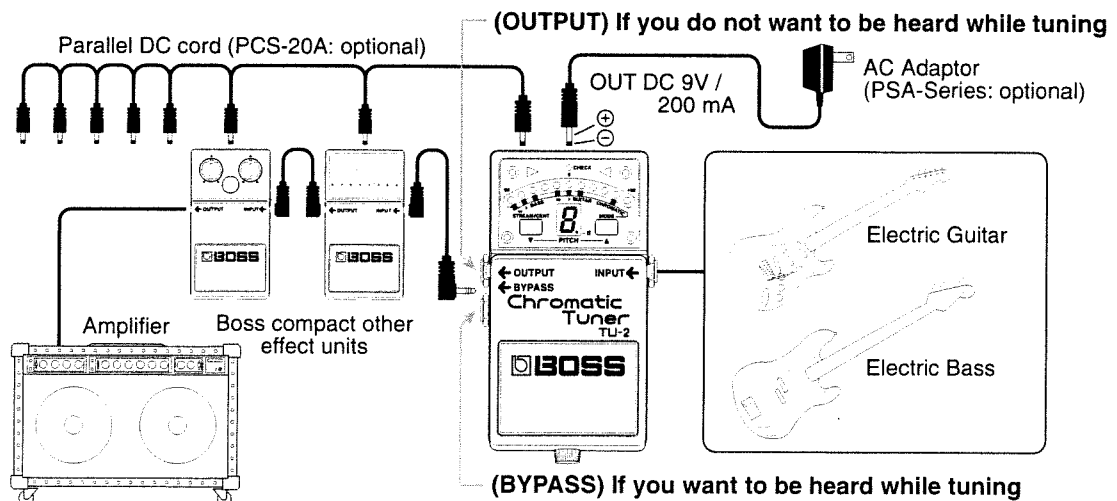

13

Turning on the power

* Always make sure to have the volume level of your amp turned down before switching on power. Even with the volume all the way down, you may still hear some sound when the power is switched on, but this is normal, and does not indicate a malfunction.

If you are using an AC adapter

The power will be turned on when you connect the AC adapter to the DC 9V In jack.

If you are using a battery

The power will be turned on when you insert a plug into the Input jack.

When the power is turned on, the meter will light to indicate the current tuning mode. Then the note name / string number indicator will indicate the first digit of the currently selected standard pitch.

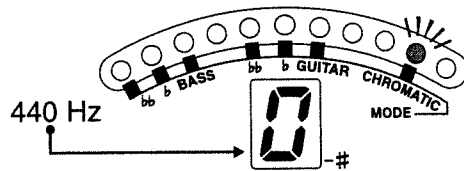

14

Tuning in chromatic mode

* If you wish to change the standard pitch, do so before you begin tuning (page 20).

1. Press the MODE select switch several times to make "CHROMATIC" light.

* When the TU-2 is shipped from the factory Chromatic mode is selected.

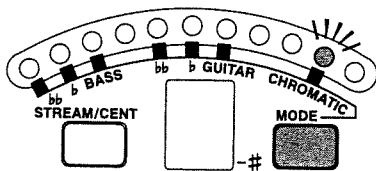

2. If the tuner is not on (CHECK should be lit), press the pedal to turn it on.

3. Play a single note on your instrument.

The name of the note closest to the pitch of the input sound will appear in the note name / string number indicator, and the meter will indicate the pitch deviation.

(Note name display)

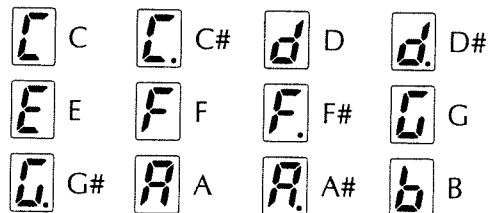

4. Tune your instrument.

15

Tuning in Guitar mode

* If you wish to change the standard pitch, do so before you begin tuning (page 20).

1. Press the MODE select switch several times to make "GUITAR" light.

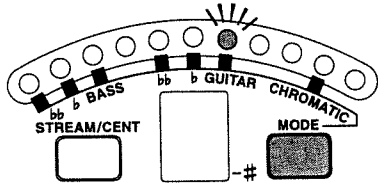

If you are using flat tuning (semitone down) make "b" light. If you are using double flat tuning (whole step down) make "bb" light.

Flat tuning

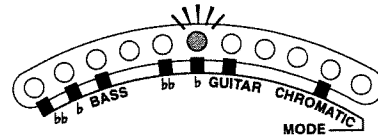

Double flat tuning

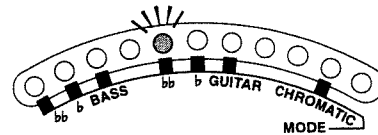

16

2. If the tuner is not on (CHECK should be lit), press the pedal to turn it on.
3. Play a single note on your instrument.
The string number closest to the pitch of the input sound will appear in the note name / string number indicator, and the meter will indicate the pitch deviation.

(String number display)

1 1st string E	2 2nd string B
3 3rd string G	4 4th string D
5 5th string A	6 6th string E

4. Tune your instrument.

17

Tuning in Bass mode

* If you wish to change the standard pitch, do so before you begin tuning (page 20).

1. Press the **MODE** select switch several times to make "BASS" light.

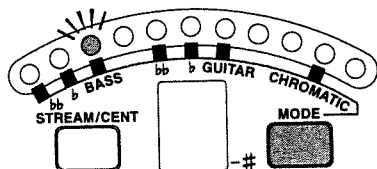

If you are using flat tuning (semitone down) make "b" light. If you are using double flat tuning (whole step down) make "bb" light.

Flat tuning

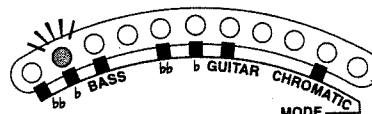

Double flat tuning

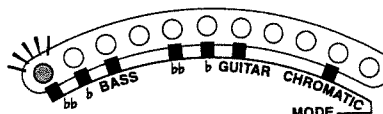

18

2. If the tuner is not on (CHECK should be lit), press the pedal to turn it on.
3. Play a single note on your instrument.
The string number closest to the pitch of the input sound will appear in the note name / string number indicator, and the meter will indicate the pitch deviation.

(String number display)

- | | |
|-----------------------------|-----------------------|
| 1 1st string G | 2 2nd string D |
| 3 3rd string A | 4 4th string E |
| 5 LoB (5th string) B | |

4. Tune your instrument.

19

Adjusting the standard pitch

1. Simultaneously press the MODE select switch and the STREAM/CENT select switch.

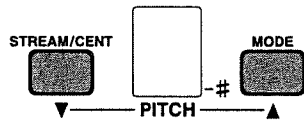

2. The first digit of the currently selected standard pitch (0, if 440 Hz) will blink in the note name / string number display.
3. Press the MODE select switch to change the standard pitch as follows.

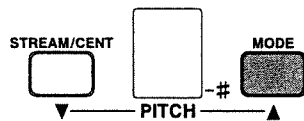

440 → 441 → 442 → 443
 ↑ ↓
 439 ← 438 ← 445 ← 444

When you press the STREAM/CENT select switch, the standard pitch will change as follows.

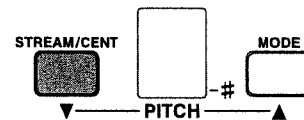



440 ← 441 ← 442 ← 443
 ↓ ↑
 439 → 438 → 445 → 444

The standard pitch will be memorized until the power is turned off. When you turn off the power, the standard pitch will be reset to 440 Hz.

20

Memorizing the standard pitch

With the factory settings, the TU-2 will return to a standard pitch of 440 Hz when the power is turned off. If you wish to leave the standard pitch at a setting of other than 440 Hz, you can use the following procedure to memorize the standard pitch.

1. Turn on the power while holding down the MODE select switch. The note name / string number indicator will show "n" (standard pitch not memorized). 
2. While continuing to hold down the MODE select switch, press the STREAM/CENT select switch within two seconds to make the note name / string number indicator light "P" (standard pitch memorized). 
3. When you release the meter display method select switch and the MODE select switch, the TU-2 will return to normal operation.

With this setting, the standard pitch will be memorized even if the power is turned off.

21

Storefront demo display

1. Turn on the power while holding down the STREAM/CENT select switch.
2. Continue holding down the switch for approximately two seconds.
3. The storefront demo display mode will begin. Release the switch.
4. The demo will continue until you turn the power off and on again, or until you operate the pedal switch.

* Do not use when operating on batteries. This will run the battery down.

22

Changing the battery

When the CHECK indicator goes dim or no longer lights while an effect is on, it means that the battery is nearly dead and must be replaced.

Replace the battery following the steps below.

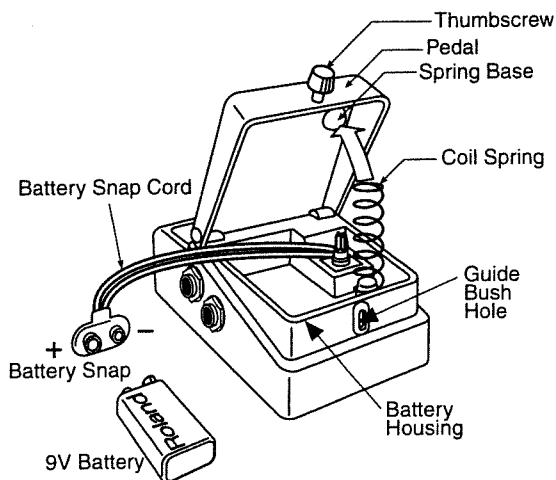

1. Loosen the thumbscrew at the front of the pedal, then lift the pedal upwards to open the unit.

* The thumbscrew can be left in the pedal while changing the battery.

2. Remove the old battery from the battery housing, and remove the battery snap connected to it.
3. Connect the battery snap to the new battery, and place the battery inside the battery housing.

* Be sure to carefully observe the battery's polarity (+ versus -).

4. Slip the coil spring onto the spring base on the back of the pedal, then close the pedal.
- * Carefully avoid getting the snap cord caught in the coil spring.

5. Finally, insert the thumbscrew into the guide bush hole and fasten it securely.

Various types of tuning

By using Chromatic mode you can tune in a variety of ways.

First, tune normally to get each string in tune. Then refer to the following tables and adjust each string to the appropriate note name.

Open D

	Raise↑/↓Lower	Note name
6th string	↓	D
5th string	—	A
4th string	—	D
3rd string	↓	F#
2nd string	↓	A
1st string	↓	D

Open G

	Raise↑/↓Lower	Note name
6th string	↓	D
5th string	↓	G
4th string	—	D
3rd string	—	G
2nd string	—	B
1st string	↓	D

Regular tuning

	Raise↑/↓Lower	Note name
6th string	—	E
5th string	—	A
4th string	—	D
3rd string	—	G
2nd string	—	B
1st string	—	E

Open E

	Raise↑/↓Lower	Note name
6th string	—	E
5th string	↑	B
4th string	↑	E
3rd string	↑	G#
2nd string	—	B
1st string	—	E

Open A

	Raise↑/↓Lower	Note name
6th string	—	E
5th string	—	A
4th string	↑	E
3rd string	↑	A
2nd string	↑	C#
1st string	—	E

24

Drop D

	Raise↑/↓Lower	Note name
6th string	↓	D
5th string	—	A
4th string	—	D
3rd string	—	G
2nd string	—	B
1st string	—	E

Semitone flat

(Guitar \flat is also possible)

	Raise↑/↓Lower	Note name
6th string	↓	D#
5th string	↓	G#
4th string	↓	C#
3rd string	↓	F#
2nd string	↓	A#
1st string	↓	D#

1 and a half steps flat

	Raise↑/↓Lower	Note name
6th string	↓	C#
5th string	↓	F#
4th string	↓	B
3rd string	↓	E
2nd string	↓	G#
1st string	↓	C#

DADGAD

	Raise↑/↓Lower	Note name
6th string	↓	D
5th string	—	A
4th string	—	D
3rd string	—	G
2nd string	↓	A
1st string	↓	D

1 note flat

(Guitar \flat is also possible)

	Raise↑/↓Lower	Note name
6th string	↓	D
5th string	↓	G
4th string	↓	C
3rd string	↓	F
2nd string	↓	A
1st string	↓	D

2 whole tones flat

	Raise↑/↓Lower	Note name
6th string	↓	C
5th string	↓	F
4th string	↓	A#
3rd string	↓	D#
2nd string	↓	G
1st string	↓	C

25

Specifications

TU-2: Chromatic Tuner

Reference Pitch A4 = 438 to 445 Hz (1 Hz step)
Tuning Range C0 (16.35 Hz) to C8 (4186 Hz)
Tuning Accuracy +/-3 cents
Input Impedance 1 MΩ
Controls STREAM/CENT select switch, MODE select switch, Pedal switch
Indicators Meter, Note name/String number indicator, Tuning guide indicators,
Check indicator
Connectors Input jack, Output jack, Bypass jack, DC 9V In jack, DC 9V Out jack
Power Supply DC 9V: Dry battery (6F22/9V), AC Adaptor (PSA-Series: Optional)
Current Draw 55 mA (Max.)

* *Expected battery life under continuous use:*

Carbon: 1.5 hours (When the tuner is continuously on)

6 hours (When the tuner is on for one minute and off
for three minutes)

Alkaline: 6 hours (When the tuner is continuously on)

These figures will vary depending on the actual conditions of use.



26



Dimensions 70 (W) x 125 (D) x 55 (H) mm
2-3/4 (W) x 4-15/16 (D) x 2-3/16 (H) inches
Weight 420 g / 15 oz (including battery)
Accessories Owner's Manual, Dry battery; 6F22/9V (Carbon), Roland Service
Options AC Adaptor PSA-Series, Parallel DC Cord PCS-20A

* *In the interest of product improvement, the specifications and/or appearance of this unit are subject to change without prior notice.*







USING THE UNIT SAFELY

INSTRUCTIONS FOR THE PREVENTION OF FIRE, ELECTRIC SHOCK, OR INJURY TO PERSONS

About  **WARNING** and  **CAUTION** Notices

 WARNING	Used for instructions intended to alert the user to the risk of death or severe injury should the unit be used improperly.
 CAUTION	Used for instructions intended to alert the user to the risk of injury or material damage should the unit be used improperly. * Material damage refers to damage or other adverse effects caused with respect to the home and all its furnishings, as well to domestic animals or pets.

About the Symbols

	The  symbol alerts the user to important instructions or warnings. The specific meaning of the symbol is determined by the design contained within the triangle. In the case of the symbol at left, it is used for general cautions, warnings, or alerts to danger.
	The  symbol alerts the user to items that must never be carried out (are forbidden). The specific thing that must not be done is indicated by the design contained within the circle. In the case of the symbol at left, it means that the unit must never be disassembled.
	The  symbol alerts the user to things that must be carried out. The specific thing that must be done is indicated by the design contained within the circle. In the case of the symbol at left, it means that the power-cord plug must be unplugged from the outlet.

----- **ALWAYS OBSERVE THE FOLLOWING** -----

28

WARNING

- Before using this unit, make sure to read the instructions below, and the Owner's Manual. 

- Do not open (or modify in any way) the unit or its AC adaptor. 



- Do not attempt to repair the unit, or replace parts within it (except when this manual provides specific instructions directing you to do so). Refer all servicing to your retailer, the nearest Roland Service Center, or an authorized Roland distributor, as listed on the "Information" page. 

- Never use or store the unit in places that are: 

- Subject to temperature extremes (e.g., direct sunlight in an enclosed vehicle, near a heating duct, on top of heat-generating equipment); or are 
- Damp (e.g., baths, washrooms, on wet floors); or are
- Humid; or are
- Exposed to rain; or are
- Dusty; or are
- Subject to high levels of vibration.

- Make sure you always have the unit placed so it is level and sure to remain stable. Never place it on stands that could wobble, or on inclined surfaces. 

29



- Use only the specified AC adaptor (PSA-Series), and make sure the line voltage at the installation matches the input voltage specified on the AC adaptor's body.  

- When using a DC 9V Out jack, make sure that the total current consumption of this unit and other effects being supplied does not exceed 200 mA. 

- Avoid damaging the power cord. Do not bend it excessively, step on it, place heavy objects on it, etc. A damaged cord can easily become a shock or fire hazard. Never use a power cord after it has been damaged. 

30

- This unit, either alone or in combination with an amplifier and headphones or speakers, may be capable of producing sound levels that could cause permanent hearing loss. Do not operate for a long period of time at a high volume level, or at a level that is uncomfortable. If you experience any hearing loss or ringing in the ears, you should immediately stop using the unit, and consult an audiologist. 

- Do not allow any objects (e.g., flammable material, coins, pins); or liquids of any kind (water, soft drinks, etc.) to penetrate the unit.  

- Immediately turn the power off, remove the AC adaptor from the outlet, and request servicing by your retailer, the nearest Roland Service Center, or an authorized Roland distributor, as listed on the "Information" page when: 
 - The AC adaptor or the power-supply cord has been damaged; or
 - Objects have fallen into, or liquid has been spilled onto the unit; or
 - The unit has been exposed to rain (or otherwise has become wet); or
 - The unit does not appear to operate normally or exhibits a marked change in performance.



- In households with small children, an adult should provide supervision until the child is capable of following all the rules essential for the safe operation of the unit. 





- Protect the unit from strong impact. (Do not drop it!) 

- Do not force the unit's power-supply cord to share an outlet with an unreasonable number of other devices. Be especially careful when using extension cords—the total power used by all devices you have connected to the extension cord's outlet must never exceed the power rating (watts/ amperes) for the extension cord. Excessive loads can cause the insulation on the cord to heat up and eventually melt through. 





- Before using the unit in a foreign country, consult with your retailer, the nearest Roland Service Center, or an authorized Roland distributor, as listed on the "Information" page. 



31

- Batteries must never be recharged, heated, taken apart, or thrown into fire or water. 

- Never climb on top of, nor place heavy objects on the unit. 
- Never handle the AC adaptor body, or its plugs, with wet hands when plugging into, or unplugging from, an outlet or this unit. 
- Before moving the unit, disconnect the AC adaptor and all cords coming from external devices. 
- Before cleaning the unit, turn off the power and unplug the AC adaptor from the outlet (p. 13). 
- Whenever you suspect the possibility of lightning in your area, disconnect the AC adaptor from the outlet. 

 **CAUTION**

- The unit and the AC adaptor should be located so their location or position does not interfere with their proper ventilation. 
- Always grasp only the plug or the body of the AC adaptor when plugging into, or unplugging from, an outlet or this unit. 
- Whenever the unit is to remain unused for an extended period of time, disconnect the AC adaptor. 
- Try to prevent cords and cables from becoming entangled. Also, all cords and cables should be placed so they are out of the reach of children. 

- If used improperly, batteries may explode or leak and cause damage or injury. In the interest of safety, please read and observe the following precautions (p. 23). 

- Carefully follow the installation instructions for batteries, and make sure you observe the correct polarity. 
- Remove the batteries whenever the unit is to remain unused for an extended period of time.
- If a battery has leaked, use a soft piece of cloth or paper towel to wipe all remnants of the discharge from the battery compartment. To avoid inflammation of the skin, make sure that none of the battery discharge gets onto your hands or skin. Exercise the utmost caution so that none of the discharge gets near your eyes. Immediately rinse the affected area with running water if any of the discharge has entered the eyes.

- Never keep batteries together with metallic objects such as ballpoint pens, necklaces, hairpins, etc.

- Used batteries must be disposed of in compliance with whatever regulations for their safe disposal that may be observed in the region in which you live.



CE For EU Countries
 This product complies with the requirements of European Directive 89/336/EEC.

For the USA

**FEDERAL COMMUNICATIONS COMMISSION
 RADIO FREQUENCY INTERFERENCE STATEMENT**

This equipment has been tested and found to comply with the limits for a Class B digital device, pursuant to Part 15 of the FCC Rules. These limits are designed to provide reasonable protection against harmful interference in a residential installation. This equipment generates, uses, and can radiate radio frequency energy and, if not installed and used in accordance with the instructions, may cause harmful interference to radio communications. However, there is no guarantee that interference will not occur in a particular installation. If this equipment does cause harmful interference to radio or television reception, which can be determined by turning the equipment off and on, the user is encouraged to try to correct the interference by one or more of the following measures:

- Reorient or relocate the receiving antenna.
- Increase the separation between the equipment and receiver.
- Connect the equipment into an outlet on a circuit different from that to which the receiver is connected.
- Consult the dealer or an experienced radio/TV technician for help.

Unauthorized changes or modification to this system can void the users authority to operate this equipment. This equipment requires shielded interface cables in order to meet FCC class B Limit.

For Canada

NOTICE

This Class B digital apparatus meets all requirements of the Canadian Interference-Causing Equipment Regulations.

AVIS

Cet appareil numérique de la classe B respecte toutes les exigences du Règlement sur le matériel brouilleur du Canada.

 Roland®

G601744103

UPC

G601744103



12981

 **BOSS**