

INSTRUCTION
MANUAL

CHROMATIC TUNER
TU-12
Digital Processing

Connecting Chart

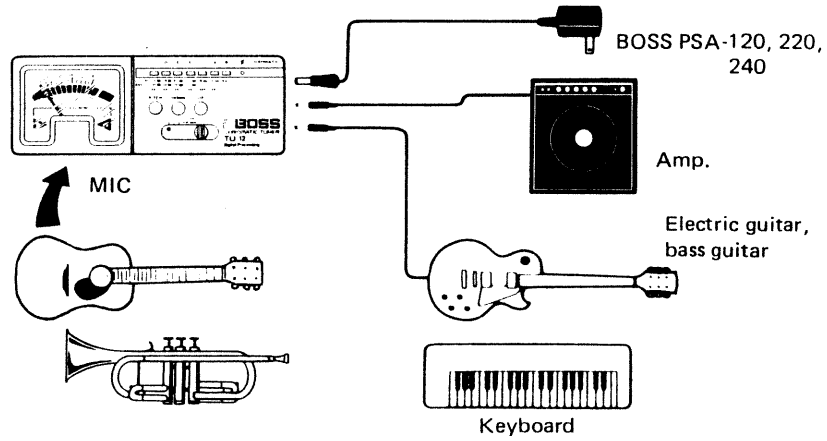

Front Panel Description

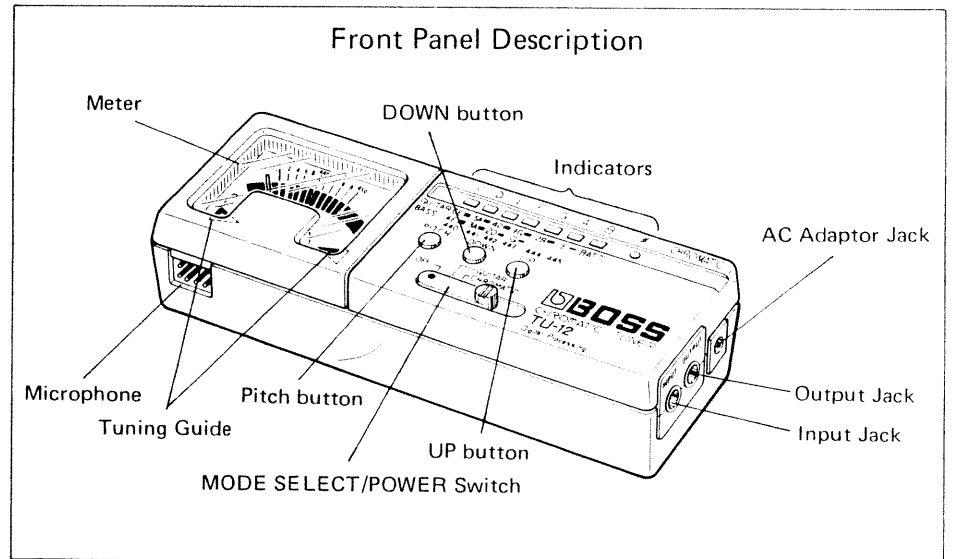

OPERATION [1] Chromatic Tuning

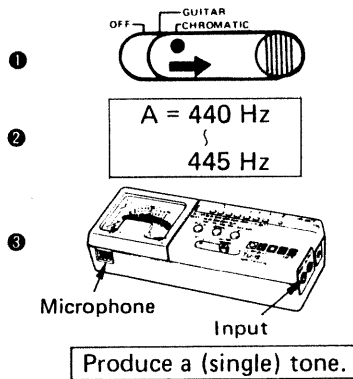

<How to check a tone with the Indicators>

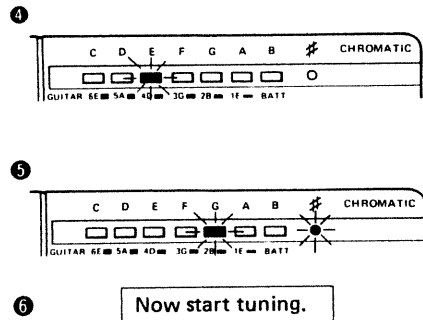

Set the MODE SELECT/POWER Switch to **CHROMATIC**.

Select the pitch. The TU-12 has the preset pitch, **A=440Hz**. (Refer to "Selecting of Pitch")

- a) If tuning the acoustic instrument, put it close to the Microphone.
- b) If tuning the electronic/electric instrument, connect it to the Input Jack by using a connecting cord.

The indicator nearest to that tone will flash.

(Example 1) If the Indicator under "E" lights as shown in the figure, it means the tone produced is near "E".

(Example 2) If the Indicators under "G" and "#" light simultaneously, it means the tone near "G#" is produced.

Tune it referring to <How to check a tone with Meter and Tuning Guide> mentioned later.

OPERATION [2] Tuning Guitars or Bass Guitars

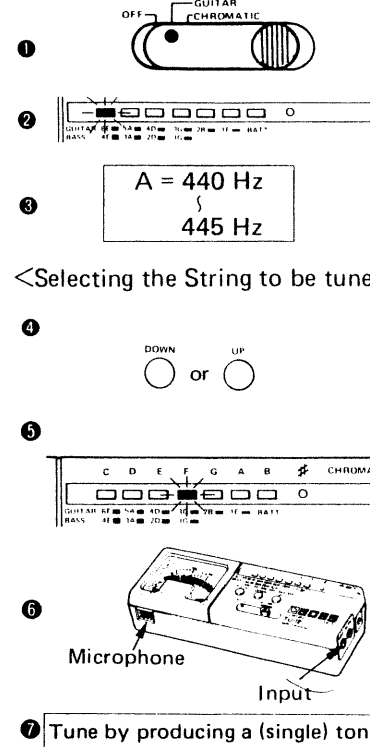

Set the MODE SELECT/POWER Switch to **GUITAR**.

For guitars, the indicator of 6E (for the 6th string) will light. For bass guitars, the indicator of 4E (for the 4th string) will light. The symbols (i.e. 6E, 5A, 4D etc.) under the Indicators show the number of the string and its pitch.

Select the pitch. The TU-12 has the preset pitch, **A=440Hz**. (Refer to "Selecting of Pitch")

Select the number of the string to be tuned by pressing the **UP** (or **DOWN**) button. (Example)

In case of the figure on the left, you can tune the **3rd string** of a guitar and the **1st** of bass guitar.

- a) If tuning the acoustic guitar, put its sound hole close to the Microphone.
- b) If tuning the electric guitar, connect it to the Input Jack by using a connecting cord.

Tune it by producing a (single) tone. For tuning method, please refer to <How to check a tone with Meter and Tuning Guide> mentioned later.

Selecting of Pitch

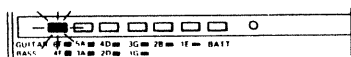

While you hold the Pitch button down, the Indicator will blink showing that the preset pitch is **A=440Hz**.

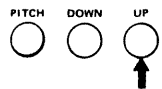

Select the desired pitch by pressing the **UP** (or **DOWN**) button while the Pitch button is held down. The blinking of the Indicator will cease when you release the Pitch button. However, the selected pitch will remain until the POWER Switch is turned off.

How to check a tone with Meter and Tuning Guide

1. Chromatic Mode

When a tone is produced, the Indicator shows the name of the tone (C~B) and the Meter shows its pitch at the same time.

(Example 1) Pitch A=440Hz



(Example 2) Pitch A=443Hz

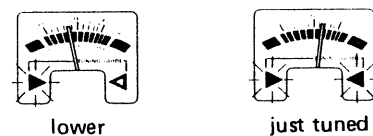

2. GUITAR Mode

Before tuning your guitar with this unit, tune it roughly by checking tension of the strings etc.

(Example 1) Pitch A=440Hz

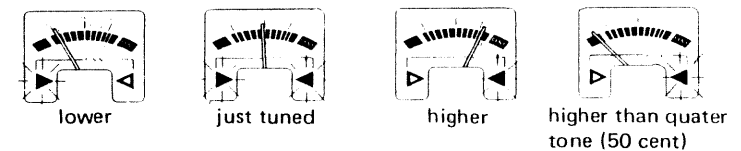

(Example 2) Pitch A=443Hz



RADIO AND TELEVISION INTERFERENCE

Warning – This equipment has been verified to comply with the limits for a Class B computing device, pursuant to Subpart J, of Part 15, of FCC rules. Operation with non-certified or non-verified equipment is likely to result in interference to radio and TV reception."

The equipment described in this manual generates and uses radio-frequency energy. If it is not installed and used properly, that is, in strict accordance with our instructions, it may cause interference with radio and television reception.

This equipment has been tested and found to comply with the limits for a Class B computing device in accordance with the specifications in Subpart J, of Part 15, of FCC Rules. These rules are designed to provide reasonable protection against such a interference in a residential installation. However, there is no guarantee that the interference will not occur in a particular installation. If this equipment does cause interference to radio or television reception, which can be determined by turning the equipment on and off, the user is encouraged to try to correct the interference by the following measure:

- Disconnect other devices and their input/output cables one at a time. If the interference stops, it is caused by either the other device or its I/O cable. These devices usually require Roland designated shielded I/O cables. For Roland devices, you can obtain the proper shielded cable from your dealer. For non Roland devices, contact the manufacturer or dealer for assistance.

If your equipment does cause interference to radio or television reception, you can try to correct the interference by using one or more of the following measures:

- Turn the TV or radio antenna until the interference stops.
- Move the equipment to one side or the other of the TV or radio.
- Move the equipment farther away from the TV or radio.
- Plug the equipment into an outlet that is on a different circuit than the TV or radio. (That is, make certain the equipment and the radio or television set are on circuits controlled by different circuit breakers or fuses.)
- Consider installing a rooftop television antenna with coaxial cable lead-in between the antenna and TV.

If necessary, you should consult your dealer or an experienced radio/television technician for additional suggestions. You may find helpful the following booklet prepared by the Federal Communications Commission:

"How to Identify and Resolve Radio-TV Interference Problems"

This booklet is available from the U.S. Government Printing Office, Washington, D.C., 20402, Stock No. 004-000-00345-4.

Battery Replacement (9V x 1)

If the indicator under **B** starts flashing during operation, proper tuning function is no longer available. Please replace the battery with a new one.

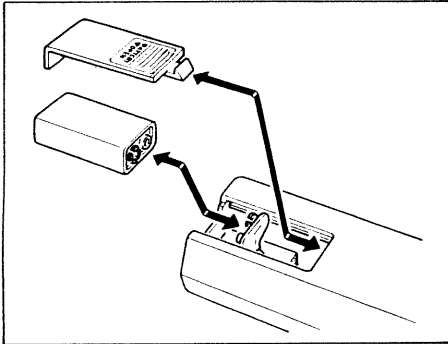

How to replace the battery

- 1 Remove the lid of the Battery Housing.
- 2 Take out the battery and separate it from the Battery Connector.
- 3 Place a new battery. (Be sure that the polarity is correct.)
- 4 Close the lid securely.

Important

- If the TU-12 is not to be used for a long time, remove the battery to prevent the trouble caused by battery leakage.

AC Adaptor

For AC operation, be sure to use the BOSS AC Adaptor PSA-120, 220 or 240 depending on the voltage system in your country, and never use one Adaptor for two units simultaneously.

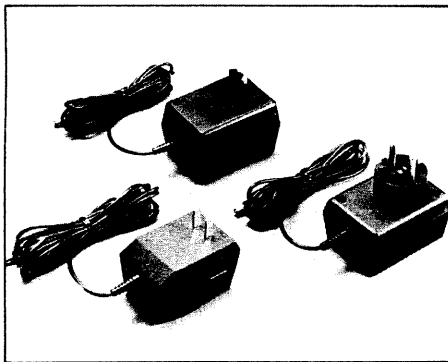

Note

- If the B indicator starts flashing while the TU-12 is being operated with the AC Adaptor, tuning is not possible. If this happens, turn the TU-12 off, then turn it on again.
- When an amplifier is connected to the TU-12, set the POWER switch of the TU-12 to OFF immediately after tuning is completed to avoid unnecessary consumption of the battery. Moreover, increasing the volume of the amplifier with the TU-12 on may cause noise.

Storing the TU-12 in the Carrying Case BCB-6.

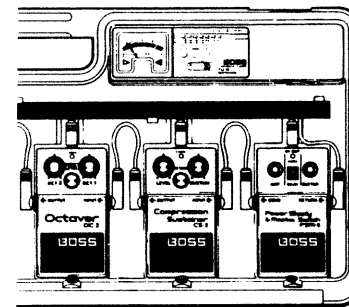

Bescheinigung des Herstellers / Importeurs

Hiermit wird bescheinigt, daß der/die/das

CHROMATIC TUNER TU-12

(Gerät, Typ, Bezeichnung)

in Übereinstimmung mit den Bestimmungen der

Amtsbl. Vfg 1046 / 1984

(Amtsblattverfügung)

funk-entstört ist.

Der Deutschen Bundespost wurde das Inverkehrbringen dieses Gerätes angezeigt und die Berechtigung zur Überprüfung der Serie auf Einhaltung der Bestimmungen eingeräumt.

Roland Corporation Osaka / Japan

Name des Herstellers/Importeurs

SPECIFICATIONS

Power Consumption	Max. 20mA
Tuning Range	C ₁ (32.70Hz) to B ₅ (987.77Hz)
Accuracy	± 1 cent
Master Oscillator	Quartz (3.579545MHz)
Standard Pitch	440 to 445Hz 1Hz step
Jacks	Input, Output, AC Adaptor
Dimensions	145(W) x 35(H) x 53(D) mm/ 5-7/16 x 1-3/8 x 2-1/16 in
Weight	170 g/6 oz

* Specifications are subject to change without notice.

 Roland®

2602080200

UPC

2602080200



18981

 **BOSS**