



SX-700 STUDIO EFFECTS PROCESSOR



Owner's Manual









USING THE UNIT SAFELY

INSTRUCTIONS FOR THE PREVENTION OF FIRE, ELECTRIC SHOCK, OR INJURY TO PERSONS









About WARNING and CAUTION Notices







 WARNING	Used for instructions intended to alert the user to the risk of death or severe injury should the unit be used improperly.
 CAUTION	Used for instructions intended to alert the user to the risk of injury or material damage should the unit be used improperly. * Material damage refers to damage or other adverse effects caused with respect to the home and all its furnishings, as well to domestic animals or pets.

About the Symbols









	The  symbol alerts the user to important instructions or warnings. The specific meaning of the symbol is determined by the design contained within the triangle. In the case of the symbol at left, it is used for general cautions, warnings, or alerts to danger.
	The  symbol alerts the user to items that must never be carried out (are forbidden). The specific thing that must not be done is indicated by the design contained within the circle. In the case of the symbol at left, it means that the unit must never be disassembled.
	The  symbol alerts the user to things that must be carried out. The specific thing that must be done is indicated by the design contained within the circle. In the case of the symbol at left, it means that the power cord plug must be unplugged from the outlet.

----- ALWAYS OBSERVE THE FOLLOWING -----

 WARNING	
• Do not open (or modify in any way) the unit or its AC adaptor. 	
• Do not attempt to repair the unit, or replace parts within it (except when this manual provides specific instructions directing you to do so). Refer all servicing to your dealer, or qualified Roland service personnel. 	
• Never use or store the unit in places that are: <ul style="list-style-type: none"> • Subject to temperature extremes (e.g., direct sunlight in an enclosed vehicle, near a heating duct, on top of heat-generating equipment); or are • Damp (e.g., baths, washrooms, on wet floors); or are • Humid; or are • Dusty; or are • Subject to high levels of vibration. 	
• This unit should be used only with a rack or stand that is recommended by Roland. 	
• When using the unit with a rack or stand recommended by Roland, the rack or stand must be carefully placed so it is level and sure to remain stable. If not using a rack or stand, you still need to make sure that any location you choose for placing the unit provides a level surface that will properly support the unit, and keep it from wobbling. 	
• Avoid damaging the power cord. Do not bend it excessively, step on it, place heavy objects on it, etc. A damaged cord can easily become a shock or fire hazard. Never use a power cord after it has been damaged. 	
• Do not allow any objects (e.g., flammable material, coins, pins); or liquids of any kind (water, soft drinks, etc.) to penetrate the unit. 	

 WARNING	
• Immediately turn the power off, remove the AC adaptor from the outlet, and request servicing by your dealer or qualified Roland service personnel when: <ul style="list-style-type: none"> • The AC adaptor, the power-supply cord, or the plug has been damaged; or • Objects have fallen into, or liquid has been spilled onto the unit; or • The unit has been exposed to rain (or otherwise has become wet); or • The unit does not appear to operate normally or exhibits a marked change in performance. 	
• In households with small children, an adult should provide supervision until the child is capable of following all the rules essential for the safe operation of the unit. 	
• Protect the unit from strong impact. (Do not drop it!) 	
• Do not force the unit's power-supply cord to share an outlet with an unreasonable number of other devices. Be especially careful when using extension cords—the total power used by all devices you have connected to the extension cord's outlet must never exceed the power rating (watts/amperes) for the extension cord. Excessive loads can cause the insulation on the cord to heat up and eventually melt through. 	
• Before using the unit in a foreign country, consult with your dealer, or qualified Roland service personnel. 	

⚠ CAUTION

- The unit and the AC adaptor should be located so their location or position does not interfere with their proper ventilation. 
- Always grasp only the plug on the AC adaptor cord when plugging into, or unplugging from, an outlet or this unit. 
- Whenever the unit is to remain unused for an extended period of time, disconnect the AC adaptor. 
- Try to prevent cords and cables from becoming entangled. Also, all cords and cables should be placed so they are out of the reach of children. 
- Never climb on top of, nor place heavy objects on the unit. 
- Never handle the AC adaptor or its plugs with wet hands when plugging into, or unplugging from, an outlet or this unit. 
- Before moving the unit, disconnect the AC adaptor and all cords coming from external devices. 
- Before cleaning the unit, turn off the power and unplug the AC adaptor from the outlet (p. 8). 
- Whenever you suspect the possibility of lightning in your area, disconnect the AC adaptor from the outlet. 

⚠ CAUTION

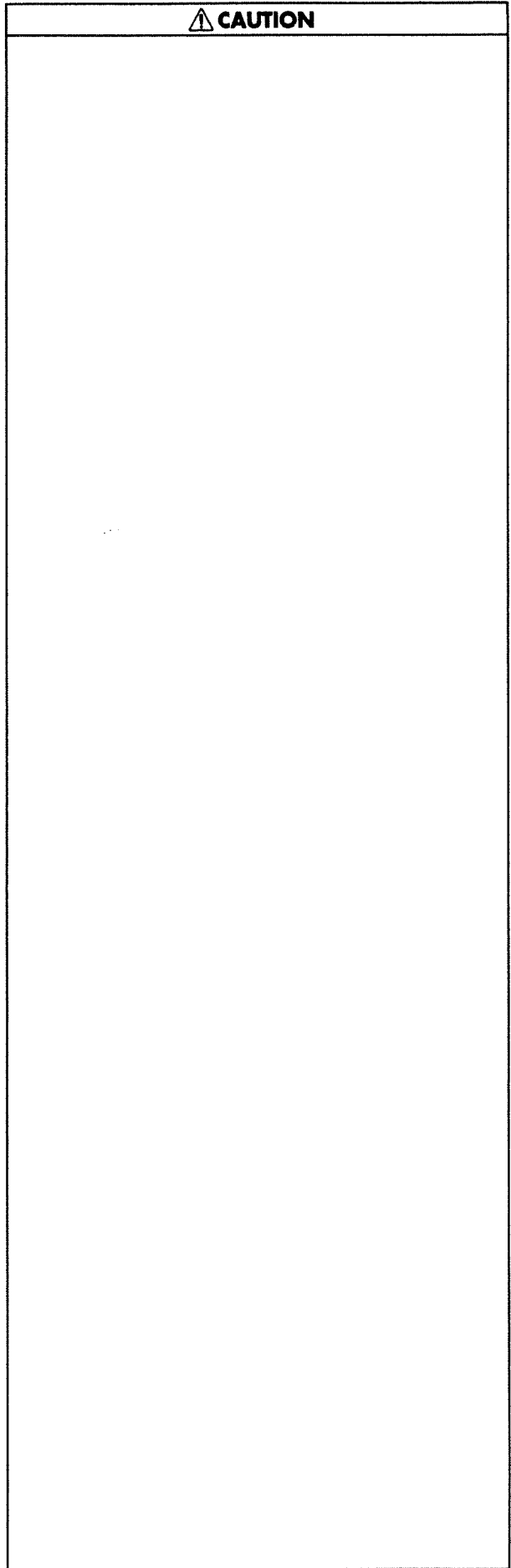

Introduction

Thank you for purchasing the BOSS SX-700 Studio Effects Processor. In order to take full advantage of the SX-700's functionality, and to enjoy years of trouble-free service, please read this manual carefully.

Before using this unit, carefully read the sections entitled: "USING THE UNIT SAFELY" and "IMPORTANT NOTES" (p. 2-3; p. 6). These sections provide important information concerning the proper operation of the unit. Additionally, in order to feel assured that you have gained a good grasp of every feature provided by your new unit, this manual should be read in its entirety. The manual should be saved and kept on hand as a convenient reference.

Main Features

High-quality Effects

The SX-700's specially designed circuitry creates effects which rival the quality of studio equipment costing much more.

Assignable Effectors

The effectors can be assigned to various algorithms. This gives you the freedom to make and change the sequence of connections without the restrictions of fixed algorithms.

A "Harmonist" Generates Four-note Harmony

The on-board Harmonist (real-time harmonizer) makes it possible to add harmonies of up to four parts to the input signal...including vocal input!

Built-in RSS (Roland Sound Space)

RSS, which creates stereophonic sonic images in three-dimensional spaces, are built in to the unit.

Illuminated Buttons

Illuminated panel buttons for each effector not only let you select and edit the Effectors directly, but also let you know at a glance which Effectors are on.

How to Use This Manual

This manual explains the procedures and functions for normal use, and how to make various settings. It is divided into five major sections. Read each section as necessary.

At the end of the manual an alphabetical index is provided. If you have questions about operation, refer to the index.

Section 1 Try out the SX-700

This section explains the basic setup and operation of the SX-700, such as connecting external devices and selecting effect settings stored in memory.

Section 2 Modifying Various Settings

This section explains how to modify effect settings. Read this section when you wish to change the settings of various functions.

Section 3 Effect Guide

This section explains the functions of the effect parameters.

Section 4 Using MIDI

This section explains how external MIDI devices can be used to control the SX-700, and how data can be transmitted and received via MIDI. Read this section when you wish to use the MIDI functions of the SX-700.

Section 5 Appendix

This section contains information about matters such as factory-default settings and what to do when the SX-700 doesn't work as expected.

Contents

USING THE UNIT SAFELY	2
Main Features	4
How to Use This Manual	4
IMPORTANT NOTES	6
Panel Descriptions	7

Section 1 Try out the SX-700 8

Connections	8
Power-on/Standby	9
Power-on	9
Adjusting the Input Level	9
Adjusting the Output Level	9
Selecting an Effect	10
About the Screen Display	10
Effect Status	10
Selecting Effect Sounds from the Front Panel	10
Selecting Effect Sounds by MIDI Messages	10
Switching Bypass On/Off	11
Switching Bypass On/Off from the Panel	11
Switching Bypass On/Off with a Foot switch	11

Section 2 Modifying Various Settings 12

Before You Begin Creating Sounds	12
User Area and Preset Area	12
About the Contents of the Display	12
The Structure of Patches	13
Sound Editing Procedure	14
Effect Sound Settings	14
Copying a Patch	14
Selecting unit (Effector) connections from among algorithms ..	15
Assigning Effectors to units	15
Turning Effectors on or off	16
Settings for Each Effects Processor	16
Effect Copy	17
Settings for the output level and output balance	17
Control Assign Settings	18
Modifying the Patch Name	21
Canceling Changes	21
Storing the Modified Settings (The Write Operation)	22
Utility Function Settings	22
Utility Function Parameters	23

Section 3 Effect Guide 24

The Structure of Algorithms	24
The Functions of Effectors	27
EQUALIZER	27
MODULATION	28
Stereo Chorus	28
Stereo 2Band Chorus	28

Stereo Flanger	29
Stereo Phaser	30
2Voices Harmonist	31
4Voices Harmonist	31
2Voices Pitch Shifter	33
4Voices Pitch Shifter	33
Rotary	34
Space Chorus	35
DELAY	36
Simple Delay	36
3Tap Delay	36
4Tap Delay	37
Stereo Delay	37
Quad Delay	38
Ducking Delay	38
Band Pass Delay	39
Reverb	42
Room1/2/3	42
Hall1/2	42
Garage	43
Plate	43
Non-Linear	43
RSS	45
3D Panner	45
Single 3D	45
Dual 3D	45
Quad 3D	45
Before Using RSS	47

Section 4 Using MIDI 48

How MIDI Can Be Used	48
MIDI Utility Function Settings	49
MIDI Related Parameters	49
Program Change Map Settings	50
Transmitting/Receiving Data Via MIDI	51
Transmitting Data (Bulk Dump)	51
Receiving Data (Bulk Load)	52

Section 5 Appendix 53

About MIDI	53
1. How MIDI messages are transmitted and received	53
2. Main types of MIDI message used by the SX-700	54
About the MIDI Implementation Chart	55
Restoring the Factory Settings (Initialization)	55
Troubleshooting	56
MIDI Implementation Chart	57
Specifications	58
Index	59

IMPORTANT NOTES

In addition to the items listed under "USING THE UNIT SAFELY" on page 2 – 3, please read and observe the following:

Power Supply

- Do not use this unit on the same power circuit with any device that will generate line noise (such as an electric motor or variable lighting system).
- The AC adaptor will begin to generate heat after long hours of consecutive use. This is normal, and is not a cause for concern.
- Before connecting this unit to other devices, turn off the power to all units. This will help prevent malfunctions and/or damage to speakers or other devices.

Placement

- Using the unit near power amplifiers (or other equipment containing large power transformers) may induce hum. To alleviate the problem, change the orientation of this unit; or move it farther away from the source of interference.
- This device may interfere with radio and television reception. Do not use this device in the vicinity of such receivers.
- Do not expose the unit to direct sunlight, place it near devices that radiate heat, leave it inside an enclosed vehicle, or otherwise subject it to temperature extremes. Excessive heat can deform or discolor the unit.

Maintenance

- For everyday cleaning wipe the unit with a soft, dry cloth or one that has been slightly dampened with water. To remove stubborn dirt, use a mild, non-abrasive detergent. Afterwards, be sure to wipe the unit thoroughly with a soft, dry cloth.
- Never use benzene, thinners, alcohol or solvents of any kind, to avoid the possibility of discoloration and/or deformation.

Repairs and Data

- Please be aware that all data contained in the unit's memory may be lost when the unit is sent for repairs. Important data should always be backed up in another MIDI device (e.g., a sequencer), or written down on paper (when possible). During repairs, due care is taken to avoid the loss of data. However, in certain cases (such as when circuitry related to memory itself is out of order), we regret that it may not be possible to restore the data, and Roland assumes no liability concerning such loss of data.

Memory Backup

- This unit contains a battery which powers the unit's memory circuits while the main power is off. When this battery becomes weak, the message shown below will appear in the display. Once you see this message, have the battery replaced with a fresh one as soon as possible to avoid the loss of all data in memory. To have the battery replaced, consult with your dealer, or qualified Roland service personnel.

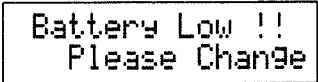

```
Battery Low !!  
Please Change
```

Additional Precautions

- Please be aware that the contents of memory can be irretrievably lost as a result of a malfunction, or the improper operation of the unit. To protect yourself against the risk of losing important data, we recommend that you periodically save a backup copy of important data you have stored in the unit's memory in another MIDI device (e.g., a sequencer).
- Unfortunately, it may be impossible to restore the contents of data that was stored in the unit's memory once it has been lost. Roland Corporation assumes no liability concerning such loss of data.
- Use a reasonable amount of care when using the unit's buttons, sliders, or other controls; and when using its jacks and connectors. Rough handling can lead to malfunctions.
- When connecting / disconnecting all cables, grasp the connector itself—never pull on the cable. This way you will avoid causing shorts, or damage to the cable's internal elements.
- When you need to transport the unit, package it in the box (including padding) that it came in, if possible. Otherwise, you will need to use equivalent packaging materials.

Panel Descriptions

< Front Panel >

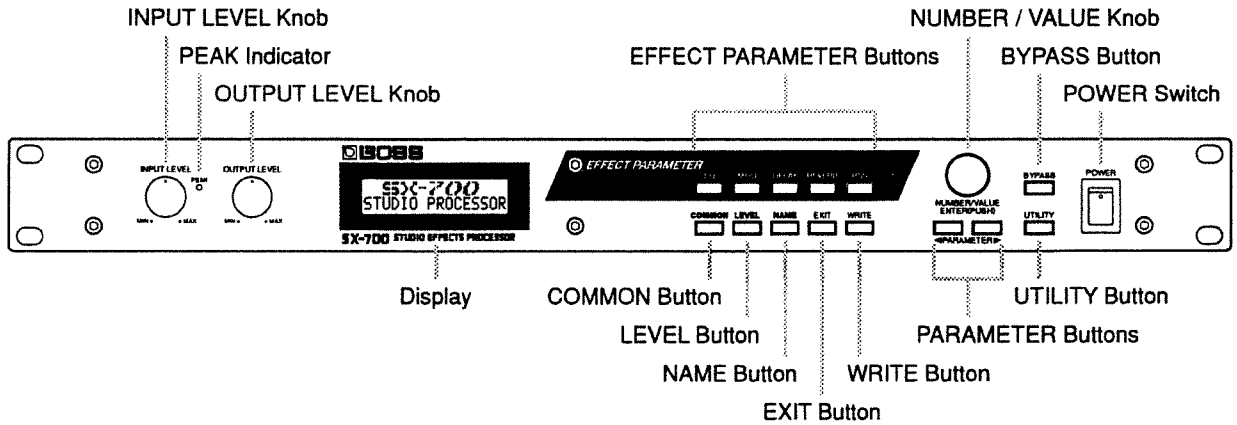

* In this manual, the number/value knob is referred to as either the NUMBER knob or as the VALUE knob.

< Rear Panel >

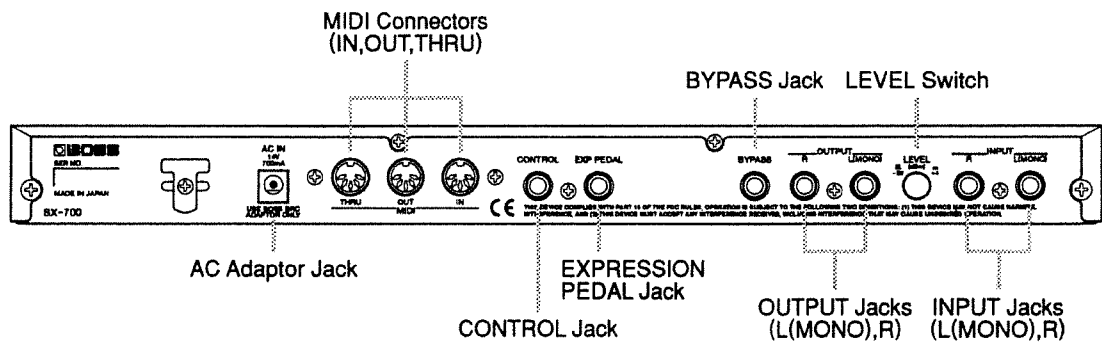

Section

1

Try out the SX-700

Connections

Make the connections as described below, depending on how you want to use the SX-700.

- * Before making any connections, be sure to turn down the volume on your amp and/or mixer, and be sure to turn off the power to all the components in your system. This will help prevent equipment from damage or malfunction.
- * The volume on your amplifier should be turned up only after switching on all the other units.
- * If your amp/speaker system is monaural, connect the SX-700 using the L(MONO) jack.

Connecting a Mixer (SEND/RETURN)

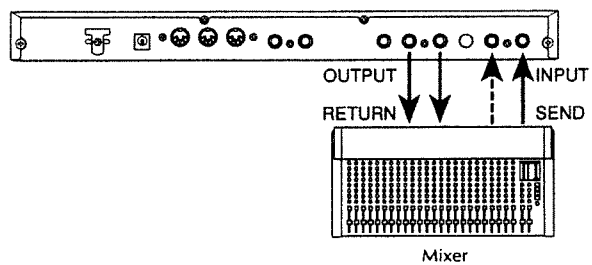

- * Be sure the setting of the LEVEL switch matches the input and output levels of the mixer that you're using.

Connecting a Keyboard

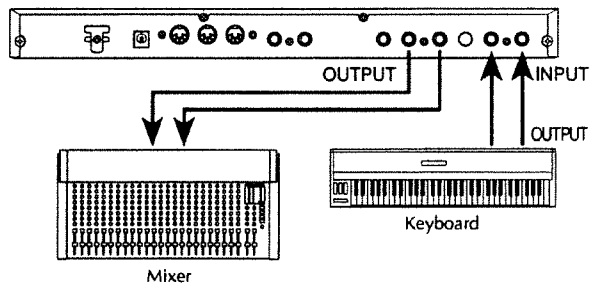

- * The LEVEL switch will normally be set at -20 dBm.

Connecting External Devices

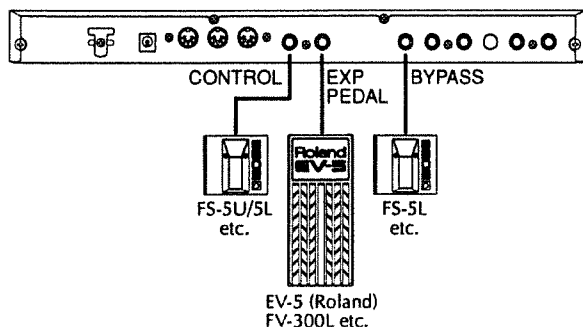

- When using an expression pedal, be sure to use either a Boss FV-300L + PCS-33 (Roland) or an EV-5 (Roland).
- Set the volume of the expression pedal (connected to the EXP PEDAL jack) to the "MIN" position.
- Howling could be produced depending on the location of microphones relative to speakers. This can be remedied by:
 1. Changing the orientation of the microphone(s).
 2. Relocating microphone(s) at a greater distance from speakers.
 3. Lowering volume levels.
- To prevent the inadvertent disruption of power to your unit (should the plug be pulled out accidentally), and to avoid applying undue stress to the AC adaptor jack, anchor the power cord using the cord hook, as shown in the illustration.

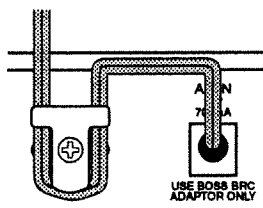

- When connecting an FS-5U/5L foot pedal (sold separately) to the CONTROL or BYPASS jack, set the polarity switch as shown in the following figure.

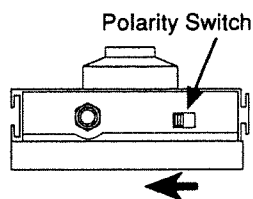

Power-on/Standby

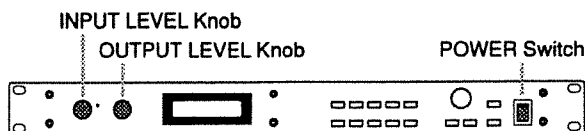

Power-on

Once the connections have been completed (p.8 – 9), turn on power to your various devices in the order specified. By turning on devices in the wrong order, you risk causing malfunction and/or damage to speakers and other devices.

(Sound Module) → SX-700 → External Effects Device → Mixer → Power Amplifier

The following display will appear, and after several seconds the SX-700 will be ready for use. This display indicates that the unit is in the "Play mode."

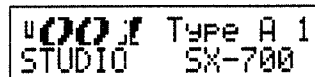

- Raise the amplifier/mixer volume after all devices have been turned on.
- When the power is turned on, the last-selected Patch number on the SX-700 will be selected.
- The unit contains a protection circuit that momentarily mutes the output after the power is turned on. Normal operation will be possible in a second or two.
- To adjust the display contrast, refer to p.23.

Adjusting the Input Level

Use the INPUT LEVEL knob to adjust the input level of the connected instrument. Rotate the knob so that the orange light of the PEAK indicator lights during input peaks.

- The PEAK indicator lights to indicate the input or output level:

- Green:** Lights when an input signal is present.
- Orange:** Lights 6 dB before reaching the clipping level (the level at which distortion occurs).
- Red:** Lights 1 dB before reaching the clipping level (the level at which distortion occurs).

- If the input level is too high, the SX-700 will not produce the desired effects.

Adjusting the Output Level

Adjust the output level for the SX-700.

Selecting an Effect

Use the panel controls to choose the Patch number that corresponds to the effect that you want to use. The effect sounds are grouped into a total of 256 Patch numbers made up of U1 to U128 (User area) and P1 to P128 (Preset area).

Patch numbers can be selected only when the Play mode is selected. If something other than the Play mode is shown in the display, press [EXIT] to return to the Play mode.

** The effects stored in the Patch numbers in the preset area are described in "Patch Name Table". When the SX-700 is shipped, the contents of the User area and the Preset area are identical.*

About the Screen Display

The following information is shown in the Play mode.

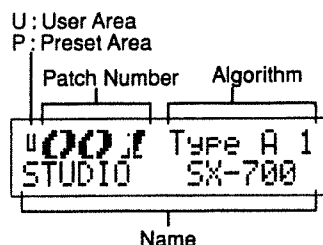

Effect Status

When an effect stored in a Patch number is switched on or off, the Effect Parameter button for the corresponding Effector lights or goes out.

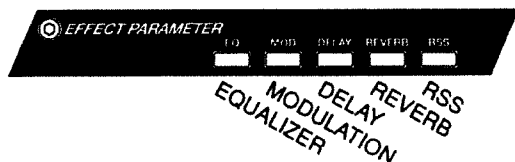

Selecting Effect Sounds from the Front Panel

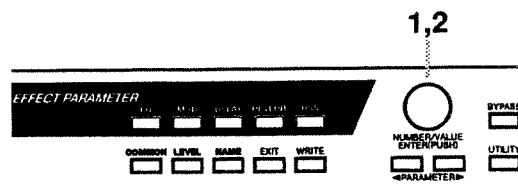

- 1 Rotate the NUMBER knob to choose the Patch number you wish to use.

Simply choosing a Patch number does not cause the effect sound to be heard.

The display shows some information about the selected Patch number (the algorithm name and the Patch name) and the Patch name will flash.

- 2 Press the NUMBER knob.

The effect sound is switched and the Patch name stops flashing.

Selecting Effect Sounds by MIDI Messages

SX-700 Patches can be selected by Program Change messages from an external MIDI device. The relationship between Program Numbers and SX-700 Patch numbers can be changed by editing the settings of the Program Change Map (p.50).

Switching Bypass On/Off

If you wish to output only the direct (input) sound, switch the Bypass circuit on. (The Bypass function on the SX-700 doesn't use any digital circuits, only analog circuits.)

You can switch Bypass on and off using the [BYPASS] button on the front panel or with a foot switch connected to the BYPASS jack on the rear panel.

** The Bypass function can be converted to a Mute function. For details refer to "BYPASS MODE" (p.23).*

Switching Bypass On/Off from the Panel

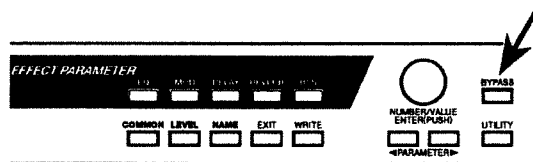

Bypass is turned ON and OFF by pressing the panel's [BYPASS] button. Bypass is ON when the button's indicator is lit.

Switching Bypass On/Off with a Foot switch

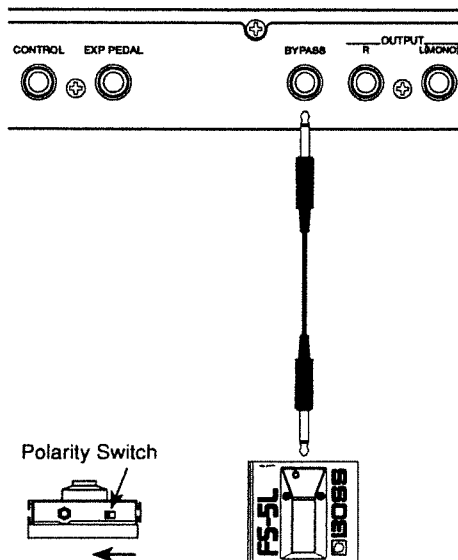

When a foot pedal (such as the Roland FS-5L or Roland FS-1; optional) has been connected to the BYPASS jack, each press of the pedal switches Bypass on or off.

Section

2

Modifying Various Settings

The settings that determine the connection order of the internal effects processors, and the settings for each processor, are collectively known as a "Patch number." The SX-700 contains 256 Patch numbers. This section explains how to edit the contents of a Patch number to create a new effect sound, and how to store your new settings.

Before You Begin Creating Sounds

Before you begin creating sounds there are several things that you need to understand.

User Area and Preset Area

The 256 Patches in the SX-700 are divided into the User area and the Preset area.

User area (U1 – U128)

Patch numbers in the User area can be used to store effect sounds that you create.

Preset area (P1 – P128)

The Preset area contains 128 Patch numbers already set with a variety of effects.

You can't store an effect sound you've made in the Preset area, but you can use the effect sounds in the Preset area as a basis for creating new effect sounds. The new effects you create can be stored under Patch numbers in the User area.

About the Contents of the Display

The following information appears in the display during editing.

< When Parameter Settings Are Being Modified >

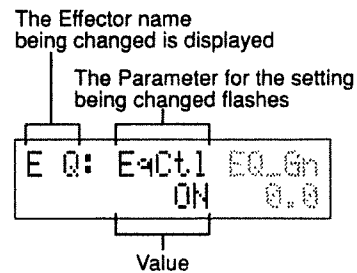

< When EXIT Is Pressed to Display the Screen for the Play Mode >

"U" or "F" appears as highlighted text to indicate that editing is in progress.

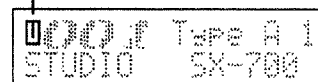

The Structure of Patches

Each of the SX-700's Patch numbers is made up of the following elements. You should understand how these elements are related to each other before you start using them.

Five Types of Effectors

The SX-700 contains five different Effectors. These five types are listed below.

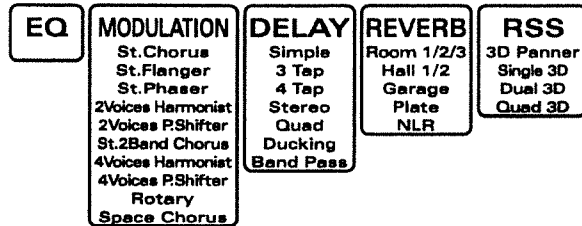

Algorithms That Determine Effector Connections

The connections for the Effectors are selected from among the 19 preset algorithms.

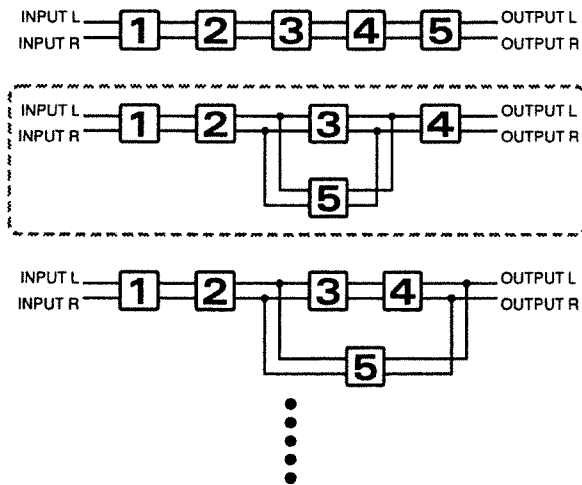

Assignment of Effectors to Units

The five Effectors can be assigned to five units. The same Effector cannot be assigned to two or more units at the same time. There are also some algorithms with fixed Effector assignments that can't be changed.

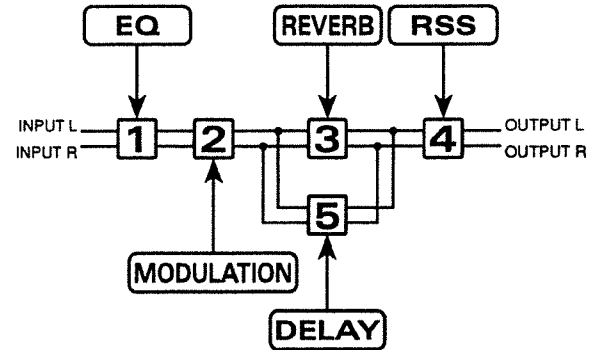

Additional Information

In addition to the elements that determine Effector connections, each Patch number contains the elements described below.

- **On/off for each effects processor**
This parameter turns the effect on or off for each Effector.
- **Settings for each effects processor**
Each Effector is made up of a number of Parameters. This determines the settings for each of the Parameters.
- **Setting for the output level**
This parameter balances the volume of the effect sound (output) and the direct sound (input).
- **Control assign (three types)**
This controls the target parameters set for each Patch from an external instrument. Three types of control assigns can be set for each Patch.
- **Patch name**
This parameter attaches a name to effect sounds created for each Patch (to facilitate grouping).

Sound Editing Procedure

- 1 Select a Patch that is close to the effect sound you want to create.
- 2 Copy the contents of the selected Patch number to an unneeded Patch number (in the User area).
 - * If you wish to modify the contents of the Patch number selected in step 1, there is no need to copy the data.
- 3 Modifying the contents of the selected Patch number.

Follow the appropriate procedure for the kind of modifications you want to make.

 - 3-1 Selecting unit (Effector) connections from among algorithms (p.15)
 - 3-2 Assigning Effectors to units (p.15)
 - 3-3 Turning Effectors on or off (p.16)
 - 3-4 Setting Effectors (p.16)
 - 3-5 Setting the output levels (p.17)
 - 3-6 Setting control assigns (p.18)
 - 3-7 Assigning a name to the new effect sound (p.21)

- 4 Storing the new effect sound. (p.22)

The new effect sound is temporary, and unless you save it, will revert to its previous settings when you switch off the power or switch Patches. If you want to save your new effect sound, use "The Write Operation" (p.22).

Effect Sound Settings

Check out "Section 3 Effect Guide" (p.24) for an explanation of the abbreviations and notation conventions for Effectors and Parameters.

Copying a Patch

This function copies the settings for one Patch number to another Patch number without changing the settings.

(Procedure)

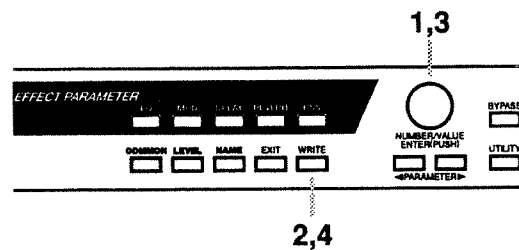

- 1 Rotate the NUMBER knob to choose the Patch number that you want to copy from (i.e., the source Patch). Then press the NUMBER knob to switch to the source Patch.

- 2 Press [WRITE].

The copy page will appear.

```
PATCH COPY TO  
[0001] > [0002]
```

- 3 Use the NUMBER knob to select the Patch number that you want to copy to (the destination Patch number).

The effect sound switches to the effect sound of the destination Patch.

* To cancel the operation, press [EXIT] and you will return to the Play mode.

- 4 Press [WRITE] to execute the copy operation.

The copy destination Patch number will be selected, and you will return to the Play mode.

Selecting unit (Effector) connections from among algorithms

The connections for the units (Effectors) are selected from among the 19 preset algorithms.

(Procedure)

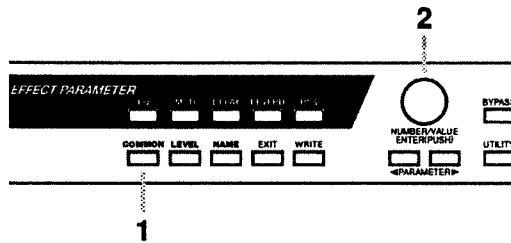

- 1 Press the [COMMON] button several times to call up the algorithm selection screen.

The currently selected algorithm appears in the display.

* *Take a look at “The Structure of Algorithms” (p.24) for an explanation of how the information on the display corresponds to the actual connection.*

```
CMN: =1=2=3=4=5=
A 1
```

- 2 Rotate the VALUE knob to select the desired algorithm.

The connections for the algorithms appear in the display.

* *Each press of the VALUE knob toggles between a display of the connection diagram and a display of the algorithm name.*

- 3 When you're finished making your selection...

- If you want to continue with changing another item, make the modification according to what you want to do.
- If you wish to save the settings, use the Write operation (p.22).

Assigning Effectors to units

The five Effectors can be assigned to five units.

The same Effector cannot be assigned to two or more units at the same time.

* *There are also some algorithms with fixed Effector assignments that can't be changed by these procedures.*

(Procedure)

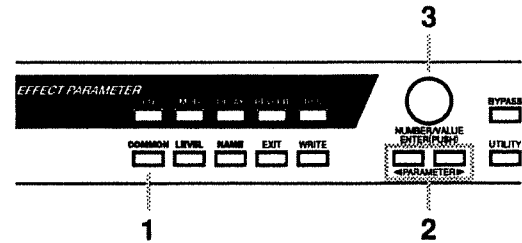

- 1 Press the [COMMON] button several times to call up the screen for assigning Effectors to units.

The current settings appear in the display.

```
Flash
CMN: Unit1 Unit2
[E Q] [MOD]
```

- 2 Use the PARAMETER [◀] [▶] to make the unit with the Effector to be changed start to flash.

* *Make the changes in sequence, starting with the lowest unit number (1 through 5).*

- 3 Rotate the VALUE knob to assign the Effector.

* *You can't select an Effector already assigned to a unit number.*

- 4 Repeat steps 2 and 3 until you've assigned Effectors to all units.

- 5 When you're finished making your selection...

- If you want to continue with changing another item, make the modification described below according to what you want to do.
- If you wish to save the settings, use the Write operation (p.22).

Turning Effectors on or off

This parameter turns the Effectors in use to "Effect On," and the ones not in use to "Effect Off." The corresponding EFFECT PARAMETER buttons for Effectors set to "Effect On" light to show that they are active.

* An Effector set to "Effect Off" normally sends input sound unchanged to output. (That is, throughput occurs.) If Effectors connected in parallel are all set to "Effect Off," their sound is muted.

(Procedure)

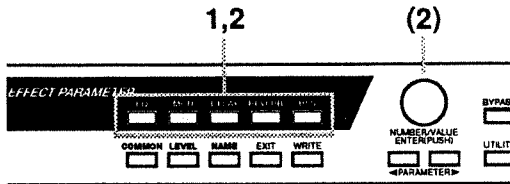

- 1 Press the EFFECT PARAMETER button that corresponds to the effect you wish to turn on or off.

The settings for the selected Effector appear in the display.

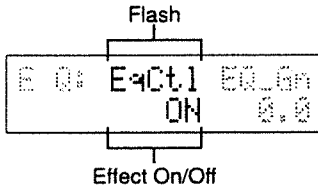
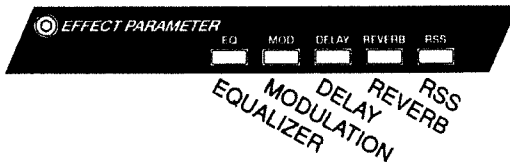

- 2 Once again, press the EFFECT PARAMETER button that corresponds to the effect you wish to switch. The effect will be turned on or off.

You can also toggle the effect on or off by rotating the VALUE knob.

- 3 Repeat steps 1 and 2 to turn each effect on/off.

- 4 When you finish making settings...

- If you want to continue with changing another item, make the modification according to what you want to do.
- If you wish to save the settings, use the Write operation (p.22).

< MEMO >

While settings parameters (see the next section), pressing the EFFECT PARAMETER button that corresponds to the Effector that you're making settings for causes the effect to be switched on or off while maintaining the parameter settings.

Settings for Each Effects Processor

Each Effector is made up of a number of Parameters. By individually modifying the values for these parameters, you can create original effect sounds.

(Procedure)

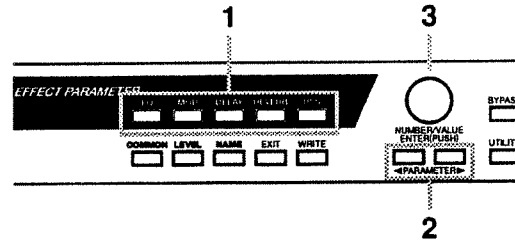

- 1 Press the EFFECT PARAMETER button that corresponds to the effect you wish to edit.

The parameters for the selected Effector appear in the display.

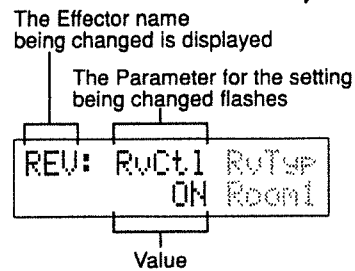
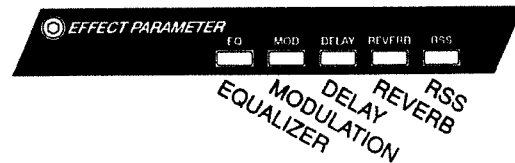

- 2 Use the PARAMETER [◀] [▶] to make the unit with the Effector to be changed start to flash.

* Holding down a PARAMETER [◀] [▶] causes the displayed parameters to change sequentially.

- 3 Use the VALUE knob to change the setting. By pressing the VALUE knob while you rotate it, you can make the value change faster.

- 4 Repeat steps 2 and 3 to finish making effect settings.

- 5 If necessary, switch the Effector in step 1 and continue with the procedure.

- 6 When you finish making settings...

- If you want to continue with changing another item, make the modification according to what you want to do.
- If you wish to save the settings, use the Write operation (p.22).

Effect Copy

This function copies parameter settings (in units of an individual effect) from another Patch number. It is convenient to use this function when you wish to use the same settings for a given effect in several Patch numbers.

* *An Effector of identical type is automatically selected.*

(Procedure)

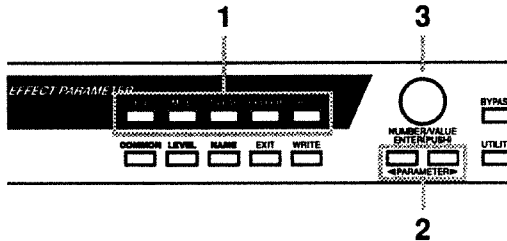

- 1 Press the Effect Parameter button that corresponds to the effect that you wish to copy.
- 2 Use PARAMETER [◀] [▶] to access the following parameter (EFFECT COPY).

```

E D: COPY+[EDIT]
STUDIO  SK-700
    
```

- 3 Use the NUMBER knob to select the copy-source Patch number. The effect sound switches to the effect sound of the source Patch.
 - * *The Patch number using an Effector of the same type is automatically selected for the copy source.*
 - * *If you want to return to the setting in use before copying, choose "EDIT."*
- 4 When you finish making settings...
 - If you want to continue with changing another item, make the modification described below according to what you want to do.

Settings for the output level and output balance

This sets the master and direct output levels, as well as the output level and output balance of the effect and direct sounds for each Effector (except the Equalizer).

The level and balance settings that can be made are described below.

* *The balance and output level settings for the effectors are structured as follows.*

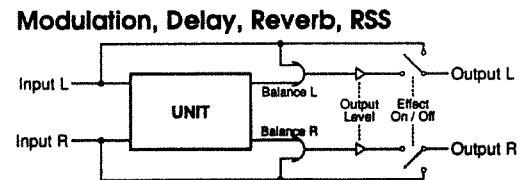
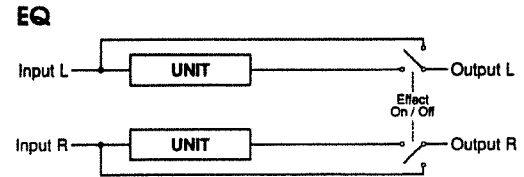

(OUT_L: Output Level L)

(OUT_R: Output Level R)

This adjusts the output level for each channel.

(Dirct: Direct Level)

This adjusts the output level for the direct sound. Setting the value to "Thru" causes analog direct output to be made.

(MBalL: Modulation Balance L)

(MBalR: Modulation Balance R)

(M_OUT: Modulation Output Level)

This adjusts the volume balance of the direct and effect sounds of Modulation for each channel. It also adjusts the output level for Modulation.

(DBalL: Delay Balance L)

(DBalR: Delay Balance R)

(D_OUT: Delay Output Level)

This adjusts the volume balance of the direct and effect sounds of Delay for each channel. It also adjusts the output level for Delay.

(RBall: Reverb Balance L)

(RBalR: Reverb Balance R)

(R_OUT: Reverb Output Level)

This adjusts the volume balance of the direct and effect sounds of Reverb for each channel. It also adjusts the output level for Reverb.

(3Ball: RSS Balance L)

(3BalR: RSS Balance R)

(3_OUT: RSS Output Level)

This adjusts the volume balance of the direct and effect sounds of RSS for each channel. It also adjusts the output level for RSS.

(Procedure)

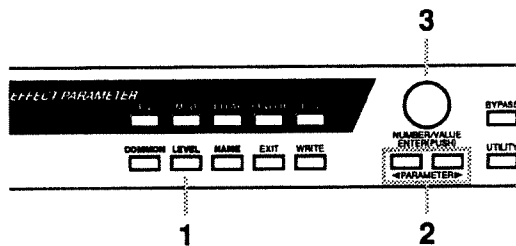

1 Press [LEVEL] to call up the level setting screen.

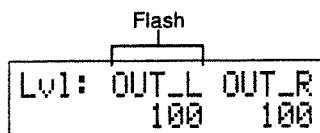

2 Use the PARAMETER [◀] [▶] to make the parameter for the output balance or output level to be changed start to flash.

3 Use the VALUE knob to change the output balance or output level. Pressing the VALUE knob as you turn it causes the amount of change to increase.

4 Repeat steps 2 and 3 until you've finished changing each output balance or output level.

5 When you're finished with making your selection...

- If you want to continue with changing another item, make the modification according to what you want to do.
- If you wish to save the settings, use the Write operation (p.22).

Control Assign Settings

These settings allow you to control SX-700 parameters as you play, either from external MIDI devices or from pedals connected to the SX-700. For each Patch number, you can specify up to three parameters and the controller that will control each parameter.

Target: the parameter that will be controlled.

Specify the parameter you wish to control. The following parameters can be selected as targets.

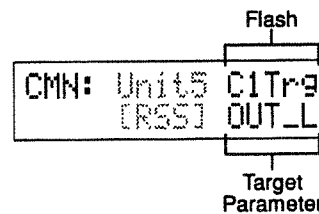

- Effect On/Off for each effect
- Output levels
- Effect unit parameters
- BYPASS On/Off

* You may assign two or more controllers to control the same target, but in such a case, avoid using two (or more) controllers to simultaneously modify the target parameter. This can produce unwanted noise.

* When you switch to a Patch number that uses the Control assign function, an effect sound that doesn't use Control assign is output initially. Once you operate the external instrument to send information to the SX-700, the effect sound produced by the corresponding operation is output.

Target value range

Operations on the external device will modify the value of the target parameter within the range of the “minimum” and “maximum” values you specify.

For on/off-type controllers such as footswitches, “Off” (CLOSE) will produce the “minimum value” and “On” (OPEN) will produce the “maximum value.” For continuous controllers such as expression pedals or pitch bend levers, the value will change within the range of the specified “minimum” and “maximum.” If the target is an on/off type parameter, it will be switched on or off by values above or below the central value of the controller.

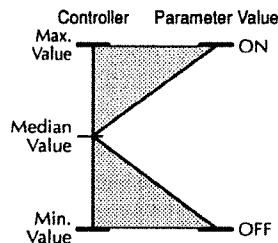
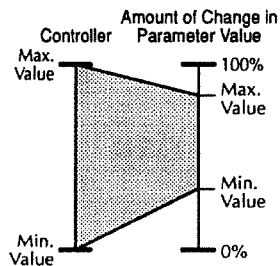
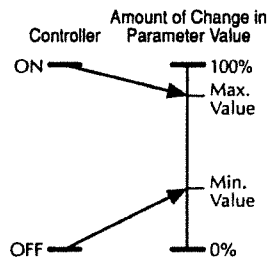
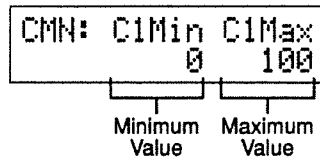

- * The range available for setting will depend on the selected target.
- * If you set the “minimum value” above the “maximum value,” the direction of parameter change will be reversed.
- * If after setting the “minimum” and “maximum” values you then change the target, the settings may change. After changing the target, check that the target value range has not changed.

Source:

the controller that will control the parameter.

Selection for the controller (source) that will control the target parameter.

The following controllers can be selected as sources.

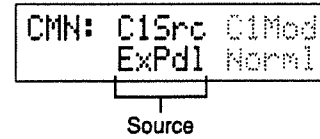

... (No controller):

Values will not be altered under the control of an external device.

ExpPd1:

An expression pedal connected to the expression pedal jack (optional: FV-300L + PCS-33 (Roland), EV-5 (Roland))

CtISW:

A foot switch (optional: FS-5U, FS-5L, FS-1 (Roland), DP-2 (Roland) etc.) connected to the Control jack

PtBnd:

Pitch Bend messages from an external MIDI instrument: Operation of the Pitch Bend lever (wheel)

AftTch:

Aftertouch messages from an external MIDI instrument: Force with which the keys on the keyboard are pressed (after initially being played)

Note#:

Note number messages from an external MIDI instrument: Position of the keys on the keyboard

Veloc:

Velocity messages from an external MIDI instrument: Force with which the keys on the keyboard are played

C#008:

Control Change messages from an external MIDI instrument (Controller Number 1 – 31 or 64 – 95): Operation of sliders, pedals, etc.

- * Up to three Control Assign settings can be made for each Patch (unused control assign source must be set to “. . .”).

Source Mode: the result of operating a foot switch.

This setting determines how the target parameter value will be affected when you operate a momentary-type foot switch (optional: FS-5U, DP-2 (Roland), etc.).



Norm1 (Normal):

The parameter will normally be off (minimum value), and will be on (maximum value) only while the foot switch is depressed.

Toggl (Toggle):

The parameter will switch between off (minimum) and on (maximum) value each time you press the foot switch.

** If you have connected a latch-type foot switch (optional: FS-5L, FS-1 (Roland), etc.) or if you have not selected a foot switch as the controller, this setting should be left at "Normal."*

(Momentary-type and latch-type foot switches)

If you use a foot switch to switch Effects On/Off

You may use either a momentary-type or a latch-type foot switch. When using a momentary-type, select "Toggle." When using a latch-type, select "Normal." In either case, Effect On/Off will alternate each time you press the foot switch.

If you want an effect to become more pronounced while you depress a foot switch, or for the effect to be on only while the foot switch is depressed...

Use a momentary-type foot switch, and select "Normal." In this case, the setting (on/off) will depend on whether the foot switch is depressed or not. This type of operation is not possible with a latch-type foot switch.

(Procedure)

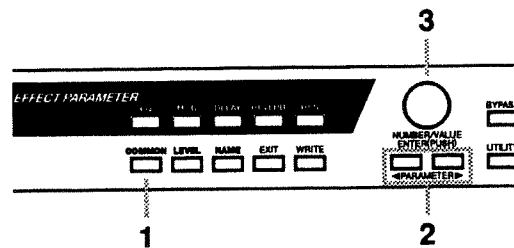

- 1 Press the [COMMON] button several times to call up the screen for assigning Effectors to units.

The current settings appear in the display.



- 2 Use the PARAMETER [◀] [▶] to select the parameter to be changed (from among the those following) and get it to flash.

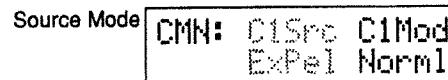
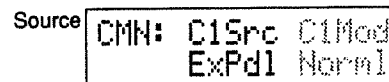
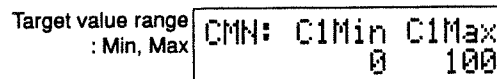
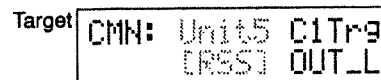

- 3 Rotate the VALUE knob to change the setting.
- 4 Repeat steps 2 and 3 to make all desired control assign settings.
- 5 When you finish making settings...
 - If you want to continue with changing another item, make the modification according to what you want to do.
 - If you wish to save the settings, use the Write operation (p.22).

Modifying the Patch Name

Each Patch can have a name consisting of up to 16 characters. You can freely assign names to each Patch you create to remind yourself of the type of sound or the name of the song it will be used with.

(Procedure)

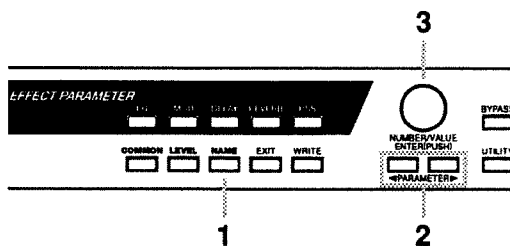

- 1 Press [NAME].

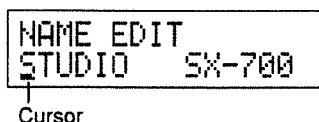

- 2 Use PARAMETER [◀] [▶] to move the cursor to the character you wish to edit.
- 3 Use the VALUE knob to modify the character.

* Pressing the VALUE knob switches you among uppercase characters, lowercase characters, numerals, and spaces.

- 4 Repeat steps 3 and 4 to create the entire Patch name.
- 5 When you finish making settings...
 - If you want to continue with changing another item, make the modification according to what you want to do.
 - If you wish to save the settings, use the Write operation (p.22).

Canceling Changes

To cancel changes (edits) in an effect sound and return to the original values, use the following procedure.

(Procedure)

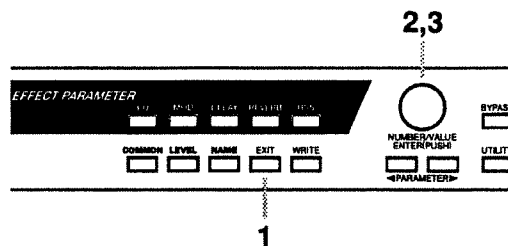

- 1 While making changes, press [EXIT] to return to the Play mode. The display will show a symbol indicating that the settings have been modified.

"U" or "F" appears as highlighted text to indicate that editing is in progress.

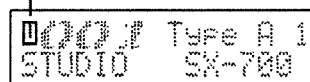

- 2 Rotate the NUMBER knob to choose another Patch number.

Simply choosing a Patch number does not cause the effect sound to be switched.

The display shows some information about the selected Patch number (the algorithm name and the Patch name). The Patch name will flash.

- 3 Press the NUMBER knob to switch to the Patch number you selected in step 2.

The display shows a confirmation message to tell you that the Patch will be switched without saving the changes in memory.

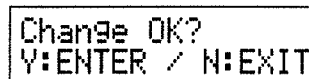

< If You Want to Cancel the Changes >

Press the NUMBER knob again. The changes you've made are lost, and the SX-700 switches to the Patch number you chose in step 2.

< If You Want to Continue with Making Changes >

Press [EXIT].

Operation returns to the Play mode, keeping the changes you've made.

Storing the Modified Settings (The Write Operation)

Patch settings you modify are temporary and will return to the original settings when you select another Patch (or turn the unit off). If you wish to keep the modified settings, use the Write operation.

(Procedure)

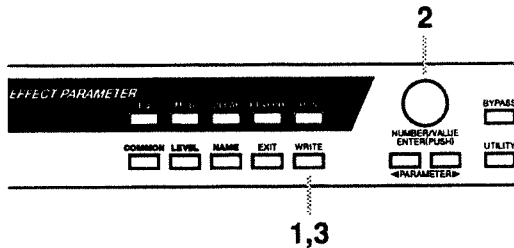

- 1 When you finish making settings, press [WRITE].

The following display will appear.

```
PATCH WRITE TO
[EDIT] > [0000]
```

- 2 Use the NUMBER knob to select the write-destination Patch number.

** If you wish to store the new settings in the original Patch number, this step is not necessary.*

** Patch numbers P1 – P128 are the Preset area, and cannot be used to store your new Patches. If you have modified the settings of a Preset area Patch, you can store it in a User area (U1 – U128) Patch number.*

** To cancel the write operation and return to editing, press [EXIT].*

- 3 Press [WRITE].

The modified settings will be stored in the Patch number you specified in step 2. When the Write operation is completed, the Play mode screen will reappear.

Utility Function Settings

The following pages explain the SX-700's Utility functions, which allow you to configure the unit for the setup you are using.

** For more information about MIDI, check out "MIDI Utility Function Settings" (p.49).*

** For more information about initialization, see "Restoring the Factory Settings (Initialization)" (p.55).*

(Procedure)

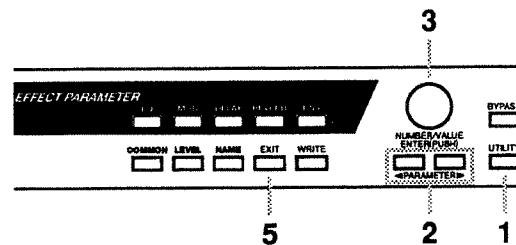

- 1 Press [UTILITY].

The button's indicator will up, and you're ready to make settings for the Utility function.

- 2 Use PARAMETER [◀] [▶] to access the parameter that you wish to edit.

** If you continue pressing a PARAMETER button, the parameters will be displayed in succession.*

- 3 Use the VALUE knob to change the setting. The value will change more rapidly if you press the VALUE knob as you rotate it.

- 4 Repeat steps 2 and 3 to set the desired Utility parameters.

- 5 Press [EXIT] to return to the Play mode screen and end the operation.

Utility Function Parameters

(STANDARD PITCH) (435 – 445Hz)

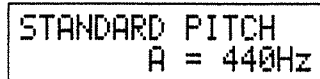

STANDARD PITCH
A = 440Hz

“Standard pitch” is the frequency of the note A4 (middle A on a piano) that is used as the standard to which all other notes are tuned.

With the SX-700, you can set the standard pitch for recognizing the names of notes input to the Harmonist.

** At the factory settings, this is set to 440 Hz.*

(BYPASS MODE) (BYPASS, MUTE)

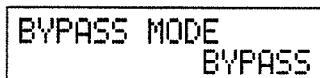

BYPASS MODE
BYPASS

Specify the result of turning BYPASS On.

BYPASS: Input sounds are output unchanged.

MUTE: Nothing will be output from any OUTPUT jack; i.e., the SX-700 will be muted (silent).

** This is set to “BYPASS” when the unit was shipped.*

(PARAMETER HELP) (ON, OFF)

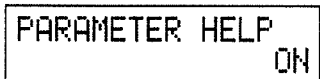

PARAMETER HELP
ON

When Parameter Help is set to “ON,” details about parameter names appear in the display when you press the VALUE knob while making Effector settings.

(LCD CONTRAST) (0 – 15)



LCD CONTRAST
15

Depending on the location of the SX-700, the display may be difficult to read. In such a case, adjust the display contrast.

(MIDI CHANNEL) (1 – 16) (P.49)

(MIDI OMNI MODE) (OMNI ON, OMNI OFF) (P.49)

(MIDI DEVICE ID) (1 – 32) (P.49)

(MIDI PROGRAM CHANGE RECEIVE) (ON, OFF) (P.49)

(MIDI PROGRAM CHANGE MAP) (P.50)

(MIDI BULK DUMP) (P.51)

(MIDI BULK LOAD) (P.52)

(FACTORY PRESET) (P.55)

This procedure returns (initializes) the SX-700’s settings to their factory-default values. For more information, check out “Restoring the Factory Settings (Initialization)”. (p.55)

Section

3

Effect Guide

The Structure of Algorithms

An algorithm determines the connections of the units (Effectors). Some 19 Algorithms are available. This section describes how these algorithms are structured.

1 : Type A1

CMN: =1=2=3=4=5=
A 1



2 : Type A2

CMN: =1=2=3=4=
A 2 L=5=F

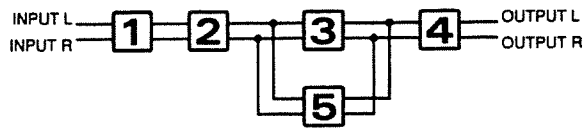

3 : Type A3

CMN: =1=2=3=4=
A 3 L=5=F

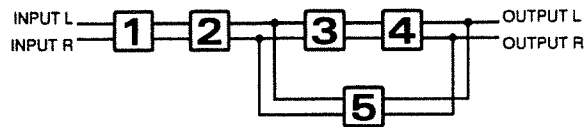

4 : Type A4

CMN: =1=2=3=4=
A 4 L=5=F

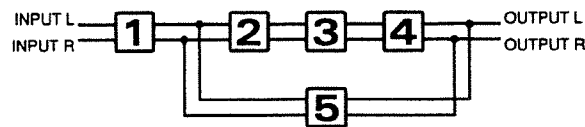

5 : Type A5

CMN: $\overline{1=2=3=4}$
A 5 $\overline{L=5}$

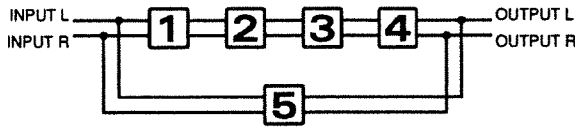

10 : Type B1

CMN: $\overline{1=2=3=4=5}$
B 1

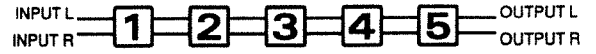

6 : Type A6

CMN: $\overline{1=2=3}$
A 6 $\overline{L=4=5}$

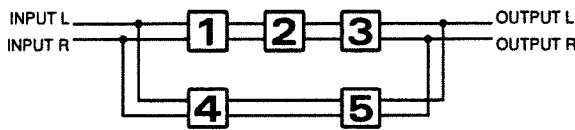

11 : Type B2

CMN: $\overline{1=2=3=4}$
B 2 $\overline{L=5}$

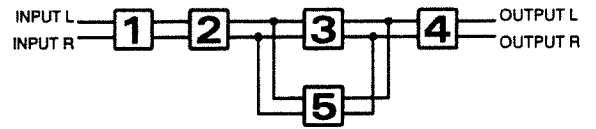

7 : Type A7

CMN: $\overline{1=2=4}$
A 7 $\overline{L=3=5}$

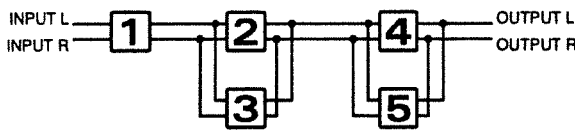

12 : Type B3

CMN: $\overline{1=2=3=4}$
B 3 $\overline{L=5}$

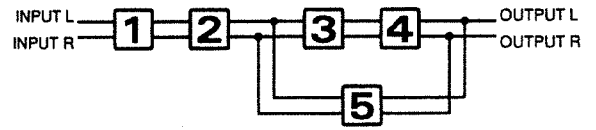

8 : Type A8

CMN: L: $\overline{1=2=3}$
A 8 R: $\overline{4=5}$

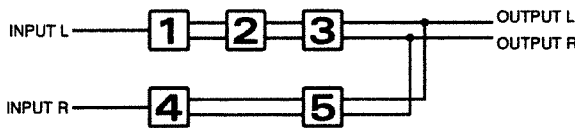

13 : Type B4

CMN: $\overline{1=2=3=4}$
B 4 $\overline{L=5}$

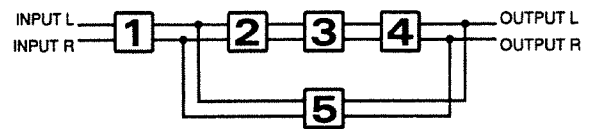

9 : Type A9

CMN: L: $\overline{1=2=5}$
A 9 R: $\overline{3=4}$

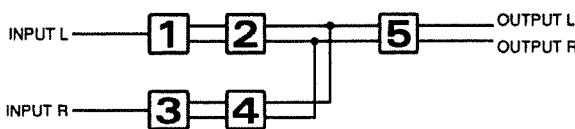

14 : Type B5

CMN: $\overline{1=2=3=4}$
B 5 $\overline{L=5}$

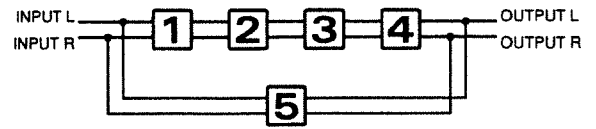

15 : Type B6

CMN: =1=2=3=4=
B 6 L:4=5=

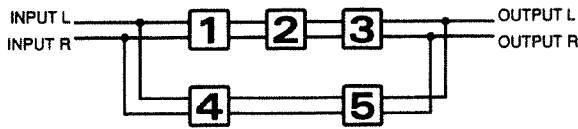

16 : Type B7

CMN: =1=2=4=
B 7 L:3 L:5

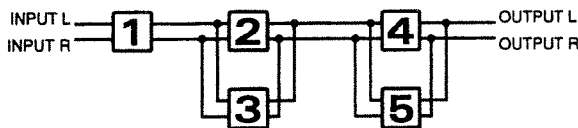

17 : Type B8

CMN: L:-1=2=3=
B 8 R:-4=5=

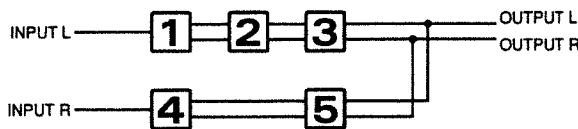

18 : Type B9

CMN: L:-1=2=5=
B 9 R:-3=4=

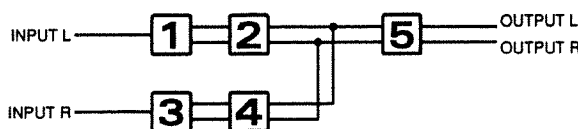

19 : Type C1

CMN: =E=[D+M]R
C 1 L:3

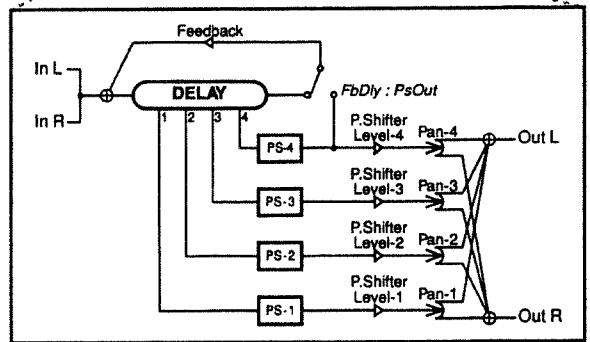
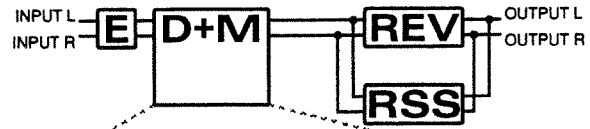

19 : Type C1

Type A1-9

EQ	MODULATION St.Chorus St.Flanger St.Phaser 2Voices Harmonist 2Voices PShifter	DELAY Simple 3 Tap 4 Tap Stereo Quad Ducking Band Pass	REVERB Room 1/2/3 Hall 1/2 Garage Plate NLR	RSS 3D Panner Single 3D Dual 3D Quad 3D
-----------	--	--	---	--

Type B1-9

EQ	MODULATION St.Chorus St.Flanger St.Phaser 2Voices Harmonist 2Voices PShifter St.2Band Chorus 4Voices Harmonist 4Voices PShifter Rotary Space Chorus	DELAY Simple 3 Tap 4 Tap Stereo	REVERB Room 1/2/3 Hall 1/2 Garage Plate NLR	RSS 3D Panner Single 3D Dual 3D
-----------	--	--	---	---

Type C1

EQ	DELAY+MODULATION 4 Tap 4Voices PShifter	REVERB Room 1/2/3 Hall 1/2 Garage Plate NLR	RSS 3D Panner Single 3D Dual 3D
-----------	--	---	---

The Functions of Effectors

This section explains each effect and the function of the parameters which make up each effect.

** The sound being input to each effect is called the “direct sound,” and the sound modified by the effect is called the “effect sound.”*

EQUALIZER

EqCtl	EQ ON/OFF	OFF, ON		
LowFq	EQ Low Frequency	200	2.0k	[Hz]
LowGn	EQ Low Gain	-12.0	+12.0	[dB]
Low_Q	EQ Low Q	Shelv, 0.3 – 10		
MidFq	EQ Middle Frequency	200	8.0k	[Hz]
MidGn	EQ Middle Gain	-12.0	+12.0	[dB]
Mid_Q	EQ Middle Q	0.3	10	
HigFq	EQ High Frequency	2.0k	20.1k	[Hz]
HigGn	EQ High Gain	-12.0	+12.0	[dB]
Hig_Q	EQ High Q	Shelv, 0.3 – 10		
EQ_Gn	EQ Total Gain	-12.0	+12.0	[dB]

This is a three-band parametric equalizer. (The three bands are bass, midrange and treble). The bass and treble bands can be switched between peaking or shelving type by the “Q” parameter.

Equalizer On/Off

This parameter turns the equalizer effect on/off.

Low Frequency

This parameter sets the central frequency for the bass equalizer.

Low Gain

This parameter sets the gain (amount of boost or cut) for the bass equalizer.

Low Q

This parameter sets the range of change in gain (amount of boost or cut) for the frequency set by the Low Frequency parameter. A larger value results in a narrower range of change.

Setting this value to “Shelv (Shelving)” makes the bass equalizer act as a shelving equalizer.

Middle Frequency

This parameter sets the central frequency for the midrange equalizer.

Middle Gain

This parameter sets the gain (amount of boost or cut) for the treble equalizer.

Middle Q

This parameter sets the range of change in gain for the frequency set by the Middle Frequency parameter. A larger value results in a narrower range of change.

High Frequency

This parameter sets the central frequency for the treble equalizer.

High Gain

This parameter sets the gain (amount of boost or cut) for the treble equalizer.

High Q

This parameter sets the range of change in gain for the frequency set by the High Frequency parameter. A larger value results in a narrower range of change.

Setting this value to “Shelv (Shelving)” makes the treble equalizer act as a shelving equalizer.

Total Gain

This parameter adjusts the volume after the equalizer stage.

MODULATION

One type each can be selected (from among the following Effectors) as Modulation for each Patch number.

* Effector selection is made with "MdTyp (Modulation Type)."

- Chors: Stereo Chorus
- Flang: Stereo Flanger
- Phase: Stereo Phaser
- 2V-HR: 2Voices Harmonist
- 2V-PS: 2Voices Pitch Shifter
- 2BCho*: Stereo 2Band Chorus
- 4V-HR*: 4Voices Harmonist
- 4V-PS*: 4Voices Pitch Shifter
- Rotry*: Rotary
- Space*: Space Chorus

* Effectors indicated by an asterisk ("*") can be selected with algorithm numbers B1 to B9.

Stereo Chorus

Stereo 2Band Chorus

< Stereo Chorus >

MdCtl	Modulation On/Off	OFF, ON	
MdTyp	Modulation Type		
Input	Input Mode	Mono, Stereo	
Rate	Rate	0	100
Depth	Depth	0	100
CH-PD	Pre Delay	0.0	50.0 [ms]
LFO	LFO Waveform	Tri, Sin	
Phase	Phase	0	360 [deg]
XMix	Cross Mix Level	0	100
MPanL	Pan L	100:0	0:100
MPanR	Pan R	100:0	0:100

< Stereo 2Band Chorus >

MdCtl	Modulation On/Off	OFF, ON	
MdTyp	Modulation Type		
Input	Input Mode	Mono, Stereo	
Lo-Rt	Low Band Rate	0	100
Lo-Dp	Low Band Depth	0	100
Lo-PD	Low Band PreDly	0.0	50.0 [ms]
LoLFO	Low LFO Waveform	Tri, Sin	
Lo-Ph	Low Phase	0	360 [deg]
Hi-Rt	High Band Rate	0	100
Hi-Dp	High Band Depth	0	100
Hi-PD	High Band PreDly	0.0	50.0 [ms]
HiLFO	High LFO Waveform	Tri, Sin	
Hi-Ph	High Phase	0	360 [deg]
Xover	Crossover Frequency	100	4.00k [Hz]
MxLev	Mix Level	100:0	0:100

This is a Chorus effect for stereo output. A sound with a subtly shifted pitch is added to the direct sound, making the final output sound thicker and broader. With "Stereo 2Band Chorus," the frequency components of the direct sound are split into two bands, and a split-band chorus that allows different settings for each band is applied to both bands.

Modulation On/Off

This parameter turns the chorus effect on/off.

Modulation Type

This parameter selects the type of modulation.

Input Mode

This parameter toggles between stereo and monaural input signals.

Mono:

This produces a chorus for mono input with the left and right channels mixed.

Stereo (Stereo):

This produces a chorus for stereo input with Chorus applied separately to the left and right channels.

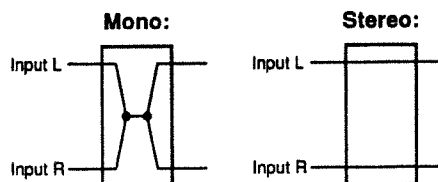

Rate

This parameter adjusts the rate of the Chorus effect.

Depth

This parameter adjusts the depth of the Chorus effect. To use it to produce a "doubling" effect, set the value to "0."

Pre Delay

This parameter adjusts the time needed for the effect sound to be output after the direct sound has been output. By setting a longer Pre Delay time, you can obtain an effect that sounds like more than one sound is being played at the same time (doubling effect).

LFO Waveform

This parameter selects an LFO (low-frequency oscillator) waveform for the Chorus.

Tri (Triangle):

This applies a Chorus effect with few undulations. (A standard Chorus effect is applied with "Tri.")

Sin (Sine):

This produces a Chorus effect with more undulations than "Tri."

Phase

This parameter adjusts the difference in LFO phase between the left and right channels. The two channels are perfectly in phase with a value of "0," and completely out-of-phase with a setting of "180."

Cross Mix Level

This parameter adjusts the rate at which the output of one channel is added to the output of the other channel. Varying this setting can making the resulting sound "fatter."

Crossover Frequency * Stereo 2Band Chorus only

This parameter sets the frequency at which the frequency components of the direct sound are divided into bass and treble bands.

Pan L * Stereo Chorus only

This parameter adjusts the amount of pan Chorus sound (stereo position) for the left channel.

Pan R * Stereo Chorus only

This parameter adjusts the amount of pan Chorus sound (stereo position) for the right channel.

Mix Level * Stereo 2Band Chorus only

This parameter separately adjusts the volume levels of the "Low" and "High" Chorus sounds.

Stereo Flanger

MdCtl	Modulation On/Off	OFF, ON
MdTyp	Modulation Type	
Input	Input Mode	Mono, Stero
Rate	Rate	0 100
Depth	Depth	0 100
Manu	Manual	0 100
Resnc	Resonance	-100 100
LFO	LFO Waveform	Tri, Sin, Exp, Ofw1, Ofw2
Phase	Phase	0 360 [deg]
MGtMd	Gate Mode	OFF, E, D+E
MGtSp	Gate Slope	0 100
MGtRt	Gate Rate	0 100
MGtWd	Gate Width	0 100

This is a true two-channel stereo flanger that adds undulations to the sound. The depth of the effect can be increased to obtain a sound that moves up and down, like a jet taking off or landing.

Modulation On/Off

This parameter turns the flanger effect on/off.

Modulation Type

This parameter selects the type of modulation.

Input Mode

This parameter toggles between stereo and monaural input signals.

Mono:

This produces a chorus for mono input with the left and right channels mixed.

Stereo (Stereo):

This produces a chorus for stereo input with Chorus applied separately to the left and right channels.

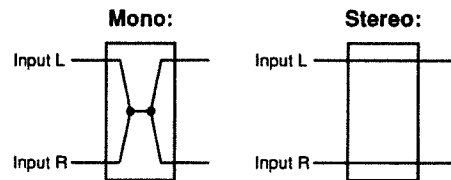

Rate

This parameter sets the rate of the flanging effect.

Depth

This parameter determines the depth of the flanging effect.

Manual

This parameter sets the central frequency for applying the effect.

Resonance

This parameter determines the amount of resonance (feedback). Increasing the value will emphasize the effect, creating a more unusual sound. Setting it to a negative value will create resonance having a reversed phase.

LFO Waveform

This selects an LFO (low-frequency oscillator) waveform for the Flanger.

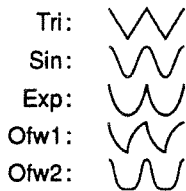

Phase

This parameter adjusts the difference in LFO phase between the left and right channels. The two channels are perfectly in phase with a value of "0," and completely out-of-phase with a setting of "180."

Gate Mode

This makes the setting for operation of the Gate function, which cyclically opens and closes Flanger output.

OFF:

The Gate function is not used.

E (Effect):

The Gate function is applied only to the effect sound.

D+E (Direct + Effect):

The Gate function is applied to both the direct sound and the effect sound.

Gate Slope

This adjusts the time until the gate is opened or closed completely.

Gate Rate

This adjusts the length of the cycle for opening and closing the gate.

Gate Width

This adjusts the time interval for which the gate remains open.

Stereo Phaser

MdCtl	Modulation On/Off	OFF, ON	
MdTyp	Modulation Type		
Input	Input Mode	Mono, Stereo	
Mode	Phaser Type	4Stag, 8Stag	
Rate	Rate	1	100
Depth	Depth	0	100
Manu	Manual	0	100
Resnc	Resonance	0	100
Phase	Phase	0	360 [deg]

This is a true two-channel stereo phaser that takes the direct sound and adds a phase-shifted sound to it, producing a broader sound that seems to revolve.

Modulation On/Off

This parameter turns the phaser effect on/off.

Modulation Type

This parameter selects the type of modulation.

Input Mode

This parameter toggles between stereo and monaural input signals.

Mono :

This produces a phaser effect for mono input with the left and right channels mixed.

Stero (Stereo):

This produces a phaser effect for stereo input with chorus applied separately to the left and right channels.

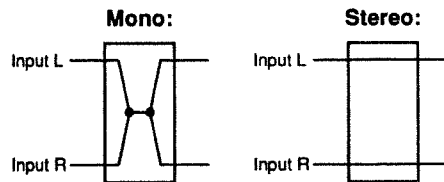

Phaser Type

Selection for the type of phaser effect.

4Stag (4Stage):

This is a four-phase effect. A light phaser effect is obtained.

8Stag (8Stage):

This is an eight-phase effect. It is the most popular phaser effect.

Rate

This parameter sets the rate of the Phaser effect.

Depth

This parameter determines the depth of the Phaser effect.

Manual

This parameter adjusts the center frequency of the phaser effect.

Resonance

This parameter determines the amount of resonance (feedback). Increasing the value will emphasize the effect, creating a more unusual sound. Setting it to a negative value will create resonance having a reversed phase.

Phase

This parameter adjusts the phase difference between the left and right channels.

2Voices Harmonist

4Voices Harmonist

< 2Voices Harmonist >

MdCtl	Modulation On/Off	OFF, ON	
MdTyp	Modulation Type		
Scale	Scale	Major, Minor	
Key	Key	C	B
Inv1	Voice 1 Interval	▼Oct	▲Oct
Inv2	Voice 2 Interval	▼Oct	▲Oct
Lvl-1	Voice 1 Level	0	100
Pan-1	Voice 1 Pan	100:0	0:100
Lvl-2	Voice 2 Level	0	100
Pan-2	Voice 2 Pan	100:0	0:100
Detct	Pitch Detect Ch	Norml, Lch, Rch	
HrSrc	Harmonist Source	Gnrl1, Gnrl2, Vocal	
[TBL]	Scale Table		
	In	C	B
	Out[V1]	▼Oct	▲Oct
	Out[v1]	▼Oct	▲Oct
	Out[V2]	▼Oct	▲Oct
	Out[v2]	▼Oct	▲Oct

< 4Voices Harmonist >

MdCtl	Modulation On/Off	OFF, ON	
MdTyp	Modulation Type		
Scale	Scale	Major, Minor	
Key	Key	C	B
Inv1	Voice 1 Interval	▼Oct	▲Oct
Inv2	Voice 2 Interval	▼Oct	▲Oct
Inv3	Voice 3 Interval	▼Oct	▲Oct
Inv4	Voice 4 Interval	▼Oct	▲Oct
Lvl-1	Voice 1 Level	0	100
Pan-1	Voice 1 Pan	100:0	0:100

Lvl-2	Voice 2 Level	0	100
Pan-2	Voice 2 Pan	100:0	0:100
Lvl-3	Voice 3 Level	0	100
Pan-3	Voice 3 Pan	100:0	0:100
Lvl-4	Voice 4 Level	0	100
Pan-4	Voice 4 Pan	100:0	0:100
Detct	Pitch Detect Ch	Norml, Lch, Rch	
HrSrc	Harmonist Source	Gnrl1, Gnrl2, Vocal	
[TBL]	Scale Table		

In	C	B	*User Scale
Out[V1]	▼Oct	▲Oct	*User Scale
Out[V2]	▼Oct	▲Oct	*User Scale
Out[V3]	▼Oct	▲Oct	*User Scale
Out[V4]	▼Oct	▲Oct	*User Scale

This function creates a harmony part (in the scale of the song being played). You can add either a two- or four-voice harmony.

You should avoid playing chords when using the Harmonist.

* Be sure to set the standard pitch (p.23) before using the Harmonist.

Modulation On/Off

This parameter turns the Harmonist on/off.

Modulation Type

This parameter selects the type of modulation.

Scale

This parameter sets the scale for the song.

Key

This parameter sets the key for the song. If you make the appropriate key setting, the harmony that is generated will be appropriate for the song.

The key of the song will be as follows depending on the number of symbols (# , b) appearing in the staff.

Major C F B^b E^b A^b D^b G^b

Minor Am Dm Gm Cm Fm B^bm E^bm

Major G D A E B F[#]

Minor Em Bm F[#]m C[#]m G[#]m D[#]m

Interval

This parameter determines the pitch interval (relative to the input note) at which the harmony will be generated. You can specify an interval of up to +/- 2 octaves relative to the input note.

** If the harmony part produced is not what you expected, you can set the Note name of the output sound with respect to the Note name of the input sound and switch to the user scale. If you select the user scale, the parameter will be displayed as "USER." For details, refer to "About the User Scale."*

Level

This parameter adjusts the volume level of the voices.

Pan

This parameter adjusts the stereo position (pan) for the voices.

Pitch Detect Channel

The Harmonist function detects the pitch of the input note and produces the appropriate harmony. This parameter sets the input channel that is used for detecting the pitch.

Norm1 (Normal):

This is for stereo input. The INPUT Jack L is used to detect the pitch.

L ch: The INPUT Jack L is used exclusively as input for detecting the pitch. The effect is applied only to the INPUT Jack R, which is treated as a monaural input.

R ch: The INPUT Jack R is used exclusively as input for detecting the pitch. The effect is applied only to the INPUT Jack L, which is treated as a monaural input.

Harmonist Source

This Parameter sets the sound source used for input, allowing the Harmonist to accurately recognize the input notes.

Gnr1 (General1):

Instruments (other than vocal) are used as the sound source; strings etc.

Gnr2 (General2):

Instruments (other than vocal) are used as the sound source; horns etc.

Vocal:

A vocal sound source is used.

Scale Table

This sets the User Scale for the Harmonist. You can turn the VALUE knob to copy the User Scale for another Patch number, or press the VALUE knob to set a new User Scale. The ways to make settings are explained in detail on the next section.

About the User Scale

If the resulting harmony is not what you had anticipated, you can create the harmony using the user scale you specify here. You can make separate user scale settings for each Patch number and for each voice.

On the SX-700, make user scale settings as follows.

(Procedure)

- 1 While editing the Harmonist, use [PARAMETER [◀] [▶] to get the next parameter ("Table") to flash.

```
MOD: HrSrc [TBL]
      Vocal ↗Edit
```

< Copying and Using a Scale Stored for Another Patch Number >

- 2 Use the NUMBER knob to choose the Patch number that you want to copy from (the source Patch). Selecting the Patch number makes the user scale change.

< Setting a New User Scale or Changing the User Scale >

- 2 Press the NUMBER knob. The following display screen appears.

[2Voices Harmonist]

```
  In   V1  v1  V2  v2
In : U1  v1  U2  v2
pC  *C  *C  *C  *C
```

In: The Note name of the input sound is displayed.

V1, 2: The Note names of the output sounds (relative to the input sound) are displayed. This sets the names of the notes output to Voice 1 and Voice 2 when the pitch of the input sound is higher than the sound input immediately before.

v1, 2: The Note names of the output sounds (relative to the input sound) are displayed. This sets the names of the notes output to Voice 1 and Voice 2 when the pitch of the input sound is lower than the sound input immediately before.

[4Voices Harmonist]

```
  In   V1  V2  V3  V4
In : U1  U2  U3  U4
pC  *C  *C  *C  *C
```

In: The Note name of the input sound is displayed.

V1-4: The Note names of the output sounds (relative to the input sound) are displayed. This is performed with V1 - 4 for each voice.

- 3 Use PARAMETER [◀] [▶] to get "IN" to flash.
Turn the VALUE knob to display the Note name of the input sound to be changed.
- 4 Use PARAMETER [◀] [▶] to get the voice whose scale you want to change to flash.
Rotate the VALUE knob to set the Note name of the output sound relative to the input sound.
- 5 Repeat steps 2 and 3 to set the Note names of the output sounds relative to the Note names of each of the input sounds and complete the user scale.
- 6 Press [EXIT] to finish making settings for the user scale.

- * When a user scale has been set, "User" is displayed for the "Interval" parameter.
- * If you want to cancel the user scale and return to the original scale, use the VALUE knob to modify the "Interval" parameter and set the height interval of the sound applied to the input sound for each voice.

2Voices Pitch Shifter

4Voices Pitch Shifter

< 2Voices Pitch Shifter >

MdCtl	Modulation On/Off	OFF, ON
MdTyp	Modulation Type	
Mode	Pitch Shifter Mode	1, 2, 3, 4, 5, Mono
PCrm1	Voice 1 Pitch	-24 +24
Fine1	Voice 1 Fine	-50 +50
PCrm2	Voice 2 Pitch	-24 +24
Fine2	Voice 2 Fine	-50 +50
Lvl-1	Voice 1 Level	0 100
Pan-1	Voice 1 Pan	100:0 0:100
Lvl-2	Voice 2 Level	0 100
Pan-2	Voice 2 Pan	100:0 0:100
Detct	Pitch Detect Ch	Norml, L ch, R ch, . . .
PsSrc	Input Source	Gnr11, Gnr12, Vocal, . . .

< 4Voices Pitch Shifter >

MdCtl	Modulation On/Off	OFF, ON
MdTyp	Modulation Type	
Mode	Pitch Shifter Mode	1, 2, 3, 4, 5, Mono
PCrm1	Voice 1 Pitch	-24 +24
Fine1	Voice 1 Fine	-50 +50
PCrm2	Voice 2 Pitch	-24 +24
Fine2	Voice 2 Fine	-50 +50
PCrm3	Voice 3 Pitch	-24 +24
Fine3	Voice 3 Fine	-50 +50
PCrm4	Voice 4 Pitch	-24 +24
Fine4	Voice 4 Fine	-50 +50
Lvl-1	Voice 1 Level	0 100
Pan-1	Voice 1 Pan	100:0 0:100
Lvl-2	Voice 2 Level	0 100

Pan-2	Voice 2 Pan	100:0	0:100
Lvl-3	Voice 3 Level	0	100
Pan-3	Voice 3 Pan	100:0	0:100
Lvl-4	Voice 4 Level	0	100
Pan-4	Voice 4 Pan	100:0	0:100
Detct	Pitch Detect Ch	Norml, L ch, R ch, . . .	
PsSrc	Input Source	Gnr11, Gnr12, Vocal, . . .	

This Effector changes the pitch of the original sound (up or down) within a range of two octaves. Two- or four-voice pitch-shifted sounds are output simultaneously.

Modulation On/Off

This parameter turns the pitch shifter effect on/off.

Modulation Type

This parameter selects the type of modulation.

Pitch Shifter Mode

This parameter selects the mode of the Pitch Shifter.

1 through 5:

These are standard Pitch Shifters that allow a chord to be input. Higher mode numbers result in a slower response but less feeling of discord (undulations in sound).

Mono :

Compared with conventional Pitch Shifters, this produces no feeling of discord (undulations in sound). This mode is for monaural input.

Pitch

This parameter adjusts the amount of change in the pitch-shifted sound, in semi-tone steps. The setting can be made within a range of two octaves (+/- 24 semi-steps).

Fine

This parameter is used for fine adjustment of the amount of change in the pitch-shifted sound.

* If you were to shift the value of this parameter through its entire range (starting at -50 and finishing at +50) you would realize a total change of one semitone in the pitch.

Level

This parameter adjusts the volume of the pitch shifter sound.

Pan

This parameter adjusts the amount of panning (stereo positioning) in the pitch-shifted sound.

Pitch Detect Channel • "Pitch Shifter Mode: Mono" only

The Pitch Shifter function detects the pitch of the input note and produces the appropriate harmony. This parameter sets the input channel that is used for detecting the pitch.

Norml (Normal):

This is for stereo input. The left channel is used to detect the pitch.

L ch: The left channel is used exclusively as input for detecting the pitch. The effect is applied only to the right channel, which is treated as a monaural input.

R ch: The right channel is used exclusively as input for detecting the pitch. The effect is applied only to the left channel, which is treated as a monaural input.

...: The settings are such that this parameter is not used.

Input Source • "Pitch Shifter Mode: Mono" only

This Parameter sets the sound source used for input, allowing the Pitch Shifter to accurately recognize the input pitch.

Gnr1 (General1):

Instruments (other than vocal) are used as the sound source; strings etc.

Gnr2 (General2):

Instruments (other than vocal) are used as the sound source; horns etc.

Vocal:

A vocal sound source is used.

...:

The settings are such that this parameter is not used.

This parameter simulates an old-fashioned rotary speaker, which added undulations to the sound by rotating the speaker as it played.

A real rotary speaker has a switch to select slow or fast rotation. Its horn (treble-range speaker) and rotor (bass-range speaker) can also be rotated independently. The ROTARY Effector has parameters that can be used to re-create these subtle effects.

It's also possible to simulate the distortion produced by a rotary speaker's vacuum-tube amp (Overdrive).

Modulation On/Off

This parameter turns the rotary effect on/off.

Modulation Type

This parameter selects the type of modulation.

Speed Select

This parameter changes the simulated speaker's rotating speed (SLOW or FAST).

Horn Speed <FAST>

This parameter adjusts the speed of rotation for the horn when set to "FAST."

Rotor Speed <FAST>

This parameter adjusts the speed of rotation for the rotor when set to "FAST."

Horn Speed <SLOW>

This parameter adjusts the speed of rotation for the horn when set to "SLOW."

Rotor Speed <SLOW>

This parameter adjusts the speed of rotation for the rotor when set to "SLOW."

Rise Time; Horn

This parameter adjusts the time it takes for the rotation speed of the horn to change when switched from "SLOW" to "FAST."

Rise Time; Rotor

This parameter adjusts the time it takes for the rotation speed of the rotor to change when switched from "SLOW" to "FAST."

Fall Time; Horn

This parameter adjusts the time it takes for the rotation speed of the horn to change when switched from "FAST" to "SLOW."

Rotary

MdCtl	Modulation On/Off	OFF, ON		
MdTyp	Modulation Type			
Speed	Speed Select	SLOW, FAST		
HFast	Horn Speed<FAST>	5.00	10.00	[Hz]
RFast	Rotor Speed<FAST>	5.00	10.00	[Hz]
HSlow	Horn Speed<SLOW>	0.05	5.00	[Hz]
RSlow	Rotor Speed<SLOW>	0.05	5.00	[Hz]
H-Ris	Rise Time;Horn	1	100	
R-Ris	Rise Time;Rotor	1	100	
H-Fal	Fall Time;Horn	1	100	
R-Fal	Fall Time;Rotor	1	100	
R:H	R:H Mix Balance	90:10	10:90	
Mode	Mic Setting Mode	OfMic, OnMic		
H-Dpt	Horn Depth	0	100	
R-Dpt	Rotor Depth	0	100	
H-Trm	Horn Tremolo	0	100	
R-Trm	Rotor Tremolo	0	100	
Difs	Diffusion	0	100	
OD-SW	Overdrive On/Off	OFF, ON		
Gain	Overdrive Gain	0	100, ...	
Drive	Overdrive Drive	1	100, ...	
OD-Lv	Overdrive Level	0	100, ...	

Fall Time; Rotor

This parameter adjusts the time it takes for the rotation speed of the rotor to change when switched from "FAST" to "SLOW."

R : H Mix Balance

This parameter adjusts the volume balance between the horn and rotor.

Mic Setting Mode

This parameter switches the position of the microphone used to record the sound of the rotary speaker.

OfMic (Off Mic):

This simulates the sound recorded by a microphone positioned at a distance from the rotary speaker. There are few undulations in the sound. This setting is good for instruments such as a jazz organ.

OnMic (On Mic):

This simulates the sound recorded by a microphone positioned close to the rotary speaker. The sound has many undulations. This setting is good for instruments such as a rock organ.

Horn Depth

This parameter adjusts the amount of depth in the Doppler effect for the horn.

Rotor Depth

This parameter adjusts the amount of depth in the Doppler effect for the rotor.

Horn Tremolo

This parameter adjusts the amount of change in volume for the horn.

Rotor Tremolo

This parameter adjusts the amount of change in volume for the rotor.

Diffusion

This parameter adjusts the "fatness" of the sound.

Overdrive On/Off

This parameter turns Overdrive on and off.

Overdrive Gain

This parameter adjusts the input level for Overdrive. Larger values result in greater distortion.

... : The settings are such that this parameter is not used.

* When set to "0," no sound is output.

Overdrive Drive

This parameter adjusts the amount of distortion.

... : The settings are such that this parameter is not used.

Overdrive Level

This parameter adjusts the output level for Overdrive.

... : The settings are such that this parameter is not used.

Space Chorus

MdCtl	Modulation On/Off	OFF, ON
MdTyp	Modulation Type	
Input	Input Mode	Mono, Stereo
Mode	Space Mode	1, 2, 3, 4, 1+4, 2+4, 3+4

This chorus effect simulates the sound from Roland's well-known SDD-320 Dimension D.

Modulation On/Off

This parameter turns the space chorus effect on/off.

Modulation Type

This parameter selects the type of modulation.

Input Mode

This parameter toggles between stereo and monaural input signals.

Mono:

This produces a space chorus for mono input with the left and right channels mixed.

Stereo (Stereo):

This produces a space chorus for stereo input with Space Chorus applied separately to the left and right channels.

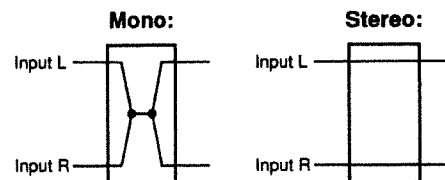

Space Mode

This parameter lets you choose how the chorus changes.

DELAY

This parameter creates a distinctive effect (such as a thicker sound) by applying a delayed sound to the direct sound. The Tempo function can be used to set the delay time in real time with a foot pedal or an external MIDI instrument.

One type can be selected for each Patch number from among the following.

* The selection of the Delay type is made with "DIType (Delay Type)."

- Simp:** Simple Delay
- 3 Tap:** 3Tap Delay
- 4 Tap:** 4Tap Delay
- Stero:** Stereo Delay
- Quad*:** Quad Delay
- Duck*:** Ducking Delay
- BPF_D*:** Band Pass Delay

* Effectors indicated by asterisk ("*") can be selected with algorithm numbers A1 to A9.

Simple Delay

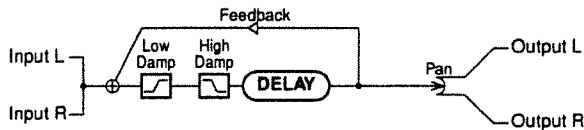

DICtl	Delay On/Off	OFF, ON		
DIType	Delay Type			
Delay	Delay Time	0.1	1400	[ms]
FbLvl	Feedback Level	-100	100	
D_Pan	Delay Pan	100:0	0:100	
LDpFq	Low Damp Frequency	50	4.00k	[Hz]
LDpGn	Low Damp Gain	-20.0	0.0	[dB]
HDpFq	High Damp Frequency	250	16.0k	[Hz]
HDpGn	High Damp Gain	-20.0	0.0	[dB]

Tempo	Tempo	25	250
TpSrc	Tempo Source	... , Manu, MIDI, CtlSW, MIDI C#1 - 31, 64 - 95	
Note	Delay Time as Note	... , 1/4 - 1.0	

This is a simple, single delay for monaural input.

3Tap Delay

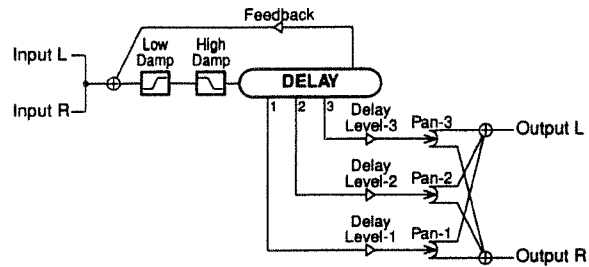

DICtl	Delay On/Off	OFF, ON		
DIType	Delay Type			
Dly-1	Delay Time 1	0.1	1400	[ms]
Dly-2	Delay Time 2	1	200	[%]
Dly-3	Delay Time 3	1	200	[%]
FbDly	Feedback Delay Time	1	200	[%]
FbLvl	Feedback Level	-100	100	
D_Lv1	Delay Level 1	0	100	
D_Lv2	Delay Level 2	0	100	
D_Lv3	Delay Level 3	0	100	
DPan1	Delay Pan 1	100:0	0:100	
DPan2	Delay Pan 2	100:0	0:100	
DPan3	Delay Pan 3	100:0	0:100	
LDpFq	Low Damp Frequency	50	4.0k	[Hz]
LDpGn	Low Damp Gain	-20.0	0.0	[dB]
HDpFq	High Damp Frequency	250	16.0k	[Hz]
HDpGn	High Damp Gain	-20.0	0.0	[dB]

Tempo	Tempo	25	250
TpSrc	Tempo Source	... , Manu, MIDI, CtlSW, MIDI C#1 - 31, 64 - 95	
Note1	Delay Time 1 as Note	... , 1/4 - 1.0	

The delay times for "Delay Time 2" and "Delay Time 3" are set as a ratio of "Delay Time 1".

* If a delay time exceeds the maximum, the maximum delay time is used.

4Tap Delay

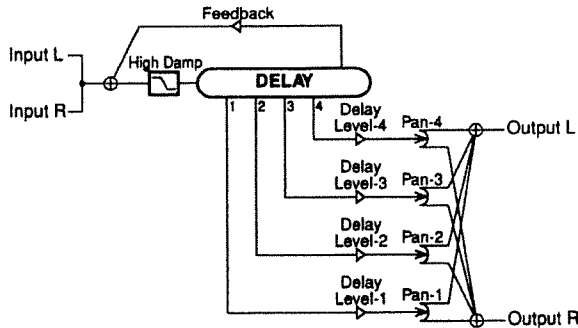

DICtl	Delay On/Off	OFF, ON	
DITyp	Delay Type		
Dly-1	Delay Time 1	0.1	1400 [ms]
Dly-2	Delay Time 2	0.1	1400 [ms]
Dly-3	Delay Time 3	0.1	1400 [ms]
Dly-4	Delay Time 4	0.1	1400 [ms]
FbDly	Feedback Delay Time	0.1	1400 [ms]
FbLvl	Feedback Level	-100	100
D_Lv1	Delay Level 1	0	100
D_Lv2	Delay Level 2	0	100
D_Lv3	Delay Level 3	0	100
D_Lv4	Delay Level 4	0	100
DPan1	Delay Pan 1	100:0	0:100
DPan2	Delay Pan 2	100:0	0:100
DPan3	Delay Pan 3	100:0	0:100
DPan4	Delay Pan 4	100:0	0:100
HDpFq	High Damp Frequency	250	16.0k [Hz]
HDpGn	High Damp Gain	-20.0	0.0 [dB]
Tempo	Tempo	25	250
TpSrc	Tempo Source	· · ·, Manu, MIDI, CtISW, MIDI C#1 – 31, 64 – 95	
Note1	Delay Time 1 as Note	· · ·, 1/4 – 1.0	
Note2	Delay Time 2 as Note	· · ·, 1/4 – 1.0	
Note3	Delay Time 3 as Note	· · ·, 1/4 – 1.0	
Note4	Delay Time 4 as Note	· · ·, 1/4 – 1.0	
NoteF	Feedback Time as Note	· · ·, 1/4 – 1.0	

This delay allows four delay times to be set independently.

Stereo Delay

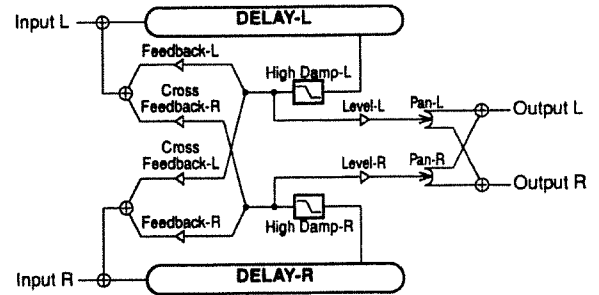

DICtl	Delay On/Off	OFF, ON	
DITyp	Delay Type		
Dly-L	Delay Time L	0.1	700 [ms]
Dly-R	Delay Time R	0.1	700 [ms]
FbLvL	Feedback Level L	-100	100
FbLvR	Feedback Level R	-100	100
D_LvL	Delay Level L	0	100
D_LvR	Delay Level R	0	100
DPanL	Delay Pan L	100:0	0:100
DPanR	Delay Pan R	100:0	0:100
DpFqL	High Damp Frequency L	250	16.0k [Hz]
DpGnL	High Damp Gain L	-20.0	0.0 [dB]
DpFqR	High Damp Frequency R	250	16.0k [Hz]
DpGnR	High Damp Gain R	-20.0	0.0 [dB]
XFLvL	Cross Feedback Level L	-100	100
XFLvR	Cross Feedback Level R	-100	100
Tempo	Tempo	25	250
TpSrc	Tempo Source	· · ·, Manu, MIDI, CtISW, MIDI C#1 – 31, 64 – 95	
NoteL	Delay Time L as Note	· · ·, 1/4 – 1.0	
NoteR	Delay Time R as Note	· · ·, 1/4 – 1.0	

This is a true stereo delay applied independently to the left and right inputs. This can also be used to apply cross-feedback.

Quad Delay

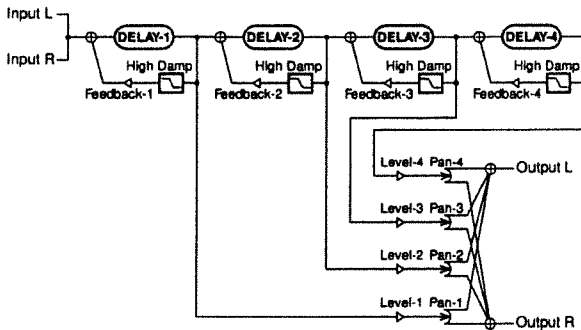

DICtl	Delay On/Off	OFF, ON	
DIType	Delay Type		
Dly-1	Delay Time 1	0.1	1400 [ms]
Dly-2	Delay Time 2	0.1	1400 [ms]
Dly-3	Delay Time 3	0.1	1400 [ms]
Dly-4	Delay Time 4	0.1	1400 [ms]
FbLv1	Feedback Level 1	-100	100
FbLv2	Feedback Level 2	-100	100
FbLv3	Feedback Level 3	-100	100
FbLv4	Feedback Level 4	-100	100
D_Lv1	Delay Level 1	0	100
D_Lv2	Delay Level 2	0	100
D_Lv3	Delay Level 3	0	100
D_Lv4	Delay Level 4	0	100
DPan1	Delay Pan 1	100:0	0:100
DPan2	Delay Pan 2	100:0	0:100
DPan3	Delay Pan 3	100:0	0:100
DPan4	Delay Pan 4	100:0	0:100
HDpFq	High Damp Frequency	250	16.0k [Hz]
HDpGn	High Damp Gain	-20.0	0.0 [dB]

* "Dly-1" + "Dly-2" + "Dly-3" + "Dly-4" ≅ 1400ms

This algorithm connects four independent delays in series.

Ducking Delay

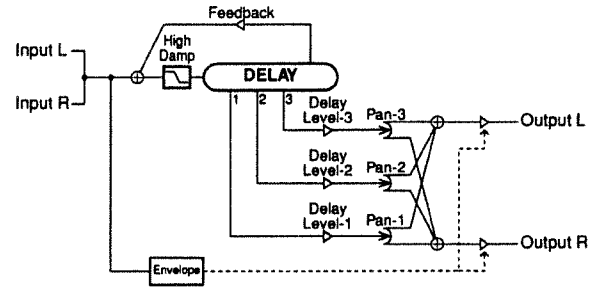

DICtl	Delay On/Off	OFF, ON	
DIType	Delay Type		
Dly-1	Delay Time 1	0.1	1400 [ms]
Dly-2	Delay Time 2	0.1	1400 [ms]
Dly-3	Delay Time 3	0.1	1400 [ms]
FbDly	Feedback Delay Time	0.1	1400 [ms]
FbLvl	Feedback Level	-100	100
D_Lv1	Delay Level 1	0	100
D_Lv2	Delay Level 2	0	100
D_Lv3	Delay Level 3	0	100
DPan1	Delay Pan 1	100:0	0:100
DPan2	Delay Pan 2	100:0	0:100
DPan3	Delay Pan 3	100:0	0:100
HDpFq	High Damp Frequency	250	16.0k [Hz]
HDpGn	High Damp Gain	-20.0	0.0 [dB]

DckMd Ducking Mode OFF, ON

DckSs Ducking Sensitivity 0 100

DckDp Ducking Depth 0 100

DckRs Ducking Rise Time 0 100

Tempo Tempo 25 250

TpSrc Tempo Source ···, Manu, MIDI, CtlSW, MIDI C#1 – 31, 64 – 95

Note1 Delay Time 1 as Note ···, 1/4 – 1.0

Note2 Delay Time 2 as Note ···, 1/4 – 1.0

Note3 Delay Time 3 as Note ···, 1/4 – 1.0

NoteF Feedback Time as Note ···, 1/4 – 1.0

This delay varies the output level of the delayed sound according to the level of the direct sound. Large levels for the direct sound cause the delayed sound to be suppressed, whereas lower levels result in louder delayed sounds.

Band Pass Delay

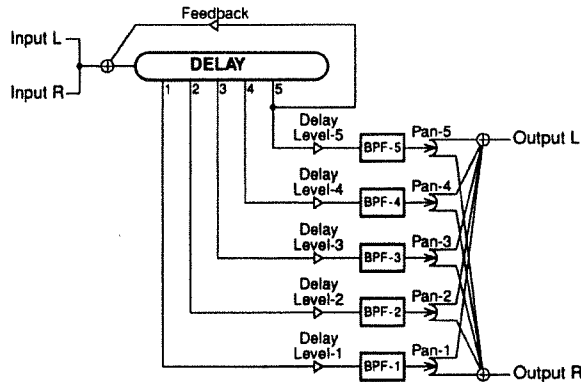

DICtl	Delay On/Off	OFF, ON	
DITyp	Delay Type		
Dly-1	Delay Time 1	0.1	1400 [ms]
Dly-2	Delay Time 2	0.1	1400 [ms]
Dly-3	Delay Time 3	0.1	1400 [ms]
Dly-4	Delay Time 4	0.1	1400 [ms]
Dly-5	Delay Time 5	0.1	1400 [ms]
FbLvl	Feedback Level	-100	100
D_Lv1	Delay Level 1	0	100
D_Lv2	Delay Level 2	0	100
D_Lv3	Delay Level 3	0	100
D_Lv4	Delay Level 4	0	100
D_Lv5	Delay Level 5	0	100
DPan1	Delay Pan 1	100:0	0:100
DPan2	Delay Pan 2	100:0	0:100
DPan3	Delay Pan 3	100:0	0:100
DPan4	Delay Pan 4	100:0	0:100
DPan5	Delay Pan 5	100:0	0:100
Freq1	BPF 1 Frequency	C0(16.4)	C8(4.19k) [Hz]
Freq2	BPF 2 Frequency	C0(16.4)	C8(4.19k) [Hz]
Freq3	BPF 3 Frequency	C0(16.4)	C8(4.19k) [Hz]
Freq4	BPF 4 Frequency	C0(16.4)	C8(4.19k) [Hz]
Freq5	BPF 5 Frequency	C0(16.4)	C8(4.19k) [Hz]
Q_1_2	BPF 1/2 Q	1.0	24.0
Q_345	BPF 3/4/5 Q	1.0	24.0
FiMix	BPF Mix Balance	100:0	0:100

This delay is provided with band-pass filters for each of five delays. (A band-pass filter makes output for only a set frequency band.)

Delay On/Off

This parameter turns the delay effect on/off.

Delay Type

This parameter selects the type of delay.

Tempo

This parameter sets the tempo for the song.

Tempo Source

This parameter sets the controller (source) used to manipulate the delay time.

“...”:

This is the normal setting. The delay time set for “Delay Time” is used.

“Manu”:

The delay times set with “Tempo” and “note” are used.

“MIDI”:

The tempo is synchronized to the MIDI clock received via the MIDI IN connector. This setting is used for synchronization with a sequencer’s performance tempo.

“CtlSW”:

The tempo with which a foot pedal (connected to the CONTROL jack) is tapped is used.

MIDI C#1 – 31 or 64 – 95:

Tempo is input by MIDI Control Change messages. The controller number is specified here.

Delay Time

This parameter adjusts the delay time (i.e., the interval for which sound is delayed).

With “3Tap Delay,” the delay time for the “Delay Time 1” is taken to be 100%, and the delay times of “Delay Time 2” and “Delay Time 3” are adjusted accordingly.

Feedback Delay Time

This parameter adjusts the delay time for the feedback sound.

Feedback Level

This parameter adjusts the amount of feedback. Changing the amount of feedback causes the number of times the delayed sound is repeated to change as well. Negative values cause a feedback sound of inverted phase to be output.

Level

Adjusts the volume of the delay sound.

Delay Pan

This parameter adjusts the stereo panning (L/R position) of the effect sound.

Low Damp <Frequency>

This parameter adjusts the frequency at which the low-frequencies are damped (Low Damp). The delay sound in the band below this frequency is damped.

Low Damp <Gain>

This parameter adjusts the amount of damping for Low Damp. No low-frequency damping occurs when set to "0."

High Damp <Frequency>

This parameter adjusts the frequency at which high-frequencies are damped (High Damp). Delay sounds occurring beyond this frequency are damped.

High Damp <Gain>

This parameter adjusts the amount of damping for High Damp. No high-frequency damping occurs when set to "0."

Cross Feedback Level

This parameter adjusts the amount of feedback output to the other channel. Negative values cause a feedback sound of inverted phase to be output.

Delay Time as Note

This parameter sets delay time as notes. The delay time is set according to the tempo, with each beat taken to be one quarter note.

Feedback Time as Note

This sets the delay time for the feedback sound in terms of note length. The delay time is set as a function of the tempo, with the tempo beat taken to be a quarter note.

Ducking Mode

This switches the ducking effect on or off.

Ducking Sensitivity

This parameter sets the sensitivity of the ducking effect with respect to the level of the direct sound. Larger values result in a greater ducking effect at high levels.

Ducking Depth

This parameter adjusts the intensity of the ducking effect. Larger values produce a greater ducking effect.

Ducking Rise Time

This parameter adjusts the time interval between the beginning of the delayed sound and the point at which it reaches its maximum volume level.

BPF Frequency (Band-pass Filter Frequency)

This adjusts the central frequency (or the note name used as the center) for the band-pass filter. The frequency is adjusted when "Parameter Help" (p.23) is off, and the note name is used for adjustment when on.

BPF Q (Band-pass Filter Q)

This adjusts the range of output with respect to the frequency set with the BPF Frequency parameter. Larger values result in a progressively narrower range (band) of output.

BPF Mix Balance

This adjusts the output balance of the delay sound which does not use the band-pass filter and the delay sound which does use the band-pass filter.

What is Tempo Delay

Tempo Delay allows you to set the delay to a desired tempo simply by tapping on a foot switch in time to the song you are playing.

(Procedure)

- 1 While editing Delay, use PARAMETER [◀] [▶] to get the next parameter ("Tempo Source") to flash. Rotate the VALUE knob to choose the controller (source) used to manipulate the delay time.

```
DLY: Tempo TpSrc
      =120 CtISW
```

MIDI:

The tempo is synchronized to the MIDI clock received via the MIDI IN connector. This setting is used for synchronization with a sequencer's performance tempo.

CtISW:

The tempo with which a foot pedal (connected to the CONTROL jack) is tapped is used.

MIDI C#1 – 31 or 64 – 95:

Tempo is input by MIDI Control Change messages. The controller number is specified here.

- * *Tempo delay is not applied when either of the following two types has been selected.*

"...":

The delay time set for "Delay Time" is used.

"Manu":

The delay times set with "Tempo" (song tempo) and "Note" are used.

- 2 Use PARAMETER [◀] [▶] to get the next parameter ("Delay Time as Note") to flash. Rotate the VALUE knob to set the delay interval.

```
DLY: NoteL NoteR
      ♪ 1/2 ♪ 1/2
```

This setting determines the spacing of the delay relative to the time between taps of the foot switch (standard tempo: the length of a quarter note) which is considered as "1."

The time between taps of the foot switch and the note setting work together to determine the delay time as follows.

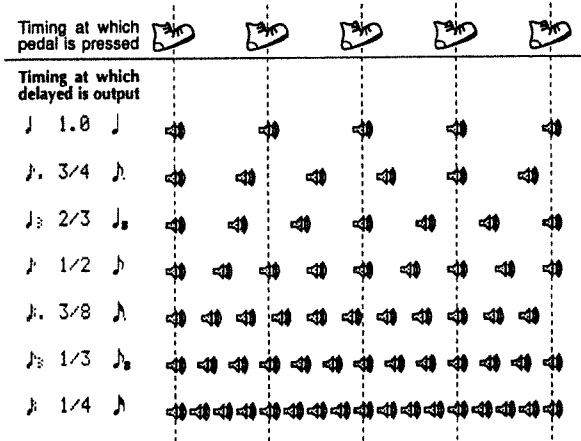

- 3 Repeat step 2 to set the note for all delays.

* *The number used for the note setting varies according to the type of delay.*

For a Patch that uses tempo delay, tapping the foot switch four or more times at regular intervals in synchronization with the tempo of the song will determine the standard tempo. This standard tempo, together with the note setting, determine the delay time.

* *Once set, the standard tempo will be retained until you tap the foot switch to set a new standard tempo, or until the power is turned off.*

* *Delay time can be set to a maximum 1400 (700) ms. If the Standard tempo and the note setting would specify a delay time of greater than 1400 (700) ms, the actual delay time will be 1400 (700) ms.*

Reverb

Reverberation (or reverb) is the effect caused by sound waves decaying in an acoustic space, or a digital simulation thereof. This decay occurs because sound waves bounce off many walls, ceilings, objects, etc. in a very complex way. These reflections, coupled with absorption by various objects, dissipate the acoustic energy over a certain period of time (called the decay time). The ear perceives this phenomenon as a continuous wash of sound.

The SX-700 can create eight types of reverb, one of which can be selected for each Patch number.

* *The selection of the type of reverb is made with "RvTyp (Reverb Type)."*

Room1	Room2	Room3
Hall1	Hall2	
Garage	Plate	NLR : Non-Linear

Room1/2/3

< Room1 >

RvCtl	Reverb On/Off	OFF, ON		
RvTyp	Reverb Type			
RevTm	Reverb Time	0.06	32.0	[s]
PrDly	Reverb Pre Delay	0	200	[ms]
RSize	Reverb Room Size	5.6	32.6	[m]
Dnsty	Density	0	99	
ERLvl	ER Level	0	99	
RIDns	Release Density	0	99	
LoDFq	Low Damp Freq	50	4.00k	[Hz]
LoDmp	Low Damp Gain	-36.0	0.0	[dB]
HiDFq	High Damp Frequency	4.00k	20.1k	[Hz]
HiDmp	High Damp Gain	-36.0	0.0	[dB]
HiCut	High Cut Frequency	200	20.1k	[Hz]
GtMod	Gate Mode	Thru, Duck, Gate		
GtThr	Gate Threshold	0	100	
GtATm	Gate Attack Time	1	100	
GtHTm	Gate Hold Time	1	100	
GtRTm	Gate Release	1	100	

< Room2 >

RvCtl	Reverb On/Off	OFF, ON		
RvTyp	Reverb Type			
RevTm	Reverb Time	0.06	32.0	[s]
PrDly	Reverb Pre Delay	0	200	[ms]
RSize	Reverb Room Size	1	10	
Dnsty	Density	0	99	
ERLvl	ER Level	0	99	
LoDFq	Low Damp Frequency	50	4.00k	[Hz]
LoDmp	Low Damp Gain	-36.0	0.0	[dB]
HiDFq	High Damp Frequency	4.00k	20.1k	[Hz]
HiDmp	High Damp Gain	-36.0	0.0	[dB]
HiCut	High Cut Frequency	200	20.1k	[Hz]

< Room3 >

RvCtl	Reverb On/Off	OFF, ON		
RvTyp	Reverb Type			
RevTm	Reverb Time	0.06	32.0	[s]
PrDly	Reverb Pre Delay	0	200	[ms]
RSize	Reverb Room Size	1	8	
Dnsty	Density	0	99	
ERLvl	ER Level	0	99	
RIDns	Release Density	0	99	
LoDFq	Low Damp Frequency	50	4.0k	[Hz]
LoDmp	Low Damp Gain	-36.0	0.0	[dB]
HiDFq	High Damp Frequency	4.00k	20.1k	[Hz]
HiDmp	High Damp Gain	-36.0	0.0	[dB]
HiCut	High Cut Frequency	200	20.1k	[Hz]

Simulates the reverberation in a small room.
 "Room1" is also provided with a Gate function.

Hall1/2

< Hall1 >

RvCtl	Reverb On/Off	OFF, ON		
RvTyp	Reverb Type			
RevTm	Reverb Time	0.06	32.0	[s]
PrDly	Reverb Pre Delay	0	200	[ms]
RSize	Reverb Room Size	1	10	
Dnsty	Density	0	99	
ERLvl	ER Level	0	99	
LoDFq	Low Damp Frequency	50	4.00k	[Hz]
LoDmp	Low Damp Gain	-36.0	0.0	[dB]
HiDFq	High Damp Frequency	4.00k	20.1k	[Hz]
HiDmp	High Damp Gain	-36.0	0.0	[dB]
HiCut	High Cut Frequency	200	20.1k	[Hz]

< Hall2 >

RvCtl	Reverb On/Off	OFF, ON		
RvTyp	Reverb Type			
RevTm	Reverb Time	0.06	32.0	[s]
PrDly	Reverb Pre Delay	0	200	[ms]
RSize	Reverb Room Size	1	8	
Dnsty	Density	0	99	
ERLvl	ER Level	0	99	
RIDns	Release Density	0	99	
LoDFq	Low Damp Frequency	50	4.00k	[Hz]
LoDmp	Low Damp Gain	-36.0	0.0	[dB]
HiDFq	High Damp Frequency	4.00k	20.1k	[Hz]
HiDmp	High Damp Gain	-36.0	0.0	[dB]
HiCut	High Cut Frequency	200	20.1k	[Hz]

Simulates the reverberation in a concert hall.

Garage

RvCtl	Reverb On/Off	OFF, ON		
RvTyp	Reverb Type			
RevTm	Reverb Time	0.06	32.0	[s]
PrDly	Reverb Pre Delay	0	200	[ms]
RSize	Reverb Room Size	1	8	
Dnsty	Density	0	99	
ERLvl	ER Level	0	99	
RIDns	Release Density	0	99	
LoDFq	Low Damp Frequency	50	4.00k	[Hz]
LoDmp	Low Damp Gain	-36.0	0.0	[dB]
HiDFq	High Damp Frequency	4.00k	20.1k	[Hz]
HiDmp	High Damp Gain	-36.0	0.0	[dB]
HiCut	High Cut Frequency	200	20.1k	[Hz]

This type simulates the reverberations which occur in a garage. This produces a reverb with many reflected sounds, such as those obtained in an enclosed room with hard walls.

Plate

RvCtl	Reverb On/Off	OFF, ON		
RvTyp	Reverb Type			
RevTm	Reverb Time	0.06	32.0	[s]
PrDly	Reverb Pre Delay	0	200	[ms]
RSize	Reverb Room Size	1	6	
Plate	Plate Type	1	4	
Brill	Plate Brilliance	0	100	
Depth	Plate Depth	0	100	
Dnsty	Density	0	99	
ERLvl	ER Level	0	99	
LoDFq	Low Damp Frequency	50	4.00k	[Hz]
LoDmp	Loq Damp Gain	-36.0	0.0	[dB]
HiDFq	High Damp Frequency	4.00k	20.1k	[Hz]
HiDmp	High Damp Gain	-36.0	0.0	[dB]
HiCut	High Cut Frequency	200	20.1K	[Hz]

Simulates plate reverberation (a reverb unit that uses the vibration of a large metallic plate).

Non-Linear

RvCtl	Reverb On/Off	OFF, ON		
RvTyp	Reverb Type			
PrDly	Reverb Pre Delay	0	200	[ms]
Dnsty	Density	0	99	
ERLvl	ER Level	0	99	
NLR<>	NLR Type	L->R, Norml, L<-R		
Ratio	Envelope Time Ratio	50	120	[%]
EnvT1	Envelope Time 1	0	1000	[ms]
EnvT2	Envelope Time 2	0	1000	[ms]
EnvT3	Envelope Time 3	0	1000	[ms]
EnvT4	Envelope Time 4	0	1000	[ms]
EnvL1	Envelope Level 1	0	100	
EnvL2	Envelope Level 2	0	100	
EnvL3	Envelope Level 3	0	100	
FbDly	NLR Feedback Time	1	1000	
FbLvl	NLR Feedback Level	-100	100	
HiCut	High Cut Frequency	200	20.1k	[Hz]

* "EnvT1" + "EnvT2" + "EnvT3" + "EnvT4" \cong FbDly

This type uses digital processing to create an artificial reverb that is distinctly different from a natural reverb.

Reverb On/Off

This parameter turns the reverb effect on/off.

Reverb Type

This parameter selects the type of reverb.

Reverb Time

This parameter adjusts the duration (time) of the reverb.

Pre Delay

This parameter adjusts the time interval between the direct sound and the beginning of the reverb sound.

Room Size

This parameter adjusts the size of the room which is simulated. The range of settings that can be made varies according to the type of reverb that you select.

Density

This parameter adjusts the density of the reverb effects.

Early Reflection Level

This parameter adjusts the volume level of the initial reflected sound.

Release Density

This parameter adjusts the density of the sound that reaches the listener after many repeated reflections.

Low Damp <Frequency>

This parameter adjusts the frequency at which the low-frequencies are damped (Low Damp). The reverb sound in the band below this frequency is damped.

Low Damp <Gain>

This parameter adjusts the amount of damping for Low Damp. No low-frequency damping occurs when set to "0."

High Damp <Frequency>

This parameter adjusts the standard frequency at which the high-frequencies are damped (High Damp). The reverb sound in the band above the standard frequency is damped.

High Damp <Gain>

This parameter adjusts the amount of damping for High Damp. No high-frequency damping occurs when set to "0."

High Cut Frequency

This parameter adjusts the frequency at which a low-pass filter starts to be applied. The effect is applied to the reverb sound.

Gate Mode

This makes the setting for operation of the Gate function.

Thru:

The Gate function is not used.

Duck (Ducking):

This does just the opposite of the Gate function. The gate begins to close when the level of the direct sound exceeds the threshold level, and begins to open when the direct-sound level falls below the threshold level.

Gate:

The gate begins to open when the level of the direct sound exceeds the threshold level, and begins to close when the direct-sound level falls below the threshold level.

Gate Threshold Level

This parameter is for the Gate function. It adjusts the standard level for controlling opening and closing of the gate.

Gate Attack Time

This parameter is for the Gate function. It adjusts the time between the direct sound exceeding the threshold level and the opening of the gate.

Gate Hold Time

This parameter is for the Gate function. It adjusts the time interval between the gate opening and closing completely.

Gate Release Time

This parameter is for the gate function. It adjusts the time from when the hold time ends to when the sound is completely muted.

Plate Type

You can choose any of four different plates. Larger values result in a more metallic sound with expanded high frequencies.

Plate Brilliance

This parameter adjusts the brilliance of the reverb.

Plate Depth

This parameter adjusts the depth of the reverb.

Non-linear Type

This parameter selects the type of panning for output.

L->R:

Panning is from the left channel to the right channel.

Normal (Normal):

A broader sound with no panning is output.

L<-R:

Panning is from the right channel to the left channel.

Envelope Time Ratio

This parameter sets the amount of expansion or contraction of overall time while maintaining the time ratios of the various envelopes.

Envelope Time1; T1
Envelope Time2; T2
Envelope Time3; T3
Envelope Time4; T4

This parameter adjusts the time to each point.

Envelope Level1; L1
Envelope Level2; L2
Envelope Level3; L3

This parameter adjusts the output level at each point.

** If nonlinear length (T1 + T2 + T3 + T4) exceeds 1,000 ms, the sound of the exceeding portion is cut off.*

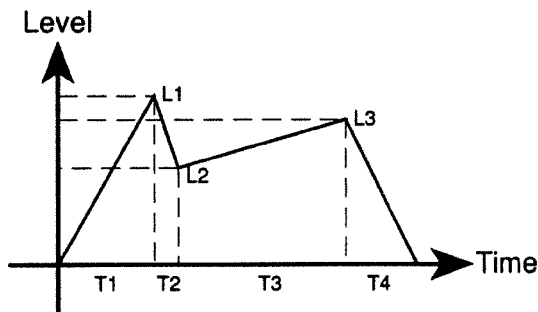

NLR Feedback Time

This parameter adjusts the delay time for the nonlinear feedback sound.

NLR Feedback Level

This parameter adjusts the volume level of the nonlinear feedback sound.

RSS

RSS (Roland Sound Space) is an effector that creates a three-dimensional sonic field. RSS can make the sound seem to revolve around the listener (3D Panner), and can also let you orient the sonic image at a position above, below, before, behind, or to one side or the other of the listener.

** To get the most out of the effects that RSS can provide, be sure to read "Before Using RSS" (p.47).*

The following four types are available, and you can select any one of these for each Patch number.

** The selection of the type is made with "RsTyp(RSS)."*

Paner: 3D Panner

Singl: Single 3D

Dual: Dual 3D

Quad: Quad 3D

** Quad 3D can be selected with algorithm numbers A1 to A9.*

3D Panner

RsCtl	RSS On/Off	OFF, ON	
RSTyp	RSS Type		
Speed	Panner Speed	1	10
Dir	Panner Direction	CW 5	CCW 5
Start	Start Position	L180	R180
Elev	Elevation	-54	54
Trig	Panner Trigger	· · ·, Signl, CtlSW	

This parameter creates an effect where the sound seems to revolve around the listener!

Single 3D

Dual 3D

Quad 3D

< Single 3D >

RsCtl	RSS On/Off	OFF, ON	
RSTyp	RSS Type		
Azmt	Azimuth	R180	L180
Elev	Elevation	-54	54

< Dual 3D >

RsCtl	RSS On/Off	OFF, ON	
RsTyp	RSS Type		
Azmt1	Azimuth 1	R180	L180
Azmt2	Azimuth 2	R180	L180
Elev1	Elevation 1	-54	54
Elev2	Elevation 2	-54	54
RsLv1	RSS Level 1	0	100
RsLv2	RSS Level 2	0	100

< Quad 3D >

RsCtl	RSS On/Off	OFF, ON	
RSTyp	RSS Type		
Azmt1	Azimuth 1	R180	L180
Elev1	Elevation 1	-54	54
RsLv1	RSS Level 1	0	100
Azmt2	Azimuth 2	R180	L180
Elev2	Elevation 2	-54	54
RsLv2	RSS Level 2	0	100
Azmt3	Azimuth 3	R180	L180
Elev3	Elevation 3	-54	54
RsLv3	RSS Level 3	0	100
Azmt4	Azimuth 4	R180	L180
Elev4	Elevation 4	-54	54
RsLv4	RSS Level 4	0	100

The sound can be panned from side to side as well as forward and backward and up and down from the standpoint of the listener. The position of the sound is determined by the Azimuth and Elevation settings. A single position with monaural input can be produced with "Single 3D," a single position with stereo left- and right-channel input can be produced with "Dual 3D," and four positions can be produced with "Quad 3D."

* The sound positioned with "Quad 3D" depends on what Effectors are connected before "Quad 3D."

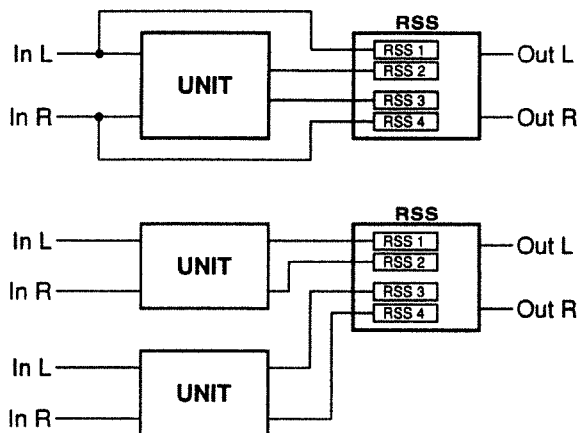

RSS On/Off

This parameter turns the 3D Pan effect on or off.

RSS Type

This parameter selects the type of RSS.

Panner Speed

This parameter adjusts the speed with which the position of the sound moves.

Panner Direction

This sets the direction of rotation and the number of turns for the stereo sound position.

When set to "CW" or "CCW," the stereo position continues to rotate.

When the number of turns has been set, rotation is begun from the "Start Position" by the "Trigger," continues for the set number of turns, then returns to the ordinary stereo position.

CW: Clockwise revolution

CCW: Counterclockwise revolution

Start Position

This parameter sets the position from which the 3D Panner starts to revolve. This parameter moves the sound horizontally along the perimeter of an imaginary sphere. The setting can be made within a range of about 180 degrees to the left or right, with the standard setting ("0") indicating a position directly in front of the listener.

Azimuth

This parameter moves the sound horizontally along the perimeter of an imaginary sphere. The setting can be made within a range of about 180 degrees to the left or right, with the standard setting ("0") indicating a position directly in front of the listener.

Elevation

[With "3D Panner"]

This parameter sets the height at which the position revolves. The setting is made as the number of degrees above the front of the listener (0).

[With Other Than "3D Panner"]

This parameter moves the sound vertically along the perimeter of an imaginary sphere. The setting is made as the number of degrees from the front of the listener (0).

Panner Trigger

This parameter specifies the information that serves as the trigger for starting the revolution of the sound from the "Start Position."

... : The settings are such that this parameter is not used.

Signal (Signal) :

Revolution is started by a sound input to the SX-700.

CtlSW (Control Switch) :

Revolution is started by depressing a foot pedal connected to the CONTROL jack.

RSS Level

This parameter adjusts the volume level.

Before Using RSS

RSS creates a three-dimensional stereo sound position and can make the sound seem to come from the front, back, or sides of the listener, or even from above or below. However, a few conditions need to be met in order to demonstrate the full effect of RSS. You should give special attention to the following points.

When using loud speakers

- A non-reverberant control room is suitable for use with the RSS.
- Speaker system of coaxial or virtual coaxial design are suitable for use with the RSS.
 - * *Monitor the sound at the sweet spot of the RSS.*

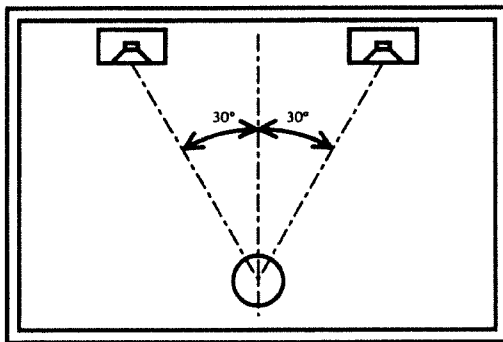

- For best results the speaker should be placed close to the rear wall and far from the side wall. Do not place the speakers too far apart. Excessive room reverberation will also have an adverse affect upon the sonic result.
 - * *Confirming sound position may be difficult if the volume is too low (or too high).*

About Connection with Other Effectors

For the SX-700, assign RSS to a unit close to output. The desired effect may not be obtained if the Pitch Shifter or some other effector which changes the tone of the original sound is connected after RSS. The connection should also be made before the SX-700 when using in combination with other effector devices.

When Using the SX-700's "Dual 3D" and "Quad 3D"

When using "Dual 3D" and "Quad 3D" with each of these set to a different stereo position, the output sounds may interfere with each other and cause the stereo effect to be lost when the same sound is input to the left and right channels of the unit which has RSS.

Section

4

Using MIDI

How MIDI Can Be Used

On the SX-700 you can use MIDI to perform the following operations.

Select Patches

Program Change messages received from an external MIDI device can select Patches on the SX-700. The relationship between MIDI Program Change numbers and the SX-700 Patches can be set by the Program Change Map (p.50).

With the connections in the following diagram, changing Program Numbers on an external MIDI device will cause Program Change messages to be transmitted to the SX-700, causing it to select the appropriate Patch number.

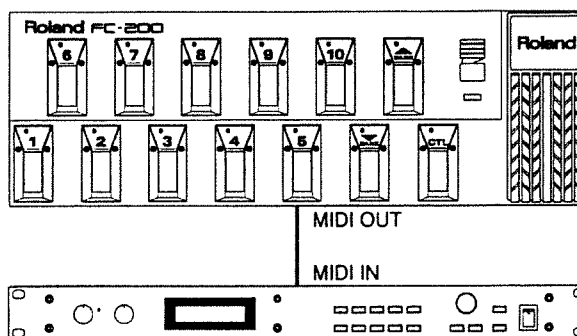

Control specified parameters

Control Changes can be used to control specified SX-700 parameters during your performance. The Control Assign settings (p.18) determine the SX-700 parameter that is controlled by each MIDI message.

Transmit data

SX-700 settings, such as effect sounds etc., can be transmitted as exclusive messages to other MIDI devices. This allows another SX-700 to be given the same settings, or effect sound settings to be stored in a sequencer or other data storage device.

MIDI Utility Function Settings

The following pages explain the MIDI-related utility functions of the SX-700. Make settings as needed for your situation.

The following utility functions are provided.

- [MIDI CHANNEL] 1-16
- [MIDI OMNI MODE] OMNI ON, OMNI OFF
- [MIDI DEVICE ID] 1 – 32
- [MIDI PROGRAM CHANGE RECEIVE] ON, OFF
- [MIDI PROGRAM MAP]
- [MIDI BULK DUMP]
- [MIDI BULK LOAD]

(Procedure)

* When using the following functions, please refer to the procedure given for each.

- [MIDI PROGRAM MAP] (P.50)
- [MIDI BULK DUMP] (P.51)
- [MIDI BULK LOAD] (P.52)

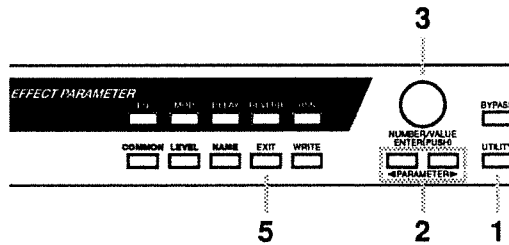

- 1 Press [UTILITY]. The button's indicator lights to show that settings can be made for the Utility function.
- 2 Use PARAMETER [◀] [▶] to get the parameter to be changed to flash.
- 3 Use the VALUE knob to change the parameter. If you press the VALUE knob while you rotate it, the value will change more rapidly.
- 4 Repeat steps 2 and 3 to set the desired utility function parameters.
- 5 Press [EXIT] to end the procedure and return to the Play mode.

MIDI Related Parameters

(MIDI CHANNEL) (1 – 16)



Set the MIDI channel used for transmitting and receiving MIDI messages.

* With the factory settings, the MIDI channel will be channel "1."

(MIDI OMNI MODE) (OMNI ON, OMNI OFF)

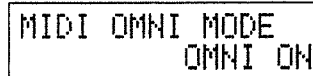

If Omni Mode is turned on, MIDI data will be received on all channels, regardless of the MIDI Channel setting.

* Even if Omni mode is turned on, system exclusive data is received only if the device ID numbers match ("Device ID" setting).

* With the factory settings, the setting is Omni On.

(MIDI DEVICE ID) (1 – 32)

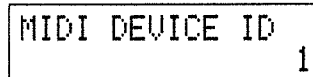

Determines the device ID used for transmitting and receiving exclusive messages.

* At the factory settings, the device ID is set to "1."

(MIDI PROGRAM CHANGE RECEIVE) (ON, OFF)

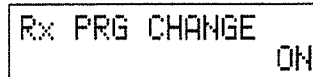

This setting determines whether Program Change messages from an external MIDI instrument are received.

ON: Program Change messages are received and Patch numbers on the SX-700 are switched.

OFF: Program Change messages are not received.

* This parameter is set to "ON" when the SX-700 is shipped from the factory.

Program Change Map Settings

When using Program Change messages sent from an external MIDI device to select SX-700 Patches, you can freely specify the relationship between the Program Change number that was received and the SX-700 Patch that will be selected.

When shipped from the factory, the MIDI Program Change numbers correspond to the same numbers in the SX-700's User area.

(Procedure)

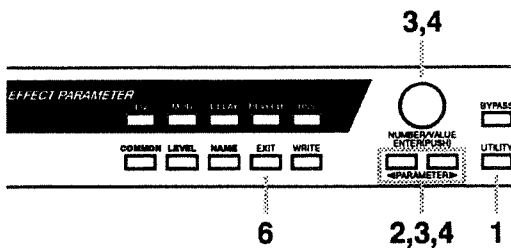

- 1 Press [UTILITY]. The button's indicator lights to show that settings can be made for the Utility function.
- 2 Use PARAMETER [◀] [▶] to access the following parameter (PROGRAM CHANGE MAP) in the display.

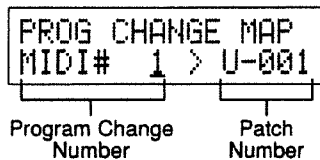

- 3 Use PARAMETER [◀] [▶] to move the cursor to the Program Change number, and use the VALUE knob to specify the Program Change number to be received.
- 4 Use PARAMETER [◀] [▶] to move the cursor to the Patch number, and use the VALUE knob to specify the SX-700 Patch number that will correspond to the received Program Change number.
- 5 Repeat steps 3 and 4 to complete the Program Change map by specifying the Patch number that will correspond to each Program Change number.
- 6 Press [EXIT] to return to the Play mode.

* When sending Bank Select messages (Controller Number 0 and 32) from an external MIDI instrument, you can switch Patches directly as shown below.

Bank Select 0:

This switches to the Program Change number of the MIDI Program Change Map.

Bank Select 1:

This switches directly to the Patch number in the User Area.

Bank Select 2:

This switches directly to a Patch number in the Preset Area.

Transmitting/Receiving Data Via MIDI

The SX-700 can use exclusive messages to set another SX-700 to the same settings, or to transmit its settings to a device (such as a sequencer) for storage. The process of transmitting such data is called a "Bulk Dump," and the process of receiving such data is called a "Bulk Load."

Data that can be transmitted

The following types of data can be transmitted. When transmitting data, you can specify the starting and ending points of the data to be sent, so only the desired data is transmitted.

Display	Data that is transmitted
SYSTEM	All data not included in the Patches
U1 – U128	The setting contents of Patches U1 – 128

Transmitting Data (Bulk Dump)

< Connections >

When saving the data to a sequencer

Make connections as shown below, and set the sequencer to a condition ready to receive exclusive messages.

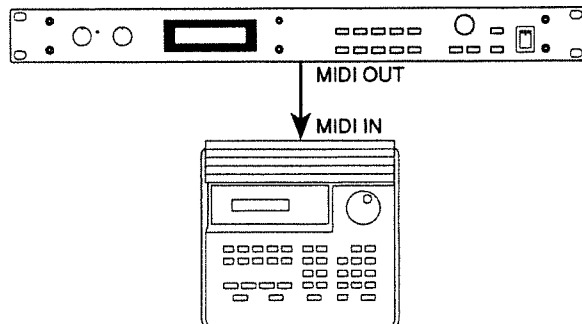

* For details on sequencer operation, refer to the manual for the sequencer you are using.

When copying the data to another SX-700

Make the connections shown in the figure below, and set the receiving and sending instruments to the same Device ID.

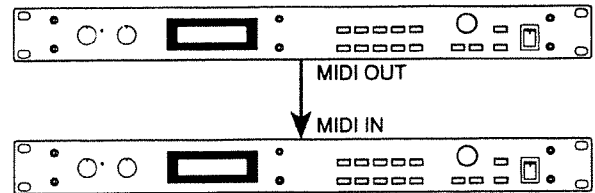

< Transmission Procedure >

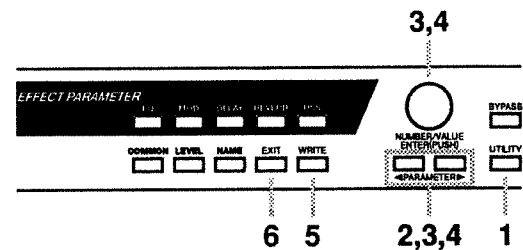

- 1 Press [UTILITY]. The button's indicator lights to show that settings can be made for the Utility function.
- 2 Use PARAMETER [◀] [▶] to access the following parameter (BULK DUMP) in the display.

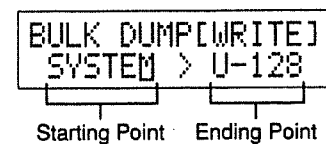

- 3 Use PARAMETER [◀] [▶] to move the cursor to "start," and use the VALUE knob to display the first data.
- 4 Use PARAMETER [◀] [▶] to move the cursor to "end," and use the VALUE knob to display the last data.
- 5 Press [WRITE] to send the data.



When the transmission has been completed, the previous display will reappear.

- 6 Press [EXIT] to return to the Play mode.

Receiving Data (Bulk Load)

< Connections >

When transferring data in a sequencer to the SX-700

Make the connections shown below. Set the SX-700 to the same Device ID that was used when the data was stored on the sequencer.

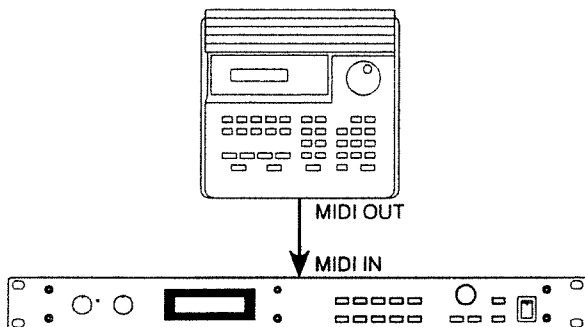

* For details on sequencer operation, refer to the manual for the device you are using.

< Reception Procedure >

Exclusive (SysEx) messages, including bulk load data, can be received at any time. When such data is received, the display changes to show the following screen.

```
MIDI BULK LOAD
receiving...
```

- * All operations on the SX-700 are disabled while SysEx messages are being received.
- * Only SysEx messages on the matching Device ID are received.
- * If you are in the process of changing the settings for an effect when data is received, the settings for the effect being changed are not affected by the incoming data.

Section 5

Appendix

About MIDI

MIDI is an acronym for Musical Instrument Digital Interface, and is a world-wide standard for allowing electronic musical equipment to communicate by transmitting digital messages (such as performance information and sound selections). Any MIDI equipped device is able to transmit applicable types of data to another MIDI equipped device, even if the two devices are different models or were made by different manufacturers.

With MIDI, performance information (such as playing a key or pressing a pedal) is transmitted as MIDI Messages.

1. How MIDI messages are transmitted and received

First, we will explain briefly how MIDI messages are transmitted and received.

MIDI connectors

The following three connectors are used to convey MIDI messages. MIDI cables are connected to these connectors as required.

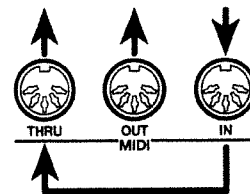

MIDI IN: This connector receives messages from another MIDI device.

MIDI OUT: This connector transmits messages from this device.

MIDI THRU: This connector re-transmits the messages that are received at MIDI IN.

MIDI channels

MIDI is able to independently control more than one MIDI device over a single MIDI cable. This is possible because of the concept of MIDI channels.

The idea of MIDI channels is somewhat similar to the idea of television channels. By changing channels on a television set, you can view a variety of programs. This is because the information of a particular channel is received when the channels of the transmitter and receiver match.

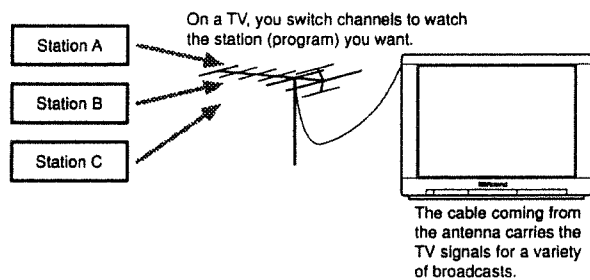

MIDI uses sixteen channels (1-16), and MIDI messages will be received by the instrument (the receiving device) whose channel matches the channel of the transmitter.

** If Omni mode is on, data of all MIDI channels will be received regardless of the MIDI channel setting. If you do not need to control a specific MIDI channel, you may use Omni On.*

2. Main types of MIDI message used by the SX-700

MIDI includes many types of messages that can convey a variety of information. MIDI messages can be broadly divided into two types; messages that are handled separately by a MIDI channel (channel messages), and messages that are handled without reference to a particular MIDI channel (system messages).

< Channel Messages >

These messages are used to convey performance information. Normally these messages perform most of the control. The way in which a receiving device will react to each type of MIDI message will be determined by the settings (and design) of the receiving device.

Program Change messages

These messages are generally used to select sounds, and include a Program number from 1 to 128 which specifies the desired sound.

Control Change messages

These messages are used to enhance the expressiveness of a performance. Each message includes a controller number, and the settings of the receiving device will determine what aspect of the sound will be affected by Control Change messages of a given control number.

The specified parameters can be controlled with the SX-700.

Aftertouch Messages

These messages convey the ongoing changes in the value of 'Aftertouch.' They contain information about the amount of pressure applied to keys on a keyboard, and usually are used to cause a change in the nuance of the sound (vibrato or modulation, for example). There are two types of Aftertouch; Channel and Polyphonic.

Channel Aftertouch provides control based on individual MIDI channels. No matter which specific keys are pressed more firmly, the effect is applied equally to all notes on the same MIDI channel.

Polyphonic Aftertouch provides control on an individual key (note) basis. Even though it may share the same MIDI channel with other notes, any particular key that has more pressure put on it will produce a unique effect.

The SX-700 responds to Channel Aftertouch messages which can be assigned to control a selected parameter.

Pitch Bend Messages

These messages convey the action of a Pitch Bend Lever (Wheel) that is found on many synthesizers. On the SX-700, these messages can be used to control selected parameters.

Note Messages

Note messages convey the musical notes played during a performance. On the SX-700, Note On/Off messages (press/release of keys) for specific Note Numbers (position on the keyboard), as well as Velocity messages (force applied when pressing a key) can be used to control selected parameters.

< System Messages >

System messages include exclusive messages, messages used for synchronization, and messages used to keep the MIDI system running correctly. Exclusive messages are the main type of message in this category used by the SX-700.

Exclusive Messages

Exclusive messages handle information related to a unit's own unique sounds, or other device-specific information. Generally, such messages can only be exchanged between devices of the same model by the same manufacturer. Exclusive messages can be employed to save the settings for Effects Programs into a sequencer, or for transferring such data to another SX-700.

The two instruments must be set to the same device ID numbers when exchanging SysEx messages.

About the MIDI Implementation Chart

MIDI allows a variety of messages to be exchanged between instruments, but it is not necessarily the case that all types of message can be exchanged between any two MIDI devices. Two devices can communicate only if they both use the types of messages that they have in common.

Thus, every owner's manual for a MIDI device includes a "MIDI Implementation Chart." This chart shows the types of message that the device is able to transmit and receive. By comparing the MIDI implementation charts of two devices, you can tell at a glance which messages they will be able to exchange. Since the charts are always of a uniform size, you can simply place the two charts side by side.

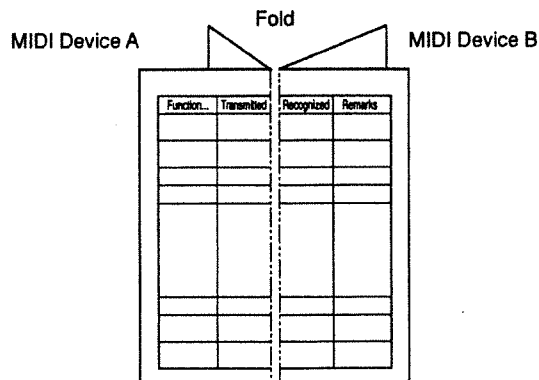

* A "MIDI Implementation" booklet (optional) containing a detailed explanation of the SX-700's MIDI capabilities is also available. Programmers or other interested users can order this booklet from a Roland dealer.

Restoring the Factory Settings (Initialization)

If you wish to restore the SX-700 to the factory settings, use the following procedure (Initialization). You can choose to initialize all settings, or initialize only a specified area of data, such as Patch data in the User area or system settings such as Utility data.

The following types of data can be initialized.

Display Shows	Settings Initialized
System	All parameters accessed through the UTILITY Mode
U-1	Settings for Patch Number U-1
U-2	Settings for Patch Number U-2
⋮	⋮
U-127	Settings for Patch Number U-127
U-128	Settings for Patch Number U-128

(Procedure)

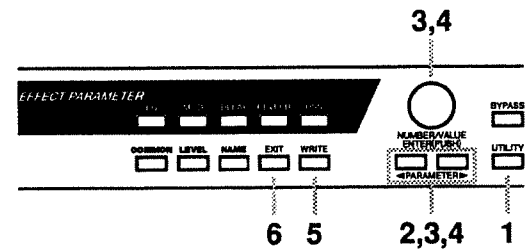

- 1 Press [UTILITY]. The button's indicator lights to show that settings can be made for the Utility function.
- 2 Use PARAMETER [◀] [▶] to access the following parameter (FACTORY PRESET) in the display.

```

FACT INIT[WRITE]
SYSTEM > U-128
    
```

Starting Point Ending Point

- 3 Use PARAMETER [◀] [▶] to move the cursor to "start," and use the VALUE knob to display the first data to be initialized.
- 4 Use PARAMETER [◀] [▶] to move the cursor to "end," and use the VALUE knob to display the last data to be initialized.
- 5 Press [WRITE], and the data of the specified area will be initialized.
- 6 Press [EXIT] to return to the Play mode.

Troubleshooting

If there is no sound or other operational problems occur, first check through the following solutions. If you cannot resolve the problem, contact your dealer or a Roland service station.

No Sound / Volume Too Low

Are the connection cables broken?

Try using a different set of connection cables.

Is the SX-700 correctly connected to the other devices?

Check connections with the other devices. (p.8)

Is the connected amp/mixer turned off, or the volume lowered?

Check the settings of your amp/mixer system.

Is the INPUT Level knob lowered?

Adjust the INPUT Level knob to an appropriate position. (p.9)

Is the OUTPUT Level knob lowered?

Adjust the OUTPUT Level knob to an appropriate position. (p.9)

Is Bypass turned on?

If the BYPASS On operation has been set to "MUTE," setting BYPASS On will mean that the direct sound is not output either. (p.11, 23)

Is each effect set correctly?

There may be little or no sound if the values for Level parameters are too low.

Is "Output Level" specified as a control assign Target?

Move the controller to which it is assigned.

Sound Is Distorted (the clip indicator lights frequently)

Have you adjusted the INPUT LEVEL knob?

Adjust the INPUT LEVEL knob to an appropriate setting. (p.9)

Have you adjusted the OUTPUT LEVEL knob?

Adjust the OUTPUT LEVEL knob to an appropriate setting. (p.9)

Are the output levels set appropriately?

Adjust the output levels.

Are the levels of connected devices excessively high?

Adjust the output levels of connected devices to an appropriate setting.

Patch Number Does Not Change

Is something other than the Play mode screen (p.9) shown in the display?

On the SX-700, Patches can be selected only when the Play mode screen is displayed. Press [EXIT] to return to the Play mode screen.

Parameters Specified with Control Assign Can't Be Controlled

When using a foot switch connected to the CONTROL jack

Check the Control assign setting (p.18).

When using MIDI to control parameters

Make sure that the MIDI channels of both devices match. (p.49)

Make sure that the Controller numbers you are using match. (p.18)

MIDI Messages Are Not Received

Are the MIDI cables damaged or broken?

Try another set of MIDI cables.

Is the SX-700 connected correctly to the other MIDI device?

Check connections with the other MIDI device.

Do the MIDI channel settings of both devices match?

Make sure that the MIDI channels of both devices match. (p.49)

MIDI Implementation Chart

Function***		Transmitted	Recognized	Remarks
Basic Channel	Default Changed	1 - 16	1 - 16	Memorized
Mode	Default Messages Altered	x x *****	OMNI ON/OFF x x	Memorized
Note Number	True Voice	x *****	o *1 *****	
Velocity	Note ON Note OFF	x x	o *1 x	
After Touch	Key's Ch's	x x	x o *1	
Pitch Bend		x	o *1	
Control Change	0, 32 1 - 31 33 - 63 64 - 95	x x x x	o *2 o *1 o *1, *3 o *1	Bank Select
Prog Change	True #	x *****	o *4 0 - 127	1 - 128
System Exclusive		o	o	
System Common	Song Pos Song Sel Tune	x x x	x x x	
System Real Time	Clock Commands	x x	o x	
AUX Messages	Local ON/OFF All Notes OFF Active Sense Reset	x x x x	x x x x	
Notes	*1: Recognizes messages designated for use for "realtime control over parameters." *2: MSB data of a value of 03H or higher, and the LSB are ignored. *3: LSB of Controller Number 1 - 31. *4: Can be set manually to o/x, and permanently memorized.			

Mode 1 : OMNI ON, POLY
Mode 3 : OMNI OFF, POLY

Mode 2 : OMNI ON, MONO
Mode 4 : OMNI OFF, MONO

o : Yes
x : No

Specifications

SX-700 : Studio Effects Processor

AD Conversion

18 bit 128 times Oversampling $\Delta\Sigma$ Modulation

DA Conversion

18 bit 16 times Oversampling $\Delta\Sigma$ Modulation

Sampling Frequency

44.1 kHz

Program Memories

256: 128 (User) + 128 (Preset)

Frequency Response

5 Hz to 55 kHz -1/+0 dB (Direct)

12 Hz to 20 kHz -1/+0 dB (Effect)

Nominal Input Level

+4 /-20 dBm (Selectable with LEVEL Switch)

Input Impedance

400 k Ω

Nominal Output Level

+4 /-20 dBm (Selectable with LEVEL Switch)

Output Impedance

3.6 k Ω or less

Dynamic Range

105 dB or greater (IHF-A, LEVEL Switch: +4 dBm) (Direct)

95 dB or greater (IHF-A, LEVEL Switch: +4 dBm) (Effect)

Controls

<Front>

INPUT LEVEL Knob

OUTPUT LEVEL Knob

NUMBER/VALUE Knob

POWER Switch

EFFECT PARAMETER Buttons

EQ

MOD

DELAY

REVERB

RSS

COMMON Button

LEVEL Button

NAME Button

EXIT Button

WRITE Button

PARAMETER Button L/R

BYPASS Button

UTILITY Button

<Rear>

LEVEL Switch

Display

16 characters, 2 lines (backlit LCD)

Indicator

PEAK Indicator

Connectors

<Rear>

INPUT Jack L(MONO)/R

OUTPUT Jack L(MONO)/R

BYPASS Jack

Expression Pedal Jack

CONTROL Jack

MIDI Connectors(IN, OUT, THRU)

AC ADAPTOR Jack

Power Supply

AC 14 V; Supply AC Adaptor

(BOSS BRC-120, 230, 240)

Current Draw

700 mA

Dimensions

482 (W) x 197 (D) x 44 (H) mm

19 (W) x 7-3/4 (D) x 1-3/4 (H) inches

(EIA-1U rack mount type)

Weight

2.0 kg /4 lbs 7 oz (excluding the AC Adaptor)

Accessories

Owner's Manual

AC Adaptor: BOSS BRC-120, 230, 240

Options

Foot Switch: FS-5U, FS-5L

Expression Pedal: EV-5 (Roland),

FV-300L + PCS-33 (Roland)

* 0 dBm = 0.775 Vrms

* The specifications for this product are subject to change without prior notice.

Index

Symbols

2Voices Harmonist	31
2Voices Pitch Shifter	33
3D Panner	45
3Tap Delay	36
4Tap Delay	37
4Voices Harmonist	31
4Voices Pitch Shifter	33

A

About MIDI	53
Aftertouch Messages	54
Algorithms	13, 15, 24
Assigning Effectors to units	15

B

Band Pass Delay	39
Before Using RSS	47
Bulk Dump	51
Bulk Load	52
Bypass	11
BYPASS MODE	23

C

Canceling Changes	21
Channel Messages	54
Connections	8
Control Assign	18
Control Change messages	54
Copying a Patch	14

D

DELAY	36
Delay Balance	17
Delay Output Level	17
Direct Level	17
Display	10, 12
Dual 3D	45
Ducking Delay	38

E

Effect Copy	17
Effect Sound Settings	14
Effect Status	10
Effector	13, 15
Effectors on or off	16
EQUALIZER	27
Exclusive Messages	54

G

Garage	43
--------------	----

H

Hall	42
How to Use This Manual	4

I

Implementation Chart	55
IMPORTANT NOTES	6
Initialization	55
Input Level	9

L

LCD CONTRAST	23
LEVEL switch	8

M

MIDI	48
MIDI CHANNEL	49
MIDI channels	53
MIDI DEVICE ID	49
MIDI Implementation Chart	57
MIDI PROGRAM CHANGE RECEIVE	49
MIDI Utility	49
MODULATION	28
Modulation Balance	17
Modulation Output Level	17

N

Name	21
Non-Linear	43
Note Messages	54
NUMBER knob	7

O

Output Balance	17
Output Level	9, 17

P

Panel Descriptions	7
PARAMETER HELP	23
PEAK indicator	9
Pitch Bend Messages	54
Plate	43
Play mode	9
Polarity switch	9
Power-on	9
Preset area	12
Program Change Map	50
Program Change messages	54

Q

Quad 3D	45
Quad Delay	38

R

Receiving Data	52
Restoring the Factory Settings	55
Reverb	42
Reverb Balance	18
Reverb Output Level	18
Room	42
Rotary	34
RSS	45
RSS Balance	18
RSS Output Level	18

S

Selecting an Effect	10
Settings for Each Effects Processor ...	16
Simple Delay	36
Single 3D	45
Sound Editing	14
Source	19
Source Mode	20
Space Chorus	35
Specifications	58
STANDARD PITCH	23
Stereo 2Band Chorus	28
Stereo Chorus	28
Stereo Delay	37
Stereo Flanger	29
Stereo Phaser	30
Storing the Modified Settings	22
System Messages	54

T

Target	18
Target value range	19
Tempo Delay	41
The Structure of Patches	13
Toggle	20
Transmitting Data	51
Troubleshooting	56
Type A	26
Type B	26
Type C	26

U

Unit	13, 15
User area	12
User Scale	32
USING THE UNIT SAFELY	2
Utility Function	22

V

VALUE knob	7
------------------	---

W

Write Operation	22
-----------------------	----

Memo

Memo

Information

When you need repair service, call your local Roland Service Station or the authorized Roland distributor in your country as shown below.

ARGENTINA

Instrumentos Musicales
S.A.
Florida 638
(1005) Buenos Aires
ARGENTINA
TEL: (01) 394 4029

BRAZIL

Roland Brasil Ltda.
R. Coronel Octaviano da Silveira
203 05522-010
Sao Paulo BRAZIL
TEL: (011) 843 9377

CANADA

Roland Canada Music Ltd.
(Head Office)
5480 Parkwood Way Richmond
B. C., V6V 2M4 CANADA
TEL: (604) 270 6626

Roland Canada Music Ltd.
(Toronto Office)
Unit 2, 109 Woodbine Downs
Blvd, Etobicoke, ON
M9W 6Y1 CANADA
TEL: (0416) 213 9707

MEXICO

Casa Veerkamp, s.a. de c.v.
Mesones No. 21 Col. Centro
Mexico D.F. 06080 MEXICO
TEL: (905) 709 3716

La Casa Wagner de
Guadalajara s.a. de c.v.
Av. Corona No. 202 S.J.
Guadalajara, Jalisco Mexico
C.P.44100 MEXICO
TEL: (03) 613 1414

PANAMA

Productos Superiores, S.A.
Apartado 655 - Panama 1
REP. DE PANAMA
TEL: 26 3322

U. S. A.

Roland Corporation U.S.
7200 Dominion Circle
Los Angeles, CA. 90040-3696,
U. S. A.
TEL: (0213) 685 5141

VENEZUELA

Musiland Digital C.A.
Av. Francisco de Miranda,
Centro Parque de Cristal, Nivel
C2 Local 20 Caracas
VENEZUELA
TEL: (02) 285 9218

AUSTRALIA

Roland Corporation
Australia Pty. Ltd.
38 Campbell Avenue
Dee Why West. NSW 2099
AUSTRALIA
TEL: (02) 982 8266

NEW ZEALAND

Roland Corporation (NZ)
Ltd.
97 Mt. Eden Road, Mt. Eden,
Auckland 3, NEW ZEALAND
TEL: (09) 3098 715

HONG KONG

Tom Lee Music Co., Ltd.
Service Division
22-32 Pun Shan Street, Tsuen
Wan, New Territories, HONG
KONG
TEL: 2415 0911

INDONESIA

PT CITRARAMA
BELANTIKA
Kompleks Perkantoran Duta
Merlin Blok E No.6—7
Jl. Gajah Mada No.3—5, Jakarta
10130,
INDONESIA
TEL: (021) 3850073

KOREA

Cosmos Corporation
Service Station
261 2nd Floor Nak-Won Arcade
Jong-Ro ku, Seoul, KOREA
TEL: (02) 742 8844

MALAYSIA

Bentley Music SDN BHD
No.142, Jalan Bukit Bintang 55100
Kuala Lumpur, MALAYSIA
TEL: (03) 2443333

PHILIPPINES

G.A. Yupangco & Co. Inc.
339 Gil J. Puyat Avenue
Makati, Metro Manila 1200,
PHILIPPINES
TEL: (02) 899 9801

SINGAPORE

Swee Lee Company
BLOCK 231,
Bain Street #03-23
Bras Basah Complex,
SINGAPORE 0718
TEL: 3367886

CRISTOFORI MUSIC PTE
LTD
335, Joo Chiat Road SINGAPORE
1542
TEL: 3450435

TAIWAN

Siruba Enterprise (Taiwan)
Co., LTD.
Room. 5, 9fl. No. 112 Chung Shan
N.Road Sec.2 Taipei, TAIWAN,
R.O.C.
TEL: (02) 561 3339

THAILAND

Theera Music Co., Lt d.
330 Vereng Nakorn Kasem, Soi 2,
Bangkok 10100, THAILAND
TEL: (02) 2248821

BAHRAIN

Moon Stores
Bad Al Bahrain Road,
P.O.Box 20077
State of BAHRAIN
TEL: 211 005

IRAN

TARADIS
Mir Enad Ave. No. 15, 10th street
P. O. Box 15875/4171 Teheran,
IRAN
TEL: (021) 875 6524

ISRAEL

Haliit P. Greenspoon &
Sons Ltd.
8 Reizif Ha'aliya Hashnya St.
Tel-Aviv-Yafo ISRAEL
TEL: (03) 6823666

JORDAN

AMMAN Trading Agency
Prince Mohammed St. P. O. Box
825 Amman 11118 JORDAN
TEL: (06) 641200

KUWAIT

Easa Husain Al-Yousifi
P.O. Box 126 Safat 13002
KUWAIT
TEL: 5719499

LEBANON

A. Chahine & Fils
P.O. Box 16-5857 Gergi Zeidan St.
Chahine Building, Achrafieh
Beirut, LEBANON
TEL: (01) 335799

OMAN

OHI Electronics &
Trading Co. LLC
P. O. Box 889 Muscat
Sultanate of OMAN
TEL: 706 010

QATAR

Badie Studio & Stores
P.O.Box 62,
DOHA QATAR
TEL: 423554

SAUDI ARABIA

SAF Music Center
AL-Khobar 31952, P. O. Box 1366
SAUDI ARABIA
TEL: (03) 898 3311

Abdul Latif S. Al-Ghamdi
Trading Establishment
Al-Tamini Commercial And
Residential Center Al-Khobar
Dharan Highway W/Hamood St.
P. O. Box 3631 Al-Khobar
31952 SAUDI ARABIA
TEL: (03) 898 2332

SYRIA

Technical Light & Sound
Center
Khaled Ebn Al Walid St.
P.O.Box 13520
Damascus - SYRIA
TEL: (011) 2235 384

TURKEY

Barkat Sanayi ve Ticaret
Siraselievir Cad. Guney Ishani No.
86/6 Taksim, Istanbul TURKEY
TEL: (0212) 2499324

U.A.E

Zak Electronics & Musical
Instruments Co.
Zabeel Road, Al Sherooq Bldg.,
No. 14, Grand Floor DUBAI
U.A.E.
P.O. Box 8050 DUBAI, U.A.E
TEL: (04) 360715

EGYPT

Al Fanny Trading Office
9, Ebn Hagar Ai Askalany Street,
Ard El Golf, Heliopolis, Cairo,
11341 EGYPT
TEL: (02) 4171828
(02) 4185531

MAURITIUS

Philanne Music Center
4th, Floor Noll, Happy World
House Sir William Newton Street
Port Luis MAURITIUS
TEL: 242 2986

REUNION

FO - YAM Marcel
25 Rue Jules MermanZL
Chaudron - BP79 97491
Ste Clotilde REUNION
TEL: 28 29 16

SOUTH AFRICA

That Other Music Shop
(PTY) Ltd.
11 Melle Street (Cnr Melle and
Juta Street)
Braamfontein 2001
Republic of SOUTH AFRICA
TEL: (011) 403 4105

Paul Bothner (PTY) Ltd.
17 Werdmuller Centre Claremont
7700
Republic of SOUTH AFRICA
TEL: (021) 64 4030

AUSTRIA

E. Dematte & Co.
Neu-Rum Siemens-Strasse 4
A-6040 Innsbruck P.O.Box 83
AUSTRIA
TEL: (0512) 26 44 260

BELGIUM/HOLLAND/ LUXEMBOURG

Roland Benelux N. V.
Houtstraat 1 B-2260 Oevel-
Westerlo BELGIUM
TEL: (014) 575811

CYPRUS

Radex Sound Equipment
Ltd.
17 Diagorou St., P.O.Box 2046,
Nicosia CYPRUS
TEL: (02) 453 426
(02) 466 423

DENMARK

Roland Scandinavia A/S
Langebrogade 6 Post Box 1937
DK-1023 Copenhagen K.
DENMARK
TEL: 32 95 3111

FRANCE

Guillard Musiques Roland
ZAC de Rosarge Les Echets 01700
MIRIBEL FRANCE
TEL: 7226 5060

Guillard Musiques Roland
(Paris Office)
1923 rue Léon Geoffroy 94400
VITRY-SUR-SEINE FRANCE
TEL: (1) 4680 86 62

FINLAND

Roland Scandinavia As,
Filial Finland
Lauttasaarentie 54 B
Fin-00201 Helsinki, FINLAND
P. O. Box No. 109
TEL: (0) 682 4020

GERMANY

Roland Elektronische
Musikinstrumente
Handelsgesellschaft mbH.
Oststrasse 96, 22844 Norderstedt,
GERMANY
TEL: (040) 52 60090

GREECE

V. Dimitriadis & Co. Ltd.
20, Alexandras St. & Bouboulinas
54 St. 106 82 Athens, GREECE
TEL: (01) 8232415

HUNGARY

Intermusica Ltd.
Warehouse Area 'DEPO' Pf.83
H-2046 Torokbalint, HUNGARY
TEL: (01) 1868905

IRELAND

The Dublin Service Centre
Audio Maintenance
Limited
11 Brunswick Place Dublin 2
Republic of IRELAND
TEL: (01) 677322

ITALY

Roland Italy S. p. A.
Viale delle Industrie, 8
20020 Arese Milano, ITALY
TEL: (02) 93581311

NORWAY

Roland Scandinavia Avd.
Kontor Norge
Lilleakervelen 2 Postboks 95
Lilleaker N-0216 Oslo
NORWAY
TEL: 273 0074

POLAND

P. P. H. Brzostowicz Marian
61-502 Poznan, ul. Filarecka 11,
TEL: (061) 332 665
03-624 Warszawa, ul. Blokowa32,
TEL: (02) 679 44 19

PORTUGAL

Caius - Tecnologias Audio e
Musica, Lda.
Rue de Catarina 131
4000 Porto, PORTUGAL
TEL: (02) 38 4456

RUSSIA

PETROSHOP
Vershavskoe, Shosse, 27-1
Moscow, RUSSIA
TEL: 095 901 0892

INVASK Limited

Lenina Str. 13-342
Krasnogorsk 143400
Moscow Region, RUSSIA
TEL: 095 564 61 44

SPAIN

Roland Electronics
de Espana, S. A.
Calle Bolivia 239 08020 Barcelona,
SPAIN
TEL: (93) 308 1000

SWEDEN

Roland Scandinavia A/S
Danvik Center 28 A, 2 tr.
S-131 30 Nacka SWEDEN
TEL: (08) 702 0020

SWITZERLAND

Roland (Switzerland) AG
Musitronic AG
Gerberstrasse 5, CH-4410 Liestal,
SWITZERLAND
TEL: (061) 921 1615

UNITED KINGDOM

Roland (U.K.) Ltd., Swansea
Office
Atlantic Close, Swansea
Enterprise Park SWANSEA
West Glamorgan SA7 9FJ,
UNITED KINGDOM
TEL: (01792) 702701

No.	Patch Name	Algorithm	No.	Patch Name	Algorithm
001:	WIDE REVERB		033:	CONCERT HALL	
002:	BELL REVERB		034:	SIDE REF. HALL	
003:	CHORUS REVERB		035:	BATHROOM	
004:	3D FLANGE REV		036:	SPREAD IMAGE	
005:	3D PHASE REV		037:	WARM PLATE	
006:	ROTARY OD		038:	WARM ROOM	
007:	HI BAND CHORUS		039:	REVOLUTION	
008:	LARGE HALL #1		040:	MODEL 147	
009:	LARGE HALL #2		041:	FAST CHURCH	
010:	PHASE CHORUS		042:	SLOW OVERDRIVE	
011:	4TAP DELAY		043:	FAST CHURCHEESE	
012:	320+SPACE DELAY		044:	FAT DRIVE	
013:	ROTATE FLANGER		045:	WIDE ENSEMBLE	
014:	ENSEMBLE REVERB		046:	NLR PHASER	
015:	GARAGE		047:	ROOF REFLECTION	
016:	ARENA		048:	OCEAN FLOOR	
017:	FALLIN DOWN		049:	WAREHOUSE	
018:	RISE UP		050:	RICH REFLECTION	
019:	3D HR ROOM REV		051:	CAVE	
020:	SLIGHT CHORUS		052:	BLIZZARD	
021:	SPIRAL		053:	LIVE HOUSE	
022:	TINY BUBBLES		054:	FLYING BIRD	
023:	MELLOW DELAY		055:	BIG FOOT	
024:	BELL RSS		056:	REBOUND DELAY	
025:	RADIO VOICE		057:	BALLROOM	
026:	HOPPING DELAY		058:	MUSIC CLUB	
027:	DELAY PANNER		059:	LIGHT REVERB	
028:	PANNING DLY+REV		060:	ILLUSION	
029:	METAL GARAGE		061:	TWINKLE DELAY	
030:	WIDE ROOM		062:	DISTANCE CHORUS	
031:	LARGE ROOM		063:	DUCKING REVERB	
032:	DEEP HALL		064:	CATHEDRAL	

SX-700

Patch Name Table



No.	Patch Name	Algorithm	No.	Patch Name	Algorithm
065:	CHURCH		097:	WATER	
066:	THEATER		098:	PS DOUBLING 3D	
067:	TRIPLE TEMP DLY		099:	SHAKE DELAY #2	
068:	SPECIAL REVERB		100:	STEREO ALTERNATE	
069:	MONO>STEREO		101:	SHORT WAVE	
070:	MONO>STEREO 2		102:	QUAD DELAY	
071:	RHODES 1		103:	140 PLATE	
072:	OCT +1 & -1		104:	WIDE PLATE	
073:	RICH PLATE		105:	ANSWER PLATE	
074:	GATE PANNER		106:	DRUM AMBIENCE	
075:	JET PANNER		107:	TILED ROOM	
076:	NIAGARA		108:	STRINGS HALL	
077:	MURMUR DELAY		109:	KICK GATE	
078:	DETUNE CHORUS		110:	BIG SNARE	
079:	DENSE PLATE		111:	CLEAR ROOM	
080:	BRIGHT PLATE		112:	VOCAL ROOM	
081:	BASEMENT		113:	REFLECT AMBIENCE	
082:	CORRIDOR		114:	WARM CORRIDOR	
083:	DEEP CORRIDOR		115:	KARAOKE	
084:	GALACTIC HALL		116:	SIMPLE DLY>REV	
085:	OUTER SPACE		117:	BPF-DELAY + NLR	
086:	ROUND DELAY		118:	TEMPO DLY CtISW	
087:	SPACE LEAD		119:	MIDICLK DELAY	
088:	TREMOLO FOR STR		120:	CTL TRIG PANNER	
089:	MODULATION_PITCH		121:	GATE FLANGER	
090:	TRI LFO		122:	SORROW	
091:	MINOR CHORD		123:	PANNER DELAY	
092:	OCT UP & DOWN		124:	ROTATE LOW	
093:	OD LFO		125:	ROTATE HIGH	
094:	BROKEN PIANO		126:	HUMAN VOICE	
095:	WAVELET		127:	WONDER PHASE	
096:	FANTASIA		128:	ROTARY & RSS	

For the U.K.

IMPORTANT: THE WIRES IN THIS MAINS LEAD ARE COLOURED IN ACCORDANCE WITH THE FOLLOWING CODE.

BLUE: NEUTRAL
BROWN: LIVE

As the colours of the wires in the mains lead of this apparatus may not correspond with the coloured markings identifying the terminals in your plug, proceed as follows:

The wire which is coloured BLUE must be connected to the terminal which is marked with the letter N or coloured BLACK.
The wire which is coloured BROWN must be connected to the terminal which is marked with the letter L or coloured RED.
Under no circumstances must either of the above wires be connected to the earth terminal of a three pin plug.

For Nordic Countries

Apparatus containing Lithium batteries

ADVARSEL!

Lithiumbatteri - Eksplosionsfare ved fejlagtig håndtering.
Udskiftning må kun ske med batteri af samme fabrikat og type.
Levér det brugte batteri tilbage til leverandøren.

VARNING!

Explosionsfara vid felaktigt batteribyte.
Använd samma batterityp eller en ekvivalent typ som rekommenderas av apparattillverkaren.
Kassera använt batteri enligt fabrikantens instruktion.

ADVARSEL!

Lithiumbatteri - Eksplosjonsfare.
Ved utskifting benyttes kun batteri som anbefalt av apparatfabrikanten.
Brukt batteri returneres apparatleverandøren.

VAROITUS!

Paristo voi räjähtää, jos se on virheellisesti asennettu.
Vaihda paristo ainoastaan laitevalmistajan suosittelemaan tyyppiin. Hävitä käytetty paristo valmistajan ohjeiden mukaisesti.

For Europe



This product complies with the requirements of European Directive 89/336/EEC.

For the USA

FEDERAL COMMUNICATIONS COMMISSION RADIO FREQUENCY INTERFERENCE STATEMENT

This equipment has been tested and found to comply with the limits for a Class B digital device, pursuant to Part 15 of the FCC Rules. These limits are designed to provide reasonable protection against harmful interference in a residential installation. This equipment generates, uses, and can radiate radio frequency energy and, if not installed and used in accordance with the instructions, may cause harmful interference to radio communications. However, there is no guarantee that interference will not occur in a particular installation. If this equipment does cause harmful interference to radio or television reception, which can be determined by turning the equipment off and on, the user is encouraged to try to correct the interference by one or more of the following measures:

- Reorient or relocate the receiving antenna.
- Increase the separation between the equipment and receiver.
- Connect the equipment into an outlet on a circuit different from that to which the receiver is connected.
- Consult the dealer or an experienced radio/TV technician for help.

Unauthorized changes or modification to this system can void the users authority to operate this equipment.
This equipment requires shielded interface cables in order to meet FCC class B Limit.

For Canada

CLASS B NOTICE

This digital apparatus does not exceed the Class B limits for radio noise emissions set out in the Radio Interference Regulations of the Canadian Department of Communications.

CLASSE B AVIS

Cet appareil numérique ne dépasse pas les limites de la classe B au niveau des émissions de bruits radioélectriques fixés dans le Règlement des signaux parasites par le ministère canadien des Communications.

For Australia

The supply cord of this transformer cannot be replaced; if the cord is damaged, the transformer should be discarded.

 Roland®

70783723

UPC

70783723



10961

 **BOSS**

70783723

'95-12-B3-11SE