

Roland®

# SRQ-2031



## Owner's Manual

Before using this unit, carefully read the sections entitled: "IMPORTANT SAFETY INSTRUCTIONS" (p. 2), "USING THE UNIT SAFELY" (p. 3, 4), and "IMPORTANT NOTES" (p. 5). These sections provide important information concerning the proper operation of the unit. Additionally, in order to feel assured that you have gained a good grasp of every feature provided by your new unit, owner's manual should be read in its entirety. The manual should be saved and kept on hand as a convenient reference.

The explanations in this manual include illustrations that depict what should typically be shown on the display. Note, however, that your unit may incorporate a newer, enhanced version of the system (e.g., includes newer sounds), so what you actually see in the display may not always match what appears in the manual.

Copyright © 2000 ROLAND CORPORATION

All rights reserved. No part of this publication may be reproduced in any form without the written permission of ROLAND CORPORATION.

	<b>CAUTION</b> RISK OF ELECTRIC SHOCK DO NOT OPEN	
<b>ATTENTION:</b> RISQUE DE CHOC ELECTRIQUE NE PAS OUVRIR		
<b>CAUTION:</b> TO REDUCE THE RISK OF ELECTRIC SHOCK, DO NOT REMOVE COVER (OR BACK). NO USER-SERVICEABLE PARTS INSIDE. REFER SERVICING TO QUALIFIED SERVICE PERSONNEL.		



The lightning flash with arrowhead symbol, within an equilateral triangle, is intended to alert the user to the presence of uninsulated "dangerous voltage" within the product's enclosure that may be of sufficient magnitude to constitute a risk of electric shock to persons.



The exclamation point within an equilateral triangle is intended to alert the user to the presence of important operating and maintenance (servicing) instructions in the literature accompanying the product.

INSTRUCTIONS PERTAINING TO A RISK OF FIRE, ELECTRIC SHOCK, OR INJURY TO PERSONS.

## IMPORTANT SAFETY INSTRUCTIONS

### SAVE THESE INSTRUCTIONS

**WARNING** - When using electric products, basic precautions should always be followed, including the following:

1. Read these instructions.
2. Keep these instructions.
3. Heed all warnings.
4. Follow all instructions.
5. Do not use this apparatus near water.
6. Clean only with a damp cloth.
7. Do not block any of the ventilation openings. Install in accordance with the manufacturers instructions.
8. Do not install near any heat sources such as radiators, heat registers, stoves, or other apparatus (including amplifiers) that produce heat.
9. Do not defeat the safety purpose of the polarized or grounding-type plug. A polarized plug has two blades with one wider than the other. A grounding type plug has two blades and a third grounding prong. The wide blade or the third prong are provided for your safety. When the provided plug does not fit into your outlet, consult an electrician for replacement of the obsolete outlet.
10. Protect the power cord from being walked on or pinched particularly at plugs, convenience receptacles, and the point where they exit from the apparatus.
11. Only use attachments/accessories specified by the manufacturer.
12. Never use with a cart, stand, tripod, bracket, or table except as specified by the manufacturer, or sold with the apparatus. When a cart is used, use caution when moving the cart/apparatus combination to avoid injury from tip-over. 
13. Unplug this apparatus during lightning storms or when unused for long periods of time.
14. Refer all servicing to qualified service personnel. Servicing is required when the apparatus has been damaged in any way, such as power-supply cord or plug is damaged, liquid has been spilled or objects have fallen into the apparatus, the apparatus has been exposed to rain or moisture, does not operate normally, or has been dropped.

For the U.K.

**IMPORTANT:** THE WIRES IN THIS MAINS LEAD ARE COLOURED IN ACCORDANCE WITH THE FOLLOWING CODE.

BLUE: NEUTRAL  
 BROWN: LIVE

As the colours of the wires in the mains lead of this apparatus may not correspond with the coloured markings identifying the terminals in your plug, proceed as follows:  
 The wire which is coloured BLUE must be connected to the terminal which is marked with the letter N or coloured BLACK.  
 The wire which is coloured BROWN must be connected to the terminal which is marked with the letter L or coloured RED.  
 Under no circumstances must either of the above wires be connected to the earth terminal of a three pin plug.

# USING THE UNIT SAFELY

## INSTRUCTIONS FOR THE PREVENTION OF FIRE, ELECTRIC SHOCK, OR INJURY TO PERSONS

### About ⚠ WARNING and ⚠ CAUTION Notices

<b>⚠ WARNING</b>	Used for instructions intended to alert the user to the risk of death or severe injury should the unit be used improperly.
<b>⚠ CAUTION</b>	Used for instructions intended to alert the user to the risk of injury or material damage should the unit be used improperly. * Material damage refers to damage or other adverse effects caused with respect to the home and all its furnishings, as well to domestic animals or pets.

### About the Symbols

	The ⚠ symbol alerts the user to important instructions or warnings. The specific meaning of the symbol is determined by the design contained within the triangle. In the case of the symbol at left, it is used for general cautions, warnings, or alerts to danger.
	The ⓧ symbol alerts the user to items that must never be carried out (are forbidden). The specific thing that must not be done is indicated by the design contained within the circle. In the case of the symbol at left, it means that the unit must never be disassembled.
	The ● symbol alerts the user to things that must be carried out. The specific thing that must be done is indicated by the design contained within the circle. In the case of the symbol at left, it means that the power-cord plug must be unplugged from the outlet.

### ALWAYS OBSERVE THE FOLLOWING



#### ⚠ WARNING

- Before using this unit, make sure to read the instructions below, and the Owner's Manual.
- Do not open or perform any internal modifications on the unit.
- Do not attempt to repair the unit, or replace parts within it (except when this manual provides specific instructions directing you to do so). Refer all servicing to your retailer, the nearest Roland Service Center, or an authorized Roland distributor, as listed on the "Information" page.
- Never use or store the unit in places that are:
  - Subject to temperature extremes (e.g., direct sunlight in an enclosed vehicle, near a heating duct, on top of heat-generating equipment); or are
  - Damp (e.g., baths, washrooms, on wet floors); or are
  - Humid; or are
  - Exposed to rain; or are
  - Dusty; or are
  - Subject to high levels of vibration.
- This unit should be used only with a rack or stand that is recommended by Roland.
- When using the unit with a rack or stand recommended by Roland, the rack or stand must be carefully placed so it is level and sure to remain stable. If not using a rack or stand, you still need to make sure that any location you choose for placing the unit provides a level surface that will properly support the unit, and keep it from wobbling.









#### ⚠ WARNING

- The unit should be connected to a power supply only of the type described in the operating instructions, or as marked on the unit.
- Do not excessively twist or bend the power cord, nor place heavy objects on it. Doing so can damage the cord, producing severed elements and short circuits. Damaged cords are fire and shock hazards!
- This unit, either alone or in combination with an amplifier and headphones or speakers, may be capable of producing sound levels that could cause permanent hearing loss. Do not operate for a long period of time at a high volume level, or at a level that is uncomfortable. If you experience any hearing loss or ringing in the ears, you should immediately stop using the unit, and consult an audiologist.
- Do not allow any objects (e.g., flammable material, coins, pins); or liquids of any kind (water, soft drinks, etc.) to penetrate the unit.
- In households with small children, an adult should provide supervision until the child is capable of following all the rules essential for the safe operation of the unit.
- Protect the unit from strong impact. (Do not drop it!)

**⚠ WARNING**

- Do not force the unit's power-supply cord to share an outlet with an unreasonable number of other devices. Be especially careful when using extension cords—the total power used by all devices you have connected to the extension cord's outlet must never exceed the power rating (watts/amperes) for the extension cord. Excessive loads can cause the insulation on the cord to heat up and eventually melt through. 
- Before using the unit in a foreign country, consult with your retailer, the nearest Roland Service Center, or an authorized Roland distributor, as listed on the "Information" page. 

**⚠ CAUTION**

- The unit should be located so that its location or position does not interfere with its proper ventilation. 
- Always grasp only the plug on the power-supply cord when plugging into, or unplugging from, an outlet or this unit. 
- Try to prevent cords and cables from becoming entangled. Also, all cords and cables should be placed so they are out of the reach of children. 
- Never climb on top of, nor place heavy objects on the unit. 
- Never handle the power cord or its plugs with wet hands when plugging into, or unplugging from, an outlet or this unit. 
- Before moving the unit, disconnect the power plug from the outlet, and pull out all cords from external devices. 
- Before cleaning the unit, turn off the power and unplug the power cord from the outlet. 
- Whenever you suspect the possibility of lightning in your area, pull the plug on the power cord out of the outlet. 

# IMPORTANT NOTES

In addition to the items listed under "IMPORTANT SAFETY INSTRUCTIONS" and "USING THE UNIT SAFELY" on pages 2 and 3, please read and observe the following:

## Power Supply

- Do not use this unit on the same power circuit with any device that will generate line noise (such as an electric motor or variable lighting system).
- Before connecting this unit to other devices, turn off the power to all units. This will help prevent malfunctions and/or damage to speakers or other devices.

## Placement

- Using the unit near power amplifiers (or other equipment containing large power transformers) may induce hum. To alleviate the problem, change the orientation of this unit; or move it farther away from the source of interference.
- This device may interfere with radio and television reception. Do not use this device in the vicinity of such receivers.
- To avoid possible breakdown, do not use the unit in a wet area, such as an area exposed to rain or other moisture.

## Maintenance

- For everyday cleaning wipe the unit with a soft, dry cloth or one that has been slightly dampened with water. To remove stubborn dirt, use a cloth impregnated with a mild, non-abrasive detergent. Afterwards, be sure to wipe the unit thoroughly with a soft, dry cloth.
- Never use benzine, thinners, alcohol or solvents of any kind, to avoid the possibility of discoloration and/or deformation.

## Additional Precautions

- Please be aware that the contents of memory can be irretrievably lost as a result of a malfunction, or the improper operation of the unit. To protect yourself against the risk of losing important data, we recommend that you periodically save a backup copy of important data you have stored in the unit's memory in another MIDI device (e.g., a sequencer).
- Unfortunately, it may be impossible to restore the contents of data that was stored in another MIDI device (e.g., a sequencer) once it has been lost. Roland Corporation assumes no liability concerning such loss of data.

- Use a reasonable amount of care when using the unit's buttons, sliders, or other controls; and when using its jacks and connectors. Rough handling can lead to malfunctions.
- Never strike or apply strong pressure to the display.
- When connecting / disconnecting all cables, grasp the connector itself—never pull on the cable. This way you will avoid causing shorts, or damage to the cable's internal elements.
- A small amount of heat will radiate from the unit during normal operation.
- To avoid disturbing your neighbors, try to keep the unit's volume at reasonable levels (especially when it is late at night).
- When you need to transport the unit, package it in the box (including padding) that it came in, if possible. Otherwise, you will need to use equivalent packaging materials.
- Use a cable from Roland to make the connection. If using some other make of connection cable, please note the following precautions.
  - Some connection cables contain resistors. Do not use cables that incorporate resistors for connecting to this unit. The use of such cables can cause the sound level to be extremely low, or impossible to hear. For information on cable specifications, contact the manufacturer of the cable.

# Table of Contents

<b>USING THE UNIT SAFELY .....</b>	<b>3</b>
<b>IMPORTANT NOTES .....</b>	<b>5</b>
<b>Table of Contents .....</b>	<b>6</b>
<b>Features .....</b>	<b>7</b>
Low-Noise, High-Quality Sounds (24bit AD/DA)	7
Easy Operation .....	7
Noise Gate Function .....	7
Time Alignment Function .....	7
“Wide” Function Allows Control of Multiple Bands	7
Search Function .....	7
Flat Function .....	7
Link Function .....	7
16 User Memory Bank .....	7
31 Bands x 2 Channels in a 1U Size Unit .....	7
Bypass Control with a Foot switch (p. 33) .....	7
<b>Front and Rear Panel .....</b>	<b>8</b>
Front Panel .....	8
Rear Panel .....	8
LCD Display .....	8
<b>Basic Operations .....</b>	<b>9</b>
Before You Begin .....	9
Connections .....	10
Turning On the Power .....	13
To Set the Input and Output Level .....	14
Internal Signal Flow .....	14
Setting the Input Level .....	14
Setting the Output Level (OUTPUT) .....	14
Changing the Input/Output Routing (INPUT	
SELECT) .....	15
To Let the Signals Bypass the Effect (BYPASS) .....	16
To Disable the Controls (LOCK) .....	16
Locking the Controls .....	16
Unlocking the Controls .....	16
Setting the Lock Function Level .....	17
To Edit System Parameters .....	17
Setting the Gain Level Controlling Range By Steps	
(STEP GAIN) .....	17
Readjusting the Frequency slider (CALIBRATION)	
18 .....	18
Adjusting the Contrast of the Display (LCD	
CONTRAST) .....	19
Changing How Things Are Displayed (GAIN	
SYMBOL) .....	19
Adjusting the Output Level	
(OUTPUT) .....	20
Link Function	
(LINK) .....	20
Noise Gate	
(NOISE GATE) .....	20
Time Alignment	
(TIME ALIGNEMENT) .....	20
Lock Function	
(LOCK) .....	20
Morphing	
(MORPHING) .....	20
Foot Switch	
(FOOT SWITCH) .....	20
MIDI .....	20
<b>To Select Channels .....</b>	<b>21</b>
Setting Each Channel .....	21
Controlling a Pair of Stereo Signals (LINK) .....	21
Linking Both Channels .....	21

Selecting the Link Type .....	22
Copying the Settings of One Channel to the Other	
22 .....	22
<b>Sound Creation .....</b>	<b>23</b>
Adjusting the Tone (Editing the Graphic Equalizer) .....	23
Normal Use of the Equalizer .....	23
About the Play Mode .....	23
Setting the Entire Gain Level Back to 0 dB (FLAT).	
24 .....	24
Detecting the Feedback Point (SEARCH) .....	24
Drawing an Easy EQ Curve Line (SWEEP) .....	26
Simultaneously Adjusting A Wide Range Of	
Adjacent Bands (WIDE) .....	26
Smoothing the Transition Between Memories	
(MORPHING) .....	27
To Cut the Gain of Selected Frequencies to -60dB	
(TOTAL CUT) .....	28
Reducing the Remaining Noise (NOISE GATE) .....	29
To Refine the Time Lag Between Channel Outputs	
(TIME ALIGNMENT) .....	30
To Recover the Settings (UNDO/REDO) .....	30
<b>To Store/Recall the Present Settings</b>	
<b>(MEMORY SAVE/LOAD) .....</b>	<b>31</b>
To Store the Current Settings (MEMORY SAVE) .....	31
To Recall the Stored Settings (MEMORY LOAD) .....	32
<b>Remote Control .....</b>	<b>33</b>
Using A Foot Switch .....	33
To Let the Signals Bypass the Effect (BYPASS) .....	33
Recalling Memorized Settings in Turns (MEMORY	
ROTATION) .....	33
Use With MIDI Devices .....	34
About MIDI .....	34
Changing settings from External MIDI Devices .....	35
Sending and Receiving Settings Via MIDI (BULK	
DUMP/LOAD) .....	37
<b>Reference .....</b>	<b>40</b>
Troubleshooting .....	40
There is No Sound or the Sound is Too Low .....	40
The Sound is Distorted .....	40
MIDI Messages Are Not Being Received .....	40
Display Messages .....	40
Equalizer Characteristics .....	41
User Interface Guide .....	42
MIDI Implementation Chart .....	43
Block Diagram .....	44
<b>Specification .....</b>	<b>45</b>
<b>Index .....</b>	<b>46</b>

# Features

## Low-Noise, High-Quality Sounds (24bit AD/DA)

With the 24-bit AD/DA converter, this unit provides low-noise, high-quality sounds.

## Easy Operation

The Frequency slider and dial encoder ensure simple and quick analog-like command of this unit.

## Noise Gate Function

Cuts the noise that enters as a mixture with input signals heard at soundless points. The 24-bit AD/DA converter ensures overall noise reduction with this unit, and also reduces noise from external sources (p. 29).

## Time Alignment Function

In a system consisting of multiple speakers, the Time Alignment (delay) function allows you to correct for the negative effects on sound quality that can occur as the result of the differences in the amount of time it takes for sound to arrive from the various speakers. In addition to the delay time, the distance is indicated in the display, which should make it easier to quickly perform onsite adjustments (p. 30).

## “Wide” Function Allows Control of Multiple Bands

The Wide function enables you to control a desired range of frequencies simultaneously at scenes where easy and quick equalizing is required (p. 26).

## Search Function

Simply by moving the Frequency slider, you can carry out equalization much like you can with a parametric EQ. This comes in handy when you want to do things such as find the point where feedback occurs, or find that sweet spot (p. 24).

## Flat Function

You can reset the EQ curve line into a flat position (p. 24).

## Link Function

By linking CH1 and CH2, you can operate both channels simultaneously (p. 21).

## 16 User Memory Bank

You can recall up to 16 memorized programs at certain scenes, and also compare several EQ settings with a touch of a button (p. 31).

## 31 Bands x 2 Channels in a 1U Size Unit

## Bypass Control with a Foot switch (p. 33)

# Front and Rear Panel

## Front Panel

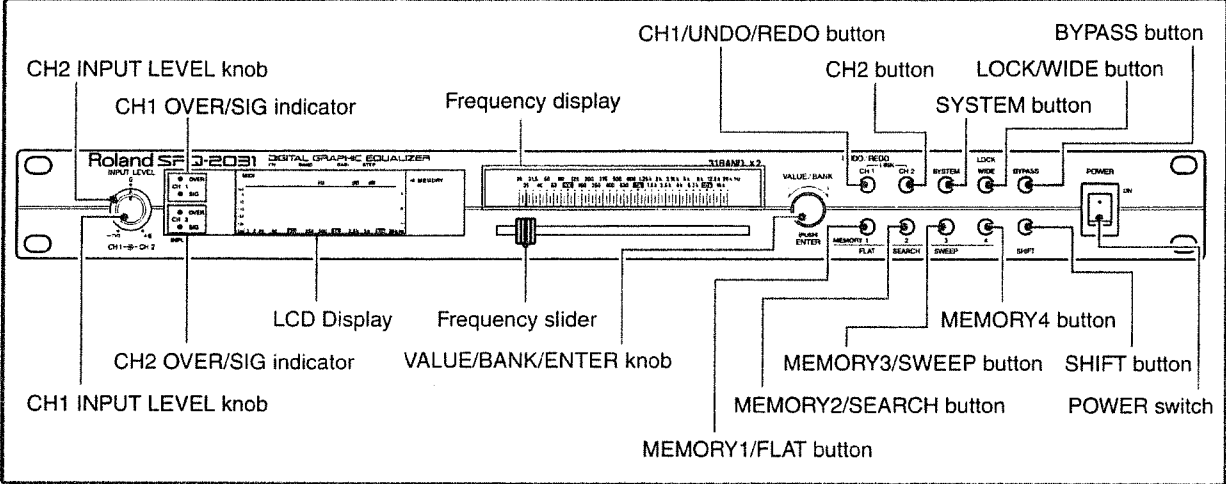

## Rear Panel

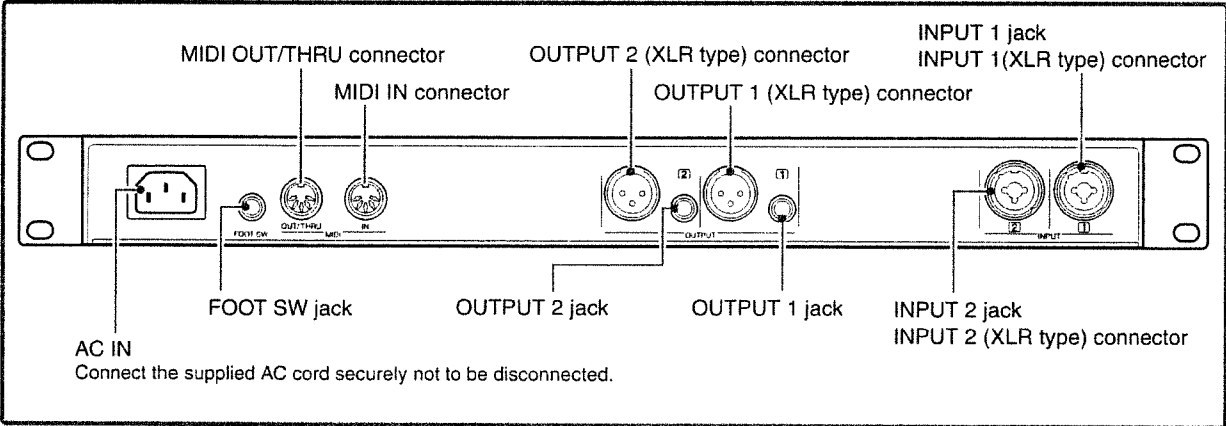

## LCD Display

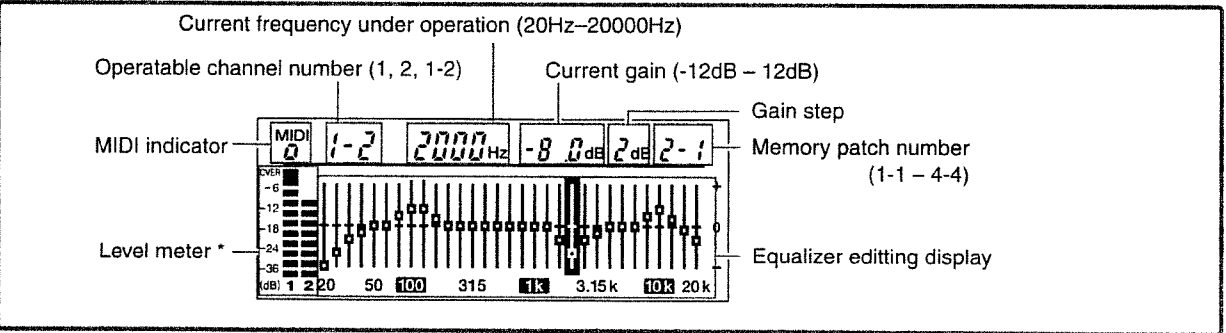

\* The Level Meter shows the output level of the EQ setting (p. 14).



# Basic Operations

## Before You Begin

Do the necessary preparations before you start operations.

### NOTE

- If you are using this unit alone, attach the supplied rubber stand to the bottom.
- Use the washers included with the unit when rack-mounting the unit.

## Notes on making the connections

When making connections, be sure to observe these precautions. Otherwise, you risk malfunction and/or damage to other connected equipment.

- To prevent malfunction and/or damage to speakers or other devices, always turn down the volume, and turn off the power on all devices before making any connections.
- Do not connect the SRQ-2031 to the output of a power amplifier.
- The pin assignment for the XLR type connectors (input) is as shown below. Before making any connections, make sure that this pin assignment is compatible with that of all your other devices.

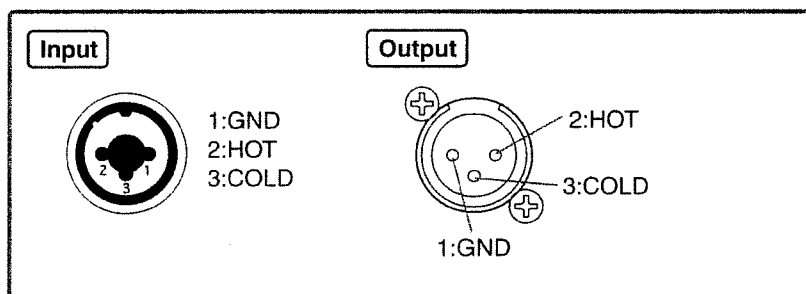

- The phone jacks support balanced input/output using TRS standard stereo plugs. (Also accepts unbalanced input.)

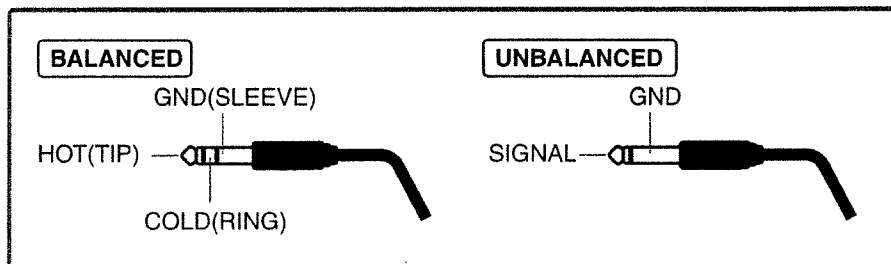

### NOTE

Do not connect to an XLR connector and a TRS plug at the same time.

## Basic Operations

### Connections

The SRQ-2031 can be connected up in various ways depending on how it is to be used. Refer to the example setups that are given in the following.

#### Using with an Entire PA System

This is an example of a connection that uses the SRQ-2031 for processing sound equalizing to all devices that are connected to the mixing console. You can adjust the tone of the total output sound.

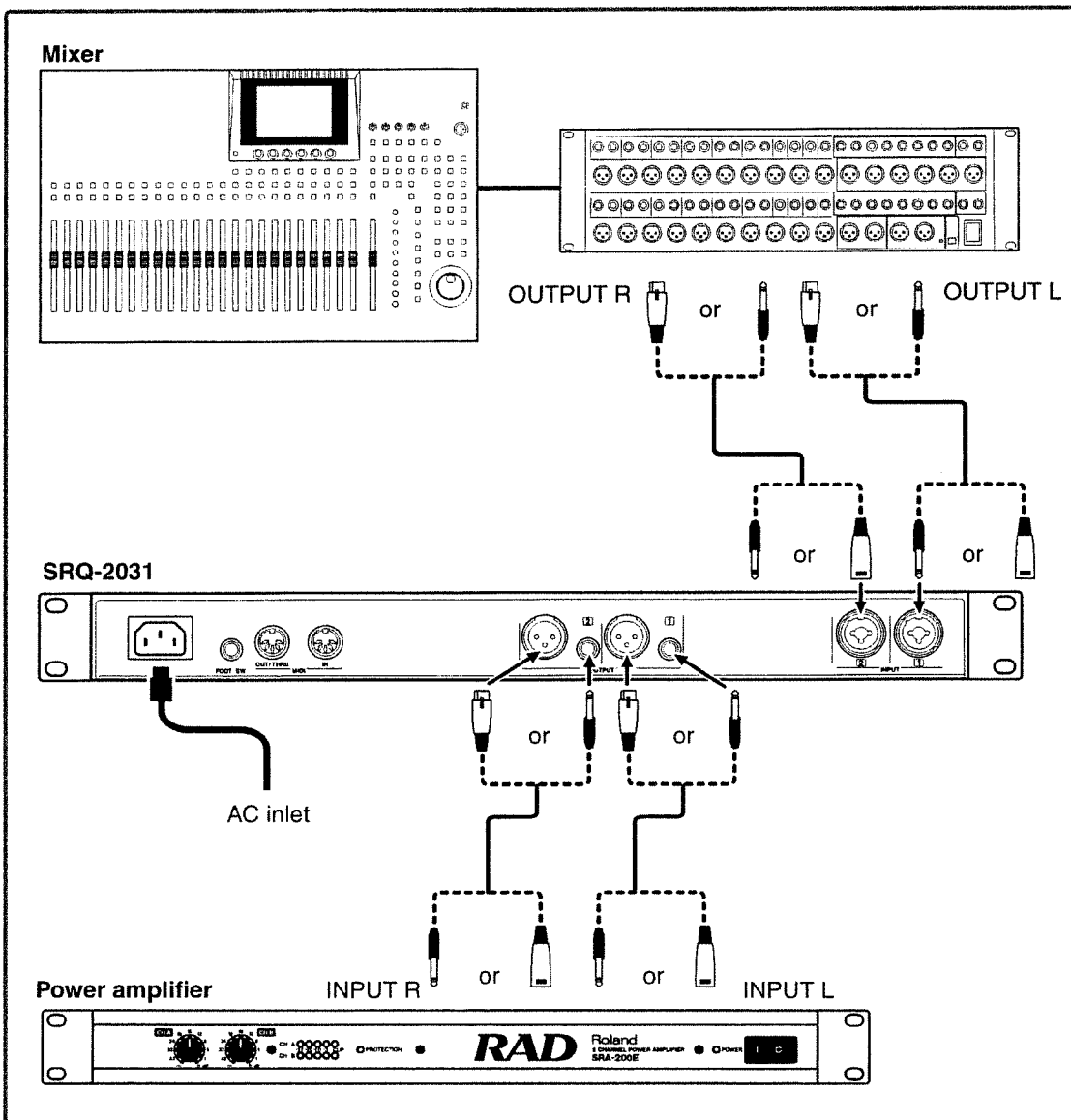

A signal that's been input in monaural can be output on two channels if you change the internal signal routing (p. 15). Connect other equipment or the mixer to INPUT 1 or INPUT 2.

### Using With a Specific Microphone or Instrument

This is an example of a connection that uses the SRQ-2031 with only a specific microphone or instrument. When the SRQ-2031 for a microphone, connect the microphone to a channel insertion on a mixer.

#### Inserting on a Mixing Channel

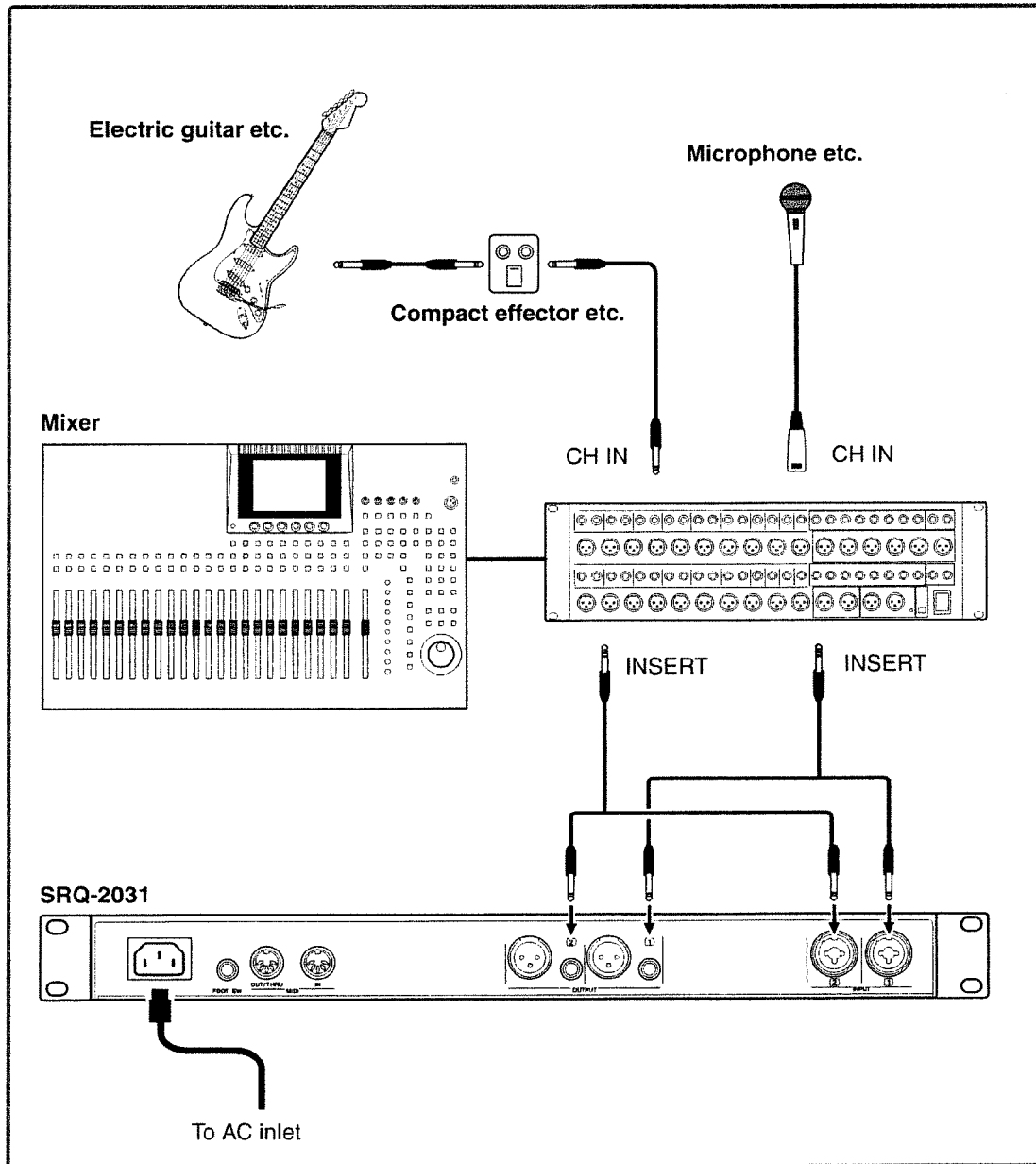

Basic Operations

When connecting the cables, be sure to use the specified cables for your mixer.

## Basic Operations

### Connecting Instruments Directly

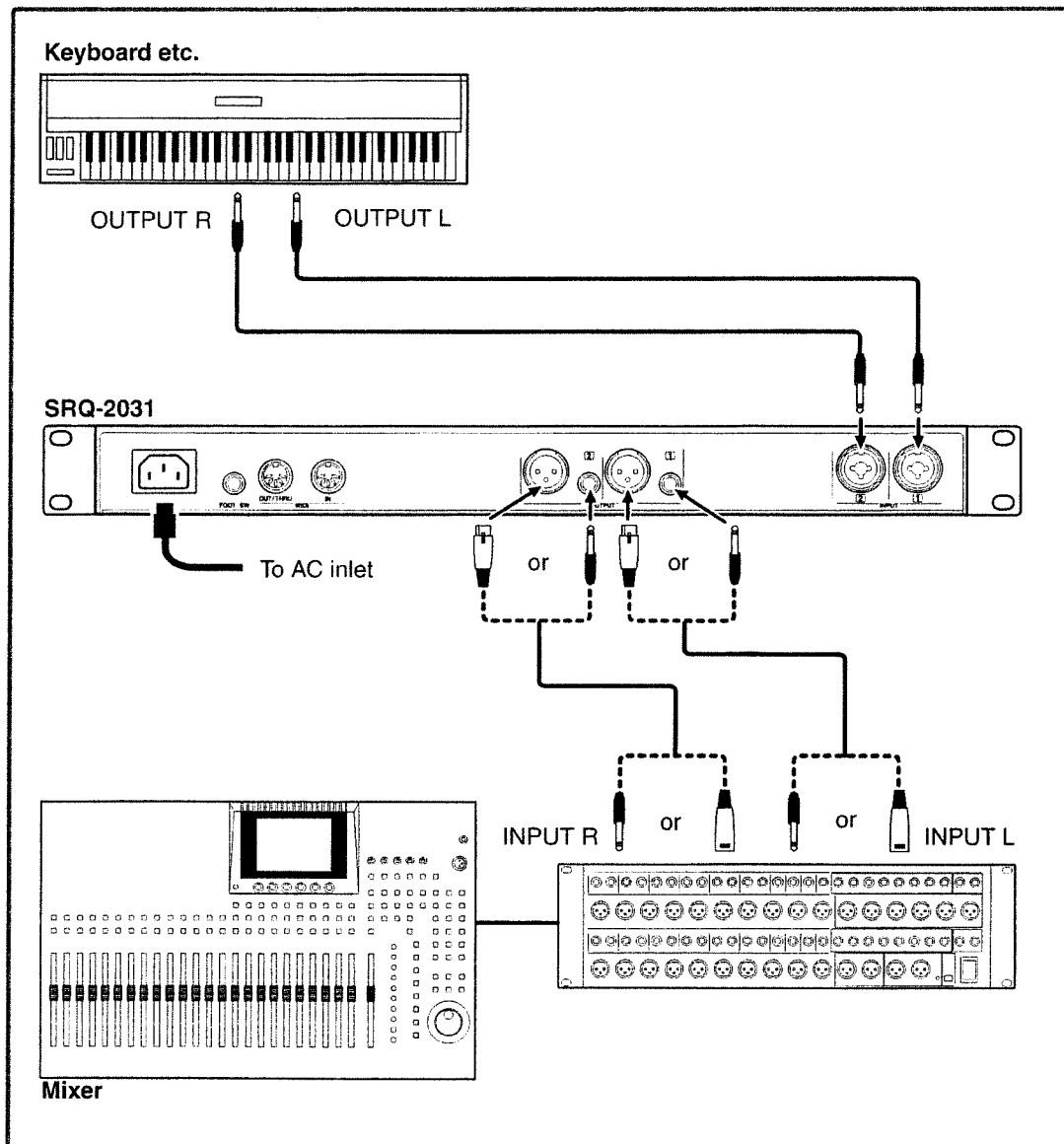

A signal that's been input in monaural can be output on two channels if you change the internal signal routing (p. 15). Connect other equipment or the mixer to INPUT 1 or INPUT 2.

## Connecting External Devices

You can remotely control some of the functions of the SRQ-2031 using a connected foot switch (p. 33).

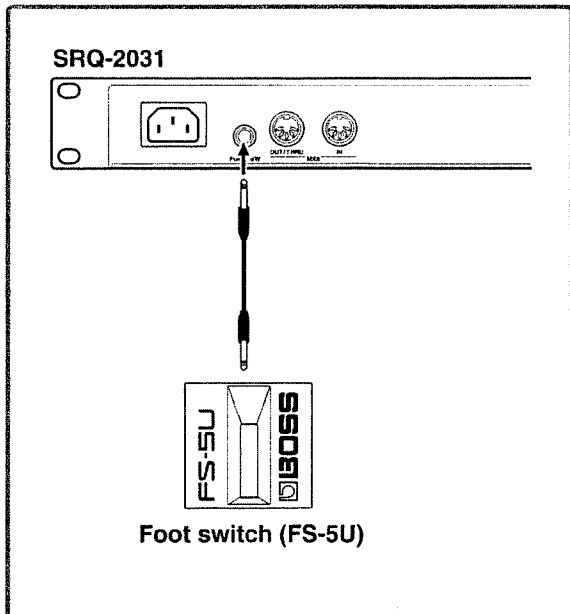

- When connecting a foot switch (FS-5U; sold separately) to the FOOT SW jack, set the polarity switch as shown below.

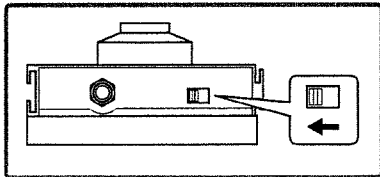

## Turning On the Power

Once the connections have been completed (p. 10), turn on the power to your various devices in the order specified. By turning on devices in the wrong order, you risk causing malfunction and/or damage to speakers and other devices.

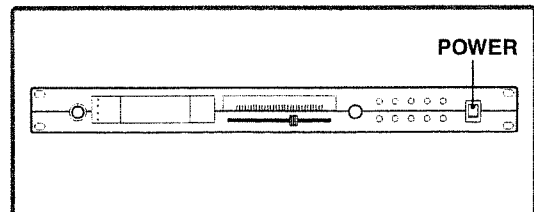

Power on your equipment as described in the following. After the devices are powered on, set the volumes to each connected device equipment.

- Turn the volume controls on your equipment all the way down before powering up.

**Keyboards, etc. → SRQ-2031 → Mixing Console → Power Amplifier**

A few seconds after power-up, the display changes as shown below. This is the default status called "Play Mode" (p. 23).

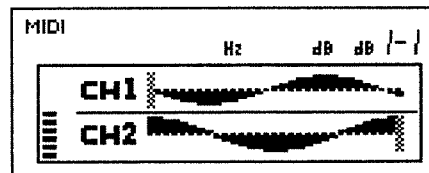

- This unit is equipped with a protection circuit. A brief interval (a few seconds) after power-up is required before the unit can operate normally.
- When powered off, the SRQ-2031 will send out any input signal directly through the output.
- Depending on the placement of the SRQ-2031, you may experience difficulty reading the display. In this case, you can adjust the contrast of the display (p. 19).

## Turning Off the Power

Power down your equipment in the reverse order of the power-on procedure.

### Points to check before powering down

Make sure that the volumes of all connected audio equipment is turned all the way down.

- If you leave the volume levels of your equipment turned up when you turn off the power, a loud noise may occur that can cause damage to your equipment.



When the "KEEP POWER ON" message (p. 40) appears in the display, do not turn off the power. If you do, the unit may return to the initial factory setting.

## Basic Operations

### To Set the Input and Output Level

#### Internal Signal Flow

The diagram below provides an overview of the audio signal flow. For further information, see the Block Diagram (p. 44).

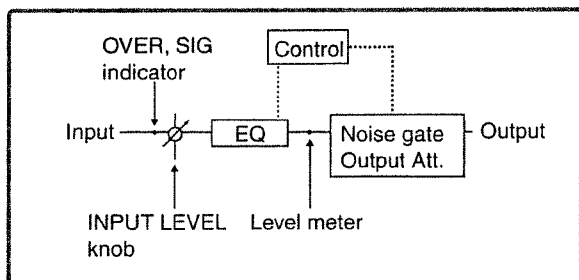

The level meter on this unit indicates the EQ output level, and is positioned in front of the level meter control. To adjust the overall output level, refer to "Setting the Output Level" (p. 14).

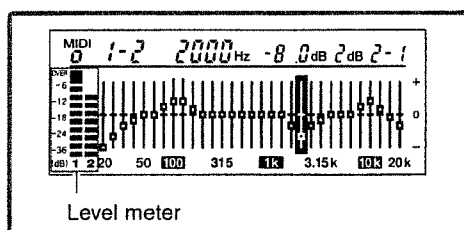

When the level meter shows input overload during the EQ setting, audio signals are distorted. Be sure to set the input signals to an appropriate level.

#### Setting the Input Level

Set the preferred input level for input signals. The SRQ-2031 has a two-channel input, and you can adjust the input level for each channel individually.

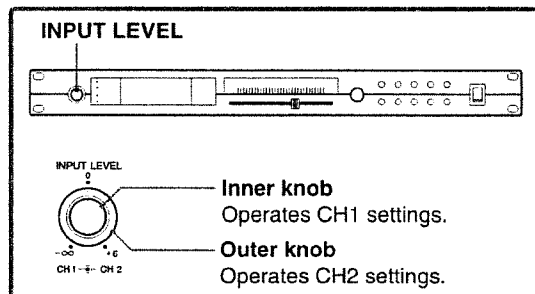

#### For Balanced Output

It is recommended that the [INPUT LEVEL] knob be normally positioned at "0." The "0" position is the Uni-Gain position, where the output level is the same as the level of input signals.

When the unit is accepting sound signals, "SIG" lights in green.

If OVER lights up, reduce the output level from the connected devices.

#### For Unbalanced Output

With the [INPUT LEVEL] knob positioned at 0 the volume goes down at BYPASS mode (p. 16). To set the level to Uni-Gain, adjust the level of the input signals by turning [INPUT LEVEL].

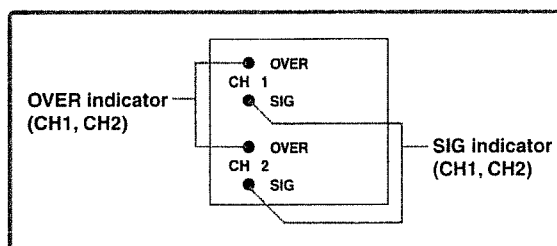

#### Setting the Output Level (OUTPUT)

Set the output level for each connected equipment. You can adjust the output level from each channel individually.

You can also readjust out-of-phase signals by inverting the phase on each channel.

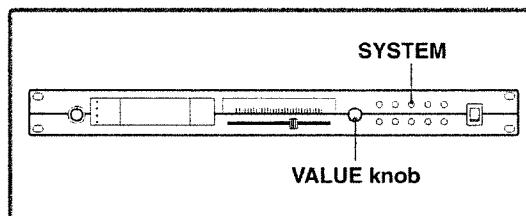

1. Press [SYSTEM].

[SYSTEM] lights in green, and the "SYSTEM SETTING" screen appears.

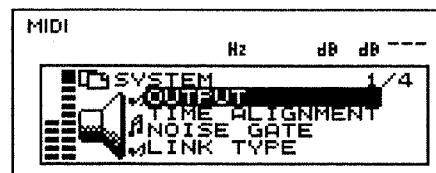

- Turn [VALUE] to select "OUTPUT," then press [VALUE].

The "OUTPUT" screen appears.

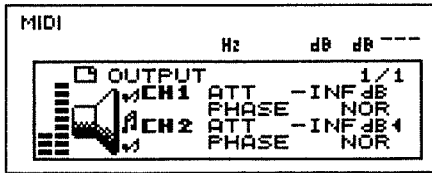

- Turn [VALUE] to select the value you wish to adjust, then press [VALUE].

• **CH 1 ATT**

Adjusts the output level from channel 1.  
0dB -- -60dB, -INF (-∞) dB

• **CH 1 PHASE**

Sets the phase for channel 1.  
NOR : Normal phase  
INV : Inverted phase

• **CH 2 ATT**

Adjusts the output level from channel 2.  
0dB -- -60dB, -INF (-∞) dB

• **CH 2 PHASE**

Sets the phase for channel 2.  
NOR : Normal phase  
INV : Inverted phase

- Turn [VALUE] to adjust the output level.  
Press [SYSTEM] twice. The settings are placed in effect, and you're returned to the Play Mode.



The output level is stored to the system memory when you store a setting (p. 31).

## Changing the Input/Output Routing (INPUT SELECT)

You can output a monaural input source separately from CH1 and CH2 by changing the internal signal flow.



Since the unit divides the signal before EQ, the EQ settings for CH1 and CH2 are reflected to each output signal.

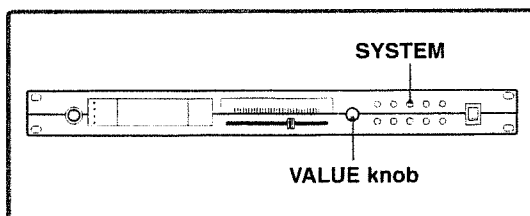

- Press [SYSTEM].

[SYSTEM] lights in green, and the "SYSTEM SETTING" screen appears.

- Turn [VALUE] to select "INPUT SELECT," then press [VALUE].

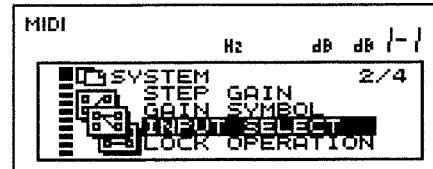

The "INPUT SELECT" screen appears.

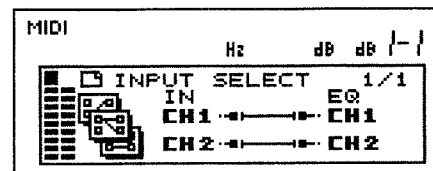

- Turn [VALUE] to define the INPUT and OUTPUT routes.

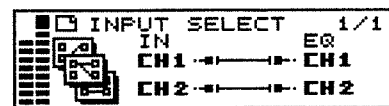

Set the routes for 2-channel input and 2-channel output.



Route the CH 1 input source to CH1 and CH2 output separately.



Route the CH 2 input source to CH1 and CH2 output separately.



Route each of the 2-channel input source to its opposite output channel.

When you press [SYSTEM], the "NOW WORKING KEEP POWER ON" message appears in the display, and the settings are placed in effect, then the "SYSTEM SETTING" screen reappears.

Press [SYSTEM] again to go to the Play Mode.



At BYPASS mode, the signal path remain as CH1-CH1, CH2-CH2, regardless to these settings

### To Let the Signals Bypass the Effect (BYPASS)

You can disable the equalizing effect and send the input signal directly through the output, by using the BYPASS function.

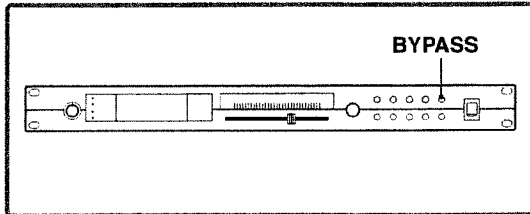

1. Press [BYPASS].  
[BYPASS] lights in orange, and the BYPASS function is on.

### To Turn Off the BYPASS Function

Press [BYPASS] once again to turn off the light of the button.



You can also turn on/off the BYPASS function using a foot switch (FS-5U; sold separately) (p. 33).



The BYPASS settings are stored to the system memory when you store a setting (p. 31).

### To Disable the Controls (LOCK)

You can disable the functions of buttons and knobs on the panel and protect the settings by turning on the LOCK function. The LOCK function can be set to either “all controls” or “all controls except the [MEMORY] buttons.”

### Locking the Controls

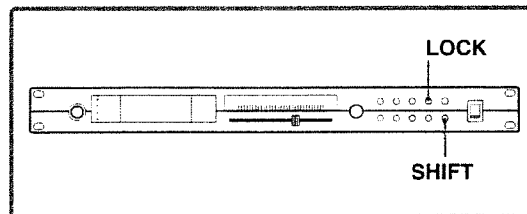

1. While pressing [SHIFT], press [LOCK].  
“LOCK LEVEL 1” or “LOCK LEVEL 1” appears in the display, and the LOCK function is turned on.

### Unlocking the Controls

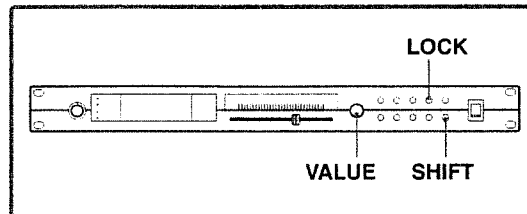

1. While pressing [SHIFT] and [VALUE], press [LOCK].



The LOCK function setting remains effective even after you power-off the unit.



## Setting the Lock Function Level

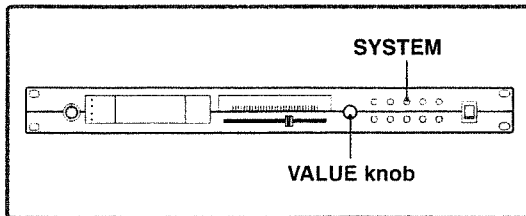

1. Press [SYSTEM].  
[SYSTEM] lights in green, and the "SYSTEM SETTING" screen appears.
2. Turn [VALUE] to select "LOCK OPERATION," then press [VALUE].

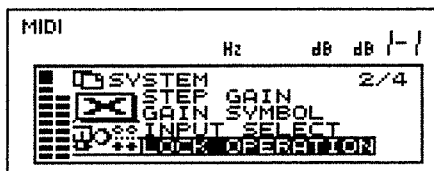

The "LOCK OPERATION" screen appears.

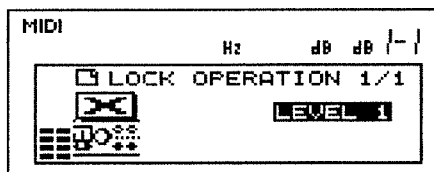

3. Turn [VALUE] to select "LEVEL 1" or "LEVEL 2," then press [VALUE].
  - **LEVEL 1**  
Locks all controls except the [MEMORY] buttons.
  - **LEVEL 2**  
Locks all controls.

When you press [SYSTEM], the "NOW WORKING KEEP POWER ON" message appears in the display, and the settings are placed in effect, then the "SYSTEM SETTING" screen reappears.

Press [SYSTEM] again to go to the Play Mode



The MIDI remote control function works during the LOCK function is ON.

## To Edit System Parameters

This chapter explains the system setup of this unit.

### Setting the Gain Level Controlling Range By Steps (STEP GAIN)

You can set the controlling range by steps when adjusting the overall value of the gain level. The "rough" step setting enables you to change the value faster, while the "smooth" step setting can be used for intensive adjustment of the equalizer.

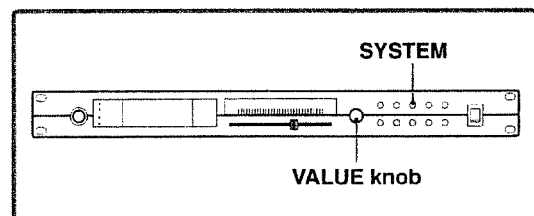

1. Press [SYSTEM].  
[SYSTEM] lights in green, and the "SYSTEM SETTING" screen appears.
2. Turn [VALUE] to select "STEP GAIN," then press [VALUE].

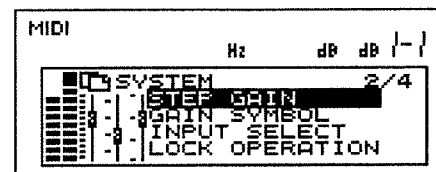

The "STEP GAIN" screen appears.

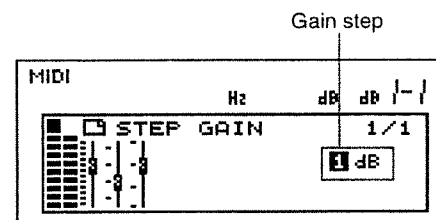

3. Turn [VALUE] to adjust the gain steps.  
You can select the steps from 1 to 6 dB.

Press [SYSTEM] twice. The settings are placed in effect, and you're returned to the Play Mode.



The gain steps are stored in system memory when you save your settings (p. 31).

## Basic Operations

### Readjusting the Frequency slider (CALIBRATION)

If the frequency rate shown in the display does not properly reflect the position of the Frequency slider, you can fine-adjust its position.



The fine tuning is carried out one calibration marking at a time. Once you have started the readjustment, be sure to complete the procedure. Otherwise, the setting will not take effect.

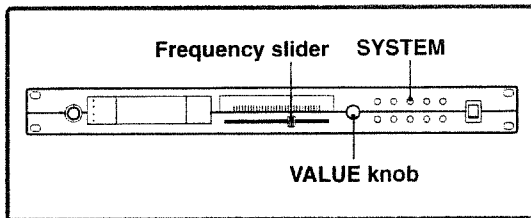

1. Press [SYSTEM].  
[SYSTEM] lights in green, and the "SYSTEM SETTING" screen appears.
2. Turn [VALUE] to select "CALIBRATION," then press [VALUE].

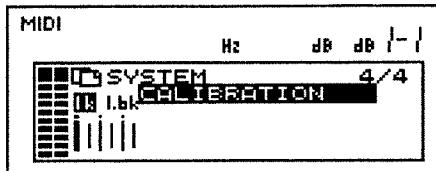

The "CALIBRATION" screen appears.

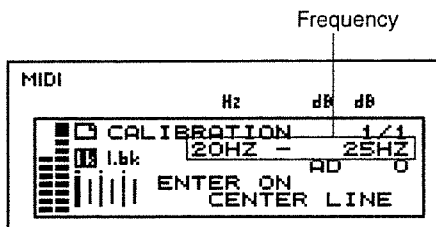

3. Move the Frequency slider so it points at the middle of the displayed frequency rate, then press [VALUE].  
Move the Frequency slider according to the displayed frequency rate as shown below.

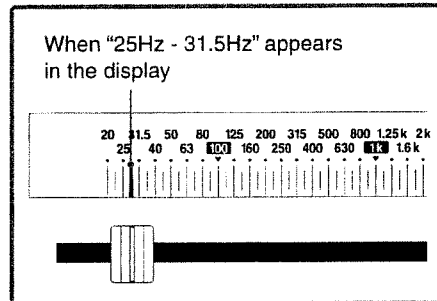

Press [VALUE]. The adjustment has been set, and the next frequency is shown in the display.

4. Repeat Step 3 to set the rest of the frequency rates.  
Proceed while checking the frequency rates shown in the display.

After the fine-tuning procedure is completed, the "NOW WORKING KEEP POWER ON" message appears in the display. The settings are placed in effect, and the "SYSTEM SETTING" screen reappears.

Press [SYSTEM] again to go to the Play Mode.

#### To Cancel the Readjusting

Press [SYSTEM] at any point during this operation. Any adjustments made up to this point are discarded, and the "SYSTEM SETTING" screen reappears. Press [SYSTEM] again to go to the Play Mode.

## Adjusting the Contrast of the Display (LCD CONTRAST)

You may wish to adjust the contrast of the display immediately after power-up, under unusual viewing conditions, or after the unit has been on for an extended period of time. Adjust the brightness of the screen as explained in the following.

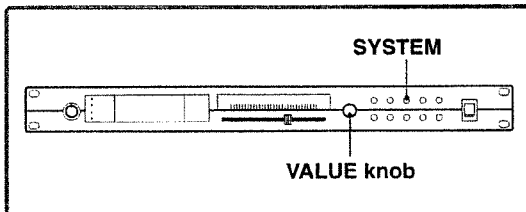

1. Press [SYSTEM].  
[SYSTEM] lights in green, and the "SYSTEM SETTING" screen appears.
2. Turn [VALUE] to select "LCD CONTRAST," then press [VALUE].

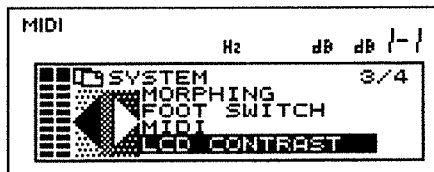

The "LCD CONTRAST" screen appears.

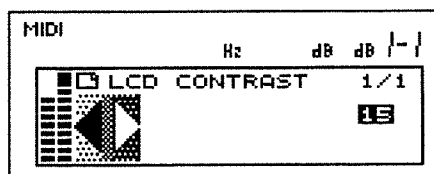

3. Turn [VALUE] to adjust the contrast of the display.

When you press [SYSTEM], the "NOW WORKING KEEP POWER ON" message appears in the display, and the settings are placed in effect, then the "SYSTEM SETTING" screen reappears.

Press [SYSTEM] again to go to the Play Mode.

## Changing How Things Are Displayed (GAIN SYMBOL)

You can change the display patterns of the frequency rates and the gain levels on the equalizer editing display (3 types).

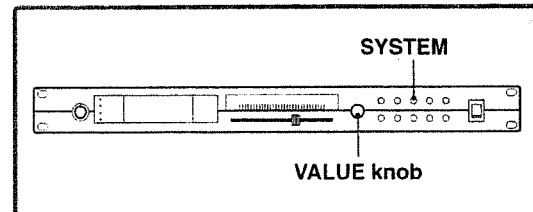

1. Press [SYSTEM].  
[SYSTEM] lights in green, and the "SYSTEM SETTING" screen appears.
2. Turn [VALUE] to select "GAIN SYMBOL," then press [VALUE].  
The "GAIN SYMBOL" screen appears.

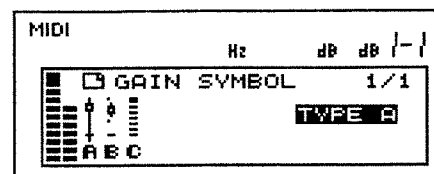

3. Turn [VALUE] to select the desired display pattern.

- TYPE A



- TYPE B

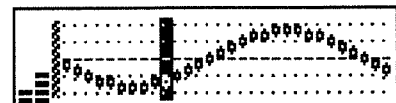

- TYPE C



Press [SYSTEM] twice. The settings are placed in effect, and you're returned to the Play Mode.

### HINT

The display pattern is stored to the system memory when you store a setting (p. 31).

## Basic Operations

The SRQ-2031 has the following System Parameters. You can edit the parameters on the "SYSTEM" editing screen. For further information about these parameters, read the reference pages for each parameter.

### Adjusting the Output Level (OUTPUT)

You can adjust the signals' output level according to each connected device (p. 14).

### Link Function (LINK)

You can adjust the gain level of both left and right channels of a stereo signal, and/or couple them for related settings (p. 21).

### Noise Gate (NOISE GATE)

By deleting all sound below a certain level, you can reduce the remaining noise that can be heard at soundless periods (p. 29).

### Time Alignment (TIME ALIGNEMENT)

If the speakers that are connected to the channels are placed at a wide distance, you can adjust the sound time lag for each channel using a delay effect (p. 30).

### Lock Function (LOCK)

You can prevent the settings from being changed by unintentional action to controls on the panel (p. 16).

### Morphing (MORPHING)

You can flatten the changing instant between 2 to 4 Memories. You can do this by MIDI control (p. 36), or you can set the Frequency slider to control the morphing during the Play Mode (p. 27).

### Foot Switch (FOOT SWITCH)

You can remotely control some functions of this unit by connecting a foot switch (p. 33).

### MIDI

You can set up the SRQ-2031 for MIDI connections (p. 34).

# To Select Channels

When setting the equalizer, first select a channel and then operate on the editing screen.

You can select from channel 1 (CH1) and channel 2 (CH2).

You can also link both channels and edit them together.

## Setting Each Channel

Set the equalizer for each channel.

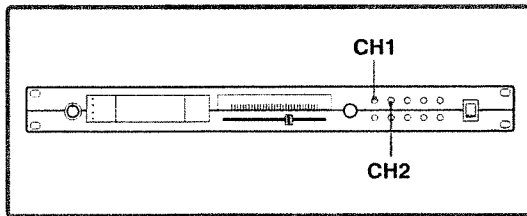

To set each channel separately, press [CH1] or [CH2] to select the channel you wish to control.

The selected button lights in green, and the equalizer editing screen appears.

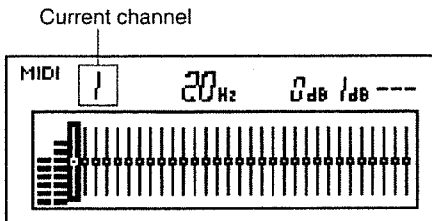

## Controlling a Pair of Stereo Signals (LINK)

You can control both left and right channels of a stereo signal at the same time. The LINK function also enables you to arrange for both channels to keep the same settings, or to give the same amount of change to the gain level for each channel.

## Linking Both Channels

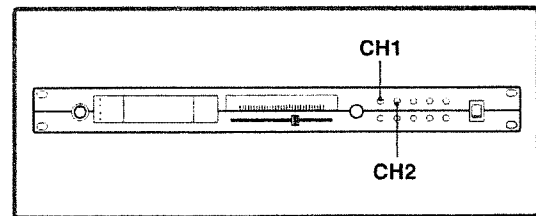

1. Press [CH1] and [CH2] at the same time.  
[CH1] and [CH2] blink, and the "LINK" screen appears.

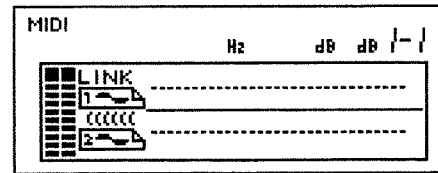

2. Press [CH1] or [CH2].  
[CH1] and [CH2] light in green, and the equalizer editing screen appears.

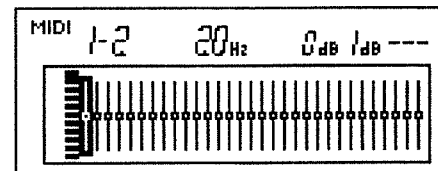

Settings made affect both channels.

## To Select Channels

### Selecting the Link Type

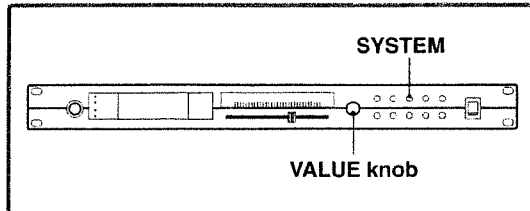

1. Press [SYSTEM].  
[SYSTEM] lights in green, and the "SYSTEM SETTING" screen appears.
2. Turn [VALUE] to select "LINK TYPE," then press [VALUE].

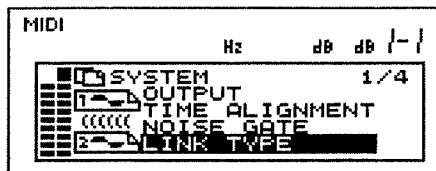

The "LINK TYPE" screen appears.

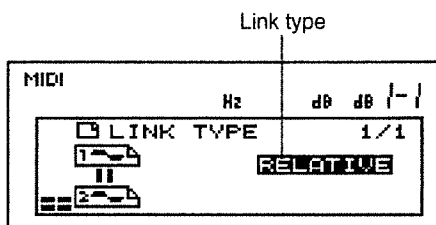

3. Turn [VALUE] to select the desired link type.
  - **ABSOLUTE**  
Both channels' gain level settings are the same.
  - **RELATIVE**  
Only the changed rate of the gain level to one channel will be related to the other.

Press [SYSTEM] twice. The settings are placed in effect, and you're returned to the Play Mode.



The link type is stored to the system memory when you store a setting (p. 31).

### Copying the Settings of One Channel to the Other

You can copy the entire settings of one channel to the other.

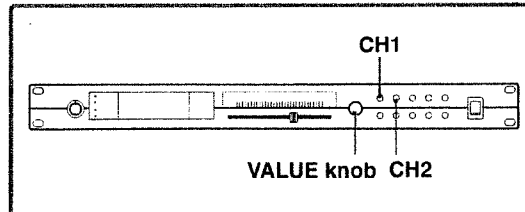

1. Press and hold down [CH1] or [CH2] for more than 2 seconds.
  - **When copying from [CH1] to [CH2]**  
Press and hold down [CH2].
  - **When copying from [CH2] to [CH1]**  
Press and hold down [CH1].

The pressed button blinks, and the "COPY" screen appears.

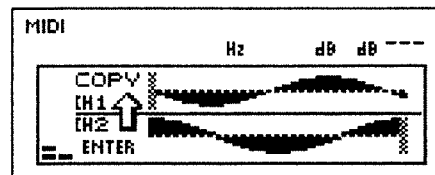

2. Press [VALUE].  
Copying begins.  
After Copying is completed, the system returns to the Play Mode.



You can undo the copying operation by holding down [SHIFT] while you press [UNDO/REDO]. To redo the canceled copy, together press [SHIFT] and [UNDO/REDO] again (p. 30).

# Sound Creation

## Adjusting the Tone (Editing the Graphic Equalizer)

You can adjust the equalizer using the [VALUE] knob and the Frequency slider while looking at the display.

You can also flatten the equalizer with a touch of a button (p. 24), create an easy tone curve (p. 26), or detect the point at which feedback occurs (p. 24).

### Normal Use of the Equalizer

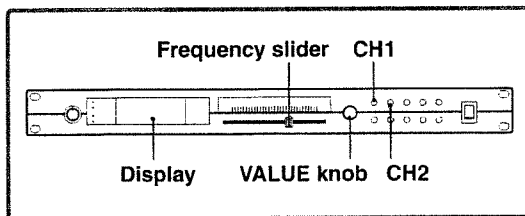

1. Press the [CH] button ([CH1] or [CH2]) to select the channel you wish to set up (p. 21).  
The pressed [CH] button lights in green, and the equalizer editing screen appears.
2. Use the Frequency slider to select the frequency whose gain level you wish to adjust.

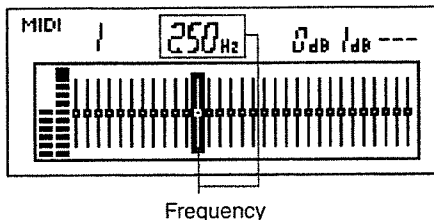

You can also select a frequency by pressing in while turning [VALUE]. Also, if you keep holding down [VALUE] after press-turning it, the frequency rates continue to move in the direction you turned the knob.

3. Turn [VALUE] to adjust the gain level.

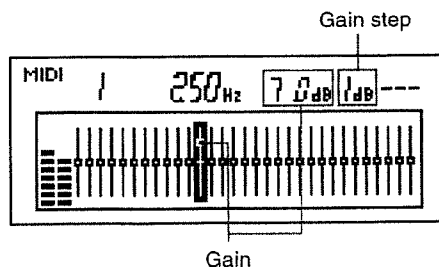

You can change the adjusting gain steps (p. 17).



You can adjust the gain level in increments of 0.1dB by turning [VALUE] while pressing [SHIFT].

4. Repeat Steps 2 to 3 to adjust other values.
5. Press the [CH] button that is lit in green.  
The system returns to the Play Mode.

### About the Play Mode

A few seconds after power-up, the display changes as shown below. This is the default position called "Play Mode."

In Play Mode, the current EQ settings curve and the output level are shown in the display.

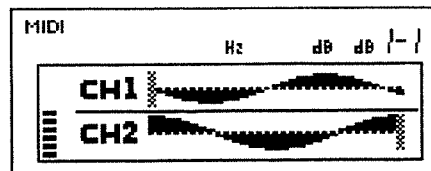

### Functions Controllable in the Play Mode

- Memory Storage (p. 31)
- Memory Recall (p. 32)
- Morphing Control (p. 30)
- UNDO/REDO (p. 30)

You can only perform these functions in the Play Mode.

### How to Return to the Play Mode from Editing Modes

#### System Editing Screen

Press [SYSTEM] until the [SYSTEM] indicator is extinguished.

#### Equalizer Editing Screen

Press the lit [CH1] or [CH2].

#### SEARCH Screen

Press the lit [CH1] or [CH2] twice.

#### SWEEP Screen

Press the lit [CH1] or [CH2] twice.

#### WIDE Screen

Press the lit [CH1] or [CH2] twice.

## Setting the Entire Gain Level Back to 0 dB (FLAT)

You can set the entire gain level back to 0 dB with a touch of a button. This is convenient when you wish to perform settings all over again.

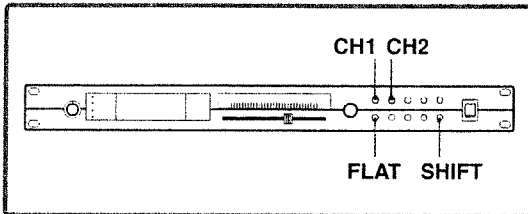

1. Press the [CH] button ([CH1] or [CH2]) to select the channel you wish to set back to 0 dB. (p. 21)  
The selected [CH] button lights in green, and the equalizer editing screen appears.
2. Together press both [SHIFT] and [FLAT].  
The entire gain level on the selected channel returns to 0 dB.



The FLAT function can also be used when performing SEARCH, WIDE, SWEEP.

## Detecting the Feedback Point (SEARCH)

You can easily detect the point at which feedback occurs by looking at the display.

### Searching the Point of Feedback

This is convenient for detecting the frequency of the center of a snare drum, or for finding the cause of an unpleasant sound.

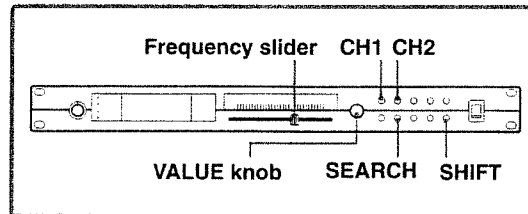

1. Press the [CH] button ([CH1] or [CH2]) to select the channel you wish to set up. (p. 21)  
The selected [CH] button lights in green, and the equalizer editing screen appears.
2. Together press both [SHIFT] and [SEARCH].  
The "SEARCH SETTING" screen appears.

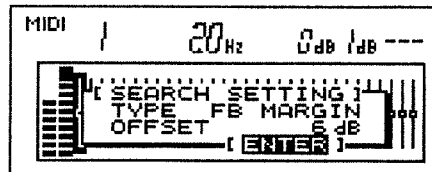

3. Turn [VALUE] to move the cursor to "TYPE," then press [VALUE].
4. Turn [VALUE] to select "MANUAL," then press [VALUE].
5. Turn [VALUE] to move the cursor to "OFFSET," then press [VALUE].
6. Turn [VALUE] to set the gain level, then press [VALUE].

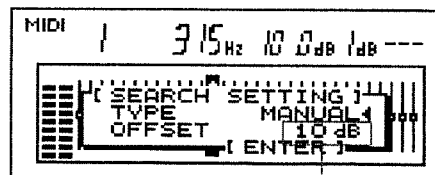

Offset level



- Turn [VALUE] to move the cursor to "ENTER," then press [VALUE].  
The equalizer editing screen appears.
- Move the Frequency slider to find the point at which feedback occurs.

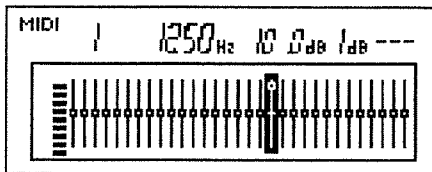

- At the point at which feedback occurs, turn [VALUE] to reduce the gain level.  
The reduced gain level will be reflected to the preset gain level.

To return to the Play Mode, press [SEARCH] twice (or either [CH] button once).

### Taking the Margin of the Feedback Point

You can detect the point at which feedback occurs by first boosting the gain level to make it easier to cause a feedback, and then moving the boosted bandwidth around.

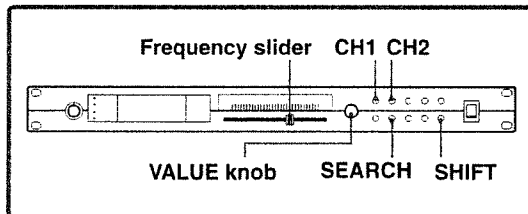

- Press the [CH] button ([CH1] or [CH2]) to select the channel you wish to set up. (p. 19)  
The selected [CH] button lights in green, and the equalizer editing screen appears.
- Together press both [SHIFT] and [SEARCH].  
The "SEARCH SETTING" screen appears.

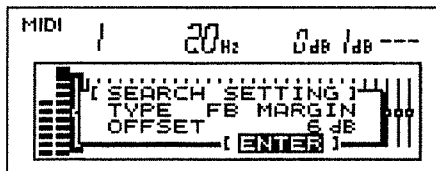

- Turn [VALUE] to move the cursor to "TYPE," then press [VALUE].
- Turn [VALUE] to select "FB MARGIN," then press [VALUE].

- Turn [VALUE] to move the cursor to "OFFSET," then press [VALUE].
- Turn [VALUE] to set the gain level, then press [VALUE].  
The gain level is boosted as has been set.

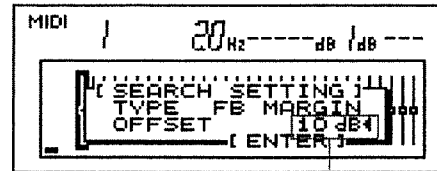

Offset level

- Turn [VALUE] to move the cursor to "ENTER," then press [VALUE].  
The equalizer editing screen appears.
- Move the boosted band around with the Frequency slider to detect the point at which feedback occurs.

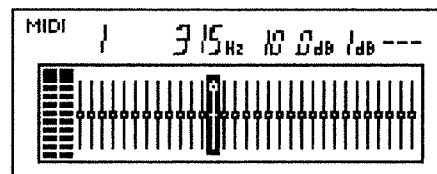

- At the point at which feedback occurs, turn [VALUE] to reduce the gain level.  
The reduced gain level will be reflected to the preset gain level. If you reduce the gain level enough to prevent the feedback, the margin created will be counted as an offset level to the original gain.

To return to the editing screen, press [SEARCH] twice (or either [CH] button once).

## Drawing an Easy EQ Curve Line (SWEEP)

You can easily draw a rough EQ curve line by using the Frequency slider and the [VALUE] knob.

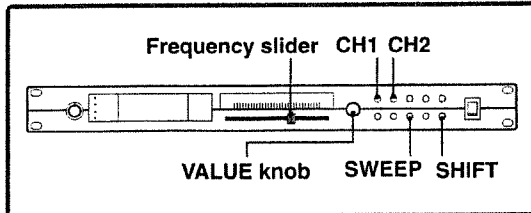

1. Press the [CH] button ([CH1] or [CH2]) to select the channel you wish to set up. (p. 21)  
The selected [CH] button lights in green, and the equalizer editing screen appears.
2. Together press both [SHIFT] and [SWEEP].  
[SWEEP] lights up.
3. While looking at the display, use the Frequency slider to move through the frequencies you wish to draw an EQ curve line, and turn while pressing [VALUE] to adjust the gain level.

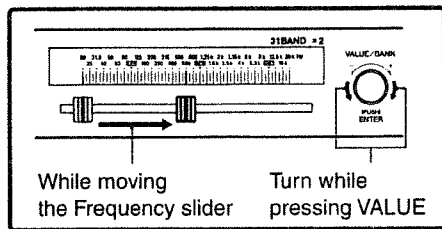
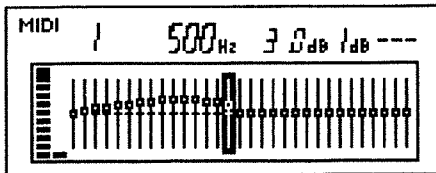

To return to the editing screen, press [SWEEP] twice (or either [CH] button once).

## Simultaneously Adjusting A Wide Range Of Adjacent Bands (WIDE)

You can set the gain level of a wide range of adjacent frequencies on both sides of a selected band.

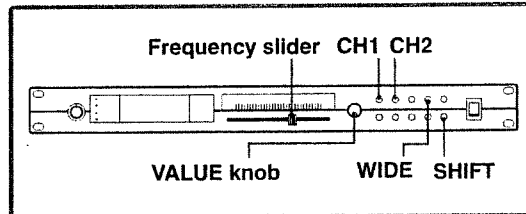

1. Press the [CH] button ([CH1] or [CH2]) to select the channel you wish to set up. (p. 21)  
The pressed [CH] button lights in green, and the equalizer editing screen appears.
2. Press [WIDE].  
The "WIDE SETTING" screen appears.

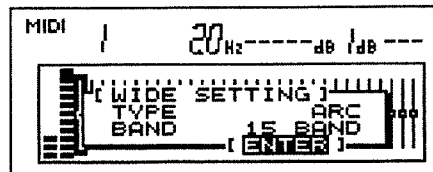

3. Turn [VALUE] to move the cursor to "TYPE," then press [VALUE].
4. Turn [VALUE] to select "FIX" or "ARC," then press [VALUE].

• **When "ARC" is selected**

You can angle the pattern of the EQ gain level within the selected group of frequencies.

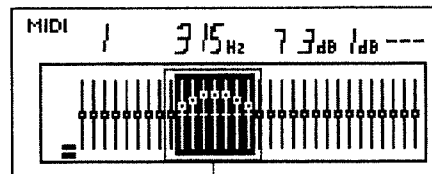

Selected frequencies

• **When "FIX" is selected**

You can boost or reduce the entire gain level of the selected group of frequencies.

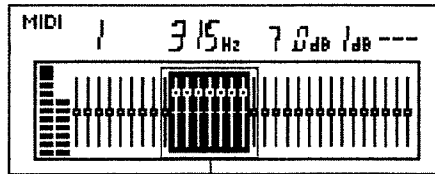

Selected frequencies

- Turn [VALUE] to move the cursor to "BAND," then press [VALUE].
- Turn [VALUE] to select the number of frequencies you wish to change as a group, then press [VALUE].

You can select from the following:

**3 BAND, 7 BAND, 11BAND, 15BAND**

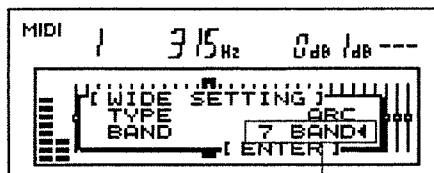

Number of selected frequencies

- Turn [VALUE] to move the cursor to "ENTER," then press [VALUE].  
The equalizer editing screen appears.
- Move the Frequency slider to the frequency you wish to edit, and turn [VALUE] to adjust the gain level.

To return to the editing screen, press [WIDE] twice (or either [CH] button once).



At Step 8, you can change the number of frequencies you wish to change as a group by pressing and holding down [VALUE] while you turn it.



While on the WIDE mode, you can cut the gain level of the entire group of the selected frequencies by using the TOTAL CUT function (p. 26).

## Smoothing the Transition Between Memories (MORPHING)

You can smooth the transition between 2 to 4 memories. You can do this by MIDI control (p. 34), or you can set the Frequency slider to do the controlling during the Play Mode.



To be able to use this function, you must first store the desired settings as memories. (p. 31)

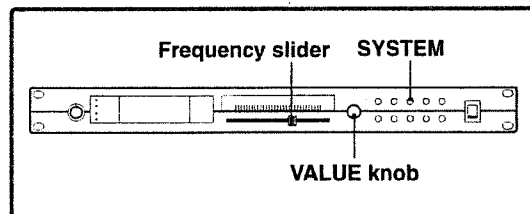

- Press [SYSTEM].  
[SYSTEM] lights in green, and the "SYSTEM SETTING" screen appears.
- Turn [VALUE] to select "MORPHING," then press [VALUE].  
The "MORPHING" screen appears.

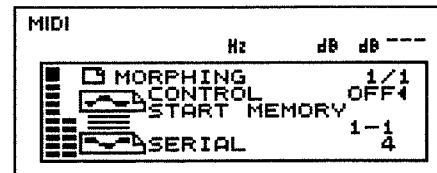

- Turn [VALUE] to select "CONTROL," then press [VALUE].
- Turn [VALUE] to select "ON," then press [VALUE].  
To turn MORPHING off, select "OFF."
- Turn [VALUE] to select "START MEMORY," then press [VALUE].

## Sound Creation

6. Turn [VALUE] to select the lowest number of memories you want to morph, then press [VALUE].

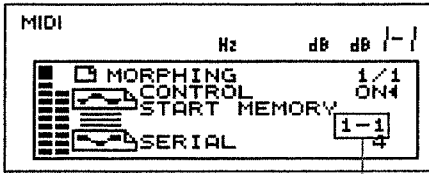

Memory number

7. Turn [VALUE] to select "SERIAL," then press [VALUE].
8. Turn [VALUE] to select the number of memories (up to 4) to morph, then press [VALUE].

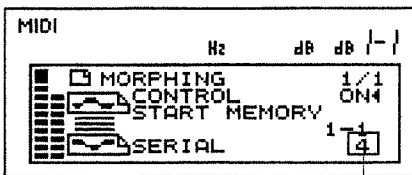

Memory number for the Morphing function

9. Press [SYSTEM] twice to return to the Play Mode.
10. Use the Frequency slider to control morphing.  
The morphing memories are assigned to the Frequency slider. These memories are morphed by moving the Frequency slider.

### Example: Morphing the memories 1-1, 1-2, 1-3

Select "1-1" at the "START MEMORY" field in Step 6, and select "3" at the "SERIAL" field in Step 8, and s above.

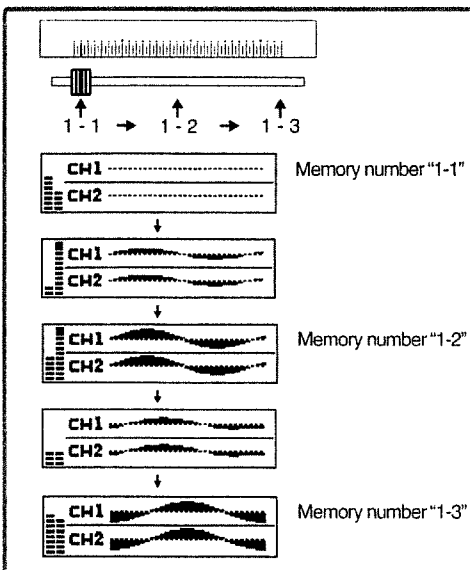

## To Cut the Gain of Selected Frequencies to -60dB (TOTAL CUT)

You can cut the gain level of a selected frequency to -60dB with a touch of a button. This is convenient for erasing an always heard noise at a certain frequency.

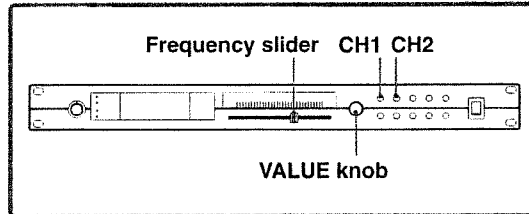

- Press the [CH] button ([CH1] or [CH2]) to select the channel you wish to set up. (p. 21)  
The selected [CH] button lights in green, and the equalizer editing screen appears.
- Use the Frequency slider to select the bandwidth you wish to cut.
- Press [VALUE].  
The gain value of the selected bandwidth is cut.

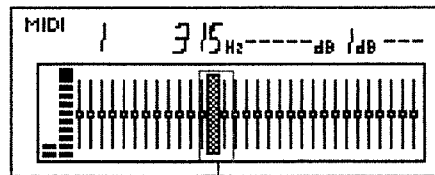

Frequency to be cut

If you press [VALUE] again, the system returns to its previous state.



If you use this function while on WIDE mode (p. 26), you can cut the gain level of the entire group of the selected frequencies.

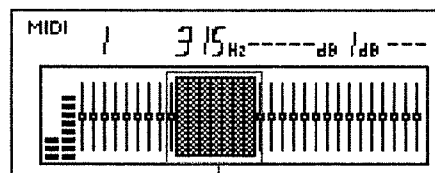

Frequencies to be cut

## Reducing the Remaining Noise (NOISE GATE)

By deleting all sound below a certain level, you can reduce the remaining noise that can be heard at soundless periods.

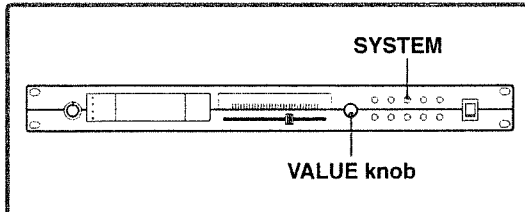

1. Press [SYSTEM].  
[SYSTEM] lights in green, and the "SYSTEM SETTING" screen appears.
2. Turn [VALUE] to select "NOISE GATE," then press [VALUE].  
The "NOISE GATE" screen appears.

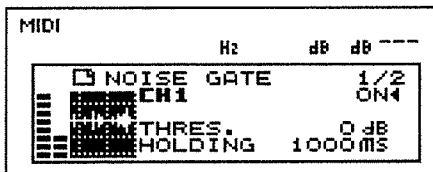

3. Turn [VALUE] to select the parameter you wish to edit.

### The "NOISE GATE CH1" Screen

Sets the Noise Gate for "CH1".

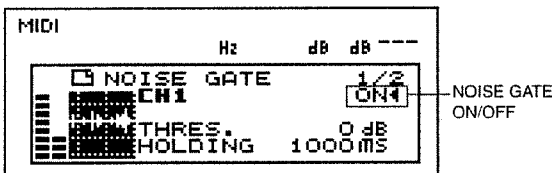

- "THRES." (THRESHOLD)  
Sets the point from which the level is to be reduced.

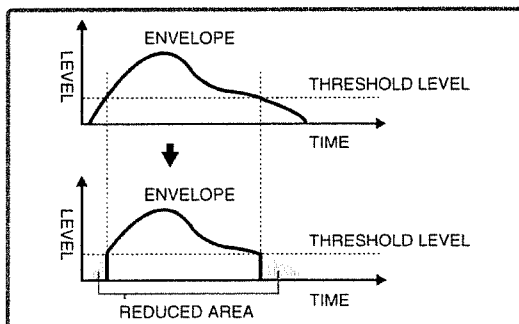

- "HOLDING" (HOLDING TIME)

Sets the time before release, when the signal goes down at the level below the threshold.

You can suppress the frequent intervals between the Gate on/off's that occur when the signals act with instability over and under the threshold level.

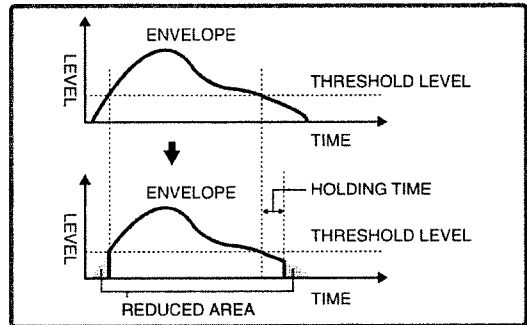

### The "NOISE GATE CH2" Screen

Sets the Noise Gate for "CH2".

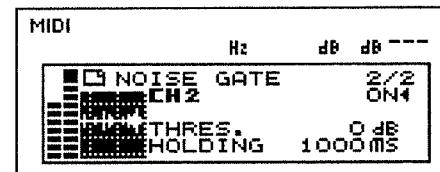

Setting operations are the same as that for "CH1."

4. Turn [VALUE] to adjust the selected parameter.

Press [SYSTEM] twice. The settings are placed in effect, and you're returned to the Play Mode.



The NOISE GATE setting is stored in system memory when you save your settings (p. 31).

## To Refine the Time Lag Between Channel Outputs (TIME ALIGNMENT)

If the speakers that are connected to the channels are placed at a wide distance, you can adjust the sound time lag for each channel using a delay effect.

This unit calculates the time and distance for TIME ALIGNMENT, and shows the rate at 340m per sound velocity.

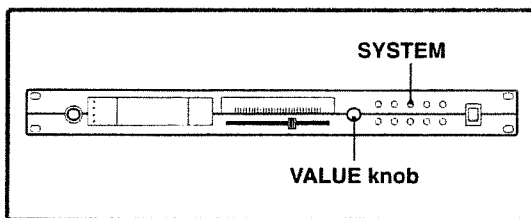

1. Press [SYSTEM].  
[SYSTEM] lights in green, and the "SYSTEM SETTING" screen appears.
2. Turn [VALUE] to select "TIME ALIGNMENT," then press [VALUE].  
The "TIME ALIGNMENT" screen appears.

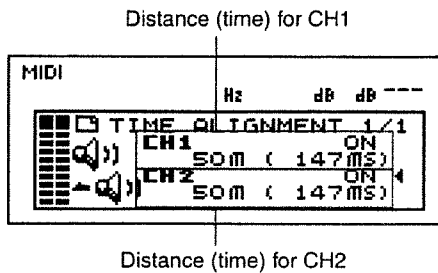

3. Turn [VALUE] to select the channel you wish to edit, then press [VALUE].
4. Turn [VALUE] to select "ON," then press [VALUE].  
To turn TIME ALIGNMENT off, select "OFF."
5. Turn [VALUE] to move the cursor to the Distance (Time) field, then press [VALUE].
6. While looking at the display, turn [VALUE] to adjust the values (Distance or Time).

Press [SYSTEM] twice. The settings are placed in effect, and you're returned to the Play Mode.



The TIME ALIGNMENT is stored in system memory when you save your settings (p. 31).

## To Recover the Settings (UNDO/REDO)

Directly after a change has been made to the settings, you can recover the previous state, or recall the changed settings again.

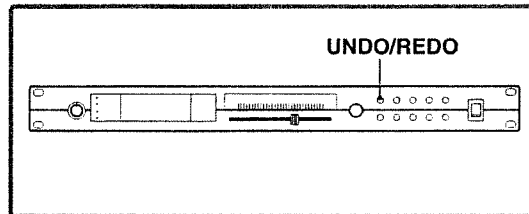

To recover the previous settings, press both [SHIFT] and [UNDO/REDO] directly after you have changed the settings. By pressing these buttons again, you can recall the changed settings again.

The UNDO/REDO function works for the following:

- **CHANNEL COPY (p. 22)**  
The system returns to its state before the CHANNEL COPY operation.
- **MEMORY LOAD (p. 32)**  
The system returns to its state before the MEMORY LOAD operation.
- **PLAY MODE (p. 23)**  
If you press both [SHIFT] and [UNDO/REDO] at the Play Mode directly after you have changed the EQ settings, the system returns to the Play Mode state before any changes have been made.

# To Store/Recall the Present Settings (MEMORY SAVE/LOAD)

You can store up to 16 patterns of EQ settings as memories (MEMORY SAVE). You can always recall these memories for instant use (MEMORY LOAD).

## To Store the Current Settings (MEMORY SAVE)

The following settings can be stored in each memory.

- EQ Curve
- BYPASS ON/OFF (p. 16)
- OUTPUT (p. 14)
- TIME ALIGNMENT (p. 30)
- NOISE GATE (p. 29)
- LINK TYPE (p. 22)
- STEP GAIN (p. 17)
- GAIN SYMBOL (p. 19)

The EQ settings can be stored to the following Memory numbers.

**1-1, 1-2, 1-3, 1-4, 2-1, 2-2, 2-3, 2-4**

**3-1, 3-2, 3-3, 3-4, 4-1, 4-2, 4-3, 4-4**

The number on the left denotes the Bank, while the number on the right denotes the Bank sub-number.

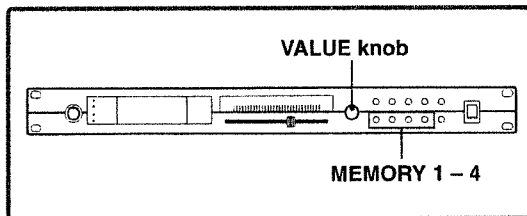

1. After you have finished the EQ settings, go back to the Play Mode.
2. Turn [VALUE] to select the Bank number of the Memory Number you wish to store the current settings.

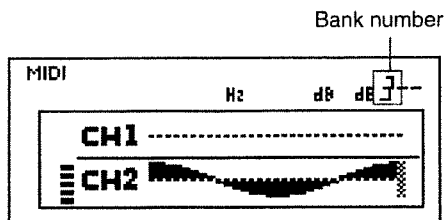

3. Press and hold down [MEMORY 1]-[MEMORY 4] for over 2 seconds.

The selected [MEMORY] button will enter the Bank sub-number.

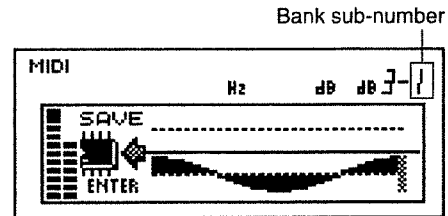

The pressed [MEMORY] button blinks, and "SAVE" appears in the display.

4. Press [VALUE].

The "NOW WORKING KEEP POWER ON" (p. 40) message appears in the display, and the current settings are stored to the selected Memory number.

### Example: To store the current settings to "3-1"

Turn [VALUE] to select "3," then press [MEMORY 1] for over 2 seconds. "SAVE" appears in the display.

Press [VALUE].

## To Store/Recall the Present Settings (MEMORY SAVE/LOAD)

### To Recall the Stored Settings (MEMORY LOAD)

By calling up stored settings, the settings for the following can be called up.

- EQ Curve
- BYPASS ON/OFF (p. 16)
- OUTPUT (p. 14)
- TIME ALIGNMENT (p. 30)
- NOISE GATE (p. 29)
- LINK TYPE (p. 22)
- STEP GAIN (p. 17)
- GAIN SYMBOL (p. 19)

The EQ settings can be recalled from the following Memory numbers.

**1-1, 1-2, 1-3, 1-4, 2-1, 2-2, 2-3, 2-4**

**3-1, 3-2, 3-3, 3-4, 4-1, 4-2, 4-3, 4-4**

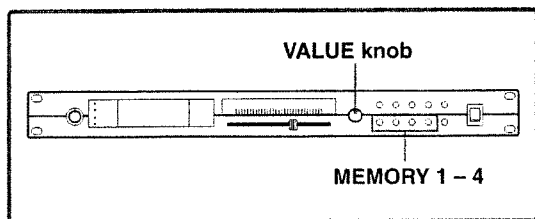

1. After you have finished the EQ settings, go back to the Play Mode.
2. Turn [VALUE] to select the Bank number of the Memory number you wish to recall.

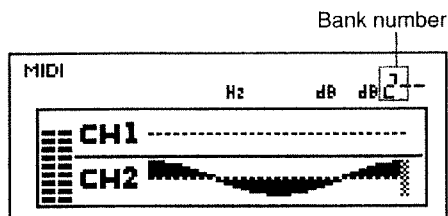

3. Press [MEMORY 1]-[MEMORY 4] to select the Bank sub-number of the Memory number.

The pressed [MEMORY] button will enter the Bank sub-number of the Memory number.

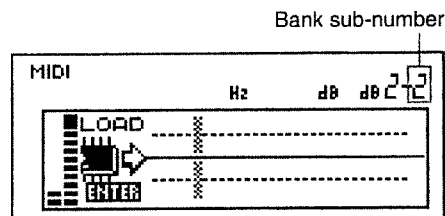

The pressed [MEMORY] lights up, and "LOAD" appears in the display.

4. Press [VALUE].

The selected memory is recalled.

#### Example: To recall the settings that are stored to "2-2"

Turn [VALUE] to select "2," then press [MEMORY 2] for over 2 seconds. "LOAD" appears in the display.

Press [VALUE].



If you press both [SHIFT] and [UNDO/REDO] together right after this operation, the recalled memory will be dismissed. If you press both [SHIFT] and [UNDO/REDO] together right after this again, the previously recalled memory will recover. (p. 30)



# Remote Control

## Using A Foot Switch

By connecting a foot switch to the FOOT SW port, you can lead signals through a bypass, or recall a memorized setting.

### To Let the Signals Bypass the Effect (BYPASS)

You can control the BYPASS function (p. 16) using a foot switch.

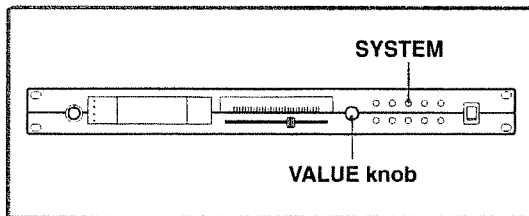

1. Press [SYSTEM].  
[SYSTEM] lights in green, and the "SYSTEM SETTING" screen appears.
2. Turn [VALUE] to select "FOOT SWITCH," then press [VALUE].  
The "FOOT SWITCH" display appears.

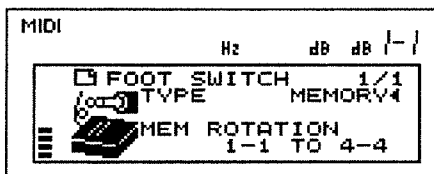

3. Turn [VALUE] to move the cursor to the upper field, then press [VALUE].
4. Turn [VALUE] to select "BYBASS" at the "TYPE" field.

Press [SYSTEM] twice. The settings are placed in effect, and you're returned to the Play Mode.

## Recalling Memorized Settings in Turns (MEMORY ROTATION)

By pressing the foot switch, you can recall memories in turns over and over again. On this unit, you can set the desired range of memory numbers you wish to recall.

This function works only in Play Mode.

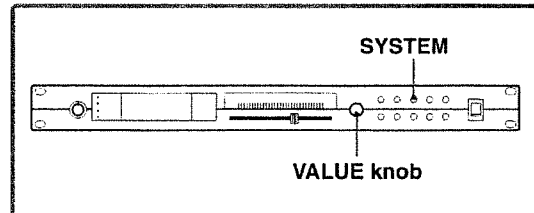

1. Carry out the same Steps 1-3 as in the previous "BYPASS" section.
2. Turn [VALUE] to select "MEMORY" at the "TYPE" field, then press [VALUE].
3. Set the desired range of memory numbers.  
The SRQ-2031 can store up to 16 EQ settings to memory numbers "1-1" to "4-4" (p. 31). You can set the foot switch to select from these within the desired memory number range.

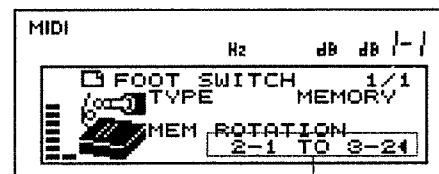

Range of selected memories

- 1 Turn [VALUE] to move the cursor to the memory number on the left side of the "MEM ROTATION" field.
- 2 Turn [VALUE] to select the smallest memory number you wish to recall, then press [VALUE].
- 3 Turn [VALUE] to move the cursor to the memory number on the right side of the "MEM ROTATION" field.
- 4 Turn [VALUE] to select the largest memory number you wish to recall, then press [VALUE].

**Example: When you select "1-2" at Step 2, and "2-3" at Step 4.**

Each time you press the foot switch, the selection occurs as follows.

"1-2" → "1-3" → "1-4" → "2-1" → "2-2" → "2-3"

↑

Press [SYSTEM] twice. The settings are placed in effect, and you're returned to the Play Mode.

## Use With MIDI Devices

### About MIDI

This chapter explains MIDI fundamentals, and how the SRQ-2031 interacts with MIDI messages.

#### What Is MIDI?

MIDI stands for "Musical Instrument Digital Interface." This is a standard used throughout the world for the purpose of exchanging music data between electronic instruments and computers.

MIDI-compatible devices can exchange performance information with each other, regardless of manufacturer or model.

#### MIDI Connectors

MIDI messages (MIDI data or information) are exchanged using the following three types of connectors.

##### MIDI IN

For receiving MIDI messages from another device.

##### MIDI OUT

For sending MIDI messages from the master device.

##### MIDI THRU

For sending out unchanged MIDI messages received from another device.



On this unit, you can change functions of MIDI THRU/OUT connector as below at the "SYSTEM"- "MIDI" setting screen.

#### SOFT THRU

- ON : Both OUT and THRU functions are available.
- OFF : Only OUT function is available.

#### MIDI Channels

MIDI sends its information over several channels. To get messages to function as intended, you need to set the channel of the receiver so it matches that of the sender.

### MIDI Messages Used by the SRQ-2031

MIDI uses a variety of MIDI messages to convey the various kinds of expression possible in a performance. MIDI messages can be broadly divided into two kinds: messages handled on a per-channel basis (Channel Messages), and messages that are handled irrespective of particular MIDI channels (System Messages).

#### Channel Messages

These are messages for transmitting performance operations.

##### Control change messages

Each function is distinguished by Controller Numbers, and can select parameters that have been set before operation. The selected parameters can be adjusted by changing the controlling values.

##### Program change messages

These are used for selecting a memory.

#### System Messages

These are messages (SysEx messages) that hold settings of devices.

By using these messages, you can send parameter settings to a sequencer for storage, or re-create identical settings on another SRQ-2031.



To exchange SysEx Messages, you must first set the same ID number to both devices. (p. 38)

### MIDI Implementation Chart

The MIDI Implementation Chart is where you can check the types of MIDI messages the device can send and receive. When using MIDI devices, compare the charts for each device, and confirm the compatible MIDI messages.

The MIDI Implementation Chart for the SRQ-2031 can be found at page 43.



A separate publication titled "MIDI Implementation" is also available. It provides complete details concerning the way MIDI has been implemented on this unit. If you should require this publication (such as when you intend to carry out byte-level programming), please contact the nearest Roland Service Center or authorized Roland distributor.

## Changing settings from External MIDI Devices

By sending Control Change or Program Change messages from an external device, you can change settings of the SRQ-2031.

### Setting the Reception Channel for MIDI Messages

Set the SRQ-2031 so that you can receive MIDI messages sent from an external device.

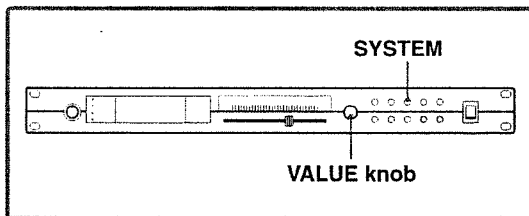

1. Press [SYSTEM].  
[SYSTEM] lights in green, and the "SYSTEM SETTING" screen appears.
2. Turn [VALUE] to select "MIDI," then press [VALUE].  
The "MIDI" screen appears.

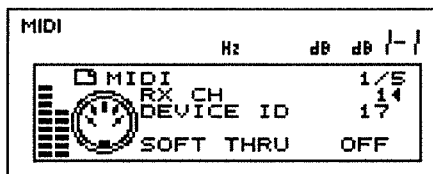

3. Turn [VALUE] to select "RX CH," then press [VALUE].
4. Turn [VALUE] to select the receiving channel.
  - **1-16**  
To receive MIDI messages from the selected channel.
  - **OMNI**  
To receive all MIDI messages.
  - **OFF MIDI**  
Messages cannot be received.

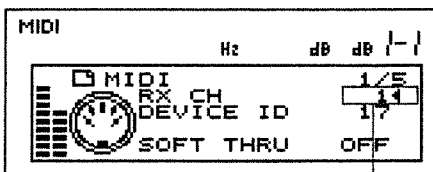

Selected channel

When you press [SYSTEM], the "NOW WORKING KEEP POWER ON" message appears in the display, and the settings are placed in effect, then the "SYSTEM SETTING" screen reappears.

Press [SYSTEM] again to go to the Play Mode.

## Remote Control of the SRQ-2031 from an External MIDI Device (Control Change)

To operate this system from an external device, you must first set the receiving channel for MIDI messages as described on the left.

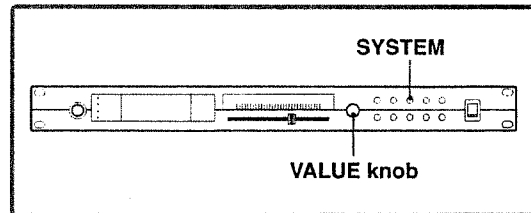

1. Press [SYSTEM].  
[SYSTEM] lights in green, and the "SYSTEM SETTING" screen appears.
2. Turn [VALUE] to select "MIDI," then press [VALUE].  
The "MIDI" screen appears.

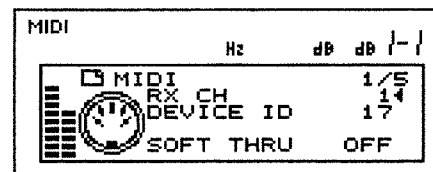

3. Turn [VALUE] to select the desired parameter, then press [VALUE].

### The LEVEL editing screen

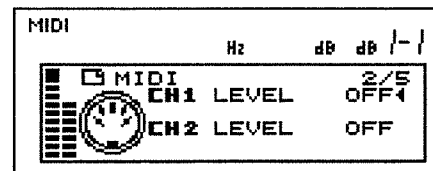

#### • LEVEL

Sets the volume.

**OFF** : Not Accepted

**CC01 - CC31, CC64 - CC95**

: Control Number 1 - 31, 64 - 95

Control Value	Setting Values
0	- ∞
1 - 61	-60dB - 0dB

## Remote Control

### The BYPASS/MORPHING editing screen

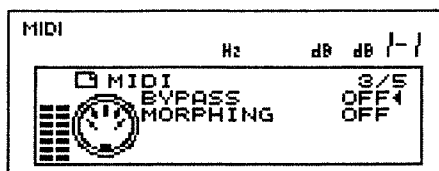

#### • BYPASS

Sets the Controller Number to switch on/off the BYPASS function.

**OFF** : Not Accepted

**CC01 – CC31, CC64 – CC95**

: Control Number 1 – 31, 64 – 95

Control Value	Setting Values
0 – 63	OFF
64 – 127	ON

#### • MORPHING

Sets the Controller Number to control Morphing.

**OFF** : Not Accepted

**CC01 – CC31, CC64 – CC95**

: Control Number 1 – 31, 64 – 95

Control Value	Setting Values
1 – 127	Correspond to the L/R of faders

### The CH SELECT/FRQ SELECT/GAIN SET Editing Screen

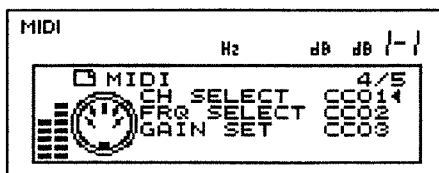

#### • CH SELECT

Sets the Controller Number for selecting the channel (CH1 or CH2) whose gain level you wish to adjust.

**OFF** : Not Accepted

**CC01 – CC31, CC64 – CC95**

: Control Number 1 – 31, 64 – 95

Control Value	Setting Values
0	CH1
1	CH2

#### • FRQ SELECT

Sets the Controller Number for selecting the frequency whose gain level you wish to control.

**OFF** : Not Accepted

**CC01 – CC31, CC64 – CC95**

: Control Number 1 – 31, 64 – 95

Control Value	Setting Values
0 – 30	Corresponds to every frequency from 20 through 20,000 Hz (31 bands)

#### • GAIN SET

Sets the Controller Number for setting the gain level.

**OFF** : Not Accepted

**CC01 – CC31** : MSB

**CC33 – CC63** : LSB

On this unit you can set the gain level in increments of 0.1 dB within 24 dB (240 steps). To manipulate these 240 GAIN STEPS, you use two Controller Numbers, in pairs consisting of the MSB (CC1–CC31), and the LSB (CC33–C63).

#### CONTROLLER NUMBERS CORRESPONDENCE

MSB	LSB
CC1	CC33
CC2	CC34
1	1
CC31	CC63

The GAIN SET screen on this unit works as the MSB Controller Number selection screen. When you select the MSB, the LSB Controller Number will be set automatically. When you adjust the gain level, send the control value to both MSB and LSB channels. The relations between the gain level and the MSB/LSB values are as listed below.

#### VALUE (MSB-LSB) – GAIN RELATIONS

MSB (CC1 – 31)	LSB (CC33 – 63)	GAIN
1	0 – 112	+0.8dB – +12dB
0	0 – 127	-12dB – +0.7dB
1	127	TOTAL CUT ON
1	126	TOTAL CUT OFF

**VALUE (MSB-LSB) – GAIN RELATIONS**

MSB (CC1 - 31)	LSB (CC33 - 63)	GAIN
1	112	+12dB
1	102	+11dB
1	92	+10dB
1	82	+9dB
1	72	+8dB
1	62	+7dB
1	52	+6dB
1	42	+5dB
1	32	+4dB
1	22	+3dB
1	12	+2dB
1	2	+1dB
0	119	+0dB
0	109	-1dB
0	99	-2dB
0	89	-3dB
0	79	-4dB
0	69	-5dB
0	59	-6dB
0	49	-7dB
0	39	-8dB
0	29	-9dB
0	19	-10dB
0	9	-11dB
0	0	-12dB

4. Turn [VALUE] to select the desired Controller Number, then press [VALUE].

When you press [SYSTEM], the “NOW WORKING KEEP POWER ON” message appears in the display, and the settings are placed in effect, then the “SYSTEM SETTING” screen reappears.

Press [SYSTEM] again to go to the Play Mode.

**Selecting a memory from an External MIDI Device (Program Change)**

To select a memory from an external MIDI device, you must first set the receiving channel for MIDI messages (p. 35).

The program change message corresponds to the memory number as below.

MSB	LSB
0	1-1
1	1-2
16	4-4

**Sending and Receiving Settings Via MIDI (BULK DUMP/LOAD)**

With the SRQ-2031, you can use SysEx Messages to re-create identical settings on another SRQ-2031, or send the EQ settings to a sequencer for storage. be under same settings, or record the EQ settings to a sequencer or other devices. This transmission of SysEx messages is called “Bulk Dump,” and reception is called “Bulk Load.”

**Data Transfer (BULK DUMP)**

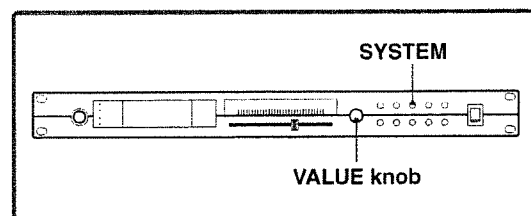

**Saving Data on a Sequencer**

Connect the devices as shown below, then get the sequencer ready for receiving SysEx messages.

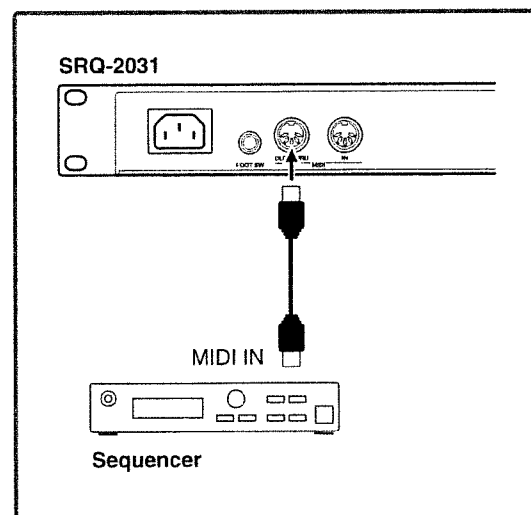

**NOTE**

Read the instructions in the manual of the sequencer you are using.

## Remote Control

1. Press [SYSTEM].  
[SYSTEM] lights in green, and the "SYSTEM SETTING" screen appears.
2. Turn [VALUE] to select "MIDI," then press [VALUE].  
The "MIDI" screen appears.

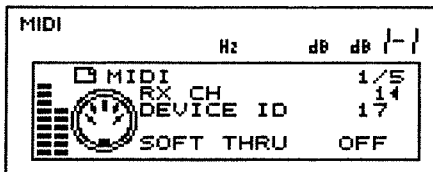

3. Turn [VALUE] to select "BULK DUMP," then press [VALUE].
4. Turn [VALUE] to select the data you wish to transmit, then press [VALUE].

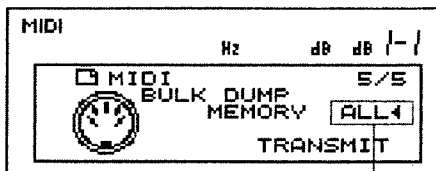

Settings to be sent

- **ALL**  
Transfer all settings
  - **SYS**  
Transfer all settings except the patches
  - **TEMP**  
Transfer the currently selected patch
  - **"1-1" - "4-4"**  
Transfer the selected memory number
5. Set the sequencer to Recording mode.
  6. Turn [VALUE] to select "TRANSMIT," then press [VALUE].  
Data transfer begins.  
After the data transfer has been completed, the display returns to its previous state.
  7. Set the sequencer to Stop mode.

When you press [SYSTEM], the "NOW WORKING KEEP POWER ON" message appears in the display, and the settings are placed in effect, then the "SYSTEM SETTING" screen reappears.

Press [SYSTEM] again to go to the Play Mode.

## Copying Data to Another SRQ-2031

Connect the devices as shown below.

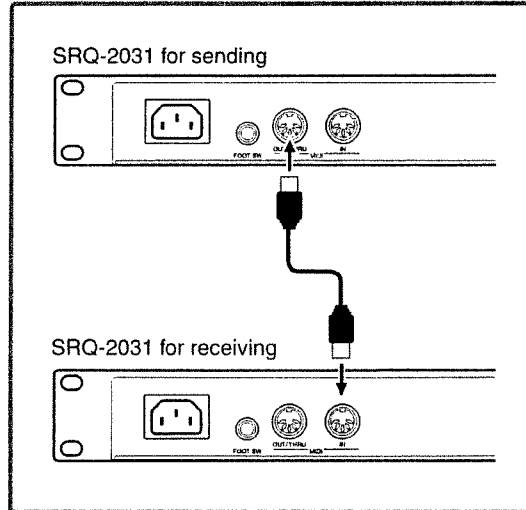

1. Press [SYSTEM].  
[SYSTEM] lights in green, and the "SYSTEM SETTING" screen appears.
2. Turn [VALUE] to select "MIDI," then press [VALUE].  
The "MIDI" screen appears.

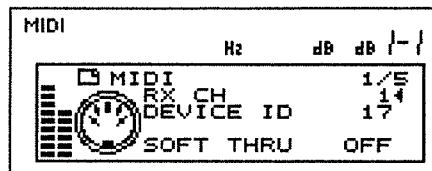

3. Turn [VALUE] to select "DEVICE ID," then press [VALUE].
4. Turn [VALUE] to select the device ID number, then press [VALUE].

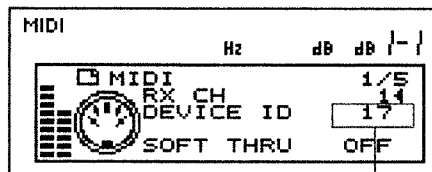

Device ID



**NOTE**  
Make sure that the ID numbers of both SRQ-2031s correspond to each other.

5. Turn [VALUE] to select "BULK DUMP," then press [VALUE].
6. Turn [VALUE] to select the data you wish to transmit, then press [VALUE].

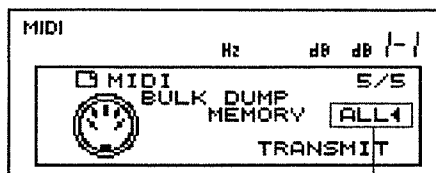

Settings to be sent

- **ALL**  
Transfer all settings
  - **SYS**  
Transfer all settings except the patches
  - **TEMP**  
Transfer the currently selected patch
  - **"1-1" - "4-4"**  
Transfer the selected memory number
7. Turn [VALUE] to select "TRANSMIT," then press [VALUE].  
Data transfer begins.  
After the data transfer is complete, the display returns to its previous state.

When you press [SYSTEM], the "NOW WORKING KEEP POWER ON" message appears in the display, and the settings are placed in effect, then the "SYSTEM SETTING" screen reappears.

Press [SYSTEM] again to go to the Play Mode.

## Receiving Settings (BULK LOAD)

Connect the devices as shown below, and set the same ID to this unit as that used when you saved data to the sequencer. (p. 38)

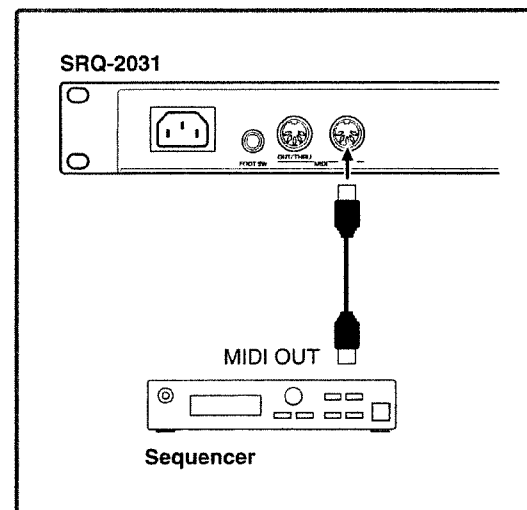

Read the instructions in the manual of the sequencer you are using.

1. Set the sequencer to the Play Mode.  
Data transfer begins.  
During transfer, "O" blinks at the MIDI signal transmit indicator in the LCD display. If you are receiving ALL or "1-1"-"4-4" setting data, the "MSR RECEIVED KEEP POWER ON" message (p. 40) appears in the display after data transfer is complete.  
After data transfer is complete, the display returns to its previous state.
2. Set the sequencer to Stop mode.



During reception of SysEx Messages, all controls of the SRQ-2031 are disabled.

# Reference

## Troubleshooting

---

If you encounter problems with the operation of the SRQ-2031, first check the following points.

If these instructions still do not resolve your problems, consult your nearest Roland Service Center or an authorized Roland distributor.

### There is No Sound or the Sound is Too Low

- **Is there a break in the cable?**
  - Try replacing the connected cable.
- **Is the SRQ-2031 properly connected to other devices?**
  - Check the connections. (p. 10)
- **Is the volume of the connected device turned down?**
  - Check the settings of the connected device.
- **Is the [INPUT LEVEL] knob turned down?**
  - Set [INPUT LEVEL] to the appropriate position. (p. 14)
- **Is the NOISE GATE turned on?**
  - Try turning the NOISE GATE off. (p. 29)
- **Is "OUTPUT" set to "-INF" or to a low position?**
  - Increase the output level. (p. 14)
- **Are you using a cable that contains a resistor?**
  - Use a connection cable that does not contain a resistor (Roland PCS Series, etc.).

### The Sound is Distorted

- **Is the Output Level of the connected device too high?**
  - Adjust the output of the connected device to a more suitable level.
- **Is the Input Level knob set at an appropriate position?**
  - Set the input level to the appropriate position. (p. 14)

### MIDI Messages Are Not Being Received

- **Could there be a break in the MIDI cable?**
  - Try replacing the MIDI cable.
- **Is the SRQ-2031 properly connected to other MIDI devices?**
  - Check the connections to the MIDI devices. (p. 37)
- **Do the MIDI channel numbers on the SRQ-2031 correspond to those on the other MIDI devices?**
  - Set the same MIDI channel numbers to those corresponding devices. (p. 35)
- **If you are Bulk Loading from another SRQ-2031, are the device ID numbers set to the same?**
  - Set the same ID number for both units. (p. 38)

## Display Messages

---

This is a list of messages that may be displayed to prevent serious accidents, when there is an operational malfunction, or if a procedure is not properly executed. Respond as indicated in the messages.

### "NOW WORKING KEEP POWER ON"

Appears when saving a setting to the unit.

Response: Do not turn off the power while displayed. If you do, the unit may return to the initial factory setting.

### "PARAMETER ERROR!! NOW LOADING PRESET"

Cause: The unit was turned off while the "KEEP POWER ON" message was on display. The unit is loading the initial factory setting while this message is displayed for about 20 seconds.

Response: After the initializing is finished, the unit starts up as usual. You can now use it again.

### "MIDI ERROR!! BUFFER FULL"

Cause: More MIDI messages were received at once than the SRQ-2031 was able to process.

Response: Reduce the amount of MIDI messages that are being transmitted to the SRQ-2031.

### "MSR RECEIVED KEEP POWER ON"

Indicates that MSR messages have been successfully received during BULK LOAD.

("MSR:MEMORY SAVE REQUEST" For close information, refer to a separately sold MIDI Implementations document.)

Response: Do not turn off the power while displayed. If you do, the unit may return to the initial factory setting.



# Equalizer Characteristics

---

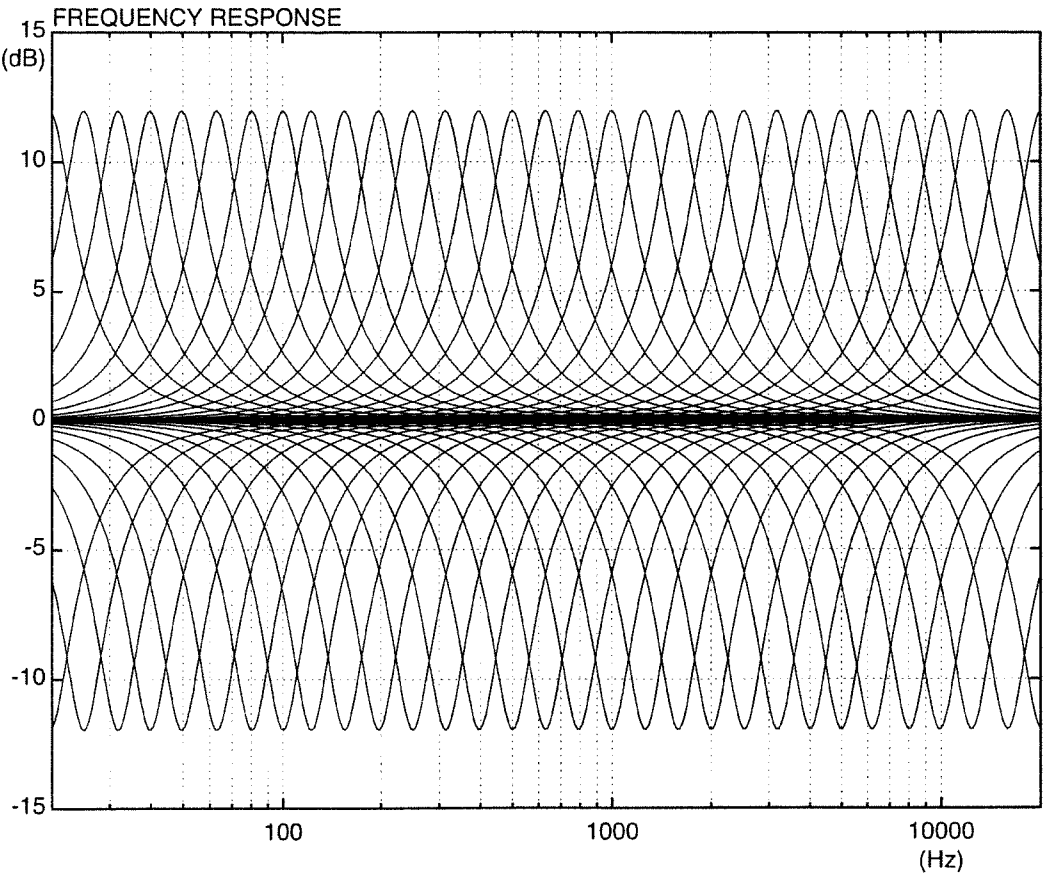

# User Interface Guide

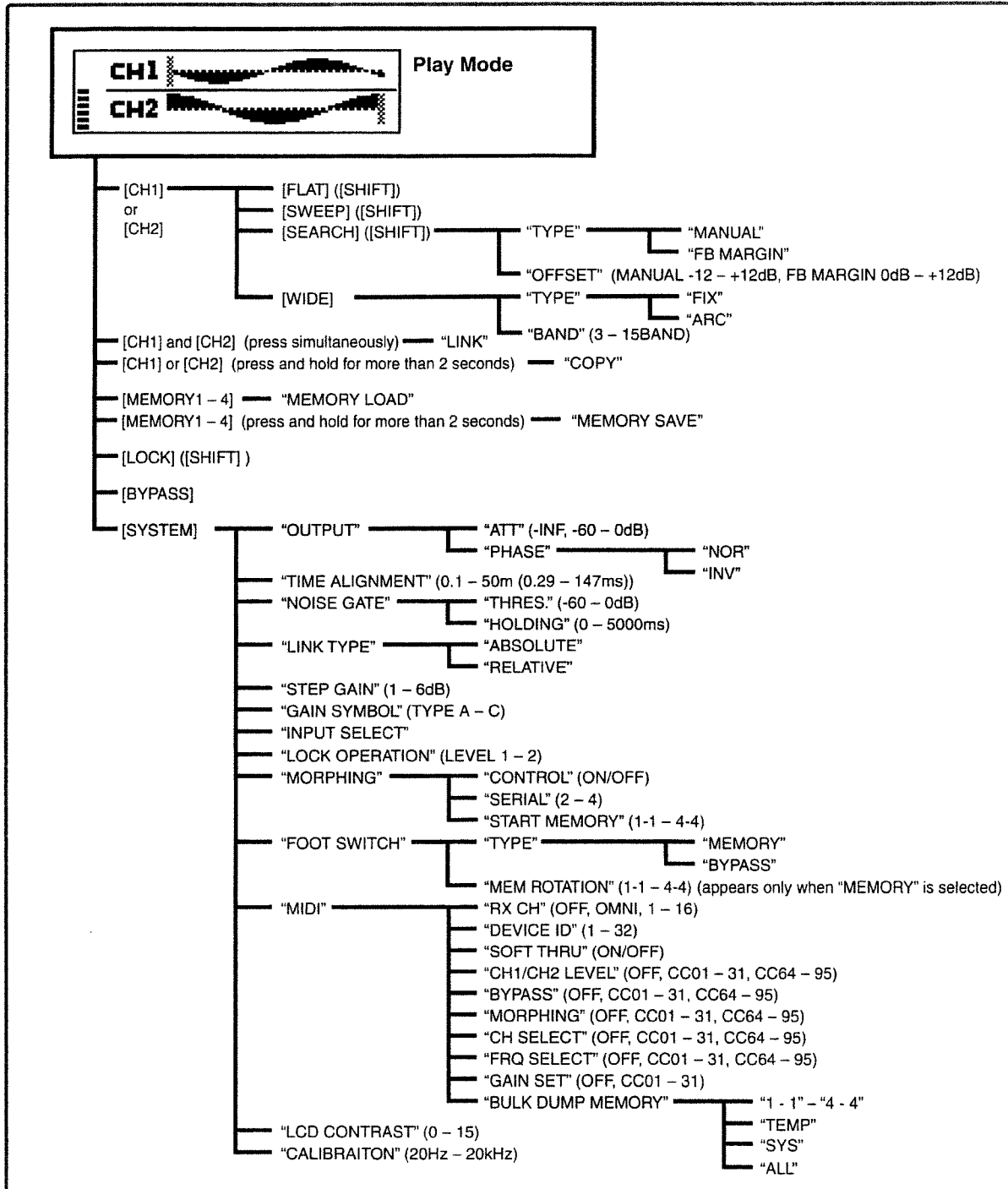

Characters and numbers enclosed in square brackets [ ] (for example [SYSTEM]) indicate buttons and knobs on the front panel. Characters and numbers enclosed in double quotation marks " " (for example "MIDI") indicate the editing mode names shown in the display.

## MIDI Implementation Chart

Date : Dec. 15, 1994 Version : 1.00

Function...	Transmitted	Recognized	Remarks
Basic Default Channel Changed	X X	1-16 1-16	
Mode Default Messages Altered	X X *****	OMNI ON/OFF X X	* 2
Note Number : True Voice	X *****	X X	
Velocity Note On Note Off	X X	X X	
After Key's Touch Channel's	X X	X X	
Pitch Bend	X	X	
Control 1 - 31 Change 33 - 63 64 - 95	X X X	O O O	*2 *1 *2 *1
Program Change : True Number	O *****	O 0-15	User memory 1-1 to 4-4
System Exclusive	O	O	
System : Song Position Common : Song Select : Tune Request	X X X	X X X	
System : Clock Real Time : Commands	X X	X X	
Aux : All Sound Off Messages : Reset All Controllers : Local On/Off : All Notes Off : Active Sensing : System Reset	X X X X X X	X X X X X X	
Notes	* 1 LSB for controller number 1 - 31 * 2 Recognize messages for controlling parameters		

Mode 1 : OMNI ON, POLY  
Mode 3 : OMNI OFF, POLYMode 2 : OMNI ON, MONO  
Mode 4 : OMNI OFF, MONOO : Yes  
X : No

A separate publication titled "MIDI Implementation" is also available. It provides complete details concerning the way MIDI has been implemented on this unit. If you should require this publication (such as when you intend to carry out byte-level programming), please contact the nearest Roland Service Center or authorized Roland distributor.

# Block Diagram

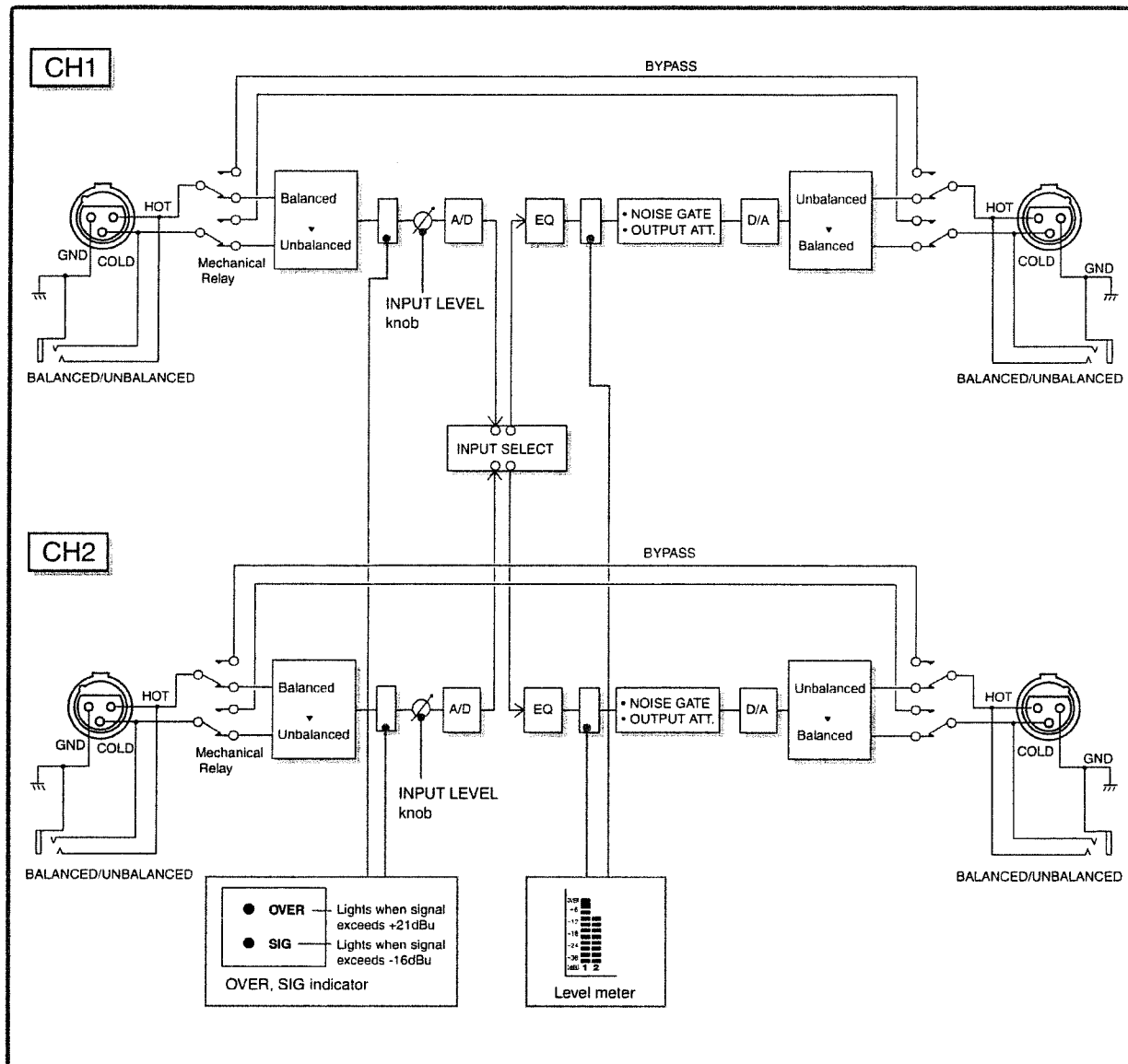

# Specification

- **AD Conversion**

24 bit linear (64 times oversampling)

- **DA Conversion**

24 bit linear (128 times oversampling)

- **Sampling Frequency**

44.1 kHz

- **Program memory**

16 memories

- **Frequency Response**

20 Hz to 20 kHz -1 / +0 dB

- **Nominal Input Level**

+4 dBu

- **Input Impedance**

10 k ohms (HOT-COLD)

10 k ohms (HOT-GND, COLD-GND)

- **Nominal Output Level**

+4 dBu

- **Non-clipping Maximum Input Level**

+21 dBu

- **Non-clipping Maximum Output Level**

+21 dBu

- **Output Impedance**

600 ohms (HOT-COLD)

300 ohms (HOT-GND, COLD-GND)

- **Recommended Load Impedance**

Balanced Output: 6 k ohms or greater

Unbalanced Output : 3 k ohms or greater

- **Total Harmonic Distortion**

0.05 % or less (1kHz; level control: +/- 0 dB; equalizer

level: +/- 0 dB)

- **Residual Noise Level**

-80 dBu (IHF-A; level control: +/- 0 dB; equalizer level: +/-

0 dB, typ.)

- **Equalizer Control**

Center Frequency: 20, 25, 31.5, 40, 50, 63, 80, 100, 125, 160,

200, 250, 315, 400, 500, 630, 800, 1k, 1.25k, 1.6k, 2k, 2.5k,

3.15k, 4k, 5k, 6.3k, 8k, 10k, 12.5k, 16k, 20k [Hz]

Variable Range : +/- 12dB, -60dB

- **Controls**

Frequency slider

VALUE/BANK (PUSH ENTER) knob

CH1, CH2, SYSTEM, WIDE, BYPASS, FLAT (MEMORY1),

SEARCH (MEMORY2), SWEEP (MEMORY3), MEMORY4,

SHIFT button

INPUT LEVEL knob (CH1, CH2)

Power Switch

- **Indicators**

Peak Indicator

Signal Indicator

Bypass Indicator

- **Display**

Graphic LCD (Back Light)

- **Connectors**

Input Connector (XLR type, 1/4 inch phone type)

Output Connector (XLR type, 1/4 inch phone type)

XLR type 1:GND, 2:HOT, 3:COLD

phone type T:HOT, R:COLD, S:GND

- **FOOT SW Jack**

MIDI connector (IN, OUT/THRU)

- **Power Supply**

AC 117 V, AC 230 V or AC 240 V

- **Power Consumption**

6 W (AC 117 V), 8 W (AC 230 V), 8 W (AC 240 V)

- **Dimensions**

482.0 (W) x 222.0 (D) x 44.0 (H) mm

19 (W) x 8-3/4 (D) x 1-3/4 (H) inches

(EIA-1U rack mount type)

- **Weight**

2.5 kg/ 5 lbs 9 oz

- **Accessories**

Owner's Manual

Roland service

Rubber Feet

AC cord

Rack Mount Washer (x4)

- **Options**

Foot Switch: FS-5U (BOSS)

\* 0 dBu = 0.775 Vrms

\* In the interest of product improvement, the specifications and/or appearance of this unit are subject to change without prior notice.

# Index

- A**  
ABSOLUTE ..... 22  
ARC ..... 26
- B**  
Bank ..... 31–32  
Block Diagram ..... 44  
BYPASS ..... 16, 33
- C**  
CALIBRATION ..... 18  
Channel copy ..... 22  
Connections ..... 10
- D**  
Data Transfer (BULK DUMP) ..... 37
- E**  
Editing ..... 23  
Equalizer Characteristics ..... 41
- F**  
FB MARGIN ..... 25  
Feedback Margin ..... 25  
Feedback Point ..... 25  
FIX ..... 27  
FLAT ..... 24  
Foot Switch ..... 33
- G**  
GAIN SYMBOL ..... 19
- H**  
HOLDING TIME ..... 29
- I**  
Input Level ..... 14
- L**  
LCD CONTRAST ..... 19  
LINK ..... 21  
LOCK ..... 16
- M**  
MANUAL ..... 24  
MEMORY LOAD ..... 32  
MEMORY ROTATION ..... 33  
MEMORY SAVE ..... 31  
MIDI ..... 34  
MIDI Channel ..... 34  
MIDI Implementation Chart ..... 43  
MORPHING ..... 27
- N**  
NOISE GATE ..... 29
- O**  
Output Level ..... 14
- P**  
PHASE ..... 15  
Play Mode ..... 23
- R**  
Receiving data (BULK LOAD) ..... 39  
RELATIVE ..... 22
- S**  
SEARCH ..... 24  
Specification ..... 45  
STEP GAIN ..... 17  
System Parameter ..... 17
- T**  
THRESHOLD ..... 29  
TIME ALIGNMENT ..... 30  
TOTAL CUT ..... 28  
Troubleshooting ..... 40  
TRS standard plug ..... 9  
Turning On the Power ..... 13
- U**  
UNDO/REDO ..... 30  
User Interface Guide ..... 42
- W**  
WIDE ..... 26

## Information

When you need repair service, call your nearest Roland Service Center or authorized Roland distributor in your country as shown below.

### AFRICA

#### EGYPT

**Al Fanny Trading Office**  
P.O. Box 2904,  
El Horrieh Heliopolis, Cairo,  
EGYPT  
TEL: (02) 4185531

#### REUNION

**Maison FO - YAM Marcel**  
25 Rue Jules Merman, ZL  
Chaudron - BF79 97491  
Ste Clothilde REUNION  
TEL: 28 29 16

#### SOUTH AFRICA

**That Other Music Shop  
(PTY) Ltd.**  
11 Melle Street (Cnr Melle and  
Juta Street)  
Braamfontein, 2001,  
Republic of SOUTH AFRICA  
TEL: (011) 403 4105

**Paul Bothner (PTY) Ltd.**  
17 Werdmuller Centre Claremont  
7700  
Republic of SOUTH AFRICA

P.O. Box 23032  
Claremont, Cape Town  
SOUTH AFRICA, 7735  
TEL: (021) 64 4030

### ASIA

#### CHINA

**Beijing Xinghai Musical  
Instruments Co., Ltd.**  
6 Huangmunchang Chao Yang  
District, Beijing, CHINA  
TEL: (010) 6774 7491

#### HONG KONG

**Tom Lee Music Co., Ltd.  
Service Division**  
22-32 Pun Shan Street, Tsuen  
Wan, New Territories,  
HONG KONG  
TEL: 2415 0911

#### INDIA

**Rivera Digitec (India) Pvt. Ltd.**  
409, Nirman Kendra Mahalaxmi  
Flats Compound Off. Dr. Edwin  
Moses Road, Mumbai-400011,  
INDIA  
TEL: (022) 498 3079

#### INDONESIA

**PT Citra Inti Rama**  
Jl. Cideng Timur No. 15j-150  
Jakarta Pusat  
INDONESIA  
TEL: (021) 6324170

#### KOREA

**Cosmos Corporation**  
1461-9, Seocho-Dong,  
Seocho Ku, Seoul, KOREA  
TEL: (02) 3486-8855

#### MALAYSIA

**Bentley Music SDN BHD**  
140 & 142, Jalan Bukit Bintang  
55100 Kuala Lumpur, MALAYSIA  
TEL: (03) 2443333

#### PHILIPPINES

**G.A. Yupangco & Co. Inc.**  
339 Gil J. Puyat Avenue  
Makati, Metro Manila 1200,  
PHILIPPINES  
TEL: (02) 899 9801

#### SINGAPORE

**Swee Lee Company**  
150 Sims Drive,  
SINGAPORE S87381  
TEL: 748-1669

#### CRISTOFORI MUSIC PTE LTD

Bik 3014, Bedok Industrial Park E,  
#02-2148, SINGAPORE 489980  
TEL: 243 9555

#### TAIWAN

**ROLAND TAIWAN  
ENTERPRISE CO., LTD.**  
Room 5, 9fl. No. 112 Chung Shan  
N.Road Sec.2, Taipei, TAIWAN,  
R.O.C.  
TEL: (02) 2561 3339

#### THAILAND

**Theera Music Co., Ltd.**  
330 Vergn NakornKasem, Soi 2,  
Bangkok 10100, THAILAND  
TEL: (02) 2248821

#### VIETNAM

**Saigon Music**  
138 Tran Quang Khai St.,  
District 1  
Ho Chi Minh City  
VIETNAM  
TEL: (08) 844-4068

### AUSTRALIA/ NEW ZEALAND

#### AUSTRALIA

**Roland Corporation  
Australia Pty., Ltd.**  
38 Campbell Avenue  
Dee Why West. NSW 2099  
AUSTRALIA  
TEL: (02) 9982 8266

#### NEW ZEALAND

**Roland Corporation (NZ) Ltd.**  
97 Mt. Eden Road, Mt. Eden,  
Auckland 3, NEW ZEALAND  
TEL: (09) 3098 715

### CENTRAL/LATIN AMERICA

#### ARGENTINA

**Instrumentos Musicales S.A.**  
Florida 656 2nd Floor  
Office Number 206A  
Buenos Aires  
ARGENTINA, CP1005  
TEL: (54-11) 4-393-6057

#### BRAZIL

**Roland Brasil Ltda.**  
R. Coronel Octaviano da Silveira  
203 05522-010  
Sao Paulo BRAZIL  
TEL: (011) 3743 9377

#### COSTA RICA

**JUAN Bansbach  
Instrumentos Musicales**  
Ave. 1. Calle 11, Apartado 10237,  
San Jose, COSTA RICA  
TEL: (506)258-0211

#### CHILE

**Comercial Fancy S.A.**  
Avenida Rancagua #0330  
Providencia Santiago, CHILE  
TEL: 56-2-373-9100

#### EL SALVADOR

**OMNI MUSIC**  
75 Avenida Notre YY Alameda,  
Juan Pablo 2, No. 4010  
San Salvador, EL SALVADOR  
TEL: (503) 262-0788

#### MEXICO

**Casa Veerkamp, s.a. de c.v.**  
Av. Toluca No. 323, Col. Olivar  
de los Padres 01780 Mexico D.F.  
MEXICO  
TEL: (525) 668 04 80

#### La Casa Wagner de

**Guadalajara s.a. de c.v.**  
Av. Corona No. 202 S.J.  
Guadalajara, Jalisco Mexico  
C.P.44100 MEXICO  
TEL: (3) 613 1414

#### PANAMA

**SUPRO MUNDIAL, S.A.**  
Boulevard Andrews, Albrook,  
Panama City,  
REP. DE PANAMA  
TEL: (507) 315-0101

#### PARAGUAY

**Distribuidora De  
Instrumentos Musicales**  
J.E. Olear y ESQ. Manduvira  
Edeficio, El Dorado Planta Baja  
Asuncion PARAGUAY  
TEL: 595-21-492147

#### PERU

**VIDEO Broadcast S.A.**  
Portinari 199 (ESQ. HALS),  
San Borja, Lima 41,  
REP. OF PERU  
TEL: 51-14-758226

#### URUGUAY

**Todo Musica S.A.**  
Cuareim 1844, Montevideo,  
URUGUAY  
TEL: 5982-924-2335

#### VENEZUELA

**Musicland Digital C.A.**  
Av. Francisco de Miranda,  
Centro Parque de Cristal, Nivel  
C2 Local 20 Caracas  
VENEZUELA  
TEL: (02) 285 9218

### EUROPE

#### AUSTRIA

**Roland Austria GES.M.B.H.**  
Siemensstrasse 4, P.O. Box 74,  
A-6063 RUM, AUSTRIA  
TEL: (0512) 26 44 260

#### BELGIUM/HOLLAND/ LUXEMBOURG

**Roland Benelux N. V.**  
Houtstraat 3, B-2260, Oevel  
(Westerlo) BELGIUM  
TEL: (014) 575811

#### DENMARK

**Roland Scandinavia A/S**  
Nordhavnsvej 7, Postbox 880,  
DK-2100 Copenhagen  
DENMARK  
TEL: (039)16 6200

#### FRANCE

**Roland France SA**  
4, Rue Paul Henri SPAAK,  
Parc de l'Esplanade, F 77 462 St.  
Thibault, Lagny Cedex FRANCE  
TEL: 01 600 73 500

#### FINLAND

**Roland Scandinavia As,  
Filial Finland**  
Lauttasaarentie 54 B  
Fin-00201 Helsinki, FINLAND  
TEL: (9) 682 4020

#### GERMANY

**Roland Elektronische  
Musikinstrumente HmbH.**  
Osstrasse 96, 22844 Norderstedt,  
GERMANY  
TEL: (040) 52 60090

#### GREECE

**STOLLAS S.A.**  
Music Sound Light  
155, New National Road  
26422 Patras, GREECE  
TEL: 061-435400

#### HUNGARY

**Intermusica Ltd.**  
Warehouse Area 'DEPO' Pf.83  
H-2046 Torokbalint, HUNGARY  
TEL: (23) 511011

#### IRELAND

**Roland Ireland**  
Audio House, Belmont Court,  
Donnybrook, Dublin 4,  
Republic of IRELAND  
TEL: (01) 2603501

#### ITALY

**Roland Italy S. p. A.**  
Viale delle Industrie 8,  
20020 Arese, Milano, ITALY  
TEL: (02) 937-78300

#### NORWAY

**Roland Scandinavia Avd.  
Kontor Norge**  
Lilleakerveien 2 Postboks 95  
Lilleaker N-0216 Oslo  
NORWAY  
TEL: 273 0074

#### POLAND

**P. P. H. Brzostowicz**  
UL. Gibraltarska 4,  
PL-03664 Warszawa POLAND  
TEL: (022) 679 44 19

#### PORTUGAL

**Tecnologias Musica e Audio,  
Roland Portugal, S.A.**  
RUA DE SANTA CARARINA  
131/133, 4000-450 PORTO  
PORTUGAL  
TEL: (022) 208 4456

#### ROMANIA

**FBS LINES**  
Plata Libertatii 1,  
RO-4200 Cheorgheni  
TEL: (066) 164-609

#### RUSSIA

**Slami Music Company**  
Sadogava-Triumfalnaja st., 16  
103006 Moscow, RUSSIA  
TEL: 095 209 2193

#### SPAIN

**Roland Electronics  
de España, S. A.**  
Calle Bolivia 239, 08020  
Barcelona, SPAIN  
TEL: (93) 308 1000

#### SWEDEN

**Roland Scandinavia A/S  
SWEDISH SALES OFFICE**  
Danvik Center 28, 2 tr.  
S-131 30 Nacka SWEDEN  
TEL: (08) 702 0020

#### SWITZERLAND

**Roland (Switzerland) AG  
Musitronic AG**  
Gerbenstrasse 5, CH-4410 Liestal,  
SWITZERLAND  
TEL: (061) 921 1615

#### UKRAINE

**TIC-TAC**  
Mira Str. 19/108  
P.O. Box 180  
295400 Munkachevo, UKRAINE  
TEL: (03131) 414-40

#### UNITED KINGDOM

**Roland (U.K.) Ltd.**  
Atlantic Close, Swansea  
Enterprise Park, SWANSEA  
SA7 9FJ,  
UNITED KINGDOM  
TEL: (01792) 700139

### MIDDLE EAST

#### BAHRAIN

**Moon Stores**  
Bab Al Bahrain Road,  
P.O. Box 20077  
State of BAHRAIN  
TEL: 211 005

#### CYPRUS

**Radex Sound Equipment Ltd.**  
17 Diagonou St., P.O. Box 2046,  
Nicosia CYPRUS  
TEL: (02) 453 426

#### ISRAEL

**Halilit P. Greenspoon &  
Sons Ltd.**  
8 Retzif Fa'aliya Hashnya St.  
Tel-Aviv-Yahou ISRAEL  
TEL: (03) 6823666

#### JORDAN

**AMMAN Trading Agency**  
Prince Mohammed St. P.O. Box  
825 Amman 11118 JORDAN  
TEL: (06) 4641200

#### KUWAIT

**Easa Husein Al-Yousifi**  
Abdullah Salem Street,  
Safat KUWAIT  
TEL: 5719499

#### LEBANON

**A. Chahine & Fils**  
P.O. Box 16-5857 Gergi Zeidan St.  
Chahine Building, Achrafieh  
Beirut, LEBANON  
TEL: (01) 335799

#### QATAR

**Badie Studio & Stores**  
P.O. Box 62,  
DOHA QATAR  
TEL: 423554

#### SAUDI ARABIA

**aDawlah Universal  
Electronics APL**  
P.O. Box 2154 ALKHOBAR 31952,  
SAUDI ARABIA  
TEL: (03) 898 2081

#### SYRIA

**Technical Light & Sound  
Center**  
Khaled Ibn Al Walid St.  
P.O. Box 13520  
Damascus - SYRIA  
TEL: (011) 2235 384

#### TURKEY

**Barkat muzik aletleri ithalat  
ve ihracat Ltd Sti**  
Siraselviler cad. Guney is hani 84-  
86/6, Taksim, Istanbul. TURKEY  
TEL: (0212) 2499324

#### U.A.E.

**Zak Electronics & Musical  
Instruments Co. L.L.C.**  
Zabeel Road, Al Shercoq Bldg.,  
No. 14, Grand Floor DUBAI  
U.A.E.  
TEL: (04) 3360715

### NORTH AMERICA

#### CANADA

**Roland Canada Music Ltd.  
(Head Office)**  
5480 Parkwood Way Richmond  
B. C., V6V 2M4 CANADA  
TEL: (0604) 270 6626

#### Roland Canada Music Ltd.

**(Toronto Office)**  
Unit 2, 109 Woodbine Downs  
Blvd, Etobicoke, ON  
M9W 6Y1 CANADA  
TEL: (0416) 213 9707

#### U. S. A.

**Roland Corporation U.S.**  
5100 S. Eastern Avenue  
Los Angeles, CA 90040-2938,  
U. S. A.  
TEL: (323) 890 3700

As of June 1, 2000 (Roland)

For EU Countries



This product complies with the requirements of European Directives EMC 89/336/EEC and LVD 73/23/EEC.

For the USA

### FEDERAL COMMUNICATIONS COMMISSION RADIO FREQUENCY INTERFERENCE STATEMENT

This equipment has been tested and found to comply with the limits for a Class B digital device, pursuant to Part 15 of the FCC Rules. These limits are designed to provide reasonable protection against harmful interference in a residential installation. This equipment generates, uses, and can radiate radio frequency energy and, if not installed and used in accordance with the instructions, may cause harmful interference to radio communications. However, there is no guarantee that interference will not occur in a particular installation. If this equipment does cause harmful interference to radio or television reception, which can be determined by turning the equipment off and on, the user is encouraged to try to correct the interference by one or more of the following measures:

- Reorient or relocate the receiving antenna.
- Increase the separation between the equipment and receiver.
- Connect the equipment into an outlet on a circuit different from that to which the receiver is connected.
- Consult the dealer or an experienced radio/TV technician for help.

Unauthorized changes or modification to this system can void the users authority to operate this equipment.  
This equipment requires shielded interface cables in order to meet FCC class B Limit.

For Canada

### NOTICE

This Class B digital apparatus meets all requirements of the Canadian Interference-Causing Equipment Regulations.

### AVIS

Cet appareil numérique de la classe B respecte toutes les exigences du Règlement sur le matériel brouilleur du Canada.



# Additions to the SRQ-2031 Owner's Manual

The text in this supplement was mistakenly omitted from the SRQ-2031 Owner's Manual. Please add the following sentences where indicated. We apologize for any inconvenience.

Add the following sentence to "Turning On the Power" (p. 12)

- After the power is turned on, Memory Number "1-1" is automatically called up.

Add the following sentence to "Turning Off the Power" (p. 12)

- Settings in effect before the power is turned off are lost. If you want to retain these, save the settings before turning off the power (p. 31).

Add the following sentences to "Saving the Current Settings" (p. 31)

- After the power is turned on, Memory Number "1-1" is automatically called up. Save the settings you want called up automatically when the power is turned on to Memory "1-1."

Add the following text to "Functions Controllable in the Play Mode" (p. 23)

- LOCK function (p. 16)
- LINK function (p. 21)
- Copy function (p. 22)





 Roland®

---

**71675645**

UPC 71675645



12981

**Roland**