

Roland

P/V SYNTHESIZER SPV-355

OWNER'S MANUAL

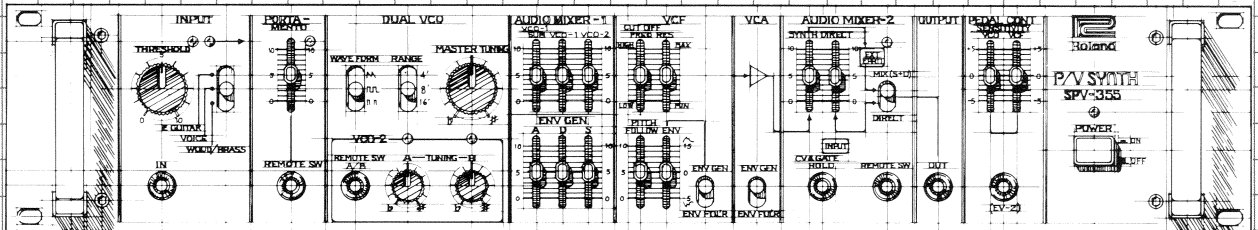

The Roland Rack

P/V SYNTHESIZER

The SPV-355 is a new non-keyboard synthesizer using a superior pitch-to-voltage converter for never-before control stability and accuracy. Now a guitarist or wind instrument player, or even a vocalist can use their instrument to control a synthesizer.

FEATURES

- Four sound sources can be freely mixed: Two VCO's, sub oscillator, and the direct (original) sound.
- VCO-2 can be set for two independent tunings and switched back and forth remotely with a foot switch.
- The envelope follower can be used to produce many delicate nuances of sound.
- Input and output connections are easy because the input and output levels are the same.
- Most of the important functions can be remote controlled, a feature very important in live performance.
- Provision for external CV (1V/oct) and gate pulse inputs for control of the SPV-355 from an external source such as a sequencer or even a synthesizer keyboard controller.

BEFORE STARTING

- Make sure that the line voltage in you are meets the requirements given in the specifications (p. 19).
- Check with your local Roland dealer if you want to use the SPV-355 in a foreign country.
- Plug the SPV-355 in before turning on the power switch.

PRECAUTIONS

- Do not open this unit.
- Unplug this unit when it is not to be used for long periods of time. Unplug by grasping the plug rather than pulling on the cord.
- Be careful not to place heavy objects on the power cord.
- Avoid using this unit in very high or low temperature locations. Also keep away from heaters and coolers since this type of equipment will affect circuit and pitch stability.
- Avoid using this unit in very dusty or humid places.
- If it is necessary to use this unit in an area with neon or fluorescent lights, keep it as far away from these lights as possible since they will induce high levels of noise. Sometimes changing the angle of this unit in relation to the lights will help reduce noise.
- When connecting this unit, plug the cord into the external amplifier first, then plug the other end of the cord into the SPV-355 output. To disconnect, remove the cord from the SPV-355 first, then from the amplifier.
- To clean this unit, wipe with a cloth dampened with a neutral cleanser. Do not use solvents such as paint thinner.

CONTENTS

CONTROL Names			
Front Panel	3		
Rear Panel	3		
Connections			
Front Panel	4		
Rear Panel	4		
External Control	4		
Operation			
Basic Setting	5		
Input Section	5		
Synthesizer Section	6		
Dual VCO (Voltage Controlled Oscillator)	6		
Portamento	7		
Audio Mixer-1	8		
Envelope Generator	8		
VCF (Voltage Controlled Filter)	8		
		About the Envelope Follower	10
		VCA (Voltage Controlled Amplifier)	10
		Audio Mixer-2	10
		Pedal Control	11
		Rear Panel	11
		Obtaining Good Results with the SPV-355	12
		Sample Sounds	13
		SPV-355 Block Diagram	18
		Rack Mounting the SPV-355	18
		Specifications	19

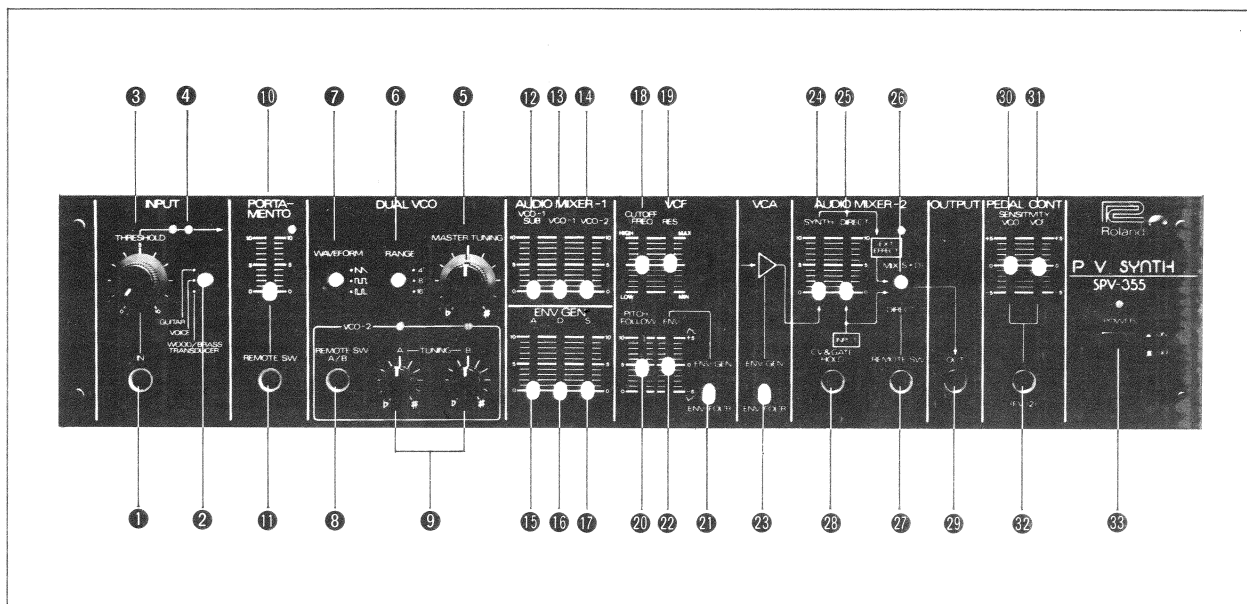

- | | | |
|--|---|---|
| <ul style="list-style-type: none"> ① INPUT Jack (p. 5) ② INPUT SELECTOR Switch (p. 5) ③ THRESHOLD Control (p. 5) ④ INPUT LEVEL INDICATORS (p. 5) ⑤ MASTER TUNING Control (p. 6) ⑥ RANGE Switch (p. 6) ⑦ WAVEFORM Switch (p. 6) ⑧ REMOTE A/B SWITCHING Jack (p. 6) ⑨ A TUNING Control; B TUNING Control (p. 6) ⑩ PORTAMENTO Control (p. 7) ⑪ PORTAMENTO REMOTE SWITCHING Jack (p. 7) | <ul style="list-style-type: none"> ⑫ VCO-1 SUB LEVEL Control (p. 8) ⑬ VCO-1 LEVEL Control (p. 8) ⑭ VCO-2 LEVEL Control (p. 8) ⑮ A (ATTACK TIME) Control (p. 8) ⑯ D (DECAY TIME) Control (p. 9) ⑰ S (SUSTAIN LEVEL) Control (p. 8) ⑱ VCF CUTOFF FREQUENCY Control (p. 9) ⑲ VCF RESONANCE Control (p. 9) ⑳ VCF PITCH FOLLOW Control (p. 9) ㉑ VCF ENVELOPE SELECTOR Switch (p. 9) ㉒ VCF ENVELOPE LEVEL Control (p. 9) | <ul style="list-style-type: none"> ㉓ VCA ENVELOPE SELECTOR Switch (p. 10) ㉔ SYNTHESIZER LEVEL Control (p. 10) ㉕ DIRECT LEVEL Control (p. 10) ㉖ MIX/DIRECT SELECTOR Switch (p. 11) ㉗ MIX/DIRECT REMOTE SWITCHING Jack (p. 11) ㉘ CV & GATE HOLD Jack (p. 11) ㉙ OUTPUT Jack (p. 11) ㉚ VCO SENSITIVITY LEVEL Control (p. 11) ㉛ VCF SENSITIVITY LEVEL Control (p. 11) ㉜ FOOT VOLUME Jack (p. 11) ㉝ POWER Switch |
|--|---|---|

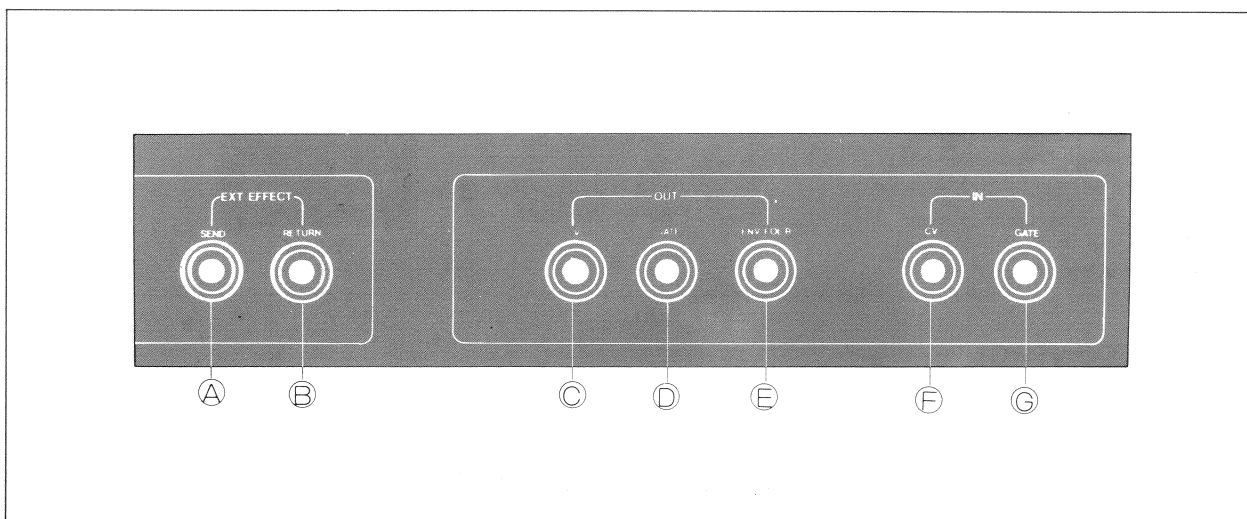

- Ⓐ EXT EFFECT SEND Jack (p. 11)
- Ⓑ EXT EFFECT RETURN Jack (p. 11)
- Ⓒ CV OUT Jack (p. 11)
- Ⓓ GATE OUT Jack (p. 11)
- Ⓔ ENV FOL'R Jack (p. 11)
- Ⓕ CV IN Jack (p. 11)
- Ⓖ GATE IN Jack (p. 11)

CONNECTIONS

FRONT PANEL

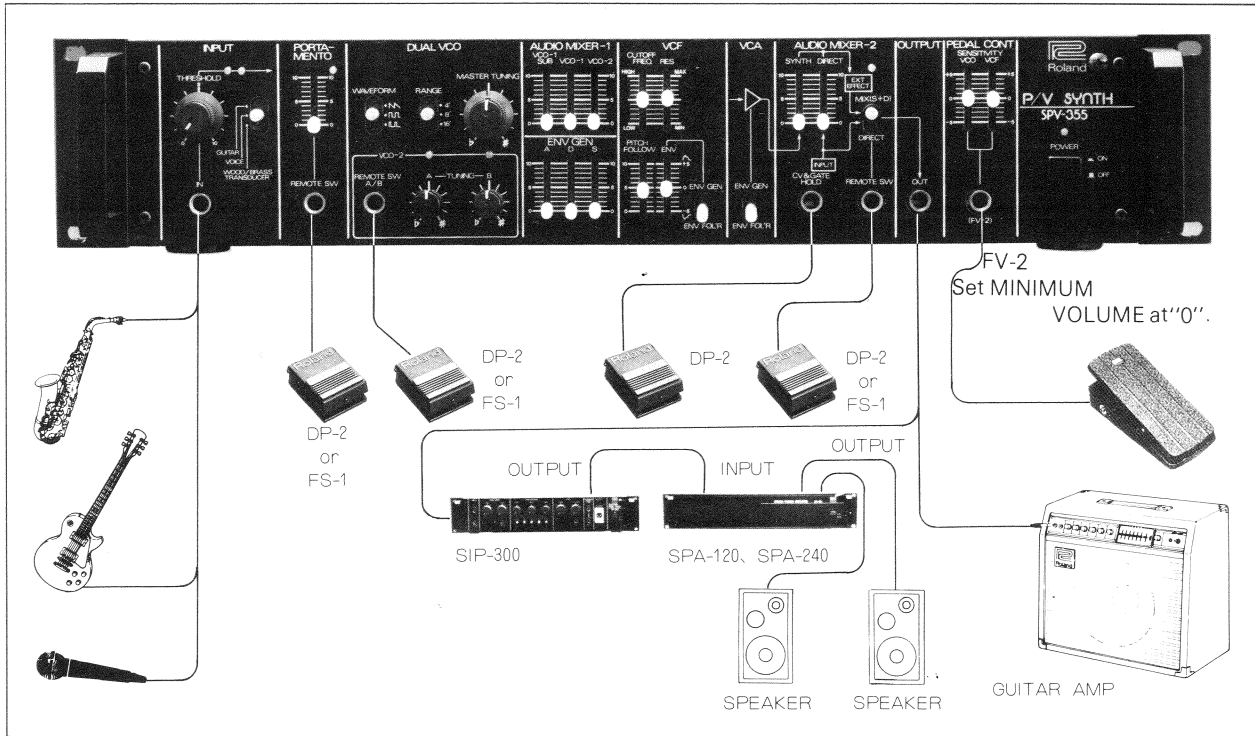

REAR PANEL

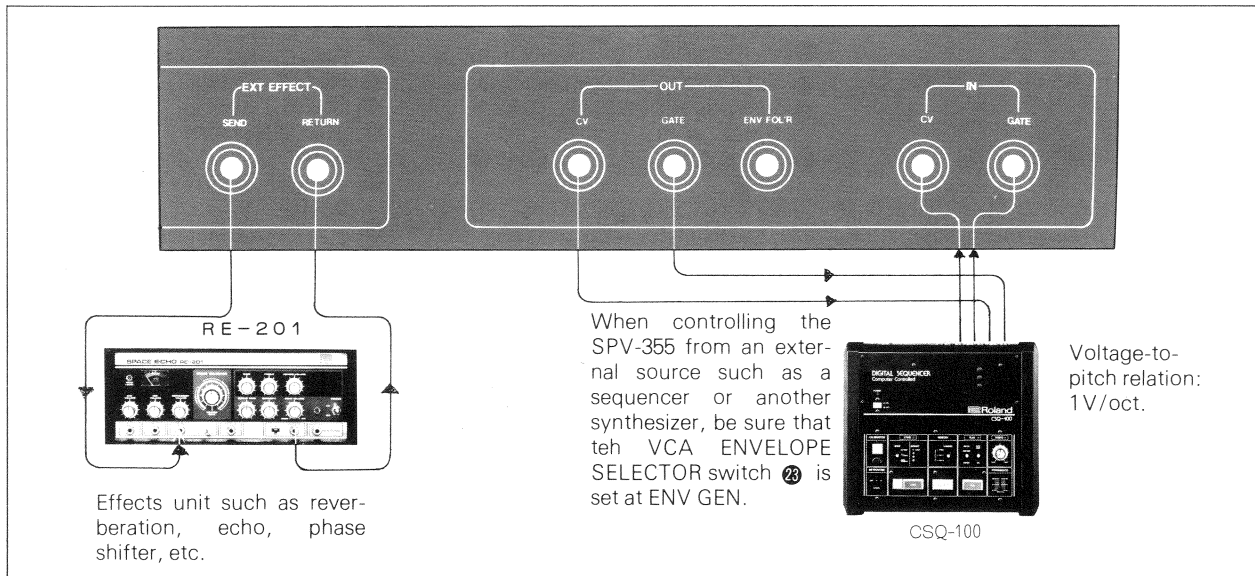

REMOTE CONTROL

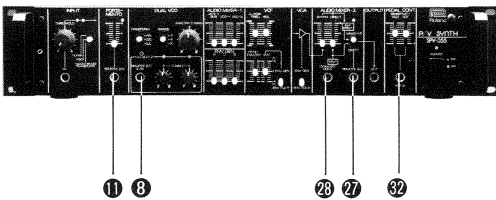

8	REMOTE	DP-2	Depress: A Tuning; Release: B tuning	p. 6
	A/B Sw.	FS-1	Alternates between A and B tuning with each depression	
11	PORTAMENTO	DP-2	Depress: Portamento ON	p. 7
	REMOTE Sw.	FS-1	Alternates between ON and OFF with each depression	
27	MIX/DIRECT	DP-2	Depress: MIX(S + D); Release: DIRECT only	p. 11
	REMOTE Sw.	FS-1	Alternates between MIX(S + D) and DIRECT with each depression	
28	CV & GATE HOLD Sw.	DP-2	Depress: HOLD; Release: NORMAL	p. 11
32	VCO SENS	FV-1	Amount of control depends on position of VCO slider 31 above jack	p. 11
	VCF SENS	FV-1	Amount of control depends on position of VCF slider 31 above jack	

OPERATION

BASIC SETTING

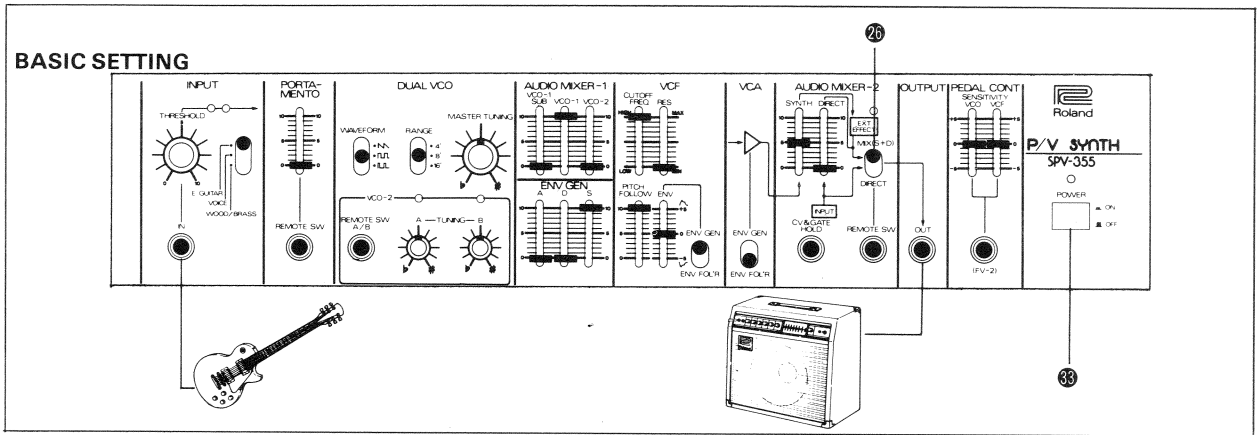

1. Turn on the POWER Switch 38 only after making all connections to other equipment.

- The internal circuits require approximately 15 minutes of warm-up time before they become completely stable.

2. Volume Adjustment

(1). Set the AUDIO MIXER-2 MIX/DIRECT SELECTOR switch 26 at DIRECT.

- In this condition, the input sound passes through the SPV-355 without being affected by any of the other controls and the output level is the same as the input level.

NAMES AND FUNCTION OF THE CONTROLS

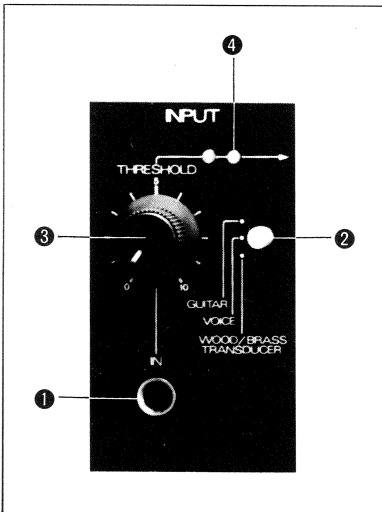

• INPUT SECTION

In addition to providing the audio input to the SPV-355, the INPUT SECTION performs two important functions:

(1). Pitch-to-voltage conversion:

The input audio signal is analyzed and converted into a control voltage for controlling the SYNTHESIZER SECTION pitch.

(2). Gate pulse generation:

When the input signal level goes above a certain predetermined point, a gate pulse is generated for triggering the synthesizer functions.

- The SPV-355 uses the standard of 1V/oct. This means that a pitch shift of one octave in the input signal will cause a one volt shift in control voltage.

(2). Play the instrument connected to the input and adjust the external amplifier for the desired sound level.

3. Set the INPUT SELECTOR switch 2 to match the input and adjust the THRESHOLD control 3 so that the red INPUT LEVEL INDICATOR 4 lights occasionally on loud notes.

4. Set the remaining controls as shown above and try producing sound.

- With this setting, the VCO-1 output is the 8' square wave.

- The DIRECT sound does not appear at the output.

- Whenever you have trouble producing sound while experimenting with the SPV-355, it is usually a good idea to return to this standard setting and start again.

5. Try producing various sounds with the SYNTHESIZER SECTION (see Sample Sounds, p. 13).

- The SYNTHESIZER SECTION operates just like any other voltage controlled synthesizer. Synthesizer theory is explained in the following pages.

■ INPUT

1 INPUT JACK

For connecting inputs such as an electric guitar or vocal microphone.

2 INPUT SELECTOR Switch

Set this switch to match the input instrument being used.

E (electric) GUITAR: for electric guitar
VOICE: for vocal microphones
WOOD/BASS: for acoustic instruments equipped with a pickup

- Bass instruments cannot be used (see p. 12).

3 THRESHOLD Control

The synthesizer requires a gate pulse for triggering sounds. Since the input sound varies greatly, it is necessary to decide on a level above which the gate pulse will be ON and below which it will be OFF. This is the purpose of the THRESHOLD control 3. Use the INPUT LEVEL INDICATORS 4 to set the THRESHOLD control 3 at its optimum position (see below).

- The threshold level for the start of the input sound is slightly higher than the threshold level at the end of the sound.

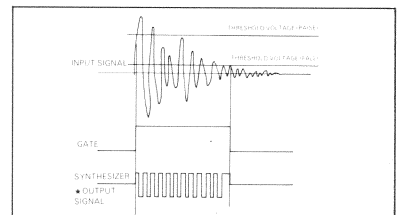

4 INPUT LEVEL INDICATORS

The green indicator lights when the gate pulse is ON, or in other words, when the synthesizer is being triggered. The red indicator lights for overloads when the input level is too high. Adjust the THRESHOLD control 3 so that while playing the input instrument, the green indicator lights and the red indicator flashes only occasionally.

- The SPV-355 is a monophonic instrument and therefore cannot play chords.

- The SPV-355 will not operate correctly if more than one pitch is fed into the input simultaneously.

- See "Obtaining Good Results with the SPV-355", p. 12.

● SYNTHESIZER SECTION

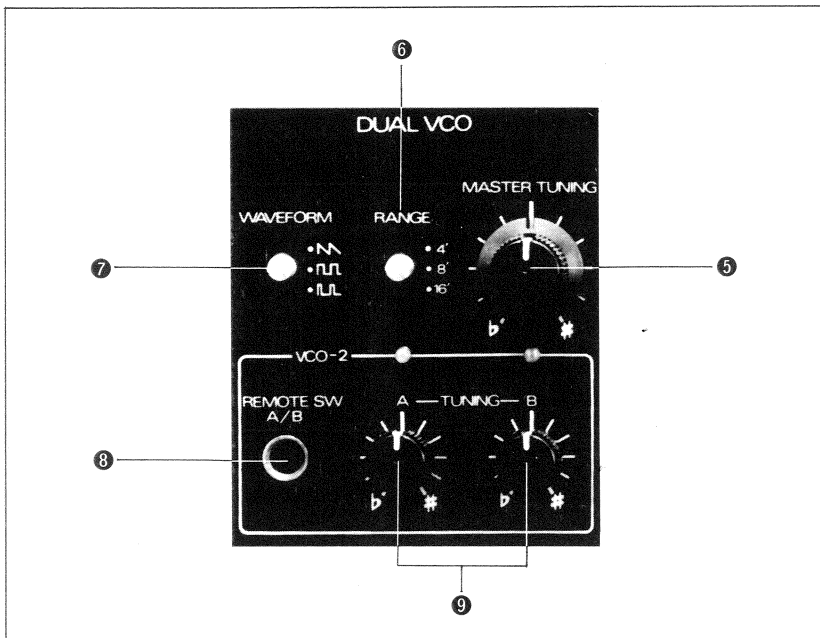



● DUAL VCO (Voltage Controlled Oscillator)

An oscillator is an electronic circuit which generates a waveform, or in this case, sound. Voltage controlled means that a control voltage is used to determine the frequency or pitch produced by the oscillator. The control voltage used to control pitch is derived from the INPUT SECTION or comes from the CV INPUT jack  on the rear panel.

● MASTER TUNING Control

Used for simultaneously tuning VCO-1 and VCO-2. The tuning range is approximately ± 250 cents (100 cents = minor second).

● Tuning:

With the standard setting (top of p. 3), move the MIXER-2 DIRECT LEVEL control  up. The output sound will consist of the direct sound plus the VCO-1 sound. Set the MASTER TUNING control  so that VCO-1 is in unison with the direct sound.

● RANGE Switch

Determines the pitch range of VCO-1 and VCO-2. At 8', pitches will be the same as the input signal pitches. At 4', VCO pitches will be one octave higher than the input, and at 16' one octave lower.

● WAVEFORM Switch

Used to select the waveform to be generated by the two VCO's (see box at the right).

● REMOTE A/B SWITCHING Jack





Using the A and B TUNING controls  (below), the tuning of VCO-2 can be instantly shifted by means of a foot pedal (Roland DP-2). When the pedal is depressed, VCO-2 tuning will be determined by the A TUNING control; when released, by the B TUNING control.

●When there is no connection at the REMOTE A/B SWITCHING jack , VCO tuning will be determined by the B TUNING control.

●If the Roland FS-1 Foot Switch is used, VCO-2 tuning will alternate between A and B tuning each time the switch is depressed.

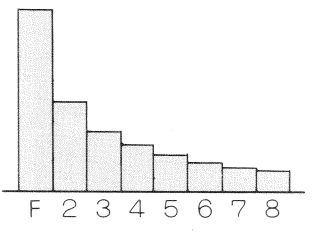
● A TUNING Control; B TUNING Control

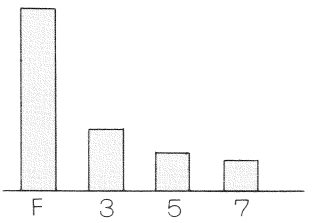
Determines the tuning of VCO-2 in relation to VCO-1; see REMOTE A/B SWITCHING jacks  above.

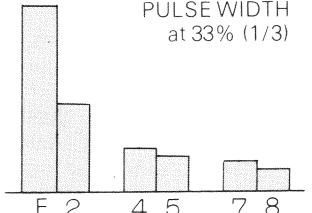
WAVEFORM	DESCRIPTION	HARMONIC CONTENT
 Sawtooth Wave	<p>The sawtooth wave is the most often used waveform because it is very rich in tone color. It contains all harmonics, as shown in the graph at the right. Harmonics are frequencies which are multiples of the fundamental (or pitch) frequency of the sound.</p>	<p>F: Fundamental</p> 
 Square Wave	<p>The square wave is also rich in tone color but contains only the odd numbered harmonics. The square wave is also rich in tone color but contains only the odd numbered harmonics. The square wave sounds much like a clarinet and is often used to produce woodwind instrument sounds, or the sound of the xylophone.</p>	
 Pulse Wave	<p>The harmonic content of the pulse wave will depend on the width of the pulses in the wave. In the graph at the right, the pulse ratio is 33% or 1/3; therefore, the third harmonic and all its multiples (3, 6, 9, 12, etc.) are missing from the sound.</p>	<p>PULSE WIDTH at 33% (1/3)</p> 

★ Tuning VCO-2

After setting the MASTER TUNING control ⑤ as shown above, set the AUDIO MIXER-2 DIRECT LEVEL control ⑫ at "0" and raise the AUDIO MIXER-1 VCO-2 LEVEL control ⑬ to produce both VCO sounds. Use the B TUNING control ⑨ to tune VCO-2 to the desired interval in relation to VCO-1.

Next, connect a DP-2 Foot Pedal to the REMOTE A/B SWITCHING jack ⑧ and while holding the pedal depressed, use the A TUNING control ⑥ to tune VCO-2.

★ Effective Use of the Tuning Controls

1. If the B TUNING control is set very slightly away from perfect unison with VCO-1, a chorus effect is produced. The accordion would be a good example of a sound using this effect.
2. When the B TUNING control is set at unison with VCO-1 and A TUNING at a perfect fourth or perfect fifth above, a foot switch can be used to add the feeling of chords to the music.
3. When the B TUNING control is set a major third above VCO-1 and the A TUNING control a minor third above, a foot switch can be used to produce major and minor chords in the music.

● PORTAMENTO

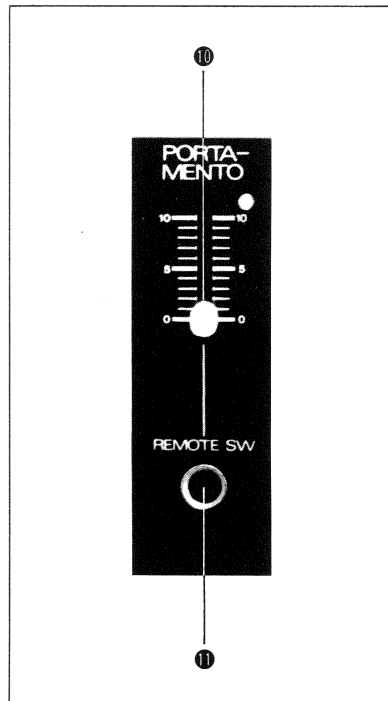

● PORTAMENTO

Portamento is the effect of sliding from one pitch to another such as is sometimes used in trombone or string instrument playing.

⑩ PORTAMENTO Control

This slider determines the amount of time required to slide from one pitch to the next. At "0", there is no portamento effect; at "10", portamento time is maximum.

⑪ PORTAMENTO REMOTE SWITCHING Jack

This jack is used for controlling the ON/OFF function of the portamento effect by means of a foot switch (DP-2 or FS-1). When the DP-2 Foot Pedal is depressed, the indicator next to the slider lights showing that the portamento is in effect. When the pedal is released, the indicator goes out showing that the portamento effect is OFF.

With the FS-1 Foot Switch, the effect will alternate between ON and OFF each time the switch is pressed.

● AUDIO MIXER-1

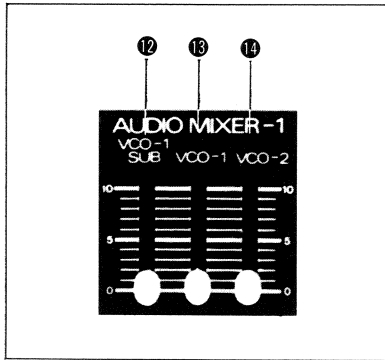

12 VCO-1 SUB LEVEL Control

The VCO-1 sub-oscillator generates a pitch one octave below the VCO-1 pitch. This slider determines the amount of this lower level pitch which is to be mixed with the synthesizer output sound.

● The sub-oscillator produces a square wave only.

13 VCO-1 LEVEL Control

Determines the level of the VCO-1 sound.

14 VCO-2 LEVEL Control

Determines the level of the VCO-2 sound.

★ AUDIO MIXER-1 serves the purpose of mixing together the three synthesizer outputs: VCO-1 SUB, VCO-1, and VCO-2. The output of this mixer is sent to the VCF.

■ ENV GENERATOR

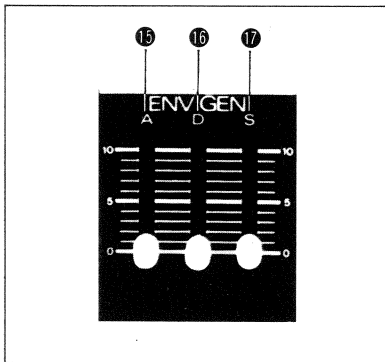

The envelope generator is triggered into operation by means of the gate pulse and generates a voltage whose level varies with time according to how the controls are set. The most common use of this control voltage output is for control of the loudness of the synthesizer output sound.

15 A (ATTACK TIME) Control

This control determines the amount of time required for output sound of the synthesizer to jump to maximum loudness once the envelope generator has been triggered. At "0", the time is very short (1ms) and produces a very percussive sound. When the control is raised, the sound fades in much like a violin which is bowed slowly.

16 D (DECAY TIME) Control

The control determines the amount of time required for the sound level to fall to the level set by the SUSTAIN control 17 (below). At "0", decay time is very short (2ms).

17 S (SUSTAIN LEVEL) Control

This control determines the output level of notes which are sustained. At "0", the output level will be minimum. At "10", the output level will be the same as the level reached at the end of attack time.

The gate pulse triggers the envelope generator into operation and the sound rises (attack time) to its maximum level, then falls (decay time) to the level set by the SUSTAIN control 17. This level is then held until the gate pulse ceases.

PARTS OF ENVELOPE

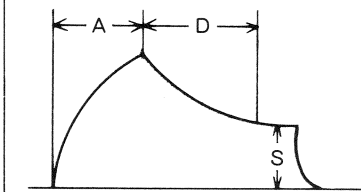

■ VCF (Voltage Controlled Filter)

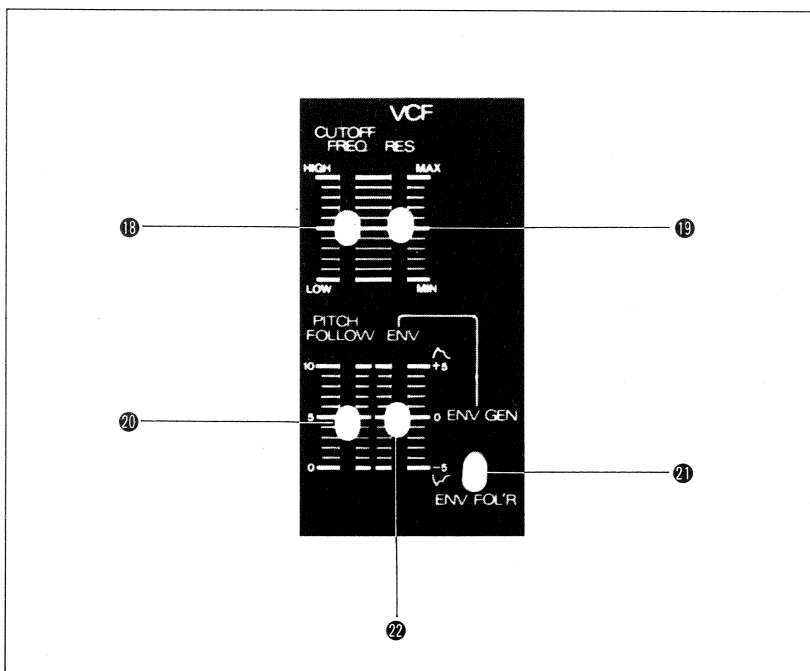

The VCF (voltage controlled filter) is a filter whose filtering characteristics are controlled by a control voltage. The VCF controls the tone color of the synthesizer output sound by removing and/or accenting harmonics contained in the sound coming from AUDIO MIXER-1.

18 VCF CUTOFF FREQUENCY Control

The VCF is a low pass filter. This means that it passes low frequencies and blocks higher frequencies. The CUTOFF FREQUENCY control 18 determines the rough dividing line between those frequencies which are passed and those which are not.

With the CUTOFF FREQUENCY control 18 at "10", the VCF passes all sound without affecting it. If the slider is slowly moved downwards, the filter will begin to slowly shave off the upper harmonics of the sound coming from AUDIO MIXER-1. This has the effect of rounding the sharp corners of the waveform which passes through the VCF. With the CUTOFF FREQUENCY control 18 at MIN (minimum), almost all sound is removed by the VCF.

19 VCF RESONANCE Control

The RESONANCE control 19 serves to accent the frequencies at the cutoff point of the VCF. (The cutoff point of the VCF is determined by the position of the VCF CUTOFF FREQUENCY control 18 above). At "0", the RESONANCE control 19 has no effect. The effect becomes stronger the higher the control is raised. At about "8" or so, the frequencies at the cutoff point of the VCF are accented so strongly that the VCF starts to oscillate by itself, or in other words, it begins generating sound even with no input to the VCF. The frequency or pitch of this sound is determined by the position of the VCF CUTOFF FREQUENCY control 18.

Sounds which are particularly associated with the synthesizer are produced by setting the VCF RESONANCE control 19 high (but lower than "8") and causing the VCF cutoff frequency to sweep up and/or down when notes are produced.

Raising the VCF RESONANCE control 19 has the effect of lowering the level of the output sound; with some settings it may be necessary to raise the external amplifier volume control.

20 VCF PITCH FOLLOWER Control

This control allows the VCF cutoff frequency to be controlled by means of the pitch control voltage derived from the SPV-355 input signal. The tone color of most instruments changes with pitch; higher pitches are usually brighter. This effect can be imitated by raising the PITCH FOLLOWER control 20 so that the VCF cutoff frequency follows the VCO pitch changes. The tone color will remain unchanged for all pitches but because of the way we hear, the higher pitches will sound brighter. If the VCF PITCH FOLLOWER control 20 is set at "0", the VCF cutoff frequency will remain fixed. Lower pitches will be farther away from the cutoff point, thus they will be brighter. Higher pitches will be nearer the cutoff frequency, or even above it, in which case it is possible that all or most of the sound would be cut off.

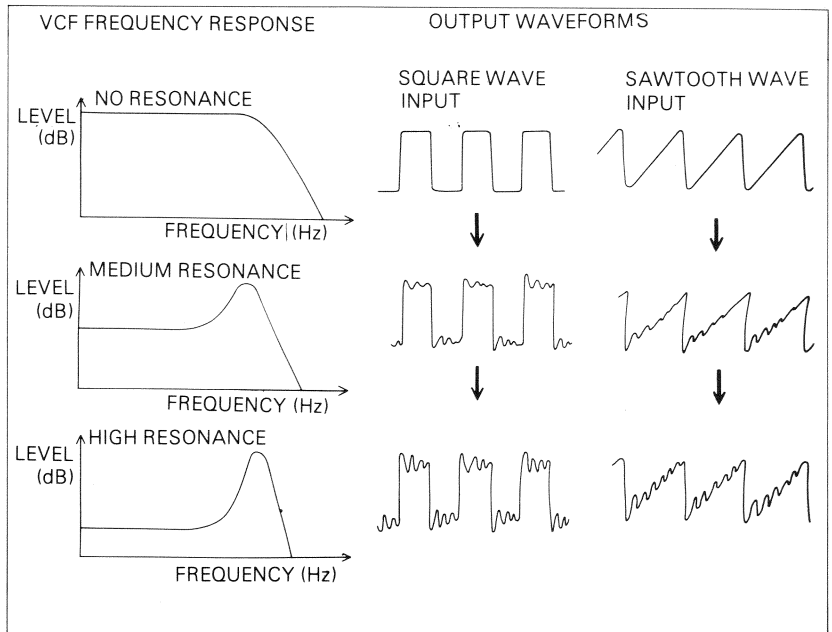
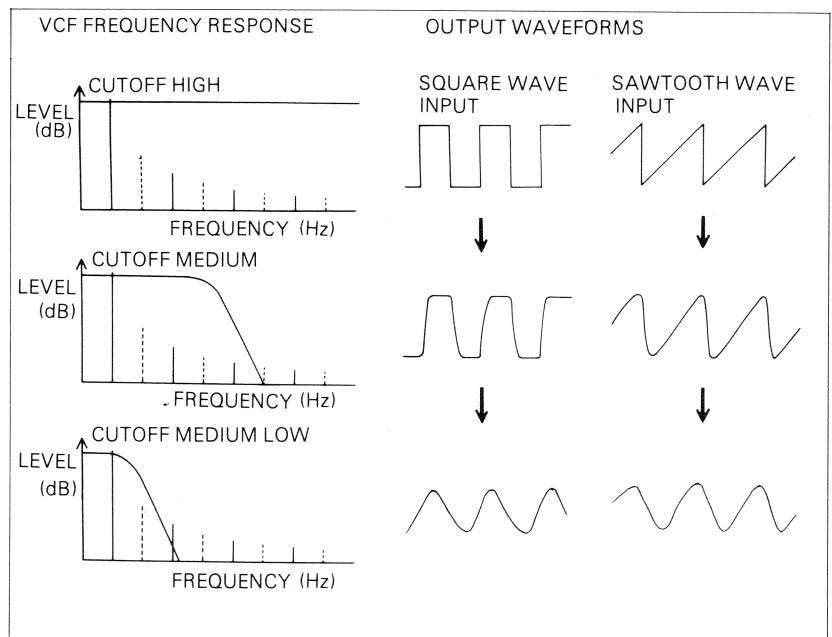

21 VCF ENVELOPE SLECTOR Switch

Selects the envelope source to be used for control of the VCF cutoff frequency. At ENV GEN (envelope generator), the VCF cutoff frequency will follow the shape of the envelope produced by the envelope generator (p. 8). At ENV FOL'R (envelope follower, see p. 10), the VCF cutoff frequency will follow the envelope (loudness contour) of the SPV-355 input signal.

22 VCF ENVELOPE LEVEL Control

Determines the depth and polarity of control that the envelope source will have on the VCF cutoff frequency.

At the center "0" mark, the envelope source does not affect the VCF. Moving the slider up will cause the VCF cutoff frequency to follow the contour of the envelope source. Moving the slider

down will cause the VCF cutoff frequency to follow the envelope source, but in the opposite direction. In other words, when the envelope voltage moves upward, the cutoff frequency will move downwards.

• With the VCF ENVELOPE LEVEL control 22 up, the VCF CUTOFF FREQUENCY control 18 should be kept low; with the VCF ENVELOPE LEVEL control 22 down, the VCF CUTOFF FREQUENCY control 18 should be kept high. If this is not done, the envelope source will have little or no effect on the cutoff frequency.

★ **About the ENVELOPE FOLLOWER**

The tone color of many instruments will change during the production of each note. This effect can be imitated by controlling the VCF cutoff frequency with the envelope generator. Since the SPV-355 uses an audio signal as its major control input, it is possible to extract the original envelope from this signal and use it to control both the VCA (explained below) and the VCF. The result is a very natural sound. Using the envelope follower to control the VCF while using a guitar, for example, can produce very effective results since the tone color will vary with and can be controlled by your picking technique.

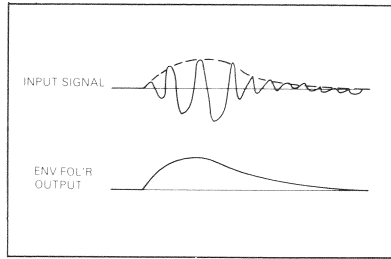

● As can be seen in the block diagram of the SPV-355 (p. 18), the gate pulse is derived from the input signal by detecting the input signal level, whereas the envelope follower voltage is derived from the input waveform itself. If there is no input signal, as will usually be the case when using the gate and CV inputs on the rear panel, the envelope follower will not work.

● **VCA**

(Voltage Controlled Amplifier)

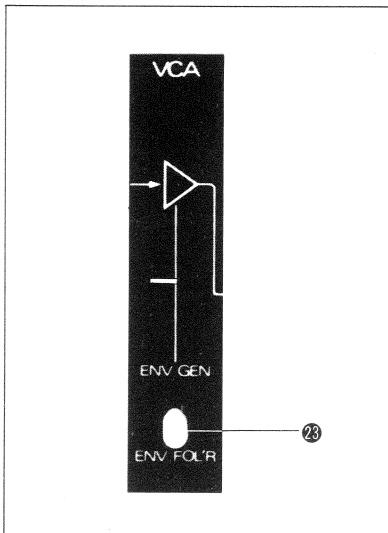

The VCA (voltage controlled amplifier) is an amplifier whose output level is controlled by a control voltage. Normally, the VCA is controlled by the envelope source so that the loudness of the synthesizer output sound will follow the shape of the controlling envelope.

23 **VCA ENVELOPE SELECTOR Switch**

Selects the envelope source to be used for control of the VCA. At ENV GEN (envelope generator), the output sound of the synthesizer will follow the loudness contours produced by the envelope generator; at ENV FOL'R (envelope follower), the output level of the synthesizer will follow the loudness contours of the input signal.

● **AUDIO MIXER-2**

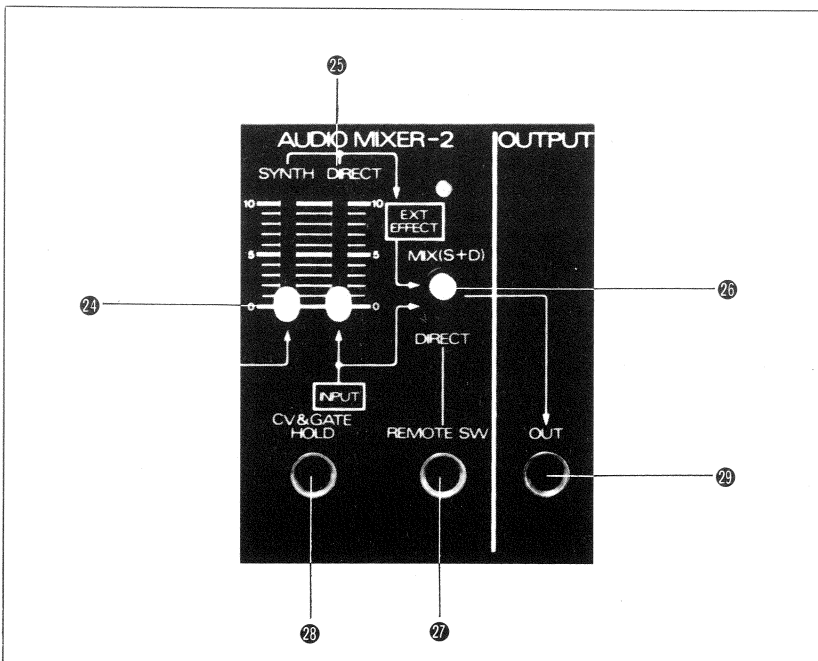

AUDIO MIXER-2 is used for mixing the output of the synthesizer with the direct signal before going to the SPV-355 OUTPUT jack 28

24 **SYNTHESIZER LEVEL control**

Controls the output level of the sound produced with the synthesizer.

25 **DIRECT LEVEL Control**

This slider controls the output level of the audio signal which is taken directly from the input stage of the SPV-355.

26 MIX/DIRECT SELECTOR Switch

This switch allows simple and instantaneous switching between the synthesizer + direct and direct only sounds. At DIRECT, the signal at the OUTPUT jack 29 is exactly the same as the signal at the INPUT jack 1. At MIX (S + D) (synthesizer + direct), the indicator above the switch lights and the output of AUDIO MIXER-2 appears at the OUTPUT jack 29.

27 MIX/DIRECT REMOTE SWITCHING Jack

This jack allows the MIX/DIRECT SELECTOR switch 26 function to be controlled remotely with a pedal switch (DP-2) or foot switch (FS-1).

28 CV & GATE HOLD Jack

To use this function, set the VCA ENVELOPE SELECTOR switch 23 at ENV GEN and connect a pedal switch (DP-2) to the CV & GATE HOLD jack 28. If the pedal is pressed while the synthesizer is producing sound, this note will be held until the pedal is released. Pressing the pedal causes the pitch control voltage to the VCO to be held and holds the synthesizer gate pulse ON.

Since the gate pulse is not used when using the envelope follower function, the gate hold function will not operate if the VCA ENVELOPE SELECTOR switch 23 is in the ENV FOL'R position. If the pedal is pressed using the envelope follower, the VCO pitch control voltage will be held so that all notes produced will have the same pitch.

29 OUTPUT Jack

● PEDAL Control

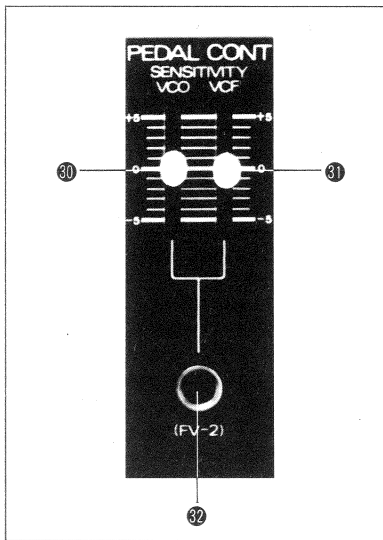

30 VCO SENSITIVITY LEVEL Control

This control determines the depth of control a foot volume control will have on the VCO pitch. At center '0', the pedal will have no effect. If the control is raised, pressing the pedal down will cause the VCO pitch to rise. If the control is lowered, pressing the pedal will cause the VCO pitch to fall.

31 VCF SENSITIVITY LEVEL Control

Determines the depth of control a foot pedal will have on the VCF cutoff frequency.

● When using the FV-2 Foot Volume, be sure to set the MINIMUM VOLUME control at "0".

32 FOOT VOLUME Jack

This jack is for using a foot volume control (FV-2) to manually control the VCO pitch and/or VCF cutoff frequency.

● REAR PANEL

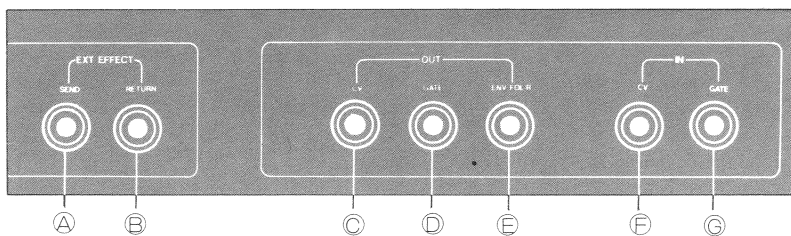

A EXT (external) EFFECT SEND Jack

When using an external effect unit, connect this jack to the effect unit input jack.

B EXT (external) EFFECT RETURN

When using an external effect unit, connect this jack to the output of the effect unit.

● Since the external effect device will be in series with the SPV-355, the effect device should be set for EFFECT + DIRECT output.

● When not using an external effect device, there should be no connections at the EFFECT SEND A and EFFECT RETURN B jacks.

C CV OUT Jack

The output at this jack is the control voltage which is derived from the pitch of the SPV-355 input signal. For controlling an external synthesizer, connect to the external synthesizer's CV input.

D GATE OUT Jack

The output at this jack is the gate pulse which is derived from the SPV-355 input signal. For triggering an external synthesizer, connect to the external synthesizer's gate input.

E ENV FOL'R (Envelope Follower) OUT Jack

The output of this jack is the envelope voltage derived from the envelope follower. For control of an external synthesizer, connect directly to the external synthesizer's VCF and/or VCA modulation inputs.

F CV IN Jack

This jack allows control of the SPV-355 pitch from an external control voltage source such as an external synthesizer keyboard controller or sequencer. The internal connection to the INPUT SECTION (p. 5) pitch circuits is cut when using this jack.

G GATE OUT Jack

This jack allows triggering of the SPV-355 from an external source such as a synthesizer keyboard controller or a sequencer. The internal connection to the INPUT SECTION (p. 5) gate circuit is broken when using this jack.

★ Obtaining Good Results with the SPV-355

If you use an oscilloscope to look at the waveform produced by music instruments, you will find that it is extremely complex. This is because the sound contains many harmonics in addition to the basic fundamental pitch. Each instrument produces its own unique waveform. The function of the input section of the PV-355 is to eliminate

these upper harmonics leaving only the fundamental from which the pitch can be determined and converted into a control voltage. Good results are easier to obtain when the input sound is mellow and contains few harmonics. With very little practice, you should be able to produce good results from the SPV-355 using only ordinary playing

techniques. The following hints should be helpful.

★ Hints for Good Operation

Overall:

1. Use only a monophonic melody line source for control.
2. Be careful of hum and noise from the external sound source since these can cause tracking errors (see "Tracking Errors" below).
3. Bass instruments (string bass, bass guitar, tuba, etc.) cannot be used.

Electric Guitar:

1. Use a pickup close to the neck.
2. Set the guitar TONE and VOLUME control at maximum.
3. Prefer higher finger positions (above the fifth fret).
4. Tracking errors become more difficult with higher pitches, so higher pitches should be preferred.
5. Mute all strings which are not in use. Each note should be produced only after the previous note has been completely dampened.
6. A humbucking pickup is better than a single coil pickup.
7. Each guitar is an individual instrument and will tend to produce its own particular tracking error problems. The key to this problem is experimentation; know what can be done and what cannot be done with the instrument in question.
8. If you sit on top of an amplifier while playing, this can cause hum and/or tracking errors in the SPV-355.

Wind Instruments:

1. Use a contact pickup (connect directly to the INPUT jack ①).
2. Avoid using a vocal microphone. Wind disturbances will cause tracking errors.
3. Play with a soft tone and use a moderate amount of tonguing.
4. Striking keys or valves with great force can cause the pickup to produce thumps which in turn cause tracking errors.

Vocal Microphone:

1. Do not use a microphone with a built-in low cut filter. Dynamic microphones will probably work best.
2. Open your mouth wide when singing into the microphone.

★ Tracking Errors

Tracking refers to the ability of the synthesizer VCO to follow the pitch of the input sound. With some instruments, certain playing techniques can produce sound with a fundamental which is extremely unstable. This can cause the synthesizer and direct sound to be of different pitches, or can cause the synthesizer to lose its sense of pitch altogether, as happens when you try to play chords on the input instrument.

★ Input Pitch Limitations

The pitch-to-voltage converter has a lower limit of 70Hz below which the pitch-to-voltage conversion will not be accurate. Also, with pitches which approach this limit, tracking errors can occur more easily. The second string on the electric bass (D one ledger line below the bass cleff) produces a frequency of about 73Hz.

● SAMPLE SOUNDS

Clarinet

Since the square wave already sounds very clarinet-like, it is used as the foundation for the clarinet sound.

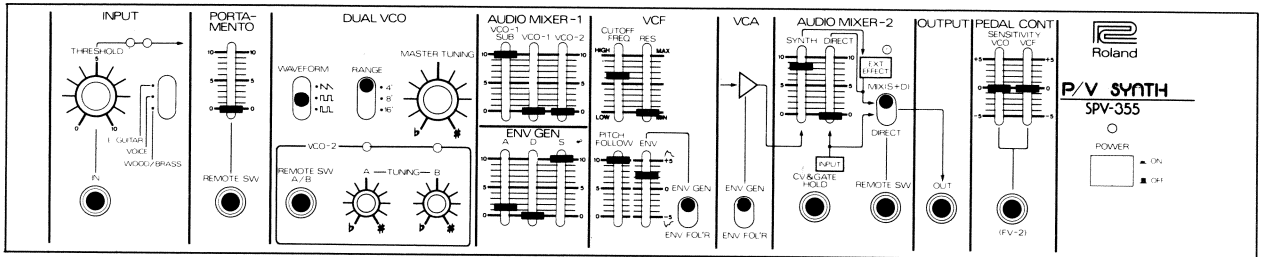

Oboe

The oboe is very rich in harmonics and uses the pulse wave. The VCF RESONANCE control 10 is raised so as to accent the frequencies at the cutoff point of the VCF.

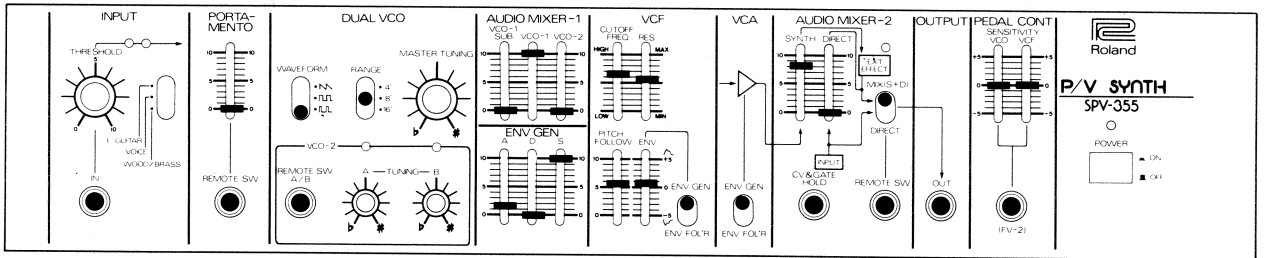

Trumpet

The trumpet uses the sawtooth wave. The envelope generator is used to control the VCF cutoff frequency to produce a brassy sound. Try various settings of the envelope generator ATTACK control 15

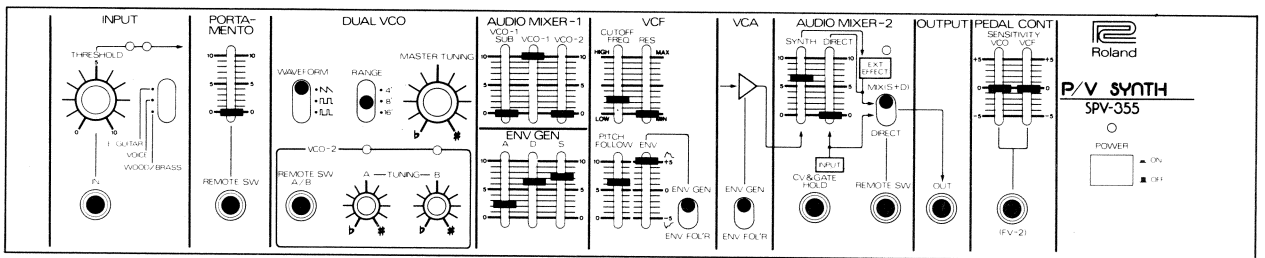

Violin

The violin sound uses the 8' sawtooth wave output of the VCO. The VCF CUTOFF FREQUENCY control 18 is set high. Change the envelope generator ATTACK control 15 to match the

particular phrasing and playing style desired.

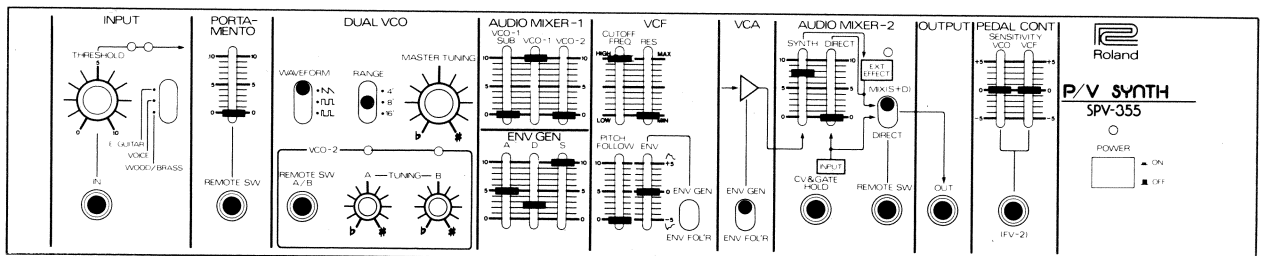

Cello

The 'cello sound uses the 16' pulse wave. VCO-2 is used to give depth to the sound. Tune VCO-2 to near unison with VCO-1.

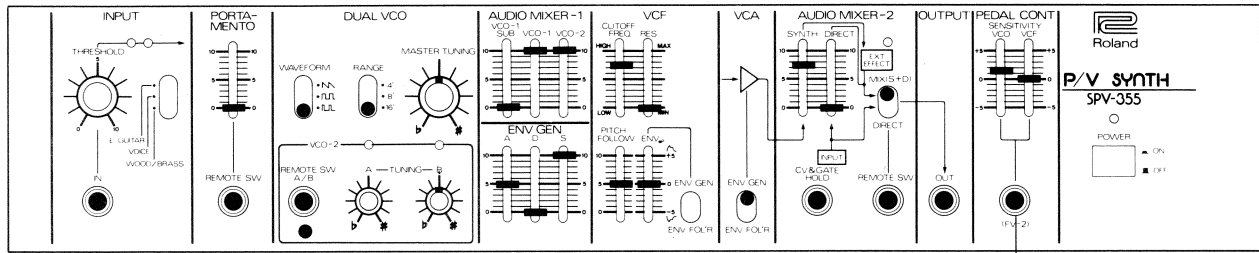

F V-2

Accordion

Tune VCO-2 to near unison with VCO-1.

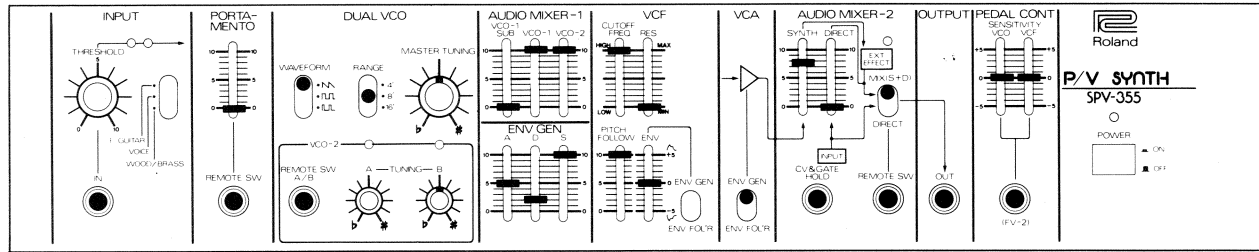

Jazz Organ

Tune VCO-2 to near unison with VCO-1. Use the VCO-1 SUB oscillator to fatten the sound, if desired.

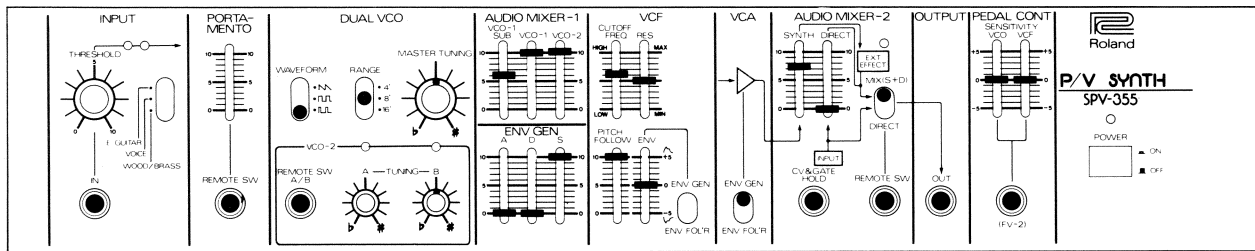

Xylophone

The xylophone sound uses the 4' square wave. Adjust the sound using the envelope generator DECAY (16) and SUSTAIN (17) controls.

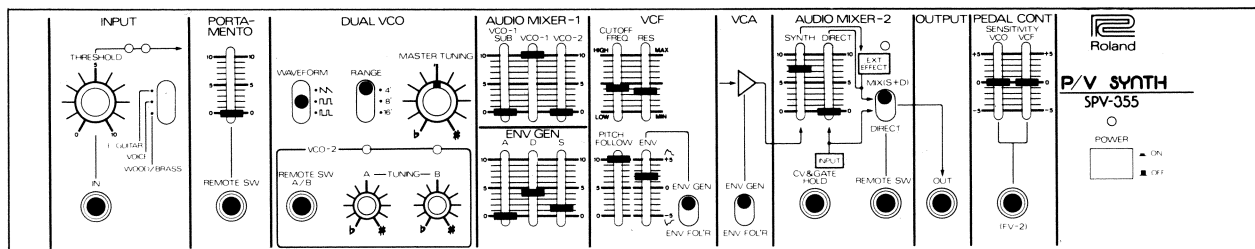

Bass Drum

Many percussion instrument sounds can be imitated by raising the VCF RESONANCE control 19 to maximum and using the VCF as the sound source instead of the VCO. The VCF CUTOFF

FREQUENCY control 18 determines the pitch of the output sound and be adjusted to produce other sounds such as tom toms, congos, bongos, etc.

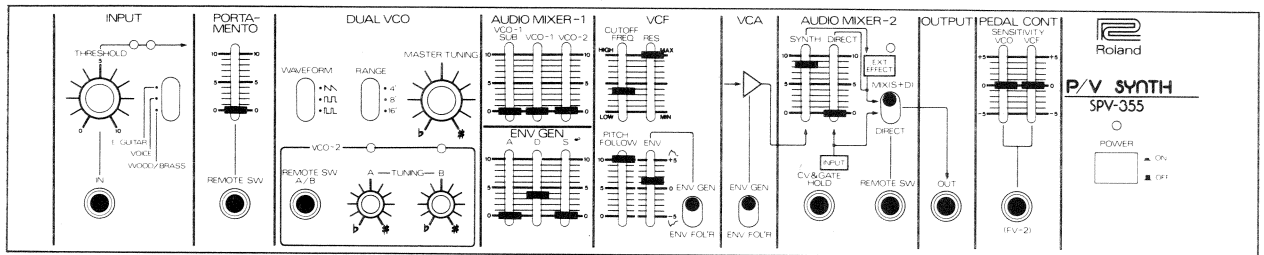

Funny Cat

With this sound, the envelope generator is used to control the cutoff frequency of the VCF. With the RESONANCE control 19 raised, this causes the tone color of the sound to change during the attack portion of the

sound. This sound is also good with VCO-2 and/or VCO-1 SUB added. If the envelope generator settings are changed, there will be a large change in the tone color of the sound.

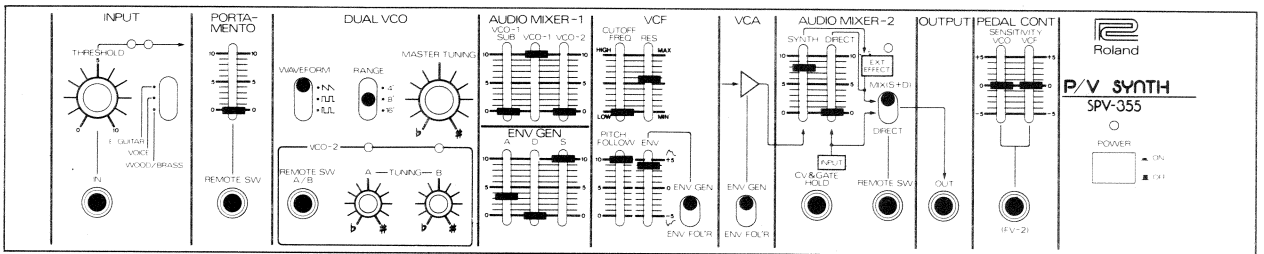

Synthesizer Drum

This sound is produced by means of an oscillating VCF. The frequency produced by the VCF is controlled by the envelope generator.

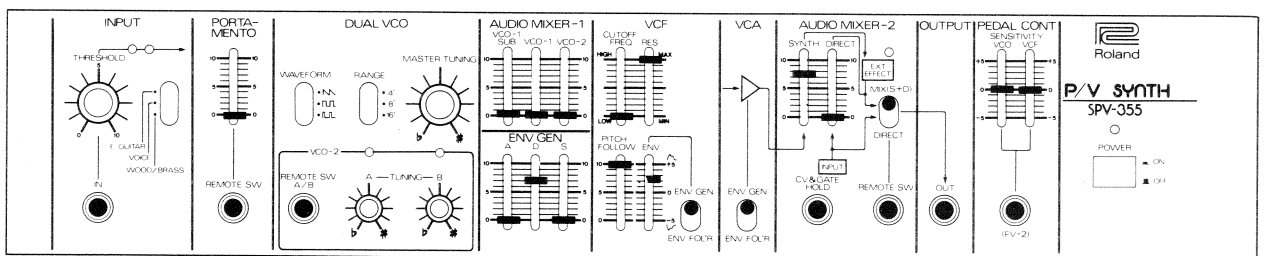

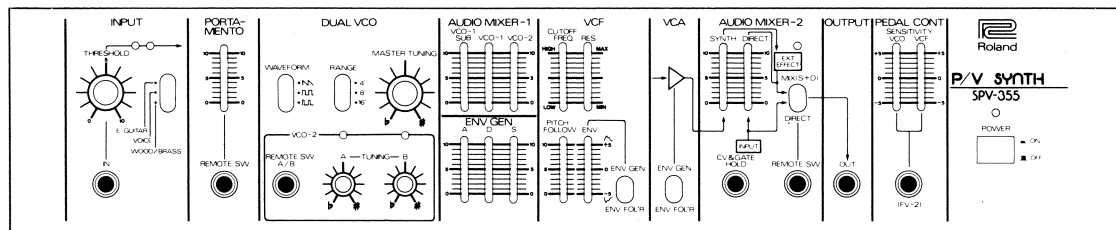
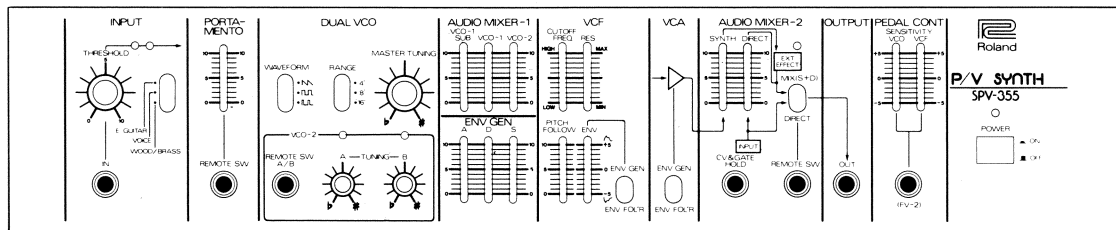
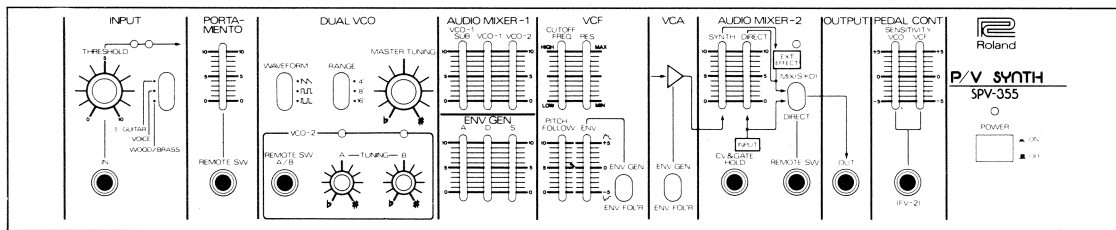
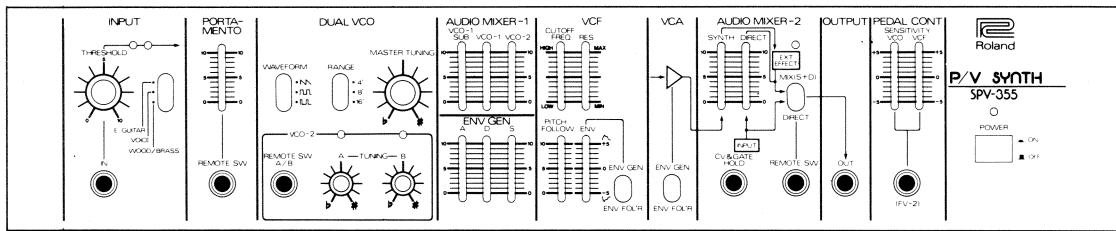
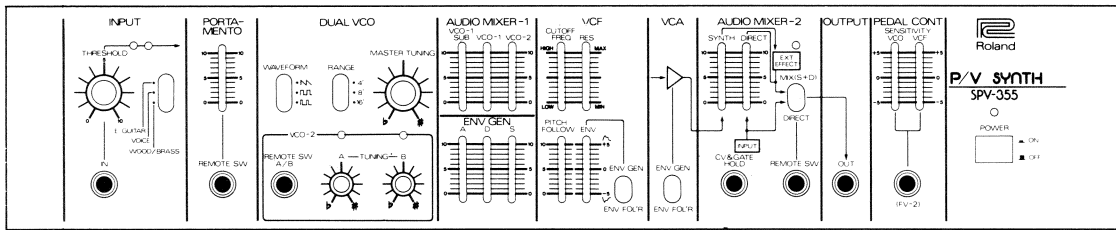
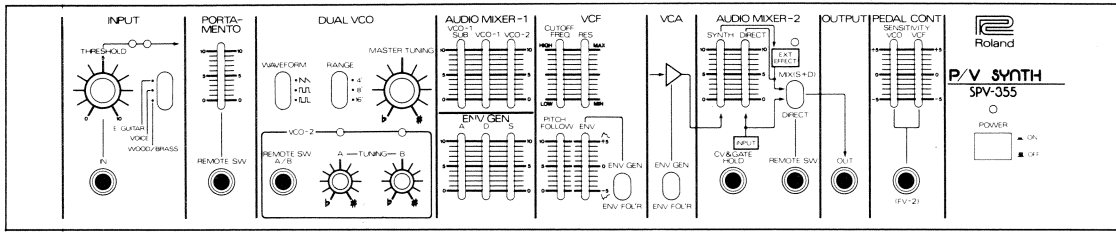

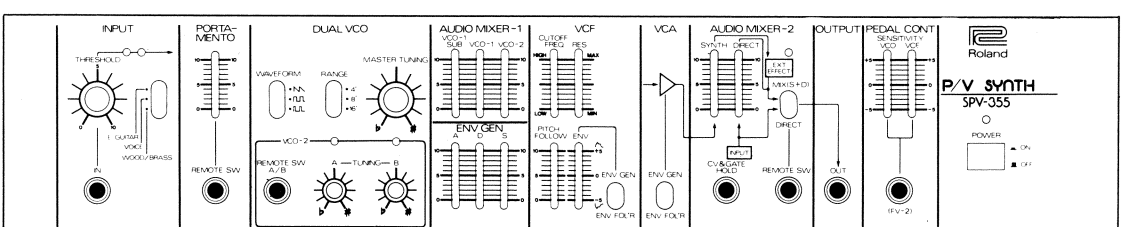
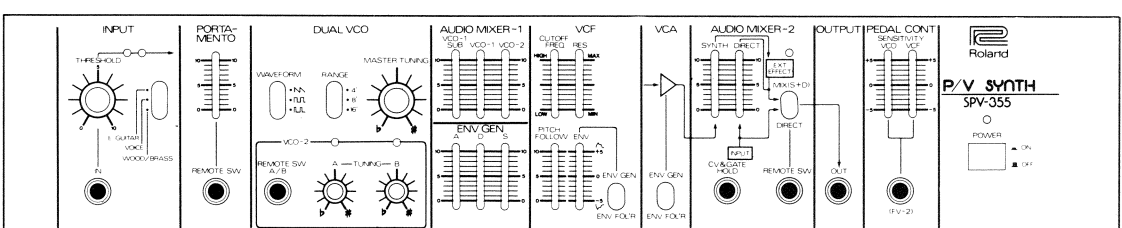
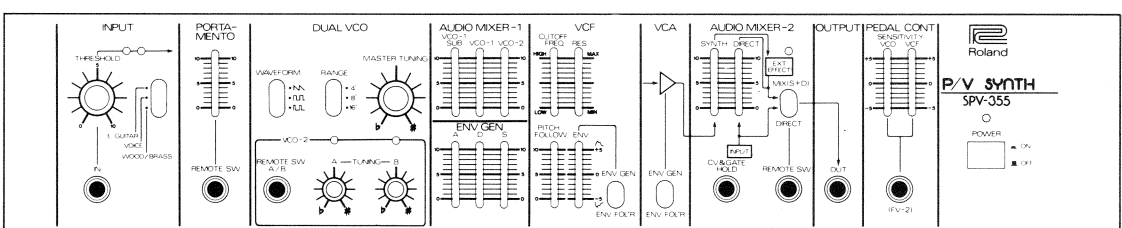
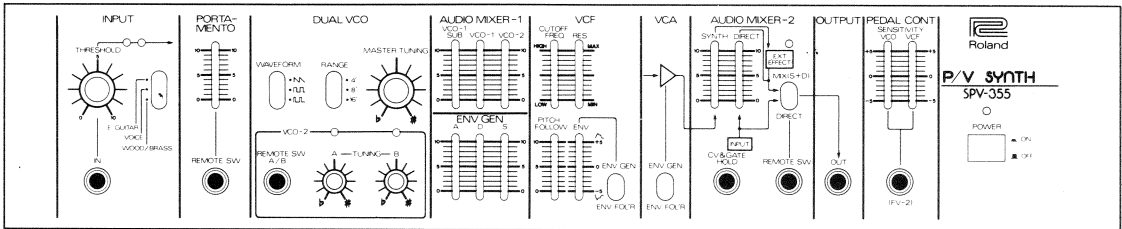
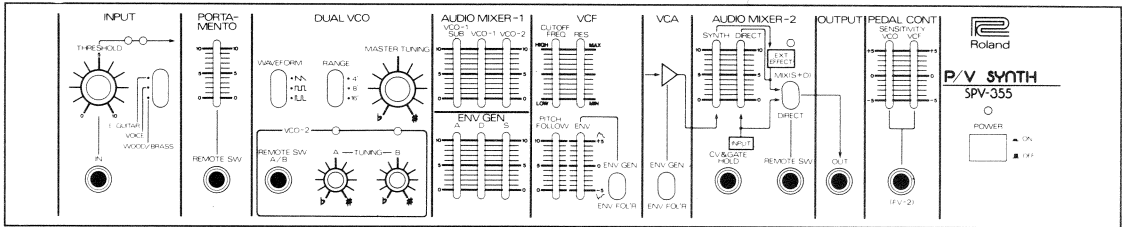
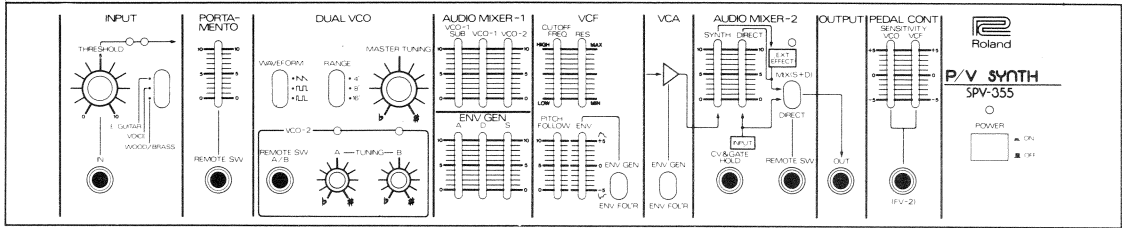

BLOCK DIAGRAM

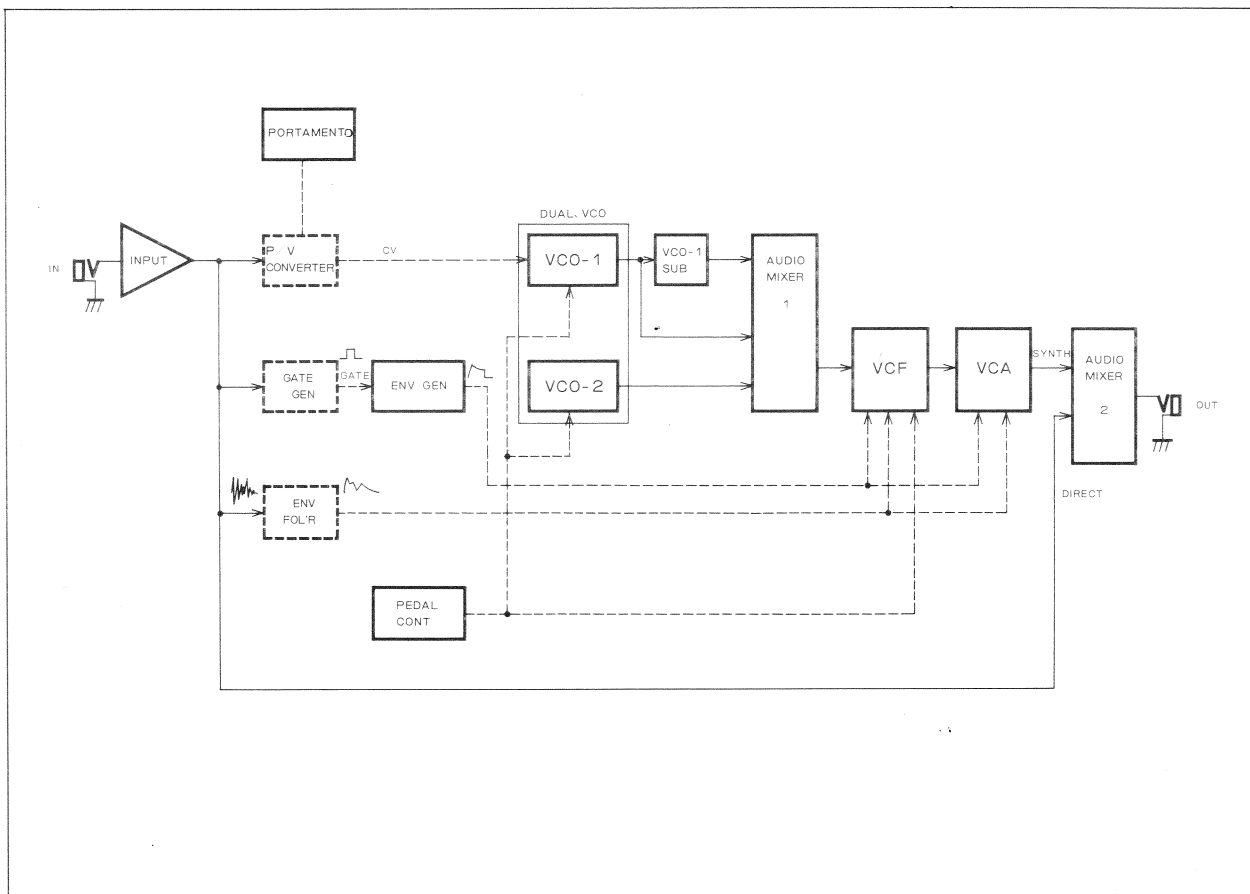

● Rack Mounting the SPV-355

The SPV-355 can be mounted in a standard 19" rack using 6mm screws as shown in the drawing.

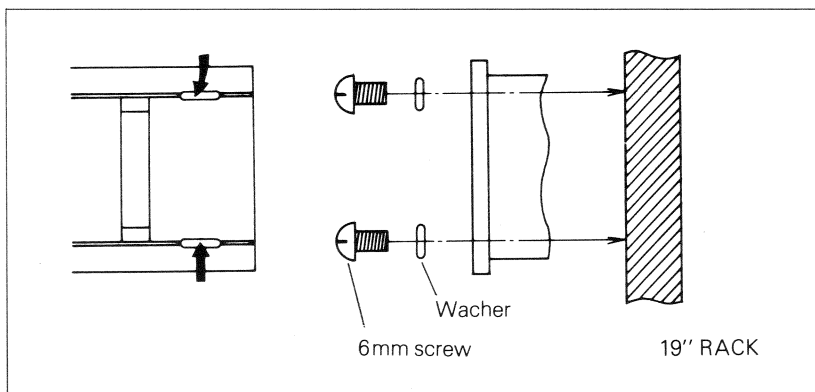

● SPECIFICATIONS

SPV-355 P/V SYNTHESIZER

INPUT SECTION Controls

- THRESHOLD Control ③
- INPUT SELECTOR Switch ②
- INPUT LEVEL INDICATORS ④

SYNTHESIZER SECTION controls

- Dual VCO (VCO-1, VCO-2)
- WAVEFORM Switch (/ □ ▭ ▮) ⑦
- RANGE Switch (4', 8', 16') ⑥
- MASTER TUNING Control (±250 cents) ⑤
- A TUNING Control (±1200 cents) ⑨
- B TUNING Control (±1200 cents)
- TUNING INDICATORS (A, B)
- VCO-1 SUB (1 octave down, ▭)

PORTAMENTO Controls

- PORTAMENTO Control (0–3s) ⑩
- PORTAMENTO ON/OFF INDICATOR

AUDIO MIXER-1 Controls

- VCO-1 SUB LEVEL Control
- VCO-1 LEVEL Control
- VCO-2 LEVEL Control

VCF Controls

- CUTOFF FREQUENCY Control (10Hz–20kHz) ⑪
- RESONANCE Control (0 – self oscillation) ⑫
- PITCH FOLLOW Control ⑬
- ENVELOPE SLECTOR Switch (ENV GEN; ENV FOL'R) ⑭
- ENVELOPE LEVEL Control (/ ▭) ⑮

VCA Controls

- ENVELOPE SELECTOR Switch (ENV GEN; ENV FOL'R) ⑯

ENVELOPE GENERATOR Controls

- ATTACK TIME Control (1ms–3.5s) ⑰
- DECAY TIME Control (2ms–7s) ⑱
- SUSTAIN LEVEL Control (0–100%) ⑲

AUDIO MIXER-2 Controls

- SYNTHESIZER LEVEL Control ⑳
- DIRECT LEVE Control ㉑
- MIX/DIRECT SELECTOR Switch ㉒
- MIX/DIRECT INDICATOR

PEDAL CONTROL SECTION

- VCO SENSITIVITY LEVEL Control ㉓
- VCF SENSITIVITY LEVEL Control ㉔

CONNECTORS

Input and output

- INPUT Jack ①
- OUTPUT Jack (input/output level = 1:1) ㉕

Remote Controls

- VCO-2 tuning: REMOTE A/B SWITCHING Jack ②
- PORTAMENTO REMOTE ON/OFF SWITCHING Jack ③
- AUDIO MIXER-2: MIX/DIRECT REMOTE SWITCHING Jack ㉖
- CV & GATE HOLD Jack ㉗
- PEDAL CONTROL: VCO/VCF FOOT VOLUME Jack ㉘

REAR PANEL

- CV OUT Jack (1V/oct) ㉙
- GATE OUT Jack (OFF: 0V; ON: +15V) ㉚
- ENV FOL'R OUT Jack (0– +10V) ㉛
- CV IN Jack (1V/oct) ㉜
- GATE IN Jack (Threshold: +3.8V) ㉝
- EFFECT SEND Jack ㉞
- EFFECT RETURN Jack ㉟

POWER SWITCH ㉟ with indicator

Power Consumption: 13W

Dimensions:

482(W) × 92(H) × 350(D) mm
Fits standard 19" rack (EIA-2U)

Weight: 5.7kg

Accessories:

Pedal Switch (DP-2)
2.5m Connection Cord (PJ-1)

OPTION



DP-2



FS-1

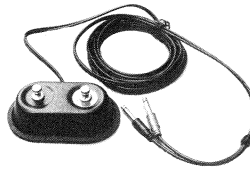

FS-2

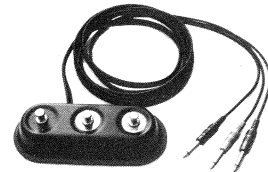

FS-3



FV-2

 Roland®

10260

UPC

10260



10981

Roland