

SP-808

GROOVE SAMPLER

OWNER'S MANUAL

Thank you, and congratulations on your choice of the SP-808 groove sampler.

Before using this unit, carefully read the sections entitled: "IMPORTANT SAFETY INSTRUCTIONS" (p. 2), "USING THE UNIT SAFELY" (p. 3), and "IMPORTANT NOTES" (p. 8, 9). These sections provide important information concerning the proper operation of the unit. Additionally, in order to feel assured that you have gained a good grasp of every feature provided by your new unit, Owner's manual should be read in its entirety. The manual should be saved and kept on hand as a convenient reference.



About the Symbols in This Manual

Words or symbols enclosed in [square brackets] indicate panel buttons or controls. For example, [VARI PITCH] signifies the Vari-Pitch button.

- * The explanations in this manual include illustrations that depict what should typically be shown by the display. Note, however, that your unit may incorporate a newer, enhanced version of the system (e.g., includes newer sounds), so what you actually see in the display may not always match what appears in the manual.
- * All product names mentioned in this document are trademarks or registered trademarks of their respective owners.

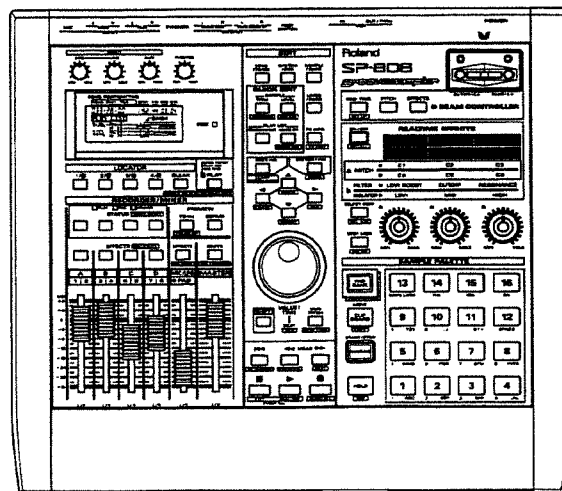
Contents	4
Parameter List	168
Index	178



	CAUTION RISK OF ELECTRIC SHOCK DO NOT OPEN	
ATTENTION: RISQUE DE CHOC ELECTRIQUE NE PAS OUVRIR		
CAUTION: TO REDUCE THE RISK OF ELECTRIC SHOCK, DO NOT REMOVE COVER (OR BACK). NO USER-SERVICEABLE PARTS INSIDE. REFER SERVICING TO QUALIFIED SERVICE PERSONNEL.		



The lightning flash with arrowhead symbol, within an equilateral triangle, is intended to alert the user to the presence of uninsulated "dangerous voltage" within the product's enclosure that may be of sufficient magnitude to constitute a risk of electric shock to persons.



The exclamation point within an equilateral triangle is intended to alert the user to the presence of important operating and maintenance (servicing) instructions in the literature accompanying the product.

INSTRUCTIONS PERTAINING TO A RISK OF FIRE, ELECTRIC SHOCK, OR INJURY TO PERSONS.

IMPORTANT SAFETY INSTRUCTIONS SAVE THESE INSTRUCTIONS

WARNING - When using electric products, basic precautions should always be followed, including the following:

1. Read all the instructions before using the product.
2. Do not use this product near water — for example, near a bathtub, washbowl, kitchen sink, in a wet basement, or near a swimming pool, or the like.
3. This product should be used only with a cart or stand that is recommended by the manufacturer.
4. This product, either alone or in combination with an amplifier and headphones or speakers, may be capable of producing sound levels that could cause permanent hearing loss. Do not operate for a long period of time at a high volume level or at a level that is uncomfortable. If you experience any hearing loss or ringing in the ears, you should consult an audiologist.
5. The product should be located so that its location or position does not interfere with its proper ventilation.
6. The product should be located away from heat sources such as radiators, heat registers, or other products that produce heat.
7. The product should be connected to a power supply only of the type described in the operating instructions or as marked on the product.
8. The power-supply cord of the product should be unplugged from the outlet when left unused for a long period of time.
9. Care should be taken so that objects do not fall and liquids are not spilled into the enclosure through openings.
10. The product should be serviced by qualified service personnel when:
 - A. The power-supply cord or the plug has been damaged; or
 - B. Objects have fallen, or liquid has been spilled into the product; or
 - C. The product has been exposed to rain; or
 - D. The product does not appear to operate normally or exhibits a marked change in performance; or
 - E. The product has been dropped, or the enclosure damaged.
11. Do not attempt to service the product beyond that described in the user-maintenance instructions. All other servicing should be referred to qualified service personnel.

For the USA

GROUNDING INSTRUCTIONS

This product must be grounded. If it should malfunction or breakdown, grounding provides a path of least resistance for electric current to reduce the risk of electric shock.

This product is equipped with a cord having an equipment-grounding conductor and a grounding plug. The plug must be plugged into an appropriate outlet that is properly installed and grounded in accordance with all local codes and ordinances.

DANGER: Improper connection of the equipment-grounding conductor can result in a risk of electric shock. Check with a qualified electrician or serviceman if you are in doubt as to whether the product is properly grounded. Do not modify the plug provided with the product — if it will not fit the outlet, have a proper outlet installed by a qualified electrician.

For the U.K.

WARNING: THIS APPARATUS MUST BE EARTHED
IMPORTANT: THE WIRES IN THIS MAINS LEAD ARE COLOURED IN ACCORDANCE WITH THE FOLLOWING CODE.
 GREEN-AND-YELLOW: EARTH, BLUE: NEUTRAL, BROWN: LIVE

As the colours of the wires in the mains lead of this apparatus may not correspond with the coloured markings identifying the terminals in your plug, proceed as follows:

The wire which is coloured GREEN-AND-YELLOW must be connected to the terminal in the plug which is marked by the letter E or by the safety earth symbol  or coloured GREEN or GREEN-AND-YELLOW.

The wire which is coloured BLUE must be connected to the terminal which is marked with the letter N or coloured BLACK.

The wire which is coloured BROWN must be connected to the terminal which is marked with the letter L or coloured RED.

The product which is equipped with a THREE WIRE GROUNDING TYPE LINE PLUG must be grounded.

SCSI 端子についてのご注意

VS-1680 と VS-880EX には、外部機器を接続するための SCSI 端子 (D-SUB 25 ピン・タイプ) が標準で装備されています。また、VS-840、SP-808、A-6 には、エクスパンション・ボードを取り付けたときに SCSI 端子が増設されます。SCSI 端子が装備されている場合は、以下の注意文をお読みください。

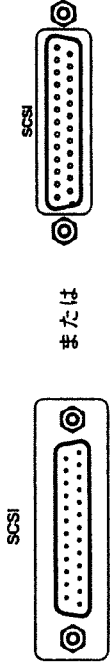

または

SCSI 端子には取扱説明書に記載されている SCSI 機器だけを接続してください。故障の原因になりますので、たとえ端子の形状が同じでも、RS-232C 接続タイプやパラレル接続タイプの機器を接続することは絶対におやめください。

RS-232C 接続タイプ
パラレル接続タイプ
など

SCSI 接続タイプ

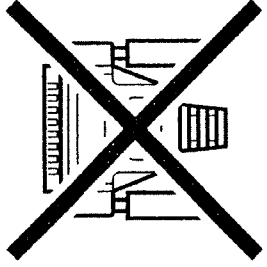
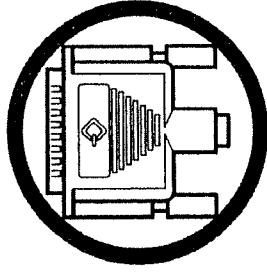

Important Notes Concerning the SCSI

The VS-1680 and VS-880EX provides the SCSI connector (DB-25 type), allowing you to connect to external SCSI devices. For the VS-840, SP-808 and A-6, the SCSI connector is provided by installing the expansion board. When the SCSI connector is provided, read the following instructions.

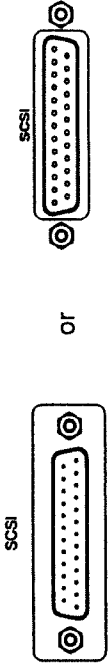

or

Connect the SCSI connector of your unit with external SCSI-type devices that is described in Owner's Manual only. Be careful not to connect any other devices (such as RS-232C-type devices, parallel-type devices, etc.) even though that have similar-looking connectors.

RS-232C type,
Parallel type,
etc.

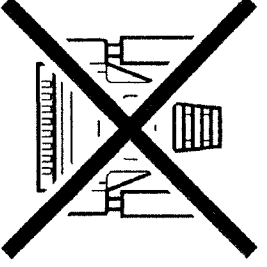
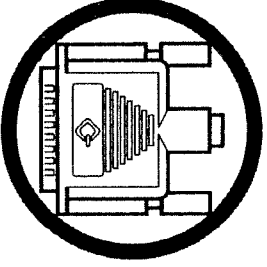

SCSI type









USING THE UNIT SAFELY

INSTRUCTIONS FOR THE PREVENTION OF FIRE, ELECTRIC SHOCK, OR INJURY TO PERSONS

About WARNING and CAUTION Notices









 WARNING	Used for instructions intended to alert the user to the risk of death or severe injury should the unit be used improperly.
 CAUTION	Used for instructions intended to alert the user to the risk of injury or material damage should the unit be used improperly. * Material damage refers to damage or other adverse effects caused with respect to the home and all its furnishings, as well to domestic animals or pets.

About the Symbols







	The  symbol alerts the user to important instructions or warnings. The specific meaning of the symbol is determined by the design contained within the triangle. In the case of the symbol at left, it is used for general cautions, warnings, or alerts to danger.
	The  symbol alerts the user to items that must never be carried out (are forbidden). The specific thing that must not be done is indicated by the design contained within the circle. In the case of the symbol at left, it means that the unit must never be disassembled.
	The  symbol alerts the user to things that must be carried out. The specific thing that must be done is indicated by the design contained within the circle. In the case of the symbol at left, it means that the power-cord plug must be unplugged from the outlet.

----- ALWAYS OBSERVE THE FOLLOWING -----

WARNING

- Before using this unit, make sure to read the instructions below, and the Owner's Manual. 
- Do not open or perform any internal modifications on the unit. 
- Make sure you always have the unit placed so it is level and sure to remain stable. Never place it on stands that could wobble, or on inclined surfaces. 
- Avoid damaging the power cord. Do not bend it excessively, step on it, place heavy objects on it, etc. A damaged cord can easily become a shock or fire hazard. Never use a power cord after it has been damaged. 
- In households with small children, an adult should provide supervision until the child is capable of following all the rules essential for the safe operation of the unit. 
- Protect the unit from strong impact. (Do not drop it!) 
- Do not force the unit's power-supply cord to share an outlet with an unreasonable number of other devices. Be especially careful when using extension cords—the total power used by all devices you have connected to the extension cord's outlet must never exceed the power rating (watts/amperes) for the extension cord. Excessive loads can cause the insulation on the cord to heat up and eventually melt through. 
- Before using the unit in a foreign country, consult with your retailer, the nearest Roland Service Center, or an authorized Roland distributor, as listed on the "Information" page. 

CAUTION

- Always grasp only the plug on the power-supply cord when plugging into, or unplugging from, an outlet or this unit. 
- Try to prevent cords and cables from becoming entangled. Also, all cords and cables should be placed so they are out of the reach of children. 
- Never climb on top of, nor place heavy objects on the unit. 
- Never handle the power cord or its plugs with wet hands when plugging into, or unplugging from, an outlet or this unit. 
- Before moving the unit, disconnect the power plug from the outlet, and pull out all cords from external devices. 
- Before cleaning the unit, turn off the power and unplug the power cord from the outlet (p. 20). 
- Whenever you suspect the possibility of lightning in your area, pull the plug on the power cord out of the outlet. 

Contents

About the Symbols in This Manual	1
USING THE UNIT SAFELY	3
IMPORTANT NOTES	8
What is Sampling?	10
What is "Phrase Sampling?"	10
About the SP-808	10

Chapter 1 Introduction: Let's Make Some Sounds

What the SP-808 Can Do (Applications and Features).....	11
Panel Descriptions	12
Connections	19
Setting Up Connections with Other Devices for Using the SP-808	19
When Connecting an Electric Guitar or Bass.....	20
Microphones That Can Be Used with the SP-808	20
Turning the Power On and Off.....	20
Inserting and Removing a Disk	21
Changing the Shading of the Display (Contrast Setting)	21
Calling Up and Switching the Basic Screens (Level Meter, Play List, Big Time).....	21
Other Information Screens (Contrast/Info and Mixer View).....	22
If an Unfamiliar Screen Appears (How to Return to the Basic Screens)	23
About the Internal Zip Drive.....	23
Concerning Zip Media That Can Be Used by the SP-808	23
Preparing New Zip Disks for Use (Format Disk)	24
Setting the Sample Rate	24
Maximum Sampling Times and Data Storage Available on Zip Disks	24
Checking the Remaining Memory on Zip Disks.....	25
Listening to the Demo Songs (How to Play Songs and Samples).....	25
Setting the Overall Volume (MASTER Fader)	25
Setting the Headphone Volume	25
Setting the Volume for Each Track (Track Faders)	25
Calling Up a Different Song (Switching Songs).....	26
Adding Sample Sounds by Pressing the Pads	26
Selecting Pad Banks.....	26
Temporarily Muting the Output (Master Out Mute).....	26
Applying Effects to the Demo Songs.....	27
Changing Effects with Three Knobs	28
Controlling the Master Filter/Isolator.....	28
Controlling the Multi-purpose Effects	29
Using Hand Movements to Change the Sounds (D Beam Controller).....	30
Varying the Pitch	30
Playing Designated Samples.....	30
Setting the D Beam Controller Sensitivity	31

Simultaneous Use of the D Beam Function with Multiple SP-808s	31
Setting the Time Location (Playback Position).....	31
Using the VALUE/TIME Dial	31
Using [◀◀] and [▶▶]	31
Changing the Measure and Beat Display to Hours, Minutes and Seconds	31
Jumping to a Set Location (Locator)	32
Changing the Locator's Position	32
Fitting Precisely to the Beginning of the Sound (Preview) ...	33
Setting the Song Position with Scrutinizing the Sound Before and After ([TO] [FROM]).....	33
Setting the Song Position Like as Scrubbing a Tape (Scrub Preview).....	33
Setting the Playback Time in Preview and Scrub Preview	33
Restoring the Settings to Factory Condition	34

Chapter 2 Playing Samples on the Pads

What are the 64 Pad Banks?.....	35
Basic Method for Playing Samples	35
The Number of Samples That Can Be Played Simultaneously (Track-Related Information).....	35
Can Samples from Different Pad Banks Be Played Together?.....	35
Changing the Way Samples Are Played and Stopped with the Pads (Pad Play)	36
Loop Expression (Loop Mode)	36
Stop Playing a Sample When Another Pad is Pressed (MUTE GROUP).....	37
Having the Sound Continue Even After Releasing the Pad (Hold Function)	37
Setting the Overall Volume and Stereo Balance of the Pads	38
Adjusting the Pitch Like Tape Speed Controlling (Vari-Pitch).....	39
Adding Effects to Samples	40
Using the D Beam Controller to Play Samples	41
Selecting the Pads to Be Played in Each Bank	41
Adjusting the Hand Positions for Switching Samples.....	42
Checking the Pad Samples Without Sending Them to the MASTER OUT (Pad Cue Function)	42

Chapter 3 Sampling Sounds

The Sampling Procedure	43
Setting Stereo and Mono	44
Sampling After Making Loop and Play Settings	44
Automatically Beginning Sampling with Sound Input.....	44
Preventing the Start of the Sound from Being Missed (Pre-Trigger).....	45

Automatic Setting of the Start (and End) Point
 When Sampling is Finished (Auto Trim)45
 Separating the Sample at the Silent Portions and Assigning the
 Sections to Multiple Pads After Sampling (Auto Divide)45
 If "Disk Full." Appears in the Display46
Using the Equalizer (EQ).....47
Sampling While Adding Effects.....48
Resampling the SP-808's Output.....49
 Sampling Song (Track) Phrases to Pads.....49
 Resampling Pad Samples to Other Pads.....49

Chapter 4 Processing Samples

Setting Sample Volume (Sample Level)50
Displaying Sample Tempo Correctly
(Specifying the Number of Beats).....50
Changing the Points Where the Sounds
Start and Stop51
 What are Start and Loop Points, and Length?51
Expanding and Compressing Samples and Changing
the Length and Tempo (Time Stretch).....52
 Matching the Length or Tempo with Another Sample's One53
Changing a Sample's Pitch.....53
Storing a Sample Out of the Pads Temporarily (Clipboard).....54
 Moving Samples to Other Pads54
 Copying Part of a Song to a Pad.....55
Deleting Samples (Delete Sample).....55
 Using the Clipboard55
 Deleting All the Samples in a Pad Bank At Once56
Creating Duplicates of Samples (Copy Sample).....56
 Using the Clipboard56
 Copying All of Samples in a Banks to Other Banks57
Distributing a Sample Among Multiple Pads
(Divide Sample).....57
 Automatically Dividing Samples at Silent Portions Within Them58
 Pressing a Button to Mark Divisions58
Reversing the Sample Like a Tape Backwards
(Create Reversal)59
Undoing the Immediately Preceding
Operation (Undo)59

Chapter 5 Arranging Samples (Phrases) to Create Songs

What are Tracks?60
 The Concept of Measures, Beats, and Ticks.....60
 The Relationship Between Songs and Phrases60
Creating New Songs.....62
 Creating and Naming New Songs62

Setting Measure Bars to Fit the Sample.....62
 Creating a Song with the Reference Sample Already
 Included63
Recording Your Pads Performance
(Event Realtime Recording).....63
 Starting Recording with Counting In63
 If "Drive Too Busy." Appears in the Display65
 Recording While Correcting Shifts in Timing
 (Quantize)65
 Rerecording Only a Specified Segment
 (Punch-In and Punch-Out).....65
 Punching In and Out Automatically at Specified Points.....66
 Monitoring the Sound During Punch-In and Punch-Out66
 Playing and Stopping the Metronome67
 Setting the Metronome Volume67
Recording by Pressing the Pads One at a Time (Step Recording) ...68
 Changing Volume in Step Recording70
Changing the Song Tempo70
 Adjusting the Tempo of the Entire Song.....70
 Changing the Tempo and Rhythm of Each Measure71
Saving Song Data72
 To Change the Name of a Song72
 Data Saved in the Save Procedure72
 Preventing Accidental Erasure of Songs (Protect).....72
 Deleting Songs (Delete Song).....73

Chapter 6 Recording Directly to the Tracks Without Using the Pads

Direct Recording Like Multitrack Tape Recorder
(Track Audio Recording).....74
 Monaural Recording75
 Recording While Listening to Another Track75
 Why Does the Remaining Recording Time Decrease,
 Even When Overwriting During Recording?.....75
 Using the Fader to Set the MIC/LINE Input Level75
 Recording a Specified Segment of the Song
 Over Again (Punch-In and Punch-Out)76
 Using Auto Punch-In/Out in Track Audio
 Recording.....76
 Monitoring the Sound During Punch-In and Punch-Out77
Recording with Effects and the Channel Equalizer.....77
 Recording with the Internal Effects77
 Adding Effects Only to the Sounds Being Recorded
 or Monitored (When Using Send/Return)78
 Adding Effects Only to the Sounds Being Recorded
 or Monitored (When Using Insert)78
 Recording with the Channel Equalizer78
Bouncing Tracks.....79
 If the Recorded Sound is Distorted
 (Recording Attenuator).....81
Recording Without Using the Mixer.....81

Chapter 7 Editing Recorded Tracks [1] (Quick Edit)

Determining the Segment to Be Edited	82
Selecting a Segment (Region In/Out)	82
Selecting a Phrase (Mark Phrase)	83
Editing Selected Segments	84
Erase	84
Cutting Segments (Cut)	84
Pasting to a Different Location (Paste)	85
Inserting Into a Different Location	85

Chapter 8 Editing Recorded Tracks [2] (Selecting from the Menu)

Finely Adjusting the Timing of Each Phrase (Adjust Timing)	87
Fine Adjustment of Expression Timing	87
Changing the Volume of Each Phrase	88
Editing Selected Segments	89
Moving to a Selected Track and Location (Move)	89
Repeated Pasting to Selected Tracks (Paste)	89
Repeated Insertion to Selected Points (Insert)	90

Chapter 9 Recording to an External Recorder (Mixdown)

The Mixer Setup (Image)	91
The Mixdown Process	92
To Have a Stereo Track Played Back in Monaural	92
Adding Internal Effects During Mixdown	93
Setting Track's Effect Send Level	93
The Difference Between "Pre-Fader" and "Post-Fader"	94
Inserting Compressor / EQ to MASTER OUT	94
When the Effects Sounds are Distorted (Effects Pre Attenuator)	94
Using AUX IN/OUT	95
Setting the Send Level and Stereo Balance to AUX OUT	95
Using the External Effects (Send/Return)	95
Using AUX IN as an Auxiliary Input	95
Using AUX OUT as an Auxiliary Output	96
Used With MIC/LINE IN	96

Chapter 10 Using the Internal Effects

The Different Uses of the Send/Return and Insert Methods	97
Applying Effects Using the Send / Return Method	97
Applying Adding Effects Using the Insert Method	97
What It Means When [EFFECTS] is Illuminated or Unlit	97

Editing and Saving Effects	98
Selecting the Type of Effect (Algorithm)	98
Effects are Edited in Each of the Following Screens	98
Saving Settings to the User Effects Patches	100
The Algorithms and Effects	101
01 ISOLATOR & FILTER	101
02 CENTER CANCELLER	102
03 STEREO DYNAMICS PROCESSOR	103
04 REVERB & GATE	105
05 TAPE ECHO 201	107
06 EZ DELAY	108
07 DELAY RSS	109
08 ANALOG DELAY & CHORUS (Virtual Analog Delay + Virtual Analog Chorus)	111
09 DIGITAL CHORUS	112
10 4 BUTTON CHORUS 320	113
11 VINTAGE FLANGER 325	113
12 2x BOSS FLANGER	114
13 STEREO PITCH SHIFTER	115
14 80s PHASER	116
15 STEREO AUTO WAH	117
16 STEREO DISTORTION	118
17 PHONOGRAPH (Analog Record Simulator)	120
18 RADIO TUNING	121
19 LO-FI PROCESSOR	121
20 VIRTUAL ANALOG SYNTH (Virtual Analog Synthesizer)	123
Getting Smooth Changes in Effects During Song Playback	128
Using the Realtime Effects Section	128
When Changes Made with the Realtime Effects Knobs Are Too Wide	128
How the Realtime Effects Knobs Function Immediately After Effects Are Switched	129
Using the D Beam Controller	129
Assigning Functions to the Effects	129
Using the Effects as an Analog Synthesizer	130

Chapter 11 Utilizing the Step Modulator

What is the Step Modulator?	131
Basic Operation	131
Setting the Final Step Number and Value of Each Step	132
Determining the Tempo/Synchronizing with a Song	133
Copying and Using Step Modulator Settings from Another Patch	133
An Example of a Combination of Effects	134
Combining Filter-Related Effects	134
Combining Delay-Related Effects	135

Combining with the Virtual Analog Synthesizer135

Chapter 12 Other Convenient Functions

Starting the Sound with Releasing the Track Mute Simultaneously (Track Voice Reserve)137
 The Effect of Turning on Track Voice Reserve137

Naming the Pad Banks138

Protecting the Pad Bank's 16 Samples138

Rearranging Samples To Prevent Empty Pads in the Pad Bank (Renumber)139

Connecting and Using a Foot Switch139
 Starting and Stopping Song Playback139
 Getting a Damper Pedal Effect140
 Playing Designated Samples in Each Pad Bank140
 Turning Effects On and Off140
 Punching In and Out During Recording140
 Switching the Foot Switch Input (DP-2/GPI)140

Setting the [SHIFT] Function as "Press to Shift/Press Again to Release"141

Increasing Remaining System Memory (Cleanup Disk)142

Disable Indicating the Saving Confirmation Message at Disk Ejection and Switching Songs 142

Copying Effects Patches to Other Disks143

Create a Backup Disk Only Use the Internal Drive144

Confirm or Specify the Tempo by the Tapping Button Interval144

Chapter 13 Functions Using the Multi I/O Expansion

Installing the SP808-OP1 Multi I/O Expansion145
 What You Can Do with the SP808-OP1 Multi I/O Expansion145

Using the DIGITAL IN and OUT Connectors146
 Using the DIGITAL IN146
 Using the DIGITAL OUT146
 Preventing Digital Copying of Finished Works146

Functions Using the External Zip Drive (SCSI Connection)147
 Connecting the Zip Drive147
 Creating a Backup Disk148
 Loading Samples from an External Zip Drive149
 Loading Songs from an External Zip Drive149

Outputting the Sounds on Each Track Separately150

Chapter 14 Linking with Other MIDI Devices

About MIDI151
 Switching the MIDI OUT/THRU Connector151

Using MIDI to Control the SP-808 from Another Device151
 Playing Samples151
 Switching Pad Banks152
 Switching the Effects Patches152
 Playing the Internal Effects Virtual Synthesizer152
 Changing Mixer Settings152

Synchronization with a Sequencer or Drum Machine153
 Synchronization Types (MTC/MIDI Clock)153
 Synchronizing Another MIDI Device to the SP-808 (MTC, MIDI Clock)154
 Synchronizing the SP-808 to Another MIDI Device (MTC)155
 Offsetting Synchronization by a Constant Interval (MTC Offset)156
 Control All Synchronized Machines by One Specified Device (MMC)156
 Synchronizing with MultiTrack Recorders and Video Equipment157

Using a MIDI Sequencer to Record and Playback Mixer Operation157

Controlling Other MIDI Devices with the D Beam Controller158

Using the Metronome to Sound External MIDI Sound Module159

Other MIDI Matters159
 MIDI System Exclusive159

Chapter 15 Appendices

Troubleshooting160

Major Message List (In alphabetical order)166

Parameter List168

MIDI Implementation170

MIDI Implementation Chart176

Specifications177

Index178

IMPORTANT NOTES

In addition to the items listed under "IMPORTANT SAFETY INSTRUCTIONS" and "USING THE UNIT SAFELY" on pages 2 and 3, please read and observe the following:

Power Supply

- Do not use this unit on the same power circuit with any device that will generate line noise (such as an electric motor or variable lighting system).
- Before connecting this unit to other devices, turn off the power to all units. This will help prevent malfunctions and/or damage to speakers or other devices.

Placement

- Using the unit near power amplifiers (or other equipment containing large power transformers) may induce hum. To alleviate the problem, change the orientation of this unit; or move it farther away from the source of interference.
- This device may interfere with radio and television reception. Do not use this device in the vicinity of such receivers.
- Observe the following when using the unit's Zip disk drive. For further details, refer to "Before Using Zip Disks."
 - Do not place the unit near devices that produce a strong magnetic field (e.g., loudspeakers).
 - Do not move the unit or subject it to vibration while the drive is operating.
 - Do not transport the unit with the Zip disk left inserted in the drive.
- Do not expose the unit to direct sunlight, place it near devices that radiate heat, leave it inside an enclosed vehicle, or otherwise subject it to temperature extremes. Excessive heat can deform or discolor the unit.

Maintenance

- For everyday cleaning wipe the unit with a soft, dry cloth or one that has been slightly dampened with water. To remove stubborn dirt, use a cloth impregnated with a mild, non-abrasive detergent. Afterwards, be sure to wipe the unit thoroughly with a soft, dry cloth.
- Never use benzine, thinners, alcohol or solvents of any kind, to avoid the possibility of discoloration and/or deformation.

Disclaimer of Liability

- Roland assumes no liability for any loss of user data, irrespective of cause, and shall not be held liable for damages, including compensation, for any direct or indirect loss suffered by the user. A backup of your disk includes your important data or sounds should be periodically created.

Additional Precautions

- Use a reasonable amount of care when using the unit's buttons, sliders, or other controls; and when using its jacks and connectors. Rough handling can lead to malfunctions.
- Never strike or apply strong pressure to the display.

- When connecting/disconnecting all cables, grasp the connector itself—never pull on the cable. This way you will avoid causing shorts, or damage to the cable's internal elements.
- A small amount of heat will radiate from the unit during normal operation.
- To avoid disturbing your neighbors, try to keep the unit's volume at reasonable levels. You may prefer to use headphones, so you do not need to be concerned about those around you (especially when it is late at night).
- When you need to transport the unit, package it in the box (including padding) that it came in, if possible. Otherwise, you will need to use equivalent packaging materials.

Before Using Zip Disks

Handling the Zip Disk Drive

- Install the unit on a solid, level surface in an area free from vibration. Installing the unit at an extreme angle may result in malfunction or damage to the Zip drive.
- Avoid using the unit immediately after it has been moved to a location with a level of humidity that is greatly different than its former location. Rapid changes in the environment can cause condensation to form inside the drive, which will adversely affect the operation of the drive and/or damage Zip disks. When the unit has been moved, allow it to become accustomed to the new environment (allow a few hours) before operating it.
- When inserting a disk into the Zip disk drive, be sure to insert it all the way in. If the disk should become stuck when you attempt to remove it, do not attempt to use force.
- Do not insert any type of disk other than specified Zip disks.
- Remove any Zip disk from the drive before powering up or down.
- To prevent damage to the Zip disk drive's heads, always try to hold the Zip disk in a level position (not tilted in any direction) while inserting it into the drive. Push it in firmly, but gently. Never use excessive force.

Handling Zip Disks

- A Zip disk is storage media composed of a cartridge containing a magnetized metal disk. Microscopic precision is required to enable storage of large amounts of data on such a small surface area. To preserve their integrity, please observe the following when handling Zip disks:
 - Do not open the disk's shutter and touch the magnetic surface or insert foreign objects.
 - Do not use or store Zip disks in dirty or dusty areas.
 - Do not store Zip disks in direct sunlight or in humid places such as the inside of closed automobiles (storage temperature: -22 – $+51^{\circ}\text{C}$, humidity: 10–90%).

- Do not expose Zip disks to magnetic fields, such as those generated by loudspeakers.
- The identification label should be firmly affixed to the disk. Should the label come loose while the disk is in the drive, it may be difficult to remove the disk.
- Put the disk back into its case for storage.
- Zip disks feature no tabs, such as those on floppy discs, used to prevent accidental erasure of data. When necessary, use the Protect function (for songs, → p. 72; for banks, → p. 138) to protect data.

Precautions for Use with the SP-808

- In the following situations, do not turn off the power to the unit.
 - When the disk indicator is flashing (such as during sampling)
 - When the message "KEEP POWER ON!" appears in the display
 - When a bar graph showing the progress of processing appears in the display

In the above, data is being written to the disk or to flash memory. Turning off the power in such instances damages the data in the SP-808 or on the disk is damaged, after which it cannot be recovered. This may also result in damage to equipment.

- Data recorded on Zip disks may be lost as a result of damaged equipment, operational mistakes, or other similar causes. Furthermore, Zip disks have a limited period of use, so using a disk continuously for long periods may result in the loss of data on the disk. **Always make backup copies of important data (such as works used commercially) to protect the data.**
- Recording (or sampling), public performance, broadcast, or any other use of copyrighted CDs, records, tapes, images, broadcasts, or performances without consent of the copyright holder is prohibited by law. Roland Corporation shall not be held liable for any violation of copyright that users may commit through the use of the SP-808.
- The SP-808 does not feature SCMS. This is because the SP-808 was designed solely for the creation of music without the addition of further limitations, including those on digital connections for the recording of non-copyrighted works (such as users' own original works). Do not use the SP-808 for violating copyright laws.

SCMS (Serial Copy Management System)

This is a function for the protection of copyrighted works on MD players and other commercial digital audio devices. Copies made using digital connections are limited to second generation copies.

- If no processes involving the reading or writing to the disk in the internal Zip drive are performed for 30 minutes, the SP-808 automatically goes into **sleep mode**. This function helps extend the useful life of Zip disks inserted in the SP-808. In Sleep mode, the internal disk stops rotating, and the SONG POSITION display appears as shown below.

d 15c SLEEP...

If an operation requires the reading and writing of data, first return to the normal operating status. It takes about two to three seconds to do this.

- Do not strike the pads (1–16) forcefully (there is no function detecting different degrees of striking force). Hitting the pads with more force than is necessary may cause malfunctioning or damage to the pads or drive.
- The demo songs and samples on the disk that is included with the SP-808 have the Protect feature (preventing accidental erasure → p. 72, 138) applied. If after removing this protection changes are then made to a song or sample, the condition of that data as it was when the unit was shipped from the factory cannot be restored.
- At most, the SP-808 can play a total of four song playback and pad (sample) sounds simultaneously (regardless of whether these sounds are in stereo or monaural). When a song is stopped, a total of four pads sounds can be played. However, when Track Voice Reserve (p. 137) is on, the number of pads sounds that can be played may be more limited.
- When using MIDI to control the SP-808, you can use an external keyboard as you would a drum sound device, with each key being assigned a single sample (pad). As with Roland's S Series samplers and general MIDI sound generators, keyboards cannot be used to play these sounds according to musical scales.
- You can record while using Vari-Pitch (p. 39). This allows an effect similar to that of changing the tape speed on a multi-track recorder. However, when the sampling rate is set to 44.1 kHz, the Vari-Pitch cannot be adjusted upwards.
- The D Beam Controller may not function properly in the following types of environment. Determine beforehand whether or not the D Beam Controller can be used in these places.
 - In places where there is strong direct sunlight
 - In places where fluorescent lamps are very close.
 - In situations where there is an extreme amount of smoke (such as is used to create a stageless effect)
 - In places where objects in the vicinity interfere with the sensor such that the sensor indicator remains lit even after the sensitivity is adjusted (p. 31).

MEMO The D Beam Controller is provided under license from Interactive Light, Inc.

What is Sampling?

Sampling is the conversion of analog audio signals to numerical values, and the subsequent recording of these values. As a musical instrument, a sampler converts audible sounds into digital data, and stores the data in semiconductor memory. It also plays back such sounds when requested to do so by the performance data. Initially, memory for samplers was very expensive, so samplers could not be supplied with large amounts of memory. Since long samples were not possible, only short segments of musical instrument sounds could be sampled and played on a keyboard. Samplers were used mainly for things like taking a one-note sample of a trumpet, then getting a realistic-sounding trumpet sound when playing on a keyboard; or for sampling an orchestra hit sound, and playing it back in one shot.

What is "Phrase Sampling?"

In recent years, in keeping with the ever-increasing popularity of personal computers, the price of computer memory has dropped tremendously. This has allowed samplers to be equipped with large amounts of memory, making much longer samples possible. Phrase sampling uses lengthy samples and stores them as performance phrases. Today, one of the most common ways of creating music is to loop sampled phrases, then use sequencers to combine the different parts.

To put together an accompaniment (backing track) with a new groove, you can sample phrases from a drum pattern (break beat), or bass pattern that has a groove you like, change the tempo (in beats per minute) or pitch of the phrase, and alter the feel by changing the sound using equalization, or by applying effects.

Then, after adding vocals or rapping, or by playing instruments along with it, you've created an original tune. Using phrase sampling in this way to create music (something which originated with hip-hop, house, and other kinds of dance music) is a method that has now spread to popular music in general.

About the SP-808

The SP-808 Groove Sampler represents a new concept in sampler/recorders based on the use of phrase sampling. It comes equipped with all the functions you need for creating and performing songs. Using Zip disks for storage provides memory capacity unthinkable with previous samplers, allowing the realization of extended sampling times. You can use phrase sampling without having to worry about how much memory remains, in circumstances that allow you to have numerous samples ready to play immediately. You can also use other samples the moment you insert a different Zip disk. The SP-808 is also fully equipped with "time stretch" function and effects such as vintage device emulation to process samples. Using the samples you have put together, you can compose backing tracks with the SP-808's four-track stereo digital recorder, and record vocal, rap, and instrument performances as well. You can enjoy using a variety of editing features that are included—many of which are unavailable on tape recorders.

Rather than simply playing back finished pieces, you can now experience interactive, real-time performances when playing back works you've created, by pressing the pad to play back the sounds, and using the D Beam Controller.

The SP-808 brings these functions together organically, resulting in a musical composing environment never before available. We hope you enjoy using the SP-808 fully and create your own new music.

What the SP-808 Can Do (Applications and Features)

- The SP-808 accesses its internal Zip drive directly, allowing up to approximately 64 minutes of high-quality sound recording and samples (at a mono sample rate of 32 kHz; "Main Specifications" on p. 177).
- Full use of stereo sampling and resampling of the Master Out (p. 49).
- You can play samples instantly with the 16 pads (p. 35).
- You can freely expand (stretch) sample length (playback time) without changing the pitch (p. 52).
- You can arrange and edit stereo samples on four tracks and easily create songs (p. 60).
- Just as with a multitrack tape recorder, you can record directly to the tracks and bounce (ping pong) material recorded to the tracks as well (p. 74).
- Mixing is easy with the SP-808's stereo two-input, four-track mixer (p. 91).
- The SP-808's effects make use of 20 unique algorithms, such as **virtual analog synth** and **tape echo** (p. 97).
- The dedicated three effects knob, allows speedy tone changes (p. 28, 128).
- You can use the built-in **Step Modulator** to control effects allows you to have effects change rhythmically (p. 131).
- You can use the **D Beam Controller** which detects hand or other motion, to control pitch and tone changes (p. 30, 129).
- With the optional SP808-OP1 Multi-I/O expansion installed, an external Zip drive connector for backing up data, direct out jacks for each track and digital in and out connectors (optical and coaxial) can be added (p. 145).

Panel Descriptions

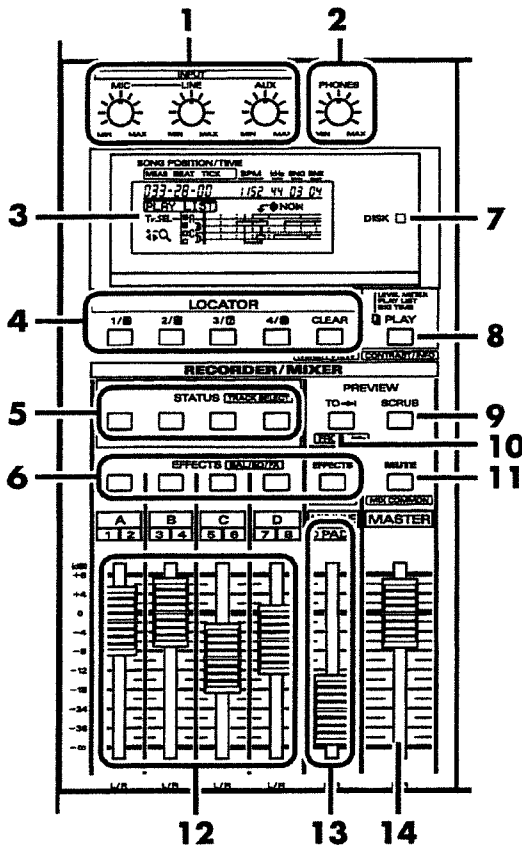

1 INPUT MIC, INPUT LINE, INPUT AUX

→ Input Sensitivity Knobs (MIC, LINE, AUX)

These are used to set the basic levels for each input. Set the levels so that the "IN" bar meters in the Level Meter screen (p. 21) do not go over the dotted line in the upper part of the screen. You can also cut off (mute) signal by rotating the knob completely to the left.

2 PHONES

→ Headphone Knob

Adjusts the headphone volume.

3 Display

Shows various information depending on the particular operation being performed.

Whenever the power is turned on, the Level Meter screen is shown first. Different screens are displayed with each function that is called up.

Displays at the very top are (from left to right) the current song position (measure, beat, and tick) and time (hour, minute, second, and frame), tempo (in beats per minute or BPM), sample rate (32 = 32 kHz, 44 = 44.1 kHz), song number, and pad bank number.

4 LOCATOR

→ LOCATOR

With the four LOCATOR buttons, you can register up to eight points in a song for later recall. (For directions on how to record and delete locate points, please refer to p. 32.) By pressing each button, you can move instantly to that button's preset position. Additionally, you can use these locate points to define regions for automatic Punch-In and Punch-Out Recording (p. 66, 76).

(MEMO) Holding down [SHIFT] and pressing [CLEAR] changes the display to the Mixer View screen (p. 22).

5 STATUS

→ Track STATUS Buttons

Determine the status including record, playback, and mute for each of the tracks. The status switches as shown below each time the button is pressed.

Normal: PLAY (green) → MUTE (off) → RECORD (red)

(MEMO) When audio recording (p. 74) is selected, tracks can also be selected as BOUNCE source tracks (orange).

Note that you cannot be switched to red when one of other tracks has already been selected as RECORD destination (red).

When the Pad Sampling screen is displayed, the sequence is as follows:

MUTE (off) → SAMPLING (orange) → PLAY (green)

(MEMO) When in the Play List screen (p. 22), holding down [SHIFT] while pressing [STATUS] selects and deselects that track as the target track when specifying a region or when setting Phrase Markers.

6 EFFECTS

→ Channel EFFECTS Buttons

With the internal effects in the Send/Return position (p. 97), signals sent to effects can be turned on and off (the indicator is lit when turned on).

When the effects are in the Channel Insert position, you can have the effects turned on and off for selected channels only.

When the effects are in the Master Insert position, Turning on/off of all buttons are synchronized.

(NOTE) Depending on the function assigned to the fader (indicated by whether or not the "PAD" indicator is on), the button for the MIC/LINE Channel works as the EFFECT button for either the pad sound or the mic or line input signal.

(MEMO) When this is pressed while [SHIFT] is held down, the screen for each type of setting for that channel (equalizer, left-right balance, effect send level, etc.) is called up.

7 DISK

→ Disk Indicator

Lights when the internal Zip drive is accessed. (If the optional SP808-OP1 Multi-I/O expansion is installed, this also lights when an external Zip drive is accessed.)

8 PLAY

→ PLAY Button

These four basic screens of three types (Level Meter (two types), Play List, and Big Time → p. 21) are called up and switched in sequence.

MEMO Holding down [SHIFT] and pressing [PLAY] changes the display to the Contrast Setting/Information screen (p. 22).

9 (PREVIEW) SCRUB

→ SCRUB PREVIEW Button

When set to "On," a very short segment of the song leading up to (or starting from the) current position is played back repeatedly. Using this in conjunction with the VALUE/TIME dial allows you to get an authentic-feeling scrub (manually rotating a reel of analog tape to cue to the beginning of a song or other position on a tape → p. 33 for more detailed information).

10 (PREVIEW) TO

→ PREVIEW "to Now" Button

Each time this button is pressed, a very short segment of the song leading up to the current position is played. Pressing the button while [SHIFT] is held down changes the action to a "From Now" function, whereby a very short segment of the song is played starting from the current position (→ p. 33 for more on settings during playback).

This is a convenient function for even greater precision in checking and adjusting the current position of the song.

11 MUTE

→ MASTER OUT MUTE Button

This temporarily mutes the output of the MASTER OUT only. The button switches to the light on and off alternately when it pressed each time.; the sound is muted while the button is illuminated (however, AUX output and the signal to the headphones are not muted).

When pressed with [SHIFT] held down, the screen for settings related to the total mixer section and the effects position is called up.

12 A, B, C, D

→ TRACK Faders

These control each track's volume level. When tracks are being recorded to (when the indicator lights red), the faders adjust recording monitor volume.

13 MIC/LINE (PAD)

→ MIC/LINE Fader (PAD Fader)

Adjusts the input levels (from LINE IN and MIC IN). Depending on the settings, it can also function as the playback volume level fader for pad samples. This is preset at the factory to the latter (the PAD indicator is lit (p. 75)). The shortcut operation to switch is pressing the [SCRUB] while [SHIFT] being held down.

MEMO In either case, this fader has no effect on the signals from AUX IN.

14 MASTER

→ MASTER Fader

Adjusts the overall volume (the signal level from the MASTER OUT).

MEMO This fader has no effect on the signals from AUX IN.

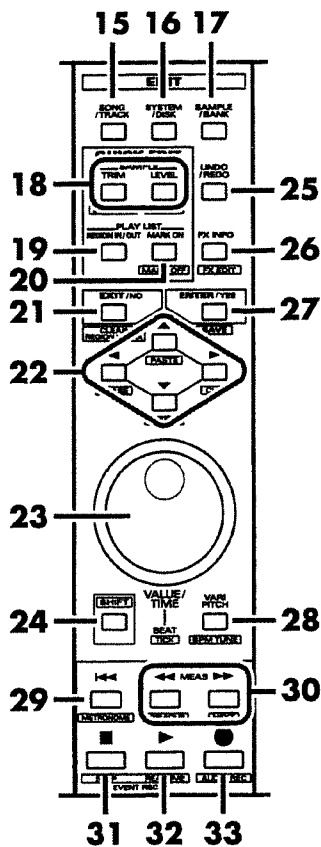

15-17 EDIT

→ Button Group For Calling Up Edit Condition
 Call up the screens in which each type of editing function and parameter is set.

15 SONG/TRACK

→ SONG/TRACK Edit Button
 Calls up the Edit and setting menu for songs and tracks. (Pressing [PLAY] returns one of the basic screens to the display.) Press [▲] or [▼] to select menu items then press [ENTER/YES] to set the selection. When it pressed while [SHIFT] being held down, this button switches the MTC synchronization (p. 153) between master and slave.

16 SYSTEM/DISK

→ System Settings/Disk Function Button
 Calls up the system- or disk-related function and settings menus. (Pressing [PLAY] returns one of the basic screens to the display). Press [▲] or [▼] to select menu items then press [ENTER/YES] to set the selection.

17 SAMPLE/BANK

→ SAMPLE/BANK Settings Button
 Calls up the menus for sample processing and editing as well as for pad- and pad bank-related editing and settings menus. (Pressing [PLAY] returns one of the basic

screens to the display.) Press [▲] or [▼] to select menu items then press [ENTER/YES] to set the selection.

18 (QUICK EDIT) SAMPLE

By pressing these buttons (alone or while holding down [SHIFT]), you can jump directly to the settings screen for samples. The two buttons call up the four following functions.

- TRIM:** Sets the points where a sample's sound starts and stops.
- LEVEL:** Sets the sample volume level.
- STRETCH:** Stretch (expand/compress) the time of the sample.
- PITCH:** Changes the pitch only.

19-20 (QUICK EDIT) PLAY LIST

The two buttons below are for performing edit operations in the Play List screen.

19 REGION IN/OUT

→ Region Designation Button
 In the Play List screen (p. 22), this button is used to specify selected regions of songs (pressing this while in other screens automatically calls up the Play List). You can immediately cut and paste specified region by pressing [SHIFT] while moving the cursor (for directions → p. 82).

20 MARK ON

→ Phrase Specifying (MARK) Button
 In the Play List screen (p. 22), this button is used to specify selected phrases. You can immediately cut and paste specified phrases by pressing [SHIFT] while moving the cursor (for directions → p. 83). By pressing this button while holding down [SHIFT], you can delete Markers from phrases one by one.

21 EXIT/NO

→ EXIT/NO Button
 In screens following menus or in similar circumstances, press when you wish to exit to a previous screen. When messages asking questions are displayed, press this button to answer "No."

(Except for the purpose of indicating "No" to direct questions, this normally serves the function of **exiting from a screen** rather than deleting any settings.)

22 ▲, ▼, ◀, ▶

→ Cursor Buttons (Up, Down, Left, Right)
 These are used primarily when selecting settings values (they are also used to switch among the screens in the composed displays). When pressed while holding down [SHIFT] in the Play List screen, these are used in editing selected ranges (p. 84).

23 VALUE/TIME

→ VALUE/TIME Dial

Change the settings for items selected with the cursor or by other means. In screens that do not feature numerical values or other settings (for example, the Level Meter screen and Play List screen (p. 21)), this is used to move the current position forward and back within the song. In regular conditions, rotating the dial moves the position in increments of one beat; when rotated while holding down [SHIFT], the position is moved in units of one tick (1/96 of a beat).

MEMO To move in units of measure, press [◀◀] or [▶▶].

24 SHIFT

→ SHIFT Button

Pressing this in conjunction with other buttons changes the other buttons' functions. When a button is pressed while [SHIFT] is held down, the function or screen printed in the box below the button is selected.

25 UNDO/REDO

→ UNDO/REDO Button

Undoes previous recording, processing, or editing operation (and returns the song to conditions prior to the operation). The button is operational only when it illuminated. Pressing the button immediately following the undo operation executes the redo function (re-executes the undone operation, or "undoes the undo").

NOTE Undo is applies only to the very last performed step.

26 FX INFO

→ Realtime Effects Knob Information Button

Calls up the Realtime Effects knob Information screen, wherein the current effects settings status is indicated by a knob icon.

Pressing this button while holding down [SHIFT] calls up the Effects Edit screen (p. 98).

27 ENTER/YES

→ ENTER/YES Button

Select (enter) the menu or execute the functions. When messages asking questions are displayed, also press this button to answer "Yes."

28 VARI PITCH

→ VARI-PITCH Button

Executes the **Vari-Pitch** function (simulating the tape speed control on a tape recorder) on the sound being played back. Vari-Pitch is switched on (the pitch is changed) and off (normal) alternately when the button is pressed. Additionally, pressing this button while holding down [SHIFT] calls up the screen for adjusting the tempo and the width of the Vari-Pitch.

NOTE When the sample rate is set to "44" (44.1 kHz), the pitch cannot be adjusted upward with Vari-Pitch.

MEMO Using Vari-Pitch results in a corresponding change in the song's playback tempo, lending an effect like that of speeding up recorded tape. However, changing the playback tempo does not have a corresponding effect on the Vari-Pitch.

29 [◀◀]

→ TO TOP Button

Jumps to the beginning of the song. This functions as the Metronome ON/OFF button while [SHIFT] is held down (p. 67).

30 [◀◀][▶▶]

→ Measure Increase and Decrease Buttons

Press the [▶▶] to advance to the top of the next measure; press the [◀◀] to jump back to the top of the previous measure. When these buttons are held down continuously, they function like fast forward and rewind controls (with no sound produced while in operation).

In the Play List screen, these buttons are pressed while holding down [SHIFT] to jump from one phrase to the top or the end of the next (or previous) phrase in sequence on a selected track.

During Step Recording, [◀◀] functions as a Back Step button (returns you to the preceding step) and [▶▶] adds a rest (p. 68).

31 [■]

→ STOP Button

Stops playback (or recording) of the song. It is also pressed to release the SP-808 from record standby condition (p. 63, 74). When pressed while holding down [SHIFT], the Event Step Recording function is selected, simultaneously calling up that screen (p. 68).

With the Track Voice Reserve function on, when the song is stopped the STOP button is also used in an auxiliary capacity for switching [STATUS] (p. 137).

32 [▶] (PLAYBACK)

→ PLAYBACK Button

Starts playback of the song from the current position (time) in the song. Additionally, pressing this button starts recording in record standby condition (p. 63, 74). In Step Recording, pressing this button adds a tie (carrying a sound from a preceding step over to the following step) (p. 68). When pressed while holding down [SHIFT], the Event Realtime Recording function is selected, simultaneously calling up related settings items (p. 63).

33 [●]

→ RECORD Button

Pressing this during Track Recording puts the SP-808 in record standby condition. Pressing [●] while holding down [SHIFT] selects Track Audio Recording, simultaneously calling up related settings items (p. 74).

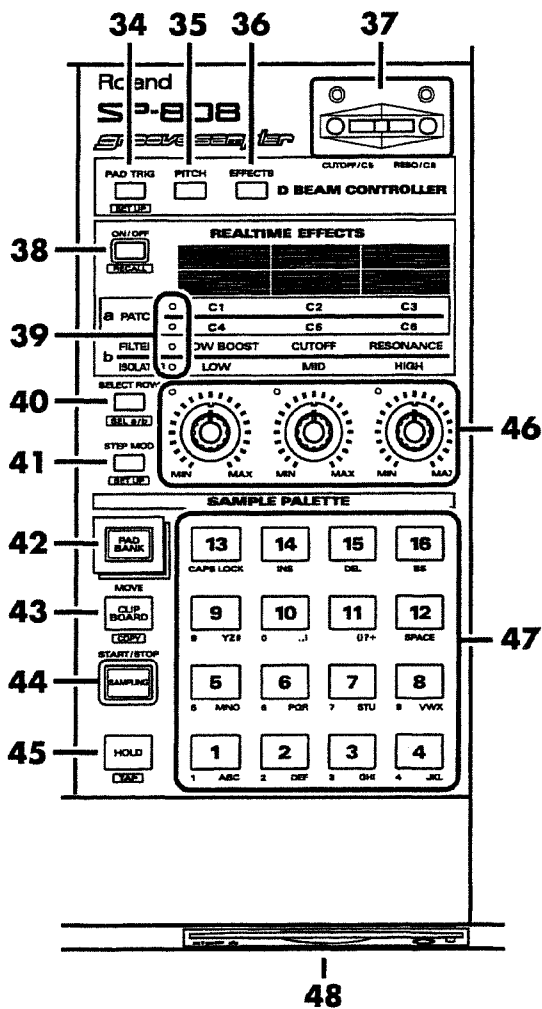

34 (D Beam) PAD TRIG

→ D Beam PAD TRIGGER Button

When this is switched on, you can use the movements of your hand to play samples on specified pads with the D Beam Controller.

To designate samples to be played (two samples in each pad bank), with the PAD TRIGGER button held down, press the two pads one after the other (see p. 30 for more details).

Pressing this button while holding down [SHIFT] calls up the screen (SET UP) in which you can make settings of the D Beam Controller as a whole, such as sensitivity adjustments.

35 (D Beam) PITCH

→ D Beam PITCH Down Button

When this is switched on, you can use the movements of your hand to lower the entire pitch of the system with the D Beam Controller. The drop in pitch varies with the distance between your hand and the sensor (see p. 30 for more details).

36 (D Beam) EFFECTS

→ D Beam EFFECTS Button

When this is switched on, you can use the movements of your hand to change the effects settings with the D Beam Controller. The effects that can be changed are the same as those controlled by the Realtime Effects C5 and C6 knobs (see p. 129 for more details).

37 D BEAM CONTROLLER

→ D Beam Controller Section

The sensor on the panel detects the movements of your hand or other object, and allows you to change the pitch of the song or samples, achieve continuous changes in internal effects settings and sound samples assigned to the pads.

38 (REALTIME EFFECTS) ON/OFF

→ This switches the internal effects on and off (the indicator lights when effects are on). This switch allows you to turn effects off without making any changes to the mixer arrangement or Send and Return status.

39 Parameter Row Select Indicator

These indicate which row of items ("a" or "b"; or, upper or lower), will be controlled by the Effects Knobs.

40 SELECT ROW

→ Effect Knob Function Select Button

Pressing this with [SHIFT] held down switches the current effects between "a," general effects patches that may be freely arranged, and "b" total output isolator and filter functions (p. 28).

Pressing this button without [SHIFT] selects the row of effects that the effects knobs act upon, switching between the upper and lower rows indicated on the panel within each of the "a" and "b" groups listed above.

41 STEP MOD

→ STEP MODULATOR Button

Controls the Step Modulator (a function that lets you change effect sounds in rhythm → p. 131). Press the button to turn the function on and off alternately. Although depending on the setting, this may also be used for other operations such as increasing the step one by one. Pressing this button while holding down [SHIFT] calls up the screen in which you can make settings related to the Step Modulator (p. 131).

42 PAD BANK

→ PAD BANK Switch

This calls up the list of the SP-808's 64 individual pad banks. Rotate the VALUE/TIME dial to switch the pad bank to be selected while the screen is being shown. Press [ENTER/YES] then exit the screen simultaneously

calling up the selected pad bank. If depress one of the 16 pads with [PAD BANK] held down, the pad bank that has same number as the pressed pad is selected.

(NOTE) *All samples being played at this time stop sounding, except for any samples being held.*

43 CLIPBOARD

→ CLIPBOARD Button

Moves (or copys) samples from one pad to another rapidly. Pressing this button while one of the pads is held down, temporarily keeps the sample on the [CLIPBOARD]. Pressing the button again along with another pad moves the sample to the new pad. (for more instructions on other functions, see → Copying, p. 56; Deleting, p. 55; Moving Track Sound to Pads, p. 55).

44 SAMPLING

→ SAMPLING Button

Calls up the Sampling screen (p. 43). In that screen, this button is also used to start and stop the sampling.

(NOTE) *You can not press this during any song playing back. When you sample the sounds from songs to pads, first stop playback, press [SAMPLING] and specify the track to be sampled (see → p. 49).*

45 HOLD

→ HOLD Button

Keeps on playing the sample after you release the pad. When you are playing a pad sample that is set to stop playing when it released, but you want the sound to continue even after you release the pad, press [HOLD] while pressing the desired pad. Pressing [HOLD] once releases the hold, and the selected sample stops playing (see → p. 37).

While hold down [SHIFT] and tap this button repeatedly along with the desired rate (tempo), that tempo is shown on the display by BPM unit (p. 52, 71, 144).

46 Realtime Effects Knobs

Change the effects settings in realtime. Assignings of effect setting (parameter) to each knob can be stored to effects patches.

The indicators to the upper left of the effects knobs are lit when the effects are active at the knobs' current positions.

47 1-16

→ Pads (1-16)

You can assign up to 16 samples to these pads. You can make various settings to each sample (p. 36), such as whether to have the sample sounded only while the pad is pressed, or to have the sample play when the pad is pressed and stopped by pressing the pad again.

The pads are also used as character keys for entering names (p. 62) for songs, banks, and effects patches.

48 Zip Drive

The internal Zip drive.

(NOTE) *Before switching the power off, be sure to press the EJECT button located below the disk slot and remove the disk.*

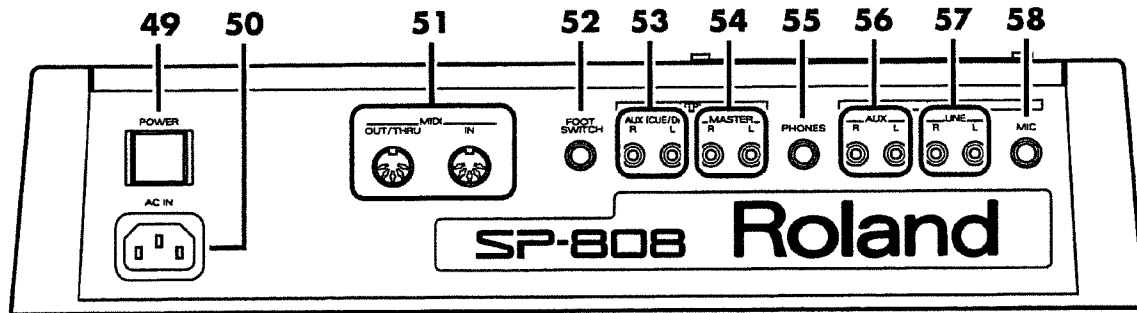

49 POWER

→ POWER Switch

Turns the SP-808's power on and off.

(NOTE) *Always eject the Zip disk from the drive before turning the power off. Furthermore, if any changes have been made to song and/or effects patches, such data also need to be saved onto the Zip disk before the power is turned off.*

50 AC IN

→ AC IN

The AC power cord (accessory) is connected here.

51 MIDI IN, OUT/THRU

→ MIDI Connectors

External MIDI devices are connected to these (for more information on how to do this, see → p. 151).

52 FOOT SWITCH

→ Foot Switch Jack

The optional DP-2 pedal switch is connected here. Various operations, including starting and stopping playback of songs and playing sampled sounds, can be performed using the pedal switch (for selecting functions, see → p. 139).

53 OUTPUT—AUX L, R

→ AUX (Auxiliary) OUT Jacks

The auxiliary output jacks. They are used in sending signals to external effects devices and in the Pad Cue function (p. 42). Additionally, with a Multi-I/O expansion installed you can use these as D-Track direct output jacks (p. 150).

(NOTE) *The volume is determined by the mixer's internal settings. It is not changed with the MASTER fader.*

54 OUTPUT—MASTER L, R

→ MASTER OUT Jacks

The main audio signal output jacks. The MASTER fader controls the output level.

55 PHONES

→ Headphones Jack

Connect stereo headphones to this jack. Depending on the AUX OUT Jack mode settings, you can select the sound only from the MASTER OUT, or a mixture of the sounds from MASTER OUT and AUX OUT (p. 42).

56 INPUT—AUX L, R

→ AUX (Auxiliary) IN Jacks

These stereo inputs are used for returning the signals from external effect or certain other purposes. Based on settings you can select from the two types of processing for the input signals as shown below (p. 95).

- The signal is not recorded (always output via the MASTER OUT).
- The signal is recorded during sampling (or during audio recording to the tracks).

57 INPUT—LINE L, R

→ LINE IN Jacks

These stereo input jacks are for connecting musical instruments, CD players, or other similar devices. The signals from these inputs are recorded during sampling or recording audio to tracks.

58 INPUT—MIC

→ MIC IN Jack

A microphone can be connected here. The signal from this input is recorded as the source of MIC and LINE channel sampling or recording audio to tracks. The signal is fixed to the center position of the stereo panning.

For jack and connector names and functions with the SP808-OP1 (Multi-I/O Expansion), see → p. 145.

Connections

Setting Up Connections with Other Devices for Using the SP-808

The following outlines the minimum setup necessary to use the SP-808.

- Stereo audio device (such as a keyboard amp, PA system, home stereo set, or similar equipment), or stereo headphones
- Microphone, musical instrument, CD player, or other recording source

- Appropriate cable for connecting each device
- Zip disk (accessory)

After obtaining all of the above items connect each device, referring to the figure below.

NOTE To prevent malfunction and/or damage to speakers or other devices, always turn down the volume, and turn off the power on all devices before making any connections.

MEMO Use commercially available plug or cable adaptors when connecting devices with standard jacks to the LINE IN/OUT jacks.

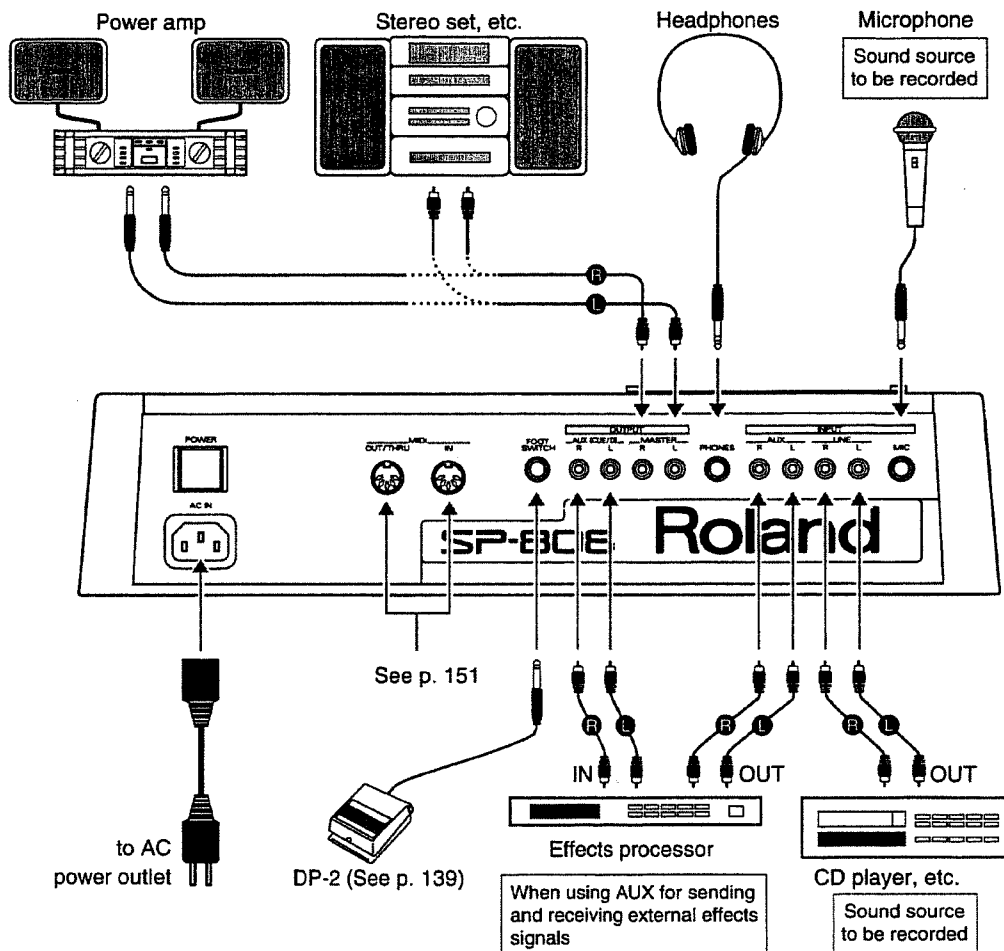

When Connecting an Electric Guitar or Bass

Due to mismatched impedance (an electrical property), sound quality may suffer if you connect an electric guitar or electric bass directly to the SP-808.

Take the following steps if connect it directly.

- Use an external effect that has an electronic On/Bypass switch (such as one from the BOSS series of effects) connected between the instrument and the SP-808.
→ This type of effect features an input impedance matching that of electric guitars, but uses a relatively low output impedance. This works even in the bypass position (when no effect is applied).
- Use a guitar or bass that has an internal preamp, or that uses active pickups.
→ These kinds of guitars and basses feature relatively low output impedance.

Microphones That Can Be Used with the SP-808

With a microphone plugged into the SP-808's MIC jack, the knob can adjust the input level over a wide range. Thus, most dynamic or electret condenser microphones for vocals and instruments can be used.

(NOTE) The INPUT MIC knob setting varies with the type of mic used. Note if setting the input sensitivity is too high may result in noise and distortion.

(NOTE) If the following mics connected directly, the SP-808 will not work properly.

- Professional condenser mics that require phantom power
- Compact stereo mics that use TRS (tip/ring/sleeve) plugs (the same kind used with stereo headphones)
- Mics with extremely low output levels

Turning the Power On and Off

(NOTE) Once the connections have been completed (p. 19), turn on power to your various devices in the order specified. By turning on devices in the wrong order, you risk causing malfunction and/or damage to speakers and other devices.

Ext. Zip drive (p. 147) → SP-808 → MIDI devices → Power amp

Turning the Power On

1. Press the POWER switch.

The power is turned on.

2. When "Please Insert Zip Disk" appears in the display, insert the accessory Zip disk into the internal drive.

After several seconds, the Level Meter screen will be appeared in the display. Preparations are completed. At this time, a previously saved song and the pad bank that can be selected.

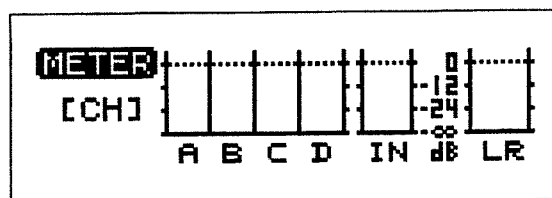

Channel Meter

(NOTE) When a new Zip disk or a Zip disk that has been used with another device is inserted, the confirmation message "...NOT SP-808 Disk.Format Now?" asking whether or not you want to format the disk appears in the display.

When you press [ENTER/YES], "Format (44.1k:QUICK) ARE YOU SURE?" is displayed. Press [ENTER/YES] again at this point, the formatting is executed. Before executing the format, you can select the sample rate (44.1 kHz or 32 kHz) for the disk (p. 24) with the VALUE/TIME dial. By pressing [←], you can also use the dial to select the format type (p. 24); choose either QUICK or FULL. For now, let's go with the QUICK format with a 44.1-kHz sample rate.

(NOTE) Formatting a disk on the SP-808 erases all of the disk's contents.

Turning the Power Off

1. Press the EJECT button to eject the disk.

The confirming procedure of the song saving that follows "Removing a Disk" described in next item is executed. After complete this procedure the disk is ejected.

2. "Please insert Zip Disk." is displayed, then press the POWER switch.

This turns off the power.

Inserting and Removing a Disk

When inserting a disk, gently insert the disk directly into the drive and make sure the disk is not reversed.

Use the following procedure when removing disks.

Ejecting the Disk After Saving Changes to (Overwriting) Songs

1. Press the round EJECT button located to the lower right of the disk slot.

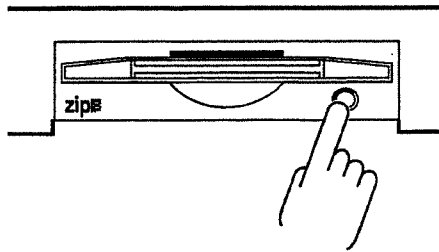

"Save Current Song? (Overwrite Only.);" appears in the display.

2. Press [ENTER/YES].

After the overwritten song is saved, the disk is ejected.

Ejecting the Disk Without Saving Songs

1. Press the round EJECT button located to the lower right of the disk slot.

"Save Current Song? (Overwrite Only.);" appears in the display.

2. Press [EXIT/NO].

"Eject, (Not Saved) ARE YOU SURE?" appears in the display.

3. Press [ENTER/YES] and the disk is ejected.

Pressing [EXIT/NO] cancels ejection of the disk.

(NOTE) The save process that is performed when ejecting disks is limited to overwriting (changes made to the same song). If you want to save the current song as a separate song, or if you want to change the song name carry out the Song Save procedure (p. 72) before ejecting the disk.

(NOTE) The necessity of saving effects patches is not confirmed when the disk is ejected. Use the effect patch Save procedure (p. 100) when saving data as an effect patch.

Changing the Shading of the Display (Contrast Setting)

The display contrast will be changed depending on the temperature as well as with the angle of viewing. Use the following procedure to adjust the contrast of the screen if viewing becomes difficult.

Adjusting the Contrast

1. Hold down [SHIFT] and press [PLAY] to call up "CONTRAST/INFO" screen.
2. Rotating the VALUE/TIME dial changes the screen contrast; set the value appropriate for the best viewing (in a range from 1–16, with 16 providing the greatest screen contrast).
3. Press [EXIT/NO].

You are returned to the basic screen.

(MEMO) This setting is saved automatically when the disk is ejected (or at other appropriate times), and is retained even while the power is off.

Calling Up and Switching the Basic Screens (Level Meter, Play List, Big Time)

The SP-808's basic screens are called up by pressing [PLAY] at the bottom of the display. The basic screens include the following (four) screens of three types, and each one can be switched in sequence by pressing [PLAY].

The Level Meter Screen

This consists of two separate screens, one is displays the group of track and mic/line channel meters, and the other one is the AUX In/Out meters (Press [PLAY] to switch the screens). When recording audio signals to tracks, the meters indicate the track recording levels. In the AUX Meter screen, also "Fx" indicates the effects send level when the internal effects are in the Send/Return position (p. 93).

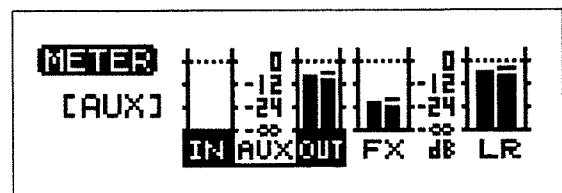

AUX Meter

→ Immediately after the power is turned on, the Track and Mic/Line Channel Meters screen is displayed.

Play List Screen

In this screen, you can check the phrases recorded onto the tracks by looking at their position and length within boxes (rectangles).

The dotted vertical lines on the screen indicate bars.

The area indicated on the screen can be widened by pressing [←] and narrowed by pressing [→].

You can also specify desired intervals by pressing [REGION IN/OUT] or [MARK ON]. The selected interval can then be pasted or deleted with one touch (p. 82, 84).

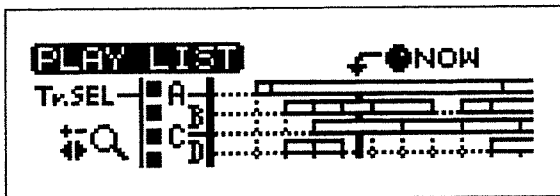

Big Time Screen

In this screen, the indicated location in the song (the song position) that usually appears in small characters at the very top of other screens is expanded to fill the entire display. The units indicated can be switched according to your needs (p. 31, Measure/Beat/Tick or Hour/Minute/Second/Frame). When performing on darkened stages or in other such situations, using this screen makes the time display easier to see.

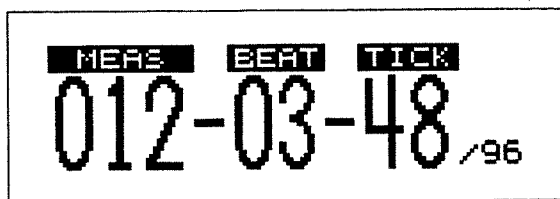

Other Information Screens (Contrast/Info and Mixer View)

Besides the basic screens, there are two other screens that provide the following basic information (pressing [PLAY] while in either of these screens returns to the basic screens described above to the display).

Contrast Setting and Information Screen

→ To call up this screen, hold down [SHIFT] and press [PLAY].

The screen contrast can be adjusted with the VALUE/TIME dial. This screen is also used for checking the currently selected song name (SNG), pad bank name (BNK), recording time remaining (Remain), and the amount of memory remaining to make song (SngData).

All items in this screen other than contrast can only be confirmed, not adjusted. As for changes to each of the other items, change song names when carrying out the Save procedure (p. 72) or in the Edit screen and change pad bank names in the Bank Edit screen (p. 138).

MEMO Change the width of the Vari-Pitch in the BPM Tune screen (p. 39).

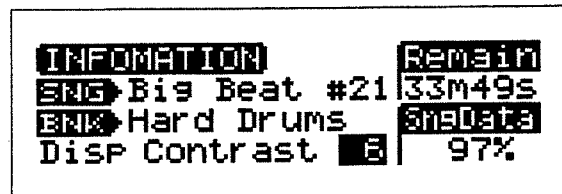

Mixer View Screen

→ To call up this screen, hold down [SHIFT] and press the Locator [CLEAR].

You can check the mixer settings represented graphically in this screen and also make rough adjustments to settings. You can confirm the left-right balance, the sent level to AUX OUT and the internal effects of each of Track A-D and the input channels. Furthermore, by pressing [←] or [→] to move the arrow (Δ) at the bottom of the screen and rotating the VALUE/TIME dial, you can work the controls for each of these parameters to change their settings. For more precise settings, hold down [SHIFT] and press [EFFECTS] for each channel to call up the settings screen for each individual channel.

MEMO Pressing [PLAY] returns to the basic screens on the display.

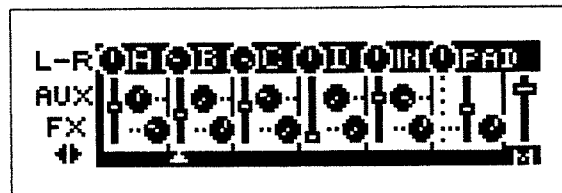

If an Unfamiliar Screen Appears (How to Return to the Basic Screens)

While you're still not that familiar with the operation of the unit, you could easily wind up in an unfamiliar screen. In such instances, you can press [PLAY] to return to one of the basic screens (the one most recently selected).

About the Internal Zip Drive

The SP-808 uses 100-megabyte Zip disks. Zip disks, while featuring high-speed access and high-capacity storage, can also be exchanged instantly, just like floppy disks. The SP-808 makes use of this feature, using **virtual memory sampling** technology for direct disk access, and expression of sounds.

(NOTE) "Zip" is a trademark of Iomega Corporation (U.S.A.).

(NOTE) Before turning off the SP-808's power, always make sure to follow the correct procedure for removing the disk (p. 21).

(NOTE) Never move the SP-808, nor subject it to physical shock or vibration with a disk inserted in the drive.

(NOTE) As with personal computers and similar devices, turning the power off while data is being written to disk will result in the loss of data. Be careful not to allow the power cord to become accidentally disconnected, and take care to prevent similar accidents.

(NOTE) Never turn the power off while the message "KEEP POWER ON!" appears in the display, even if the disk drive does not seem to be in operation. Switching the power off while this message is displayed will cause system settings and all effects patches to be lost.

Concerning Zip Media That Can Be Used by the SP-808

The SP-808 uses only commercial Zip system disk media specified as "Zip 100."

(NOTE) Do not forcibly insert incompatible media into the disk drive—doing so may result in damage to the unit.

If a Zip disk that has been used with personal computers or other devices is inserted into the SP-808's drive, the confirmation message "...NOT SP-808 Disk. Format Now?" asking if you wish to format the disk for use in the SP-808 appears in the display. Press [ENTER/YES] at this point, the SP-808 proceeds to format the disk. Note that in this case, all contents of the disk are permanently lost. (After formatting, the disk may then be used in the SP-808.)

(NOTE) While the entire contents of disks cannot be protected (from accidental erasure) on the SP-808, you can set protection for songs (p. 72) and pad banks (p. 138).

Preparing New Zip Disks for Use (Format Disk)

In order to use a Zip disk with the SP-808, first the disk must be formatted. When a new Zip disk (or a Zip disk that has been used in another device) is inserted, the screen for the formatting procedure is called up (p. 20).

(NOTE) *When a disk is formatted, all contents on the disk are permanently lost.*

If you want to initialize a disk (completely erasing all contents) that has already been used with the SP-808, reformat the disk using the following procedure.

Reformatting Disks

1. Press [SYSTEM/DISK].
2. Press [▲] or [▼] to select "Format Disk?" and press [ENTER/YES].
3. Press [▲] or [▼] to select "SamplingRate?" (sampling rate—details follow).
4. Rotate the VALUE/TIME dial to select either "44.1" or "32."
5. Press [▲] or [▼] to select "Format Type."
6. Rotate the VALUE/TIME dial to select either "QUICK" or "FULL."
QUICK: This executes a process that only logically voids the data on the disk. This allows the formatting to be accomplished quickly. This method is usually selected.
FULL: This process physically erases all data sectors on the disk, completely clearing the disk. This increases the reliability of disks, particularly those that have been used previously on other equipment. FULL formatting takes about 10 minutes to complete.
7. Press [ENTER/YES].
"Erase ALL data, ARE YOU SURE?" appears in the display.
8. Pressing [ENTER/YES] again executes the formatting.

With the SP808-OP1 (optional expansion → see p. 145) installed in the SP-808

When an external Zip drive is not connected, "TargetDrive" which appears in the top of the screens displayed after Step 3, is usually fixed at "INTERNAL" (internal drive). When an external Zip drive is connected, this may change to "EXT.ID5" or indicate another drive (this number indicates the SCSI-ID: → see p. 148).

Even when the disk designated for formatting is in an external drive, the procedure is basically carried out the same way (however, when there is no disk placed in the drive, the message "Can't Execute.(No Disk.))" appears

on the screen).

Setting the Sample Rate

In general, a higher **sample rate** gives you playback with better fidelity sound with extended high range. Conversely, selecting a lower sample rate makes it possible to get longer recording and playback times with the same amount of memory (although there are cases in some musical styles where a lower sample rate is chosen intentionally with the aim of a blurring the high end or achieving some similar change in the sound quality).

With the SP-808, you can select from two sample rates: 44.1 kHz (suitable for CDs and MDs) and 32 kHz. However, this setting can only be made when the disk is formatted (previous section). Furthermore, only one sample rate can be selected for use on any one disk. Data with differing sample rates cannot be resided on the same disk.

The amount of variation available with the Vari-Pitch function (p. 39) also changes with the sample rate. When 44.1 kHz is selected as the sample rate, the pitch can be adjusted within a range of 18.1%–100% (although the pitch can be adjusted downward only); when the sample rate is set to 32 kHz, the pitch is adjustable in a range of 25.0%–137.8% (adjustment both upwards and down is possible).

The sample rate is usually indicated where "kHz" is located in the upper part of the display. "44" indicates 44.1 kHz, and "32" indicates 32 kHz.

Technical Note

The **sample rate**, also referred to as the sampling frequency, denotes the processing of sound in kilohertz (kHz). In the digital conversion of analog signals (such as audio signals), this numerical value indicates the number of times per second the sound is digitally encoded. For example, at a sample rate of 32 kHz, the sound is digitally encoded 32,000 times each second, and the numerical value each time the sound is encoded is then recorded to memory (on the SP-808, it is recorded to the Zip disk).

Maximum Sampling Times and Data Storage Available on Zip Disks

The following indicates the maximum total recording time, including sampling to pads, direct recording to tracks, etc., available with Zip disks (stereo recording consumes as twice much as monaural recording time).

- At a sample rate of 44.1 kHz:** Approximately 46 minutes
- At a sample rate of 32 kHz:** Approximately 64 minutes
- Maximum number of samples:** 1,024 (16 pads x 64 pad banks)

Arranging samples (phrases) in a song also consumes song data memory which differs from audio wave memory. The following indicates the maximum memory allotted for any one song; this figure cannot be exceeded.

With each "press and release" of a pad constituting one "event", one song (with a total of four tracks) can record approximately 2,000 events.

MEMO Up to 64 songs can be recorded to one disk.

MEMO Maximum data capacity may vary somewhat depending on conditions. Besides these events on tracks, mixer settings and settings related to MIDI synchronization are also included in songs.

In addition, 99 User effects patches can also be saved to disks (whereas the display contrast and other settings related to the overall system are automatically stored internally by the SP-808).

Technical Note

The SP-808 employs Roland's original audio encoding technology "R-DAC," which allows extended recording and playback times while keeping high sound quality. Moreover, since it is engineered to share sonic waveforms as much as possible (for example, no new waveform is created when a measure is simply copied), you can actually record and play back much longer songs than the recording times mentioned above would indicate.

Checking the Remaining Memory on Zip Disks

To check the amount of recording time left on the disk, hold down [SHIFT] and press [PLAY] to call up the Information screen.

Here, along with such information as the song name, you can check the amount of time (Remain), in minutes and seconds, that remains available for recording (the indication in this screen will change depending on whether stereo or monaural recording is specified in the Recording (Sampling) screen).

In addition, you can also check the remaining song data memory, which is indicated as a percentage.

MEMO The remaining time for audio recording is also indicated in the Sampling and Track Direct Recording screens.

Listening to the Demo Songs (How to Play Songs and Samples)

The disk that comes with the SP-808 includes some demonstration songs. Try giving these songs a listen.

1. **Confirm that your amp, headphones and other equipment is properly connected.**
2. **Following the steps described in "Turning the Power On and Off" (p. 20), turn on the power to the SP-808.**
The Level Meter screen appears in the display.
3. **Move the faders for Tracks A–D to the level indicated by the red bold marker line (0 dB).**
4. **Turn down the MASTER fader.**
5. **Press [▶] (PLAYBACK) and gradually raise the MASTER fader.**

Set the volume of the demo song to the appropriate level.

6. **Press [■] to stop playback of the song. When you press [◀◀] and the press [▶] (PLAYBACK) again, the song is played back from the beginning again.**

MEMO Recording, public performance, broadcast, or any other use of the demonstration songs contained on the included disk, other than for your own personal enjoyment, without consent of the copyright holder is prohibited by law.

Setting the Overall Volume (MASTER Fader)

The volume level from the MASTER OUT is adjusted with the MASTER fader. Additionally, the relative volume of the left and right channels in the stereo field can be set with the mixer's Master Balance (p. 92). Initially, it is set to 0 (equal levels).

Setting the Headphone Volume

The headphone volume control knob is used to set the volume of headphones to the PHONES jack (however, if the Master level is completely turned down, then even if you turn up the headphone knob, the sound from MASTER OUT will be inaudible.)

MEMO If the mixer is set to "CUE" while in AUX OUT Jack mode (p. 42), you can listen to the sound from AUX OUT mixed with the regular output. The AUX OUT volume is set with AUX OUT Level (p. 95) in the mixer.

Setting the Volume for Each Track (Track Faders)

The volume of each stereo Track A–D is set with the Track faders (A–D).

Let's Make Some Sounds

The stereo balance for each track can be adjusted either in the Mixer View screen (hold down [SHIFT] and press [CLEAR] → see p. 22) or in the Track A-D screen (p. 92).

NOTE Unless each track's [STATUS] is switched to "PLAY" (in which status the indicator is green), the sound won't be played, even with the faders raised. For example, if a track is set to "MUTE" (indicator off), then the playback sound for that track cannot be heard, regardless of the fader position. To return the indicator to green, press [STATUS] 1-3 times.

Calling Up a Different Song (Switching Songs)

Some demo songs are provided on the disk that comes with the SP-808. Use the following procedure to switch the songs.

1. Press [SONG/TRACK].
2. Confirm to choose "Select Song?" and press [ENTER/YES].
The list of songs appears in the display.
3. Press [▲] or [▼] (or rotate the VALUE/TIME dial) to highlight the desired song.
4. Press [ENTER/YES].
"Save Current Song? (Overwrite Only.*)" appears in the display.
5. Before switching the song, press [ENTER/YES] if you want to protect the song from being overwritten; if you are not going to save the song, Press [EXIT/NO].
When [ENTER/YES] is pressed, the current song is saved and the selected song is called up. When [EXIT/NO] is pressed, the message "ARE YOU SURE" is first displayed. If you press [ENTER/YES], the selected song is called up without the current song being saved.

MEMO To discontinue the procedure, press [PLAY].

MEMO When SongSave Confirm (which asks whether or not you want to save the current song; see p. 142) is set to "OFF," then the designated song is directly called up when you press [ENTER/YES] in Step 4.

Adding Sample Sounds by Pressing the Pads

When you press [■] to stop playback of the song, the 16 pads light in red. The pads that are illuminated have samples (sounds) recorded to them. Press a pad that is lit to play the sample recorded to it. The pad flashes while the sample is played.

When shipped from the factory, phrase-sample loops lasting from one to several measures or sound-effects are

assigned to each pad. Press the pads now to play these sounds.

MEMO A maximum of four sounds can be layered by pressing the pads simultaneously.

MEMO When all of [STATUS] are "PLAY" (lit green), during playback of a demo song, all of the pads remain unlit and even when the pads are pressed, the samples are not sounded. Pressing [STATUS] for the appropriate tracks causes the unlit (muted) pad to become lit. This way, you can play the sounds assigned to the pads and thus layer sound effects and other sounds during playback of songs, even demo songs (limited by the number of muted tracks).

Selecting Pad Banks

When sampling (p. 43) different kinds of phrases and sounds, each sound (sample) is assigned to one of the pads. A set of samples (recorded to the set of 16 pads) is referred to as a **Pad Bank**.

With the SP-808, 64 pad banks are stored on one disk. Use the following procedure to switch among them.

1. Press [PAD BANK].
The Pad Bank List screen appears in the display.
2. Rotate the VALUE/TIME dial to select the pad bank.
3. Press [ENTER/YES].
That pad bank is selected, and you leave that screen.

When (calling up any of the first to sixteenth pad banks),
 1. Press [PAD BANK].
 2. Press the pad number 1-16 corresponding to the pad bank you want to call up.
That number pad bank is selected, and you leave that screen.
Now, try switching pad banks and playing a sample in a different pad bank.

Temporarily Muting the Output (Master Out Mute)

By pressing [MUTE] above the MASTER fader, you can cut off the output from MASTER OUT. Each time the button is pressed, the light switches on (red) and off alternately. The output is muted while the button is illuminated.

HINT This has no effect on the output from the headphones or AUX OUT. You can use this function when, for example, during a live performance you want to use the headphones to review the tune you are going to have the SP-808 play next, while the audience listens to the sound from some other instrument or device (such as a turntable).

Applying Effects to the Demo Songs

You can add effects to the demo songs. When the internal effects are turned on, effects can be applied using either the send/return or insert methods. (For descriptions of what send/return and insert mean, → see p. 93, 97.) For more detailed information about effects, please refer to Chapters 9 and 10 (for the procedure to add effects to pad samples, → see p. 40).

Adding Effects to the Demo Songs

1. Press **REALTIME EFFECTS [ON/OFF]** to turn on the effects, illuminating the button.
2. If the indicator for the **REALTIME EFFECTS "b"** (second row on the bottom) is lit, hold down **[SHIFT]** and press **[SELECT ROW]** to switch to "a" (**PATCH**, second row on the top) (for more details on "a" and "b," → see p. 28).
3. Press **[FX INFO]** and rotate the **VALUE/TIME** dial to select the effects patches (effects patches: prerecorded group of effects settings → see p. 98).
4. When you press **[ENTER/YES]**, the selected effects patches is called up.
5. Press **[▶]** (**PLAYBACK**) to begin playback of the song; effects are added to the sound.
6. Press **[PLAY]** to return to the basic screens.

Changing the Effect Volume of Individual Tracks

If the **[EFFECTS]** indicators for each track are blinked when turning off the **REALTIME EFFECTS [ON/OFF]** it means that the effects are switched to Send/Return. At this point, you can change the effect volume for each track individually.

Continuing from Step 5 above:

6. Hold down **[SHIFT]** and press **[EFFECTS]** for the track for which you want to change the effects volume.
7. Press **[▼]** or **[▶]** to select the numerical value of "Fx" (indicating the effect level setting).
8. Rotate the **VALUE/TIME** dial to increase or decrease the value, checking the sound to confirm that the effect level has been changed.
9. Press **[PLAY]** to return to the basic screens.

MEMO By pressing **[EFFECTS]** above the faders for Tracks A–D, the effect Send for each of these tracks is switched on (indicator lit) and off (indicator off).

About Automatic Arrangement of Effects

The placement of the SP-808's effects can arranged in a variety of ways with the internal mixer. These settings are usually saved to the disk in the Song Save procedure (p. 72) (whereby the location of the effects is updated along with the selected Patch the next time the same song is loaded). However, you can also **store effects locations as independent effects patches**. The demo song effects are not set in the Song (mixer), but rather in the location in the effects patches where the effects are placed. Thus when switching the Patch in Step 3 above, the effects are automatically recorded to where the effect patch is loaded (the Send/Return position or the position inserted in the MASTER OUT).

To Fix the Positioning of the Effects for All Patches

1. Hold down **[SHIFT]** and press **[MUTE]** to call up "MIX COMMON" screen.
2. Press **[▼]** twice and select "FxLoc." (Effects position).
With demo songs, "–FX PATCH" is selected.
3. Rotate the **VALUE/TIME** dial to specify the desired position, such as "SEND/RETURN," or "INS MASTER" (Insert to MASTER OUT), for the effects.
4. Press **[PLAY]** to return to the basic screens.

MEMO For more detailed information on other effects arrangements and more, please refer to p. 91, 93.

NOTE Some of the later preset patches use the VIRTUAL ANALOG SYNTH algorithm with the Step Modulator or the D Beam Controller. (You can trigger the sounds with the pressing **[STEP MOD]** or the D Beam.) If these patches are selected, there are no changes for the sample (or song) sounds when the effect is turned on. (Some demo songs in the supplied disk use this type of patch.)

NOTE Noise may occur with some types of effects when the effects patches are selected. If the playback device is at high volume levels, then to protect the speakers and other device from damage, either turn off the **REALTIME EFFECTS [ON/OFF]** or lower the volume on the playback device before selecting the effects patches.

Changing Effects with Three Knobs

You can change the effects settings at anytime with the knobs in the Realtime Effects section on the right side of the panel (which we'll refer to as the effects knobs from now on).

There are two ways the internal effects interact with the Realtime effects.

- a. multi-purpose effects (which can be arranged in various ways with the mixer, with 20 different algorithms)
Setting changes you make can be saved as one of up to 99 user effects patches (p. 100).
- b. Master Filter/Isolator (a frequency range filter that is applied only to the MASTER OUT insertion)
The next time the SP-808 is turned on, its initial conditions are restored, wherein only the one of these is registered (p. 29).

The effects knobs are enabled under the most of operational condition (you can change the settings even when the effects themselves are not active).

Controlling the Master Filter/Isolator

When shipped, neither "a" nor "b" has been used in the demo songs. At this time, try out "b," the Master Filter/Isolator, on a demo song.

For instructions on how to work "a" (overall effects as patches), see p. 128.

Controlling the Master Filter/Isolator

1. Prepare the demo song for playback (p. 25).
2. Turn the effects on by pressing REALTIME EFFECTS [ON/OFF]; illuminating the button.
3. Hold down [SHIFT] and press [SELECT ROW] so that the "b:FILTER ISOLATOR" indicator is lit.

Each time this button is pressed, the lit indicator switches between "a:PATCH" and "b:FILTER ISOLATOR" alternately.

a	PATCH	<input type="radio"/>	C1	C2	C3
		<input type="radio"/>	C4	C5	C6
b	FILTER	<input type="radio"/>	LOW BOOST	CUTOFF	RESONANCE
	ISOLATOR	<input type="radio"/>	LOW	MID	HIGH

SELECT ROW



4. Press [SELECT ROW] to select the upper row (FILTER).
- Each time this button is pressed, the lit indicator switches between the upper and lower rows alternately.

5. While the demo song is being played back, rotate the effects knobs.

Indicators for effects knobs that are rotated are lit. The following changes can be made.

LOW BOOST

Turning up this knob amplifies the low end, giving the sound a lot of bass (you have no effect when this is turned to "MIN").

CUTOFF

This knob works like an analog synthesizer filter cutoff frequency control (this is preset with "MAX" as the reference point when you purchased the SP-808) (p. 102).

RESONANCE

This allows you to change the tone as you would a synthesizer's filter resonance (with no resonance when set to "MIN") (p. 102).

6. Press [SELECT ROW] and select the lower row (ISOLATOR).

7. Rotate the effects knobs.

The effects knob indicators are lit and the following changes can be made (each knob is referenced at the center).

LOW: Turning down the knob (counterclockwise) reduces the low end of the sound; turning it down all the way completely cuts the low end.

MID: Turning down the knob reduces the midrange of the sound; turning it down all the way completely cuts the midrange.

HIGH: Turning down the knob reduces the high end of the sound; turning it down all the way completely cuts the high end.

(MEMO) When the LOW, MID, and HIGH knobs are all completely turned down, then no sound is output.

(MEMO) You can check the status of changes made with the effects knobs in the Effect Information screen. Press [FX INFO] to call up the screen.

To undo changes made with the effects knobs and return to the original conditions (RECALL):

1. Hold down [SHIFT] and press [SELECT ROW] so that the "b:FILTER ISOLATOR" indicator is lit.
2. Hold down [SHIFT] and press REALTIME EFFECTS [ON/OFF].

The current material is returned to its initial conditions.

When an effect patch has been called up in "a", using "PATCH RECALL" returns the patch to the conditions when it was selected.

This operation works only within the currently selected effects, either "a" or "b."

MEMO There are other parameters within "b" (Master Filter/Isolator) that are not indicated on the panel. To work with these settings, then with "b:FILTER/ISOLATOR" selected in Realtime Effects, call up the Effects Settings screen (hold down [SHIFT] and press [FX INFO]). Since the detailed processes and settings items are based on the "Isolator/Filter" algorithm within the "a" (PATCH) group, please refer to the explanation of that algorithm (p. 101).

MEMO The content of the "b:FILTER/ISOLATOR" settings, including the effect knob settings, reverts to initial conditions the next time the power is turned on. Initial Master Filter/Isolator conditions are stored in the SP-808 as a single separate effect patch (p. 98). If necessary, the initial conditions may be changed with the following procedure.

1. Press [SYSTEM/DISK] to call up the System Edit Menu screen.
2. Press [▲] or [▼] to select "Keep Mst.Fil&Iso?" and press [ENTER/YES].
3. When "ARE YOU SURE?" appears in the display, press [ENTER/YES] again.

The current settings are recorded as initial conditions for the Realtime Effects "b" (Master Filter/Isolator) group.

The next time the unit is turned on, these settings are recalled when Master Filter/Isolator is called up. The Patch Save operation (p. 100) has no effect on the saving of the "b" group.

Controlling the Multi-purpose Effects

You can also use the three effect knobs to adjust parameters when the "a:PATCH" group is selected. As an example, try selecting the internal effect Virtual Tape Echo and adjust the effect knobs.

Controlling Effects Patches with the Effect Knobs

1. Hold down [SHIFT] and press [SELECT ROW] to select "a:PATCH."
2. Apply effects using the Send/Return method (p. 93, 94).
As shipped from the factory, this step is unnecessary when a demo song is called up.
3. Select P84 "05>TapeEch" for the effects patches (Press [FX INFO] and rotate the VALUE/TIME dial to select the patch, then press [ENTER/YES]).
Check to make sure that the indicator in the upper row (C1, C2, C3) is lit.
4. Press [EFFECTS] on each track that only you wish to add effects to be illuminated (if blinking, press REALTIME EFFECTS [ON/OFF]).

5. As the song or sample is being played back, the indicators light and the effects change when you rotate each of the effect knobs.

The following shows the changes that can be made smoothly to the Patch P84 selected in Step 1, just as if you were operating a tape echo machine.

C1: Echo repeat rate
C2: Number of repeats
C3: Echo sound volume

6. Press [SELECT ROW]; the indicator for the lower row (C4, C5, C6) is lit (the indicators for the effect knobs go off).
7. When an effect knob is rotated, its indicator is lit, and the effect is changes. The following changes can be made to Patch P84.

C4: The degree of wow and flutter (rotational irregularity) of the tape used for the echo effects
C5: Echo sound treble control
C6: Echo sound bass control

About the assigning of effects parameters to the knobs (C1-C6)

The effects that are assigned to each of the effect knob can be displayed for confirmation by pressing [FX INFO] to call up the **Effect Information screen** (indicated are the effects parameter assigned in the currently selected row, either the upper row (C1-C3) or lower row (C4-C6)). You can change these effects assignments as you like (p. 99). You can also save sets of altered effect as effects patches (p. 100).

To restore effect settings

Holding down [SHIFT] and pressing REALTIME EFFECTS [ON/OFF] executes "EFFECTS RECALL." As result of this, the effects back to the status which called up the patch t first. The patch recall is effective only within the currently selected group ("a" or "b").

To disable (bypass) the effects

Press REALTIME EFFECTS [ON/OFF], turning off the button light. You can bypass effects this way at any time (regardless of effect position or whether or not Realtime Effects has been used in controlling the effects).

To save more precise setting changes

See p. 98-100 for more on how to change and save regular effects patches settings used in the "a" group (C1-C6).

Using Hand Movements to Change the Sounds (D Beam Controller)

The D Beam Controller in the upper right corner of the panel has a pair of sensors that can detect motion (such as your hand movements) in front of it, and then change the sound based on this. This lets you add a visual dimension to live performances, or other such situations. Check out the D Beam Controller, using demo songs and samples from the included disk.

Varying the Pitch

You can lower the overall playback pitch by changing the position (height) of your hand or an object above the sensor.

Lowering the Pitch

1. While playing back a looped sample (such as that on pad 5 in pad bank 01 on the included disk), press the D Beam Controller's [PITCH].
2. When the button is lit, move your hand slowly over the sensor.
3. When you move your hand closer to the sensor, the pitch drops.
This gives you an effect resembling that of tape speed being slowed down.
4. Pull your hand away from the sensor.
The original pitch is restored.
5. Press [PITCH].
The button light goes out, and the function is turned off.

(NOTE) You cannot raise the pitch with the D Beam Controller. Furthermore, the drop in pitch may be lessened if operated while the Vari-Pitch function (p. 39) is in use. This is due to the predetermined limit in the drop in overall pitch (p. 39), regardless of the Vari-Pitch and Pitch Down.

You can select the extent of the pitch change along three steps with the following procedure.

Changing the Width of the Pitch Down

1. Hold down [SHIFT] and press [PAD TRIG].
"D BEAM SETUP" is called up.
2. Press [▼] or [▲] to select "Pitch Width."
3. Rotate the VALUE/TIME dial to set the pitch change width, selecting from "NARROW," "MEDIUM," and "WIDE."
4. Press [PLAY].
Return to the basic screen.

(NOTE) Depending on the surrounding environment and lighting conditions, the D Beam Controller could go into action unexpectedly, even though you haven't put your hand near it. As a result, the pitch could get changed, then remain at an undesired level. Should this occur, you will need to adjust the beam sensitivity (p. 31).

Playing Designated Samples

You can play the pads' samples just by moving your hand. You can also change the tone by changing your hand position (left and right, up and down).

Using Hand Movements to Play Samples (Differentiating by Hand Position Left and Right)

1. Call up pad bank 01 on the included disk and press a pad to make sure the sound is produced.
2. Press the D Beam Controller [PAD TRIG].
3. When the button is illuminated, move your hand above the left side of the sensor.
The left indicator (CUTOFF/C5) is blinked and the sample on pad 1 is played.
4. Bring your hand to the right side of the sensor.
Now, the right indicator (RESO/C6) is blinked and the sample on pad 2 is played.
5. Remove your hand from the sensor's field.
The sound stops.
6. Press [PAD TRIG].
The button light goes off and the function is turned off.

Two samples from each pad bank can be assigned to the D Beam Controller. While holding down [PAD TRIG], press the two pads in succession to select each of the samples to be used in Steps 3 and 4.

Differentiating the Samples by Height Rather than Lateral Movement

1. Hold down [SHIFT] and press [PAD TRIG].
"D BEAM SETUP" is called up.
2. Press [▼] or [▲] to select "Trigger Type."
3. Rotate the VALUE/TIME dial to change "L ↔ R" to "HEIGHT."
4. Press [PLAY] to return to the basic screens.

(MEMO) Settings changes are automatically saved in the SP-808, even when you remove the disk.

When "HEIGHT" is selected, you can differentiate two samples by height of your hand (interval of your hand and the sensor). For example, if you switch to "HEIGHT" from the factory setting and use the pad bank 01, when you move your hand about 40 to 50 centimeters (16 to 20 inches) above the sensor, the sample on pad 1 is played. Then you bring your hand in closer to the sensor so that the distance between them is about 1/3, the sample on pad 2 is played.

If you press two pads in succession while holding down [PAD TRIG], the sample of the pad pressed first is assigned to be played when your hand is higher, and the other is assigned to lower. You can also select the height at which the two samples are switched (p. 42). You can further set the point (height) at which the sample starts playing (p. 31).

(NOTE) Depending on the surrounding environment and lighting conditions, the D Beam Controller could go into action unexpectedly, even though you haven't put your hand near it. As a result, the pitch could get changed, then remain at an undesired level. Should this occur, you will need to reset the beam sensitivity (p. 31).

Besides lowering the pitch and playing samples, the D Beam Controller can also be used for controlling internal effects (p. 129).

Setting the D Beam Controller Sensitivity

This sets the approximate distance at which the effect begins to be applied.

Setting the D Beam Controller Sensitivity

1. Hold down [SHIFT] and press [PAD TRIG].
"D BEAM SETUP" is called up.
2. Confirm that "Sens L(C5)" is selected.
3. Move your hand above the D Beam Controller to make sure the effect is being added.
4. Slowly draw your hand away from the sensor until you find the point where the effect no longer is added.
5. If the point where the effect stops is too far, rotate the VALUE/TIME dial to lower the "Sens" value; if too close, raise the value.
6. Repeat Steps 4 and 5 until you achieve the exactly the desired sensitivity.
7. Back to step 2 and press [▼] to select "R(C6)".
8. Set the value by same procedure as steps 3 to 6.
9. Press [PLAY] to return to the basic screens.

MEMO Settings changes are automatically saved in the SP-808, even when you remove the disk.

MEMO You can adjust the sensitivity automatically by following the procedure. Hold down [SHIFT] and press D BEAM [EFFECTS] then press [ENTER/YES] **without putting your hand above the sensor.**

Simultaneous Use of the D Beam Function with Multiple SP-808s

When using more than one SP-808, such as during a performance on stage, operating the D Beam Controller of more than one of the machines at the same time can cause the unintended triggering of the controllers due to interference with the beams. To avoid this kind of problem, you will need to set the "Beam ID number" so that **the same number is not used by more than one machine.**

Setting the D Beam Controller ID Number

1. Hold down [SHIFT] and press [PAD TRIG] to call up "D BEAM SETUP" screen.
2. Press [▼] repeatedly to select "Beam ID" parameter.
3. Rotate the VALUE/TIME dial to select a number from 1 to 4.

When using multiple SP-808s simultaneously, be sure to assign each machine a different number.

4. Press [PLAY] to return to the basic screens.

MEMO These changes are automatically saved to the disk, even when the disk is removed, as well as in other situations.

Setting the Time Location (Playback Position)

When recording, playing back, or editing songs, you may need to set the song position at a desired point in the song, like a tape recorder's fast forward and rewind capabilities to go to that point quickly. Depending on your goals and circumstances, there are some ways to do this with the SP-808.

The song position indicated at the very top of the display is divided into three parts: "MEAS" (measure), "BEAT," and "TICK". The tick is the smallest timing unit use in songs; on the SP-808 **one tick is 1/96 of a beat.** You can set the song position with reference to the indications.

Using the VALUE/TIME Dial

Although used mostly for adjusting parameter settings, this dial is also used in changing the song position (time location) in the Play List screen (p. 22) and in screens in which no values or settings are changed. Ordinarily, rotating the dial changes the position in beat units (BEAT), or in ticks (TICK) when rotated while [SHIFT] is held down.

MEMO Use [◀◀] or [▶▶] to make changes in measure units (see next item).

Using [◀◀] and [▶▶]

The SP-808's [◀◀] and [▶▶] are buttons for moving forward and back through the song a measure at a time. Press [▶▶] to jump to the next measure and [◀◀] to jump to the previous measure. This is especially convenient when working with Play List Quick Edit (p. 82). They are useful for a variety of tasks, such as pasting or deleting phrases that begin and end at measure bar lines and afterwards changing the composition.

By holding down the [◀◀] or [▶▶] buttons, you can continuously jump through the measures. This resembles a tape recorder's fast forward and rewind functions but without any sound produced during use.

Furthermore, by pressing [◀◀] or [▶▶] while holding down [SHIFT] in the Play List screen (p. 22), you can jump sequentially from the top and end of one phrase to the next or previous one on the selected track.

Changing the Measure and Beat Display to Hours, Minutes and Seconds

Rather than using the MEASURE/BEAT/TICK format, you can also have the indication of the current song position displayed in HOUR/MINUTE/SECOND/FRAME format instead (when shipped from the factory, one frame is set as 1/30 of a second).

Display the Song Position in Hours, Minutes and Seconds

1. Press [SYSTEM/DISK] once.
"System Edit Menu" appears in the display.
2. Check to make sure that "Set System Param?" is selected, then press [ENTER/YES].
3. Press [▼] to select "TimeDisp." (Time Display).
4. Rotate the VALUE/TIME dial to select "TIME CODE."
5. Press [PLAY] to return to the basic screens.

MEMO Settings changes are automatically saved in the SP-808, even when you remove the disk.

MEMO Usually, the HOUR/MINUTE/SECOND/FRACTION display is a sub-display appearing at the top of the Big Time screen (one of the basic screens called up when [PLAY] is pressed). When switching the format so that HOUR/MINUTE/SECOND/FRACTION are used as the basic units, then the sub-display in the Big Time screen is switched as well, indicating the song position in MEASURE/BEAT/TICK format.

Jumping to a Set Location (Locator)

You can use Locator below the display screen to register up to eight song positions (time locations) to the four buttons. When you press a button with a song position registered to it (the button is lit), you instantly jump to that position. This is convenient for marking boundaries in the composition of a song.

Registering Song Positions (Time Locations) to the Locator Buttons

1. Either by pressing [◀◀] or [▶▶] or by rotating the VALUE/TIME dial, move to the song position you want to register.
2. Press any button LOCATOR [1]–[4] (when registering to [5]–[8], hold down [SHIFT] while pressing one of the [1]–[4] buttons).
The button is illuminated and that song position is registered to the button.
3. Press an illuminated button in another position.
You jump to the position registered to that button.

MEMO You can register positions even during playback of songs.

MEMO You can jump to other positions during playback, it takes a little while after the jump for playback to begin.

Deleting Registered Positions

1. While holding down [CLEAR], press the button of the Locator you wish to delete.
The button's light goes off and the registration is deleted.

MEMO Use the following procedure to delete registration of buttons [5]–[8].

For example, when deleting the registration to [6], first, while continuing to press [CLEAR], then hold down [SHIFT] and press [2] (6).

Changing the Locator's Position

Making Fine Adjustments to the Registered Location

1. Press [SONG/TRACK].
2. Press [▲] or [▼] to select "Locator?".
3. Press [ENTER/YES].
The positions registered to the buttons [1]–[8] are indicated in MEASURE/BEAT/TICK format.
4. Press [▲], [▼], [→], or [←] to select the value for the fine adjustment.
5. Rotate the VALUE/TIME dial to change the value.
6. Press [PLAY] to return to the basic screens.

MEMO As Locator information constitutes one portion of the song data, the changes you make are saved along with the rest of the song when you save (p. 72) the song.

Fitting Precisely to the Beginning of the Sound (Preview)

When jumping to the beginning of songs, editing, registering Locators, and so on during recording or playback, it may be necessary to make finer adjustments to the current song position (time location). The Preview function lets you precisely adjust the position while you check how it sounds.

MEMO The Preview function normally indicates **song position**. However, while setting sample starts or loop points and length (p. 51), the function switches to indicate the **editing point** for that sample. Furthermore, for the latter, by holding down [SHIFT] while rotating the VALUE/TIME dial, you can adjust the position of the point in roughly 100 extremely fine increments.

Setting the Song Position with Scrutinizing the Sound Before and After ([TO] [FROM])

The left PREVIEW [TO] refers to its function of setting playback the "To Now Time" (to the current song position). Each time this button is pressed, only a very short segment of the song leading up to the current position is played. By rotating the VALUE/TIME dial to move the current song position forward or back while listening closely to the playback, you can finely adjust the current position with ease. Pressing the button while [SHIFT] is held down changes this function to "From Now Time," with a very short segment of the song played back starting from the current position.

Adjusting the Current Position (Time Location) with the Preview Function

1. Press [STATUS] for the track whose sound you want to adjust until it changes to PLAY (indicator is green).
2. Each time PREVIEW [TO] is pressed, a segment starting one second before the current position and ending at the current position is played back.
3. Pressing the same button while holding down [SHIFT] changes the function to [FROM], whereby a very short segment of the song is played back starting from the current position to one second after the current position.
4. While listening to the sounds, rotate the VALUE/TIME dial to finely adjust the current position.

HINT Pressing [TO] is a convenient way to find the beginning of a section with sound present; [FROM] for finding the point where sound breaks off.

Setting the Song Position Like as Scrubbing a Tape (Scrub Preview)

With open-reel analog tape decks, the starting point of a desired segment can be found by listening carefully, and slowly rotating the reels by hand. This is known as **scrub**. With the SP-808's Preview function active, you can find the start of a sound in the same way as you would with scrub by using the following procedure.

Scrub-Type Preview

1. Press [SCRUB].

The screen changes, now showing the changes in level over time (waveform graph), before and after the current time location. The segment from 0.045 seconds before the current time location, to the current location is played back repeatedly.

2. Press [STATUS] for the track you want to listen.

3. Referring to the sound and the screen, rotate the VALUE/TIME dial with [SHIFT] held down to progress through the segment starting with no sound and leading to point where you want the sound to start.

4. When the current song position meets the point where the beginning of the sound is just faintly audible, press [SCRUB] again.

Scrub Preview is canceled.

5. If necessary, reconfirm the current position the usual way with the PREVIEW [TO] or [FROM].

MEMO Only the one track specified in Step 2 can be played back during Scrub.

MEMO When you want to align the **point where the sound stops** instead of where it starts, hold down [SHIFT] while pressing [TO] in Step 3 to switch the from TO to FROM. This way, you can get an extremely short (From Now Time function) Scrub ending 0.045 seconds after the current song position. While still in Scrub, you can switch between "To Now" and "From Now" modes by pressing [TO] or [TO] + [SHIFT] (= FROM) respectively.

Setting the Playback Time in Preview and Scrub Preview

At the time your SP-808 was shipped from the factory, Preview playback time was set to one second. In addition, the length of the repeated playback in Scrub was set to 45 milliseconds (0.045 seconds). You can change these times as needed.

1. Press [SYSTEM/DISK] and check to make sure "Set System Param?" is selected.
2. Press [ENTER/YES].
3. Press [▲] or [▼] to select "PreviewLength."
4. Rotate the VALUE/TIME dial to set the value (1.0–10.0 seconds).
5. Press [▼] to select "Scrub Length."

6. Rotate the VALUE/TIME dial to set the value (25–100 milliseconds).
7. Press [PLAY] to return to the basic screens.

MEMO Settings changes are automatically saved in the SP-808, even when you remove the disk.

Restoring the Settings to Factory Condition

NOTE The demo songs and samples on the disk that is included with the SP-808 are protected (in song/pad bank units) from being erased or deleted. Once you turn the protection off (p. 72, 138) and then edit or make changes to them, they cannot be restored to their original state, so exercise due caution when using these procedures.

Restoring the Overall System Parameters to Their Original Status

1. Press [SYSTEM/DISK].
"System Edit Menu" appears in the display.
2. Press [▼] to select "Init SystemParam?"
3. Press [ENTER/YES].
"ARE YOU SURE?" appears in the display.
4. Press [ENTER/YES] again.
All parameters related to the overall system are restored to what they were originally, when shipped from the factory.
5. Press [PLAY] to return to the basic screens.
Items set when you press [SYSTEM/DISK] and select "Set System Param?" are not stored on the disk, but in the memory on SP-808 itself, and are retained even while the power is turned off. These save processes are carried out automatically at such times as when the disk is ejected.

Returning the User Effects Patches to the Factory Settings (Same as Preset Patches)

The User effects patches are written to the disk.

When a disk is formatted (p. 24), the contents of the Preset patches are copied to the User patches on the disk just as is done at the factory. However, all songs and samples on the disk are lost.

There is no function that restores the contents of the User patches to factory conditions (i.e. the same as the Preset patches) without losing the songs and samples on the disk. If really necessary, use the effect Save function to save each Preset patch to the User area one at a time.

Chapter 2 Playing Samples on the Pads

What are the 64 Pad Banks?

Each group of samples assigned to the panel's 16 pads is a **Pad Bank**. There are 64 pad banks in all, meaning that a maximum of 1,024 samples (64 pad banks of 16 samples each) can exist on one disk. Each pad bank can be given a name (p. 138).

Basic Method for Playing Samples

Samples are played by pressing the pads to which they are recorded (the pads are lit red). In addition, you can play samples by pressing a pedal switch (model DP-2: sold separately) connected to the FOOT SWITCH jack (p. 139). In this case, one of the 16 samples in each pad bank can be selected as the one to be played with the foot switch (p. 140). Furthermore, with the D Beam Controller, you can play samples using the movement of your hand in the air (p. 30).

(NOTE) *Regarding the number of sounds that can be played simultaneously, depending on the track status of the song, illumination of pads may be turned off, and the sound being played may stop (for more detailed information, please see the next item "Track-Related information").*

The Number of Samples That Can Be Played Simultaneously (Track-Related Information)

Combining the sounds from playback of tracks being as well as pads, a maximum of **four stereo sounds** can be played at the same time. As opposed to other ordinary samplers, with the SP-808 there are no worries about assigning two voices to the same pad when sampling in stereo. Since every channel in the track section as well as the mixer section is set up in stereo, allowing you to fully exploit the possibilities of stereo sampling.

(NOTE) *The maximum number of simultaneous sounds does not increase with monaural sampling (although this uses only half the memory consumed in stereo sampling).*

(MEMO) *If more than four pads are pressed at the same time, the most recently pressed pad take precedence in sounding, and the sample on the pad pressed earlier stop playing. However, samples held with the hold function (p. 37) continue to play. Additionally, samples that have been assigned as loops (p. 36) are given priority over non-looped samples.*

Track-Related Information

In playing back tracks, one track consumes one stereo voice. Furthermore, playback of tracks takes precedence over sounds from the pads. Thus, if [STATUS] on all four Tracks A-D are set to "PLAY" (lit green) during playback of a song the samples on the pads cannot be played.

When layering pad samples while playing back tracks, at least one track's [STATUS] must be set to "MUTE". In other words, the number of muted tracks equals the number of stereo sounds that can be played with the pads.

(NOTE) *When the **Track Voice Reserve** function (p. 137) is turned on, the number of pads that can be sounded simultaneously is limited by the number of channels whose STATUS is set to "MUTE" (accordingly, in this case, when not even one track is set to "MUTE," no sounds can be made with the pads).*

Can Samples from Different Pad Banks Be Played Together?

When you switch pad banks, the samples in the pad bank being switched out of stop playing. However, samples that are held using the Hold function (p. 37) continue to play until the hold is cancelled. You can also layer the sounds by continuing to press a pad while playing a sample from another pad bank.

However, you cannot play more than the limit of four stereo sounds simultaneously.

You can play the 16 samples assigned to the pads using MIDI Note messages from an external device (p. 151). However, samples from different pad banks basically cannot be played together as same reason as the pad playing.

Changing the Way Samples Are Played and Stopped with the Pads (Pad Play)

Basic operation of the pads can be selected from the three ways of "Pad Play" parameter shown below.

GATE: Press pad → Start playing sound.
Release pad → Stop playing sound.

TRIGGER: Press pad → Start playing sound.
Release pad → Keep on playing.
Press pad again → Stop playing.

DRUM: Press pad → Start playing sound (Stop automatically when the sample reached to the end point (p. 51)).

Setting the Pad Response

1. Press the pad with the sample to be set.
2. Press [SAMPLE/BANK].
3. Check to make sure that "Set System Param?" is selected.
4. Press [ENTER/YES] and check to make sure the cursor is in the row containing "PadPlay."
5. Rotate the VALUE/TIME dial to select "GATE," "TRIGGER," or "DRUM."
6. Press [PLAY] to return to the basic screens.

MEMO Settings changes are automatically saved in the SP-808, even when you remove the disk.

MEMO When continuously setting different samples from within the same pad bank, after Step 5, press the pads, and then carry out Step 5 again. When setting samples in other pad banks, switch the pad banks after Step 6.

Setting the pads to "DRUM" disable the loop expression setting (see next item), and the samples can be played only once each time the pad is pressed. This setting is useful when playing phrases using MIDI drum pads or similar devices. Furthermore, when "DRUM" is selected samples cannot be interrupted once they start, so you have to be careful for the settings when playing extremely long samples.

Loop Expression (Loop Mode)

A continuous replaying of a sample from the start point to the end point (or replaying of a segment within the sample) is referred as a **loop**. The SP-808 uses loops to replay phrases and create basic rhythms.

In each sample, one of the following three modes related to looped phrases can be selected.

OFF: Not looped

START-END: Looped (from the start point to the end point)

LOOP-END: Looped (from the loop point to the end point)

Ordinarily, loops running from the start point to the end point are turned on and off by selecting "START-END" or "OFF" (for more on the meaning of each "point" and the procedure for changing the points, → see p. 51). Use the following procedure to switch the mode.

Setting the Loop Mode

1. Press the pad of the sample to be set.
2. Press [SAMPLE/BANK].
3. Check to make sure that "Set System Param?" is selected.
4. Press [ENTER/YES].
5. Press [▼] to select "LoopMode."
6. Rotate the VALUE/TIME dial to select "OFF," "START-END," or "LOOP-END."
7. Press [PLAY] to return to the basic screens.

MEMO Settings changes are automatically saved in the SP-808, even when you remove the disk.

MEMO When continuously setting different samples from within the same pad bank, press the pads after Step 6, and then carry out Step 6 again. When setting samples in other pad banks, switch the pad banks after Step 6.

MEMO The screen in Step 5 may also be called up by pressing [TRIM] of the QUICK EDIT (SAMPLE) then pressing [▲] once.

Stop Playing a Sample When Another Pad is Pressed (MUTE GROUP)

Set the samples which you do not want to play simultaneously each other to the same mute group. The SP-808 features seven mute groups, with all samples in the same **mute group** being prevented from sounding. In the case of any overlap, then regardless of the possible number of expressed sounds remaining, the sample that would be played first is muted.

Setting Sample Mute Groups

1. Press the pad of the sample to be set.
2. Press [SAMPLE/BANK].
3. Check to make sure that "Set System Param?" is selected.
4. Press [ENTER/YES].
5. Press [▼] to select "MuteGroup."
6. Rotate the VALUE/TIME dial to select from "OFF," "GROUP-1," ..., or "GROUP-7."
7. Press [PLAY] to return to the basic screens.

MEMO Settings changes are automatically saved in the SP-808, even when you remove the disk.

MEMO When continuously setting different samples from within the same pad bank, press the pads after Step 6, and then carry out Step 6 again. When setting samples in other pad banks, switch the pad banks after Step 6.

MEMO The screen in Step 5 may also be called up by pressing [LEVEL] in the QUICK EDIT (SAMPLE) then pressing [▼] once.

Application of Mute Groups

By assigning to the same mute group samples that do not play because of their overlap, you can reduce the number of voices used and thus suppress the interruption of other samples being played.

Furthermore, when switching samples while using Trigger mode to play multiple looped samples, you may feel it is complicated that process of pressing a pad to start with simultaneously pressing another to stop. In such instances, by assigning these samples to the same mute groups, you can have the first sample stop playing just by pressing one of the next pad, making this very convenient.

Having the Sound Continue Even After Releasing the Pad (Hold Function)

You may want to have samples that have been set to "GATE" in the Pad Play settings (p. 36) continue to play even after you release the pads. In such instances, it can be convenient to use the Hold function.

How to Use Hold

1. Play a looped sample that has been set to "GATE."
2. Press [HOLD] before releasing the pad.

[HOLD] is illuminated, and the sample is held. Even after releasing [HOLD] or the pad, the sound of the sample continues to play.

3. Press [HOLD] once more.

[HOLD] light goes off, and with the hold lifted, the sound then stops.

Adding Other Samples to the Current Holding Samples

While in Hold in Step 2 above (where the sample continues to play even after you release the pad)...

3. Press another pad to play an additional sample; while pressing the pad, also press [HOLD].

The two samples are held, and the sound of the sample continues to play even after releasing [HOLD] or the pad.

4. Press [HOLD] once more.

[HOLD] light goes off, and with the hold lifted, the sound then stops.

HINT The Hold function can also be used in a similar effect with samples that have been set to "TRIGGER" in the Pad Play settings (p. 36).

Setting the Overall Volume and Stereo Balance of the Pads

You can set the volume level and left-right balance of the stereo output for whole samples when you press the pads, just as is done with each of the Tracks A–D and the MIC/LINE input channel.

By pressing [▲] or [▼] to select “Pads Level” in Step 3, you can then also adjust the volume level by rotating the VALUE/TIME dial.

(NOTE) While the PAD indicator is lit, the pad volume cannot be changed with the VALUE/TIME dial in the Mixer View screen (p. 22), and the screens in Steps 1 and 2 (the volume can only be adjusted with the fader).

Adjusting the Overall Volume Level of Samples

Depending on the settings, the MIC/LINE fader serves the two following purposes.

- 1: For adjusting the volume level of the input signal from MIC IN or LINE IN (PAD indicator is lit) (p. 75)
- 2: For adjusting the volume level of sample pads those are pressed (the indicator “PAD” is lit)

When shipped from the factory, this is set to 2: Pad Volume Setting. Thus, by moving the faders up or down you can adjust the pad volume when you press the pads.

(MEMO) When in “1:” (with the indicator “PAD” is not lit), you can adjust the pad volume in the same screen as the stereo balance setting (see next item).

Adjusting the Overall Stereo Balance of the Samples

1. Hold down [SHIFT] and press the MIC/LINE channel's [EFFECTS].
The MIC/LINE (Pad) Channel Settings screen appears in the display.
2. Press [▼] repeatedly until the third screen (Pad-Related Settings) appears in the display (fig.).
3. Press [▲] or [▼] to select “Balance.”
4. Rotate the VALUE/TIME dial to adjust the left-right balance.
5. Press [PLAY] to return to the basic screens.

(MEMO) These settings changes are saved to the disk when the song is saved (p. 72).

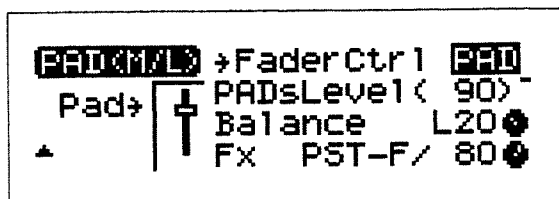

With stereo samples, changing the “Balance” changes the left-right volume balance. With monaural samples, this works like a panpot control.

Adjusting the Pitch Like Tape Speed Controlling (Vari-Pitch)

If you want to achieve the same effect as that of adjusting tape speed on a multitrack tape recorder, use the **Vari-Pitch** function. Vari-Pitch works simultaneously with pad sample sounds and sounds on the tracks. Just as with tape, you can sample (audio record) sounds with the holding pitch up or down.

The available range of pitch adjustment depends on the sample rate (p. 24). When the sample rate is set to 44.1 kHz, the pitch can only be adjusted downward.

At 44.1 kHz:	18.1%–100%
At 32 kHz:	25.0%–100.0%–137.8%

MEMO 100.0% indicates the pitch is the same as when Vari-Pitch is turned off. Setting the Vari-Pitch to 50% halves the “playback speed,” and lowers the pitch by one octave.

Turning Vari-Pitch On and Off

1. Press [VARI PITCH].

The button is illuminated, and the Vari-Pitch function is turned on.

2. Press [VARI PITCH] again.

The button light goes off, and the pitch is back to the original.

Changing the Range of Adjustment in Vari-Pitch

1. Hold down [SHIFT] and press [VARI PITCH].

“BPM TUNE” screen appears in the display.

2. Press [▼] once to highlight the value displayed in “VARI PITCH ***.0%.”

3. Rotate the VALUE/TIME dial to change the pitch.

By repeatedly pressing [VARI PITCH], you can toggle between the original pitch and altered pitch to compare them as you make the setting.

4. Press [PLAY] to return to the basic screens.

MEMO These settings changes are saved to the disk when the song is saved (p. 72).

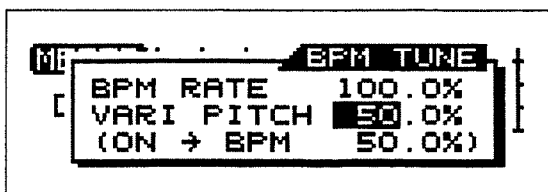

MEMO You cannot use Vari-Pitch to change the pitch in only one part of the system (e.g. only songs, pads, specified tracks, etc.). Furthermore, as with tapes and records, when the pitch is lowered, the sound takes longer to play than it does at the original pitch. When you want to process only a specific sample, or if you want to change the length and the sound of a sample separately, use the Stretch function (p. 52) or Change Pitch function (p. 53) to the samples.

MEMO Sampling (or audio recording) with the pitch lowered tends to make output the high-end sounds more difficult. Additionally, sampling or (or audio recording) with the pitch raised reduces the available recording time. Turn Vari-Pitch off whenever it is not needed.

NOTE If you go below the certain pitch (about under 50% when the sample rate is 44.1 kHz), some noises are introduced into the playback sound; this is not a malfunction.

NOTE When using Vari-Pitch, some of the numerical values in the internal effects settings (such as indicated Delay and Reverb times or indicated frequencies of equalizers) may not correspond to the actual behavior. When Vari-Pitch is on, use these values as relative estimates.

MEMO When using Vari-Pitch during playback of songs, the tempo (length of each measure) is also shortened or lengthened accordingly. However, even if the playback tempo is adjusted, the Vari-Pitch does not make any corresponding change.

Adding Effects to Samples

When you press a pad to play a sample, you can add the internal effects to the sound.

First turn on the internal effects, then add the effect to the sample using either the send/return or the insert method (for descriptions of what send/return and insert mean, → see p. 93, 97).

Turning the Internal Effects On

1. Press **REALTIME EFFECTS [ON/OFF]** to turn on the effects, the button is lit.
2. If the indicator for the **REALTIME EFFECTS "b" (FILTER/SOLATOR)** is lit, hold down **[SHIFT]** and press **[SELECT ROW]** to switch to "a" (PATCH)

MEMO For more detailed informations of regarding Realtime Effects, refer to the next item).

Adding Effects to Samples (Send/Return Method)

After carrying out Steps 1 and 2 to enable the effects:

3. Hold down **[SHIFT]** and press **[MUTE]** to call up "MIX COMMON" screen.
4. Press **[▼]** twice and select "FxLoc." (Effects Location).
5. Rotate the **VALUE/TIME** dial to select "SEND/RETURN." The effects are set in the Send/Return position.
6. Confirm that the indicator "PAD" is lit (if it is not lit, see "**MEMO**" section described below).
7. Press **[EFFECTS]** right above the **MIC/LINE** fader, the button is lit.
8. Press **[FX INFO]**.
9. Rotate the **VALUE/TIME** dial to select the effect patch, and press **[ENTER/YES]** to fix the selection.
10. Hold down **[SHIFT]** and press the **MIC/LINE (pad) channel's [EFFECTS]**.
11. Press **[▼]** repeatedly until the third screen (Pad-Related Settings) appears in the display.
12. Press **[▲]** or **[▼]** to highlight the "Fx" (effect level settings) value.
13. Rotate the **VALUE/TIME** dial to raise the value and press to pad to make sure the effect is being applied to the sample.

MEMO If the PAD indicator is not lit in Step 6: Hold down **[SHIFT]** and press the **MIC/LINE (pad) channel's [EFFECTS]**, and press **[▼]** repeatedly until the third screen (Pad-Related Settings) appears in the display, then select "FaderCtrl." Rotate the **VALUE/TIME** dial to change this setting from "INP" to "PAD," and when the **PAD** indicator is lit, go on to Step 7.

Also this switching can execute by Pressing **[SCRUB]** while **[SHIFT]** is held down.

Adding Effects to Samples (Insert Method)

After carrying out Steps 1 and 2 to enable the effects:

3. Hold down **[SHIFT]** and press **[MUTE]** to call up "MIX COMMON" screen.
4. Press **[▼]** twice and select "FxLoc." (Effects Location).
5. Rotate the **VALUE/TIME** dial to select "INS MASTER." The effects are set to the insertion for the MASTER OUT.
6. Press **[FX INFO]**.
7. Rotate the **VALUE/TIME** dial to select the effect patch, and press **[ENTER/YES]** to fix the selection.
8. Press to pad to make sure the effect is being applied to the sample.

MEMO When "INS MASTER" is selected in Step 5, the effects are inserted into the overall output from MASTER OUT. When you press **[EFFECTS]** for any specific channel in the mixer section (for example, the **MIC/LINE IN** channel), all of other **[EFFECTS]** are illuminated simultaneously.

NOTE SP-808 has no "Pad Channel Insertion" function for the effects. When you press a pad to play a sample during playback of a song (tracks), you cannot use insertion effects (distortion, for example) for the sample pads only. However if you need then you can get the same kind of effect with the following procedure.

After carrying out Steps 1 and 2 to enable the effects:

3. Hold down **[SHIFT]** and press **[MUTE]** to call up "MIX COMMON" screen.
4. Press **[▼]** twice and select "FxLoc." (Effects Location).
5. Rotate the **VALUE/TIME** dial to select "SEND/RETURN." The effects are set to the Send/Return position.
6. Hold down **[SHIFT]** and press the **MIC/LINE (pad) channel's [EFFECTS]**, then press **[▼]** repeatedly until you get to the third screen (Pad-Related Settings).
7. If "FaderCtrl" is set to "PAD," first rotate the **VALUE/TIME** dial to change this to "INP."
8. Under this condition, press the **[EFFECTS]** on each of channels and turn all lights off.
9. Rotate the **VALUE/TIME** dial to change the "FaderCtrl" setting to "PAD" (if the **MIC/LINE (pad) channel's [EFFECTS]** is not lit at this point, press the button to turn the light on.)

10. Press [▼] or [←] and rotate the VALUE/TIME dial to select "PRE-F" (Pre-Fader) for the "Fx" setting.

11. Completely turn down the MIC/LINE (pad) fader to cut the direct sound, and rotate the VALUE/TIME dial to increase or decrease the "Fx" level setting that appears on the screen, adjusting the volume level for all of the pads.

(The normal setting for this is 100.)

Another technique is perform resampling while applying the effects then play that.

MEMO When adding effects to a sample, just as when adding effects to songs, you can change the effect with the Realtime Effects knobs (p. 128). You can also control effects with the D Beam Controller (p. 129) or Step Modulator (p. 131).

Using the D Beam Controller to Play Samples

With the D Beam Controller, you can play specified samples only move your hand in the air (p. 30). If under the condition that samples can be played, you can trigger the specified samples in each pad bank by pressing the D Beam Controller [PAD TRIG] and moving your hand above the sensor. At this time, the beam can be used to sound up to two samples. Which of the two samples is to be played can be determined as follows.

- The height (distance from the sensor)—high or low—at which you move your hand
- The sensor's field—left or right—in which you move your hand (p. 30)

Both functions can be switched in the D Beam Controller's Setup screen.

(Select by holding down [SHIFT] and pressing [PAD TRIG] then pressing [▲] or [▼] to get to "Trigger Type" and then rotating the VALUE/TIME dial to select "HEIGHT" or "L ↔ R".)

MEMO In either case, playing and stopping of the samples, or whether the samples are looped or not conform to the settings in Pad Play (p. 36) and Loop (p. 36).

Selecting the Pads to Be Played in Each Bank

When using height to determine which of the two samples is to be played, the sound played when moving your hand closer (low) to the D Beam Controller's sensor is called the lower sample, and the sound played when moving your hand farther away (high) from the D Beam Controller's sensor is called the upper sample.

Procedure for Determining Samples to be Played

While holding down [PAD TRIG], press two pads in succession. The pad pressed first is selected as the upper sample, and the other one pressed afterwards is selected as the lower sample.

MEMO This setting also can confirm and change in "BeamAsgn Upper(L)/Lower(R)" screen. (mentioned below)

1. Press [SAMPLE/BANK].
2. Select "Set Bank Param?" by [▼] or [▲].
3. Press [ENTER/YES] then press [▼] three times.

MEMO When distinguishing the two samples by moving your hand in the sensor's left or right fields, rather than by height, the samples are selected as the same way as above (with the sample of the pad pressed first assigned to the D Beam's left field). The selection of samples in each pad bank is saved to the disk when the disk is ejected.

Adjusting the Hand Positions for Switching Samples

You can adjust the distance from the sensor dividing the upper and the lower zones when using height to determine which of the two samples is to be played.

MEMO The height that triggers the upper sample is obedient to Sensitivity setting (p. 31).

Determining the Distance at Which the Sounds Switch

1. Press [PAD TRIG] to make the D Beam Controller play the samples.
2. Hold down [SHIFT] and press [PAD TRIG]; "D BEAM SETUP" screen is called up.
3. Press [▲] or [▼] to select "Upper/Lower."
4. Rotate the VALUE/TIME dial to set the height which the sample is switched from upper to lower in the whole playable area by percentage.
5. Press [PLAY] to return to the basic screens.

MEMO Settings changes are automatically saved in the SP-808, even when you remove the disk.

NOTE The "Upper/Lower" setting mentioned above is disabled when using the left and right fields to separate the samples to be played.

Checking the Pad Samples Without Sending Them to the MASTER OUT (Pad Cue Function)

When performing live, there will be times when you want to check the sounds on each pad without having the sounds sent to the MASTER OUT. In such instances, use the Pad Cue function. By pressing a pad while holding down [SHIFT], the sample's sound is not sent to the MASTER OUT, but is sent only to the headphones and the AUX (CUE/D) OUT.

Turning the Pad Cue Function On

1. Hold down [SHIFT] and press [MUTE] to call up "MIX COMMON" screen.
2. Press [▼] repeatedly to switch to "AUX In&Out" (third screen).
3. Press [▼] to select "OutJackMode" and rotate the VALUE/TIME dial to switch to "PAD CUE."
4. Press [PLAY] to return to the basic screens.
5. When you hold down [SHIFT] and press one of the pads, you can then hear the sound through the headphones (the sound is not sent to the MASTER OUT).

Pad Cue can also be used while tracks or other samples are being played back, as long as the number of sounds expressed simultaneously is within the range (four stereo sounds).

MEMO When you put Pad Cue in effect, the output of the AUX OUT is heard through the headphones.

Chapter 3 Sampling Sounds

Now try sampling some of your favorite sounds to the pads. The following example describes how the line input of a sound on a CD is sampled.

NOTE Audio recording (sampling) of other's copyrighted works, other than in special cases such as for your own personal enjoyment, without consent of the copyright holder is prohibited by law.

Do not make illicit recordings. Roland Corporation assumes no liability for any damages or claims, including legal judgements and monetary damages claimed by copyright holders, resulting from the use of this Roland product for unlawful recording.

NOTE The original data that was on the supplied disk cannot be restored once you alter its content by the sampling or other performance. We recommend that you first make a duplicate disk, using the procedure described on p. 148.

Checking Your Connections

Connect the LINE OUT or AUX OUT of your CD player or other device to the SP-808's LINE IN (L/R) using a commercially available cable (stereo RCA phono). Turn on the CD player and have a CD that can be sampled ready for playback.

The Sampling Procedure

Switch the pad bank (p. 26). The latter of pad banks on the demo disk, named "Blank," contain no samples. Select one of these, and try sampling a sound to it.

Before beginning the procedure, turn off the indicator "PAD" right above the MIC/LINE fader. (While pressing [SHIFT] press [SCRUB], you can turn it off easily.) After that, position the fader at the red thick marker (0 dB).

Sampling the Input Signal.

1. Press [PLAY] to call up "LEVEL MATER" (CH side) screen.
2. Playback the CD and turn up the LINE IN knob to the appropriate signal level.
The sounds can be heard from the head phones or the amplifier.
3. Operate the CD player to play the part you want to sample.
4. Adjust "IN" meter with LINE IN knob so that the meter moves at as high level as possible without exceeding the limit shown as dotted line. (Adjust the MONITOR volume with Master fader.)
5. Stop playing back the CD once. Press [SAMPLING] to show "SAMPLING" screen.

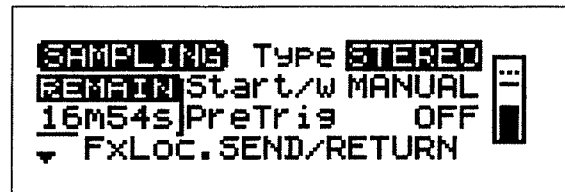

Adjust the meter with MIC/LINE fader so that the meter moves at as high level as possible without exceeding the limit shown as dotted line.

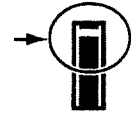

6. If necessary, press another pad to change the sampling destination.
7. Playback the CD again and press [SAMPLING] (START/STOP) to be timed match with the sound.
"Now Sampling..." appears in the display. Indicating that sampling has begun.
8. Press [SAMPLING] (START/STOP) again. Sampling is stopped and "Finished check result. OK? (Yes/No)" appears in the display.
9. Stop playing back the CD. Press any pad to play a resulting sample. If you are satisfied with the result, press [ENTER/YES]. (Return to step 5.)
10. If you wish to do it over again, press [EXIT/NO] at step 8.
"Try Again" appears in the display for approximately one second. The sampling operation is voided. Return to step 5.
11. Press [PLAY] to return to the basic screen.

MEMO If there are already samples in all pads at Step 5, "Select PAD." appears in the display. Press the pad and specify the sampling destination in Step 6. If necessary, press [PAD BANK] to change the bank as well (p. 26).

NOTE When there is a sample already recorded to the pad specified in Step 6, "Overwrite?" appears in the display. This is a confirmation message if it is acceptable to erase the existing sample. If the sample can be erased, press [ENTER/YES]. If you want to keep the sample, select another unoccupied pad and proceed to Step 7.

MEMO To cancel the procedure while in progress, press [PLAY].

About Saving Data

Sampling waveform data is written to the disk during sampling as needed. Furthermore, settings related to each individual sample saved internally once, and automatically saved to the disk as the situation calls, such as when pad banks are changed or when the disk is removed (no particular save procedure, such as those for songs and effects patches, is necessary).

Setting Stereo and Mono

Determine whether sampling will be done in stereo or monaurally before you begin.

Sampling Stereo and Monaural Settings

1. Press [SAMPLING] to call up "SAMPLING" screen.
2. Check to see that "Type" is selected, and rotate the VALUE/TIME dial to set either "STEREO" or "MONO."
3. Continue the procedure described in "Sampling" above, starting from Step 6.

Monaural sampling allows you to keep memory consumption on the disk to half of that used in stereo sampling (although the maximum polyphony does not change).

Sampling After Making Loop and Play Settings

You can also determine whether or not a sample loops (p. 36) before the sampling is done. You can set how the pad works (playing the sample only while being pressed, playing the sample when pressed and stopping when pressed again, etc.) the same way (p. 36).

Sampling After Making Loop and Play Settings

1. Press [SAMPLING] to call up "SAMPLING" screen.
2. Press [▼] repeatedly until you get to the second screen.
3. Press [▼] or [▲] to get to the "Loop" value.
4. Rotate the VALUE/TIME dial to select one of the following settings.

Loop Settings Values (see p. 36 for more detailed information)

- OFF: Loop is not played
- ON (S-E): Loop is played from the start point to the end point
- ON (L-E): Looped is played from the loop point to the end point

5. Press [▲] to go to the "Pad Play" value.
6. Rotate the VALUE/TIME dial to make the setting.
Pad Play Settings Values (see p. 36 for more detailed information)

GATE: Sound is played only when the pad is pressed.

TRIG: Pressing the pad starts the sound, and pressing it again stops the sound.

DRUM: When the pad is pressed, the sound plays once and stop at the end point.

7. Continue the procedure described in "Sampling" above, starting from Step 6.

Automatically Beginning Sampling with Sound Input

When shipped from the factory, the SP-808 is set for manual sampling so that sampling begins when [SAMPLING] is pressed. By changing the settings, you can begin sampling automatically upon detecting sound input.

Beginning Sampling Upon Detection of Sound Input

1. As described in Steps 1–6 of "Sampling" on p. 43, set levels and otherwise prepare the SP-808 for sampling.
2. Press [▲] or [▼] to go to the "Start/w (Start with...)" value.
3. Rotate the VALUE/TIME dial to change from "MANUAL" to "LEV.1–LEV.8."
The numeral at the end refers to the setting of the signal level at which sampling is begun (1 being the minimum level).
4. Ready the sampling source sound for immediate play (for example, press pause on the CD player at the spot to be played).
5. Press [SAMPLING] (START/STOP).
"Waiting Signal" appears in the display, indicating sampling standby mode.
6. When the sound is input, it is detected; "Now sampling" appears in the display, and sampling begins.
7. When you press [SAMPLING] (START/STOP) again, sampling stops.
8. Operate as described in "Sampling" on p. 43, starting from Step 8.

What the "Start/w (Start with...)" setting means

MANUAL: Sampling is begun manually (this is the setting is made at the factory)

LEV.1–LEV.8: Sampling begins according to the sound input. The numeral at the end (1–8) means the signal level at which sampling is begun (1 is the minimum level).

In addition, selecting "PAD" or "SONG" puts the sampler in standby mode, just like pressing [SAMPLING] (START) in Step 5. With "PAD" sampling begins at the same time as you press the pad of your choice, and with "SONG" sampling starts with playback of a song. (The sounds from the pads and songs can also be sampled → see p. 49.)

Preventing the Start of the Sound from Being Missed (Pre-Trigger)

Depending on the conditions at the sampling, the start of the sample sound may be cut off. If required, by setting the **Pre-Trigger time** sampling is begun slightly ahead of the sampling operation or input of sound, which eliminates this problem.

Setting the Pre-Trigger

1. Press [SAMPLING] to call up "SAMPLING" screen.
2. Press [▼] to get to the "PreTrig" value.
3. Rotate the VALUE/TIME dial to select from "OFF", "20", "40", "80", "160" or "320" (in milliseconds).

Automatic Setting of the Start (and End) Point When Sampling is Finished (Auto Trim)

When the top or the end of a new sample contain no sound space, the start point and end point (p. 51) can be automatically set so that the silent space is eliminated. Activate this function (Auto Trim) before sampling if you need.

Activating Auto Trim

1. Press [SAMPLING] to call up "SAMPLING" screen.
2. Press [▼] repeatedly until you get to the second screen.
3. Press [▲] or [▼] to get to the "Auto Trim" value.
4. Rotate the VALUE/TIME dial to set "ON."
5. Continue the sampling procedure described in "Sampling" on p. 43 start from Step 5.

When Auto Trim is on, after sampling the segment from the start point to the end point is automatically set to the area contains signal.

(NOTE) The silent portions processed with Auto Trim are at the top and the end of the sampled wave only.

Technical Note

The signal level that this function uses to determine the presence or absence of sound is fixed, and the setting cannot be changed. If required, try using the manual Trim function (p. 51).

3

Separating the Sample at the Silent Portions and Assigning the Sections to Multiple Pads After Sampling (Auto Divide)

If the sample contains one or more long stretches of silence, you can divide the samples from the silent parts into two or more and assign to multiple pads. Activate this function (Auto Divide) before sampling.

Activating Auto Divide

1. Press [SAMPLING] to call up "SAMPLING" screen.
2. Press [▼] repeatedly until you get to the second screen.
3. Press [▲] or [▼] to get to the "Auto Divide" value.
4. Rotate the VALUE/TIME dial to select from "0.5", "1.0", "1.5" or "2.0" (in seconds).
5. Continue the sampling procedure described in "Sampling" on p. 43 start from Step 2.

When Auto Divide is set (except set to OFF), after sampling the portions contains no recorded waveforms are detected and the sample sounds are divided from these place into two or more then assigned to multiple pads. The value selected in Step 4 (0.5, 1.0, 1.5, or 2.0) specifies the length of time (in seconds) silent portions must last to be acted upon. For example, if "1" is selected, phrases lasting approximately one seconds or more are marked as boundaries, with the resulting sections divided there.

The resulting group of finished samples is sent beginning to end to the pads specified by the sampling destination, and housed in **empty pads in the same pad bank** in numerical order. If all 16 pads are occupied, the message "PADs are Full.Use Next Bank?" appears in the display. If you press [ENTER/YES], then the samples are assigned in sequence to the open pads in the next pad bank. If you press [EXIT/NO], the remaining samples are entered in pad 16 without being divided.

Technical Note

The signal level that this function uses to determine the presence or absence of sound is fixed, and the setting cannot be changed.

If “Disk Full.” Appears in the Display

If the process is interrupted during sampling, and “Disk Full. OK?” appears in the display, it means that **the disk’s memory is used up**. If you press [ENTER/YES], you then exit from the Sampling screen (however, the sounds recorded up to that point is kept on the disk). In such instances, execute the Cleanup Disk function. This deletes wasted space being consumed on the disk and secures new memory.

(NOTE) You cannot undo the Cleanup Disk function.

Executing the “STANDARD” type function limits the changes in Sample Trim (p. 51) made afterwards.

Increasing the Remaining Memory with Cleanup Disk

1. Press [SYSTEM/DISK] to call up the menu.
2. Press [▲] or [▼] to select “Cleanup Disk” and press [ENTER/YES].
3. Rotate the VALUE/TIME dial to switch the “Type” setting (“QUICK” or “STANDARD”—details as follow)
4. Press [ENTER/YES].
5. The confirmation message “ARE YOU SURE?” appears in the display; press [ENTER/YES].

The new memory is added.

Type Settings in Step 3

“QUICK”

- Among the data on the disk, only **entire waveforms which are not used in any samples or on any tracks** are deleted.
- Although this method secures less memory when compared to the STANDARD method, the process is finished in less time.
- The functions that can be executed such as Sample Trim (p. 51), do not change after the process.

“STANDARD”

- As much as possible, data including partial waveforms used in samples and on tracks, except for those portions actually sounded (used), is deleted.
- Although this method maximizes the recovery of memory, the process takes more time.
- Editing to be the start points earlier and the end points later (p. 51) becomes impossible.
- Waveform data in each phrase on the tracks from the beginning of the waveforms to where they start playing, as well as data after points specified by “Wave End Point” (p. 87) are erased.
- When multiple locations in a waveform are used in different samples or tracks, the portions of the waveforms that lie between those are not deleted.

If there is no increase in the remaining memory even after Cleanup Disk is executed, first delete unneeded data (for songs → see p. 73; for pad banks → see p. 56; for samples → see p. 55) then try Cleanup Disk again.

A rough figure of the time remaining is indicated as “Remain **m**s” in the Sampling screen (monaural sampling time is twice that of stereo). Check this display as sampling progresses, and if the remaining memory is running out perform the Cleanup Disk procedure.

(NOTE) If you have a number of different songs overfilling a disk, then you may not be able to proceed with operations, with the last song left unfinished. **When creating new songs, start with Zip disks that have plenty of available memory.**

Using the Equalizer (EQ)

Normally, sampled external input sound passes through the mixer section's MIC/LINE channel. The MIC/LINE channel features a 3-band parametric equalizer which can be used to freely adjust the levels of each of the high-, mid-, and low-frequency ranges.

This equalizer is not limited to use for sampling, but can be applied anytime to any input sound through the MIC/LINE channel.

(NOTE) *The equalizer does not work with the sample sounds which played when the pads are pressed.*

Applying the Equalizer to Sound Input

1. Hold down [SHIFT] and press the [EFFECTS] button above the MIC/LINE fader, calling up "MIC/LINE" screen.
2. Press [▼] repeatedly until you get to the second screen (EQ).
3. Press [▲] or [→] to select "EQ" and set it to "ON."
4. Press [▲], [▼], [←] or [→] to select each item (shown below) on the page while confirming the changes of the sound input, and make the setting by rotating the VALUE/TIME dial.
5. Press [PLAY] to return to the basic screens.

This is a list describes the different settings for Step 4.

Hi (500 Hz–16 kHz):

Frequency point for the high range. Mostly the levels in the range over this frequency are changed.

Hi (+12–-12 dB):

Increases or decreases the high range volume.

Mid (200 Hz–8.0 kHz):

Frequency point for the midrange. Levels in the range centered on this frequency are changed.

Mid (+12–-12 dB):

Increases or decreases the midrange volume.

Mid-Q (0.5–8.0):

Changes the width of midrange. The higher value makes midrange narrower.

Low (40 Hz–1.5 kHz):

Frequency point for the low range. Mostly the levels in the range under this frequency are changed.

Low (+12–-12 dB):

Increases and decreases the low range volume.

If You Don't Understand the Equalizer Settings Well

The tone can be adjusted with the each of gain values (Hi, Mid, Low) the same way treble, mid, and bass control knobs on a guitar amp, car stereo or other device are used to adjust the tone. (Leave the other settings as the were set when the SP-808 was shipped.)

3

Technical Note

These channel equalizers are 3-band parametric type (which allows you to change the frequency point). Shelving type equalizers (which boost or cut the sound over or under the specified frequency) are use for the high and low ranges, a peaking type (which boosts or cuts in a peaking form the frequency range about the specified center frequency) is used for the midrange.

Additionally, when Vari-Pitch (p. 39) is in use, some of the numerical values such as the frequency display of equalizers may not correspond to the actual values. When Vari-Pitch is on, use these values as relative estimates.

(NOTE) *If sound is being input while the channel equalizers are being adjusted, some clicking noise may arise. When connecting extremely fragile external devices, take care not to allow them to become damaged by excessive input.*

Sampling While Adding Effects

With the SP-808's internal effects, you can perform sampling while adding any of the internal effects to the input sound.

Preparations for Sampling While Adding Internal Effects by the Send/Return Method

1. Turn on the effects (press REALTIME EFFECTS [ON/OFF], illuminating the button).
2. If the indicator for the REALTIME EFFECTS "b" (FILTER/SOLATOR) is lit, hold down [SHIFT] and press [SELECT ROW] to switch to "a" (PATCH).
3. Turn off the MIC/LINE fader's "PAD" indicator, if it lit (hold down [SHIFT] and press the Preview [SCRUB] button).
4. Put the effects in the Send/Return position. (Hold down [SHIFT] and press [MUTE], press [▼] twice to select "FxLoc." and rotate the VALUE/TIME dial to switch to "SEND/RETURN.")
5. Press the MIC/LINE channel [EFFECTS] button and the button lights orange.
6. Decide on the effect patch. (Press "FX INFO" and rotate the VALUE/TIME dial to select the effect patch then press [ENTER/YES].)
7. Call up the MIC/LINE channel settings screen (hold down [SHIFT] and press the MIC/LINE channel [EFFECTS] button).
8. Determine the effect level (press [▼] and [▶] to move to the "Fx" value, then rotate the VALUE/TIME dial to set the level).
9. Call up "MIX COMMON" screen's effect-related page (hold down [SHIFT] and press [MUTE], then press [▼] repeatedly until you get to the second screen).
10. Mix the signals returned from effect to the sampling source (press [▲] or [▼] to go to the "Return" value and rotate the VALUE/TIME dial to select "REC (orPlay)."

This completes the preparations. When you press [SAMPLING], calling up the Sampling screen and sample the input sound using the usual process (p. 43), the effects that you hear are also sampled. However, sample only with the MIC/LINE channel [EFFECTS] button illuminated orange.

MEMO Location of the effects (FxLoc.) is also able to change in the Sampling screen.

MEMO To cancel the operation, press [PLAY].

Preparations for Sampling While Adding Insertion Effects

1. Turn on the effects (press REALTIME EFFECTS [ON/OFF], the button is lit).
2. If the indicator for the REALTIME EFFECTS "b" (FILTER/SOLATOR) is lit, hold down [SHIFT] and press [SELECT ROW] to switch to "a" (PATCH).
3. Put the effects in the Insert position. (Hold down [SHIFT] and press [MUTE] then press [▼] twice to select "FxLoc.", and rotate the VALUE/TIME dial to switch to "INS RECORD.")
4. Decide on the effect patch. (Press "FX INFO" and rotate the VALUE/TIME dial to select the effect patch then press [ENTER/YES].)

This completes the preparations. In the screen called up after you press [SAMPLING] (START/STOP), check to make sure the effect is being applied. (When "INS RECORD" is selected, the condition of the effect cannot be checked unless the Sampling screen is active.) When the input sound is sampled using the usual process (p. 43), the sound with the added effects is sampled.

MEMO You can also change the effect position (Step 3 above) using "FxLoc." in the Sampling screen (p. 43). The effect position selected in the Sampling screen remains even after you exit the Sampling screen.

Resampling the SP-808's Output

Phrases on Tracks A–D and samples sounded when the pads are pressed can be sampled again. This is referred to as **resampling**.

In resampling, you can add effects and even create new samples by sampling changes; by the Realtime Effects knobs, the D Beam Controller, and the Step Modulator (p. 131), together.

NOTE When adding effects by the send/return method, if the effect sound is not being sampled, check to see if it is set to be sampled in "MIX COMMON" screen. Hold down [SHIFT] and press [MUTE], and press [▼] repeatedly to go to the second screen (FX-Signal). If "Return" is set to "PLAY_ONLY," then press [▲] or [▼] to move the cursor and rotate the VALUE/TIME dial to switch to "REC (orPlay)."

Additionally, switch the inserted effects from the MASTER OUT (INS MASTER) to the recording signals (INS RECORD) (p. 48). You can also change the effect position in "FxLoc." in the sampling screen (p. 43).

Sampling Song (Track) Phrases to Pads

Sampling Song (Track) Phrases

1. Press [SAMPLING] (START/STOP) to call up "SAMPLING" screen.
All tracks are put in MUTE status (unlit).
2. Press [STATUS].
The status of the tracks to be sampled in order change to BOUNCE (bounce source/lit orange = track to be recorded).
3. Press [▶] (PLAYBACK) and the selected track is played.
4. Adjust the levels with each of the track faders. When using multiple source tracks, balance their sounds as well.
5. Just as with a CD, play back the point you want to sample.
6. Press [SAMPLING] (START/STOP) to sample the sounds to the pads (p. 43).

MEMO Immediately after Step 1, if you select the symbol "▶" for the "Start/w" setting in the screen, pressing [SAMPLING] (START) puts sampling in standby. If you play back the song at this point, sampling automatically begins at the same time.

MEMO In Step 2, if [STATUS] is pressed again, the button lights green. Tracks in this status can be monitored when played back, but they are not sampled.

NOTE Ordinarily, up to four stereo sounds, including all the phrases on tracks and pad samples, can be played simultaneously. However, **during sampling (audio recording), a maximum of only three stereo sounds can be played at the same time.** Thus, in Step 2 above, the buttons for all four tracks cannot be lit orange (or green) and selected for recording (or monitoring).

When external sounds are being input, they are sampled along with the sounds from tracks that are played back. When not needed, turn the LINE and MIC input sensitivity knobs all the way down.

Furthermore, if after start playing a sample and tap another pad, that pad's sound is also sampled. However, playing multiple pads or adding effects can be cause of distortion in the sample. In such instances, redo sampling after turn down the level of the pad bank slightly by LINE/MIC fader while the Indicator "PAD" is lit.

Resampling Pad Samples to Other Pads

Resampling Pad Samples

1. Check to see that the PAD indicator above the LINE/MIC fader is lit (if not, hold down [SHIFT] and press [SCRUB] to switch to on).
2. Press [SAMPLING] to call up "SAMPLING" screen.
3. Select "PAD" for the "Start/w" setting on the screen.
4. Press the source pad to play the sound, and adjust the level with the fader while checking the meter at the right of the screen.
5. Press the pad to designate the sampling destination.
6. Press [SAMPLING] (START) to put sampling in standby mode.
7. Press the source pad; sampling begins automatically.
8. Press [SAMPLING] (STOP) to stop sampling.

MEMO If resampling while adding insertion effects, set "FxLoc." in the Sampling screen to INS RECORD.

NOTE When resampling, a maximum of three sounds can be played simultaneously. Each time you add one of the track sounds ([STATUS] are illuminated orange or green), the number of pads that can be played is reduced by one.

Chapter 4 Processing Samples

You can process and edit the 1,024 samples (16 pads x 64 pad banks) on a disk in a variety of ways, such as by adjusting the volume and pitch.

(NOTE) Phrases arranged on tracks at the recording (p. 63, 68) by the pad operation will independ from the source samples. The phrases on the tracks (songs) are not affected in any way by the processing of samples introduced in this chapter. When you want to process the sounds in a song, work on a sample taken from one of the pads, and then replace that on the track. If the original sample has been deleted, copy the phrase to pad via [CLIPBOARD] (p. 55) or resample the track phrase to a pad (p. 49) then process that.

(MEMO) There are two types of processing/editing samples; one is create a new sample on other pad, other one is change only setting on the same pad.

Setting Sample Volume (Sample Level)

You can set and save the volume level per sample individually, which sounds when the pad is pressed. This allows adjustment of the volume balance among the different samples.

Setting the Volume of Each Sample

1. Press the Quick Edit SAMPLE [LEVEL] button.
2. Rotate the VALUE/TIME dial to set the "Level."
3. Press [PLAY] to return to the basic screens.

These changes are automatically saved to the disk, even when the disk is removed, as well as in other situations (no save procedure is necessary).

(MEMO) The screen shown in Step 2 is called up after pressing [SAMPLE/BANK], but pressing [LEVEL] calls it up instantly.

(MEMO) The volume can be set to any value from 0 to 100. This setting is also directly reflected to the volume level of phrases (p. 60) on the tracks which are event-recorded by pressing the pads.

Displaying Sample Tempo Correctly (Specifying the Number of Beats)

The sample tempo is indicated in BPM (Beats Per Minute) on the upper right of the Sample Editing/Processing screens, which are called up from "Set Sample Param?" item in the menu of [SAMPLE/BANK]. However, in order to have this indicated properly, it is necessary to make your SP-808 recognizes the **type and number of notes** of the sample. This setting is made as follows.

(MEMO) This is initially set to $\text{♩} \times 4$ (four quarter notes) for each sample.

Entering Sample Note Length (to Display the Tempo)

1. Press the pad of the sample you want to change.
2. Press [SAMPLE/BANK] and check to make sure "Set Sample Param?" is selected.
3. Press [ENTER/YES], then press [▲] or [▼] to go to "BPM BaseNote."
4. Rotate the VALUE/TIME dial to select the note type.
5. Press [▼] to go to "x__".
6. Set the number of notes for the sample by rotating the VALUE/TIME dial.
7. Press [PLAY] to return to the basic screens.

These changes are automatically saved to the disk, even when the disk is removed, as well as in other situations (no save procedure is necessary).

(MEMO) The tempo displayed (in BPM) is normally figured as one beat equalling a quarter note. (For example, an eighth note works out to be a half of a beat, a half note is twice of one beat, and these are then indicated.)

Changing the Points Where the Sounds Start and Stop

You can set the beginning and end of the interval of a sample when the pad is pressed, and then save this setting. Additionally, you can also specify a loop's playback range. These are determined by the start, loop points and length to end (next item).

For each point, 0 indicates the start point with the position of the final point expressed by a number of up to seven digits. (The position of the end point set indirectly as the Length value, that is, the length from the start or loop point to the end point.)

What are Start and Loop Points, and Length?

Start Point

This is the point at which playback begins. Set this so that the unused blank space at the beginning of a sample is bypassed and so the sample comes in with good timing.

Loop Point

This is the point at which playback of the loop (second time and later) begins. Set this when you want the loop to begin at a point other than the start point.

Length (→END)

This determines the playback length between the start or loop point and the end point (the position where playback finishes). Set this so that no unnecessary sounds appear at the end of the sample. When playing loops, this also determines the length of one cycle of the loop.

If the loop point value is set higher than that of the start point when the loop is played, the loop point is read after the start point. Conversely, when the value is set lower than the start point's, the loop point is read before the start point.

Setting Each Point

1. Press the Quick Edit **SAMPLE** [TRIM] button, calling up the screen containing "StartPoint," "LoopPoint," and "Length(→END)."
2. Press the pad for the sample you want to change.
3. Press [▼] or [▲] to select the settings item.
4. While pressing the pad to play the sample to be changed, rotate the VALUE/TIME dial to make the setting.

The value can have a maximum of seven digits; you can press [←] or [→] to select the digit you want to change, and then raise or lower that number. The length value is also increased or decreased when the start point or loop point is moved. (Start/Loop points are able to be changed without changing length by rotating the dial while pressing [■].)

5. Press [PLAY] to return to the basic screens.

These changes are automatically saved to the disk, even when the disk is removed, as well as in other situations (no save procedure is necessary).

MEMO By holding down [SHIFT] while rotating the VALUE/TIME dial in Step 4, you can set each value in exact doubles or halves (doubled, doubled again, etc.—or 1/2, 1/4, etc.).

MEMO Whether the sample is looped or not is set with Loop mode (p. 36). (This setting item is in the same screen that appears in Step 1. After pressing [TRIM], just press [▲] to call it up.)

MEMO The screen shown in Step 1 is called up after pressing [SAMPLE/BANK]; however, pressing [TRIM] calls it up instantly.

MEMO To repeat the interval from the start point to the end point, select "START-END" in Loop mode.

START-END

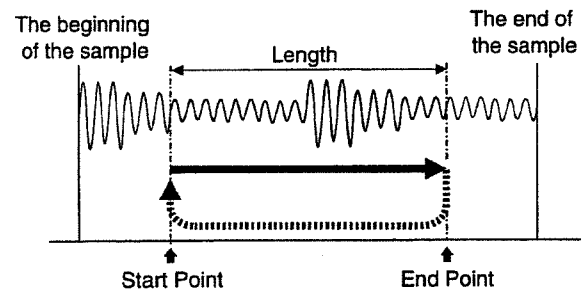

MEMO To repeat the interval from the loop point to the end point, select "LOOP-END" in Loop mode. (When "OFF" or "START-END" is selected the loop point is not indicated, and it cannot be set.) At this time, the point at which "Length(→End)" starts is changed from the start point to the loop point.

LOOP-END

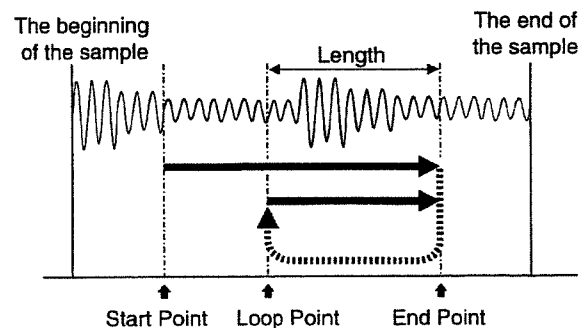

MEMO While changing the end point or loop point, in order to effectively edit even extremely long samples, the beginning of the sounds can be automatically switched to play **not from the start point, but from just before the end point**.

Processing Samples

MEMO When the cursor is at "StartPoint" "LoopPoint" or "Length(→End)" (the cursor must be at one of these), you can **use the Preview functions (Including Scrub) at each of these points**. For more on the basic operation of the Preview functions, please refer to p. 33.

MEMO If you press [ENTER/YES] while the value of "StartPoint" is selected (high lighted), the wave form on the disk currently used as a sample, sounds from the beginning. While listening this sound press [ENTER/YES] again, that time location is set as a start point automatically. When the "Length(→End)" or "LoopPoint" is selected, you can set the end or loop point with the same procedure as above.

MEMO In Step 4, by selecting and setting the next item down "New BPM" you can **specify the amount of expansion or compression in terms of the tempo that is to be used afterwards**. ("Ratio" and "New BPM" are always changed simultaneously.)

MEMO While the New BPM value being selected, holding down [SHIFT] and tap [HOLD] repeatedly with your favorite rate, that pressed rate is set automatically as a tempo.

MEMO If there is another sample already occupying the destination pad, the message "Overwrite?" appears in the display. If deleting the existing sample is acceptable, then press [ENTER/YES].

MEMO Although the Stretch screen is ordinarily called up by pressing [SAMPLE/BANK] then selecting "Stretch Time?" and pressing [ENTER/YES], the procedure used in Step 1 allows you to call up this screen instantly.

Expanding and Compressing Samples and Changing the Length and Tempo (Time Stretch)

You can use the Stretch function of sample playback time to match the length or tempo with between phrase samples.

NOTE The stretching process may take more time to carry out than other functions. Furthermore, the sound quality of samples undergoing this processing may suffer somewhat when compared to the original samples. In addition, with this function, in order to correctly calculate the tempo and achieve high-quality results from the stretching process, it is necessary first to "Displaying Sample Tempo Correctly (p. 50)", and based on that **specify the number of beats in the source sample**.

Specifying the Amount of Expansion or Compression as a Percentage or in Terms of Tempo

1. Hold down [SHIFT] and press the Quick Edit SAMPLE [TRIM] button to call up "TIME STRETCH" screen.
2. Check to select "Source" (source sample), and either press the pad or rotate the VALUE/TIME dial to select the pad that is to be expanded or compressed.
3. Press [▲] or [▼] to select "To" (destination pad), and either press the pad or rotate the VALUE/TIME dial to select the pad which the processed sample is to be written.
4. Press [▲] or [▼] to select "Ratio," and rotate the VALUE/TIME dial to specify the amount of expansion or compression within the range from 50.0% to 150.0% (with 100.0% corresponding to the original length).
5. Press [ENTER/YES].
After a while, the processed sample is assigned to the designated destination pad.
6. Press [PLAY] to return to the basic screens.
These changes are automatically saved to the disk, even when the disk is removed, as well as in other situations (no save procedure is necessary).

Matching the Length or Tempo with Another Sample's One

With the Stretch function, you can match a sample playback time length with the other sample's one. In such instances, you can also have the reference sample's length be halved or doubled. Furthermore, you can be up or down a tempo to match with the other sample's one.

Expanding or Compressing the Length of One Sample to Match That of Another

1. Hold down [SHIFT] and press the Quick Edit SAMPLE [TRIM] button to call up the "TIME STRETCH" screen.
2. Check to select "Source" (source sample), and either press the pad or rotate the VALUE/TIME dial to select the pad that is to be expanded or compressed.
3. Press [▼] to select "To" (destination pad), and either press the pad or rotate the VALUE/TIME dial to select the pad which the processed sample is to be written.
4. Press [▼] to select "Type," and rotate the VALUE/TIME dial to go to "LENGTH."
5. Press [▲] or [▼] to select "Match/w" and specify the sample whose length is to act as reference by pressing its pad, or by rotating the VALUE/TIME dial.
6. Press [▼] to select "x1" and rotate the VALUE/TIME dial to select the proportion of reference sample length to be used. (If you want the length to be the same as that of the reference sample, select "x1"; if you want the length to be half that of the reference sample, select "x1/2"; to double the length, select "x2.")
7. Press [ENTER/YES].

After a while, the processed sample is assigned to the designated destination pad.

8. Press [PLAY] to return to the basic screens.

These changes are automatically saved to the disk, even when the disk is removed, as well as in other situations (no save procedure is necessary).

MEMO The length of new sample becomes as same as the "Length(→End)" setting of the source sample (p. 51).

NOTE By the setting at step 5 and 6, if the stretch range exceed the top/bottom limits, "Can't Execute. (Out of 50.0%–150.0%)" message is appeared and you can't execute the procedure.

MEMO If [TEMPO] is selected in Step 4, the expansion ratio is set so that the tempo matches that of the sample set in Step 5. However, to correctly calculate the tempo, then as described on p. 50, first it is necessary to specify the number of beats for both the source sample and the reference sample to which its is being matched. The setting in Step 6 is unnecessary.

Furthermore, due to the limitations in precision when calculating the tempos, there may be a slight difference in the tempo of the resulting sample.

Changing a Sample's Pitch

Use the Change Pitch function to change the pitch of one sample, and then save the changed sample as a new sample. This function differs from the Vari-Pitch function (p. 39) in that it can change the pitch of individual samples and change only the pitch, without causing any change in the playback time. Use each of these functions according to your particular needs.

NOTE Change Pitch takes more time than other kinds of sample processing. In addition, the sound quality of samples undergoing this processing may suffer somewhat when compared to original samples.

Creating a New Sample by Changing a Sample's Pitch

1. Hold down [SHIFT] and press the Quick Edit SAMPLE [LEVEL] button to call up "CHANGE PITCH" screen.
2. Check to select "Source" (source sample), and either press the pad or rotate the VALUE/TIME dial to select the pad that the pitch to be changed.
3. Press [▼] to select "To" (destination pad), and either press the pad or rotate the VALUE/TIME dial to select the pad which the processed sample is to be written.
4. Press [▼] to select "Grade," and rotate the VALUE/TIME dial to select the quality of the sound after the pitch changing process, adjustable in five levels (details next page).
5. Press [▲] or [▼] to select "NewPitch," and rotate the VALUE/TIME dial to set the interval of the pitch changing by semitone unit.
6. Press [▲] or [▼] to select "P.Fine," and rotate the VALUE/TIME dial to set the fine pitch adjustment, in cents (hundredths of a semitone).
7. Press [ENTER/YES].

After a while, the processed sample is assigned to the designated destination pad.

8. Press [PLAY] to return to the basic screens.

These changes are automatically saved to the disk, even when the disk is removed, as well as in other situations (no save procedure is necessary).

MEMO In Step 6, "Grade" refers to the five levels of sound quality that can be selected for the resulting sample. In general, the higher value less the sound suffers. However, disturbances in the rhythm may occur in some phrases. Try changing the setting, and select the most appropriate one.

NOTE If there is another sample already occupying the destination pad, the message "Overwrite?" appears in the display. If deleting the existing sample is acceptable, then press [ENTER/YES].

MEMO Although the Change Pitch screen is ordinarily called up by pressing [SAMPLE/BANK], then selecting "Change Pitch?" and pressing [ENTER/YES], the procedure used in Step 1 allows you to call up this screen instantly.

Storing a Sample Out of the Pads Temporarily (Clipboard)

You may think it convenient to store the sample out of the pad bank temporarily, when you process or edit samples over different pad banks or when you want to rearrange samples in a pad bank. In such instances, use the clipboard function. The clipboard can hold one sample at a time.

NOTE *Any samples in the clipboard are lost when the power is turned off. Do not leave any sample you need in the clipboard; make sure to return the sample to a pad and remove the disk before turning off the power.*

Moving Samples to Other Pads

By transferring samples from the pads to [CLIPBOARD], and from [CLIPBOARD] to other pads, you can quickly move samples from one pad to another.

Placing Samples in the Clipboard

1. While pressing the pad (which lights) which you want to move the sample, press [CLIPBOARD].

The pad is cleared (unlit), and [CLIPBOARD] is illuminated.

2. When you press [CLIPBOARD], the sample which temporarily stored outside the pad is played.

If [CLIPBOARD] is lit (already contains a sample), the message "Overwrite OK?" appears in the display. If it is all right to delete the existing sample, then press [ENTER/YES]. If not, press [EXIT/NO] to cancel the procedure.

NOTE *The sample stored in the clipboard is played in Step 2 is for confirming the sample. Samples played by pressing [CLIPBOARD] are slightly delayed compared to when they are played on the pads.*

MEMO *When [SHIFT] is held down during these procedures, above you can copy the sample (p. 56) instead of move it.*

Returning Samples from the Clipboard to the Pads

1. While pressing [CLIPBOARD], press the destination pad.

[CLIPBOARD] is cleared (unlit), and the destination pad is illuminated.

2. Press the pad to play the sample in order to confirm that it was moved.

In Step 1, if the destination pad already contains sample (if it is illuminated), the message "Overwrite OK?" appears in the display. If it is all right to delete the existing sample, then press [ENTER/YES]. If not, press [EXIT/NO] to cancel the procedure.

Copying Part of a Song to a Pad

Using the **Mark Phrase** function (p. 83), you can copy the phrases in the specified songs (tracks) to the pads via clipboard.

Copying Marked Track Phrases to Pads

1. Following the procedure described on p. 83, mark the phrase on the track.

Mark **only one** phrase. If you set more than one mark, you will not be able to copy the phrase to pads.

2. While pressing the illuminated [MARK ON], press [CLIPBOARD].

The [MARK ON] light goes off, and [CLIPBOARD] is illuminated.

3. Press [CLIPBOARD] to confirm that the phrase played as the same sound as the source phrase.

4. While pressing [CLIPBOARD], press the copy-destination pad.

The phrase is copied from the clipboard to the pad.

(NOTE) In Step 2, if [CLIPBOARD] already contains a sample (if it is illuminated), the message "Overwrite OK?" appears in the display. If it is all right to delete the existing sample, then press [ENTER/YES]. If not, press [EXIT/NO] to cancel the procedure.

(NOTE) Phrases whose ranges are specified with the Region In/Out function (p. 82) cannot be copied to the clipboard using this procedure.

Deleting Samples (Delete Sample)

By deleting unneeded samples, you can open up more pads for use. There are a number of ways to delete samples.

(NOTE) Even when a sample is deleted, there is no resulting increase in available recording time. To increase this remaining time, perform the Cleanup Disk procedure (p. 46) after deleting the sample.

Deleting with "Delete Sample"

1. Press EDIT [SAMPLE/BANK].
2. Press [▲] or [▼] to select "DELETE?" and press [ENTER/YES].
The sample to be deleted (the pad number) appears in the display.
3. Press a pad or rotate the VALUE/TIME dial to select the sample to be deleted.
4. Press [ENTER/YES].
The sample is deleted.
5. Press [PLAY] to return to the basic screens.

(MEMO) Repeat Steps 3 and 4 when deleting multiple samples.

Using the Clipboard

You can use the clipboard function (p. 54) when deleting samples. (If a sample you need is in [CLIPBOARD] first move that sample to an appropriate pad.)

An Example of Quickly Deleting Samples in Pads 1, 3, and 4

1. While pressing pad [1], press [CLIPBOARD] ([CLIPBOARD] is illuminated. The pad [1] light goes off.)
2. While pressing pad [3], press [CLIPBOARD]. Press [ENTER/YES] as it blinks (the pad [3] light goes off).
3. While pressing pad [4], press [CLIPBOARD]. Press [ENTER/YES] as it blinks (the pad [4] light goes off).

(MEMO) Only the last sample deleted (from pad [4]) remains in [CLIPBOARD].

Deleting All the Samples in a Pad Bank At Once

Deleting with Erase Bank

1. Press **EDIT [SAMPLE/BANK]** to call up the menu.
2. Press **[▲]** or **[▼]** to select “Erase Bank?” and press **[ENTER/YES]**.
The name and number of the pad bank to be deleted appears in the display.
3. Rotate the **VALUE/TIME** dial to select the pad bank to be deleted.
4. Press **[ENTER/YES]**.
The confirmation message “ARE YOU SURE?” appears in the display.
5. Press **[ENTER/YES]** again.
All samples on the specified pad bank are deleted.
6. Press **[PLAY]** to return to the basic screens.

MEMO Repeat Steps 3–5 when deleting multiple pad banks.

Creating Duplicates of Samples (Copy Sample)

You can duplicate a sample to another pad. This is a convenient way to play the sample when arrange the same sound to several pads then specify the different reading regions or change the way to sound “GATE” or “TRIGGER” (Pad Play:p. 36). There are two ways to copy the samples to other pads; one is “pad to pad” function by using clipboard, and other one is copy the samples in a whole pad bank at once.

MEMO When copies are made using Copy Sample, the waveforms in the original sample are employed to the greatest extent possible. As a result, large amounts of remaining sampling time are not used up when copying samples.

Using the Clipboard

You can also use the clipboard function (p. 54) to copy samples to other pads. If you carry out the procedure for moving a sample from one pad to another **while pressing [SHIFT]**, you can copy the sample without deleting the original.

Using the Clipboard to Copy Samples

1. With **[SHIFT]** held down, press **[CLIPBOARD]** while pressing the pad (lit) containing the sample you want to copy.
[CLIPBOARD] is illuminated. This time, the source pad is not cleared (it stays lit).
2. While pressing **[CLIPBOARD]**, press the copy-destination pad.
[CLIPBOARD] is cleared (the light goes off), and the copy-destination pad is illuminated.
3. Press the pad to play the sample, so you know that the same sample has been copied.

In Steps 1 and 2, if either [CLIPBOARD] or the destination pad already contains a sample (if it is illuminated), the message “Overwrite OK?” appears in the display. If it is all right to delete the existing sample, then press **[ENTER/YES]**. If not, press **[EXIT/NO]** to cancel the procedure.

MEMO If **[SHIFT]** is held down while the sample is returned from [CLIPBOARD] to the pads in Steps 2 and 3, the sample remains in [CLIPBOARD].

Copying All of Samples in a Banks to Other Banks

Duplicating with the Copy Bank Function

1. Press **EDIT** [**SAMPLE/BANK**].
2. Press [**▲**] or [**▼**] to select "Copy Bank?" and press **[ENTER/YES]**.

The names and numbers of "Source" (the copy-source bank), and "To" (the copy-destination bank) appear in the display.

3. While pressing [**▲**] or [**▼**] to select the two items above, press the pads or rotate the **VALUE/TIME** dial to specify each of the pad banks.
4. Press **[ENTER/YES]**.

The samples are copied.

5. Press **[PLAY]** to return to the basic screens.
- The results are automatically saved to the disk, even when the disk is removed, as well as in other situations (no save procedure is necessary).

MEMO Repeat Steps 3 and 4 when copying multiple pad banks.

NOTE If the copy-destination pad bank already contains even one sample, the message "Overwrite OK?" appears in the display. If it is all right to delete any existing samples, then press **[ENTER/YES]**. If not, press **[EXIT/NO]** to cancel the procedure.

Distributing a Sample Among Multiple Pads (Divide Sample)

After sampling long phrases, you may want to divide the sample into two parts, and assign the latter part of the sample to another pad as a new sample. This is called the Divide Sample function. This is convenient when, after sampling for a long stretch, you then want to cut off a shorter portion and assign it to another pad. The division point becomes the original sample's end point decided by the "LENGTH(→END)" setting (p. 51).

MEMO The divided sample on the pads copy the source sample on them and are set their new start points. (Only the sounds are divided, not the internal waveform.)

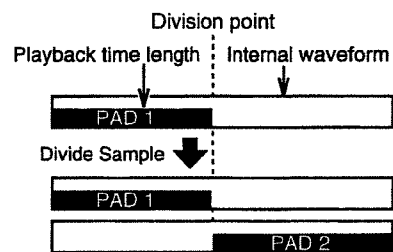

Specifying a Division Point and Dividing a Sample in Two

1. Set the original sample's end point at the location you want to separate the sample (p. 51).
 2. Press **EDIT** [**SAMPLE/BANK**].
 3. Press [**▼**] to select "Divide?" and press **[ENTER/YES]**.
 4. Rotate the **VALUE/TIME** dial to select "END POINT" for the "Type" setting.
 5. Select the pad and pad bank numbers of "Source" (the source sample) and "To" (the destination for the divided samples) by pressing [**▲**], [**▼**], [**←**], or [**→**] then set the items (press the pads or rotate the **VALUE/TIME** dial).
 6. Press **[ENTER/YES]**.
- The sample are divided.
7. Press **[PLAY]** to return to the basic screens.

The results are automatically saved to the disk, even when the disk is removed, as well as in other situations (no save procedure is necessary).

NOTE If a divide destination pad already contains a sample, the message "Overwrite OK?" appears in the display. If it is all right to delete the existing sample, then press **[ENTER/YES]**. If not, press **[EXIT/NO]** to cancel the procedure.

Automatically Dividing Samples at Silent Portions Within Them

You can have the silent portions within a sample detected, and then have boundaries inserted, and the sample divide automatically. In Step 4 above, selecting **AUTO** (either **AUTO (1.0)**, **AUTO (0.5)**, **AUTO (1.5)**, or **AUTO (2.0)**) instead of **END POINT** executes the division. The value within the parenthesis (1.0, 0.5, 1.5, or 2.0) specifies the length of time the silent portion must be to recognized as a division point. For example, at "**AUTO (1.0)**," a silence one second or longer is recognized as a phrase boundary, and a division is set there.

MEMO In this case, it is not necessary to carry out the setting in Step 1 (end point).

What Occurs When "AUTO" is Selected

- The group of divided samples is assigned to the sequential pads specified at "to" in order (although any pads already containing samples are passed over as the samples are written).
- If there aren't enough pads to accommodate the last division of the sample, "PADs are Full. Use Next Bank?" appears in the display.
If **[ENTER/YES]** is pressed, distribution of the samples continues with the pads in the next pad bank.
If **[EXIT/NO]** is pressed, the remaining parts are written to the last available pad as one sample.

MEMO If you want only the resulting parts of the sample to be neatly arranged within the pad bank, select pad [1] of an empty pad bank as the destination. To clear a pad bank, use the Erase Bank function (p. 56).

Pressing a Button to Mark Divisions

Divide Where the Button is Pressed

1. Press **EDIT [SAMPLE/BANK]**.
2. Press **[▼]** to select "Divide?" and press **[ENTER/YES]**.
3. Rotate the **VALUE/TIME** dial to select "**MANUAL**" for the "Type" setting.
4. Select the pad and pad bank numbers of "Source" (the source sample) and "To" (the destination for the divided samples) by pressing **[▲]**, **[▼]**, **[←]** or **[→]** then set the items (press the pads or rotate the **VALUE/TIME** dial).
5. Press **[ENTER/YES]**; the source sample begins to play.
6. Press **[ENTER/YES]** each time you want to set a division point.

Bound the point where the button is pressed, division process is executed.

7. Press **[PLAY]** to return to the basic screens.

The results are automatically saved to the disk, even when the disk is removed, as well as in other situations (no save procedure is necessary).

MEMO After Step 6, the divided source sample is reconstructed in a newly created sample. If you want to continue dividing the sample, repeat Steps 5 and 6.

NOTE If a divide destination pad already contains a sample, the message "Overwrite OK?" appears in the display. If it is all right to delete the existing sample, then press **[ENTER/YES]**. If not, press **[EXIT/NO]** to cancel the procedure.

Reversing the Sample Like a Tape Backwards (Create Reversal)

Create Reversal is a function to create a sample sound which sounds like the reversing tape recorder. The waveform data from the start point to the end point of the source sample is read from the end to the beginning, and the a sample created from this data is assigned to a different pad.

Making a Reversed Sample

1. Press **EDIT [SAMPLE/BANK]**.
2. Press [**▲**] or [**▼**] to select "Create Reversal?" and press **[ENTER/YES]**.
3. Check "Source" (the source sample) is selected.
4. Either press a pad or rotate the **VALUE/TIME** dial to select the numbers of the source pad bank and source sample.
5. Select "To" (the source sample), and press a pad or rotate the **VALUE/TIME** dial to select the numbers of the destination pad bank and sample.
6. Press **[ENTER/YES]**.
Create Reversal is executed.
7. Press **[PLAY]** to return to the basic screens.
8. Press the destination pad to confirm the results.

(NOTE) If the destination pad already contains a sample, the message "Overwrite OK?" appears in the display. If it is all right to delete the existing sample, then press **[ENTER/YES]**. If not, press **[EXIT/NO]** to cancel the procedure.

(NOTE) The settings of Pad Play or Loop in the new created sample will be the same as the source sample's one. However, the loop point setting is ignored.

Undoing the Immediately Preceding Operation (Undo)

The status of the processing and editing functions introduced in this chapter can be restored **after the processes are executed, but before another operation is performed**. This feature is known as "undo." If immediately after executing a step that step can be undone, the **[UNDO/REDO]** button is illuminated. If **[UNDO/REDO]** is pressed, the most recently performed processing or editing of the sample is undone.

(MEMO) If after pressing **[UNDO/REDO]** you find that you didn't really want to undo the last step, press **[UNDO/REDO]** once more to cancel the undo (redo).

(NOTE) Settings parameters called up when "Set Sample Param?" is selected from the menu that appears when **EDIT [SAMPLE/BANK]** is pressed cannot be undone. (This is also the case for those parameters called up by Quick Edit **[TRIM]** or **[LEVEL]**.)

[UNDO/REDO] flashes when a step can be undone.

Chapter 5 Arranging Samples (Phrases) to Create Songs

When the pad samples (phrases and sound effects) are sounded in a sequential order, they can be made into songs. Sounds that are arranged sequentially this way are called **songs**. Songs are created using a variety of methods as explained in this and following chapter.

(NOTE) *To save the songs you create, and the data they contain to disks, be sure to run the Save procedure before turning off the power.*

(NOTE) *Mixer settings, effect patches, and other data are also saved along with the song.*

(NOTE) *When creating a song by arranging samples that are recorded to the pads, the sounds comprising the song and the original samples do not effect each other directly. For example, if the sounds on the pad samples used as source material for a song are deleted, those sounds, once saved as a song, are not lost.*

What are Tracks?

Just as do commercial MTRs (multitrack tape/disk recorders), the SP-808 features **tracks** on which sounds can be arranged, recorded, and played back in sequential order. Tracks are like lanes on a road. In general take a tape-based four-track recorder for example, you can play four monaural sounds simultaneously. The SP-808 features **four stereo tracks**, allowing you to play four stereo (or monaural, if desired) sounds simultaneously.

You can freely edit (p. 82, 87), add effects (p. 27, 93), and bounce (p. 79) the sounds on the tracks, making the remixing process very easy.

(NOTE) *You cannot layer multiple sounds or play two different sounds on the same track (regardless of whether stereo or monaural). Furthermore, when you want to press a pad during playback of a song to play its sound, first you must mute at least one track (pressing [STATUS] for that track, turning off its indicator) to stay within the maximum polyphony.*

(NOTE) *Sounds on the tracks may include "SFX", narration or other sounds besides musical phrases. However, in order to distinguish them from sounds on the pads (called samples), the sounds on the tracks are referred to as **phrases**.*

The Concept of Measures, Beats, and Ticks

Some digital recording devices for producing music track, control song location by hours/minutes/seconds/frames like professional video instruments (one frame being 1/30 to 1/24 of a second in length). However, the SP-808 uses the **measure (MEAS)**, **beat (BEAT)**, and **tick (TICK)** as the units of its basic system for measuring the current location in a song (the **tick, 1/96 of a beat**, is the smallest unit in a song on the SP-808). Thus, songs on the SP-808 are based on the concept of tempo, and in changing the tempos of songs containing multiple phrases, the intervals between the beginning of one phrase and the beginning of the next are lengthened and shortened. The overall tempo a song is changed in the "BPM TUNE" screen (hold down [SHIFT] and press [VARI PITCH]). Tempo change information can also be written to the top of each measure in the Tempo Map screen (p. 71).

Technical Note

When necessary, such as for synchronizing the time with the image on the screen, the "MEAS/BEAT/TICK" indicated at the upper left of the screen can be changed to an Hour/Minute/Second/Frame readout (p. 31). However, this is for reference only. Even if switched to this indication, designation of timing during editing of the song is conducted in measures, beats, and ticks.

The Relationship Between Songs and Phrases

The song tempo can be changed in the BPM Tune screen (p. 70) or Tempo Map screen (p. 71). When the tempo is slowed down, the interval during which the phrase sounds is lengthened. Conversely, increasing the tempo makes the interval shorter. However, in either case, **you cannot change the performance tempo of the phrases (the tempo when the phrase is audio-recorded) themselves.**

To change the tempo of a phrase so that it matches the song tempo, expand or compress the time of pad sample (Stretch function → see p. 52), and place it on the track again. Alternatively, if you don't mind the phrase's pitch being changed, you can also use the Vari-Pitch function (p. 39) to adjust the tempo of the entire song.

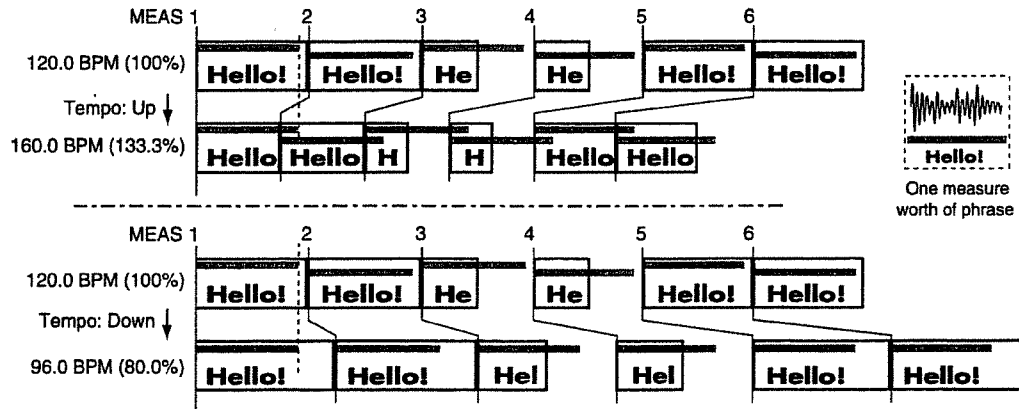

A case of Vari-Pitch

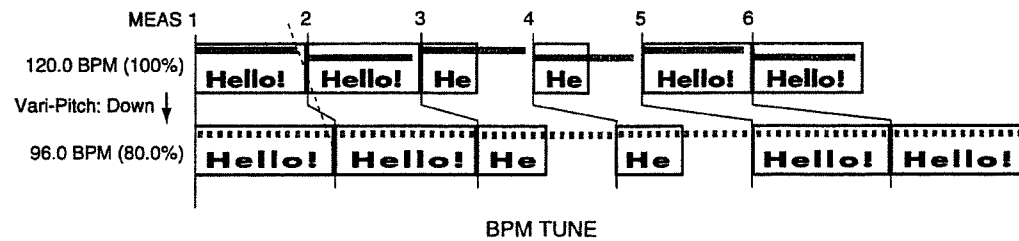

Phrases on Song (or track) are recorded as described below

Play the sample selected for recording:

1. From which measure, beat, and tick where the change to begin;
2. Start from the position *** units from the beginning of the sample; and
3. For ○○ beats and ○○ ticks then mute the sample.

The data in 1-3 sets the phrase represented by the outlined

rectangle displayed in the Play List screen.

Depending on the process at the recording, the data of item 1 and 3 are set.

In the case of recording the phrases on the song by pressing the pad, the sample's start point is reflected to the data number which skip play the sample songs from the beginning in 2. This value can be changed with the Adjust Timing function (p. 87).

(NOTE) Depending on the actual sampling time or other factors, the length of time of a sample on the disk is determined. Even if the apparent play length of 3 above is expanded, the sound stops upon reaching the edit point, before the end point determined in 3. Thus, the sound may stop even when the apparent phrase (the outlined rectangle) is indicated in the Play List screen.

Creating New Songs

Prepare a new song on the disk for the recording of new phrases. To bring a new song into being, use the Create New Song function.

Creating and Naming New Songs

The SP-808 can save up to 64 songs on one Zip disk. You can use up to 12 characters to name each song.

MEMO The songs are assigned a number from 1 to 64. A newly created song is automatically assigned to the lowest number not currently assigned to any song. There is no need to set the open number to the new song it.

Creating a New Song and Selecting the Name

1. Press [SONG/TRACK].
2. Press [▼] or [▲] to select "Create New Song?" and press [ENTER/YES].

An available song number is automatically selected, and the temporary name "New Song **" (with ** being the song number) appears in the display.

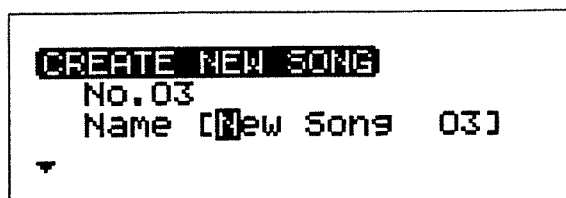

3. Press [←] or [→] to move the cursor and rotate the VALUE/TIME dial or use the pads to select the song name.
4. Press [ENTER/YES].
The message "Save Current Song? (Overwrite Only.*)" appears in the display.
5. If you want to save current song, press [ENTER/YES]. If you don't want to save it, press [EXIT/NO].

If you press [ENTER/YES], then after the current song is saved, it is recreated as a new song and then called up again. If [EXIT/NO] is pressed, a new song is called up without the current song being saved.

MEMO Press [PLAY] to cancel this procedure and return to the basic screens.

Using the Pads as Character Input Buttons

You can use the pads to enter characters when selecting the song name in Step 3 (at that stage they do not function as pads for playing sounds).

Press [←] or [→] to select the cursor position, and press the pads to select the characters. For example, when the [2] (D, E, F) pad is pressed, the character indicated on the screen changes in a repeating sequence "2→d→e→f→2→d→e..."

- [13] (CAPS): Pressing this turns the pads illumination on and off; capital letters are entered when the pad is illuminated.
- [14] (INS): Pressing this inserts a space at the cursor, moving any characters after the inserted space move back by one space.
- [15] (DEL): Pressing this deletes the selected characters, moving any characters after the deleted space move forward one space.
- [16] (BS): Pressing this moves the cursor to left side with deleting the previous character.

NOTE New songs are set with the tempo at 120.00 BPM (beats per minute) and time signature 4/4. If you want to change these settings, use the following procedure or change them in the Tempo Map screen (p. 71).

Setting Measure Bars to Fit the Sample

Normally, phrases lasting one or two measures are sampled to the pads, and songs are created from these source sounds. Setting the measure bars and tempo to conform to the samples that are already recorded makes the editing progress more smoothly. When creating a new song (see previous item), use the following procedure to set measure bars according to the specified rhythm and have the tempo automatically set to match that of the source samples.

NOTE This function does not work correctly if the number of beats in the sample is not specified. To calculate the tempo of the sample correctly, use the procedure described on p. 50 to specify the number of beats.

Creating a Song with Measure Bars and Tempo that Conform to a Sample

1. Create and name a new song using Steps 1–3 in the previous item "Creating a New Song and Selecting the Name."
2. Press [▼].

A settings parameter other than the song name appears in the display.

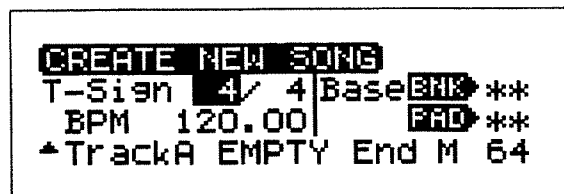

3. Press [▲], [▼], [←], or [→] to select “T-Sign” (Time Signature, meaning the rhythm), and rotate the VALUE/TIME dial to select the rhythm.
4. Select “BASE” (specifying the tempo for the reference sample) as well. (first “BNK- PAD-” is indicated, followed by the tempo of 120.00 BPM).
5. Press the pads or rotate the VALUE/TIME dial to select the sample (the tempo calculated from this sample is then set).
6. Press [ENTER/YES].
“Save Current Song? (Overwrite Only)” appears in the display.
7. If you want to save this as a song beforehand, press [ENTER/YES]. If you do not want to save this song, press [EXIT/NO].
If you press [ENTER/YES], after the current song is saved, it is recreated as a new song and then called up again. If [EXIT/NO] is pressed, a new song is called up without the current song being saved.

MEMO In Step 4 above, instead of specifying a sample, you can also rotate the VALUE/TIME dial to directly input the “BPM” (Tempo) and go on to create the song.

Creating a Song with the Reference Sample Already Included

By specifying a sample in Step 5 of “Creating a Song with Measure Bars and Tempo that Conform to a Sample,” you can create a new song using the all the data recorded in the sample, from beginning to end.

Creating a Song from a Sample Recorded to Track A

1. Carry out Steps 1–5 of “Creating a Song with Measure Bars and Tempo that Conform to a Sample.”
2. Press [▼] to select “Track A.”
3. Rotate the VALUE/TIME dial to call up “GUIDE” (arranging the Guide Sample).
At first, this is set to “EMPTY” (no Guide Sample arranged).
4. Select “End M” (for the number of the last measure), and rotate the VALUE/TIME dial to select the last measure to which the Guide will be pasted.
5. Carry out Steps 6 and 7 of “Creating a Song with Measure Bars and Tempo that Conform to a Sample.”

Recording Your Pads Performance (Event Realtime Recording)

Starting Recording with Counting In

Now, let’s try recording the phrases by pressing pads onto the new song’s track created in the operation on p. 62.

MEMO In real-time recording of pad performance, which are called **events**, are recorded to the tracks as the **timing with which the pads are pressed and released**. Since the sounds themselves are not recorded to any track, no remaining recording time is used up. Additionally, you do not need to set any recording levels. However, you cannot apply effects or use the equalizer, and you cannot record sounds from multiple pads onto the same track. In this case, you must use Audio Recording (p. 74) to record these sounds to the tracks.

5

Recording Pad Events in Realtime

When Calling Up Event Realtime Recording for the First Time

1. Press [←←] and confirm that the “SONG POSITION” indicated in the display shows “001-01-00.”
2. Hold down [SHIFT] and press [▶] (PLAYBACK).
The Event Realtime Recording function is called up. At the same time, [●] begins to flash, and the metronome sound starts playing. The screen display switches to “EVENT REC (REALTIME)”.



3. Confirm “Quantize” is set to Off and “Start/w” (start with) is set to Cnt2M (COUNT IN 2; details follow).
4. Press [STATUS] once or twice until the red light flashes.
5. Press [▶] (PLAYBACK).
After two measures of the metronome’s count sound, recording begins (the flashing red [STATUS] and [●] change to steady illumination, and the basic screens return to the display).

Arranging Samples (Phrases) to Create Songs

6. Press a pad to play the sample along with the metronome's rhythm and the "SONG POSITION display."
7. Press [■] to stop recording, then press [⏮] to jump back to the beginning of the song.
8. Press [▶] (PLAYBACK) to play back the recording of the event; the sound played in Step 6 is reproduced.

(NOTE) Only one recording track can be selected in Step 4. When selected a different track to record on, first press the flashing red [STATUS] to turn it off, then select another track.

When the Previous Recording Has Been "Event Realtime" type

Event Realtime Recording is selected already, so at Step 2, press [●] blinks and the metronome starts sounding (the display does not switch to the "EVENT REC (REALTIME)" screen). In this condition, if the recording track is specified (Step 3) and press [▶] (PLAYBACK), then recording begins according to the settings made before in the "EVENT REC REALTIME" screen. During recording (or while in standby mode), to return to the "EVENT REC (REALTIME)" screen and change the settings in that screen, hold down [SHIFT] and press [▶] (PLAYBACK).

(MEMO) Instead of jumping back to the beginning of the song in Step 1, you can also move to another desired position in the song and begin recording from there.

(NOTE) When you record on a track that already has data stored on it, pressing the pad overwrites the data on the previously recorded material, which is thus lost.

(MEMO) By holding down a pad that is set to loop playback, then the sample is recorded repeatedly (though still handled as a single phrase on the track). Furthermore, changes in the sound of the sample from the "GATE," "TRIGGER," and "DRUM" settings (p. 36) are also recorded onto the track just the way they are actually played.

(NOTE) When recording with the song's measure bars and tempo ignored, and at other times when the metronome is unnecessary during recording, you can stop the metronome by holding down [SHIFT] and pressing [⏮] (the count sound metronome is not turned off).

To Change the Number of Measures of Count Sound

In Step 3, press [▲] to select "Start/w and rotate the VALUE/TIME dial to change the number as follows,

"[▶] (PLAYBACK)":

When [▶] (PLAYBACK) is pressed, recording begins at the same time.

"Cnt1M"(COUNT IN 1 MEASURE):

Recording begins after one measure count-in.

"Cnt2M"(COUNT IN 2 MEASURE):

Recording begins after two measures of count sound.

Starting Recording Whenever One of The Pads Is Tapped in Standby Mode

In Step 4, replace Start w/ with "[PAD]." Recording begins when one of the pads is tapped.

To Return to the Status at the Immediately Preceding Stage

Right after recording, after listening to the result played back, you can press [UNDO/REDO] to return to the previous conditions.

To Record While Listening to Sounds on Another Track

You can listen to sounds on a previously recorded track while using the pads to record to a different track. Raise the fader of the previously recorded track ([STATUS] is illuminated green) then you can perform Realtime Recording while listening to the sound on the other track.

If you are going to match the length and tempo of the sample to the previously recorded phrase, use the Stretch function (p. 52) for processing before you start recording.

(MEMO) If you are trying to press multiple pads simultaneously, if a pad is pressed even an instant later than another, the sound of the sample on the first pad stops, and is replaced by the sample from the pad that is pressed later. When recording multiple pads to a track so that you can layer their sounds (up to a maximum of three), just as in the previous section, use the track Audio Recording function (p. 74).

(NOTE) When there are no phrases at all on the track, [STATUS] are not illuminated green even when pressed. Furthermore, in Event Recording, differs from Audio Recording of tracks, you cannot designate tracks other than those being recorded to as bounce source tracks (illuminated orange).

If “Drive Too Busy.” Appears in the Display

In Step 6 of Event Realtime Recording (previous item), in cases such as when the intervals of pressing pads are too short, you may be unable to play back the sounds. At such times, the warning message “Drive Too Busy.” appears in the display during playback. This matter occurs when the demand for data exceeds the speed at which data from the Zip disk can be read. The rough figure of minimum interval to press pads for accessing data is about 0.3 seconds, (but) depending on the conditions such as selecting sequential phrases on the same track, or writing status to the disk, it will be changed widely.

If this matter does occur, use the following procedure to change the recording method to eliminate problems in playing these sounds.

- In Audio Recording (p. 74) to record to the tracks, record the sounds played when the pads are pressed.
- In Event Step Recording (p. 68), record with the **New Phrase** parameter set to “SINGLE.”

With the above method, the multiple phrases designated by the pads are recorded as a collective single phrase. When you look at the Play List, the parts that were recorded are displayed in a single, unbroken box, meaning you can play the sounds correctly as intended.

NOTE With either method, recording time of the total length of the phrases is consumed.

Recording While Correcting Shifts in Timing (Quantize)

The smallest timing division registered when Event Recording is 1/96 of a beat. Thus, in Event Realtime Recording, getting the timing just right when you are recording, for example, measures of four or eight beats can be very difficult. The **Quantize** function, which corrects unmatch in timing while recording progresses, is perfect for this sort of situation.

Recording with Quantize

1. Hold down [SHIFT] and press [▶] (PLAYBACK).
2. Press [STATUS] of the track for recording once or twice until the red light flashes.
3. Press [▲] to select “Start/w” and rotate the VALUE/TIME dial to set the starting method (p. 64).
4. Press [▼] or [▲] to select “Quantize” and rotate the VALUE/TIME dial to set the preciseness with which Quantize will correct timing mistakes.

Set Quantize so that unmatchs are corrected to the closest note. This way, timing of the sounds that are played is matched to the measure bars and each beat as well.

“MEAS”: To the top of each measure

- “J” : The measure is divided into 192 ticks for timing
- “J” : The measure is divided into 96 ticks for timing
- “ $\frac{3}{8}$ ” : The measure is divided into 64 ticks for timing
- “ $\frac{1}{2}$ ” : The measure is divided into 48 ticks for timing
- “ $\frac{3}{4}$ ” : The measure is divided into 32 ticks for timing
- “ $\frac{1}{4}$ ” : The measure is divided into 24 ticks for timing
- “ $\frac{1}{8}$ ” : The measure is divided into 16 ticks for timing
- “OFF”: Recorded as played on the pads, with no correction

5. Press [▶] (PLAYBACK).

Recording begins according to the setting in Step 3. Now press the pads to play their sounds (this also return to the basic screens).

6. Press [■] to stop recording.

In Realtime Recording, when samples are one measure in length and Quantize is set to “MEAS,” you can record phrases quickly and systematically.

NOTE Quantize does not apply to the timing with which you release the pads.

NOTE When using Quantize, more than one sound may be sent to the same track simultaneously when the pads are pressed. In this case, only the pad pressed latest is effective and only the sound of that pad is recorded.

Rerecording Only a Specified Segment (Punch-In and Punch-Out)

During playback, you can switch tracks in and out of recording mode only for selected segments. This is referred to as **Punch-In and Punch-Out**. This is convenient in such instances as when you want to record over mistakes only in the same part.

Event Realtime Recording with Punch-In and Punch-Out

If you are already working in Event Realtime Recording, start from Step 3 of the following procedure.

1. Hold down [SHIFT] and press [▶] (PLAYBACK). [●] flashes, and the display is switched to the “EVENT REC (REALTIME)” screen (set “Start/w” to [▶] (PLAYBACK), and select the Quantize function if necessary).
2. Press [■] to exit from record standby mode.
3. Press [STATUS] of the track for recording once or twice until the red light flashes.
4. Press [▶] (PLAYBACK) at a song position just before the point where you want to start recording.

With [STATUS] left flashing from Step 3, start playback of the song.

Arranging Samples (Phrases) to Create Songs

5. Press [●] at the point you want to record.

Recording starts, and [STATUS] and [●] both change from flashing to steady illumination.

6. Samples are recorded as you press their pads.

7. Press [■] to stop recording.

MEMO When you press [●] during recording (step 5–7) you can switch the function punch out punch in punch out alternately.

Using a Foot Switch to Punch In and Out

You can press a foot switch instead of [●] to operate Punch-In and Punch-Out. Connect a designated device (such as the optional DP-2) to the Foot Switch jack on the rear panel, and assign the Punch-In/Out function with the following procedure.

1. Press [SYSTEM/DISK] and [ENTER/YES], in that sequence.
2. Press [▼] or [▲] to select the "FSW Func" parameter.
3. Rotate the VALUE/TIME dial until "PUNCH I/O" is displayed.
4. Press [PLAY] to return to the basic screens.

NOTE When punching in and out repeatedly during the similar segment of the song, shifts in the timing each time you punch in or out can result instead in a number of extremely short phrases being inserted near the punch-in and punch-out points. In such instances, the "Drive Too Busy" warning (p. 65) may appear during playback, and the sounds of those short parts may not be played. When you do want to punch in and out repeatedly over the same section, use the Auto Punch-In/Out function (following item), which allows you to precise punch in and out at the same times, thus avoiding this problem.

Punching In and Out Automatically at Specified Points

On the SP-808, you can automatically switch into and out of recording mode over a segment defined by two points that are specified with the **Locator function** (p. 32), allowing you to punch in and out automatically.

Using Auto Punch-In/Out

First register two Locators determining the points where recording begins and ends (p. 32).

1. Hold down [SHIFT] and press [▶] (PLAYBACK). [●] flashes, and the display is switched to the "EVENT REC REALTIME" screen (set "Start/w" to [▶] (PLAYBACK), and select the Quantize function if necessary).
2. Press [▼] or [▲] to select "AutoPunch" and rotate the VALUE/TIME dial to set this to "ON."
3. Numbers are indicated in "[]-[]" at the bottom of the display.

These numerals indicate the Locator registration numbers 1–8. The left number indicates the Punch-In point (where recording begins), and the right number indicates the Punch-Out point (where recording stops).

4. Press [←] or [→] and rotate the VALUE/TIME dial to set these numbers.

Only the Locator number for registering the position is selected.

5. While conducting the recording just as in regular Event Realtime Recording (p. 63), with Auto Punch-In/Out lets you record only in that segment specified in Step 4.

Monitoring the Sound During Punch-In and Punch-Out

You can listen to the sounds that are being newly recorded from punch-in to punch-out.

In the interval up to punch-in (and from punch-out), you can listen to the sounds which "already recorded on the tracks" and "from hitting the pads". (This is the case only in Realtime recording.)

You cannot make sounds by hitting the pads simultaneously, however, when the tracks unspecified for recording are all in playback mode ([STATUS] lights green or orange.). In this case you can select the monitor settings from following two, before punch-in (or after punch-out) by switching the monitor in system settings.

SOURCE: This setting allows you to hear the sounds from the pads.

TRACK: This setting allows you to hear the sounds of phrases already recorded to the tracks.

When shipped from the factory, this is set to "TRACK".

Switching the Monitor Before (After) Punch-In and Punch-Out

1. Press [SYSTEM/DISK] and press [ENTER/YES].
2. Press [▼] or [▲] to move to "Mon(PrePunch)" and rotate the VALUE/TIME dial to select "SOURCE" or "TRACK" mentioned above.
3. Press [PLAY] to return to the basic screens.

MEMO This switching can do by the shortcut operation that Pressing [SYSTEM/DISK] while [SHIFT] held down.

NOTE When punching out manually, there is a brief moment between the time you punch out and the time the sound on the track begins to play again.

Playing and Stopping the Metronome

The metronome sounds automatically during Event Realtime Recording, and stops automatically when recording stops. **If you don't want the metronome to play during recording, hold down [SHIFT] and press [F4].** "MetronomeOFF" appears in the display, and the metronome is prevented from sounding during recording. To turn the metronome back on, then once again hold down [SHIFT] and press [F4].

To Have the Metronome Sound at All Times

You can select from the following two functions for the metronome while it is on.

"REC": The metronome plays only during Realtime Recording.

"ALWAYS": The metronome plays at all times, regardless of whether a song is in playback, is stopped, or is being recorded.

Use the following procedure to switch the metronome setting to "ALWAYS." You can turn the metronome on and off manually by holding down [SHIFT] and pressing [F4] as described above.

Having the Metronome Play Always

1. Press [SYSTEM/DISK].
2. Check "Set System Param?" is selected and press [ENTER/YES].
3. Press [▼] or [▲] to select "Metro.," and rotate the VALUE/TIME dial to change from "INT (REC)" to "INT (ALWAYS)".
4. Press [PLAY] to return to the basic screens.

In Step 3 of the procedure you can select "MIDI (REC)" or "MIDI (ALWAYS)" as well. Select these if you are using an external MIDI sound source for the metronome (p. 159).

NOTE The metronome can also be made to sound if you **set the number of sample's beats** (for indicating the tempo → see p. 50), which is unrelated to the above mentioned setting (when "note" and "number of notes" in that screen are selected and highlighted).

In this case, you can still turn the metronome on and off by holding down [SHIFT] and pressing [F4].

Setting the Metronome Volume

The metronome sound is output from MASTER OUT. However, the metronome volume does not change, even when the Master fader is turned down. Use the following procedure to change the metronome volume.

Changing the Metronome Volume

1. Press [SYSTEM/DISK].
2. Check "Set System Param?" is selected and press [ENTER/YES].
3. Press [▼] or [▲] to select "Metro.Level," and rotate the VALUE/TIME dial to set the volume (from 0 to 100).
4. Press [PLAY] to return to the basic screens.

Recording by Pressing the Pads One at a Time (Step Recording)

On the SP-808, with the song stopped, you can record phrases to the tracks by pressing the pads, like inputting characters with a word processor. This is known as **Event Step Recording** (afterwards referred to as "Step Recording"). For example, by pressing [1], [1], [1], and [3], the phrase that would be played back from pressing those samples [1] (three times) and [3] (one time) is recorded in a preset interval (step). The length of the step is based on the length of the song's measures.

In Step Recording, the buttons have the following functions.

Pad [1]–[16]:

Pressing these records the pad samples, and advances the current song position one step.

[▶] (PLAYBACK):

Holds the phrase in the immediately preceding step over to the current step (Tie).

[▶▶]:

Records a rest of one step length, and advances the song position one step.

[◀◀]:

Return to the previous step.

If You Become Confused About Button Functions During Recording

In the following the "STEP REC" (Step Recording) screen, press [▼] once or twice so that the display switches to "Usage Info." Recording continues even when you switch to this screen. (Press [▲] to return to the previous screen.)

An Example of Step Recording

When recording to the track with pads [1] and [2] each holding a sample as shown below.

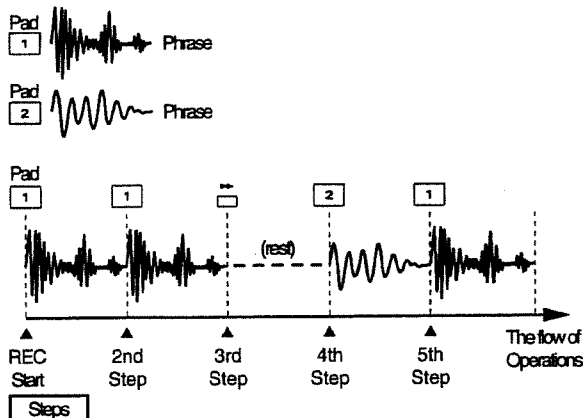

1. Set the position in the song where recording begins at the top of any measure (p. 31).
2. Hold down [SHIFT] and press [■]. (If the previous recording was made in Step Recording, then just press [●].)

The "STEP REC" screen is called up, and the following is displayed.

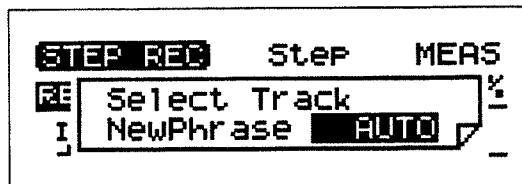

3. Press [STATUS] of the track you want to record so that its red light flashes.

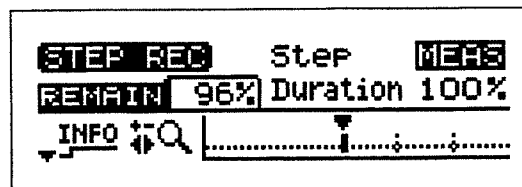

4. Press [▲] to select "Step" and rotate the VALUE/TIME dial to specify the step (input interval) in notes. For example, you could set quarter notes (96 ticks) or another setting (details follow).
5. Make sure that "Duration" is set to "100%" (details follow).
6. When you press pad [1], recording begins simultaneously, and [1] of STEP 1 in the figure is recorded. When [1] is pressed again, it is also recorded in STEP 2.
7. Pressing [▶▶] records a rest at STEP 3.

8. Pressing pad [2] records [2] at STEP 4.
9. Pressing pad [1] records [1] at STEP 5. Pressing [▶] (PLAYBACK) here extends (ties) the phrase in STEP 5 one more step, with the portion [1] recorded.
10. Press [■] to stop recording and return to the basic screens.
11. Return to the beginning of the recording, and press [▶] (PLAYBACK) to listen to the results. If you want to over record this, press [UNDO/REDO].

NOTE If you continue pressing [▶] (PLAYBACK) (tie), even when recording an apparently lengthy phrase, if you go beyond the length of the sample itself (the actual length of the sample as it was recorded), there will be no sound. However, with pads set to loop playback, the results in Step Recording are similarly repeated, allowing you to record one long phrase.

NOTE If [STATUS] is pressed in Step 3, you can select a different track for recording. However, you will then be unable to undo the step recording done up to that point.

Meaning of the "Step" Parameter

The step sets the interval by which the phrases is advanced with each operation performed during recording. It is usually set with reference to notes.

"SMPL" (Sample): This sets the recording to advance by the number of ticks corresponding to the length of the pad sample (at the current tempo).

"MEAS" (Measure): The step advances to the top of the following measure (factory settings).

- " ♩ ": The step advances by 192 ticks
- " ♪ ": The step advances by into 96 ticks
- " ♪♩ ": The step advances by into 64 ticks
- " ♪♩♩ ": The step advances by into 48 ticks
- " ♪♩♩♩ ": The step advances by into 32 ticks
- " ♪♩♩♩♩ ": The step advances by into 24 ticks
- " ♪♩♩♩♩♩ ": The step advances by into 16 ticks
- " ♪♩♩♩♩♩♩ ": The step advances by into 12 ticks

NOTE If this is set to "MEAS", the input position right after starts recording is fundamentally the beginning of the next measure. However, if the current position is on the beginning of the measure, from there recording starts.

NOTE If set to "SMPL," the length of the step varies with the pad pressed. This is convenient when you want to have recording of the pad sample fit right up against the preceding sample without having to worry about song tempo or measure bars. (In this case, even if the sample length matches the measures in a song, due to irregularities in performance, a gradual shift may occur between the timing of the sample and the measures in the song.) If you then press [▶▶] to add a rest, the rest has the length of the

preceding sample is input. (In "SMPL," [▶▶] is not recognized if pressed before the first pad.)

Meaning of the "Duration" Parameter

In contrast to the step (input interval), Duration sets that how long a phrase to be held within a step by VALUE/TIME dial. This setting can be adjusted within the range from 1% to 100%, with 100% being the normal setting.

For example, perhaps you want to conduct Step Recording with the step set to "MEAS" (one measure), repeatedly pressing a pad containing a one-measure phrase. In this case, when Duration is set to 50%, while the phrases are recorded from the beginning of each measure, the duration of the phrase itself is only half the length of the measure.

Here is an example of Step Recording with a pad containing the same sample pressed repeatedly.

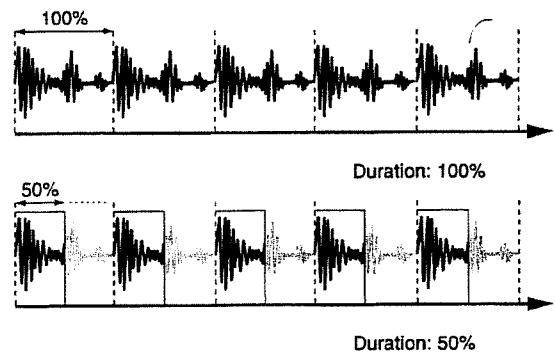

Meaning of the "NewPhrase" Parameter

In Step 2 on p. 68, the parameter "NewPhrase" appears in the display. This setting determines whether the phrases are recorded as multiple separate phrases, or one phrase in the interval between the start and end of the step recording. This is initially set to "AUTO," but you can select from the three following settings by rotating the VALUE/TIME dial.

"MULTI": The recording consists of multiple separate phrases. With some arrangements and tempos, certain phrases may not be played.

"SINGLE": This records multiple phrases as one new single phrase. Although every phrase is played, the recording time corresponding to the length of the phrase is used up.

"AUTO": This automatically switches between "MULTI" and "SINGLE," depending on recording conditions.

In playing back songs, the SP-808 accesses data from the Zip disk from time to time. Because of this, when you record an extremely short phrase, the message "Drive Too Busy." may appear in the display, and that phrase, or the phrase in the same track that immediately follows it may not be played. (This limitation varies with conditions).

To avoid this, **when recording notes that are shorter than the standard divisions to steps, do not record them as short, separate phrases, but rather record them as part of one combined phrase.** (This can be checked in the Play List screen).

This process judges the condition of each parameter in Step Recording, and is executed automatically. If you find you want to avoid this automatic determination, you can save the results of the step recording as a phrase, and thus save the input conditions as they are. "NewPhrase" is the setting for accomplishing this.

Furthermore, even when this is set to "AUTO," depending on changes to the conditions after recording (tempo changes, for example), some of the separated phrases may not be played.

Changing Volume in Step Recording

In Step Recording, the volume of the recorded phrase is as same as the pad sample used for recording.

The SP-808 plays samples at a fixed volume, regardless of how hard the pads are pressed or hit. To change the volume of each step during Step Recording, try setting up some pads containing the same sample, but with only the volume changed, and then using the different pads have the sample played at different volumes.

To make the Same Sample to Multiple Pads

Hold down [SHIFT] and use the clipboard (p. 56) to copy the sample to multiple pads.

To Change the Volume of Each Pad

Press SAMPLE [LEVEL] then you can change the volume setting for each pad (p. 50).

Changing the Song Tempo

The basic tempo of the song is determined by the **Tempo Map** (p. 71). Information regarding tempo changes in the form of **which measure to start from, the time signature, and the tempo (in beats per minute, or BPM)** are stored in the Tempo Map. A song's final tempo (indicated by "BPM" at the top of the display), is the **tempo of the current measure according to the Tempo Map**, as determined in the tempo adjustment or the Vari-Pitch settings made in the "BPM TUNE" screen.

Adjusting the Tempo of the Entire Song

Rapid adjust the tempo of whole of the song is done in the "BPM TUNE" screen.

Adjusting the Tempo of the Entire Song as a Percentage

1. Hold down [SHIFT] and press [VARI PITCH], calling up the "BPM TUNE" screen.
2. Make sure "BPM RATE" is selected.
3. Rotate the VALUE/TIME dial to set the change to be made to the tempo (as a percentage, with 100% indicating the reference tempo).

The BPM at the top of the display changes.

4. Press [PLAY] to return to the basic screens.

(MEMO) This adjustment can be made during playback as well. The percent value is adjustable within the range from 50.0% to 200.0%. (The actual tempo is limited to a range of 20.0 BPM to 500.0 BPM.)

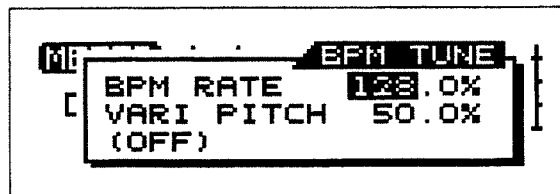

When during playback of a song, perform the Vari-Pitch (p. 39) the tempo (the time used for playing back each measure) of the entire song is also changed. However, the converse is not the case, meaning that even if the whole song's tempo is changed, there is no corresponding change in the Vari-Pitch.

Changing the Tempo and Rhythm of Each Measure

To change tempo remaining “BPM TUNE” setting (tempo adjustment and the Vari-Pitch) as “100%”, change the reference of each measure in Tempo Map. By changing the Tempo Map, you can set a different rhythm and tempo for each measure.

The unaltered Tempo Map, containing only the tempo information set when a new song is created (p. 62), is recorded at the first measure. (If you do not set this, the default is 4/4 measures at 120 BPM.) If necessary, you can add the tempo change information at a later measure.

(NOTE) Songs cannot be played back while the Tempo Map screen is displayed.

(NOTE) The information regarding changes in the basic rhythm and tempo can be recorded only at the **beginning of the measure**. You cannot record information regarding changes in the basic rhythm and tempo at any other point in the measure.

Changing Rhythm and Basic Tempo in the Tempo Map

1. Press [SONG/TRACK].
2. Press [▼] or [▲] to select “Tempo Map?” and press [ENTER/YES].
“T-MAP” (Tempo Map) appears in the display.
3. Press [←] or [→] to highlight values for “T-Sign” (time signature), that is, the numerator and denominator values in the “4/4” that appears.
4. Rotate the VALUE/TIME dial to select the values.
For example, select 3 and 4 to get 3/4 time.
5. Press [←] or [→] to highlight the BPM value (to raise or lower the value).
6. Rotate the VALUE/TIME dial to select the value for the basic tempo.
7. Press [PLAY] to return to the basic screens.

(MEMO) When changing the basic rhythm of a sample, in Steps 5 and 6 you can also input the tempo of the sample that is displayed at the right of top in the “SAMPLE PARAM” screens such as the SAMPLE [TRIM]’s one.

(MEMO) While the BPM value being selected, holding down [SHIFT] and tap [HOLD] repeatedly with your favorite rate, that pressed rate is set automatically as a tempo.

Adding Rhythm and Tempo Change Information During the Song

1. Press [SONG/TRACK].
2. Press [▼] or [▲] to select “Tempo Map?” and press [ENTER/YES].
“T-MAP” (Tempo Map) appears in the display.
3. Hold down [SHIFT] and press [▼] to add new change information (INSERT).
4. Press [←] to highlight the measure numbers (for example, “002”) indicated at the left of each added line.
5. Rotate the VALUE/TIME dial to set the number of the measure where the tempo or rhythm is to be changed.
6. Press [←] or [→] and rotate the VALUE/TIME dial to select the “T-Sign” and “BPM” for the added lines.
7. Repeat Steps 3–6 to record any necessary change information to the Tempo Map.
8. When deleting added lines, hold down [SHIFT] and press [←] (ERASE) while the parameter in that line being highlighted.
9. Press [PLAY] to return to the basic screens.

5

To Move Tempo and Rhythm Change Information Forward or Back as a Block

Use [▶▶] and [◀◀] (the function of [▶▶] and [◀◀] change only in the Tempo Map screen).

[▶▶]: This advances **all the tempo and rhythm change information in a line or continuous group of lines with the highlighted parameters** by one measure.

[◀◀]: This moves the information back one measure number.

(NOTE) This function is disabled when parameters in the “TOP” line are highlighted.

(NOTE) The Tempo Map and “BPM TUNE” screen settings are saved in the Save procedure as part of the song’s data.

Saving Song Data

Phrase arranging and tempo changing data is lost when the power is turned off or when you switch to another song. To keep these data, **save the song to a disk**. When you save a song, mixer and Locator settings, effect patch selections, and other information is also saved.

(NOTE) *System settings and pad sample data automatically saved to the disk from time to time (they don't need saving operation).*

Saving by Overwriting with Deleting Old Data

1. Hold down [SHIFT] and press [ENTER/YES], calling up the "SAVE" screen.
2. Press [▼] or [▲] to select "SONG" and press [ENTER/YES] to call up the "SAVE SONG" screen.
3. Make sure the "Overwrite" is selected and press [ENTER/YES].
4. "You lose old SONG data, ARE YOU SURE?" appears in the display; press [ENTER/YES].
5. After the save is executed, press [PLAY] to return to the basic screens.

(NOTE) *If in Step 2 you select "Overwrite ALL" instead of "SONG," the effect patches are simultaneously overwritten (p. 98).*

Saving a Song as a New Song

1. Hold down [SHIFT] and press [ENTER/YES], calling up the "SAVE" screen.
2. Press [▼] or [▲] to select "SONG" and press [ENTER/YES] to call up the "SAVE SONG" screen.
3. Press [▼] to select "Save as New" and press [ENTER/YES].
The screen for entering the song name appears in the display.
4. In the same way as when creating a new song (p. 62), press the cursor buttons and rotate the VALUE/TIME dial (or press the pads) to select and enter the characters for the song name.
5. Press [ENTER/YES] to execute the save.
6. Press [PLAY] to return to the basic screens.

(MEMO) *Even when duplicating the contents of the same song on a disk, You can use the "Save as New" function. If you save a song immediately after loading it, you can create the new song just by changing the name.*

To Change the Name of a Song

If you select "Overwrite" when saving a song, the name of the song does not change. When you want to change the song's name and then overwrite the data, first use the following procedure to change the name of the song, and then overwrite.

Changing the Song Name

1. Press [SONG/TRACK] and then press [▼] to select "Set Song Param?".
2. Press [ENTER/YES].
3. Press [←] or [→] to select the characters for the song name, and as in the procedure for creating new songs (p. 62), rotate the VALUE/TIME dial or press the pads to set new name.
4. Press [PLAY] to return to the basic screens.

(NOTE) *As same as other song-related parameters, unless the changed song name is saved, it is lost when the power is turned off.*

Data Saved in the Save Procedure

When the song is saved, the following data is saved mainly, and is restored when the song is called up.

- The arrangement of phrases on the tracks, and track mute status ([STATUS] is either lights green or off)
- Mixer-related information (parameters in the screen that is called up when you hold down [SHIFT] and press either [MUTE] or each channel's [EFFECTS]. (The fader setting is not included.)
- Effect patch selections
- Tempo Map and BPM TUNE (including Vari-Pitch) settings
- Locator settings
- Song name, Voice Track Reserve (p. 137), and MIDI synchronization settings

Preventing Accidental Erasure of Songs (Protect)

You can protect important songs from accidental overwriting or deletion (Delete: following item). When a song is protected, the overwriting and delete operations cannot be executed with that song. Furthermore, sound data that is even partially used in a song (or pad bank) is not deleted when the Cleanup Disk operation (p. 46) is performed.

(NOTE) The Protect settings apply to **the song on the disk** (not the current song itself). Thus, even when protect is on, you can conduct editing and recording procedure without interruption.

(NOTE) Even when you delete a song, the remaining recording time is not increased until the Cleanup Disk procedure (p. 46) is carried out. Additionally, any song data used in the deleted song that is also used in another song or pad sample is unaffected by the Cleanup Disk function.

Applying the Protect Feature to Songs on the Disk

1. Call up the song to be protected.
2. Press [SONG/TRACK].
3. Press [▼] to select "Song Protection" at the end of the menu.
4. Press [ENTER/YES] to call up the "TURN SONG PROTECTION" screen, then rotate the VALUE/TIME dial to select song.
5. Confirm that "(Now OFF→Turn ON)" appears in the display, and press [ENTER/YES] (protect is turned on).
6. Press [PLAY] to return to the basic screens.

Carrying out the same procedure on a protected song turns the protect function off. (In Step 5, "(Now ON→Turn OFF)" appears in the display.

(MEMO) You can also protect pad banks (p. 138).

Deleting Songs (Delete Song)

Use the following procedure to delete unneeded songs from the disk.

Deleting Songs from the Disk

1. Press [SONG/TRACK].
2. Press [▼] or [▲] to select "Delete Song?" and press [ENTER/YES].
3. The number and name of the song appear in the display; rotate the VALUE/TIME dial to select it to be deleted.
4. The confirmation message "ARE YOU SURE?" appears in the display.
5. When you press [ENTER/YES], the song is deleted from the disk.
6. Press [PLAY] to return to the basic screens.

(NOTE) The song currently called up cannot be deleted from the disk. If necessary, after calling up another song (p. 26) before deleting the song.

(NOTE) If you try to delete a protected song, a warning message appears in the display, and you cannot continue with the procedure.

Chapter 6 Recording Directly to the Tracks Without Using the Pads

Direct Recording Like Multitrack Tape Recorder (Track Audio Recording)

The previous chapter introduces Event Recording, which records pad performance to the tracks, not audio. Alternatively, with **direct recording to the tracks (Track Audio Recording)**, you can record sounds by operating the SP-808 as you would an Multitrack Tape Recorder. This is great if you want to overdub melody part, vocals, rap, or whatever, all while listening to the backing parts of pad samples arranged on another track.

NOTE With the SP-808, you cannot record simultaneously to multiple stereo tracks. You can record only to the one enabled track (with its [STATUS] button flashing or illuminated in red (Recording)).

Recording Directly to the Tracks (Track Audio Recording)

When first calling up the Track Audio Recording function:

1. Confirm that indicator "PAD" above the MIC/LINE fader is not illuminated.

You can also turn the light off by holding down [SHIFT] and pressing PREVIEW [SCRUB] (p. 75).

2. Check your connections (p. 19) and raise the Master fader up to a suitable level.
3. Press [PLAY] several times until the channel Level Meter screen is called up.
4. With the MIC/LINE fader at the 0 dB level (red line), turn up the MIC or LINE IN sensitivity knob to raise the sound input.
5. Adjust the MIC or LINE input so that the level of the "IN" meter registers as high an input as possible without going over the dotted line at the top.
6. Move the song position to the point where recording is to begin.
7. Hold down [SHIFT] and press [●].

This calls up the Track Audio Recording function. At the same time, [●] begins to flash. The screen switches to "AUDIO→Tr."

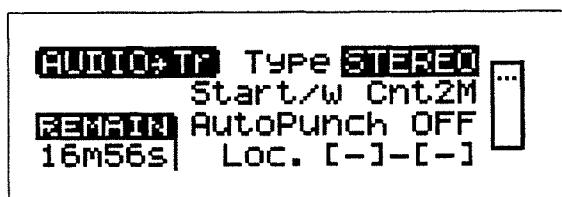

8. Press [STATUS] for the recording track 1–3 times so that it flashes in red.
9. When sound is input, the level meter on the right of the display begins to move; confirm the output by listening the sound from the connected amplifier or headphones.
You can adjust the monitoring volume with the channel fader of the track to be recorded. This has no effect on the recording level.
10. Confirm that "Start/w" is set to "[▶] (PLAYBACK)" and "AutoPunch" is set to "OFF."
11. Press [▶] (PLAYBACK) to begin recording.
You can record volume changes, including fade-outs, by moving the MIC/LINE fader.
12. Press [■] to stop recording.
13. Return to the position where recording started, press [▶] (PLAYBACK) to begin recording, and check the results. (To return to conditions prior to the recording, press [UNDO/REDO] at this point.)
14. Press [PLAY] to return to the basic screens.

If the Previous Recording was Made Using Track Audio Recording:

Since Track Audio Recording is already selected, at Step 7, just press [●] (at this point, although [●] is flashing, the display does not switch to the "AUDIO→Tr" screen). In this condition, if the recording track is specified (Step 8) and [▶] (PLAYBACK) pressed, then recording begins according to the settings made before in the "AUDIO→Tr" screen. During recording (or while in standby mode), to return to the "AUDIO→Tr" screen and change the settings in that screen, hold down [SHIFT] and press [●].

In Track Audio Recording, you can record extremely long samples, and you can get the same results as you would with samples recorded to the tracks in Event Recording.

NOTE The metronome does not play in Track Audio Recording (according to factory settings). If you need the metronome to play during recording, hold down [SHIFT] and press [⏪] to turn it on. However, the metronome always plays in count-in part.

To Take Advantage of the Count-In or Pad Performance to Start Recording

By selecting "Start/w" and rotating the VALUE/TIME dial to set on of the following, you can change the method used to start recording.

[▶] (PLAYBACK):

Recording starts when [▶] (PLAYBACK) is pressed, with no count-in.

Cnt1M (COUNT IN 1 MEASURE):

When [▶] (PLAYBACK) is pressed, recording starts after one measure count-in.

Cnt2M (COUNT IN 2 MEASURE):

When [▶] (PLAYBACK) is pressed, recording starts after two measures count-in.

[PAD]:

Recording start the instant any of the pads is pressed.

MEMO At the factory settings, this is set to "[▶] (PLAYBACK)."

Monaural Recording

At "Type" in the Track Audio Recording screen in Step 7 above, you can select either "STEREO" or "MONO." This is set to "STEREO" at the factory settings. To switch to monaural recording, use [▲] and VALUE/TIME dial to change the setting to "MONO" before recording.

MEMO If you select monaural recording, you can save disk space consumed by recording. (monaural recording uses half the disk space consumed by stereo recording).

MEMO When there is sufficient disk space remaining, you can conduct stereo recording, and then during playback, use the mixer to change it to a mono sound (p. 92).

Recording While Listening to Another Track

The track which already has a phrase by recording or editing, can switch between "PLAY" and "MUTE" by pressing [STATUS]. By pressing "PLAY" before you begin recording, you can record while listening to (monitoring) that track.

The track monitor volume can be changed with the channel fader on each track. (If the fader is turned all the way down, the track is inaudible.)

NOTE In recording to the tracks with Track Audio Recording, only when one of the tracks [STATUS] set to "REC" (flashing in red), you can set another track's status to "BOUNCE" (to be bounced, illuminated in orange). The track to be bounced is not only used for monitoring, but also becomes a source for recording (p. 79).

NOTE When using the send/return method to apply effects, the effect can not be added to the track used for monitoring (according to the factory settings → see p. 78).

Why Does the Remaining Recording Time Decrease, Even When Overwriting During Recording?

Just as with an ordinary tape recorder, you can layer sounds by recording sounds to a track that already contains phrases. In such instances, the phrase that was previously on the track is overwritten, but the disk space it used is not restored. Therefore, even when recording repeatedly to the same measure, disk space (the remaining time for recording) gradually decreases.

This is due to the fact that the SP-808 does not delete any data residing on the disk until the Cleanup Disk procedure (p. 46) is performed. (Even when [UNDO/REDO] is pressed to undo a step, the data that would then be restored with the Redo function is saved.)

If you don't have sufficient disk space, then carry out the Cleanup Disk procedure.

6

Using the Fader to Set the MIC/LINE Input Level

The MIC/LINE fader adjusts the overall sound level from the inputs (both MIC and LINE). However, at the factory settings this is set so that it adjusts the volume of the pads (this is indicated when the indicator "PAD" above the MIC/LINE fader is lit). This can be switched if necessary to have the fader function as an input level fader.

MEMO Even when set to factory settings, you can set the input level with each of the "MIC" and "LINE" input sensitivity knobs.

Switching What the MIC/LINE Fader Controls

MEMO The shortcut **holding down [SHIFT] and pressing "PREVIEW[SCRUB]"** in any screen can be also used instead of this operation. (use the same method to return to the previous setting.)

1. Hold down [SHIFT] and press the MIC/LINE channel [EFFECTS].

The MIC/LINE(PAD) Channel settings screen "MIC/LINE" appears.

2. Press [▼] in several times to select "FaderCtrl" (the third screen) and rotate the VALUE/TIME dial to select "PAD" or "INP" (input).
3. Press [PLAY] to return to the basic screens.

MIC/LINE channel [EFFECTS] is also preset at the factory settings to function as an on/off switch for effects added to the pads (using send/return). You can use the above procedure to change this setting to "INP" as well, and have the button function as the effect on/off switch for the MIC/LINE input signals.

Recording Directly to the Tracks Without Using the Pads

NOTE The volume of either the MIC/LINE input sounds or pad sample sounds, which controlled by the MIC/LINE fader cannot be adjusted by rotating the VALUE/TIME dial in screens such as the Mixer View screen (p. 22) or the screen in Steps 1 and 2, (it can only be adjusted with the MIC/LINE fader).

Furthermore, The operations on this manual is described on condition that the MIC/LINE fader function is set to "PAD" at the factory settings.

Recording a Specified Segment of the Song Over Again (Punch-In and Punch-Out)

In Track Audio Recording, you can switch into (punch in) and out (punch out) of record mode for a specified segment of the song during playback. This is convenient when you want to record one section within the part or song over again.

Track Audio Recording Using Punch-In and Punch-Out

If already selected in Track Audio Recording, start from Step 3. The procedure is basically the same as that used in Event Realtime Recording (p. 65).

1. **Hold down [SHIFT] and press [●].**
[●] begins to flash, and the display switches to the "AUDIO→Tr" screen (set "Start/w" to "[▶]" (PLAYBACK), and if necessary, change the "Type" setting → See p. 75).
2. **Press [■] to exit record standby mode.**
3. **Press [STATUS] for the recording track 1–3 times so that it flashes in red.**
4. **Move the song position to a point ahead of where recording is to begin and press [▶] (PLAYBACK).**
Playback of the song begins, with [STATUS] flashing (from Step 3).
5. **When you reach the point where you want recording to begin, press [●].**
The flashing of [STATUS] and [●] changes to steady illumination, and recording begins.
6. **Press [■] to stop recording.**

MEMO You can punch in and out alternately each time you press [●] during recording (Steps 5–7).

Using a Foot Switch to Punch In and Out

You can press a foot switch instead of [●] to operate Punch-In and Punch-Out. Connect a designated device (such as the optional DP-2) to the Foot Switch jack on the rear panel, and set "FSW Func" to "PUNCH I/O" in system settings (p. 139).

NOTE When punching in and out repeatedly during the same segment of the song, shifts in the timing each time you punch in or out can result in a number of extremely short phrases being inserted near the punch-in and punch-out points. In such instances, the "Drive Too Busy." warning (p. 65) may appear during playback, and the sounds of those short parts may not be played. When you do want to punch in and out repeatedly over the same section, use the Auto Punch-In/Out function (following item), which allows you to precise punch in and out at the same times, thus avoiding this problem.

Using Auto Punch-In/Out in Track Audio Recording

As in Event Realtime Recording, you can automatically switch into and out of recording mode over a segment defined by two points that are specified with the **Locator function** (p. 32), allowing you to punch in and out automatically.

Using Auto Punch-In/Out

First register two Locators determining the points where recording begins and stops (p. 32).

1. **Hold down [SHIFT] and press [●].**
[●] flashes, and the display is switched to the "AUDIO→Tr" screen (set "Start/w" to "[▶]" (PLAYBACK), and set the "Type" if necessary).
2. **Press [▲] or [▼] to select "AutoPunch" and rotate the VALUE/TIME dial to set this to "ON."**
3. **Numbers are indicated in "[-]-[-]" at the bottom of the display.**
These numerals indicate the Locator registration numbers 1–8. The left number indicates the Punch-In point (where recording begins), and the right number indicates the Punch-Out point (where recording stops).
4. **Press [←] or [→] and rotate the VALUE/TIME dial to set the numbers in "[-]-[-]."**
Only the Locator numbers which registered the positions can be selected.
5. **While conducting the recording just as you ordinarily would in Track Audio Recording (p. 74), Auto Punch-In/Out lets you record only in that segment specified in Step 4.**

Monitoring the Sound During Punch-In and Punch-Out

You can listen to the sounds that are being newly recorded from punch-in to punch-out.

There are two ways to switch the monitor settings for listening to the sound up to the punch-in (or after punching out).

SOURCE: This setting allows you to hear the sounds of the recording source such as pads, MIC/LINE input.

TRACK: This setting allows you to hear the sounds of phrases already recorded to the tracks.

Switching the Monitor Before (After) Punch-In and Punch-Out

MEMO This switching can do by the shortcut operation that Pressing [SYSTEM/DISK] while [SHIFT] held down.

1. Press [SYSTEM/DISK] and press [ENTER/YES].
2. Press [▼] or [▲] to move to "Mon(PrePunch)" and rotate the VALUE/TIME dial to select "SOURCE" or "TRACK" mentioned above.
3. Press [PLAY] to return to the basic screens.

NOTE When punching out manually, there is a brief moment between the time you punch out and the time the sound on the track begins to play again.

Recording with Effects and the Channel Equalizer

Recording with the Internal Effects

You can record MIC/LINE input sounds while adding the internal effects. Procedures for both the send/return and insert methods are described below.

Preparations for Recording with Internal Effects Using the Send/Return Method

1. Press REALTIME EFFECTS [ON/OFF] to turn on the effects, its indicator illuminates.
 2. If the Realtime Effects Controller indicator "b" (FILTER ISOLATOR) is lit, hold down [SHIFT] and press [SELECT ROW] to switch to "a" (PATCH).
 3. Hold down [SHIFT] and press [MUTE] to call up the "MIX COMMON" screen.
 4. Press [▼] twice, and select the "FxLoc." (Effects Location) parameter.
 5. Rotate the VALUE/TIME dial to select "SEND/RETURN," the effects is set on the Send/Return position.
 6. With the indicator "PAD" off, press the MIC/LINE channel [EFFECTS] illuminating it. (When the indicator "PAD" is lit, hold down [SHIFT] and press [SCRUB] before this Step.)
 7. Press [FX INFO] and rotate the VALUE/TIME dial to select the effect patch, then press [ENTER/YES].
 8. Hold down [SHIFT] and press MIC/LINE channel [EFFECTS] to call up the MIC/LINE Channel settings screen.
 9. Press [▼] or [←] to select the "Fx" value, and rotate the VALUE/TIME dial to select the effect send level.
- This completes the preparations. When you record MIC/LINE input sounds using the usual procedure (p. 74) the sound is recorded with effects added.

MEMO To cancel the operation, you can press [PLAY] to return to the basic screens. Otherwise, the other details of this operation are the same as in ordinary recording.

Preparations for Recording with Internal Effects Using the Insert Method

1. Press REALTIME EFFECTS [ON/OFF] to turn on the effects, its indicator illuminates..
2. If the Realtime Effects Controller indicator "b" (FILTER ISOLATOR) is lit, hold down [SHIFT] and press [SELECT ROW] to switch to "a" (PATCH).

3. Hold down [SHIFT] and press [MUTE] to call up the "MIX COMMON" screen.
4. Press [▼] twice, and select the "FxLoc." (Effects Location) parameter.
5. Rotate the VALUE/TIME dial to select "MIC/L PRE-EQ" or "MIC/L PST-EQ," the effects is set to the Insert to Input position.
6. Press [FX INFO] and rotate the VALUE/TIME dial to select the effect patch, then press [ENTER/YES].

This completes the preparations. Confirm the effects are being applied. When you record MIC/LINE input sounds using the usual procedure (p. 74) the sound is recorded with effects added.

MEMO When recording sounds from sources other than the MIC/LINE input (such as when bouncing tracks or recording pad sounds in audio), select "INS RECORD" at Step 5, to insert the effects to the combined sounds in the recording path. Furthermore, in this instance you must be in record standby mode in order to check the condition of the effects.

Adding Effects Only to the Sounds Being Recorded or Monitored (When Using Send/Return)

When necessary, specify whether or not the sound of the effect is to be recorded along with. This function is determined by the "(Effects) Return" parameter in the mixer section.

Setting "(Effects) Return"

1. Hold down [SHIFT] and press [MUTE] to call up the "MIX COMMON" screen.
2. Press [▼] repeatedly to get to the second screen (FX-Signal).
3. Press [▲] or [▼] to select "Return" and rotate the VALUE/TIME dial to set "(Effects) Return" (to "REC (orPLAY)" or "PLAY-ONLY").
4. Press [PLAY] to return to the basic screens.

What the Settings Mean

"REC (orPLAY)":

During recording or sampling, the sound of the effect signal returned from EFFECTS(Send/Return method) is also recorded (sounds are recorded with the effect added).

"PLAY-ONLY":

The sound of the effect signal returned from EFFECTS(Send/Return method) is not recorded (the effects is added only to the monitor sound).

MEMO This is set to "REC (orPlay)" at the factory settings.

When Set to "REC (orPlay)"

Even when a track's [EFFECTS] is on (indicator illuminates), if the indicator [STATUS] illuminates in green (PLAY) or off (MUTE), the indicator [EFFECTS] turns off during recording, and the sound from that track are not sent to the effects. This is because phrases sent from the tracks other than those being recorded (bounce source tracks: following item) are prevented from being mixed with the signals going to the effects.

To disable this processing, then also set "Send Ch.Mute," which is right below "Return," to "MANUAL" in Step 3. (This parameter can only be set when "(Effects) Return" is set to "REC (orPlay).") When set to "PLAY-ONLY," the MANUAL function is fixed, with "*****" appearing in the display.)

Adding Effects Only to the Sounds Being Recorded or Monitored (When Using Insert)

When Adding Effects Only to the Recorded Sound

Instead of having the internal effects inserted into the entire recording line ("INS_RECORD"), insert them only into the MIC/LINE channel ("MIC/L PRE-EQ" or "MIC/L PST-EQ"). Set the effect position by holding down [SHIFT] and pressing [MUTE], pressing [▼] twice, then rotating the VALUE/TIME dial (Steps 4 and 5 in "Preparations for Recording with Internal Effects Using the Insert Method" → see p. 77, 78).

Inserting the Effects Only Into the Monitor Sound

Using the same procedure described above, insert the effect into MASTER OUT ("INS MASTER"). This way, effects are added to the total monitor sound, but not to the sounds being recorded.

Recording with the Channel Equalizer

In the same way as when sampling to pads (p. 47), you can record the sound of the MIC/LINE input channel after changing its tone with the equalizer. To call up the Equalizer settings screen, hold down [SHIFT] and press [EFFECTS] above the MIC/LINE fader, calling up the MIC/LINE screen, and then press [▼] four times, and the Equalizer settings screen is displayed.

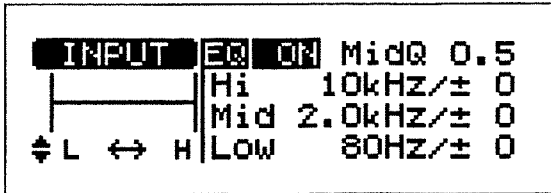

Press [▲], [▼], [←], or [→] to select each of the parameters, rotate the VALUE/TIME dial to change the settings to get the equalization the way you want it.

The mixer section MIC/LINE Channel screen is composed from three parts; press [▼] repeatedly to switch through them in sequence. You can make equalizer and other settings shown below to the MIC/LINE input sound (or pad samples).

First screen:

- Change to monaural or leave as is (Merge-L&R ON, OFF)
- Left-Right level balance (Balance L63–0–R63)
- MIC/LINE input Channel AUX output position (pre-/post-fader) and level settings (Aux PST-F/, PRE-F/ 0–100)
- MIC/LINE input Channel effects send position (pre-/post-fader) and signal send level settings (Fx PST-F/, PRE-F/ 0–100)

Second screen

- 3-Band Equalizer settings for sound input from MIC/LINE IN (p. 47)

Third screen

- Fader control function settings (FaderCtrl, Input = INP: Pad = PAD)
- Overall pad volume (PADsLevel 0–100)
- Left-Right level balance (Balance L63–0–R63)
- Pad effects send position (pre-/post-fader) and signal send level settings (Fx PST-F/, PRE-F/ 0–100)

MEMO For more detailed information refer to the mixer-related explanations (p. 91–).

Bouncing Tracks

In Track Audio Recording, you can also **bounce** tracks, just as you can do with Multi-track Tape Recorder. Bouncing Tracks is playing back sounds from multiple tracks and mixing them down for recording to one track. Combining recorded tracks by this way allows you to exceed the limits imposed by the number of tracks and to continue with recordings again and again.

Technical Note

The SP-808's internal processing, just like that of CDs and MDs, is **fully digital**. Unlike tape-based analog recording devices, there is no marked degradation of the sound quality or increase in noise when you bounce tracks. However, if you repeatedly bounce the same phrase more than necessary, and don't perform the level adjustment correctly, you may discover that the sound suffers a very slight loss of quality, and you may sense the introduction of some noise. Note that you can help prevent the degradation in sound quality that could result from repeated bouncing by increasing the sample rate (p. 24) from 32 kHz to 44.1 kHz.

An Example of Bouncing Tracks B and C to Track D

If Track Audio Recording has already been selected, start from Step 3.

1. Hold down [SHIFT] and press [●].

Set "Start/w" to "[▶] (PLAYBACK)." If necessary, change the "Type" setting (stereo or monaural) (→ See p. 75).

2. Press [■] to return to the basic screens.

3. Check your connections (p. 19), and raise the Master fader up to a suitable level.

4. Set the song position so close to the point where bouncing will begin.

5. Press the Track D [STATUS] so that it flashes in red (REC).

6. Press the Track B and C [STATUS] so that they are illuminated in orange (BOUNCE).

7. Press [PLAY] 1–3 times to call up the Channel Meter screen (CH).

8. Press [▶] (PLAYBACK) to begin playback.

Raise the B and C faders and check to make sure that the Track D meter is moving. (The meter for the recording destination track becomes a recording level meter.)

MEMO The volume of recording monitor can be changed with the fader of the track which selected in step 5. (However, channel equalization has no effect on the monitored audio.)

Recording Directly to the Tracks Without Using the Pads

(NOTE) If you want to monitor the recording sounds in bouncing situations, you must set the system parameter "Mon(PrePunch)" to "SOURCE" (the factory setting is TRACK). Try to switch this if you can not monitor the recording sound when the fader is raised and the bar-meter is responding. (Hold down [SHIFT] and press [SYSTEM/DISK] for the shortcut.)

9. Use the Track B and C faders to adjust the recording level and balance between the two tracks.

Just as when sampling (p. 43), adjust the recording level so that the Track D level meter is moving at as high a level as possible without exceeding maximum levels.

10. Stop playback and return to where the bouncing starts.

11. Press [●], it starts flashing.

12. Press [▶] (PLAYBACK) to begin the bouncing. Press [■] to stop the bouncing procedure.

13. Return to the point in Step 10, and press [▶] (PLAYBACK) to play back the sounds and check the results. (To return to conditions prior to the bouncing, press [UNDO/REDO] at this point.)

14. Press [PLAY] to return to the basic screens.

(NOTE) If there is any input signals to MIC/LINE IN during bouncing, that sound is recorded as well. **When the input is not necessary, turn the MIC and LINE IN input sensitivity knobs to "MIN."**

(MEMO) The sounds from any samples played when the pads are pressed are also recorded. However, if during bouncing three of the track [STATUS] are set to "PLAY" (illuminated in green) or "BOUNCE" (illuminated in orange), then the limit of sounds that can be played back is limited, and the samples are not played.

(MEMO) The monitor volume is adjusted with the channel fader of the recording track. This does not affect the recording level at all.

To Adjust Stereo Bounce, Effect Send Level, and Other Settings for Each Bounce Source Track.

When bouncing tracks, you can set stereo bounce, effect send level, and other settings for each bounce source track. This is done in the screens for "Track A-D." To display these screens, hold down [SHIFT] and press [EFFECTS] above the selected track's fader.

The mixer section "Track A-D" screens are composed from two parts for each track; Press [▲] or [▼] in several times to toggle between the two screens. You can play back or bounce tracks with the following settings made to the sounds that are played back.

First screen

- Change to monaural or leave as is (Merge-L&R)
- Left-Right level balance (Balance)
- AUX output position (pre-/post-fader) and level settings of the track (AUX Send)
- Effects send position (pre-/post-fader) and signal send level settings for the track (Effects Send)

Second screen

- 3-Band Equalizer settings for the sounds played back on the track (as done with the MIC/LINE input channel in the same screen → see p. 79)

Press [▲], [▼], [←], or [→] to select each of these parameters, and rotate the VALUE/TIME dial to make the setting. (Press [PLAY] to return to the basic screens.) The mixer-related settings are save along with the song data when the song is saved (p. 72).

When Using All Tracks A-D

When bouncing tracks, you must leave at least one track empty for recording. However, if you want to combine tracks while all of the tracks are in use, you can use the following technique. (For more information about editing functions such as Paste (p. 89) and Cut (p. 84), please refer to the following chapter.)

1. All tracks in use....

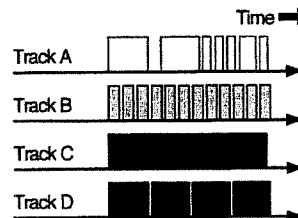

2. Use the Paste function (p. 89) to copy a phrase from Track A to a portion of Track B containing no sounds (The portion V copied from Track A can not be erased there).

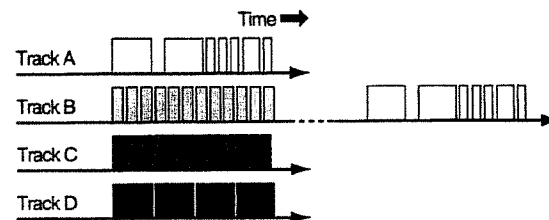

3. Bounce the material from Tracks B–D to Track A.

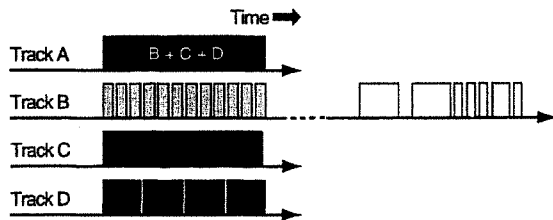

4. Use Cut (p. 84) to delete the unnecessary portion of Track B. The sounds on Tracks C and D are now also unnecessary, so these tracks are available for new recording.

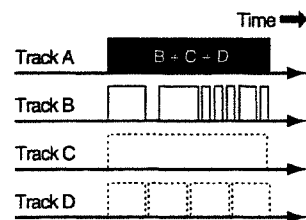

If the Recorded Sound is Distorted (Recording Attenuator)

When bouncing tracks, the signal levels from multiple tracks are combined, and you may be unable to get the proper levels if you don't get the faders down. Additionally, just when you have got the balance between each track right, you may find the level meter peaking a little too much. In such instances, you can use the mixer's attenuators to prevent the sound of the recording from becoming distorted.

Preventing Distortion with the Recording Path Attenuator

1. Hold down [SHIFT] and press [MUTE] to call up the "MIX COMMON" screen.
2. Press [▼] to select "RecAtt" (recording attenuator).
3. Rotate the VALUE/TIME dial to select the appropriate level of attenuation; select 0, -3, -6, -12, -18, or -24 dB (no attenuation is applied when 0 dB is selected).
4. Press [PLAY] to return to the basic screens.

NOTE If no attenuation is needed, then return the setting to "0 dB." If attenuation is left on, you will later be unable to get sufficient volume, even with the faders raised.

Recording Without Using the Mixer

In Track Audio Recording (or when sampling with the pads), the MIC/LINE input channel is used. This allows use of the send/return method for adding internal effects, changing to stereo balance, and use of the SP-808's faders in adjusting recording levels.

To record (or sample) with even simpler settings, use the **AUX IN** as the input for recording. In this case, the internal mixer lines and functions are not used, allowing you to record directly to the tracks (or sample directly to the pads (for the mixer figure, → see p. 91).

Connect the device to be used for the AUX IN input and make changes to the settings as shown below.

Recording Through AUX IN

1. Hold down [SHIFT] and press [MUTE] to call up the "MIX COMMON" screen.
2. Press [▼] in several times to get to the third screen (AUX In&Out).
3. Rotate the VALUE/TIME dial to change the "In" setting from "THRU (→LINE)" to "REC (orPLAY)."

During recording, the sound input through AUX IN is also recorded.

4. Press [PLAY] to return to the basic screens.

MEMO Adjust the level with the AUX IN input sensitivity knob.

NOTE Completely turn down the MIC and LINE input sensitivity knobs and fully lower all faders except "MASTER."

NOTE You cannot record the sound with internal effects or equalization applied.

MEMO If you are using AUX IN and OUT as send and return jacks for an external effect, use the above settings when recording the returned effect sound.

Chapter 7 Editing Recorded Tracks [1] (Quick Edit)

You can freely cut out, rearrange, and copy phrases on the tracks. This makes it easy to make tracks by repeating phrases (break beats), and to create new versions of songs (by changing their makeup). There are two ways to edit songs, as shown below.

Quick Edit:

You can make settings and editing visually and quickly while watching the Play List screen (p. 22).

Edit performed in each of the Edit screens:

This is for editing data such as throughout the tracks.

This chapter explains the easy Quick Edit procedures. With Quick Edit, you can cut out, paste, insert, and erase material on the tracks.

(NOTE) In Quick Edit, you cannot paste or insert data into a different track, and you can not use the function to repeat a number of times. These procedures can be performed in Edit condition (Chapter 8 → see p. 89, 90).

(NOTE) In Quick Edit, no confirmation messages, such as "ARE YOU SURE?", appear in the display when you carry out a step. Furthermore, when you execute a number of steps continuously, **pressing [UNDO/REDO] only works to the very last step made.** To prevent important songs becoming unrecoverable through trail and error or accidental operations, start editing only after saving the song (p. 72).

Going Through the Quick Edit Process

1. Set the segment of the song to be edited.
2. When pasting or inserting, move the current song position to the point where you want to paste or insert material.
3. Hold down [SHIFT] and press one of the cursor buttons to execute.

Next, each of the procedures is explained in detail.

Determining the Segment to Be Edited

Setting of the segment to be edited is done in the Play List screen, using either the Region In/Out function or the Mark Phrase function.

Selecting a Segment (Region In/Out)

Setting Segments with Region In/Out

1. Press [PLAY] 1–3 times to switch to the Play List screen.
2. Hold down [SHIFT] and press the [STATUS] button on each track, highlighting the "Tr.SEL" box in black only for the tracks that are to have segments selected for editing (more than one track can be selected).

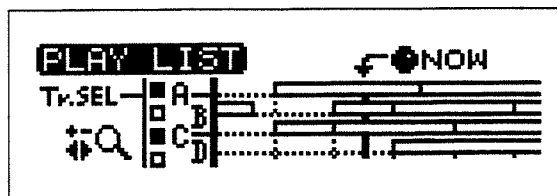

3. Move the current song position to the starting point of the segment.
4. Press [REGION IN/OUT] to specify the beginning (in point) of the segment.

The button starts blinking.

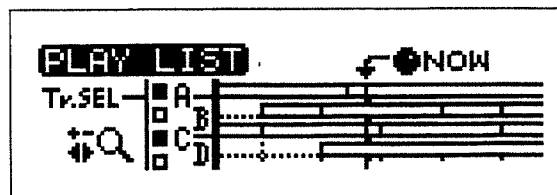

5. Move the current song position to the end point of the segment.

The phrases are highlighted in black, and selecting a segment is complete.

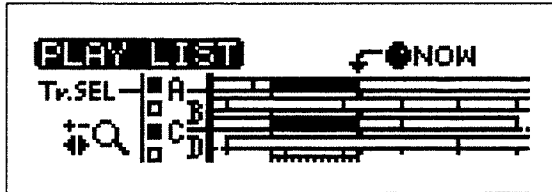

6. Press [REGION IN/OUT] to specify the end (out point) of the segment.

The phrase is highlighted in black then set the segment ([REGION IN/OUT] is turned the light on).

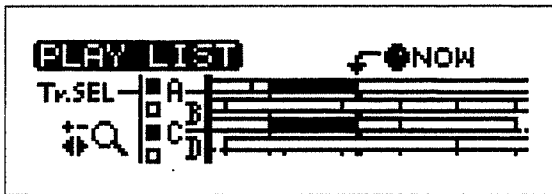

MEMO To completely cancel these settings for a segment, hold down [SHIFT] and press [EXIT/NO].

MEMO Instead of performing Steps 3–6, you can also select the segment by pressing [REGION IN/OUT] twice (once for the in point, and once for the out point) as the song progresses.

To set the current song position to the top and end of the phrase on a track (PREVIOUS/NEXT function)

In the Play List screen, by holding down [SHIFT] and pressing [▶▶], you can jump the current song position in to the beginning and end of the next phrase on the track in sequence. This is convenient in step 3 when you select the phrases unrelated with measures and beat by Region In/Out. (By holding down [SHIFT] and pressing [◀◀], you can jump the current song position in sequence to the end and beginning of the previous phrase.)

Selecting a Phrase (Mark Phrase)

Setting Segments with Mark Phrase

1. Press [PLAY] 1–3 times to switch to the Play List screen.
2. Hold down [SHIFT] and press the [STATUS] button on the track to be set, highlighting the “Tr.SEL” box in black (more than one track can be selected).
3. Move the current song position to the point of the phrase to be set (marked).
4. Press [MARK ON].

The entire phrase is highlighted in black, and the phrase is then set ([MARK ON] is turned the light on).

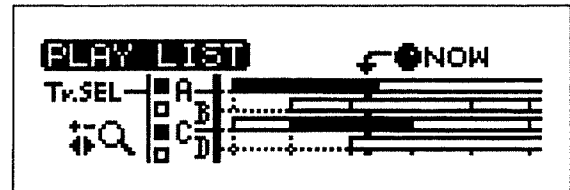

7

5. Repeat Steps 2–4 to set segments as needed.

You can also select multiple phrases simultaneously.

MEMO To delete a mark from a single phrase, move the current song position to that phrase, then while holding down [SHIFT], press [MARK ON]. To delete all marks, hold down [SHIFT] and press [EXIT/NO].

MEMO Instead of step 3 and 4, you can mark a phrase at the point by pressing [MARK ON] while the song is playing back.

Editing Selected Segments

Erase

The erase function deletes phrases from tracks and clears the selected segment. (Erase is enabled only in Quick Edit. It does not appear in the Edit menu called up when [SONG/TRACK] is pressed.)

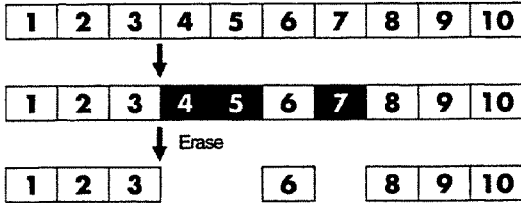

The Erase Process

- Using either Region In/Out or mark points, select the segment to be erased.

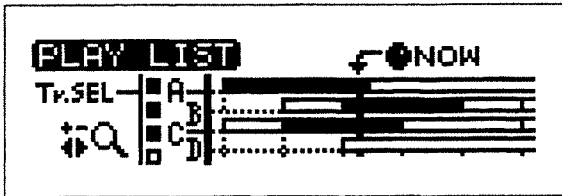

- Hold down [SHIFT] and press [←] (ERASE).
The phrase in the selected segment is deleted from track.

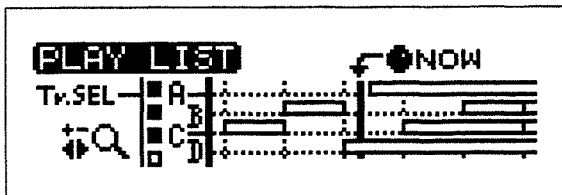

Cutting Segments (Cut)

The Cut function removes the phrase in the selected segment from the track, and moves all the following phrases forward. This is analogous to splicing audio tape or movie film. (Cut is enabled only in Quick Edit. It does not appear in the Edit menu called up when [SONG/TRACK] is pressed.)

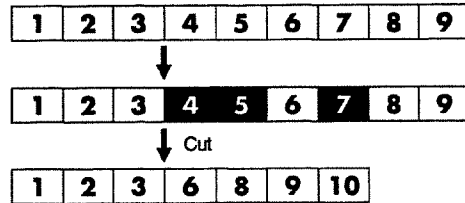

The Cut Process

- Using either Region In/Out or mark points, select the segment to be cut.

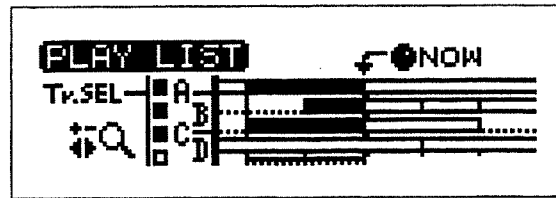

- Hold down [SHIFT] and press [→] (CUT).
The phrase in the selected segment is cut from track and the following phrases are then moved ahead to fill the space left behind.

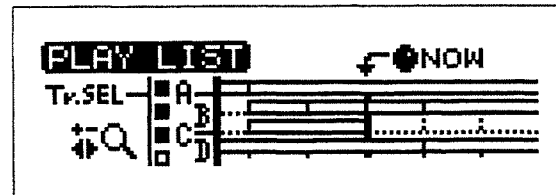

HINT If you cut a segment that does not start and end exactly on a beat or measure bar, the following phrases that are moved up will not conform to the measures, which then makes editing inconvenient. When cutting segments, you can use the [←] or [→] (the Measure buttons) or Region In/Out to make sure the segment is cut out in measure unit measures before continuing.

Pasting to a Different Location (Paste)

The Paste function takes a phrase in the selected segment and writes (copies) the same phrase to another selected location.

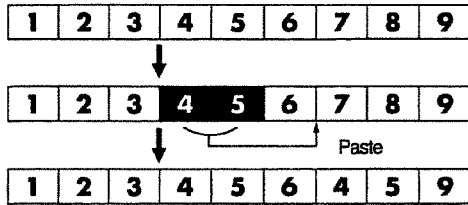

NOTE In Quick Edit, the paste destination is limited to **any location on the same track**. Paste to other tracks or paste in several times are enabled in the Paste screen (next chapter) called up from the [TRACK/DISK] menu.

The Paste Process

- Using either Region In/Out or mark points, select the segment to be used as the paste source.

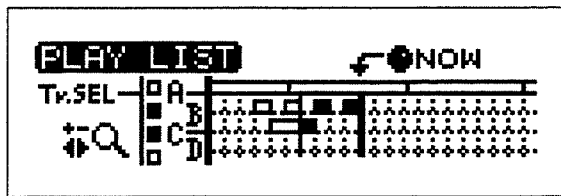

- Move the current song position to the paste destination

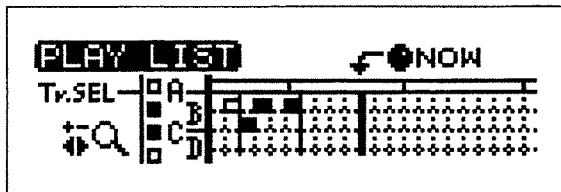

- Hold down [SHIFT] and press [▲] (PASTE).

The phrase in the selected segment is pasted to the selected location. When this is done, the phrase previously in that location is overwritten. (After pasting, the current song position moves to the **end of the segment containing the paste destination**. The segment containing the paste source phrase is not affected.)

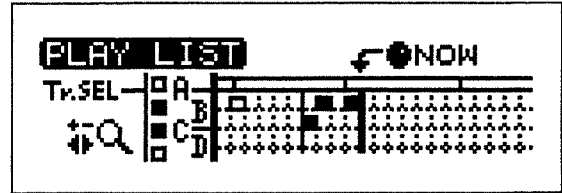

- To paste the same phrase again, repeat Step 3.

NOTE If the paste source in Step 1 is not continuous (has gaps in between material), the portions of the paste destination corresponding to those gaps is not deleted, but remains as is.

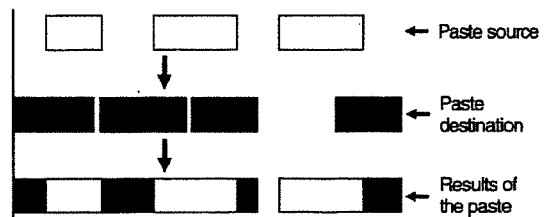

Inserting Into a Different Location

The Insert function takes a phrase in the selected segment and inserts the same phrase to another selected location, moving back the phrases that come after that location.

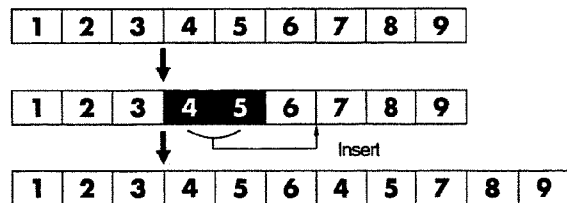

NOTE In Quick Edit, the insert destination is limited to **any location on the same track**. Insert to other tracks or insert in several times are enabled in the Edit condition (next chapter).

The Insert Process

1. Using either Region In/Out or mark points, select the segment to be used as the insert source.

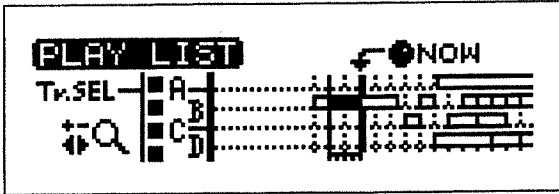

2. Move the current song position to the insert destination

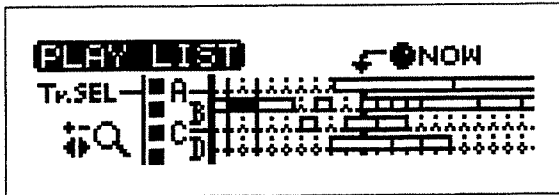

3. Hold down [SHIFT] and press [] (INSERT).

The phrase in the selected segment is inserted to the selected location, and the phrase that follow are moved back. After inserting, neither the current song position nor the segment containing the insert source phrase is affected.

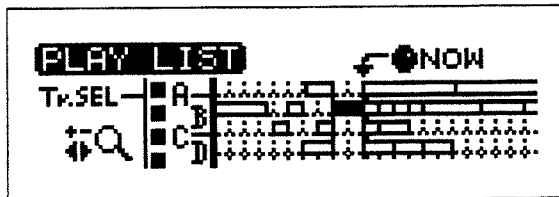

4. To insert the same phrase again, repeat Steps 1-3.

HINT If you select a segment that does not start and end exactly on a beat or measure bar, the following phrases that are moved back will not conform to the measures, which then makes editing inconvenient. When inserting segments, you can use the [◀◀] or [▶▶] (the Measure buttons) or Region In/Out to make sure the segment is inserted in measure unit before continuing.

Technical Note

Even when you paste and insert, no new audio data is created on the disk (the existing data is utilized). Therefore, the remaining recording time for sampling or Track Audio Recording does not decrease.

Even when you erase and cut, this is not directly reflected in the remaining time for recording (or sampling). This is due to the fact that the SP-808 **does not delete any data residing on the disk until the Cleanup Disk procedure (p. 46) is performed.** (This is to improve operational response.) If you don't have sufficient disk space, then carry out the Cleanup Disk procedure.

Chapter 8 Editing Recorded Tracks [2] (Selecting from the Menu)

The following functions are available in the **Edit** menu, which is called up when [SONG/TRACK] is pressed.

- Adjust Timing
- Move
- Paste
- Insert

MEMO You can paste and insert to other tracks, and also set the number of performance. (Perform paste/insert once in the same track can be done in Quick Edit past/insert. →p. 85).

Finely Adjusting the Timing of Each Phrase (Adjust Timing)

Fine Adjustment of Expression Timing

The positioning of phrases on the tracks (the time of expression) is determined with the following formats.

- From which measure, beat, and tick number (Start)
- The length of expression in beats and ticks (Duration)

The **Adjust Timing** function is for changing these values. You can also make other settings to phrases in the same screen, such as volume level.

Adjust Timing comprises three screens.

The first screen is for selecting phrases, and the second and third screens are for changing settings.

Adjusting the Timing of Phrase Expression

1. Press [SONG/TRACK].
2. Press [▲] or [▼] to select "Adjust Timing?" and press [ENTER/YES].

The Adjust Timing screen is called up.

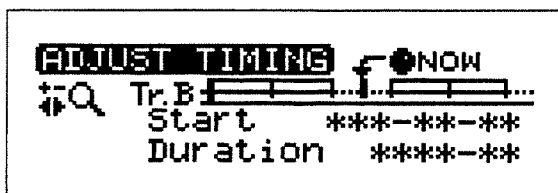

3. Select target track by pressing its [STATUS] while [SHIFT] is held down.

The selected track (A–D) appears in "Tr."

4. Rotate the VALUE/TIME dial to change the current song position.

The phrases are **highlighted in black in sequence** on the screen as you run through them.

5. When the phrase to be adjusted is highlighted, press [▼].

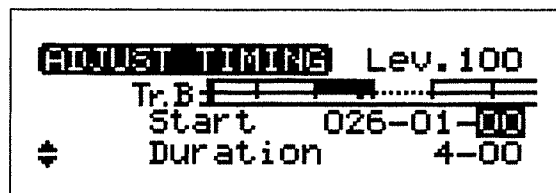

That phrase is selected, and the Edit screen is called up.

6. Press [▲] or [▼] to select "Start," and press [←] or [→] and rotate the VALUE/TIME dial to change the setting (measure, beat, and tick).
7. Select "Duration" (the phrase length) in the same way, and rotate the VALUE/TIME dial to change that value (number of beats and ticks).
8. If required, press [▼] repeatedly until the third screen is displayed, select "WaveOffset" or "WaveEnd" (explained below), and rotate the VALUE/TIME dial to change the value (up to a maximum of seven digits).
9. Press [PLAY] to return to the basic screens.
Save the song (p. 72) to save these changes.

MEMO Pressing [UNDO/REDO] immediately after this procedure restores the settings current at Step 4.

NOTE The extent to which the "Start" (Step 6) and "Duration" (Step 7) of a phrase can be changed is limited by the phrase before and after it; that is, phrases on the same track cannot be overlapped. In addition, one beat, as indicated here, always means a quarter note (96 ticks). This is not affected by the rhythm in each measure.

Offset and End Point

The SP-808 reads waveform data from the specified disk according to the arrangement of the phrases on the tracks. **WaveOffset** and **WaveEnd**, the parameters selected in Step 8, determine which part of the waveform data is used for to a phrase.

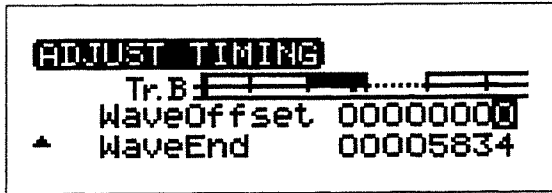

WaveOffset:

This specifies and changes the **starting point for reading** the disk's waveforms. The specified point is placed at the position determined in Adjust Timing "Start" (in the second screen).

WaveEnd:

This specifies and changes the **end point for reading** the disk's waveforms. If this point is before the end of the segment resulting from the "Duration" setting in Adjust Timing (in the second screen), then even though still within the phrase, the sound stops.

MEMO If a pad contains a looped sound recorded in Event Recording (Realtime or Step), then the end point of the loop on the track is designated.

NOTE If "LOOP-END" was the sampling mode used during Event Recording, you cannot select a value smaller than that fixed value.

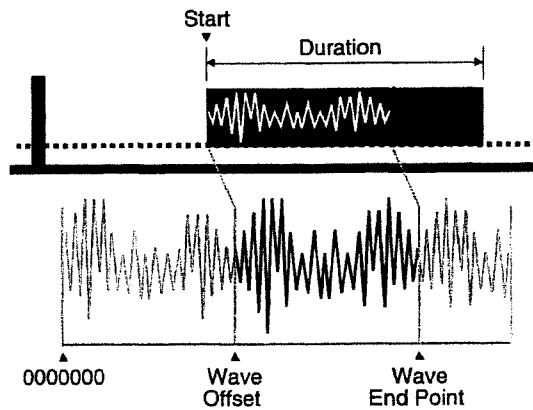

In both Offset and End point are indicated by 7-digits values likewise the sample reading start points (p. 51). The amount of time indicated by "0000001" is determined by the sample rate (at 32 kHz and with Vari Pitch off, this equals 1/2,000 of a second). This does not change with tempo and measure length.

Technical Note

The initial Offset value varies according to the form in which the phrase is arranged on the track.

For example, suppose a sample's start point is delayed (p. 51) by "0000320," and a pad sound is recorded to the track in Event Realtime Recording (p. 63). In this case, a gap lasting "0000320" appears ahead of the point where the sound data used by the phrase on the track begins to play.

On the other hand, the initial Offset value for phrases recorded in Direct Recording (p. 74) is set to "0000000."

The Relationship Between Cleanup Disk and "Wave End Point"

Of the waveforms used by phrases on the tracks, what is deleted in the "STANDARD" (p. 46) Cleanup Disk procedure is the portion from the beginning of the phrase to the start point. The portion that comes after the "Duration" is not ordinarily deleted. Therefore, when trying to place only a small part of a lengthy recorded (or sampled) phrase in a song, the remaining available recording time may not increase much, even after the Cleanup Disk operation is performed.

However, in this case, **the part in the phrase that comes after the end point (WaveEnd) is deleted.** In this case, perform clean up disk after move forward the end point of each phrases within the area it does not affect the phrase sounding you need. This will allow you to free up more recording time.

Changing the Volume of Each Phrase

In the **second screen of the Adjust Timing** mentioned above, **the volume of each phrase** is indicated in the upper right corner of the screen. You can change the volume (0-100) of the selected phrase by highlighting the numerical value and then rotating the VALUE/TIME dial to change the number.

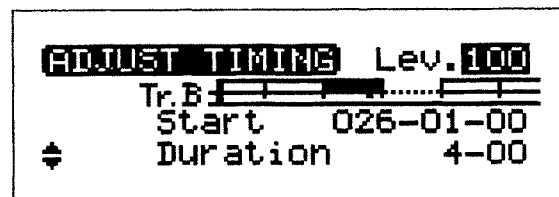

MEMO The value before the change represents the volume which set to the pad when pressed during Event Recording (phrases created in Track Audio Recording register 100). "100" indicates the volume at the recording (or sampling).

Editing Selected Segments

Moving to a Selected Track and Location (Move)

This function is for transferring material to other points in the song. The Move function allows you to move a selected segment **even to a selected position on another track**. (If moving a segment to another point on the same track, you can also use Paste (p. 85) along with the Erase function (p. 84) in Quick Edit.)

Moving a Selected Segment

1. Press [SONG/TRACK].
2. Press [▲] or [▼] to select "Move?" and press [ENTER/YES].
3. Press [←] or [→] to select "Track A→A" and rotate the VALUE/TIME dial to select the "move source track" and the "move destination track" (select A, B, C, or D, or all tracks A–D for each).
4. Press [▲], [▼], [←], or [→] to select each of the digits for "In Time" (measure, beat, and tick), and rotate the VALUE/TIME dial to set the start point of the move source.
5. Rotate the VALUE/TIME dial to set the "Out Time" (the move source end point).
6. Rotate the VALUE/TIME dial to set the "Move To" (the move destination).
7. Press [ENTER/YES].
The confirmation message "ARE YOU SURE?" appears in the display.
8. Press [ENTER/YES] to execute the move. The phrase previously existing at the move destination is overwritten and deleted.)
9. To cancel the move, press [UNDO/REDO] immediately after it is executed. When the move is completed, press [PLAY] to return to the basic screens.

MEMO In Step 3, if "A–D" (all tracks) is selected as the move source, the selection of "A–D" as the move destination is determined automatically ("A–D" cannot be selected as the move destination in any other case.)

MEMO If the illuminated Locator button (p. 32) is pressed during Steps 4–6, the position registered to that Locator is selected for the parameter being set.

Repeated Pasting to Selected Tracks (Paste)

This function allows you paste a selected segment to any position in the song, **including points on other tracks**, and to set the **number of times** the segment is to be pasted.

Pasting a Selected Segment to Another Position

1. Press [SONG/TRACK].
2. Press [▲] or [▼] to select "Paste?" and press [ENTER/YES].
3. Press [←] or [→] to select "Track A→A" and rotate the VALUE/TIME dial to select the "paste source track" and the "paste destination track" (select A, B, C, or D, or all tracks A–D for each).
4. Press [▲], [▼], [←], or [→] to select each of the digits for "In Time" (measure, beat, and tick), and rotate the VALUE/TIME dial to set the start point of the paste source.
5. Rotate the VALUE/TIME dial to set the "Out Time" (the end point of paste source).
6. Rotate the VALUE/TIME dial to set the "Paste To" (the start point of paste destination).
7. Select "Repeat Times" and rotate the VALUE/TIME dial to select the number of times the paste to be repeated.
8. Press [ENTER/YES].
The confirmation message "ARE YOU SURE?" appears in the display.
9. Press [ENTER/YES] to execute the paste. The phrase previously existing at the paste destination is overwritten and deleted.)
10. To cancel the paste, press [UNDO/REDO] immediately after it is executed. When the paste is completed, press [PLAY] to return to the basic screens.

MEMO In Step 3, if "A–D" (all tracks) is selected as the paste source, the selection of "A–D" as the paste destination is determined automatically (and "A–D" cannot be selected as the paste destination in any other case).

MEMO If the illuminated Locator button (p. 32) is pressed during Steps 4–6, the position registered to that Locator is selected for the parameter being set.

Repeated Insertion to Selected Points (Insert)

This function allows you insert a selected segment to any position in the song, **including points on other tracks**, and to set **the number of times** the segment to be inserted.

Inserting a Selected Segment at Another Position

1. Press [SONG/TRACK].
2. Press [▲] or [▼] to select "Insert?" and press [ENTER/YES].
3. Press [←] or [→] to select "Track A→A" and rotate the VALUE/TIME dial to select the "Insert source track" and the "Insert destination track" (select A, B, C, or D, or all tracks A-D for each).
4. Press [▲], [▼], [←], or [→] to select each of the digits for "In Time" (measure, beat, and tick), and rotate the VALUE/TIME dial to set the start point of the insert source.
5. Rotate the VALUE/TIME dial to set the "Out Time" (the end point of insert source).
6. Rotate the VALUE/TIME dial to set the "Insert To" (the start point of insert destination).
7. Select "Repeat Times" and rotate the VALUE/TIME dial to select the number of times the insertion to be repeated.
8. Press [ENTER/YES].
The confirmation message "ARE YOU SURE?" appears in the display.
9. Press [ENTER/YES] to execute the paste. The phrase previously existing at the insert destination is overwritten and deleted.)
10. To cancel the insertion, press [UNDO/REDO] immediately after it is executed. When the insertion is completed, press [PLAY] to return to the basic screens.

MEMO In Step 3, if "A-D" (all tracks) is selected as the insert source, the selection of "A-D" as the insert destination is determined automatically (and "A-D" cannot be selected as the insert destination in any other case).

MEMO If the illuminated Locator button (p. 32) is pressed during Steps 4-6, the position registered to that Locator is selected for the parameter being set.

MEMO If you cut a segment that does not start and end exactly on a beat or measure bar, the following phrases will not conform to the measure bars, which then makes editing inconvenient. When inserting segments, it is best to edit the segment by measure units before continuing.

Chapter 9 Recording to an External Recorder (Mixdown)

After you have finished arranging and recording the phrases on the tracks, you can then go on to dub the song to an external recording device (such as an MD, DAT, or cassette tape recorder) while adjusting the volume balance and effects to come up with a finished product. This operation is known as **mixdown**. Correct operation of the internal mixer now becomes the key to this process.

The Mixer Setup (Image)

The SP-808's mixer section makes the internal connections shown below.

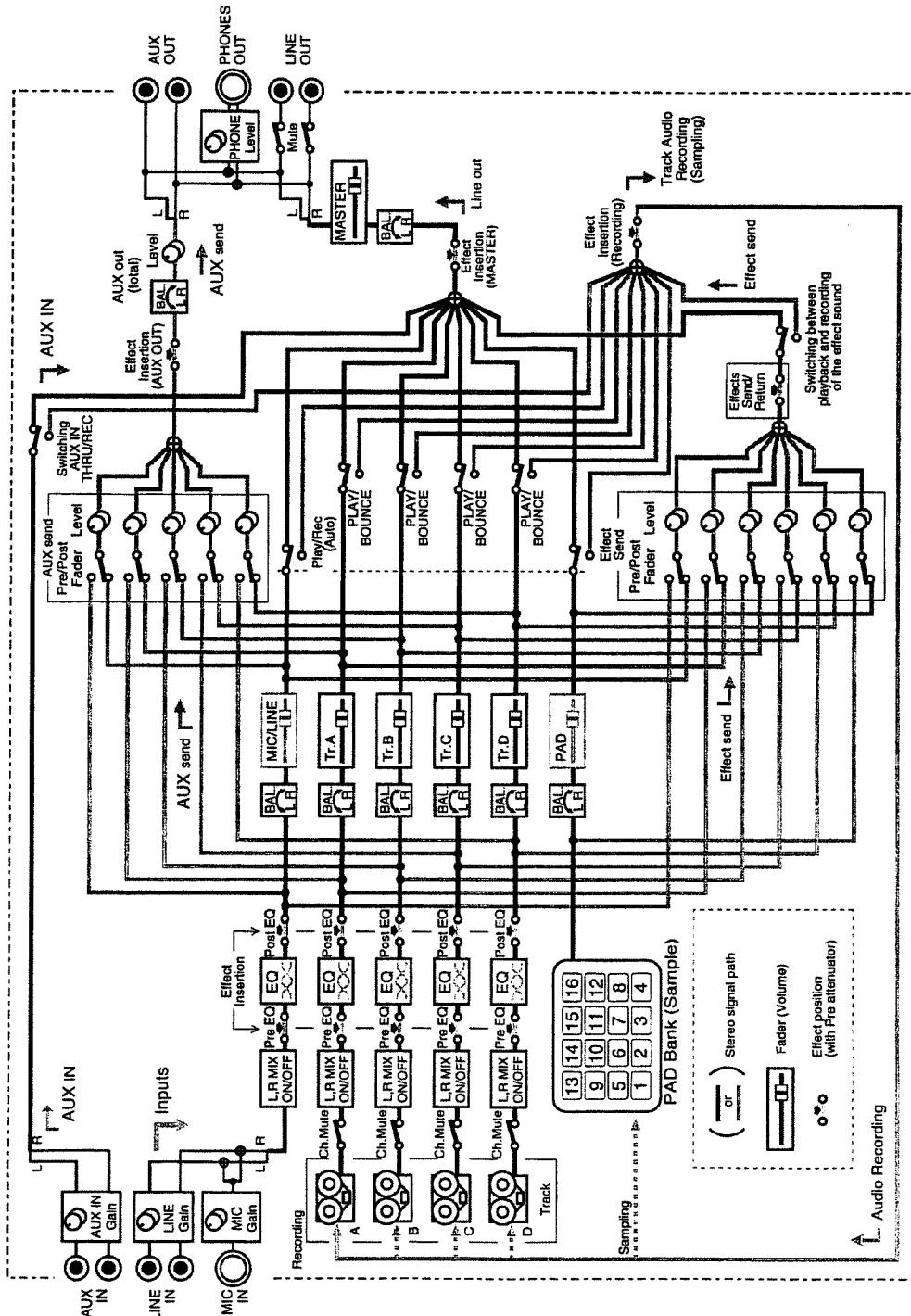

Recording to an External Recorder (Mixdown)

NOTE The mixer settings (except the fader position and some other settings) are preserved as a part of the song data when the song is saved (p. 72).

The Mixdown Process

The mixdown proceeds as shown below.

1. Connect the SP-808's MASTER OUT to the input of the external recorder.

The optional SP808-OP1 expansion is required to make the digital connection (p. 145).

2. Select effect patch of the internal effects and set it up in the mixer.
3. Press [STATUS] for the tracks to be played back so that they are illuminated in green.
4. Hold down [SHIFT] and press the Locator [CLEAR] to switch to the Mixer View screen (p. 22).
5. Play back the song from the beginning, and move the faders to achieve the volume balance you desire.
6. Press [←] or [→] to select settings such as effect send level and left-right balance for each track, and rotate the VALUE/TIME dial to make the settings.
7. Adjust the tone of each track with the equalizer (description following).
8. Adjust the recording level of the external recorder.
9. Start recording with the external recorder, then start playback on the SP-808.

Mixdown then begins.

MEMO For more detailed settings in Steps 4 and 5, hold down [SHIFT] and press [EFFECTS] on each channel, and make the settings in each track's screen. Press [▼] repeatedly to call up the Equalizer screen in Step 6.

Using the Equalizer

Pressing track's [EFFECTS] while [SHIFT] is held down, and pressing [▼] some times calls up the Equalizer screen. The equalizer used for each track is exactly the same 3-band parametric equalizer used for the MIC/LINE input. (For descriptions of each parameter displayed on the screen, → see p. 47.)

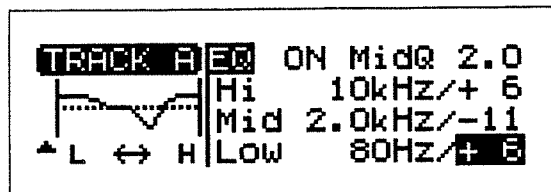

If the Stereo Balance of MASTER OUT is Uneven

Hold down [SHIFT] and press [MUTE] to call up the "MIX COMMON" screen and press [▲] to select "Balance," then rotate the VALUE/TIME dial to adjust the setting.

The range of the adjustment is from L63 (left output only) to 0 (equal left-right balance) to R63 (right output only).

To Have a Stereo Track Played Back in Monaural

Whether a phrase on the track is recorded in stereo or monaural is determined whenever it is recorded in Track Audio Recording (or when sampled to the pads). However, with the following procedure, you can **mix the left and right sounds** and play all stereo phrases on the tracks monaurally.

Playing Stereo Phrases in Monaural

1. Hold down [SHIFT] and press the track's [EFFECTS] to call up the Tr.A-D screen.
2. Check to make sure that "Merge-L&R" is selected and rotate the VALUE/TIME dial to set this to "ON."
3. Press [PLAY] to return to the basic screens.

HINT The "Balance" parameter is found in the screen that is called up in Step 1. If you select this by pressing [▲] and then rotate the VALUE/TIME dial to change the setting, the left-right volume balance then changes. When "Merge-L&R" is set to "ON" (monaural output), then the effect of changing "Balance" is like that of adjusting the panpot on an ordinary audio mixer.

Adding Internal Effects During Mixdown

Whenever adding effect, not only during mixdown, make sure the following two points are in ready.

1. Press **REALTIME EFFECTS [ON/OFF]**, illuminating it, to turn the effects on.
2. If the Realtime Effects Controller “b” (**FILTER ISOLATOR**) indicator is lit, hold down **[SHIFT]** and press **[SELECT ROW]** to switch to “a” (**PATCH**).

The Location of the Internal Effects in the Mixer

During mixdown, the main ways the internal effects are used are shown below.

Send/Return:

(The signal which level sent to the effects can be determined for each individual track, is mixed into the output through the common effects. This is used for reverb and similar effects.)

Master Insert:

(This inserts the effects into the final stereo output sent to the external recording device. This is selected for compression or Equalization to the overall signal.)

Channel Insert:

(The effect is inserted into a single specified track.)

These are selected with the following procedure.

1. Hold down **[SHIFT]** and press **[MUTE]** to call up the “**MIX COMMON**” screen.
2. Press **[▼]** twice, to move to “**FxLoc.**” (effects location).
3. Rotate the **VALUE/TIME** dial to select setting from the following.

Send/Return: “**SEND/RETURN**”

Master Insert: “**INS MASTER**”

Channel Insert: “**Tr.A PRE-EQ**” or “**Tr.A POST-EQ**”
(here “**Tr.A...**” is shown, indicating that in this case, Track A is selected).

4. Press **[PLAY]** to return to the basic screens.

When Channel Insert is Selected in Step 3

This selects whether the effect is added before or after the channel **equalizer**. When set to “**PRE-EQ**” (pre-equalizer), the effect is added before the equalizer; when set to “**POST-EQ**” (post-equalizer) the effect is added after the equalizer.

Generally, this is set to “**PRE-EQ**.” “**POST-EQ**” is used in such instances as when boosting or cutting specific frequency ranges of the signal before it goes to the effects.

For example, this is effective with the effects such as distortion and compression.

Setting Track’s Effect Send Level

When using send/return to add effects, press **[EFFECTS]** for each track channel to switch the effects for each track on and off.

(MEMO) If rather than just being illuminated, **[EFFECTS]** flashes instead when pressed, this indicates that the effect itself is turned off. When **REALTIME EFFECTS [ON/OFF]** is pressed, **[EFFECTS]** then stops flashing, and stays illuminated, indicating that the effects are active.

Furthermore, the signal level sent to the effects by each channel is set with the following procedure.

1. Hold down **[SHIFT]** and press the track’s **[EFFECTS]** to call up the track setting screen.
2. Press **[▼]** or **[▶]** to select the value at the right end of the “**Fx**” row (the effect send level).
3. Rotate the **VALUE/TIME** dial to make the setting.
4. Press **[PLAY]** to return to the basic screens.

If selecting an effect patch, use send/return to add the effect.

(Press **[FX INFO]** and rotate the **VALUE/TIME** dial to specify the effect patch, and press **[ENTER/YES]**.)

The Difference Between “Pre-Fader” and “Post-Fader”

When using the effects in send/return, this determines whether the signal is sent to the effect before or after it goes through each channel’s fader (or the stereo balance setting).

Pre-Fader:

Changing the fader value or stereo balance has no effect on the signal level sent to the effects.

Post-Fader:

Lowering the fader reduces the signal sent to the effects. This is also reflected by the channels’ stereo balance settings.

Setting Pre- and Post-Fader for the Effects

1. Hold down [SHIFT] and press track’s [EFFECTS] to call up the track setting screen.
2. Press [▼] or [▶] to select “PRE-F”(pre-fader) (or “PST-F”(post-fader)) in “Fx.”
3. Rotate the VALUE/TIME dial to switch between “PRE-F” and “PST-F.”
4. Press [PLAY] to return to the basic screens.

Inserting Compressor / EQ to MASTER OUT

During mixdown, you may want to control the signal you are going to send to the external recording device by adding compressor (limiter) to the output. In this case, set the internal effects to Master Insert (INS MASTER) (p. 93).

(MEMO) The SP-808 features algorithms (forming the basic composition of the effects) in the internal effects to use for this. (such as The effect patch P82 “03>CompEtc” which includes the comp/limiter, enhancer, parametric equalizer, and noise suppressor connected in series. → See p. 103)

When using the internal effects for other purposes (such as for total reverb), you may use the external compressor or equalizer. In such instances, connect the external effects between the SP-808 and the external recording device.

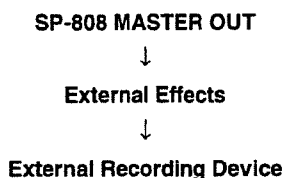

For the effects used without dry sound (compressor, equalizer, etc.), it is not effective to connect the effects to the AUX IN/OUT using the send/return method.

When the Effects Sounds are Distorted (Effects Pre Attenuator)

Combining the signals from each of the tracks and sending the signal to the effects while the resulting level remains increased can cause the signal to exceed the effect’s allowable input level, causing the sound to distort. In such instances, use the mixer’s attenuator, performing the following procedure to suppress the level.

Preventing Distortion with the Effect Input Attenuator

1. Hold down [SHIFT] and press [MUTE] to call up the “MIX COMMON” screen.
2. Press [▼] three times to call up the “FX-Signal” page.
3. Confirm that “PreFX Att” (effect pre attenuator) is selected.
4. Rotate the VALUE/TIME dial to select the appropriate level of attenuation; select 0, -3, -6, -12, -18, or -24 dB (no attenuation is applied when 0 dB is selected).
5. Press [PLAY] to return to the basic screens.

(NOTE) If no attenuation is needed, then return the setting to “0 dB.” If attenuation is left on, you will later be unable to send a strong enough signal to the effects.

Using AUX IN/OUT

The SP-808's mixer section includes stereo AUX IN and OUT capabilities.

The Sound Input from the AUX IN Jacks

Besides being able to mix output into MASTER OUT, you can use AUX IN to record to the tracks (or sample to the pads).

To the AUX OUT Jacks

After the levels of the individual tracks are determined, they are combined and sent out in stereo here. The total output level and stereo balance of AUX OUT can be set separately from the signal send level from each of the channels (p. 96).

Whether the output level is affected by the channel faders (post-fader) or not (pre-fader) is determined in each channel.

Now, here is the process, along with some points to be aware of, described in concrete terms.

Setting the Send Level and Stereo Balance to AUX OUT

The following five channels can function as sources of signals to AUX OUT.

- Tracks A, B, C, and D
- MIC/LINE INPUT

(NOTE) Signals cannot be sent to AUX OUT from the pads.

Setting AUX OUT for Each Channel

1. Hold down [SHIFT] and press [EFFECTS] for the tracks or MIC/LINE channel to call up the settings screens (for "Track A (-D)" or "MIC/LINE").
2. Press [▲], [▼], or [←] to select "PRE-F" (or "PST-F") in "Aux."
3. Rotate the VALUE/TIME dial to switch between "PRE-F" and "PST-F." (described below)
4. Press [▶] to select the value at the right end of the "Aux" row (the AUX send level).
5. Rotate the VALUE/TIME dial to set the signal send level.
6. Press [PLAY] to return to the basic screens.

The settings in Steps 2 and 3 determine the point from which the signal is sent to AUX for each channel. If "PST-F" (post-fader) is selected, the output level is influenced by the channel faders; it is affected by the channel stereo balance settings as well. When set to "PRE-F" (pre-fader), the channel faders and stereo balance settings have no effect on the signal level to AUX OUT.

Using the External Effects (Send/Return)

The SP-808 features one internal effect system. By using AUX IN/OUT, you can combine this with your own external effects device, and then add one more effects system using Send/Return. This is convenient when, for example, you want to insert the internal effects into a channel or into the MASTER OUT while simultaneously adding reverb with the external effects device.

Stereo connections for external effects are commonly made as shown below.

SP-808 AUX OUT → External Effects Device IN

SP-808 AUX IN ← External Effects Device OUT

(NOTE) Turn off the direct (dry) sound of the external effects device, outputting only the effect sound

(NOTE) Connect only full stereo or comparable **two input/two output-type** devices. Monaural devices or comparable **single input/single output-type stereo** devices are not suitable for connecting to the SP-808's AUX OUT.

(MEMO) The send level to the effects from each channel is set as described in "Setting AUX OUT for Each Channel."

(NOTE) With factory settings, the returned effect sound is recorded automatically when you use Track Audio Recording (or sampling to the pads). If you don't want the effect sounds from a connected external effects device to be recorded, after referring to the following section, "Using AUX IN as an Auxiliary Input," change the "AUX IN" setting to "THRU (→LINE)."

Using AUX IN as an Auxiliary Input

Besides being a return input for external effects devices, AUX IN can also be used as a general-purpose stereo input. Sound that's been input here is normally sent to MASTER OUT with its level unchanged.

Furthermore, during audio recording (or sampling), sound input from AUX IN is also recorded (at the factory settings). If necessary, you can also set AUX IN so that sound input from it is not recorded at all.

Preventing Sound Input from AUX IN from Being Recorded

1. Hold down [SHIFT] and press [MUTE] to call up the "MIX COMMON" screen.
2. Press [▼] repeatedly to call up the third screen (AUX In&Out)..
3. Press [▲] to select "In."
4. Rotate the VALUE/TIME dial to change the setting from "REC (orPLAY)" to "THRU(→LINE)."
5. Press [PLAY] to return to the basic screens.

Using AUX OUT as an Auxiliary Output

Besides functioning as a way to send signals to external effects devices (mentioned above), AUX OUT can also be used as a multi-purpose stereo output. By sending the pre-fader (p. 94) signal from each channel, you can set the levels for all of the channels (Tracks A–D and MIC/LINE) independently from MASTER OUT. Additionally, you can output the pad sounds from AUX OUT.

Setting the AUX OUT Level and the Stereo Balance

1. Hold down [SHIFT] and press [MUTE] to call up the “MIX COMMON” screen.
2. Press [▼] repeatedly to call up the third screen (AUX In&Out).
3. Press [▼], [▲], or [←] to select “Out Lev.”
4. Rotate the VALUE/TIME dial to set the Aux out level.
5. Press [→] to select “Bal.”
6. Rotate the VALUE/TIME dial to set the Aux out stereo balance.
7. Press [PLAY] to return to the basic screens.

An Example of Using AUX OUT as a Monitor Out

You can use the AUX OUT as a Monitor Out when playing back sounds from the SP-808 during a performance on stage. For example, you may want the sounds going out to the audience from Tracks A–C to be recorded as well as sent out from MASTER OUT. You can have percussion instruments playing quarter notes repeatedly, or some other kind of rhythm guide sound on Track D output from AUX OUT. With this setup, you can connect AUX OUT to a monitor headphone amp for the drummer.

When You Want to Use the Insert Method to Add Internal Effects to AUX OUT

When setting up the effects (such as in the third MIX COMMON screen → see p. 93), by selecting “INS AUX-OUT,” you can insert the effects into AUX OUT.

AUX OUT can also be used as a pad cue (p. 42). Furthermore, if you are using an optional multi I/O expansion, you can use it as a Track D direct out. (With the multi I/O expansion, Tracks A–C are already equipped with direct outs.) In either case you can switch the function in AUX Out Jack mode.

1. Hold down [SHIFT] and press [MUTE] to call up the “MIX COMMON” screen.
2. Press [▼] repeatedly to call up the third screen (AUX In&Out).
3. Press [▼] to select “OutJackMode.”
4. Rotate the VALUE/TIME dial to select from “AUX” (usual setting), “PAD CUE” (Pad Cue function → see p. 42), and “Track D” (Track D direct out → see p. 150).
5. Press [PLAY] to return to the basic screens.

Used With MIC/LINE IN

MIC/LINE IN is active not only when sampling, but also all the time. You can use MIC/LINE IN to insert equalizer and effects independently and send signals to AUX OUT. Thus, as an input during mixdown, it offers greater functionality than AUX OUT.

- When mixing down during synchronization (p. 153) with an external MIDI sequencer, connect the output of the external sound device and mix down.
- When equalizing the sound returned from external effects devices, use this for input return instead of AUX IN.
- When performing live, by connecting a headset mic, you can mix in your voice.

You can find other uses for this as well.

(NOTE) With the optional SP808-OP1 installed, when you receive signals from the DIGITAL OUT of an external device, the MIC/LINE IN jack cannot be used (only AUX IN can be used).

Chapter 10 Using the Internal Effects

The Different Uses of the Send/Return and Insert Methods

Examples of the use of the send/return and insert methods were introduced previously; in the sections on sampling (Chapter 3), track audio recording (Chapter 6), and mixdown (Chapter 9). In the following, the differences in the ways Send/Return and Insert are used is explained.

Applying Effects Using the Send/Return Method

You can use the send/return method with the effects types which mix the source sounds with the effected sounds (such as reverb or delay). With the send/return method, the effect can be used in multiple mixer channels. Furthermore, the send level from each channel can be adjusted, which means that the amount of effect can also be adjusted for each channel.

MEMO For a description of the procedure for adding effects, please refer to "Adding Internal Effects During Mixdown" (p. 93).

MEMO The send/return method uses an effects patch which has its source sound volume settings (e.g. Dry Level) set to 0.

MEMO If the effect sound is distorted, you can trim the input level to effects with the attenuator (PreFxAtt) in the second screen of the "MIX COMMON" screen. (p. 94)

MEMO In the Mixer View screen, you can adjust the send level to the effects while watching the status of all the channels. To call up the screen, hold down [SHIFT] and press LOCATOR [CLEAR]. To change settings, press [←] or [→] to move ▲ at the bottom of the screen to the desired channel, then rotate the VALUE/TIME dial to make the changes.

NOTE The signal of effects return is usually mixed into MASTER OUT. In addition, during track audio recording or sampling, it is automatically returned to the tracks or pads. However, when the "Return" parameter in the second screen of the "MIX COMMON" is set to "PLAY-ONLY," then even during track audio recording or sampling, the effects sound is mixed into MASTER OUT. In this condition, the effects sound is not recorded.

Applying Effects Using the Insert Method

The effects that use only processed sounds (such as compressor, wah, phaser or etc.) without mixing the dry sounds, are normally inserted into the mixer signal path. You can select MASTER OUT, AUX OUT, the input of each channel, or the recording signal line, as the insert destination. To add the effects with the insert method, switch the effects to the Insert position (p. 93) and press REALTIME EFFECTS [ON/OFF] to turn the effects on.

MEMO When inserting into each channel, you can either have the signal be input before the channel's equalizer (PRE-EQ), or after equalization (POST-EQ) (p. 93).

MEMO You can also use the effects that mix the dry sounds with the processed sounds (such as reverb or delay) with insert method. In such instances, the dry sound volume settings are raised in the effects patches. (It is acceptable not to raise the setting when the effect sound alone is being used for a particular effect.)

What It Means When [EFFECTS] is Illuminated or Unlit

[EFFECTS] for each channel (Tracks A, B, C, and D and MIC/LINE) determines whether or not that channel has effects applied to it. However, this changes according to the effect position, as shown below.

With the Send/Return Method

Illuminated: The signal is sent to the effects.

Flashing: The signal is being sent to the effects, but the effect (REALTIME EFFECTS [ON/OFF]) is turned off.

Unlit: The signal is not sent to the effects.

Pressing REALTIME EFFECTS [ON/OFF]:
This turns the effects on and off.

Pressing [EFFECTS]:
This determines whether the signal is sent to the effects or not.

NOTE Even when [EFFECTS] is illuminated, no effect is added if the effect send level is turned completely down.

When Inserting Into One of Mixer Channels

Illuminated: The effect is inserted into the channel, and the effect is turned on.

Flashing: The effect is inserted into the channel, but the effect is turned off.

Unlit: The effect is not inserted into the channel, and no effect is applied.

Pressing REALTIME EFFECTS [ON/OFF]:
This turns the effects on and off.

Pressing [EFFECTS] when illuminated or flashing:
Same as above.

Pressing [EFFECTS] when it is not lit:
Nothing occurs.

When Inserting Into MASTER OUT or the Recording Signal Line

Illuminated: The effect is inserted and turned on.

Unlit: The effect is turned off.

Using the Internal Effects

Pressing **REALTIME EFFECTS [ON/OFF]**:

This turns the effects on and off.

Pressing **[EFFECTS]** when illuminated:

This turns all effects off.

When Inserting Into AUX Out

All **[EFFECTS]** are unlit. Nothing occurs when they are pressed.

Pressing **REALTIME EFFECTS [ON/OFF]**:

This turns the effects on and off.

Editing and Saving Effects

The SP-808's internal effects are furnished with 99 different (read-only) Preset effects patches. You can also edit the effects settings and then save them as (rewritable) User effects patches (99 of these can be saved on a single Zip disk).↗

Editing progresses as shown below.

1. Select the type of effects (the algorithm) to be edited.
2. Edit the effects.
3. Save to a specified User effects patch.

Selecting the Type of Effect (Algorithm)

You can select one of twenty different effect algorithms (type of effects). When switching algorithms, select one from the Preset effects patches P80-P99 in the Effects Information screen (press **[FX INFO]** and rotate the **VALUE/TIME** dial to select, then press **[ENTER/YES]** to set). These effects patches have been prepared as templates for creating patches.

(MEMO) For further descriptions of each algorithm's function, please refer to p. 101-128.

Algorithm	Template Effects patch	Function
01 ISOLATOR & FILTER	P80 01>Iso&Fil	Isolator + Filter
02 CENTER CANCELER	P81 02>Ct.Canc	Center Canceler
03 STEREO DYNAMICS PROCESSOR	P82 03>CompEtc	Comp/Limiter, Enhancer, Other Effects
04 REVERB & GATE	P83 04>Rev&Gat	Pre-EQ + Reverb + Gate
05 TAPE ECHO 201	P84 05>TapeEch	Virtual Tape Echo
06 EZ DELAY	P85 06>ezDelay	Digital Delay
07 DELAY RSS	P86 07>DlayRSS	3-D Stereo Delay
08 ANALOG DELAY & CHORUS	P87 08>AnlgD&C	Virtual Analog Delay + Chorus
09 DIGITAL CHORUS	P88 09>DigiCho	Digital Chorus
10 4 BUTTON CHORUS 320	P89 10>4butn C	SDD-320 (Spatial Effect) Simulator
11 VINTAGE FLANGER 325	P90 11>FIng325	SBF-325 (Analog Flanger) Simulator
12 2x BOSS FLANGER	P91 12>FIngBx2	Two Virtual "BOSS Flangers" Connected in Parallel
13 STEREO PITCH SHIFTER	P92 13>Pit-Sft	Stereo Pitch Shifter
14 80s PHASER	P93 14>80sPhas	Two 1980's-Type Rack Mount Phasers (Stereo Linked)
15 STEREO AUTO WAH	P94 15>2xA.Wah	Stereo Auto Wah
16 STEREO DISTORTION	P95 16>2xDist	Stereo Distortion
17 PHONOGRAPH	P96 17>Records	Analog Record Simulator
18 RADIO TUNING	P97 18>Radio	AM Radio Simulator
19 LO-FI PROCESSOR	P98 19>Lo-Fi	Bit Dropped/Sampling Frequency Dropped
20 VIRTUAL ANALOG SYNTH	P99 20>AnlgSyn	Virtual Analog Synthesizer (and Ring Modulator) + Delay, etc.

Effects are Edited in Each of the Following Screens

1. In the "FX SW" (Effects Switch) screen, select the effects patches and turn the each section of effects on and off.

(To call up the "FX SW" screen, hold down **[SHIFT]** and press **[FX INFO]**.)

2. In the "FX" (Parameter List) screen, select and set the parameters in each effect.

(To call up this screen from "FX SW," highlight abbreviation of the effect name, and press **[ENTER/YES]**.)

3. In the "SAVE" screen, save the content of effects' settings to effects patches.

(To call up the Save screen, hold down **[SHIFT]** and press **[ENTER/YES]** (p. 100).)

(MEMO) If required, effects parameters can be assigned to the Realtime Effects knobs, D Beam Controller, or Step Modulator, and the changing range, can be set in the **Control Assign screen** (how to call this up is described later).

MEMO In the "FX LOCATION" (Effects Location Register) screen, you can make the effects position in mixer is memorized to the effects patch. When you set the mixer's "FxLoc." setting to "-- (FX PATCH)" the memorized positions are selected when that effects patch is called up (how this is called up is explained later).

The operations in each screen are described in concrete terms below.

"FX SW" (Effects Switch) Screen

The effect in use is laid out horizontally. Press [▲], [▼], [←], or [→] to highlight and set each parameter, including the effects patch number, abbreviations of the effect name (e. g. EQ and Rev), "CTL" (control), and "LOC" (location). You can select effects patches and turn them on and off by rotating the VALUE/TIME dial.

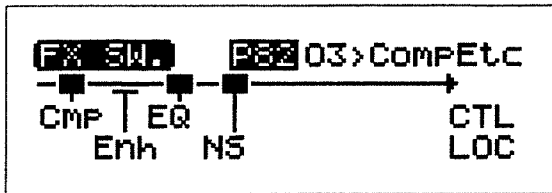

While the Effects Patch Number is Highlighted

VALUE/TIME dial:

Rotate to switch to ready another patch for switching.

[ENTER/YES]:

Press to execute the switch to the patch selected with the VALUE/TIME dial. (If this is pressed without the VALUE/TIME dial having been used, the beginning of the Parameter List screen is called up.)

NOTE Any changes made to the settings are nullified if the patch is switched before the changes are saved.

While the Effect Name's Abbreviations is Highlighted

VALUE/TIME dial:

Rotate to turn EQ, Rev, and each of the other effects on and off.

[ENTER/YES]:

Press to call up the Parameter List screen for that effects section.

NOTE The number of effects sections varies with the algorithm.

While CTL is Highlighted

[ENTER/YES]:

Press to switch to the Control Assign screen.

(The VALUE/TIME dial is disabled.)

While LOC is Highlighted

[ENTER/YES]:

Press to switch to the Effect Locator Register screen. (LOC stands for Location. The VALUE/TIME dial is disabled.)

Parameter List Screen

Here, you can make changes to the detailed parameters in each of the effects (e. g. time and level for reverb), which are displayed in list form.

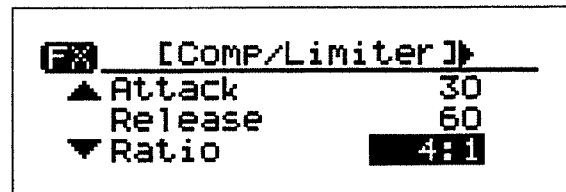

[▲] and [▼]:

Press these to highlight and select parameter.

VALUE/TIME dial:

Rotate to change the parameter's setting.

[←] and [→]:

Press these to switch the effects in algorithms that are used by multiple effects.

[EXIT/NO]:

Press this to return to the "FX SW" screen.

Control Assign Screen

Make settings to the signals controlling C1–C6 (C5 and C6 share the value with the D Beam Controller) and Step Modulator and the effects parameters controlling [StM1] and [StM2] in this screen.

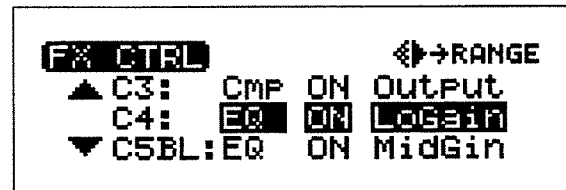

[▲] and [▼]:

Press these to select control signal to be set.

C1–C4: Assignment to the Realtime Effects knob.

Using the Internal Effects

C5BL, C6BR: Assignment to the Realtime Effects knob or the D Beam Controller's left (BL) and right (BR) sides.

StM1, StM2: Assignment to the two value changings which outputted from Step Modulator.

VALUE/TIME dial:

Rotate to change the control signal settings.

[←] and [→]:

Press these to switch the Control Assign screen to the Range screen in which the control signal range is determined vice versa. Also use the cursor moving buttons once on the Range screen.

[EXIT/NO]:

Press this to return to the "FX SW" screen.

[MEMO] Please refer to "Using the Realtime Effects Section" (p. 128).

[NOTE] The Range screen is the only screen that appears in the Control Assign screen for the "b" group of effects (Master Filter/Isolator). This assignment is fixed.

[NOTE] When parameters that are switched on or off are assigned to the Realtime Effects knobs, the boundary between on and off is normally at the center position. However, only with **Trigger In** of Algorithm 20, "VIRTUAL ANALOG SYNTH," when **controlling the effect with the D Beam Controller**, the parameter is turned off by completely lowering the number, and raising it even slightly from that position turns the parameter on. (This is to secure sufficient leeway for the effect to be turned on when using the D Beam Controller to play sounds.)

Effects Location Register Screen

This screen is used for setting the positions of the effects to be memorized in effects patches. The setting here is effective only when "FxLoc." in the "MIX COMMON" screen (p. 27) is set to "-" (PATCH). If you want to check the current "FxLoc." setting, it is indicated in the square brackets ([]) at the bottom of the screen.

```
FX LOCATION
PatchLoc INS MASTER
          <Now Invalid>
Mixer... [SEND/RETURN ]
```

VALUE/TIME dial:

Rotate to select the effect position.

[EXIT/NO]:

Press this to return to the "FX SW" screen.

([ENTER/YES], [▲], [▼], [←], and [→] have no function.)

Saving Settings to the User Effects Patches

Changes to the effects settings are lost if the power is turned off or if you switch to a different effects patch. Use the **procedure for saving effects patches** when you want to save these changes. When you save a patch, the controller assignment, effective ranges, and the Step Modulator settings are also save as patch data.

Saving Effects Patches

1. Hold down [SHIFT] and press [ENTER/YES] to call up the Save screen.
2. Press [▼] to select "EFFECTS PATCH" and press [ENTER/YES]; this takes you to the "SAVE EFFECTS PATCH" screen.
3. Rotate the VALUE/TIME dial to select the User effects patch to be used as the save destination.
4. If required, press [▼] to move the cursor to the line containing the effects patch name, and set that name. (Press [←] or [→] and rotate the VALUE/TIME dial or press the pads to input the name. This is the same process described when entering the song name on p. 72.)
5. Press [ENTER/YES].
The confirmation message "ARE YOU SURE?" appears in the display.
6. Press [ENTER/YES] again, the save is executed.
7. Press [PLAY] to return to the basic screens.

[NOTE] When saving an effects patch, any patch previously stored in the User effects patch specified as the save destination is lost.

[NOTE] If you select "OverwriteALL" instead of "EFFECTS Patch" in Step 2, the Save Song procedure (p. 72) is carried out simultaneously. In this case, a message warning that the old song and effects patch data will be lost appears in the display. Press [ENTER/YES] to execute the save.

[NOTE] In Step 3, the source effects patch number is temporarily assigned to the save destination. If the source effects patch is one of the Preset effects patches, "***" is indicated for the destination number. In this case, you cannot save the patch unless you set the save destination effects patch number.

The Algorithms and Effects

The function and parameters of each algorithm is described in the following.

NOTE The parameter names of algorithms that faithfully reproduce vintage analog effects device have been named after the original machines' parameters. Therefore, similar effects parameters may still be named differently.

NOTE When you use an algorithm which has the function that synchronize the time or cycle to the song tempo, if "?" appears before the note symbol you set, it is because the upper (or lower) limit of the setting range has been exceeded, and that the synchronization is not correct.

NOTE The effects knobs, the D Beam Controller, and the Step Modulator can control specified effects parameters. Please note, however, that depending on the parameter selected, there might be some switching noise while these effects controllers are working.

01 ISOLATOR & FILTER

A 3-band isolator, filter, and low booster are connected in stereo in series.

MEMO This algorithm is applied using the insert method.

MEMO The **Master Filter/Isolator** which obtained by switching "a:PATCH" to "b:FILTER ISOLATOR" in the Realtime Effects section, is composed by the same algorithm as this. However, it differs about it has no capability to use the isolator and the other effects at same time.

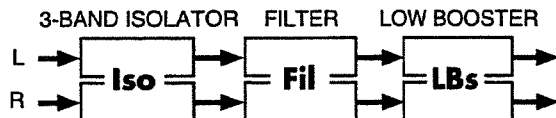

Iso (3-Band Isolator)

This effect separates the input sound into three frequency bands, High, Mid, and Low, and cuts or extracts them.

Level High

Level Mid

Level Low

Value: -60 dB – $+4\text{ dB}$

These cut (or increase) each frequency band. At -60 dB , the sound becomes inaudible. 0 dB is equivalent to the input level of the sound.

AntiPhs Md (Mid Anti-Phase On/Off)

Value: ON, OFF

Level (Mid Anti-Phase Level)

Value: 0–100

AntiPhs Lo (Low Anti-Phase On/Off)

Value: ON, OFF

Level (Low Anti-Phase Level)

Value: 0–100

This turns the Anti-Phase function on and off and sets the level settings for the low and mid frequency ranges. When turned on, the counter-channel of stereo sound is inverted and added to the signal. The level setting allows you to achieve the effect of extracting only a particular part. (This is effective only for stereo source.)

MEMO In this algorithm, the functions of the machines that make up the basics for remix artists and pro DJs have been minutely analyzed and reproduced. Whereas with ordinary equalizers, some sound is still audible even when the gain is turned all the way down, the Isolator completely cuts off the sound. By turning this on and off and changing each level in realtime, you can get the effect of having the sound of particular parts appear and disappear.

Fil (Filter)

These filters allow you to modify the frequency response of the input sound widely and give sound a style.

Type

Value: LPF, BPF, HPF, NOTCH

Sets the type of filter used.

LPF (Low pass filter):

Passes frequencies below the cutoff frequency.

BPF (Band pass filter):

Passes frequencies near the cutoff frequency.

HPF (High pass filter):

Passes frequencies above the cutoff frequency.

NOTCH (Notch filter):

Passes frequencies other than those near the cutoff frequency.

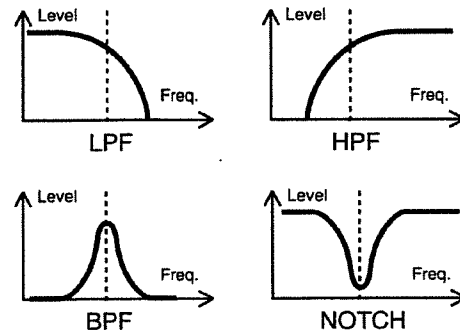

Slope (oct)

Value: -12 dB , -24 dB

Sets the filter's attenuation slope (-24 dB per one octave: steep; -12 dB per one octave: shallow).

CutOffFreq (Cutoff Frequency)

Value: 0–100

Sets the filter's cutoff frequency. Set this closer to zero, the cutoff frequency becomes lower; set closer to 100, the cutoff frequency becomes higher.

Resonance

Value: 0–100

Sets the filter's resonance level. Raising the setting increases resonance near the cutoff frequency, giving the sound a special characteristic.

(NOTE) *If the resonance value is raised too much, loud strange sound (known as oscillation) begins to appear. Take care not to allow this sound to damage your ears or your playback equipments. Press REALTIME EFFECTS [ON/OFF] to stop this immediately.*

Gain

Value: 0–24 dB

This compensates for the volume dropped in the cut frequency range with some filters. The level of compensation increases as the value is increased, and raise the volume.

LBs (Low Booster)

This emphasizes the bottom to create a heavy bass sound.

BoostLevel

Value: 0–100

Increasing this value gives you a heavier low end. (Depending on the Isolator and filter settings this effect may be hard to distinguish.)

02 CENTER CANCELLER

Center Canceller is an effect that cuts out the sounds positioned in the middle of the stereo field. Furthermore, a 3-band parametric equalizer is connected in series.

(MEMO) *This algorithm is applied using the insert method.*

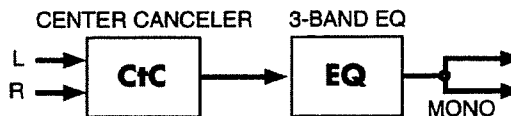

CtC (Center Canceller)

This cuts sounds in the center of the stereo field (such as vocals).

Position (Cancel Position)

Value: -50–+50

This is for finer adjustment of the cut position. Adjust this so that the sound is cut fully.

Lo-F Limit (Low Frequency Limit)

Value: THRU, 20–2000 Hz

Hi-F Limit (High Frequency Limit)

Value: 1.0–20.0 kHz, THRU

These set the upper and lower limits of the frequency range to be cut. When "THRU" is selected, the frequencies to be cut are not limited.

(HINT) *The sound is outputted in monaural. Although you can get a similar effect by using the Anti-Phase function in Algorithm 01 (Isolator + Filter), this algorithm differs in that you can specify the upper and lower frequency limits of the effect. This is especially effective when cutting vocals, for example.*

(NOTE) *This has no effect if the input sound is monaural. Additionally, even in stereo, the result of cutting may differ depending on the particular recording.*

EQ (3-Band Equalizer)

This equalizer works in three frequency ranges: Low, Midrange, and High. You can set the frequencies and boost or cut the level.

Low Type

Value: SHELV, PEAK

This switches the Low EQ curve characteristics (peaking-type/shelving-type: refer to figure in next page).

Low GainValue: -12 – $+12$ dB

Sets the gain (boost or cut) of the equalizer.

Low Freq

Value: 20–2000 Hz

Sets the reference for the frequency range to be boost or cut. With the peaking-type equalizer, this means the center frequency; with the shelving-type equalizer, this becomes the cutoff frequency.

Low Q

Value: 0.3–16.0

When the low-frequency equalizer is set to the peaking type, this sets the bandwidth of the sound that is boost or cut. As the frequency value becomes bigger the bandwidth becomes narrower. (refer to the figure; this is disabled with the shelving-type equalizer.)

Mid GainValue: -12 – $+1$ 2dB**Mid Freq**

Value: 200–8000 Hz

Mid Q

Value: 0.3–16.0

Just as the low-frequency equalizer, this sets the gain, center frequency, and Q (bandwidth) for the midrange equalizer.

(This is a peaking-only equalizer.)

High Type

Value: SHELVE, PEAK

Frequency response of the shelving type has opposite curve of the next figure (Low EQ).

High GainValue: -12 – $+12$ dB**High Freq**

Value: 1.4–20.0 kHz

High Q

Value: 0.3–16.0

Just as the low-frequency equalizer, this sets the gain, center frequency, and Q (bandwidth) for the high-frequency equalizer.

Out LevelValue: -12 – $+12$ dB

Sets the output volume.

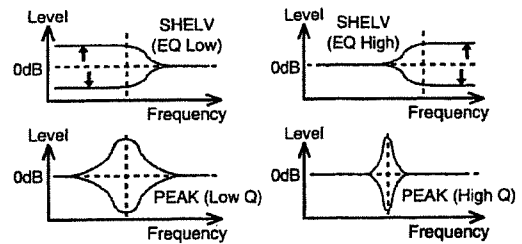
**03 STEREO DYNAMICS PROCESSOR**

A comp/limiter, enhancer, 3-band equalizer, and noise suppressor are connected in series. This is a convenient as an overall effect applied during mixdown, or as a way to compensate for input sounds when sampling.

MEMO This algorithm is applied using the insert method.

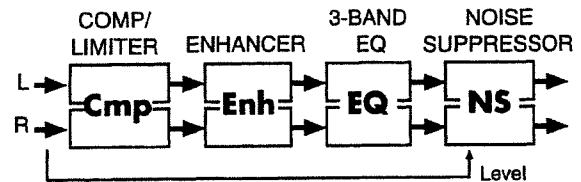
**Comp (Comp/Limiter)**

This effect is able to use as a compressor, which controls inconsistencies in sound levels by suppressing high sound levels while lifting weaker signals, or as a limiter that prevents the signal from reaching exceedingly high levels.

ThresholdValue: -60 –0 dB

Sets the volume level at which the compression begins.

Attack

Value: 0–100

Sets the time after the sound volume is crossed the threshold level until compression begins.

Release

Value: 0–100

Sets the time for compression to stop after the sound falls back under the threshold level.

Ratio

Value: 1.5:1, 2:1, 4:1, 100:1

Sets the “source sound:output sound” compression ratio.

Using the Internal Effects

Out Level

Value: -60 – $+12$ dB

Sets the output volume.

HINT When used as a limiter, set the Ratio to 100:1 with a short release time. If the volume exceeds the threshold level, the sound is suppressed instantly detected as the excess input.

Enh (Enhancer)

This effect regulates the high-end overtones, clarifying the sound and the sound contour.

Sens

Value: 0–100

Sets the degree to which the Enhancer is applied.

Frequency

Value: 1.0–10.0 kHz

Sets the lower limit of the frequencies to which the enhancement effect is added.

MX Level

Value: 0–100

Sets the level of the overtones produced by the Enhancer that is mixed in with the source sound.

Out Level

Value: 0–100

Sets the output volume.

EQ (3-Band Equalizer)

This equalizer works in three frequency ranges: Low, Midrange, and High. You can set the frequencies and boost or cut the level.

Low Type

Value: SHELV, PEAK

Low Gain

Value: -12 – $+12$ dB

Low Freq

Value: 20–2000 Hz

Low Q

Value: 0.3–16.0

Mid Gain

Value: -12 – $+12$ dB

Mid Freq

Value: 200–8000 Hz

Mid Q

Value: 0.3–16.0

High Type

Value: SHELV, PEAK

High Gain

Value: -12 – $+12$ dB

High Freq

Value: 1.4–20.0 kHz

High Q

Value: 0.3–16.0

Out Level

Value: -12 – $+12$ dB

These parameters are the same as those in the 3-band equalizer in Algorithm 2 (CENTER CANCELLER) (p. 102, 103).

NS (Noise Suppressor)

This suppresses noise (such as background noise and hum from mics) when no sound is being played. The noise suppressor watches at the input level at the top of the chain of effects, and when there is no input, turns down any output at the end.

Threshold

Value: 0–100

Sets the volume level at which starts muting. Set the value higher when there is a lot of noise, and if there is less noise, decrease the value.

Release

Value: 0–100

Sets the time from when the muting starts until the volume reaches 0.

MEMO If the threshold level is set too low, the effect is lost; when set too high, even the sounds you want will be muted. In addition, if the release time is set too long, the releasing noise becomes audible; when set too short, it sounds unnatural. Set these to suitable point for the input noise conditions at the time.

04 REVERB & GATE

This digital reverb creates a variety of room or hall reverberation sounds. A 3-band equalizer is placed in series ahead of the reverb. Furthermore, you can get additional special effects with the gate function.

MEMO Use the send/return method with this algorithm.

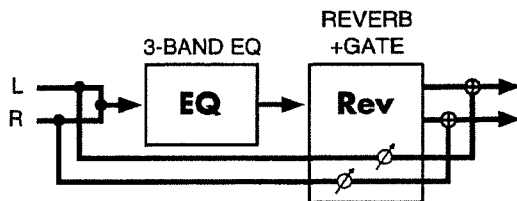

EQ (3-Band Equalizer)

This equalizer works in three frequency ranges: Low, Midrange, and High. You can set the frequencies and boost or cut the level.

Low Type

Value: SHELV, PEAK

Low Gain

Value: -12 – $+12$ dB

Low Freq

Value: 20–2000 Hz

Low Q

Value: 0.3–16.0

Mid Gain

Value: -12 – $+12$ dB

Mid Freq

Value: 200–8000 Hz

Mid Q

Value: 0.3–16.0

High Type

Value: SHELV, PEAK

High Gain

Value: -12 – $+12$ dB

High Freq

Value: 1.4–20.0 kHz

High Q

Value: 0.3–16.0

Out Level

Value: -12 – $+12$ dB

These parameters are the same as those in the 3-band equalizer in Algorithm 2 (CENTER CANCELLER) (p. 102).

Rev (Reverb & Gate)

This is a high-quality digital reverb. It is also equipped with a gate function to cut the reverb sound as it is produced, providing you with gated reverb, reverse reverb, ducking reverb, and other particular effects.

Room Size

Value: 5–40 m

Sets the size of the room. For example, the setting "10m" gives you reverb as it would sound in a single space 10 meters wide.

Rev Time

Value: 0.1–32 sec

Sets the reverb time in seconds.

Pre Delay

Value: 0–200 msec

Sets the delay time between the source sound and the point at which the reverb sound is started. This indicates distance from the source of the sound.

Diffusion

Value: 0–100

Increasing this value intensifies the sense of spatial width. This is effective when playing back in stereo.

Density

Value: 0–100

Increasing this value makes the reverb sound denser. For hall or garage sounds, make this thinner.

Early Ref. (Early Reflection)

Value: 0–100

When the value for this is set higher, the volume of the early reflections is increased.

(Early reflections are the direct reflections off the walls. You can hear this scattered in the beginning of the reverb sound.)

Using the Internal Effects

LoDampFreq

Value: 50 Hz–4000 Hz

Sets the upper frequency limit of the range to be damped by "Low Damp." The Low Damp function damps the low frequency band of the reverb sound quicker than other bands, which makes for a clearer reverb effect.

LoDampGain

Value: ~36 dB–0 dB

Sets the degree of the Low Damp.

HiDampFreq

Value: 1 kHz–20 kHz

In the natural world, the high frequencies in reverberation die out quicker than other bands. High Damp, by attenuating the higher frequencies first, makes the reverb sound more natural.

Sets the lower frequency limit of the range to be damped.

HiDampGain

Value: 36 dB–0 dB

Sets the degree of the High Damp.

HINT By combining Low Damp and High Damp, you can indicate the qualities of the room such as surface material (or the sound absorption properties thereof.)

HiCutFreq

Value: 0.2 kHz–20 kHz

Upper band than this frequency of the reverb sound are gently cut to make the reverberation more stable. This does not make time-based changes.

GT Switch (Gate Switch)

Value: OFF, ON

This turns on and off the gate function that cuts the output of the reverb sound based on the volume of the source sound.

GT Mode

Value: GATE, DUCK

GATE: (Gate Reverb) When the source volume falls below a certain level, the gate closes, giving the effect of the reverb sound being cut with a gate reverb.

DUCK: (Ducking Reverb) When the source volume gets high enough, the gate closes, which gives a ducking reverb-type effect. Stop the reverb sound only when input loud sound so that prevent the play sound become unclear.

GT Thresh (Threshold Level)

Value: 0–100

Sets the input volume level at which starts closing the gate to cut the reverb sound.

GT Attack

Value: 1–100

Sets the time it takes the gate fully opens after being triggered.

GT Hold

Value: 1–100

Sets the time it takes the gate starts closing after the instant the source sound goes under the threshold level.

GT Release

Value: 1–100

Sets the time it takes the gate fully closes after passes by the hold time.

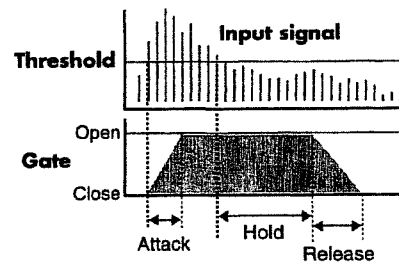

FX Level

Value: 0–100

Sets the volume of the reverb sound. When use this algorithm in insertion, lower it to get a balance with the dry level.

Dry Level

Value: 0–100

Sets the volume of the source sound. Set this to 0 when using the send/return method. Raise this when using the insert method to mix the source sound into the output.

HINT To make the gate settings easy when using the gate function to get special reverb effects, make reverb times longer. In such instances, instead of using Low Damp or High Damp to change the tone, do this with the High Cut frequency settings or through equalization at an earlier stage. To get sharp gate reverb, make the attack and release times extremely short, and set expression time to match the rhythm with the hold time setting. To get reverse reverb, make the attack time plenty long, and keep the release time short.

05 TAPE ECHO 201

This virtual tape echo gives you real tape delay sound.

MEMO This algorithm is usually used with the send/return method.

TpE (Tape Echo)

This simulates the tape echo part of Roland's RE-201 Space Echo.

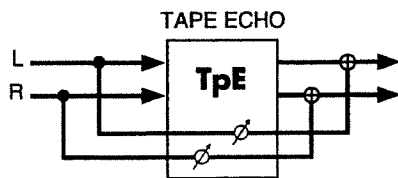

Mode

Value: 1-7

The RE-201 had three playback heads to make different delay times (Short, Medium, and Long delay) at once. Use Modes 1-7 to set the combination of playback heads to be used. For example, in Mode 4, the short and middle heads are selected, and this is indicated by "4:S+M" on the screen.

Repeat Rate

Value: 0-100

Sets the tape speed. This corresponds to the delay time in a contemporary delay effect. As the value is increased, the interval of the delay sounds is shortened.

Intensity

Value: 0-100

Sets the repeat times of the delayed sound. This is analogous to a contemporary delay's feedback setting. Raising this value increases the number of repeats.

Bass Treble

Value: -100-+100

These are the echo sound's bass and treble adjustments. When set to 0, they make no change to the sound.

Head S Pan

Head M Pan

Head L Pan

Value: L63-R63

These are the pan (left-right) settings for each of the heads for Short, Medium, and Long delay time. This parameter does not appear on the original RE-201.

Tape Dist.

Value: 0-5 (Tape Distortion)

This parameter adds the distortion characteristic of tape. It reproduces that subtle change in tone that can only be measured with equipments. The distortion gets more intense as the value is increased.

W/F Rate (Wow/Flutter Rate)

W/F Depth (Wow/Flutter Depth)

Value: 0-100

The wavering of multiple pitches that appears from tape wear and irregularities in rotation is called wow and flutter. (This phenomenon is called "wow" when it occurs at slow rotation speeds, and "flutter" when the tape is run quickly.) The wavering becomes more rapid the higher the Wow/Flutter rate is set. The wavering deepens as the Wow/Flutter depth setting is increased.

FX Level

Value: 0-100

Sets the volume of the echo sound. When use this algorithm in insertion, lower it to get a balance with the dry level.

Dry Level

Value: 0-100

Sets the volume of the source sound. Set this to 0 when using the send/return method. Raise this when using the insert method to mix the source sound into the output.

HINT Since the RE-201 SPACE ECHO has been released in 1974, a great number of fans are still using. This algorithm faithfully reproduces the sound of the original unit's tape echo section based on the real unit and the data when it was developed. What's more, it includes settings to express the sway caused by the motor, distortion, and panning for each of the three heads (something the original lacked). Now, you can easily get this warm, Lo-Fi echo sound, something different than the clear sound of today's digital delays. You can change the repeat rate (tape speed) with the Realtime Effects knobs, and enjoy the realistic feeling of operating this vintage device.

06 EZ DELAY

This is a simple digital delay featuring high-quality sound. Depending on the length of the delay you set, you can get long echoes, thick sounds, or spatial sounds. You can also synchronize the delay time with song tempos.

MEMO This algorithm is usually used with the send/return method.

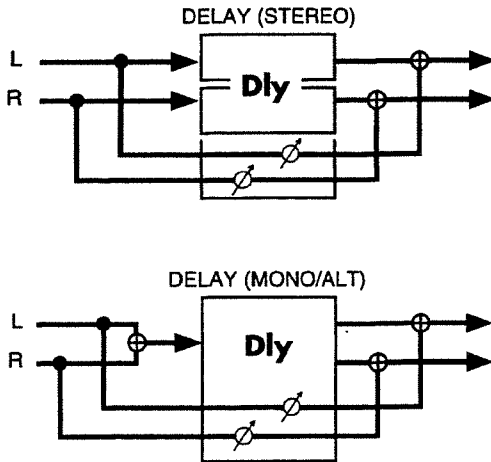

Dly (EZ Delay)

This digital delay can be switched between stereo, mono, and alternate settings, and the delay time can be synchronized with a song's tempo. It features a maximum delay of 1200 msec (1.2 seconds).

Mode

Value: MONO, ST, ALT

This switches stereo, monaural, or alternate.

MONO: This is a single-input, dual-output delay. Stereo sound (left and right) are mixed before being input.

ST: This is a dual-input, dual-output delay. The delay sound output features the same stereo placement as that of the input.

ALT: The left and right delay sound output alternately.

Time

Value: 1–1200 msec

Sets the delay time, that is, the elapsed time between the source sound and the delay sound. When in mono or stereo mode, the settings value is limited by the left-right shift settings. In alternate mode, this is limited to 0–600 msec.

When Tempo Sync (explained below) is active, this setting is not effective, and you cannot make this setting.

L-R Shift

Value: L1199–R1199 msec

Of the delayed sounds on the left and right, the delay time is increased on only one side, shifting expression of the sound. Depending on the time setting, settings values may be limited. This is disabled in alternate mode, and you cannot make its setting.

L-R Order

Value: L>>R, L<<R

In alternate mode, this setting determines which of the left or right sides has the delay sound before the other (at L>>R, the left side is expressed first; when set to L<<R, the right side is expressed first). This is disabled in alternate mode, and you cannot make its setting.

Feedback

Value: 0–100

Sets the repeat times for the delay sound. When set to 0, each delayed sound is played only once.

Tempo Sync

Value: OFF, $\frac{1}{2}$, $\frac{3}{4}$, $\times 1$

Set this when synchronizing the delay time to the song tempo. When you select the note, the delay time is set to match the length of the note. When not synchronizing, turn this off.

LoDampFreq

Value: 50 Hz–4000 Hz

Sets the upper frequency limit of the range to be damped by "Low Damp." The Low Damp function damps the low frequency band of the delay sound quicker than other bands, which makes for a clearer delay effect.

LoDampGain

Value: 36 dB–0 dB

Sets the degree of the Low Damp.

HiDampFreq

Value: 1 kHz–20 kHz

In the natural world, the high frequencies in echo die out quicker than other bands. High Damp, by attenuating the higher frequencies first, makes the delay sound more natural.

Sets the lower frequency limit of the range to be dampened.

HiDampGain

Value: 36 dB–0 dB

Sets the degree of the High Damp.

FX Level

Value: 0-100

Sets the volume of the delay sound. When use this algorithm in insertion, lower it to get a balance with the dry level.

Dry Level

Value: 0-100

Sets the volume of the source sound. Set this to 0 when using the send/return method. Raise this when using the insert method to mix the source sound into the output.

NOTE When synchronizing to a song's tempo, if the set note length is longer (or shorter) than the possible range of delay time settings, the delay time can not correspond to the note length. Furthermore, the precision of the delay time and song tempo differ. If left to develop over long periods, the two may drift apart.

07 DELAY RSS

This is a single-in/dual-out delay with RSS (Roland Sound Space) effects added to the output. When heard through stereo speakers, a space of 90 degrees between the left and right sides (of your head) opens up and a widened three-dimensional delay sound is can be heard within that space.

You can also synchronize the delay time to the tempo of the song.

MEMO This is usually added with the send/return method.

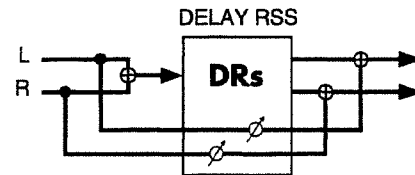

RSS (Roland Sound Space) is a special effects technology that allows you to play three-dimensional sounds with ordinary stereo speakers. RSS technology is used, in part, in this algorithm, which gives you the effect of having the sound placed right on either side of you (outside the field defined by the left and right speakers). (Some of Roland effects processors with dedicated RSS installed, you can freely control the direction, whether above, below, or behind, as well as the distance, near or far, that the sound apparently comes from.)

To have the RSS effect exhibited to the fullest extent, take note of the following points.

- It works best in rooms with little reverberation.
- Single-way speakers are most appropriate. Furthermore, coaxial or virtual coaxial speakers are also acceptable.
- On the sides, keep speakers as far away from walls as possible.
- Do not separate the left and right speakers too much.
- Listen from the optimal position, as shown below.

**For Stereo Speakers**

This sound is made to be played specifically through speakers. The proper effect cannot be obtained if listened to through headphones.

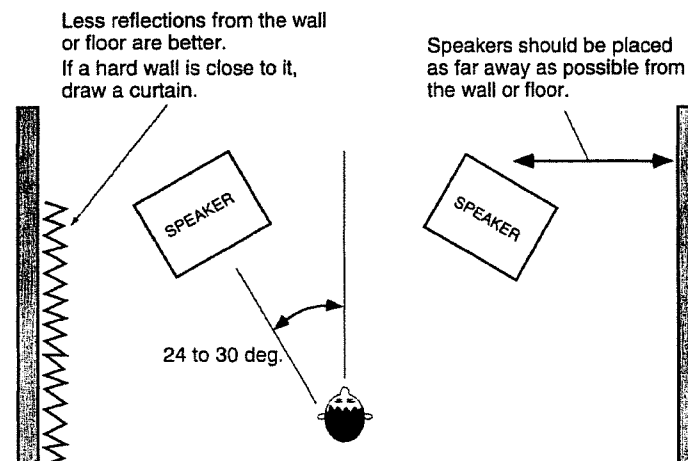

DRs (Delay RSS)

This single-input delay features RSS effects for widened spatial characteristics. This is a variation of delay type effects.

Time

Value: 0–1200 msec

Sets the delay time, that is, the elapsed time between the source sound and the delay sound. The settings range is limited by the RSS shift and L-R shift (explained below) settings. When Tempo Sync (explained below) is active, this setting is not effective and you cannot make this setting.

Feedback

Value: 0–100

Sets the repeat time for the delay sound. When set to 0, each delayed sound is played only once.

RSS Shift

Value: \pm 1200–0– \pm 1200 msec

The delay time only of the RSS-processed sound is further increased to shift expression of the sound. This setting is limited by the delay time and L-R shift settings.

L-R Shift

Value: L1200–R1200 msec

Of the left and right RSS output, the delay time is increased on only one side, shifting expression of the sound. Depending on the time setting and RSS shift settings, the settings range may be limited.

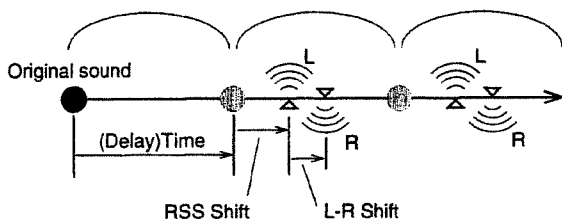

Tempo Sync

Value: OFF, $\frac{1}{2}$, $\frac{3}{4}$, $\times 1$

Set this when synchronizing the delay time to the song tempo. When not synchronizing, set this "OFF." When you select the note, the delay time is set to the note length corresponding to the tempo.

LoDampFreq

Value: 50 Hz–4000 Hz

Sets the upper frequency limit of the range to be damped by "Low Damp." The Low Damp function damps the low frequency band of the delay sound quicker than other bands, which makes for a clearer delay effect.

LoDampGain

Value: -36 dB–0 dB

Sets the degree of the Low Damp.

HiDampFreq

Value: 1 kHz–20 kHz

In the natural world, the high frequencies in echo die out quicker than other bands. High Damp, by attenuating the higher frequencies first, makes the delay sound more natural.

Sets the lower frequency limit of the range to be damped.

HiDampGain

Value: 36 dB–0 dB

Sets the degree of the High Damp.

FX Level (Effect Total Level)

Mono.D (Monaural Delay Level)

RSS D (RSS Delay Level)

Value: 0–100

Sets the volume of the delay sound. The monaural delay and RSS delay sound volumes are each adjustable, and the overall effects volume is set with the total level setting.

Dry Level

Value: 0–100

Sets the volume of the source sound. Set this to 0 when using the send/return method. Raise this when using the insert method to mix the source sound into the output.

MEMO Normally, you can really grasp the RSS effect by setting the monaural delay level to 0. With the L-R shift set to 0 (no shift), the RSS effect may be difficult to hear. The points to be aware of when synchronizing the delay to the song's tempo are the same as those in algorithm 06 EZ DELAY.

08 ANALOG DELAY & CHORUS (Virtual Analog Delay + Virtual Analog Chorus)

This algorithm reproduces the sound of the BOSS CE-1 Chorus Ensemble, which first came out in 1976. To reproduce the sound of the unit at the time, a monaural analog-type delay is first inserted in series.

MEMO This algorithm is normally use with the insert method, but depending on the settings, may be used with the send/return method.

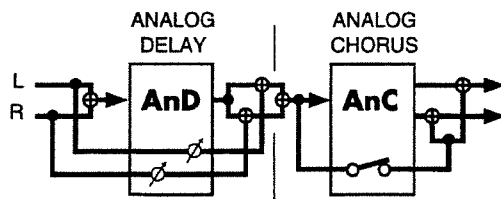

AnD (Virtual Analog Delay)

This effect simulates the compact analog delays used for guitars in the 1980s. This imparts the analog delay's characteristic mood, giving you that soft, velvety sound.

Repeat Rate

Value: 0–100

This corresponds to the delay time in a current delay effects unit. The higher the value selected, the shorter the interval of the delay sound.

Intensity

Value: 0–100

Sets the repeat time of the delayed sound. This is analogous to a current delay effect's feedback setting.

Raising this value increases the number of repeats.

Echo Level

Value: 0–100

Sets the volume of the delay sound.

Dry Level

Value: 0–100

Sets the volume of the source sound. Set this to 0 when using the send/return method. Raise this when using the insert method to mix the source sound into the output.

MEMO This reproduces such parameters as the frequency response of the BOSS compact analog echo in the middle 80's. As it simulates the limitation of the performance of "BBD (analog IC)" as well, delay times are shorter than with other delay effects. Although the actual unit had no dry level setting, it is included in this algorithm in the interests of convenience.

AnC (Virtual Analog Chorus)

This algorithm reproduces the sound of the BOSS CE-1 Chorus Ensemble. It adds a vibrating effect and breadth to the source sound.

CE Mode

Value: CHORS, VIB

This switches the sound between chorus and vibrato modes (see MEMO).

Intensity

Value: 0–100

When CE Mode is CHORS(Chorus), this sets the pitch vibrato speed.

Depth (VIB)

Value: 0–100

When CE Mode is VIB(Vibrato), this sets the pitch vibrato depth.

Rate (VIB)

Value: 0–100

When CE Mode is VIB(Vibrato), this sets the pitch vibrato speed.

Direct Out

Value: OFF, ON

This switch determines whether or not the source sound (although monaural) is mixed in. On the original CE-1 this was fixed at ON. When set to OFF, it can be used with the send/return method as well.

OutputMode

Value: MONO, ST-1, ST-2

This switches the output format (mono/stereo). This includes two different stereo settings.

MONO(Mono): Output is monaural.

ST-1(Stereo-1): Chorus sound of the pitch vibration which phase is inverted between left and right is mixed with the source sound. This is a broader chorus, with a weaker feeling of placement.

ST-2(Stereo-2): The left output contains the source sound, and the right side has the wavering chorus sound.

MEMO This algorithm faithfully reproduces the sound of the original CE-1 based on the specifications when it was developed. In Chorus mode(CHORS), you can get the effect of pitch vibrato chorus added to the source sound. In Vibrato mode (VIB), the waveform and rate of the wavering of the pitch differ from those of chorus. (Although later BOSS vibrato

Using the Internal Effects

effects do not mix in the source sound, the CE-1 mixed the source sound when switched to vibrato as well.) The output mode was added to a later model, the CE-3. (The sounds of the CE-1 are reproduced by "MONO" and "ST-1.")

09 DIGITAL CHORUS

This is a dual-input/dual output stereo digital chorus featuring independent left and right signal channels. It offers a wide variety of chorus effects, with no degradation of the sound.

MEMO Depending on the setting, this can be used with either the send/return method or the insert method.

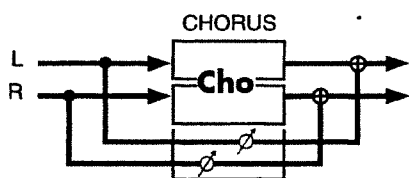

Cho (Stereo Digital Chorus)

This effect gives the sound spatial breadth while adding vibrato.

Rate

Value: 0–100

Sets the rate of the pitch vibrato.

Depth

Value: 0–100

Sets the depth of the pitch vibrato.

LFO Phase

Value: 0–180 deg

Sets the degrees of left and right phase shift in the Low Frequency Oscillator (LFO) that produces the pitch vibrato (see HINT).

Bass

Treble

Value: -100–+100

These are the chorus bass and treble settings. When set to 0, they make no change to the sound.

Cross Mix

Value: -100–+100

This inputs the left chorus sound into the right channel, and the right side chorus into the left, thereby creating a greater sense of breadth.

The plus setting makes the chorus sound return in normal phase, and the minus setting makes it return in inverted phase.

FX Level

Value: 0–100

Sets the volume of the chorus sound. This is ordinarily set to 100.

Dry Level

Value: 0–100

Sets the volume of the source sound. Set this to 0 when using the send/return method. Raise this when using the insert method to mix the source sound into the output.

HINT When setting the LFO phase, you can shift the timing of the rising and falling of the pitch in the left and right chorus sound. At 0 deg. (0 degree), the left and right pitches rise and fall together. At 180 degrees, they are completely opposite. Setting a slight shift, especially with monaural input, brings out the broadening effect.

By setting a negative value for the Cross Mix as a "hidden flavor," you can get stereo chorus that features a particular floating sensation.

10 4 BUTTON CHORUS 320

This algorithm reproduces the sound of Roland's SDD-320 spatial expression effects. When output is in stereo, greater breadth is added.

MEMO The original SDD-320 was for insertion, but depending on the settings, this algorithm can be used with either the send/return method or the insert method.

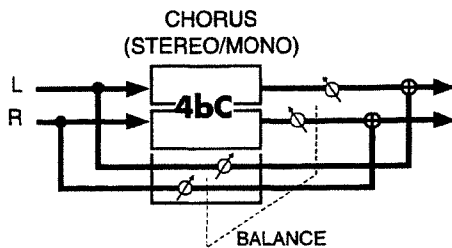

4bC (Virtual SDD-320)

This effect creates spatial breadth.

Input

Value: MONO, ST

This setting determines whether stereo source sound is converted to mono (MONO) or left as is (ST). (On the SDD-320, this was accomplished with the input jack connections.)

ModeButton

Value: 1-4, 1+4, 2+4, 3+4

The SDD-320 features four mode buttons for changing the effect. This setting determines which buttons are to be pressed. ("1+4" represents the condition when Buttons 1 and 4 are pressed simultaneously.)

Dry/FX Bal

Value: 0-100

Sets the volume balance between the source sound and the effect sound. A setting of 50 gives you the same balance as that of the SDD-320. At 0 only the source sound is output, at 100 only the effect. When used with the send/return method, set this to 100.

MEMO This effect changes subtly depending on the mode button settings. Try out each mode and select the most suitable one. The Roland SDD-320, released in 1979 and produced for eight years, was an remarkable analog effect that added spatial breadth. The panel featured only five buttons (four mode buttons and an OFF button), that allowed the user to switch the effects. Although a chorus-type effect, its special feature was the natural-sounding breadth it got without the heavy vibrato. This model still has a great number of fans like remix artist, and so on.

11 VINTAGE FLANGER 325

This algorithm reproduces the sound of Roland's SBF-325 analog flanger. You can get three different types of flanger sounds (adding a metallic swelling sound to the source sound) and chorus like effect.

MEMO This algorithm is applied using the insert method.

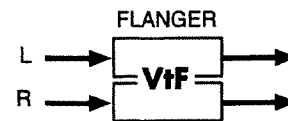

VtF (Vintage Flanger)

FX Mode

Value: FL1, FL2, FL3, CHO

Sets the effect type. Try out each mode and select the most suitable one.

FL1: (Flanger 1) A general monaural flanger

FL2: (Flanger 2) A stereo flanger that utilizes the stereo placement of the source sound

FL3: (Flanger 3) A cross mix flanger that providing a more intense effect

CHO: (Chorus) Chorus effect

Rate

Value: 0-100

Sets the rate of the swelling of the flanger sound. In Tempo Sync this is disabled, and you can not make the settings.

Depth

Value: 0-100

Sets the depth of the swelling of the flanger sound.

Manual

Value: 0-100

Sets the center frequency for the effect. This changes the pitch of the flanger's metallic sound.

Feedback

Value: 0-100

Sets the intensity of the flanger's effect. It is disabled in Chorus mode.

MEMO As this faithfully reproduces the action of the SBF-325, setting the value too high may result in oscillation. Take care to prevent sounds from extreme oscillation from damaging your ears or your equipment. To stop oscillation sounds immediately, press REALTIME EFFECTS [ON/OFF].

CH-R Modu. (Right Channel Modulation Phase)

Value: NORM, INV

This is usually set to "Normal" (NORM). Setting this to "Invert" (INV) inverts the phase of the modulation (rise and fall) in the right channel. You can get the modulation effect in the left and right channels being opposite from each other.

Phase CH-L (Left Channel Phase)

Phase CH-R (Right Channel Phase)

Value: NORM, INV

Sets the phase of the left and right channels when the source sound is mixed with the flanging sound. "Normal" (NORM) corresponds to positive phase (+), "Invert" (INV) to inverted, or negative phase (-). This changes the breadth of the sound. Check the sound with the effect, and select the most appropriate setting.

Tempo Sync

Value: OFF, 1/3 - 4

Set this when synchronizing the Rate setting to the song tempo. When not synchronizing, set this "OFF." When you select the note, the Rate setting is disabled, and the Rate is set the note length corresponding to the song tempo. When synchronizing to a song's tempo, if the length of the note is set longer (or shorter) than that of the possible range of the Rate settings by the change of song tempo, the Rate can not correspond to the note length. Furthermore, the precision of the Rate setting and song tempo differ. If left to develop over long periods, the two may gradually drift apart.

MEMO This algorithm faithfully reproduces the sound of the SBF-325, provides numerous variations on the effects, and creates the powerful sounds with the characteristic of analog flanger. The SBF-325 analog flanger, released in 1979, was produced for about five years. Even now, it is prized by musicians, including those in the dance music scene, but is one of machines those are becoming harder to get a hold of.

12 2 × BOSS FLANGER

This algorithm features a pair of the same flanger circuits used in the BOSS compact flangers, connected in parallel for stereo input.

MEMO This algorithm is applied using the insert method.

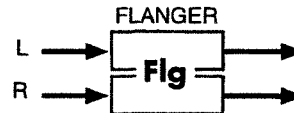

Flg (Stereo Flanger)

This adds a particular metallic-sounding modulation to the source sound.

Model Type

Value: NORM, HI-B

This selects the model of flanger simulated.

NORM: (Normal type <BOSS BF-2>)

HI-B: (High-Band type <BOSS HF-2>)

Setting HI-B raise the flanging sound one octave above that at the NORM.

Manual

Value: 0-100

Sets the center frequency for the effect. This changes the pitch of the flanger's metallic sound.

Depth

Value: 0-100

Sets the depth of the swelling of the flanger sound.

Rate

Value: 0-100

Sets the rate of the swelling of the flanger sound. In Tempo Sync this is disabled, and you cannot make this setting.

Resonance

Value: 0-100

Sets the intensity of the flanger's effect. This corresponds to the "Feedback" setting in Algorithm 11.

NOTE Setting the Resonance value too high may result in extreme oscillation. Take care to prevent this sound from damaging your ears or your playback equipment. To stop oscillation sounds immediately, press REALTIME EFFECTS [ON/OFF].

LFO Phase

Value: 0–180 deg

Sets the degrees of left and right phase shift in the Low Frequency Oscillator (LFO) that produces the flanging cycle. You can change the timing of the rise and fall of the modulation in the left and right channels. At 0 deg. (0 degree), the effects sounds of left and right rise and fall together. At 180 degrees, they are completely opposite.

Cross FB (Cross Feedback)

Value: -100–+100

This setting makes the flanging sound of each of right and left channels return to the input of the opposite channel. This gives an even stronger flanging effect. The plus indicates the flanging sound is returned in normal phase, and the minus that the sound is returned in phase inverted.

NOTE *Setting the Cross Feedback value too high may result in extreme oscillation. Take care to prevent this sound from damaging your ears or your playback equipment. To stop oscillation sounds immediately, press REALTIME EFFECTS [ON/OFF].*

Cross Mix

Value: -100–+100

This setting makes the flanging sound from each of the right and left channels mix it with the flanging sound of the opposite channel.

Switching to the plus side mixes them in phase, and switching to the minus side has them mixed in phase inverted.

Tempo SyncValue: OFF, $\frac{1}{3}$ - 0 X4

Set this when synchronizing the Rate to the song tempo. When not synchronizing, set this "OFF." When you select the note, the Rate setting is disabled, and the Rate is set the note length corresponding to the tempo. When synchronizing to a song's tempo, if the length of the note is set longer (or shorter) than that of the possible range of the Rate settings by the change of song tempo, the Rate can not correspond to the note length. Furthermore, the precision of the Rate and song tempo differ. If left to develop over long periods, the two may gradually drift apart.

HINT *Cross Feedback and Cross Mix are the effect that you cannot get even with two actual flangers connected in parallel. These parameters have been added to this algorithm with consideration given to their use in stereo. By setting a negative value for the Cross Mix, you can get stereo flanging effect that features a particular floating sensation.*

13 STEREO PITCH SHIFTER

This algorithm features two pitch shifters arranged in parallel, making it stereo compatible. It can shift the pitch of the input signal up to one octave up or down.

MEMO *This algorithm can be used with either the insert method or the send/return method.*

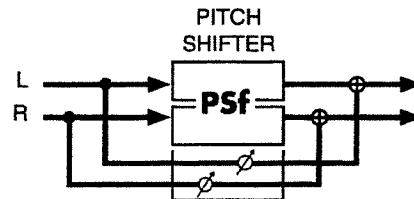
**Psf (Stereo Pitch Shifter)**

This effect changes the pitch of the source sound. The degrees of pitch shift can be set separately for each channel.

Stereo Link

Value: ON, OFF

This selects whether the pitch shift in left and right channels are to be linked or set independently. When set to "ON," the right channel pitch shifter settings conform to those set for the left channel.

Grade

Value: 1, 2, 3, 4, 5

Sets the grade of the effect sound. The higher the value is set, the more natural-sounding can be obtained; however, this increases the delay from the source sound as well. Depending on the setting, you may be able to hear some disruption of drums and other parts, so select the suitable setting after listening to the sound at different settings.

10

L ch Pitch (Left Channel Pitch)

Value: -12–+12

Fine (Left Channel Fine Pitch)

Value: -100–+100

R ch Pitch (Right Channel Pitch)

Value: -12–+12

Fine (Right Channel Fine Pitch)

Value: -100–+100

These set the degrees of left and right pitch shift. You can adjust the pitch shift in semitones with "Pitch" and in cents (1/100 of a semitone) with "Fine" for minute adjustment of the pitch shift. When Stereo Link is on, changes to the right channel settings are ignored.

FX Level

Value: 0–100

Sets the volume of the effect.

Dry Level

Value: 0–100

Sets the volume of the source sound.

HINT When simply changing the pitch of the source sound, set the dry level to 0 and use with the insert method.

14 80s PHASER

This algorithm features two analog-type phasers arranged in parallel, making it stereo compatible. The sound as it cyclically drifts in and out of phase is added to the source sound, creating the modulation with the characteristic of phasers.

MEMO This algorithm is used with insert method. If used with the send/return method and mix the source sound, which may weaken the effect.

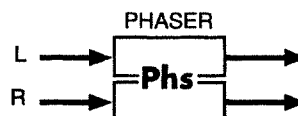

Phs (Stereo Phaser)

This effect features two linked monaural phasers arranged in parallel.

Shift Mode

Value: 4STG, 8STG

This sets the number of stages in the pitch shift circuit (four (4STG) or eight (8STG)). Setting this to eight stages (8STG) increases the number of the frequency points that sound is canceled, giving a sharper effect.

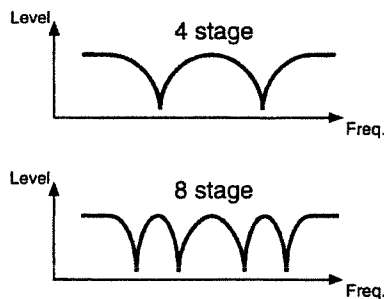

CenterFreq

Value: 0–100

Sets the center frequency to which the phaser effect is applied. Increasing this value moves the effect point of the phaser into higher frequency ranges.

Resonance

Value: 0–100

Increasing this value gives a more distinctive sound to the effect.

HINT Setting the Resonance value too high may result in extreme oscillation. Take care to prevent this sound from damaging your ears or your playback equipment. To stop oscillation sounds immediately, press REALTIME EFFECTS [ON/OFF].

LFO1

One of two oscillators (LFO1, LFO2) included in this effect, this oscillator creates swelling sound.

Rate (LFO1 Rate)

Value: 0–100

Sets the rate of the swelling sound. When Tempo Sync is active, this is not effective, and you cannot make this setting.

Depth (LFO1 Depth)

Value: 0–100

Sets the depth of the swelling sound.

Phase

Value: NORM, INV

Sets the phase of both left and right swelling. When set to "Normal" (NORM), both are same phase; when set to "Invert" (INV), the phase of right channel is inverted.

T.Sync (LFO1 Tempo Sync)

Value: OFF, $\frac{1}{2}$, $\frac{1}{4}$, $\frac{1}{8}$, $\frac{1}{16}$, $\times 4$

This setting synchronizes the LFO1 rate to the tempo of the song. When not synchronizing, set this "OFF." When you select the note, the LFO1 rate setting is disabled, and the LFO1 rate is set the note length corresponding to the tempo. When synchronizing to a song's tempo, if the length of the note is set longer (or shorter) than that of the possible range of LFO1 rate settings by the change of song tempo, the LFO1 rate can not correspond to the note length. Furthermore, the precision of the LFO1 rate and song tempo differ. If left to develop over long periods, the two may gradually drift apart.

LFO2**Rate (LFO2 Rate)**

Value: 0–100

Depth (LFO2 Depth)

Value: 0–100

Phase (LFO2 Phase)

Value: 0–100

These are the LFO2 settings. The functions of these parameters are the same as those for LFO1 (however, there is no Tempo Sync function).

HINT This algorithm reproduces the sound of the 2U rack-mount phasers of the early 1980s. Two monaural single-input, single output phasers are arranged in parallel. Two oscillators (LFO) which create the swelling sound installed into each phaser, allowing the creation of complex modulation patterns. The rates of the swelling sounds from LFO1 and

LFO2 differ. LFO1 creates an extremely slow modulation, whereas that of LFO2 is faster. You can set the phase of each one independently, and by creating a large swell with LFO1 and a very short wavering with the phase inverted in LFO2, you can give the sound a feeling of great breadth.

15 STEREO AUTO WAH

Wah is an effect created by changing a filter's frequency response over time, giving a particular kind of tone change. This algorithm gives you two type of wah, one based on the volume of the sound source, and a periodic wah based on the Low Frequency Oscillator (LFO).

MEMO This algorithm is applied using the insert method.

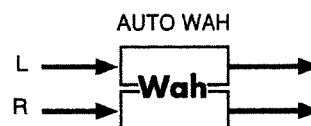
**Wah (Stereo Auto Wah)**

This algorithm features two auto wahs arranged in parallel, making it stereo compatible.

Filter Type

Value: LPF, BPF

Sets the type of filter used to make the wah (for more on filters, please refer to the figure → p. 101).

LPF: (Low pass filter) Passes frequencies below the cut-off frequency. This allows wah over a wide range of frequencies.

BPF: (Band pass filter) Passes frequencies near the cut-off (center) frequency. This lets you keep the wah within a narrow range.

Polarity

Value: DOWN, UP

When applying the wah effect through changes in the source sound volume, this setting is for selecting whether the effect is to be in the high frequencies (UP) or lower frequencies (DOWN).

Frequency

Value: 0–100

Sets the reference frequency for the wah effect. The higher the value is set, the higher the frequency is.

Peak

Value: 0–100

Sets the degree of the wah effect near the reference frequency. The range narrows as the value increases; as you lower the value, you get the wah effect over a wider range.

Trig.Sens (Trigger Sens)

Value: 0–100

Sets the sensitivity level when wah is added through changes in the source sound volume. The wah effect is added at lower volumes as the value increases.

LFO

This setting gives a cyclical or periodic wah effect.

Rate (LFO Rate)

Value: 0–100

Sets the rate of the periodic wah sound. During Tempo Sync, this is disabled, and you cannot make this setting.

Depth (LFO Depth)

Value: 0–100

Sets the depth of periodic the wah sound.

Phase (LFO Phase)

Value: 0–180deg

This shifts the phase of the Low Frequency Oscillator (LFO) that produces the opening/closing cycle of the stereo wah. You can change the timing of the cyclic wah effects in the left and right channels. At “0deg” (0 degrees), the wah effects of left and right open and close together. At 180 degrees, they are completely opposite.

T.Sync

Value: OFF, 1/2, 3/4, 1, 2, 4

This setting synchronizes the LFO Rate to the tempo of the song. When not synchronizing, set this “OFF.” When you select the note, the LFO Rate setting is disabled, and the LFO Rate is set the note length corresponding to the tempo. When synchronizing to a song’s tempo, if the length of the note is set longer (or shorter) than that of the possible range of LFO Rate settings by the change of song tempo, the LFO Rate can not correspond to the note length.

HINT When you want only to get a periodic wah sound from the LFO, set Trigger Sens to 0. Conversely, if you want the wah effect to reflect the source sound, set the LFO depth to 0. When both are set to 0, you can use the D Beam Controller to change the frequency, and get the “manual wah” (pedal wah) effect.

16 STEREO DISTORTION

This algorithm reproduces the sound of an analog distortion, that distorts the source sound, then sends the output through an equalizer and noise suppressor. The three parts are arranged in series. Since this is a stereo effect, sounds are distorted without changing their position in the stereo field, so you can perform with a punchy, Lo-Fi sound.

MEMO This algorithm is added with the insert method.

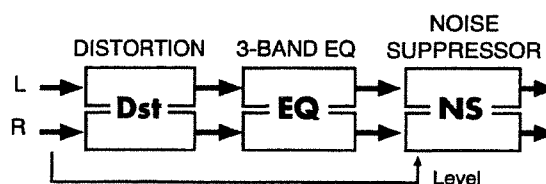

Dst (Stereo Distortion)

This is a virtual analog distortion that reproduces the sound of compact effects for guitars.

Gain

Value: 0–100

Sets the degree of distortion. At the source sound with low volume levels, there may be no distortion, even with the value increased.

Tone

Value: 0–100

This adjusts the brightness of the sound. When this value is set high, the distortion is loud and bright.

Out Level

Value: 0–100

Sets the output volume. Distortion also increases the volume levels; you can use this parameter to control it.

MEMO Two distortion units are linked and arranged in parallel (left and right) to make the algorithm stereo compatible. If you can't adjust the tone enough with the Tone control, use the equalizer at the next stage.

EQ (3-Band Equalizer)

This equalizer works in three frequency ranges: Low, Mid, and High range. You can set the frequencies and boost or cut the level.

Low Type

Value: SHELV, PEAK

Low Gain

Value: -12-+12 dB

Low Freq

Value: 20-2000 Hz

Low Q

Value: 0.3-16.0

Mid Gain

Value: -12-+12 dB

Mid Freq

Value: 200-8000 Hz

Mid Q

Value: 0.3-16.0

High Type

Value: SHELV, PEAK

High Gain

Value: -12-+12 dB

High Freq

Value: 1.4-20.0 kHz

High Q

Value: 0.3-16.0

Out Level

Value: -12-+12 dB

These parameters are the same as those in the 3-band equalizer in Algorithm 2 (CENTER CANCELLER) (p. 102, 103).

NS (Noise Suppressor)

This effect suppresses noise (such as hum) at times when no sound is being played. Watches the input level at the beginning of the effect path; when there is no input, turn down the final output.

Threshold

Value: 0-100

Sets the volume level to start muting. Set the value higher when there is a lot of noise, and if there is less noise, decrease the value.

Release

Value: 0-100

Sets the transition time from when the noise suppression starts to the point where the volume reaches 0.

HINT These have the same functions as those in Algorithm 03 (STEREO DYNAMICS PROCESSOR) (p. 103). When distorting drum phrases, make the release time short to achieve a gate-like effect.

17 PHONOGRAPH (Analog Record Simulator)

This algorithm reproduces the sound of an analog record played on a record player. This includes the various noises with the characteristic of records and the uneven rotation of older turntables.

MEMO This algorithm is applied using the insert method.

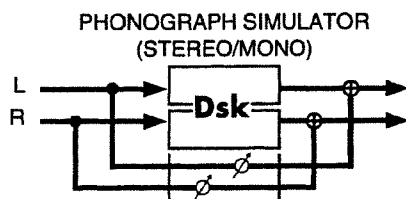

Dsk (Phonograph)

This effect is like the sound of an analog record being played.

Input

Value: MONO, ST

Use this setting to select either a stereo or monaural record player for the effect.

SignalDist (Signal Distortion)

Value: 0–100

Sets the degree of distortion. The higher the value is set, the more the sound is distorted.

Freq.Range

Value: 0–100

Sets the frequency response of the record player. Lowering the value degrades the frequency characteristics, making the sound resemble that from an older system.

Disk Type

Value: LP, EP, SP

Sets the turntable rotation speed. This influences the cycles of scratches and noises being played.

LP: 33 1/3 r.p.m.

EP: 45 r.p.m.

SP: 78 r.p.m.

Noise Total

Value: 0–100

Total noise level.

Scratch

Value: 0–100

Scratches on the record.

Dust

Value: 0–100

Dust on the record.

Hiss

Value: 0–100

Continuous hissing noise.

These settings add the typical record's noise. The noises increase as the values are raised. Set each of the Scratch, Dust, and Hiss noise levels to get a balance, then adjust the overall amount of noise with the Total Noise Level control.

W/F Total

Value: 0–100

Total wow and flutter.

Wow

Value: 0–100

Wow, long cycle rotational irregularity.

Flutter

Value: 0–100

Flutter, short cycle rotational irregularity.

Random

Value: 0–100

Random rotational irregularity.

These settings determine the rotational irregularities of the record player. Set each of the Wow, Flutter, and Random levels to get a balance, then adjust the overall depth of the effect with the Total Wow/Flutter control.

FX Level

Value: 0–100

Sets the volume of the effect sound. It is ordinarily set to 100.

Dry Level

Value: 0–100

Sets the volume of the source sound. It is ordinarily set to 0. Raise this when you want to mix the source sound.

HINT When reproducing the sound of old records such as SPs, you can make it sound more realistic by setting Input to "MONO." This effect continues to make the noises during the "record's silent parts." To quickly stop making this noise, press REALTIME EFFECTS [ON/OFF] to turn off the effect.

MEMO If you use effects patches based on this algorithm by inserting any one of tracks, and the track is silent (or song is not played back), the effects sounds (phonograph like noise) may be muted by playing pads. You can avoid this by turning on the Track Voice Reserve function (p. 137).

18 RADIO TUNING

This algorithm reproduces the sound of an AM radio playing.

MEMO This algorithm is applied using the insert method.

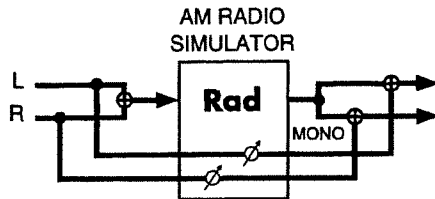

Rad (AM Radio Simulator)

This effect makes it sound like the source sound is being played from an AM radio.

Tuning

Value: ± 50 – ± 50

This setting adjusts the degree of noise that occurs when tuning a radio. A setting of 0 corresponds to exact tuning.

Noise Level

Value: 0–100

Sets the noise level.

Freq.Range

Value: 0–100

Sets the frequency response of the radio. Lowering the value worsens the frequency characteristics, making the sound appear to be coming from a tiny radio speaker.

FX Level

Value: 0–100

Sets the volume of the effect sound. It is ordinarily set to 100.

Dry Level

Value: 0–100

Sets the volume of the source sound. It is ordinarily set to 0. Raise this when you want to mix the source sound.

MEMO At any Noise Level setting beside 0, the radio noise continues even when there is no source sound. When inserting the effect into MASTER OUT, the noise remains. To quickly stop making this noise, press REALTIME EFFECTS [ON/OFF] to turn off the effects.

MEMO If you use effects patches based on this algorithm by inserting any one of tracks, and the track is silent (or song is not played back), the effects sounds (radio like noise) may be muted by playing pads. You can avoid this by turning on the Track Voice Reserve function (p. 137).

19 LO-FI PROCESSOR

By changing the bit count and sample rate, this algorithm recreates the Lo-Fi (Low-Fidelity) sounds of the early digital samplers and similar machines. After the Lo-Fi processor, a filter to change the tone and a noise suppressor are arranged in series.

MEMO This algorithm is applied using the insert method.

MEMO Lo-Fi is a reverse formation of the term "Hi-Fi" (high fidelity), with the corresponding opposite meaning. The technique of using Lo-Fi processing to "degrade the sound" is often used in today's dance music scene and in other forms of contemporary music.

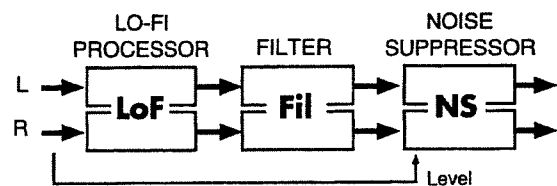

LoF (Lo-Fi Processor)

PreFilter (Pre-Process Filter)

Value: ON, OFF

This is the switch of the filter placed before the Lo-Fi processing. When set "ON," this suppresses the digital distortion by lowering sample rates.

Sample Rate

Value: 1/2–1/32

Sets the fraction of current sample rates to be used for processing.

Down to...

Value: 16–1 bit

This setting is for reducing the bit count. When this is set to 16 bit, the bit count currently used is preserved.

PostFilter (Post-Process Filter)

Value: OFF, ON

This is the switch of the filter placed after the Lo-Fi processing. Like the pre-process filter. When set "ON," this suppresses the digital distortion by lowering sample rates.

FX Level

Value: 0–100

Sets the volume of the effect sound. It is ordinarily set to 100.

Using the Internal Effects

Dry Level

Value: 0–100

Sets the volume of the source sound. It is ordinarily set to 0. Raise this when you want to mix the source sound.

MEMO Both the pre-process and post-process filters are necessary components in general digital sound processing. These allow the suppression of digital distortion that occurs when the sample rate is lowered, or to allow distortion when turned off.

Flt (Filter)

These filters allow you to greatly affect the frequency response of the input sound. There are four types from which to select.

Type

Value: LPF, BPF, HPF, NOTCH

Sets the type of filter used (please refer to the figure on p. 101).

- LPF:** (Low pass filter) Passes frequencies below the cutoff frequency.
- BPF:** (Band pass filter) Passes frequencies near the cutoff frequency.
- HPF:** (High pass filter) Passes frequencies above the cutoff frequency.
- NOTCH:** (Notch filter) Passes frequencies other than those near the cutoff frequency.

Slope (oct)

Value: -12 dB, -24 dB

Sets the filter's slope characteristics at the cutoff frequency (-24 dB at one octave: steep; -12 dB at one octave: shallow).

CutOffFreq (Cutoff Frequency)

Value: 0–100

Sets the filter's cutoff frequency. Set this closer to zero, the cutoff frequency becomes lower; set closer to 100, the cutoff frequency becomes higher.

Resonance

Value: 0–100

Sets the filter's resonance level. Raising the setting increases resonance near the cutoff frequency, giving the sound a special characteristic.

NOTE If the resonance value is raised to much, extreme oscillation can arise. Take care not to allow this sound to damage your ears or your playback equipment. To stop this oscillation immediately, press **REALTIME EFFECTS [ON/OFF]**.

Gain

Value: 0–24 dB

Using some filters, the volume of the sound may be dropped by cutting frequency range of source sound. In this case, this compensates for the drop in volume. The level of compensation increases as the value is increased, raising the volume.

MEMO These functions are the same as those in Algorithm 1 (ISOLATOR & FILTER) (→ see p. 101). By lowering the bit count or sample rate and then filtering the signal, you can produce cool Lo-Fi sounds.

NS (Noise Suppressor)

This effect suppresses noise (such as hum) at times when no sound is being played. Watches the input level at the beginning of the effect path; when there is no input, turn down the final output.

Threshold

Value: 0–100

Sets the volume level to start muting. Set the value higher when there is a lot of noise, and if there is less noise, decrease the value.

Release

Value: 0–100

Sets the transition time from when the noise suppression starts to the point where the volume reaches 0.

MEMO These functions are the same as those in Algorithm 03 (STEREO DYNAMICS PROCESSOR) (p. 103).

20 VIRTUAL ANALOG SYNTH (Virtual Analog Synthesizer)

This algorithm recreates the functions of analog synthesizers in the 1970s. If you control the parameters with the Step Modulator, D Beam Controller, or externally with MIDI messages, you can get analog synthesizer sounds with the virtual VCO (Voltage Controlled Oscillator). Furthermore, with sections corresponding to VCF (Voltage Controlled Filter) and VCA (Voltage Controlled Amplifier), you can also process external sound input as is. Additionally, a ring modulator is included, and with

the output from the delay and chorus (or flanger), it can be used as a powerful multipurpose filter/effect device.

(MEMO) Both insert and send/return methods can be used with this algorithm. When you use effects patches based on this algorithm by inserting any one of tracks, and the track is silent (or song is not played back), the synth sounds may be muted by playing pads. You can avoid this by turning on the Track Voice Reserve function (p. 137).

(NOTE) Other than the delay and chorus/flanger, the effect portions of this algorithm cannot be turned off.

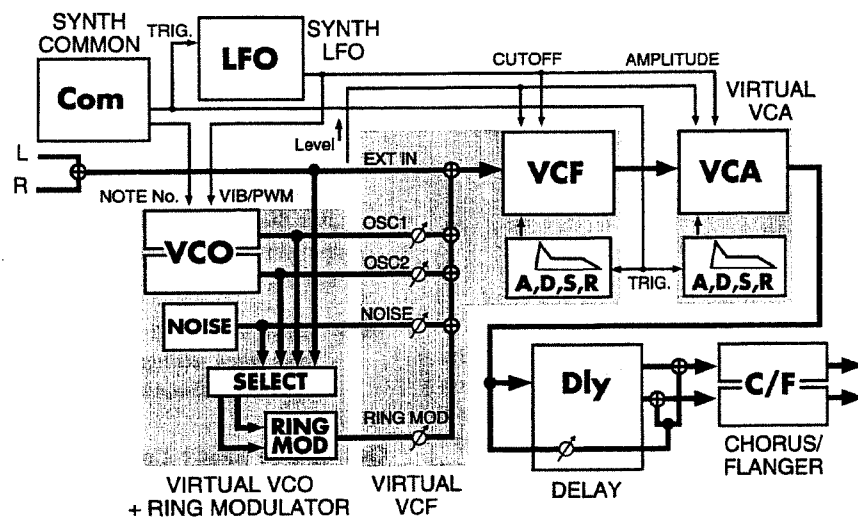

Com (Common)

These are parameters related to overall control of the synthesizer.

Trigger In

Value: ON, OFF

This turns the synthesizer sound on and off. Setting this from "OFF" to "ON" corresponds to pressing a key on the keyboard.

Velocity

Value: 0-127

Note Number

Value: C1-G9

Sets which key is pressed (note number) and the strength or force at pressing key (velocity).

Portamento

Value: OFF, ON

This turns on and off the portamento effect (the smooth gliding of the synthesizer sound from one pitch to another).

Porta Time (Portamento Time)

Value: 0-100

Sets the transition time for the portamento effect to change pitches. The elapsed time increases as the value is increased.

(NOTE) Near the upper and lower note number limits, pitches may not change, or the changes may be unstable (this changes with the conditions in each of the parameter settings).

LFO (Low Frequency Oscillator)

The LFO is the oscillator that creates an swelling sound. By greatly increasing the values for parameters such as VCO vibrato, PWM depth, and LFO depth (explained below), you can get various kinds of vibrating sounds (periodic, cyclical changes) in tone and pitch.

Fade Time (Start Delay)

Value: 0-100

Sets the elapsed time between the moment Trigger In turns "ON" and the point at which the modulation from the LFO reaches the designated depth. As the value is increased, the elapsed time increases, gradually deepening the swelling.

Using the Internal Effects

Rate

Value: 0–100

Sets the rate of the vibration. When set to 0, the rate is approximately 0.1 Hz (10 seconds per cycle), and at a setting of 100, the rate is approximately 20 Hz (20 cycles per second). In Tempo Sync this is disabled, and you cannot make this setting.

Waveform

Value: TRI, SQR, SAW, S/H

Sets the waveform of the vibration.

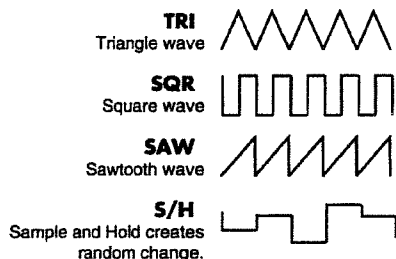

Tempo Sync

Value: OFF, $\frac{1}{2}$, $\frac{1}{4}$, $\frac{1}{8}$, $\times 4$

This setting synchronizes the rate to the tempo of the song. When not synchronizing, set this "OFF." When you select the note, the rate setting is disabled, and the rate is set the note length corresponding to the tempo. When synchronizing to a song's tempo, if the length of the note is set longer (or shorter) than that of the possible range of rate settings by the change of song tempo, the rate can not correspond to the note length.

VCO (Virtual VCO + Ring Modulator)

This reproduces the VCO (Voltage Controlled Oscillator) virtually. It comprises two oscillators, OSC1 and OSC2, a noise generator, and ring modulator. Settings include those for the waveforms that are the basis of synthesizer sounds and pitch settings for the two oscillators.

Oc1 Pt. KF (Oscillator Pitch Key Follow)

Value: OFF, ON

This setting determines whether the pitch of Oscillator 1 (hereafter OSC1) changes according to the Note Number in Common (ON) or not (OFF).

Oc1 Wave (OSC1 Waveform)

Value: TRI, PLS, SAW

Sets the waveform for the sound produced by OSC1.

- TRI: (Triangle wave) A clear sound with few overtones.
PLS: (Pulse wave) This sound varies depending on the settings in the following parameters (OSC1 Pulse Wave, OSC1 Pulse Wave Modulation)
SAW: (Sawtooth wave) A thick sound filled with overtones.

Oc1 PulseW (OSC1 Pulse Width)

Value: 0–100

Sets the pulse width when the "pulse wave" (PLS) is selected for the OSC1 waveform. Increasing the value narrows the pulse width. This has no effect if the OSC1 waveform is not set to "pulse wave" (PLS).

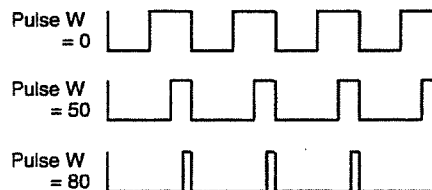

Oc1 PWM (OSC1 Pulse Width Modulation)

Value: 0–+100

When OSC1 Wave is set to "pulse wave" (PLS), this set the depth which the LFO vibrates the pulse width. This gives the characteristic cyclical change in tone. Increasing the value deepens the effect. This is effective only when the OSC1 waveform is set to "pulse wave" (PLS).

NOTE When both OSC1 Pulse Width and OSC1 Pulse Width Modulation settings are large, the periodic or cyclical sound may become inaudible.

Oc1 Coarse (OSC1 Coarse Tuning)

Value: -24–+24

Oc1 Fine (OSC1 Fine Tuning)

Value: -100–+100

Sets the pitch of the sound from OSC1. With 0 as the reference, coarse tuning adjusts the pitch in semitone increments, fine tuning in cents (1/100 of a semitone).

Oc1 Vib (OSC1 Vibrato Depth)

Value: 0–100

Sets the depth of the OSC1 vibrato (the cyclical change in pitch caused by the LFO).

Oc1 X-Mod (OSC1 Cross Modulation)

Value: 0–100

Sets the depth of the OSC1 cross modulation effect (the modulation of the OSC1 pitch by oscillation from the OSC2). As the value is increased, the increased overtones make the sound more powerful.

Oc2 Pt. KF (Oscillator Pitch Key Follow)

Value: OFF, ON

Oc2 Wave (OSC2 Waveform)

Value: TRI, PLS, SAW

Oc2 PulseW (OSC2 Pulse Width)

Value: 0–100

Oc2 PWM (OSC1 Pulse Width Modulation)

Value: 0–100

Oc2 Coarse (OSC2 Coarse Tuning)Value: ~ 24 – ~ 24 **Oc2 Fine (OSC2 Fine Tuning)**Value: ~ 100 – ~ 100 **Oc2 Vib (OSC2 Vibrato Depth)**

Value: 0–100

These are the settings for OSC2. The effect of these settings are the same as those in OSC1 (there is no cross modulation included in OSC2).

RingM (Ring Modulator Source 1)**Src2 (Ring Modulator Source 2)**

Value: Src1 OSC1, OSC2, NOISE, EXIN

You can select from two ring modulator inputs. Besides the oscillators OSC1 and OSC2, “NOISE” (noise) or “EXIN” (external input) may also be selected.

HINT By multiplying the ring modulator’s two inputs each other, you can create sounds that include numerous overtones not found in either waveform. You can get metallic sounds unrelated to any sense of harmony. To play the VCO’s sounds (OSC1, OSC2, noise generator, and ring modulator), raise the volume level of each in the VCF mixer at the next stage.

The synthesizer sounds are tuned to A4 (440.0 Hz). If you want to have A4 set to 442 Hz, set the Fine reference setting of Oc1 and Oc2 above not to ± 0 , but to ± 8 .

VCF (Virtual VCF)

This reproduces, virtually, the VCF (Voltage Controlled Filter). The sounds from the VCO or input from external sources are processed with a filter that moves the cutoff frequency as needed, and creates brightness (or hardness) in the tone and changes in tone brightness over time. There is a mixer to set the input level from each of the sound generators at the input section of the VCF.

Osc1 → VCF (Input level from OSC1)**Osc2 → VCF (Input level from OSC2)****Noise → VCF (Input level from the noise generator)****ExtIn → VCF (Input level from the external input)****RingM → VCF (Input level from the ring modulator)**

Value: 0–100

Sets the input level to the VCF from each of the sound generators. Mute unneeded sounds by setting them to 0.

FilterType

Value: LPF, BPF, HPF, NOTCH

Sets the type of filter used (p. 101).

LPF: (Low pass filter) Passes frequencies below the cutoff frequency.

BPF: (Band pass filter) Passes frequencies near the cutoff frequency.

HPF: (High pass filter) Passes frequencies above the cutoff frequency.

NOTCH: (Notch filter) Passes frequencies other than those near the cutoff frequency.

Slope (oct)

Value: -12 dB, -24 dB

Sets the filter’s slope characteristics at the cutoff frequency (-24 dB at one octave: steep; -12 dB at one octave: shallow).

Some analog synthesizers featured -12 dB/octave, -24 dB/octave, or other slopes.

CutOff Frq (Cutoff Frequency)

Value: 0–100

Sets the filter’s cutoff frequency. Set this closer to zero, the cutoff frequency becomes lower; set closer to 100, the cutoff frequency becomes higher.

This setting varies with the addition of changes from the envelope, LFO, and other changes.

Resonance

Value: 0–100

Sets the filter’s resonance level. Raising the setting increases resonance near the cutoff frequency, giving the sound a special characteristic.

NOTE If the resonance value is raised to much, extreme oscillation can arise. Take care not to allow this sound to damage your ears or your playback equipment. To stop this oscillation immediately, press **REALTIME EFFECTS [ON/OFF]**.

Env.Depth (Envelope Depth)Value: ~ 100 – ~ 100

Sets the depth of the Filter Envelope (the function of changing the filter’s frequency characteristics over time).

Attack (Attack Time)

Value: 0–100

The elapsed time starting at the point Trigger In is switched “ON” to the point at which the cutoff frequency reaches the peak value.

Decay (Decay Time)

Value: 0–100

The elapsed time from the point at which the cutoff frequency reaches the peak value until reaching to the sustain level (next item).

Sustain (Sustain Level)

Value: 0–100

The level of the cutoff frequency after the decay time (previous item) is passed and until Trigger In is switched "OFF."

Release (Release Time)

Value: 0–100

The elapsed time from when Trigger In is switched "OFF" until the cutoff frequency return to the original (pre-attack) value.

These are the filter envelope settings. Select the contour through the attack, decay, sustain, and release, and set the degree of effect with the envelope depth. If a negative value is selected for the envelope depth, the envelope shape is inverted.

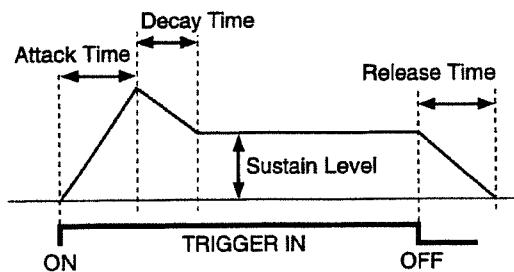

LFO Depth

Value: 0–100

Sets the depth of the vibrating cutoff frequency by the LFO.

As the value is increased, the cyclical tone change gets bigger.

ExtLev.Flw (External Input Level Follow)

Value: 100–100

Sets the degree to which the linked external input volume level changes the cutoff frequency. As the value is increased, you get an effect in which the tone changes more dynamical according to the rhythm of the input.

CutOff KF (Cutoff Key Follow)

Value: OFF, ON

This setting determines whether the cutoff frequency changes according with the Note Number in Common (ON) or not (OFF).

Velo Sens (Velocity Sens)

Value: 0–100

Sets the degree to which the cutoff frequency reflects the value of the Velocity in Common. As the value is increased, the cutoff frequency which follows the Velocity (the strength or force at pressing key) gets higher.

VCA (Virtual VCA)

This reproduces, virtually, the VCA (Voltage Controlled Amplifier).

Sounds from the VCF are amplified as they change over time, and the resulting amplified volume levels and changes are then output.

Init.Gain (Initial Gain)

Value: 0–100

Sets the reference volume. When set to any value except 0, sound plays even when the Trigger In is turned off, with the volume increasing as the value is increased. (Volume changes based on the envelope, LFO, or other input are added to this volume level.) Thus, when setting Trigger In for regulation of sound expression, set this to 0, and regulate the volume with the envelope depth.

Env.Depth (Envelope Depth)

Value: 0–200

Sets the depth of the envelope (the function of changing the amplifier's volume over time).

Attack (Attack Time)

Value: 0–100

The elapsed time from when Trigger In is switched "ON" to the point of maximum volume.

Decay (Decay Time)

Value: 0–100

The elapsed time from the point of maximum volume until reaching the sustain level (next item).

Sustain (Sustain Level)

Value: 0–100

The volume level after passage of the decay time (previous item) up until Trigger In is switched "OFF."

Release (Release Time)

Value: 0–100

The elapsed time from when Trigger In is switched "OFF" until the volume reaches its minimum value.

These are the volume envelope settings. Select the contour with attack, decay, sustain, and release, and set the degree of effect with the envelope depth.

LFO Depth

Value: 0–100

Sets the depth of the wavering volume (tremolo effect). As the value is increased, the variation in volume increases.

ExtLev.Flw (External Input Level Follow)

Value: 0–100

Sets the degree to which changes in the tremolo effect are linked to and controlled by the external input volume level. As the value is increased, you get an effect in which the synthesizer sound is played intermittently according to the rhythm of the external input (such as drum phrases).

Velo Sens (Velocity Sens)

Value: 0–100

This sets the degree to which the volume corresponds to the value of the Velocity in Common. As the value is increased, the volume level which follows the Velocity (the strength or force at pressing key) is increased.

Dly (Simple Delay)

This digital delay can be switched between monaural and alternate modes (left and right channels mutually). The maximum delay of 2400 msec (2.4 seconds) provides long echoes, fat, or thick sounds.

Mode

Value: MONO, ALT

This switches the mode of the delay.

MONO: (Monaural) A single-input, single-output delay

ALT: (Alternate) A single-in, dual-out stereo delay in which the left and right outputs are alternated (alternated delay).

Time

Value: 1–2400 msec (MONO), 1–1200 msec (ALT)

Sets the delay time, that is, the elapsed time between the source sound and the delay sound. This setting is not effective during Tempo Sync, and you cannot make this setting.

Feedback

Value: 0–100

Sets the repeat times for the delay sound. When set to 0, each delayed sound is played only once. (if the Mode is "Alternate" (ALT), delayed sound in each channel are played only once.)

Tempo SyncValue: OFF, $\frac{1}{2}$ - 2

Set this when synchronizing the Delay Time to the song tempo. When not synchronizing, set this "OFF." When you select the note, the Delay Time is set to match the length of the note.

FX Level

Value: 0–100

Sets the volume of the delay sound. Adjust this after getting a balance with the dry level.

Dry Level

Value: 0–100

Sets the volume of the source sound. It is ordinarily set to 100.

MEMO The delay is abbreviated on the screen as "Dly." Although it resembles Algorithm 6 (EZ DELAY), some functions, such as High or Low Damp, are omitted, and some other functions have been simplified. In monaural mode, you can get a long delay of 2.4 seconds at maximum. You can also use this simply and effectively as a long delay machine by setting the VCF input to "ExtIn→VCF" (external input) and then raising only that.

C/F (Chorus/Flanger)

This effect can select either a chorus effect, which adds spaciousness and a wavering effect to the sound, or a flanger effect, which adds a metallic undulation (rising and falling sound).

Mode (Effect Mode)

Value: CHORS, FLANG

This is used to select either the chorus or flanger. Setting this to "CHORS" adds an effect of spaciousness and wavering, and setting it to "FLANG" adds the flanger effect, a metallic undulation (rising and falling sound).

Mod LR Phs (Modulation LR Phase)

Value: NORM, INV

This setting determines whether the timing of the pitch wavering and undulation (rise and fall) coincides (NORM), or inverts (INV).

Rate

Value: 0–100

Sets the rate of the wavering and undulation of the chorus and flanger sounds. This is disabled in Tempo Sync, and you cannot make this setting.

Depth

Value: 0–100

Sets the depth of the wavering and undulation of the chorus and flanger sounds.

Manual

Value: 0–100

When the effect mode is switched to Flanger, this sets the center frequency for the effect, changing the pitch of the flanger's metallic sound. This has no effect in Chorus mode.

Resonance

Value: 0–100

Sets the intensity of the flanger effect. This has no effect in Chorus mode.

Tempo Sync

Value: OFF, $\frac{1}{2}$ - $\times 4$

Set this when synchronizing the Rate to the song tempo. When not synchronizing, set this "OFF." When you select the note, the Rate setting is disabled, and the Rate is set the note length corresponding to the tempo. When synchronizing to a song's tempo, if the length of the note is set longer than that of the possible range of rate settings by the change of song tempo, the Rate can not correspond to the note length.

MEMO The oscillator (LFO) used to create these chorus and flanger sounds separates from the common oscillator used by the synthesizer as a whole.

About the Sounds Generated by Effects Algorithms Themselves

The three effects algorithms, "17 PHONOGRAPH," "18 RADIO TUNING," "20 VIRTUAL ANALOG SYNTH" have a function that generates sounds such as Radio (or Phonograph) like noise or synth sound without any signal input. Usually, the levels of these effects sounds are fixed to the value of the effects patch parameters. However, when you use these algorithms by inserting any one of tracks, the effect level follows the level setting of each phrase on the track (p. 88) for certain reasons of mixer processing. If you need to avoid this situation, set the level of all phrases on the track to a regular level (100) by bouncing, etc.

Getting Smooth Changes in Effects During Song Playback

You can freely change the effects during playback of the song. (Press [FX INFO], rotate the VALUE/TIME dial to make your selection, and press [ENTER/YES].)

However, because of noise that arises during switching of the effects, the effect sound is temporarily muted.

In this kind of situation, by resampling (p. 49), you can create a separate sample to be used with different effects added where needed, giving the same effect of switching the effects during the song, but without the noise. You can also use Program Change Messages from external MIDI devices to switch the effects. MIDI Channel 11 is used for this purpose (p. 152).

Using the Realtime Effects Section

You can change the effects settings instantly with the Realtime Effects knobs. An example of using the "b" Master Filter/Isolator with the pad samples was described in chapter 1 (p. 28). By selecting patches (a:PATCH), you can use the same basic method when adding effects to sounds that are played back.

- Press [FX INFO].
The settings of the current effect is indicated in the display by icons representing the control knobs.
- Hold down [SHIFT] and press [SELECT ROW].
This toggles between the two groups, "a" Patch and "b" Master Filter/Isolator.
- Press [SELECT ROW].
This switches between the rows of parameters in the group alternately ("a" for C1–C3 ←→ C4–C6).
- Hold down [SHIFT] and press REALTIME EFFECTS [ON/OFF].
Any changes made to the effects patch with the Realtime Effects knobs are undone, and the patch is restored to the conditions at the time it was called up.

When Changes Made with the Realtime Effects Knobs Are Too Wide

If you select the Realtime Effects "a:PATCH" group, you can freely assign effects parameters to the Realtime Effects knobs C1–C6. Furthermore, you can set the range of change to the effects that occurs between the "MIN" (minimum) and "MAX" (maximum) positions. These settings are made in the control assign screen ("FX CTRL", p. 99). In the screen, press [→] to call range values and set them with [▲], [▼], [←], [→], and the

VALUE/TIME dial. These settings are saved along with other settings in "Saving to effects patches" (p. 100).

MEMO In the "b" Master Filter/Isolator group, the functions of the Realtime Effects knobs are permanently fixed, controlling the indicated parameters. However, as with the "a" Patch group, you can change the knobs' adjustment ranges.

How the Realtime Effects Knobs Function Immediately After Effects Are Switched

When the indicator to the upper left of any of the Realtime Effects knobs is lit (red), it means that the current position of the control is the same as that for the setting in the current effects patch. Immediately after switching the effects, the effects settings are in a condition in which they are saved to the patch. Therefore, since the position of the Realtime Effects knobs do not correspond to the effects settings, the indicators go off.

When rotating the Realtime Effects knobs, the effects settings reflect the position of the Realtime Effects knobs. In such instances, there are two ways you can select to have this done.

- JUMP:** The instant the Realtime Effects knob is rotated, the settings change to match the knob's position.
- NULL:** Even if the knob is rotated, the setting does not change until the current settings value surpasses that of the stored value. After that, the settings change to match the knob's position.

MEMO This is set to "JUMP" at the factory settings.

Switching the "NULL" and "JUMP" Functions

1. Press [SYSTEM/DISK].
2. Confirm that "Set System Param?" is selected, then press [ENTER/YES].
3. Press [▼] repeatedly until you have moved to "KnobContol."
4. Select either JUMP or NULL by rotating the VALUE/TIME dial.
5. Press [PLAY] to return to the basic screens.

These settings are automatically saved whenever the disk is ejected, as well as in other situations.

Using the D Beam Controller

When controlling the effects with the D Beam Controller, there are two types of the beam sensor can use, the left side beam (BL: Beam Left) and the right side beam (BR: Beam Right). Many of the Preset effects patches are already assigned to one or the other of the D Beams. With a Preset effects patch called up, press the D BEAM CONTROLLER [EFFECTS] so that it is illuminated, then move your hand within the sensor area to try out the effect.

MEMO The effective distance of the D Beam Controller can be changed with the sensitivity adjustment (see →p. 31).

Assigning Functions to the Effects

When the Realtime Effects "a" (PATCH) group is selected, you can freely assign effects parameters to the left and right D Beam controllers. These settings are made in the Effect Edit screen. Make the settings in the "Control Assign screen" (p. 99) in "Editing Effects" described earlier.

The Realtime Effects knobs controlling C5 and C6 also are used to adjust the D Beam Controller's BL and BR respectively. Therefore, when using both the D Beam Controller and the Realtime Effects knobs at the same time, it is better to use the Realtime Effects knobs C1-C4.

MEMO You can also set the range of the effects parameter that is changed by the action you bring your hand closer to the sensor of the D Beam Controller after it is detected. The procedure is the same as that for changing the effect with the knobs.

NOTE These settings are saved along with other settings as described in "Saving to Effects Patches" (p. 100).

Using the Effects as an Analog Synthesizer

With the internal effects Algorithm 20, "VIRTUAL ANALOG SYNTH," you can use the effects section as a monophonic synthesizer. There are some ways to control its expression and pitch.

Playing the Synthesizer with the Realtime Effects Knobs

When adding synthesizer effect sounds without playing notes in exact steps, you can easily play and stop the synthesizer sounds using the Realtime Effects knobs. For example, the following parameters could be assigned with the Realtime Effects knobs. (For more information on the assignment procedure → p. 98, see the explanation of the parameters → p. 123.)

C1: Trigger In

C2: Note Number

C3–C6: VCF Cutoff Frequency or Resonance, LFO Rate or LFO Depth, or other parameters of your choice

Rotate C1 to the right to sound the synthesizer, to the left to turn it off. Rotate C2 to change the pitch. With the Portamento in Common "ON," these pitch changes glide from one to the next smoothly.

During playback of looped songs or samples, many effects are played in time with the rhythm. Furthermore, synchronizing the LFO with the song's tempo can also be very effective (p. 124).

Playing Effects with the Step Modulator

By assigning synthesizer's "NoteNumber" in Common to be controlled by the Step Modulator, you can have synthesizer bass or Techno-type melodies play automatically. In such instances, using the Realtime Effects knobs in conjunction with the D Beam Controller to change the parameters while playing the effects is also effective.

For more detailed information, please see "Combining with the V-Analog Synthesizer" in Chapter 12 "Utilizing the Step Modulator" (p. 135).

MEMO Only extremely simple melodies can be played by the Step Modulator. To play more complex melodies automatically, use the SP-808 in combination with a MIDI sequencer.

HINT You can also insert the effects into the mixer's MIC/LINE IN, and using the Step Modulator to play the sound, sample the synthesizer sound, and use that sample as an element in a new song.

Playing Effects with the D Beam Controller

When assigning the effects functions to the D Beam Controller (C5BL and C6BR) as described on p. 99 and p. 129, you can assign TriggerIn in Common to one knob (C5BL). With this setup, you can press the D Beam Controller [EFFECTS], illuminating it, and play the synthesizer sounds by moving your hand above the sensor. By assigning the VCF Cutoff Frequency or Note Number in Common to the other knob (C6BR), you can enjoy changing the tone by moving your hand up or down.

Playing Effects with the Note Messages from External MIDI Devices

Set the function of "Trigger In" in Common to play the synthesizer sounds. **When MIDI Note Messages are sent from an external MIDI device via Channel 11, the synthesizer sound corresponding to that note number is played.**

MEMO Velocity included in MIDI Note Messages play sounds according to the VCF and VCA Velocity Sens settings.

MEMO For more about MIDI Messages corresponding to parameters other than notes, please see the MIDI Implementation Chart (p. 176).

Chapter 11 Utilizing the Step Modulator

What is the Step Modulator?

The Step Modulator is a virtual recreation of the analog sequencers found in those big analog synthesizers in the 1970s. You can get a variety of effects, for example arrange the playback sound to Techno-type sound.

- You can set the parameter setting of the internal effects to the preset value up to 16 steps in order.
- Switching of the values (step progression) can be synchronized to song tempos. Furthermore, you can proceed manually (by pressing the buttons) one step at a time.
- When you select the Algorithm 20, "VIRTUAL ANALOG SYNTH" of the internal effects, you can get an arpeggiator-like effect without any external sound module.

(MEMO) The SP-808's Step Modulator is based on the SYSTEM-182 sequencer unit (released in 1979) from Roland's SYSTEM-100M Series System Synthesizers. Like the SYSTEM-182, the 8-step, 2-channel setup can be arranged, in series for a single system creating up to 16 steps, or for a dual system with a maximum of 8 steps each in parallel, the output of which can then be sent to the internal effects.

About Analog Sequencers

In today's electronic instruments world, generally a sequencer means multi-function automatic playback equipment (such as variety types of MIDI sequencer or computer sequencer software, etc.). Analog sequencers are the predecessors of these functions.

In the 1970s, analog sequencers were produced for the purpose of controlling analog synthesizers. The pitch, tone, and volume of synthesizers at the time were voltage-controlled. Thus, an analog sequencer with, for example, 16 steps would be set up with 16 separate voltage control knobs lined on the panel, and would output the voltage determined by the positions of these knobs along with the tempo that was set in order. By sending this voltage to the various parts of an analog synthesizer, the sequencer could repeat extremely rapid melodies, and the tone could be made to change cyclically in steps.

(NOTE) In the Save procedure, the Step Modulator settings are saved as one part of the effects settings making up the total effects patch. (p. 100)

(NOTE) The effects saving procedure can be performed while the step modulator is working. In the case, [STEP MOD] blinks when that effects patch is called out next time and inform the user to use the step modulator (press [STEP MOD]). Effects can be saved even while the step modulator is working. After being saved in this way, [STEP MOD] will blink when the effects patch is called up the next time, reminding you to use the step modulator (press [STEP MOD]).

Basic Operation

The Step Modulator data is installed in Each Preset effects patch. Let's use this data to get a basic understanding of how to operate the Step Modulator. Step Modulator can be started and stopped in most of the screens by pressing [STEP MOD]. Here, in order to check out how the settings affect the Step Modulator's behavior, let's work from the Step Modulator settings screen.

(MEMO) To check out how the Step Modulator works, first select Effects Patch P99, then put the effects in the Send/Return position.

1. Press [FX INFO], rotate the VALUE/TIME dial to select Effects Patch P99, and press [ENTER/YES].

Effects Patch P99:

This is the template for the Algorithm 20 "VIRTUAL ANALOG SYNTH." With the following procedure, running the Step Modulator recreates the automatic playback performances of the analog sequencers.

2. Hold down [SHIFT] and press [MUTE] to call up the "MIX COMMON" screen.
3. Press [▼] twice to select "FxLoc" (Effects Location).
4. Rotate the VALUE/TIME dial to get to "SEND/RETURN."
5. Hold down [SHIFT] and press [STEP MOD] to call up the Step Modulator settings screen.

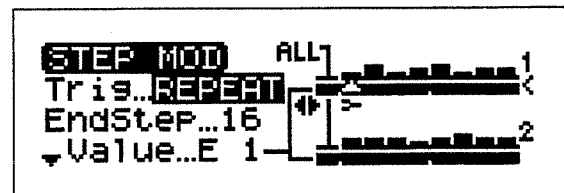

6. Press [STEP MOD]; an analog synthesizer sound is played back in arpeggiator-style phrase repeatedly.

Press [STEP MOD] once again to stop playback. During the progression, [STEP MOD] is illuminated.

Since the "Trig" (Trigger) is set to "REPEAT," the Step Modulator plays back sounds repeatedly. Changing this setting changes the performance behavior of the Step Modulator.

Changes in the Performance of the Step Modulator Made with the "Trig" Setting

- 1STEP:** The phrase progress one step each time [STEP MOD] is pressed.
- SINGLE:** The phrase is run through from beginning to end once each time [STEP MOD] is pressed. If [STEP MOD] is pressed during the progression, the phrase stops at that step.
- REPEAT:** When [STEP MOD] is pressed, the phrase repeats until [STEP MOD] is pressed again. If [STEP MOD] is pressed during the progression, the phrase stops at that step. Pressing [STEP MOD] while the phrase is stopped begins the progression from the beginning.
- MEAS:** During playback of the song, each time the measure bar is crossed, the progression begins from the first step. Stopping the song simultaneously stops the Step Modulator.
- SngPLY:** When the song is played back, the steps are played from the beginning, and repeat thereafter. Stopping the song stops the Step Modulator simultaneously.

Rotate the VALUE/TIME dial to select a "Trig" setting other than "REPEAT" and check out the change in what the Step Modulator does when you press [STEP MOD].

MEMO Changes in values the Step Modulator produces come in two groups, "StM1" and "StM2." (The effects controlled by "StM1" and "StM2" are designated in the Effect Edit screen. Hold down [SHIFT] and press [FX INFO], [▶] (CTL), and [ENTER/YES] in order to call up the settings screen. → p. 99)

Setting the Final Step Number and Value of Each Step

The Step Modulator settings screen (STEP MOD) is composed of two screens. The first page (referred to in Step 5 above) contains the following settings parameters.

Press [▲], [▼], [←], or [→] to select item then rotate the VALUE/TIME dial to set them.

Trig (Trigger)

Value: 1STEP, SINGLE, REPEAT, MEAS, SngPLY
This sets the progression of the Step Modulator step.

EndStep

Value: 1-16
This setting determines the Step Modulator's number of steps.

Series Motion and Parallel Motion

When "EndStep" is set from 9 to 16, you can only have one step progression running at a time. This is called **series motion**. If "EndStep" is set at 8 or below, two different step progressions can be run simultaneously. This is referred to as **parallel motion**.

The switch between parallel motion and series motion is made automatically when step number (EndStep) setting is at either 8 or below, or 9 or above.

Value

Value: 0-127/Each Step

This sets the input value to the effects for each Step 1-16. Eight steps are displayed at the top of the screen and eight at the bottom, and the value for each of the total of 16 steps is indicated in bar graph form.

Press [▶] first, and then [▲], [▼], [←], or [→] to move the "△" up, down, left, or right, allowing you to select the step whose value you want to set. At this point, the value for "Value" is highlighted; you can now rotate the VALUE/TIME dial to set the value.

MEMO When the "Note Number" of the Algorithm 20 "VIRTUAL ANALOG SYNTH" is assigned to the Step Modulator signals ("StM1" and "StM2") the values are not the numerals 0-127, but change to the names of the sounds **RST (Rest), TIE, D-, D#, E-, ..., F#9, G9** (p. 135).

MEMO You can copy all of the settings related to the Step Modulator, including step values, from other effects patches. (p. 133)

An Example of the Producing Values from the Step Modulator

The way to produce values from the two groups in the Step Modulator ("StM1" and "StM2") depends on the setting of the EndStep (series motion or parallel motion) as shown below.

STEP	1	2	3	4	5	6	7	8
	0	10	25	30	44	52	68	75
Value	_____							
STEP	9	10	11	12	13	14	15	16

If "EndStep" is set to "6"

This is under eight, so parallel motion is selected. The values for each Step No. 1-6 are sent to "StM1," with the values for No. 9-14 going to "StM2."

"StM1" → (0, 10, 25, 30, 44, 52,) (0, 10, 25, 30, 44, 52,) (0, 10, 25, repeating)

"StM2" → (81, 96,103,118,121, 77,) (81, 96,103,118,121, repeating)

If "EndStep" is set to "10"

This is over nine, so series motion is selected. The values for each Step No. 1-10 are sent to both "StM1" and "StM2."

"StM1" → (0, 10, 25, 30, 44, 52, 68, 75, 81, 96,) (0, 10, 25, 30, 44, 52, repeating)

"StM2" → Same as StM1

These are indicated in bar graph form in the display.

**Determining the Tempo/
Synchronizing with a Song**

After Step 5 of "Basic Operation" mentioned before, press [▼] repeatedly brings you to the second screen. The parameters determining the Step Modulator's running tempo are here. Press [▲], [▼], [←], or [→] to select the parameter, and rotate the VALUE/TIME dial to make the setting.

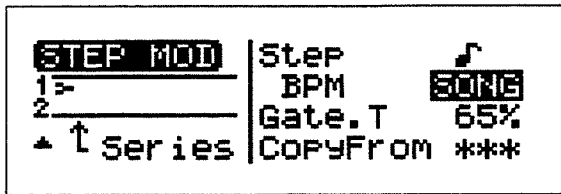

Step...

Value: ♪ - ○

This is the setting that determines the kind of notes and the tempo thus interpreted for one step in the Step Modulator.

BPM

Value: SONG, 20.0-500.0

This parameter sets the Step Modulator tempo in terms of BPM (Beats Per Minute). Selecting "SONG" synchronizes the Step Modulator's tempo and the current tempo of the song. When you set the value in the range of 20.0-500.0, it runs at fixed tempo independent of the song's tempo.

(MEMO) This tempo setting is set at quarter notes (96 ticks in the song) receiving one beat. This is fixed, affected neither by the note selection in "Step" above nor by the song's specified measure rhythm.

Gate.T

Value: EXTN, 1-100 (%), LINK

You can control "TriggerIn" (ON/OFF) in the effects algorithm 20 "VIRTUAL ANALOG SYNTH," and have the synth sound played at step divisions, or have the song play only when Step Modulator is active. This can be enabled, and settings made, only when selecting patches with the **Algorithm 20 "VIRTUAL ANALOG SYNTH"** in the effects.

(MEMO) Algorithms are the basic compositions of the effects upon which the effects patches are based (p. 98).

Control Gate by the "Gate.T"

"TriggerIn" in the effects algorithm 20 "VIRTUAL ANALOG SYNTH" is the parameter that turns the synth sound on and off. The Step Modulator's "Gate.T" turns "TriggerIn" on and off then plays synth sounds intermittently.

CopyFrom

Value: P01-P99, U01-U99, MST

Use this when copying settings related to the Step Modulator from another effects patch.

Copying and Using Step Modulator Settings from Another Patch

You can copy and make use of **all settings related to the Step Modulator** over from another preexisting effects patch.

1. Hold down [SHIFT] and press [STEP MOD] to call up the Step Modulator setup screen.
2. Press [▼] repeatedly to advance to the second screen, and highlight "CopyFrom" at the very bottom.
3. Rotate the VALUE/TIME dial to specify the copy source patch.

MST: MASTER FILTER/ISOLATOR

P01-P99: Preset Patches

U01-U99: User Patches

4. Press [ENTER/YES] to execute the copy.

(NOTE) You must save the patch to save the settings (p. 100).

An Example of a Combination of Effects

The Step Modulator is one of the function to control the internal effects likewise the Realtime Effects knobs or the D Beam Controller. Use the following procedure to set which effect parameter (value settings) is to be changed by the step value of the two series ("StM1" and "StM2") generated by the Step Modulator.

MEMO Before performing this procedure, hold down [SHIFT] and press [SELECT ROW] to switch to **a: PATCH**. If the internal effects are set to the **b: MASTER FILTER/SOLATOR**, what is affected is fixed, as shown below.

"StM1" → Filter "CutoffFreq"

"StM2" → Filter "Resonance"

Specifying the Effect Parameters to Be Changed

1. Hold down [SHIFT] and press [FX INFO] to call up the Effect Edit screen.
2. Rotate the VALUE/TIME dial to select the desired effects patch, then press [ENTER/YES].
3. Press [←] to highlight "CTL" (Control) in the lower, right of the screen.
4. Press [ENTER/YES] to call up the screen for setting C1–C6 (Realtime Effects knobs and D Beam Controller) and the "StM1" and "StM2" (Step Modulator) assignments.
5. Press [▲] or [▼] to select the row with "StM1" or "StM2."
6. Rotate the VALUE/TIME dial to specify the effect parameter to be changed by "StM1" and "StM2."
7. Press [PLAY] to return to the basic screens.

To save these settings, use the procedure to save the effects patches (p. 100).

Each step in Step Modulator can be set with a value from 0 (minimum) to 127 (maximum). This changes the effect setting specified in Step 6. You can set the range of change for both "StM1" and "StM2" with the following procedure.

Specifying the Range of Changes to the Effects Values

Continuing from Step 5 above:

6. Press [←] to call up the Change Range settings screen.
(StM1 ○○ ↔ ○○, StM2 ○○ ↔ ○○)
7. Press [▲], [▼], [←], or [→] to highlight the left or right of " ↔ " settings values.

8. Rotate the VALUE/TIME dial to set the range of change. (The setting to the left of " ↔ " is the status when the value of the Step Modulator output is 0. The setting on the right side is when the output value is 127.)

9. Press [PLAY] to return to the basic screens.

To save these settings, use the procedure to save the effects patches (p. 100).

MEMO Immediately after changed the assignment of the effect parameter, this becomes that parameter's "minimum ↔ maximum" setting.

MEMO If the internal effects are set to the **b: MASTER FILTER/SOLATOR**, then the range is set at 0–100. (The parameters are also fixed, with "StM1" set to Filter "CutoffFreq" and "StM2" to Filter "Resonance.")

Combining Filter-Related Effects

You can get a variety of interesting effects by combining filter effects (changing frequency components) or modulation effects (vibration of the tone) with the Step Modulator.

By applying the Step Modulator to "CenterFreq" in Algorithm 14 "80s PHASER" (Effects Patch P93), you can get a step phaser-like effect (which changes the tone in steps). (In this case, set both "LFO1 Depth" and "LFO2 Depth" to 0.)

You can get similar effects (step flanger type) with flanger algorithms as well. Change "Manual" in Algorithm 11 "VINTAGE FLANGER" (Effects Patch P90) or Algorithm 12 "2x BOSS FLANGER" (Effects Patch P91). (In either case, set "Depth" to 0.)

When changing such frequency-related settings as "Frequency" (Cutoff Frequency) parameter in "STEREO AUTO WAH," "ISOLATOR & FILTER," and similar algorithms with "StM1," and with "StM2" assigned to such parameters as "PEAK" and "RESONANCE," you can get even more dynamic changes. Furthermore, if you set the number of Step Modulator steps (EndStep) to "2," and Trigger (Trig) to "1STEP," the filter opens changes each time you press [STEP MOD]. This way, you can get an effect like that of switching preset filters.

The step modulator can control the specified effects parameter. Please understand; depending on the parameter selection, there might be some switching noises while the step modulator is working.

Combining Delay-Related Effects

The delay effect Algorithms contain parameters for effect sound volume ("FX Level" in "EZ DELAY," "DELAY RSS," and "TAPE ECHO 201" and "Echo Level" in "ANALOG DELAY & CHORUS" as well as others). By changing these with the Step Modulator, you can get the effect of turning the delay on and off as the song progresses.

An Example Adding Delay in Only One of Four Measures

Set up a song with a 4/4 time signature. Select a delay-type effect for the song, and then carry out the following procedure.

In the Effects Patch

- Assign an effect sound volume parameter (such as "FX Level") to "StM1."
- Set "0 ↔ 100" for the "StM1" effect value range.
- Set the other delay parameters on the deeper side.

In the Step Modulator

"Trig" → "SngPLY"
 "EndStep" → "4"
 "Value1-4" → "0, 0, 0, 100"
 "BPM" → "SONG (Song Synchronization)"
 "Step" → Whole Note.

In this state, when you start playback from the beginning of the song, only one measure out of every four has the delay sound added. With the algorithm one that can be synchronized to the song tempo, this adds another interesting effect.

Combining with the Virtual Analog Synthesizer

By controlling the algorithm 20 "VIRTUAL ANALOG SYNTH" with the Step Modulator, you can perform Techno-style phrases with the sounds of a vintage synthesizer played through an analog sequencer. In addition, using the ring modulation (p. 125) in time with the rhythm gives you a variety of different effects.

An Example of Playing a Phrase of Sixteenth Notes at BPM 140.0

Select an effects patch using the Algorithm 20 "VIRTUAL ANALOG SYNTH" (such as Effects Patch P99), and make the following settings.

In the Effects Patch

- Assign "NoteNumber" to "StM1."
- Turn on "Oscillator Key Follow" (Oc1 Pt. KF, Oc2 Pt. KF).

In the Step Modulator

"Trig" → "REPEAT"
 "EndStep" → "16"
 "BPM" → "140.0"
 "Step" → "♪"
 "Gate.T" → "70%."
 "Value1-16" → "B2, A2, G2, F#2, B2, A2, G2, C3 TIE, C3, G2, F2, C3, G2, F2, A2, C3"

MEMO When the "Note Number" of the Algorithm 20 "VIRTUAL ANALOG SYNTH" is assigned to the Step Modulator signals ("StM1" and "StM2") the values are not the numerals 0-127, but change to the names of the sounds **RST (Rest)**, **TIE**, **D-**, **D#**, **E-**, ..., **F#9**, **G9**.

- When "RST" is selected, the gate is not opened, which results in a rest.
- When "TIE" is selected, the gate in the previous step is held opened, resulting in a tie.

In this example, the following sounds are played. (The overall pitch can also be adjusted up or down within the effects)

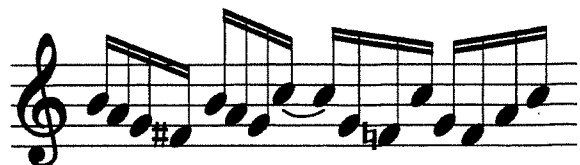

Utilizing the Step Modulator

About "Gate.T (Gate Time)"

When the Algorithm 20 "VIRTUAL ANALOG SYNTH" is being controlled, you can set the way to turn the effect's (the synthesizer's) "TriggerIn" (ON: sounding/OFF: stopped) "ON" or "OFF" with the Step Modulator. This is the **Gate Time**.

EXTN (External Control)

The effect's (the synthesizer's) "TriggerIn" is not turned on or off at each step.

1%-100%:

The "TriggerIn" is turned on in time with the beginning of each step in the Step Modulator. After that, it is turned off until the next step. The interval between the time it is turned on and then turn off is shortened as the value is decreased, and lengthened as the value is increased. Setting the value closer to 1% results in more of a staccato (short and clipped) sound, nearer to 100% in tenuto (long, drawn out) sound. (Please refer to the figure below.)

LINK:

Running the Step Modulator turns "TriggerIn" on, and stopping the Step Modulator turns it off. It cannot be turned on and off for each step.

Change in the "TriggerIn" ON/OFF status from the Gate.T setting

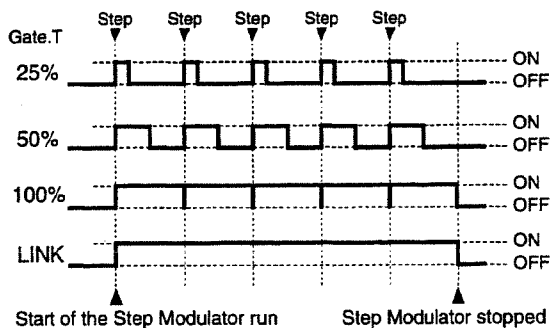

NOTE The control using Gate Time is conducted independently of "StM1" and "StM2." Furthermore, when "StM1" or "StM2" is also assigned to "TriggerIn," control by the Gate Time is given a priority. (When Gate Time is set to "EXTN," it follows the control of "StM1" and "StM2.")

Chapter 12 Other Convenient Functions

Starting the Sound with Releasing the Track Mute Simultaneously (Track Voice Reserve)

In normal operation during playback, the following can occur:

- When pressing [STATUS] to switch from Mute status (unlit) to Play status (illuminated in green), a moment elapses between the time the mute is released and when the sound begins to play.
- When, as you hold down a pad (or perform a similar action) to keep the pad samples playing continuously, and press [▶] (PLAYBACK), then all the pad sounds stop.

You can avoid these problems by turning on the Track Voice Reserve function.

Turning On Track Voice Reserve

1. Press [SONG/TRACK].
2. Press [▼] to select "Set Song Parameter?" and press [ENTER/YES].
3. Press [▼] or [▲] to select the "Tr.VoiceReserve" parameter.
4. Rotate the VALUE/TIME dial to set it to "ON."
5. Press [PLAY] to return to the basic screens.

(NOTE) Track Voice Reserve is stored in each song. If you turn off the power or switch to another song without saving the song(p. 72), any changes you have made will be voided.

(MEMO) The SP-808's internal sound production capabilities (four stereo channels) are used both by the tracks (4) and pads, and can be switched whenever desired. In normal use, instances such as those mentioned above pose little problem. However, in such situations as DJ performances, there are times when the operator wants to use [STATUS] like the channel Mute button on conventional audio mixers. (This is for situations like when starting a sound playing right at the start of a measure or for rapid switching between **play and stop**). Furthermore, one could easily imagine wanting to start a phrase loop playing at first, and then begin playback of the song at just the right timing. In such instances, you can benefit from the Track Voice Reserve function.

The Effect of Turning on Track Voice Reserve

During playback of a song, pressing [STATUS] of the playing track(illuminated in green) switches the button light to **flashing green (MUTE)**. In this condition, pressing [STATUS] again returns the track status PLAY (the button is illuminated in green again) and playback of the sounds on the tracks begins instantly.

(MEMO) To set the track status MUTE ([STATUS] of the track flashes green) before beginning playback of the song, press [STATUS] of the track at PLAY status (illuminated in green) while hold down [■]. Pads (samples) being played continue to do so, even if [▶] (PLAYBACK) is pressed.

The following limits are applied while Track Voice Reserve is "ON."

- The number of pads that can be played simultaneously, **even when the song is stopped**, is limited by the number of tracks whose [STATUS] are not illuminated.
- During playback, you cannot switch track's [STATUS] which is not illuminated(MUTE status) to illuminate in green (PLAY status). You cannot switch the mute-status track to play.
- During playback, the track's [STATUS] which illuminates green starts to flashing when [STATUS] is pressed. You can not turn the track's [STATUS] illumination.

Naming the Pad Banks

One disk holds 64 pad banks. You can name any pad bank using up to ten characters. Pad bank names are indicated in the pad bank Edit screens for copying (p. 57), erasing (p. 56), and other functions. In addition, you can confirm the name of the current pad bank in the "CONTRAST/INFO" screen (hold down [SHIFT] and press [PLAY]).

It can be convenient to give the descriptive names to the pad banks, like the ones shown below.

- Sample Types ("DrumLoop 1," "Male Voice," "SFX," etc.)
- Names of songs in that samples of the pad bank are used the most
- Date of sampling or memo (such as "Aug.7, 97" or "5/12 9:30 p.m.")

Naming a Pad Bank

1. Call up the pad bank to be named (p. 26).
2. Press [SAMPLE/BANK], then press [▼] or [▲] to select "Set Bank Param?"
3. Press [ENTER/YES].
4. Check to make sure that the parameter "Name" is selected.
5. While pressing [←] or [→] to move the character position, rotate the VALUE/TIME dial or press the pads to select the characters to be entered.
6. Press [PLAY] to return to the basic screens.

These changes are automatically saved to the disk when the disk is ejected, as well as in other situations (no save procedure is necessary).

Using the Pads as Character Entry Buttons

As in Step 5 above, when the cursor is positioned at a pad bank name or the like, the pads then can be used as character entry buttons. (In such instances, they do not function as pads for expressing sounds.)

For example, with Pad [2] (DEF), the characters in the series "2 → d → e → f → 2 → d → e..." are switched each time the pad is pressed.

[13] (CAPS LOCK) The pad illumination is turned on or off each time the pad is pressed. When illuminated it functions as a **CAPS LOCK** (Capital Letters).

[14] (INS) Pressing this inserts a space and moves the characters that come afterwards back one space.

[15] (DEL) Pressing this deletes a space and moves the characters that come afterwards up one space.

[16] (BS) Pressing this deletes the character and then moves the cursor to one space ahead of the current position.

Protecting the Pad Bank's 16 Samples

In order to prevent the pad samples being lost due to mistakes in operations or from accidentally being overwritten, you can add protection by carrying out the Protect procedure. When a pad bank (or sample within the pad bank) is protected, the following takes place.

- When you try to sample, the warning message "Bank is Protected." appears in the display.
- You cannot call up the setting parameter screen (such as those called up when you press [SAMPLE/BANK]) and select "Set Sample Param?" or "Set Bank Param?"
- If you attempt to erase a pad bank or sample, or if you try to edit the content in a pad bank, the warning message appears in the display, and you cannot continue with the procedure.
- When copying or moving pad banks or samples, and the copy or move destination is designated, you cannot execute the procedure if the destination is protected.
- When renumbering the pad banks, if a selected number is within a range of protected numbers, then you cannot execute the procedure.
- When formatting disks, the protect warning message is displayed repeatedly.

Adding and Removing Protection for Pad Banks

1. Press [SAMPLE/BANK], then press [▼] to select "Bank Protection."
2. Press [ENTER/YES] to call the "TURN BANK PROTECTION" screen, then select the Pad Bank with the VALUE/TIME dial.
3. Confirm that "(Now OFF → Turn ON)" appears in the display.
4. Press [ENTER/YES] to turn the protection on (protecting the pad bank).
To remove the protection, press [ENTER/YES] once more in the same screen.
5. Press [PLAY] to return to the basic screens.

These changes are automatically saved to the disk, even when the disk is removed, as well as in other situations (no save procedure is necessary).

The Different Kind of Song Protection

You can also add protection to songs (p. 72). Since this protects **the song on the disk**, you can still edit the song data currently loaded into the SP-808. (Since this is in a form that cannot be overwritten, this song is protected.) In contrast, with protection of pad banks (including the samples within), (because no save procedure is necessary for saving samples and pad banks), changes are prevented by the SP-808.

Rearranging Samples To Prevent Empty Pads in the Pad Bank (Renumber)

By using the **Renumber** function, you can move samples that scattered throughout Pads Banks 1–64 up together to free up pad numbers for new use.

An Example

When Samples A, b, C, ...X, and Y are arranged on Pad Banks 01–04 as shown below. ("-" indicates an empty pad.)

	[PAD #]															
	1	2	3	4	5	6	7	8	9	10	11	12	13	14	15	16
Bank01	A	B	-	-	-	-	C	-	-	-	-	-	-	-	-	D
Bank02	-	E	F	-	-	-	-	-	G	H	I	J	-	-	-	K
Bank03	L	-	-	-	M	N	-	-	O	P	-	Q	R	S	T	U
Bank04	-	-	-	-	-	-	V	-	-	W	X	-	-	-	-	Y

In contrast to this, by specifying as the selected range Pad Banks 02 and 03, and then carrying out Renumber, the result is as shown below.

	[PAD #]															
	1	2	3	4	5	6	7	8	9	10	11	12	13	14	15	16
Bank01	A	B	-	-	-	-	C	-	-	-	-	-	-	-	-	D
Bank02	E	F	G	H	I	J	K	L	M	N	O	P	Q	R	S	T
Bank03	U	-	-	-	-	-	-	-	-	-	-	-	-	-	-	-
Bank04	-	-	-	-	-	-	V	-	-	W	X	-	-	-	-	Y

MEMO Banks 01 and 04 remain unchanged. Banks 02 and 03 are stuffed with samples in from towards.

Rearranging Samples (Renumber)

1. Press [SAMPLE/BANK] and press [▼] to select "Renumber?"
2. Press [ENTER/YES].
The range of pad banks to be rearranged is indicated in the display.
3. Press [▼] or [▲] and rotate the VALUE/TIME dial to select the range of pad banks whose pad numbers are to be loaded with moved samples.
Taking the example above, set "From" (the starting pad bank number) with "02" and "To" (the end pad bank number) with "03."
4. Press [ENTER/YES].
The confirmation message "ARE YOU SURE?" appears in the display.
5. Press [ENTER/YES] to execute the operation.
6. Press [PLAY] to return to the basic screens.

Connecting and Using a Foot Switch

You can connect a foot switch to the Foot Switch jack and use it for one of the following functions.

- "PLAY/STOP" Start and stop of playing back song
- "DAMPER" For a damper pedal effect
- "SAMPL TRIG" Playing designated samples in each pad bank
- "FX ON/OFF" Turning effects on and off
- "PUNCH I/O" Punching in and out during recording

Use the following procedure to switch among these functions.

Switching Functions with the Foot Switch

1. Press [SYSTEM/DISK].
2. Check to make sure that "Set System Param?" is selected, then press [ENTER/YES].
3. Press [▼] or [▲] to select the "FSW Func" (Foot Switch Function) parameter.
4. Rotate the VALUE/TIME dial to select from "PLAY/STOP," "DAMPER," "SAMPL TRIG," "FX ON/OFF," or "PUNCH I/O."
5. Press [PLAY] to return to the basic screens. (These changes are automatically saved to the disk when the disk is ejected, as well as in other situations (no save procedure is necessary).)

MEMO These are system-common parameters, so only one setting at a time can be made, regardless of the song or disk.

Starting and Stopping Song Playback

In the procedure above, when "FSW Func" is set to "PLAY/STOP," the foot switch functions in the same way as [▶] (PLAYBACK) on the front panel. This way, you can use the foot switch to start and stop playback.

- When you press the foot switch, playback of the song begins, starting from the current song position indicated in the display.
- Press the foot switch during playback, and playback stops. Press the foot switch once more to begin playback from the point where it had stopped.
- The foot switch cannot be used for jumping to the beginning or moving the position within the song. Use the buttons and VALUE/TIME dial on the SP-808 itself to do this.

Getting a Damper Pedal Effect

In the procedure above, when “Pad Play” (p. 36) is set to “GATE,” the pads function like the keys of a keyboard instrument: **press to play, release to stop**. At this time, if “FSW Func” is set to “DAMPER,” (p. 140) you can use the foot switch to get the same effect as a piano’s damper pedal.

- While the foot switch is pressed, the sound does not stop, even if you release the pad.
- When you take your foot off the switch, the sound that was being held then stops (if the pad is pressed continuously, the pad sound keeps on playing.)

(NOTE) For the playback sound of the pads, the damper pedal effect of the foot switch differs from the [HOLD] effect on the panel. When you take your foot off the switch, the held sound stops. When [HOLD] is on, the sound continues even if you remove your hand from the pad. If you press [HOLD] while pressing another pad, that sound is added to the sound being held. The held sound is removed only if you press [HOLD].

Playing Designated Samples in Each Pad Bank

In the procedure above, when “FSW Func” is set to “SAMPL TRIG,” you can use the foot switch to play pre-determined samples in each pad bank.

Designating the Samples to Be Played in Each Pad Bank with the Foot Switch

1. Call up the pad bank for selection.
2. Press [SAMPLE/BANK].
3. Press [▼] or [▲] to select “Set Bank Param?” and press [ENTER/YES].
4. Press [▼] or [▲] to select the “FootSwAssign” parameter.
5. Rotate the VALUE/TIME dial to select the pad numbers (1–16).
6. Press [PLAY] to return to the basic screens. (These changes are automatically saved to the disk when the disk is ejected, as well as in other situations (no save procedure is necessary).

(MEMO) The way to playback samples (Loop On or Off, stop playback by releasing your foot, keep on playing until pressing the switch again, etc.) depends of the setting of the sample parameter.

Turning Effects On and Off

In the procedure on p. 140, when “FSW Func” is set to “FX ON/OFF,” the foot switch has the same function as the REALTIME EFFECTS [ON/OFF] on the front panel. This way, you can use the foot switch to turn effects on and off.

- You can turn the effects on or off anytime, regardless of the location of the effects.
- When the effects are on, REALTIME EFFECTS [ON/OFF] is illuminated; when they are off, it is not illuminated.

Punching In and Out During Recording

In the procedure on p. 140, when “FSW Func” is set to “PUNCH I/O,” the foot switch can be used to control punching in and out when recording to the tracks. For more detailed information, please refer to the procedure described in “Using the Foot Switch to Punch In and Out” in “Recording Over Only Selected Segments (Punch-In and Punch-Out).” (p. 65, 76)

Switching the Foot Switch Input (DP-2/GPI)

The Roland DP-2 (Pedal Switch) or the BOSS FS-5U can be connected to the Foot Switch jack. Additionally, by carrying out the following procedure to change the settings, you can use the jack as a GPI (General Purpose Interface) jack as well.

Using the Foot Switch Jack as a GPI Jack

1. Press [SYSTEM/DISK].
2. Check to make sure that “Set System Param?” is selected, then press [ENTER/YES].
3. Press [▼] or [▲] to select the “FSW Type” parameter.
4. Rotate the VALUE/TIME dial to switch “DP-2” to “GPI.”
5. Press [PLAY] to return to the basic screen.
6. Remove the disk, then turn the power off, then on again.

(NOTE) This setting does not take effect until the power is first turned off and then on again.

(NOTE) These are system-common parameters, so regardless of the song or disk, only one setting can be made at a time.

About GPI

GPI (General Purpose Interface) refers to a control jack found on professional/consumer-use video peripheral equipment, such as editing machines and titling devices. By connecting a device that supports GPI to the SP-808, the same functions as obtained with a foot switch (playback of samples and start/stop of songs) can be controlled from the external device.

Setting the [SHIFT] Function as "Press to Shift/Press Again to Release"

While [SHIFT] is held down, the entire system goes into **Shift condition**. In Shift condition, the functions of many buttons change. (e.g. → In Shift condition, LOCATOR [CLEAR] changes to [MIXER VIEW], which calls up the Mixer screen.

The [SHIFT] function can be selected from the following choices with the "ShiftLock" parameter.

"OFF"

Shift condition is in effect only while [SHIFT] is held down. Releasing the button restores the normal conditions. (Factory Setting)

"ONCE"

Pressing [SHIFT] once holds the Shift condition. Once any other button is pressed, the Shift function is carried out one time, after which the function is lifted, and normal conditions are restored. Even if you press [SHIFT] again, the Shift function is lifted, as well.

"ON"

Pressing [SHIFT] once holds the Shift condition. Afterwards, the Shift condition is not lifted, even after another button is pressed, using the Shift function. Press [SHIFT] again to lift the function, restoring normal conditions.

Selecting the Function for [SHIFT]

1. Press [SYSTEM/DISK] to call up the "System Edit Menu" screen.
2. Check to make sure that "Set System Param?" is selected. Press [ENTER/YES].
3. Press [▼] or [▲] to select the "ShiftLock" parameter.
4. Rotate the VALUE/TIME dial to select from "OFF," "ONCE," or "ON."
5. Press [PLAY] to return to the basic screens. (These changes are automatically saved to the disk when the disk is ejected, as well as in other situations, and no save procedure is necessary).

MEMO These are system-common parameters, so regardless of the song or disk, only one setting can be made at a time.

Increasing Remaining System Memory (Cleanup Disk)

On the SP-808 when you delete part of a song or pad sample, the disk space (the remaining recording time) does not increase right away. To increase the remaining recording time, execute the **Cleanup Disk function**. Cleanup Disk function deletes unneeded waveform data completely from the disk.

Deleting Unexpressed Waveform Data From the Disk to Increase the Remaining Recording Time

1. Press [SYSTEM/DISK], and press [▼] or [▲] to select "Cleanup Disk?"
2. Press [ENTER/YES].
3. Rotate the VALUE/TIME dial to set "Type" to "QUICK" or "STANDARD"

QUICK: Deletes only waveforms which are not used for playing back at all.

STANDARD: In addition to "QUICK," this deletes the waveform data which are not used for playing back at the beginning and the ending of each phrases in use.

4. Press [ENTER/YES]; the message "You Can NOT Undo. ARE YOU SURE?" appears in the display.
5. Press [ENTER/YES] to execute Cleanup Disk.

(MEMO) The progress of the operation is indicated by a bar graph on the screen. If you specify "QUICK" in Step 3, although the number of the waveform to be deleted is limited, the process is finished in comparatively less time.

Disable Indicating the Saving Confirmation Message at Disk Ejection and Switching Songs

Normally, when you press the Eject button, the confirmation message "Save Current Song?" appears in the display. If you press [ENTER/YES] in response, after the process of saving the song by overwriting old material is finished, the disk is ejected.

However, in such instances as during live performances, you may want to exchange disks quickly, as with a CD player. In such cases, you can press the disk's Eject button to directly remove the disk. (At this time, as during Select Song, no confirmation message is displayed.)

Eject a Disk Instantly After Press the Disk Eject Button.

1. Press [SYSTEM/DISK].
2. Check to make sure that "Set System Param?" is selected, then press [ENTER/YES].
3. Press [▼] or [▲] to select the "SongSave Confirm" parameter.
4. Rotate the VALUE/TIME dial to set this to "OFF."
5. Press [PLAY] to return to the basic screens.

These changes are automatically saved to the disk when the disk is ejected, as well as in other situations (no save procedure is necessary).

(MEMO) These are system-common parameters, so regardless of the song or disk, only one setting can be made at a time.

Copying Effects Patches to Other Disks

Sometimes you will want to use a User effects patch on the disk to another song or sample on another disk. In such instances, the **Copy Effects Only** function copies the patch to another disk. This lets you copy a single patch and assign it to a selected number of the another disk. Furthermore, you can copy a whole of the 99 User effects patches to make an exact duplicate disk.

(NOTE) Note that when you execute this function, the patch data of the copy destination number (or all patches) on the copy destination disk is lost.

1. Insert the disk containing the copy source patch into the SP-808's Zip drive.
2. Press [SYSTEM/DISK].
3. Press [▼] or [▲] to select "Copy FX Only?," then press [ENTER/YES].

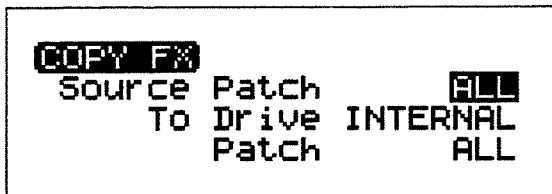

4. Press [▲] to select "Source Patch" (the patch being copied).
5. Rotate the VALUE/TIME dial to set the number (ALL, U01-U99). To copy all of the patches to a separate disk, select "ALL."
6. Press [▼] to select "(To) Patch" (the patch receiving the copy).
7. Rotate the VALUE/TIME dial to set the number (ALL, U01-U99). If "ALL" is selected in Step 4, then it is automatically selected here (in all other cases, "ALL" cannot be selected).
8. Press [ENTER/YES], and "Save Current Song? (Overwrite Only.*)" appears in the display.
9. Before ejecting the copy source disk, if you do not want to save changes to the current song, press [EXIT/NO]; if you want, the press [ENTER/YES].

If you press [EXIT/NO], then things are left as is. If you press [ENTER/YES], then after overwriting and saving, the disk is ejected. "Insert Destination Disk." appears in the display.

10. Insert the copy destination disk.

"Copy FX Patches. ARE YOU SURE?" appears in the display.

11. Press [ENTER/YES].

The effects patch from the copy source disk (ejected in Step 9) are copied to the specified patch numbers on the disk inserted in Step 10.

(MEMO) If you press [EXIT/NO] at Step 11, "COPY FX Canceled." appears in the display for a few seconds and the process is canceled, returning the SP-808 to the status that as just after the power is turned on (with no disk).

With the optional OP808-01 (Multi I/O Expansion) installed and an external Zip drive connected, you can also specify the external drive as the "To Drive" in Step 3. ("EXT.ID5" and other information is indicated.) Without the OP808-01, only the internal drive (INTERNAL) can be specified. Furthermore, the copy source is always the internal drive.

When Specifying an External Zip Drive as the Destination Drive

Continuing from Step 7 above:

8. Press [ENTER/YES].

"Copy FX Patches. ARE YOU SURE?" automatically appears in the display.

9. Press [ENTER/YES].

The designated patches from the SP-808's disk are copied to the specified patch numbers on the disk in the external drive. (If there is no disk in the external drive, "Can't Execute.(No Disk.*)" appears in the display, and you cannot execute the copy.

Create a Backup Disk Only Use the Internal Drive

You will need to make an exact duplicate disk to back up a disk includes your important songs or samples in case of losing or corrupting your data accidentally or disk's span of use. Basically, making a backup disk is executed by using the Multi I/O Expansion (SP-808-OP1) and the external Zip drive.

However, if you do not have these devices, you can make a backup disk only using the internal drive and the internal memory. In this case, we are regretted about that you have to take a while to repeat insert and eject a copy source disk and a copy destination disk alternately 64 times.

Please read "Making Duplicate Disks with the Copy Disk All Function" on p. 148 for detailed procedure. The description in the section "When you select [INTERNAL] (Internal drive) in Step 4..." and the following steps mentioned before are explained how to make a back up disk.

Confirm or Specify the Tempo by the Tapping Button Interval

While hold down [SHIFT] and tap [HOLD] repeatedly along with the desired rate (tempo), that tempo is shown on the display by BPM unit.

This is convenient when you want to know the tempo BPM value which you are going to create.

In the following situations, you can set the tempo by the procedure described above, instead of inputting by the VALUE/TIME dial.

- When "Tempo" value is selected in the Tempo Map screen (p. 71).
- When "NewBPM" value is selected in the Stretch Time screen (p. 52).

Chapter 13 Functions Using the Multi I/O Expansion

The optional **Multi I/O Expansion SP808-OP1** can be installed in the SP-808's rear panel. The SP808-OP1 is an expansion kit adding functions that let you connect external digital devices to the SP-808 and get direct outputs from the tracks.

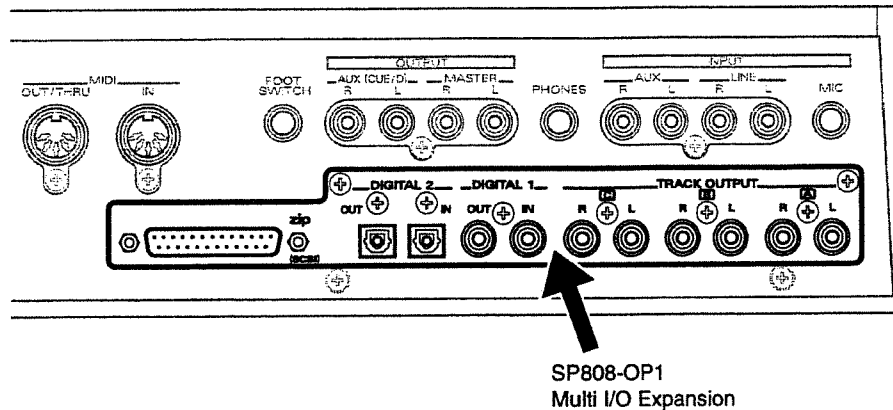

Installing the SP808-OP1 Multi I/O Expansion

(MEMO) For more information about installing the SP808-OP1, consult your SP-808 dealer or nearest Roland service center.

(NOTE) When the SP808-OP1 is installed, it takes a moment for checking connection of the SCSI devices to start up.

What You Can Do with the SP808-OP1 Multi I/O Expansion

With the SP808-OP1 installed, you can enjoy the following functions.

- Make digital (S/P DIF) connections with digital audio devices (CD players, MD players, and DAT recorders). You can perform sampling and mixdown in the digital-domain without declining the sound quality.
- Connect a SCSI-type Zip drive and create backup disks (duplications of the disk in the internal drive) easier and quicker.
- Select songs and samples on external Zip disks and load them on the SP-808's internal drive.
- Output the sounds of each track separately. This is convenient when you want to use the SP-808 in combination with an external audio mixer.

(NOTE) The following functions are not available, even with the SP808-OP1 Multi I/O Expansion installed.

Examples of What You Cannot Do

- Use analog inputs (MIC/LINE IN) and digital inputs (DIGITAL IN1, DIGITAL IN2) simultaneously (The outputs may be used simultaneously).
- Use DIGITAL IN 1 (coaxial connector) and DIGITAL IN 2 (optical connector) simultaneously (The outputs may be used simultaneously).
- Output anything but the MASTER OUT (AUX OUT or direct out from the tracks) from digital outputs (DIGITAL OUT 1, DIGITAL OUT 2).
- Perform **data backup** of the SP-808 through a digital connection to a DAT recorder or similar device.
- Use Vari-Pitch while one of DIGITAL IN is in use.
- Use DIGITAL IN/OUT with converting sample rate.
- Connect to any device (such as hard disks, CD-R drives, personal computers, and other SP-808s) except for an external SCSI-type Zip drive.
- Insert disks used for other purposes (such as disks for other samplers or for personal computers) into the external Zip drive and load sound data to the internal drive.
- Record (or perform sampling) directly to a disk in an external Zip drive.
- Play back songs or samples directly from a disk in the external Zip drive.

Using the DIGITAL IN and OUT Connectors

Installation of the SP808-OP1 extends the DIGITAL IN and OUT connectors in coaxial type (DIGITAL 1) and optical type (DIGITAL 2).

Only digital audio devices conforming to S/P DIF (Sony/Philips Digital Interface Format) can be connected to the DIGITAL IN and OUT connectors. (Many general digital audio devices which feature the same form of digital stereo input and output connectors as the SP808-OP1, are conforming to S/P DIF. Take note, some multitrack recorders, even having the same connector type, feature a different transmission format.)

Using the DIGITAL IN

The inputs **LINE IN (or MIC IN)**, the **DIGITAL 1 (coaxial)** and **DIGITAL 2 (optical)** connectors cannot be used simultaneously. To receive digital audio signals from the DIGITAL IN connectors, switch the connectors using the following procedure.

MEMO AUX IN and DIGITAL IN can be used simultaneously.

MEMO Before carrying out the procedure to switch the connectors, first connect the SP-808's DIGITAL IN connector with the DIGITAL OUT connector of the external device, using a commercially available audio coaxial cable or optical cable for digital audio signal to connect them.

Selecting the Input Source

1. Press [SYSTEM/DISK].
2. Check to make sure that "Set System Param?" is selected, then press [ENTER/YES].
3. Confirm that "InputSource" is selected.
4. Rotate the VALUE/TIME dial to select "MIC/LINE" (analog), "DIGITAL1" (coaxial), or "DIGITAL2" (optical).
5. Press [PLAY] to return to the basic screens. (This change is automatically saved to the disk when the disk is ejected, as well as in other situations, so no save procedure is necessary).

If no signal is coming in through the DIGITAL IN connectors, then wait for a few seconds at Step 4, the message "D.In Unlock. Use Analog In?" appears in the display. (This is indicated when, for example, the connections are not properly made, or when the power of the connected device is turned off.) Press [ENTER/YES], switching to the analog inputs (MIC/LINE), and returning to the screen at Step 3.

If [ENTER/YES] is not pressed, the message stays on the screen while the SP-808 waits for the digital audio signal to receive correctly. As soon as receiving the signal,

"D.In Locked." appears in the display, indicating that the connection has been made properly.

If the signals fail to send to the connectors properly while DIGITAL IN is in use, "D.In Unlock. Use Analog In?" reappears in the display as well. At this point, the current operation, whether playback, recording, or another procedure, is canceled or stopped.

NOTE If there is no SP808-OP1 installed, then DIGITAL 1 and DIGITAL 2 cannot be selected.

MEMO These are system-common parameters, so only one setting at a time can be made, regardless of the song or disk. These settings are automatically saved whenever the disk is ejected, as well as in other situations.

NOTE Only the digital audio signals that have the same sample rate as; which are specified at the format the Zip disk currently in use, can be accepted. For example, when receiving digital audio signals from a CD player (at a sample rate of 44.1 kHz), if the Zip disk in the SP-808 is formatted at 32 kHz, then "Wrong Sample Rate." appears in the display at Step 4, and the SP-808 is forced to switch to the analog inputs (MIC/LINE).

NOTE When receiving digital audio signals from devices that use the Vari-Pitch function (such as Roland's VS series hard disk recorders), turn off the Vari-Pitch function of the sending device. If due to the Vari-Pitch the actual sample rate exceeds 44.1 kHz, the receiving SP-808 may malfunction, and playback equipment as well as your ears may suffer damage from the resulting noise.

Using the DIGITAL OUT

The extended DIGITAL OUT 1 and DIGITAL OUT 2 connectors output the same sound signals as the analog MASTER OUT, but in digital form. All outputs (including the analog output) can be used simultaneously. Connect the DIGITAL IN connector of a DAT recorder or MD recorder, using a commercially available coaxial cable or optical cable for digital audio signal to connect the devices.

Preventing Digital Copying of Finished Works

When recording to DAT recorders or MD recorders using the digital connection (such as when mixing down), you can prevent any digital copies of the finished product (tapes or MDs) to another. This function is called **Digital Copy Protect**. You can have DATs or MDs recorded through a digital connection with the SP-808 act the same way as digital copies on MDs recorded from CD players.

NOTE With commercial audio CDs, only one generation of digital copying onto DAT tapes or MDs (child/daughter) from CDs (parent/mother) can be made. The reproduced sound recorded with a digital connection cannot then be rerecorded with a digital connection again (creating another MDs (grandchild/granddaughter) from the MDs (child/daughter)).

Applying Digital Copy Protect

1. Press [SYSTEM/DISK].
2. Check to make sure that "Set System Param?" is selected, then press [ENTER/YES].
3. Press [▼] to select "D.CopyProtect."
4. Rotate the VALUE/TIME dial to set this to "ON."
Digital copying of DATs and MDs recorded through digital connections is prevented.
5. Press [PLAY] to return to the basic screens.
These settings are automatically saved to the disk when the disk is ejected, as well as in other situations, so no save procedure is necessary).

With the above procedure, you can prevent your digital-ly copied master tapes from being copied further onto another DAT or MD.

(NOTE) Initial DAT recorders may be completely unable to record digital audio signals from the SP-808's DIGITAL OUT, if the Digital Copy Protect is "ON." These are recorders that are not compatible with SCMS (a currently popular copy-right protection system). In such instances, record with Digital Copy Protect turned off. Furthermore, even with Digital Copy Protect turned off, recordings via digital connection cannot be made on recorders with inconsistent sample rates (44.1 kHz or 32 kHz on the SP-808).

Functions Using the External Zip Drive (SCSI Connection)

An external Zip drive can connect to the extended SCSI connector on the SP808-OP1. This allows copying of samples and songs from disk to disk. Furthermore, this permits the creation of backup disks easier and quicker to safeguard against the loss of data from damaged or old disks.

(NOTE) Zip drives are precision devices. Improper connection or use may result in malfunction, corrupted data, or damage to the unit. Be sure to carefully read the owner's manual for the Zip drive as well.

Connecting the Zip Drive

After first turning off the power of all devices, connect the SP-808 and the Zip drive as shown in the illustration, taking care to secure the connectors by fastening the screws firmly. Do not plug or unplug the SCSI cable while the power is on.

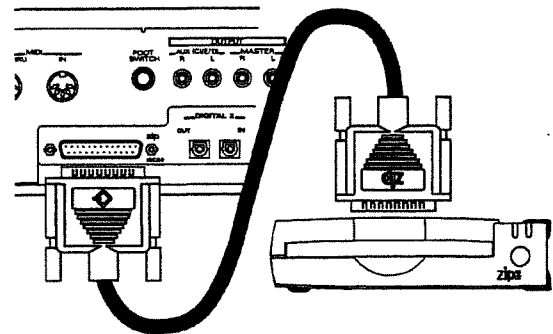

When finished the connections and confirm the Zip drive SCSI ID number and terminator settings (mentioned below), turn on the power of the equipment.

(NOTE) When turning on the power, always turn on the Zip drive before the SP-808.

(NOTE) When connecting the Zip drive, use an appropriate SCSI cable (such as the original cable provided with the Zip drive) that fulfills the conditions listed below.

- Connectors on both ends of the SCSI cable must be DB-25 type (take care not to use similar-looking serial cables).
- The cable should be as short as possible.
- It must have the correct impedance (110 ohms \pm 10%) and be completely shielded.

Number of SCSI Devices That Can Be Connected

In general, a maximum of eight SCSI devices can be connected in any one series (SCSI chain). However, with the SP-808, that number is limited to three, the SP-808 itself and up to two Zip drives. Zip drives are the only SCSI devices that can be connected to the SP-808. Furthermore, "5" and "6" are the only SCSI ID numbers (see following item) that can be assigned to these Zip drives (as of 2/98).

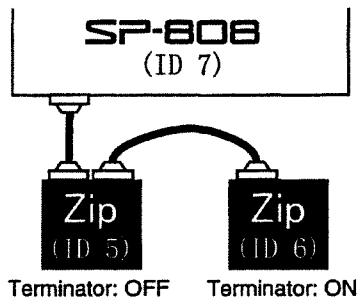

Setting the SCSI ID Number

Devices connected with SCSI connections are distinguished by what are known as **SCSI ID** numbers (0-7). In order to have each SCSI device operate properly, it is necessary to set the SCSI ID numbers for each of the SCSI-connected devices **so that no two devices have the same SCSI ID number.**

The SP-808's SCSI ID number is fixed at "7." Set the SCSI ID numbers for any connected Zip drives so that they are not shared by any other connected device. (For instructions on how to set the Zip drives' SCSI ID numbers, please refer to your Zip drive owner's manual.)

SCSI Terminators

In general, in order to have devices connected with SCSI connections work properly, a **terminator** must be attached only to the last device in a SCSI chain. The SP-808 and Zip drive feature built-in terminators.

Since the SP-808 is always one of the last device in the SCSI chain, the terminator is always on. When connecting only one Zip drive, also switch that Zip drive's terminator to "On." When connecting two Zip drives, switch on the terminator only of the drive at the other end of the SCSI chain (the drive connected by only one cable).

(NOTE) For instructions on how to turn the Zip drives' terminators on and off, please refer to your Zip drive owner's manual.

(NOTE) Do not double the terminators (for example, do not attach a separate external terminator to a Zip drive when its internal terminator is switched on).

Creating a Backup Disk

A Zip disk is an expendable product, so its period of usefulness is not unlimited. Before your important songs or samples are lost, or before the data can be corrupted, use an external Zip drive to make exact duplicate disks thus backing up the data.

(NOTE) The backup procedure deletes all former data on the destination disk. However, you can use Zip disks that are not formatted for use with the SP-808 for this operation. **Make sure that you do not mistakenly use disks containing data you want to keep for backup.**

Making Duplicate Disks with the Copy Disk All Function

1. Insert the copy source disk in the internal drive.
2. Press [SYSTEM/DISK], then press [▼] or [▲] to select "Copy Disk All?"
3. Press [ENTER/YES].
4. Rotate the VALUE/TIME dial to specify the copy destination drive (To Drive).

The SCSI ID number, such as "EXT.ID5," appears in the display.

5. Press [▼] to move to the "Verify" parameter.
6. Rotate the VALUE/TIME dial to select either "ON" or "OFF."

ON: This confirms that the copy is done correctly during the process. This ensures that copies are true duplicates.

OFF: The copy is not checked. Copying takes less time when this is selected.

7. Insert the copy destination disk in the external Zip drive.
8. Press [ENTER/YES] twice.

All contents of the internal drive are copied to the disk in the external Zip drive.

With Verify turned off, copying takes approximately four and a half minutes; with Verify on, it takes about seven minutes.

(NOTE) When Verify is on, if an error is detected, "Verify Error." appears in the display, and copying is canceled. If when you try again but the problem still reappears, the disk itself may be damaged (or too old). In addition, this problem may arise if SCSI connections (choice of cables and terminator settings) are not appropriate.

(MEMO) When you select **INTERNAL (Internal drive)** in Step 4, you can make a backup disk only by the internal drive. You do not need to connect the external drive. In this case, the procedure after Step 9 is changed described as below. (In this case, the Verify function is disabled.)

9. Press [ENTER/YES] to start the disk copy process. In a few seconds the disk is ejected, then "Insert Destination Disk." is appeared.
10. Insert the destination disk and press [ENTER/YES].
In a few seconds, the disk is ejected and "Insert Source Disk." is appeared.
11. Insert the destination disk again, the message in Step 9 is reappeared.
12. Follow the indication and repeat insert and eject the disk 64 times.
13. "Disk Copy Completed." is appeared then back to the initial (before the procedure) condition.

(NOTE) Finish the saving procedure before starting the disk copy if the called song or Effects Patches are in change.

Loading Samples from an External Zip Drive

You can load samples, either single samples or pad banks, from a disk in an external Zip drive to the disk in the internal drive. This process is called **Load External Sample**.

(NOTE) This function **always loads data from the external drive to the internal drive**. In the Copy Disk All and Copy Effect processes, the flow of data is in the opposite direction.

The Load External Sample Process

1. Insert the disk containing the pad bank (or sample) to be loaded in the external Zip drive.
2. Press [SYSTEM/DISK], then press [▼] to select "Load Ext. Sample?"
3. Press [ENTER/YES].
4. If there is more than one Zip drive connected, rotate the VALUE/TIME dial to specify "From Drive" (the source drive).
The SCSI ID number, such as "EXT.ID5," appears in the display.
5. Press [▼] or [▲] to select "Source."
6. Rotate the VALUE/TIME dial to specify the pad bank and sample to be loaded. Press [←] or [→] to select to either the pad bank or a sample.
The "****" in "BANK*- #" indicates the pad bank number (01-64 or ALL) to be loaded; "#" refers to a single sample pad number (1-16 or ALL).
7. Press [▼] to select "To Int." (the destination pad bank or sample), then rotate the VALUE/TIME dial to select the pad bank or sample on the SP-808's drive.
If "ALL" is selected in Step 6, then "ALL" is automatically selected for the load destination as well (otherwise, "ALL" cannot be selected).
8. Press [ENTER/YES] to start the loading process.
When "ALL" is specified for the pad bank or sample for

loading, the confirmation message "ARE YOU SURE?" appears in the display. In addition, if when loading only one sample if other sample already exists at the load destination, the confirmation message for overwriting is displayed. Press [ENTER/YES] in either case to start the load.

9. Press [PLAY] to return to the basic screen.

(NOTE) If in Step 6, if you specify only one sample, then you cannot designate a number for a sample that doesn't exist in the load source. (You can specify "ALL" without regard to the presence or absence of particular samples).

If you select "ALL," then even a blank disk will be loaded as is.)

(NOTE) If in Step 6 you select "ALL" for the load source pad banks and then execute the load, then all of the pad banks and all of the samples are loaded onto the disk in the internal drive. Note that any pad samples that had been on the disk in the internal drive are lost. (This does not affect the sounds on the tracks.)

Loading Songs from an External Zip Drive

You can load songs from disks in the external Zip drive to the internal drive one song at a time. This process is known as **Load External Song**. When loading a song (the arrangement of phrases and mixer settings) the sounds (waves) used in the song's phrases are also loaded to the disk in the internal drive.

(NOTE) This function **always loads data from the external drive to the internal drive**. In the Copy Disk All and Copy Effect processes, the flow of data is in the opposite direction.

The Load External Song Process

1. Insert the disk containing the song to be loaded in the external Zip drive.
2. Press [SYSTEM/DISK], then press [▼] to select "Load Ext. Song?"
3. Press [ENTER/YES].
4. If there is more than one Zip drive connected, rotate the VALUE/TIME dial to specify "From Drive" (the source drive).
The SCSI ID number, such as "EXT.ID5," appears in the display.
5. Press [▼] or [▲] to select "Source."
6. Rotate the VALUE/TIME dial to specify the song to be loaded (01-64 or ALL). When a number is selected, the song name is also displayed.
7. Press [ENTER/YES] to start the loading process.
8. Press [PLAY] to return to the basic screen.

(NOTE) You cannot specify the song's load destination number. The lowest available number is selected automatically. Therefore, no preexisting songs are lost by being overwritten.

(NOTE) Sometimes messages such as "Disk Full." or "Can't Make New Wave." indicating insufficient memory may appear in the display. In such instances, you may be able to accomplish loading after first deleting any unneeded material on the disk in the internal drive, and then carrying out the Cleanup Disk procedure (p. 46). You may also be prevented from loading all the songs on the disk when the message "Over 64 Songs." is displayed. In this case, load the songs one at a time until all available song numbers are used.

Outputting the Sounds on Each Track Separately

Installing the SP808-OP1 lets you available with stereo direct output jacks for Tracks A, B, and C ("TRACK OUTPUT" A-LR, B-LR, C-LR). This is convenient when you want to use the SP-808 in combination with an external audio mixer.

The sounds on each of the three tracks is output at the levels at which they were recorded.

(NOTE) The channel faders are disabled.

(NOTE) If Track Voice Reserve (p. 137) is turned on, the sounds are always sent whether the [STATUS] is lit green or not.

(MEMO) The monitor sound recorded at the time of recording is output.

(MEMO) The dedicated Track D direct output jack is not enabled. If necessary, you can switch the **OutJackMode** settings so that the AUX OUT jack is used as the Track D output.

Switching the AUX OUT Connector to Function as the Track D Direct Output

1. Hold down [SHIFT] and press [MUTE] to call up the "MIX COMMON" screen.
2. Press [▼] repeatedly to select "OutJackMode" in "AUX In&Out," the third screen.
3. Rotate the VALUE/TIME dial to select "TRACK D."
4. Press [PLAY] to return to the basic screens.

These changes are saved to the disk as part of the song data.

Chapter 14 Linking with Other MIDI Devices

About MIDI

MIDI, short for Musical Instrument Digital Interface, is a universal standard allowing for the exchange of performance information among electronic instruments and computers. The SP-808, which conforms to the MIDI standard, is equipped with two MIDI connectors, MIDI IN and MIDI OUT (providing MIDI THRU as well). By using these connectors to connect to other MIDI devices, a variety of applications are possible.

About the MIDI Implementation Chart

The MIDI implementation chart (p. 176) allows you to quickly check the MIDI messages that the SP-808 can send and receive. Compare the implementation charts of the SP-808 and other MIDI devices, and use the messages that both of them are capable of communicating.

MEMO For more detailed information on the SP-808's MIDI specifications, please refer to "MIDI Implementation."

Switching the MIDI OUT/THRU Connector

Generally there are three types of MIDI connectors.

MIDI IN:

MIDI messages from other MIDI devices are received here.

MIDI OUT:

MIDI messages from the SP-808 are sent out here.

MIDI THRU:

This sends out MIDI messages received at MIDI IN as is.

On the SP-808, MIDI OUT and MIDI THRU are combined into one connector. Although this connector is set at the factory to MIDI OUT, it can be changed as needed.

Switching MIDI OUT/THRU

1. Press [SYSTEM/DISK] and then press [▼] to select the "Set MIDI Param?"
2. Press [ENTER/YES] to call up the MIDI settings screen.
3. Press [▼] or [▲] to select "Out/Thru Select."
4. Rotate the VALUE/TIME dial to set either "OUT" or "THRU."
5. Press [PLAY] to return to the basic screens.

This setting is automatically saved whenever the disk is ejected, as well as in other situations.

Using MIDI to Control the SP-808 from Another Device

With the SP-808, you can carry out the following operations with MIDI messages from another MIDI device.

Playing Samples

You can play the sixteen different samples in the selected pad bank with MIDI Note Messages sent to the SP-808 from a keyboard, drum pads, or other MIDI device.

To play the SP-808's samples, one of the MIDI Channels 1-10 is selected. (MIDI Channels 11-16 are used by the mixer section and parts.)

MEMO In general, in the exchange of MIDI messages, it is necessary to match the **MIDI channels** of the sending and receiving devices. MIDI channels 1-16 are used for this.

Changing the MIDI Channel Used for Playing Samples

1. Press [SYSTEM/DISK] and then press [▼] to select the "Set MIDI Param?"
2. Press [ENTER/YES] to call up the MIDI settings screen.
3. Check to make sure "Pads Rx Ch." is selected.
4. Rotate the VALUE/TIME dial to select the channel (1-10).

If set to "OFF," then no samples are played, regardless of the channel.

5. Press [PLAY] to return to the basic screens.

This setting is automatically saved whenever the disk is ejected, as well as in other situations.

NOTE MIDI Note Messages cannot be sent by tapping the SP-808's pads.

The following shows the correspondence between the pads and MIDI Note Numbers (numbers indicating key position) as set at the factory. These settings determine which of the SP-808's pads is played when, for example, a key on a connected keyboard is played.

Pad	1	2	3	4	5	6	7	8
MIDI Note	C3 48	C#3 49	D3 50	D#3 51	E3 52	F3 53	F#3 54	G3 55
Pad	9	10	11	12	13	14	15	16
MIDI Note	G#3 56	A3 57	A#3 58	B3 59	C4 60	C#4 61	D3 62	D#3 63

MIDI Note Numbers use the pads' 16 numbers in sequence. You are free to set the key you wish to assign the first pad (Pad [1]).

Changing the Correspondence Between the Pads and Note Numbers

1. Press [SYSTEM/DISK] and then press [▼] to select the "Set MIDI Param?"
2. Press [ENTER/YES].
3. Select "Rx Note (Pad1)" by pressing [▲] or [▼].
4. Rotate the VALUE/TIME dial to select the note number.
5. Press [PLAY] to return to the basic screens.

(NOTE) This setting is automatically saved whenever the disk is ejected, as well as in other situations.

Switching Pad Banks

Only the sixteen samples in the selected pad bank are played using MIDI Note Messages. To change the pad bank, use **Program Change Messages**.

Program numbers 1–64 are effective when sent to the SP-808 for this purpose. These numbers are used in sequence to select Pad Bank 1 through Bank 64. Program numbers 65–128 are ignored.

(NOTE) SP-808 takes a few short time from receiving program change to switch the pad banks.

Switching the Effects Patches

You can switch the effects patches in the SP-808 by using **Control Change Message** and **Program Change Message** in MIDI Channel 11 from other external MIDI device.

(NOTE) MIDI Channel 11 is the channel used for switching effects patches. This cannot be changed.

Selecting the Preset Patches (P01–P99)

1. Send Controller Number 0 with a control change value of 0 to the SP-808.
2. Send a program change to the SP-808 with the effects patch number (1–99) as the program number.

Selecting the User Patches (U01–U99)

1. Send Controller Number 0 with a control change value of 64 to the SP-808.
2. Send a program change to the SP-808 with the effects patch number (1–99) as the program number.

Selecting the Master Filter/Isolator

1. Send Controller Number 0 with a control change value of 64 to the SP-808.
2. Send a program change to the SP-808 with Program Number 100.

(NOTE) When selecting Preset patches, Program Changes 100–128 are ignored. When selecting User patches, program Changes 101–128 are also ignored.

(MEMO) If you send only program changes without sending the Controller Number 0, effects patches in the currently selected Preset patches or User patches are played.

Playing the Internal Effects Virtual Synthesizer

You can send MIDI Note Messages from a keyboard or sequencer to play the internal effects virtual synthesizer.

Select an effects patch that uses Algorithm 20 "VIRTUAL ANALOG SYNTH" (e. g. P99 "20 ▶ AnlgSyn"). Set the "Trigger In" is to "On," the synthesizer sounds are played. In this condition, when **MIDI Note Messages on MIDI Channel 11** are received, the synthesizer sounds corresponding to note numbers are played.

(NOTE) MIDI Channel 11 is used for this function. This cannot be changed.

(MEMO) For more on MIDI messages other than those corresponding to notes, please refer to the MIDI Implementation Chart.

Changing Mixer Settings

You can change settings in the mixer section with MIDI Control Change Messages sent from MIDI sequencers or other MIDI devices.

The MIDI channels as assigned as shown below. The functions of MIDI Channels 11–16 are fixed and cannot be changed.

Channels 1–10 are selected for use with the pads (p. 151):

Pad Bank

Channel 11: MASTER OUT

Channels 12–15: Tracks A, B, C, and D, in order

Channel 16: MIC/LINE fader (for input other than AUX IN)

The volume, stereo balance, and signal levels sent to the internal effects and AUX OUT can be set with Control Change Messages.

The mixer section does not include the following functions.

- Sending the pad sounds to AUX OUT
- Sending from MASTER OUT to AUX OUT
- Sending from MASTER OUT to effects in the Send/Return position

MEMO Except when set to MASTER OUT, MIDI Channel 11 can also be used even for switching effects patches. (p. 152)

The following Controller Numbers are use for controlling of the mixer.

Controller Number	Control Object
7	Each channel faders
10	Stereo balance (1 (Left)–64 (Center)–128 (Right))
91	Signal level sent to the internal effects (Send/Return method)
92	Signal level sent to AUX OUT

For example, if the SP-808 receives a Control Change Message with a Control Number 91 and a value of 0 through MIDI Channel 13, then the signal level sent to the channel effects of Track B instantly becomes 0.

MEMO When these mixer settings are changed on the SP-808, similar Control Change Messages are sent from MIDI OUT. (You can turn this off when not needed. From [SYSTEM/DISK], select "Set MIDI Param?" to call up the MIDI screen, and set the "Mixer,D-Beam" parameter to "STOP.")

Synchronization with a Sequencer or Drum Machine

By synchronizing the song tempo with a MIDI sequencer or other MIDI device, you can add the SP-808's audio phrases to MIDI performances. Additionally, you can also synchronize the SP-808 to MTC-compatible multi-track recorders or video equipment.

Synchronization Types (MTC/MIDI Clock)

You can play back and record SP-808 songs while synchronized with a MIDI sequencer or other MIDI device. There are two ways to achieve synchronization.

- Using MTC (MIDI Time Code) (p. 154, 155)
- Using MIDI Clock (p. 154)

With the SP-808 as a slave and another device as a master, only MTC synchronization is possible.

MEMO The device which controlling synchronization (the machine sending MIDI messages controlling time or tempo) is referred to as the **master**, and the machine which receiving and following these messages is known as the **slave**.

What is MTC?

MTC (MIDI Time Code) refers to MIDI messages prepared for precise synchronization of MIDI devices with such machines as professional tape recorders and video equipment. The master sends absolute time (Hours/Minutes/Seconds/Frames from the top), and the slave changes its time to match. In order of use MTC, the other machine also must be compatible with MTC synchronization.

Because the slave device (and this can mean a MIDI sequencer) functions according to its own internal tempo management, the true measure and beat may not be coincided that which is displayed.

What is MIDI Clock?

MIDI Clock is MIDI information prepared mainly for the purpose of synchronizing performances of MIDI sequencers or drum machines. The master device sends clock messages at intervals conforming to its own tempo, and the slave acts according to those messages. (Imagine the master clapping its hands, and the slave performing to the beat.) The SP-808, based on measure bars, also sends the MIDI Clock information reflecting tempo changes arising from use of the Vari-Pitch function. When synchronizing with the drum machine as slave, the drum machine's tempo ends up following the SP-808's Vari-Pitch.

Linking with Other MIDI Devices

When synchronizing with MTC, the SP-808 can act as either master or slave. Furthermore, to get the measure displays of the SP-808 and the other MIDI device to coincide, the measure bars of both devices must be coincident. The actual progress of the SP-808's measures is determined by each of the parameters in the Tempo Map (p. 71), BPM Tune (p. 70), and Vari-Pitch (p. 39). When aligning the display of the measure bars, first match these settings to those in the synchronizing device.

MEMO The synchronization settings are saved as one part of the song data and the settings for each song can be recalled when the song is selected.

Synchronizing Another MIDI Device to the SP-808 (MTC, MIDI Clock)

Using MTC to Synchronize Another Device with the SP-808 as Master

1. Confirm that the MIDI OUT/THRU connector is set to MIDI OUT (p. 151).
2. Connect the SP-808's MIDI OUT to the MIDI IN of the other device (such as a MIDI sequencer) with a MIDI cable.
3. Set the SP-808's MIDI-related parameters (including SyncSource and MTC Type, see next item for details).
4. Set the other device as the slave for MTC synchronization (refer to the owner's manual for the other device).
5. Put the other device in standby status so that it is prepared for synchronized action (refer to the owner's manual for the other device).
6. Begin playback of a song on the SP-808.
The song of the other device is started and synchronized with SP-808.

Setting the SP-808's Parameters about the MIDI Synchronization

1. Press [SONG/TRACK], then press [▼] to select "Set Song Param?"
2. Press [ENTER/YES].
3. Press [▼] or [▲] to select the "SyncSource" parameter, and rotate the VALUE/TIME dial until "INTERNAL" appears.

INTERNAL: The SP-808 is set as the master. SP-808 runs according to its own time management.

EXT.MTC: This makes the SP-808 as the slave. It runs according to the MTC received from the other device.

4. Press [▼] to select "(Sync) Out" and rotate the VALUE/TIME dial until "MTC" appears.

"(Sync) Out" sets the type of synchronization signal sent from the MIDI OUT connector.

OFF: Synchronization signals are not sent.
MIDI CLK: MIDI Clock is sent.
MTC: MIDI Time Code is sent.

5. Press [▼] to select "MTC Type" and rotate the VALUE/TIME dial to select the type of MTC that matches the format of the other device.

- 30: 30 frames per second
Pro audio equipment, NTSC format (U.S. and Japan) black and white video devices, etc.
- 29.97N: 29.97 frames per second, non-drop format
NTSC format color video devices and other machines
- 29.97D: 29.97 frames per second, drop format
NTSC format color video devices for broadcast and other machines
- 25: 25 frames per second
SECOM/PAL format (Europe and elsewhere) video and audio devices, film, etc.
- 24: 24 frames per second
U.S. film and other applications

6. Press [PLAY] to return to the basic screens.

To save the settings, hold down [SHIFT] and press [ENTER/YES] to call up the Save screen, then save the song (p. 72).

NOTE Be absolutely sure to set the same type of MTC for both machines.

MEMO The MTC sent by the SP-808 has 0h/0m/0s/0f at the beginning of the song. However, when MTC Offset (p. 156) is selected, this time will follow the setting for the MTC Offset.

Using MIDI Clock to Synchronize Another Device with the SP-808 as Master

1. Confirm that the MIDI OUT/THRU connector is set to MIDI OUT (p. 151).
2. Connect the SP-808's MIDI OUT to the MIDI IN of the other device (such as a MIDI sequencer) with a MIDI cable.
3. Press [SONG/TRACK], then press [▼] to select "Set Song Param?"
4. Press [ENTER/YES].
5. Press [▼] or [▲] to select the "SyncSource" parameter, and rotate the VALUE/TIME dial until "INTERNAL" appears.

INTERNAL: The SP-808 is set as the master. Actions occur with reference to the SP-808's own time management.

EXT.MTC: This makes the SP-808 as the slave. It runs according to the MTC received from the other device.

6. Press [▼] to select “(Sync) Out” and rotate the VALUE/TIME dial until “MIDI CLK” appears.

“(Sync) Out” sets the type of synchronization signal sent from the MIDI OUT connector.

OFF: Synchronization signals are not sent.
 MIDI CLK: MIDI Clock is sent.
 MTC: MIDI Time Code is sent.

7. Press [PLAY] to return to the basic screens.
8. Set the other device as the slave for MIDI Clock synchronization (refer to the owner’s manual for the other device).
9. Put the other device in standby status so that it is prepared for synchronized action (refer to the owner’s manual for the other device).

10. Begin playback of a song on the SP-808.
 Playback of the song is synchronized with the other device.

To save the settings, hold down [SHIFT] and press [ENTER/YES] to call up the Save screen, then **save the song** (p. 72).

(MEMO) The SP-808’s MIDI Clock is sent according to the progress of the measures determined by the Tempo Map (p. 71), BPM Tune (p. 70), and Vari-Pitch (p. 39) parameters. First make these settings so that match those of the phrases on the tracks.

Synchronizing the SP-808 to Another MIDI Device (MTC)

(NOTE) At times, MTC messages sent by computer MIDI sequencer software or similar means may be unstable. Synchronize with the SP-808 as the master whenever possible.

Using MTC to Synchronize the SP-808 with Another Device as the Master

1. Connect the SP-808’s MIDI IN to the MIDI OUT of the other device (such as a MIDI sequencer) with a MIDI cable.
2. Set the SP-808’s MTC-related parameters (including SyncSource and MTC Type).
3. Put the other device in standby mode to send MTC (refer to the owner’s manual for the other device).
4. Press [▶] (PLAYBACK) on the SP-808.
 The button flashes, and the SP-808 is put in synchronization standby mode.
5. Play back the song on the other device.
 The SP-808 is also begins synchronized playback.

Setting the SP-808’s MTC-Related Parameters

1. Press [SONG/TRACK], then press [▼] to select “Set Song Param?”
2. Press [ENTER/YES].
3. Press [▼] to select the “SyncSource” parameter, and rotate the VALUE/TIME dial until “EXT.MTC” appears.

INTERNAL: The SP-808 is set as the master. Actions occur with reference to the SP-808’s own time management.

EXT.MTC: This makes the SP-808 as the slave. It runs according to the MTC received from the other device.

4. Press [▼] to select “MTC Type” and rotate the VALUE/TIME dial to select the MTC type matching that of the other device.

- 30: 30 frames per second
 Pro audio equipment, NTSC format (U.S. and Japan) black and white video devices, etc.
- 29.97N: 29.97 frames per second, non-drop format
 NTSC format color video devices and other machines
- 29.97D: 29.97 frames per second, drop format
 NTSC format color video devices for broadcast and other machines
- 25: 25 frames per second
 SECOM/PAL format (Europe and elsewhere) video and audio devices, film, etc.
- 24: 24 frames per second
 U.S. film and other applications

5. Press [PLAY] to return to the basic screens.
 To save the settings, hold down [SHIFT] and press [ENTER/YES] to call up the Save screen, then **save the song** (p. 72).

(NOTE) Be absolutely sure to set the same type of MTC for both machines.

About “Err Level” (MTC Error Level)

With the SP-808 as slave during synchronization, the SP-808 checks whether or not the MTC is being sent correctly at any time. If MTC is not sent continuously, the SP-808 determines that there is a problem with MTC synchronization and stops playback of the song. **MTC Error Level** sets the basis for this determination.

Setting "Err Level" (MTC Error Level)

After performing Steps 1–4 above:

5. Press [▼] to select "(MTC) Err Level" and rotate the VALUE/TIME dial to set the value (1–10).

As the value is set higher, the degree of permissible error becomes increase, so even if there is some degree of problem with the reception of MTC, slave playback is allowed to continue.

Offsetting Synchronization by a Constant Interval (MTC Offset)

MTC sent and received by the SP-808 normally sets the beginning of a song at Hour 0, Minute 0, Second 0, Frame 00. However, by setting **MTC Offset** in the following procedure, you can shift the song's starting time. This is convenient when you want the SP-808 to begin playback of a song at a set time, such as when synchronizing the SP-808 to moving images.

Setting MTC Offset

1. Press [SONG/TRACK], then press [▼] to select "Set Song Param?"
2. Press [ENTER/YES].
3. Press [▼] or [▲] to select the "(MTC) Offset."
4. Press [←] or [→] to move to each place in "00:00:00:00" (Hour/Minute/Second/Frame), and rotate the VALUE/TIME dial to set the time location for the start of the song (Measure 1, Beat 1, Tick 0).
5. Press [PLAY] to return to the basic screens.

To save the settings, hold down [SHIFT] and press [ENTER/YES] to call up the Save screen, then **save the song** (p. 72).

When MTC Offset is Set

Slave Time: The SP-808 begins playback at the point reached with reference to the offset time set in the MTC sent from the other device.

Master Time: When the SP-808 begins playback of the song, MTC is sent with the offset time added to it.

MEMO Also the time location indicated in the SP-808's display is added to the offset time.

Control All Synchronized Machines by One Specified Device (MMC)

The SP-808 is compatible with **MMC (MIDI Machine Control)**. MMC is a kind of MIDI System Exclusive Message (p. 159) providing control of multiple devices from the operations of a single machine.

When used in combination with MMC-compatible MIDI sequencers and hard disk recorders, you can play back, stop, and advance songs through the operation of just one machine.

NOTE Particulars regarding compatibility with MMC vary with the device. The SP-808's MMC compatibility is explained in the included MIDI Implementation Chart.

NOTE There is no correspondence between the master (the device controlling operations, or sending end) and the slave (receiving end) in MMC and the master (time coordinating device) and the slave in synchronization.

Preparing for MMC

1. Prepare each machine for MTC synchronization (p. 154, 155).
2. If the MTC slave device is to be the MMC master, connect the MIDI OUT of that device with the MIDI IN of the other devices (for the transmission of MMC).
3. Set each device to act as either master or slave in MMC synchronization. For the SP-808's settings, please refer to "MMC Master and Slave Settings."

When the MMC master device is run, operation of the MMC slave devices proceeds according to the master device.

MMC Master and Slave Settings

1. Press [SONG/TRACK], then press [▼] to select "Set Song Param?"
2. Press [ENTER/YES].
3. Press [▼] to select the "MMC Mode."
4. Rotate the VALUE/TIME dial to select the master and the slave in MMC synchronization.

OFF: MMC information is not exchanged.

MASTER: This sets the SP-808 as the MMC master.

SLAVE: This sets the SP-808 as the MMC slave.

5. Press [PLAY] to return to the basic screens.

To save the settings, hold down [SHIFT] and press [ENTER/YES] to call up the Save screen, then **save the song** (p. 72).

(NOTE) When making a MIDI connection between two SP-808s, by moving the faders or turning the knobs on the sending SP-808, Control Change Messages are then sent, which may result in the inability of the SP-808 on the receiving end to make certain independent settings. In such instances, do not send Control Change Message from the sending SP-808.

1. Press [SYSTEM/DISK] on the sending SP-808, and press [▼] to select "Set MIDI Param?"
2. Press [ENTER/YES] to call up the MIDI settings screen.
3. Press [▼] to select "Mixer, D-Beam" and rotate the VALUE/TIME dial until "STOP" appears.
4. Press [PLAY] to return to the basic screens.

This setting is automatically saved whenever the disk is ejected, as well as in other situations.

(NOTE) When using the SP-808 in combination with other devices as well, the same kind of problem can occur due to overlap in MIDI channels. Thus, in this case as well, stop transmission of fader or knob information.

(MEMO) When synchronizing with MIDI Clock (this is especially so with the SP-808 as master), except for MMC, playback, stop, and other information from MIDI System Realtime Messages are also sent.

Synchronizing with MultiTrack Recorders and Video Equipment

When synchronizing with digital multitrack recorders that cannot send or receive MTC, a dedicated synchronization device is required. These devices are commercially available from each manufacturer of multitrack recorders and other manufacturers.

To achieve synchronization with professional video equipment and other machines that use SMPTE time code, use a commercially available "SMPTE time code ↔ MTC" converter.

With the addition of simple attachments, some consumer video devices (such as digital video decks) may also be synchronized with the SP-808.

For more information on such devices for synchronization, consult your SP-808 dealer.

Using a MIDI Sequencer to Record and Playback Mixer Operation

When synchronizing with a sequencer, you can send information regarding fader movements and other operations during the song as MIDI messages. By recording these messages with the sequencer, you can reproduce operations such as fader movements during synchronized playback. This allows you to perform Auto Mixing (Compu Mix).

(MEMO) The MIDI messages that to be sent (MIDI Channel and Controller Number assignments) are the same as the received messages that are mentioned in "Changing Mixer Settings" (p. 152).

(NOTE) Since Realtime Effects knob movements and Step Modulator operations are not sent and received as MIDI messages, they cannot be used in Auto Mixing. Furthermore, the D Beam Controller information similarly cannot be used (as this information is sent only, not received).

Preparing for Auto Mixing

1. Make the connections as shown in the figure.

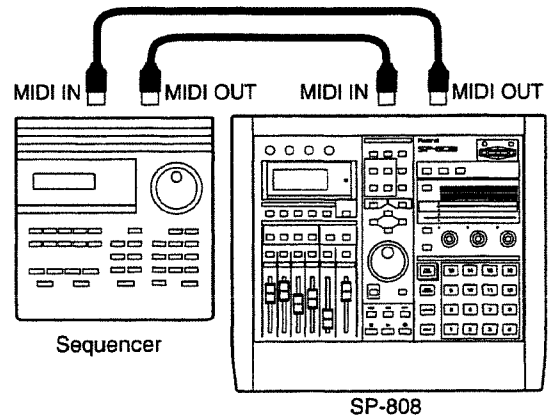

2. Press [SYSTEM/DISK] and press [▼] to select the "Set MIDI Param?"
3. Press [ENTER/YES] to call up the MIDI settings screen.
4. Press [▼] to select "Mixer,D-Beam," and if set to "STOP," rotate the VALUE/TIME dial to select "SEND."
5. Hold down [▼] to select "Out/Thru Select," and then as before, rotate the VALUE/TIME dial, this time selecting "OUT."
6. Hold down [SHIFT] and press LOCATOR [CLEAR] to call up the Mixer View screen.

When these preparations have been completed, put the MIDI sequencer in standby mode for Realtime Recording, synchronizing the functions of both machines. As you move the faders and perform other operations on the SP-808, the information is recorded by the MIDI sequencer.

When it is time to check the results, you can synchronize playback of the recorded segment in the Mixer View screen.

About MIDI Local Control

In general, on devices used in the recording of performance or panel information to MIDI sequencers, MIDI Local Control is set by turning the connection between the sound generator and the controller (keyboard or knobs and other controls) on or off. This is to prevent information from both the controller and from MIDI IN from coming in at the same time which might happen when there is a looped MIDI sequencer connection (IN → OUT, OUT → IN). However, the **SP-808 includes no Local Control setting**. This is because there is no function for recording pad operations to MIDI sequencers (since they can be recorded to the SP-808's own internal tracks) in addition to the fact that overlapping mixer information still has no great effect on operations. Thus, the MIDI Local Control setting is unnecessary for Auto Mixing.

Controlling Other MIDI Devices with the D Beam Controller

The D Beam Controller can convey the movements of your hand or other objects as MIDI information. It uses the following messages to do this.

MIDI Channel:

11 (Channel for MASTER OUT) (Fixed)

Controller Number	D Beam Controller
80 (C5)	BL (Left Side)
81 (C6)	BR (Right Side)

When controlling other MIDI devices with the D Beam Controller, set the MIDI Channel on the receiving end (the other device) to 11 to enable it to respond to the Control Change Messages as desired. (The Controller Number cannot be changed.)

(NOTE) If the (MIDI) System setting's "Mixer, D-Beam" parameter is set to "STOP," the MIDI messages are not sent. In this case, use the following procedure to change the setting to "SEND."

1. Press [SYSTEM/DISK] and press [▼] to select the "Set MIDI Param?"
2. Press [ENTER/YES] to call up the MIDI settings screen.
3. Press [▼] to select "Mixer,D-Beam" and rotate the VALUE/TIME dial to select "SEND."
4. Press [PLAY] to return to the basic screens.

This setting is automatically saved whenever the disk is ejected, as well as in other situations.

(MEMO) When "STOP" is selected in Step 3 above, transmission of the D Beam Controller Control Change Messages is stopped.

Using the Metronome to Sound External MIDI Sound Module

Although you can have the SP-808's metronome sound during recording and at other times (p. 67), you can also have external MIDI sound module play as the metronome.

(NOTE) First, connect the SP-808's MIDI OUT with the MIDI IN of the external MIDI sound module.

Playing the Metronome with an External Sound Module

1. Press [SYSTEM/DISK] and press [▼] to select the "Set System Param?"
2. Press [ENTER/YES] to call up the System settings screen.
3. Press [▼] or [▲] to select "Metro. Sound" and rotate the VALUE/TIME dial to select "MIDI (REC)" or "MIDI (ALWAYS)."
4. Press [SYSTEM/DISK], then press [▼] to select "Set MIDI Param?" and press [ENTER/YES].
5. Press [▼] or [▲] to select "Metronome Ch." (Metronome MIDI Channel) and rotate the VALUE/TIME dial to select the MIDI Channel (1-16) matching with the connected MIDI sound module.
6. Press [▼] to select "Accent Note" and rotate the VALUE/TIME dial to set the note for the accented sound.
7. Press [▼] to select "Velocity" (Accent Velocity) and rotate the VALUE/TIME dial to set the strength of the accented sound (MIDI Velocity value).
8. Press [▼] to select "Normal Note" and rotate the VALUE/TIME dial to set the note for the unaccented sounds.
9. Press [▼] to select "Velocity" (Normal Velocity) and rotate the VALUE/TIME dial to set the strength of the unaccented sounds (MIDI Velocity value).
10. Press [PLAY] to return to the basic screens.

These settings are automatically saved whenever the disk is ejected, as well as in other situations.

(MEMO) If "MIDI (REC)" or "MIDI (ALWAYS)" is selected in Step 3, the "Metro.Level" (metronome volume) settings is disabled. In this case, use the volume control of the external sound module to adjust the volume of the metronome.

(MEMO) If the metronome sound from the MIDI sound device does not play with the selected note and velocity settings, check the MIDI Channel setting (Step 5) and the connections between the MIDI sound device and your audio equipment.

Other MIDI Matters

MIDI System Exclusive

MIDI System Exclusive Messages are messages used for sending and receiving data particular to one type of device.

On the SP-808, MIDI System Exclusive Messages are used for sending and receiving MMC (MIDI Machine Control → p. 156) and MTC. They are not used for other functions.

(NOTE) MIDI cannot be used for exchanging data between SP-808s. This is done by exchanging Zip disks.

(NOTE) Settings that cannot be changed with Control Change and Program Change Messages thus cannot be changed externally with MIDI.

Chapter 15 Appendices

Troubleshooting

If you encounter problems with the operation of the SP-808, first check the following points. If after these steps the problem is still unresolved, consult your nearest Roland service center or authorized Roland distributor. If you have trouble understanding any message that is displayed, please refer to the Major Message List (p. 166).

There is No Sound

There is no sound whatsoever

- Is the power of the SP-808 or any connected device turned on?
- Are all of the connections correct? (p. 19)
- Is any of the connection cables broken?
- Is the amp or mixer volume turned up?
- Is the Master fader up?
- Is [MUTE] illuminated red?
 - Press [MUTE] to turn off the button light.

There is no sound through the headphones

- Is the headphones knob (PHONES) turned up?

Sounds input from external sources are not being output

- Are the input sensitivity knobs (INPUT LINE and INPUT MIC) turned up?
- Is the MIC/LINE fader up?
 - Hold down [SHIFT] and press [SCRUB] so that the (PAD) indicator is no longer lit, then adjust the MIC/LINE fader.
- Are the cables connected correctly?

There is no pad (sample) sound

- Is the sample on an assigned pad (one that is illuminated)?
- Was the sound sampled with no signal?
- Is the pad volume (PadsLevel) in the mixer turned up?
 - Hold down [SHIFT] and press [SCRUB] so that the (PAD) indicator is lit, then adjust the MIC/LINE fader.

- Is the volume setting (Volume) for the individual samples turned up?

→ Press [LEVEL] in Quick Edit and adjust the volume level.

- Including tracks, are there four stereo sounds being played?

(NOTE) If all the tracks' [STATUS] are illuminated green (PLAY), then press [STATUS] for any tracks that are not presently needed.

(NOTE) If Track Voice Reserve (p. 137) is on and all the tracks' [STATUS] are illuminated green (PLAY), even when the song is stopped, no pad sounds are played.

→ Press [SONG/TRACK] and select "Set Song Param?," and then turn the Track Voice Reserve off.

(NOTE) Samples in the same mute group (p. 37) are prevented from being played simultaneously.

There is no sound from the song (tracks)

- Are the track faders up?
- Are any track [STATUS] illuminated green (PLAY)?
- Are the tracks empty or recorded with no signal?

(NOTE) If extremely short phrases (shorter than about 0.3 seconds) are created in Event Realtime Recording, then portions of the preceding and following phrases may not be played back (depending on the placement of the phrases). (p. 65)

There is no sound only when the effects are in use

- Is there an effects patch inserted which completely cuts off the sound?
 - Press REALTIME EFFECTS [ON/OFF] to turn the Realtime Effects off.
- Is the output level of the inserted effects patch raised?
 - Hold down [SHIFT] and press [FX INFO], and then press [ENTER/YES] to call up the level screen; turn up the output level of the effects patch.

Sometimes the sound does not play right away

- The disk goes into Sleep mode (stops revolving) if no operation requiring reading or writing to or from the disk is performed within 30 minutes. Several seconds is required to produce sound after the sleep mode.

Unintended effects are added to the sound

- Are the internal effects turned on?
 - Press REALTIME EFFECTS [ON/OFF] to turn the effects off.

Playback of Songs and Samples (Pads)

The sound from the pad does not stop

- Is the sample PlayMode setting set to "DRUM"?
 - Because the sound is played up until the end point, it may seem that with long samples the sound indeed does not stop.

NOTE If the sample's loop setting (p. 36) is set to "OFF," then the sound stops at the end point, regardless of the "PlayMode" settings.

Pad sounds start playing suddenly, even when the pad is not pressed

- Is the D Beam Controller [PAD TRIG] illuminated?
 - Press [PAD TRIG] to turn off its light.

The song is not played in the right pitch

- Is Vari-Pitch (p. 39) on?
 - Press [VARI PITCH] to turn off its light.
- Is the D Beam Controller [PITCH] illuminated?
 - Press [PITCH] to turn off its light.
- Have you added an effect that features pitch changes (such as Stereo Pitch Shifter)?
 - Press REALTIME EFFECTS [ON/OFF] to turn it off.

During playback, the sound is not immediately produced, even when [STATUS] is switched the illumination to green (PLAY)

- Is Track Voice Reserve (p. 137) turned off?
 - Press [SONG/TRACK] and select "Set Song Param?", then turn the Track Voice Reserve on.

The song does not play back, even when [▶] (PLAYBACK) is pressed ([▶] is flashing)

- Is the song's "SyncSource" setting (p. 154) set to "MTC"?
 - Switch the song's "SyncSource" setting to "INTERNAL" (hold down [SHIFT] and press [SONG/TRACK]).

Regarding Track Audio Recording and Sampling

The level meters move according to the sound from external sound input, but the sound can not be recorded

- Is Event Realtime Recording selected?
 - When recording input sounds, hold down [SHIFT] and press [●] to select Track Audio Recording.

Sampling does not begin, even when [SAMPLING] is pressed

- Is the appropriate "Start/w" setting (p. 43, 44) selected?

The effects sounds can not be recorded or sampled

- Are the effects not being inserted in the MASTER OUT?
 - To add effects to the entire sound when recording or sampling, set the effects position to "INS RECORD."
- Is the "Return" setting in the MIX COMMON screen set to "PLAY-ONLY" (when the send/return method is in use)?
 - When the effects sounds are to be recorded, select "REC(orPLAY)." (Hold down [SHIFT] and press [MUTE] to call up the MIX COMMON screen, and in the second screen's "Return" settings, select "REC(orPLAY)").

Sound from the AUX IN can not be recorded

- Is "THRU(→LINE)" selected for the "In" setting in the mixer's "AUX In&Out"?
 - Hold down [SHIFT] and press [MUTE] to call up the MIX COMMON screen, and for the "In" parameter in the third screen's "AUX In&Out" settings, select "REC(orPLAY)."

The sound being recorded right before and after punching in and out cannot be monitored

- Is the "PrePunch" setting set to "TRACK" (p. 66)?
 - Hold down [SHIFT] and press [SYSTEM/DISK], select "SOURCE" for the "PrePunch" setting.

The recorded or sampled sound is very distorted or noisy

- Is the input level at the appropriate setting?
 - Set levels correctly in both the Level Meter screen and the Sampling screen.
- Is the distortion a result of mixing multiple channels or pads?

(NOTE) When bouncing tracks, or in other situations, distortion can result from excessive levels caused by the addition of the sounds from multiple channels during mixing.

- Lower the faders or adjust the recording attenuator (p. 81).
- Is a distortion effect being applied to the sound?
- Is the distortion being caused by equalization?
 - Hold down [SHIFT] and press [EFFECTS], then press [▼] until the Equalizer screen is called up, and turned the equalizer off.

(NOTE) Depending on the equalizer settings, the sound may be distorted even when not at excessive levels.

- Is any input sensitivity knob not currently in use turned up?
 - To avoid additional noise, completely turn down any input sensitivity knob not in use.

The recording comes out in monaural sound

- Is the sampling or the recording "Type" setting set to "MONO" (p. 44, 75)?
- Is the mixer "Merge-L&R" setting turned on? (p. 92)
- Does the effects patch you are using feature monaural output?

When sampling, the very beginning of the sound is missing

- Is the "Start/w" setting (p. 44) value "Lev.1-8" set too high?

When Using the Internal Effects

The effects can not be applied

- Is REALTIME EFFECTS [ON/OFF] turned on (illuminated)?
- Is the "FXLoc." setting (determining the arrangement of effects in the mixer) set appropriately?
 - Hold down [SHIFT] and press [MUTE] to call up the MIX COMMON screen, and change the "FXLoc." setting.

Effects using in the send/return method can not be applied

- Are any channel [EFFECTS] on (illuminated)?
 - Press the track [EFFECTS] to turn them on.
- (NOTE)** Note that the "PAD" and "MIC/LINE" [EFFECTS] can be turned on and off independently.
- Is the effects send level for each channel set to 0?
 - Hold down [SHIFT] press the Locator [CLEAR] to select the Mixer View screen and rotate the VALUE/TIME dial to increase the value for each "FX" setting.

The effect period is not correctly synchronized with the tempo of the song

- Does "?" appear at the left of the "Tempo Sync" settings for each of the effects?
 - Proper synchronization cannot be achieved if the tempo is set beyond the range of tempos that can be synchronized.

(NOTE) The tempo cannot be synchronized directly with the pad samples. Match the tempo of the song to the sample, then synchronize the effects to the tempo.

The effects parameters cannot be controlled by the Realtime Effects knobs

- Is the parameter you are trying to adjust assigned to the Realtime Effects knobs? (p. 99)
- Is the changing range of the parameter set correctly? (p. 128)

(NOTE) If the system's "Knob Control" setting (p. 129) set to "NULL," the settings value does not change until the position of the Realtime Effects knob is the same as that corresponding to the current value.

- If necessary, switch the setting to "JUMP."

- Is the D Beam Controller [EFFECTS] on?

NOTE Parameters assigned to the C5 and C6 knobs are influenced by the operation of the D Beam Controller.

Disks and Memory

Even when sounds on tracks and pads are erased, the remaining recording time (remain time) does not increase

- Have you carried out the Cleanup Disk operation (p. 46)?

NOTE When waveforms on the disk are shared by samples created by copying, dividing, or in other operations, then even if the Cleanup Disk operation is carried out, remaining recording time still may not be freed up.

When Using the Step Modulator

The Step Modulator does not work as expected, even when [STEP MOD] is pressed

- Are the appropriate settings, such as the "Trig" setting selected in the Setup screen (p. 132)?
- Have the effects patch parameter assignment and range settings been carried out correctly (p. 99)?

With analog synth patches, the pitch of the note played differs from the note that is set

- Are the oscillator tunings properly set?
 - Using "Coarse" and "Fine," set the tuning for each oscillator correctly (p. 124).
- Is Oscillator Key Follow set to off?
 - Change the "Pt. KF" setting to "On." (p. 124)
- Unintended pitches can result from the gently gliding pitch changes when Portamento (p. 123) is turned on.

When Using the D Beam Controller

The sensor's red indicator stays on

- Is something in the vicinity of the sensor blocking the beam?
- Is the D Beam sensitivity (p. 31) properly adjusted?
 - If you Hold down [SHIFT] and press the D BEAM CONTROLLER [EFFECTS], and then press [ENTER/YES] without putting your hand in the sensor's field, the D Beam Controller's sensitivity setting is automatically set to the conditions reflecting this.

The right D Beam effect doesn't come when multiple SP-808s are in use simultaneously

- Does more than one SP-808 have the same Beam ID?
 - Hold down [SHIFT] and press D BEAM CONTROLLER [PAD TRIG], and then select "Beam ID" settings, making the settings so that no two and more devices have the same ID number.

The Metronome

The internal metronome does not sound

- Is the metronome off?
 - Hold down [SHIFT] and press [◀◀] to turn on the metronome.
- Is the metronome level set to 0?
 - After pressing [SYSTEM/DISK] and [ENTER/YES] in that order, raise the "Metro.level."
- Is the metronome set to be played by an external sound device?
 - After pressing [SYSTEM/DISK] and [ENTER/YES] in that order, and set the "Metro." setting to "INT."

The metronome is not being sounded by the connected external MIDI device

- Is the volume of the external MIDI device turned down?
- Is the SP-808's MIDI OUT connected to the MIDI IN of the external sound device?
- Are the MIDI channels used for the metronome matched? (p. 159)

When Using the SP-808 with Other MIDI Devices

The overall MIDI performance is poor

- Is the MIDI cable connected properly?
- Is the MIDI cable broken?
- Is the "Out/Thru Select" setting (p. 151) correct?

(NOTE) When set to "THRU," the MIDI OUT/THRU connector functions as a Thru connector.

The pad sounds don't reflect the note messages from the external device

- Does the pad receive channel match the send channel of the external MIDI device that is sending the signals?
 - Press [SYSTEM/DISK], then select "Set MIDI Param?" and set the "Pads RX Ch." setting so that it matches that of the external MIDI device.

MIDI drum pads (such as the SPD-20) are connected, but the sound is cut off right after being played, or repeated striking sounds cannot be played

- Is the "PadPlay" sample parameter setting at "DRUM" (p. 36)?

The SP-808 and the connected external MIDI device are not well synchronized

- Are the parameters related to synchronization (p. 153–155) properly set?

(NOTE) Set the slave device so that it receives synchronization messages, and the master device that it can send the synchronization messages as it plays back the song.

When Augmenting the SP-808 with the SP808-OP1

The input signal from DIGITAL IN is not audible

- Is the system's "Input Source" setting correct?
 - Press [SYSTEM/DISK] and [ENTER/YES] in order, and then set the "Input Source" setting to "DIGITAL1" or "DIGITAL2" (whichever is to be used).

(NOTE) The DIGITAL IN connectors and the MIC/LINE IN cannot be used at the same time. If you wish to have simultaneous digital and analog input, use AUX IN.

- Are digital signals being sent from the external device?
 - Some audio devices do not output digital signals except while in Play mode. In such instances, after putting the audio device in Standby (Pause) mode, put the SP-808 in record mode or other desired status.
- Is the sample rate compatible?
 - When inputting digital signals from CD or MD players, use a Zip disk formatted at 44.1 kHz.

(NOTE) The SP-808 cannot receive/handle 48-kHz digital signals.

- Are the formats of the digital signals matched?
 - Use digital audio devices conforming to the S/P DIF format.

(NOTE) Some multitrack recorders using specialized formats cannot be connected to the SP-808.

Vari-Pitch is turned off when the digital input is selected

- The Vari-Pitch function cannot be used when digital input is used.

The external Zip drive is not being recognized

- Are SCSI connections and terminator settings correct? (p. 148)
- Are any Zip drive device ID numbers being used by more than one device? (p. 148)
- Is the power to any Zip drive not turned on?

Other Problems

The foot switch is connected, but it is not working as intended

- Have you made the appropriate system "FSW Type" setting?
 - Press [SYSTEM/DISK] and [ENTER/YES] in order, and make the "FSW Type" setting. (p. 140)

Previous data is not being saved on the Zip disk (when the power is on)

- Carry out the Save procedure before turning the power off or ejecting the disk. (p. 72, 100)

The data on the Zip disk is corrupted or damaged

→ Damaged or corrupted data cannot be restored (data must be backed up first).

(NOTE) *In some cases, by selecting "FULL" for the format type, such disks may be used as blank disks. However, since these disks may be damaged or broken, do not store important data on them.*

(NOTE) *Damaged data may be caused by the following:*

- Disks reaching the end of useful life
- Turning off the power while the disk is running.
- Subjecting disks to magnetism or strong physical shocks.
- Using disks in operating environment other than those stipulated in "IMPORTANT NOTES" (p. 8) or in the printed material included with the SP-808.

Viewing the display is difficult because it is completely white (or completely dark)

→ Adjust the contrast.

(MEMO) *You can adjust the contrast by holding down the Locator [CLEAR] and rotate the VALUE/TIME dial.*

Major Message List (in alphabetical order)

ARE YOU SURE?

Are you sure to delete or change the data?

Audio REC → Track

Audio recording to the track is ready.

Auto Setup Sens?

Start auto-setup the sense of D Beam controller.

Bank is Protected.

Cannot execute because the pad bank is protected.

Canceled.

Procedure is canceled.

Can't Execute.(Out of 50%–150%)

Time stretch cannot be executed because the stretch ratio is out of limit (50%–150%).

Can't Make New Wave (New Song).

Cannot execute because the total number of audio waveforms (or songs) exceeds the limit per disk.

↑ Change? (YES/NO)

Change to the displayed effects patch?

Creating phrase...

New phrase is being created. (for step recording)

D.In Locked.

Digital input received the signal correctly.

D.In Unlock.Use Analog In?

Digital input does not receive the signal. Do you use analog input?

diSc SLEEP... (at SONG POSITION display)

Disk drive fell asleep (stops spinning) with no reading (writing) command for 30 minutes.

Disk Full.

Procedure is interrupted because the disk memory is fully occupied.

Disk is NOT Ready.

Disk is not inserted in the external drive.

Disk Medium Error.

Read/write from/to the disk is not completed. There may be some defect on the disk surface.

Drive Too Busy.

Cannot playback completely because phrase is too short and the location is too close for the disk speed. (p. 65)

Eject Canceled.

Disk eject is canceled.

Eject,(Not Saved) ARE YOU SURE?

Disk is ejected while song is not saved. Are you sure?

Event REC (Realtime)

Realtime event recording to the track is ready.

Finished. Check Result. OK?

Sampling is finished. Please check the result. Press [ENTER/YES] if you are satisfied.

Hit ENTER to Divide

Hit [ENTER/YES] at the point you wish to divide the sample. (for manual divide of sample)

Hit ENTER to Set

Hit [ENTER/YES] at the point you wish to set. (for setting start point, etc. of sample)

Hit Pad to REC start.

Hit any of the sample pads to start recording.

KEEP POWER ON!

Data is being saved to the internal memory. Never switch the power off.

Memory Full.

Cannot execute because of the lack of song event memory.

Metronome ON (OFF)

Metronome is turned on (off).

MTC Sync. master → SLAVE

SF-808 is switched to the slave of MTC synchronization. Cannot play the song without external device connected.

MTC Sync. slave → MASTER

SP-808 is switched to the master of MTC synchronization.

No Disk Space.

Cannot execute because remaining recording time is not enough.

No Disk Space for New Phrase.

Remaining recording time is not enough for new phrase. (for step recording)

No Memory for UNDO. Continue?

Song event memory is not enough and you cannot undo once you execute. Do you continue to proceed?

Not SP-808 Disk.

Disk on the external drive is not formatted for SP-808.

...NOT SP-808 disk. Format Now?

Unformatted disk is inserted to SP-808. Are you sure to format the disk? All the data on the disk will be erased.

Now Sampling...

Now sampling is proceeded. Press [SAMPLING] again to stop.

Overwrite?**Overwrite OK?**

Sample is existed on the pad you selected, and will be lost by overwriting. Are you OK?
(for sampling and sample editing)

Over 64 Songs.

Total number of songs exceeds the limit (64 songs) and cannot be executed.

Pre-Punch Monitor source → TRACK

Recording monitor source (p. 66) is set to "TRACK."

Pre-Punch Monitor track → SOURCE

Recording monitor source (p. 66) is set to "SOURCE."

Preset FX Patch used. Overwrite SONG only, ARE YOU SURE?

Preset effects patch is used in the song, and only song data but effects setting is overwritten. Are you sure?

Save Current Song? (Overwrite Only.)

Do you save the current song before executing?

SCSI Checking...

Checking the connection of SCSI device (external drive).

Select One.

Multiple phrases are selected and cannot be executed. Mark only one phrase.

Song is Protected.

Song is protected and cannot be executed.

Song Protected. Can't Save! EJECT?

Song is protected and cannot overwrite and save. Do you eject the disk without saving the song?

Song Protected. Can't Save! SELECT?

Song is protected and cannot overwrite and save. Do you select another song without saving the current song?

Verify Error.

Error is found after verifying the duplicated disk.

Wrong Disk.

Wrong disk is inserted. Please insert the correct disk. (for creating backup disk)

Wrong Sample Rate.

Sample rate on the external drive disk is different from the internal disk.

Parameter List

SAMPLE PARAMETER

([SAMPLE/BANK] "Set Sample Param?")

Parameter	Value	Page
PadPlay	GATE, TRIG, DRUM	36
LoopMode	OFF, ON(S-E), ON(L-E)	36
StartPoint	00000000-99999999	51
LoopPoint	00000000-99999999	51
Length(End)	00000000-99999999	51
BPM BaseNote	o - ♩	50
X	0-255	50
VolumeLevel	0-100	50
MuteGroup	OFF, GROUP-1-GROUP-7	37

BANK PARAMETER

([SAMPLE/BANK] "Set Bank Param?")

Parameter	Value	Page
Name	(10 characters)	138
FootSwAssign	1-16	140
BeamAssign Upper	1-16	41
Lower	1-16	41

SYSTEM PARAMETER

COMMON ([SYSTEM/DISK] "Set System Param?")

Parameter	Value	Page
InputSource	MIC/LINE, DIGITAL1, DIGITAL2	146
Mon(PrePunch)	SOURCE, TRACK	66
Metro.	INT(REC), INT(ALWAYS), MIDI(REC), MIDI(ALWAYS)	67, 159
Metro.Level	0-100	67
PreviewLength	1.0-10 sec	33
ScrubLength	25-100 msec	33
SongSave Confirm	ON, OFF	142
FSW Func	PLAY/STOP, DAMPER, SAMPL TRIG, FX ON/OFF, PUNCH I/O	139
FSW Type	DP-2, GPI	140
TimeDisp.	MEASURE, TIMECODE	31
ShiftLock	OFF, ONCE, ON	141
KnobControl	JUMP, NULL	129
D.CopyProtect	OFF, ON	147

MIDI ([SYSTEM/DISK] "Set MIDI Param?")

Parameter	Value	Page
Pads Rx Ch.	OFF, 1-10	151
RxNote(Pad1)	0(C-) - 112(E 8)	152
Mixer, D-Beam	STOP, SEND	158
Metronome Ch.	1-16	159
Accent Note	C(-)-G9	159
Velocity	1-127	159
Normal Note	C(-)-G9	159
Velocity	1-127	159
Out/Thru Select	OUT, THRU	151

D-BEAM SETUP ([SHIFT] + D BEAM [PAD TRIG])

Parameter	Value	Page
Sens L(C5)	1-16	31
R(C6)	1-16	31
TriggerType	HEIGHT, L< >R	41
Upper/Lower	0%-100%	42
PitchWidth	NARROW, MEDIUM, WIDE	30
Beam ID	1-4	31

DISPLAY CONTRAST ([SHIFT] + [PLAY])

Parameter	Value	Page
Disp Contrast	1-16	21

SONG PARAMETER

SONG PARAMETER ([SONG/TRACK] "Set Song Param?")

Parameter	Value	Page
Name	(10 characters)	72
Tr.VoiceReserve	ON, OFF	137
SyncSource	INTERNAL, MTC	154
Out	OFF, MIDI CLK, MTC	154
MTC Type	30, 29.97N, 29.97D, 25, 24	154, 155
Error Level	1-10	156
Offset	00:00:00:00-23:59:59:29	156
MMC Mode	OFF, MASTER, SLAVE	156

BPM TUNE ([SHIFT] + [VARI PITCH])

Parameter	Value	Page
BPM RATE	50%-200%	70
VARI PITCH	18.1%-100.0% (44.1kHz), 25.0%-137.8% (32kHz)	39

LOCATOR SETUP ([SONG/TRACK] "Locator?")

Parameter	Value	Page
LOC 1-LOC 8	001-01-00 - 999-04-95	32

MIXER COMMON SETUP ([SHIFT] + [MUTE])

Parameter	Value	Page
MasterLevel	0-127	25
Balance	L63-L01, 0, R01-R63	92
Rec Att	0, -3, -6, -12, -18, -24 dB	81
FxLoc	SEND/RETURN, INS MASTER, INS RECORD, INS AUX-OUT, MIC/L PRE-EQ, MIC/L PST-EQ, Tr.A PRE-EQ, Tr.A POST-EQ, Tr.B PRE-EQ, Tr.B POST-EQ, Tr.C PRE-EQ, Tr.C POST-EQ, Tr.D PRE-EQ, Tr.D POST-EQ, --(FX PATCH)	49, 78, 93, 96, 100
FX PreFx Att	0, -3, -6, -12, -18, -24 dB	94
Return	REC(orPLAY), PLAY-ONLY	78
Send Ch.Mute	AUTO, MANUAL	78
AUX In	THRU(-LINE), REC(orPLAY)	95
Out Lev	0-127	96
Bal	L63-L01, 0, R01-R63	96
OutJackMode	AUX, PAD CUE, Track D	42, 96

MIXER TRACK (A-D) SETUP ([SHIFT] + A-D [EFFECTS])

Parameter	Value	Page
(Track) Level	0-127	25
Merge-L&R	ON, OFF	92
Balance	L63-L01, 0, R01-R63	92
Aux (Send Position)	PRE-F, PST-F	95
(Level)	0-127	95
FX (Send Position)	PRE-F, PST-F	94
(Level)	0-127	93
EQ Switch	ON, OFF	92
High Freq	500 Hz-16 kHz	92
Gain	-12-+12 dB	92
Mid Freq	200 Hz-8.0 kHz	92
Gain	-12-+12 dB	92
Q	0.5, 1.0, 2.0, 4.0, 8.0	92
Low Freq	40 Hz-1.5 kHz	92
Gain	-12-+12 dB	92

MIXER MIC/LINE & PAD SETUP ([SHIFT] + MIC/LINE [EFFECTS])

Parameter	Value	Page
(Input) Level	0-127	75
Merge-L&R	ON, OFF	79
Balance	L63-L01, 0, R01-R63	79
Aux (Send Position)	PRE-F, PST-F	95
(Level)	0-127	95
FX (Send Position)	PRE-F, PST-F	79
(Level)	0-127	79
EQ Switch	ON, OFF	47
High Freq	500 Hz-16 kHz	47
Gain	-12-+12 dB	47
Mid Freq	200 Hz-8.0 kHz	47
Gain	-12-+12dB	47
Q	0.5, 1.0, 2.0, 4.0, 8.0	47
Low Freq	40 Hz-1.5 kHz	47
Gain	-12-+12 dB	47
FaderCtrl	INP, PAD	75
PADsLevel	0-127	79
Balance	L63-L01, 0, R01-R63	79
FX (Send Position)	PRE-F, PST-F	79
(Level)	0-127	79

(MEMO) Each of SAMPLE, BANK, and SYSTEM parameters are written (saved) in the disk (SYSTEM is written in the internal flash memory) whenever the disk is ejected or other certain process. You do not need to perform the saving procedure like SONG (or the Effects Patches).

(MEMO) In addition to the SYSTEM PARAMETER described above, the internal flash memory can memorize the REAL-TIME EFFECTS (b) FILTER/ISOLATOR settings. (p. 29)

(MEMO) In addition to the SONG PARAMETER described above, the followings are saved into the disk as each song's information.

Each track's STATUS settings, Assignment of phrases on the tracks (p. 87), Tempo Map (p. 71), Master Mute (p. 26), Effects ON/OFF and Patch selection, etc.

(MEMO) About the EFFECTS PATCH PARAMETERS, please refer to the section of each algorithm (p. 101-128) and STEP MODULATOR (p. 131).

MIDI Implementation

Model SP-808

Version 1.00
Mar. 25 1998

1. RECOGNIZED RECEIVE DATA

■ Channel Voice Message

● Note On/Off

Receive the note number which is designated with "RxNote", in the MIDI channel number which is designated with "Pads Rx Ch." in the system parameter "2. Set MIDI Param?". Receive only when the effect patch including VIRTUAL ANALOG SYNTH (algorithm 20) is selected.

Status	Second	Third
9nH	mmH	llH

n = MIDI Channel No.: 00H-09H (ch.1-ch.10) (*1)
0AH (ch.11) (*2)
mm = Note No.: 00H-7FH (0-127)
ll = Velocity: 01H-7FH (1-127) / 00H = NOTE OFF

*1 Only receive pads.
*2 Only when the effect patch including VIRTUAL ANALOG SYNTH (algorithm 20) is selected.

● Control Change

Parameters on the Mixer section can be received and by the control change messages when "Mixer,D-Beam" in the SYSTEM parameter ("2.Set MIDI Param?") is set to "SEND."

Status	Second	Third
BnH	mmH	llH

n = MIDI Channel No.: 0AH-0FH (ch.11-ch.16: see below)
mm = Mixer Parameter No.: (see below)
ll = Mixer Parameter Value: 00H-7FH (0-127)

Mixer Parameter and MIDI Channel/Control Change No.

<Mixer Channel Strip>

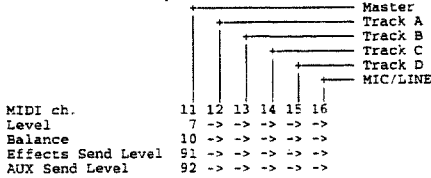

○ Bank select (MSB/LSB)

Switches the effect bank of Preset/User.

Status	Second	Third
BnH	00H	mmH
BnH	20H	llH

n = MIDI Channel No.: 0AH (ch.11)
mm = upper byte of bank number: 00H, 40H (0, 64)
ll = lower byte of bank number: 00H

Bank Select		Program Change	Patch Number
MSB	LSB		
00H	00H	00H-62H (0-98)	Preset #01-#59
40H	00H	00H-62H (0-98)	Preset #01-#59
40H	00H	63H (99)	master Isolator/Filter

● Program Change

Works as bank switch when MIDI channel number is set for playing the sample.
Works as Effects patches switch when channel number is set to 0AH.

Status	Second
CnH	ppH

n = MIDI Channel No.: 00H-09H (ch.1-ch.10)
0AH (ch.11)
pp = Program No.: 00H-63H (0-99)

■ System Common Messages

● MIDI Time Code Quarter Frame Messages

The transmitted time counts are summed to "MTC Offset Time" as the song top is "00:00:00:00". The SP-808 synchronizes with the time counts which are summed to "MTC Offset Time" as the song top is "00:00:00:00" if the SONG parameter "Sync Source" is "MTC".

Status	Second
F1H	mmH (= 0nnndddd)

nnn = Message type: 0 = Frame count LS nibble
1 = Frame count MS nibble
2 = Seconds count LS nibble
3 = Seconds count MS nibble
4 = Minutes count LS nibble
5 = Minutes count MS nibble
6 = Hours count LS nibble
7 = Hours count MS nibble
dddd = 4 bit nibble data: 0H-FH (0-15)

If the upper and lower 4 bits of the count are combined, these bit fields are assigned as follows.

Frame Count	xxxxyyyy	Reserved (000)
xxx		Frame No. (0-29)
yyyyy		

Seconds Count	xyyyyyyy	Reserved (00)
xx		Seconds Count (0-59)
yyyyyy		

Minutes Count	xyyyyyyy	Reserved (00)
xx		Minutes Count (0-59)
yyyyyy		

Hours Count	xyzzzzzz	Reserved (0)
x		Time Code type
yy		0 = 24 Frames/Sec 1 = 25 Frames/Sec 2 = 30 Frames/Sec (Drop Frame) 3 = 30 Frames/Sec (Non Drop Frame)
zzzzz		Hours

■ System Realtime Message

● Start

Status
FAH

● Continue

Status
FBH

● Stop

Status
FCH

■ System Exclusive Message

Status	Data Bytes	Status
F0H	iiH, ddH, ..., eeH	F7H

Byte	Description
F0H	Status of System Exclusive Message
iiH	Manufacturer ID
	41H Roland's Manufacturer ID
	7EH Universal Non Realtime Message
	7FH Universal Realtime Message
ddH	Data: 00H-7FH (0-127)
eeH	Data
F7H	EOX (End of System Exclusive Message)

○ About Model ID

For Data Request (RQ1) and Data Set (DT1), SP-808 uses 00H 0FH as a Model ID

● Universal System Exclusive Message

○ INQUIRY MESSAGE

↳ Identity Request

Status	Data Bytes	Status
F0H	7EH, Dev, 06H, 01H	F7H

Byte	Description
F0H	Status of System Exclusive Message
7EH	Universal System Exclusive Message Non Realtime Header
Dev	Device ID (10H or 7FH)
06H	General Information (sub ID #1)
01H	Identify Request (sub ID #2)
F7H	EOX (End of System Exclusive Message)

The message is used to request the particular information of the SP-808.
 The SP-808 does not transmit the message.
 If the SP-808 received the message and the device ID of the message is same as 10H or 7FH, the SP-808 transmits the following Identity Reply message.

↳ MIDI Machine Control Commands

Status	Data Bytes	Status
F0H	7FH, Dev, 06H, aaH, ..., bb	F7H

Byte	Description
F0H	Status of System Exclusive Message
7FH	Universal System Exclusive Message Realtime Header
Dev	Device ID (10H or 7FH)
06H	MMC Command Message
aaH	Command
bbH	Command
F7H	EOX (End of System Exclusive Message)

* See "2. MIDI Machine Control" section.

↳ MIDI Machine Control Responses

Status	Data Bytes	Status
F0H	7FH, Dev, 07H, aaH, ..., bb	F7H

Byte	Description
F0H	Status of System Exclusive Message
7FH	Universal System Exclusive Message Realtime Header
Dev	Device ID (10H or 7FH)
07H	MMC Response Message
aaH	Response
bbH	Response
F7H	EOX (End of System Exclusive Message)

* See "2. MIDI Machine Control" section.

● Data Transfer (RQ1, DT1)

○ Data Request (RQ1)

Status	Data Bytes	Status
F0H	41H, Dev, 00H, 0EH, 11H, aaH, bbH, ccH, ssH, ssH, ssH, Sum	F7H

Byte	Description
F0H	Status of System Exclusive Message
41H	Manufacturer ID (Roland)
Dev	Device ID
00H 0EH	ModelID (SP-808)
11H	Command ID (RQ1)
aaH	Address MSB
bbH	Address
ccH	Address LSB
ssH	Size MSB
ssH	Size
ssH	Size LSB
Sum	Checksum
F7H	EOX (End of System Exclusive Message)

The message is used to request data to the SP-808.
 The SP-808 does not transmit this message.
 The SP-808 transmits the requested data using Data Set(DT1) under following condition when it received the message.

1. The requested address correspond to the specified parameter base address of the SP-808.
2. The requested size is over 1 byte.

○ Data Set (DT1)

Status	Data Bytes	Status
F0H	41H, Dev, 00H, 0EH, 12H, aaH, bbH, ccH, ddH, ..., eeH, Sum	F7H

Byte	Description
F0H	Status of System Exclusive Message
41H	Manufacturer ID (Roland)
Dev	Device ID
00H 0EH	Model ID (SP-808)
12H	Command ID (DT1)
aaH	Address MSB
bbH	Address
ccH	Address LSB
ddH	Data
eeH	Data
Sum	Checksum
F7H	EOX (End of System Exclusive Message)

↳ The message is received under the following condition

If the device ID on the message is same as that of the receive device, and the address on the message correspond to the specified parameter base address, the received data are stored from the specified parameter base address.
 If the interval of received messages is shorter than 25 msec, the SP-808 can not work the receive message procedure correctly.

↳ The message is transmitted under the following condition

When the SP-808 transmit the data on the requested parameter after receiving the Data Request message (RQ1).

* See "2. Data Transfer Address Map" for more details of the transfer parameters.

2. MIDI Machine Control

■ MIDI Machine Control Details

● STOP (MCS)

Status	Data Bytes	Status
F0H	7FH, Dev, 06H, 01H	F7H

Byte	Description
F0H	Status of System Exclusive Message
7FH	Universal System Exclusive Message Realtime Header
Dev	Device ID (10H or 7FH)
06H	MMC Command Message
01H	STOP (MCS)
F7H	EOX (End of System Exclusive Message)

If the device ID on the message was as same as that of the receiving 10H or 7FH, the SP-808 stops immediately.

● PLAY (MCS)

Status	Data Bytes	Status
F0H	7FH, Dev, 06H, 02H	F7H

Byte	Description
F0H	Status of System Exclusive Message
7FH	Universal System Exclusive Message Realtime Header
Dev	Device ID (10H or 7FH)
06H	MMC Command Message
02H	PLAY (MCS)
F7H	EOX (End of System Exclusive Message)

If the device ID on the message was as same as that of the receiving 10H or 7FH, the SP-808 goes into the playback condition.

● DEFERRED PLAY (MCS)

Status	Data Bytes	Status
F0H	7FH, Dev, 06H, 03H	F7H

Byte	Description
F0H	Status of System Exclusive Message
7FH	Universal System Exclusive Message Realtime Header
Dev	Device ID (10H or 7FH)
06H	MMC Command Message
03H	DEFERRED PLAY (MCS)
F7H	EOX (End of System Exclusive Message)

If the device ID on the message was as same as that of the receiving 10H or 7FH, the SP-808 goes into the playback condition after the locate operation.

Appendices

● FAST FORWARD (MCS)

Status	Data Bytes	Status
F0H	7FH, Dev, 06H, 03H	F7H

Byte	Description
F0H	Status of System Exclusive Message
7FH	Universal System Exclusive Message Realtime Header
Dev	Device ID (10H or 7FH)
06H	MMC Command Message
03H	DEFERRED PLAY (MCS)
F7H	EOX (End of System Exclusive Message)

If the device ID on the message was as same as that of the receiving 10H or 7FH, the SP-808 goes into the fast forward condition.

● REWIND (MCS)

Status	Data Bytes	Status
F0H	7FH, Dev, 06H, 05H	F7H

Byte	Description
F0H	Status of System Exclusive Message
7FH	Universal System Exclusive Message Realtime Header
Dev	Device ID (10H or 7FH)
06H	MMC Command Message
05H	REWIND (MCS)
F7H	EOX (End of System Exclusive Message)

If the device ID on the message was as same as that of the receiving 10H or 7FH, the SP-808 goes into the rewind condition.

● RECORD STROBE

Status	Data Bytes	Status
F0H	7FH, Dev, 06H, 06H	F7H

Byte	Description
F0H	Status of System Exclusive Message
7FH	Universal System Exclusive Message Realtime Header
Dev	Device ID (10H or 7FH)
06H	MMC Command Message
06H	RECORD STROBE
F7H	EOX (End of System Exclusive Message)

If the transport switch [REC] was pressed out of the recording condition, the SP-808 transmits as the device ID 7FH.

● RECORD EXIT

Status	Data Bytes	Status
F0H	7FH, Dev, 06H, 07H	F7H

Byte	Description
F0H	Status of System Exclusive Message
7FH	Universal System Exclusive Message Realtime Header
Dev	Device ID (10H or 7FH)
06H	MMC Command Message
07H	RECORD EXIT
F7H	EOX (End of System Exclusive Message)

If the device ID on the message was as same as that of the receiving 10H or 7FH, the SP-808 exits from the record condition.

● MMC RESET

Status	Data Bytes	Status
F0H	7FH, Dev, 06H, 0DH	F7H

Byte	Description
F0H	Status of System Exclusive Message
7FH	Universal System Exclusive Message Realtime Header
Dev	Device ID (10H or 7FH)
06H	MMC Command Message
0DH	MMC RESET
F7H	EOX (End of System Exclusive Message)

If the device ID on the message was as same as that of the receiving 10H or 7FH, the SP-808 resets all communication channels related with MMC.

● WRITE

Status	Data Bytes	Status
F0H	7FH, Dev, 06H, 40H, ccH, ddH, eeH, ..., ffH, ...	F7H

Byte	Description
F0H	Status of System Exclusive Message
7FH	Universal System Exclusive Message Realtime Header
Dev	Device ID (10H or 7FH)
06H	MMC Command Message
40H	WRITE
ccH	Information Bytes follows the command
ddH	The name of the writable Information Field
eeH	Information Field Format
ffH	Field names and data
F7H	EOX (End of System Exclusive Message)

If the device ID on the message was as same as that of the receiving 10H or 7FH, the SP-808 writes the data to the specified information field.

● MASKED WRITE

Status	Data Bytes	Status
F0H	7FH, Dev, 06H, 41H, 04H, ddH, eeH, ffH, ggH	F7H

Byte	Description
F0H	Status of System Exclusive Message
7FH	Universal System Exclusive Message Realtime Header
Dev	Device ID (10H or 7FH)
06H	MMC Command Message
41H	MASKED WRITE
04H	Number of Bytes follows the command
ddH	The name of the masked type writable Information Field
eeH	Byte number to write in the Bit Map
ffH	Bit location of the bit map byte to change
ggH	New data to write to the specified bit map byte
F7H	EOX (End of System Exclusive Message)

If the device ID on the message was as same as that of the receiving 10H or 7FH, the SP-808 writes the data to the specified bit map byte.

● LOCATE (MCP)

○ Format 1—LOCATE [I/F]

Status	Data Bytes	Status
F0H	7FH, Dev, 06H, 44H, 02H, 00H, nnH	F7H

Byte	Description
F0H	Status of System Exclusive Message
7FH	Universal System Exclusive Message Realtime Header
Dev	Device ID (10H or 7FH)
06H	MMC Command Message
44H	LOCATE (MCP)
02H	Number of Bytes
00H	"I/F" sub command
nnH	Information Field (08H, 09H, 0AH, 0BH, 0CH, 0DH, 0EH, 0FH)
F7H	EOX (End of System Exclusive Message)

If the device ID on the message was as same as that of the receiving 10H or 7FH, the SP-808 locates the selected time location stored to the specified information field.

○ Format 2—LOCATE [TARGET]

Status	Data Bytes	Status
F0H	7FH, Dev, 06H, 44H, 06H, 01H, hrH, mnH, scH, frH, ffH	F7H

Byte	Description
F0H	Status of System Exclusive Message
7FH	Universal System Exclusive Message Realtime Header
Dev	Device ID (10H or 7FH)
06H	MMC Command Message
44H	LOCATE (MCP)
06H	Number of Bytes
01H	"TARGET" sub command
hrH, mnH, scH, frH, ffH	Standard Time with Sub Frame
F7H	EOX (End of System Exclusive Message)

If the device ID on the message was as same as that of the receiving 10H or 7FH, the SP-808 locates the specified time location received from the command.

● MOVE

Status	Data Bytes	Status
F0H	7FH, Dev, 06H, 4CH, 02H, ddH, ssH	F7H

Byte	Description
F0H	Status of System Exclusive Message
7FH	Universal System Exclusive Message Realtime Header
Dev	Device ID (10H or 7FH)
06H	MMC Command Message
4CH	MOVE
02H	Number of Bytes
ddH	Name of the Efficient Destination Information Field (08H,09H,0AH,0BH,0CH,0DH,0EH,0FH)
ssH	Name of the Efficient Source Information Field (01H)
F7H	EOX (End of System Exclusive Message)

If the device ID on the message was as same as that of the receiving 10H or 7FH, the SP-808 transfers the data on the selected source information field to the destination Information Field, if the name of both information fields is efficient.

3. TRANSMITTED DATA

■ Channel Voice Message

● Note On/Off

When "Metro." in the SYSTEM parameters(1.Set System Param?) is "MIDI", MIDI note number/velocity of MIDI channel number which is assigned to the Metronome is transmitted.

Status	Second	Third
9nH	mmH	llH
n = MIDI Channel No.:	00H-0FH (ch.1-ch.16) (*1)	
mm = Note No.:	00H-7FH (0-127)	
ll = Velocity:	01H-7FH (1-127) / 00H = NOTE OFF	

*1 Only when transmitting Metronome.

● Control Change

Parameters on the Mixer section can be received and transmitted by the control change messages when "MIDI Mixer Control Type (*1)" in the SYSTEM parameter is set to "C.C."

Status	Second	Third
BnH	mmH	llH
n = MIDI Channel No.:	0AH-0FH (ch.11-ch.16: see below)	
mm = Mixer Parameter No.:	(see below)	
ll = Mixer Parameter Value:	00H-7FH (0-127)	

Mixer Parameter and MIDI Channel/Control Change No.

<Mixer Channel Strip>

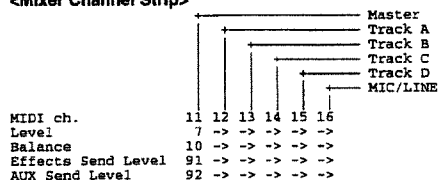

<Master Block> MIDI ch. = 11

Level	7
Balance	10
D Beam Controller	L 80
D Beam Controller	R 81
Effects Send Level	91
AUX Send Level	92

■ System Common Messages

● MIDI Time Code Quarter Frame Messages

MIDI Time Code Quarter Frame Messages can be transmitted while the SP-808 is running (Playing or Recording) if the SONG parameter "Sync Src" is "INTERNAL" and "Sync Out" is "MTC". The transmitted time counts are summed to "MTC Offset Time" as the song top is "00:00:00:00".

Status	Second
FIH	mmH (= 0nnrdddd)

runn = Message type:	0 = Frame count LS nibble
	1 = Frame count MS nibble
	2 = Seconds count LS nibble
	3 = Seconds count MS nibble
	4 = Minutes count LS nibble
	5 = Minutes count MS nibble
	6 = Hours count LS nibble
	7 = Hours count MS nibble
dddd = 4 bit nibble data:	0H-FH (0-15)

If the upper and lower 4 bits of the count are combined, these bit fields are assigned as follows.

Frame Count	xxxxxxx	Reserved (000)
xxxx	xxxxxxx	Frame No. (0-29)
yyyyy		
Seconds Count	xxxxxxx	Reserved (00)
xx	xxxxxxx	Seconds Count (0-59)
yyyyyy		
Minutes Count	xxxxxxx	Reserved (00)
xx	xxxxxxx	Minutes Count (0-59)
yyyyyy		
Hours Count	xyzzzzz	Reserved (0)
x	xyzzzzz	Time Code type
yy		0 = 24 Frames/Sec
		1 = 25 Frames/Sec
		2 = 30 Frames/Sec (Drop Frame)
		3 = 30 Frames/Sec (Non Drop Frame)
zzzzz		Hours

● Song Position Pointer

The current position is transmitted with the Song Position Pointer Message before the SP-808 starts to run or after the locate operation, when "Sync Src" is "INTERNAL" and "Sync Out" is "MIDI CLOCK".

Status	Second	Third
F2H	mmH	nnH
mm,nn = Song Position Point:	00H 00H-7FH	7FH

■ System Realtime Message

Transmitted when "Sync Src" is "INTERNAL" and "Sync Out" is "MIDI CLOCK".

● Timing Clock

Status
F8H

● Start

Status
FAH

● Continue

Status
FBH

● Stop

Status
FCH

■ System Exclusive Message

Status	Data Bytes	Status
F0H	iiH, ddH, ..., eeH	F7H
Byte	Description	
F0H	Status of System Exclusive Message	
iiH	Manufacturer ID	
	41H Roland's Manufacturer ID	
	7EH Universal Non Realtime Message	
	7FH Universal Realtime Message	
ddH	Data: 00H-7FH (0-127)	
eeH	Data	
F7H	EOX (End of System Exclusive Message)	

Appendices

○ About Model ID

For Data Request (RQ1) and Data Set (DT1), SP-808 uses 00H 0EH as a Model ID.

● Universal System Exclusive Message

○ INQUIRY MESSAGE

◆ Identity Reply

Status	Data Bytes	Status
F0H	7EH, Dev, 06H, 02H, 41H, 7CH, 00H, 00H, 00H, 00H, 00H, ssH, ssH F7H	

Byte	Description
F0H	Status of System Exclusive Message
7EH	Universal System Exclusive Message Non Realtime Header
Dev	Device ID
06H	General Information (sub ID #1)
02H	Identify Request (sub ID #2)
41H	Manufacturer ID (Roland)
0EH 01H	Device Family Code (SP-808)
00H 00H	Device Family No.
00H	
00H	
ssH ssH	Software Revision Level
F7H	EOX (End of System Exclusive Message)

◆ MIDI Machine Control Commands

Status	Data Bytes	Status
F0H	7FH, 7FH, 06H, aaH, ..., bbH	F7H

Byte	Description
F0H	Status of System Exclusive Message
7FH	Universal System Exclusive Message Realtime Header
7FH	Device ID
06H	MMC Command Message
aaH	Command
bbH	Command
F7H	EOX (End of System Exclusive Message)

* See "4. MIDI Machine Control" section.

◆ MIDI Machine Control Responses

Status	Data Bytes	Status
F0H	7FH, 7FH, 07H, aaH, ..., bbH	F7H

Byte	Description
F0H	Status of System Exclusive Message
7FH	Universal System Exclusive Message Realtime Header
7FH	Device ID
07H	MMC Response Message
aaH	Response
bbH	Response
F7H	EOX (End of System Exclusive Message)

* See "4. MIDI Machine Control" section.

4. MIDI Machine Control

■ MIDI Machine Control Details

● STOP (MCS)

Status	Data Bytes	Status
F0H	7FH, 7FH, 06H, 01H	F7H

Byte	Description
F0H	Status of System Exclusive Message
7FH	Universal System Exclusive Message Realtime Header
7FH	Device ID
06H	MMC Command Message
01H	STOP (MCS)
F7H	EOX (End of System Exclusive Message)

If the transport switch [STOP] was pressed, the SP-808 transmits as the device ID 7FH.

● DEFERRED PLAY (MCS)

Status	Data Bytes	Status
F0H	7FH, 7FH, 06H, 03H	F7H

Byte	Description
F0H	Status of System Exclusive Message
7FH	Universal System Exclusive Message Realtime Header
7FH	Device ID
06H	MMC Command Message
03H	DEFERRED PLAY (MCS)
F7H	EOX (End of System Exclusive Message)

If the transport switch [PLAY] was pressed, the SP-808 transmits as the device ID 7FH.

● RECORD STROBE

Status	Data Bytes	Status
F0H	7FH, 7FH, 06H, 06H	F7H

Byte	Description
F0H	Status of System Exclusive Message
7FH	Universal System Exclusive Message Realtime Header
7FH	Device ID
06H	MMC Command Message
06H	RECORD STROBE
F7H	EOX (End of System Exclusive Message)

If the transport switch [REC] was pressed out of the recording condition, the SP-808 transmits as the device ID 7FH.

● RECORD EXIT

Status	Data Bytes	Status
F0H	7FH, 7FH, 06H, 07H	F7H

Byte	Description
F0H	Status of System Exclusive Message
7FH	Universal System Exclusive Message Realtime Header
7FH	Device ID
06H	MMC Command Message
07H	RECORD EXIT
F7H	EOX (End of System Exclusive Message)

If the transport switch [REC] was pressed while recording, the SP-808 transmits as the device ID 7FH.

● MMC RESET

Status	Data Bytes	Status
F0H	7FH, 7FH, 06H, 0DH	F7H

Byte	Description
F0H	Status of System Exclusive Message
7FH	Universal System Exclusive Message Realtime Header
7FH	Device ID
06H	MMC Command Message
0DH	MMC RESET
F7H	EOX (End of System Exclusive Message)

When powered on and song loaded the SP-808 transmits as the device ID 7FH.

● LOCATE (MCP)

○ Format 2—LOCATE [TARGET]

Status	Data Bytes	Status
F0H	7FH, 7FH, 06H, 44H, 06H, 01H, hrH, mnH, scH, frH, ffH	F7H

Byte	Description
F0H	Status of System Exclusive Message
7FH	Universal System Exclusive Message Realtime Header
7FH	Device ID
06H	MMC Command Message
44H	LOCATE (MCP)
06H	Number of Bytes
01H	"TARGET" sub command
hrH, mnH, scH, frH, ffH	Standard Time with Sub Frame
F7H	EOX (End of System Exclusive Message)

If the efficient locate switch is pressed, the SP-808 transmits as the device ID 7FH.

● The efficient information Field

The followings are the efficient Information Field on the SP-808.

The name of the efficient destination Information Field:

- 01H SELECTED TIME CODE
- 08H GP0 / LOCATE POINT
- 09H GP1
- 0AH GP2
- 0BH GP3
- 0CH GP4
- 0DH GP5
- 0EH GP6
- 0FH GP7
- 4FH TRACK RECORD READY

5. Appendices

● Decimal and Hexadecimal table

(Hexadecimal number is shown with H.)

In MIDI documentation, data values and addresses/sizes of system exclusive messages etc. are expressed as hexadecimal values for each 7 bits.

The following table shows how these correspond to decimal numbers.

dec	hex	dec	hex	dec	hex	dec	hex
0	00H	32	20H	64	40H	96	60H
1	01H	33	21H	65	41H	97	61H
2	02H	34	22H	66	42H	98	62H
3	03H	35	23H	67	43H	99	63H
4	04H	36	24H	68	44H	100	64H
5	05H	37	25H	69	45H	101	65H
6	06H	38	26H	70	46H	102	66H
7	07H	39	27H	71	47H	103	67H
8	08H	40	28H	72	48H	104	68H
9	09H	41	29H	73	49H	105	69H
10	0AH	42	2AH	74	4AH	106	6AH
11	0BH	43	2BH	75	4BH	107	6BH
12	0CH	44	2CH	76	4CH	108	6CH
13	0DH	45	2DH	77	4DH	109	6DH
14	0EH	46	2EH	78	4EH	110	6EH
15	0FH	47	2FH	79	4FH	111	6FH
16	10H	48	30H	80	50H	112	70H
17	11H	49	31H	81	51H	113	71H
18	12H	50	32H	82	52H	114	72H
19	13H	51	33H	83	53H	115	73H
20	14H	52	34H	84	54H	116	74H
21	15H	53	35H	85	55H	117	75H
22	16H	54	36H	86	56H	118	76H
23	17H	55	37H	87	57H	119	77H
24	18H	56	38H	88	58H	120	78H
25	19H	57	39H	89	59H	121	79H
26	1AH	58	3AH	90	5AH	122	7AH
27	1BH	59	3BH	91	5BH	123	7BH
28	1CH	60	3CH	92	5CH	124	7CH
29	1DH	61	3DH	93	5DH	125	7DH
30	1EH	62	3EH	94	5EH	126	7EH
31	1FH	63	3FH	95	5FH	127	7FH

- Decimal values such as MIDI channel, bank select, and program change are listed as one (1) greater than the values given in the above table.
- A 7-bit byte can express data in the range of 128 steps. For data where greater precision is required, we must use two or more bytes. For example, two hexadecimal numbers aa bbH expressing two 7-bit bytes would indicate a value of $aa \times 128 + bb$.
- In the case of values which have a ± sign, 00H = -64, 40H = ±0, and 7FH = +63, so that the decimal expression would be 64 less than the value given in the above chart. In the case of two types, 00 00H = -8192, 40 00H = ±0, and 7F 7FH = +8191.
- Data marked "nibbled" is expressed in hexadecimal in 4-bit units. A value expressed as a 2-byte nibble 0a 0bH has the value of $a \times 16 + b$.

<Ex.1> What is 5AH in decimal system?
5AH = 90 according to the above table.

<Ex.2> What in decimal system is 12034H in hexadecimal of every 7 bit?
12H = 18, 34H = 52 according to the above table. So $18 \times 128 + 52 = 2356$.

<Ex.3> What in decimal system is 0A 03 09 0D in nibble system?
0AH = 10, 03H = 3, 09H = 9, 0DH = 13 according to the table.
So $((10 \times 16 + 3) \times 16 + 9) \times 16 + 13 = 41885$.

<Ex. 4> What in nibble system is 1258 in decimal system?

```

16) 1258
   78 ... 10
   4 ... 14
   0 ... 4
    
```

0 = 00H, 4 = 04H, 14 = 0EH, 10 = 0AH According to the table.
So it is 00 04 0E 0AH.

● Example of system exclusive message and Checksum calculation

On Roland system exclusive message (DT1), checksum is added at the end of transmitted data (in front of F7) to check the message is received correctly. Value of checksum is defined by address and data (or size) of the system exclusive message to be transmitted.

◆ How to calculate checksum (Hexadecimal number is shown with H)

Checksum is a value which lower 7 bit of the sum of address, size and checksum itself turns to be 0.

If the address of the system exclusive message to be transmitted is aa bb ccH and data or size is dd ee ffH,

$$\begin{aligned}
 &aa + bb + cc + dd + ee + ff = \text{sum} \\
 &\text{sum} / 128 = \text{quotient and odd} \\
 &\text{When odd is 0, 0 = checksum} \\
 &\text{When odd is other than 0, 128 - odd = checksum}
 \end{aligned}$$

MIDI Machine Control (MMC) Command, Information Field / Response Reference

● Commands Recognized

Command	Action
01H STOP	STOP
02H PLAY	PLAY
03H DEFERRED PLAY	PLAY
04H FAST FORWARD	FF
05H REWIND	REW
06H RECORD STROBE	REC/PUNCH IN
07H RECORD EXIT	PUNCH OUT
0DH MMC RESET	RESET
40H WRITE	Write to Information Fields
41H MASKED WRITE	Set Track Status Information Fields
44H 00H LOCATE I/F	LOCATE (Read Locator)
44H 01H LOCATE TARGET	LOCATE (Designated Time)
4CH MOVE	Move between Information fields

● Commands Transmitted

Command	Action
01H STOP	STOP
03H DEFERRED PLAY	PLAY
06H RECORD STROBE	REC/PUNCH IN
07H RECORD EXIT	PUNCH OUT
0DH MMC RESET	RESET
44H 01H LOCATE TARGET	LOCATE

● Valid Information Fields / Response

Information Field	Interpret	Valid Commands
01H SELECTED TIME CODE	Current Time	MOVE (FROM)
08H GP0/LOCATE POINT	Locator 1	MOVE (FROM), MOVE (TO), WRITE
09H GP1	Locator 2	MOVE (FROM), MOVE (TO), WRITE
0AH GP2	Locator 3	MOVE (FROM), MOVE (TO), WRITE
0BH GP3	Locator 4	MOVE (FROM), MOVE (TO), WRITE
0CH GP4	Locator 5	MOVE (FROM), MOVE (TO), WRITE
0DH GP5	Locator 6	MOVE (FROM), MOVE (TO), WRITE
0EH GP6	Locator 7	MOVE (FROM), MOVE (TO), WRITE
0FH GP7	Locator 8	MOVE (FROM), MOVE (TO), WRITE
4FH TRACK RECORD READY	Track Status	MASKED WRITE, WRITE

- SP-808 transforms the Information Fields GP0-GP7 which are written by the MMC WRITE COMMAND (40H) to MEASURE/BEAT/TICK format data which accord with current tempo and time signature, and then registers them to the locators 1-8.

Groove Sampler
Model SP-808

MIDI Implementation Chart

Date: May. 6, 1998
Version: 1.01

Function ...		Transmitted	Recognized	Remarks
Basic Channel	Default	1-16	1-16	
	Changed	1-16 *5	1-10 *6	
Mode	Default	Mode 3	Mode 3	
	Messages Altered	x *****	x x	
Note Number	True Voice	0-127	0-127	
		*****	0-127	
Velocity	Note ON	1-127	o	
	Note OFF	x 9n, v = 0	x	
After Touch	Key's	x	x	
	Ch's	x	x	
Pitch Bend		x	x	
Control Change	0, 32	o	o	Bank Select (Effects) Level Balance D Beam Controller L D Beam Controller R Effects Send Level AUX Send Level
	7	o	o	
	10	o	o	
	80	o	x	
	81	o	x	
	91	o	o	
92	o	o		
Program Change	True #	x ***** *****	o *1 0-63 0-99	Pad Bank Effects Patch
System Exclusive		x	x	
Common	Quarter Frame	o *2	o *3	
	Song Position	o *4	x	
	Song Select	x	x	
	Tune	x	x	
System Realtime	Clock	o	x	
	Commands	o	o	
Aux Messages	All Sounds OFF	x	o	
	Reset All Controllers	x	x	
	Local ON/OFF	x	x	
	All Notes OFF	x	o (123-127)	
	Active Sensing	o	o	
	System Reset	x	x	
Notes		*1 Change Pad Bank when MIDI CH = 1-10. Change Effects Patches when MIDI CH = 11. *2 "SyncSource" = "INTERNAL" and "SyncOut" = "MTC Only." *3 "SyncSource" = "MTC Only." *4 "SyncSource" = "INTERNAL" and "SyncOut" = "MTC Only." *5 Only the MIDI channel used for metronome can be changed. (The others are fixed.) *6 Only the MIDI channels used for switching pad bank and triggering samples can be changed. (The others are fixed.)		

Mode 1: OMNI ON, POLY
Mode 3: OMNI OFF, POLY

Mode 2: OMNI ON, MONO
Mode 4: OMNI OFF, MONO

o: Yes
x: No

Specifications

SP-808: Groove Sampler

Audio Data Format

SP-808 Original Format (R-DAC)

Maximum Polyphony

Stereo x 4 (Total)

Number of Tracks

Stereo Track x 4

Simultaneous Recordable Tracks

One stereo pair of tracks

Sample rate

44.1 kHz/32.0 kHz (When Vari-Pitch is off.)

Sampling Memory Capacity

Zip disk 100 M Bytes

Sampling (Recording) Time

46 min. approx. (Sample rate: 44.1 kHz, Monaural)

64 min. approx. (Sample rate: 32.0 kHz, Monaural)

* *Varies by Vari-Pitch status and other conditions.*

Signal Processing

AD Conversion: 20 bit, 64 times oversampling

DA Conversion: 20 bit, 128 times oversampling

Internal Processing: 24 bit (Digital Mixer section)

Internal Memory

System Setup: 1

Zip disk

Song: 64

Sample Bank: 64

Sample: 1024

Effect Patch: 99 Presets, 99 Users

Track Recording Method

Event Recording (Realtime, Step)

Audio Recording

Phrase Event Memory

Approx. 2000 Phrase Events per song

Channel Equalizer

3-band Parametric x 5 (Tracks A-D, Input)

MIDI Sync Method

Master: MIDI Clock, MTC & MMC

Slave: MTC & MMC

Frequency Response

44.1 kHz: 10 Hz-21 kHz (+0/-3 dB)

32.0 kHz: 10 Hz-15 kHz (+0/-3 dB)

Nominal Input Level

Mic: -50~-20 dBu

Line In, AUX In: -10~+4 dBu

Input Impedance

Line, AUX In: 47 k ohms

Mic: 100 k ohms

Nominal Output Level

AUX Send, Master Out: -10 dBu

Output Impedance

AUX Send, Master Out: 2 k ohms

Headphones: 10 ohms

Recommended Load Impedance

AUX Send, Master Out: 10 k ohms or greater

Headphones: 4-600 ohms

S/N Ratio

AUX Send, Master Out: 92 dB (Line, A/D-D/A, IHF-A, typ.)

Display

69.0 x 25.0 mm (backlit LCD)

Connectors

Mic Input Jack (1/4 inch phone type)

Line Input Jacks, L, R (RCA phono type)

AUX Input Jacks, L, R (RCA phono type)

Master Output Jacks, L, R (RCA phono type)

AUX Output Jacks, L, R (RCA phono type)

Headphones Jack (Stereo 1/4 inch phone type)

Footswitch Jack (1/4 inch phone type)

MIDI Connectors (In, Out/Thru)

* *Available with SP808-OP1 Multi I/O Expansion is installed.*

SCSI Connector (25-pin D-SUB type)

Coaxial Digital In Connector

Coaxial Digital Out Connector

Optical Digital In Connector

Optical Digital Out Connector

Track Direct Out x 3, L, R (RCA phono type)

Power Supply

AC 117 V, 230 V, 240 V

Power Consumption

21 W

Dimensions

394 (W) x 343 (D) x 99 (H) mm

15-9/16 (W) x 13-9/16 (D) x 3-15/16 (H) inches

Weight

4.3 kg / 9 lbs 8 oz (excluding SP808-OP1)

Accessories

AC Cord, Owner's Manual, Effects Patch List, Stickers,

"Let's Try" leaflet, Demo Zip disk

Options

Multi I/O Expansion SP808-OP1

(0 dBu = 0.775 V rms)

(NOTE) *In the interest of product improvement, the specifications and/or appearance of this unit are subject to change without prior notice.*

Index

1-0

4bC (4-button Chorus)113

A

A, B, C, D.....13
 AC IN18
 ALWAYS (Metronome)67
 ASSIGN (Foot Switch)140
 AUDIO REC→Audio Recording
 AUX12,18, 21, 25, 26, 42, 96
 Switching the ~ OUT Connector to Function
 as the Track D Direct Output150
 Using ~ IN/OUT95
 Using ~ OUT as an Auxiliary Output.....96
 Accent Note (Metronome).....159
 Adjust Timing87
 AnC (Analog Chorus).....111
 AnD (Analog Delay)111
 Analog
 ~ Chorus.....111
 ~ Delay111
 ~ Flanger113
 ~ Sequencer.....131
 ~ Synthesizer123, 130, 135
 ~type Phaser.....116
 Attack103, 106, 125
 Attenuator.....81, 94
 Audio Recording74
 Auto (AUTO)
 ~ DIVIDE.....45, 58
 ~ Mixing157
 ~ New Phrase69
 ~ Trim (When Sampling is Finished).....45
 ~ Wah117

B

BAL/EQ/FX (Each Channel Settings).....12
 BANK/BNK16, 22, 26, 35, 41
 Copy ~57
 Erase ~56
 ~ Param138
 ~ Protection.....138
 BASE (Create New Song)62
 BEAM.....→D BEAM Controller
 BEAT.....15, 22, 31, 60
 BIG TIME22
 BOUNCE.....49, 75, 79
 BPF.....101,117,122, 125
 BPM10, 12, 52, 60, 71, 133, 144
 ~ Base Note50
 ~ TUNE70
 BS138
 Balance (Stereo Balance)38, 80
 Bank16, 26, 35, 41

Adding Protection for Pad ~s138
 Copy ~57
 Erase ~56
 Naming a Pad ~138
 Base Note50
 Beam (D Beam Controller)16, 30, 31
 ~ (Effect)129
 ~ (MIDI).....158
 ~ (Pitch Down)30
 ~ (to Play Samples)41
 Beam Assign.....41
 Beam ID.....31
 Beat31
 Big Time22
 Bouncing Tracks79

C

C/F (Chorus/Flanger)127
 C1, C2, C3, C4, C5, C5BL, C6, C6BR99, 100
 CAPS LOCK138
 CHANGE PITCH.....53
 CLEAR REGION/MARK→To completely cancel
 these settings for a segment
 CLIPBOARD.....17, 54, 55
 COAXIAL145, 146
 COMMON
 MIX ~27, 40, 48, 77, 78
 SYSTEM ~168
 CONTRAST13, 21, 22
 COPY
 DIGITAL ~146
 ~ BANK57
 ~ DISK144
 ~ Disk All148
 ~ FX Only143
 ~ From (Step Modulator).....133
 CtC (CENTER CANCELER)102
 CTL (Effect).....99
 CUE
 AUX OUT.....25, 96
 PAD ~42
 CUT (TRACK)84
 CUTOFF (Freq)102,125
 Center Canceller102
 Change Pitch53
 Changing the Shading of the Display (Contrast Setting)21
 Cho (Stereo Digital Chorus).....112
 Chorus111, 112, 113, 127
 Cleanup Disk.....46, 142
 Clear
 (Locator)32
 (To delete marks)83
 Cmp (Comp Limiter).....103
 Coaxial.....145, 146
 Com (Common/Synth).....123
 Common123

Comp/Limiter.....103
 Confirm.....142
 Connecting the Zip Drive.....147
 Connection.....19
 Contrast.....13 ([SHIFT] + [PLAY]), 21, 22
 Control.....99, 129
 Controller.....30, 129
 Copy
 Digital ~ Protect.....147
 ~ (Bank).....57
 ~ (Sample).....56
 ~ (Step Modulator).....133
 ~ Disk All.....148
 ~ Effects Only.....143
 Counting in (Event Realtime Recording).....63
 Create
 ~ New Song (Create New Song).....62
 ~ Reversal.....59
 Create New Song.....62
 Create Reversal.....59
 Creating Songs
 Arranging Samples to Create Songs.....60
 Create New Song (Creating New Songs).....62
 Creating a Song with Measure Bars and Tempo
 that Conform to a Sample.....62
 Creating a Song with the Reference Sample
 Already Included.....63
 Ctrl.....75
 Cue.....42, 96
 Cut.....84

D

D BEAM/D BEAM CONTROLLER ...16, 31, 41, 129, 158
 D Beam Controller
 (PITCH).....30
 Assigning Functions to the Effects (EFFECTS).....129
 Controlling Other MIDI Devices with the ~.....158
 Playing Designated Samples.....30
 Setting the ~ Sensitivity.....31
 D.Copy Protect.....147
 DAMPER.....139
 DEL (Delete).....138
 DIGITAL.....112, 146
 DISK.....14, 21, 46, 142, 144, 148
 DP-2.....→Foot Switch
 DRUM.....36, 44
 DRs (Delay RSS).....110
 DUCK (Reverb).....106
 Damper Pedal.....140
 Delay
 Analog ~.....111
 EZ ~.....108
 Simple ~.....127
 Tape ~ (Echo).....107
 When using Vari-Pitch.....39
 ~ RSS.....109, 110

Delete
 ~ Sample.....55
 ~ Song.....73
 Digital
 Applying ~ Copy Protect.....147
 Using the ~ IN and OUT Connectors.....146
 ~ Chorus.....112
 ~ Delay.....108
 Disk.....14, 46, 144
 Before Using Zip ~s.....8
 Checking the Remaining Memory on Zip ~s.....25
 Copy (Copy Disk All).....148
 Creating a Backup ~.....148
 Disable Indicating the Saving
 Confirmation Message at ~ Ejection.....142
 Format ~.....24
 If "Disk Full" Appears in the Display.....46
 Increasing Remaining System Memory
 (Cleanup Disk).....142
 Inserting and Removing a ~.....21
 Maximum Sampling Times and Data Storage
 Available on Zip ~s.....24
 Display the Song Position in Hours, Minutes
 and Seconds.....32
 Distortion.....118
 Divide.....45, 57, 58
 Dly
 ~ (EZ DELAY).....108
 ~ (Simple Delay/Synthesizer).....127
 Drive.....8, 17, 20
 Drive Too Busy.....65
 Dsk (PHONOGRAPH).....120
 Dst (Stereo Distortion).....118
 Ducking Reverb.....106
 Duration.....68, 69, 87, 88

E

EDIT.....14
 EDIT (Processing/Editing).....14
 SAMPLE/BANK (Processing/Editing samples) ...50-59
 TRACK (Editing Recorded Tracks).....82-90
 EFFECTS.....12, 16
 ~ (D Beam).....129
 ~ (Recorder/Mixer).....27, 29, 48, 77, 93, 94, 95, 97
 EMPTY (Create New Song).....62
 END (LOOP).....36, 51, 88
 ENTER/YES.....15
 EQ (Equalizer).....47, 78, 94, 102, 104, 105, 118
 ERASE.....56
 EVENT REC
 REALTIME.....63-67
 STEP.....68-73
 EXIT.....14
 EXT
 ~ ID (Zip).....143, 148, 149
 ~ MTC.....155
 EXTN (Step Modulator).....136

Appendices

Editing	
(processing/ ~ samples)	50
(~ Recorded Tracks)	82, 87
~ Effects	98
Editing Selected Segments	84–86
Effects	12, 27, 29, 48, 77, 93
Adding Internal ~ During Mixdown	93
Applying ~ Using the Insert Method	97
Changing ~ with Three Knobs (Realtime Effects)	28
Copying ~ Patches to Other Disks	143
Editing and Saving ~	98
Playing the Synthesizer with the Realtime ~ Knobs	
(Analog Synthesizer)	130
Returning the User ~ Patches to the Factory Settings	
(Same as Preset Patches)	34
Saving ~ Patches	100
Selecting the Type of ~ (Algorithm)	98
Setting Pre- and Post-Fader for the ~	94
Switching the ~ Patches (MIDI)	152
The Algorithms and ~	101–128
To Fix the Positioning of the ~	27
Turning ~ On and Off	140
Using the External ~ (Send/Return)	95
Using the Realtime ~ Section	128
Using the ~ as an Analog Synthesizer	130
~ Location Register Screen	100
~ Pre Attenuator	94
Electric Guitar (Connections)	20
End	
Wave ~ Point (Track)	88
~ M (the Number of the Last Measure)	63
~ Point (Sample)	45, 51
End M	→the Number of the Last Measure
End Point (Sample Loop)	45, 51
End Step (Step Modulator)	132
Enh (Enhancer)	103, 104
Enhancer	104
Equalizer (EQ)	47, 77–79, 94, 102, 104, 105, 118
Erase	56, 84
~ (Track)	84
~ Bank	56
Erase Bank	56
Error Level	155
Error Level (MTC)	155
Event	63
~ Realtime Recording	63
~ Step Recording	68
Expression	36, 87
External Zip Drive	147–150

F

FILTER	28, 101, 117, 125, 134
FOOT SWITCH/FSW (Foot Switch)	18, 66, 76, 139, 140
FROM (from)	13, 33
FULL	24
FX	
~ EDIT	→Editing and Saving Effects
~ INFO	15
~ Loc	93

~ PATCH	100
~ Signal	49
Fader	25, 75, 94
Fader Ctrl	75
File (Filter)	28, 101, 117, 122, 123, 125, 134
Filter	28, 101, 122
Final Step Number (Step Modulator)	132
Flanger	113, 114, 127
Flg (Flanger)	114
Foot Switch	18
Designating the Samples to Be Played in	
Each Pad Bank with the ~	140
Switching Functions with the ~	139
Using a ~ to Punch In and Out	66, 76
Using the ~ Jack as a GPI Jack (DP-2/GPI)	140
Format	20, 24
;Format Type	24
;Sampling Rate	24
;Target Drive	24
Format Disk	24
Frequency (Freq)	102–106, 108, 110, 116, 117, 119, 120, 125
From	33

G

GATE (Reverb)	105
~T (Step Modulator)	133
GPI	140, 141
GROUP	37
GT (Gate)	106
GUIDE	63
Gate	105, 133
Group	→MUTE GROUP
Guide Sample	63

H

HEIGHT (BEAM)	30
HOLD	17, 37, 144
Headphones	12, 18, 25, 42
Hold	17, 37, 144
How to Return to the Basic Screens	23

I

ID	
Beam ~	31
SCSI ~	147–149
INS	138
INS AUX-OUT	96
INS MASTER	27, 40, 93
INS RECORD	48, 78
INSERT	
~ (Tempo Map)	71
~ (Track Insert)	85, 86, 90
INTERNAL/INT	143, 154
ISOLATOR	16, 28, 101
In Time	89, 90

Information.....15
 Init System Param.....34
 Initialize
 ~ (Disk).....→Format
 ~ (Restoring the Settings to Factory Condition).....34
 Input Source (Digital In).....146
 Insert.....85, 90
 ~ (Effect).....40, 48, 77
 ~ (Track).....85, 96
 ~ (Tempo Map).....71
 Iso (3-band isolator).....101
 Isolator.....28, 101

J

JUMP.....129
 Jump.....129
 Jumping to the Beginning of Songs.....33

K

Keep Mst.Fil&Iso.....29
 Knob (Effect Knob).....129
 Knob Control.....129

L

L↔R (D Beam Controller).....30
 LBs (Low Booster).....102
 LENGTH.....53
 Scrub/Preview ~.....33
 ~ (→End).....51
 LEV.....44
 LEVEL.....14, 50
 LEVEL METER (Level Meter Screen).....21
 LFO (SYNTH LFO) (Low Frequency Oscillator).....123
 LINE.....12, 13, 38, 75, 95, 146
 INPUT ~.....12
 MIC/ ~.....13, 38, 75, 146
 THRU (→ ~).....95
 LOC/LOCATOR.....12, 32, 33
 LOOP-END.....36, 51, 88
 LOW BOOST.....28
 Length.....33, 51, 53
 Level
 Sample ~.....14, 50
 ~ Meter.....21
 Line.....12, 13, 38, 75, 95
 MIC/LINE Fader.....75
 ~ In.....13, 38, 95
 Lo-Fi.....121
 LoF (Lo-Fi Processor).....121
 Load.....149
 Load Ext.Sample.....149
 Load Ext.Song.....149
 Loc (FxLoc.).....93
 Locator.....12, 32, 33
 Changing the Locator's Position.....32

Registering Song Positions (Time Locations)
 to the Locator Buttons.....32
 Loop
 Setting the ~ Mode.....36
 ~ End (LOOP-END).....36, 51, 88
 ~ Point.....51
 Loop Mode.....36
 Loop Point.....51
 Low Booster.....102
 Lower (D Beam).....42

M

M
 Cnt1-, Cnt2~.....63, 75
 End ~.....63
 MANUAL.....58
 MARK ON/OFF.....14, 55, 83
 MASTER
 (MMC).....156
 (MTC, MIDI Clock).....154
 INS ~.....27, 40, 93
 MASTER OUT.....18
 Inserting Compressor/EQ to ~.....94
 Insertion for the ~.....40
 MEAS (MEASURE).....31, 65, 69, 75, 132
 MEASURE.....31
 MEDIUM (D BEAM/PITCH).....30
 METER (Level Meter Screen).....21
 METRONOME (Metronome).....15, 63, 64, 67, 74, 159
 MIC.....12, 13, 20, 38, 75, 146
 INPUT ~.....12, 20
 MIC/L PRE-EQ/PST-EQ.....78
 MIC/LINE.....13, 38, 75, 146
 MIDI.....18, 151, 153, 154, 157, 159
 MIX COMMON ([SHIFT]+[MUTE]).....27, 40, 48, 77, 78
 MIXER VIEW (Mixer View Screen).....22
 MMC.....156
 MONO.....44, 75
 MOVE.....89
 MTC.....153-157
 MUTE.....13
 Manual.....113, 114
 Mark
 ~ On/Off (select/delete).....83
 ~ Phrase.....55, 83
 Master (Synchronization).....153-158
 Master Filter/Isolator.....28
 Match/w.....53
 Memory (Zip Disk).....25
 Merge-L&R.....92
 Metronome.....15, 63, 64, 67, 74, 159
 Having the ~ Play Always.....67
 Playing and Stopping the ~.....67
 Setting the ~ Volume.....67
 Using the ~ to Sound External MIDI Sound Module.....159
 Microphone (Mic).....12, 13, 20, 38, 75

Appendices

MIC/LINE	13, 38, 75, 96
MIC/LINE Fader	13, 38, 75
~s That Can Be Used with the SP-808	20
Mix Down	91, 93
Mixer	22
Changing ~ Settings (MIDI)	152
~ View screen	22
The Location of the Internal Effects in the ~	93
The ~ Setup (Image)	91
Mode	
AUX OUT JACK ~	96
LOOP ~ (Loop ~)	36, 51
Out Jack ~	96
Mon (Pre Punch)	66
Move	54, 89
Multi I/O Expansion	145
Multi-purpose Effects	29
Mute	26
MASTER OUT ~	13, 26
Starting the Sound with Releasing the Track ~	
Simultaneously	137
~ Group	37
Mute ([STATUS] indicator off)	26

N

NARROW (D Beam/Pitch)	30
NEXT	→The Beginning of the Phrase
NO ([EXIT/NO])	14
NOTCH (Filter)	101
NS (Noise Suppressor)	104, 122
NULL	129
Name	
~ (Song)	72
~ (Effects Patch)	100
~ (Pad Bank)	138
New BPM	52
New Phrase	69
New Pitch	53
Noise Suppressor	104, 122
Normal Note	159
Note	
(type and number of ~s)	50
BPM Base ~	50
Normal/Accent ~ (Metronome)	159
Playing Effects with the ~ Messages	
(Analog Synthesizer)	130
Playing Samples (MIDI)	151
Rx ~ (Pad 1)	152
Null	129
Number of Beats	50
Number of the Last Measure	63

O

ON/OFF	
REALTIME EFFECTS [-]	16
ONCE ([SHIFT])	141
OPTICAL	146

OUT Jack mode (AUX OUT)	96
OUT Time	89, 90
OUT / THRU (MIDI)	151
Offset	87, 156
(MTC) ~	156
Wave ~	87
On Off (Effect)	16, 99
Optical	145, 146
Out Jack Mode	96
Out/Thru Select (MIDI)	151
Outputting the Sounds on Each Track Separately	150

P

P.Fine	53
PAD	
~ BANK	16, 35
~ CUE	42
~ Play	36
~ TRIG (D BEAM)	30, 41
~s RX Ch	151
Panel Descriptions	12
PASTE	85, 89
PATCH (Effect Patch)	27, 97-100
PHONES	12, 18
PHONOGRAPH	120
PITCH	
(D BEAM) ~	16, 30
CHANGE ~	53
Lch/Rch ~	115
VARI ~	15, 39
PLAY	13
PLAY LIST	12, 14, 21, 22
PLAY-ONLY	49, 78, 97
PLAY/STOP (Foot Switch)	139
PLAYBACK button [▶]	15
POWER	18
PRE-F/PST-F	94
PREVIEW	13, 33
PREVIOUS	→The Beginning of the Phrase
PSf Stereo Pitch Shifter)	115
PUNCH I/O (Foot Switch)	139
Pad	17
Between the ~s and Note Numbers (MIDI)	152
Changing the Way Samples Are Played and	
Stopped with the ~s (~ Play)	36
Having the Sound Continue Even After	
Releasing the ~ (Hold Function)	37
Rearranging Samples To Prevent Empty ~s in	
the Pad Bank (Renumber)	139
Recording Your ~s Performance	63
Setting the Overall Volume and Stereo	
Balance of the ~s	38
~ Cue	42
Pad Bank	16, 35
Adding Protection for ~s	138
Can Samples from Different ~s Be Played Together?	35
Copying All of Samples in a Banks to Other Banks	57

Deleting All the Samples in a ~ At Once.....	56
Designating the Samples to Be Played in	
Each ~ with the Foot Switch.....	140
Naming the ~s.....	138
Selecting ~s.....	26
Switching ~s (MIDI).....	152
Pad Play.....	44
Paral. (STEP MOD).....	→Parallel Motion
Parallel Motion (Step Modulator).....	132
Paste (Track).....	85, 89
Patch (Effect Patch).....	98–100
Patch Loc (FxLoc.).....	→To Fix the Positioning of the Effects
Phaser.....	116
Phrase	
Top and end of the ~ (PREVIOUS/NEXT).....	83
Changing the Volume of Each ~.....	88
Finely Adjusting the Timing of Each ~ (Adjust Timing).....	87
New Phrase.....	69
Playing Stereo ~s in Monaural.....	92
Phs (Stereo Phaser).....	116
Pitch.....	15, 16
Changing the Width of the ~ Down	
(D Beam Controller).....	30
Grade (Change Pitch).....	53, 115
Vari ~.....	39
~ Shifter.....	115
Pitch Width (D Beam).....	30
Play.....	13
~ List.....	13, 21–22
Playback.....	25, 33, 139
Position.....	102
Power.....	20
Pre-Fader.....	94
Pre-Trigger.....	45
PreFX Att.....	94
PrePunch.....	66
PreTrig.....	45
Preview.....	13, 33
Preview Length.....	33
Protect	
Digital Copy ~.....	147
~ (Bank).....	138
~ (Song).....	72, 73
Protection.....	73, 138
Punch In/Out	
Auto ~.....	66, 76
Monitoring the Sound During ~.....	66, 77
Using a Foot Switch to ~.....	66, 76, 140
~ (Event Realtime Recording).....	65
~ (Track Audio Recording).....	76
Q	
QUICK (Format).....	142
Quantize.....	65
Quick Edit.....	14, 82

R

REALTIME (EVENT REC).....	63–67
REALTIME EFFECTS.....	28, 29, 97–130
REC.....	12, 63–68, 75, 78, 81
REC (orPLAY).....	49, 78
RECALL (EFFECTS PATCH).....	28
REGION IN/OUT.....	14, 82, 83
Rad (AM Radio Simulator).....	121
Radio Tuning.....	121
Realtime.....	28, 63, 128
Event ~ Recording.....	63
~ Effects.....	28, 128
~ Effects (“a” or “b”).....	16
Rec Att.....	81
Recorder	
Recording to an External ~.....	91
Recording	
Adding Effects Only to the Sounds Being Recorded.....	78
Bouncing Tracks.....	79
If the Recorded Sound is Distorted.....	81
Maximum ~ Times (Sampling).....	24
Monaural ~.....	75
Recording Directly to the Tracks.....	74
~ Through AUX IN.....	81
~ to an External Recorder (Mix Down).....	91
~ with the Channel Equalizer.....	78
~ with the Internal Effects.....	77
Region In/Out (Selecting a Segment).....	14, 82, 83
Remain.....	22, 25, 46
Renumber.....	139
Repeat Times (Insert).....	90
Repeat Times (Paste).....	89
Restoring the Settings to Factory Condition.....	34
Rev (Reverb & Gate).....	105
Reverb.....	105
Reversal	
Create ~.....	59
Reversal (Reverse).....	59
Rx Note (Pad1).....	152

S

SAMPL TRIG (Foot Switch).....	139
SAMPLE.....	14, 35, 149
SAMPLING.....	17
SAVE.....	72, 100
SCRUB.....	13, 33
SCSI.....	147, 148
SEL a/b.....	→Realtime Effect (“a” or “b”)
SELECT ROW.....	16, 128
SEND/RETURN.....	48, 77, 78, 93
SET UP	
~ (D Beam).....	30
~ (Step Modulator).....	133
SHIFT.....	15, 141
SINGLE (Step Modulator).....	132

Appendices

SLAVE (MMC)	156
SLAVE (MTC)	155
SONG POSITION	31, 63
SONG/SNG	14, 26, 60–73, 149
SONG/TRACK	14, 87–90
STANDARD	46
START-END	36
START/STOP	43
STATUS	12
STEP MOD (Step Modulator)	131–133
STEP REC (Step Recording)	68–70
STEREO	44, 75
STOP	
PLAY/~ (Foot Switch)	139
STRETCH	14, 52
SWITCH (Foot Switch)	18, 66, 76, 139, 140
SYSTEM	34
SYSTEM/DISK	14
Sample	
Adding Effects	40
Automatically Dividing ~s at Silent Portions	58
Basic Method for Playing ~s	35
Changing a ~'s Pitch	53
Changing the Length and Tempo (Stretch Time)	52
Changing the MIDI Channel Used for Playing ~s	151
Copy ~	56
Delete ~s	55
Displaying ~ Tempo (Specifying the Number of Beats)	50
Distributing a ~ Among Multiple Pads (Divide Sample)	57
Hold	37
Load External ~	149
Loading ~s from an External Zip Drive	149
MUTE GROUP	37
Matching the Length or Tempo with Another ~'s One	53
Moving ~s to Other Pads	54
Pad Cue Function	42
Processing (Editing)	50–59
Rearranging ~s (Rename)	139
Reversing the ~ Like a Tape Backwards (Create Reversal)	59
Setting Sample Volume (Sample Level) (QUICK EDIT LEVEL)	50
Setting the Overall Volume and Stereo Balance of the ~s	38
Storing a ~ Out of the Pads Temporarily (Clipboard)	54
The Number of ~s That Can Be Played Simultaneously (Track-Related Information)	35
Using the D Beam Controller to Play	30, 41
~ Rate	24
~ Trigger (Foot Switch)	139
Sampling	17
Assigning the Sections to Multiple Pads (Auto Divide)	45
Automatically Beginning ~ with Sound Input	44
Resampling	49
The ~ Procedure	43
~ After Making Loop and Play Settings	44
~ Song (Track) Phrases	49
~ Stereo and Monaural Settings	44
~ While Adding Effects	48
Sampling Rate	24
Save	
~ (Effect Patch)	100
~ (Song)	72
Scrub	13, 33
Scrub Length	33
Select Song	26
Select Song (Switching Songs)	26
Selecting a Segment	82, 83
To completely cancel these settings for a segment	83
Send Ch.Mute	78
Send Return	48, 78, 93
Sens (D Beam)	31
Sensitivity	31
Sensitivity (D Beam Controller)	31
Series	→Series Motion
Series Motion (Step Modulator)	132
Set MIDI Param	151, 152, 157–159
;Accent Note	159
;Metronome Ch.	159
;Mixer, D-Beam	157, 158
;Normal Note	159
;Out/Thru Select	151
;Pads RX Ch.	151
;Rx Note (Pad1)	152
;Velocity	159
Set Song Param	72, 137, 154–156
;Err Level (MTC Err Level)	155
;MMC Mode	156
;MTC Type	154
;Name	72
;Offset	156
;Sync Source/Out	154, 155
;Tr.Voice Reserve	137
Set System Param	31, 33, 67, 129, 139, 141, 142, 146, 147
;D.Copy Protect	147
;FSW Func/Type (Foot Switch)	66, 139
;Input Source	146
;Knob Control	129
;Metro.	67
;Metro.Level	67
;Mon (PrePunch)	66
;Preview Length	33
;Scrub Length	33
;Shift Lock	141
;Song Save Confirm	142
;Time Disp	32
Set Up	
~ (D Beam Controller)	30
~ (The Step Modulator settings screen)	132
Setting AUX OUT for Each Channel	95
Setting Track's Effect Send Level	93
Shift	15, 141
Shift Lock	141
Signal	
FX~	→The Location of the Internal Effects in the Mixer
FX~	49
Slave (Synchronization)	153, 156
Slope (oct)	101, 122, 125

Song
 Adjusting the Tempo of the Entire ~70
 Calling Up a Different ~ (Switching ~s).....26
 Changing the Tempo and Rhythm of Each Measure
 (Tempo Map).....71
 Changing the ~ Tempo70
 Copying Part of a ~ to a Pad55
 Delete ~73
 Loading ~s from an External Zip Drive149
 Preventing Accidental Erasure of Songs (Protect).....72
 Saving ~ Data72
 Starting and Stopping ~ Playback (Foot Switch)139
 To Change the Name of a ~72
 Song Protection73
 Song Save Confirm142
 Source
 Input ~146
 StM1, StM2 (Step Modulator)99, 100, 134
 Start36, 43, 63, 74
 Start Point51
 Start/W
 ~ (Sampling)44, 45
 ~ (Song Recording)63, 64, 74, 79
 Status12
 Step Modulator131
 An Example of the Producing Values from the ~132
 Changes in the Performance of the ~ Made
 with the "Trig" Setting.....132
 Copying and Using ~ Settings from Another Patch...133
 Determining the Tempo/Synchronizing with a Song ...133
 Playing Effects with the ~ (Synthesizer).....130
 Step Recording68-70
 Stereo/Monaural44, 75
 Stop139
 Stretch (Time ~).....14, 52
 Stretch Time.....14, 52
 Switch66, 76, 139, 140
 Switching the Basic Screens21
 Sync Out.....154, 155
 Sync Source.....154
 Synchronization153-158
 Synth123, 130, 135
 Synth Common123
 System14, 34

T

T-MAP (TEMPO MAP).....71
 T-Sign71
 T.Sync117
 TAP144
 TEMPO (Tempo).....53, 71, 108, 114, 115, 117, 127, 128
 TICK31
 TIME15, 22, 52, 89, 90
 TIME CODE32
 TIMING
 ADJUST ~87
 TRACK14, 82-90

TRACK OUTPUT150
 TRACK SELECT...→More Than One Track can be Selected
 TRIG→PAD TRIG
 TRIGGER (Trig)36, 41, 45, 123, 132, 136
 TRIM.....14, 36, 45
 TUNE
 BPM ~70
 Tap144
 Tape Echo.....107
 Target Drive.....24
 Target Pad→Delete (Sample)
 Tempo.....52, 71, 108, 114, 115, 117, 127, 128
 Tempo Map71
 The Beginning of the Phrase83
 The Different Uses of the Send/Return and
 Insert Methods97
 Tick60
 Time22, 52
 MIDI ~ Code (MTC)153-156
 ~ Code (Display)32
 ~ Stretch14, 52
 Time Disp.....32
 Timing87
 Recording While Correcting Shifts in ~ (Quantize).....65
 To Have a Stereo Track Played Back in Monaural92
 TpE (Tape Echo).....107
 Tr.Voice Reserve137
 Track14, 82-90
 Track Voice Reserve137
 Trigger
 Pre ~45
 ~ (D Beam)41
 ~ (Effect/Synthesizer)123
 ~ (Pad Play)36
 ~ (Step Modulator)132-136
 Trim
 Auto ~45
 ~ (Quick Edit)14
 Tune (Tempo).....70
 Type24, 75, 140, 154
 FSW ~140
 Format ~24
 MTC ~154

U

UNDO/REDO.....15
 Undo15
 Unlock (D.in ~).....166
 Upper (D Beam)42
 Upper/Lower (D BEAM)42
 Using the VALUE/TIME Dial31

V

VALUE (Step Modulator).....132
 VARI-PITCH15

Appendices

VCA (Virtual VCA)	126
VCF (Virtual VCF)	125
VCO (Virtual VCO + Ring Modulator)	124
VIEW (Mixer View screen)	22
Value (Step Modulator)	132
Vari-Pitch	15, 39
Velocity	123, 159
Velocity (Effect/Synth)	159
Volume	
(Overall ~ of the Pads)	38
(~ of Each Phrase)	88
(~ of Each Sample)	50
~ (AUX Out Level)	96
~ (Metronome)	67
~ (Overall/Headphones/Each Track)	25
Volume for Each Track (Track Faders)	25
VtF (Vintage Flanger)	113

W

WIDE (D BEAM/PITCH)	30
Wah	117
Wah (Stereo Auto Wah)	117
Wave	
~ End	87
~ Offset	87

Y

YES	15
YES ([ENTER/YES])	15

Z

Zip	17
~ DISK	8, 20
~ Drive	17



This product complies with the requirements of European Directives EMC 89/336/EEC and LVD 73/23/EEC.

For EU Countries

FEDERAL COMMUNICATIONS COMMISSION RADIO FREQUENCY INTERFERENCE STATEMENT

This equipment has been tested and found to comply with the limits for a Class B digital device, pursuant to Part 15 of the FCC Rules. These limits are designed to provide reasonable protection against harmful interference in a residential installation. This equipment generates, uses, and can radiate radio frequency energy and, if not installed and used in accordance with the instructions, may cause harmful interference to radio communications. However, there is no guarantee that interference will not occur in a particular installation. If this equipment does cause harmful interference to radio or television reception, which can be determined by turning the equipment off and on, the user is encouraged to try to correct the interference by one or more of the following measures:

- Reorient or relocate the receiving antenna.
- Increase the separation between the equipment and receiver.
- Connect the equipment into an outlet on a circuit different from that to which the receiver is connected.
- Consult the dealer or an experienced radio/TV technician for help.

Unauthorized changes or modification to this system can void the users authority to operate this equipment.
This equipment requires shielded interface cables in order to meet FCC class B Limit.

For the USA

NOTICE

This Class B digital apparatus meets all requirements of the Canadian Interference-Causing Equipment Regulations.

For Canada

AVIS

Cet appareil numérique de la classe B respecte toutes les exigences du Règlement sur le matériel brouilleur du Canada.

Information

When you need repair service, call your nearest Roland Service Center or authorized Roland distributor in your country as shown below.

AFRICA

EGYPT

Al Fanny Trading Office
P.O. Box 2904,
El Horrieh Heliopolis, Cairo,
EGYPT
TEL: (02) 4185531

REUNION

Maison FO - YAM Marcel
25 Rue Jules Mermet
Chaudron - BP79 97491
Ste Clothilde REUNION
TEL: 28 29 16

SOUTH AFRICA

That Other Music Shop
(PTY) Ltd.
11 Melle Street (Cnr Melle and
Juta Street)
Braamfontein 2001
Republic of SOUTH AFRICA
TEL: (011) 403 4105

Paul Bothner (PTY) Ltd.
17 Werdmuller Centre Claremont
7700
Republic of SOUTH AFRICA

P.O. Box 23032
Claremont, Cape Town
SOUTH AFRICA, 7735
TEL: (021) 64 4030

ASIA

CHINA

Beijing Xinghai Musical
Instruments Co., Ltd.
6 Huangmunchang Chao Yang
District, Beijing, CHINA
TEL: (010) 6774 7491

HONG KONG

Tom Lee Music Co., Ltd.
Service Division
22-32 Pun Shan Street, Tsuen
Wan, New Territories,
HONG KONG
TEL: 2415 0911

INDIA

Rivera Digitec (India) Pvt. Ltd.
409, Nirman Kendra Mahalaxmi
Flats Compound Off. Dr. Edwin
Moses Road, Mumbai-400011,
INDIA
TEL: (022) 498 3079

INDONESIA

PT Citra Inti Rama
Jl. Cideng Timur No. 15J-15O
Jakarta Pusat
INDONESIA
TEL: (021) 6324170

KOREA

Cosmos Corporation
Service Station
261 2nd Floor Nak-Won Arcade
Jong-Ro ku, Seoul, KOREA
TEL: (02) 742 8844

MALAYSIA

Bentley Music SDN BHD
140 & 142, Jalan Bukit Bintang
55100 Kuala Lumpur, MALAYSIA
TEL: (03) 2443333

PHILIPPINES

G.A. Yupangco & Co. Inc.
339 Gil J. Puyat Avenue
Makati, Metro Manila 1200,
PHILIPPINES
TEL: (02) 899 9801

SINGAPORE

Swee Lee Company
150 Sims Drive,
SINGAPORE 367381
TEL: 748-1669

CRISTOFORI MUSIC PTE LTD

Bk 3014, Bedok Industrial Park E,
#02-2148, SINGAPORE 489980
TEL: 243 9555

TAIWAN

ROLAND TAIWAN
ENTERPRISE CO., LTD.
Room 5, 9fl. No. 112 Chung Shan
N.Road Sec.2, Taipei, TAIWAN,
R.O.C.
TEL: (02) 2561 3339

THAILAND

Theera Music Co., Ltd.
330 Veng NakornKasem, Soi 2,
Bangkok 10100, THAILAND
TEL: (02) 2248821

VIETNAM

Saigon Music
138 Tran Quang Khai St.,
District 1
Ho Chi Minh City
VIETNAM
TEL: (08) 844-4068

AUSTRALIA/ NEW ZEALAND

AUSTRALIA

Roland Corporation
Australia Pty., Ltd.
38 Campbell Avenue
Dee Why West, NSW 2099
AUSTRALIA
TEL: (02) 9982 8266

NEW ZEALAND

Roland Corporation (NZ) Ltd.
97 Mt. Eden Road, Mt. Eden,
Auckland 3, NEW ZEALAND
TEL: (09) 3098 715

CENTRAL/LATIN AMERICA

ARGENTINA

Instrumentos Musicales S.A.
Florida 656 2nd Floor
Office Number 206A
Buenos Aires
ARGENTINA, CP1005
TEL: (54-11) 4- 393-6057

BRAZIL

Roland Brasil Ltda.
R. Coronel Octaviano da Silveira
203 05522-010
Sao Paulo BRAZIL
TEL: (011) 3743 9377

CHILE

Comercial Fancy S.A.
Avenida Rancagua #0330
Providencia Santiago, CHILE
TEL: 56-2-373-9100

EL SALVADOR

OMNI MUSIC
75 Avenida Notre y Alameda
Juan Pablo 2 No. 4010
San Salvador, EL SALVADOR
TEL: (503) 262-0788

MEXICO

Casa Veerkamp, s.a. de c.v.
Av. Toluca No. 323 Col. Olivar de
los Padres 01780 Mexico D.F.
MEXICO
TEL: (525) 668 04 80

La Casa Wagner de
Guadalajara s.a. de c.v.
Av. Corona No. 202 S.J.
Guadalajara, Jalisco Mexico
C.P.44100 MEXICO
TEL: (3) 613 1414

PANAMA

Productos Superiores, S.A.
Apartado 655 - Panama 1
REP. DE PANAMA
TEL: (507) 270-2200

URUGUAY

Todo Musica
Cuareim 1488, Montevideo,
URUGUAY
TEL: 5982-924-2335

VENEZUELA

Musidigital Digital C.A.
Av. Francisco de Miranda,
Centro Parque de Cristal, Nivel
C2 Local 20 Caracas
VENEZUELA
TEL: (02) 285 9218

EUROPE

AUSTRIA

Roland Austria GES.M.B.H.
Siemensstrasse 4, P.O. Box 74,
A-6063 RUM, AUSTRIA
TEL: (0512) 26 44 260

BELGIUM/HOLLAND/ LUXEMBOURG

Roland Benelux N. V.
Houtstraat 3 B-2260 Oevel
(Westerlo) BELGIUM
TEL: (014) 575811

DENMARK

Roland Scandinavia A/S
Nordhavnsvej 7, Postbox 880
DK-2100 Copenhagen
DENMARK
TEL: (039)16 6200

FRANCE

Roland France SA
4, Rue Paul Henri SPAAK
Parc de l'Esplanade F 77 462 St.
Thibault Lagny Cedex FRANCE
TEL: 01 600 73 500

FINLAND

Roland Scandinavia As,
Filial Finland
Lauttasarentie 54 B
Fin-00201 Helsinki, FINLAND
TEL: (9) 682 4020

GERMANY

Roland Elektronische
Musikinstrumente
Handelsgesellschaft mbH.
Oststrasse 96, 22844 Norderstedt,
GERMANY
TEL: (040) 52 60090

GREECE

STOLLAS S.A.
Music Sound Light
155, New National Road
26422 Patras, GREECE
TEL: 061-435400

HUNGARY

Intermusica Ltd.
Warehouse Area 'DEPO' Pf.83
H-2046 Torokbalint, HUNGARY
TEL: (23) 511011

IRELAND

Roland Ireland
Audio House, Belmont Court,
Donnybrook, Dublin 4,
Republic of IRELAND
TEL: (01) 2603501

ITALY

Roland Italy S. p. A.
Viale delle Industrie, 8
20020 Arese Milano, ITALY
TEL: (02) 937-76300

NORWAY

Roland Scandinavia Avd.
Kontor Norge
Lilleakerveien 2 Postboks 95
Lilleaker N-0216 Oslo
NORWAY
TEL: 273 0074

POLAND

P. P. H. Brzostowicz
Ul. Gibraltarska 4.
PL-03664 Warszawa POLAND
TEL: (022) 679 44 19

PORTUGAL

Tecnologias Musica e Audio,
Roland Portugal, S.A.
RUA SANTA CATARINA
131 - 4000 Porto-PORTUGAL
TEL: (02) 208 44 56

ROMANIA

FBS LINES
Plata Libertatii 1.
RO-4200 Cheorgheni
TEL: (066) 164-609

RUSSIA

Slami Music Company
Sadajava-Triumfalnaja st., 16
103006 Moscow, RUSSIA
TEL: 095 209 2193

SPAIN

Roland Electronics
de España, S. A.
Calle Bolivia 239 08020 Barcelona,
SPAIN
TEL: (93) 308 1000

SWEDEN

Roland Scandinavia A/S
SWEDISH SALES OFFICE
Danvik Center 28, 2 tr.
S-131 30 Nacka SWEDEN
TEL: (08) 702 0020

SWITZERLAND

Roland (Switzerland) AG
Musitronic AG
Gerberstrasse 5, CH-4410 Liestal,
SWITZERLAND
TEL: (061) 921 1615

UKRAINE

TIC-TAC
Mira Str. 19/108
P.O. Box 180
295400 Munkachevo, UKRAINE
TEL: (03131) 414-40

UNITED KINGDOM

Roland (U.K.) Ltd.
Atlantic Close, Swansea
Enterprise Park SWANSEA
SA7 9FJ,
UNITED KINGDOM
TEL: (01792) 700139

MIDDLE EAST

BAHRAIN

Moon Stores
Bab Al Bahrain Road,
P.O. Box 20077
State of BAHRAIN
TEL: 211 005

CYPRUS

Radex Sound Equipment Ltd.
17 Diagorou St., P.O. Box 2046,
Nicosia CYPRUS
TEL: (02) 453 426

ISRAEL

Halilit F. Greenspoon &
Sons Ltd.
8 Retzif Fa'aliya Hashnaya St.
Tel-Aviv-Yahoe ISRAEL
TEL: (03) 6823666

JORDAN

AMMAN Trading Agency
Prince Mohammed St. P.O. Box
825 Amman 11118 JORDAN
TEL: (06) 4641200

KUWAIT

Easa Husain Al-Yousifi
P.O. Box 126 Safat 13002
KUWAIT
TEL: 5719499

LEBANON

A. Chahine & Fils
P.O. Box 16-5857 Gergi Zeidan St.
Chahine Building, Achrafieh
Beirut, LEBANON
TEL: (01) 335799

OMAN

OHI Electronics & Trading
Co. LLC
P.O. Box 889 Muscat
Sultanate of OMAN
TEL: 959085

QATAR

Badie Studio & Stores
P.O. Box 62,
DOHA QATAR
TEL: 423554

SAUDI ARABIA

aDawiah Universal
Electronics APL
P.O. Box 2154 ALKHOBAR 31952,
SAUDI ARABIA
TEL: (03) 898 2081

SYRIA

Technical Light & Sound
Center
Khaled Ibn Al Walid St.
P.O. Box 13520
Damascus - SYRIA
TEL: (011) 2235 384

TURKEY

Barkat Muzik aletleri ithalati
ve ihracat limited ireketi
Siraselviler Cad. Billurcu Sok.
Mucadelle Cikmeze No. 11-13
Taksim, Istanbul, TURKEY
TEL: (0212) 2499324

U.A.E.

Zak Electronics & Musical
Instruments Co.
Zabeel Road, Al Sheroq Bldg.,
No. 14, Grand Floor DUBAI
U.A.E.
P.O. Box 8050 DUBAI, U.A.E.
TEL: (04) 360715

NORTH AMERICA

CANADA

Roland Canada Music Ltd.
(Head Office)
5480 Parkwood Way Richmond
B. C., V6V 2M4 CANADA
TEL: (0604) 270 6626

Roland Canada Music Ltd.
(Toronto Office)
Unit 2, 109 Woodbine Downs
Blvd, Etobicoke, ON
M9W 6Y1 CANADA
TEL: (0416) 213 9707

U. S. A.

Roland Corporation U.S.
5100 S. Eastern Avenue
Los Angeles, CA 90040-2938,
U. S. A.
TEL: (323) 890 3700

As of June 11, 1999

Let's Try **SP-808** GROOVESAMPLER

Roland

① Listening to the Demo Songs

Choosing a Demo Song

1. Press [SONG/TRACK]. --
 Highlight "Select Song?" --
 Press [ENTER/YES]. --
2. Highlight the desired song with the VALUE/TIME dial. --
 Press [ENTER/YES]. --
 Try "01 CHIMERA."
3. Press [ENTER/YES] according to the message displayed. --

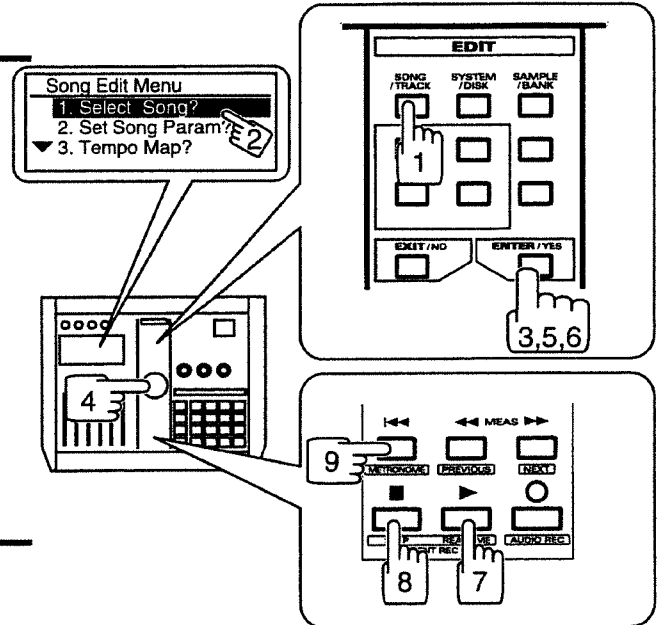

Playing the Song

4. Press [▶] --
 to play the song.
 Press [■] --
 to stop.
 Press [◀◀] --
 to go back to the beginning of the song.

② Playing Phrases

Play phrases by pressing the pads.

1. Press the pads that are lit in red. --
 * No phrases are recorded on the pads that are not lit.
2. To have samples continue to play, hold down the pad and, --
 press [HOLD]. --
 Press [HOLD] again to stop the sound.

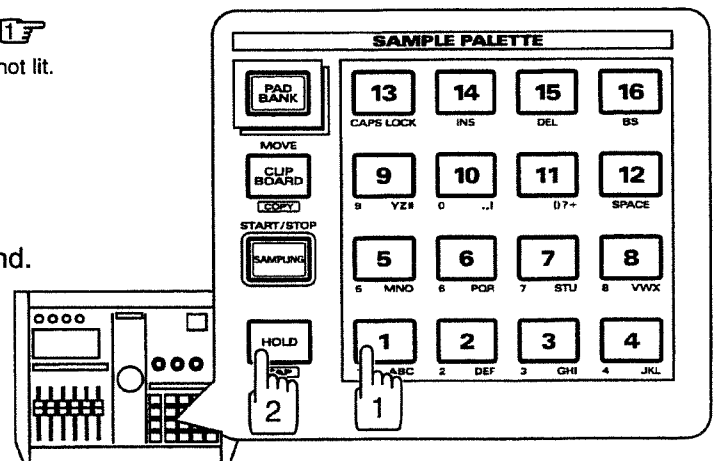

③ Switching the Pad Bank

Try more samples by switching the pad bank.

Pad Bank

A pad bank consists of 16 pads, and the SP-808 has 64 pad banks. So, the SP-808 can contain up to 1024 phrases per disk.

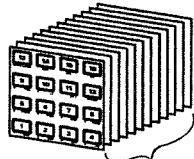

16 pads x 64 pad banks = 1024 pads

1. Press [PAD BANK]. -- **1**
Press any of pads 1–14 -- **2**
which contain demo phrases.
You can directly select the first 16 of the 64 pad banks.
2. Press the pads -- **3**
and play phrases.

* When you choose a demo song, a pad bank containing phrases that fit the song is selected automatically.

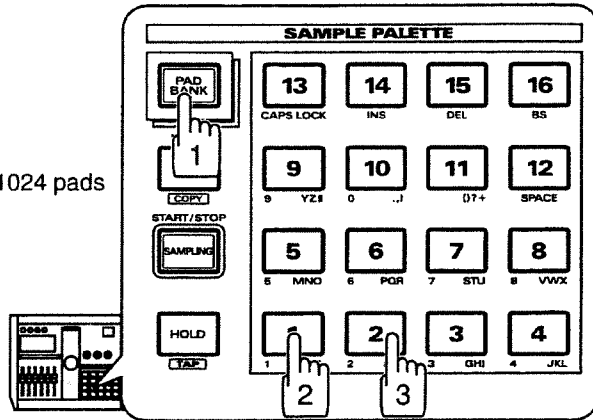

④ Applying Effects

Apply effects and control them from the panel.

1. To have samples continue to play, hold down the pad, -- **1**
and press [HOLD]. -- **2**
2. Hold down [FX INFO], -- **3**
and press any of pads 1–16. -- **4**
You can directly select the first 16 of the 99 effect patches.
3. Effect parameters which can be controlled by three knobs are displayed. -- **5**
4. Turn the effect on.
Press REALTIME EFFECTS [ON/OFF] -- **6**
and turn on the light.

Press [EFFECTS] on PAD and TRACK A/B/C/D and turn on the light.

-- **7**

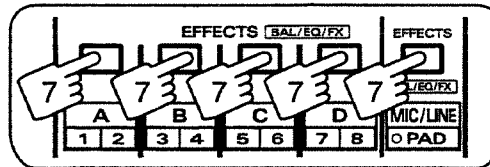

5. Turn the knobs -- **8**
and control the effects in real time.
6. Try the Step Modulator.
Press [STEP MOD] -- **9**
and turn on the light.
Effects parameter values are changed by the step modulator.
Press [STEP MOD] again to stop.
7. To recall the original effects settings, hold down [SHIFT] -- **10**
and press REALTIME EFFECTS [ON/OFF]. -- **11**

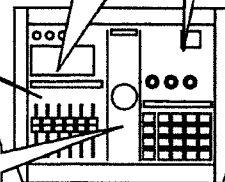
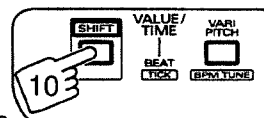
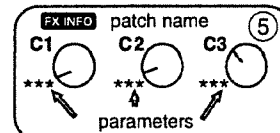
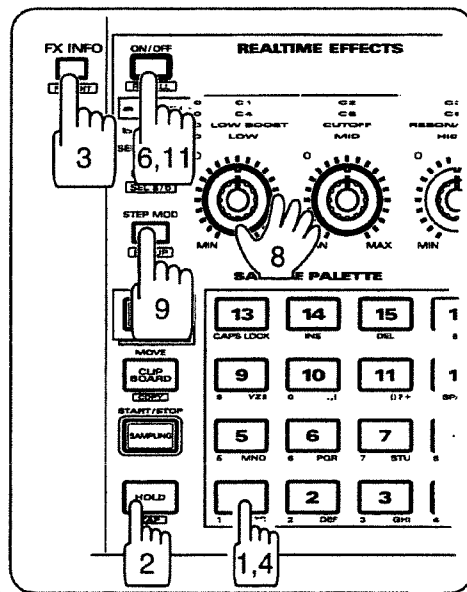

⑤ Playing Phrases and Controlling the Pitch with the D Beam

Playing Phrases with the D Beam

1. Press [PAD TRIG] -- and turn on the light.
2. Move your hands over the controller, -- and play the phrases.

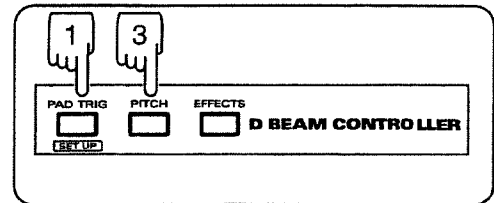

Controlling the Playback Pitch with the D Beam

1. To play the phrase, hold the pad, and press [HOLD].
2. Press [PITCH] -- and turn the light.
3. Move your hands up and down over the controller. -- You can lower the overall playback pitch by the height of your hand.

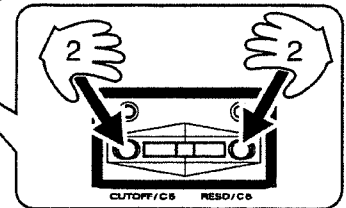
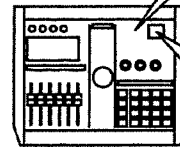

⑥ Controlling Effects with the D Beam

1. To play the phrase, hold down the pad, and press [HOLD].
2. To turn the effects on, press [ON/OFF] -- and turn on the light.
3. Press [EFFECTS] -- and turn on the light.
Press [EFFECTS] on the PAD -- and turn on the light.
4. Move your hands over the controller. -- You can control two effects parameters with the left and right beams.

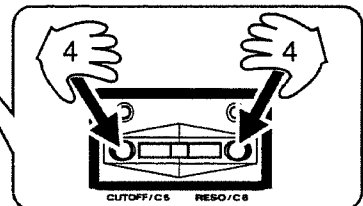
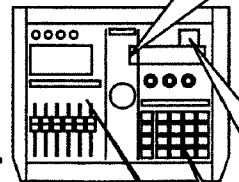
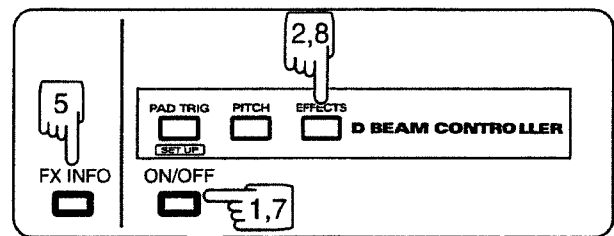

Application Controlling the Synthesizer Sound with the D Beam

1. While holding [FX INFO], -- press pad 14 -- to select the effect patch "SY:Beam #1."
2. To turn the effect on, press [ON/OFF] -- and turn on the light.
3. Press [EFFECTS] -- and turn on the light.
4. Move your hands over the controller -- to change the pitch of synthesizer sound.

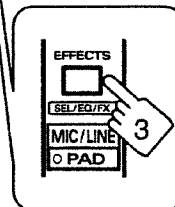
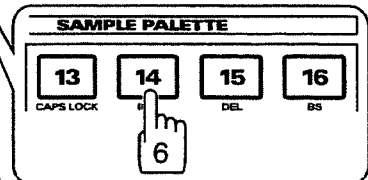

7 Sampling

- To select a blank pad bank, press [PAD BANK], -- and press pad 15 or 16. --
- To go into sampling mode, press [SAMPLING]. --
The pad at which the sample will be stored lights in red.
- Press [SAMPLING] again -- to start sampling.
- Press [SAMPLING] once more -- to stop sampling.
- Press the pad -- to check the result.
- If the result is OK, press [ENTER/YES] -- and next sampling is ready.
If not OK, press [EXIT/NO] -- to cancel, and try again from 3.
- Press [EXIT/NO] -- to get out of sampling mode.

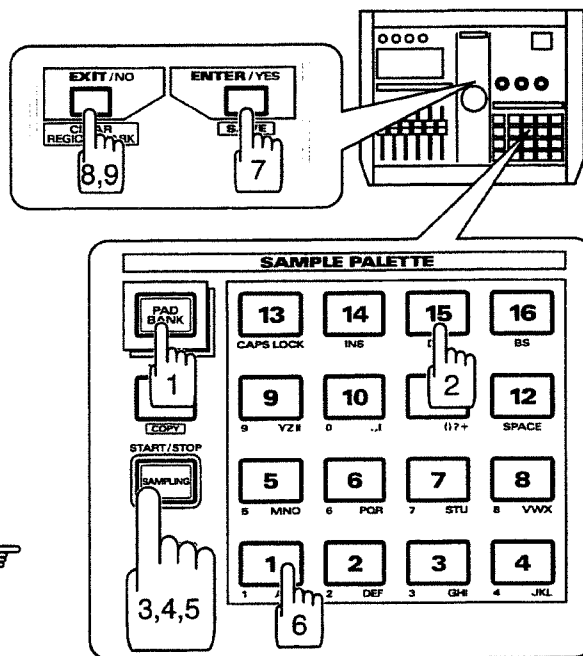

Application Auto Divide Function

Auto Divide Function

If the sound source to be sampled includes silent partitions of a certain length, the SP-808 can divide the sample at the silent parts and assign each of them to different pads. This makes it convenient to sample audio sources, including lots of sample phrases such as those on a sample library CD, and play each phrase with a different pad.

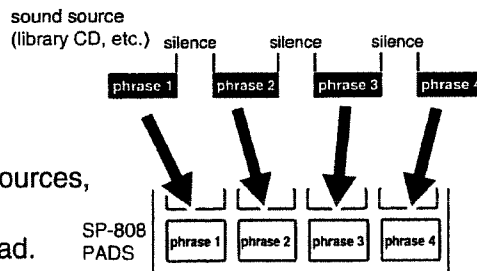

- To go into sampling mode, press [SAMPLING]. --
- Press [▼] -- several times to highlight "Auto Divide."
- Set the length of the silent part (OFF, 0.5/1.0/1.5/2.0 seconds) to be detected with VALUE/TIME dial. --
- Proceed with sampling according to the above "Sampling."
- Press [UNDO] to retry sampling. --

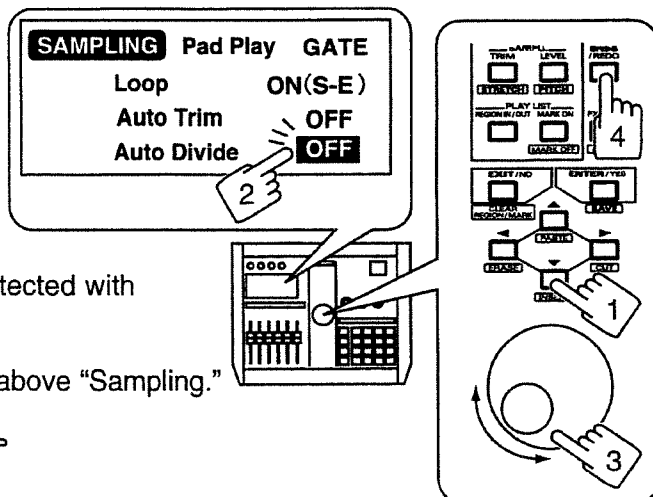

SP-808 Effects Patch List/エフェクト・パッチ・リスト

[DL] ECHO/DELAY (エコー/ディレイ)

Number 番号	Patch name パッチ名	algorithm アルゴリズム	Description 説明
P01 (U17)	DL:Digi?	<EzD>	Distinctive digital delay. ステレオ・デジタル・ディレイ。
P02 (U18)	DL:Tape!	<201>	Distinctive tape echo. テープ・エコー (つまみへの反応をP01と比較可能)。
P03 (U01)	DL:3hSPACE	<201>	Echo pattern with three tape heads. 3ヘッドを全て使った深いテープ・エコー。
P04 (U19)	DL:Analog+	<201>	Compact Analog delay. コンパクト・アナログ・ディレイ。
P05 (U20)	DL:Hi-Pass	<Syn>	Adds delay only to high range. Frequency variable with knob. 高域だけにかかるディレイ、つまみで周波数を変更可能。
P06 (U02)	DL:RSS Alt	<RSS>	RSS delay with alternate panning. RSS音が左右交互に鳴るディレイ。
P07 (U21)	DL:Snd OnS	<Syn>	Long delay (max. 2.4 sec.). For sound-on-sound orchestration. 最長2.4秒のソング同期ロング・ディレイ、サウンド・オン・サウンド効果用。
P08 (U22)	DL:Dub-Box	<Syn>	Various delay pattern with song BPM sync. For dub. ソングに同期して音符等が変化するダブ・ミックス用ディレイ。

[IS/CC] ISOLATOR/CENTER CANCELER (アイソレーター/センター・キャンセラー)

Number 番号	Patch name パッチ名	algorithm アルゴリズム	Description 説明
P09 (U23)	IS:HiCandl	<Iso>	Isolator cancelling high range. アイソレーター、高域をキャンセル。
P10 (U24)	IS:Low-Phs	<Iso>	Stereo anti-phasing at low range. 低域へのステレオ・アンチ・フェーズ効果。
P11 (U25)	CC:VoCandl	<C.C>	Cancels the center of stereo source. ボーカル・キャンセラー (ステレオ入力の中央に定位する音を消す)。

[CH] CHORUS (コーラス)

Number 番号	Patch name パッチ名	algorithm アルゴリズム	Description 説明
P12 (U26)	CH:HiFiCho	<Cho>	Clear wide-range digital chorus. クリアで広帯域なデジタル・コーラス。
P13 (U27)	CH:CE1+Dly	<CE1>	BOSS CE-1 + analog delay. BOSS CE-1 + アナログ・ディレイの柔らかい音。
P14 (U28)	CH:CE1/Vib	<CE1>	Vibrato on CE-1. BOSS CE-1のビブラート・モード。
P15 (U05)	CH:CE3/+E	<CE1>	Reverse-phased stereo chorus on BOSS CE-3. CE-3の空間位相反転コーラス。
P16 (U29)	CH:SBF-325	<SBF>	Chorus mode on Roland SBF-325 flanger. SBF-325フランジャーのコーラス・モード。
P17 (U30)	CH:SDD/3+4	<SDD>	Roland SDD-320 (buttons 3+4). ローランドSDD-320、ボタン3と4の同時押し。
P18 (U31)	CH:RSSrund	<RSS>	Surround effect by RSS for monaural sources. RSSによるサラウンド効果、モノラルの入力音が広がって定位。

[PT] PITCH SHIFTER (ピッチ・シフター)

Number 番号	Patch name パッチ名	algorithm アルゴリズム	Description 説明
P19 (U32)	PT:ST Dtun	<Psf>	Stereo detune for thickening the source. ステレオ・デチューン、豊満感を演出。
P20 (U06)	PT:OctDown	<Psf>	Pitch shifter with an octave down. 1オクターブ下げるピッチ・シフター。
P21 (U33)	PT:TriadCd	<Psf>	Makes a chord from a single note. Major/minor selectable with knob. 単音がコードになり、つまみでメジャー/マイナーを切り替え可能。

[FL] FLANGER (フランジャー)

Number 番号	Patch name パッチ名	algorithm アルゴリズム	Description 説明
P22 (U04)	FL:HardJet	<BF2>	Metallic jet flanger. 派手な典型的ジェット・フランジャー。
P23 (U34)	FL:Hi-Band	<BF2>	BOSS HF-2 compact pedal x 2 for stereo. BOSSのHF-2の2台ステレオ接続。
P24 (U35)	FL:SBF-#3	<SBF>	Mode 3 (Cross-mix) on Roland SBF-325. SBF-325のモード3 (クロス・ミックス・フランジャー)。
P25 (U36)	FL:Step/Bm	<SBF>	Step flanger with D Beam effects. ステップ・フランジャー (Dビーム効果付き)。
P26 (U37)	FL:Measure	<BF2>	Flanger with the song BPM sync. Sound changes by measure. ソング同期、小節ごとに効果が変わるフランジャー。

[WA] WAH (ワウ)

Number 番号	Patch name パッチ名	algorithm アルゴリズム	Description 説明
P27 (U07)	WA:TrigWah	<Wah>	Touch sensitive wah triggered with the input level over threshold. 一定入力音量を超える度に自動的にかかるワウ。
P28 (U38)	WA:Cyclic	<Wah>	LFO-controlled wah. LFOで周期的に変化するワウ。
P29 (U39)	WA:Envelop	<Syn>	Opens/closes to input level change as well as D Beam. 入力音量に追従して細かく開閉するワウ、Dビームも可。

[PH] PHASER (フェーザー)

Number 番号	Patch name パッチ名	algorithm アルゴリズム	Description 説明
P30 (U40)	PH:4stage	<Phs>	Vintage four-stage phaser. 初期の4段フェーザー。
P31 (U03)	PH:See-Saw	<Phs>	See-saw phasing between L/R (eight-stage type). 左右で上昇・下降が逆のシーソー・フェーザー (8段)。
P32 (U41)	PH:2LFO'80	<Phs>	Modulation with dual LFO's (song BPM sync with Step Mod.). 2重LFOの複雑なモジュレーション (ステップ・モジュレーターでソング同期)。
P33 (U42)	PH:Step/Bm	<Phs>	Phasing with step modulator and D Beam. ステップ及びDビームによるフェージング。

[LF] LO-FI (ロー・ファイ系)

Number 番号	Patch name パッチ名	algorithm アルゴリズム	Description 説明
P34 (U13)	LF:RingMd1	<Syn>	Distinctive ring modulator. リング・モジュレーター。
P35 (U43)	LF:RingMd2	<Syn>	Ring modulator's variation. リング・モジュレーターのバリエーション。
P36 (U44)	LF:Clippin'	<Dst>	Clipping distortion of analog circuit. アナログ回路風の歪みを付加。
P37 (U10)	LF:DrumDist	<Dst>	Stereo distortion for lo-fi breakbeats. ドラムのLo-Fi化を狙ったステレオ・ディストーション。
P38 (U45)	LF:BullHrn	<Syn>	Sound of small-sized bullhorn. 小型拡声器風の音。
P39 (U11)	LF:RateBit	<LoF>	Lo-Fi processor, low down the sample rate and bits. ビット落ちとレノサンプル・レート落ちによるLo-Fiサウンド。
P40 (U46)	LF:BadTune	<Rad>	AM radio noise. Tuning with knob. AMラジオ。ノブでチューニング。
P41 (U47)	LF:Vinyl33	<Dsk>	33 r.p.m. vinyl record. 仮想33回転ビニール・レコード。
P42 (U12)	LF:SP disk	<Dsk>	SP record played bamboo stylus. 仮想 SPレコード・竹針プレーヤー。

[RV] REVERB (リバーブ)

Number 番号	Patch name パッチ名	algorithm アルゴリズム	Description 説明
P43 (U48)	RV:MidRoom	<Rev>	Room reverberation. 中くらいの部屋の残響。
P44 (U49)	RV:LrgHall	<Rev>	Large concert hall reverberation. 大ホールの残響。
P45 (U50)	RV:Cathdrl	<Rev>	Acoustics of a very large, high-ceiling church. 大聖堂の残響。
P46 (U51)	RV:SoftAmb	<Rev>	Simulated reverberation of rooms with minimal wall reflections. 反射音が少ない空間の響き。
P47 (U52)	RV:RoomAmb	<Rev>	Reverberation of rooms with good acoustics. 生々しい部屋鳴り。
P48 (U08)	RV:LrgClub	<Rev>	Simulated reverberation of large dance floor. 大規模クラブでの残響。
P49 (U53)	RV:ClubFlr	<Rev>	Simulated reverberation of small dance floor. 小さいクラブでの残響。
P50 (U54)	RV:LngCave	<Rev>	Simulated reverberation of deep caves. 深い洞窟の残響。
P51 (U55)	RV:Garage	<Rev>	Reverb that enhances unique drum sounds in a garage. ドラム向けのガレージ風リバーブ。
P52 (U56)	RV:Plate	<Rev>	Distinctive bright plate reverb. 明るいプレート・リバーブ。
P53 (U57)	RV:Gated	<Rev>	Distinctive gate reverb. 典型的なゲート・リバーブ、つまみで感度 (GT Thr) を調整。
P54 (U58)	RV:Revers	<Rev>	Reversed reverb. リバース・ゲート・リバーブ。
P55 (U59)	RV:Duckin'	<Rev>	Ducking reverb (adds reverb to lower level signal only). 入力レベルが高いとリバーブが消えるダッキング・リバーブ。

[DN] STEREO DYNAMICS PROCESSOR (ステレオ・ダイナミクス・プロセッサー)

Number 番号	Patch name パッチ名	algorithm アルゴリズム	Description 説明
P56 (U60)	DN:DanceEQ	<Dyn>	Boosts low and high ranges for more groove. ダンス向けイコライジング。
P57 (U61)	DN:Loudnes	<Dyn>	Slightly boosted lows and highs. ラウドネス効果。
P58 (U09)	DN:Hard+GT	<Dyn>	Hard compression and gate for more groove. ダンス向けハード・コンプ+ゲート効果。
P59 (U62)	DN:TotalCp	<Dyn>	Total compression for broadcasting mixing. 放送用ミックスなどに向くトータル・コンプレッション。
P60 (U63)	DN:Limiter	<Dyn>	Stereo limiter to limit peak signals. ステレオ・リミッター。
P61 (U64)	DN:Enhance	<Dyn>	Stereo enhancer. ステレオ・エンハンサー。

[SY] VIRTUAL ANALOG SYNTHESIZER (仮想アナログ・シンセ)

Number 番号	Patch name パッチ名	algorithm アルゴリズム	Description 説明
P62 (U14)	SY:Beam #1	<Syn>	Aggressive synth sound controlled with D Beam. Dビームで鳴らす攻撃的なシンセ音。
P63 (U65)	SY:Beam #2	<Syn>	Vintage synth sound controlled with D Beam. Dビームで鳴らす古典的なシンセ音。
P64 (U15)	SY:StepBs1	<Syn>	Synth bass pattern 1 (with step modulator pattern). シンセ・ベース1 (ステップ・モジュレーター)。

Number 番号	Patch name パッチ名	algorithm アルゴリズム	Description 説明
P65 (U66)	SY:StepBs2	<Syn>	Synth bass pattern 2 (with step modulator pattern). シンセ・ベース2 (ステップ・モジュレーター)。
P66 (U67)	SY:StepTk1	<Syn>	Techno sequence 1 (with step modulator pattern). テクノ・シーケンス1 (ステップ・モジュレーター)。
P67 (U68)	SY:StepTk2	<Syn>	Techno sequence 2 (with step modulator pattern). テクノ・シーケンス2 (ステップ・モジュレーター)。
P68 (U16)	SY:StepTk3	<Syn>	Techno sequence 3 (with step modulator pattern). テクノ・シーケンス3 (ステップ・モジュレーター)。
P69 (U69)	SY:StepTk4	<Syn>	Techno sequence 4 (with step modulator pattern). テクノ・シーケンス4 (ステップ・モジュレーター)。
P70 (U70)	SY:StepTk5	<Syn>	Techno sequence 5 (with step modulator pattern). テクノ・シーケンス5 (ステップ・モジュレーター)。
P71 (U71)	SY:StepTk6	<Syn>	Techno sequence 6 (with step modulator pattern). テクノ・シーケンス6 (ステップ・モジュレーター)。
P72 (U72)	SY:70Step1	<Syn>	70's synth sequence 1 (with step modulator pattern). 70年代風シンセ・パターン (ステップ・モジュレーター) 1。
P73 (U73)	SY:70Step2	<Syn>	70's synth sequence 2 (with step modulator pattern). 70年代風シンセ・パターン (ステップ・モジュレーター) 2。
P74 (U74)	SY:80Step1	<Syn>	80's synth sequence 1 (with step modulator pattern). 80年代風シンセ・パターン (ステップ・モジュレーター) 1。
P75 (U75)	SY:80Step2	<Syn>	80's synth sequence 2 (with step modulator pattern). 80年代風シンセ・パターン (ステップ・モジュレーター) 2。
P76 (U76)	SY:StpWind	<Syn>	Storm simulated with noise generator and filter. 嵐 (ノイズ+フィルターを使った効果音)。

[SL] SLICER (スライサー)

Number 番号	Patch name パッチ名	algorithm アルゴリズム	Description 説明
P77 (U77)	SL:Slicer1	<EzD>	Slicer (press [STEP MOD]). スライサー1。[STEP MOD]を押すと音がリズムミカルに刻まれる。
P78 (U78)	SL:Slicer2	<EzD>	Slicer (press [STEP MOD]). スライサー2。P77のバリエーション。
P79 (U79)	SL:+Delay	<EzD>	Slicer + Delay (press [STEP MOD]). ディレイ効果つきのスライサー。

[WA] Template (アルゴリズム選択用 ひな形) * See Owner's Manual p. 98. * 取扱説明書P.98参照。

Number 番号	Patch name パッチ名	algorithm アルゴリズム	Description 説明
P80 (U80)	01>Iso&Fil	<Iso>	3-band isolator + filter. 3バンド・アインソレーター+フィルター。
P81 (U81)	02>Cl.Canc	<C.C>	Center canceler. センター・キャンセラー。
P82 (U82)	03>CompEtc	<Dyn>	Comp/limiter, enhancer, other Effects. コンプ/リミッター+エンハンサー他。
P83 (U83)	04>Rev&Gat	<Rev>	Pre EQ + reverb + gate. プリEQ+リバーブ+ゲート。
P84 (U84)	05>TapeEch	<201>	Virtual tape echo (Roland RE-201). 仮想テープ・エコー (ローランドRE-201のテープ・エコー部)。
P85 (U85)	06>ezDelay	<EzD>	Digital delay. デジタル・ディレイ。
P86 (U86)	07>DlayRSS	<RSS>	3-D stereo delay. 3次元定位ステレオ・ディレイ。
P87 (U87)	08>AnlgD&C	<CE1>	"Virtual analog" delay + chorus. 仮想アナログ・ディレイ+アナログ・コーラス。
P88 (U88)	09>DigiCho	<Cho>	Digital chorus. デジタル・コーラス。
P89 (U89)	10>4butn C	<SDD>	Roland SDD-320 (spacious effect). ローランドSDD-320 (空間エフェクト)。
P90 (U90)	11>Fng325	<SBF>	Roland SBF-325 (analog flanger). ローランドSBF-325 (アナログ・フランジャー)。
P91 (U91)	12>FngBx2	<BF2>	Virtual "BOSS compact flanger" x 2 for stereo. 仮想「BOSSフランジャー」2個の並列接続。
P92 (U92)	13>Pit-Sft	<Psf>	Stereo pitch shifter. ステレオ・ピッチシフター。
P93 (U93)	14>80sPhas	<Phs>	80's rackmount phaser x 2 for stereo. 80年代型ラック式フェーザー2台。
P94 (U94)	15>2xA.Wah	<Wah>	Stereo auto wah. ステレオ・オート・ワウ。
P95 (U95)	16>2xDist	<Dst>	Stereo distortion. ステレオ・ディストーション。
P96 (U96)	17>Records	<Dsk>	Analog record simulator. アナログ・レコード・シミュレーター。
P97 (U97)	18>Radio	<Rad>	AM radio simulator. AMラジオ・シミュレーター。
P98 (U98)	19>Lo-Fi	<LoF>	Lo-fi processor for lower sampling bit/rate. ビット落ちとレノサンプル・レート落とし。
P99 (U99)	20>AnlgSyn	<Syn>	Virtual analog synthesizer (and Ring Modulator) + delay, etc. 仮想アナログ・シンセ+ディレイ、他。

* The P80-P99 in this list lets you know the meaning of the each algorithm indicated by the abbreviated three letters.

* 3文字の省略表記のそれぞれが示すアルゴリズムは、このリストのP80~P99で確認できます。

* Please note; the user area (U01-U99) at the factory settings is the same as the preset Patch, but the different order.

* 出荷時のユーザー・エリア (U01~U99) は、内容はプリセット・パッチと同じですが、順番が異なりますのでご注意ください。

* The effects patches P(U)77-79 called "Slicer" change the volume full to zero rhythmically with the step modulator. When the step modulator is stopped, these patches make one of two performances the sounds are continued or stopped. So for live performance or such situations, it is more convenient that you prepare the "sliced" samples on the other pads by resampling with slicer.

* エフェクト・パッチ、P (U) 77~79のスライサーは、音量をステップ・モジュレーターでリズムミカルに開閉する効果です。機能上、ステップ・モジュレーターを止めたタイミングによって、音が鳴り続ける場合と、止まる場合があります。このためライブ・パフォーマンスなどでは、スライサーのかかった音をあらかじめリサンプリングして、元のサンプルとは別のパッドに用意しておくとう便利です。

Top 16 Patches of User Area (Hold down [FX INFO] and press PAD [1]-[16].)

ユーザー・エリアの先頭16パッチ ([FX INFO] を押したまま PAD [1] ~ [16] を押す。)

Number 番号	Patch name パッチ名	algorithm アルゴリズム	Description 説明
U01 (P03)	DL:3hSPACE	<201>	Echo pattern with three tape heads. 3ヘッド全て使った深いテープ・エコー。
U02 (P06)	DL:RSS Alt	<RSS>	RSS delay with alternate panning. RSS音が左右交互に鳴るデレイ。
U03 (P31)	PH:See-Saw	<Phs>	See-saw phasing between L/R (eight-stage type). 左右で上昇・下降が逆のシーソー・フェーザー (8段)。
U04 (P22)	FL:HardJet	<BF2>	Metallic jet flanger. 派手な典型的ジェット・フランジャー。
U05 (P15)	CH:CE3/+E	<CE1>	Reverse-phased stereo chorus on BOSS CE-3. BOSS CE-3の空間位相反転コーラス。
U06 (P20)	PT:OctDown	<Psf>	Pitch shifter with an octave down. 1オクターブ下げるピッチ・シフター。
U07 (P27)	WA:TrigWah	<Wah>	Touch sensitive wah triggered with the input level over threshold. 一定入力音量を超える度に自動的にかかるワウ。
U08 (P48)	RV:LrgClub	<Rev>	Simulated reverberation of large dance floor. 大規模クラブでの残響。
U09 (P58)	DN:Hard+GT	<Dyn>	Hard compression and gate for more groove. ダンス向けハード・コンプ+ゲート効果。
U10 (P37)	LF:DrmDist	<Dsb>	Stereo distortion for Lo-Fi breakbeats. ドラムのLo-Fi化を狙ったステレオ・ディストーション。
U11 (P39)	LF:RateBit	<LoF>	Lo-Fi processor, low down the sample rate and bits. ビット落とし/サンプリング・レート落としによるLo-Fiサウンド。
U12 (P42)	LF:SP disk	<Dsk>	SP record played bamboo stylus. 仮想SPレコード、竹針プレーヤー。
U13 (P34)	LF:RingMd1	<Syn>	Distinctive ring modulator. リング・モジュレーター。
U14 (P62)	SY:Beam #1	<Syn>	Aggressive synth sound controlled with D Beam. Dビームで鳴らす攻撃的なシンセ音。
U15 (P64)	SY:StepBs1	<Syn>	Synth bass pattern 1 (with step modulator pattern). シンセ・ベース1 (ステップ・モジュレーター)。
U16 (P68)	SY:StepTk3	<Syn>	Techno sequence 3 (with step modulator pattern). テクノ・シーケンス3 (ステップ・モジュレーター)。

Contents of the Pad Banks of the Accessory Disk/付属ディスクのパッド・バンクの内容

Bank 01, 02:	The phrases used in the demo-song "CHIMERA" and some phrases/sound-FX matched with the tempo (135.0 BPM).	バンク01, 02:	デモ曲「CHIMERA」に使われたフレーズと「CHIMERA」のテンポ (135.0 BPM) に合ったフレーズや効果音等。
Bank 03, 04:	The phrases used in the demo-song "deep cavity" and some phrases/sound-FX matched with the tempo (161.5 BPM).	バンク03, 04:	デモ曲「deep cavity」に使われたフレーズと「deep cavity」のテンポ (161.5 BPM) に合ったフレーズや効果音等。
Bank 05, 06:	The phrases used in the demo-song "Effective" and some phrases/sound-FX matched with the tempo (170.0 BPM).	バンク05, 06:	デモ曲「Effective」に使われたフレーズと「Effective」のテンポ (170.0 BPM) に合ったフレーズや効果音等。
Bank 07:	Sound-FX.	バンク07:	SFX (各種効果音)。
Bank 08:	Guitars & Bases.	バンク08:	ギター、ベース。
Bank 09:	Synth & Keyboards.	バンク09:	シンセサイザー、キーボード。
Bank 10-14:	Rhythm phrases divided in tempo groups.	バンク10~14:	テンポごとに分けたリズム・フレーズ集。
Others:	Blank banks.	その他:	空きバンク。

SP-808 Demo Song List/デモ・ソング・リスト

1. CHIMERA	HEIGO TANI	谷丙午	Copyright © 1998, Roland Corporation
2. deep cavity	Ryeland Allison	ライランド・アリソン	Copyright © 1998, Silver Outlet Music, BMI
3. Effective	Roland Corporation	ローランド株式会社	Copyright © 1998, Roland Corporation
4. CHIMERA (Extended Mix)	HEIGO TANI	谷丙午	Copyright © 1998, Roland Corporation
5. Effective (Extended Mix)	Roland Corporation	ローランド株式会社	Copyright © 1998, Roland Corporation

HEIGO TANI (谷 丙午)

Heigo Tani is a DJ, musician and musical instrument freak, who shares a techno unit called ATOM/Co-Fusion/AS TWO MEN with DJ WADA, and has released records from Japan (Sublim Records), New York (Tribal America), Germany (Plastic City), UK (Positiva UK), etc. He is also a member of the two-man techno unit called "urn" which has been using the Internet for their activities. They use the Internet for live performances while synchronizing two MC-303's.
Web site: www.softbank.co.jp/music/urn/

HEIGO TANI (谷 丙午)

DJ WADAとATOM/Co-Fusion/AS TWO MENというテクノユニットを組み、今までに日本 (サブライムレコード)、NY (トライバル・アメリカ) ドイツ (プラスチックシティ)、UK (ポジティブUK) などのレーベルからレコードをリリースするDJ兼ミュージシャン及び楽器おたく。またインターネットを中心に活動するurn (ウラン) という2人組みテクノユニットにも参加。2台のMC-303を同期させてインターネットを交えたライブなどを行っている。
URL: <http://www.softbank.co.jp/music/urn/>

Ryeland Allison (ライランド・アリソン)

Ryeland makes electronics groove at the speed of sound, including computer controlled transistor rhythm. Busy Bee on the Quake Coast fashioning Distorted Reality, Cyberian sounds, and during twilight his dynamism plunders vibrancy at once among peace-loving frequencies. He jiggles remote to youth righteousness, enclosing his testament to ambrosial positive relatives, buzzing all serviceable results. He is honored to introduce this to you.

Ryeland Allison (ライランド・アリソン)

ロサンゼルスを中心に活躍しているハウス、テクノ系アーティスト。『オーディエンスの魂を揺さぶるような大音量のテクノ・サウンドで世界平和に貢献したい!!!』彼が光榮に思うことは、このスローガンに基づく自分の作品を一人でも多くの人に聴いてもらうことである。

- * Some phrase patterns from the MC-505 such as P125 (Ryeland Allison) are used in the demo songs (3 and 5) as well as phrase samples in the SP-808 demo disk.
- * SP-808の同梱ディスクでは、P125 (ライランド・アリソン) 他、いくつかのMC-505のフレーズ・パターンを、デモ曲 (3, 5) およびフレーズ・サンプルとして使用しています。
- * When shipped from the factory, the demo songs No. 1-5 and the pad banks No. 1-14 are protected.
- * 出荷時は、デモ・ソング1~5、パッド・バンク1~14がプロテクトされています。
- * The track D of the demo song "CHIMERA" is not in used. The track B of "Effective" has phrases but it is muted, you can here the sound when you turn the [STATUS] in green (PLAY).
- * 「CHIMERA」のトラックDは未使用です。「Effective」のトラックBはフレーズがありますがミュート (消音) されており、[STATUS] を押して緑に点灯させると聴けます。
- * All rights reserved. Unauthorized use of this material for purposes other than private, personal enjoyment is a violation of applicable laws.
- * これらのデモ・ソングを個人で楽しむ以外に権利者の許諾なく使用することは、法律で禁じられています。

 Roland®

71018090

UPC

71018090

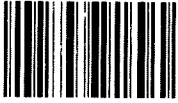

1899:

Roland