

BOSS

SP-202 Dr. Sample

Owner's Manual

Thank you, and congratulations on your choice of the BOSS SP-202 Dr. Sample.

Before using this unit, carefully read the sections entitled: "USING THE UNIT SAFELY" and "IMPORTANT NOTES" (page 2-3; page 17). These sections provide important information concerning the proper operation of the unit. Additionally, in order to feel assured that you have gained a good grasp of every feature provided by your new unit, this manual should be read in its entirety. The manual should be saved and kept on hand as a convenient reference.

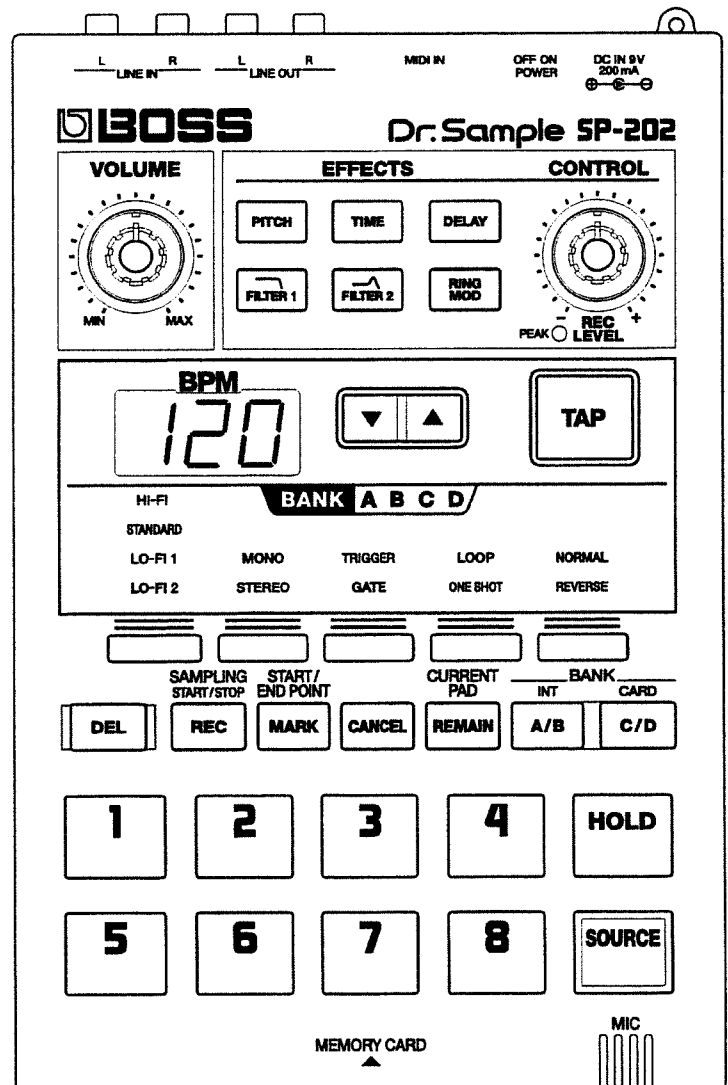



USING THE UNIT SAFELY

INSTRUCTIONS FOR THE PREVENTION OF FIRE, ELECTRIC SHOCK, OR INJURY TO PERSONS

About ⚠ WARNING and ⚠ CAUTION Notices

⚠ WARNING	Used for instructions intended to alert the user to the risk of death or severe injury should the unit be used improperly.
⚠ CAUTION	Used for instructions intended to alert the user to the risk of injury or material damage should the unit be used improperly. * Material damage refers to damage or other adverse effects caused with respect to the home and all its furnishings, as well to domestic animals or pets.

About the Symbols

	The ⚠ symbol alerts the user to important instructions or warnings. The specific meaning of the symbol is determined by the design contained within the triangle. In the case of the symbol at left, it is used for general cautions, warnings, or alerts to danger.
	The ⚡ symbol alerts the user to items that must never be carried out (are forbidden). The specific thing that must not be done is indicated by the design contained within the circle. In the case of the symbol at left, it means that the unit must never be disassembled.
	The ⏻ symbol alerts the user to things that must be carried out. The specific thing that must be done is indicated by the design contained within the circle. In the case of the symbol at left, it means that the power-cord plug must be unplugged from the outlet.

----- ALWAYS OBSERVE THE FOLLOWING -----

⚠ WARNING

- Before using this unit, make sure to read the instructions below, and the Owner's Manual. 

- Do not open (or modify in any way) the unit or its AC adaptor. 

- Do not attempt to repair the unit, or replace parts within it (except when this manual provides specific instructions directing you to do so). Refer all servicing to your dealer, or qualified Roland service personnel. 

- Never use or store the unit in places that are: 
 - Subject to temperature extremes (e.g., direct sunlight in an enclosed vehicle, near a heating duct, on top of heat-generating equipment); or are
 - Damp (e.g., baths, washrooms, on wet floors); or are
 - Humid; or are
 - Dusty; or are
 - Subject to high levels of vibration.

- Make sure you always have the unit placed so it is level and sure to remain stable. Never place it on stands that could wobble, or on inclined surfaces. 

- Use only the specified AC adaptor (PSA-120/230/240), and make sure the line voltage at the installation matches the input voltage specified on the AC adaptor's body. Other AC adaptors may use a different polarity, or be designed for a different voltage, so their use could result in damage, malfunction, or electric shock. 

⚠ WARNING





- Avoid damaging the power cord. Do not bend it excessively, step on it, place heavy objects on it, etc. A damaged cord can easily become a shock or fire hazard. Never use a power cord after it has been damaged. 

- This unit, either alone or in combination with an amplifier and headphones or speakers, may be capable of producing sound levels that could cause permanent hearing loss. Do not operate for a long period of time at a high volume level, or at a level that is uncomfortable. If you experience any hearing loss or ringing in the ears, you should immediately stop using the unit, and consult an audiologist. 







- Do not allow any objects (e.g., flammable material, coins, pins); or liquids of any kind (water, soft drinks, etc.) to penetrate the unit. 

- Immediately turn the power off, remove the AC adaptor from the outlet, and request servicing by your dealer or qualified Roland service personnel when: 
 - The AC adaptor or the power-supply cord has been damaged; or
 - Objects have fallen into, or liquid has been spilled onto the unit; or
 - The unit has been exposed to rain (or otherwise has become wet); or
 - The unit does not appear to operate normally or exhibits a marked change in performance.







WARNING

- In households with small children, an adult should provide supervision until the child is capable of following all the rules essential for the safe operation of the unit. 
- Protect the unit from strong impact. (Do not drop it!) 
- Do not force the unit's power-supply cord to share an outlet with an unreasonable number of other devices. Be especially careful when using extension cords — the total power used by all devices you have connected to the extension cord's outlet must never exceed the power rating (watts/amperes) for the extension cord. Excessive loads can cause the insulation on the cord to heat up and eventually melt through. 
- Before using the unit in a foreign country, consult with your dealer, or qualified Roland service personnel. 
- Batteries must never be recharged, heated, taken apart, or thrown into fire or water. 

CAUTION

- The unit and the AC adaptor should be located so their location or position does not interfere with their proper ventilation. 
- Always grasp only the plug or the body of the AC adaptor when plugging into, or unplugging from, an outlet or this unit. 
- Whenever the unit is to remain unused for an extended period of time, disconnect the AC adaptor. 
- Try to prevent cords and cables from becoming entangled. Also, all cords and cables should be placed so they are out of the reach of children. 
- Never climb on top of, nor place heavy objects on the unit. 
- Never handle the AC adaptor body, or its plugs, with wet hands when plugging into, or unplugging from, an outlet or this unit. 
- Before moving the unit, disconnect the AC adaptor and all cords coming from external devices. 

CAUTION

- Before cleaning the unit, turn off the power and unplug the AC adaptor from the outlet (page 9). 
- Whenever you suspect the possibility of lightning in your area, disconnect the AC adaptor from the outlet. 
- If used improperly, batteries may explode or leak and cause damage or injury. In the interest of safety, please read and observe the following precautions (page 8). 

 - Carefully follow the installation instructions for batteries, and make sure you observe the correct polarity. 
 - Avoid using new batteries together with used ones. In addition, avoid mixing different types of batteries.
 - Remove the batteries whenever the unit is to remain unused for an extended period of time.
 - If a battery has leaked, use a soft piece of cloth or paper towel to wipe all remnants of the discharge from the battery compartment. Then install new batteries. To avoid inflammation of the skin, make sure that none of the battery discharge gets onto your hands or skin. Exercise the utmost caution so that none of the discharge gets near your eyes. Immediately rinse the affected area with running water if any of the discharge has entered the eyes.
 - Never keep batteries together with metallic objects such as ballpoint pens, necklaces, hairpins, etc.
- Used batteries must be disposed of in compliance with whatever regulations for their safe disposal that may be observed in the region in which you live. 

Contents

Main features	5	Sampling time / Checking the remaining time	24
Front and rear panel	6	Deleting an individual sample	25
Inserting the batteries	8	Deleting all samples	25
Connections	8	Viewing and changing the BPM value after sampling	25
DJ system setup	8		
Turning on the power	10		
Turning off the power	10		
Important Notes	11		

Quick start

Listen to the samples	12
Using effects in your performance	13
Sampling your own sounds	14
Using the SP-202 as a voice effector	15

Section 1. Playing the SP-202

Changing the bank	16
Using the Hold function to play a sample	16
Using a pad to control the sound of the external input (Source pad)	17
Mixing samples with the microphone or external input (Source Mix)	17
Calculating BPM (tempo)	18
Maximum polyphony and note priority	19

Section 2. Sampling

Sampling from a microphone	20
Sampling from a CD (line recording)	21
Hi-Fi sampling / Long sampling (Sampling Grade)	22
Automatically starting sampling (Auto Sampling)	23

Section 3. Changing how the sample plays (Editing)

Playing a phrase repeatedly (Loop Playback)	26
Playing the sound only once (One Shot Playback)	26
Playing only the desired portion of a sound (Changing the Start/End Point)	27
Deleting unwanted portions (Truncate)	28
Reverse playback (play backward)	28
Make the sound play only while you press the pad (Gate Playback)	29
Make the sound continue playing even if you release the pad (Trigger Playback)	29
Checking the current pad	30

Section 4. Using effects

Pitch (and tempo) change (Pitch Control)	31
Tempo change without affecting the pitch (Time Stretch)	32
Pitch change without affecting the tempo (Pitch Control and Time Stretch)	32
Using delay	33
Using a filter	33
Using the ring modulator	34
Applying an effect to the external input	34

Main Features

Section 5. Saving data to a memory card

Formatting a memory card	35
Saving to a memory card (Save)	36
Loading data from a memory card (Load)	36
Protecting data on a memory card	37

Section 6. Using the SP-202 as a MIDI sound source

Setting the MIDI channel	38
Normal use	38
Using the SP-202 as a rhythm sound module	38
Restoring the MIDI settings to their factory values	39
Notes when using MIDI	39

Section 7. Creating break-beats

Sampling various phrases	40
Matching the tempo (BPM) of each sample (Time Stretch)	41
Playing break-beats	41

Section 8. Appendix

Error message	42
Troubleshooting	42
MIDI Implementation Chart	43
Specifications	44
Index	45

Copyright © 1997 BOSS CORPORATION

All rights reserved. No part of this publication may be reproduced in any form without the written permission of BOSS CORPORATION.

Long sampling

Long sampling times are possible, with up to 32 seconds of high-quality sampling (HI-FI) or up to 4 minutes 20 seconds of LO-FI 2.

Smart media (optional) can be used to allow even longer sampling.

Six powerful types of effects are built-in

A total of six effects are built-in, including a Time Stretch function that changes the tempo without affecting the pitch (ideal for break-beats!), two types of filter that are indispensable for Techno, and a ring modulator that is even more effective when used on human voice. The filter and ring modulator can also be applied to the sound from an external input.

Display and edit tempo as BPM

The BPM (tempo) of a sampled phrase is calculated and displayed automatically, and you can edit by BPM values or display Time Stretch changes as BPM values.

Sampling grade can be specified for each sample

For each sample, you can select either Hi-Fi for high sound quality or Lo-Fi for long sampling times, allowing you to make the best use of available memory.

Source Mix function

The Source Mix function lets you combine sampled sounds with the sound from external input. This is convenient for live performances such as Rap backed by sampled sounds.

High-capacity memory cards (SmartMedia) are supported

The SP-202 can use SmartMedia as memory cards. When a 4 Mbyte card is used, over 30 minutes of sampling is possible. The 16 sampled sounds in internal memory can be saved on a card as a set, with up to seven sets (each with 16 samples) on a card.

* "SmartMedia" is a trademark of Toshiba Corporation.

Runs on batteries

The SP-202 can use batteries as its power supply. Phrases that catch your ear can be sampled anytime and anywhere, for impromptu performances. Make music in your room, on stage or in the street!

Front and rear panel

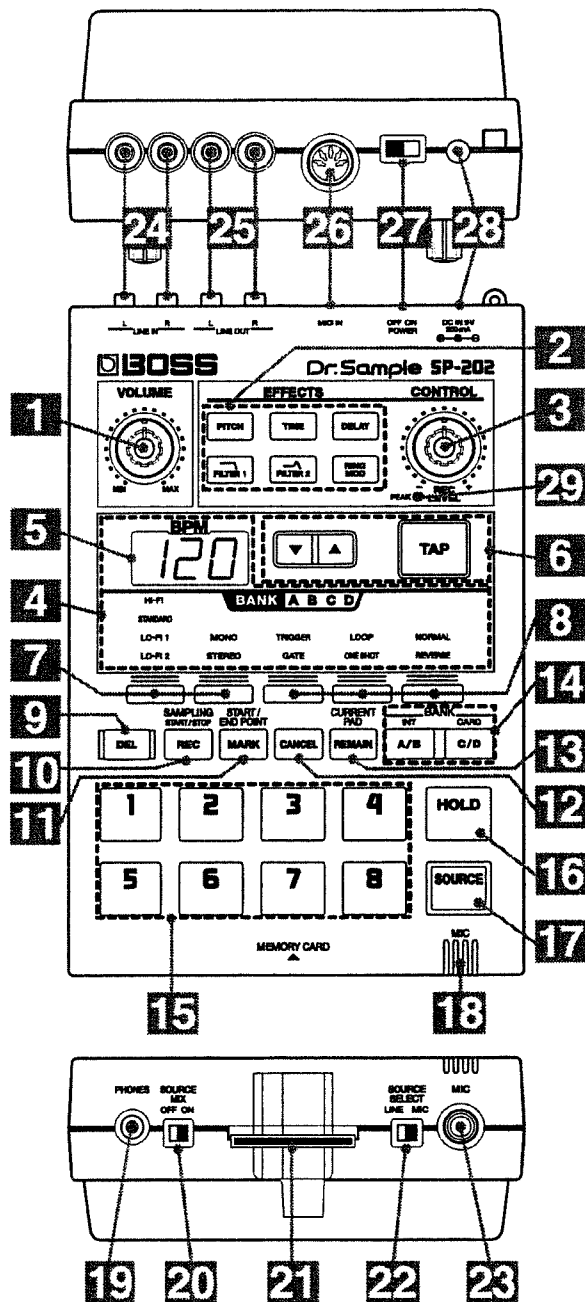

1. Volume knob

Adjust the volume.

2. Effect buttons (EFFECTS)

These turn the effects on/off. When an effect is on, the button will light.

With the exception of PITCH, multiple buttons cannot be turned on simultaneously.

3. Control knob (CONTROL)

Normally this is used to control the effects. During sampling, it is used to adjust the sampling level.

4. Display

This will light to indicate various settings for the pad which sounded last (referred to as the "current pad").

5. BPM display

Normally this indicates the BPM (tempo) value of the sample. It can also display the remaining available sampling time.

6. BPM setting buttons

During sampling, these set the BPM (tempo). If you already know the BPM, you can use the ▼ ▲ buttons to input the numerical value. If you do not know the tempo, and wish to input it as you listen to the phrase to be sampled, press the TAP pad in time with the phrase.

7. Sampling setting buttons

These buttons set conditions for sampling.

● Sampling grade setting button

This sets the sampling grade (high-quality sampling / long sampling).

● Mono/stereo setting button (MONO/STEREO)

This specifies whether sampling will be monaural or stereo.

8. Edit buttons

These buttons specify how the sample will be played back.

● Trigger/Gate setting button (TRIGGER/GATE)

● Loop/One-shot setting button (LOOP/ONE SHOT)

● Normal/Reverse setting button (NORMAL/REVERSE)

9. Delete button (DEL)

Use this button to delete a sample. During the delete process, the button will light.

10. Sampling button (REC)

Use this button to begin/end sampling.

11. Mark button (MARK)

Use this button when you wish to sound only a portion of a sampled sound. While this button is lit, only the specified portion will sound.

12. Cancel button (CANCEL)

Use this button to cancel a sampling or sample delete operation (i.e., while REC or DEL is blinking).

13. Remain button (REMAIN)

When this button is pressed, the BPM display will indicate the remaining time available for sampling.

At the same time, the button for the current pad and the button for the effect which is being controlled by the Control knob will blink.

14. Bank buttons (BANK)

These buttons switch sample banks. The A/B button switches between internal banks A and B. The C/D button switches between banks C and D when a memory card is used.

15. Pads

When you press a pad, the sample assigned to that pad will sound. While it is sounding, the pad will light.

16. Hold pad (HOLD)

If you hold down this pad while pressing another pad, the sample will continue to play even after you release the pad.

17. Source pad (SOURCE)

By using this pad you can sound/silence the sound from an external input without having to sample it, and can apply effects to the sound.

18. Built-in microphone

You can use this microphone to sample sounds.

19. Headphone jack (PHONES)

A set of headphones can be connected here to hear the same sound as the line outputs. The jack is for a stereo miniature type plug.

20. Source mix switch (SOURCE MIX)

When this switch is ON, the sounds of the samples and the external input (microphone or line in) will be mixed and output.

21. Memory card slot (MEMORY CARD)

A memory card (SmartMedia: optional) can be inserted here. A card can be used to store (backup) the data from internal memory. It is also possible to use card banks C/D to record long samples that the internal memory could not accommodate.

22. Source select switch (SOURCE SELECT)

When this switch is in the MIC position, you can sample from a microphone (external or built-in). When it is in the LINE position, you can sample from a device connected to the line in jacks.

23. External mic jack

When you wish to use an external microphone, connect it to this jack. When an external microphone is used, the built-in microphone will automatically be defeated.

24. Line in jacks (LINE IN L,R)

These inputs are stereo RCA phono type jacks for connection to a CD player or other sound source from which you wish to sample.

25. Line out jacks (LINE OUT L, R)

These audio outputs are stereo RCA phono type jacks for connection to an amp or mixer through which you wish to play the sampled sounds.

26. MIDI connector

This can be connected to an external MIDI device (sequencer or keyboard) so that the external device can control the SP-202. Use a MIDI cable (optional) for connection.

27. Power switch

This turns the power on/off.

28. AC adaptor jack

Use this when you wish to connect a separately sold AC adaptor.

* Be sure to use only the specified AC adaptor. Using any other adapter can cause malfunctions.

29. Peak indicator (PEAK)

This indicator helps you to adjust the level when sampling. For optimal sampling, adjust the level so that this indicator lights occasionally.

Connections

Inserting the batteries

Detach the lid of the battery case located on the bottom of the unit, and referring to the diagrams on the bottom, insert the batteries making sure to observe the correct polarity. Then close the lid firmly.

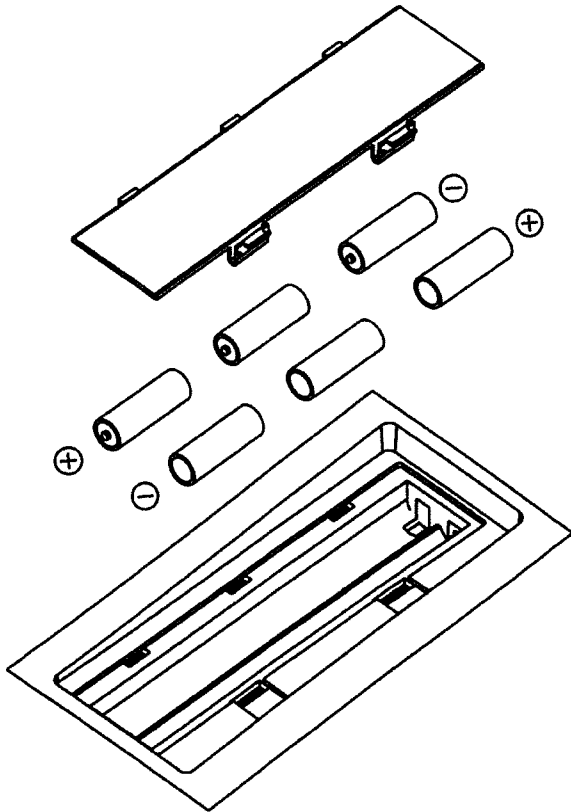

When the battery runs down, the BPM display will become darker than normal.

When this occurs, replace the battery immediately.

- * The contents of the SP-202's internal memory will be preserved even if the battery runs down.

The SP-202 does not contain an amp or mixer. In order to hear the sound, you will need an amp, audio system, or headphones etc. Refer to the diagram at right and connect the SP-202 with your external equipment.

- * AC adaptor, Audio cables, MIDI cables, stereo headphones and microphone are not included. These can be purchased separately at your dealer.
- * To prevent malfunction and/or damage to speakers or other devices, always turn down the volume, and turn off the power on all devices before making any connections.

DJ system setup

When sampling from a record, set the mixer fader to the record player position (maximum).

The volume level during sampling is adjusted by the SP-202's REC level (page 20, 21) and by the mixer's effect send level.

Mixer settings

CH 1	Input: line	Effect: OFF
CH 2	Input: PHONO	Effect: ON

- * Settings may be different depending on the mixer. For details refer to the owner's manual for your mixer.

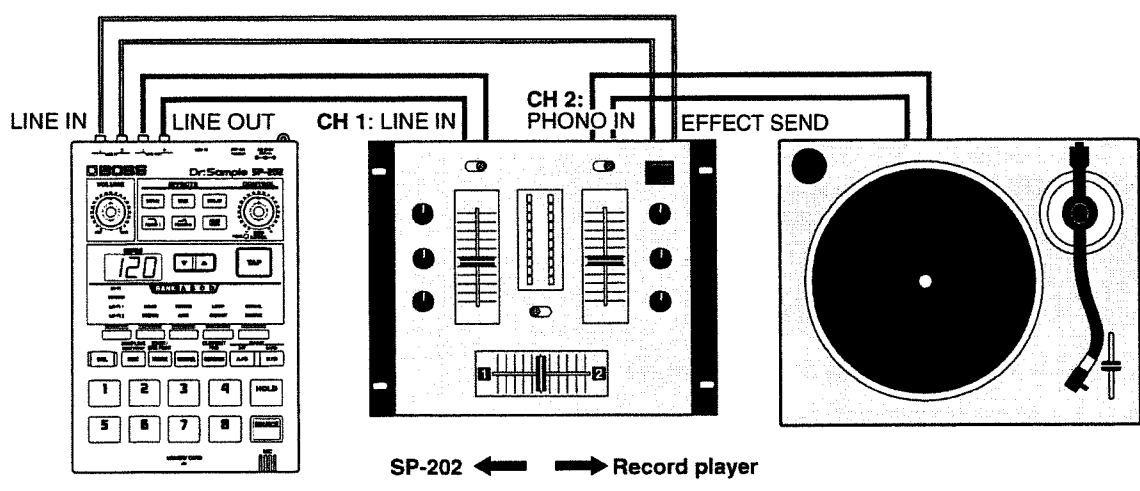
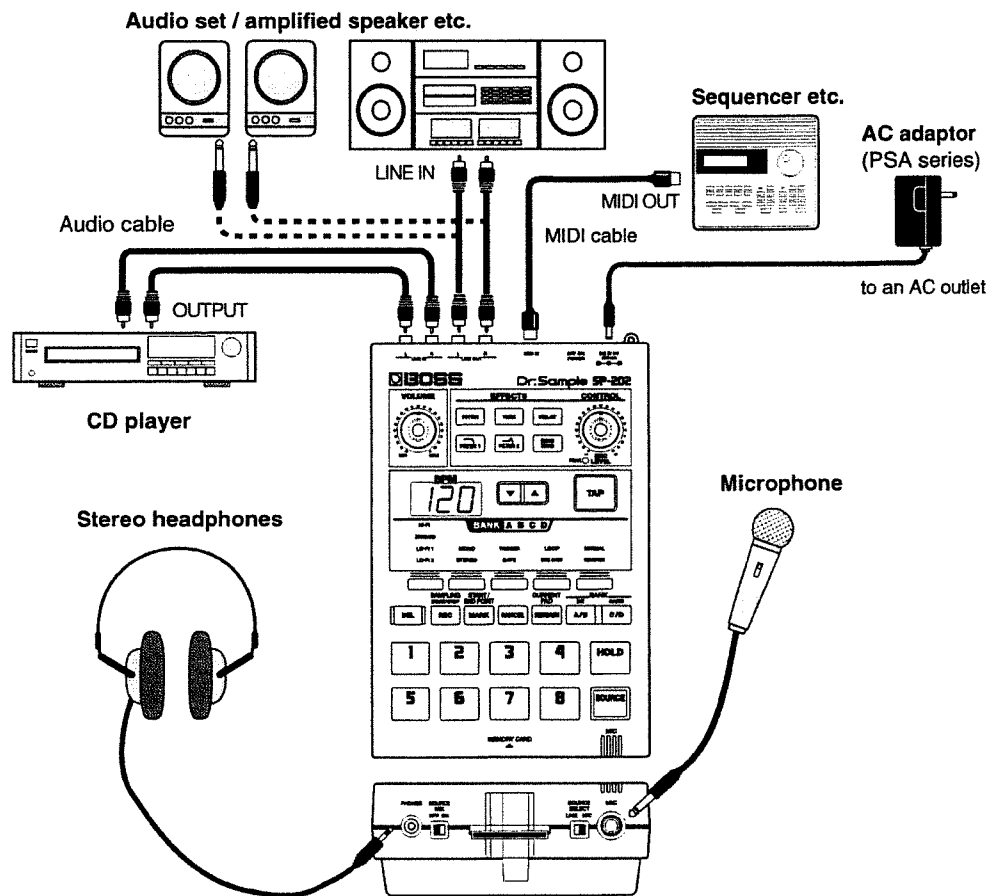

Turning on the power

Once the connections have been completed (page 8, 9), turn on power to your various devices in the order specified. By turning on devices in the wrong order, you risk causing malfunction and/or damage to speakers and other devices.

1. Before you turn on the power, make sure of the following points.

- Is the SP-202 correctly connected to the external equipment?
- Are the volume controls of the SP-202 and of the connected amp/mixer set to their minimum position?

2. Turn the SP-202's power switch ON.

The BPM display will indicate "202" for several seconds. The decimal points will also blink.

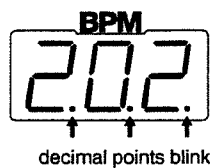
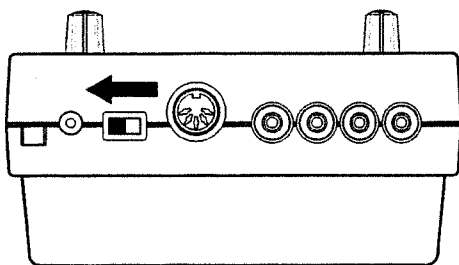

3. Turn on the power of your amp/mixer etc.

4. Rotate the VOLUME knob to adjust the SP-202's volume.

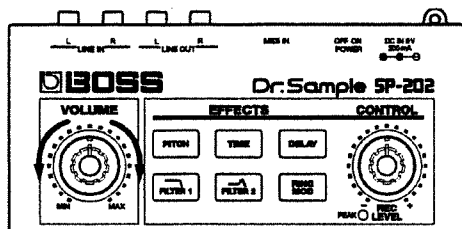

Also adjust the volume of the connected amp/mixer etc.

- * This unit is equipped with a protection circuit. A brief interval (a few seconds) after power up is required before the unit will operate normally.
- * If you turn on the power with a memory card already inserted, the decimal points will blink for several seconds until the memory card is detected. The unit will not operate during this time.
- * Never turn off the power while the decimal points are blinking.

● Turning off the power

1. Before you turn off the power, make sure that the volumes of the SP-202 and the connected amp/mixer are set to their minimum position.

2. Turn off the power of the amp/mixer etc.

3. Turn the SP-202's power switch to the OFF position.

- * Never turn off the power while the decimal points are blinking.

Important Notes

In addition to the items listed under "USING THE UNIT SAFELY" on page 2-3, please read and observe the following:

Power Supply: Use of Batteries -----

- Do not use this unit on the same power circuit with any device that will generate line noise (such as an electric motor or variable lighting system).
- The AC adaptor will begin to generate heat after long hours of consecutive use. This is normal, and is not a cause for concern.
- The use of an AC adaptor is recommended as the unit's power consumption is relatively high. Should you prefer to use batteries, please use the alkaline type.
- When installing or replacing batteries, always turn off the power on this unit and disconnect any other devices you may have connected. This way, you can prevent malfunction and/or damage to speakers or other devices.
- Before connecting this unit to other devices, turn off the power to all units. This will help prevent malfunctions and/or damage to speakers or other devices.

Placement -----

- Using the unit near power amplifiers (or other equipment containing large power transformers) may induce hum. To alleviate the problem, change the orientation of this unit; or move it farther away from the source of interference.
- This device may interfere with radio and television reception. Do not use this device in the vicinity of such receivers.
- Do not expose the unit to direct sunlight, place it near devices that radiate heat, leave it inside an enclosed vehicle, or otherwise subject it to temperature extremes. Excessive heat can deform or discolor the unit.

Maintenance -----

- For everyday cleaning wipe the unit with a soft, dry cloth or one that has been slightly dampened with water. To remove stubborn dirt, use a cloth impregnated with a mild, non-abrasive detergent. Afterwards, be sure to wipe the unit thoroughly with a soft, dry cloth.
- Never use benzine, thinners, alcohol or solvents of any kind, to avoid the possibility of discoloration and/or deformation.

Repairs and Data -----

- Please be aware that all data contained in the unit's memory may be lost when the unit is sent for repairs. Important data should always be backed up on a Memory card (SmartMedia), or written down on paper (when possible). During repairs, due care is taken to avoid the loss of data. However, in certain cases (such as when circuitry related to memory itself is out of order), we regret that it may not be possible to restore the data, and Roland assumes no liability concerning such loss of data.

Warranty Disclaimer-----

- In no event shall Roland be liable for any direct, consequential, incidental, or any other damages which may result from your use of, or inability to use the SP-202. These damages may include, but are not limited to the following events which could occur during your use of the SP-202:
 - Inability to realize profits.
 - Permanent loss of your music data.
 - Inability to continue using the SP-202, or devices that have been connected to it.

Additional Precautions -----

- Please be aware that the contents of memory can be irretrievably lost as a result of a malfunction, or the improper operation of the unit. To protect yourself against the risk of losing important data, we recommend that you periodically save a backup copy of important data you have stored in the unit's memory on a Memory card (SmartMedia).
- Unfortunately, it may be impossible to restore the contents of data that was stored on a Memory card (SmartMedia) once it has been lost. Roland Corporation assumes no liability concerning such loss of data.
- Use a reasonable amount of care when using the unit's buttons, sliders, or other controls; and when using its jacks and connectors. Rough handling can lead to malfunctions.
- When connecting/disconnecting all cables, grasp the connector itself—never pull on the cable. This way you will avoid causing shorts, or damage to the cable's internal elements.
- To avoid disturbing your neighbors, try to keep the unit's volume at reasonable levels. You may prefer to use headphones, so you do not need to be concerned about those around you (especially when it is late at night).
- When you need to transport the unit, package it in the box (including padding) that it came in, if possible. Otherwise, you will need to use equivalent packaging materials.

Before Using Cards-----

Using Memory Cards

- Carefully insert the DATA card all the way in—until it is firmly in place.

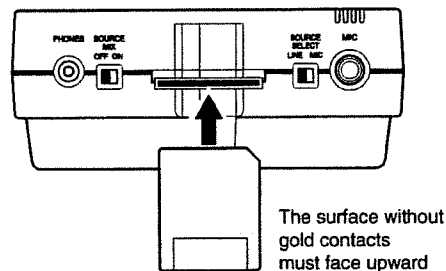

- Never touch the terminals of the DATA card. Also, avoid getting the terminals dirty.

Quick start

Listen to the samples

When the SP-202 is shipped from the factory, 1–8 of bank A already contain samples. Let's listen to these samples.

What is a sample?

A sample is a piece of sampled sound (a “waveform”) together with various settings that determine how it can be played during a performance, which has been assigned to a pad.

What is a bank?

The samples that are assigned to each of the eight pads are collectively referred to as a bank. The SP-202 has four banks: A–D.

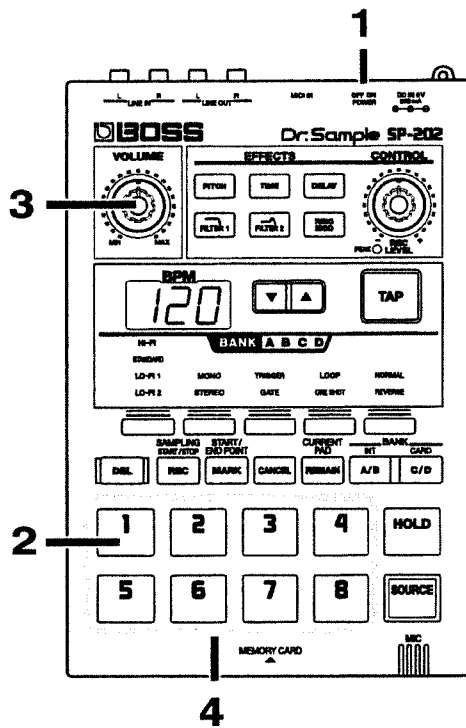

1. Turn the power switch ON.

2. Press pad 1. (Pad 1 will light.)

* Bank A's 7 and 8 in the factory-set samples will play only while you continue pressing the pad.

3. Raise the SP-202's VOLUME knob appropriately, and while pressing pad 1, gradually raise the volume of your amp or monitor speaker.

4. After verifying that you hear the sound, try pressing pads 2–8 as well.

* If pressing a pad does not produce sound, make sure that bank A is selected (BANK A is lit). If a different bank is selected, press the BANK INT A/B button to switch to bank A.

* The volume is not affected by the force with which you press a pad. Applying excessive force to a pad will cause malfunctions.

* The SP-202 is able to sound up to four pads simultaneously. If you press additional pads in an attempt to play more, the sound of the first-pressed pad will be turned off (pad dark) to make way for the newly-pressed pad (last-note priority). However depending on the settings, it may not be possible to sound four pads simultaneously. For details refer to page 19 “Maximum polyphony and note priority.”

* The factory samples differ from those on the supplied CD. If you erase the factory samples, they cannot be restored (unless you have created a backup beforehand.)

* If you press the TRIGGER/GATE button to make TRIGGER light, the sample will alternate between playing (pad lit) and stopped (pad dark) each time you press the pad. For details refer to page 29 “Make the sound continue playing even if you release the pad.”

Using effects in your performance

The SP-202 has six effects which can add special character to the sound. Here's how to try out these effects and hear what they can do.

- * The on/off status of the effects can be specified for each sample.
- * With the exception of PITCH, only one effect can be used for each sample.
- * When effects are used, fewer notes can be played simultaneously. For details refer to page 19 "Maximum polyphony and note priority."

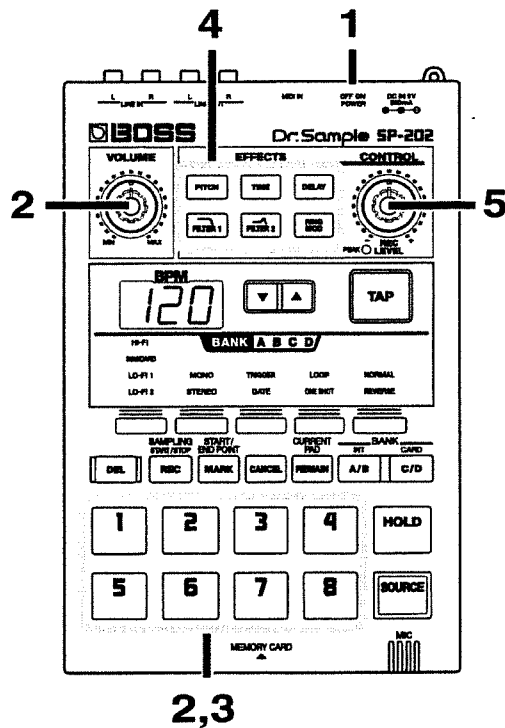

1. Turn the power switch ON.
2. Raise the SP-202's VOLUME knob appropriately, and while pressing pad 1-8, gradually raise the volume of your amp or monitor speaker.
3. Press a pad to sound the sample to which you wish to apply an effect.
4. Press one of the EFFECTS buttons. (The button you press will light.)
An effect is on when the button is lit, and off when it is dark.
5. Rotate the CONTROL knob. The sound will change correspondingly.

Sampling your own sounds

Here's how to sample some new sounds into the pads of bank B (which do not contain samples when the SP-202 is shipped).

* Unauthorized sampling from a CD, record, tape, video production, or broadcast whose copyright is owned by a third party is forbidden by law, with the exception of special cases such as private use.

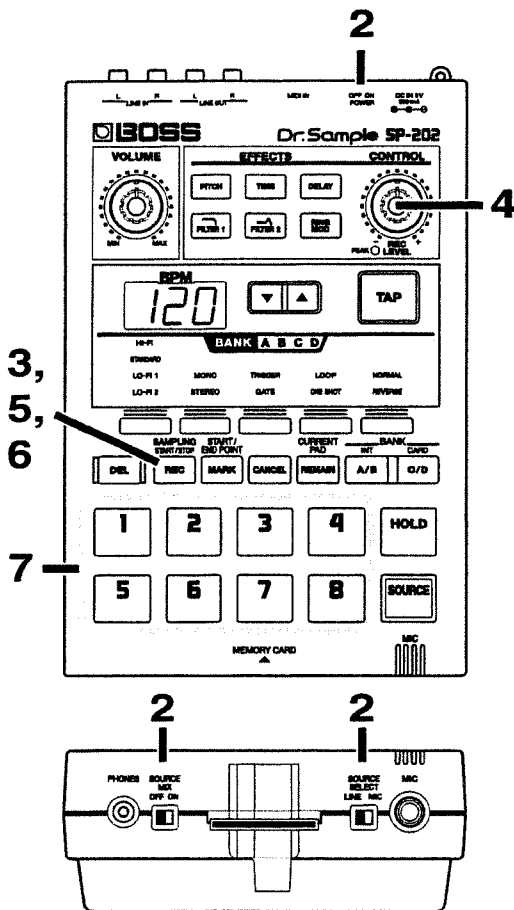

1. Connect your CD player. (page 8, 9)

2. Make sure that the SP-202's SOURCE MIX switch is OFF, and the SOURCE SELECT switch is in the LINE position. Then turn the SP-202's power switch ON.

* If you wish to sample from the microphone, set the SOURCE SELECT switch to MIC.

3. Press the SAMPLING START/STOP button.

The REC button will blink, and the SP-202 will be in standby mode. At this time, a pad to which no sample has been assigned will automatically be selected and will blink.

* If you now decide not to sample, press the CANCEL button. The REC button will go dark.

4. Adjust the sampling level.

Start playback of the CD, and rotate the REC LEVEL knob so that the PEAK indicator lights occasionally.

Preparations for sampling are now complete. Stop the CD player, and place it in playback standby mode.

5. Start playback on the CD player, and in synchronization with the beginning of the CD sound, press the SAMPLING START/STOP button.

The REC button will light, and sampling will start.

6. When you come to the point where you wish to stop sampling, press the SAMPLING START/STOP button. Sampling will end, and the blinking pad will go dark.

* If you exceed the maximum possible sample time, sampling will stop automatically.

7. Press the pad that went dark, and you will hear the sound that you just sampled.

* If undesired sound or silence was recorded at the beginning or end of the sample, you can make settings so that only the desired portion is played back. For details refer to page 27 "Playing only the desired portion of a sound."

● If you don't like the sampled sound

Delete the sound that you sampled, and start again from step 3. The procedure is as follows.

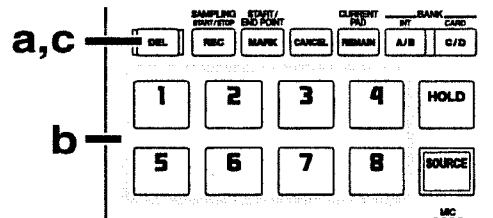

a. Press the DEL button. (The button will blink.)

b. Press the pad to which the unwanted sample is assigned. (The pad will blink.)

c. Press the DEL button.

The DEL button will light. When it goes dark, the delete operation has been completed.

* Never turn off the power while the DEL button is lit.

Using the SP-202 as a voice effector

The SP-202 lets you apply the FILTER 1/2 and RING MOD (ring modulator) effects to an external input.

In this section, let's apply the ring modulator to a voice, making it sound like a robot.

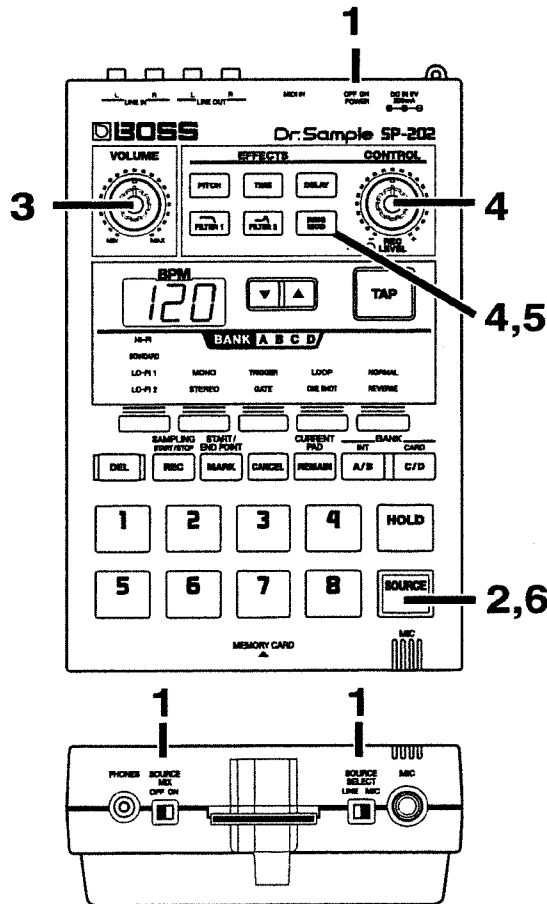

1. Set the SOURCE MIX switch OFF, the SOURCE SELECT switch to MIC, and turn the power switch ON.

2. Press the SOURCE pad. (The pad will light.)

* With the factory settings, the sound will be heard only while you continue pressing the pad.

3. Raise the SP-202's VOLUME appropriately, and speak into the microphone while you gradually raise the volume of your amp or monitor speaker.

* Howling could be produced depending on the location of microphones relative to speakers. This can be remedied by:

1. Changing the orientation of the microphone(s).
2. Relocating microphone(s) at a greater distance from speakers.
3. Lowering volume levels.

4. Press the RING MOD button to make it light.

The ring modulator will apply to the sound from the microphone, producing an effect as if a robot were speaking. You can rotate the CONTROL knob to adjust the depth of the effect.

5. Press the RING MOD button once again to make it go dark, and the effect will no longer apply.

In the same way, go ahead and try FILTER 1 and 2.

6. Release the SOURCE pad, and the sound from the microphone will no longer be heard.

* If you wish to use an external microphone, connect it to the MIC jack. The external microphone will automatically take priority over the internal microphone.

* It is not possible to use two or more FILTER 1/2 or RING effects simultaneously.

* If you press another pad while the SOURCE pad is lit, the sound of the microphone may be interrupted. Also, pressing the SOURCE pad while the sound of a pad 1-8 is playing may cause the sound of pads 1-8 to be interrupted. This can occur when the maximum polyphony is exceeded. For details refer to page 19 "Maximum polyphony and note priority."

* When the SOURCE SELECT switch is in the LINE position, an effect can be applied to the audio from the line input.

* If the TRIGGER/GATE button has been pressed to make TRIGGER light, pressing a pad will alternate between starting the sound (pad lit) and stopping the sound (pad dark), so that the sample will continue to sound while the pad is lit. For details refer to page 29 "Make the sound continue playing even if you release the pad."

* If distortion occurs because the input level is too high, or noise is a problem because the input level is too low, you can adjust the input level according to "If noise is a problem" on page 34.

Section 1. Playing the SP-202

On the SP-202, you can play samples by pressing pads 1-8 and the BANK buttons.

Pads which are playing a sample will light, and the display will show the settings for the pad which was last pressed to play it. (This pad is referred to the "current pad.")

Changing the bank

The eight samples assigned to the eight pads are collectively referred to as a "bank," and the SP-202 allows you to use four banks, A-D. Banks A and B are banks inside the SP-202, and banks C and D are in an optional memory card.

This means that up to 32 samples can be available.

- * When the power is turned on, bank A is selected.

(How the Banks are organized)

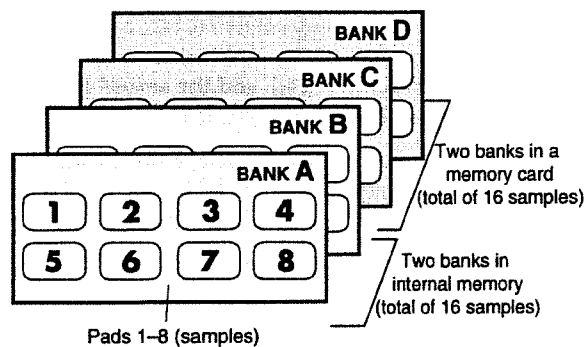

● Changing between banks A/B

Press the BANK INT A/B button to make either BANK A or B light.

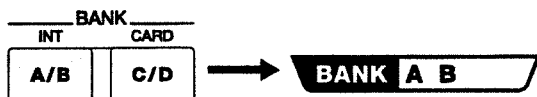

● Changing between banks C/D

Press the BANK CARD C/D button to make either BANK C or D light.

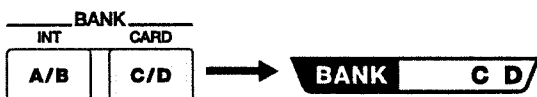

- * If a memory card is not inserted into the slot, it is not possible to select banks C/D by pressing the BANK CARD C/D button.
- * When the SP-202 is shipped from the factory, only bank A contains samples.

- * When you change banks, pad 1 of the selected bank will always be the current pad.
- * Never remove the memory card while a sample of bank C/D is playing.
- * If you insert a card which has not been used by the SP-202 (i.e., not formatted by the SP-202) and press the BANK CARD C/D button, C/D/REC will blink. If you then press the REC button, the card will be formatted. Do not turn off the power or remove the card while formatting is in progress. When a card is formatted, the data in the card will be erased.

Using the Hold function to play a sample

With the factory settings, the samples assigned to bank A pad 7 and 8 will sound only while the pad is being pressed, and will stop when you release the pad. However you can use the Hold function to cause the sample to continue sounding even after you release the pad.

This is convenient when you have a looped phrase sample that you wish to continue playing. In the following procedure, we will explain how to use the Hold function with the bank A pad 7 as an example.

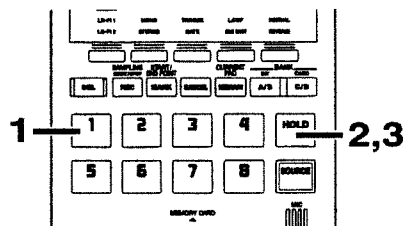

1. Make sure that bank A is lit, and press pad 7 to sound the looped sample.
 2. Before you release the pad, press the HOLD pad. This turns on Hold, and the sample will continue to sound even after you release the pad.
 3. Press the HOLD pad once again to stop the sound.
- * The pad will remain lit while the sample is playing.
 - * The instant that you press the HOLD pad once again to cancel Hold, all sounds will stop, including those sounds which were not being held.
 - * By making Gate playback / Trigger playback settings (page 29) you can produce the same result without pressing the HOLD pad. Gate playback / Trigger playback can be specified independently for each pad 1-8.

Using a pad to control the sound of the external input (Source pad)

On the SP-202, you can use a pad to play/stop the sound from the external input and apply an effect to this sound without having to sample it.

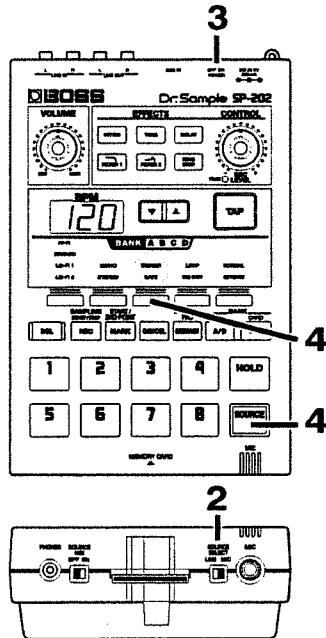

1. If you wish to control a CD player etc., connect it to **LINE IN**. If you wish to use an external microphone, connect it to the **MIC** jack.

2. If the external input is a line source, set the **SOURCE SELECT** switch to **LINE**. If it is a microphone (internal or external), set **SOURCE SELECT** to **MIC**.

* If you use the **LINE IN**, the output will be stereo.

3. Turn the power switch **ON**.

4. The external input will be heard as long as you press the **SOURCE** pad.

If **GATE** is lit, the sound will be heard only while you press the **SOURCE** pad, and it will be silenced when you release the pad (the pad will go dark).

If **TRIGGER** is lit, pressing the **SOURCE** pad will alternate between sound (pad lit) and silence (pad dark).

GATE and **TRIGGER** can be switched by pressing the **TRIGGER/GATE** button.

* The **FILTER 1/2** and **RING MOD** effects can also be used. For details refer to page 34 "Applying an effect to the external input."

* If distortion occurs because the input level is too high, or noise is a problem because the input level is too low, you can adjust the input level according to "If noise is a problem" on page 34.

Mixing samples with the microphone or external input (Source Mix)

The SP-202 provides a Source Mix function that lets you combine the microphone input or external input with playback of the samples, without your having to connect a mixer.

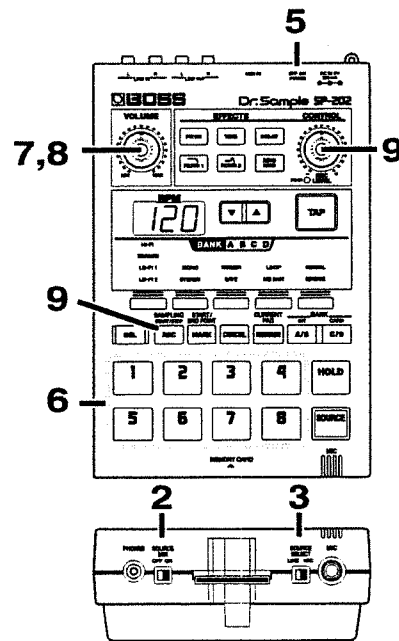

1. Record the samples (phrases or sound effects etc.) that you wish to use into the SP-202.

* It will be most convenient to limit the samples used in a single song to the number that can be selected without having to change banks.

2. Turn the SP-202's **SOURCE MIX** switch **ON**.

3. If you wish to mix samples with the microphone input, set the **SOURCE SELECT** switch to **MIC**. To mix samples with a CD, select **LINE**.

4. If you are using an external microphone, connect the microphone to the **MIC** jack. If you are using a CD, connect it to **LINE IN** (refer to page 8, 9).

5. Turn the power switch **ON**.

6. Press pads to play the desired samples.

7. Slowly raise the volume of your amplifier or monitor speaker as you sing to the microphone or playback the CD.

Then gradually raise the **VOLUME** knob on the SP-202.

8. If you wish to adjust the volume of the samples, rotate the **VOLUME** knob.

9. If you wish to adjust the volume of the microphone or external input, press the **REC** button to enter sample-standby mode, and rotate the **CONTROL** knob.

When you finish making adjustments, press the **CANCEL** button.

- * You can also adjust the volume of the microphone or external input by rotating the **CONTROL** knob while holding down the **CANCEL** button.

Calculating BPM (tempo)

On the SP-202 you can press the **TAP** button along with the rhythm so that the corresponding BPM value (tempo) will be calculated and displayed.

- * You can calculate the BPM value when the BPM value is 40–200. When the BPM value is less or more than that, the value indication will not change.

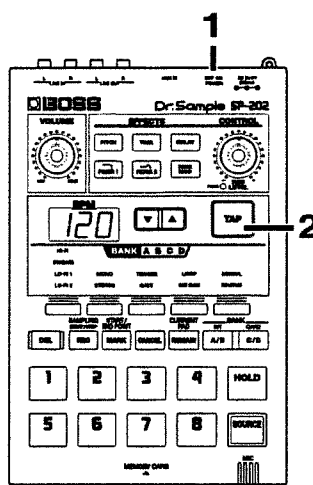

1. Turn the power switch **ON**.

- * If **BPM** is specified for the current pad at this time, that value will be shown.

2. Press the **TAP** button in time with the quarter notes of the rhythm. When you have pressed four or more times, the **BPM** will be displayed for several seconds. (The decimal points beneath the numerals will blink.) Then the **BPM** display for the current pad will reappear.

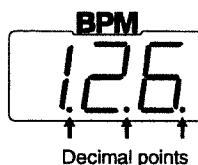

- * This function is also available while samples are playing back. This function is not available during sampling standby mode, or during recording.

Maximum polyphony and note priority

The SP-202 can play up to four notes simultaneously. Using an effect or a stereo sample will occupy two or more notes of this capability. This means that in some cases, there will be fewer than four notes available. For details refer to the following table which shows the number of voices used in each case, and the list of examples.

If pads are pressed to request more notes than can be sounded simultaneously, the first-played sound will be turned off, and the newly-requested sample will sound (last-note priority).

* If you change the current pad, the sample assigned to the current pad will be treated as the last-played note.

● Number of voices used

	Internal memory		Memory card		Source pad
	MONO	(STEREO)	MONO	(STEREO)	(STEREO)
Normal playback	1	(2)	3	(4)	(2)
Reverse playback	2	(4)	-	(-)	(-)
Time stretch	3	(-)	-	(-)	(-)
Delay	3	(-)	-	(-)	(-)
Filter (1/2)	2*	(4)	4	(-)	(4)
Ring modulator	2*	(4)	4	(-)	(4)

Up to a total of 4 voices can be used simultaneously.

- : Not available.

* : Will be 3 in the case of HI-FI.

● Examples of maximum simultaneous notes

1. Normal mono playback x 4 = 4
2. Normal stereo playback x 2 = 4
3. Mono time stretch x 1 + normal mono playback x 1 = 4
4. Mono filter (not HI-FI) x 1 + normal mono playback x 2 = 4
5. Mono filter (HI-FI) x 1 + normal mono playback x 1 = 4
6. Mono filter (not HI-FI) x 1 + mono ring modulator (not HI-FI) x 1 = 4
7. Normal mono playback x 2 + normal source pad playback x 1 = 4
8. Stereo playback from a memory card x 1 = 4

Section 2. Sampling

Please note that Banks A/B in the SP-202 and Banks C/D in the memory card have different numbers of voices of the samples and different ways of handling the effects (Refer to "Maximum polyphonic and priority" on page 19). Therefore, select which bank you should sampling, after considering the above points.

If you have already sampled a sound to every pad, or if you have used up the available sampling time, you will need to first delete one or more unwanted samples, and then record your new sample to a vacant pad.

(Refer to page 25, "Deleting an individual sample")

- * Unauthorized sampling from a CD, record, tape, video production, or broadcast etc. whose copyright is owned by a third party is forbidden by law, with the exception of special cases such as private use.

Sampling from a microphone

When the SP-202 is shipped from the factory, the pads of bank B are vacant. Let's try sampling to these pads.

In the procedure given below, we will use an external microphone to record a sample to pad 2 of bank B.

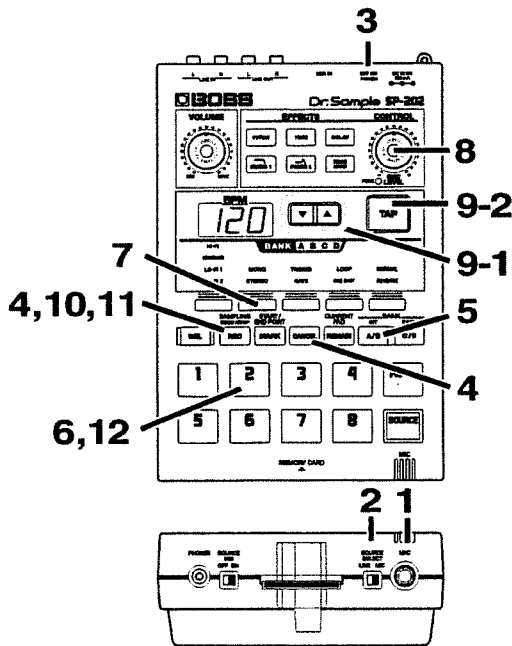

1. Connect an external microphone to the MIC jack.
2. Set the SOURCE SELECT switch to MIC.
3. Turn the power switch ON.

4. Press the SAMPLING START/STOP button.

The REC button will blink, and the SP-202 will enter standby mode.

- * If at this point you wish to stop sampling, press the CANCEL button. The REC button will go dark.

5. Press the BANK INT A/B button to make B light.

6. Press pad 2.

7. Make sure that MONO is lit.

If STEREO is lit, press the MONO/STEREO button to make MONO lit.

- * Even if you sample with a setting of STEREO, the same sound will be recorded for both L and R if the input is monaural. In this case, the sound will be the same as if you had sampled using MONO, but it will use two notes of polyphony.

8. While the desired sound is being picked up by the microphone, rotate the REC LEVEL knob to adjust the sampling level so that PEAK lights occasionally.

If you make the BPM (tempo) setting before you begin sampling, pressing the SAMPLING START/STOP button will cause the stop time (End Point) to automatically be set to a beat of the BPM value that was in effect before you pressed the button, and the MARK button will light. (Refer to page 27 "Playing only the desired portion of a sound")

There are two ways to enter the BPM. If you already know the desired setting, you can enter it numerically. If not, press the TAP pad in time with the tempo (Tap input).

9-1. To enter a numerical value, press the ▲ ▼ buttons to select the desired value.

If you continue holding down a button, the value will increase or decrease continuously.

9-2. If you wish to use Tap Input, listen to the sound that you wish to sample, and press the TAP button in time with the beat of the sound.

When you have pressed the button four times or more, the value will be input (displayed).

- * A tempo in the range of 40–200 can be specified. (When PITCH is OFF)
- * You may reverse the order of steps 5–9, or make them as many times as desired.

10. Press the SAMPLING START/STOP button.

The REC button will light, and sampling will begin.

- * Never turn off the power while sampling is in progress.

11. When you wish to stop sampling, press the SAMPLING START/STOP button. Sampling will end, and the blinking pad will go dark.

- * The BPM will automatically be calculated and displayed according to the time length that was sampled. (If BPM was input, this will be the time between the Start and End points.)

If the sampling time is two or more measures or is less than one measure, the BPM display value may be double or half the correct value. In this case, press the ▼ ▲ buttons to set the desired value. (Refer to page 25 "Viewing and changing the BPM value after sampling") Please be aware that in some cases (such as triple meter), it may not be possible to calculate or adjust the BPM value accurately.

- * If you press the blinking pad (i.e., the one currently being sampled) instead of pressing the SAMPLING START/STOP button, sampling will end, and the currently-sampled sound will automatically be played back.

12. Press the pad (2) which went dark, and the sound that you just sampled will playback.

- * Once a sound has been sampled, it is not possible to change it from mono to stereo, or from stereo to mono.

Sampling from a CD (line recording)

Let's sample a sound from the included audio CD in stereo.

In the procedure given below, we will record the sample to pad 3 of bank B.

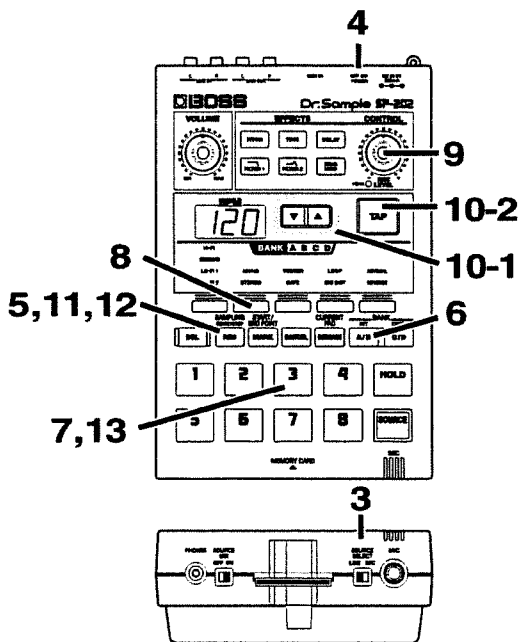

1. Connect your CD player. (page 8, 9)

2. Turn on the power of your CD player, and put the included CD in play-standby mode.

3. Set the SOURCE SELECT switch to LINE.

4. Turn the power switch ON.

5. Press the SAMPLING START/STOP button.

The REC button will blink, and the SP-202 will enter standby mode.

- * If at this point you wish to stop sampling, press the CANCEL button. The REC button will go dark.

6. Press the BANK INT A/B button to make B light.

7. Press pad 3.

8. Press the MONO/STEREO button to make STEREO light.

- * Even if you sample with a setting of STEREO, the same sound will be recorded for both L and R if the input is monaural. In this case, the sound will be the same as if you had sampled using MONO, but it will use two notes of polyphony.

9. Start playback of the CD, and rotate the REC LEVEL knob to adjust the sampling level so that PEAK lights occasionally.

When you finish making this adjustment, stop the CD player, and put it once again in play-standby mode.

If you make the BPM (tempo) setting before you begin sampling, pressing the SAMPLING START/STOP button will cause the stop time (End Point) to automatically be set to a beat of the BPM value that was in effect before you pressed the button, and the MARK button will light. (Refer to page 27 "Playing only the desired portion of a sound")

There are two ways to enter the BPM. If you already know the desired setting, you can enter it numerically. If not, press the TAP pad in time with the tempo (Tap input).

10-1. To enter a numerical value, press the ▼ ▲ buttons to select the desired value.

If you continue holding down a button, the value will increase or decrease continuously.

10-2. If you wish to use Tap Input, playback the CD, and press the TAP button in time with the beat.

When you have pressed the button four times or more, the value will be input (displayed).

- * A tempo in the range of 40-200 can be specified. (When PITCH is OFF)

* You may reverse the order of steps 6–10, or make them as many times as desired.

11. Start playback of the CD, and in synchronization with the beginning of the desired sound from the CD, press the SAMPLING START/STOP button. The REC button will light, and sampling will begin.

* Never turn off the power while sampling is in progress.

12. When you wish to stop sampling, press the SAMPLING START/STOP button. Sampling will end, and the blinking pad will go dark.

* The BPM will automatically be calculated and displayed according to the time length that was sampled. (If BPM was input, this will be the time between the Start and End points.)

If the sampling time is two or more measures or is less than one measure, the BPM display value may be double or half the correct value. In this case, use the ▼ ▲ buttons to set the desired value. (Refer to page 25 “Viewing and changing the BPM value after sampling”) Please be aware that in some cases (such as triple meter), it may not be possible to calculate or adjust the BPM value accurately.

* If you press the blinking pad (i.e., the one currently being sampled) instead of pressing the SAMPLING START/STOP button, sampling will end, and the currently-sampled sound will automatically be played back.

13. Press the pad (3) which went dark, and the sound that you just sampled will playback.

* Once a sound has been sampled, it is not possible to change it from mono to stereo, or from stereo to mono.

Hi-Fi sampling / Long sampling (Sampling Grade)

For each pad of the SP-202, you can specify one of four grades (Sampling Grades) at which the sample will be recorded. If getting a high-quality recording is more important than the length of the sample, select HI-FI (high sound quality). If sampling time is more important than the sound quality, select LO-FI 1 or 2.

* For the possible sampling times at each grade, refer to page 24 “Sampling time / Checking the remaining time.”

In the following example, we will explain the procedure for selecting LO-FI 1 and recording a long sample.

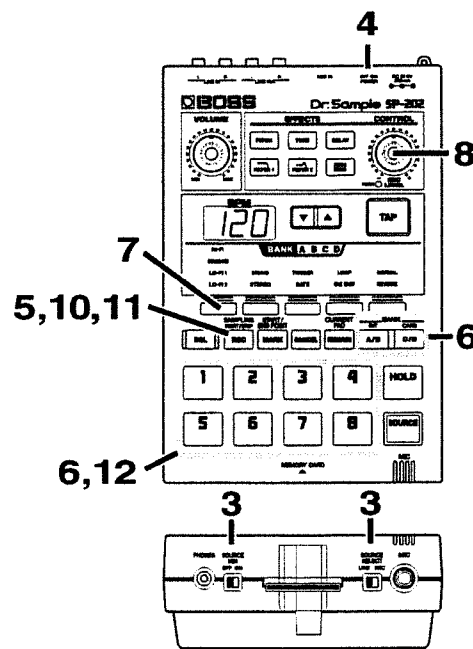

1. Connect your CD player. (page 8, 9)

2. Turn on the power of your CD player, and put the included CD in play-standby mode.

3. Set the SOURCE MIX switch to OFF, and the SOURCE SELECT switch to LINE.

4. Verify the settings you made in step 3, and turn the power switch ON.

5. Press the SAMPLING START/STOP button.

The REC button will blink, and the SP-202 will enter standby mode.

* If at this point you wish to stop sampling, press the CANCEL button. The REC button will go dark.

6. Press the BANK INT A/B button (or the CARD C/D button if you are using a memory card) and then pad to specify the bank and pad.

The selected pad will blink.

7. Press the sampling grade setting button several times until LO-FI 1 lights.

- * A certain amount of time is required for the grade to be changed. It cannot be changed while the decimal points of the BPM display are blinking. Wait for the grade to change before you press the button again.

- * By selecting LO-FI 2, you can record even longer samples than with LO-FI 1.

8. Start playback of the CD, and rotate the REC LEVEL knob to adjust the sampling level so that PEAK lights occasionally.

- * Regardless of the sampling grade, the input sound will be heard without change when you are in standby mode or during sampling.

9. Stop the CD player, and put it once again in play-standby mode at a location before the phrase that you wish to sample.

10. Start playback of the CD, and in synchronization with the beginning of the desired sound from the CD, press the SAMPLING START/STOP button.

The REC button will light, and sampling will begin.

- * Never turn off the power while sampling is in progress.

11. When you wish to stop sampling, press the SAMPLING START/STOP button. Sampling will end, and the blinking pad will go dark.

- * If you press the blinking pad (i.e., the one currently being sampled) instead of pressing the SAMPLING START/STOP button, sampling will end, and the currently-sampled sound will automatically be played back.

12. Press the pad which went dark, and the sound that you just sampled will playback.

- * Once a sound has been sampled, it is not possible to change its Sampling Grade setting.

Automatically starting sampling (Auto Sampling)

The SP-202 provides an Auto Sampling feature which automatically begins sampling when the input sound (signal) exceeds a specified level. This is convenient when you wish to begin sampling from the introduction of a song.

If you make the following settings to specify the sampling start level, sampling will begin automatically when the input exceeds the specified level.

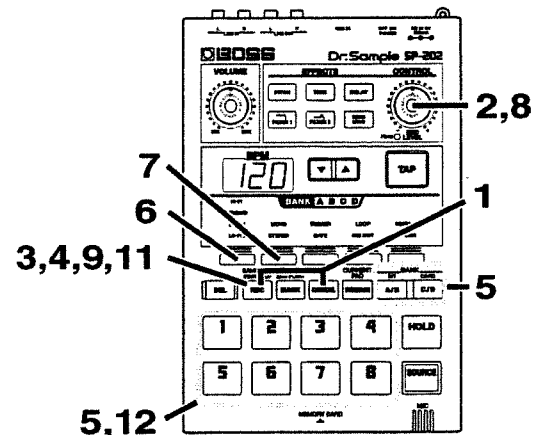

1. Hold down the CANCEL button and press the REC button.

The REC button will blink.

2. Rotate the REC LEVEL knob to adjust the level.

The level at which the PEAK indicator lights will be the sampling start level. Rotating the knob toward the right will raise the level. At this time, the BPM display will show the sampling start level (nine steps 0-8).

Example display: - 3 -

- * When the display is "- 0 -", normal sampling is selected (auto sampling will not be used).

- * If at this point you decide not to sample, press the CANCEL button. The REC button will go dark.

3. Press the REC button to set the sampling start level.

The REC button will change from lit to dark.

- * The other settings for sampling are the same as for normal sampling.

4. Press the SAMPLING START/STOP button.

The REC button will blink, and the SP-202 will be in standby mode. At the same time, the BPM display will indicate the sampling start level.

5. Press the BANK INT A/B button (or the CARD C/D button if you are using a memory card) and a pad to specify the bank and pad into which you wish to sample the sound.

The selected pad will blink.

6. Press the sampling grade setting button to set the sampling grade.

7. Press the MONO/STEREO button to specify either stereo or mono sampling.

8. Rotate the REC LEVEL knob to adjust the sampling level so that PEAK lights occasionally.

* Since this step adjusts the sampling level, the sampling start level that you specified earlier will not change.

9. Press the REC button.

The REC button will light, and the SP-202 will wait for an input signal.

10. When the input from the LINE IN or MIC rises above the sampling start level, the REC button will light and sampling will start.

When sampling starts, the display will change to “-- --”.

* Never turn off the power while sampling is in progress.

11. When you wish to stop sampling, press the SAMPLING START/STOP button. Sampling will end, and the blinking pad will go dark.

* The tempo will automatically be calculated and displayed according to the time length of the sample. (Refer to page 25 “Viewing and changing the BPM value after sampling”)

* If you press the blinking pad (i.e., the one currently being sampled) instead of pressing the SAMPLING START/STOP button, sampling will end, and the currently-sampled sound will automatically be played back.

12. Press the pad which went dark, and the sound that you just sampled will playback.

● To stop auto sampling

If you wish to stop auto sampling, use the following procedure.

1. Hold down the CANCEL button and press the REC button.

The REC button will blink.

2. Rotate the CONTROL knob all the way to the left until the BPM display reads “- 0 -”.

3. Press the REC button.

■ Sampling time / Checking the remaining time

The possible sampling times for internal memory and a memory card are as follows.

The times shown here are the total times for the sixteen samples of banks A/B (for internal memory) or banks C/D (for a memory card).

Sampling grade	Internal memory	Memory card (Optional)	
		2M byte	4M byte
HI-FI:	0m 32s	2m 14s	4m 27s
STANDARD:	1m 05s	4m 27s	8m 55s
LO-FI 1:	2m 10s	8m 55s	17m 51s
LO-FI 2:	4m 20s	17m 51s	35m 43s

* If you use stereo sampling, the possible sampling times will be half the times listed.

* When the SP-202 is shipped from the factory, bank A already contains demonstration sample sounds, meaning that the available sampling time will be less than the times shown in the above table.

● Checking the remaining sampling time

When you press the REMAIN button, the BPM display will indicate the length of time remaining if you were to record at the HI-FI setting.

(Example display)

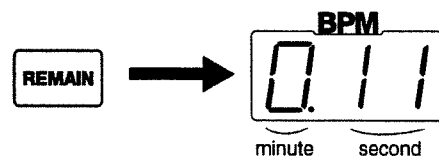

* Please be aware that the displayed remaining time may not be precisely accurate.

Deleting an individual sample

Here's how to delete just an individual sample.

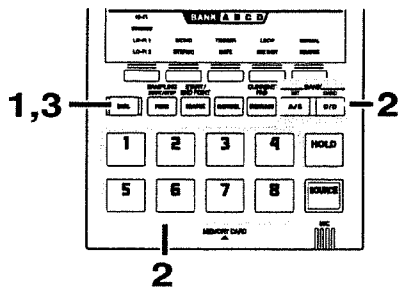

1. Press the DEL button. (Blinking)
2. Press the BANK INT A/B button (or the CARD C/D button if you are using a memory card) and press a pad to specify the bank and pad that contains the sample you wish to delete.

The selected pad will blink.

- * If you press a pad to which no sample is assigned, nothing will happen.
- * If you decide not to delete, press the CANCEL button.

3. Press the DEL button.

The DEL button will blink. When the sample has been deleted, the button will go dark.

- * Never turn off the power while the DEL button is lit.

Deleting all samples

You can delete all samples from the SP-202's internal memory or memory card in one operation.

- * The PITCH settings and MIDI settings will also be deleted at the same time.
- * If you delete all samples on the memory card, the data in the backup area (refer to page 35) will be automatically deleted. So, please check the data carefully before deleting.

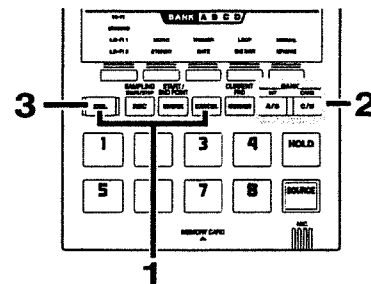

1. Hold down the CANCEL button and press the DEL button.

The DEL button will blink.

2. If you wish to delete the contents of internal memory, press the BANK INT A/B button (A and B will blink). If you wish to delete the contents of card memory, press the BANK CARD C/D button (C and D will blink).

- * If you decide not to delete, press the CANCEL button.

3. Press the DEL button (lit), and the data will be deleted.

The DEL button will blink. When the sample has been deleted, the button will go dark.

- * Never turn off the power while the DEL button is lit.

Viewing and changing the BPM value after sampling

If you did not set the BPM before sampling, the BPM will be calculated automatically from the time length of the sample, and displayed.

- * Since the decimal place of the BPM is rounded up or down, a slight error may occur.

Depending on the sampling time, the calculated BPM value may be half or double the correct BPM. In this case, use the ▼▲ buttons to set the correct value.

Press ▼ to halve the displayed value, or press ▲ to double it.

Section 3. Changing how the sample plays (Editing)

The display shows the sample settings of the last-sounded pad (the current pad) or the BPM (tempo) value.

By pressing one of the edit buttons, you can modify (edit) the way in which the sample of the current pad will play.

If you have pressed two or more pads to play samples, and are unsure which pad is the current pad, press the REMAIN button. The pad which blinks is the current pad. For details refer to page 30 "Checking the current pad."

* Settings that you edit while samples are playing are saved into memory when all pads have finished sounding. For this reason, never turn off the power while sounds are playing.

Playing a phrase repeatedly (Loop Playback)

If you have sampled a phrase of several measures and wish to play it back repeatedly, use Loop Playback.

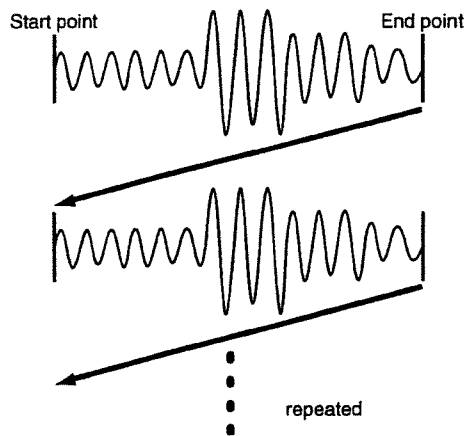

1. Press the pad which contains the sample that you wish to playback as a loop. (I.e., specify the current pad.)

The pad will light, and the sample will sound.

2. Press the LOOP/ONE SHOT button to make LOOP light.

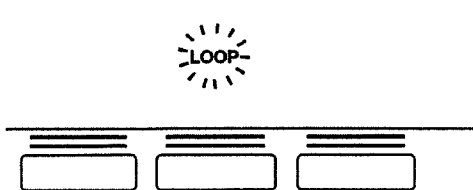

* If you make LOOP light during One Shot playback, Loop Playback will be selected immediately.

Playing the sound only once (One Shot Playback)

For sounds (such as drums) that you want to playback only once when you press the pad, use One Shot Playback.

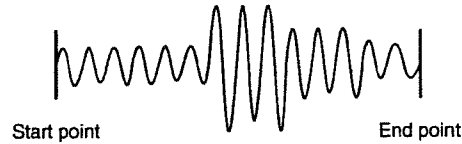

1. Press the pad which contains the sample for which you wish to specify One Shot Playback. (I.e., specify the current pad.)

The pad will light, and the sample will sound.

2. Press the LOOP/ONE SHOT button to make ONE SHOT light.

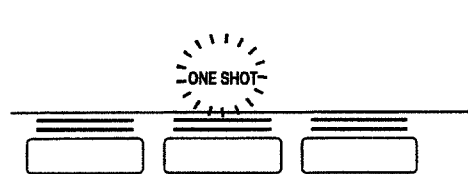

* If you make ONE SHOT light during Loop playback, One Shot Playback will be selected after the currently-playing sound has ended.

* When you playback, if there is an interval of silence at the beginning of the sound or an unwanted portion at the end of the sound, you can use the editing operation described in the following section "Playing only the desired portion of a sound."

Playing only the desired portion of a sound (Changing the Start/End Point)

On the SP-202, the area of the waveform data which will actually playback can be specified/memorized independently for each sample.

The point at which the waveform data will begin playing is called the **Start Point**, and the point at which it will stop playing is called the **End Point**.

If the sound you sampled contains unwanted material at the beginning, adjust the Start Point so that the unwanted portion is not heard. If the unwanted material is at the end, adjust the End Point. In this way, you can make only the desired portion playback.

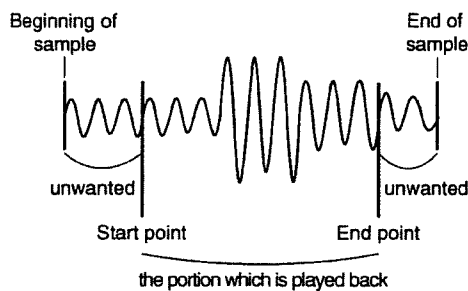

* When you modify the Start Point or End Point settings, the BPM will be calculated according to the newly specified time, and displayed. If the sampling time is two or more measures or is less than one measure, the BPM display value may be double or half the correct value. In this case, use the ▼ ▲ buttons to set the desired value. (Refer to page 25 "Viewing and changing the BPM value after sampling")

Also, please be aware that in some cases (such as triple meter), it may not be possible to calculate or adjust the BPM value accurately.

● Adjusting both the Start and End points

1. Press the pad to which the sample you wish to edit is assigned. (Specify the current pad)

The pad will light, and the sample will sound.

* For gate playback, continue pressing the pad.

2. At the location where you wish to set the Start Point, press the MARK button.

The MARK button will blink, and the BPM display will indicate "-- --".



* If you now set the BPM (tempo), the End Point will automatically be adjusted to the location of the beat closest to the timing (i.e., an interval of beats measured from the Start Point according to the BPM value) which set when you next press the MARK button. You can select the desired BPM value either by pressing the ▼ ▲ buttons, or by pressing the TAP pad four times or more in time with the tempo.

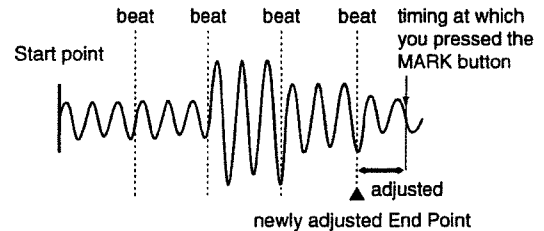

3. At the location where you wish to set the End Point, press the MARK button once again.

When the MARK button lights, the setting is completed.

* If the setting was not made as desired, press the lit MARK button while the sound is still playing to make it go dark, and re-do the procedure from step 1.

● Adjusting only the End Point

1. Hold down the MARK button, and press the pad which contains the sample that you wish to edit. (Specify the current pad)

The pad will light, and the sample will sound.

* In the case of Gate playback, continue holding the pad.

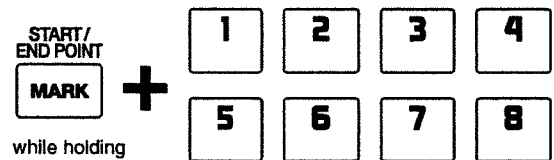

2. Release the MARK button.

The MARK button will blink, and the BPM display will indicate "-- --".

* If you now set the BPM (tempo), the End Point will automatically be adjusted to the location of the beat closest to the timing (i.e., an interval of beats measured from the Start Point according to the BPM value) which set when you next press the MARK button. You can select the desired BPM value either by pressing the ▼ ▲ buttons, or by pressing the TAP pad four times or more in time with the tempo.

3. At the location where you wish to set the End Point, press the MARK button.

When MARK lights, the setting is complete.

* If the setting was not made as desired, press the lit MARK button while the sound is still playing to make it go dark, and re-do the procedure from step 1.

● Adjusting only the Start Point (End Point is the end of the sample)

1. Hold down the MARK button, and press the pad which contains the sample that you wish to edit. (Specify the current pad)

The pad will light, and the sample will sound.

* In the case of Gate playback, continue holding the pad.

2. When you reach the desired Start Point, press the MARK button.

The MARK button will blink.



3. Press the pad (or in the case of Gate playback, release the pad) to stop playback.

The MARK button will light, and the setting will be completed.

* If the setting was not made as desired, press the lit MARK button while the sound is still playing to make it go dark, and re-do the procedure from step 1.

Deleting unwanted portions (Truncate)

When you specify the Start/End Points (page 27–28), unused portions of waveform data will occur. By deleting (Truncating) these portions, you can make more efficient use of memory.

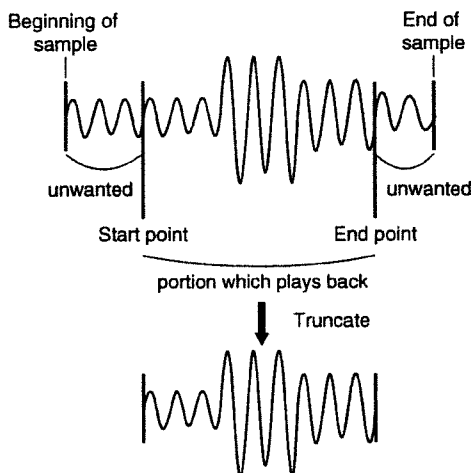

1. Press the pad which contains the sample that you wish to Truncate. (Specify the current pad)

The pad will light, and the sample will sound.

2. Make sure that the Start and End Points have been set (the MARK button is lit).

3. Press the DEL button.

The DEL button will blink.



4. Press the MARK button.

The MARK button will blink.

5. Press the DEL button.

The DEL button will light, and after several seconds will go dark, indicating that the Truncate operation has been completed.

After the waveform has been Truncated, the MARK button will go dark.

* Never turn off the power while the DEL button is lit.

Reverse playback (play backward)

Reverse playback makes the sample play backward, producing an effect similar to when a tape is played backward.

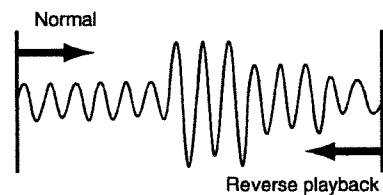

1. Press the pad which contains the sample that you wish to playback in reverse. (Specify the current pad)

The pad will light, and the sample will sound.

2. Press the NORMAL/REVERSE button to make REVERSE light.

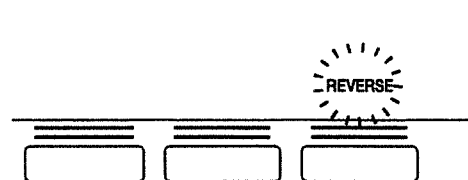

- * When Reverse playback is selected, the relation of the Start and End points will be inverted.
- * Each time you press the button, the setting will alternate between Normal and Reverse playback.
- * *It is not possible to use both Reverse Playback and Effects (page 31) simultaneously. The last-pressed button will take priority.*
- * *It is not possible to Reverse Playback a sample from a memory card.*

Make the sound play only while you press the pad (Gate Playback)

When a sound is sampled, Trigger Playback is automatically selected. (The sound will alternate between playback/stopped each time the pad is pressed, and the sample will continue repeating while the pad is lit.)

If you select Gate Playback, the sample will play when you press the pad, and will stop when you release the pad. I.e., the sample will play only while the pad is being pressed.

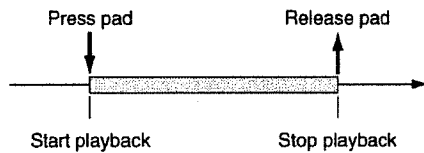

1. Press the pad which contains the sample for which you wish to select Gate Playback. (Specify the current pad)

The pad will light, and the sample will sound.

2. Press the TRIGGER/GATE button to make GATE light.



- * Each time you press TRIGGER/GATE, you will alternate between Gate Playback and Trigger Playback.
- * If ONE SHOT is lit, playback will automatically stop and the pad will go dark when the end of the sample is reached, even if you continue pressing the pad.

Make the sound continue playing even if you release the pad (Trigger Playback)

With Trigger Playback, the sound will alternate between playback/stopped each time the pad is pressed, and the sample will continue repeating while the pad is lit.

Use Trigger Playback when you wish to continue playing long phrases or looped phrases.

You will also use Trigger Playback to play samples such as drums, so that the sample will be played all the way to the end even if the pad is pressed for a brief moment.

- * After a sample is recorded, Trigger Playback will be selected automatically.

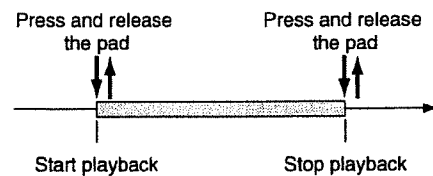

1. Press the pad which contains the sample for which you wish to select Trigger Playback. (Specify the current pad)

The pad will light, and the sample will sound.

2. Press the TRIGGER/GATE button to make TRIGGER light.



- * Each time you press TRIGGER/GATE, the setting will alternate between Gate Playback and Trigger Playback.
- * If ONE SHOT is lit, playback will automatically stop and the pad will go dark when the end of the sample is reached, even if you continue pressing the pad.

Checking the current pad

Settings for the current pad (the pad which last began playback) are shown in the display. If you have pressed two or more pads to play samples, you can use the following procedure to check which pad is the current pad.

1. Press the **REMAIN** button.

The current pad will continue blinking while you hold down the **REMAIN** button.

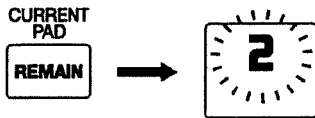

- * By pressing an edit button, you can edit the sample that is assigned to the blinking pad.
- * By holding down the **REMAIN** button and pressing a pad 1–8, you can change the current pad without sounding its sample. This is convenient when you wish to edit during a performance.
- * The changed current pad will be treated as the last-played note.

Section 4. Using effects

The SP-202 contains six types of effect.

- If you use an effect other than *PITCH*, the number of possible simultaneous notes will decrease (refer to page 19 "Maximum polyphony and note priority"). This means that there will be limitations such as not being able to play multiple samples at once, or that when multiple samples are sounding, turn on an effect button may cause the first-sounded sample to stop playing.
- Only one of the TIME/DELAY/FILTER1/FILTER2/RING MOD effects can be used for each sample. PITCH can be used simultaneously with one other effect. In this case, two of the EFFECTS buttons will light.
- The CONTROL knob will adjust the effect of the last-pressed button.

You can press the REMAIN button to verify which button will be affected by the CONTROL knob. When REMAIN is pressed, the button that will be affected by the CONTROL knob will blink.

If you want the CONTROL knob to affect a different effect button, hold down the REMAIN button and press the desired effect button.

- PITCH cannot be set independently for each sample. Once it has been set, the PITCH button will remain lit, and will affect the pitch of all samples.
- If you simultaneously play two or more samples with effects, the effect button used by the current pad will light.
- When the Sampling Grade is HI-FI, only one effect can be used. (Except for PITCH)

The previously-sounding samples which had used effects will stop playing, and the effect will change to the one used by the current pad.

However if the next-pressed pad does not use an effect, the effect specified for the previous pad will be valid. At this time, the display will show the settings of the next-pressed pad (the current pad), and the effect button that was specified by the previous pad will go dark. Rotating the CONTROL knob will not change anything.

If the Sampling Grade is Standard or LO-FI 1 or 2, the effect will not be changed in this way. However it is still impossible to simultaneously play different samples which use the same effect. If you attempt to do so, the previously-sounding sample will be stopped, and the sample of the newly-pressed pad will play. In the same way, turning on the same effect for a sample while it is sounding will cause the previously-sounding sample to be stopped.

- You cannot use the TIME/DELAY effects for the samples stored in Banks C/D no matter what sampling grade is selected.
- It is not possible to use Reverse Playback at the same time as an effect. The last-specified of the two will be valid.
- Effect settings (on/off, control) that you make while a sample is sounding will be saved into memory after all pads have finished playing. For this reason, never turn off the power while pads are sounding.

Pitch (and tempo) change (Pitch Control)

You can change the pitch of a sample. The tempo will also change at the same time. This will not affect the maximum polyphony. The pitch control can be used at the same time as one other effect.

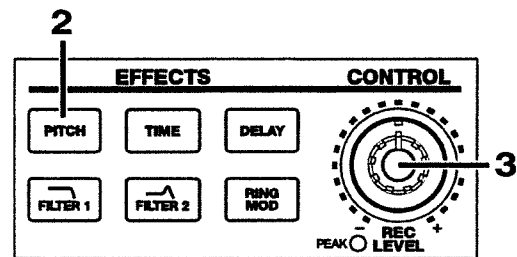

1. Press the pad that contains the sample whose pitch you wish to change. (Specify the current pad)
The pad will light, and the sample will sound.
 2. Press the PITCH button to make the button light.
 3. Rotate the CONTROL knob to adjust the pitch.
The pitch can be adjusted over a range of -20- +10% relative to the BPM value.
- * Pitch control cannot be set independently for each sample. Once you set the pitch, the PITCH button will remain lit, and the pitch of all samples will be affected.

Tempo change without affecting the pitch (Time Stretch)

If you wish to consecutively playback samples which have the same key (pitch) but a different tempo, you can use the Time Stretch function so that the natural tempo will be preserved.

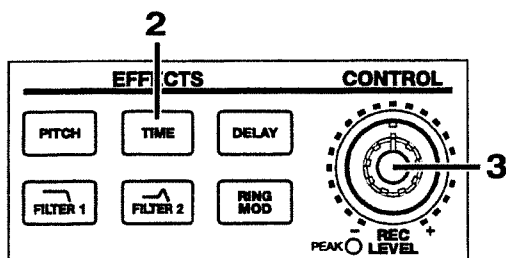

1. Press the pad that contains the sample whose tempo you wish to change. (Specify the current pad)

The pad will light, and the sample will sound.

2. Press the TIME button to make the button light.

3. Rotate the CONTROL knob to adjust the tempo.

The tempo can be adjusted over a range of -50, -24+ +25% relative to the BPM value.

- * Time Stretch can be specified independently for each sample.
- * Depending on the specified tempo, the sound may appear to "sway."

- * **Time Stretch cannot be used in the following situations**

- On stereo samples
- On samples that were recorded to banks C/D
- When reverse playback is used

Pitch change without affecting the tempo (Pitch Control and Time Stretch)

By using Pitch Control and Time Stretch together, you can modify only the pitch without changing the tempo.

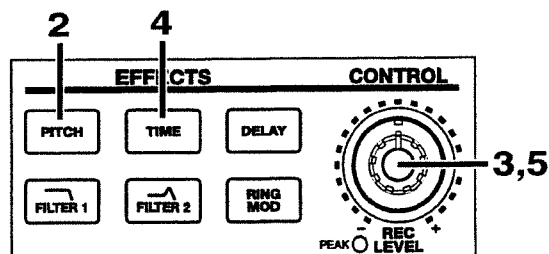

1. Press the pad that contains the sample whose pitch you wish to change. (Specify the current pad)

The pad will light, and the sample will sound.

2. Press the PITCH button to make the button light.

3. Rotate the CONTROL knob to adjust the pitch.

The tempo will also change.

4. Press the TIME button to make the button light.

5. Rotate the CONTROL knob to return the tempo to its original value.

- * Since both Pitch Control and Time Stretch are limited in the range of the change they can produce, it is not possible to create drastic changes.
- * By lowering the pitch, you can create sounds that have a strong "Lo-Fi" atmosphere.
- * When you change the pitch, the pitch of all samples will change.

Using delay

When delay is activated, the sample will play a second time (producing the delayed portion), beginning a predetermined amount of time after the start of the first playback.

- * When the sample playback stops (the pad goes dark), the delay sound will also stop, and will not sound further.

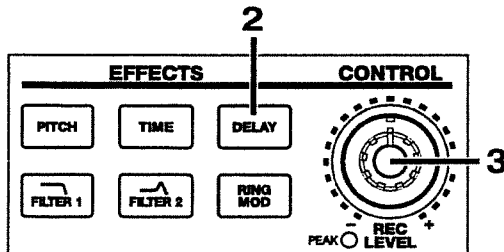

1. Press the pad which contains the sample to which you wish to apply delay. (Specify the current pad)
The pad will light, and the sample will play.

2. Press the DELAY button to make it light.

3. Rotate the CONTROL knob to adjust the delay time.

The delay time can be adjusted in the following 13 steps relative to the BPM value (tempo):

64th note, dotted 64th note, 32nd note, dotted 32nd note, 16th note, dotted 16th note, 8th note, dotted 8th note, quarter note, dotted quarter note, half note, dotted half note, and whole note.

Rotate the knob toward the left to shorten the delay time, or toward the right to lengthen the delay time.

- * You can set the delay time independently for each sample.

- * Delay cannot be used in the following situations

- On stereo samples
- On samples that were recorded to banks C/D
- When reverse playback is used

Using a filter

By using a filter you can make the tone brighter/darker, or add a distinctive character.

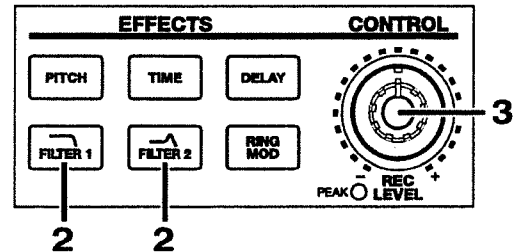

1. Press the pad which contains the sample to which you wish to apply a filter. (Specify the current pad)
The pad will light, and the sample will play.

The pad will light, and the sample will play.

2. Press the FILTER 1 or FILTER 2 button to make the button light.

FILTER 1: This filter attenuates the high frequency range of the sound. (Low Pass Filter)

FILTER 2: This filter applies resonance to give a tone a distinctive character.

3. Rotate the CONTROL knob to adjust the effect of the filter (cutoff frequency).

Rotating the knob toward the left will make the tone darker.

- * The filter can be adjusted independently for each sample.
- * If you select FILTER 2 and rotate the knob to left and right as you play the sample, a "wah" effect can be produced.

- * Filter cannot be used in the following situations

- On stereo samples that were recorded to banks C/D
- When reverse playback is used

Using the ring modulator

By using the ring modulator, you can create special effects such as changing a human voice into a mechanical-sounding robot voice, or apply it to a phrase to modifying the sense of pitch. By modifying this in time with the rhythm, you can also create unique accents.

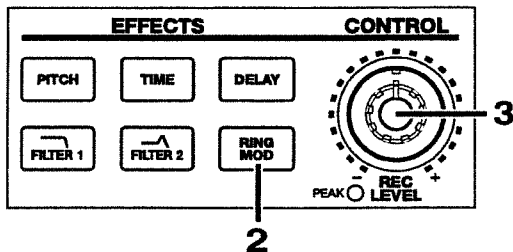

1. Press the pad which contains the sample to which you wish to apply the ring modulator. (Specify the current pad)

The pad will light, and the sample will play.

2. Press the RING MOD button to make the button light.
3. Rotate the CONTROL knob to adjust the ring modulator effect.

* The ring modulator effect can be adjusted independently for each sample.

* Ring modulator cannot be used in the following situations

- On stereo samples that were recorded to banks C/D
- When reverse playback is used

Applying an effect to the external input

Filter 1 or 2 or the ring modulator (only one of these at a time) can be applied to the external input of the SP-202.

1. Turn the SOURCE MIX switch OFF.
2. If you wish to apply the effect to the mic input, set the SOURCE SELECT switch to MIC. If you wish to apply the effect to the line input (LINE IN), set the SOURCE SELECT switch to LINE. Then turn the power switch ON.
3. Press the SOURCE pad to make the pad light.



4. Rotate the SP-202's VOLUME to an appropriate level, and while gradually raising the volume of your amp or monitor speaker, speak into the microphone or playback the CD, etc.
5. Press either the FILTER 1, FILTER 2 or RING MOD button to make the button light.
6. When you no longer wish to apply the effect, press the button once again to make it go dark.

● If noise is a problem

If distortion occurs because the input level is too high, or noise is a problem because the input level is too low, you can adjust the input level.

1. Press the REC button.
The button will blink.
2. Rotate the CONTROL knob to adjust the input level.
Rotating it toward the left will decrease the level, and rotating it toward the right will increase the level. Adjust the level so that the PEAK indicator lights occasionally.

3. Press the CANCEL button.

* You can also adjust the volume of the microphone or external input by rotating the CONTROL knob while holding down the CANCEL button.

In this way, however, the PEAK indicator do not light, so adjust the volume as you actually listen to the sound.

Section 5. Saving data to a memory card

As memory cards, the SP-202 is able to use two types of SmartMedia (S2M-5/S4M-5) sold by Roland.

S2M-5: 2 Mbytes

S4M-5: 4 Mbytes

* For details on using SmartMedia, refer to the SmartMedia owner's manual.

● Inserting a memory card

Making sure that the memory card (SmartMedia) is oriented correctly, insert it all the way into the slot.

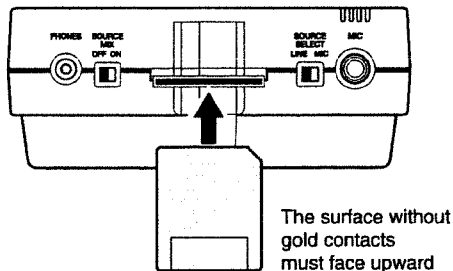

In addition to the 16 samples of banks C/D, a 2 Mbyte memory card (SmartMedia) can store (backup) up to 3 sets of internal data, and a 4 Mbyte card can store up to 7 sets of internal data in a backup area.

- * Once this portion is used as a backup area, the possible sampling time will be correspondingly less. If you wish to use long samples, either re-format the card or purchase additional SmartMedia cards.
- * If you record long samples to card memory, the backup area will be correspondingly decreased, but you can increase the backup area by recording short samples.

(More backup areas)

Sampling data	Backup area	Backup area	Backup area
C1-D8	1	2	3

(More sampling data)

Sampling data	Backup area
C1-D8	1

When you insert a memory card into the SP-202, the decimal points of the BPM display will blink for a while, and the unit will temporarily not accept button operations or MIDI messages. The same applies when the SP-202's power is turned on with a memory card already inserted.

Formatting a memory card

Before the SP-202 can use a newly purchased SmartMedia card or a card which was used by another device, the card must be formatted (initialized) by the SP-202.

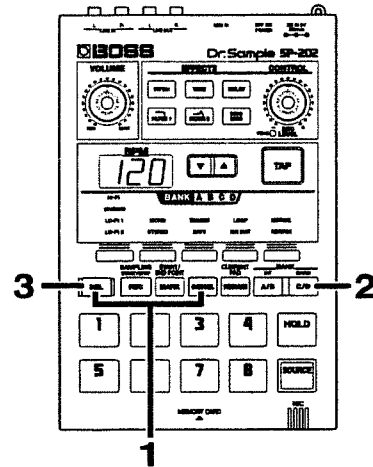

1. Hold down the CANCEL button, and press the DEL button.

The DEL button will blink.

2. Press the BANK CARD C/D button.

BANK C and D will blink.

* If you decide to cancel the format operation, press the CANCEL button.

3. Press the DEL button, and formatting will begin.

* Never turn the power off or remove the card from the slot while the DEL button is lit.

* When you format a card, all data that was in the card will be erased.

* In some cases, a SmartMedia card which was formatted by the SP-202 may no longer be usable by other SmartMedia-compatible devices.

Saving to a memory card (Save)

A set of the 16 samples in banks A/B of the SP-202's internal memory can be saved (backed up) to a backup area on a memory card.

Data that has been saved in this way cannot be played back until it is once again loaded into the SP-202.

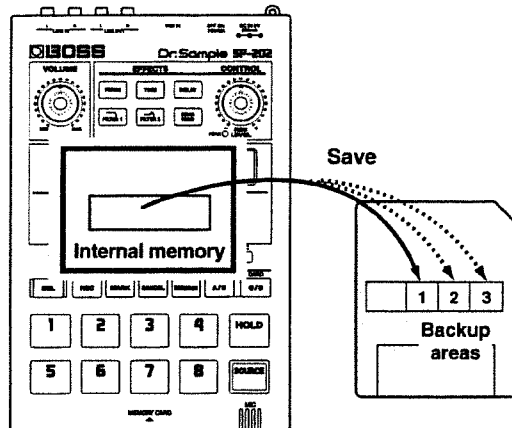

1. Hold down the CANCEL button, and press the BANK CARD C/D button.

The REC button will blink.

2. Press a pad to specify the number of the area into which you wish to save the data.

The pad that you pressed will blink.

- * If you decide to cancel the Save operation, press the CANCEL button.
- * In the case of a card to which you are saving data for the first time, it will only be possible to select 1, and pad 1 will blink when you press it.
- * For the second and subsequent Save operations to a card, the pads will light to indicate the corresponding areas which contain data. At this time, data can be saved to the areas which correspond to pads which are lit (overwrite) and the pad immediately following the lit pads (the new save destination). When you press one of these pads, it will blink.

3. Press the REC button.

The REC button will light, and the Save process will begin. While this button is lit, do not turn the power off or remove the card from the slot.

When saving has been finished, the REC button will go dark.

- * In some cases, a SmartMedia card which was used by the SP-202 may no longer be usable by other SmartMedia-compatible devices.

Loading data from a memory card (Load)

A set of data (16 samples) that was saved to a memory card can be re-loaded into internal memory in a single operation.

- * When this operation is performed, the internal data of the SP-202 will be overwritten. Be sure to make a backup of important data before you do this.

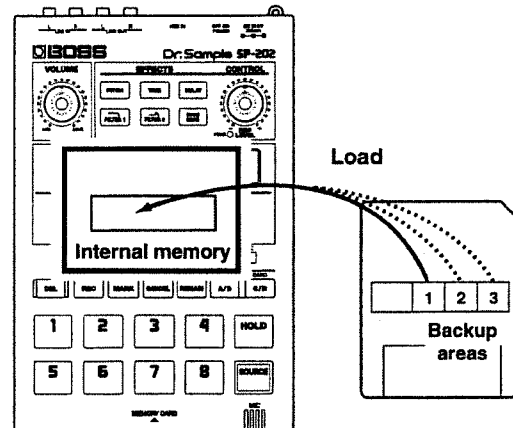

1. Hold down CANCEL and press the BANK INT A/B button.

The REC button will blink, and pads corresponding to card areas which contain data will light.

2. Press a pad to specify the card area that you wish to load into internal memory.

The pad you pressed will blink.

- * If you decide to cancel the Load operation, press the CANCEL button.

3. Press the REC button.

The REC button will light, and loading will begin. While this button is lit, do not turn the power off or remove the card from the slot.

When loading has been finished, the REC button will go dark.

Protecting data on a memory card

Write protect stickers are included with SmartMedia.

By affixing a sticker to the SmartMedia card, you can prohibit writing and erasing of data.

To avoid accidental erasure of data from SmartMedia which contains important data, we recommend that you affix a write protect sticker.

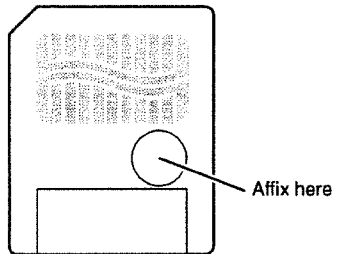

- * It is not possible to sample to a memory card (banks C/D) to which a write protect sticker is affixed.

Section 6. Using the SP-202 as a MIDI sound source

"MIDI" stands for Musical Instrument Digital Interface, and is a world-wide standard for exchanging musical performance data and sound data between electronic musical instruments and devices.

By using MIDI, you can play the SP-202 from an external MIDI device such as a sequencer or keyboard.

Use a MIDI cable to connect the MIDI OUT of the external MIDI device to the MIDI IN of the SP-202. (Refer to the connection diagram on page 8, 9)

In addition, you will need to set the transmit channel of the external MIDI device and the receive channel of the SP-202 to the same settings.

* For details on settings for your MIDI device, refer to its owner's manual.

Setting the MIDI channel

When shipped from the factory, the SP-202's receive channel is set to 1. If you wish to change this to a different channel, use the following procedure.

1. Make sure that the power is OFF.
- 2-1. If you wish to select a channel in the range of 1-8, turn the power ON while holding down the correspondingly-numbered pad 1-8.
- 2-2. If you wish to select a channel in the range of 9-16, turn the power ON while holding down the HOLD pad together with pad 1-8 that is eight less than the desired channel number.

The MIDI channel will be set to a value of 8 plus the pad number.

Example: To select channel 10, hold down the HOLD pad together with pad number 2, and turn the power ON.

* The MIDI channel setting is remembered even when the power is turned OFF.

Normal use

When the SP-202 is shipped, its pads correspond to MIDI note numbers as shown below.

● Note numbers and pads

Pads	SOURCE	A1	A2	A3	A4	A5	A6	A7	A8
Note	B1	C2	C#2	D2	D#2	E2	F2	F#2	G2
Note number	35	36	37	38	39	40	41	42	43
Pads	B1	B2	B3	B4	B5	B6	B7	B8	
Note	G#2	A2	A#2	B2	C3	C#3	D3	D#3	
Note number	44	45	46	47	48	49	50	51	
Pads	C1	C2	C3	C4	C5	C6	C7	C8	
Note	E3	F3	F#3	G3	G#3	A3	A#3	B3	
Note number	52	53	54	55	56	57	58	59	
Pads	D1	D2	D3	D4	D5	D6	D7	D8	
Note	C4	C#4	D4	D#4	E4	F4	F#4	G4	
Note number	60	61	62	63	64	65	66	67	

Receive channel: 1

When the SP-202 receives Note messages (note-on, note number) from an external MIDI device on the matching MIDI channel, the bank/pad corresponding to the received note number will light, and the sample assigned to that pad will play.

* If the pads do not light and the samples do not play, check the MIDI channel and the note numbers.

Using the SP-202 as a rhythm sound module

This section will explain how you can (for example) "use sounds that were sampled on the SP-202 to play the rhythm part of a GS sound source device."

Channel 10 is normally used for the rhythm part, so you will need to set the MIDI channel of the SP-202 to channel 10, and assign the pads to note numbers which are not used by the rhythm part of a GS sound source.

The SP-202 provides an easy way to make these settings.

1. Make sure that the power is OFF.
2. While holding down the SOURCE pad and the HOLD pad, turn the power ON.

The following settings will be made.

● Note numbers and pads

Pads	SOURCE	A1	A2	A3	A4	A5	A6	A7	A8
Note	B1	C7	C#7	D7	D#7	E7	F7	F#7	G7
Note number	95	96	97	98	99	100	101	102	103
Pads	B1	B2	B3	B4	B5	B6	B7	B8	
Note	G#7	A7	A#7	B7	C8	C#8	D8	D#8	
Note number	104	105	106	107	108	109	110	111	
Pads	C1	C2	C3	C4	C5	C6	C7	C8	
Note	E8	F8	F#8	G8	G#8	A8	A#8	B8	
Note number	112	113	114	115	116	117	118	119	
Pads	D1	D2	D3	D4	D5	D6	D7	D8	
Note	C9	C#9	D9	D#9	E9	F9	F#9	G9	
Note number	120	121	122	123	124	125	126	127	

Receive channel: 10

With these settings, the rhythm part of a GS sound source can be used simultaneously with the SP-202, and separate Note messages can be used for the rhythm notes of the GS sound source and for the samples of the SP-202.

- * When this procedure is performed, the MIDI channel will automatically be set to 10. If you wish to change the MIDI channel, refer to "Setting the MIDI channel."
- * This setting is remembered even if the power is turned OFF.
- * By holding down the SOURCE pad and turning the power ON, you can bring back the factory settings.

Restoring the MIDI settings to their factory values

If you wish to restore the MIDI settings to their factory values, use the following procedure.

1. Make sure that the power is OFF.
2. Hold down the SOURCE pad and turn the power ON.

Notes when using MIDI

When playing the SP-202's samples from an external MIDI device, the timing at which Note messages must be transmitted from the external MIDI device will be different depending on whether you are using Trigger Playback or Gate Playback to play the samples, even if you wish to play the samples for the same length of time.

(In the case of Trigger Playback)

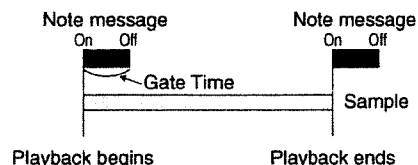

If you are using Trigger Playback, in which the playback will start/stop each time the pad is pressed, transmit Note messages at the playback start and at the playback end points. In this case, it will not matter how short the gate time of each Note message is.

(In the case of Gate Playback)

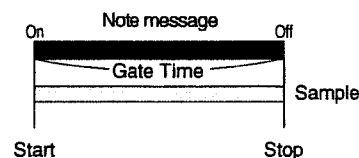

If you are using Gate Playback, in which the playback will continue only while the pad is pressed, transmit a Note message with a gate time such that the Note-on message occurs at the playback start point, and the Note-off message occurs at the playback end point.

- * The SP-202 ignores velocity data. Samples will always playback at the same volume, regardless of the velocity data in the Note message that is transmitted from the external MIDI device.
- * The pad which last received a Note-on message will be the current pad.
- * If you are continually playing back a phrase loop sample in synchronization to the performance being played by a sequencer, the rhythm may drift out of synchronization as time goes on. If this occurs, use One Shot playback instead of looping the phrase, and transmit a Note-on message to the SP-202 each measure (or each number of measures according to the length of the sample).
- * It is not possible to use MIDI Clock messages to modify the BPM setting for the SP-202's samples.

Section 7. Creating break-beats

You can sample a variety of basic phrases of a few measures (mainly rhythms) from various songs, and use them as break-beats.

This section will explain how to create break-beats, and the basic procedure of how to connect these to create a song.

Using the SP-202's Time Stretch function which allows you to modify the tempo without affecting the pitch, it's also easy to connect phrases whose tempo is different.

- * Unauthorized sampling from a CD, record, tape, video production, or broadcast etc. whose copyright is owned by a third party is forbidden by law, with the exception of special cases such as private use.

Sampling various phrases

- 1. Connect your CD player. (page 8, 9)**
- 2. Turn on the power of the CD player, and put the CD in playback standby mode.**
- 3. Set the SOURCE SELECT switch to LINE.**
- 4. Make sure that the SP-202's SOURCE MIX switch is OFF and that the SOURCE SELECT switch is LINE, and then turn the SP-202's power switch ON.**
- 5. Press the SAMPLING START/STOP button.**

The REC button will blink, and the SP-202 will be in standby mode. At this time, a pad to which no sample has been assigned will be selected automatically and will blink.

 - * If you decide to cancel the sampling operation, press the CANCEL button. The REC button will go dark.
- 6. Press the BANK INT A/B button (or if you are using a memory card, the CARD C/D button) and a pad to specify the pad and bank to which the sampled sound will be assigned.**

The selected pad will blink.

 - * Even if you press a pad to which a sample is already assigned, it will not blink.
- 7. Adjust the sampling level.**

Start playback on the CD, and rotate the REC LEVEL knob to adjust the level so that PEAK lights occasionally.
- 8. Stop the CD player, and put it once again in playback standby mode.**

- 9. Start playback of the CD, and in synchronization with the beginning of the desired sound from the CD, press the SAMPLING START/STOP button.**

The REC button will light, and sampling will begin.

- 10. When you wish to stop sampling, press the SAMPLING START/STOP button. Sampling will end, and the blinking pad will go dark.**

Press the pad and listen to the sound that you just sampled. If the sound is satisfactory, press the pad to stop playback (the pad will go dark), and continue with step 11.

- * If there is an interval of silence at the beginning of the sound or an unwanted portion at the end of the sound when you playback, you can use the editing operation described in the section "Playing only the desired portion of a sound" (page 27) so that only the desired portion is heard.

● If you don't like the sound you sampled

Delete the sound that you sampled and try the procedure again from step 5. The delete procedure is as follows.

- a. Press the DEL button. (The button will blink)**
- b. Press the pad whose sample you wish to delete. (Pad will blink)**
- c. Press the DEL button.**

The DEL button will light. When it goes dark, the delete operation has been completed.

- * Never turn the power off while the DEL button is lit.

- 11. Repeat steps 5–10 to sample the desired phrases.**

- * You may skip step 6, because when you sample, the SP-202 automatically selects a pad to which no sample has been assigned.

Matching the tempo (BPM) of each sample (Time Stretch)

When you finish sampling, use the following procedure to adjust the tempo of all samples so that they match.

1. Press the pad that contains the sample whose tempo you wish to change.

The tempo value of the currently-playing sample will be displayed.

- * This tempo is automatically calculated from the sampling time, and in some cases may be 1/2 or twice the correct value. In this case, use the ▼ ▲ buttons to adjust the tempo.

2. Press the TIME button to make the button light.

3. Rotate the CONTROL knob to adjust the tempo.

After you have adjusted the tempo, press the pad to stop the playback.

4. Repeat steps 1–3 to adjust the tempo of each sample that you wish to use.

- * Even if the BPM display value is the same, there may be some margin of error. Listen to the actual sound as you adjust the BPM value.

This completes creation for your break-beats. The following section will explain how to use these to perform.

Playing break-beats

Before you begin playing, let's edit the settings so that break-beats will be easy to play.

Refer to the following table, and specify how the break-beats will sound.

■ A basic phrase that you wish to playback continuously:
TRIGGER, LOOP

■ A special effect, or a phrase that you will use to accent part of a song:
TRIGGER (GATE), ONE SHOT

■ If you wish to alternately play several phrases:
GATE, LOOP

1. Press the pad which contains the break-beat (sample) that you wish to edit.

2. Refer to the above table, and specify the way in which the sample will play (TRIGGER/GATE, LOOP/ONE SHOT).

3. Repeat steps 1–2 to make settings for each break-beat.

This completes the settings. Press pads to play break-beats.

- * With mono sampling and when effects (other than PITCH) are not used, the SP-202 is able to playback a maximum of 4 sounds simultaneously. For details refer to page 19.
- * It is not possible to simultaneously playback two samples to which Time Stretch is applied. Be aware of the limitations to polyphony as you play. (Refer to page 19 "Maximum polyphony and note priority")

Section 8. Appendix

Error messages

When the power is turned on, the BPM display indicates "Err."

Various data necessary for operation of the SP-202 is kept in internal flash memory. If the power is turned off while data is being written to the flash memory, writing will not take place correctly, and subsequent operation can be affected.

Never turn off the power in the following situations.

- While a sample is being deleted (the DEL button is lit)
- While Truncate is being performed (the DEL button is lit)
- While loading data from a memory card (the REC button is lit)
** Also do not attempt to remove the card at this time.*
- While the decimal points in the BPM display are blinking

If the Power is turned off in the above situations, the display will indicate "Err" the next time that the power is turned on, then initialize the internal data automatically. (This will cause all internal data to be lost.)

After initialization has been completed, the SP-202 will be in the same state as when the power has been turned on normally.

Troubleshooting

Effects do not work

When effects are used on the SP-202, the polyphony (the number of voices that can be played simultaneously) will decrease because of the additional processing that is required. As far as the available number of voices, using an effect is equivalent to playing more notes simultaneously.

The table "Number of voices used" on page 19 will tell you whether or not an effect can be used and the number of voices that will be available.

● Can't use Time Stretch or Delay

- These effects cannot be used on a stereo sample.
- These effects cannot be used on samples of banks C/D, even if they are mono samples.
- These effects cannot be used if you are using reverse playback.

● Can't use any effects

- Effects cannot be used on stereo samples of banks C/D.
- If you are using reverse playback, effects cannot be used even on mono samples of bank A/B.

● Effects don't apply to reverse playback

- Effects cannot be used with reverse playback.

● The currently-playing sound stops when I turn effects on

- As shown in the table on page 19, when more than four notes are requested simultaneously, one of the previously-playing sounds will be turned off before the effect is turned on.

Can't record a sample

When shipped from the factory, the SP-202 contains eight samples in bank A, with a total of approximately 20 seconds of data.

This means that you will be able to record samples totaling only 12 seconds (for Hi-Fi) or 6 seconds (for stereo sampling).

If you wish to record longer samples than this, you will need to erase some of the factory samples, or sample to a separately sold memory card (SmartMedia).

MIDI Implementation Chart

Function...	Transmitted	Recognized	Remarks
Basic Channel Default Changed	x x	1-16 1-16	Memorized
Mode Default Messages Altered	x x *****	Mode 3 x	
Note Number : True Voice	x *****	35-67	Can be changed 95-127
Velocity Note ON Note OFF	x x	O x	v=0 or 1-127
After Touch Key's Ch's	x x	x x	
Pitch Bend	x	x	
Control Change	x	x	
Prog Change : True #	x *****	x	
System Exclusive	x	x	
System Common : Song Pos : Song Sel : Tune	x x x	x x x	
System Real Time : Clock : Commands	x x	x x	
Aux Message : All sound off : Local ON/OFF : All Notes OFF : Active Sense : Reset	x x x x x	O x x x x	
Notes			

Mode 1 : OMNI ON, POLY Mode 2 : OMNI ON, MONO
Mode 3 : OMNI OFF, POLY Mode 4 : OMNI OFF, MONO

O : Yes
X : No

Specifications

SP-202: Dr.Sample

Maximum Polyphony

4 voices

Internal Memory

Samples: 16 (2 banks)

Memory Card

Samples: 16 (2 banks)

Backup: 3 (S2M-5), 7 (S4M-5)

Maximum Sampling Time

Internal:

4 minutes 20 seconds (LO-FI 2 grade)

32 seconds (HI-FI grade)

Memory Card (Optional) :

S2M-5: 17 minutes 51 seconds (LO-FI 2 grade)

2 minutes 14 seconds (HI-FI grade)

S4M-5: 35 minutes 43 seconds (LO-FI 2 grade)

4 minutes 27 seconds (HI-FI grade)

Sampling Frequency

HI-FI: 31.25 kHz

STANDARD: 15.63 kHz

LO-FI 1: 7.81 kHz

LO-FI 2: 3.91 kHz

Data Format

SP-202 Original Format

Signal Processing

AD Conversion: 16 bit

DA Conversion: 16 bit

Nominal Input Level

Input (mic) : -60 to -30 dBm

Input (line): -26 to +4 dBm

Input Impedance

50 k Ω (line)

2 k Ω (mic)

Nominal Output Level

Output (Line): -10 dBm

Output Impedance

2 k Ω

Display

7 segments, 3 characters (LED)

Connectors

Headphone Jack (stereo miniature phone type)

MIC Jack

LINE OUT Jacks (L, R)

LINE IN Jacks (L, R)

MIDI IN Connector

AC Adaptor Jack (DC 9 V)

Power Supply

DC 9 V: Dry Batteries (LR6 (AA) type) x 6,

AC Adaptor (BOSS PSA-Series: Optional)

Current Draw

200 mA

Expected battery life under continuous use:

Alkaline: 8 hours

These figures will vary depending on the actual conditions of use.

Dimensions

145 (W) x 221 (D) x 83 (H) mm

5-3/4 (W) x 8-3/4 (D) x 3-5/16 (H) inches

Weights

850 g / 1 lb 14 oz (including batteries)

Accessories

Owner's Manual

Dry Batteries (LR6 (AA) type) x 6

Roland Service

Options

SmartMedia (S2M-5, S4M-5)

AC Adaptor PSA-Series

* $0 \text{ dBm} = 0.775 \text{ Vrms}$

* *In the interest of product improvement, the specifications and/or appearance of this unit are subject to change without prior notice.*

Index

AC adaptor jack.....	7	microphone.....	20
Auto Sampling.....	23	MIDI.....	38
backup.....	35	MIDI channel.....	38
backup area.....	35	MIDI connector.....	7
bank.....	16	Mono/stereo setting button.....	6
Bank buttons.....	7	Normal/Reverse setting button.....	6
BPM.....	18, 25	note priority.....	19
BPM display.....	6	Number of voices.....	19
BPM setting buttons.....	6	One Shot Playback.....	26
break-beats.....	40	Pads.....	7
Built-in microphone.....	7	Peak indicator.....	7
Cancel button.....	7	Pitch Control.....	31
CD.....	21	Power switch.....	7
Control knob.....	6	protect.....	37
current pad.....	6, 16, 30	Remain button.....	7
delay.....	33	remaining time.....	24
Delete button.....	6	Reverse.....	28
Deleting.....	25	rhythm sound module.....	38
Deleting all samples.....	25	ring modulator.....	34
Display.....	6	sample.....	12
DJ system.....	8	sampling.....	14, 20
Edit buttons.....	6	Sampling button.....	6
Editing.....	26	Sampling Grade.....	22
Effect buttons.....	6	Sampling grade setting button.....	6
effects.....	13, 31	Sampling setting buttons.....	6
End Point.....	27	sampling start level.....	23
Err.....	42	sampling time.....	24
external input.....	34	Save.....	36
External mic jack.....	7	Source Mix.....	17
filter.....	33	Source mix switch.....	7
Formatting.....	35	Source pad.....	7, 17
Gate Playback.....	29, 39	Source select switch.....	7
Headphone jack.....	7	Start Point.....	27
Hi-Fi.....	22	Time Stretch.....	32
Hold function.....	16	Trigger Playback.....	29, 39
Hold pad.....	7	Trigger/Gate setting button.....	6
Line in jacks.....	7	Truncate.....	28
line recording.....	21	voice effector.....	15
Lo-Fi.....	22	Volume knob.....	6
Load.....	36	write protect sticker.....	37
Loop Playback.....	26		
Loop/One-shot setting button.....	6		
Mark button.....	7		
Maximum polyphony.....	19		
Memory Card.....	11, 35		
Memory card slot.....	7		

MEMO

Important

When using the SP-202, please be sure to observe the following cautions.

The SP-202 stores sample data and various data necessary for operation in its internal flash memory or a memory card.

If the power is turned off, a memory card is removed, or the battery runs down while data in flash memory or a memory card is being written or erased, the data will not be written correctly. In such cases, not only will your important data be lost, but subsequent operation of the unit may also be affected.

Never turn off the power and remove a memory card in the following situations.

- **While a sample is being deleted (the DEL button is lit)**
- **While Truncate is being performed (the DEL button is lit)**
- **While saving data to a memory card (the REC button is lit)**
- **While loading data from a memory card (the REC button is lit)**
- **While the decimal points in the BPM display are blinking**

-
- * **If the BPM display becomes darker than normal, the battery capacity has nearly run down. Please replace the battery as soon as possible.**

If the above cautions are not observed, thereby causing the data of the internal flash memory to be damaged, the display may indicate "Err" for several seconds the next time the unit is turned on, and internal data will be automatically initialized. (All internal data is lost.)

When initialization is completed, the SP-202 will then enter the same state as following a normal power-on.

If initialization is not performed automatically, and you experience problems such as *"noise mixed with the sample sound"* or *"irregularities occurring in the samples of other pads when recording or erasure is performed,"* refer to the procedure on page 25 of the owner's manual, and completely erase either the internal memory (if the problem occurred in bank A or B) or the memory card (if the problem occurred in bank C or D).



This product complies with the requirements of European Directive 89/336/EEC.

For EU Countries

FEDERAL COMMUNICATIONS COMMISSION RADIO FREQUENCY INTERFERENCE STATEMENT

This equipment has been tested and found to comply with the limits for a Class B digital device, pursuant to Part 15 of the FCC Rules. These limits are designed to provide reasonable protection against harmful interference in a residential installation. This equipment generates, uses, and can radiate radio frequency energy and, if not installed and used in accordance with the instructions, may cause harmful interference to radio communications. However, there is no guarantee that interference will not occur in a particular installation. If this equipment does cause harmful interference to radio or television reception, which can be determined by turning the equipment off and on, the user is encouraged to try to correct the interference by one or more of the following measures:

- Reorient or relocate the receiving antenna.
- Increase the separation between the equipment and receiver.
- Connect the equipment into an outlet on a circuit different from that to which the receiver is connected.
- Consult the dealer or an experienced radio/TV technician for help.

Unauthorized changes or modification to this system can void the users authority to operate this equipment.
This equipment requires shielded interface cables in order to meet FCC class B Limit.

For the USA

NOTICE

This Class B digital apparatus meets all requirements of the Canadian Interference-Causing Equipment Regulations.

For Canada

AVIS

Cet appareil numérique de la classe B respecte toutes les exigences du Règlement sur le matériel brouilleur du Canada.

 Roland®

71452478

UPC 71452478



18951

II SP-202

 **BOSS**

01341301

'98-11-B3-31K