

BOSS

SE-70 SUPER EFFECTS PROCESSOR

Owner's Manual

... ..

... ..

... ..

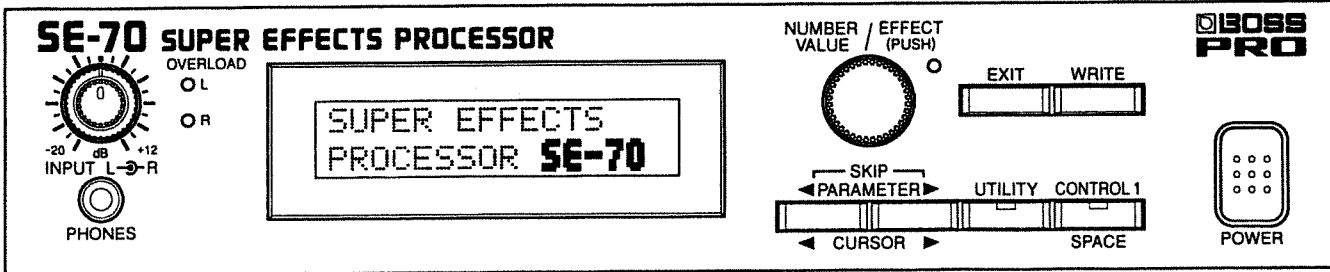

Apparatus containing Lithium batteries

ADVARSEL!

Lithiumbatteri - Eksplosionsfare ved fejlagtig håndtering.
Udskiftning må kun ske med batteri af samme fabrikat og type.
Levér det brugte batteri tilbage til leverandøren.

VARNING!

Explosionsfara vid felaktigt batteribyte.
Använd samma batterityp eller en ekvivalent typ som rekommenderas av apparattillverkaren.
Kassera använt batteri enligt fabrikantens instruktion.

ADVARSEL!

Lithiumbatteri - Eksplosjonsfare.
Ved utskifting benyttes kun batteri som anbefalt av apparatfabrikanten.
Brukt batteri returneres apparatleverandøren.

VAROITUS!

Paristo voi räjähtää, jos se on virheellisesti asennettu.
Vaihda paristo ainoastaan laitevalmistajan suosittelemaan tyyppiin. Hävitä käytetty paristo valmistajan ohjeiden mukaisesti.

Bescheinigung des Herstellers / Importeurs

Hiermit wird bescheinigt, daß der/die/das

SUPER EFFECTS PROCESSOR SE-70

(Gerät, Typ, Bezeichnung)

in Übereinstimmung mit den Bestimmungen der

Amtsbl. Vfg 1046 / 1984

(Amtsblattverfügung)

funk-entstört ist.

Der Deutschen Bundespost wurde das Inverkehrbringen dieses Gerätes angezeigt und die Berechtigung zur Überprüfung der Serie auf Einhaltung der Bestimmungen eingeräumt.

Roland Corporation Osaka / Japan

Name des Herstellers/Importeurs

FEDERAL COMMUNICATIONS COMMISSION RADIO FREQUENCY INTERFERENCE STATEMENT

This equipment has been tested and found to comply with the limits for a Class B digital device, pursuant to Part 15 of the FCC Rules. These limits are designed to provide reasonable protection against harmful interference in a residential installation. This equipment generates, uses, and can radiate radio frequency energy and, if not installed and used in accordance with the instructions, may cause harmful interference to radio communications. However, there is no guarantee that interference will not occur in a particular installation. If this equipment does cause harmful interference to radio or television reception, which can be determined by turning the equipment off and on, the user is encouraged to try to correct the interference by one or more of the following measures:

- Reorient or relocate the receiving antenna.
- Increase the separation between the equipment and receiver.
- Connect the equipment into an outlet on a circuit different from that to which the receiver is connected.
- Consult the dealer or an experienced radio/TV technician for help.

Unauthorized changes or modification to this system can void the users authority to operate this equipment.

CLASS B

NOTICE

This digital apparatus does not exceed the Class B limits for radio noise emissions set out in the Radio Interference Regulations of the Canadian Department of Communications.

CLASSE

BAVIS

Cet appareil numérique ne dépasse pas les limites de la classe B au niveau des émissions de bruits radioélectriques fixés dans le Règlement des signaux parasites par le ministère canadien des Communications.

IMPORTANT: THE WIRES IN THIS MAINS LEAD ARE COLOURED IN ACCORDANCE WITH THE FOLLOWING CODE.
BLUE: NEUTRAL BROWN: LINE

As the colours of the wires in the mains lead of this apparatus may not correspond with the coloured markings identifying the terminals in your plug proceed as follows:

The wire which is coloured BLUE must be connected to the terminal which is marked with the letter N or coloured BLACK. The wire which is coloured BROWN must be connected to the terminal which is marked with the letter L or Coloured RED.

Thank you, and congratulations on your choice of the BOSS SE-70 Super Effects Processor. The SE-70 is equipped with a wealth of high-quality effects perfect for guitars, basses, keyboards, or almost any other instrument. Additionally, a great variety of performance applications can be enjoyed by using MIDI to connect the unit with external devices.

Before starting out, please take the time to read through this manual. That way, you can feel confident that you have gained a grasp of every feature the unit provides, and will enjoy years of trouble-free service.

© Copyright 1993 by BOSS Corporation

All rights reserved. No part of this publication may be reproduced in any form without the written permission of BOSS CORPORATION.

FEATURES

Complete Selection of Effects

The SE-70 contains 35 effects and 45 algorithms (they determine the way in which effects are combined). The sound quality of individual effects rival those of many professional devices. The unit is also unusually versatile as it can be used on almost any instrument, and in demanding recording situations.

Analog Distortion

Allows you to obtain sounds with a warmth and fatness that you normally cannot get from a digital device.

Vintage Effects

Provides effects such as Slow Gear, Vibrato, and Ring Modulator which have in recent years become more difficult to find.

Sampling Capabilities

The SE-70 is equipped with its own sampler capable of recording up to 2,000 ms of sound. This allows you to obtain reverse playback by switching algorithms. It also means you can conveniently use the unit in ways which take advantage of its real-time capabilities.

Guitar and Bass Synthesis

The SE-70 is equipped with a guitar and bass synthesis feature. These can be used in the same way as the effects, without having to change any connections.

Tuner

A chromatic tuner has been included as part of the unit. For guitars and basses it displays the string name, and allows you to select from a number of tuning methods (regular, flat, or double-flat).

Metronome

The SE-70's metronome offers a complete selection of rhythms, including 8 beat, 16 beat, shuffle, and syncopation.

Real-Time Parameter Control

By using a foot-switch, expression pedal, or MIDI messages, you can obtain real-time control over parameters while you play.

2-In/2-Out Routing

The SE-70 provides for stereo input and output. This assures that the stereo image of the original input will be maintained even after effects are applied. It also allows you to process two separate signals in parallel.

MIDI Connectors

Since the SE-70 is equipped with MIDI connectors, it allows you to send the effects data to another SE-70, or into a sequencer for storage.

Mountable in 19-inch Racks

Using the optionally available RAD-50 Rack Mount Adaptor, the unit will fit perfect in a 19-inch rack.

How To Use This Manual

This manual is divided into three main sections. Together they explain the available functions, and how they are used. Also provided is a guide to all the possible settings, and instructions on how to make them.

In addition, an alphabetical index is provided at the back, making it easy to look up any functions or features you have trouble understanding.

The contents of each section are as follows:

SECTION 1 PROCESSING SOUND

1 Producing Sound

This section explains how to connect the SE-70 to your other equipment, how to select Patches, and most of the other basic procedures you need to know.

2 Creating Patches

The SE-70 allows you to create your own Patches by means of a few simple procedures. Patches can then be stored in memory. This section explains how to do this.

Patch: a collection of all the settings necessary to create a desired effects program (stored together in an easy-to-access location).

3 Settings

This section provides an explanation of the various settings that allow you to use the SE-70 in the way you require.

SECTION 2 USING MIDI

1 About MIDI

This section provides a basic introduction to the use of MIDI. Through MIDI, you will be able to use an external MIDI device to select and control the Patches on the SE-70.

2 MIDI Settings

Here the available MIDI features are explained, along with instructions on how to make settings for them.

3 Getting the Most Out of the SE-70

This section provides examples of several practical applications in which the SE-70 could be used while connected to an external MIDI device.

SECTION 3 REFERENCE

1 Reference

Here you will find information on what to do when your SE-70 is not responding as expected, along with other useful information.

TABLE OF CONTENTS

FEATURES.....	4
How to use This Manual.....	5
TABLE OF CONTENTS	6
IMPORTANT NOTES.....	8
PANEL DESCRIPTIONS.....	9

SECTION 1 PROCESSING SOUND

1 Producing Sound	12
1. Making the Connections.....	12
2. Turn on the Power.....	13
3. Adjusting the Input Level.....	14
4. Selecting Patch Numbers.....	14
1) Selection From the Panel.....	14
2) Selection Using a Foot-switch	15
3) Selection Using MIDI Messages.....	16
5. Turning Effects On/Off.....	16
1) Switching Using the Panel.....	16
2) Using a Foot-switch.....	16
3) Switching Using MIDI Messages.....	18
#Setting the Effects OFF Mode	18
2 Editing Patches	19
1. First,Some Basics About Patches.....	19
1) Composition of Patches.....	19
2) How to Edit Patches	19
2. Copying Patches	20
3. Editing the Currently Selected Patch	21
4. Revising the Patch Name	22
5. The Write Procedure	23
3 Other Settings	24
1. Using the Tuner	24
2. Using the Metronome	28
3. Setting the Mode for an Effect Remote/ Expression Pedal.....	29
4. Settings for Control 2/3	29
5. Adjusting the Display Contrast	31
6. Settings for Real-time Control Over Parameters	32

SECTION 2 USING MIDI

1 ABOUT MIDI	36
1. The Exchange of MIDI Date	36
2. MIDI Messages Recognized by the SE-70	37
2 MIDI Settings	
1. Setting the MIDI Channel and Omni Mode	39
2. Changing Patches	40
3. MIDI Control	
(Real-Time Control Over Parameters Using MIDI Messages)	42
4. Using a Foot Controller(FS-50)	44
5. Receiving and Sending Date Over MIDI	45
1) Making the Connections.....	46
2) Setting for MIDI Out/Thru.....	47
3) Date Transmission(Bulk Dump)	47
4) Date Reception(Bulk Load)	48
3 Getting the Most From Your SE-70	50
1) Setup Using a Keyboard Controller and Sound Module.....	50
2) Setup Using a Guitar	51
3) Linking Up With a Sequencer.....	52

SECTION 3 REFERENCE

Factory Preset Settings.....54

- 1. About Factory Preset Settings.....54
- 2. Restoring the Factory Presets
(Initializing the Data)54

TROUBLESHOOTING.....56

MIDI Implementation Chart.....59

SPECIFICATIONS60

INDEX.....61

INDEX TO FUNCTIONS62

IMPORTANT NOTES

Be sure to use only the adaptor supplied with the unit. Use of any other power adaptor could result in damage, malfunction, or electric shock.

[POWER SUPPLY]

When making any connections with other devices, always turn off the power to all equipment first; this will help prevent damage or malfunction.

Do not use this unit on the same power circuit with any device that will generate line noise, such as a motor or variable lighting system.

The power supply required for this unit is shown on its nameplate. Ensure that the line voltage of your installation meets this requirement.

Avoid damaging the power cord; do not step on it, place heavy objects on it etc.

When disconnecting the AC adaptor from the outlet, grasp the plug itself; never pull on the cord.

If the unit is to remain unused for a long period of time, unplug the power cord.

[PLACEMENT]

Do not subject the unit to temperature extremes (eg. direct sunlight in an enclosed vehicle). Avoid using or storing the unit in dusty or humid areas or areas that are subject to high vibration levels.

Using the unit near power amplifiers (or other equipment containing large transformers) may induce hum.

This unit may interfere with radio and television reception. Do not use this unit in the vicinity of such receivers.

[MAINTENANCE]

For everyday cleaning wipe the unit with a soft, dry cloth (or one that has been slightly dampened with water). To remove stubborn dirt, use a mild neutral detergent. Afterwards, be sure to wipe the unit thoroughly with a soft, dry cloth.

Never use benzene, thinners, alcohol or solvents of any kind, to avoid the risk of discoloration and/or deformation.

[MEMORY BACKUP]

The unit contains a battery which maintains the contents of memory while the main power is off. The expected life of this battery is 3 years or more. However, to avoid the unexpected loss of memory data, it is strongly recommended that you change the battery every 5 years. Please be aware that the actual life of the battery will depend on the physical environment (especially temperature) in which the unit is used. When it is time to change the battery, consult with qualified service personnel.

Please be aware that the contents of memory may at times be lost; when the unit is sent for repairs or when by some chance a malfunction has occurred. Important data should be stored in another MIDI device (eg. a sequencer), or written down on paper. During repairs, due care is taken to avoid the loss of data. However, in certain cases, (such as when circuitry related to memory itself is out of order) we regret that it may be impossible to restore the data.

[ADDITIONAL PRECAUTIONS]

Protect the unit from strong impact.

Do not allow objects or liquids of any kind to penetrate the unit. In the event of such an occurrence, discontinue use immediately. Contact qualified service personnel as soon as possible.

Never strike or apply strong pressure to the display.

Before using the unit in a foreign country, consult with qualified service personnel.

PANEL DESCRIPTIONS

<Front Panel>

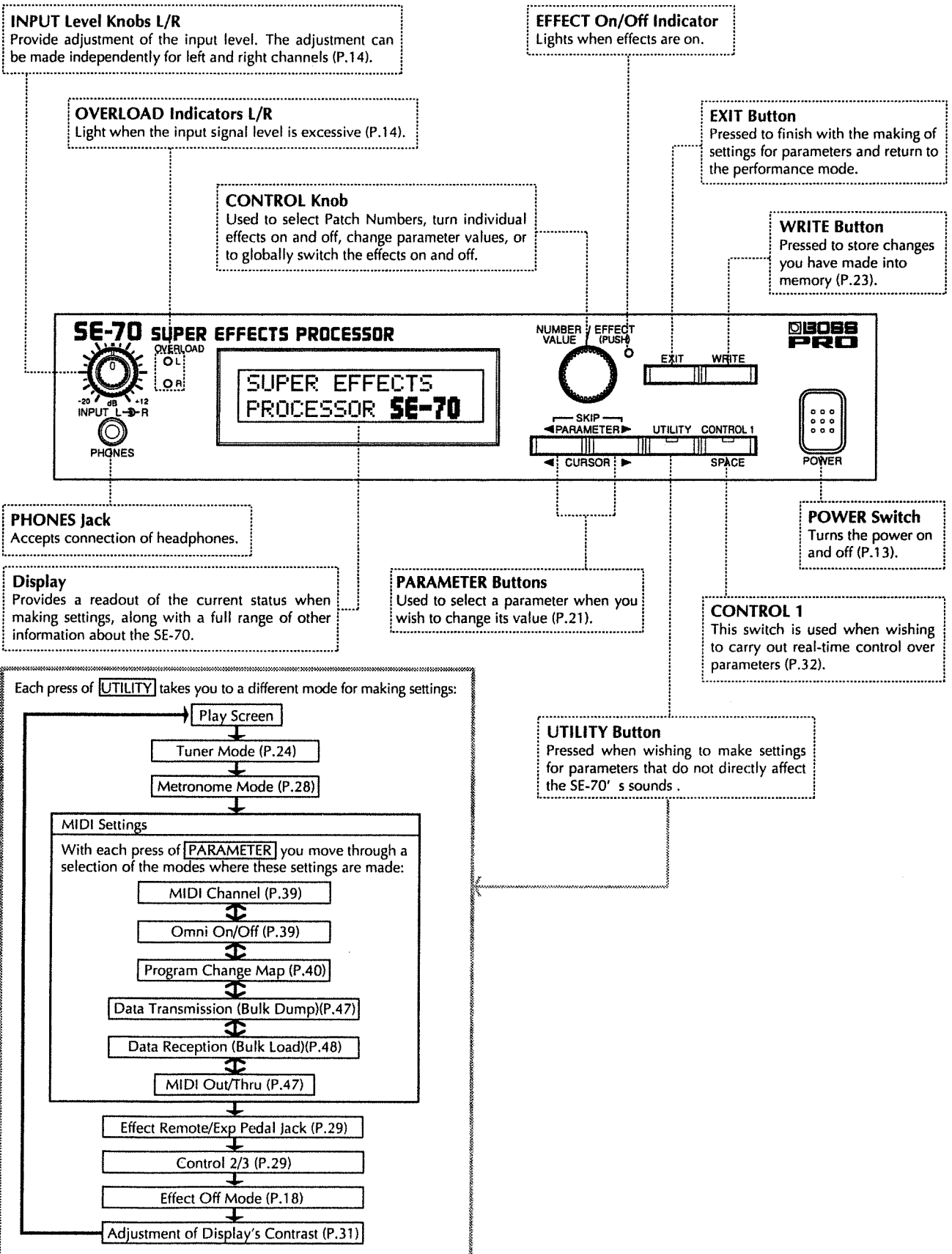

<Rear Panel>

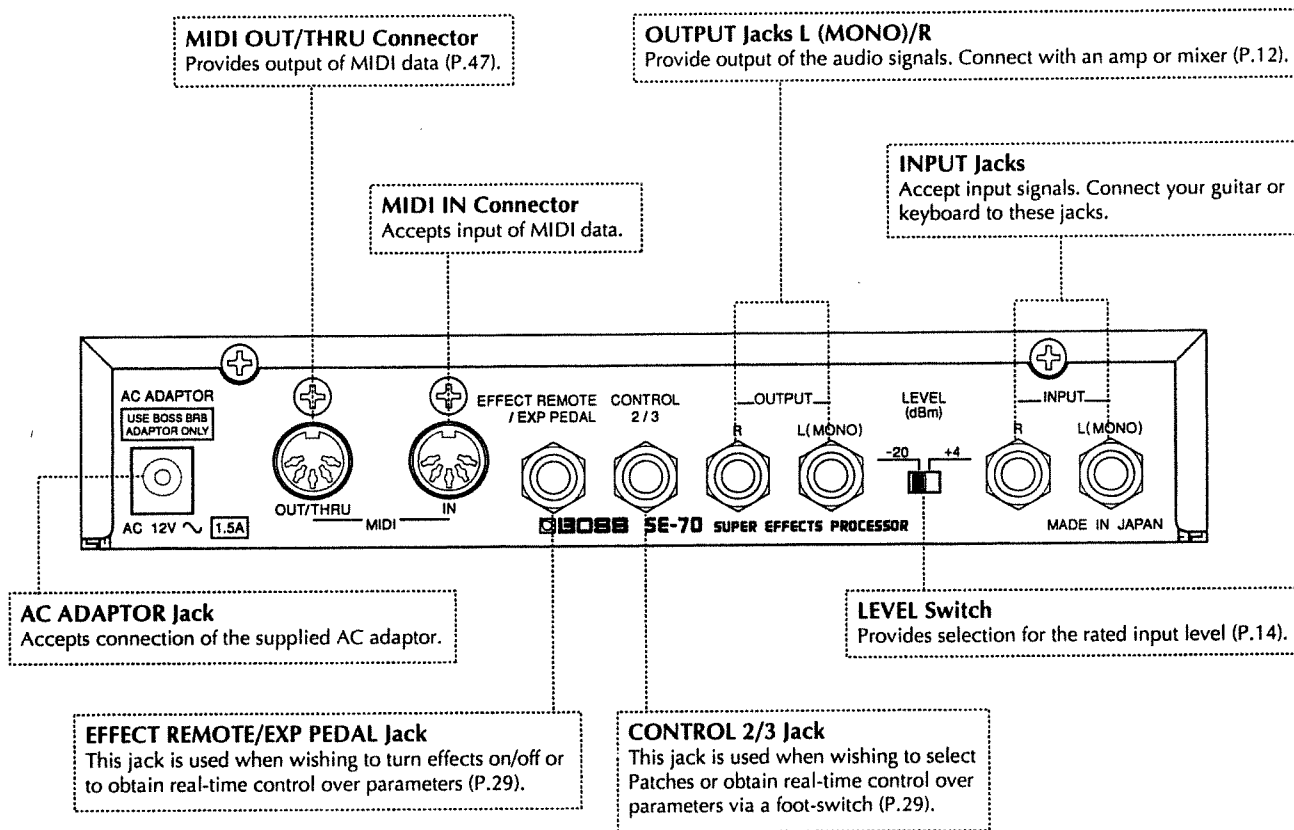

Important Note

If you are using the unit as is (ie., not going to mount it using the optional RAD-50 Rack Mount Adaptor), be sure to affix the supplied rubber feet as shown in the illustration below.

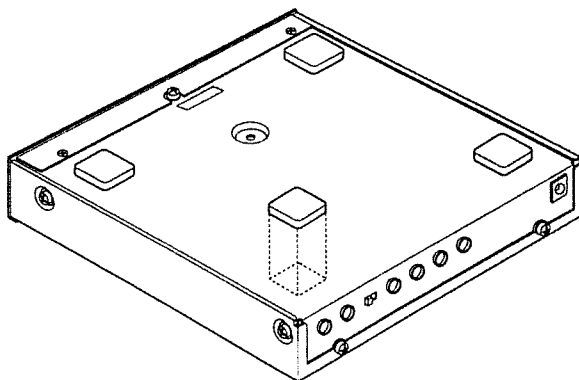



PROCESSING SOUND

SECTION

1 Producing Sound

After making the necessary connections with external devices, you'll be ready to listen to the unit's effects.

1. Making the Connections

Make the connections following one of the examples below, depending on the application you have in mind.

*** Turn off the power to all devices before attempting to make any connections. This will help prevent damage or malfunction.**

Setup using a mixer's Send/Return

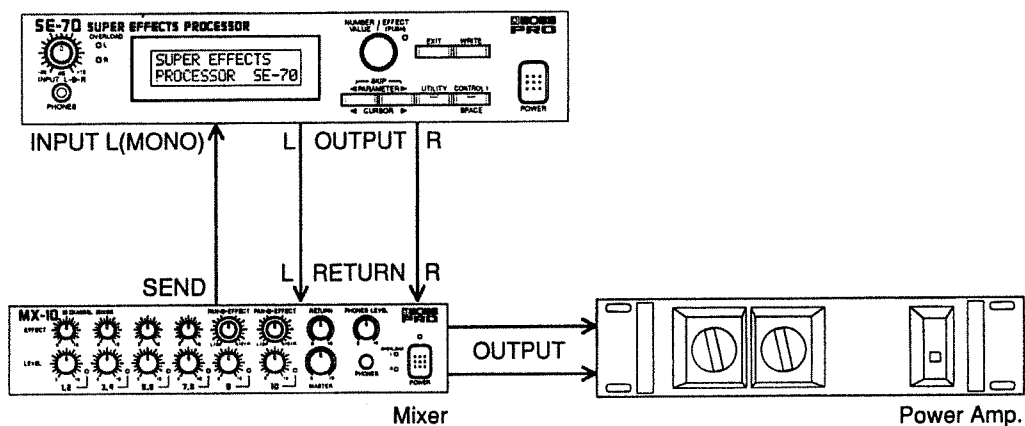

*** Check the position of the Level Switch. It should match the level used by your mixer.**

*** If connecting to Send/Return, you need to set the Effect Off mode to "Mute" (p. 18).**

Setup using a keyboard

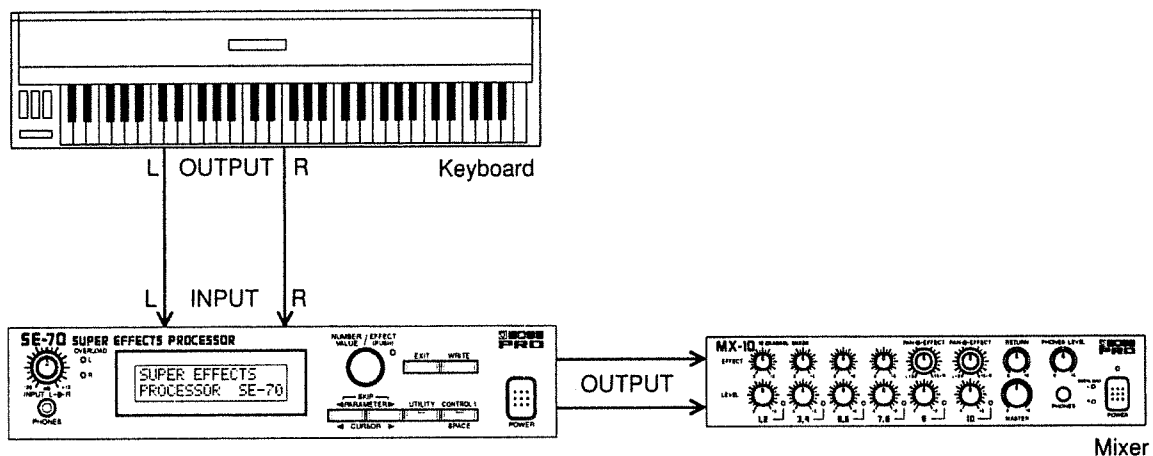

*** For most purposes, the Level Switch can be set at -20 dBm.**

*** For monaural output, use the OUTPUT L (MONO) jack.**

Setup using a guitar or bass

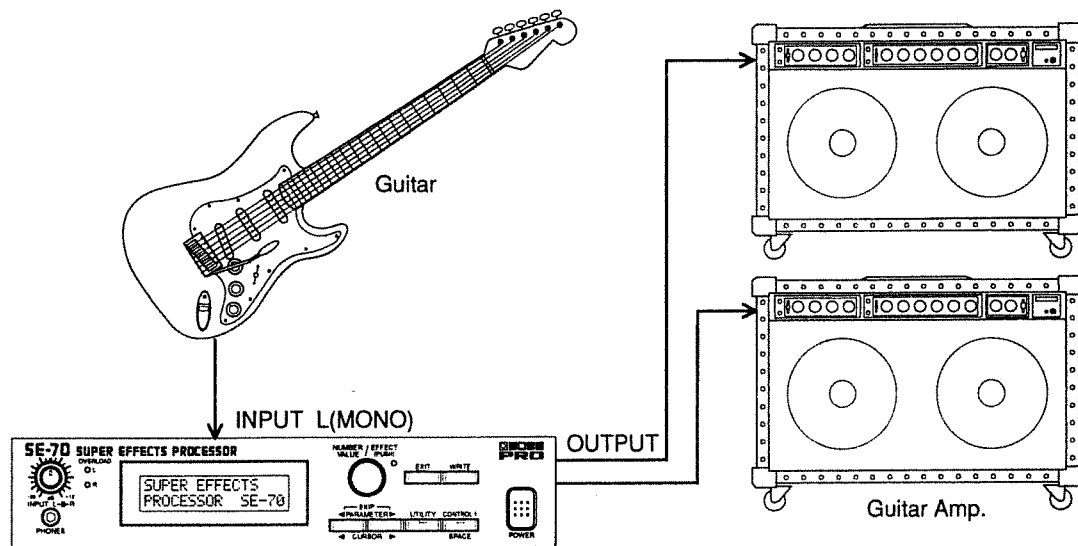

- * For most purposes, the Level Switch can be set at -20 dBm.
- * For monaural output, use the OUTPUT L (MONO) jack.

2. Turn on the Power

After re-checking all the connections, turn on the SE-70.

- * The volume on your amplifier should be raised only after the power on every connected unit has been turned on.

With power on, the following display will appear:

```
LSI:3C555  
presents...
```

```
SUPER EFFECTS  
PROCESSOR SE-70
```

A few seconds later, you will see the following display. This screen (the Play screen) appears whenever you are in the mode used for performance.

```
101 Hall  
----- Hall -----
```

- * Each time power is turned on, the Patch you used last will be selected again.
- * Since the SE-70 is equipped with a circuitry protection feature, it requires a few moments after power up before it is ready for operation.

3. Adjusting the Input Level

Adjust the Input Level until it is appropriate for the particular instrument you are using.

(1) Rotate the left and right Input Level knobs until you have them set so the corresponding OVERLOAD indicators light only on the highest input peaks.

** These indicators light at a level that is 6 dB below the clipping point (the level at which distortion will begin to occur).*

** Excessive input levels will result in a distorted output.*

** If you have the Level Switch set at “-20 dBm” and the OVERLOAD indicators light quite frequently even when you turn the Input Level knobs all the way down (-20 dBm), you should set the Level Switch to “+4 dBm” instead.*

4. Selecting Patch Numbers

About Patch Numbers

There are 145 ‘locations’ in the SE-70 where collections of settings for the effects can be stored. Each of these locations contains a “Patch,” and each one of them is assigned a “Patch Number” (1 to 145). During performance, or when wishing to make changes in the settings for your effects, any Patch you need to access can easily be selected by specifying its number.

1) Selection From the Panel

(1) Rotate the CONTROL knob.

With each turn to the right, the Patch Number will advance by one. With each turn to the left, the Patch Number will decrease by one.

The currently selected Patch Number is shown in the display.

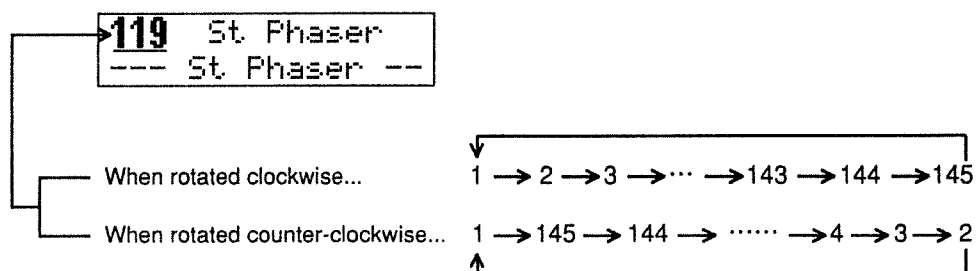

** While editing (modifying) an effect, you will not be able to select another Patch Number. To select a different Patch Number, you'll first need to carry out the 'Write' procedure, or press EXIT and return to the Play mode.*

However, if you press EXIT and then switch to a different Patch Number, you will lose any changes you made in the Patch you were editing.

2) Selection Using a Foot-switch

Once you connect an optionally available FS-5U foot-switch, you can change Patch Numbers using the pedal. For details, see "Settings for Control 2/3" (P.29).

- * *When using a foot-switch, you cannot move continuously through the Patch Numbers even though you keep the pedal depressed.*
- * *Be sure to always have the power turned OFF whenever you connect a foot-switch. An unexpected change in Patch Number could otherwise occur.*

You can obtain pedal control over the same functions provided by turning the CONTROL knob if you connect two foot-switches as shown.

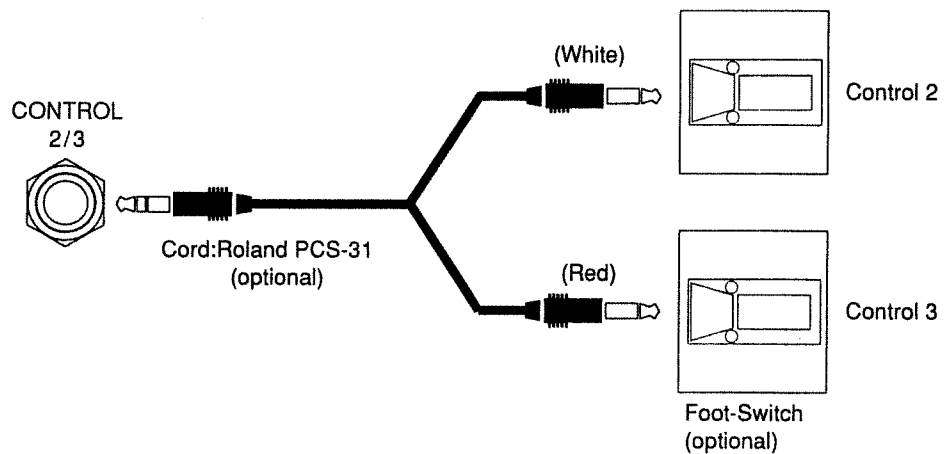

With only one foot-switch connected, the Patch Number can only be either increased or decreased with each press on the pedal.

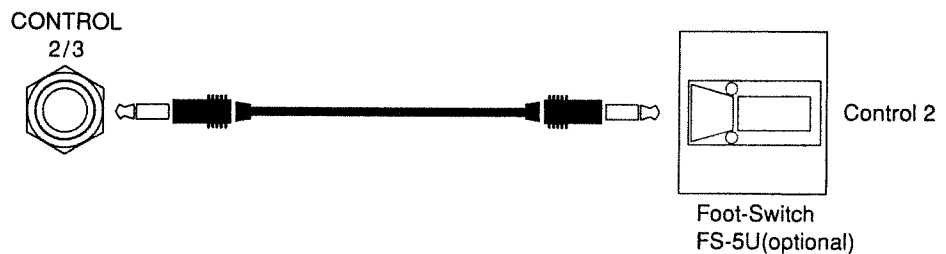

- * *Set the polarity switch on the FS-5U to the setting shown below. This way, at the moment you depress the pedal you obtain a change in the Patch Number.*

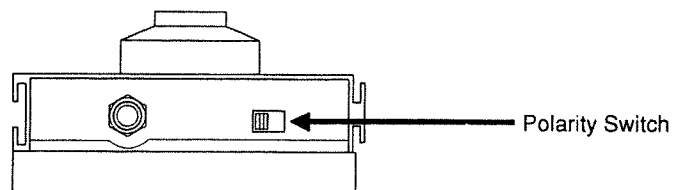

3) Selection Using MIDI Messages

MIDI Program Change messages provide for selection among (a maximum of) 128 different Patches (1 to 128). However, since the SE-70 is capable of storing more than 128 Patches, it is important to have a way to select Patches having numbers beyond the range of the Program Change Numbers. This is where this unit's Program Change Map feature becomes useful, since it allows you to arbitrarily set up a correspondence between any given Program Change Number and a Patch Number. The Program Change Map consists of a complete record for all these correspondences.

Program Change messages sent to the SE-70 can be used to select Patches. For details, refer to "About MIDI" (P.36).

5. Turning Effects On/Off

Every individual effect can be turned on and off. When off, all selected effects will either be bypassed (sound will not pass through the processors), or no sound at all will be output.

- * *Patch Numbers can be selected even when effects are turned off.*
- * *The On/Off status of the effects is not altered by any other procedures.*

1) Switching Using the Panel

Press the CONTROL knob to switch the effects ON or OFF. When the effects are ON, the EFFECT ON/OFF indicator will be lit.

2) Using a Foot-switch

By connecting an optional FS-5U or FS-5L foot-switch, you will be able to turn the effects on and off using either of the two methods below. The EFFECT ON/OFF indicator will light when the effects are ON.

Method 1

Put the Remote/Expression Pedal setting at "Remote" (UTILITY) and use an optional FS-5L pedal connected to the EFFECT REMOTE/EXP PEDAL jack to obtain control. (See "Setting the Mode for a Remote/Expression Pedal," P.29)



Method 2

Using "Settings for Real-time Control Over Parameters" (see P.32), set the Target to "Effect On/Off," and the Source to "CONTROL 2 or 3." You can then use a foot-switch (optional FS-5U or FS-5L) to obtain control.

*** Depending on whether you use an FS-5U or FS-5L, the setting you need to make for the Assign Mode within the Patch will be different. For details, refer to "Settings for Real-time Control Over Parameters" (P.32).**

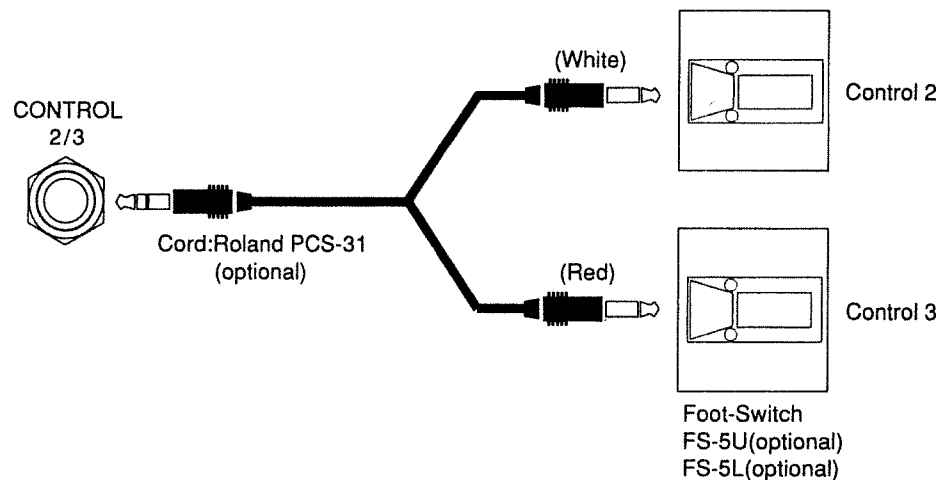

*** If using an FS-5L, set the polarity switch to the setting shown below. The indicator on the foot-switch will also light when the effects are on.**

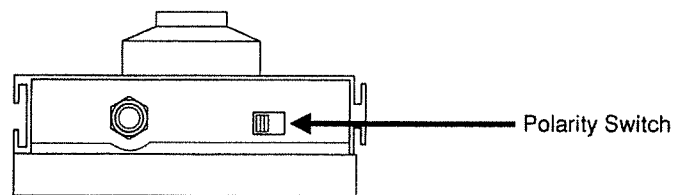

*** Set the polarity switch on the FS-5U foot-switch to the setting shown below. The effects will then be turned ON or OFF each time you step on the pedal.**

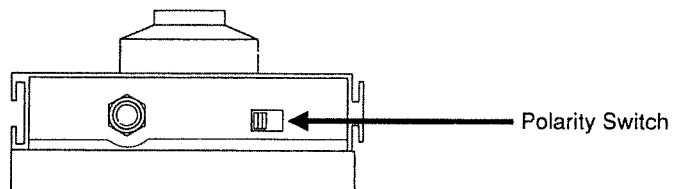

3) Switching Using MIDI Messages

MIDI messages sent to the SE-70 by an external device can be used to switch effects ON/OFF. For details, refer to "About MIDI" (P.36).

Setting the Effects OFF Mode

The unit provides a choice of whether the direct sound is to be output, or no sound at all is to be output when the effects are turned OFF.

(1) Press UTILITY enough times to reach the display shown below.

The desired setting for the Effects OFF mode is selected using the CONTROL knob.

```
Effect Off Mode
      Direct
```

```
Effect Off Mode
      Mute
```

Direct: The direct sound alone will be output.

Mute: No sound at all will be output.

(2) When completed, press EXIT to return to the Play screen.

In normal situations (with a musical instrument connected) you should set the mode to "Direct." If, however, you are using a setup where the unit is connected to a mixer's Send/Return jacks, it should be set to "Mute." If set to "Direct," there will be a change in the balance of the mixer's output between times when the effects are ON and OFF. This is because even with the effects turned OFF, the direct sound will be output.

2 Editing Patches

The SE-70 contains 145 preset Patches. This section shows you how to edit these existing Patches in order to create new ones. These new Patches can then easily be stored in memory.

1. First, Some Basics About Patches

1) Composition of Patches

About Preset areas and User's Areas

Of all the Patch Numbers from 1 to 145, numbers 101 to 145 are in the Preset Area, where you are not permitted to store any changes. Note, however, that you can save whatever changes you make to a Patch from the Preset Area, as long as you write it to a location within the User Area (No. 1 to 100).

About Algorithms

Every Patch is created based on "algorithms." An algorithm consists of settings which define which effects are to be used, and the order in which they occur. (The effects order does make a difference.) By choosing a specific algorithm, you obtain a particular set of effects and the way they are connected. Note that any unwanted effects included in an algorithm can simply be turned off.

Every time you change Patches, the algorithm that is used for the selected Patch appears in the display.

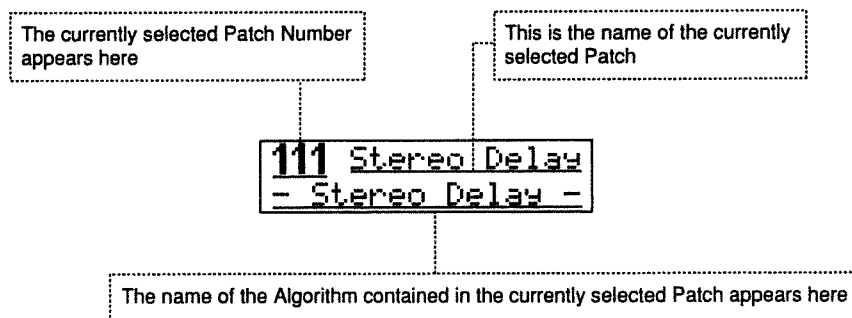

*** Patches in the Preset Area (101 to 145) use, in order, all of the algorithms, and carry settings which are representative of how each algorithm can be used.**

2) How to Edit Patches

- (1) Select a Patch that uses an algorithm that most closely creates the type of sound you have in mind (P.14).
- (2) Copy the selected Patch to another storage destination (Patch Number) which contains a Patch you do not need (P.20). If you do not need to keep the settings for a User Patch selected in (1), and intend to keep only the revised edition, this step is not necessary.

*** Patches cannot be copied to locations in the Preset Area (101 to 145).**

(3) Make the changes in the Patch (P.21).

For each effect there are a number of parameters which control the timbre (quality) of the resulting sound. To edit a Patch you must provide each of these parameters with an appropriate value.

** The available parameters will vary depending on the algorithm selected. Even when working with effects that are used in a particular algorithm, you cannot select the parameters belonging to an effect which is turned off.*

(4) Give the new Patch a name (P.22).

(5) Store the completed effects settings in memory (P.23).

All changes made in settings are only temporary. They will revert to their original values if you turn the power off or select a different Patch. In order to store the new Patch in memory you must perform a "Write" operation.

For every algorithm, the following information is shown in the display:

- 1. Parameters related to each of the effects.*
- 2. Parameters related to real-time control of the parameters.*
- 3. Patch name editing screen.*

2. Copying Patches

Copies of Patches can be made from the Play screen. When making a copy, all the data contained at one Patch location is copied to another Patch number.

** You can never copy any Patches into the Preset Area (Patch Numbers 101 to 145). Should you attempt to copy a Patch into the Preset Area, the following error message will appear in the display.*

```
Preset Area
Cannot Write !
```

(1) From the Play screen, use the CONTROL knob to select the source Patch Number, then press WRITE. The following screen will appear:

```
Patch copy to ..
111 Stereo Delay
```

(2) Using the CONTROL knob, select the destination Patch Number.

```
Patch copy to ..
21 *****
```

The Patch Name appears here

(3) Press WRITE again, and the source Patch is copied.

** To cancel the procedure, press EXIT. You will be returned to the Play screen.*

3. Editing the Currently Selected Patch

The following explains how to edit the effects for the currently selected Patch. The steps below should be followed in order to make changes in the values of the parameters. For details on each parameter, refer to the Algorithm Guide.

With algorithms which combine two or more effects, display ‘pages’—within which you can turn individual effects on or off — will appear. Within such pages, use the PARAMETER [<] >] buttons to move the cursor (underline) until it is positioned under the name of the effect you wish to change. Then either turn or push the CONTROL knob to switch the effect on or off. When an effect is turned ON, a “●” symbol appears to the left of its name. Also, any effect in an algorithm which cannot be turned off will have a “■” symbol to the left of its name.

*** The parameters for any effect which has been turned off will not be shown in the display. Similarly, if an effect provides a number of modes, only the parameters relevant to the mode which has been placed in the effect will be shown.**

(1) Using PARAMETER [<] >] buttons, select the parameter you wish to edit.

The following will appear in the display:

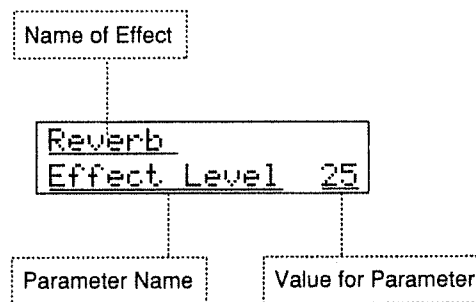

Skip Feature

You can quickly skip to the first parameter for any effect by holding down the PARAMETER button for the direction you wish to go (either [<] or [>]), and then pressing the PARAMETER button for the opposite direction. This feature comes in handy when working with algorithms containing numerous parameters.

*** The way in which the Skip function works can vary depending on the selected algorithm.**

(2) Using the CONTROL knob, change the value.

With parameters that accept wide-ranging values, you can simultaneously press and rotate the CONTROL knob to obtain a more rapid change in the value. Note, however, that not all parameters will offer this function.

You can now check how the value change affects the sound.

(3) Repeat steps (1) and (2) until your Patch is complete.

4. Revising the Patch Name

Every Patch can be given a name consisting of up to 12 characters. Whenever you have copied a Patch and then have altered its settings, it is best to rename it to avoid confusion.

** No changes can be made in the names of the preset Patches (No. 101 to 145).*

(1) After selecting the Patch you wish to rename, press PARAMETER [<] [>] until you select the screen shown below:

```
Name Edit
Stereo Delay
  |
  v
Cursor
```

(2) Using CURSOR [<] [>], move the cursor until it is positioned under the first character you wish to change. Select the new character using the CONTROL knob.

```
Name Edit
Stereo Delay
  |
  v
Cursor
```

These are the characters which are available:

```
ABCDEFGHIJKLMNOPQRSTUVWXYZ
abcdefghijklmnopqrstuvwxyz
&#%!?.,:;' "+-*/<=>()[]{}
← →0123456789
```

** You can switch between capital letters and small letters by pressing the CONTROL knob.*

** To insert a space, press SPACE (CONTROL 1). In this page, you cannot control parameters in realtime with CONTROL 1.*

5. The Write Procedure

Since all changes made in a Patch's settings (and name) are only temporary, they will revert to their original values if you turn the unit off or switch to a different Patch. To save your new settings, perform the steps below to write the program into memory.

*** The Write procedure cannot be performed if the indicator on the UTILITY button is lit. You first need to press EXIT to turn it off.**

- (1) After all settings for the Patch have been completed, press WRITE.
The following screen will appear:

```
Patch write to..  
11 *****
```

The Patch Name appears here.

*** Should you wish to cancel the Write procedure, press EXIT.**

- (2) Press WRITE again.

```
Patch write  
Writing...
```

When the Write operation has been completed, you are returned to the Play screen.

Writing to a Different Patch Number

To write your Patch to a different Patch number, use the CONTROL knob to select the desired destination after step (1) above.

```
Patch Write to..  
9 *****
```

The Patch Name appears here.

The Patch is then stored in memory when you press WRITE.

3 Other Settings

1. Using the Tuner

A chromatic tuner is incorporated into the SE-70. The tuner offers a variety of functions, such as display of note names, and settings for the output level. Additionally, when a guitar or bass is selected for the tuner type it displays the string name, and allows you to select from a number of tuning methods, including flat or double-flat tuning.

The Tuner's features are organized as shown below:

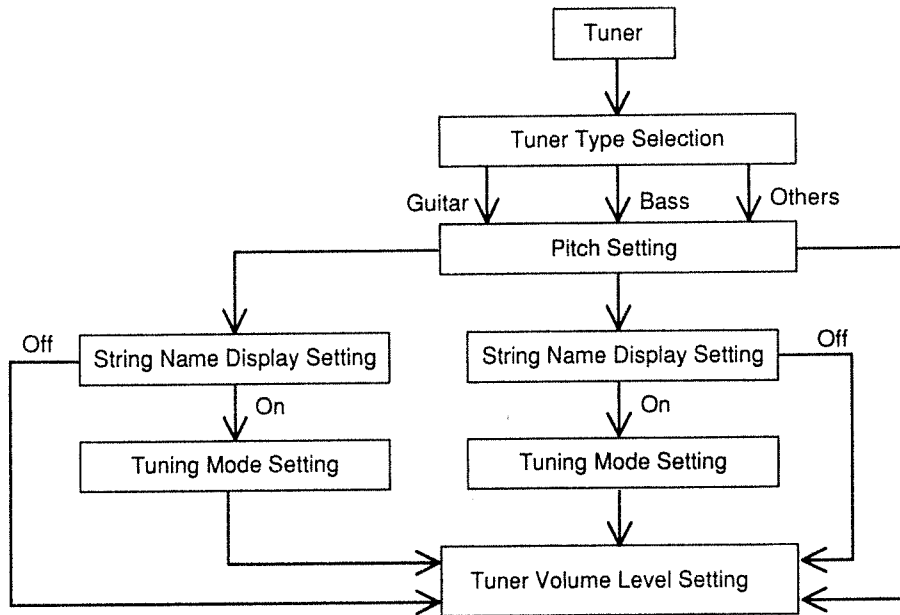

1) Switch to the Tuner mode.

(1) From the Play screen, press UTILITY to select the Tuner display page.

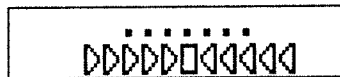

(2) Viewing the display while tuning.

While using the SE-70's Tuner, the following will appear in the display:

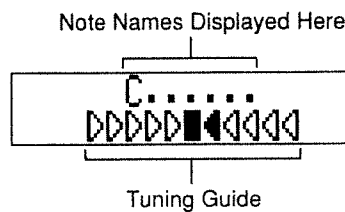

(3) Tuning

1 Play the instrument (single notes) so that signals are input to the unit. The display will show the name of the note that is closest to the pitch of the input signal.

2 While viewing the tuning guide indicators, tune the instrument until only the center indicator segment is lit. With a guitar or bass, tune each string to the note name indicated in the following chart.

Tuning Guide Display

Guitar

1st string open	E
2nd string open	B
3rd string open	G
4th string open	D
5th string open	A
6th string open	E

Bass

1st string open	G
2nd string open	D
3rd string open	A
4th string open	E
5th string open	B

Repeat steps 1 & 2 until tuning is complete.

*** When tuning a guitar that is equipped with a tremolo arm (or whammy bar), you may find that when you get one string in tune, others will drift out of tune. In such a situation first 'coarse tune' all the strings, just enough to get their Note names to appear, and then go back and 'fine tune' each string (several times if necessary).**

2) Settings for the Tuner

1. Setting the Tuner Type

Three tuner types are provided: Guitar, Bass, and Others. Select the type which best matches the instrument you are working with. From the Tuner mode, press PARAMETER [<] [>] until you have the screen shown below. Then rotate the CONTROL knob to select the Type.

```
Tuner Type
  for Guitar
```

```
Tuner Type
  for Bass
```

```
Tuner Type
  for Others
```

*** The unit is set to "Guitar" as a factory default.**

2. Setting the Pitch

(1) Press PARAMETER [<] [>] until you have the screen shown below:

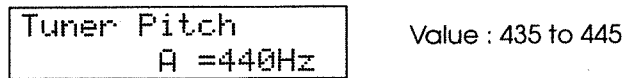

Then, rotate the CONTROL knob to set the standard pitch.

*** The pitch is set to 440 Hz as a factory default.**

*** This pitch also applies to the Main OSC (oscillator) of the Guitar Synth and Bass Synth.**

(2) When you are finished making the setting, you can either press PARAMETER [<] [>] to return to the Tuner screen, or press EXIT to return to the Play screen.

3. Settings for the String Name Display and Tuning Modes

*** The settings in this section come into play if 'Guitar' or 'Bass' has been selected as the Tuner Type. When 'Others' has been selected, these parameters will not be displayed.**

String Name Display Mode

The SE-70 is capable of displaying the name of the (open) string which corresponds to a note that has been played. Thanks to this feature, the number of the string being tuned can be matched with the number of the string shown in the display. This allows strings to be tuned accurately simply by tuning them until only the central segment of the tuning guide indicator lights. This comes in handy after you have just put new strings on your instrument.

If the correct pitch is more than 50 cents off, the triangular symbol in the display's lower-left corner will change to "▶". It changes to "▷" when the variance (either above or below) is less than 50 cents.

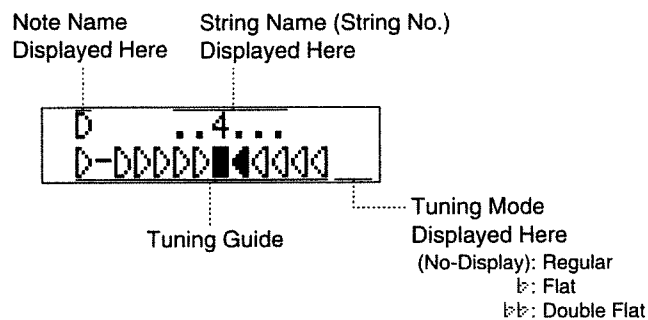

*** Ordinarily, the triangular symbol will point to the right. It will point to the left, however, if the pitch is more than 50 cents above the correct pitch for the 1st string being tuned.**

When using this mode, note the following:

*** Always play open strings while tuning. The correct string number cannot be displayed if harmonics are played.**

*** To change the string that is being tuned, be sure to mute the previous string before you start tuning the next one.**

Tuning Mode

In the String Name Display mode, you can choose from one of three Tuning modes:

- Regular: The most commonly used form of tuning.
On a guitar, from the 6th string: EADGBE
On a bass, from the 5th string: BEADG (On a 4-string bass, from the 4th string: EADG)
- Flat: Tuning where all strings are a half step lower than Regular.
- Double-Flat: Tuning where all strings are a whole step lower than Regular.

(1) Select whether String Name Display is to be ON or OFF.

From the Tuner mode, press PARAMETER [<] [>] until you have the screen shown below:

Tuner Display String Disp On	Value : On/Off
---------------------------------	----------------

Rotate the CONTROL knob to select either On or Off.

*** Once you select "Off," the following page (step (2) below) will not be displayed:**

(2) Select the Tuning Method.

Press PARAMETER [<] [>] until you have the screen shown below:

Rotate the CONTROL knob to select the Tuning Method.

Tuning Mode Regular

Tuning Mode Flat

Tuning Mode Double Flat

(3) Once you have completed your settings, you can either press PARAMETER [<] [>] to return to the Tuner screen, or press EXIT to return to the Play mode.

4. Setting the Volume Used While Tuning

Carry out the following to set the volume level you wish to use while tuning.

(1) From the Tuner mode, press PARAMETER [<] [>] until you have the screen shown below:

Tuner Level Level = 100	Value : 0 to 100
----------------------------	------------------

Rotate the CONTROL knob to select the desired volume.

(2) After the setting has been made, you can either press PARAMETER [<] [>] to return to the Tuner screen, or press EXIT to return to the Play mode.

*** Avoid placing the unit near equipment that could contain a large transformer (such as a power amplifier) when using the Tuner. Failure to do so could result in hum, making the Tuner unreliably.**

*** Whenever you are using the real-time parameter control feature to access the Tuner, and are also using an algorithm which is designed solely for L channel input (such as Guitar Multi 1), you should place the Input Level knob setting for the R channel at the same setting as the L channel.**

2. Using the Metronome

The SE-70's metronome offers a selection of 4 different rhythms. A separate volume setting can be made for each of these rhythms. (♩, ♪, ♫, ♬, ♪♩)

(1) Select whether the Metronome is to be ON or OFF.

Press UTILITY enough times to obtain the screen shown below:

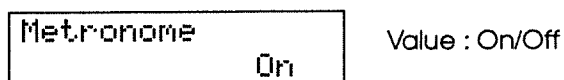

From this page, you can rotate the CONTROL knob to select either On or Off.

(2) Tempo setting.

Press PARAMETER [<] [>] until you have the screen shown below:

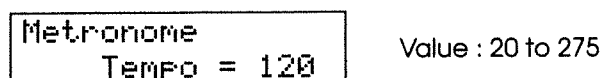

Rotate the CONTROL knob to select the desired tempo. The tempo increases as you rotate the knob clockwise. The display shows the tempo in beats per minute.

*** The tempo can be set between 20 and 275 beats per minute.**

(3) Setting the rhythm volume.

Press PARAMETER [<] [>] until you have the screen shown below:

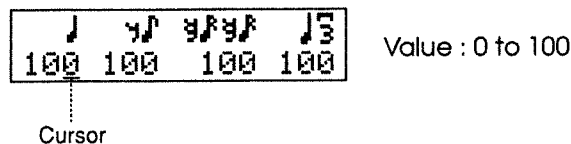

Use PARAMETER [<] [>] to move the cursor to the rhythm that you wish to use. Rotate the CONTROL knob to select the desired volume.

(4) Setting the metronome level.

Press PARAMETER [<] [>] until you have the screen shown below:

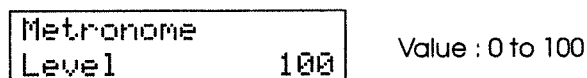

Rotate the CONTROL knob to set the overall volume of the metronome.

*** The metronome level cannot be set within each algorithm using the Master Volume.**

(5) After the setting has been made, press EXIT to return to the Play mode.

3. Setting the Mode for an Effect Remote/Expression Pedal

By connecting an optional FS-5L to the EFFECT REMOTE/EXP PEDAL jack, you will be able to turn the effects on and off with the pedal. By connecting a FV-300L or an EV-5, you can obtain real-time control over parameters.

Press **UTILITY** enough times to reach the display page shown below:

```
Effect/Exp Pedal
Effect Remote
```

```
Effect/Exp Pedal
Exp Pedal
```

Rotate the **CONTROL** knob to select from the choices below:

Effect Remote: An FS-5L will function in turning On/Off effects for the unit as a whole.

Exp Pedal: An expression pedal (FV-300L, EV-5) will provide real-time control over parameters.

(2) After the setting has been made, press **EXIT** to return to the Play mode.

4. Settings for Control 2/3

These settings determine the function that will be obtained from an FS-5U or FS-5L pedal (options) that is connected to the **CONTROL 2/3** jack.

When using 2 foot-switches

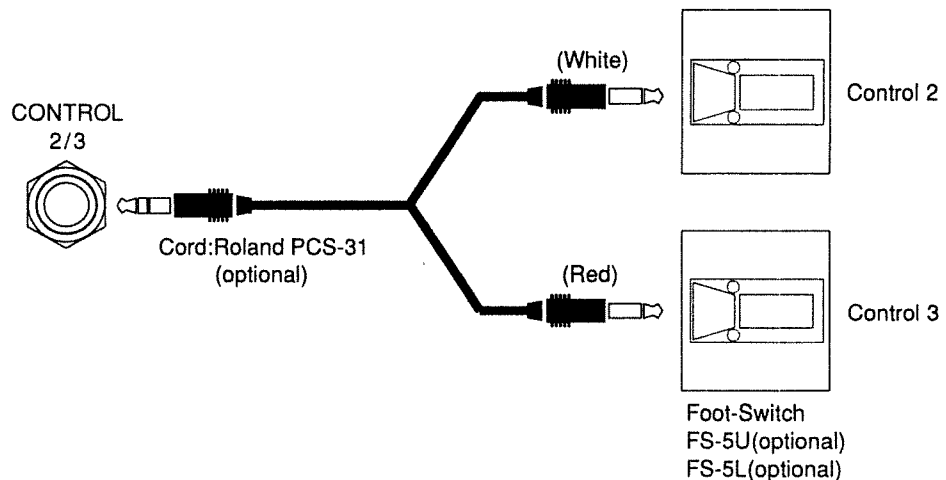

When using a single foot-switch

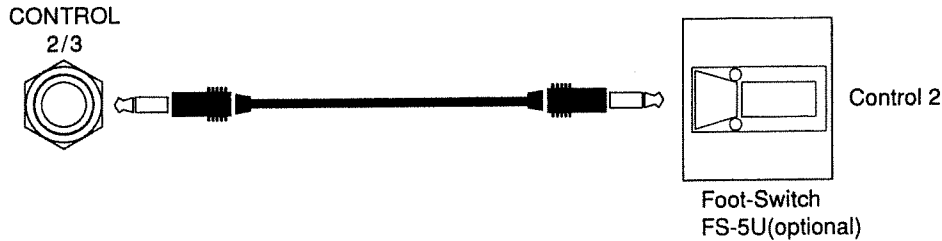

** Only Control 2 will be available if you have one switch connected to the CONTROL 2/3 jack (using a monaural plug).*

(1) Press UTILITY enough times to reach the page used for making settings for Control 2.

Rotate the CONTROL knob to select one of the choices shown below:

Control 2 Select
Number Up

Control 2 Select
Number Down

Control 2 Select
Assignable

- Number Up: Each time you step on the pedal, the Patch Number increases by one. Use an FS-5U pedal (option).
- Number Down: Each time you step on the pedal, the Patch Number decreases by one. Use an FS-5U pedal (option).
- Assignable: The pedal action will provide real-time control over parameters. Use an FS-5U or FS-5L pedal (options); whichever is appropriate.

(2) Press PARAMETER [<] [>] to switch to the Control 3 settings page.

Rotate the CONTROL knob to select one of the choices shown below:

Control 3 Select
Number Up

Control 3 Select
Number Down

Control 3 Select
Assignable

- Number Up: Each time you step on the pedal, the Patch Number increases by one. Use an FS-5U pedal (option).
- Number Down: Each time you step on the pedal, the Patch Number decreases by one. Use an FS-5U pedal (option).
- Assignable: The pedal action will provide real-time control over parameters. Use an FS-5U or FS-5L pedal (options); whichever is appropriate.

** If you have set both Control 2 & 3 to "Assignable," item (3) that follows will not be displayed.*

- (3) When using a foot-switch to change Patches, you will be able to select any Patch between 1 and 145. However, you can set a particular range of numbers within which selections can be made. That way, only the range of Patches you define will be made available.

Ordinarily, you obtain: 1 ↔ 2 ↔ 3 ↔ ... ↔ 143 ↔ 144 ↔ 145

With a range specified, you obtain: 1 ↔ 2 ↔ 3 ↔ ... ↔ 43 ↔ 44
 (Range delimited as 1 to 44 in this example.)

To specify the Patch selection range:

Press PARAMETER [<] [>] until you have the screen shown below:

Number Up/Down	Value : 1 to 145
Max 100 Min 1	

Cursor

Rotate the CONTROL knob to set the number that is to be the upper limit of the range.

Press PARAMETER [<] [>] until you have the screen shown below:

Number Up/Down	Value : 1 to 145
Max 100 Min 1	

Cursor

Rotate the CONTROL knob to set the number that is to be the lower limit of the range.

** You can step through the possible values more quickly if you press the CONTROL knob while you rotate it.*

- (4) After the settings have been made, press EXIT to return to the Play mode.

5. Adjusting the Display Contrast

You may, at times, find the display difficult to read, depending on the location of the unit or room lighting. In such cases, you can easily adjust the display contrast (brightness of the characters).

- (1) Press UTILITY until you reach the display page shown below:

LCD Contrast	Value : 0 to 15
Contrast = 15	

Rotate the CONTROL knob to adjust the contrast. The higher the value, the brighter the characters.

- (2) After the setting has been made, press EXIT to return to the Play mode.

6. Settings for Real-time Control Over Parameters

These settings are made when you wish to use external pedals or MIDI devices to control the SE-70's parameters while you play. You need to specify what type of controllers are to be used to control which parameters. Up to 4 of these assignments can be made for each Patch.

Parameters that can be controlled (Target)

Depending on the algorithm, the parameters that will be available for control will differ. For details, refer to the Algorithm Guide.

*** The target can be any of the following for all algorithms: Tuner, Metronome, Metronome Level, or Effect On/Off.**

Controllers that can be specified (Source)

The following type of controllers can be specified:

- (1) **CONTROL 1 Button, An FS-5U or FS-5L pedal switch (options) connected to the SE-70's, CONTROL 2, or CONTROL 3 jacks.**

An FV-300L or EV-5 expression pedal (option) connected to the EFFECT REMOTE/EXP PEDAL jack.

- (2) **Following types of messages received from an external MIDI device.**

Pitch Bend messages: Action of a Pitch Bend Lever (Wheel).

Aftertouch messages: Pressure applied to keyboard keys after they have been played.

Control Change messages (0 to 31, 64 to 119): Operations performed using sliders, pedals, etc.

*** For more information about MIDI messages, refer to "About MIDI" (P.36).**

*** Although you can use several sources to control the same target, noise could be produced if you operate more than one of these sources at the same time.**

The parameter value range can be specified by a "Minimum Value" and a "Maximum Value."

With controllers that simply turn something on or off, "On" is the "Maximum Value" and "Off" is the "Minimum Value."

With other controllers, such as an Expression Pedal or MIDI messages, the parameter value is continuously variable within the range defined by the "Minimum Value" and "Maximum Value."

In cases where the parameter value serves as an On/Off switch, it is turned ON if the value of the data received is greater than the median value, otherwise it is turned OFF.

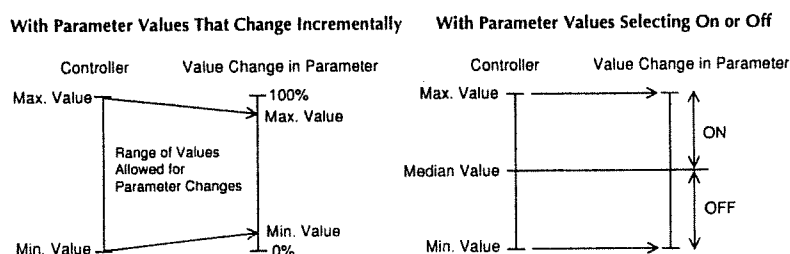

*** When the transmitter intends to turn something on or off, the "Max. Value" is transmitted for "On" and the "Min. Value" is sent for "Off."**

** Any alterations made in parameter values using the controllers during performance are temporary. If you change to a different Patch, the settings will revert to their original values.*

Before defining the Minimum and Maximum values, you need to set any jacks that you will be using for real-time control to "Assignable" from within the UTILITY mode (See "Settings for Control 2/3," P.29)

(1) Using the CONTROL knob, select the Patch for which the setting is to be made.

(2) Press PARAMETER [<] [>] to switch to the screen shown below:

Select the Target using the CONTROL knob.

```
Assign 1 Target
      Master Level
```

(3) Set the range.

Press PARAMETER [<] [>] to switch to the screen shown below:

```
Assign 1 Min
                        0
```

Using the CONTROL knob, set the Minimum Value for the range.
Press PARAMETER [<] [>] to switch to the screen shown below:

```
Assign 1 Max
                        100
```

Using the CONTROL knob, set the Maximum Value for the range.

- * The possible values for the range will vary depending on the parameter.*
- * For parameters with wide-ranging values, you can simultaneously press and rotate the CONTROL knob to obtain a more rapid change in the value. Note that not all parameters will offer this option.*
- * You can set a "Minimum Value" that is higher than the "Maximum Value." In such a case, the changes in the parameter will occur in the reversed direction.*
- * If you change the target after the settings for "Minimum Value" and "Maximum Value" have been made, you may find that these value settings have also changed.*

(4) Press PARAMETER [<] [>] to switch to the screen shown below, and select the Source.

```
Assign 1 Source
      Control 1
```

Value : Control1 to 3/Exp Pedal/
MIDI After Touch/MIDI Pitch Bend/
MIDI CC#0 to 31,64 to 119

(5) Next, you need to select the manner in which the target is to be controlled (the "Assign Mode" setting) as a result of operating the source (controller).

Press PARAMETER [<] [>] to switch to the screen shown below, and select the manner of operation you need using the CONTROL knob.

Assign 1 Mode Latch	Value : Latch/Momentary/FS-5U Latch /FS-5U Momentary/FS-5L Latch
------------------------	---

** Depending on the source which has been selected in (4), the manner in which output of the value (value of setting) takes place will vary.*

** The following applies when Control 1, MIDI Aftertouch, MIDI Pitch Bend, or MIDI CC No. 0 to 31 or 64 to 119 (Control Change numbers) have been selected as the Source:*

Latch : Each time the Source is switched ON, the unit is switched to either the minimum or maximum value.
Momentary : Ordinarily the value will be at minimum. It is set to maximum when the source is switched ON.

** When Control 2 or 3 has been selected as the source*

FS-5U Latch : Setting used when an FS-5U is connected. Each time you step on the pedal, the unit is switched to either the minimum or maximum value.
FS-5U Momentary : Setting used when an FS-5U is connected. Ordinarily the value will be set at minimum. It is set to the maximum when you step on the pedal.
FS-5L Latch : Setting used when an FS-5L is connected. Each time you step on the pedal, the unit is switched to either the minimum or maximum value.

A Few Pointers Concerning Use of the FS-5U and the FS-5L

When you wish to turn effects on/off using the foot-switch.

Both the FS-5U and FS-5L can be used for this purpose. When using the FS-5U, set the unit to FS-5U Latch. When using the FS-5L, set the unit to FS-5L Latch. With either of these pedals, effects can then be switched On/Off when you step on the pedal. With the FS-5L, you can easily tell whether the effects are On/Off by viewing the pedal LED.

When you wish to have the effect become more pronounced, or turned on when the pedal is depressed.

You will need to use an FS-5U, and set the unit to FS-5U Momentary. You can then obtain the different settings between depressing the pedal and releasing it. The FS-5L is not capable of providing such functions.

** If using CONTROL 1 as the source when controlling more than one target, the LED on CONTROL 1 will function as the setting of the smallest Assign number. (If Assign 1 is not set to anything, the LED on CONTROL 1 will function as the setting of Assign 2.)*

** To continue and make settings for controls over other parameters, repeat steps (2) through (5).*

(6) Once the settings have been made, perform the Write operation to have them stored in memory.

A graphic featuring several musical notes of varying sizes and orientations, some in solid black and others in a halftone pattern. A thick, black horizontal bar with rounded ends is positioned across the middle of the notes. The text "USING MIDI" is written in large, bold, white, sans-serif capital letters across this bar. Below the bar, the word "SECTION" is written in a smaller, bold, italicized, black, sans-serif font. A faint, circular halftone pattern is visible behind the word "SECTION".

USING MIDI

SECTION

The SE-70 is equipped with MIDI connectors. If you use these connectors to exchange data with external MIDI devices, you can select Patches from the panel of the external device, or save Patch data in another unit.

1 ABOUT MIDI

MIDI stands for “Musical Instrument Digital Interface.” This interface is based on an international standard that allows for digital data describing what has been played, or what changes have been made in sounds used, to be exchanged among various instruments. All MIDI compatible devices can share the same performance data — regardless of model or manufacturer.

MIDI converts every event that occurs during a performance into MIDI data. While an instrument is played, all the MIDI data describing what is happening is transmitted. When received by another instrument, this stream of MIDI data can be used to play it—as if the instrument itself were being played.

1. The Exchange of MIDI Data

The following explains how the exchange of MIDI data is carried out.

About MIDI Connectors

In carrying out the exchange of MIDI data, three connectors are used.

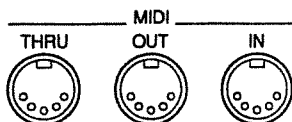

MIDI IN: Accepts data arriving from another MIDI device.

MIDI OUT: Transmits data originating in the unit itself.

MIDI THRU: Re-transmits everything that was received at MIDI IN.

To make communication by MIDI possible, the use of a special “MIDI cable” is required.

** In theory, any number of MIDI devices could be connected together using MIDI THRU connectors. However, you should try to keep the total length of all the MIDI cables used to less than 15 meters (about 49 feet). If the cable path is too long, the data transmission speed will drop, and data may not be conveyed correctly.*

** The SE-70 allows you to use its connector as either a MIDI OUT or MIDI THRU. (See “Setting for MIDI Out/Thru,” P.47).*

MIDI Channels

With MIDI, a single cable can be used for simultaneously carrying differing sets of performance information to a number of MIDI devices. This is possible thanks to the fact that MIDI allows for a multiple number of ‘channels.’

Using television as an example, MIDI channels may be easier to understand. On a TV set, different programs (from different stations) can be selected simply by switching channels. This is because the information on any individual channel is put on the screen only when the television (the receiver) is set to the same channel that is being used by the transmitter (the broadcasting station).

The cable from the antenna carries TV signals from many different broadcasting stations.

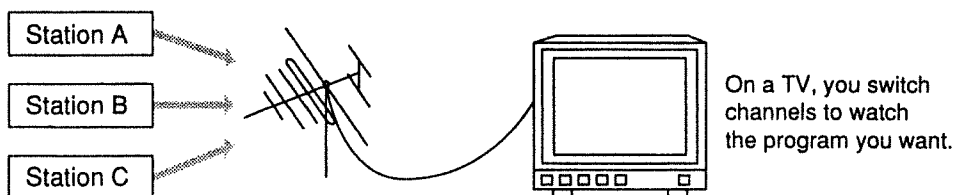

The channels available with MIDI range from 1 to 16. When a musical instrument (the receiver) is set so its channel matches the MIDI channel used by the transmitting device, the MIDI data is conveyed. If set as illustrated below, only sound module B will produce sound when you play the keyboard.

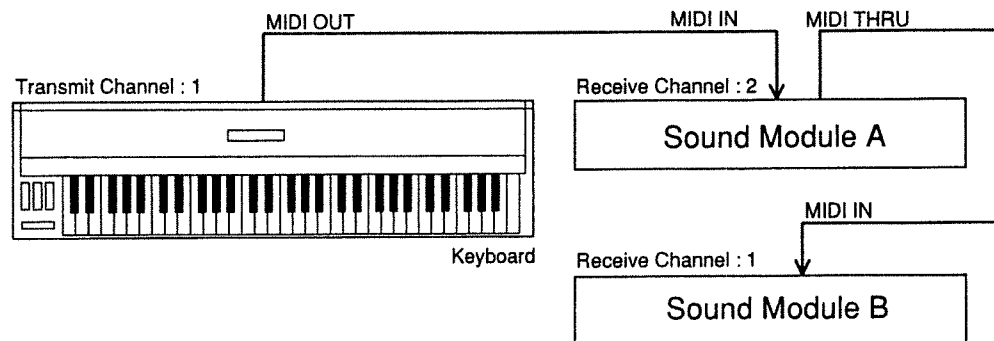

Omni Mode

When set to Omni On, MIDI data arriving on all channels can be received; regardless of any setting for a particular receive channel. The Omni Off mode is used when wishing to receive data only on a specific channel.

** The transmitting device will send out its performance information on the MIDI channel that has been specified for that purpose, regardless of whether the Omni mode is On or Off.*

2. MIDI Messages Recognized by the SE-70

“MIDI message” is a term used to refer to any of the various types of messages that can be conveyed using MIDI. MIDI messages can be divided into two main types: Messages that are managed on an individual channel basis (Channel messages), and messages that are handled independently of channels (System messages). The following covers messages that can be received/transmitted by the SE-70.

Messages Handled by Each MIDI Channel (Channel Messages)

These messages convey the events occurring during a performance. In most circumstances, these alone are sufficient for providing the necessary control. The specific type of control obtained by any particular MIDI message is greatly influenced by the settings on the receiving device.

Note Messages

Note messages convey the notes played during a performance. There are several kinds of Note messages:

- Note Number : A number representing the position of a key on the keyboard.
- Note On : Produced when a keyboard key has been pressed.
- Note Off : Produced when a keyboard key has been released.
- Velocity : Conveys the amount of strength used when keys are pressed. (Commonly called ‘volume.’)

** Note Numbers express the full range of possible keyboard keys, using the numbers 0 to 127. Middle C (C4) is Note number 60.*

** These messages are valid only for Sampler 1 and Sampler 2 on the SE-70.*

Aftertouch Messages

These messages convey information about the pressure that is further applied to a key after it has been played. There are two types of Aftertouch; Channel and Polyphonic.

Channel Aftertouch provides control on a MIDI channel basis. The effect is applied equally to all notes on the same MIDI channel, regardless of which key has the most pressure applied to it. Polyphonic Aftertouch provides control on an individual key (note) basis. Even though it may share the same MIDI channel with other notes, any particular key that has more pressure put on it will produce a slightly different effect.

The SE-70 responds to Channel Aftertouch messages, which can be assigned to control a selected parameter.

Pitch Bender Messages

Messages which convey the action of a Pitch Bend Lever (wheel).

On the SE-70, Pitch Bend messages can be used to control a selected parameter.

Program Change Messages

These messages are used for selecting sounds (Patches). When a change in the sound (Patch) is made on the transmitting unit, the number assigned to that sound or Patch (its Program Change Number) is transmitted. Any device receiving such Program Change messages will also change to its corresponding sound (Patch). This allows you to simultaneously have the SE-70 switch to an appropriate effects Patch when you change to a different sound on a keyboard. Any of the possible Program Change Numbers (1 to 128) can be used for making such changes.

Control Change Messages

These messages are used to enhance the expressiveness of a performance. Each function is identified by a unique Control Number. The functions which are available for control will vary depending on the instrument. On the SE-70, Control Change messages can be used to control selected parameters.

Exclusive Messages

Although it was stated at the beginning of this section that MIDI messages are internationally recognized by all compatible devices, Exclusive messages are the exception: they handle information unique to a particular device. In most cases, this type of message can be exchanged only between devices of the same model by the same manufacturer.

Exclusive messages can be employed to save the settings for effects into a sequencer, or for transferring such data to another SE-70.

Whenever Exclusive messages are to be used for communication, both devices must be set to the same 'Device ID' (a unique unit number). On the SE-70, the Device ID is equivalent to the MIDI channel number.

MIDI Implementation Chart

MIDI has made it possible for a wide range of musical instruments to communicate with each other, but that doesn't necessarily mean that the many types of data will all be understood. If communication between two connected MIDI devices is to be successful, it must take place using only the types of data that they have in common.

It is for this reason that every owner's manual – for all kinds of MIDI devices – always includes a MIDI Implementation Chart as a quick reference to the types of MIDI messages it is capable of handling. You should compare the MIDI Implementation Charts for any two devices in order to find out which types of you can easily compare the receiving device with the transmitting device.

** For detailed information on MIDI data of the SE-70, a separate "MIDI Implementation document" is available at any Roland Service Station.*

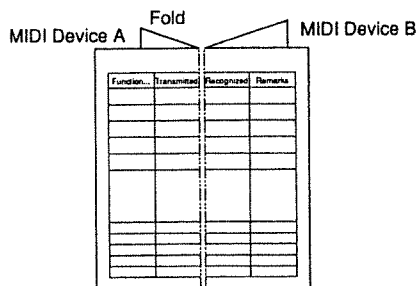

2 MIDI Settings

Convenient features that are made possible when the SE-70 is connected with external MIDI devices are explained in the following.

Changing Patch Numbers

Using Program Change messages, Patch Numbers on the SE-70 can be changed using the controls on an external MIDI unit. When you wish to remotely select effects in the SE-70 in this way, you can set the unit so you have MIDI Program Change Numbers and Patch Numbers correspond in whatever way you like. In conventional units, you would have to rearrange (by copying each of them into other locations) many of your Effects Patches in order to get them to correspond in the desired way. Thanks to the SE-70's Program Change Map feature, you can easily set up the appropriate correspondence.

Controlling Parameters Using an External MIDI Unit

Aftertouch, Pitch Bend, and Control Change messages can be used to control parameters for the effects.

Saving Data In an External MIDI Device

Using Exclusive messages, SE-70 program data can be stored in external devices (such as sequencers).

** Whenever MIDI is used it is essential that the proper channel settings be made. The MIDI channel on the SE-70 should match the channel used by the external unit.*

1. Setting the MIDI Channel and Omni Mode

Follow the steps below to set the channel used for MIDI reception/transmission. When shipped, the unit was set with the MIDI Channel at "1" and Omni Mode at "On." If left at these settings, the SE-70 will receive data arriving on any channel, but will only transmit its data on Channel 1.

(1) Press UTILITY until you arrive at the MIDI setting mode.

The indicator on the button will light.

"MIDI" should appear here.

```
MIDI *****
*****
```

(2) Press PARAMETER [<] [>] until you have the MIDI Channel or Omni Mode setting screen.

Using the CONTROL knob, set the MIDI channel or Omni Mode.

```
MIDI Channel
Channel = 1
```

Value : 1 to 16

```
MIDI Omni Mode
Omni On
```

Value : Omni On/Omni Off

(3) When complete, press either EXIT or UTILITY until the button's indicator has gone out. The previous screen will reappear.

2. Changing Patches

Through the use of Program Change messages generated by an external MIDI unit, you can change Patches on the SE-70.

** Please refer to the manual that came with your other unit for information on its sounds and Program Change Number correspondence.*

Using Another Unit to Remotely Change SE-70 Patch Numbers

Connections should be made as follows:

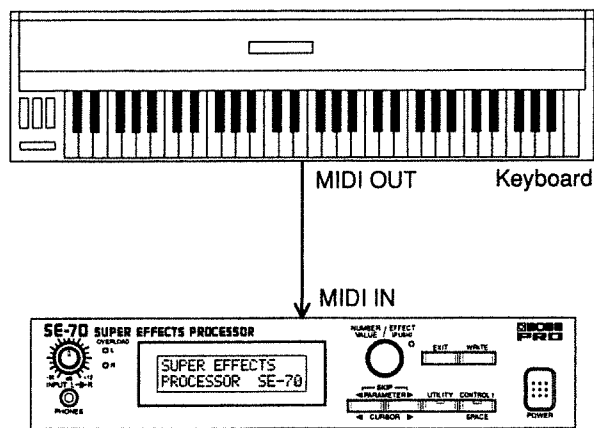

When shipped from the factory, the SE-70's Patch Numbers were matched numerically with Program Change Numbers. As a result, it will respond to MIDI Program Changes by switching to the Patch Number which has the same number as the message which was sent.

So, for example, if your keyboard sends Program No. 45 over MIDI, the SE-70 will switch to its Patch Number 45.

Correspondence Between Sounds and Effects Programs

The SE-70 provides a "Program Change Map," which allows you to easily set up the correspondence between Program Change Numbers (the numbers assigned to the sounds produced by MIDI controller units, such as synthesizers and sequencers) and Patch Numbers in the SE-70.

Although MIDI only allows for Program Change Numbers from 1 to 128, any of the SE-70's 145 Patches can be selected.

The following steps allow you to alter the Program Change Map.

(1) Press UTILITY enough times to select the MIDI setting mode.

The indicator on the button will light.

"MIDI" should appear here.

```
MIDI *****  
*****
```

(2) Press PARAMETER [<] [>] until you have the Program Change Map setting screen:

```
MIDI Program Map  
Prog# 1 → # 1
```

Cursor

Using PARAMETER [<] [>], move the cursor until it is positioned at the parameter you wish to set. Using the CONTROL knob, select both the Program Change Number (number that will be received), and the SE-70 Patch Number that you wish to be 'assigned' to it.

(3) When complete, press [EXIT] to return to the performance (Play) screen.

3. MIDI Control (Real-Time Control Over Parameters Using MIDI Messages)

Parameters on the SE-70 can be set so they will respond to certain messages (such as Aftertouch and Pitch Bend) that arrive from an external device. How such controls will be used can be set individually for each Patch Number.

MIDI Data Providing Control

You can select one of the following MIDI message types to be used as a control: Aftertouch, Pitch Bend, or Control Change (Control Numbers 0 to 31 and 64 to 119) messages.

Obtaining the Desired Control

You can set the range over which a parameter value will change in response to a MIDI message. This setting of the parameter's range is made by specifying a minimum and maximum value. For example, if you want a certain MIDI message to control Master Level, but only within an overall range of 10 to 90, you would set the minimum value at 10 and the maximum value at 90. With certain parameters, however, the control would simply involve turning something on or off. In such cases, if the value of the received MIDI message is greater than the median value, it is turned ON. If less, it is turned OFF.

With Parameter Values That Change Incrementally

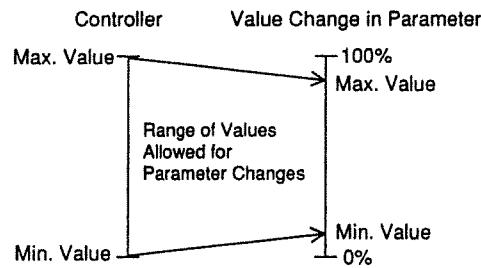

With Parameter Values Selecting On or Off

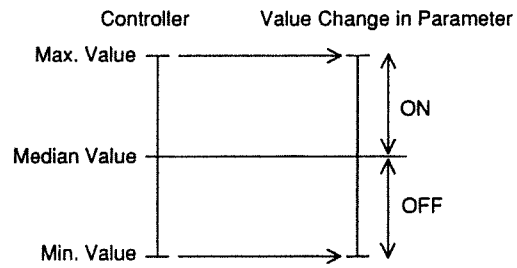

* When the transmitter intends to turn something on or off, the "Max. Value" is transmitted for "On" and the "Min. Value" is sent for "Off."

* Settings for MIDI controls are only temporary (the same as parameter settings). They will revert to their original values if you turn the power off, or switch to a different Patch. In order to make your settings permanent you must perform the "The Write Procedure" (P.23) and store the settings in memory.

(1) Using the CONTROL knob, select the Patch Number for which you wish to make a MIDI Control setting.

(2) Using PARAMETER [<] [>], select the screen shown below:

Using the CONTROL knob, select the Target.

```
Assign 1 Target
Master Level
```

(3) Set the desired range.

Use PARAMETER [<] [>] to select the screen shown below:

```
Assign 1 Min
0
```

Using the CONTROL knob, set the minimum value for the range.
Use PARAMETER [<] [>] to switch to the screen shown below:

```
Assign 1 Max
                100
```

Set the maximum value for the range using the CONTROL knob.

- * *The available range will depend on the selected parameter.*
- * *With parameters that accept wide-ranging values, you can simultaneously press and rotate the CONTROL knob to obtain a more rapid change in the value. Note, however, that not all parameters will offer this option.*
- * *You can set a "Minimum Value" that is higher than the "Maximum Value." In such a situation, the changes in the parameter will occur in the reversed direction.*
- * *If you change the parameter that is to be controlled after the setting for minimum and maximum values have been set, you may find that these values have changed. Always reset the minimum and maximum values each time you select a new parameter.*

- (4) Press PARAMETER [<] [>] to select the parameter below, then use the CONTROL knob to select the Source (MIDI messages that are to be received).

```
Assign 1 Source
                Control 1
```

- * *Although you can use several sources to control the same target, noise could be produced if you operate more than one of these sources at the same time.*

- (5) Next, you need to select the manner in which the target is to be controlled (the "Assign Mode" setting) as a result of operating the source (controller).

Press PARAMETER [<] [>] to switch to the screen shown below, and select the manner of operation you need using the CONTROL knob.

```
Assign 1 Mode
                Latch
```

Value : Latch/Momentary/FS-5U Latch/
FS-5U Momentary/FS-5L Latch

- * *Depending on the source which has been selected in (4), the manner in which output of the value (value of setting) takes place will vary.*
- * *The following applies when MIDI Aftertouch, MIDI Pitch Bend, or MIDI CC No. 0 to 31 or 64 to 119 (Control Change numbers) have been selected as the Source:*

Latch : Each time the Source is switched ON, the unit is switched to either the minimum or maximum value.
Momentary : Ordinarily the value will be at minimum. It is set to maximum when the source is switched ON.

- * *To continue and make settings for controls of other parameters, repeat steps (2) through (5).*

- (6) When complete, carry out the Write procedure (P.23) to store the settings in memory.

To write to the same Patch Number, press WRITE twice.

To write to a different Patch Number, first press WRITE, then use the CONTROL knob to select the destination Patch Number. Then press WRITE again.

4. Using a Foot Controller (FC-50)

Pedal control over the operations explained below are made possible once you connect an optional BOSS FC-50 MIDI foot controller.

The foot controller can be used to specify Program Change Numbers, which select Patch Numbers on the SE-70.

The control pedal (or an expression pedal connected to it) can be used to control specified parameters (real-time control).

Connection and Setup of a Foot Controller

Connections should be made as shown below:

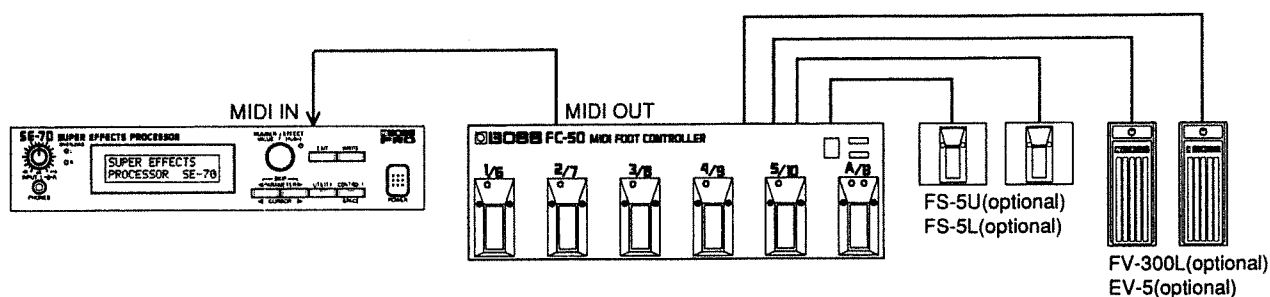

Set the FC-50 and SE-70 so their MIDI channels match.

*** Refer to P.39, and the FC-50 Owner's Manual for instructions on how to do this.**

5. Receiving and Sending Data Over MIDI

Using the SE-70's Exclusive messages, you can store Patch settings in a sequencer, or use an external MIDI device to remotely make changes in the contents of a Patch (effects settings).

On the SE-70, the transmission of Exclusive messages is carried out using a Device ID (common to all MIDI channels).

Such data transmission is referred to as a 'Bulk Dump,' whereas reception is known as a 'Bulk Load.'

About the Device ID

On page 38 in this section, we explained that Exclusive messages belong to the type of message which are not restricted to specific channels (System Messages). However, by not being sent on any specific channel, Exclusive messages cannot easily be directed to specific units if more than one SE-70 is being used within a more complex MIDI system. For this reason, recently manufactured devices have been devised so they will use a Device ID (equivalent to a Channel message) when performing Bulk Dumps and Bulk Loads. Such IDs are a number from 1 to 16. Data can be transferred only between two devices which are set to the same Device ID. On the SE-70, the Device ID is set to the same number as the MIDI channel.

The types of Bulk Data which can be transmitted are shown below. Before beginning the transmission, you can specify (in terms of start and stop points) a specific range of data to be sent.

Displayed	Contents of Transmission
System	<ul style="list-style-type: none"> •Tuner Settings (Type,Pitch,String Name Display,Mode,Level) •Metronome Settings (Temp,Rythm Levels,Level) •Effect Remote/Exp Pedal Jack •Control 2/3 •Program Change Map •Range of Patch Numbers Selectable with Foot-Switch •Effect Off Mode •Adjustment of Display Contrast
#1	•Setting for Patch Number 1
⋮	⋮
#100	•Setting for Patch Number 100
Temp (Temporary)	•Setting for a Patch which has been editing

1) Making the Connections

Saving SE-70 Data in a Sequencer

Connect the units as shown below. After setting your sequencer so it is ready to receive Bulk Data, start the transmission on the SE-70.

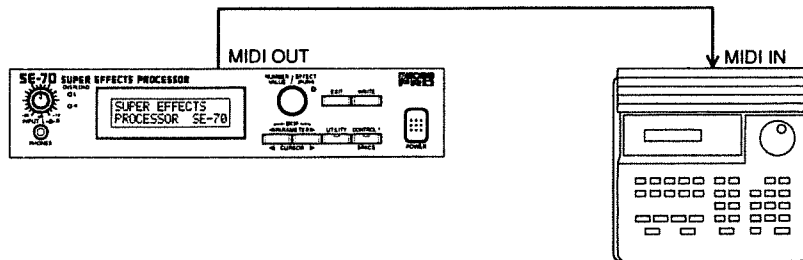

** Refer to your sequencer manual for instructions on how to do this.*

Sending Data Saved in a Sequencer to the SE-70

Connect the units as shown below. The SE-70 must then be set to the same MIDI channel that was used when the data was originally transmitted to the sequencer. Next, after setting the SE-70 so it is ready to receive Bulk Data, start the transmission from the sequencer.

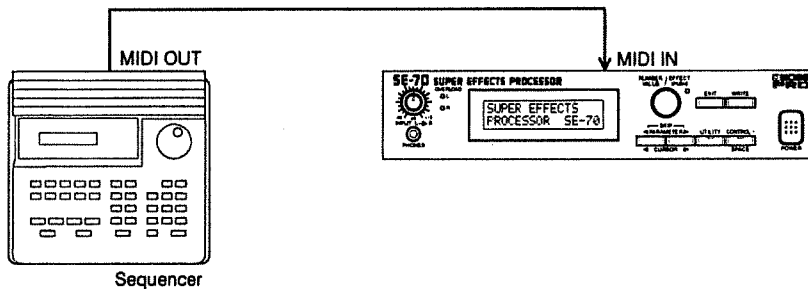

Sending Data to Another SE-70

Connect the units as shown below:

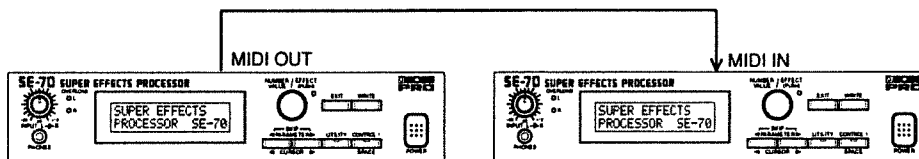

Set the Device IDs on both units to match. Next, set the receiving unit so it is ready to receive bulk data (the Bulk Load mode).

** Once the receiving SE-70 is ready to receive Exclusive messages, begin data transmission. To set the unit to the reception mode, refer to "4) Data Reception" (P.48).*

** If using a sequencer to send data to several SE-70s, you can give each of them a different Device ID. That way, the sequencer will be able to distinguish each unit, and be able to manage differing sets of data for each. Remember, though, that if you change the Device ID for an SE-70, its MIDI channel will also change.*

2) Setting for MIDI Out/Thru

- (1) Press **UTILITY** enough times to select the MIDI setting mode.

The indicator on the button will light.

"MIDI" should appears here.

```
MIDI *****  
*****
```

- (2) Press **PARAMETER** [**<**] [**>**] until you have the screen below.

Using the **CONTROL** knob, select either "Out" or "Thru."

```
MIDI Out/Thru  
MIDI Out
```

```
MIDI Out/Thru  
MIDI Thru
```

Out: Provides output during Bulk Dumps.

Thru: Passes on an exact copy of all data arriving at MIDI IN.

- (3) When complete, press **EXIT** to return to the Play screen.

3) Data Transmission (Bulk Dump)

You must set the MIDI Out/Thru to "MIDI Out" before starting a Bulk Dump. Should you attempt to carry out the Bulk Dump when the MIDI Out/Thru setting is "MIDI Thru," the following error message will appear in the display.

```
Set MIDI Thru  
To MIDI Out !
```

- (1) Press **UTILITY** until you select the mode used to make MIDI settings.

The button's indicator will light.

"MIDI" should appears here.

```
MIDI *****  
*****
```

- (2) Press **PARAMETER** [**<**] [**>**] until you select the page for Bulk Dump.

```
MIDI Bulk Dump  
System → #100
```

Cursor

Select the range of data that is to be sent. Using PARAMETER [<>] [<] , move the cursor until it is positioned at the parameter you wish to set.
Use the CONTROL knob to set the starting point and the end point.

```
MIDI Bulk Dump
System → # 10
```

Cursor

(3) Press WRITE and data transmission will begin.

While the data is being sent, the following will appear in the display:

```
Data Saving...
```

After the transfer is complete, you are returned to the following:

```
MIDI Bulk Dump
System → # 10
```

Cursor

(4) Press EXIT to return to the Play screen.

4) Data Reception (Bulk Load)

(1) Press UTILITY until you select the mode used to make MIDI settings.

The button's indicator will light.

"MIDI" should appears here.

```
MIDI *****
*****
```

(2) Press PARAMETER [<>] [<] enough times to enter the mode where the unit is ready for Bulk Load.

```
MIDI Bulk Load
Waiting...
```

-
- (3) Get the transmitting unit to start sending. While data is being received, the following is shown in the display:

```
MIDI Bulk Load
Data Receiving
```

Once reception is complete, the display will read:

```
MIDI Bulk Load
Idling...
```

While in this state, you can continue and receive other sets of Bulk Data if you wish.

- (4) When complete, press EXIT to return to the Play screen.

** Exclusive messages are not Channel messages. If the Device IDs don't match, Bulk Data cannot be received even when you are set to Omni On. Whenever you wish to transfer data, you must always have the Device ID set to the same number as the other unit.*

3 Getting the Most From Your SE-70

By combining the SE-70 with external equipment, you will be able to enjoy a variety of features that can enhance your musical capabilities. Several examples are provided as suggestions in the following.

1) Setup Using a Keyboard Controller and Sound Module

When connections are made as shown in the illustration below, you can change to a different Patch on the connected keyboard controller, and simultaneously to a Patch on the sound module, and a Patch Number on the SE-70. Additionally, the keyboard controller can be used for MIDI control and used to alter parameters in the SE-70.

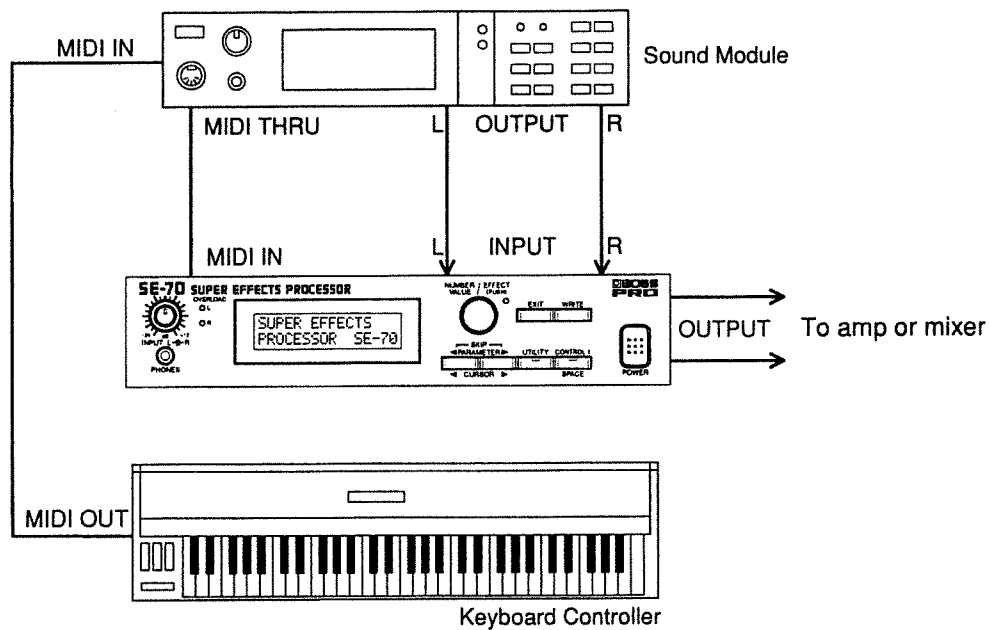

Set the keyboard controller, sound module, and SE-70 so they are all using the same MIDI channel (P.39).

The target which the keyboard controller is set to control must match the type of MIDI message that is to be received by the SE-70 (P.42).

2) Setup Using a Guitar

When connections are made as shown in the illustration below, not only can you change Patch Numbers using the foot controller, you can also use an expression pedal or control pedal to edit parameters in the SE-70.

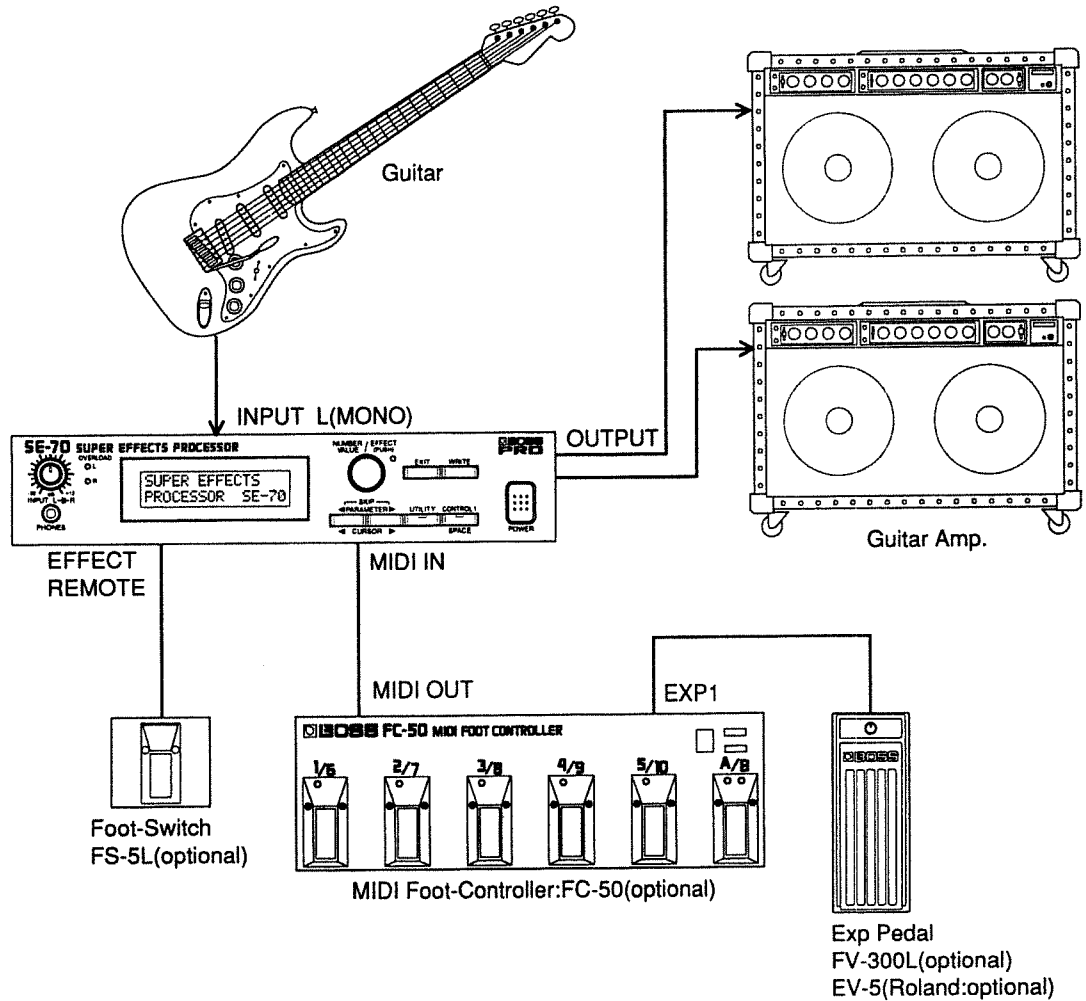

For example, if you assign real-time control over Pitch Shift to the expression pedal, you will be able to alter the pitch of the guitar with the expression pedal. Set the FC-50 and the SE-70 to the same MIDI channel.

*** For information on how to make the settings, refer to "Settings for Real-time Control Over Parameters" (P.32), and your FC-50 Owner's Manual.**

3) Linking Up With a Sequencer

When connections are made as shown in the illustration below, the Patches will be changed automatically in keeping with what is played by the sequencer.

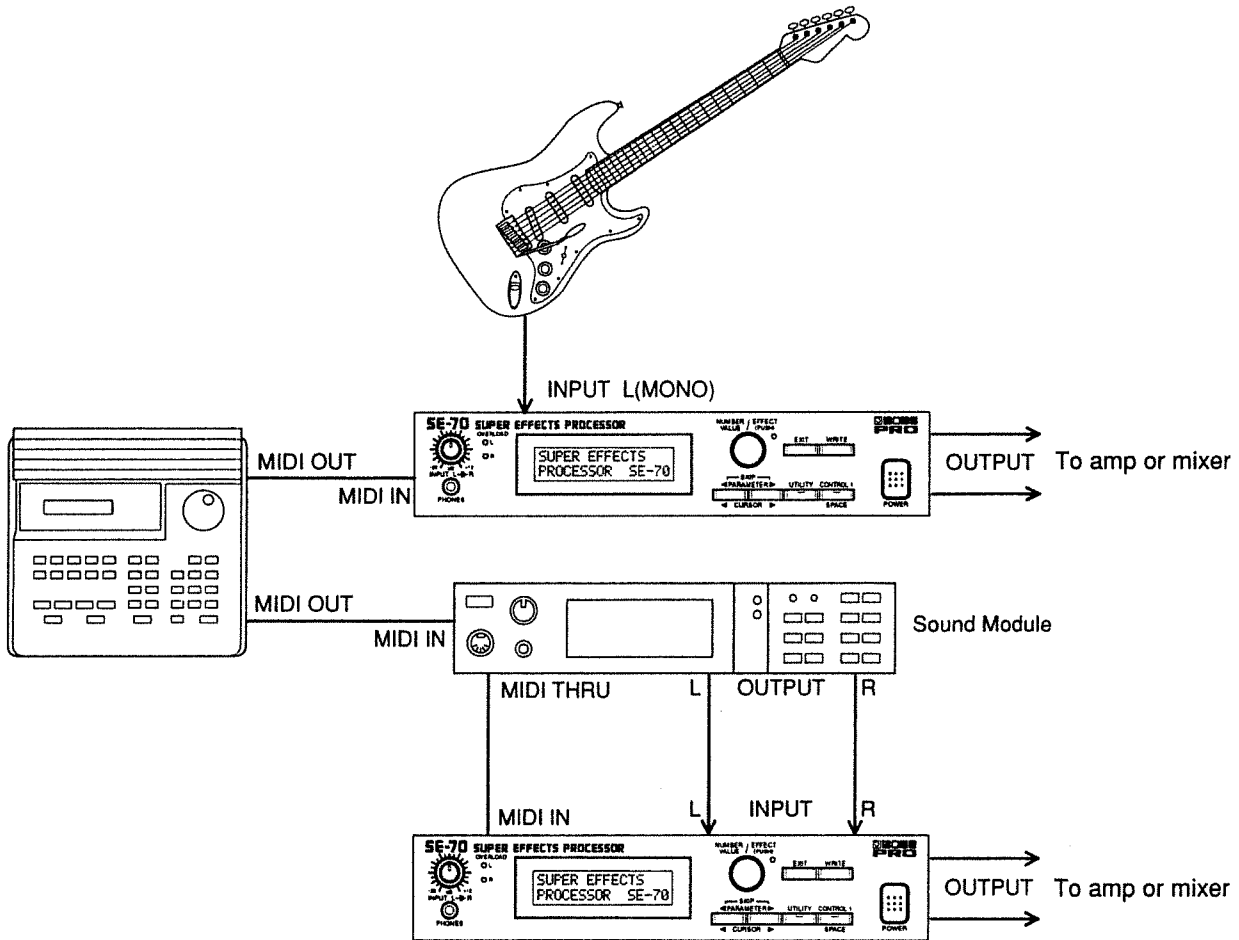

** Refer to your hardware manuals for further information.*

These are just a few examples of how different devices can be used together. You will probably be able to think of other setups that are perfect for what you have in mind.

A graphic of musical notes, including a large black eighth note and several smaller, semi-transparent notes in the background.

REFERENCE

SECTION

Factory Preset Settings

1. About Factory Preset Settings

System Data

MIDI Transmit/Receive Channel: Channel 1
Omni Mode: ON
Program Change Map: Direct numerical correspondence
Effect Remote/Exp Pedal Setting: Effect Remote
Control 1: Effect On/Off for Patches 101 to 145
Control 2: Number Up
Control 3: Number Down
Range of Patch Numbers Selectable with Foot-switch: 1 to 145
Effect Off Mode: Direct
Tuner : Type : Guitar
Pitch : 440 Hz
String Name Display : Off
Mode : Regular
Level : 100
Metronome : Tempo : 120
Rhythm Levels : ♩ :=100
♩♩ :=50
♩♩♩ :=50
♩♩♩♩ :=0
Level : 25
MIDI Out/Thru setting : MIDI Out
Display Contrast : 15
Factory Preset Type : Standard

2. Restoring the Factory Presets (Initializing the Data)

This procedure allows you to restore the contents of Patches in the User Area (and the System Data) to the original factory settings. If necessary, you can specify a specific range for this, and initialize only the Patches (or System Data) that you need.

To restore the SE-70 to the Factory Presets, follow the steps below.

Note that the SE-70 offers two sets of factory presets; "Standard" (suitable for recording or a broad range of instruments), and "Guitar."

You can initialize all settings or only those that you select.

(1) Turn the power OFF.

(2) While pushing the CONTROL knob in, turn the power ON.

The following will appear in the display:

```
Factory Preset
System → #100
```

.....
Cursor

(3) Press PARAMETER [<] to switch to the screen shown below:

Use the CONTROL knob to select the type of factory preset you wish to have restored.

```
Factory Preset
Type: Standard
```

```
Factory Preset
Type: Guitar
```

Standard: Factory presets suitable for recording and a wide variety of instruments.

Guitar: Factory presets suitable for guitar.

(4) Press PARAMETER [>] to switch to the screen shown below:

Specify the STARTING point of the range that you wish to be initialized using the CONTROL knob.

```
Factory Preset
System → #100
```

Cursor

(5) Press PARAMETER [>] to move the cursor and switch to the screen shown below:

```
Factory Preset
System → # 10
```

Cursor

Specify the ENDING point of the range that you wish to be initialized using the CONTROL knob.

** From this stage, you can go back and redo the settings for the starting point and the type by pressing PARAMETER [<].*

** Should you wish to cancel initialization of the data, press EXIT. The unit will then return to the normal startup mode.*

** The types of data which can be initialized are as follows:*

Display Shows	Settings Initialized
System	All parameters accessed through the UTILITY Mode
#1	Settings for Patch Number 1
#2	Settings for Patch Number 2
⋮	⋮
#99	Settings for Patch Number 99
#100	Settings for Patch Number 100

(6) Press WRITE, and the initialization takes place.

When initialization is complete, you are returned to the normal startup mode; as if the power had just been turned on.

TROUBLESHOOTING

If the unit does not appear to be operating properly, first check through the list that follows. If you cannot correct the problem, contact your Roland retailer or the nearest Roland Service Station.

No Sound Produced/Level Is Too Low

Have you checked for damaged cables?

Try replacing the cables.

Are connections with external devices properly made?

Check to make sure all connections are in order.

Is the volume set too low?

Check the volume on the amplifier and/or mixer you are using.

Are the Input Level knobs set properly?

Check and reset as necessary.

"Adjusting the Input Level" (P.14).

Are the settings for the Patch suitable?

Check to make sure that parameter settings, such as the one for "Level," are not set too low.

Do you have "Master Level" set to be used for real-time control, or as a MIDI Control?

You must operate the appropriate source.

See "Settings for Real-time Control Over Parameters"(P.32) and "MIDI Control" (P.42).

Do you have "Mute" set for the Effect Off Mode?

If set at "Mute" there will be no sound produced whenever the effect is off.

"Settings for the Effect Off Mode" (P.18).

Overload Indicator Lights Too Frequently During Input

Have the "Input Level Knobs" been set properly?

Adjust the Input Level Knobs.

"Adjusting the Input Level" (P.14).

Do you have the "Level Switch" on the rear panel set to the correct position?

Set the Level Switch to the "+4 dBm" position.

Is the input level too high?

Adjust the output level on the external unit to obtain the appropriate level.

The Patch Number Won't Change When the CONTROL Knob is Rotated

Are you in a mode where settings for parameters are made?

If so, press EXIT.

Is the indicator on the UTILITY button lit?

If so, press EXIT.

Write Operation Unsuccessful

Is the indicator on the UTILITY button lit?

If so, press EXIT.

Patch Numbers Won't Change When A Pedal Connected To the CONTROL 2/3 Jack is Depressed

Are you in a mode where settings for parameters are made?

If so, press EXIT.

Could you possibly have the minimum and maximum values for the Patch selection range set to the same number?

Check the Patch selection range.

See "Settings for Control 2/3" (P.29).

Do you have real-time control over parameters set for Control 2/3?

See "Settings for Real-time Control Over Parameters" (P.32), and "Settings for Control 2/3" (P.29).

MIDI Data Is Not Received

Are the MIDI cables in good working order?

Replace cables if necessary.

Are all devices connected correctly?

Check all connections carefully.

Do the MIDI Channels of connected devices match?

Check the MIDI Channels.

"Setting the MIDI Channel and Omni Mode" (P.39).

Program Change Messages Aren't Received

Are you in a mode where settings for parameters are made?

If so, press EXIT.

Is the indicator on the UTILITY button lit?

If so, press EXIT.

Using Real-time Parameter Control/MIDI Control Doesn't Provide the Desired Control Over Effects

Do you have the connected unit and the source set so they correspond?

Check the data transmitted and the data that is to be received.

See "Settings for Real-time Control Over Parameters" (P.32).

Do you possibly have the minimum and maximum values for the target set too close together?

Recheck the values for Min. and Max. for MIDI Control.

See "Settings for Real-time Control Over Parameters" (P.32).

MIDI Implementation Chart

Function...		Transmitted	Recognized	Remarks
Basic Channel	Default Changed	1—16 1—16	1—16 1—16	Memorized
Mode	Default Messages Altered	X X *****	OMNI ON/OFF X X	Memorized
Note Number	True Voice	X *****	0—127 *1 0—127	only in "Sampler1, 2"
Velocity	Note ON Note OFF	X X	X X	
After Touch	Key's Ch's	X X	X O *2	
Pitch Bend		X	O *2	
Control Change	0—31 64—119	X X	O *2 O *2	
Prog Change	True #	X *****	O 0—127	
System Exclusive		O	O	
System Common	Song Pos Song Sel True	X X X	X X X	
System Real Time	Clock Commands	X X	X X	
AUX Messages	Local ON/OFF All Notes OFF Active Sense Reset	X X X X	X X X X	
Notes	*1 It is able to select no receiving, and to Memorize. *2 Set messages for "Real-time Control Over Parameters" are recognized.			

Mode 1 : OMNI ON, POLY
 Mode 3 : OMNI OFF, POLY

Mode 2 : OMNI ON, MONO
 Mode 4 : OMNI OFF, MONO

o : Yes
 x : No

SPECIFICATIONS

SE-70:Super Effects Processor

Signal Processing

AD Conversion:16 bit linear
(64 times oversampling, delta sigma process)
DA Conversion:16 bit linear
(8 times oversampling)

Sampling Frequency

48 kHz / 32 kHz (set every algorithm)

Programs/Memory Locations

145 in Total User Area:1 to 100
 Preset Area:101 to 145

Frequency Response

10 Hz to 22 kHz +0/-3 dB (Sampling Frequency:48kHz)
10 Hz to 15kHz +0/-3 dB (Sampling Frequency:32kHz)
(0 dBm = 0.775 Vrms)

Nominal Input Level

-20/+4 dBm

Input Impedance

1M Ω

Nominal Output Level

-20/+4 dBm

Recommended Load Impedance

20 k Ω or greater

Residual Noise

-100 dBm or less (IHF-A)
(LEVEL Switch: -20 dBm,THRU)

Input Gain

-20 dB to +12 dB

Display

LCD (16 characters, 2 lines, backlit LCD)

Controls

<FRONT>

Input Level Knob (L/R)
Control Knob (Effect Button)
Parameter Button Up/Down (Cursor Button Up / Down)
Control 1 Button
Utility Button
Write Button
Exit Button
Power Switch

<REAR>

Level Switch

Connections

<FRONT>

Phones Jack

<REAR>

Input Jacks L (MONO) / R
Output Jacks L (MONO) / R
Control 2/3 Jack
Effect Remote / Exp Pedal Jack
MIDI Connectors:IN, OUT/THRU
AC Adaptor Jack

Indicators

Overload (L/R) Indicators
Effect ON/OFF Indicator
Utility Indicator
Control 1 Indicator

Power

12 V AC (BOSS BRB-120, 220, 240)

Current Draw

1.5 A

Dimensions

218 (W) x 44 (H) x 240 (D) mm
8-5/8 (W) x 1-3/4 (H) x 9-1/2 (D) inches

Weight

1.5 kg / 33 lbs

Accessories

AC Adaptor:BOSS BRB-120, 220, 240
Foot Rubber x 4
Owner's Manual
Algorithm Guide

Options

Rack Mount Adaptor RAD-50

** The RAD-10 Rack Mount Adaptor cannot be used for this unit.*

Foot Switch FS-5U, FS-5L

Insert Cable PCS-31(Roland)

(1/4 inches Phone Plug(stereo) – 1/4 inches Phone Plug(mono) x 2)

PCS-33(Roland)

(1/4 inches Phone Plug(stereo) – 1/4 inches Phone Plug(stereo))

MIDI Foot Controller FC-50

Expression Pedal FV-300L, EV-5(Roland)

** The Specifications for this product are subject to change without prior notice,in the interest of improvement.*

INDEX

A

AC Adaptor Jack.....	10
Aftertouch Message.....	38
Algorithm.....	19

C

Channel Messages.....	37
Control Change Message.....	38
CONTROL Knob.....	9
CONTROL 1 Switch.....	9
CONTROL 2/3 Jack.....	10

D

Data Reception(Bulk Load).....	48
Data Transmission(Bulk Dump)	47
Display	9

E

Effect Off Mode.....	18
Effect On/Off.....	16
EFFECT REMOTE/EXP PEDAL Jack	10
Exclusive Message.....	38
EXIT Buttons.....	9

F

Factory Preset.....	54
---------------------	----

I

INPUT JACK L(MONO)/R.....	9
INPUT Level	14
INPUT Level Knobs L/R.....	9

L

Level Switch.....	10
-------------------	----

M

Making the Connections	12
MIDI Control.....	42
MIDI Channel	36
MIDI IN Connector	10
MIDI OUT/THRU Connector	10

N

Note Messages	37
---------------------	----

O

OMNI	39
OUTPUT JACK L(MONO)/R.....	10
Overload Indicator	9

P

PARAMETER Button	9
Patch.....	5
Patch Number	14
PHONES Jack.....	9
Pitch Bender Message	38
Play Screen	13
Program Change Map	40
Program Change Message	38

R

Range of Patch Number With Foot-Switch	29
Realtime Control over Parameters	32

S

Skip Feature	21
Source.....	32
System Data	54

T

Target	32
--------------	----

U

UTILITY	9
UTILITY Button	9

W

WRITE Button	9
Write Procedure	23

INDEX TO FUNCTIONS

Please use this section as a quick reference when you're unsure of how to accomplish a specific task.

CONNECTIONS

Connecting with a mixer's Send/Return	12
Connecting a keyboard	12
Connecting a guitar or bass	13
Setting the Level Switch	14

GETTING READY

Turning on power	13
Adjusting the Input Level.....	14

PATCH NUMBERS

Selecting effects (Patch numbers) from the panel	14
Selecting effects (Patch numbers) using a foot-switch	15
Selecting effects (Patch numbers) using MIDI	16
Setting the range within which Patches are made available when selecting Patches using a foot-switch	29

EFFECTS ON/OFF

Turning effects On/Off from the panel	16
Turning effects On/Off using a foot-switch.....	16
Turning effects On/Off using MIDI messages	18
Setting the unit so no sound (not even the direct sound) is output when the effects are off	18

WORKING WITH EFFECTS

Creating an effect	21
Copy an effect (Patch number) to another Patch number	20
Altering the parameters for an effect.....	21
Changing the name of an effect.....	22
Storing an effect in memory after it has been edited (Write procedure)	23

MIDI SETTINGS

Setting the MIDI channel.....	39
Setting the Omni Mode	39
Remotely selecting Patches from an external MIDI device.....	40
Altering the Program Change Map	40
Manipulating parameters remotely from an external MIDI device (MIDI control)	42
Using a MIDI foot controller (FC-50)	44
Making the selection for MIDI Out/Thru.....	47

TRANSMISSION/RECEPTION OF DATA

Content of data to be transmitted	45
Storing SE-70 data in a sequencer	46
Loading SE-70 data from a sequencer.....	46
Sending a copy of data to another SE-70	46
Data transmission (Bulk Dump).....	47
Data reception (Bulk Load).....	48

OTHERS

Obtaining real-time control over parameters	32
Using the Tuner.....	24
Using the Metronome	28
Restoring the Factory Presets	54
Types of data which can be restored to their Factory Presets.....	55

MEMO

MEMO

Information

When you need repair service, call your local Roland Service Station or the authorized Roland distributor in your country as shown below.

U. S. A.

Roland Corporation US
7200 Dominion Circle
Los Angeles, CA. 90040-3696,
U. S. A.
TEL: (213) 685-5141

CANADA

Roland Canada Music Ltd.
(Head Office)
5480 Parkwood Way
Richmond B. C., V6V 2M4
CANADA
TEL: (604) 270-6626

Roland Canada Music Ltd.

(Montreal Office)
9425 Transcanadienne
Service Rd. N., St Laurent,
Quebec H4S 1V3, CANADA
TEL: (514) 335-2009

Roland Canada Music Ltd.

(Toronto Office)
346 Watline Avenue,
Mississauga, Ontario L4Z
1X2, CANADA
TEL: (416) 890-6488

AUSTRALIA

Roland Corporation Australia Pty. Ltd.
38 Campbell Avenue Dee
Why West. NSW 2099
AUSTRALIA
TEL: (02) 982-8266

NEW ZEALAND

Roland Corporation (NZ) Ltd.
97 Mt. Eden Road, Mt. Eden,
Auckland 3, NEW
ZEALAND
TEL: (09) 3098-715

UNITED KINGDOM

Roland (U.K.) Ltd.
Rye Close Ancells Business
Park Fleet, Hampshire GU13
8UY, UNITED KINGDOM
TEL: 0252-816181

**Roland (U.K.) Ltd.,
Swansea Office**

Atlantic Close, Swansea
Enterprise Park, Swansea,
West Glamorgan SA79FJ,
UNITED KINGDOM
TEL: (0792) 700-139

ITALY

Roland Italy S. p. A.
Viale delle Industrie 8 20020
ARESE MILANO ITALY
TEL: 02-93581311

SPAIN

Roland Electronics de España, S. A.
Calle Bolivia 239 08020
Barcelona, SPAIN
TEL: 93-308-1000

GERMANY

Roland Elektronische Musikinstrumente Handelsgesellschaft mbH.
Oststrasse 96, 2000
Norderstedt, GERMANY
TEL: 040/52 60 090

FRANCE

Musikengro
102 Avenue Jean-Jaures
69007 Lyon Cedex 07
FRANCE
TEL: (7) 858-54 60

Musikengro (Paris Office)

Centre Region Parisienne 41
rue Charles-Fourier, 94400
Vitry SUR/SEINE FRANCE
TEL: (1) 4680 86 62

BELGIUM/HOLLAND/ LUXEMBOURG

Roland Benelux N. V.
Houtstraat 1 B-2260 Oevel-
Westerlo BELGIUM
TEL: (0032) 14-575811

DENMARK

Roland Scandinavia A/S
Langebrogade 6 Box 1937
DK-1023 Copenhagen K.
DENMARK
TEL: 31-95 31 11

SWEDEN

Roland Scandinavia A/S
Danvik Center 28 A, 2 tr. S-
131 30 Nacka SWEDEN
TEL: 08-702 00 20

NORWAY

**Roland Scandinavia Avd.
Kontor Norge**
Lilleakerveien 2 Postboks 95
Lilleaker N-0216 Oslo 2
NORWAY
TEL: 22-73 00 74

FINLAND

Fazer Musik Inc.
Länsituulentie POB 169, SF-
02101 Espoo FINLAND
TEL: 0-43 50 11

SWITZERLAND

Musitronic AG
Gerberstrasse 5, CH-4410
Liestal, SWITZERLAND
TEL: 061/921 16 15

**Roland CK (Switzerland)
AG**

Postfach/Hauptstrasse 21
CH-4456 Tenniken
SWITZERLAND
TEL: 061/98 60 55
Repair Service by Musitronic AG

AUSTRIA

E. Dematte & Co.
Neu-Rum Siemens-Strasse 4
A-6021 Innsbruck Postfach
591 AUSTRIA
TEL: (051 2) 63 451

GREECE

V. Dimitriadis & Co. Ltd.
20, Alexandras Avn., GR
10682 Athens, GREECE
TEL: 01-8232415

PORTUGAL

Casa Caius Instrumentos Musicais Lda.
Rua de Santa Catarina 131
4000 Porto, PORTUGAL
TEL: 02-38 44 56

HUNGARY

Intermusica Ltd.
Warehouse Area 'DEPO'
Torokbalint, Budapest
HUNGARY
TEL: (1) 1868905

ISRAEL

D.J.A. International Ltd.
11 Bar Gyiara St., Tel Aviv
ISRAEL
TEL: 972-3-5283329

CYPRUS

Radex Sound Equipment Ltd.
17 Diagorou St., P.O.Box
2046, Nicosia CYPRUS
TEL: 453426, 466423

U.A.E

**Zak Electronics &
Musical Instruments Co.**
P.O. Box 8050
DUBAI, U.A.E
TEL: 695774

SAUDI ARABIA

**Omar Badoghaish
Trading Corp.**
P.O. Box 5980
Jeddah, SAUDI ARABIA
TEL: 966-02-6607038

KUWAIT

Easa Husain Al-Yousifi
P.O. Box 126 Safat 13002
KUWAIT
TEL: 965-5719499

LEBANON

A. Chahine & Fils
P.O. Box 16-5857
Beirut, LEBANON
TEL: 335799

TURKEY

Barkat Sanayi ve Ticaret
Siraselvilir Cad. 86/6 Taksim
Istanbul, TURKEY
TEL: 149 93 24

EGYPT

Al Fanny Trading Office
9, Ebn Hagar Askalany
Street, Ard El Golf,
Heliopolis, Cairo, EGYPT
TEL: 2917803-665918

BRAZIL

Roland Brasil Ltda.
R. Alvarenga 591 CEP-
05509 Sao Paulo BRAZIL
TEL: (011) 813-7967
Repair Service for Roland and
Rhodes products

Oliver do Brasil S.A.

Instrumentos Musicais
Rua Boturoca. 198/206
CEP 05586-010 Vila Indiana
Butanta Sao Paulo-SP
BRAZIL
TEL: (011) 813- 4039
Repair Service for BOSS products

MEXICO

**Casa Veerkamp, s.a. de
c.v.**
Mesones No. 21 Col. Centro
MEXICO D.F. 06080
TEL: (5) 709-3716

**La Casa Wagner de
Guadalajara s.a. de c.v.**
Av. Corona No. 202 S.J.
C.P.44100 Guadalajara,
Jalisco MEXICO
TEL: (36) 13-1414

VENEZUELA

Musicland Digital C.A.
Av. Francisco De Miranda,
Centro Parque Cristal, Nivel
C2 Local 20 Caracas
VENEZUELA
TEL: (2)2844497

PANAMA

Productos Superiores, S.A.
Apartado 655 - Panama 1
REP. DE PANAMA
TEL: 26-3322

ARGENTINA

**Instrumentos Musicales
S.A.**
Florida 638
(1005) Buenos Aires
ARGENTINA
TEL: (1)394-4029

HONG KONG

**Tom Lee Music Co., Ltd.
Service Division**
22-32 Pun Shan Street,
Tsuen Wan, New Territories,
HONG KONG
TEL: 415-0911

KOREA

**Cosmos Corporation
Service Station**
261 2nd Floor Nak-Won
arcade Jong-Ro ku, Seoul,
KOREA
TEL: (02) 742 8844

SINGAPORE

Swee Lee Company
Bras Basah Complex #03-23
Singapore 0178 SINGA-
PORE
TEL: 3367886

PHILIPPINES

G.A. Yupangco & Co. Inc.
339 Gil J. Puyat Avenue
Makati, Metro Manila 1200,
PHILIPPINES
TEL: (632)819-7551

THAILAND

Theera Music Co., Ltd.
330 Verng Nakorn Kasem,
Soi 2, Bangkok 10100,
THAILAND
TEL: 2248821

MALAYSIA

Syarikat Bentley
No.142, Jalan Bukit Bintang
55100 Kuala Lumpur,
MALAYSIA
TEL: 2421288

INDONESIA

PT Galestra Inti
Kompleks Perkantoran Duta
Merlin Blok C/59 Jl. Gajah
mada No.3-5 Jakarta 10130
INDONESIA
TEL: (021) 354604, 354606

TAIWAN

**Siruba Enterprise
(Taiwan) Co., LTD.**
Room. 5, 9fl. No. 112
Chung Shan N.Road Sec.2
Taipei, TAIWAN, R.O.C.
TEL: (02) 5364546

SOUTH AFRICA

**That Other Music Shop
(PTY) Ltd.**
256 Bree Street, Johannes-
burg 2001 Republic of
South Africa
TEL: 337-6573

Paul Bothner (PTY) Ltd.

17 Werdmuller Centre
Claremont 7700 Republic
of South Africa
TEL: 021-64-4030

 Roland®

70019001

UPC

70019001



10981

Roland