

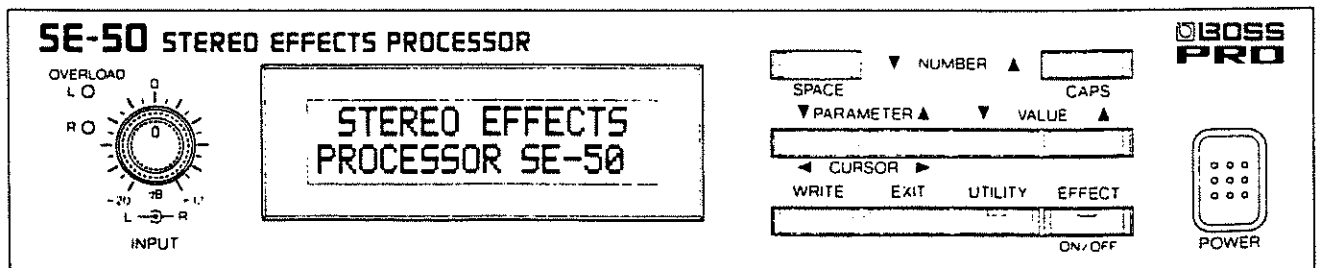

SE-50 STEREO EFFECTS PROCESSOR

Owner's Manual



For Nordic Countries

Apparatus containing Lithium batteries

ADVARSEL!

Lithiumbatteri. Eksplosionsfare.
Udskiftning må kun foretages af en sagkyndig,
og som beskrevet i servicemanual.

VARNING!

Lithiumbatteri. Explosionsrisk.
Får endast bytas av behörig servicetekniker.
Se instruktioner i servicemanualen.

ADVARSEL!

Lithiumbatteri. Fare for eksplosion.
Må bare skiftes af kvalificeret tekniker som
beskrevet i servicemanualen.

VAROITUS!

Lithiumparisto. Rajahdysvaara.
Pariston saa vaihtaa ainoastaan
alan ammattimes.

For West Germany

Bescheinigung des Herstellers/Importeurs

Hiermit wird bescheinigt, daß der/die/das
STEREO EFFECTS PROCESSOR SE-50
(Gerat. Typ. Bezeichnung)

in Übereinstimmung mit den Bestimmungen der
Amtsbl. Vfg 1046/1984
(Amtsblattverfügung)

funk-entstört ist.

Der Deutschen Bundespost wurde das Inverkehrbringen dieses Gerätes angezeigt und die Berechtigung zur Überprüfung der Serie auf Einhaltung der Bestimmungen eingeräumt

Roland Corporation Osaka/Japan

Name des Herstellers/Importeurs

For the USA

RADIO AND TELEVISION INTERFERENCE

WARNING — This equipment has been verified to comply with the limits for a Class B computing device pursuant to Subpart J of Part 15 of FCC rules. Operation with non-certified or non-verified equipment is likely to result in interference to radio and TV reception.

The equipment described in this manual generates and uses radio frequency energy. If it is not installed and used properly, that is, in strict accordance with our instructions, it may cause interference with radio and television reception. This equipment has been tested and found to comply with the limits for a Class B computing device in accordance with the specifications in Subpart J of Part 15 of FCC Rules. These rules are designed to provide reasonable protection against such interference in a residential installation. However, there is no guarantee that the interference will not occur in a particular installation. If this equipment does cause interference to radio or television reception, which can be determined by turning the equipment on and off, the user is encouraged to try to correct the interference by the following measure:

- Disconnect other devices and their input/output cables one at a time. If the interference stops, it is caused by either the other device or its cable. For non-Roland devices, contact the manufacturer or dealer for assistance.

If your equipment does cause interference to radio or television reception, you can try to correct the interference by using one or more of the following measures:

- Turn the TV or radio antenna until the interference stops.
- Move the equipment to one side or the other of the TV or radio.
- Move the equipment farther away from the TV or radio.
- Plug the equipment into an outlet that is on a different circuit than the TV or radio. That is, move either the equipment or the radio or television set and its circuits (as controlled by different circuit breakers or fuses).
- Consider installing a rooftop television antenna with coaxial cable lead-in between the antenna and TV. If necessary, you should consult your dealer or an experienced radio/television technician for additional suggestions. You may find helpful the following booklet prepared by the Federal Communications Commission: "How to Identify and Resolve Radio-TV Interference Problems."

This booklet is available from the U.S. Government Printing Office, Washington, D.C. 20402, Stock No. 004-000-00345-4.

For Canada

CLASS B

NOTICE

This digital apparatus does not exceed the Class B limits for radio noise emissions set out in the Radio Interference Regulations of the Canadian Department of Communications.

CLASSE B

AVIS

Cet appareil numérique ne dépasse pas les limites de la classe B au niveau des émissions de bruits radioélectriques fixés dans le Règlement des signaux parasites par le ministère canadien des Communications.

For the U.K.

**IMPORTANT: THE WIRES IN THIS MAINS LEAD ARE COLOURED IN ACCORDANCE WITH THE FOLLOWING CODE
BLUE NEUTRAL BROWN LIVE**

As the colours of the wires in the mains lead of this apparatus may not correspond with the coloured markings identifying the terminals in your plug proceed as follows:

- The wire which is coloured BLUE must be connected to the terminal which is marked with the letter N or coloured BLACK.
- The wire which is coloured BROWN must be connected to the terminal which is marked with the letter L or coloured RED.

Thank you, and congratulations on your choice of the BOSS SE - 50 Stereo Effects Processor. The SE - 50 is equipped with a wealth of high - quality effects which are geared perfectly for guitars, basses, keyboards and many other instruments.

Moreover, by using MIDI to connect the unit with external devices, numerous other performance possibilities can be enjoyed. Before starting out, please take the time to read this manual thoroughly . That way, you can feel confident that you have gained a grasp of every feature the unit provides, and thus will be satisfied for years to come.

FEATURES

● 2 - In, 2 - Out Routing

The SE - 50 provides true stereo performance, thanks to its 2 - In, 2 - Out system. Moreover, this means you can obtain stereo output even when using mono instruments, such as a guitar.

● Offers a Complete Selection of Algorithms

The SE - 50 employs 28 onboard algorithms. (They determine the way in which effects are combined.) As a result, you have control over the tools needed for creating almost any timbre you want.

● Pedal Control Provided

After plugging in a foot - switch, you can shift among programs simply using your foot.

● MIDI Control

Since the SE - 50 is equipped with MIDI connectors, an external MIDI device can be used to control it. Moreover, this feature allows you to transfer your SE - 50's data to a MIDI sequencer or another SE - 50.

● Mountable in 19 - inch Racks

Using the optionally available RAD - 50 Rack Mount Adaptor, the unit will fit perfectly in a 19 - inch rack.

How to Use This Manual

This manual is divided into three main sections. Together, they explain the available functions, and how they are used in performance. Also provided is a guide to all the possible settings, and instructions on how to make them. The Table of Contents should be referred to when necessary.

In addition, an alphabetical index is provided at the rear, making it easy for you to look up any items you have trouble understanding while operating the unit.

The contents of each section is as follows:

SECTION I PERFORMANCE

① Producing Sound

This section explains how to connect the SE - 50 with your other equipment, how to select Effects Programs, and most of the other basic procedures you need to know to operate the unit.

② Creating Effects Programs

Using simple procedures, the SE - 50 allows you to setup new tonal creations. Programs for these sounds can then be stored in memory. This section explains the process for doing this.

③ How the Effectors Function

An algorithm consists of a combination of effectors. Further, each effector offers a full range of parameters, which together act in determining the timbre obtained. By making changes in the parameter values, new timbres can be created. This section provides an explanation of each algorithm the SE - 50 offers, and also explains how each of their parameters plays a role in creating the effect that will be obtained.

SECTION II USING MIDI

① About MIDI

This section provides a basic introduction to the use of MIDI. If MIDI is employed, you will be able to use an external MIDI device to change and control the Effects Programs on the SE - 50.

② MIDI Settings

Here the available MIDI features are explained, along with instructions on how to make settings for them.

③ Getting the Most Out of the SE - 50

This section provides practical examples of the SE - 50 in a MIDI setup.

SECTION III REFERENCE

Here you will find information on what to do when your SE - 50 is not responding as expected, along with other useful information about the unit.

Copyright © 1990 by BOSS Corporation

All rights reserved. No part of this publication may be reproduced in any form without the written permission of BOSS CORPORATION

CONTENTS

FEATURES.....	3
How To Use This Manual.....	3
CONTENTS.....	4
IMPORTANT NOTES.....	6
PANEL DESCRIPTIONS.....	7

SECTION I PERFORMANCE

1 Producing Sound	10
1. Making the Connections.....	10
2. Turning on the Power.....	11
3. Adjusting the Input Level.....	12
4. Selection of Program Numbers.....	12
1) Selection From the Panel.....	12
2) Selection Using a Foot-switch.....	13
<input type="checkbox"/> Setting the Range of Pedal Changes in Program Number.....	14
5. Turning Effects On/Off.....	15
<input type="checkbox"/> Switching Using the Panel.....	15
<input type="checkbox"/> Using a Foot-switch.....	15
<input type="checkbox"/> Setting the Effects Off Mode.....	15
2 Changing Effects Program	17
1. First, Some Basics	
About Effects Programs.....	17
1) Composition of Effects Programs.....	17
2) Steps Taken in Creating an Effects Programs.....	17
2. Copying an Effects Program.....	19
3. Altering an Effects Program.....	19
4. The Write Procedure.....	20
5. Altering the Name of an Effects Program.....	21
3 How the Effectors Function	23
1. The Reverb Algorithms.....	23
1) HALL1 (No.101).....	25
2) HALL2 (No.102).....	27
3) ROOM (No.103).....	28
4) PLATE (No.104).....	30
5) AMBIENCE (No.105).....	31
6) GATE REVERB (No.106).....	33
7) STEREO REVERB (No.107).....	35
2. Delay Algorithms.....	37

8) MULTI DELAY (No.108).....	37
9) MULTI TAP DELAY (No.109).....	39
10) STEREO DELAY (No.110).....	41
3. Other Algorithms That Use Single Effectors.....	43
11) SPACE CHORUS (No.111).....	43
12) MULTI PITCH SHIFTER (No.112).....	45
13) STEREO PITCH SHIFTER (No.113).....	48
14) STEREO FLANGER (No.114).....	50
15) STEREO PHASER (No.115).....	52
4. Algorithms Combining Two or More Effectors.....	54
16) VOCODER (No.116).....	54
17) ROTARY (No.117).....	56
18) KEYBOARD MULTI 1 (No.118).....	58
19) KEYBOARD MULTI 2 (No.119).....	61
20) RHODES (No.120).....	64
21) GUITAR MULTI (No.121).....	68
22) VOCAL MULTI (No.122).....	72
23) STEREO ENHANCER (No.123).....	75
24) 2CH MIXER (No.124).....	77
5. Algorithms Suitable for Use With Mixers.....	80
25) REVERB1 + REVERB2 (No.125).....	81
26) GATE REVERB + REVERB (No.126).....	83
27) CHORUS + REVERB (No.127).....	85
28) DELAY + REVERB (No.128).....	87

Section II USING MIDI

1 ABOUT MIDI	92
1. The Exchange of MIDI Data.....	92
2. MIDI Messages Recognized by the SE-50.....	93
2 MIDI SETTING	95
1. Setting the MIDI Channel and OMNI Mode.....	95
2. Changing Program Numbers.....	96
3. MIDI CONTROL.....	98
4. Using a Foot Controller.....	100
(FC-100MK II)	

5. Receiving and Sending
 Data Over MIDI 101
 1) Making the Connections 101
 2) Data Transmission (Bulk Dump)..... 102
 3) Data Reception (Bulk Load)..... 103
**3) Getting the Most From
 Your SE - 50**..... 104
 1) Setup Using a Keyboard Controller
 and Sound Module 104
 2) Setup Using a Guitar..... 105
 3) Combining a Sequencer..... 106

Section III REFERENCE

Factory Preset Setting..... 108
 1. About Factory Preset Settings..... 108
 2. Restoring the Factory Presets..... 108
 (Initializing the Data)
TROUBLESHOOTING 110
The List of Algorithm..... 113
The Table of Preset Name..... 114
BLANK CHART..... 115
Roland Exclusive Messages 117
MIDI Implementation..... 121
MIDI Implementation Chart..... 134
SPECIFICATIONS..... 136
Index 137
 Index to the Unit's Functions 139

IMPORTANT NOTES

When using an AC adaptor, be sure that it is one supplied by the manufacturer. Use of any other power adaptor could result in damage, malfunction, or electric shock.

[Power Supply]

- When making any connections with other devices, always turn off the power to all equipment first; this will help prevent damage or malfunction.
- Do not use this unit on the same power circuit with any device that will generate line noise, such as a motor or variable lighting system.
- The power supply required for this unit is shown on its nameplate. Ensure that the line voltage of your installation meets this requirement.
- Avoid damaging the power cord; do not step on it, place heavy objects on it etc.
- When disconnecting the AC adaptor from the outlet, grasp the plug itself; never pull on the cord.
- If the unit is to remain unused for a long period of time, unplug the power cord.

[Placement]

- Do not subject the unit to temperature extremes (eg. direct sunlight in an enclosed vehicle). Avoid using or storing the unit in dusty or humid areas or areas that are subject to high vibration levels.
- Using the unit near power amplifiers (or other equipment containing large transformers) may induce hum.
- This unit may interfere with radio and television reception. Do not use this unit in the vicinity of such receivers.

[Maintenance]

- For everyday cleaning wipe the unit with a soft, dry cloth (or one that has been slightly dampened with water). To remove stubborn dirt, use a mild neutral detergent. Afterwards, be sure to wipe the unit thoroughly with a soft, dry cloth.
- Never use benzene, thinners, alcohol or solvents of any kind, to avoid the risk of discoloration and/or deformation.

[Memory Backup]

- The unit contains a battery which maintains the contents of memory while the main power is off. The expected life of this battery is 3 years or more. However, to avoid the unexpected loss of memory data, it is strongly recommended that you change the battery every 3 years. Please be aware that the actual life of the battery will depend on the physical environment (especially temperature) in which the unit is used. When it is time to change the battery, consult with qualified service personnel.
- Please be aware that the contents of memory may at times be lost; when the unit is sent for repairs or when by some chance a malfunction has occurred. Important data should be stored in another MIDI device (eg. a sequencer), or written down on paper. During repairs, due care is taken to avoid the loss of data. However, in certain cases, (such as when circuitry related to memory itself is out of order) we regret that it may be impossible to restore the data.

[Additional Precautions]

- Protect the unit from strong impact.
- Do not allow objects or liquids of any kind to penetrate the unit. In the event of such an occurrence, discontinue use immediately. Contact qualified service personnel as soon as possible.
- Never strike or apply strong pressure to the display.
- Before using the unit in a foreign country, consult with qualified service personnel.
- Should a malfunction occur (or if you suspect there is a problem) discontinue use immediately. Contact qualified service personnel as soon as possible.

PANEL DESCRIPTIONS

«Front Panel»

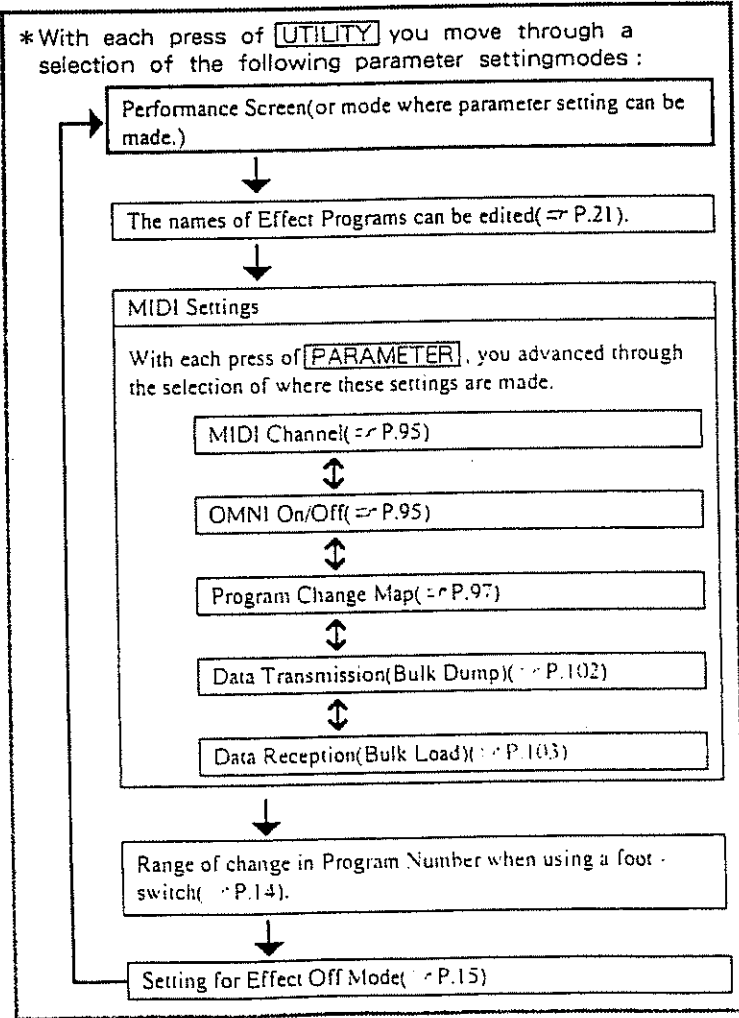
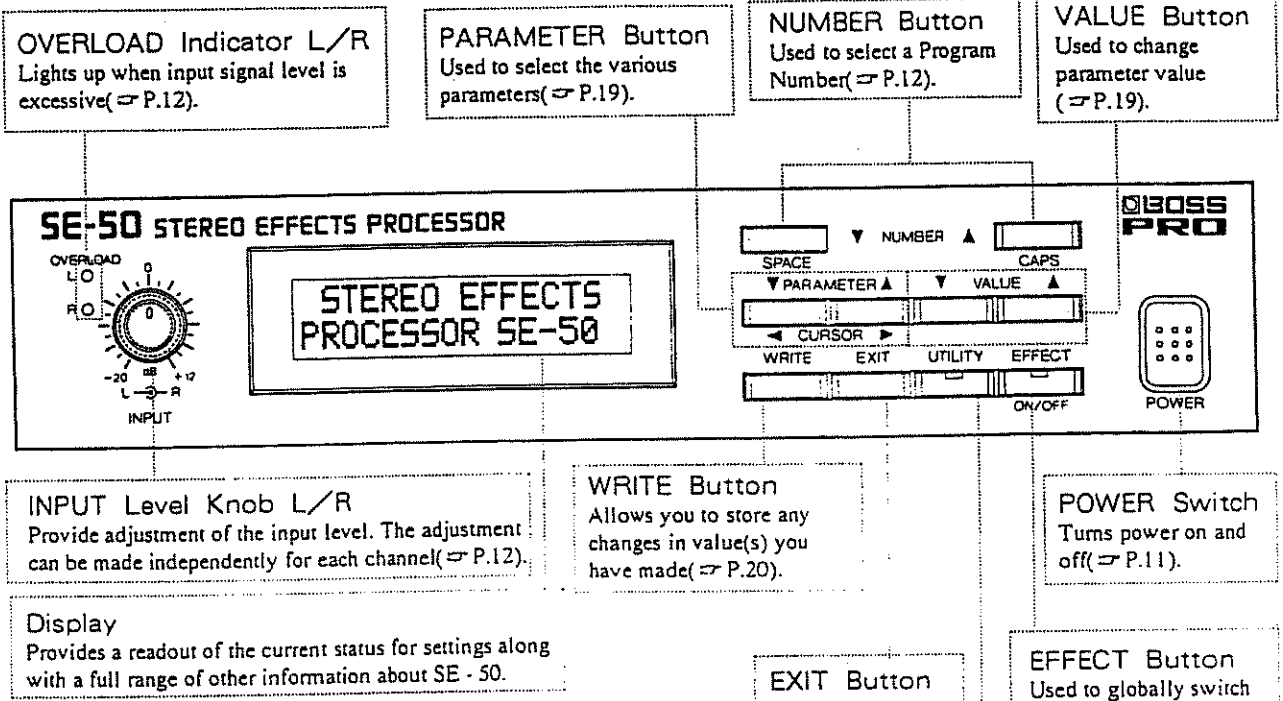

《Rear Panel》

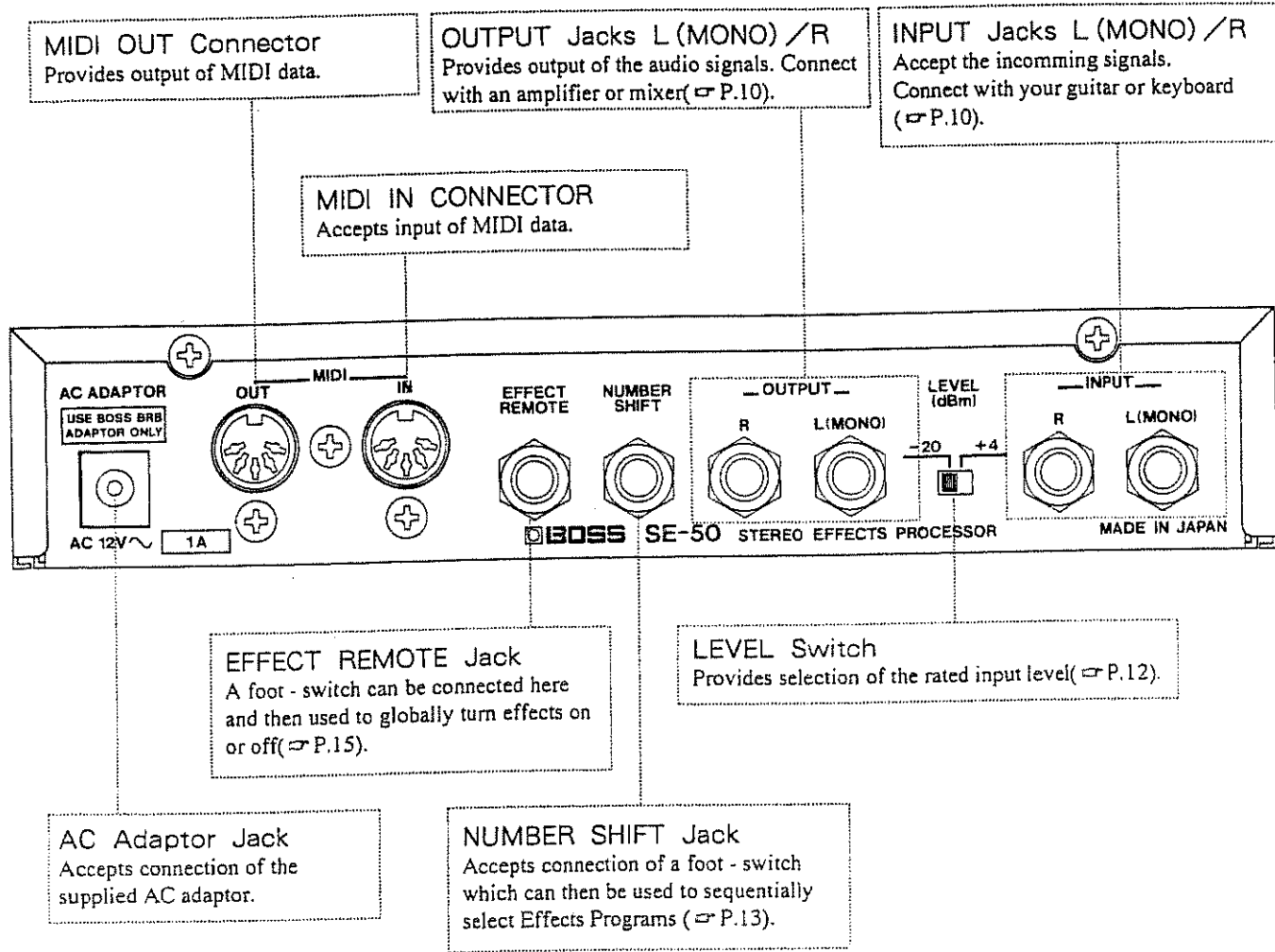

■ Important

If you are using the unit as is, that is, not going to mount it using the optional RAD-50 Rack Mount Adaptor, make sure you affix the supplied rubber feet to the unit as shown in the illustration below.

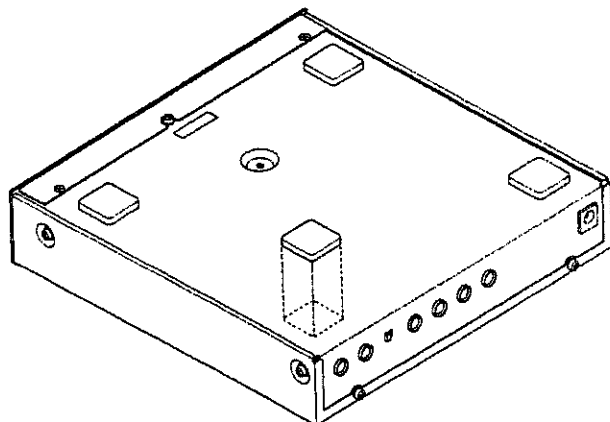

SECTION I

《PERFORMANCE》

1 Producing Sound

After making any connections with external devices, you are ready to listen to the SE - 50's Effects Programs.

1. Making the Connections

Make the connections with the SE - 50 following one of the examples below, depending on the application you have in mind.

* Always have the volume on your amplifier turned down, and have power to all devices turned off before inserting or pulling out any cords. If you attempt to make connections while power is on, not only could you damage the speakers, but other malfunctions could result.

Setup using a mixer's Send/Return

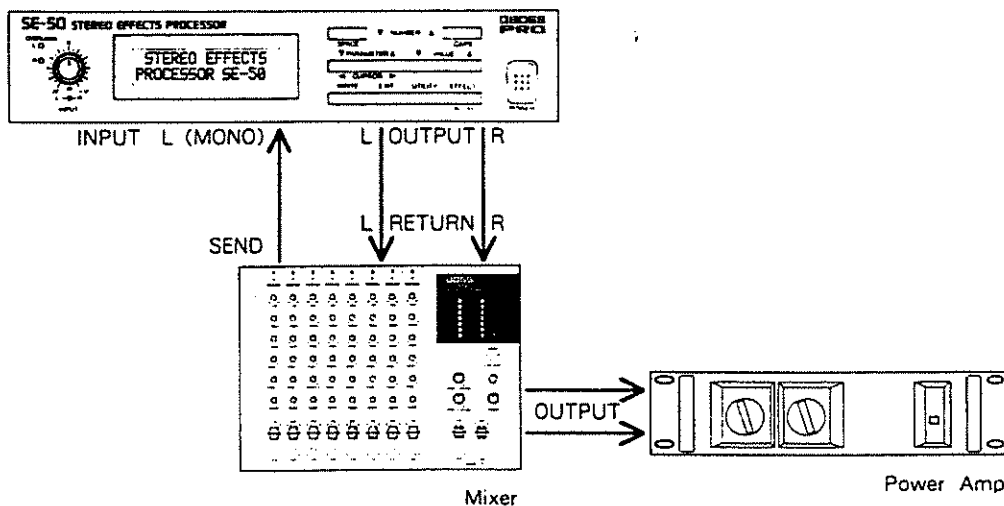

* Check the position of the Level Switch. It should be matched to the level used by the mixer you are using.

Setup using a keyboard

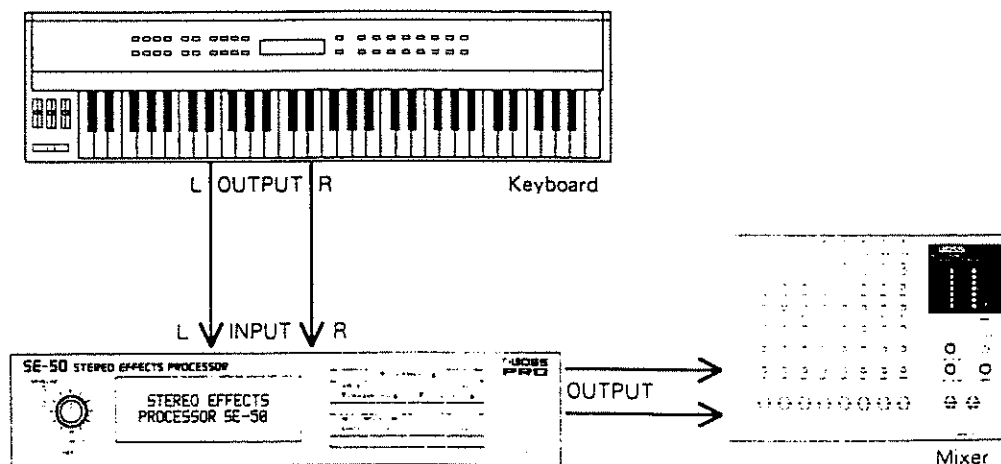

* Ordinarily, the Level Switch may be set at - 20 dBm.

* For a mono setup, make connections using only the L (MONO) jack on both input and output ends.

Setup using a guitar or bass

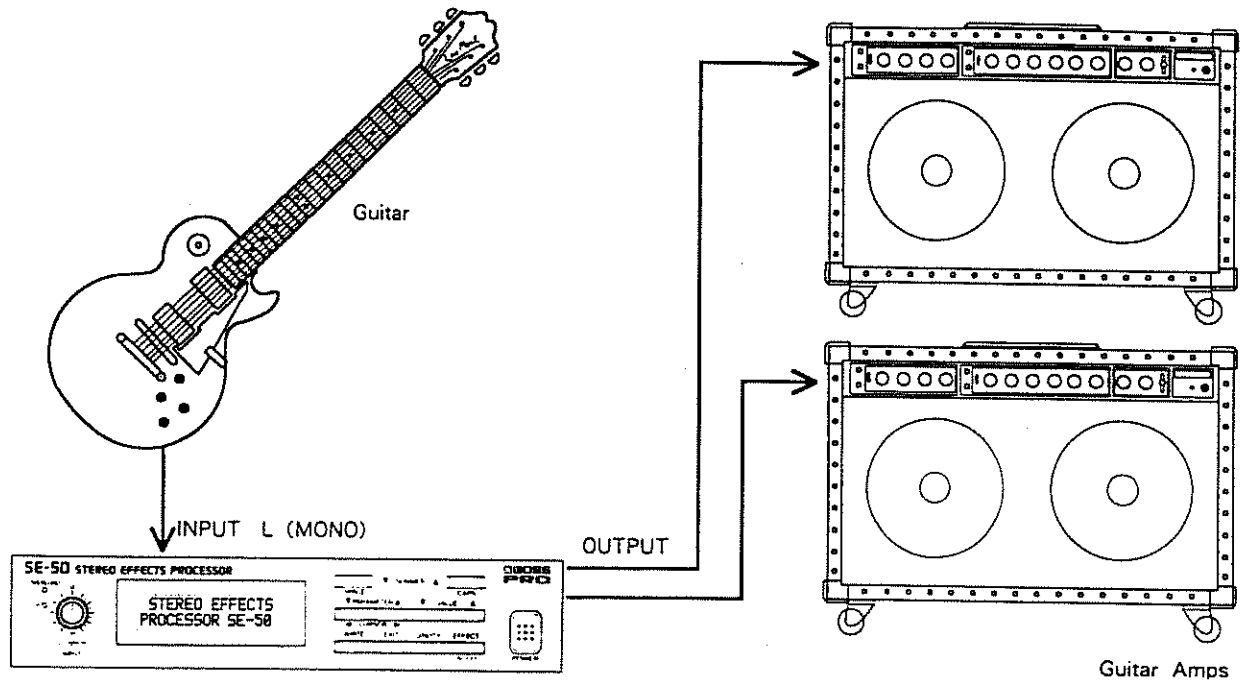

- * Ordinarily, the Level Switch may be set at - 20 dBm.
- * For mono output, make connection to only the OUTPUT L (MONO) jack.

2. Turning on the Power

After checking the connections with external units, the power switch on the SE - 50 can be turned on.

- * The volume on your amplifier should be raised only after power on every connected unit has been turned on.

With power on, the unit's display will appear as below.

```
STEREO EFFECTS
PROCESSOR SE-50
```

A few seconds later, you will see the following display. This (the performance screen) means you are in the mode used ordinarily for performance.

```
1 Hall 1
HALL 1
```

- * Each time power is turned on, you will find that the Program Number that was selected the last time the unit was on will again be selected.
- * Since the SE - 50 is equipped with a circuitry protection feature, it requires a few moments after power is turned on before it can be operated.

3. Adjusting the Input Level

The output level provided by an instrument can vary depending on the instrument. For this reason, you need to adjust the Input Level so it is suited to the particular instrument you are using.



- ① Turn the Input Level knobs (both left and right) until you have them set so the corresponding Overload indicators light briefly at the moments of the highest level of volume possible from your instrument.
 - * These indicators light up at a level that is 6 dB lower than the clipping level.
 - * Signals entering the SE - 50 are at one point converted into digital signals. If the input level is excessive, this digital conversion will be imprecise, which can lead to a reduction in the quality of the resulting sound.
 - * In cases where you have the Level Switch set to " - 20dBm", and you notice that the Overload Indicator tends to light too frequently, even though you have turned the Input Level knobs all the way down (- 20dB), you should set the Level Switch to "+4dBm".



4. Selection of Program Numbers

About Program Number



There are 128 locations in the SE - 50 where setting profiles for the effectors are stored. With such settings for each effector, there is a "Program Number" which is assigned to it. These are numbered from 1 through 128. During performance any Program Number you need can be conveniently selected.

1) Selection From the Panel

- ① Press the NUMBER   buttons.

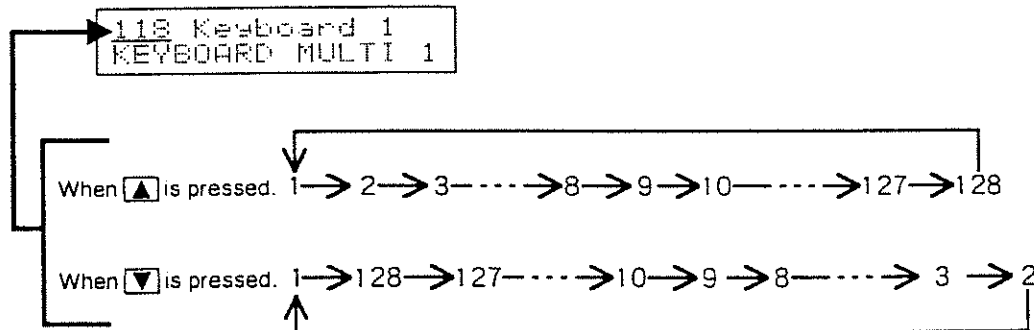
With each press of  the Program Number will increase by one. With each press of  the Program Number will decrease by one. In every case, the currently selected Program Number appears in the display.





When either of the NUMBER   is held down, you can move consecutively through the numbers.

- * While in the process of making changes in an Effect Program, you will not be able to change to another Program Number. To be able to select another Program Number, you first need to carry out the Write procedure (P. 20) for what you are working on.

2) Selection Using a Foot-switch

Once you connect the optionally available FS-5U foot-switch, you then can change Program Numbers with your foot.

- * When using a foot-switch, you cannot move consecutively through the Program Numbers even though you keep the pedal depressed.
- * Make sure to always have the power turned off whenever you connect the foot-switch. Otherwise, an unexpected change in Program Numbers could occur.

- You can obtain pedal control over the same functions provided by the NUMBER   if you connect two foot-switches as shown.

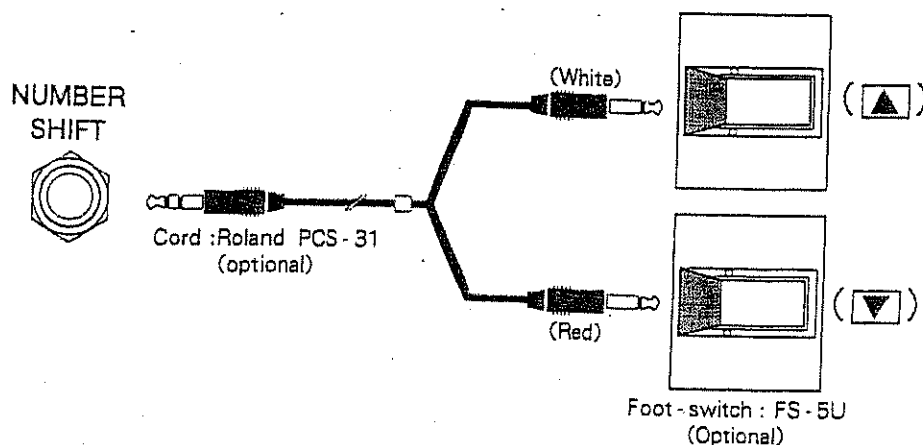

- With only one foot-switch connected, the Program Number will increase by one with each press on the pedal.

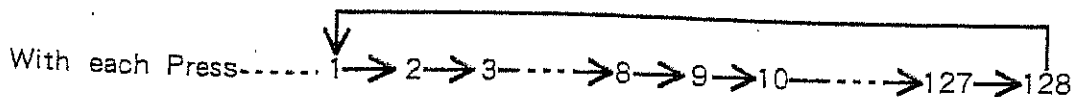
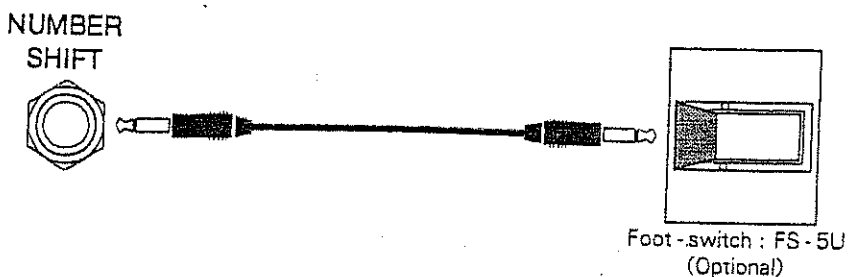

- * Set the polarity switch on the FS-5U to the setting shown below. This way, at the moment you depress the pedal, you obtain a change in the Program Number.

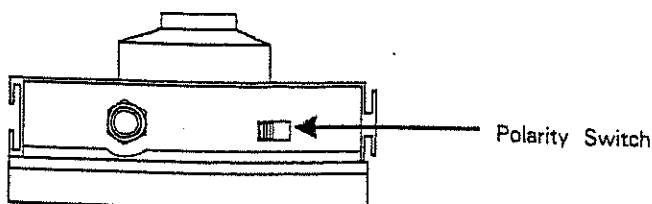

□ Setting the Range of Pedal Changes in Program Number

When a foot-switch is used to shift Program Numbers, the available numbers ordinarily range from 1 through 128. However, by setting a specific range, you can then shift among Program Numbers within that range only.

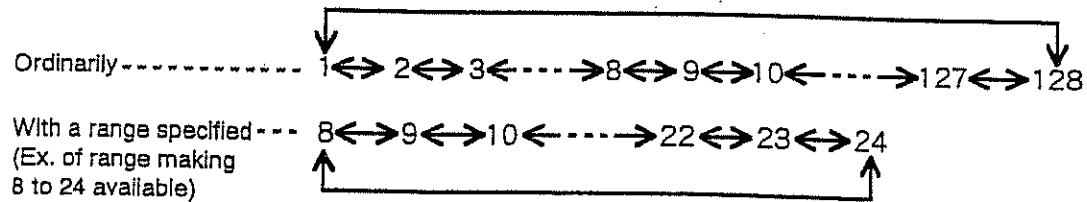

- ① Press **UTILITY** enough times to reach the screen shown below.

```
FOOT SW NUMBER
SHIFT  1 → 128  VALUE: 1 to 128
```

Lowest Program Number Highest Program Number

- ② Set the desired range. Select the lowest Program Number using **NUMBER** ▲▼. The highest Program Number is selected using **VALUE** ▲▼.

```
FOOT SW NUMBER
SHIFT  8 → 24
```

- ③ When complete, press **EXIT** to return to the performance screen.

- * If you set the Lowest Program Number so it is actually higher than the Highest Program Number, you will obtain changes in a descending order (higher to lower).
- * The Roland FC - 100MK II Foot Controller can also be used to shift Program Numbers. For instructions on use of the FC - 100MK II , refer to "4. Using a Foot Controller" (⇨ P. 100).

5. Turning Effects On/Off

All effects can be turned on and off. When turned off, all selected effectors will either be bypassed when sound is output; or no sound at all will be output. (A selection between these two options is provided.)

- * Program Numbers can be selected even when effects are turned off.
- * The On/Off status of the effects is not influenced in any way by any other procedures you perform.

Switching Using the Panel

Press **EFFECT** to turn the effects on and off. When the effects are on, the indicator on the EFFECT button will be lit.

Using a Foot-switch

By connecting an optional FS - 5L foot - switch to the EFFECT REMOTE jack, you will gain pedal control over turning the effects on and off. In this case as well, the indicator on the EFFECT button will be lit when the effects are on.

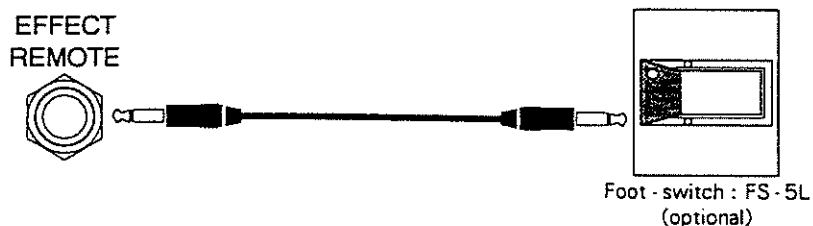

- * Set the polarity switch on the FS - 5L to the setting shown below. The indicator on the foot - switch will also light up when the effects are on.

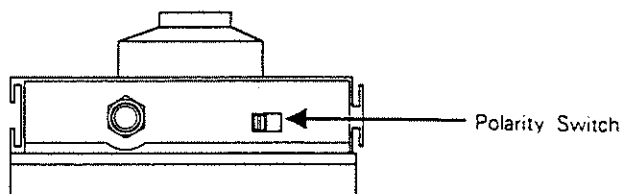

- * When the foot - switch is used to turn effects off, the EFFECT button on the panel will be inactive.

Setting the Effects Off Mode

You have a choice of whether you want only the direct sound to be output, or no sound at all to be output when the effects are turned off.

- 1 Press **UTILITY** until you reach the display shown below.

```

EFFECT OFF MODE
SELECT : DIRECT
VALUE: DIRECT MUTE
    
```

- ② Using VALUE , select the mode the unit is to assume when effects are off.

⟨EFFECT OFF : DIRECT⟩

```
EFFECT OFF MODE
SELECT : DIRECT
```

⟨EFFECT OFF : MUTE⟩

```
EFFECT OFF MODE
SELECT : MUTE
```

DIRECT: The direct sound alone will be output.

MUTE: No sound at all will be output.

- ③ When completed, press to return to the performance screen.

For ordinary use (with an instrument connected) you would normally set this to DIRECT. If you use a setup where you are connected to a mixer's Send/Return jacks however, it should be set to MUTE. Otherwise, there may be a change in the balance of the output from the mixer between times the effects are on and off. This is because even with the SE - 50 effects turned off, the direct sound that is output has been routed through the effects circuitry.

2 Changing Effects Program

The SE - 50 is equipped with a number of effectors. This section guides you through creation of new Effects Programs which combine these effectors. Once created, a program can be easily stored in memory.

1. First, Some Basics About Effects Programs

1) Composition of Effects Programs

About Program Numbers

Each Effects Program is assigned one of the Program Numbers from 1 through 128. However, numbers 101 to 128 are Presets, and as such, changes made to them cannot be written at these locations. Note, though, that you can save whatever changes you make to an Effects Program that originates as a Preset Number, as long as you write it to another location; to one of the "user" numbers from 1 through 100.

About Algorithms

Every Effects Program is created based on algorithms. An algorithm consists of settings which define a combination where certain effectors are connected with other effectors in particular ways. By choosing an algorithm, you obtain a complete change in the combination of effectors used. Moreover, should there be an effector included in an algorithm which you do not want to be used, it can simply be turned off.

Every time you shift Program Numbers, the algorithm that is used for the selected Effects Program appears in the display.

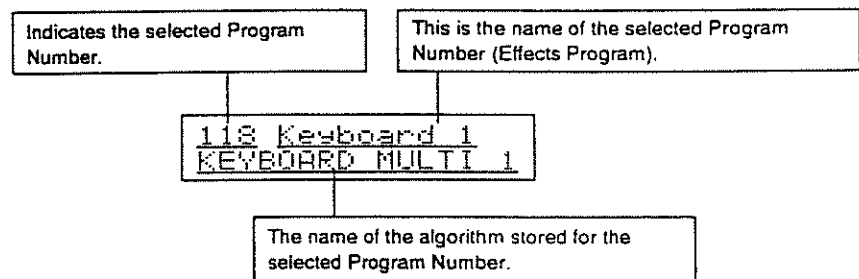

* At the Preset Numbers (Nos. 101 to 128) you will find a collection of indispensable Effects Programs which use, in order, all 28 algorithms.

2) Steps Taken in Creating an Effects Programs

Either of two methods can be employed in order to create an Effects Program: you can alter an existing program, or you can start from scratch

Altering an Existing Effects Program

- ① Select the Program Number of the Effects Program you wish to alter (P. 12)
- ② Copy the chosen Effects Program to a Program Number which contains a program you do not need (P. 19).
You do not need to copy it to another location if you have already selected a program that you are going to alter, then write over.

③ Make the changes in the Effects Program (→ P. 19).

With each effector, there are a number of parameters which control the timbre of the resulting sound. To alter an Effects Program you need to individually select these parameters, and provide them with the appropriate values.

* The parameters which can be changed will vary depending on the algorithm selected. Even when working with effectors that are used in a particular algorithm, you cannot select the parameters belonging to an effector which is turned off.

④ Store the finished Effects Program in memory (→ P. 20).

All changes made in a program's settings are only temporary. They will revert to their original values if you turn power off, or switch to a different Program Number. In order to make your changes permanent, you must perform the Write procedure, and store the program in memory.

⑤ Give the new Effects Program a name (→ P. 21).

□ Creating a Completely New Effects Program

① Select a Program Number where an algorithm that most closely matches the type of sound you have in mind is stored (→ P. 12).

The Preset Numbers (Nos. 101 to 128) offer a convenient selection for this purpose, since they represent a collection of common Effects Programs which use, one by one, all 28 algorithms.

② Copy the selected Effects Program to a Program Number which contains a program you do not need (→ P. 19).

③ Make the changes in the Effects Program (→ P. 19).

With each effector, there are a number of parameters which control the timbre of the resulting sound. To alter an Effects Program you need to individually select these parameters, and provide them with the appropriate values.

* The parameters which can be changed will vary depending on the algorithm selected. Even when working with effectors that are used in a particular algorithm, you cannot select the parameters belonging to an effector which is turned off.

④ Store the finished Effects Program in memory (→ P. 20).

All changes made in a program's settings are only temporary. They will revert to their original values if you turn power off, or switch to a different Program Number. In order to make your changes permanent, you must perform the Write procedure, and store the program in memory.

⑤ Give the new Effects Program a name (→ P. 21).

2. Copying an Effects Program

A currently selected Effects Program is copied to another Program Number as follows:

* Programs 101 through 128 are the Presets. They cannot be copied from another.

- ① Press **WRITE**.



- ② Using the NUMBER **▲** **▼** buttons, select the destination Program Number.

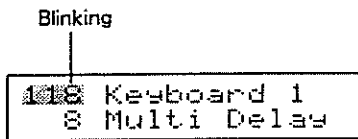

* To abort the procedure, press **EXIT**. You will be returned to the performance screen.

- ③ Press **WRITE** again, and the copy operation is performed.

When the copy operation has been completed, the Program Number stops blinking and lights steadily. You are then returned to the performance screen.

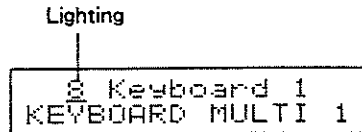

3. Altering an Effects Program

Carry out the steps below to alter the Effects Program at the currently selected Program Number. This procedure is used whenever you wish to make changes in the values for the parameters. For details of each parameter, see P. 23.



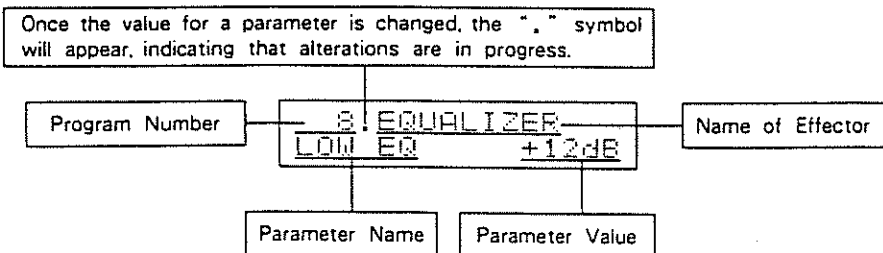

- ① Using PARAMETER **▲** **▼**, select the parameter you wish to alter.

The display will appear as below.



- ② Using the VALUE **▲** **▼**, make the changes in the value. A more rapid change in the value can be obtained by holding down the desired up or down button while you then press the opposite button.

Here, you can play your instrument and check how the value changes will affect the sound.

- * With algorithms which combine two or more effectors, there are also display pages within which you can turn individual effectors on or off. Within such pages, use the PARAMETER   to move the cursor (underline) until it is positioned under the name of the effector you wish to turn on or off. Then using the VALUE  , switch it on or off. When an effector is turned off, the "::*" symbols appear in place of its name.

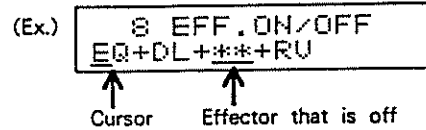

- ③ Repeat steps ① and ② until your Effects Program is complete.

4. The Write Procedure

Since all changes made in a program's settings are only temporary, they will revert to their original values if you turn power off, or switch to a different Program Number. In order to save your new settings, perform the steps below to Write the program into memory.

- * The Write procedure cannot be performed if the indicator on the UTILITY button is lit. You first need to press .

- ① After all parameters have been set as desired, press .





- * Should you wish to cancel the Write procedure, press . You will then be able to resume making alterations in parameter values.

- ② Press  again, and the write operation is performed.

When the Write operation has been completed, the Program Number stops blinking and lights steadily. You are then returned to the performance screen.



Writing to a Different Program Number

To write your Effects Program to a different Program Number, use the NUMBER   to select the destination immediately after step ① above.

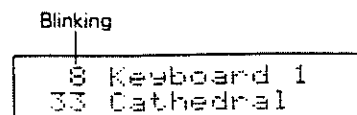

The program is stored when you press .

Rearranging the Order of Effects Program

To rearrange the order in which Effects Programs are stored, repeat the Write procedure to store them at different locations and in the order desired.

- ① If there is an Effects Program you don't want to lose at a location you wish to use, copy (Write) it to another location.
- ② Copy the Effects Program you are moving into its new location.

Repeat steps ① and ② until you have programs in the order you wish.

■ Error Message

Should you attempt to write a program into a Preset Number (101 to 128) the following error message will appear in the display :

```
118 Keyboard 1
** READ ONLY **
```

Here, press **EXIT** and you are returned to the performance screen. Then you can execute Write again, this time using a User Number (1 to 100) as the destination.

5. Altering the Name of an Effects Program

At each Program Number, a name of up to 12 characters can be assigned. It is best to make a practice of changing the name of an Effects Program after its settings have been altered. This will eliminate the confusion of having two Programs with the same name.

* No changes can be made in the names of the Preset Numbers (101 to 128).

- ① Using the NUMBER **▲▼**, select the Program Number where you are going to alter the name.

```
8 Keyboard 1
KEYBOARD MULTI 1
```

- ② Press **UTILITY** until you have the NAME EDIT page, shown below. The indicator on the button will light.

```
8 Keyboard 1
NAME EDIT ← Select this display page
```

- ③ Using the CURSOR **◀▶** (PARAMETER **▲▼**) move the cursor until it is positioned under the letter you wish to change. Select the new letter using the VALUE **▲▼**.

```
8 Keyboard 1
NAME EDIT
  ↑
  Cursor
```

- ④ When complete, press **EXIT** to return the performance screen.

These are the characters which are available:

ABCDEFGHIJKLMNOPQRSTUVWXYZ
abcdefghijklmnopqrstuvwxyz
() ← [¥] ^ _ : ; < = > ? ! " # \$ % & ' () *
+ , - . / 0 1 2 3 4 5 6 7 8 9

- * You can toggle between capital letters and small letters by pressing **CAPS** (NUMBER **▲**).
- * To insert a space, press **SPACE** (NUMBER **▼**).

3 How the Effectors Function

On the SE - 50, sound effects are designed by supplying values for the parameters that go with each effector. This section explains the effect provided by each effector, as well as how the individual parameters work.

* Whenever the term "direct sound" is used, it refers to the sound as it was when entering the effector. "Effected sound" refers to the sound after it has been modified by the effectors.

1. The Reverb Algorithms

Reverberation is produced as the result of a combination of numerous reflected sounds. For example, if you clap your hands inside a large building such as a church, you will hear the sound while it gradually fades away. Reverberation refers to sound which lingers on for a while in this way.

A number of factors act together in determining the character of a particular reverberation. These include the size (hall, room, etc.) and shape of the space in which it is produced, as well as the type of material making up the reflective surfaces (walls, etc.). The SE - 50 is equipped with the ability to digitally simulate all these factors.

The following provides further details about reverberation.

Types of Reflected Sounds

In analyzing everyday sounds we find that they can be divided into three portions: direct sound, early reflections, and late reflections. The direct sound is the sound which travels in a straight line from the source to reach the listener. Early reflections are the sounds which have been reflected back one or more times from walls, etc. Late reflections are diffused sounds which have been reflected numerous times before reaching the listener.

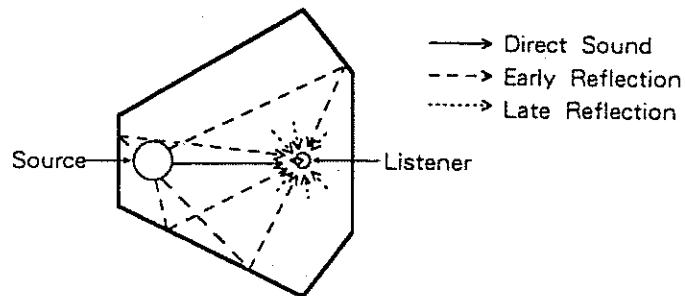

The listener will hear sound in this order: Direct sound, early reflections, then late reflections.

Relationship Between Reflections and Time

Reflected sounds reach the listener in this manner:

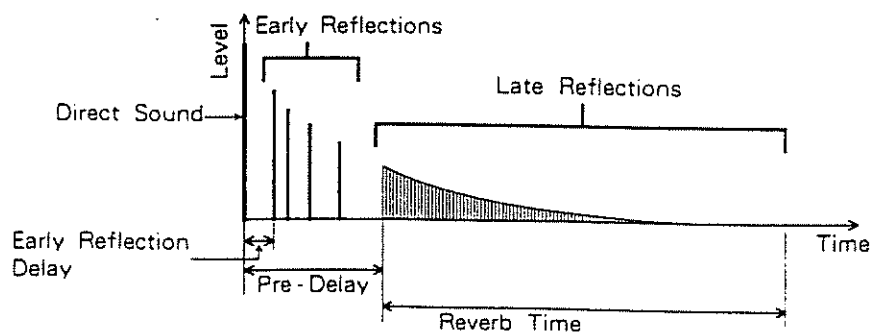

The early reflection delay is the amount of time it takes for the early reflections to arrive, counting from the moment the direct sound has been produced. The pre - delay is the amount of time it takes after the direct sound has been produced before the late reflections appear. The reverberation time is the total amount of time it takes before the sound dies out.

Reverberation is thus composed of a complex mixture of all these elements.

□ Other Factors

In addition to those factors explained so far, the character of sound is also influenced by the type of material that the reflecting surfaces are made of (Electronic equivalent: HF Damp). The application of a filter to the late reflections also affects the sound.

HF Damp

As a result of differences in the material acting as the reflecting surfaces, there will be changes in the manner in which upper frequencies attenuate. HF Damp is a parameter which provides control over the manner in which this attenuation of the higher frequency content takes place. The lower the value set for HF Damp, the more the upper frequencies will be attenuated.

Low - Pass Filter

Cuts the higher frequency content while allowing the lower frequencies to pass through.

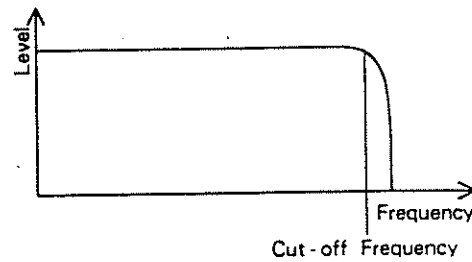

High - Pass Filter

Cuts the lower frequency content while allowing the higher frequencies to pass through.

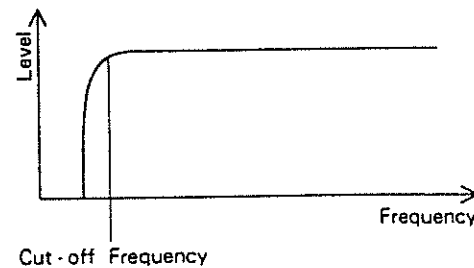

* Depending on the particular algorithms used, the reverb parameters made available for setting changes will vary. For information on the parameters you can use, refer to the explanation for each algorithm.

1) HALL1 (No.101)

101 Hall 1
HALL 1

A Reverb that simulates the natural reverberation of a hall.

REVERB

The Reverb Parameters are as follows.

101.REVERB
REV TIME 20.0s

● Reverb Time(REV TIME):0.1 to 20.0s
Adjusts the Reverb Time (⇒ P. 23).

101.REVERB
PRE DELAY 400ms

● Pre Delay(PRE DELAY):0 to 400ms
Adjusts the Pre Delay (⇒ P. 23).

101.REVERB
E.R.TYPE 1

● Early Reflection Type(E.R.TYPE):1 to 4

This parameter provides a choice of four different tone colorations that the early reflections can have (⇒ P. 23).

Type 1: Produces tone color with upper range emphasized.

Type 2: Produces tone color with mid - to - high range emphasized.

Type 3: Produces tone color having a flat response (no emphasis on any particular frequency).

Type 4: Produces tone color with mid - to - low range emphasized.

101.REVERB
E.R.DELAY 400ms

● Early Reflection Delay(E.R.DELAY):0 to 400ms
Adjusts the Early Reflection Delay (⇒ P. 23).

101.REVERB
E.R.LEVEL 100

● Early Reflection Level(E.R.LEVEL):0 to 100
Adjusts the volume of the early reflections.

101.REVERB
HF DAMP 1.0

● HF Damp(HF DAMP):0.1 to 1.0
Adjusts the degree of damping of the upper range reflections (HF Damp: ⇒ P. 24).

101.REVERB
LOW EQ +12dB

● Low EQ(LOW EQ): - 12dB to +12dB
Adjusts the tone of the lower range portion of the reverb sound.

101.REVERB
HIGH EQ +12dB

● High EQ(HIGH EQ): - 12dB to +12dB
Adjusts the tone of the upper range portion of the reverb sound.

101.REVERB
LP FILTER 12kHz

● Low - pass Filter(LP FILTER):500Hz to 12kHz, THRU

Controls the cut - off frequency of the Low - pass Filter (⇒ P. 24). When set at THRU, the Low - pass Filter is inactive.

* The Low - pass Filter does not affect the early reflections.

101.REVERB
HP FILTER 1kHz

● High - pass Filter(HP FILTER):THRU, 30Hz to 1kHz

Controls the cut - off frequency of the High - pass Filter (⇒ P. 24). When set at THRU, the High - pass Filter is inactive.

* The High - pass Filter does not affect the early reflections.

101. REVERB
LEVEL 100

● Reverb Level(LEVEL):0 to 100
Adjusts the volume of the reverberated sound.

DIRECT

Controls the Direct Sound.

101. DIRECT
LEVEL 100

● Direct Level(LEVEL):0 to 100
Adjusts the volume of the Direct Sound.

MASTER

Controls the unit's overall volume.

101. MASTER
LEVEL 100

● Master Level(LEVEL):0 to 100
Adjusts the overall volume(Actual level output by the SE - 50).

2) HALL2 (No.102)

102 Hall 2
HALL 2

Simulates the reverberation of a hall. It carries a distinctive touch in the middle range, and is ideal for vocals or guitar.

REVERB

The Reverb Parameters are as follows.

102.REVERB
REV TIME 20.0s

● Reverb Time(REV TIME):0.1 to 20.0s
Adjusts the Reverb Time (⇨ P. 23).

102.REVERB
PRE DELAY 400ms

● Pre Delay(PRE DELAY):0 to 400ms
Adjusts the Pre Delay (⇨ P. 23).

102.REVERB
HF DAMP 1.0

● HF Damp(HF DAMP):0.1 to 1.0
Adjusts the degree of damping for the upper range reflections (HF Damp: ⇨ P. 24).

102.REVERB
LOW EQ +12dB

● Low EQ(LOW EQ): - 12dB to +12dB
Adjusts the tone of the lower range portion of the reverb sound.

102.REVERB
HIGH EQ +12dB

● High EQ(HIGH EQ): - 12dB to +12dB
Adjusts the tone of the upper range portion of the reverb sound.

102.REVERB
LP FILTER 12kHz

● Low - pass Filter(LP FILTER):500Hz to 12kHz, THRU
Controls the cut - off frequency of the Low - pass Filter (⇨ P. 24). When set at THRU, the Low - pass Filter is inactive.

102.REVERB
HP FILTER 1kHz

● High - pass Filter(HP FILTER):THRU, 30Hz to 1kHz
Controls the cut - off frequency of the High - pass Filter (⇨ P. 24). When set at THRU, the High - pass Filter is inactive.

102.REVERB
LEVEL 100

● Reverb Level(LEVEL):0 to 100
Adjusts the volume of the reverberated sound.

DIRECT

Controls the Direct sound.

102.DIRECT
LEVEL 100

● Direct Level(LEVEL):0 to 100
Adjusts the volume of the direct sound.

MASTER

Controls the overall volume.

102.MASTER
LEVEL 100

● Master Level(LEVEL):0 to 100
Adjusts the overall volume (Actual level output by the SE - 50)

3) ROOM (No.103)

103 ROOM
ROOM

A Reverb that simulates the reverberation obtained inside a room.

REVERB

The following Reverb Parameters are available.

103.REVERB
REV TIME 20.0s

● Reverb Time(REV TIME):0.1 to 20.0s
Adjusts the Reverb Time (⇨ P. 23).

103.REVERB
PRE DELAY 400ms

● Pre Delay(PRE DELAY):0 to 400ms
Adjusts the Pre Delay (⇨ P. 23).

103.REVERB
E.R.TYPE 1

● Early Reflection Type(E.R.TYPE):1 to 4
This parameter provides a choice of four different tone colorations that the early reflections can have (⇨ P. 23).
Type 1: Produces tone color with upper range emphasized.
Type 2: Produces tone color with mid - to - high range emphasized.
Type 3: Produces tone color having a flat response (no emphasis on any particular frequency).
Type 4: Produces tone color with mid - to - low range emphasized.

103.REVERB
E.R.DELAY 400ms

● Early Reflection Delay(E.R.DELAY):0 to 400ms
Adjusts the Early Reflection Delay (⇨ P. 23).

103.REVERB
E.R.LEVEL 100

● Early Reflection Level(E.R.LEVEL):0 to 100
Adjusts the volume of the early reflections.

103.REVERB
HF DAMP 1.0

● HF Damp(HF DAMP):0.1 to 1.0
Adjusts the degree of damping for the upper range reflections (HF Damp: ⇨ P. 24).

103.REVERB
LOW EQ +12dB

● Low EQ(LOW EQ): - 12dB to +12dB
Adjusts the tone of the lower range portion of the reverb sound.

103.REVERB
HIGH EQ +12dB

● High EQ(HIGH EQ): - 12dB to +12dB
Adjusts the tone of the upper range portion of the reverb sound.

103.REVERB
LP FILTER 12kHz

● Low - pass Filter(LP FILTER):500Hz to 12kHz, THRU
Controls the cut - off frequency of the Low - pass Filter (⇨ P. 24). When set at THRU, the Low - pass Filter is inactive.
* The Low - pass Filter does not affect the early reflections.

103.REVERB
HP FILTER 1kHz

● High - pass Filter(HP FILTER):THRU, 30Hz to 1kHz
Controls the cut - off frequency of the High - pass Filter (⇨ P. 24). When set at THRU, the High - pass Filter is inactive.
* The High - pass Filter does not affect the early reflections.

103. REVERB
LEVEL 100

● Reverb Level(LEVEL):0 to 100
Adjusts the volume of the reverberated sound.

DIRECT

Controls the Direct Sound.

103. DIRECT
LEVEL 100

● Direct Level(LEVEL):0 to 100
Adjusts the volume of the Direct Sound.

MASTER

Controls the unit's overall volume.

103. MASTER
LEVEL 100

● Master Level(LEVEL):0 to 100
Adjusts the overall volume(Actual level output by the SE - 50).

4) PLATE (No.104)

104 Plate
PLATE

A Reverb that simulates the sound obtained with a Plate Echo (A unit employing the vibrations of a metal plate to produce reverb). Provides a metallic luster.

REVERB

The following Reverb Parameters are available.

104.REVERB
REV TIME 20.0s

- Reverb Time(REV TIME):0.1 to 20.0s
Adjusts the Reverb Time (⇒ P. 23).

104.REVERB
PRE DELAY 400ms

- Pre Delay(PRE DELAY):0 to 400ms
Adjusts the Pre Delay (⇒ P. 23).

104.REVERB
HF DAMP 1.0

- HF Damp(HF DAMP):0.1 to 1.0
Adjusts the degree of damping for the upper range reflections (HF Damp: ⇒ P. 24).

104.REVERB
LOW EQ +12dB

- Low EQ(LOW EQ): - 12dB to +12dB
Adjusts the tone of the lower range portion of the reverb sound.

104.REVERB
HIGH EQ +12dB

- High EQ(HIGH EQ): - 12dB to +12dB
Adjusts the tone of the upper range portion of the reverb sound.

104.REVERB
LP FILTER 12kHz

- Low - pass Filter(LP FILTER):500Hz to 12kHz, THRU
Controls the cut - off frequency of the Low - pass Filter (⇒ P. 24). When set at THRU, the Low - pass Filter is inactive.

104.REVERB
HP FILTER 1kHz

- High - pass Filter(HP FILTER):THRU, 30Hz to 1kHz
Controls the cut - off frequency of the High - pass Filter (⇒ P. 24). When set at THRU, the High - pass Filter is inactive.

104.REVERB
LEVEL 100

- Reverb Level(LEVEL):0 to 100
Adjusts the volume of the reverberated sound.

DIRECT

Adjusts the Direct Sound.

104.DIRECT
LEVEL 100

- Direct Level(LEVEL):0 to 100
Adjusts the volume of the direct sound.

MASTER

Controls the overall volume.

104.MASTER
LEVEL 100

- Master Level(LEVEL):0 to 100
Adjusts the overall volume (Actual level output by the SE - 50).

5) AMBIENCE (No.105)

105 Ambience
AMBIENCE

Simulates the sound that is obtained using an "ambience microphone" (A microphone used for recording; it is located away from sources of sound). Similar to Reverb, it provides a sense of spaciousness and depth.

□ AMBIENCE

The Ambience Parameters are as follows.

105.AMBIENCE
MODE 1

● Mode(MODE):1 to 4

Select a Mode to obtain the desired tone color for Ambience. The smaller the Mode number, the more the mid - to - high range will be dampened.

105.AMBIENCE
PRE DELAY 400ms

● Pre Delay(PRE DELAY):0 to 400ms

Adjusts the Pre Delay (Think of this as identical to Pre Delay for Reverb; ⇨ P. 23).

105.AMBIENCE
E.R.TYPE 1

● Early Reflection Type(E.R.TYPE):1 to 4

This parameter provides a choice of four different tone colors that the early reflections can have (⇨ P. 23).

Type 1: Produces tone color with upper range emphasized.

Type 2: Produces tone color with mid - to - high range emphasized.

Type 3: Produces tone color having a flat response (no emphasis on any particular frequency).

Type 4: Produces tone color with mid - to - low range emphasized.

105.AMBIENCE
E.R.DELAY 400ms

● Early Reflection Delay(E.R.DELAY):0 to 400ms

Adjusts the Early Reflection Delay (⇨ P. 23).

105.AMBIENCE
E.R.LEVEL 100

● Early Reflection Level(E.R.LEVEL):0 to 100

Adjusts the volume of the early reflections.

105.AMBIENCE
LOW EQ +12dB

● Low EQ(LOW EQ): - 12dB to +12dB

Adjusts the tone of the lower range portion of the ambience sound.

105.AMBIENCE
HIGH EQ +12dB

● High EQ(HIGH EQ): - 12dB to +12dB

Adjusts the tone of the upper range portion of the ambience.

105.AMBIENCE
LP FILTER 12kHz

● Low - pass Filter(LP FILTER):500Hz to 12kHz, THRU

Controls the cut - off frequency of the Low - pass Filter (⇨ P. 24). When set at THRU, the Low - pass Filter is inactive.

* The Low - pass Filter does not affect the early reflections.

105.AMBIENCE
HP FILTER 1kHz

● High - pass Filter(HP FILTER):THRU, 30Hz to 1kHz

Controls the cut - off frequency of the High - pass Filter (⇨ P. 24). When set at THRU, the High - pass Filter is inactive.

* The High - pass Filter does not affect the early reflections.

105.AMBIENCE
LEVEL 100

● Ambience Level(LEVEL):0 to 100
Adjusts the volume of the ambience sound.

DIRECT

Controls the Direct Sound.

105.DIRECT
LEVEL 100

● Direct Level(LEVEL):0 to 100
Adjusts the volume of the Direct Sound.

MASTER

Controls the unit's overall volume.

105.MASTER
LEVEL 100

● Master Level(LEVEL):0 to 100
Adjusts the overall volume (Actual level output by the SE - 50).

6) GATE REVERB (No.106)

106 Gate Reverb
GATE REVERB

A Gate Reverb that accepts stereo input. Since the effect supports stereo, the Gate Reverb sounds can be output at the same point in the stereo image as the direct sound.

What is Gate Reverb?

A unique sound can be obtained when a reverberating sound is muted partway through. This technique is known as gated reverb.

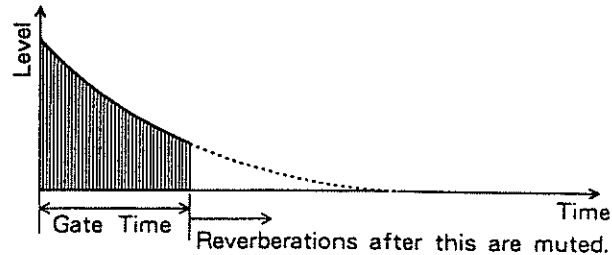

The effect is most effective when used with percussion sounds, such as a snare drum.

Additionally, the reverb sound can be reversed, producing a reverberation that gradually increases.

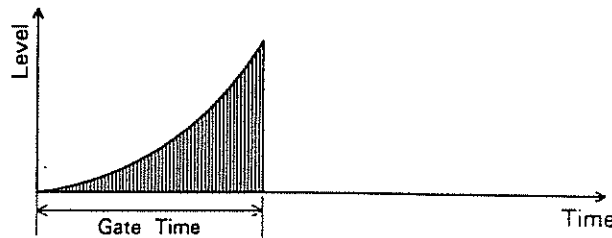

This is called a Reverse Gate. It produces extraordinary sounds that are unique to digital processing.

GATE REVERB

The following Gate Reverb Parameters are available.

106.GATE REVERB
MODE NORMAL

● Mode(MODE):NORMAL, REVERSE, LEFT → RIGHT, RIGHT → LEFT

Select the Mode providing the desired Gate Reverb.

NORMAL: The ordinary Gate Reverb

REVERSE: Reverse Gate

LEFT → RIGHT: The Gate Reverb Sound travels from left to right.

RIGHT → LEFT: Gate Reverb Sound travels from right to left.

* When using Modes "LEFT → RIGHT" or "RIGHT → LEFT", you should input the same signals to both L and R channels.

106.GATE REVERB
GATE TIME 400ms

● Gate Time(GATE TIME):5 to 400ms

Adjusts the Gate Time.

106.GATE REVERB
PRE DELAY 200ms

● Pre Delay(PRE DELAY):0 to 200ms

Adjusts the Pre Delay (See P. 23).

106.GATE REVERB
LOW EQ +12dB

● Low EQ(LOW EQ): - 12dB to +12dB

Adjusts the tone of the lower range portion of the reverb

106.GATE REVERB
HIGH EQ +12dB

● High EQ(HIGH EQ): - 12dB to +12dB
Adjusts the tone of the upper range portion of the reverb.

106.GATE REVERB
LP FILTER 12kHz

● Low - pass Filter(LP FILTER):500Hz to 12kHz, THRU
Controls the cut - off frequency of the Low - pass Filter (⇄ P. 24). When set at THRU, the Low - pass Filter is inactive.

106.GATE REVERB
HP FILTER 1kHz

● High - pass Filter(HP FILTER):THRU, 30Hz to 1kHz
Controls the cut - off frequency of the High - pass Filter (⇄ P. 24). When set at THRU, the High - pass Filter is inactive.

106.GATE REVERB
LEVEL 100

● Gate Reverb Level(LEVEL):0 to 100
Adjusts the volume of the Gate Reverb sound.

DIRECT

Controls the Direct sound.

106.DIRECT
LEVEL 100

● Direct Level(LEVEL):0 to 100
Adjusts the volume of the direct sound.

MASTER

Controls the overall volume.

106.MASTER
LEVEL 100

● Master Level(LEVEL):0 to 100
Adjusts the overall volume(Actual level output by the SE - 50).

7) STEREO REVERB (No.107)

107 St.Reverb
STEREO REVERB

Allows Reverb to be applied separately to each channel, with each having its own position in the sound image. This results in an expansiveness and sense of position that is unobtainable with conventional reverb units.

REVERB

The following Reverb Parameters are available. The settings made here are common to both channels.

107.REVERB
REV TIME 20.0s

● Reverb Time(REV TIME):0.1 to 20.0s

Adjusts the Reverb Time (⇨ P. 23).

107.REVERB
PRE DELAY 200ms

● Pre Delay(PRE DELAY):0 to 200ms

Adjusts the Pre Delay (⇨ P. 23).

107.REVERB
E.R.TYPE 1

● Early Reflection Type(E.R.TYPE):1 to 4

This parameter provides a choice from among four different tone colorations that the early reflections can have (⇨ P. 23).

107.REVERB
E.R.DELAY 200ms

● Early Reflection Delay(E.R.DELAY):0 to 200ms

Adjusts the Early Reflection Delay (⇨ P. 23).

107.REVERB
E.R.LEVEL 100

● Early Reflection Level(E.R.LEVEL):0 to 100

Adjusts the volume of the early reflections.

107.REVERB
HF DAMP 1.0

● HF Damp(HF DAMP):0.1 to 1.0

Adjusts the degree of damping for the upper range reflections (HF Damp: ⇨ P. 24).

107.REVERB
LOW EQ +12dB

● Low EQ (LOW EQ): - 12dB to +12dB

Adjusts the tone of the lower range portion of the reverb sound.

107.REVERB
HIGH EQ +12dB

● High EQ (HIGH EQ): - 12dB to +12dB

Adjusts the tone of the upper range portion of the reverb sound.

107.REVERB
LP FILTER 12kHz

● Low - pass Filter (LP FILTER):500Hz to 12kHz, THRU

Controls the cut - off frequency of the Low - pass Filter (⇨ P. 24). When set at THRU, the Low - pass Filter is inactive.

* The Low - pass Filter does not affect the early reflections.

107.REVERB
HP FILTER 1kHz

● High - pass Filter (HP FILTER):THRU, 30Hz to 1kHz

Controls the cut - off frequency of the High - pass Filter (⇨ P. 24). When set at THRU, the High - pass Filter is inactive.

* The High - pass Filter does not affect the early reflections.

107.REVERB
LEVEL 100

● Reverb Level (LEVEL):0 to 100

Adjusts the volume of the reverberated sound.

DIRECT

Controls the Direct sound.

107.DIRECT
LEVEL 100

● Direct Level(LEVEL):0 to 100

Adjusts the volume of the direct sound.

MASTER

Adjusts the overall volume.

107.MASTER
LEVEL 100

● Master Level(LEVEL):0 to 100

Adjusts the overall volume (Actual level output by the SE - 50).

2. Delay Algorithms

SE - 50 provides 3 types of Delay Algorithms. As a result, you now have ready access to a range of effects which formerly would have required you to connect together a number of separate units.

8) MULTI DELAY (No.108)

108 Multi Delay
MULTI DELAY

This algorithm lines up 5 delay processors in a row. They are organized as shown below.

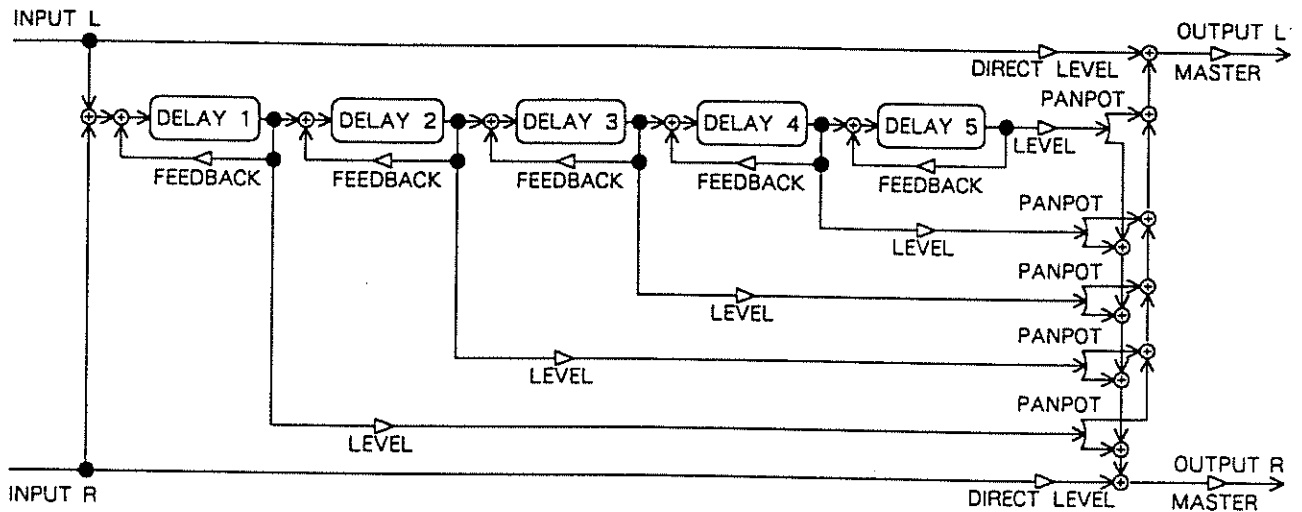

DELAY 1/2/3/4/5 The following provide adjustment of each of the Delay parameters.

108.DELAY 1
D.TIME 600ms

● Delay Time 1/2/3/4/5(D.TIME 1/2/3/4/5):

1;0 to 600ms, 2;0 to 500ms, 3;0 to 400ms, 4;0 to 300ms, 5;0 to 200ms

Adjusts the Delay Time.

108.DELAY 1
FEEDBACK 100

● Feedback 1/2/3/4/5(FEEDBACK 1/2/3/4/5):0 to 100

Feedback refers to the process of feeding a portion of the delayed sounds back into the delay unit. Here you set the amount that is to be fed back. This affects the number of repetitions occurring in the delay.

108.DELAY 1
PAN L=100 R= 0

● Panpot 1/2/3/4/5(PAN 1/2/3/4/5):L=0 to 100, R=0 to 100

Adjusts the sound image (Panpot) for the Delayed Sound.

108.DELAY 1
LEVEL 100

● Delay Level 1/2/3/4/5(LEVEL 1/2/3/4/5):0 to 100

Adjusts the volume of delayed sound.

FILTER

Low - pass Filter and High - pass Filter Parameters are provided.

108.DELAY
LP FILTER 12kHz

● Low - pass Filter(LP FILTER):500Hz to 12kHz, THRU

Controls the cut - off frequency of the Low - pass Filter (= P. 24). When set at THRU, the Low - pass Filter is inactive.

③How the Effectors Function

108.DELAY
HP FILTER 1kHz

● High - pass Filter(HP FILTER):THRU, 30Hz to 1kHz

Controls the cut - off frequency of the High - pass Filter (P. 24). When set at THRU, the High - pass Filter is inactive.

DIRECT L/R

Controls the Direct sound.

108.DIRECT
LEVEL L 100

● Direct Level L/R(LEVEL L/R):0 to 100

Adjusts the volume of the direct sound for each channel.

MASTER

Controls the overall volume.

108.MASTER
LEVEL 100

● Master Level(LEVEL):0 to 100

Adjusts the overall volume (Actual level output by the SE - 50).

9) MULTI TAP DELAY (No.109)

109 Tap Delay
MULTI TAP DELAY

This algorithm allows each of the five delays to be set independently. The five delay circuits are organized as shown below.

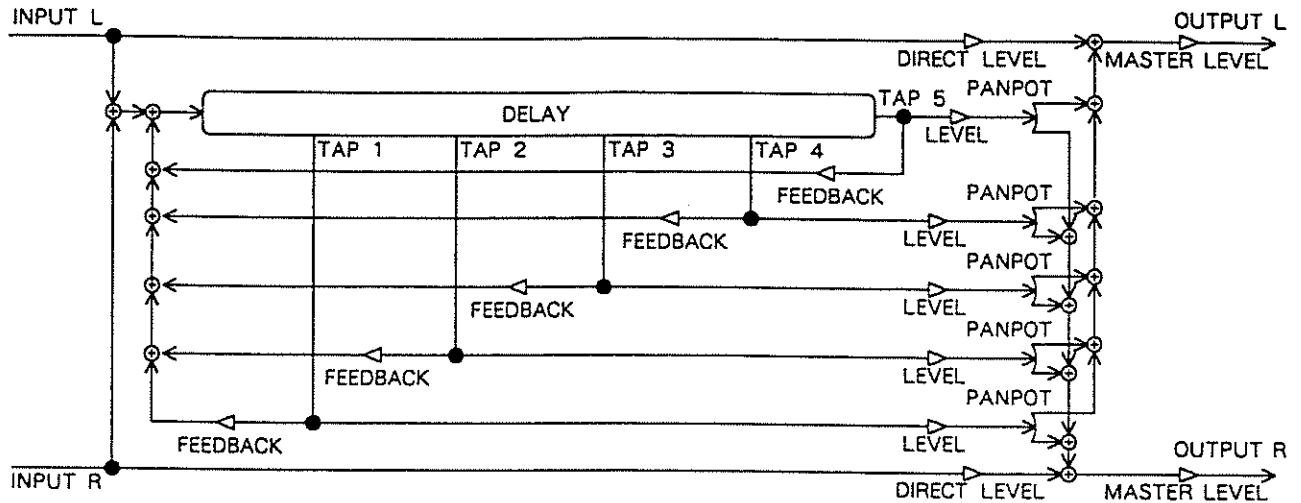

DELAY TAP 1/2/3/4/5

The following provide adjustment of each of the Delay parameters.

109.DELAY TAP 1
D.TIME 2000ms

● Delay Time 1/2/3/4/5(D.TIME 1/2/3/4/5):0 to 2000ms
Adjusts the Delay Time.

109.DELAY TAP 1
FEEDBACK 100

● Feedback 1/2/3/4/5(FEEDBACK 1/2/3/4/5):0 to 100
Feedback refers to the process of feeding a portion of the delayed sounds back into the delay unit. Here you set the amount that is to be fed back. This affects the number of repetitions occurring in the delay.

109.DELAY TAP 1
PAN L=100 R= 0

● Panpot 1/2/3/4/5(PAN 1/2/3/4/5):L=0 to 100, R=0 to 100
Adjusts the sound image (Panpot) for the delayed sound.

109.DELAY TAP 1
LEVEL 100

● Delay Level 1/2/3/4/5(LEVEL 1/2/3/4/5):0 to 100
Adjusts the volume of delayed sound.

FILTER

Low - pass Filter and High - pass Filter Parameters are provided.

109.DELAY
LP FILTER 12kHz

● Low - pass Filter(LP FILTER):500Hz to 12kHz, THRU
Controls the cut - off frequency of the Low - pass Filter (see P. 24). When set at THRU, the Low - pass Filter is inactive.

109.DELAY
HP FILTER 1kHz

● High - pass Filter(HP FILTER):THRU, 30Hz to 1kHz
Controls the cut - off frequency of the High - pass Filter (see P. 24). When set at THRU, the High - pass Filter is inactive.

DIRECT L/R

Controls the Direct sound.

109.DIRECT
LEVEL L 100

● Direct Level L/R(LEVEL L/R):0 to 100
Adjusts the volume of the direct sound for each channel.

MASTER

Controls the overall volume.

109.MASTER
LEVEL 100

● Master Level(LEVEL):0 to 100
Adjusts the overall volume (Actual level output by the SE - 50).

10) STEREO DELAY (No.110)

110 Stereo Delay
STEREO DELAY

This algorithm allows delay to be set independently for each of the two channels. The delay circuits for L and R channels are organized as shown below.

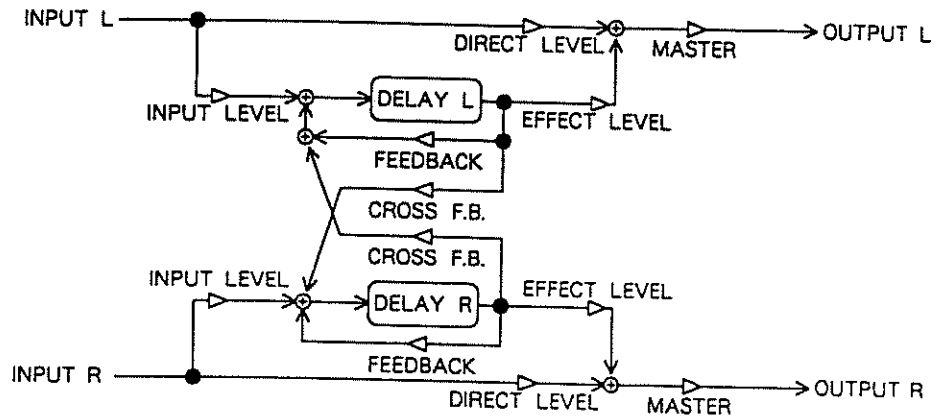

□ DELAY L/R

The following provide adjustment of each of the Delay parameters.

110.DELAY L
D.TIME 680ms

- Delay Time L/R(D.TIME L/R):0 to 680ms
Adjusts the Delay Time.

110.DELAY L
FEEDBACK 100

- Feedback L/R(FEEDBACK L/R):0 to 100
Feedback refers to the process of feeding a portion of the delayed sounds back into the delay unit. Here you set the amount that is to be fed back. This affects the number of repetitions occurring in the delay.

110.DELAY L
CROSS F.B. 100

- Cross Feedback L/R(CROSS F.B. L/R):0 to 100
This algorithm allows you to feed back a delayed signal to its opposite channel. This setting determines the amount that is to be fed back.

110.DELAY L
LP FILTER 16kHz

- Low - pass Filter L/R(LP FILTER L/R):500Hz to 16kHz, THRU
Controls the cut - off frequency of the Low - pass Filter (⇨ P. 24). When set at THRU, the Low - pass Filter is inactive.

110.DELAY L
HP FILTER 1kHz

- High - pass Filter L/R(HP FILTER L/R):THRU, 30Hz to 1kHz
Controls the cut - off frequency of the High - pass Filter (⇨ P. 24). When set at THRU, the High - pass Filter is inactive.

110.DELAY L
INPUT LEVEL 100

- Input Level L/R(INPUT LEVEL L/R):0 to 100
Adjusts the level that is input to the delay, for each channel.

110.DELAY L
EFFECT LEVEL 100

- Effect Level L/R(EFFECT LEVEL L/R):0 to 100
Adjusts the volume of delayed sound.

110.DELAY L
DIRECT LEVEL 100

● Direct Level L/R(DIRECT LEVEL L/R):0 to 100
Adjusts volume of direct sound for each channel.

MASTER

Adjusts the overall volume.

110.MASTER
LEVEL 100

● Master Level(LEVEL):0 to 100
Adjusts the overall volume (Actual level output by the SE - 50).

3. Other Algorithms That Use Single Effectors

In addition to Reverb and Delay, the SE - 50 also provides other effectors that are setup to be used alone, such as Chorus or Pitch Shifter.

11) SPACE CHORUS (No.111)

```
111 Space Chorus
SPACE CHORUS
```

By adding, to the direct sound, sound portions which have been shifted minutely in pitch, this effect adds greater fatness and spaciousness to sound.

SPACE CHORUS

The Chorus Parameters are as follows.

```
111.SPACe CHORUS
MODE 3
```

● Mode(MODE):1 to 3

A mode is selected to choose the desired fatness for the Chorus. The higher the number, the fatter the sound becomes.

```
111.SPACe CHORUS
MOD.WAVE TRI
```

● Modulation Wave (MOD.WAVE):TRI, SINE

Here the type of wave for the Chorus modulation is selected. The way the modulation works is altered as a result.

TRI (TRIANGLE: Triangle Wave) : Provides a smooth sound, without the modulation being too obvious.

SINE (SINE: Sine Wave) : Provides a distinctive, pronounced Chorus.

```
111.SPACe CHORUS
PRE DELAY 200ms
```

● Pre Delay(PRE DELAY):0 to 200ms

After the direct sound has started, this is the amount of time it takes before the Chorus effect begins. When a fairly long value is set, you obtain a "doubling" (numerous sources seem to sound at once) effect.

```
111.SPACe CHORUS
RATE 100
```

● Rate(RATE):0 to 100

Adjusts the rate of the modulation for Chorus.

```
111.SPACe CHORUS
DEPTH 100
```

● Depth(DEPTH):0 to 100

Adjusts the modulation depth for Chorus.

```
111.SPACe CHORUS
DIFFUSION 100
```

● Diffusion(DIFFUSION):0 to 100

Adjusts the extent of diffusion the Chorus will have.

* When output is mono, this parameter is not effective.

```
111.SPACe CHORUS
LEVEL 100
```

● Chorus Level(LEVEL):0 to 100

Adjusts the volume of the Chorus sound.

DIRECT

Controls the direct sound.

```
111.DIRECT
LEVEL 100
```

● Direct Level(LEVEL):0 to 100

Adjusts volume of direct sound.

MASTER

Adjusts the overall volume.

111.MASTER
LEVEL 100

● Master Level(LEVEL):0 to 100

Adjusts the overall volume (Actual level output by the SE - 50).

MIDI CONTROL

The MIDI Control parameters are as follows.

* For details on MIDI Control, see "MIDI Control" (⇨ P. 98).

111.MIDI CONTROL
RECEIVE OFF

● MIDI Control Receive(MIDI CONTROL RECEIVE):

OFF, AF TOUCH, P.BEND, #0 to #31, #64 to #95

Provides selection of the type of MIDI data to be received.

111.MIDI CTL ASN
CHORUS RATE

● MIDI Control Assign(MIDI CTL ASN):

CHORUS RATE, CHORUS LEVEL, MASTER LEVEL

Select the parameter you wish to have controlled.

111.MIDI CTL MIN

● MIDI Control Minimum(MIDI CTL MIN):

This setting specifies the lowest value that will be valid for control.

* The value must be within the range allowed for the parameter.

111.MIDI CTL MAX

● MIDI Control Maximum(MIDI CTL MAX):

This setting specifies the highest value that will be valid for control.

* The value must be within the range allowed for the parameter.

12) MULTI PITCH SHIFTER (No.112)

112 P.Shifter
PITCH SHIFTER

This Effector makes it possible to readily shift the pitch of the original sound to any pitch desired within a range spanning 2 octaves in either direction. Additionally, up to four types of pitch variations can be produced and output simultaneously. One of these can also be fed back for further processing.

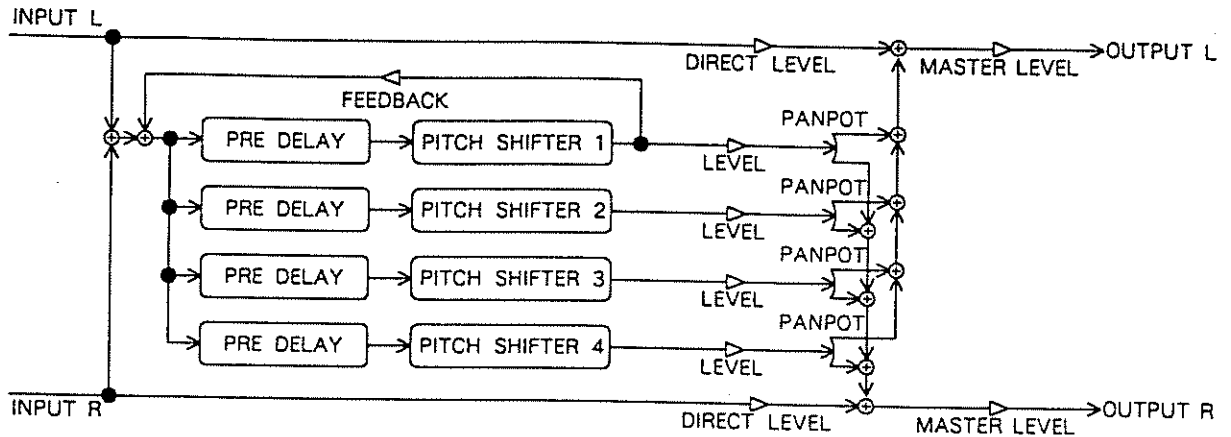

* Due to the structure, the Pitch - shifted sound may tend to be slightly delayed even if Pre Delay is set to "0 ms".

□ PITCH SHIFTER 1/2/3/4

The parameters set for Pitch Shifter are as follows.

112.P.SHIFTER 1
MODE 1

● Mode 1/2/3/4(MODE 1/2/3/4): 1 to 3

Select a Pitch Shift Mode.

Mode 1: Provides the least amount of delay for the Pitch - shifted sound. Effective when the pitch is being shifted by small amounts. As the amount of pitch change becomes greater, the wavering in the sound increases, and at times the pitch may become erratic.

Mode 2: There is less wavering compared with Mode 1, and less delay in comparison with Mode 3.

Mode 3: There is very little wavering, and it provides a pitch that is relatively precise. Useful for making wide ranging pitch changes. The shifted sounds will be somewhat delayed.

112.P.SHIFTER 1
PITCH +24

● Pitch 1/2/3/4(PITCH 1/2/3/4): - 24 to +24

Setting for the amount of Pitch Change desired, in semitones.

112.P.SHIFTER 1
FINE +50

● Fine 1/2/3/4(FINE 1/2/3/4): - 50 to +50

Provides precision adjustment of the Pitch Change

* One unit for "PITCH" is equivalent to 100 units for "FINE".

* If you assign "FINE" for MIDI Control, the values available for pitch changes will range from - 2450 to +2450.

112.P.SHIFTER 1
PRE DELAY 760ms

- Pre Delay 1/2/3/4(PRE DELAY 1/2/3/4):
1:0 to 760ms, 2:0 to 570ms, 3:0 to 380ms, 4:0 to 190ms

After the direct sound has started, this is the amount of time it takes before the pitch - shifted sound is produced. Ordinarily, it should be set at "0 ms".

112.P.SHIFTER 1
PAN L=100 R= 0

- Panpot 1/2/3/4(PAN 1/2/3/4):L=0 to 100, R=0 to 100

Adjusts the sound image for the Pitch - shifted sound (Panpot).

112.P.SHIFTER 1
FEEDBACK 100

- Feedback 1(FEEDBACK 1):0 to 100

Here you can select the amount of Pitch - shifted sound that you want to be fed back. Only the Pitch Shifter 1 sound is fed back.

112.P.SHIFTER 1
LEVEL 100

- Pitch Shift Level 1/2/3/4(LEVEL 1/2/3/4):0 to 100

Adjusts the volume of the Pitch - shifted sound.

FILTER

Here settings are made for the Low - pass and High - pass Filter parameters.

112.P.SHIFTER
LP FILTER 12kHz

- Low - pass Filter(LP FILTER):500Hz to 12kHz, THRU

Controls the cut - off frequency of the Low - pass Filter (⇔ P. 24). When set at THRU, the Low - pass Filter is inactive.

112.P.SHIFTER
HP FILTER 1kHz

- High - pass Filter(HP FILTER):THRU, 30Hz to 1kHz

Controls the cut - off frequency of the High - pass Filter (⇔ P. 24). When set at THRU, the High - pass Filter is inactive.

DIRECT L/R

Controls the Direct sound.

112.DIRECT
LEVEL L 100

- Direct Level L/R(DIRECT LEVEL L/R):0 to 100

Adjusts the volume of the direct sound for each channel.

MASTER

Controls the overall volume.

112.MASTER
LEVEL 100

- Master Level(LEVEL):0 to 100

Adjusts the overall volume (Actual level output by the SE - 50).

MIDI CONTROL

The MIDI Control parameters are as follows.

* For details on MIDI Control, see "MIDI Control" (P. 98).

112.MIDI CONTROL
RECEIVE OFF

● MIDI Control Receive(MIDI CONTROL RECEIVE):
OFF, AF TOUCH, P.BEND, #0 to #31, #64 to #95

Provides selection of the type of MIDI data to be received.

112.MIDI CTL ASN
PITCH FINE 1

● MIDI Control Assign(MIDI CTL ASN):
PITCH FINE1, MASTER LEVEL

Select the parameter you wish to have controlled.

112.MIDI CTL MIN

● MIDI Control Minimum(MIDI CTL MIN):

This setting specifies the lowest value that will be valid for control.

* The value must be within the range allowed for the parameter.

112.MIDI CTL MAX

● MIDI Control Maximum(MIDI CTL MAX):

This setting specifies the highest value that will be valid for control.

* The value must be within the range allowed for the parameter.

13) STEREO PITCH SHIFTER (No.113)

113 St.P.Shifter
ST.PITCH SHIFTER

This Effector allows you to apply Pitch Shifts independently to each channel. It provides for the pitch to be shifted up to one octave in either direction from the original sound.

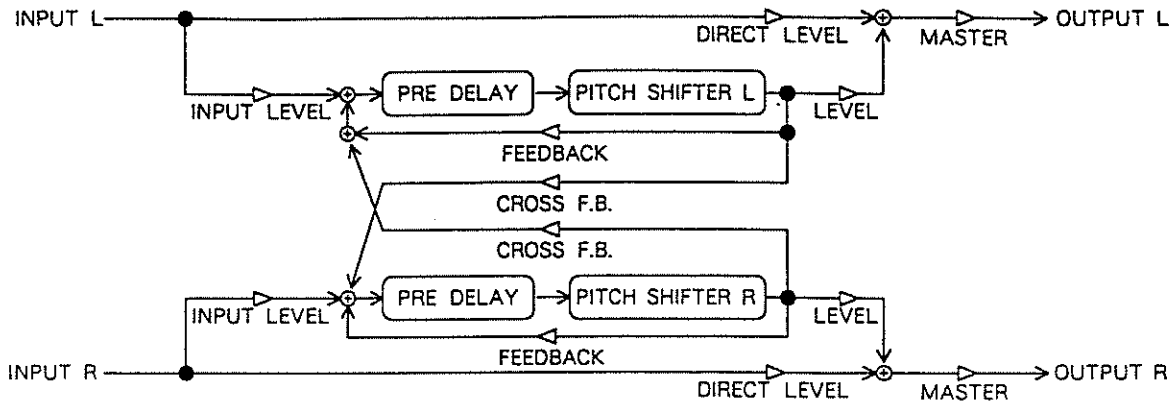

* Due to the structure, the Pitch - shifted sound may tend to be slightly delayed even if Pre Delay is set to "0 ms".

PITCH SHIFTER L/R The parameters set for Pitch Shifter are as follows.

113.P.SHIFTER L
PITCH +12

● Pitch L/R(PITCH L/R): - 12 to +12
Setting for the amount of pitch change desired, in semitones.

113.P.SHIFTER L
FINE +50

● Fine L/R(FINE L/R): - 50 to +50
Provides precise adjustment of the pitch change.
* One unit for "PITCH" is equivalent to 100 units for "FINE".
* If you assign "FINE" for MIDI Control, the values available for pitch changes will range from - 1250 to +1250.

113.P.SHIFTER L
PRE DELAY 600ms

● Pre Delay L/R(PRE DELAY L/R):0 to 600ms
After the direct sound has started, this is the amount of time it takes before the Pitch - shifted sound is produced. Ordinarily, it should be set at "0 ms".

113.P.SHIFTER L
FEEDBACK 100

● Feedback L/R(FEEDBACK L/R):0 to 100
Here you can select the amount of Pitch - shifted sound that you want to be fed back.

113.P.SHIFTER L
CROSS F.B. 100

● Cross Feedback L/R(CROSS F.B. L/R):0 to 100
This algorithm allows you to feed back a Pitch - shifted signal to its opposite channel. This setting determines the amount that is to be fed back in this way.

113.P.SHIFTER L
LP FILTER 16kHz

● Low - pass Filter L/R(LP FILTER L/R):500Hz to 16kHz, THRU
Controls the cut - off frequency of the Low - pass Filter (see P. 24). When set at THRU, the Low - pass Filter is inactive.

113.P.SHIFTER L
HP FILTER 1kHz

- High - pass Filter L/R(HP FILTER L/R):THRU, 30Hz to 1kHz

Controls the cut - off frequency of the High - pass Filter (⇨ P. 24). When set at THRU, the High - pass Filter is inactive.

113.P.SHIFTER L
INPUT LEVEL 100

- Input Level L/R(INPUT LEVEL L/R):0 to 100

Adjusts the level, for each channel, of the signals to be input for Pitch Shifter.

113.P.SHIFTER L
EFFECT LEVEL 100

- Effect Level L/R(EFFECT LEVEL L/R):0 to 100

Adjusts the volume of the Pitch - shifted sound.

113.P.SHIFTER L
DIRECT LEVEL 100

- Direct Level L/R(DIRECT LEVEL L/R):0 to 100

Adjusts the volume of the direct sound.

113.P.SHIFTER R
STEREO LINK ON

- Stereo Link (STEREO LINK):ON/OFF

When turned on, the Pitch Shifters for each channel are synchronized, so the pitch is shifted while preserving the positioning of the stereo image.

MASTER

Adjusts the overall volume.

113.MASTER
LEVEL 100

- Master Level(LEVEL):0 to 100

Adjusts the overall volume (Actual level output by the SE - 50).

MIDI CONTROL

The MIDI Control parameters are as follows.

* For details on MIDI Control, see "MIDI Control" (⇨ P. 98).

113.MIDI CONTROL
RECEIVE OFF

- MIDI Control Receive(MIDI CONTROL RECEIVE):

OFF, AF TOUCH, P.BEND, #0 to #31, #64 to #95

Provides selection of the type of MIDI data to be received.

113.MIDI CTL ASN
PITCH FINE L

- MIDI Control Assign(MIDI CTL ASN):PITCH FINE L, MASTER LEVEL

Select the parameter you wish to have controlled.

* If you wish to control FINE for both channels (L and R), set the STEREO LINK "On".

113.MIDI CTL MIN

- MIDI Control Minimum(MIDI CTL MIN):

This setting specifies the lowest value that will be valid for control.

* The value must be within the range allowed for the parameter.

113.MIDI CTL MAX

- MIDI Control Maximum(MIDI CTL MAX):

This setting specifies the highest value that will be valid for control.

* The value must be within the range allowed for the parameter.

14) STEREO FLANGER (No.114)

114 St.Flanger
STEREO FLANGER

This effector produces an effect that could be likened to the sound of a jet plane's ascent and descent. Since it supports stereo input, the Flanging effect is obtained while still preserving the positioning of the stereo image. Additionally, a Gate feature that can be periodically turned on/off is provided. This allows the sound to be muted at desired intervals.

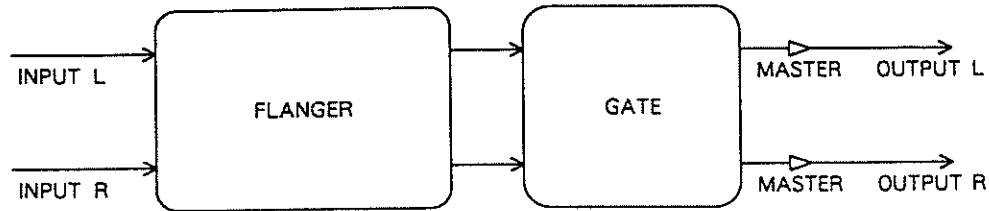

FLANGER

Settings are made for the following Flanger parameters.

114.FLANGER
MODE 2

● Mode(MODE):1, 2

Select the type of Flanging desired.

Mode 1: Provides an ordinary flanging effect.

Mode 2: Provides a more pronounced flanging effect.

114.FLANGER
RATE 100

● Rate(RATE):0 to 100

Adjusts the rate of the modulation for the Flanger.

114.FLANGER
DEPTH 100

● Depth(DEPTH):0 to 100

Adjusts the depth of the modulation for the Flanger.

114.FLANGER
MANUAL 100

● Manual (MANUAL):0 to 100

Sets the center frequency for application of the Flanger effect.

114.FLANGER
RESONANCE 100

● Resonance (RESONANCE):0 to 100

This setting determines the amount of Resonance, the higher the value, the more unique the sound becomes.

114.FLANGER
MOD.PHASE 180deg

● Modulation Phase(MOD.PHASE):0 to 180deg

Provides an adjustment for how much the modulation applied to one channel will be different than that for the other channel. When set to "0 deg", the modulation applied to both channels will be identical. With a value of "180 deg", the way the modulation is applied to one channel will be the exact opposite of that for the other channel.

GATE

The following Gate parameters are available.

114.GATE
ON/OFF ON

● On/Off(ON/OFF):ON/OFF

Turns on or off the Gate function.

114.GATE
RATE 100

● Rate(RATE):0 to 100

Adjusts the rate at which the sound will be muted.

MASTER

Adjusts the overall volume.

114.MASTER
LEVEL 100

● Master Level(LEVEL):0 to 100

Adjusts the overall volume (Actual level output by the SE - 50).

MIDI CONTROL

The MIDI Control parameters are as follows.

* For details on MIDI Control, see "MIDI Control" (→ P. 98).

114.MIDI CONTROL
RECEIVE OFF

● MIDI Control Receive(MIDI CONTROL RECEIVE):

OFF, AF TOUCH, P.BEND, #0 to #31, #64 to #95

Provides selection of the type of MIDI data to be received.

114.MIDI CTL ASN
FLANGER RATE

● MIDI Control Assign(MIDI CTL ASN):

FLANGER RATE, GATE ON/OFF, GATE ON/OFF(TRIG), GATE RATE,
MASTER LEVEL

Select the parameter you wish to have controlled.

About GATE ON/OFF (TRIG)

This function is selected when you wish to use the "Unlatch - type" Pedal (such as a Hold Pedal) or the Bender Lever (Pitch Bend or Modulation) of the keyboard in order to switch the Gate "ON/OFF". The "Unlatch - type" pedal or the Bender Lever can then be used to toggle between ON and OFF.

* If instead you prefer to obtain Gate changes only while the "Unlatch - type" pedal is kept depressed, select "GATE ON/OFF".

114.MIDI CTL MIN

● MIDI Control Minimum(MIDI CTL MIN):

This setting specifies the lowest value that will be valid for control.

* The value must be within the range allowed for the parameter.

114.MIDI CTL MAX

● MIDI Control Maximum(MIDI CTL MAX):

This setting specifies the highest value that will be valid for control.

* The value must be within the range allowed for the parameter.

15) STEREO PHASER (No.115)

115 St. Phaser
STEREO PHASER

This Effector produces a spacious sound by adding to the original sound other portions which have been shifted in phase. Since it supports stereo input, the Phaser effect is obtained while still preserving the positioning of the stereo image.

PHASER

Settings are made for the following Phaser parameters.

115. PHASER
MODE 4

● Mode(MODE):1 to 4

Provides a selection for the manner in which the Phaser is applied. The higher the number, the more pronounced the effect becomes.

115. PHASER
RATE 100

● Rate(RATE):0 to 100

Adjusts the rate at which the Phaser is applied.

115. PHASER
DEPTH 100

● Depth(DEPTH):0 to 100

Adjusts the depth at which the Phaser is applied.

115. PHASER
MANUAL 100

● Manual (MANUAL):0 to 100

Sets the center frequency for application of the Phaser effect.

115. PHASER
RESONANCE 100

● Resonance (RESONANCE):0 to 100

This setting determines the amount of Resonance. The higher the value, the more unique the sound becomes.

115. PHASER
MOD. PHASE 180deg

● Modulation Phase(MOD.PHASE):0 to 180deg

Provides an adjustment for how much the Phaser effect applied to one channel will be different than that for the other channel. When set to "0 deg", the Phaser effect is applied to both channels in an identical manner. With a value of "180 deg", the way the Phaser effect is applied to one channel will be the exact opposite of that for the other channel.

MASTER

Adjusts the overall volume.

115. MASTER
LEVEL 100

● Master Level(LEVEL):0 to 100

Adjusts the overall volume (Actual level output by the SE - 50).

MIDI CONTROL

The MIDI Control Parameters are as follows.

* For details on MIDI Control, see "MIDI Control" (P. 98).

115. MIDI CONTROL
RECEIVE OFF

● MIDI Control Receive(MIDI CONTROL RECEIVE):

OFF, AF TOUCH, P.BEND, #0 to #31, #64 to #95

Provides selection of the type of MIDI data to be received.

115.MIDI CTL ASN
PHASER RATE

- MIDI Control Assign(MIDI CTL ASN):
PHASER RATE, PHASER DEPTH, MASTER LEVEL

Select the parameter you wish to have controlled.

115.MIDI CTL MIN

- MIDI Control Minimum(MIDI CTL MIN):

This setting specifies the lowest value that will be valid for control.

* The value must be within the range allowed for the parameter.

115.MIDI CTL MAX

- MIDI Control Maximum(MIDI CTL MAX):

This setting specifies the highest value that will be valid for control.

* The value must be within the range allowed for the parameter.

4. Algorithms Combining Two or More Effectors

When two or more effectors are combined, even more interesting effects can be obtained. Algorithm numbers 116 through 124 are arranged to be suitable for a variety of instruments.

16) VOCODER (No.116)

116 Vocoder
VOCODER

This algorithm converts sound from a microphone, such as that of a person singing, to the pitch of sounds output from a keyboard. Signals arriving from a microphone are divided into 7 frequency portions. Then, each frequency portion is changed to correspond with the signals input from a keyboard. When using this algorithm, a setup such as shown below should be used.

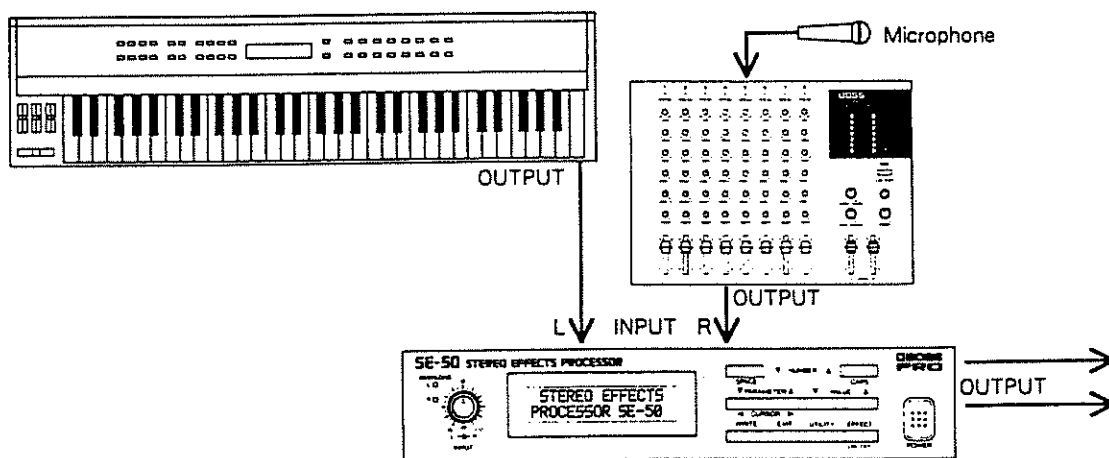

- * We recommend that the microphone should be pre - amplified first (by a mixer, etc.).
- * The sound you use on the keyboard should be of the type that sustains well, such as a brass or strings sound.

This algorithm is configured as follows:

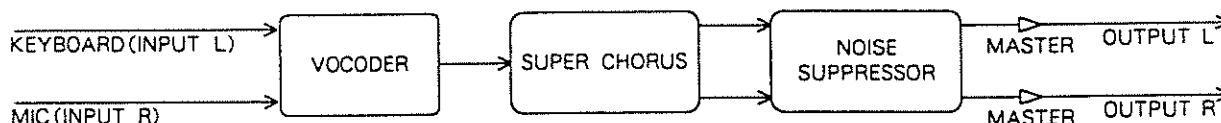

VOCODER

Settings are made for the following Vocoder parameters.

116.Vocoder
SENS 100

- Sens (SENS):0 to 100
Adjusts the input sensitivity for the microphone (R Channel).

116.Vocoder
VOICE CHAR1 100

- Voice Character 1/2/3/4/5/6/7 (VOICE CHAR 1/2/3/4/5/6/7):0 to 100
Adjusts the volume for each frequency band.

116.Vocoder
HI FREQ MIX 100

- High Frequency Mix (HI FREQ MIX):0 to 100
Enhances the upper frequencies of the sound input from a microphone. When added to the output, it makes the sound more realistic and human.

SUPER CHORUS

The Chorus parameters are as follows.

```
116.SUPER CHORUS
PRE DELAY  60ms
```

● Pre Delay(PRE DELAY):0 to 60ms

After the direct sound has started, this is the amount of time it takes before the Chorus effect begins.

```
116.SUPER CHORUS
RATE      100
```

● Rate(RATE):0 to 100

Adjusts the rate of the modulation for Chorus.

```
116.SUPER CHORUS
DEPTH     100
```

● Depth(DEPTH):0 to 100

Adjusts the modulation depth for Chorus.

* If you want to turn Chorus off, set the Pre Delay to "0 ms" and the Depth to "0".

NOISE SUPPRESSOR

The following are the parameters that are set for the Noise Suppressor. When the level of the signal input from the microphone falls below the set level, the signal is muted to eliminate unwanted noise.

```
116.N.SUPPRESSOR
THRESHOLD 100
```

● Threshold (THRESHOLD):0 to 100

This setting specifies the level at which the Noise Suppressor starts working. When the level of the microphone signal falls below this level, the signal is muted.

MASTER

Adjusts the overall volume.

```
116.MASTER
LEVEL     100
```

● Master Level(LEVEL):0 to 100

Adjusts the overall volume (Actual level output by the SE - 50).

17) ROTARY (No.117)

117 Rotary
ROTARY

This algorithm simulates a rotary speaker. It is a unique effect that is produced by the fluctuations in sound that occur when a speaker is rotated.

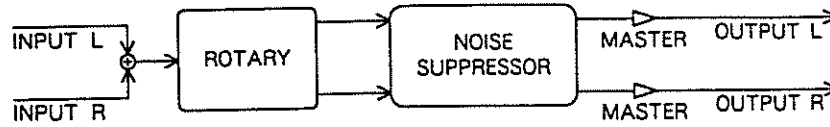

□ ROTARY

Produces a sound much like that obtained with rotary speakers. Conventionally, separate speakers rotate for the upper and lower frequency ranges. Thus with the SE - 50, separate settings are made for upper and lower ranges.

117.ROTARY
DRIVE 100

- Drive (DRIVE):0 to 100

Applies distortion to the sound.

117.ROTARY
SPEED SLOW

- Speed (SPEED):SLOW, FAST

Provides selection for the speed of the sound's undulations.

117.ROTARY
LO RATE SLOW 100

- Low Rate Slow(LO RATE SLOW):0 to 100

When SLOW is selected for SPEED, this adjusts the rate for the lower range.

117.ROTARY
LO RATE FAST 100

- Low Rate Fast(LO RATE FAST):0 to 100

When FAST is selected for SPEED, this adjusts the rate for the lower range.

117.ROTARY
HI RATE SLOW 100

- High Rate Slow(HI RATE SLOW):0 to 100

When SLOW is selected for SPEED, this adjusts the rate for the upper range.

117.ROTARY
HI RATE FAST 100

- High Rate Fast(HI RATE FAST):0 to 100

When FAST is selected for SPEED, this adjusts the rate for the upper range.

117.ROTARY
LO RISE TIME 100

- Low Rise Time(LO RISE TIME):0 to 100

This adjusts the rapidness with which the lower range will change when the Speed is switched from SLOW to FAST (or the reverse).

117.ROTARY
HI RISE TIME 100

- High Rise Time(HI RISE TIME):0 to 100

This adjusts the rapidness with which the upper range will change when the Speed is switched from SLOW to FAST (or the reverse).

117.ROTARY
LOW LEVEL 100

- Low Level(LOW LEVEL):0 to 100

Adjusts the volume of the lower range.

117.ROTARY
HIGH LEVEL 100

- High Level(HIGH LEVEL):0 to 100

Adjusts the volume of the upper range.

117. ROTARY
SEPARATION 100

● Separation(SEPARATION):0 to 100

Controls the degree to which the sound takes on an expansive quality.

NOISE SUPPRESSOR

The following are the parameters that are set for the Noise Suppressor. When the level of the signal input falls below the set level, it is muted to eliminate unwanted noise.

117. N. SUPPRESSOR
THRESHOLD 100

● Threshold (THRESHOLD):0 to 100

This setting specifies the level at which the Noise Suppressor starts working. When the level of the signal falls below this level, the signal is muted.

MASTER

Adjusts the overall volume.

117. MASTER
LEVEL 100

● Master Level(LEVEL):0 to 100

Adjusts the overall volume (Actual level output by the SE - 50).

MIDI CONTROL

The MIDI Control Parameters are as follows.

* For details on MIDI Control, see "MIDI Control" (⇨ P. 98).

117. MIDI CONTROL
RECEIVE OFF

● MIDI Control Receive(MIDI CONTROL RECEIVE):

OFF, AF TOUCH, P.BEND, #0 to #31, #64 to #95

Provides selection of the type of MIDI data to be received.

117. MIDI CTL ASN
ROTARY DRIVE

● MIDI Control Assign(MIDI CTL ASN):

DRIVE, SPEED, SPEED(TRIG), MASTER LEVEL

Select the parameter you wish to have controlled.

About SPEED (TRIG)

This function is selected when you wish to use the "Unlatch - type" Pedal (such as a Hold Pedal) or the Bender Lever (Pitch Bend or Modulation) of the keyboard in order to switch the Rotary "SPEED". The "Unlatch - type". pedal or the Bender Lever can then be used to toggle between FAST and SLOW.

* If instead you prefer to obtain speed changes only while the "Unlatch - type" pedal is kept depressed, select "SPEED".

117. MIDI CTL MIN

● MIDI Control Minimum(MIDI CTL MIN):

This setting specifies the lowest value that will be valid for control.

* The value must be within the range allowed for the parameter.

117. MIDI CTL MAX

● MIDI Control Maximum(MIDI CTL MAX):

This setting specifies the highest value that will be valid for control

* The value must be within the range allowed for the parameter.

18) KEYBOARD MULTI 1 (No.118)

118 Keyboard 1
KEYBOARD MULTI 1

This setup is designed for use with a keyboard. Since it is equipped with Delay, it goes well with synth solos.

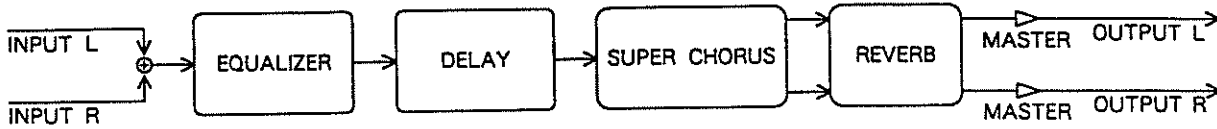

EFFECT ON/OFF

Used to turn effects on or off.

118.EFF.ON/OFF
EQ+DL+CH+RV

Using PARAMETER ▲ ▼, select the effector. Then use VALUE ▲ ▼ to turn it on or off.

EQUALIZER

The Equalizer parameters are as follows.

118.EQUALIZER
LOW EQ +12dB

● Low EQ (LOW EQ): - 12dB to +12dB

Adjusts the tone of the lower range.

118.EQUALIZER
MID FREQ 4kHz

● Middle Frequency(MID FREQ):250Hz to 4kHz

Sets the center frequency that will be employed when adjusting the middle range.

118.EQUALIZER
MID EQ +12dB

● Middle EQ(MID EQ): - 12dB to +12dB

Adjusts the tone of the middle range portion of the sound.

118.EQUALIZER
HIGH EQ +12dB

● High EQ(HIGH EQ): - 12dB to +12dB

Adjusts the tone of the high range portion of the sound.

118.EQUALIZER
LP FILTER 16kHz

● Low - pass Filter(LP FILTER):500Hz to 16kHz, THRU

Controls the cut - off frequency of the Low - pass Filter (P. 24). When set at THRU, the Low - pass Filter is inactive.

118.EQUALIZER
LEVEL +12dB

● Equalizer Level(LEVEL): - 12dB to +12dB

Adjusts the volume of the sound after it has been routed through the Equalizer.

DELAY

The following settings are made for the Delay parameters.

118.DELAY
D.TIME 800ms

● Delay Time(D.TIME):0 to 800ms

Adjusts the Delay Time.

118.DELAY
FEEDBACK 100

● Feedback (FEEDBACK):0 to 100

Feedback refers to the process of feeding a portion of the delayed sounds back into the delay circuit. Here you set the amount that is to be fed back. This affects the number of repetitions occurring in the delay.

118.DELAY
LEVEL 100

● Delay Level (LEVEL):0 to 100
Adjusts volume of delayed sound.

118.DELAY
LP FILTER 16kHz

● Low - pass Filter(LP FILTER):500Hz to 16kHz, THRU
Controls the cut - off frequency of the Low - pass Filter (⇨ P. 24). When set at THRU, the Low - pass Filter is inactive.

SUPER CHORUS

The Chorus parameters are as follows.

118.SUPER CHORUS
PRE DELAY 60ms

● Pre Delay(PRE DELAY):0 to 60ms
After the direct sound has started, this is the amount of time it takes before the Chorus effect begins.

118.SUPER CHORUS
RATE 100

● Rate(RATE):0 to 100
Adjusts the rate of the modulation for Chorus.

118.SUPER CHORUS
DEPTH 100

● Depth(DEPTH):0 to 100
Adjusts the modulation depth for Chorus.

REVERB

Settings for Reverb are as follows.

118.REVERB
REV TIME 20.0s

● Reverb Time(REV TIME):0.1 to 20.0s
Adjusts the Reverb Time (⇨ P. 23).

118.REVERB
PRE DELAY 100ms

● Pre Delay(PRE DELAY):0 to 100ms
Adjusts the Pre Delay (⇨ P. 23).

118.REVERB
LP FILTER 16kHz

● Low - pass Filter(LP FILTER):500Hz to 16kHz, THRU
Controls the cut - off frequency of the Low - pass Filter (⇨ P. 24). When set at THRU, the Low - pass Filter is inactive.

118.REVERB
LEVEL 100

● Reverb Level(LEVEL):0 to 100
Adjusts the volume of the Reverb sound.

MASTER

Adjusts the overall volume.

118.MASTER
LEVEL 100

● Master Level(LEVEL):0 to 100
Adjusts the overall volume (Actual level output by the SE - 50).

MIDI CONTROL

The MIDI Control parameters are as follows.

* For details on MIDI Control, see "MIDI Control" (P. 98).

118.MIDI CONTROL
RECEIVE OFF

● MIDI Control Receive(MIDI CONTROL RECEIVE):

OFF, AF TOUCH, P.BEND, #0 to #31, #64 to #95

Provides selection of the type of MIDI data to be received.

118.MIDI CTL ASN
CHORUS RATE

● MIDI Control Assign(MIDI CTL ASN):

CHORUS RATE, DELAY LEVEL, REVERB LEVEL, MASTER LEVEL

Select the parameter you wish to have controlled.

118.MIDI CTL MIN

● MIDI Control Minimum(MIDI CTL MIN):

This setting specifies the lowest value that will be valid for control.

* The value must be within the range allowed for the parameter.

118.MIDI CTL MAX

● MIDI Control Maximum(MIDI CTL MAX):

This setting specifies the highest value that will be valid for control.

* The value must be within the range allowed for the parameter.

19) KEYBOARD MULTI 2 (No.119)

119 Keyboard 2
KEYBOARD MULTI 2

This algorithm is designed to be used with keyboards. Through skillful use of the Phaser, it is quite effective with strings or other sustained sounds.

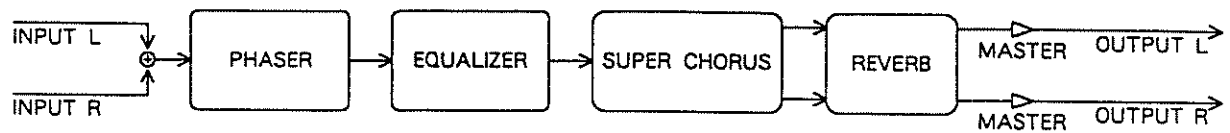

EFFECT ON/OFF

Used to turn effects on or off.

119.EFF.ON/OFF
PH+EQ+CH+RV

Using PARAMETER , select the effector. Then use VALUE to turn it on or off.

PHASER

Settings are made for the following Phaser parameters.

119.PHASER
MODE 4

● Mode(MODE):1 to 4

Provides a selection for the manner in which the Phaser is applied. The higher the number, the more pronounced the effect becomes.

119.PHASER
RATE 100

● Rate(RATE):0 to 100

Adjusts the rate at which the Phaser is applied.

119.PHASER
DEPTH 100

● Depth(DEPTH):0 to 100

Adjusts the depth at which the Phaser is applied.

119.PHASER
MANUAL 100

● Manual (MANUAL):0 to 100

Sets the center frequency for application of the Phaser effect.

119.PHASER
RESONANCE 100

● Resonance (RESONANCE):0 to 100

This setting determines the amount of Resonance. The higher the value, the more unique the sound becomes.

119.PHASER
STEP 100

● Step (STEP):0 to 100

This setting determines the shape of the phaser's waveform. With higher values, the "Steps" in the waveform become more pronounced.

EQUALIZER

The Equalizer parameters are as follows.

119.EQUALIZER
LOW EQ +12dB

● Low EQ (LOW EQ): - 12dB to +12dB

Adjusts the tone of the lower range.

119.EQUALIZER
MID FREQ 4kHz

● Middle Frequency (MID FREQ):250Hz to 4kHz

Sets the center frequency that will be employed when adjusting the middle range.

③ How the Effectors Function

119.EQUALIZER
MID EQ +12dB

- Middle EQ(MID EQ): - 12dB to +12dB
Adjusts the tone of the middle range portion of the sound.

119.EQUALIZER
HIGH EQ +12dB

- High EQ(HIGH EQ): - 12dB to +12dB
Adjusts the tone of the high range portion of the sound.

119.EQUALIZER
LEVEL +12dB

- Equalizer Level(LEVEL): - 12dB to +12dB
Adjusts the volume of the sound after it has been routed through the Equalizer.

SUPER CHORUS

The Chorus parameters are adjusted using the following.

119.SUPER CHORUS
PRE DELAY 60ms

- Pre Delay(PRE DELAY):0 to 60ms
After the direct sound has started, this is the amount of time it takes before the Chorus effect begins.

119.SUPER CHORUS
RATE 100

- Rate(RATE):0 to 100
Adjusts the rate of the modulation for Chorus.

119.SUPER CHORUS
DEPTH 100

- Depth(DEPTH):0 to 100
Adjusts the modulation depth for Chorus.

REVERB

Settings for Reverb are as follows.

119.REVERB
REV TIME 20.0s

- Reverb Time(REV TIME):0.1 to 20.0s
Adjusts the Reverb Time (⇨ P. 23).

119.REVERB
PRE DELAY 200ms

- Pre Delay(PRE DELAY):0 to 200ms
Adjusts the Pre Delay (⇨ P. 23).

119.REVERB
LP FILTER 12kHz

- Low - pass Filter(LP FILTER):500Hz to 12kHz, THRU
Controls the cut - off frequency of the Low - pass Filter (⇨ P. 24). When set at THRU, the Low - pass Filter is inactive.

119.REVERB
LEVEL 100

- Reverb Level(LEVEL):0 to 100
Adjusts the volume of the Reverb sound.

MASTER

Adjusts the overall volume.

119.MASTER
LEVEL 100

- Master Level(LEVEL):0 to 100
Adjusts the overall volume (Actual level output by the SE - 50).

MIDI CONTROL

The MIDI Control Parameters are as follows.

* For details on MIDI Control, see "MIDI Control" (P. 98).

119.MIDI CONTROL
RECEIVE OFF

● MIDI Control Receive(MIDI CONTROL RECEIVE):
OFF, AF TOUCH, P.BEND, #0 to #31, #64 to #95

Provides selection of the type of MIDI data to be received.

119.MIDI CTL ASN
PHASER RATE

● MIDI Control Assign(MIDI CTL ASN):
PHASER RATE, PHASER DEPTH, PHASER STEP, CHORUS RATE,
REVERB LEVEL, MASTER LEVEL

Select the parameter you wish to have controlled.

119.MIDI CTL MIN

● MIDI Control Minimum(MIDI CTL MIN):

This setting specifies the lowest value that will be valid for control.

* The value must be within the range allowed for the parameter.

119.MIDI CTL MAX

● MIDI Control Maximum(MIDI CTL MAX):

This setting specifies the highest value that will be valid for control.

* The value must be within the range allowed for the parameter.

20) RHODES (No.120)

120 Rhodes
RHODES

This algorithm creates a Rhodes type sound. It is most effective when used with an electronic piano sound.

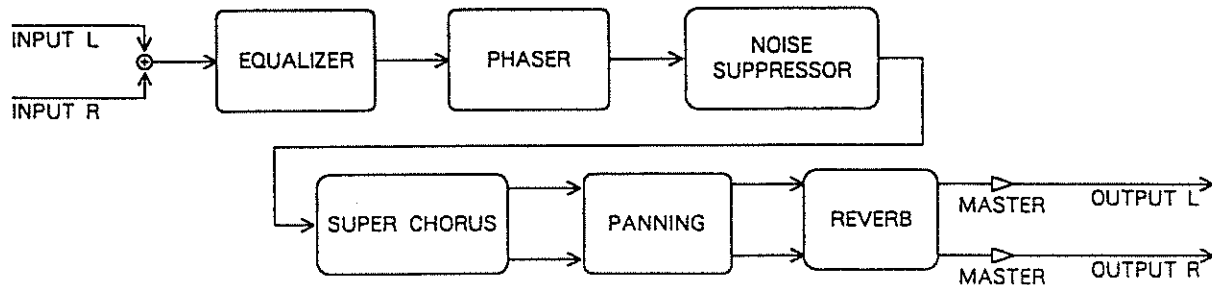

EFFECT ON/OFF

Used to turn effects on or off.

120.EFF.ON/OFF
EQ+PH+CH+PN+RV

Using PARAMETER , select the effector. Then use VALUE to turn it on or off.

EQUALIZER

Settings for the 3 - band Equalizer are as follows.

120.EQUALIZER
LOW EQ +12dB

● Low EQ (LOW EQ): - 12dB to +12dB

Adjusts the tone of the lower range.

120.EQUALIZER
MID FREQ 4kHz

● Middle Frequency (MID FREQ):250Hz to 4kHz

Sets the center frequency that will be employed when adjusting the middle range.

120.EQUALIZER
MID EQ +12dB

● Middle EQ(MID EQ): - 12dB to +12dB

Adjusts the tone of the middle range portion of the sound.

120.EQUALIZER
HIGH EQ +12dB

● High EQ(HIGH EQ): - 12dB to +12dB

Adjusts the tone of the high range portion of the sound.

120.EQUALIZER
LP FILTER 12kHz

● Low - pass Filter(LP FILTER):500Hz to 12kHz, THRU

Controls the cut - off frequency of the Low - pass Filter (≈ P. 24). When set at THRU, the Low - pass Filter is inactive.

120.EQUALIZER
LEVEL +12dB

● Equalizer Level(LEVEL): - 12dB to +12dB

Adjusts the volume of the sound after it has been routed through the Equalizer.

PHASER

Settings can be made for the following Phaser parameters.

120.PHASER
RATE 100

● Rate(RATE):0 to 100

Adjusts the rate at which the Phaser is applied.

120.PHASER
DEPTH 100

● Depth(DEPTH):0 to 100
Adjusts the depth at which the Phaser is applied.

120.PHASER
MANUAL 100

● Manual (MANUAL):0 to 100
Sets the center frequency for application of the Phaser effect.

120.PHASER
RESONANCE 100

● Resonance (RESONANCE):0 to 100
This setting determines the amount of Resonance. The higher the value, the more unique the sound becomes.

NOISE SUPPRESSOR

The following are the parameters that are set for the Noise Suppressor. When the level of the signal input falls below the set level, it is muted to eliminate unwanted noise.

120.N.SUPPRESSOR
THRESHOLD 100

● Threshold (THRESHOLD):0 to 100
This setting specifies the level at which the Noise Suppressor starts working. When the level of the signal falls below this level, the signal is muted.

120.N.SUPPRESSOR
RELEASE 100

● Release (RELEASE):0 to 100
This setting determines the amount of time it will take for sound volume to reach "0", after the Noise Suppressor has started working.

120.N.SUPPRESSOR
LEVEL 100

● Level(LEVEL):0 to 100
Adjusts the volume of the sound, after it has passed through the Noise Suppressor.

SUPER CHORUS

The Chorus parameters are as follows.

120.SUPER CHORUS
PRE DELAY 60ms

● Pre Delay(PRE DELAY):0 to 60ms
After the direct sound has started, this is the amount of time it takes before the Chorus effect begins.

120.SUPER CHORUS
RATE 100

● Rate(RATE):0 to 100
Adjusts the rate of the modulation for Chorus.

120.SUPER CHORUS
DEPTH 100

● Depth(DEPTH):0 to 100
Adjusts the modulation depth for Chorus.

PANNING

These parameters control the panning, which allows sound to be panned to the right and left when the output is in stereo.

120.PANNING
RATE 100

● Rate(RATE):0 to 100
Adjusts the rate at which the sound will pan left and right

120.PANNING
DEPTH 100

● Depth(DEPTH):0 to 100
Adjusts the volume at which the sound will pan left and right

120.PANNING
MOD.WAVE TRI

● Modulation Wave (MOD.WAVE):TRI, SQR

The manner in which the sound pans to right and left is chosen in terms of the waveform.

TRI (TRIANGLE: Triangle Wave) : Sounds move smoothly to right and left.

SQR (SQUARE: Square Wave) : Sounds move abruptly to right and left.

REVERB

Settings for Reverb are as follows.

120.REVERB
REV TIME 20.0s

● Reverb Time(REV TIME):0.1 to 20.0s

Adjusts the Reverb Time (⇒ P. 23).

120.REVERB
PRE DELAY 200ms

● Pre Delay(PRE DELAY):0 to 200ms

Adjusts the Pre Delay (⇒ P. 23).

120.REVERB
LP FILTER 12kHz

● Low - pass Filter(LP FILTER):500Hz to 12kHz, THRU

Controls the cut - off frequency of the Low - pass Filter (⇒ P. 24). When set at THRU, the Low - pass Filter is inactive.

120.REVERB
LEVEL 100

● Reverb Level(LEVEL):0 to 100

Adjusts the volume of the Reverb sound.

MASTER

Adjusts the overall volume.

120.MASTER
LEVEL 100

● Master Level(LEVEL):0 to 100

Adjusts the overall volume (Actual level output by the SE - 50).

MIDI CONTROL

The MIDI Control Parameters are as follows.

* For details on MIDI Control, see "MIDI Control" (⇒ P. 98).

120.MIDI CONTROL
RECEIVE OFF

● MIDI Control Receive(MIDI CONTROL RECEIVE):

OFF, AF TOUCH, P.BEND, #0 to #31, #64 to #95

Provides selection of the type of MIDI data to be received.

120.MIDI CTL ASN
PHASER RATE

● MIDI Control Assign(MIDI CTL ASN):

PHASER RATE, PHASER DEPTH, N.SUPPRESSOR LEVEL,
CHORUS RATE, PANNING RATE, PANNING DEPTH, REVERB LEVEL,
MASTER LEVEL

Select the parameter you wish to have controlled.

120.MIDI CTL MIN

● MIDI Control Minimum(MIDI CTL MIN):

This setting specifies the lowest value that will be valid for control.

* The value must be within the range allowed for the parameter.

120.MIDI CTL MAX

● MIDI Control Maximum(MIDI CTL MAX):

This setting specifies the highest value that will be valid for control.

* The value must be within the range allowed for the parameter.

21) GUITAR MULTI (No.121)

121 Guitar Multi
GUITAR MULTI

These settings are for use with guitars. All the effectors commonly used with guitars are included.

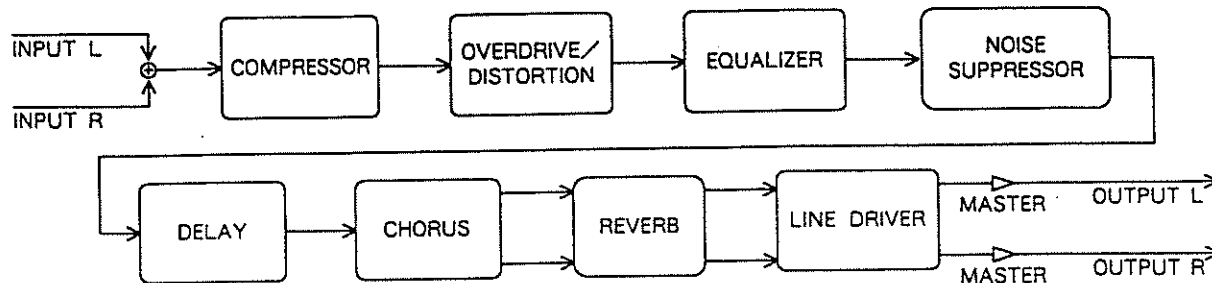

EFFECT ON/OFF

Used to turn effects on or off.

121.EFF.ON/OFF
CO+OD+Q+D+CH+R+L

Using PARAMETER ▲ ▼, select the effector. Then use VALUE ▲ ▼ to turn it on or off.

COMPRESSOR

This effector suppresses signals that have too high a level, while it enhances those that are too weak. The output signal is thus made more even.

121.COMPRESSOR
SUSTAIN 100

● Sustain(SUSTAIN):0 to 100

Sets the amount of time that weaker signals will be brought up and maintained at a certain level.

121.COMPRESSOR
ATTACK 100

● Attack (ATTACK):0 to 100

Adjusts the strength of the attack at the time sound is input.

121.COMPRESSOR
LEVEL 100

● Level (LEVEL):0 to 100

Adjusts the volume of the sound after it has passed through the compressor.

OVERDRIVE /DISTORTION

Adds distortion to sounds to make them more exciting.

121.OO/DS
MODE OD TURB OFF

● Mode(MODE):OD TURBO OFF, OD TURBO ON,
DS TURBO OFF, DS TURBO ON

This allows you to select the type of distortion. With OVERDRIVE (OD), you obtain the distortion of a tube amp. With DISTORTION (DS), the sound has a stronger distortion applied to it. When TURBO is off, the distortion is normal; when on, the middle range is emphasized.

121.OO/DS
DRIVE 100

● Drive (DRIVE):0 to 100

Controls the degree to which distortion is applied.

121.OO/DS
LEVEL 100

● Level(LEVEL):0 to 100

Adjusts the volume of the sound after it has passed through the distortion processor.

EQUALIZER

The Equalizer parameters are as follows.

```
121.EQUALIZER
LOW EQ      +12dB
```

- Low EQ (LOW EQ): - 12dB to +12dB
Adjusts the tone of the lower range.

```
121.EQUALIZER
MID FREQ    4kHz
```

- Middle Frequency(MID FREQ):250Hz to 4kHz
Sets the center frequency that will be employed when adjusting the middle range.

```
121.EQUALIZER
MID EQ      +12dB
```

- Middle EQ(MID EQ): - 12dB to +12dB
Adjusts the tone of the middle range portion of the sound.

```
121.EQUALIZER
HIGH EQ     +12dB
```

- High EQ(HIGH EQ): - 12dB to +12dB
Adjusts the tone of the high range portion of the sound.

```
121.EQUALIZER
LEVEL       +12dB
```

- Equalizer Level(LEVEL): - 12dB to +12dB
Adjusts the volume of the sound after it has been routed through the Equalizer.

NOISE SUPPRESSOR

The following are the parameters that are set for the Noise Suppressor. When the level of the signal input falls below the set level, it is muted to eliminate unwanted noise.

```
121.N.SUPPRESSOR
THRESHOLD   100
```

- Threshold (THRESHOLD):0 to 100
This setting specifies the level at which the Noise Suppressor starts working. When the level of the signal falls below this level, the signal is muted.

```
121.N.SUPPRESSOR
RELEASE     100
```

- Release (RELEASE):0 to 100
This setting determines the amount of time it will take for sound volume to reach "0", after the Noise Suppressor has started working.

```
121.N.SUPPRESSOR
LEVEL       100
```

- Level(LEVEL):0 to 100
Adjusts the volume of the sound, after it has passed through the Noise Suppressor.

DELAY

The following settings are made for the Delay parameters.

```
121.DELAY
D.TIME      1200ms
```

- Delay Time(D.TIME):0 to 1200ms
Adjusts the Delay Time.

```
121.DELAY
FEEDBACK    100
```

- Feedback (FEEDBACK):0 to 100
Feedback refers to the process of feeding a portion of the delayed sounds back into the delay circuit. Here you set the amount that is to be fed back. This affects the number of repetitions occurring in the delay.

```
121.DELAY
LEVEL       100
```

- Delay Level (LEVEL):0 to 100
Adjusts volume of delayed sound.

CHORUS

The Chorus parameters are as follows.

```
121.CHORUS
MODE STEREO 1
```

● Mode(MODE): MONO, STEREO1, STEREO2

The Chorus mode is selected here.

MONO: Output will be in mono.

STEREO 1: The Direct sound is output from the R channel, while the pitch - altered sound is output from the L Channel. These two parts become mixed in mid - air, producing the Chorus effect.

STEREO 2: Chorus sound which has its phase reversed is output on both channels. The expansiveness of the resulting sound is intensified.

* When output is mono, chorus effect is not gotten.

```
121.CHORUS
RATE 100
```

● Rate(RATE): 0 to 100

Adjusts the rate of the modulation for Chorus.

```
121.CHORUS
DEPTH 100
```

● Depth(DEPTH): 0 to 100

Adjusts the modulation depth for Chorus.

```
121.CHORUS
FEEDBACK 100
```

● Feedback (FEEDBACK): 0 to 100

This controls the amount of Feedback for the Chorus effect. The higher the value, the more distinctive the effect; a flanger - like effect can even be obtained.

REVERB

Settings for Reverb are as follows.

```
121.REVERB
REV TIME 20.0s
```

● Reverb Time(REV TIME): 0.1 to 20.0s

Adjusts the Reverb Time (⇒ P. 23).

```
121.REVERB
PRE DELAY 200ms
```

● Pre Delay(PRE DELAY): 0 to 200ms

Adjusts the Pre Delay (⇒ P. 23).

```
121.REVERB
LP FILTER 12kHz
```

● Low - pass Filter(LP FILTER): 500Hz to 12kHz, THRU

Controls the cut - off frequency of the Low - pass Filter (⇒ P. 24). When set at THRU, the Low - pass Filter is inactive.

```
121.REVERB
LEVEL 100
```

● Reverb Level(LEVEL): 0 to 100

Adjusts the volume of the Reverb sound.

LINE DRIVER

Simulates the response of a guitar amplifier. Even when connected directly to a mixer (Line Input), the sound will be free of the sparseness associated with line input, and will have more body.

```
121.LINE DRIVER
MODE 1
```

● Mode(MODE): 1, 2

The type of guitar amp simulation is chosen by its mode.

MODE1: Simulates a large tube amplifier.

MODE2: Simulates a smaller, built - in amplifier.

MASTER

Controls the overall volume.

121.MASTER
LEVEL 100

● Master Level(LEVEL):0 to 100

Adjusts the overall volume (Actual level output by the SE - 50).

MIDI CONTROL

The MIDI Control Parameters are as follows.

* For details on MIDI Control, see "MIDI Control" (P. 98).

121.MIDI CONTROL
RECEIVE OFF

● MIDI Control Receive(MIDI CONTROL RECEIVE):

OFF, AF TOUCH, P.BEND, #0 to #31, #64 to #95

Provides selection of the type of MIDI data to be received.

121.MIDI CTL ASN
OD/DS DRIVE

● MIDI Control Assign(MIDI CTL ASN):

OD/DS DRIVE, N.SUPPRESSOR LEVEL, DELAY LEVEL,
CHORUS RATE, REVERB LEVEL, MASTER LEVEL

Select the parameter you wish to have controlled.

121.MIDI CTL MIN

● MIDI Control Minimum(MIDI CTL MIN):

This setting specifies the lowest value that will be valid for control.

* The value must be within the range allowed for the parameter.

121.MIDI CTL MAX

● MIDI Control Maximum(MIDI CTL MAX):

This setting specifies the highest value that will be valid for control.

* The value must be within the range allowed for the parameter.

22) VOCAL MULTI (No.122)

122 Vocal Multi
VOCAL MULTI

This algorithm is well suited for vocals. It can also be quite effective when used with bass or acoustic guitars.

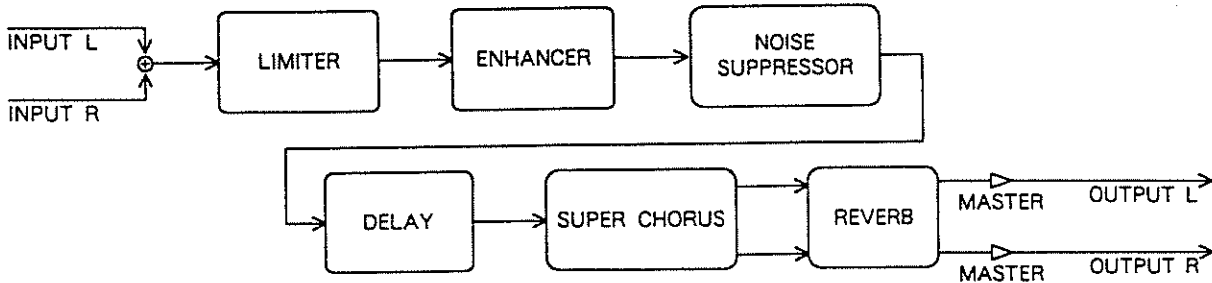

EFFECT ON/OFF

Used to turn effects on or off.

122.EFF.ON/OFF
LM+EH+DL+CH+RV

Using PARAMETER , select the effector. Then use VALUE to turn it on or off.

LIMITER

Acts in controlling signals with a high input level; this helps prevent distortion.

122.LIMITER
THRESHOLD 100

● Threshold (THRESHOLD):0 to 100

This setting specifies the level at which the Limiter starts working. When an input signal is above the set level, the signal is suppressed.

122.LIMITER
RATIO 2:1

● Ratio (RATIO):2:1, 5:1, 10:1, 20:1

Provides selection for the extent to which the signal will be suppressed while the Limiter is working (compression ratio).

122.LIMITER
RELEASE 100

● Release (RELEASE):0 to 100

This setting determines the amount of time it will take for the Limiter to stop working completely after the signal has gone below the Threshold Level.

122.LIMITER
LEVEL 100

● Level (LEVEL):0 to 100

Adjusts the volume of the signal that has been routed through the Limiter.

ENHANCER

Adds sound portions which have had their phase shifted to the source sound. This improves the sound's definition, giving it more presence (the Enhancing effect). Since settings can be made individually for upper and lower ranges, you can obtain precisely the enhancement you need for a particular situation.

122.ENHANCER
SENS 100

● Sens (SENS):0 to 100

Adjusts the extent to which the Enhancer will be applied, depending on the level of the input signal.

122.ENHANCER
LOW MIX 100

● Low Mix (LOW MIX):0 to 100

Adjusts the amount of phase - altered sound for the lower range that will be mixed in.

122.ENHANCER
HIGH MIX 100

● High Mix (HIGH MIX):0 to 100

Adjusts the amount of phase - altered sound for the upper range that will be mixed in.

NOISE SUPPRESSOR

The following are the parameters that are set for the Noise Suppressor. When the level of the input signal falls below the set level, it is muted to eliminate unwanted noise.

122.N.SUPPRESSOR
THRESHOLD 100

● Threshold (THRESHOLD):0 to 100

This setting specifies the level at which the Noise Suppressor starts working. When the signal level falls below this level, it is muted.

122.N.SUPPRESSOR
RELEASE 100

● Release (RELEASE):0 to 100

This setting determines the amount of time it will take for the sound volume to reach "0" after the Noise Suppressor has started working.

DELAY

The following settings are made for the Delay parameters.

122.DELAY
D.TIME 1200ms

● Delay Time(D.TIME):0 to 1200ms

Adjusts the Delay Time.

122.DELAY
FEEDBACK 100

● Feedback (FEEDBACK):0 to 100

Feedback refers to the process of feeding a portion of the delayed sounds back into the delay circuit. Here you set the amount that is to be fed back. This affects the number of repetitions occurring in the delay.

122.DELAY
LEVEL 100

● Delay Level (LEVEL):0 to 100

Adjusts the volume of the delayed sound.

SUPER CHORUS

The Chorus parameters are as follows.

122.SUPER CHORUS
PRE DELAY 60ms

● Pre Delay(PRE DELAY):0 to 60ms

After the direct sound has started, this is the amount of time it takes before the Chorus effect begins.

122.SUPER CHORUS
RATE 100

● Rate(RATE):0 to 100

Adjusts the rate of the modulation for Chorus.

122.SUPER CHORUS
DEPTH 100

● Depth(DEPTH):0 to 100

Adjusts the modulation depth for Chorus.

REVERB

Settings for Reverb are as follows.

122.REVERB
REV TIME 20.0s

- Reverb Time(REV TIME):0.1 to 20.0s
Adjusts the Reverb Time (⇨ P. 23).

122.REVERB
PRE DELAY 200ms

- Pre Delay(PRE DELAY):0 to 200ms
Adjusts the Pre Delay (⇨ P. 23).

122.REVERB
LP FILTER 12kHz

- Low - pass Filter(LP FILTER):500Hz to 12kHz, THRU
Controls the cut - off frequency of the Low - pass Filter (⇨ P. 24). When set at THRU, the Low - pass Filter is inactive.

122.REVERB
LEVEL 100

- Reverb Level(LEVEL):0 to 100
Adjusts the volume of the Reverb sound.

MASTER

Adjusts the overall volume.

122.MASTER
LEVEL 100

- Master Level(LEVEL):0 to 100
Adjusts the overall volume (Actual level output by the SE - 50).

MIDI CONTROL

The MIDI Control Parameters are as follows.

* For details on MIDI Control, see "MIDI Control" (⇨ P. 98).

122.MIDI CONTROL
RECEIVE OFF

- MIDI Control Receive(MIDI CONTROL RECEIVE):
OFF, AF TOUCH, P.BEND, #0 to #31, #64 to #95
Provides selection of the type of MIDI data to be received.

122.MIDI CTL ASN
CHORUS RATE

- MIDI Control Assign(MIDI CTL ASN):
CHORUS RATE, DELAY LEVEL, REVERB LEVEL, MASTER LEVEL
Select the parameter you wish to have controlled.

122.MIDI CTL MIN

- MIDI Control Minimum(MIDI CTL MIN):
This setting specifies the lowest value that will be valid for control.
* The value must be within the range allowed for the parameter.

122.MIDI CTL MAX

- MIDI Control Maximum(MIDI CTL MAX):
This setting specifies the highest value that will be valid for control.
* The value must be within the range allowed for the parameter.

23) STEREO ENHANCER (No.123)

123 St. Enhancer
STEREO ENHANCER

This algorithm combines the Limiter, Enhancer and Noise Suppressor. Since it accepts stereo input, effectors can be applied without losing any of the orientation in the sound image.

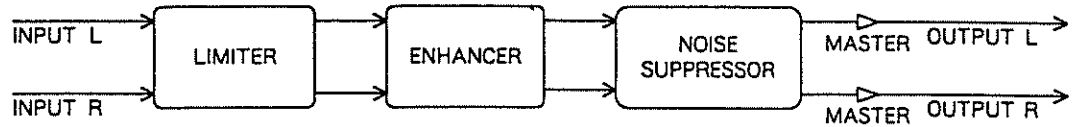

EFFECT ON/OFF

Used to turn effects on or off.

123.EFF.ON/OFF
LM+EH+NS

Using PARAMETER , select the effector. Then use VALUE to turn it on or off.

LIMITER

Controls excessive signal levels to prevent distortion.

123.LIMITER
THRESHOLD 100

● Threshold (THRESHOLD):0 to 100

Sets the level at which the limiter will start taking effect. When a signal is above the set level, the signal is suppressed.

123.LIMITER
RATIO 2:1

● Ratio (RATIO):2:1, 5:1, 10:1, 20:1

Selects the extent to which the signals will be suppressed when the Limiter is working. (compression ratio).

123.LIMITER
RELEASE 100

● Release (RELEASE):0 to 100

Adjustment for the amount of time that is to pass after the signal has gone below the threshold level before the Limiter cuts - off.

123.LIMITER
LEVEL 100

● Level (LEVEL):0 to 100

Adjusts the volume of the signal that has been routed through the Limiter.

ENHANCER

Adds sound portions which have had their phase shifted to the source sound. This improves the sound's definition, giving it more presence (the Enhancing effect). Since settings can be made individually for upper and lower ranges, you can obtain precisely the enhancement you need for a particular situation.

123.ENHANCER
SENS 100

● Sens (SENS):0 to 100

Adjusts the extent to which the Enhancer will be applied relative to the level of the input signal.

123.ENHANCER
LOW MIX 100

● Low Mix (LOW MIX):0 to 100

Adjusts the amount of phase - altered sound for the lower range that will be mixed in.

123.ENHANCER
HIGH MIX 100

● High Mix(HIGH MIX):0 to 100

Adjusts the amount of phase - altered sound for the upper range that will be mixed in.

NOISE SUPPRESSOR

The following are the parameters that are set for the Noise Suppressor. When the input signal falls below the set level, it is muted to eliminate unwanted noise.

```
123.N.SUPPRESSOR
THRESHOLD      100
```

● Threshold (THRESHOLD):0 to 100

This setting specifies the level at which the Noise Suppressor starts working. When the level of the signal falls below this level, it is muted.

```
123.N.SUPPRESSOR
RELEASE        100
```

● Release (RELEASE):0 to 100

This setting determines the amount of time it will take for sound volume to reach "0" after the Noise Suppressor has started working.

MASTER

Adjusts the overall volume.

```
123.MASTER
LEVEL          100
```

● Master Level(LEVEL):0 to 100

Adjusts the overall volume (Actual level output by the SE - 50).

24) 2CH MIXER (No.124)

124 2ch Mixer
2CH MIXER

This is a 2 - Channel mixer. The Equalizer and Noise Suppressor can be applied independently to the channels, and after this, Reverb, Delay, or Chorus can also be applied.

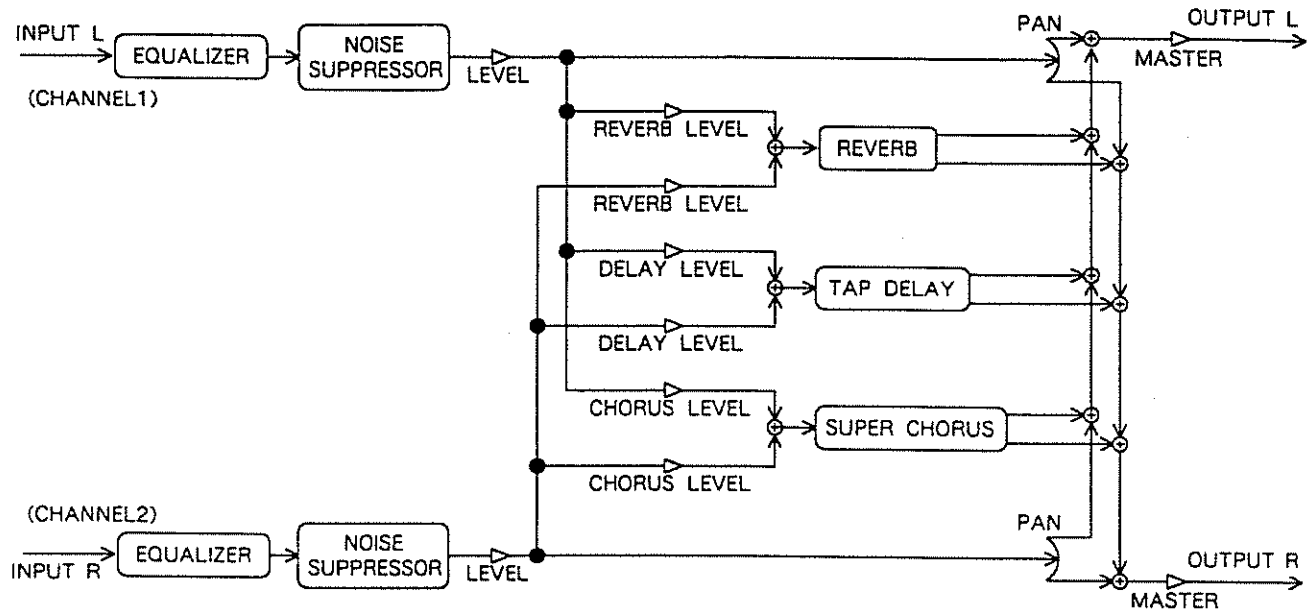

CHANNEL 1/2 EQUALIZER

The following are the Equalizer parameters, for both channels.

124.CHANNEL 1
LOW EQ +12dB

● Low EQ 1/2 (LOW EQ 1/2): - 12dB to +12dB
Adjusts the tone of the lower range.

124.CHANNEL 1
MID FREQ 4kHz

● Middle Frequency 1/2 (MID FREQ 1/2): 250Hz to 4kHz
Sets the center frequency that will be employed when adjusting the middle range.

124.CHANNEL 1
MID EQ +12dB

● Middle EQ 1/2 (MID EQ 1/2): - 12dB to +12dB
Adjusts the tone of the middle range portion of the sound.

124.CHANNEL 1
HIGH EQ +12dB

● High EQ 1/2 (HIGH EQ 1/2): - 12dB to +12dB
Adjusts the tone of the high range portion of the sound.

CHANNEL 1/2 NOISE SUPPRESSOR

For each channel the following Noise Suppressor parameters are available.

124.CHANNEL 1
NS THRESHOLD 100

● Threshold 1/2 (THRESHOLD 1/2): 0 to 100
This setting specifies the level at which the Noise Suppressor starts working. When the level of the signal falls below this level, it is muted.

```
124.CHANNEL 1
NS RELEASE 100
```

● Release 1/2 (RELEASE 1/2):0 to 100

This setting determines the amount of time it will take for sound volume to reach "0" after the Noise Suppressor has started working.

CHANNEL 1/2 MASTER

For each channel, the level sent out by the Reverb, Delay, and Chorus can be adjusted with the following.

```
124.CHANNEL 1
REVERB LEVEL 100
```

● Reverb Level 1/2 (REVERB LEVEL 1/2):0 to 100

Adjusts level of Reverb output for each channel.

```
124.CHANNEL 1
DELAY LEVEL 100
```

● Delay Level 1/2 (DELAY LEVEL 1/2):0 to 100

Adjusts level of Delay output for each channel.

```
124.CHANNEL 1
CHORUS LEVEL 100
```

● Chorus Level 1/2 (CHORUS LEVEL 1/2):0 to 100

Adjusts level of Chorus output for each channel.

```
124.CHANNEL 1
PAN L=100 R= 0
```

● Panpot 1/2 (PAN 1/2):L=0 to 100, R=0 to 100

Adjusts the positioning of the sound image for each channel.

```
124.CHANNEL 1
LEVEL 100
```

● Level 1/2 (LEVEL 1/2):0 to 100

Adjusts the volume level for each channel.

REVERB

Settings for Reverb are as follows.

```
124.REVERB
REV TIME 20.0s
```

● Reverb Time(REV TIME):0.1 to 20.0s

Adjusts the Reverb Time (⇨ P. 23).

```
124.REVERB
PRE DELAY 200ms
```

● Pre Delay(PRE DELAY):0 to 200ms

Adjusts the Pre Delay (⇨ P. 23).

```
124.REVERB
LP FILTER 12kHz
```

● Low - pass Filter(LP FILTER):500Hz to 12kHz, THRU

Controls the cut - off frequency of the Low - pass Filter (⇨ P. 24). When set at THRU, the Low - pass Filter is inactive.

```
124.REVERB
LEVEL 100
```

● Reverb Level(LEVEL):0 to 100

Adjusts the volume of the Reverb sound.

DELAY TAP

The Delay parameters are as follows.

```
124.DELAY TAP L
D.TIME 1200ms
```

● Delay Tap L, Delay Time(D.TIME):0 to 1200ms

Adjusts the amount of delay for delayed sound output on channel L.

124.DELAY TAP L
LEVEL 100

● Delay Tap L, Delay Level (LEVEL):0 to 100
Adjusts the volume of the delayed sound output on channel L.

124.DELAY TAP R
D.TIME 1200ms

● Delay Tap R, Delay Time(D.TIME):0 to 1200ms
Adjusts the amount of delay for delayed sound output on channel R.

124.DELAY TAP R
LEVEL 100

● Delay Tap R, Delay Level (LEVEL):0 to 100
Adjusts the volume of the delayed sound output on channel R.

124.DELAY TAP C
D.TIME 1200ms

● Delay Tap C, Delay Time(D.TIME):0 to 1200ms
Adjusts the amount of delay for delayed sound output at the center (L+R) position.

124.DELAY TAP C
FEEDBACK 100

● Delay Tap C, Feedback (FEEDBACK):0 to 100
Feedback refers to the process of feeding a portion of the delayed sounds back into the delay circuit. Here you set the amount that is to be fed back. This affects the number of repetitions occurring in the delay for both Delay L and R.

124.DELAY TAP C
LEVEL 100

● Delay Tap C, Delay Level (LEVEL):0 to 100
Adjusts the volume of the delayed sound output at the center position.

124.DELAY
LP FILTER 12kHz

● Low - pass Filter(LP FILTER):500Hz to 12kHz, THRU
Controls the cut - off frequency of the Low - pass Filter (≠ P. 24). When set at THRU, the Low - pass Filter is inactive.

SUPER CHORUS

The available Chorus parameters are as follows.

124.SUPER CHORUS
PRE DELAY 60ms

● Pre Delay(PRE DELAY):0 to 60ms
After the direct sound has started, this is the amount of time it takes before the Chorus effect begins.

124.SUPER CHORUS
RATE 100

● Rate(RATE):0 to 100
Adjusts the rate of the modulation for Chorus.

124.SUPER CHORUS
DEPTH 100

● Depth(DEPTH):0 to 100
Adjusts the modulation depth for Chorus.

MASTER

Adjusts the overall volume.

124.MASTER
LEVEL 100

● Master Level(LEVEL):0 to 100
Adjusts the overall volume (Actual level output by the SE - 50).

5. Algorithms Suitable for Use With Mixers

Since the SE-50 provides for stereo input, you can apply separate effects to the left and right channels. Such applications become effective when using a mixer having two or more Send/Return circuits.

OUTPUT MODE

Algorithms No. 125 through No. 128 provide the parameter "Output Mode". They are used to select the mode of output for each channel.

MONO+MONO: The effected sound for individual channels is output in mono; separately on each channel.

STEREO MIX : The effected sound for the channels is output in stereo, and is mixed when output.

Make connections as shown in one of the examples below, depending on the type of output selected.

«When the mode is MONO + MONO.»

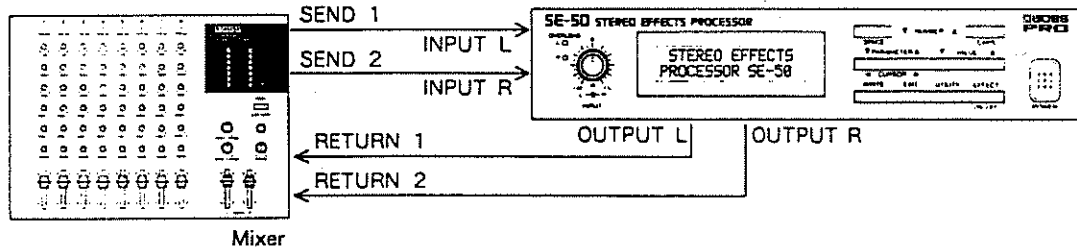

«When the mode is STEREO MIX.»

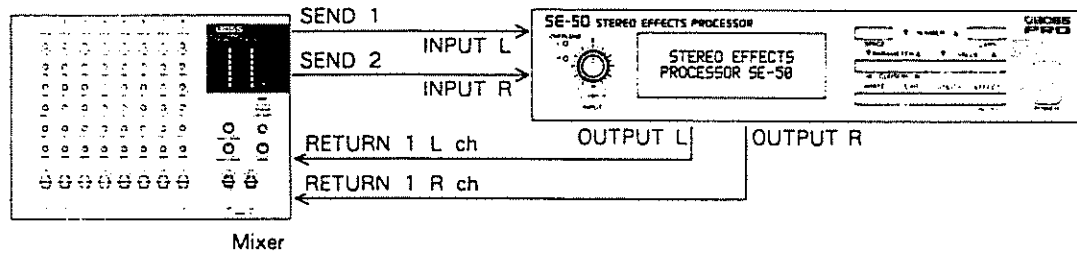

Select the Output Mode that is best for your setup.

25) REVERB1 + REVERB2 (No.125)

125.Rev1+Rev2
REVERB1+REVERB2

Allows you to apply Reverb separately for each channel.

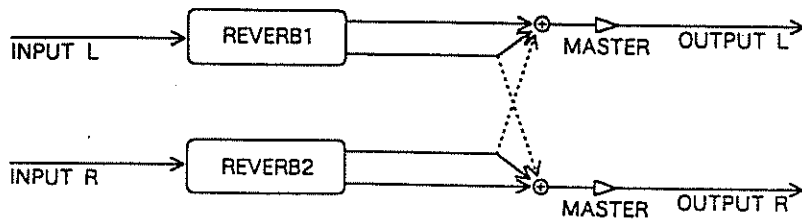

□ REVERB 1/2

The Reverb Parameters are as follows.

125.REVERB 1
REV TIME 20.0s

● Reverb Time(REV TIME):0.1 to 20.0s
Adjusts the Reverb Time (⇨ P. 23).

125.REVERB 1
PRE DELAY 200ms

● Pre Delay(PRE DELAY):0 to 200ms
Adjusts the Pre Delay (⇨ P. 23).

125.REVERB 1
HF DAMP 1.0

● HF Damp(HF DAMP):0.1 to 1.0
Adjusts the decay of upper range reflections (HF Damp: ⇨ P. 24).

125.REVERB 1
LP FILTER 12kHz

● Low - pass Filter(LP FILTER):500Hz to 12kHz, THRU
Controls the cut - off frequency of the Low - pass Filter (⇨ P. 24). When set at THRU, the Low - pass Filter is inactive.

125.REVERB 1
HP FILTER 1kHz

● High - pass Filter(HP FILTER):THRU, 30Hz to 1kHz
Controls the cut - off frequency of the High - pass Filter (⇨ P. 24). When set at THRU, the High - pass Filter is inactive.

125.REVERB 1
LEVEL 100

● Reverb Level(LEVEL):0 to 100
Adjusts the volume of the Reverb sound.

OUTPUT

Here, the Output Mode for the channels can be selected.

125. OUTPUT
MODE MONO+MONO

● Mode(MODE): MONO+MONO, STEREO MIX

Selects the Output Mode.

MONO+MONO: The effected sound for individual channels is output in mono; separately on each channel.

STEREO MIX : The effected sound for the channels is output in stereo, and is mixed when output.

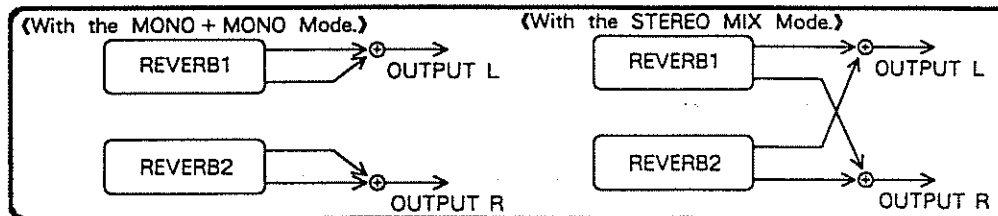

DIRECT L/R

Controls the direct sound for each channel.

125. DIRECT
LEVEL L 100

● Direct Level L/R (LEVEL L/R): 0 to 100

Adjusts the volume of direct sound, for each channel.

MASTER L/R

Controls overall volume for each channel.

125. MASTER
LEVEL L 100

● Master Level L/R (LEVEL L/R): 0 to 100

Adjusts the overall volume for each channel (Actual level output from the SE - 50).

26) GATE REVERB + REVERB (No.126)

126.Gate Rev+Rev
GATE REV.+REVERB

Allows you to apply Gate Reverb and Reverb separately for each channel.

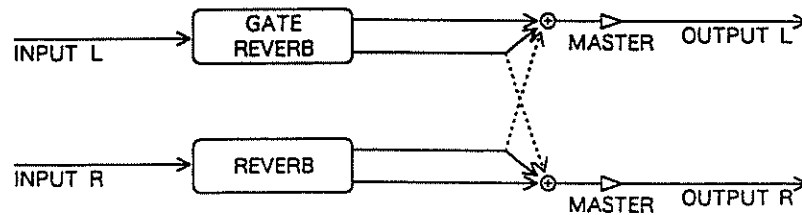

GATE REVERB

The Gate Reverb Parameters are as follows.

126.GATE REVERB
GATE TIME 200ms

● Gate Time(GATE TIME):0 to 200ms
Adjusts the Gate Time (⇨ P. 33).

126.GATE REVERB
PRE DELAY 200ms

● Pre Delay(PRE DELAY):0 to 200ms
Adjusts the Pre Delay (⇨ P. 23).

126.GATE REVERB
LP FILTER 12kHz

● Low - pass Filter(LP FILTER):500Hz to 12kHz, THRU
Controls the cut - off frequency of the Low - pass Filter (⇨ P. 24). When set at THRU, the Low - pass Filter is inactive.

126.GATE REVERB
HP FILTER 1kHz

● High - pass Filter(HP FILTER):THRU, 30Hz to 1kHz
Controls the cut - off frequency of the High - pass Filter (⇨ P. 24). When set at THRU, the High - pass Filter is inactive.

126.GATE REVERB
LEVEL 100

● Gate Reverb Level(LEVRL):0 to 100
Adjust the volume of the Gate Reverb sound.

REVERB

Reverb Parameters .

126.REVERB
REV TIME 20.0s

● Reverb Time(REV TIME):0.1 to 20.0s
Adjusts the Reverb Time (⇨ P. 23).

126.REVERB
PRE DELAY 200ms

● Pre Delay(PRE DELAY):0 to 200ms
Adjusts the Pre Delay (⇨ P. 23).

126.REVERB
HF DAMP 1.0

● HF Damp(HF DAMP):0.1 to 1.0
Adjusts the decay of upper range reflections (HF Damp: ⇨ P. 24).

126.REVERB
LP FILTER 12kHz

● Low - pass Filter(LP FILTER):500Hz to 12kHz, THRU
Controls the cut - off frequency of the Low - pass Filter (⇨ P. 24). When set at THRU, the Low - pass Filter is inactive.

126. REVERB
HP FILTER 1kHz

● High - pass Filter(HP FILTER):THRU, 30Hz to 1kHz

Controls the cut - off frequency of the High - pass Filter (P. 24). When set at THRU, the High - pass Filter is inactive.

126. REVERB
LEVEL 100

● Reverb Level(LEVEL):0 to 100

Adjusts the volume of the Reverb sound.

□ OUTPUT

Here, the Output Mode for the channels is selected.

126. OUTPUT
MODE STEREO MIX

● Mode(MODE):MONO+MONO, STEREO MIX

Selects the Output Mode.

MONO+MONO: The effected sound for individual channels is output in mono; separately on each channel.

STEREO MIX : The effected sound for the channels is output in stereo, and is mixed when output.

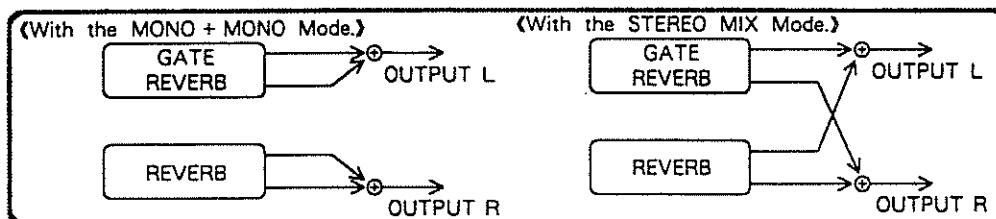

□ DIRECT L/R

Controls the direct sound for each channel.

126. DIRECT
LEVEL L 100

● Direct Level L/R(LEVEL L/R):0 to 100

Adjusts the volume of direct sound, for each channel.

□ MASTER L/R

Controls overall volume for each channel.

126. MASTER
LEVEL L 100

● Master Level L/R(LEVEL L/R):0 to 100

Adjusts the overall volume for each channel. (Actual level output by the SE - 50.)

27) CHORUS + REVERB (No.127)

127 Chorus+Rev
CHORUS + REVERB

Allows you to apply Chorus and Reverb separately for each channel.

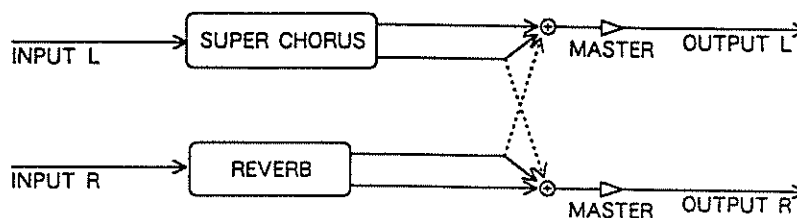

SUPER CHORUS

The Chorus parameters are as follows.

127.SUPER CHORUS
PRE DELAY 60ms

● Pre Delay(PRE DELAY):0 to 60ms

After the direct sound has started, this is the amount of time it takes before the Chorus effect begins.

127.SUPER CHORUS
RATE 100

● Rate(RATE):0 to 100

Adjusts the rate of the modulation for Chorus.

127.SUPER CHORUS
DEPTH 100

● Depth(DEPTH):0 to 100

Adjusts the modulation depth for Chorus.

127.SUPER CHORUS
LEVEL 100

● Chorus Level(LEVEL):0 to 100

Adjusts the volume of the Chorus sound.

REVERB

Settings for Reverb are as follows.

127.REVERB
REV TIME 20.0s

● Reverb Time(REV TIME):0.1 to 20.0s

Adjusts the Reverb Time (⇨ P. 23).

127.REVERB
PRE DELAY 200ms

● Pre Delay(PRE DELAY):0 to 200ms

Adjusts the Pre Delay (⇨ P. 23).

127.REVERB
HF DAMP 1.0

● HF Damp(HF DAMP):0.1 to 1.0

Adjusts the decay of upper range reflections (HF Damp: ⇨ P. 24).

127.REVERB
LOW EQ +12dB

● Low EQ(LOW EQ): - 12dB to +12dB

Adjusts the lower range portion of the reverb sound

127.REVERB
HIGH EQ +12dB

● High EQ(HIGH EQ): - 12dB to +12dB

Adjusts the upper range portion of the reverb sound

127. REVERB
LP FILTER 12kHz

● Low - pass Filter(LP FILTER):500Hz to 12kHz, THRU

Controls the cut - off frequency of the Low - pass Filter (⇨ P. 24). When set at THRU, the Low - pass Filter is inactive.

127. REVERB
HP FILTER 1kHz

● High - pass Filter(HP FILTER):THRU, 30Hz to 1kHz

Controls the cut - off frequency of the High - pass Filter (⇨ P. 24). When set at THRU, the High - pass Filter is inactive.

127. REVERB
LEVEL 100

● Reverb Level(LEVEL):0 to 100

Adjusts the volume of the Reverb sound.

□ OUTPUT

Here, the Output Mode for the channels is selected.

127. OUTPUT
MODE STEREO MIX

● Mode(MODE):MONO+MONO, STEREO MIX

Select the Output Mode.

MONO+MONO:The effected sound for individual channels is output in mono; separately on each channel.

STEREO MIX :The effected sound for the two channels is output in stereo, and is mixed when output.

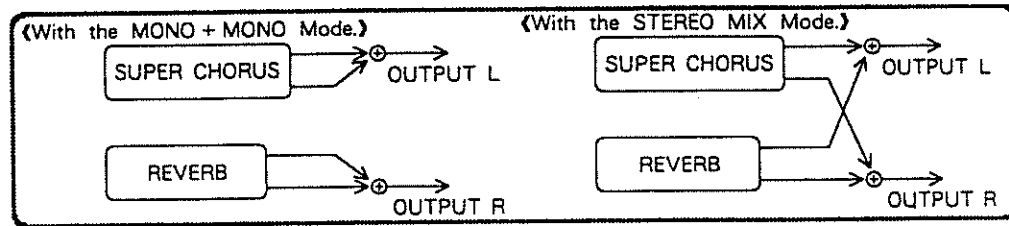

□ DIRECT L/R

Controls the direct sound for each channel.

127. DIRECT
LEVEL L 100

● Direct Level L/R(LEVEL L/R):0 to 100

Adjusts the volume of the direct sound for each channel.

□ MASTER L/R

Controls the overall volume.

127. MASTER
LEVEL L 100

● Master Level L/R(LEVEL L/R):0 to 100

Adjusts the overall volume for each channel (Actual level output by the SE - 50).

28) DELAY + REVERB (No.128)

128 Delay+Reverb
DELAY + REVERB

Allows you to apply Delay and Reverb separately for each channel.

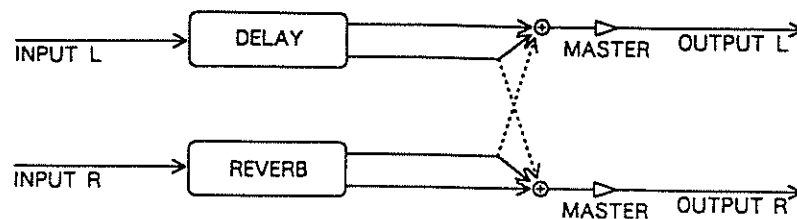

□ DELAY TAP

The Delay parameters are as follows.

128.DELAY TAP L
D.TIME 800ms

● Delay Tap L, Delay Time(D.TIME):0 to 800ms
Adjusts the amount of delay for delayed sound output on channel L.

128.DELAY TAP L
LEVEL 100

● Delay Tap L, Delay Level (LEVEL):0 to 100
Adjusts the volume of the delayed sound output on channel L.

128.DELAY TAP R
D.TIME 800ms

● Delay Tap R, Delay Time(D.TIME):0 to 800ms
Adjusts the amount of delay for delayed sound output on channel R.

128.DELAY TAP R
LEVEL 100

● Delay Tap R, Delay Level (LEVEL):0 to 100
Adjusts the volume of the delayed sound output on channel R.

128.DELAY TAP C
D.TIME 800ms

● Delay Tap C, Delay Time(D.TIME):0 to 800ms
Adjusts the amount of delay for delayed sound output at the center (L+R) position.

128.DELAY TAP C
FEEDBACK 100

● Delay Tap C, Feedback (FEEDBACK):0 to 100
Feedback refers to the process of feeding a portion of the delayed sounds back into the delay circuit. Here you set the amount that is to be fed back. This affects the number of repetitions occurring in the delay for both Delay L and R.

128.DELAY TAP C
LEVEL 100

● Delay Tap C, Delay Level (LEVEL):0 to 100
Adjusts the volume of the delayed sound output at the center position.

128.DELAY
LP FILTER 12kHz

● Low - pass Filter(LP FILTER):500Hz to 12kHz, THRU
Controls the cut - off frequency of the Low - pass Filter (⇒ P. 24). When set at THRU, the Low - pass Filter is inactive.

REVERB

Reverb Parameters.

128.REVERB
REV TIME 20.0s

● Reverb Time(REV TIME):0.1 to 20.0s
Adjusts the Reverb Time (⇒ P. 23).

128.REVERB
PRE DELAY 200ms

● Pre Delay(PRE DELAY):0 to 200ms
Adjusts the Pre Delay (⇒ P. 23).

128.REVERB
HF DAMP 1.0

● HF Damp(HF DAMP):0.1 to 1.0
Adjusts the decay of upper range reflections (HF Damp: ⇒ P. 24).

128.REVERB
LOW EQ +12dB

● Low EQ(LOW EQ): - 12dB to +12dB
Adjusts the tone of the lower range portion of the reverb sound.

128.REVERB
HIGH EQ +12dB

● High EQ(HIGH EQ): - 12dB to +12dB
Adjusts the upper range portion of the reverb sound.

128.REVERB
LP FILTER 12kHz

● Low - pass Filter(LP FILTER):500Hz to 12kHz, THRU
Controls the cut - off frequency of the Low - pass Filter (⇒ P. 24). When set at THRU, the Low - pass Filter is inactive.

128.REVERB
HP FILTER 1kHz

● High - pass Filter(HP FILTER):THRU, 30Hz to 1kHz
Controls the cut - off frequency of the High - pass Filter (⇒ P. 24). When set at THRU, the High - pass Filter is inactive.

128.REVERB
LEVEL 100

● Reverb Level(LEVEL):0 to 100
Adjusts the volume of the Reverb sound.

OUTPUT

The Output Mode for the channels can be selected.

128.OUTPUT
MODE STEREO MIX

● Mode(MODE):MONO+MONO, STEREO MIX
Selects the Output Mode.

MONO+MONO: The effected sound for individual channels is output in mono; separately on each channel.

STEREO MIX : The effected sound for the two channels is output in stereo, and is mixed when output.

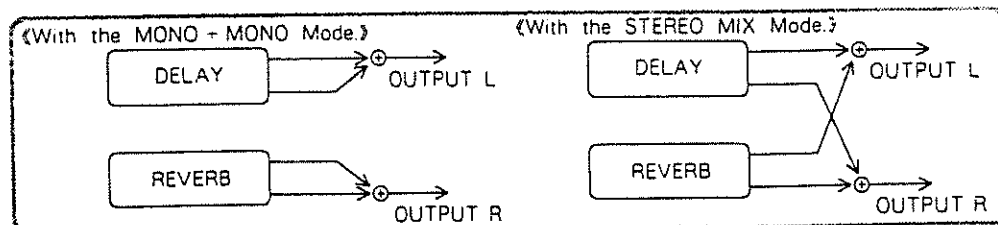

DIRECT L/R

Controls the direct sound for each channel.

128.DIRECT
LEVEL L 100

● Direct Level L/R(LEVEL L/R):0 to 100

Adjusts volume of direct sound for each channel.

MASTER L/R

Controls overall volume for each channel.

128.MASTER
LEVEL L 100

● Master Level L/R(LEVEL L/R):0 to 100

Adjusts the overall volume for each channel (Actual level output by the SE - 50).

MEMO

SECTION II

《USING MIDI》

Since the SE - 50 is equipped with MIDI connectors, it can readily be used to exchange data with external MIDI units. Using this feature, you can select Program Numbers from the panel of the external device, or store sound data from the SE - 50 in another unit.

1 ABOUT MIDI

MIDI stands for "Musical Instrument Digital Interface". It is an international standard that allows for data such as that representing the music played, or for changes in sounds used, to be exchanged among various different instruments. As long as they are MIDI compatible, all devices, regardless of differences in model or manufacturer, can exchange whatever performance data they are both equipped to understand. MIDI converts every event occurring while an instrument is played into MIDI data. When received by another instrument, this stream of MIDI data can be used to play it, much like it itself were being played.

1. The Exchange of MIDI Data

The exchange of MIDI data is carried out as explained in the following.

□ About MIDI Connectors

In carrying out the exchange of MIDI data, the 3 types of connectors shown below are used. MIDI cables are connected to these connectors in various ways depending on the method they are to be used.

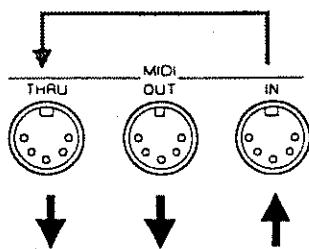

MIDI IN :Receives data from another MIDI device.

MIDI OUT :Transmits data originating in the unit.

MIDI THRU:Sends out an exact copy of the data received at MIDI IN.

* In theory, any number of MIDI devices could be connected together using MIDI THRU connectors; but it is best to consider 4 to 5 devices as being the practical limit. This is because the further down the line a device is located, the more delay there is that could occur, and the chance of error due to deterioration in signal quality increases.

* The SE - 50 is equipped only with MIDI IN and MIDI OUT connectors.

□ MIDI Channels

With MIDI, a single cable can be used for carrying differing sets of performance information, for a number of MIDI devices. This is possible thanks to the concept of a MIDI channel.

MIDI channels are in some ways similar to the channels on a television set. On a T.V., a variety of programs broadcast from different stations can be viewed by switching channels. This is because the information on any particular channel is conveyed only when the receiver is set to the same channel that is being used for transmission.

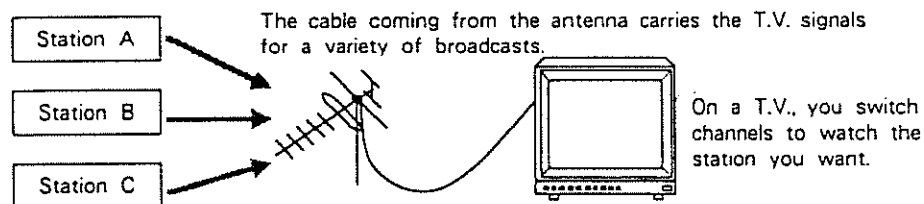

The channels available with MIDI range from 1 through 16. When a musical instrument (the receiver) is set so its channel matches the MIDI channel used by the transmitting device, the MIDI data is conveyed. When the MIDI channels are set as illustrated below, and you play the keyboard, sound will be produced by only sound module B.

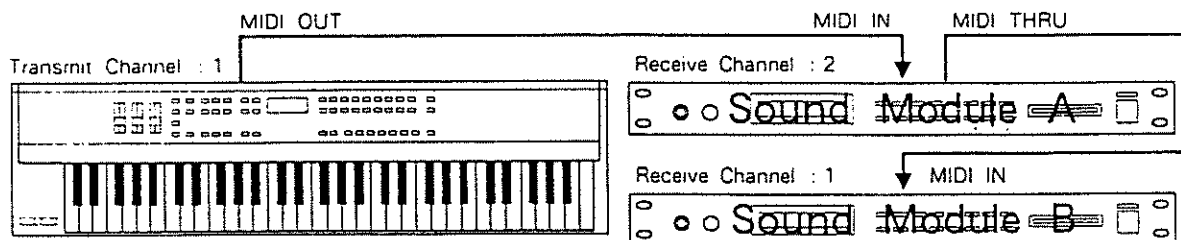

□ OMNI Mode

When set to OMNI On, MIDI data arriving on all channels can be received, regardless of any setting for a particular receive channel. The OMNI Off mode is used when wishing to receive data on a specifically chosen channel.

2. MIDI Messages Recognized by the SE - 50

In order to convey the great variety of expression possible with music, MIDI has been provided with a large range of data types (messages). MIDI messages can be divided into two main types: Messages that are handled on each channel (Channel messages); and messages that are handled independently of channels (System messages).

■ Messages Handled for Each MIDI Channel (Channel Messages)

These messages are used to convey the events of a performance. In most circumstances, they alone are sufficient for providing the necessary control. The specific results obtained by the various types of MIDI message are determined by the settings on the sound source receiving them.

Aftersustain Messages These messages convey Aftersustain, the information about the pressure applied to a key. There are two types of Aftersustain, Channel and Polyphonic.

Channel Aftersustain provides control based on each MIDI channel. No matter which key it is that is pressed most firmly, the effect is applied equally to all notes on the same MIDI channel.

Polyphonic Aftersustain provides control on an individual key (note) basis. Even though it may share the same MIDI channel with other notes, any particular key that has more pressure put on it will produce a unique effect.

The SE - 50 responds to Channel Aftersustain messages, which can be assigned to control a selected parameter.

Pitch Bender Messages

Messages which convey the action of the Bender Lever (pitch).

On the SE - 50, Pitch Bend messages can be used to control a selected parameter.

Program Change Messages

These messages are used for conveying information about changes to another sound. Sounds are changed using Program Change Numbers, numbered from 1 through 128. The Program Numbers on the SE - 50 correspond with MIDI Program Change Numbers.

Control Change Messages

These messages are used to enhance the expressiveness of a performance. Each function is identified by a Control Number. The functions which are available for control will vary depending on the instrument. On the SE - 50, Control Change messages can be assigned to control selected parameters.

Exclusive Messages

Exclusive Messages handle information such as that related to a device's own unique sounds. Generally, such messages can be exchanged only between devices of the same model and by the same manufacturer.

Exclusive Messages can be employed to save the settings for Effects Programs into a sequencer, or for transferring such data to another SE - 50.

Whenever Exclusive messages are to be used for communication, both devices need to be set to the same Unit Number. On the SE - 50 the Unit Number is equivalent to the MIDI Channel number.

● MIDI Implimentation Chart

MIDI has made it possible for a wide range of musical instruments to communicate with each other, but that doesn't mean that the many types of data will all be understood.

The only communication possible between connected MIDI devices deals with data that both of the units understand.

It is for this reason that every owner's manual, for all kinds of MIDI devices, always includes a MIDI Implementation Chart, as a quick reference to the types of MIDI messages it is capable of handling. You should compare the MIDI Implementation Charts for any two devices in order to find out which types of data can be communicated between them. Since the size of these charts is standardized, you can place them so they overlap. This way you can more easily compare the receiving device with the transmitting device.

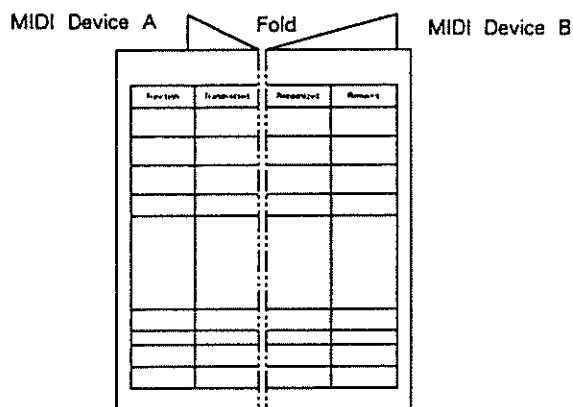

*For detailed information on how MIDI data is handled on this unit, refer to "Roland Exclusive Messages" (P. 117), and "MIDI Implementation" (P. 121).

2 MIDI SETTING

Applications made possible when the SE - 50 is connected with other MIDI - equipped units are explained in the following.

○ Changes in the Program Number

Using Program Change messages, Program Numbers on the SE - 50 can be changed using the controls on an external unit. For example, you could get the Effects Programs on the SE - 50 changed at the instant you change the timbre on a keyboard. For such setups the unit provides the convenient feature of allowing you to have MIDI Program Change Numbers and Program Numbers on the SE - 50 correspond in whatever way you need them to. Thanks to the SE - 50's Program Change Map feature, you can easily arrange the desired correspondence.

○ Controlling Parameters Using an External Unit

Aftertouch, Pitch Bend, and Control Change messages can be used to control the Effector parameters.

○ Saving Data onto an External Device

Using Exclusive messages, SE - 50 sound data can be stored in external devices, such as a sequencer.

* Whenever MIDI is used, you need to make sure that you have the MIDI channels set properly, or you won't obtain reliable communication between the units. The MIDI channel on the SE - 50 should be matched with the channel used by the external unit.

1. Setting the MIDI Channel and OMNI Mode

Follow the steps below to set the channel used for MIDI reception/transmission. When shipped, the unit was set with the MIDI Channel at "1" and OMNI Mode at "On". If left at these settings, it will receive data arriving on any channel, but will transmit on channel 1.

- ① Press **UTILITY** enough times to select the MIDI setting mode.
The indicator on the button will light.

"MIDI" should be displayed here.

```
MIDI CHANNEL
CHANNEL : 1
```

- ② Press **PARAMETER** **▲** **▼** until you have the CHANNEL or OMNI MODE setting pages.

```
MIDI CHANNEL
CHANNEL : 1
```

VALUE : 1 to 16

or

```
MIDI OMNI MODE
OMNI ON
```

VALUE : OMNI ON/OMNI OFF

- ③ Using **VALUE** **▲** **▼** set the MIDI Channel or OMNI Mode.
- ④ When completed, either press **EXIT**, or press **UTILITY** until the button's indicator has gone out, and you have returned to where you were originally.

2. Changing Program Numbers

Through the use of Program Change messages, generated by another external MIDI unit, you can obtain changes in the SE - 50 Program Numbers.

* Please refer to the manual that came with your other unit for details on how it handles Program Change Numbers.

Using Another Unit to Remotely Change SE-50 Program Numbers

Connections should be made as follows:

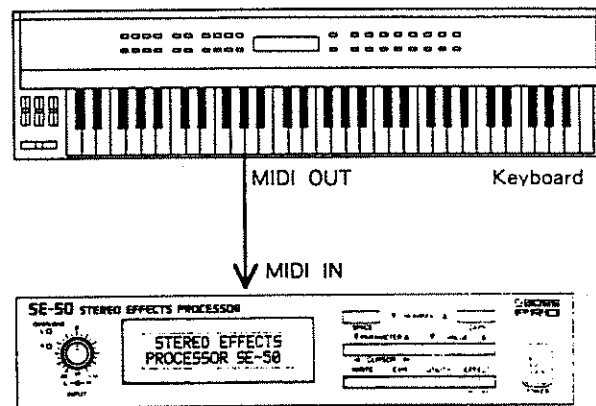

As shipped from the factory, this unit is set to respond to MIDI Program Changes by switching to the Program which has exactly the same number as the message which was sent.

So, if for example you change to a different sound on your keyboard, and as a result it sends Program Change Number 45 over MIDI, the SE - 50 will switch to its No. 45. Program Number.

Correspondence Between Sounds and Effects Programs

The SE - 50 allows you to alter its "Program Change Map", which is information that sets up the correspondence that is used between Program Change Numbers and their counterpart, Program Numbers, on the SE - 50.

The following steps allow you to alter the Program Change Map.

- ① Press **UTILITY** enough times to select the MIDI setting mode.
The indicator on the button will light.

"MIDI" should be displayed here.

```

MIDI *****
*****
    
```

- ② Press **PARAMETER** **▲** **▼** until you have the MIDI PROGRAM MAP setting page.

```

MIDI PROGRAM MAP
Pro  → No.
    
```

No. of received Program Change Number SE-50 Program Number

- ③ Using **NUMBER** **▲** **▼** set the value of a received Program Change Number, and using **VALUE** **▲** **▼** set the SE - 50 Program Number that will correspond to it.
- ④ When complete, press **EXIT** to return to the performance screen.

3. MIDI CONTROL

Parameters for Effects Programs on the SE - 50 can be set so they will respond to certain messages such as Aftertouch and Pitch Bend that arrive from an external device, and be controlled in real - time during performance.

For example, you could have the amount of pressure applied to keyboard keys (Aftertouch) directly alter the volume produced by the SE - 50; or the same pressure information could also be used to alter the timbre provided by the Effects Program. Your choices as to how such controls will be performed can be stored individually along with each Program Number.

Types of MIDI Data That Provide Control

You can select one type of MIDI message that you wish to be used as a control. The ones available are: Aftertouch, Pitch Bend, and Control Change (Control Numbers 0 to 31 and 64 to 95) messages. After selecting the type of message, you then need to specify what it will do on the SE - 50 when received, that is, which parameter it will alter. The available parameters will differ depending on the algorithm.

Fine Tuning the Control

In order to obtain exactly the changes you require, you can also choose the range within which parameter values can change in response to the MIDI message. This setting is made by specifying a minimum and maximum value. For example, if you want a certain MIDI message to control MASTER LEVEL, but only within an overall range of 50 to 100, you would set the MIN value at 50 and the MAX value at 100. For certain parameters, however, the control you need would involve simply turning them on or off. In these cases, if the value of the message received is greater than the median value, it is turned on. If less, it is turned off.

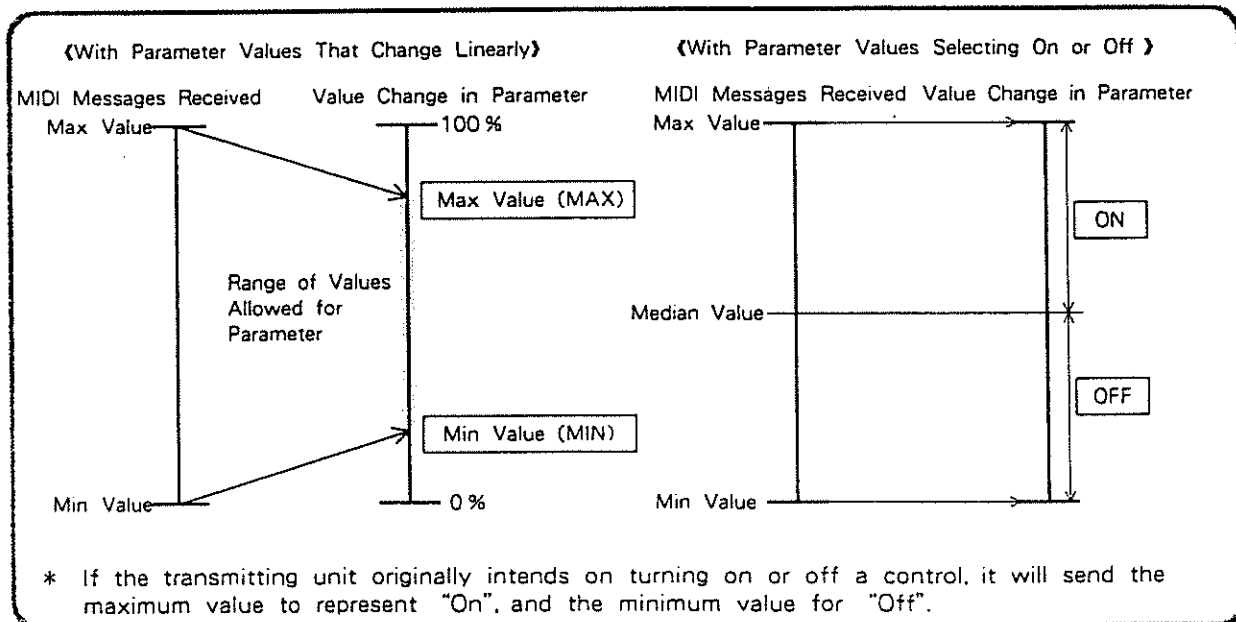

* The same as with parameter settings for Effects Programs, settings made for MIDI Control are volatile, that is, they will be lost once power is turned off, or when a change to a different Program Number is made.

To keep your settings, perform the Write procedure (see P. 20) once you have finished making them.

At the factory defaults, MIDI Control is disabled for every Program Number. To take advantage of MIDI Controls, perform the procedure below.

① Using NUMBER , select the Program Number for which you wish to make a MIDI Control setting.

② Using PARAMETER , select the parameter shown below. Then using VALUE select the type of MIDI messages you are going to receive.

MIDI CONTROL RECEIVE OFF	VALUE :OFF (Reception Disable) AF TOUCH (Aftertouch) P.BEND (Pitch Bender) 0 to 31 / 64 to 95 (Control Change Number)
-----------------------------	---

③ Using PARAMETER , select the parameter shown below. Then using VALUE select the parameter you are going to manipulate.

MIDI CTL ASN MASTER LEVEL	VALUE :The available Parameter differ depending on the individual algorithm.
------------------------------	--

* Once a parameter has been selected here, it will not act in altering the sound if you make changes in it using the normal panel operations for setting changes.

④ Using PARAMETER , select the parameter shown below. Then using VALUE set the range within which value changes will be valid (minimum and maximum values).

(Min. Value)	MIDI CTL MIN	VALUE :Each parameter has its own possible minimum.
(Max. Value)	MIDI CTL MAX	VALUE :Each parameter has its own possible maximum.

If you wish, you can also set a MIN value that is higher than the MAX value; in this case you obtain changes in a reversed direction.

⑤ When complete, carry out the Write procedure (→ P. 20) to store the settings in memory.

To write to the same Program Number, press 2 times.

To write to a different Program Number, first press once, then use NUMBER to select the destination Program Number. Then press again.

* If you change the parameter that is to be controlled after the setting for MIN and MAX values have been set, you may find that these MIN and MAX values will have been replaced by other values. To avoid this, always reset MIN and MAX values each time you select a new control parameter.

4. Using a Foot Controller (FC - 100MK II)

Pedal control over the operations explained below is made possible once you connect an FC - 100MK II foot controller (optional), or the like.

- The foot controller can be used to specify Program Change Numbers, which select Program Numbers on the SE - 50.
- The control pedal on the foot controller (or an expression pedal connected to it) can be used to control specified parameters (MIDI Control).

☐ Connection and Setup of a Foot Controller

Connections should be made as shown below.

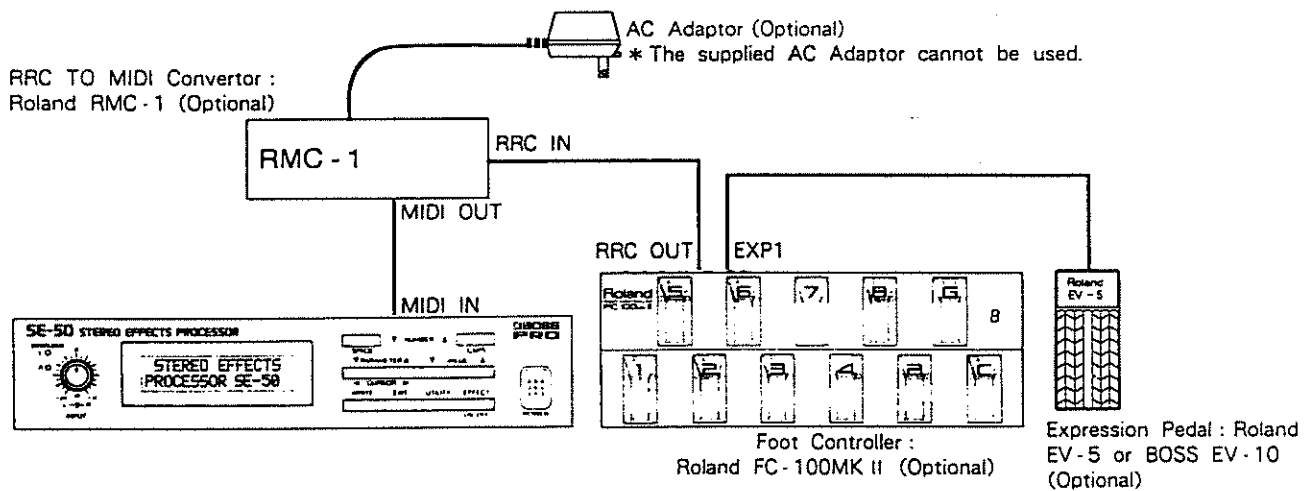

- ☐ Set the FC - 100MK II to the MIDI Foot Pedal mode, and set MIDI Mix at "Off".
* Refer to the manual that came with your FC - 100MK II for instructions on how to do this.
- ☐ Set the FC - 100MK II and SE - 50 so their MIDI Channels are matched.
* Refer to P. 95 , and the FC - 100MK II Owner's Manual for instructions on how to do this.

5. Receiving and Sending Data Over MIDI

Using MIDI Exclusive messages, you can send data containing the settings for the Effects Programs to a sequencer for storage; or remotely make changes in an Effects Program at a specified Program Number, using an external MIDI device.

On the SE - 50, the transmission of Exclusive messages is carried out on a MIDI channel.

The types of Bulk Data (data which is transmitted using Exclusive messages) which can be transmitted are as appears below. Before the transmission you can specify, in terms of start and stop points, a range to be sent.

Displayed	Content of Transmission
SYSTEM	<input type="radio"/> Program Change Map <input type="radio"/> Range of Program Numbers selectable with a foot switch.
No.1	<input type="radio"/> Setting for Program Number 1
No.2	<input type="radio"/> Setting for Program Number 2
⋮	⋮
No.99	<input type="radio"/> Setting for Program Number 99
No.100	<input type="radio"/> Setting for Program Number 100

1) Making the Connections

Saving SE - 50 Data to a Sequencer

Connect the units as shown below. After setting your sequencer so it is ready to receive Bulk Data, start the transmission on the SE - 50.

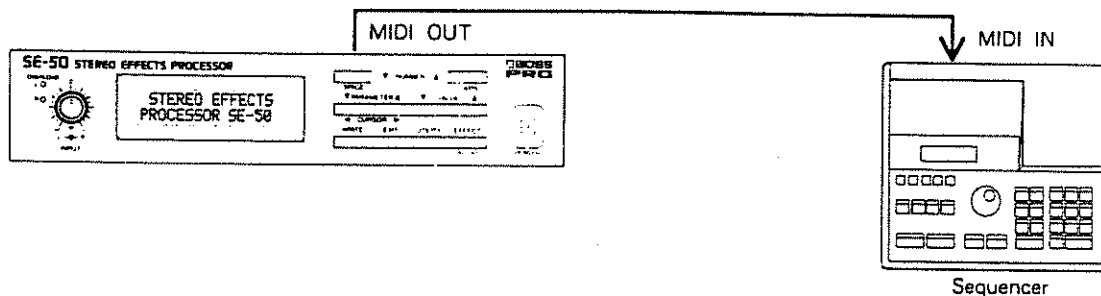

* Refer to your sequencer manual for instructions on how to do this.

Sending Data That Was Saved in a Sequencer Back to the SE - 50

Connect the units as shown below. The SE - 50 needs to be set to the same MIDI Channel that was used when the data was originally saved to the sequencer. Next, after setting the SE - 50 so it is ready to receive Bulk Data, start the transmission from the sequencer.

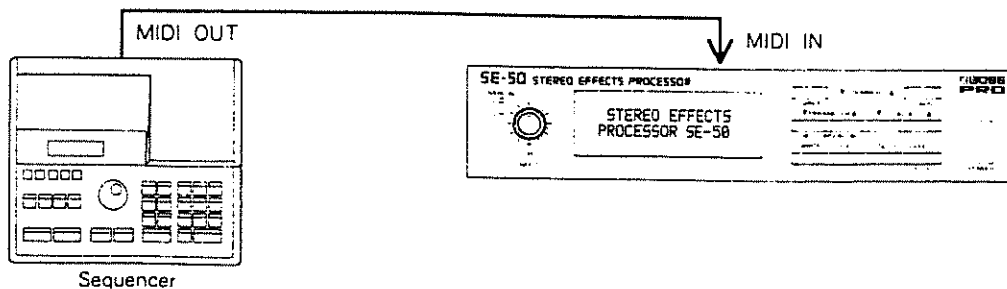

□ Sending a Copy of Data to Another SE-50

Connect the units as shown below.

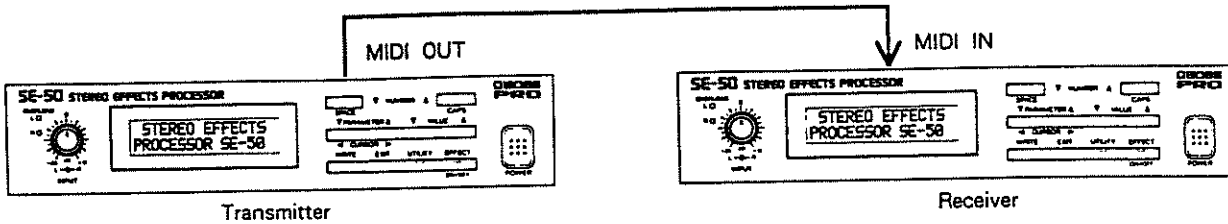

Have the MIDI Channel on both units set so they match. Next, set the receiver so it is ready to receive Bulk Data. (To the Bulk Load mode.)

* Once the receiving SE-50 is ready to receive exclusive messages, get the transmitter to start sending. To set the unit to the reception mode, refer to "3 Data Reception", P. 103.

2) Data Transmission (Bulk Dump)

- ① Press **UTILITY** until you have the mode used to make MIDI settings.

The button's indicator will light.

"MIDI" should appear here.

```
MIDI *****
*****
```

- ② Press **PARAMETER** **▲** **▼** until you have the page for setting Bulk Dump.

```
MIDI BULK DUMP      VALUE: SYSTEM, No.1 to 100
SYSTEM + No.100
```

- ③ Select the range of data that is to be sent. Use **NUMBER** **▲** **▼** to set the starting point, and **VALUE** **▲** **▼** to set the end point.

```
MIDI BULK DUMP
SYSTEM + No. 10
```

Start point for range of data to be sent. End point for range of data to be sent.

- ④ Press **WRITE**, and the data transmission will begin.

While the data is being sent, the display will appear as below:

```
DATA SAVING...
```

After the transfer has been completed, you are returned to the page you were in at step ③.

- ⑤ Press **EXIT** to return to the performance screen.

3) Data Reception (Bulk Load)

- ① Press **UTILITY** until you have the mode used to make MIDI settings.
The button's indicator will light.

"MIDI" should appear here.

```
MIDI *****
*****
```

- ② Press **PARAMETER** **▲** **▼** until you have the page for Bulk Load.

```
MIDI BULK LOAD
WAITING
```

《Ready to receive condition.》

- ③ Have the transmitter start sending.

```
MIDI BULK LOAD
DATA RECEIVING
```

《Condition where data is actually being received.》

Once the reception has been completed, the display will then change and show the page below.

```
MIDI BULK LOAD
IDLING...
```

《Reception has finished.》

When at this condition, you can continue and receive other blocks of Bulk Data if you wish.

- ④ Once the process has been completed, press **EXIT** to return to the performance screen.

* Whenever you wish to receive Bulk Data using Exclusive messages, you must always have the MIDI Channel set to the same channel as the other unit. If the channels don't match, the reception cannot be carried out even though you are set to OMNI On.

3 Getting the Most From Your SE-50

By combining the SE-50 with a range of other equipment, you will be able to enjoy a number of other features that can enhance your musical capabilities. Several examples are provided as suggestions in the following.

1) Setup Using a Keyboard Controller and Sound Module

When connections are made as shown in the illustration below, you can change to a different patch on the keyboard, and simultaneously, the patch on the sound module, and the Program Number on the SE-50 will automatically be changed as well. Moreover, you can control the parameter on the SE-50 by using the MIDI Control of a Keyboard Controller.

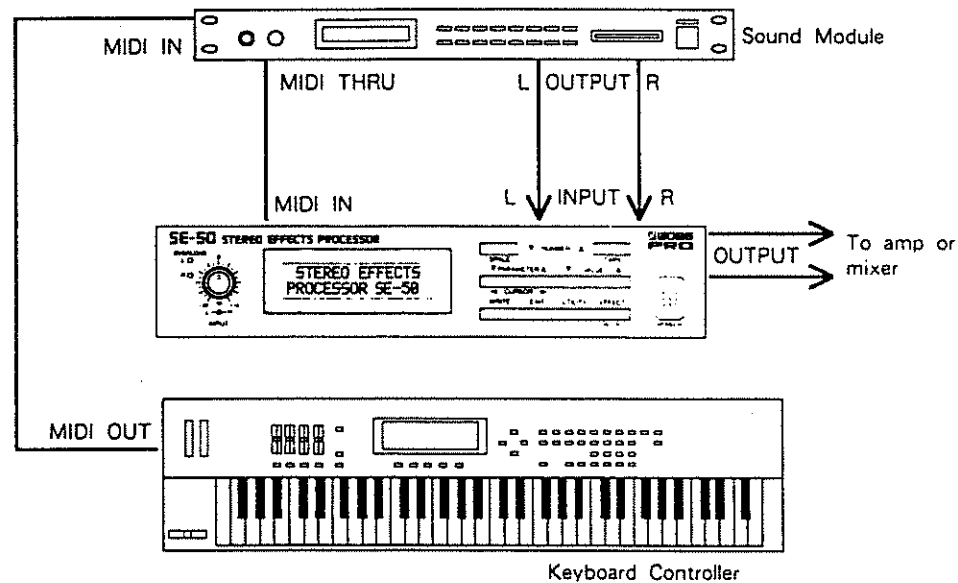

- Set the keyboard controller, sound module, and SE-50 so they are all using the same MIDI channel (⇒ P. 95).
- The received MIDI message for the SE-50 parameter (⇒ P. 99) needs to be matched with the number used by the particular control you are going to use on the keyboard.

2) Setup Using a Guitar

When connections are made as shown in the illustration below, you can change Program Numbers using the Foot Controller, and use the Expression Pedal or Control Pedal to alter parameters in the SE - 50.

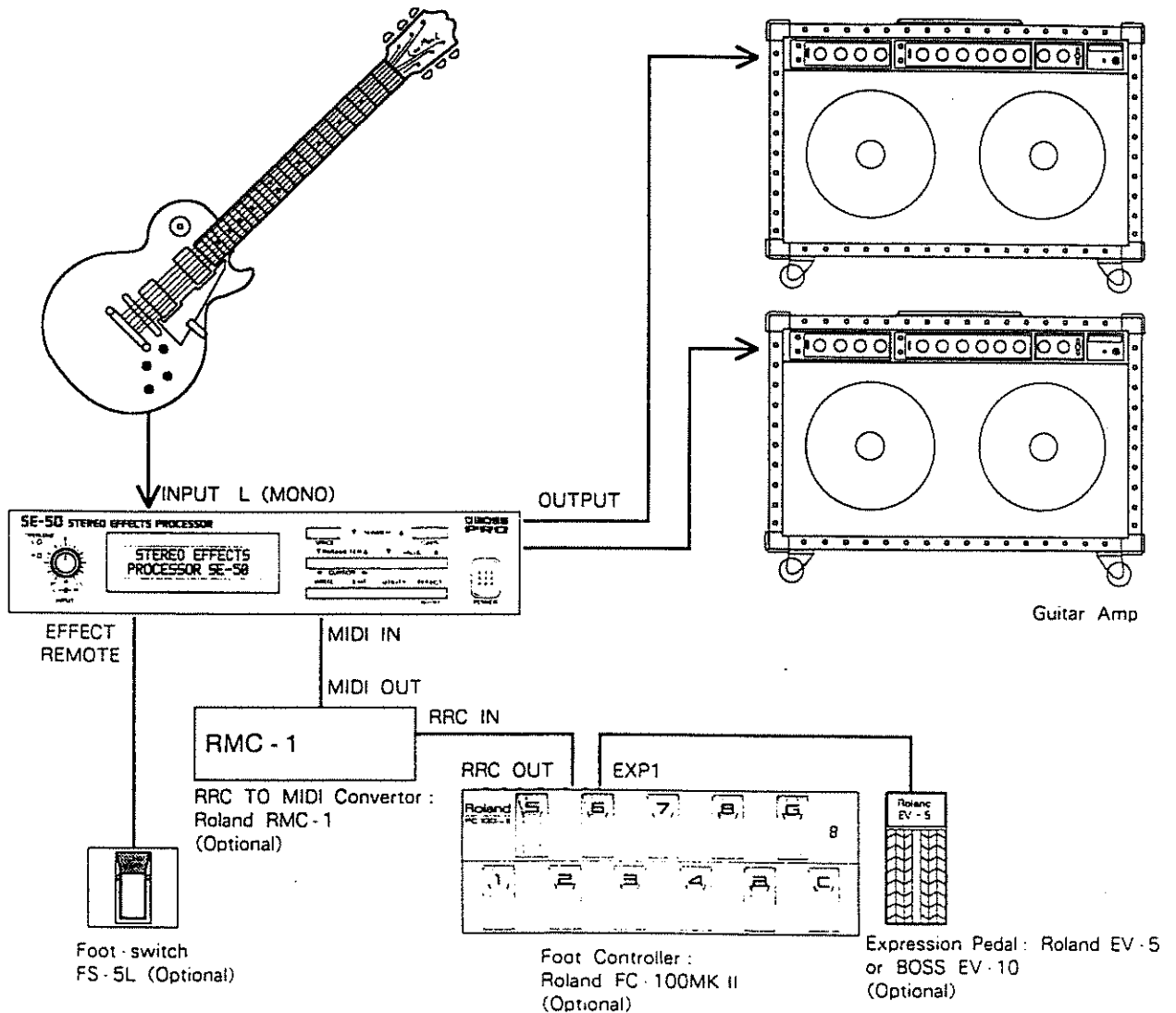

For example, if you assign FINE for Pitch Shifter to the expression pedal, you will be able to alter the pitch of the guitar with the pedal.

Set the FC - 100MK II to the MIDI Foot Pedal mode, and set MIDI Mix at "Off".

* When in the Foot Pedal mode, the factory default Control Number assignments for the FC - 100MK II are as follows:

- Control Pedal (MODE I : Latch) : 65
- Control Pedal (MODE II : Unlatch) : 64
- EXP1: 07
- EXP2: 01

Using the above information for reference, make the settings for MIDI Control on the SE - 50 (see P. 98).

3) Combining a Sequencer

When connections are made as shown in the illustration below, the Program Numbers will be changed automatically in keeping with what is played by the sequencer.

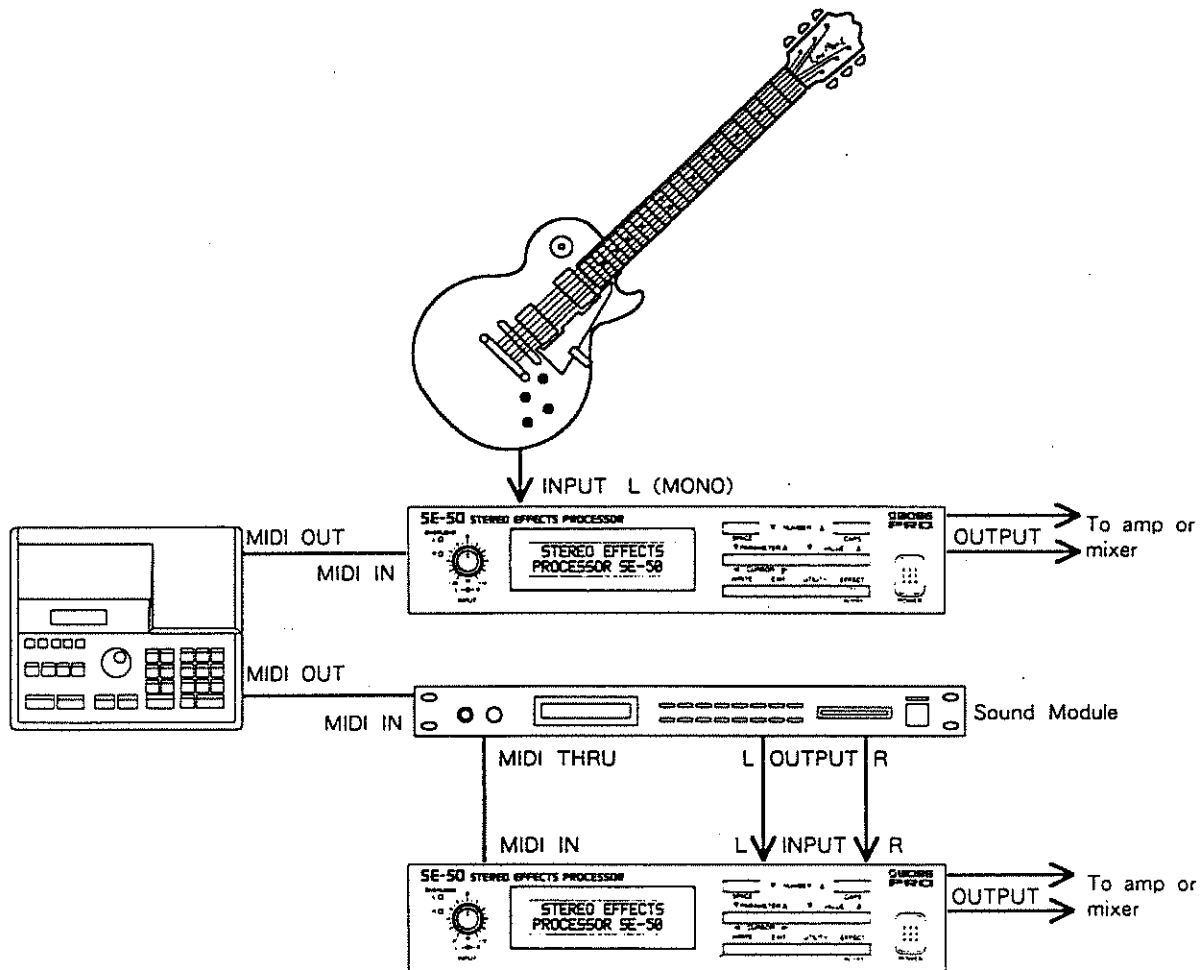

* Please refer to your equipment manuals for further information, if needed.

These are only a few examples that you could try. You will probably be able to think of other setups that are more suited to your particular needs.

SECTION III

《REFERENCE》

Factory Preset Setting

1. About Factory Preset Settings

1) System Data

MIDI Transmit/Receive Channel: Channel 1
OMNI Mode: On
Program Change Map: Direct numerical correspondence
Range of Program Numbers Selectable with Foot - switch: 1 to 128
Effect Off Mode: DIRECT

* When shipped, the unit is not set to allow external units to employ MIDI Control.

2) Preset Data

For details of the settings for each Program Number when set to Factory Presets, refer to "The List of Preset Name" (⇐ P.114).

2. Restoring the Factory Presets (Initializing the Data)

This procedure allows you to restore the contents of User Numbers and System Data to the settings made when the unit left the factory. You can specify a specific range for this, and initialize only the Program Numbers (or System Data) that you need.

To restore the SE - 50 to the Factory Presets, follow the steps below. You can either initialize all settings, or only certain ones that you select.

- ① Turn power OFF.
- ② While holding down both the PARAMETER  and VALUE  buttons, turn power ON.





Once on, the following page appears in the display:

```
Factory Preset  
V:Write N:Exit
```

- ③ Press **WRITE**.

```
Factory Preset  
SYSTEM → No.100
```

* Should you wish to cancel the initialization, press **EXIT**. Thereafter, the unit will enter the normal startup mode.

- ④ Specify the desired range that is to be initialized. Set the starting point using NUMBER  , and the end point using VALUE  .

```
Factory Preset  
SYSTEM → No. 10
```

(Ex This will cause initialization of the System Data and Program Nos. 1 to 10.)

The types of data which can be initialized are as follows:

Displayed	Settings Which Can Be Initialized.
SYSTEM	<input type="radio"/> MIDI Transmit/Receive Channel <input type="radio"/> OMNI Mode <input type="radio"/> Program Change Map <input type="radio"/> Range of Program Numbers Selectable With Foot-switch <input type="radio"/> Effect Off Mode
No.1	<input type="radio"/> Settings for Program Number 1
No.2	<input type="radio"/> Settings for Program Number 2
⋮	⋮
No.99	<input type="radio"/> Settings for Program Number 99
No.100	<input type="radio"/> Settings for Program Number 100

⑤ Press **WRITE**, and the initialization takes place.

Once the initialization has been completed, you are returned to the normal startup mode.

TROUBLESHOOTING

If for some reason you do not hear the sound you expect to, or suspect that something is wrong with the way the unit is operating, first check through the list that follows. If the problem still persists, consult with the retailer where the unit was purchased, or contact the nearest Roland Service Station.

No Sound Produced/Level Is Too Low.

- Have you checked for damaged cables?
Replace any damaged cables.

- Are connections with external devices properly made?
Check to make sure all connections are in order.

- Is the volume set too low?
Check the volume on the amplifier and/or mixer you are using.

- Are the Input Level knobs on the SE - 50 at an appropriate setting?
Check, then reposition them if necessary.
→ "3. Adjusting the Input Level" (⇨ P. 12)

- Are you certain the settings at the Program Number are suitable?
Check to make sure the parameter settings, such as those for "LEVEL", are not set too low.

- Do you have "MASTER LEVEL" set to be used as a MIDI Control?
If so, have your external MIDI device send the appropriate Control Change messages.

- Do you have "MUTE" set for the Effect Off Mode?
If set at "MUTE" there will be no sound produced whenever the effect is off.
→ "☐ Settings for the Effect Off Mode" (⇨ P. 15)

Overload Indicator Lights Too Frequently During Input.

- Have the "INPUT Level Knobs" been adjusted properly?
Adjust the INPUT Level Knobs so you have a more appropriate setting.
→ "3. Adjusting the Input Level" (⇨ P. 12)

- Do you have the "LEVEL Switch" on the rear panel set to the suitable position?
Set the Level Switch to the "+4 dBm" position.

- Is the level being output by another unit you have connected too high?
Adjust the output level on the external unit to a lower level.

The Program Number Won't Change When a NUMBER Button Is Pressed.

- Are you in a mode where settings for parameters are made?
If so, press **EXIT**.

- Is the indicator on the **UTILITY** button lit?
If so, press **EXIT**.

Sound Doesn't Change Even Though Setting Is Changed Using the VALUE Buttons.

- Do you have the parameter in question assigned to be used as a MIDI Control?

The VALUE buttons cannot be used to change the value for a parameter which has been set as a MIDI Control; in this case the unit only responds to MIDI messages.

→ "3. MIDI Control" (⇨ P. 98)

The EFFECT Button Won't Turn Effects On/Off.

- Do you have a foot - switch connected to the EFFECT REMOTE jack on the rear panel?

While a foot - switch connected to the EFFECT REMOTE jack is "Off", the EFFECT Button cannot be used to turn effects On or Off.

→ " Setting the Effects Off Mode" (⇨ P. 15)

Writing to Memory Unsuccessful When WRITE Button Is Pressed.

- Is the indicator on the UTILITY button lit?

If so, press .

Program Numbers Won't Change When Pedal Connected To "NUMBER SHIFT" Jack Is Depressed.

- Are you in a mode where settings for parameters are made?

If so, press .

- Is it possible that you have the Min. and Max. values for the allowed range of change set to the same Program Number?

Check the setting that you have for the range of change for Number Shift.

→ " Setting the Range of Pedal Changes in Program Number" (⇨ P. 14)

MIDI Data Is Not Received.

- Are you sure your cables are not damaged?

Replace cables if necessary.

- Are you connected properly with the external MIDI device?

Check your connections again.

- Do you have the MIDI Channel matched with that of the connected unit?

Check the MIDI Channel.

→ "1. Setting the MIDI Channel and OMNI Mode" (⇨ P. 95)

Program Change Messages Aren't Received.

- Are you in a mode where settings for parameters are made?

If so, press .

- Is the indicator on the UTILITY button lit?

If so, press .

Using MIDI Control Doesn't Provide the Desired Control.

- Is MIDI Control Receive set at "OFF"?

Check the setting for MIDI Control Receive.

→ "3. MIDI Control" (☞ P. 98)

- Is the effector which is to be controlled using MIDI set to "OFF"?

Check the On/Off status of the effector which you wish to control using MIDI.

→ "3. Altering an Effects Program" (☞ P. 19)

- Do you have the connected unit and MIDI Control Receive (Aftertouch and Pitch Bend messages, and Control Number) set so they correspond?

Check the data transmitted and the data to be received.

- Do you possibly have the Min. and Max. values for MIDI Control set too closely together?

Recheck the values you have for Min. and Max. for MIDI Control.

→ "3. MIDI Control" (☞ P. 98)

The List of Algorithm

Depending on the particular algorithm, the Sampling Frequency used by the SE - 50 differs.

Algorithm Number	Algorithm Name	Effect Name	Sampling Frequency (kHz)
1	HALL 1	REVERB	32
2	HALL 2	REVERB	32
3	ROOM	REVERB	32
4	PLATE	REVERB	32
5	AMBIENCE	AMBIENCE	32
6	GATE REVERB	GATE REVERB	32
7	STEREO REVERB	REVERB	32
8	MULTI DELAY	DELAY × 5	32
9	MULTI TAP DELAY	TAP DELAY × 5	32
10	STEREO DELAY	STEREO DELAY	48
11	SPACE CHORUS*	SPACE CHORUS	48
12	PITCH SHIFTER*	PITCH SHIFTER × 4	32
13	ST. PITCH SHIFTER*	STEREO PITCH SHIFTER	48
14	STEREO FLANGER*	FLANGER + GATE	48
15	STEREO PHASER*	PHASER	48
16	VOCODER	VOCODER + CHO + NS	32
17	ROTARY*	ROTARY + NS	32
18	KEYBOARD 1*	EQ + DLY + CHO + REV	48
19	KEYBOARD 2*	PH + EQ + CHO + REV	32
20	RHODES*	EQ + PH + NS + DLY + CHO + PAN + REV	32
21	GUITAR MULTI*	COMP + OD/DS + EQ + NS + DLY + CHO + REV + LD	32
22	VOCAL MULTI*	LM + EH + NS + DLY + CHO + REV	32
23	STEREO ENHANCER	LM + EH + NS	48
24	2CH MIXER	EQ + NS + REV/DLY/CHO	32
25	REVERB 1 + REVERB 2	REVERB + REVERB	32
26	GATE REVERB + REVERB	GATE REVERB + REVERB	32
27	CHORUS + REVERB	CHORUS + REVERB	32
28	DELAY + REVERB	DELAY + REVERB	32

EQ: EQUALIZER

REV: REVERB

PAN: PANNING

LD: LINE DRIVER

DLY: DELAY

PH: PHASER

COMP: COMPRESSOR

LM: LIMITER

CHO: CHORUS

NS: NOISE SUPPRESSOR

OD/DS: OVERDRIVE/DISTORTION

EH: ENHANCER

The asterisk (*) indicates those algorithm whose parameter value can be controlled by MIDI message (MIDI Control).

* As a result of a change in the Sampling Frequency, the Frequency Response changes as follows:

At the 48kHz sampling frequency: 20Hz to 20kHz (·) dB

At the 32kHz sampling frequency: 20Hz to 15kHz (·) dB

The Tabel of Preset Name

NUMBER	NAME	Algo.	NUMBER	NAME	Algo.	NUMBER	NAME	Algo.
No.1	Hall 1	1	No.44	Bright Gate	6	No.87	Metal	21
No.2	Hall 2	2	No.45	Reverse Gate	6	No.88	Clean	21
No.3	Room	3	No.46	Panning Gate	6	No.89	Lead 1	21
No.4	Plate	4	No.47	St. REV. 1	7	No.90	Modulate GT.	21
No.5	Ambience	5	No.48	St. REV. 2	7	No.91	Fuzz	21
No.6	Gate Reverb	6	No.49	St. REV. 3	7	No.92	Jazz	21
No.7	St. Reverb	7	No.50	St. REV. 4	7	No.93	Pitch Guitar	21
No.8	Multi Delay	8	No.51	Pan Delay	8	No.94	Metal Flange	21
No.9	Tap Delay	9	No.52	CRES. Delay	8	No.95	Lead 2	21
No.10	Stereo Delay	10	No.53	Pingpong DL.	8	No.96	Ballade VC.	22
No.11	Space Chorus	11	No.54	Overdub Echo	9	No.97	Short Vocal	22
No.12	Pitch Shifter	12	No.55	Analog Delay	9	No.98	Slap Bass	22
No.13	St. P. Shifter	13	No.56	Short Delay	9	No.99	Mellow Bass	22
No.14	St. Flanger	14	No.57	Cross Delay	10	No.100	AC.Guitar	22
No.15	St. Phaser	15	No.58	Long Delay	10	No.101	Hall 1	1
No.16	Vocoder	16	No.59	Space CHO 1	11	No.102	Hall 2	2
No.17	Rotary	17	No.60	Space CHO 2	11	No.103	Room	3
No.18	Keyboard 1	18	No.61	Space CHO 3	11	No.104	Plate	4
No.19	Keyboard 2	19	No.62	Space CHO 4	11	No.105	Ambience	5
No.20	Rhodes	20	No.63	Detune	12	No.106	Gate Reverb	6
No.21	Guitar Multi	21	No.64	Octave Down	12	No.107	St. Reverb	7
No.22	Vocal Multi	22	No.65	Octave Up	12	No.108	Multi Delay	8
No.23	St. Enhancer	23	No.66	Diminish	12	No.109	Tap Delay	9
No.24	2ch Mixer	24	No.67	Octave Echo	12	No.110	Stereo Delay	10
No.25	Rev1 + Rev2	25	No.68	St. P. Shift 1	13	No.111	Space Chorus	11
No.26	Gate Rev + Rev	26	No.69	St. P. Shift 2	13	No.112	Pitch Shifter	12
No.27	Chorus + Rev	27	No.70	St. Flanger 1	14	No.113	St. P. Shifter	13
No.28	Delay + Reverb	28	No.71	St. Flanger 2	14	No.114	St. Flanger	14
No.29	Mid Hall	1	No.72	Gate Flanger	14	No.115	St. Phaser	15
No.30	Large Hall	1	No.73	St. Phaser 1	15	No.116	Vocoder	16
No.31	Dark Hall	1	No.74	St. Phaser 2	15	No.117	Rotary	17
No.32	Bright Hall	2	No.75	St. Phaser 3	15	No.118	Keyboard 1	18
No.33	Cathedral	2	No.76	Rotary Fast	17	No.119	Keyboard 2	19
No.34	Live House	3	No.77	Rotary Slow	17	No.120	Rhodes	20
No.35	Dead Room	3	No.78	Rotary Drive	17	No.121	Guitar Multi	21
No.36	Brass Reverb	3	No.79	Synth. Solo	18	No.122	Vocal Multi	22
No.37	Vocal Reverb	4	No.80	Super Phaser	19	No.123	St. Enhancer	23
No.38	Drum Reverb	4	No.81	Step Phaser	19	No.124	2ch Mixer	24
No.39	Ambience 1	5	No.82	Rhodes 1	20	No.125	Rev1 + Rev2	25
No.40	Ambience 2	5	No.83	Rhodes 2	20	No.126	Gate Rev + Rev	26
No.41	Ambience 3	5	No.84	Vib	20	No.127	Chorus + Rev	27
No.42	Normal Gate	6	No.85	Tube Stack	21	No.128	Delay + Reverb	28
No.43	Dark Gate	6	No.86	Rhythm	21			

BLANK CHART

NAMING SHEET

NUMBER	NAME	Algo.	NUMBER	NAME	Algo.	NUMBER	NAME	Algo.
No.1			No.44			No.87		
No.2			No.45			No.88		
No.3			No.46			No.89		
No.4			No.47			No.90		
No.5			No.48			No.91		
No.6			No.49			No.92		
No.7			No.50			No.93		
No.8			No.51			No.94		
No.9			No.52			No.95		
No.10			No.53			No.96		
No.11			No.54			No.97		
No.12			No.55			No.98		
No.13			No.56			No.99		
No.14			No.57			No.100		
No.15			No.58			No.101	Hall 1	1
No.16			No.59			No.102	Hall 2	2
No.17			No.60			No.103	Room	3
No.18			No.61			No.104	Plate	4
No.19			No.62			No.105	Ambience	5
No.20			No.63			No.106	Gate Reverb	6
No.21			No.64			No.107	St. Reverb	7
No.22			No.65			No.108	Multi Delay	8
No.23			No.66			No.109	Tap Delay	9
No.24			No.67			No.110	Stereo Delay	10
No.25			No.68			No.111	Space Chorus	11
No.26			No.69			No.112	Pitch Shifter	12
No.27			No.70			No.113	St. P. Shifter	13
No.28			No.71			No.114	St. Flanger	14
No.29			No.72			No.115	St. Phaser	15
No.30			No.73			No.116	Vocoder	16
No.31			No.74			No.117	Rotary	17
No.32			No.75			No.118	Keyboard 1	18
No.33			No.76			No.119	Keyboard 2	19
No.34			No.77			No.120	Rhodes	20
No.35			No.78			No.121	Guitar Multi	21
No.36			No.79			No.122	Vocal Multi	22
No.37			No.80			No.123	St. Enhancer	23
No.38			No.81			No.124	2ch Mixer	24
No.39			No.82			No.125	Rev1 + Rev2	25
No.40			No.83			No.126	Gate Rev + Rev	26
No.41			No.84			No.127	Chorus + Rev	27
No.42			No.85			No.128	Delay + Reverb	28
No.43			No.86					

MIDI PROGRAM CHANGE MAP

Receive Number	NUMBER	Receive Number	NUMBER	Receive Number	NUMBER
Pro 1	No.	Pro 44	No.	Pro 87	No.
Pro 2	No.	Pro 45	No.	Pro 88	No.
Pro 3	No.	Pro 46	No.	Pro 89	No.
Pro 4	No.	Pro 47	No.	Pro 90	No.
Pro 5	No.	Pro 48	No.	Pro 91	No.
Pro 6	No.	Pro 49	No.	Pro 92	No.
Pro 7	No.	Pro 50	No.	Pro 93	No.
Pro 8	No.	Pro 51	No.	Pro 94	No.
Pro 9	No.	Pro 52	No.	Pro 95	No.
Pro 10	No.	Pro 53	No.	Pro 96	No.
Pro 11	No.	Pro 54	No.	Pro 97	No.
Pro 12	No.	Pro 55	No.	Pro 98	No.
Pro 13	No.	Pro 56	No.	Pro 99	No.
Pro 14	No.	Pro 57	No.	Pro 100	No.
Pro 15	No.	Pro 58	No.	Pro 101	No.
Pro 16	No.	Pro 59	No.	Pro 102	No.
Pro 17	No.	Pro 60	No.	Pro 103	No.
Pro 18	No.	Pro 61	No.	Pro 104	No.
Pro 19	No.	Pro 62	No.	Pro 105	No.
Pro 20	No.	Pro 63	No.	Pro 106	No.
Pro 21	No.	Pro 64	No.	Pro 107	No.
Pro 22	No.	Pro 65	No.	Pro 108	No.
Pro 23	No.	Pro 66	No.	Pro 109	No.
Pro 24	No.	Pro 67	No.	Pro 110	No.
Pro 25	No.	Pro 68	No.	Pro 111	No.
Pro 26	No.	Pro 69	No.	Pro 112	No.
Pro 27	No.	Pro 70	No.	Pro 113	No.
Pro 28	No.	Pro 71	No.	Pro 114	No.
Pro 29	No.	Pro 72	No.	Pro 115	No.
Pro 30	No.	Pro 73	No.	Pro 116	No.
Pro 31	No.	Pro 74	No.	Pro 117	No.
Pro 32	No.	Pro 75	No.	Pro 118	No.
Pro 33	No.	Pro 76	No.	Pro 119	No.
Pro 34	No.	Pro 77	No.	Pro 120	No.
Pro 35	No.	Pro 78	No.	Pro 121	No.
Pro 36	No.	Pro 79	No.	Pro 122	No.
Pro 37	No.	Pro 80	No.	Pro 123	No.
Pro 38	No.	Pro 81	No.	Pro 124	No.
Pro 39	No.	Pro 82	No.	Pro 125	No.
Pro 40	No.	Pro 83	No.	Pro 126	No.
Pro 41	No.	Pro 84	No.	Pro 127	No.
Pro 42	No.	Pro 85	No.	Pro 128	No.
Pro 43	No.	Pro 86	No.		

Roland Exclusive Messages

1 Data Format for Exclusive Messages

Roland's MIDI implementation uses the following data format for all exclusive messages (type IV) :

Byte	Description
F0H	Exclusive status
41H	Manufacturer ID (Roland)
DEV	Device ID
MDL	Model ID
CMD	Command ID
[BODY]	Main data
F7H	End of exclusive

= MIDI status : F0H, F7H

An exclusive message must be flanked by a pair of status codes, starting with a Manufacturer-ID immediately after F0H (MIDI version 1.0).

= Manufacturer ID : 41H

The Manufacturer-ID identifies the manufacturer of a MIDI instrument that triggers an exclusive message. Value 41H represents Roland's Manufacturer-ID.

= Device ID : DEV

The Device-ID contains a unique value that identifies the individual device in the multiple implementation of MIDI instruments. It is usually set to 00H - 0FH, a value smaller by one than that of a basic channel, but value 00H - 1FH may be used for a device with multiple basic channels.

= Model ID : MDL

The Model-ID contains a value that uniquely identifies one model from another. Different models, however, may share an identical Model-ID if they handle similar data.

The Model-ID format may contain 00H in one or more places to provide an extended data field. The following are examples of valid Model-IDs, each representing a unique model :

01H
02H
03H
00H, 01H
00H, 02H
00H, 00H, 01H

= Command ID : CMD

The Command-ID indicates the function of an exclusive message. The Command-ID format may contain 00H in one or more places to provide an extended data field. The following are examples of valid Command-IDs, each representing a unique function :

01H
02H
03H
00H, 01H
00H, 02H
00H, 00H, 01H

= Main data : BODY

This field contains a message to be exchanged across an interface. The exact data size and contents will vary with the Model-ID and Command-ID.

2 Address-mapped Data Transfer

Address mapping is a technique for transferring messages conforming to the data format given in Section 1. It assigns a series of memory-resident records-waveform and tone data, switch status, and parameters, for example-to specific locations in a machine-dependent address space, thereby allowing access to data residing at the address a message specifies.

Address-mapped data transfer is therefore independent of models and data categories. This technique allows use of two different transfer procedures : one-way transfer and handshake transfer.

One-way transfer procedure (See Section 3 for details.)

This procedure is suited for the transfer of a small amount of data. It sends out an exclusive message completely independent of a receiving device status.

Connection Diagram

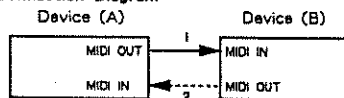

Connection at point 2 is essential for "Request data" procedures. (See Section 3.)

= Handshake transfer procedure (See Section 4 for details.)

This procedure initiates a predetermined transfer sequence (handshaking) across the interface before data transfer takes place. Handshaking ensures that reliability and transfer speed are high enough to handle a large amount of data.

Connection Diagram

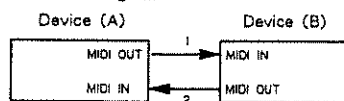

Connection at points 1 and 2 is essential.

Notes on the above two procedures

- * There are separate Command-IDs for different transfer procedures.
- * Devices A and B cannot exchange data unless they use the same transfer procedure, share identical Device-ID and Model ID, and are ready for communication.

3 One-way Transfer Procedure

This procedure sends out data all the way until it stops and is used when the messages are so short that answerbacks need not be checked. For long messages, however, the receiving device must acquire each message in time with the transfer sequence, which inserts intervals of at least 20 milliseconds in between.

Types of Messages

Message	Command ID
Request data 1	RQ1 (11H)
Data set 1	DT1 (12H)

= Request data = 1 : RQ1 (11H)

This message is sent out when there is a need to acquire data from a device at the other end of the interface. It contains data for the address and size that specify designation and length, respectively, of data required.

On receiving an RQ1 message, the remote device checks its memory for the data address and size that satisfy the request.

If it finds them and is ready for communication, the device will transmit a "Data set 1 (DT1)" message, which contains the requested data. Otherwise, the device will send out nothing.

Byte	Description
F0H	Exclusive status
41H	Manufacturer ID (Roland)
DEV	Device ID
MDL	Model ID
11H	Command ID
aaH	Address MSB
⋮	⋮
	LSB
ssH	Size MSB
⋮	⋮
	LSB
sum	Check sum
F7H	End of exclusive

Roland Exclusive Messages

- * The size of the requested data does not indicate the number of bytes that will make up a DT1 message, but represents the address fields where the requested data resides.
- * Some models are subject to limitations in data format used for a single transaction. Requested data, for example, may have a limit in length or must be divided into predetermined address fields before it is exchanged across the interface.
- * The same number of bytes comprises address and size data, which, however, vary with the Model-ID.
- * The error checking process uses a checksum that provides a bit pattern where the least significant 7 bits are zero when values for an address, size, and that checksum are summed.

= Data set 1 : DT1 (12H)

This message corresponds to the actual data transfer process. Because every byte in the data is assigned a unique address, a DT1 message can convey the starting address of one or more data as well as a series of data formatted in an address-dependent order.

The MIDI standards inhibit non-real time messages from interrupting an exclusive one. This fact is inconvenient for the devices that support a "soft-through" mechanism. To maintain compatibility with such devices, Roland has limited the DT1 to 256 bytes so that an excessively long message is sent out in separate segments.

Byte	Description
FOH	Exclusive
41H	Manufacturer ID (Roland)
DEV	Device ID
MDL	Model ID
12H	Command ID
aaH	Address MSB
⋮	⋮
⋮	⋮
⋮	⋮
⋮	LSB
ddH	Data
⋮	⋮
⋮	⋮
sum	Check sum
F7H	End of exclusive

- * A DT1 message is capable of providing only the valid data among those specified by an RQ1 message.
- * Some models are subject to limitations in data format used for a single transaction. Requested data, for example, may have a limit in length or must be divided into predetermined address fields before it is exchanged across the interface.
- * The number of bytes comprising address data varies from one Model-ID to another.
- * The error checking process uses a checksum that provides a bit pattern where the least significant 7 bits are zero when values for an address, size, and that checksum are summed.

= Example of Message Transactions

● Device A sending data to Device B

Transfer of a DT1 message is all that takes place.

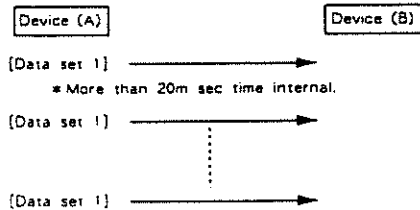

● Device B requesting data from Device A

Device B sends an RQ1 message to Device A. Checking the message, Device A sends a DT1 message back to Device B.

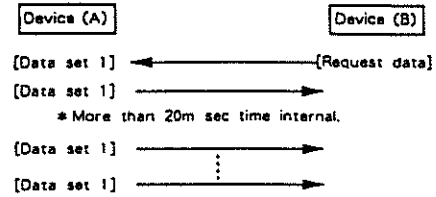

4. Handshake Transfer Procedure

Handshaking is an interactive process where two devices exchange error checking signals before a message transaction takes place, thereby increasing data reliability. Unlike one-way transfer that inserts a pause between message transactions, handshake transfer allows much speedier transactions because data transfer starts once the receiving device returns a ready signal.

When it comes to handling large amounts of data-sampler waveforms and synthesizer tones over the entire range, for example-across a MIDI interface, handshaking transfer is more efficient than one-way transfer.

Types of Messages

Message	Command ID
Want to send data	WSD (40H)
Request data	RQD (41H)
Data set	DAT (42H)
Acknowledge	ACK (43H)
End of data	EOD (45H)
Communication error	ERR (4EH)
Rejection	RJC (4FH)

= Want to send data : WSD (40H)

This message is sent out when data must be sent to a device at the other end of the interface. It contains data for the address and size that specify designation and length, respectively, of the data to be sent.

On receiving a WSD message, the remote device checks its memory for the specified data address and size which will satisfy the request. If it finds them and is ready for communication, the device will return an "Acknowledge (ACK)" message.

Byte	Description
FOH	Exclusive status
41H	Manufacturer ID (Roland)
DEV	Device ID
MDL	Model ID
40H	Command ID
aaH	Address MSB
⋮	⋮
⋮	⋮
⋮	LSB
ssH	Size MSB
⋮	⋮
⋮	⋮
⋮	LSB
sum	Check sum
F7H	End of exclusive

Otherwise, it will return a "Rejection (RJC)" message.

- * The size of the data to be sent does not indicate the number of bytes that make up a "Data set (DAT)" message, but represents the address fields where the data should reside.
- * Some models are subject to limitations in data format used for a single transaction. Requested data, for example, may have a limit in length or must be divided into predetermined address fields before it is exchanged across the interface.
- * The same number of bytes comprises address and size data, which, however, vary with the Model-ID.
- * The error checking process uses a checksum that provides a bit pattern where the least significant 7 bits are zero when values for an address, size, and that checksum are summed.

= Request data : RQD (41H)

This message is sent out when there is a need to acquire data from a device at the other end of the interface. It contains data for the address and size that specify designation and length, respectively, of data required.

On receiving an RQD message, the remote device checks its memory for the data address and size which satisfy the request. If it finds them and is ready for communication, the device will transmit a "Data set (DAT)" message, which contains the requested data. Otherwise, it will return a "Rejection (RJC)" message.

Byte	Description
F0H	Exclusive status
41H	Manufacturer ID (Roland)
DEV	Device ID
MDL	Model ID
41H	Command ID
aaH	Address MSB
⋮	⋮
⋮	⋮
⋮	LSB
ssH	Size MSB
⋮	⋮
⋮	⋮
⋮	LSB
sum	Check sum
F7H	End of exclusive

- * The size of the requested data does not indicate the number of bytes that make up a "Data set (DAT)" message, but represents the address fields where the requested data resides.
- * Some models are subject to limitations in data format used for a single transaction. Requested data, for example, may have a limit in length or must be divided into predetermined address fields before it is exchanged across the interface.
- * The same number of bytes comprising address and size data, which, however, vary with the Model-ID.
- * The error checking process uses a checksum that provides a bit pattern where the least significant 7 bits are zero when values for an address, size, and that checksum are summed.

= Data set : DAT (42H)

This message corresponds to the actual data transfer process. Because every byte in the data is assigned a unique address, the message can convey the starting address of one or more data as well as a series of data formatted in an address-dependent order.

Although the MIDI standards inhibit non-real time messages from interrupting an exclusive one, some devices support a "soft-through" mechanism for such interrupts. To maintain compatibility with such devices, Roland has limited the DAT to 256 bytes so that an excessively long message is sent out in separate segments.

Byte	Description
F0H	Exclusive status
41H	Manufacturer ID (Roland)
DEV	Device ID
MDL	Model ID
42H	Command ID
aaH	Address MSB
⋮	⋮
⋮	⋮
⋮	LSB
ddH	Data
⋮	⋮
⋮	⋮
sum	Check sum
F7H	End of exclusive

- * A DAT message is capable of providing only the valid data among those specified by an RQD or WSD message.
- * Some models are subject to limitations in data format used for a single transaction. Requested data, for example, may have a limit in length or must be divided into predetermined address fields before it is exchanged across the interface.
- * The number of bytes comprising address data varies from one model ID to another.
- * The error checking process uses a checksum that provides a bit pattern where the least significant 7 bits are zero when values for an address, size, and that checksum are summed.

= Acknowledge : ACK (43H)

This message is sent out when no error was detected on reception of a WSD, DAT, "End of data (EOD)", or some other message and a requested setup or action is complete. Unless it receives an ACK message, the device at the other end will not proceed to the next operation.

Byte	Description
F0H	Exclusive status
41H	Manufacturer ID (Roland)
DEV	Device ID
MDL	Model ID
43H	Command ID
F7H	End of exclusive

= End of data : EOD (45H)

This message is sent out to inform a remote device of the end of a message. Communication, however, will not come to an end unless the remote device returns an ACK message even though an EOD message was transmitted.

Byte	Description
F0H	Exclusive status
41H	Manufacturer ID (Roland)
DEV	Device ID
MDL	Model ID
45H	Command ID
F7H	End of exclusive

= Communications error : ERR (4EH)

This message warns the remote device of a communications fault encountered during message transmission due, for example, to a checksum error. An ERR message may be replaced with a "Rejection (RJC)" one, which terminates the current message transaction in midstream.

When it receives an ERR message, the sending device may either attempt to send out the last message a second time or terminate communication by sending out an RJC message.

Byte	Description
F0H	Exclusive status
41H	Manufacturer ID (Roland)
DEV	Device ID
MDL	Model ID
4EH	Command ID
F7H	End of exclusive

= Rejection : RJC (4FH)

This message is sent out when there is a need to terminate communication by overriding the current message. An RJC message will be triggered when:

- a WSD or RQD message has specified an illegal data address or size.
- the device is not ready for communication.
- an illegal number of addresses or data has been detected.
- data transfer has been terminated by an operator.
- a communications error has occurred.

An ERR message may be sent out by a device on either side of the interface. Communication must be terminated immediately when either side triggers an ERR message.

Byte	Description
F0H	Exclusive status
41H	Manufacturer ID (Roland)
DEV	Device ID
MDL	Model ID
4FH	Command ID
F7H	End of exclusive

Roland Exclusive Messages

= Example of Message Transactions

● Data transfer from device (A) to device (B).

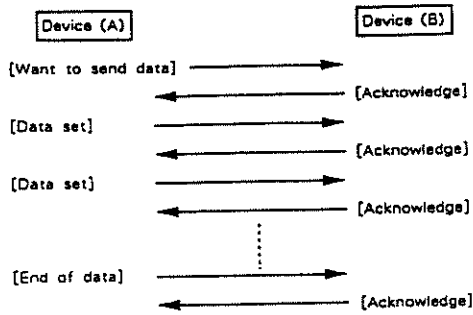

● Device (A) requests and receives data from device (B).

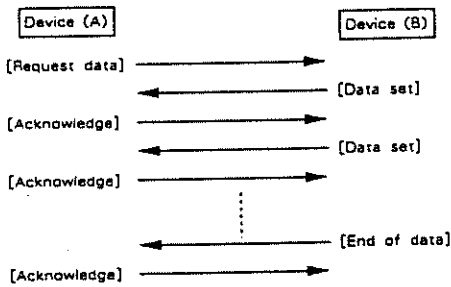

● Error occurs while device (A) is receiving data from device (B).

1) Data transfer from device (A) to device (B).

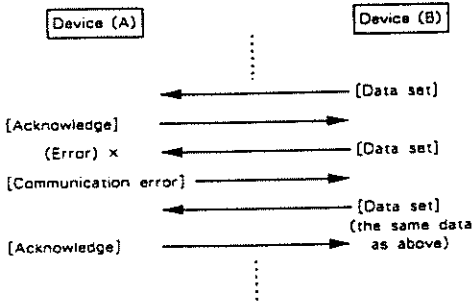

2) Device (B) rejects the data re-transmitted, and quits data transfer.

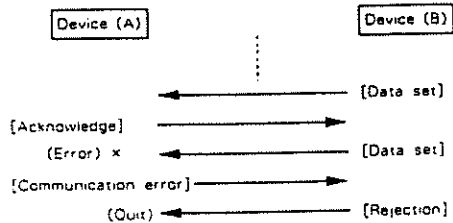

3) Device (A) immediately quits data transfer.

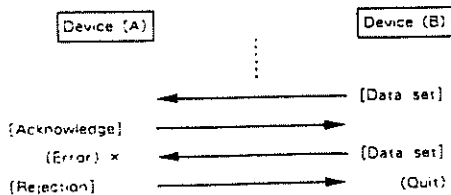

1. TRANSMITTED DATA

System Exclusive Messages

Status

F0H System Exclusive
F7H EOX (End Of System Exclusive)

Sends patch setting parameters on an external request or a bulk dump instruction.

2. RECOGNIZED RECEIVE DATA

Channel Voice Messages

● Program Change

Status Second
CnH ppH

n = MIDI Channel 0H - FH (1 - 16)
pp = Program Number 00H - 7FH (0 - 127)

Calls a patch corresponding to the received program number.

● Pitch Bend Change

Status Second Third
EnH IIH mmH
 (Data LSB) (Data MSB)

n = MIDI Channel 0H - FH (1 - 16)
II = Control Value 00H - 7FH (0 - 127)
mm = Control Value 00H - 7FH (0 - 127)

Recognizes only the MSB of the 3rd byte of data.

● Channel Pressure

Status Second
DnH vvH

n = MIDI Channel 0H - FH (1 - 16)
vv = Control Value 00H - 7FH (0 - 127)

● Control Change

Status Second Third
BnH cch vvH

n = MIDI Channel 0H - FH (1 - 16)
cc = Control Number 00H - 1FH (0 - 31) 40H - 5FH (64 - 95)
vv = Control Value 00H - 7FH (0 - 127)

System Exclusive Messages

Status

F0H System Exclusive
F7H EOX (End Of System Exclusive)

Allows generation of a request for or writing of setting parameters of a patch or temporary area.

3. EXCLUSIVE COMMUNICATIONS

The SE-50 can send and receive setting parameters to/from external MIDI instruments using exclusive messages.

Bulk dumps system data or, on a patch basis, data in the internal memory.

When set to data load mode and ready for receive status, receive exclusive messages and stores the received data into the internal memory area.

Carries out exclusive communications in accordance with protocol of Roland Exclusive Format, type IV, one way communications.

Request Data (One way) RQ1 11H

If the received exclusive message contains the addresses that match parameter addresses and the size of addresses is one or more, sends the data in these address locations patch by patch, using data set (DT1).

The device ID is the value of MIDI channel subtracted by 1. The SE-50 itself does not send this message.

Byte	Description
F0H	Exclusive status
41H	Manufacturer ID (Roland)
DEV	Device ID: DEV = 0 - FH (1ch - 16ch)
37H	Model ID (SE - 50)
11H	Command ID (RQ1)
aaH	Address MSB
aaH	Address
aaH	Address LSB
ssH	Size MSB
ssH	Size
ssH	Size LSB
sum	Checksum
F7H	EOX (End of Exclusive)

Data set (One way) DT1 12H

When set to data load mode and ready for receive data, stores the received data into the internal memory.

Sends this message in the following case.

Sends the data specified by the received "Request Data".

When bulk dump is activated, sends setting parameters patch by patch.

Byte	Description
F0H	Exclusive status
41H	Manufacturer ID (Roland)
DEV	Device ID: DEV = 0 - FH (1ch - 16ch)
37H	Model ID (SE - 50)
12H	Command ID (DT1)
aa	Address MSB
aaH	Address
aaH	address LSB
ddH	Data
:	:
sum	Checksum
F7H	EOX (End of Exclusive)

4. ADDRESS MAPPING OF PARAMETERS

The address is displayed under 7-bit hexadecimal notation.

Address	MSB		LSB
	DA	CC	DD
7bits Hex	0A	CC	DD
Binary	0000_00ab	0ccc_0ccc	0ddd_0ddd
<Description>			
a :	system data	0/1	
b :	Temporary	Internal Memory 0/1	
ccc_0ccc :	MIDI Mapping/SW Shift (System) Patch Number (Temporary/Internal Memory)		
ddd_0ddd :	MIDI Program Change No. (MIDI Mapping) SW Shift Start/End (SW Shift) Parameter Address (Temporary/Internal Memory)		

Effective address of each parameter is the start address of the corresponding block plus an offset address.

System Area

Address	Description
00 00 00H	0aaa_aaaaB MIDI Mapping Prg 1
00 00 01H	0aaa_aaaaB MIDI Mapping Prg 2
00 00 02H	0aaa_aaaaB MIDI Mapping Prg 128
00 01 00H	0aaa_aaaaB SW Shift Start
00 01 01H	0aaa_aaaaB SW Shift End

Temporary Area

Address	Description
02 00 00H	000a_aaaaB Temporary Algorithm *Table 1 - 28
02 00 01H	0000_000aB Effect On/Off (0:OFF,1:ON)
02 00 02H	0000_000aB Temporary Parameter 1 MSB
02 00 03H	0aaa_aaaaB Temporary Parameter 1 LSB
02 00 04H	0000_000aB Temporary Parameter 51 MSB
02 00 05H	0aaa_aaaaB Temporary Parameter 51 LSB
02 00 06H	0aaa_aaaaB Temporary Name 1
02 00 07H	0aaa_aaaaB Temporary Name 2
02 00 08H	0000_000aB Temporary Name 32 - 127(ASCII CODE)
02 00 09H	0aaa_aaaaB Temporary Name 12
02 00 0AH	0000_0000B Temporary End Of Name
02 00 0BH	0000_0000B Temporary SOUND CHANGE REQUEST

* Sound change request is a parameter resides only in the temporary area. Receiving this parameter after temporary area data alters the tone color.
 * The SE - 50 does not send the temporary data.

Internal Memory Area

Address	Description
03 00 00H	000a_aaaaB Number 1 algorithm *Table 1 - 28
03 00 01H	0000_0000B Number 1 DUMMY
03 00 02H	0000_000aB Number 1 Parameter 1 MSB
03 00 03H	0aaa_aaaaB Number 1 Parameter 1 LSB
03 00 04H	0000_000aB Number 1 Parameter 2 MSB
03 00 05H	0aaa_aaaaB Number 1 Parameter 2 LSB
03 00 06H	0000_000aB Number 1 Parameter 51 MSB
03 00 07H	0aaa_aaaaB Number 1 Parameter 51 LSB
03 00 08H	0aaa_aaaaB Number 1 Name 1
03 00 09H	0aaa_aaaaB Number 1 Name 2
03 00 0AH	0000_000aB Number 1 Name 32 - 127(ASCII CODE)
03 00 0BH	0aaa_aaaaB Number 1 Name 12
03 00 0CH	0000_0000B Number 1 End Of Name
03 00 0DH	0000_0000B Number 1 End Of Data
03 00 0EH	000a_aaaaB Number 100 algorithm *Table 1 - 28
03 00 0FH	0000_0000B Number 100 DUMMY
03 00 10H	0000_000aB Number 100 Parameter 1 MSB
03 00 11H	0aaa_aaaaB Number 100 Parameter 1 LSB
03 00 12H	0000_000aB Number 100 Parameter 51 MSB
03 00 13H	0aaa_aaaaB Number 100 Parameter 51 LSB
03 00 14H	0aaa_aaaaB Number 100 Name 1
03 00 15H	0aaa_aaaaB Number 100 Name 2
03 00 16H	0000_000aB Number 100 Name 32 - 127(ASCII CODE)
03 00 17H	0aaa_aaaaB Number 100 Name 12
03 00 18H	0000_0000B Number 100 End Of Name
03 00 19H	0000_0000B Number 100 End Of Data

* Even for a parameter whose setting range is 7 bits (128) or less, a pair of MSB and LSB must be sent.

Table 1 - 28

Binary figures under "Description" is the type of each parameter value, and decimal figures at the right settable range of the parameter.

If the SE - 50 receives data outside its settable range, it will fail to generate correct effects.

* Any data outside the settable range, stored in the internal memory, will be contracted to a value within the range on power-up.

* Transfer "0" if an offset address does not exist.

* Setting range of MIDI control or MIN/MAX depends on assigned parameters. Refer to Table 29 - 39.

* Table 1
HALL 1

Offset Address	Description
00H	0000_0000B algorithm 0
01H	0000_0000B DUMMY
04H	0000_000aB Par 2 MSB REVERB REV TIME MSB 0 - 199
05H	0aaa_aaaaB Par 2 LSB REVERB REV TIME LSB (0.1-20.0s)
06H	0000_000aB Par 3 MSB PRE DELAY MSB 0 - 200
07H	0aaa_aaaaB Par 3 LSB PRE DELAY LSB (0 - 400ms)
08H	0000_000aB Par 4 MSB ER TYPE MSB 0 - 3
09H	0aaa_aaaaB Par 4 LSB ER TYPE LSB (1 - 4)
0AH	0000_000aB Par 5 MSB ER DELAY MSB 0 - 200
0BH	0aaa_aaaaB Par 5 LSB ER DELAY LSB (0 - 400ms)
0CH	0000_000aB Par 6 MSB ER LEVEL MSB 0 - 100
0DH	0aaa_aaaaB Par 6 LSB ER LEVEL LSB
0EH	0000_000aB Par 7 MSB HF DAMP MSB 0 - 9
0FH	0aaa_aaaaB Par 7 LSB HF DAMP LSB (0.1-1.0)
12H	0000_000aB Par 9 MSB LOW LEVEL MSB 0 - 24
13H	0aaa_aaaaB Par 9 LSB LOW LEVEL LSB (-12--12dB)
14H	0000_000aB Par 10 MSB HI LEVEL MSB 0 - 24
15H	0aaa_aaaaB Par 10 LSB HI LEVEL LSB (-12--12dB)
16H	0000_000aB Par 11 MSB LPF MSB 0 - 10
17H	0aaa_aaaaB Par 11 LSB LPF LSB (500Hz-THRU)
18H	0000_000aB Par 12 MSB HPF MSB 0 - 11
19H	0aaa_aaaaB Par 12 LSB HPF LSB (THRU-1kHz)
1AH	0000_000aB Par 13 MSB LEVEL MSB 0 - 100
1BH	0aaa_aaaaB Par 13 LSB LEVEL LSB
1EH	0000_000aB Par 15 MSB DIRECT LEVEL MSB 0 - 100
1FH	0aaa_aaaaB Par 15 LSB LEVEL LSB
2AH	0000_000aB Par 21 MSB MASTER LEVEL MSB 0 - 100
2BH	0aaa_aaaaB Par 21 LSB LEVEL LSB
68H	0aaa_aaaaB Name 1
69H	0aaa_aaaaB Name 2
73H	0aaa_aaaaB Name 12
74H	0000_0000B End Of Name
75H	0000_0000B End Of Data

* Table 2
HALL 2

Offset Address	Description
00H	0000_0001B algorithm 1
01H	0000_0000B DUMMY
04H	0000_000aB Par 2 MSB REVERB REV TIME MSB 0 - 199
05H	0aaa_aaaaB Par 2 LSB REVERB REV TIME LSB (0.1-20.0s)
06H	0000_000aB Par 3 MSB PRE DELAY MSB 0 - 200
07H	0aaa_aaaaB Par 3 LSB PRE DELAY LSB (0 - 400ms)
08H	0000_000aB Par 4 MSB HF DAMP MSB 0 - 9
09H	0aaa_aaaaB Par 4 LSB HF DAMP LSB (0.1-1.0)
12H	0000_000aB Par 9 MSB LOW LEVEL MSB 0 - 24
13H	0aaa_aaaaB Par 9 LSB LOW LEVEL LSB (-12--12dB)
14H	0000_000aB Par 10 MSB HI LEVEL MSB 0 - 24
15H	0aaa_aaaaB Par 10 LSB HI LEVEL LSB (-12--12dB)
16H	0000_000aB Par 11 MSB LPF MSB 0 - 10
17H	0aaa_aaaaB Par 11 LSB LPF LSB (500Hz THRU)

18H	0000_000aB	Par 12 MSB	HPF	MSB	0 - 11
19H	0aaa_aaaaB	Par 12 LSB	HPF	LSB (THRU-1kHz)	
1AH	0000_000aB	Par 13 MSB	LEVEL	MSB	0 - 100
1BH	0aaa_aaaaB	Par 13 LSB	LEVEL	LSB	
1EH	0000_000aB	Par 15 MSB	DIRECT	LEVEL	MSB 0 - 100
1FH	0aaa_aaaaB	Par 15 LSB	LEVEL	LSB	
2AH	0000_000aB	Par 21 MSB	MASTER	LEVEL	MSB 0 - 100
2BH	0aaa_aaaaB	Par 21 LSB	LEVEL	LSB	
68H	0aaa_aaaaB	Name 1			
73H	0aaa_aaaaB	Name 12			
74H	0000_0000B	End Of Name			
75H	0000_0000B	END Of Data			

18H	0000_000aB	Par 12 MSB	HPF	MSB	0 - 11
19H	0aaa_aaaaB	Par 12 LSB	HPF	LSB (THRU-1kHz)	
1AH	0000_000aB	Par 13 MSB	LEVEL	MSB	0 - 100
1BH	0aaa_aaaaB	Par 13 LSB	LEVEL	LSB	
1EH	0000_000aB	Par 15 MSB	DIRECT	LEVEL	MSB 0 - 100
1FH	0aaa_aaaaB	Par 15 LSB	LEVEL	LSB	
2AH	0000_000aB	Par 21 MSB	MASTER	LEVEL	MSB 0 - 100
2BH	0aaa_aaaaB	Par 21 LSB	LEVEL	LSB	
68H	0aaa_aaaaB	Name 1			
73H	0aaa_aaaaB	Name 12			
74H	0000_0000B	End Of Name			
75H	0000_0000B	END Of Data			

* Table 3
ROOM

Offset Address	Description
00H 0000_0010B	algorithm 2
01H 0000_0000B	DUMMY
04H 0000_000aB	Par 2 MSB REVERB REV TIME MSB 0 - 199
05H 0aaa_aaaaB	Par 2 LSB REV TIME LSB (0.1-20.0s)
06H 0000_000aB	Par 3 MSB PRE DELAY MSB 0 - 200
07H 0aaa_aaaaB	Par 3 LSB PRE DELAY LSB (0 - 400ms)
08H 0000_000aB	Par 4 MSB ER TYPE MSB 0 - 3
09H 0aaa_aaaaB	Par 4 LSB ER TYPE LSB (1 - 4)
0AH 0000_000aB	Par 5 MSB ER DELAY MSB 0 - 200
0BH 0aaa_aaaaB	Par 5 LSB ER DELAY LSB (0 - 400ms)
0CH 0000_000aB	Par 6 MSB ER LEVEL MSB 0 - 100
0DH 0aaa_aaaaB	Par 6 LSB ER LEVEL LSB
0EH 0000_000aB	Par 7 MSB HF DAMP MSB 0 - 9
0FH 0aaa_aaaaB	Par 7 LSB HF DAMP LSB (0.1-1.0)
12H 0000_000aB	Par 9 MSB LOW LEVEL MSB 0 - 24
13H 0aaa_aaaaB	Par 9 LSB LOW LEVEL LSB (-12-+12dB)
14H 0000_000aB	Par 10 MSB HI LEVEL MSB 0 - 24
15H 0aaa_aaaaB	Par 10 LSB HI LEVEL LSB (-12-+12dB)
16H 0000_000aB	Par 11 MSB LPF MSB 0 - 10
17H 0aaa_aaaaB	Par 11 LSB LPF LSB (500Hz-THRU)
18H 0000_000aB	Par 12 MSB HPF MSB 0 - 11
19H 0aaa_aaaaB	Par 12 LSB HPF LSB (THRU-1kHz)
1AH 0000_000aB	Par 13 MSB LEVEL MSB 0 - 100
1BH 0aaa_aaaaB	Par 13 LSB LEVEL LSB
1EH 0000_000aB	Par 15 MSB DIRECT LEVEL MSB 0 - 100
1FH 0aaa_aaaaB	Par 15 LSB LEVEL LSB
2AH 0000_000aB	Par 21 MSB MASTER LEVEL MSB 0 - 100
2BH 0aaa_aaaaB	Par 21 LSB LEVEL LSB
68H 0aaa_aaaaB	Name 1
73H 0aaa_aaaaB	Name 12
74H 0000_0000B	End Of Name
75H 0000_0000B	END Of Data

* Table 5
AMBIENCE

Offset Address	Description
00H 0000_0100B	algorithm 4
01H 0000_0000B	DUMMY
04H 0000_000aB	Par 2 MSB AMBIENCE MODE MSB 0 - 3
05H 0aaa_aaaaB	Par 2 LSB MODE LSB (1 - 4)
06H 0000_000aB	Par 3 MSB PRE DELAY MSB 0 - 200
07H 0aaa_aaaaB	Par 3 LSB PRE DELAY LSB (0 - 400ms)
08H 0000_000aB	Par 4 MSB ER TYPE MSB 0 - 3
09H 0aaa_aaaaB	Par 4 LSB ER TYPE LSB (1 - 4)
0AH 0000_000aB	Par 5 MSB ER DELAY MSB 0 - 200
0BH 0aaa_aaaaB	Par 5 LSB ER DELAY LSB (0 - 400ms)
0CH 0000_000aB	Par 6 MSB ER LEVEL MSB 0 - 100
0DH 0aaa_aaaaB	Par 6 LSB ER LEVEL LSB
12H 0000_000aB	Par 9 MSB LOW LEVEL MSB 0 - 24
13H 0aaa_aaaaB	Par 9 LSB LOW LEVEL LSB (-12-+12dB)
14H 0000_000aB	Par 10 MSB HI LEVEL MSB 0 - 24
15H 0aaa_aaaaB	Par 10 LSB HI LEVEL LSB (-12-+12dB)
16H 0000_000aB	Par 11 MSB LPF MSB 0 - 10
17H 0aaa_aaaaB	Par 11 LSB LPF LSB (500Hz-THRU)
18H 0000_000aB	Par 12 MSB HPF MSB 0 - 11
19H 0aaa_aaaaB	Par 12 LSB HPF LSB (THRU-1kHz)
1AH 0000_000aB	Par 13 MSB LEVEL MSB 0 - 100
1BH 0aaa_aaaaB	Par 13 LSB LEVEL LSB
1EH 0000_000aB	Par 15 MSB DIRECT LEVEL MSB 0 - 100
1FH 0aaa_aaaaB	Par 15 LSB LEVEL LSB
2AH 0000_000aB	Par 21 MSB MASTER LEVEL MSB 0 - 100
2BH 0aaa_aaaaB	Par 21 LSB LEVEL LSB
68H 0aaa_aaaaB	Name 1
73H 0aaa_aaaaB	Name 12
74H 0000_0000B	End Of Name
75H 0000_0000B	END Of Data

* Table 4
PLATE

Offset Address	Description
00H 0000_0011B	algorithm 3
01H 0000_0000B	DUMMY
04H 0000_000aB	Par 2 MSB REVERB REV TIME MSB 0 - 199
05H 0aaa_aaaaB	Par 2 LSB REV TIME LSB (0.1-20.0s)
06H 0000_000aB	Par 3 MSB PRE DELAY MSB 0 - 200
07H 0aaa_aaaaB	Par 3 LSB PRE DELAY LSB (0 - 400ms)
08H 0000_000aB	Par 4 MSB HF DAMP MSB 0 - 9
09H 0aaa_aaaaB	Par 4 LSB HF DAMP LSB (0.1-1.0)
12H 0000_000aB	Par 9 MSB LOW LEVEL MSB 0 - 24
13H 0aaa_aaaaB	Par 9 LSB LOW LEVEL LSB (-12-+12dB)
14H 0000_000aB	Par 10 MSB HI LEVEL MSB 0 - 24
15H 0aaa_aaaaB	Par 10 LSB HI LEVEL LSB (-12-+12dB)
16H 0000_000aB	Par 11 MSB LPF MSB 0 - 10
17H 0aaa_aaaaB	Par 11 LSB LPF LSB (500Hz-THRU)

* Table 6
GATE REVERB

Offset Address	Description
00H 0000_0101B	algorithm 5
01H 0000_0000B	DUMMY
04H 0000_000aB	Par 2 MSB GATE REV MODE MSB 0 - 3
05H 0aaa_aaaaB	Par 2 LSB MODE LSB (NOR, RE, L&R, H&L)
06H 0000_000aB	Par 3 MSB GATE TIME MSB 0 - 79
07H 0aaa_aaaaB	Par 3 LSB GATE TIME LSB (5 - 400ms)
08H 0000_000aB	Par 4 MSB PRE DELAY MSB 0 - 200
09H 0aaa_aaaaB	Par 4 LSB PRE DELAY LSB
0AH 0000_000aB	Par 5 MSB LOW LEVEL MSB 0 - 24
0BH 0aaa_aaaaB	Par 5 LSB LOW LEVEL LSB (-12-+12dB)
0CH 0000_000aB	Par 6 MSB HI LEVEL MSB 0 - 24
0DH 0aaa_aaaaB	Par 6 LSB HI LEVEL LSB (-12-+12dB)
12H 0000_000aB	Par 9 MSB LPF MSB 0 - 10
13H 0aaa_aaaaB	Par 9 LSB LPF LSB (500Hz-THRU)
14H 0000_000aB	Par 10 MSB HPF MSB 0 - 11
15H 0aaa_aaaaB	Par 10 LSB HPF LSB (THRU-1kHz)

16H: 0000_000aB	Par 11 MSB	LEVEL	MSB	0 - 100
17H: 0aaa_aaaaB	Par 11 LSB	LEVEL	LSB	
1EH: 0000_000aB	Par 15 MSB	DIRECT	LEVEL	MSB 0 - 100
1FH: 0aaa_aaaaB	Par 15 LSB	LEVEL	LSB	
2AH: 0000_000aB	Par 21 MSB	MASTER	LEVEL	MSB 0 - 100
2BH: 0aaa_aaaaB	Par 21 LSB	LEVEL	LSB	
68H: 0aaa_aaaaB	Name 1			
73H: 0aaa_aaaaB	Name 12			
74H: 0000_0000B	End Of Name			
75H: 0000_0000B	END Of Data			

16H: 0000_000aB	Par 11 MSB	FEEDBACK	MSB	0 - 100
17H: 0aaa_aaaaB	Par 11 LSB	FEEDBACK	LSB	
18H: 0000_000aB	Par 12 MSB	PAK	MSB	0 - 100
19H: 0aaa_aaaaB	Par 12 LSB	PAK	LSB	
1AH: 0000_000aB	Par 13 MSB	LEVEL	MSB	0 - 100
1BH: 0aaa_aaaaB	Par 13 LSB	LEVEL	LSB	
1EH: 0000_000aB	Par 15 MSB	DELAY 3	D. TIME H	MSB 0 - 400
1FH: 0aaa_aaaaB	Par 15 LSB		D. TIME H	LSB
20H: 0000_000aB	Par 16 MSB		D. TIME L	MSB
21H: 0aaa_aaaaB	Par 16 LSB		D. TIME L	LSB
22H: 0000_000aB	Par 17 MSB	FEEDBACK	MSB	0 - 100
23H: 0aaa_aaaaB	Par 17 LSB	FEEDBACK	LSB	
24H: 0000_000aB	Par 18 MSB	PAK	MSB	0 - 100
25H: 0aaa_aaaaB	Par 18 LSB	PAK	LSB	
26H: 0000_000aB	Par 19 MSB	LEVEL	MSB	0 - 100
27H: 0aaa_aaaaB	Par 19 LSB	LEVEL	LSB	

2AH: 0000_000aB	Par 21 MSB	DELAY 4	D. TIME H	MSB 0 - 300
2BH: 0aaa_aaaaB	Par 21 LSB		D. TIME H	LSB
2CH: 0000_000aB	Par 22 MSB		D. TIME L	MSB
2DH: 0aaa_aaaaB	Par 22 LSB		D. TIME L	LSB
2EH: 0000_000aB	Par 23 MSB	FEEDBACK	MSB	0 - 100
2FH: 0aaa_aaaaB	Par 23 LSB	FEEDBACK	LSB	
30H: 0000_000aB	Par 24 MSB	PAK	MSB	0 - 100
31H: 0aaa_aaaaB	Par 24 LSB	PAK	LSB	
32H: 0000_000aB	Par 25 MSB	LEVEL	MSB	0 - 100
33H: 0aaa_aaaaB	Par 25 LSB	LEVEL	LSB	
36H: 0000_000aB	Par 27 MSB	DELAY 5	D. TIME H	MSB 0 - 200
37H: 0aaa_aaaaB	Par 27 LSB		D. TIME H	LSB
38H: 0000_000aB	Par 28 MSB		D. TIME L	MSB
39H: 0aaa_aaaaB	Par 28 LSB		D. TIME L	LSB
3AH: 0000_000aB	Par 29 MSB	FEEDBACK	MSB	0 - 100
3BH: 0aaa_aaaaB	Par 29 LSB	FEEDBACK	LSB	
3CH: 0000_000aB	Par 30 MSB	PAK	MSB	0 - 100
3DH: 0aaa_aaaaB	Par 30 LSB	PAK	LSB	
3EH: 0000_000aB	Par 31 MSB	LEVEL	MSB	0 - 100
3FH: 0aaa_aaaaB	Par 31 LSB	LEVEL	LSB	
40H: 0000_000aB	Par 32 MSB	DELAY	LPF	MSB 0 - 10
41H: 0aaa_aaaaB	Par 32 LSB		LPF	LSB (500Hz-THRU)
42H: 0000_000aB	Par 33 MSB		HPF	MSB 0 - 11
43H: 0aaa_aaaaB	Par 33 LSB		HPF	LSB (THRU-1kHz)
48H: 0000_000aB	Par 36 MSB	DIRECT	LEVEL L	MSB 0 - 100
49H: 0aaa_aaaaB	Par 36 LSB		LEVEL L	LSB
4AH: 0000_000aB	Par 37 MSB		LEVEL R	MSB 0 - 100
4BH: 0aaa_aaaaB	Par 37 LSB		LEVEL R	LSB
50H: 0000_000aB	Par 40 MSB	MASTER	LEVEL	MSB 0 - 100
51H: 0aaa_aaaaB	Par 40 LSB		LEVEL	LSB
68H: 0aaa_aaaaB	Name 1			
73H: 0aaa_aaaaB	Name 12			
74H: 0000_0000B	End Of Name			
75H: 0000_0000B	END Of Data			

* Table 7
STEREO REVERB

Offset	Address	Description
00H: 0000_0110B	algorithm	6
01H: 0000_0000B	DUMMY	
04H: 0000_000aB	Par 2 MSB	REVERB REV TIME MSB 0 - 199
05H: 0aaa_aaaaB	Par 2 LSB	REV TIME LSB (0.1-20.0s)
06H: 0000_000aB	Par 3 MSB	PRE DELAY MSB 0 - 200
07H: 0aaa_aaaaB	Par 3 LSB	PRE DELAY LSB (0 - 400ms)
08H: 0000_000aB	Par 4 MSB	ER TYPE MSB 0 - 3
09H: 0aaa_aaaaB	Par 4 LSB	ER TYPE LSB (1 - 4)
0AH: 0000_000aB	Par 5 MSB	ER DELAY MSB 0 - 200
0BH: 0aaa_aaaaB	Par 5 LSB	ER DELAY LSB (0 - 400ms)
0CH: 0000_000aB	Par 6 MSB	ER LEVEL MSB 0 - 100
0DH: 0aaa_aaaaB	Par 6 LSB	ER LEVEL LSB
0EH: 0000_000aB	Par 7 MSB	HF DAMP MSB 0 - 9
0FH: 0aaa_aaaaB	Par 7 LSB	HF DAMP LSB (0.1-1.0)
12H: 0000_000aB	Par 9 MSB	LOW LEVEL MSB 0 - 24
13H: 0aaa_aaaaB	Par 9 LSB	LOW LEVEL LSB (-12--+12dB)
14H: 0000_000aB	Par 10 MSB	H1 LEVEL MSB 0 - 24
15H: 0aaa_aaaaB	Par 10 LSB	H1 LEVEL LSB (-12--+12dB)
16H: 0000_000aB	Par 11 MSB	LPF MSB 0 - 10
17H: 0aaa_aaaaB	Par 11 LSB	LPF LSB (500Hz-THRU)
18H: 0000_000aB	Par 12 MSB	HPF MSB 0 - 11
19H: 0aaa_aaaaB	Par 12 LSB	HPF LSB (THRU-1kHz)
1AH: 0000_000aB	Par 13 MSB	LEVEL MSB 0 - 100
1BH: 0aaa_aaaaB	Par 13 LSB	LEVEL LSB
1EH: 0000_000aB	Par 15 MSB	DIRECT LEVEL MSB 0 - 100
1FH: 0aaa_aaaaB	Par 15 LSB	LEVEL LSB
2AH: 0000_000aB	Par 21 MSB	MASTER LEVEL MSB 0 - 100
2BH: 0aaa_aaaaB	Par 21 LSB	LEVEL LSB
68H: 0aaa_aaaaB	Name 1	
73H: 0aaa_aaaaB	Name 12	
74H: 0000_0000B	End Of Name	
75H: 0000_0000B	END Of Data	

* Table 9
MULTI TAP DELAY

Offset	Address	Description
00H: 0000_1000B	algorithm	8
01H: 0000_0000B	DUMMY	
04H: 0000_000aB	Par 2 MSB	TAP 1 D. TIME H MSB 0 - 3000
05H: 0aaa_aaaaB	Par 2 LSB	D. TIME H LSB
06H: 0000_000aB	Par 3 MSB	D. TIME L MSB
07H: 0aaa_aaaaB	Par 3 LSB	D. TIME L LSB
08H: 0000_000aB	Par 4 MSB	FEEDBACK MSB 0 - 100
09H: 0aaa_aaaaB	Par 4 LSB	FEEDBACK LSB
0AH: 0000_000aB	Par 5 MSB	PAK MSB 0 - 100
0BH: 0aaa_aaaaB	Par 5 LSB	PAK LSB
0CH: 0000_000aB	Par 6 MSB	LEVEL MSB 0 - 100
0DH: 0aaa_aaaaB	Par 6 LSB	LEVEL LSB
12H: 0000_000aB	Par 9 MSB	TAP 2 D. TIME H MSB 0 - 3000
13H: 0aaa_aaaaB	Par 9 LSB	D. TIME H LSB
14H: 0000_000aB	Par 10 MSB	D. TIME L MSB
15H: 0aaa_aaaaB	Par 10 LSB	D. TIME L LSB
16H: 0000_000aB	Par 11 MSB	FEEDBACK MSB 0 - 100
17H: 0aaa_aaaaB	Par 11 LSB	FEEDBACK LSB
18H: 0000_000aB	Par 12 MSB	PAK MSB 0 - 100

* Table 8
MULTI DELAY

Offset	Address	Description
00H: 0000_0111B	algorithm	7
01H: 0000_0000B	DUMMY	
04H: 0000_000aB	Par 2 MSB	DELAY 1 D. TIME H MSB 0 - 600
05H: 0aaa_aaaaB	Par 2 LSB	D. TIME H LSB
06H: 0000_000aB	Par 3 MSB	D. TIME L MSB
07H: 0aaa_aaaaB	Par 3 LSB	D. TIME L LSB
08H: 0000_000aB	Par 4 MSB	FEEDBACK MSB 0 - 100
09H: 0aaa_aaaaB	Par 4 LSB	FEEDBACK LSB
0AH: 0000_000aB	Par 5 MSB	PAK MSB 0 - 100
0BH: 0aaa_aaaaB	Par 5 LSB	PAK LSB
0CH: 0000_000aB	Par 6 MSB	LEVEL MSB 0 - 100
0DH: 0aaa_aaaaB	Par 6 LSB	LEVEL LSB
12H: 0000_000aB	Par 9 MSB	DELAY 2 D. TIME H MSB 0 - 300
13H: 0aaa_aaaaB	Par 9 LSB	D. TIME H LSB
14H: 0000_000aB	Par 10 MSB	D. TIME L MSB
15H: 0aaa_aaaaB	Par 10 LSB	D. TIME L LSB

19H	0aaa_aaaaB	Par 12 LSB	PAN	LSB	1FH	0aaa_aaaaB	Par 15 LSB	D.TIME H	LSB	
1AH	0000_000aB	Par 13 MSB	LEVEL	MSB 0 - 100	20H	0000_000aB	Par 16 MSB	D.TIME L	MSB	
1BH	0aaa_aaaaB	Par 13 LSB	LEVEL	LSB	21H	0aaa_aaaaB	Par 16 LSB	D.TIME L	LSB	
1EH	0000_000aB	Par 15 MSB	TAP 3	D.TIME H	MSB 0 - 2000	22H	0000_000aB	Par 17 MSB	FEEDBACK	MSB 0 - 100
1FH	0aaa_aaaaB	Par 15 LSB	D.TIME H	LSB	23H	0aaa_aaaaB	Par 17 LSB	FEEDBACK	LSB	
20H	0000_000aB	Par 16 MSB	D.TIME L	MSB	24H	0000_000aB	Par 18 MSB	CROSS FB	MSB 0 - 100	
21H	0aaa_aaaaB	Par 16 LSB	D.TIME L	LSB	25H	0aaa_aaaaB	Par 18 LSB	CROSS FB	LSB	
22H	0000_000aB	Par 17 MSB	FEEDBACK	MSB 0 - 100	2AH	0000_000aB	Par 21 MSB	LPF	MSB 0 - 11	
23H	0aaa_aaaaB	Par 17 LSB	FEEDBACK	LSB	2BH	0aaa_aaaaB	Par 21 LSB	LPF	LSB (500Hz-THRU)	
24H	0000_000aB	Par 18 MSB	PAN	MSB 0 - 100	2CH	0000_000aB	Par 22 MSB	RPF	MSB 0 - 11	
25H	0aaa_aaaaB	Par 18 LSB	PAN	LSB	2DH	0aaa_aaaaB	Par 22 LSB	RPF	LSB (THRU-1kHz)	
26H	0000_000aB	Par 19 MSB	LEVEL	MSB 0 - 100	2EH	0000_000aB	Par 23 MSB	IN. LEVEL	MSB 0 - 100	
27H	0aaa_aaaaB	Par 19 LSB	LEVEL	LSB	2FH	0aaa_aaaaB	Par 23 LSB	IN. LEVEL	LSB	
2AH	0000_000aB	Par 21 MSB	TAP 4	D.TIME H	MSB 0 - 2000	30H	0000_000aB	Par 24 MSB	EF. LEVEL	MSB 0 - 100
2BH	0aaa_aaaaB	Par 21 LSB	D.TIME H	LSB	31H	0aaa_aaaaB	Par 24 LSB	EF. LEVEL	LSB	
2CH	0000_000aB	Par 22 MSB	D.TIME L	MSB	32H	0000_000aB	Par 25 MSB	DI. LEVEL	MSB 0 - 100	
2DH	0aaa_aaaaB	Par 22 LSB	D.TIME L	LSB	33H	0aaa_aaaaB	Par 25 LSB	DI. LEVEL	LSB	
2EH	0000_000aB	Par 23 MSB	FEEDBACK	MSB 0 - 100	36H	0000_000aB	Par 27 MSB	MASTER	LEVEL	MSB 0 - 100
2FH	0aaa_aaaaB	Par 23 LSB	FEEDBACK	LSB	37H	0aaa_aaaaB	Par 27 LSB	LEVEL	LSB	
30H	0000_000aB	Par 24 MSB	PAN	MSB 0 - 100	68H	0aaa_aaaaB	Name 1			
31H	0aaa_aaaaB	Par 24 LSB	PAN	LSB	73H	0aaa_aaaaB	Name 12			
32H	0000_000aB	Par 25 MSB	LEVEL	MSB 0 - 100	74H	0000_0000B	End Of Name			
33H	0aaa_aaaaB	Par 25 LSB	LEVEL	LSB	75H	0000_0000B	END Of Data			
36H	0000_000aB	Par 27 MSB	TAP 5	D.TIME H	MSB 0 - 2000					
37H	0aaa_aaaaB	Par 27 LSB	D.TIME H	LSB						
38H	0000_000aB	Par 28 MSB	D.TIME L	MSB						
39H	0aaa_aaaaB	Par 28 LSB	D.TIME L	LSB						
3AH	0000_000aB	Par 29 MSB	FEEDBACK	MSB 0 - 100						
3BH	0aaa_aaaaB	Par 29 LSB	FEEDBACK	LSB						
3CH	0000_000aB	Par 30 MSB	PAN	MSB 0 - 100						
3DH	0aaa_aaaaB	Par 30 LSB	PAN	LSB						
3EH	0000_000aB	Par 31 MSB	LEVEL	MSB 0 - 100						
3FH	0aaa_aaaaB	Par 31 LSB	LEVEL	LSB						
40H	0000_000aB	Par 32 MSB	DELAY	LPF	MSB 0 - 10					
41H	0aaa_aaaaB	Par 32 LSB	LPF	LSB (500Hz-THRU)						
42H	0000_000aB	Par 33 MSB	HPP	MSB 0 - 11						
43H	0aaa_aaaaB	Par 33 LSB	HPP	LSB (THRU-1kHz)						
48H	0000_000aB	Par 36 MSB	DIRECT	LEVEL L	MSB 0 - 100					
49H	0aaa_aaaaB	Par 36 LSB	LEVEL L	LSB						
4AH	0000_000aB	Par 37 MSB	LEVEL R	MSB 0 - 100						
4BH	0aaa_aaaaB	Par 37 LSB	LEVEL R	LSB						
50H	0000_000aB	Par 40 MSB	MASTER	LEVEL	MSB 0 - 100					
51H	0aaa_aaaaB	Par 40 LSB	LEVEL	LSB						
68H	0aaa_aaaaB	Name 1								
73H	0aaa_aaaaB	Name 12								
74H	0000_0000B	End Of Name								
75H	0000_0000B	END Of Data								

* Table 11
SPACE CHORUS

Offset	Address	Description
00H	0000_1010B	algorithm 10
01H	0000_0000B	DUMMY
04H	0000_000aB	Par 2 MSB CHORUS MODE MSB 0 - 2
05H	0aaa_aaaaB	Par 2 LSB MODE LSB (1 - 3)
06H	0000_000aB	Par 3 MSB M.WAVE MSB 0 - 1
07H	0aaa_aaaaB	Par 3 LSB M.WAVE LSB (TRI. SINE)
08H	0000_000aB	Par 4 MSB PRE DELAY MSB 0 - 200
09H	0aaa_aaaaB	Par 4 LSB PRE DELAY LSB
0AH	0000_000aB	Par 5 MSB RATE MSB 0 - 100
0BH	0aaa_aaaaB	Par 5 LSB RATE LSB
0CH	0000_000aB	Par 6 MSB BATH MSB 0 - 100
0DH	0aaa_aaaaB	Par 6 LSB DEPTH LSB
0EH	0000_000aB	Par 7 MSB DIFFUSION MSB 0 - 100
0FH	0aaa_aaaaB	Par 7 LSB DIFFUSION LSB
10H	0000_000aB	Par 8 MSB LEVEL MSB 0 - 100
11H	0aaa_aaaaB	Par 8 LSB LEVEL LSB
12H	0000_000aB	Par 9 MSB DIRECT LEVEL MSB 0 - 100
13H	0aaa_aaaaB	Par 9 LSB LEVEL LSB
1EH	0000_000aB	Par 15 MSB MASTER LEVEL MSB 0 - 100
1FH	0aaa_aaaaB	Par 15 LSB LEVEL LSB
2AH	0000_000aB	Par 21 MSB MIDI CNT RECEIVE MSB 0 - 66
2BH	0aaa_aaaaB	Par 21 LSB RECEIVE LSB
36H	0000_000aB	Par 27 MSB MIDI CNT ASSIGN MSB 0 - 2
37H	0aaa_aaaaB	Par 27 LSB ASSIGN LSB
40H	0000_000aB	Par 32 MSB MIDI CNT MIN MSB 0 - 100 Table29
41H	0aaa_aaaaB	Par 32 LSB MIN LSB
48H	0000_000aB	Par 36 MSB MIDI CNT MAX MSB 0 - 100
49H	0aaa_aaaaB	Par 36 LSB MAX LSB
68H	0aaa_aaaaB	Name 1
73H	0aaa_aaaaB	Name 12
74H	0000_0000B	End Of Name
75H	0000_0000B	END Of Data

* Table 10
STEREO DELAY

Offset	Address	Description
00H	0000_1001B	algorithm 9
01H	0000_0000B	DUMMY
04H	0000_000aB	Par 2 MSB DELAY L D.TIME H MSB 0 - 740
05H	0aaa_aaaaB	Par 2 LSB D.TIME H LSB
06H	0000_000aB	Par 3 MSB D.TIME L MSB 0 - 740
07H	0aaa_aaaaB	Par 3 LSB D.TIME L LSB
08H	0000_000aB	Par 4 MSB FEEDBACK MSB 0 - 100
09H	0aaa_aaaaB	Par 4 LSB FEEDBACK LSB
0AH	0000_000aB	Par 5 MSB CROSS FB MSB 0 - 100
0BH	0aaa_aaaaB	Par 5 LSB CROSS FB LSB
12H	0000_000aB	Par 9 MSB LPF MSB 0 - 11
13H	0aaa_aaaaB	Par 9 LSB LPF LSB (500Hz-THRU)
14H	0000_000aB	Par 10 MSB HPP MSB 0 - 11
15H	0aaa_aaaaB	Par 10 LSB HPP LSB (THRU-1kHz)
16H	0000_000aB	Par 11 MSB IN. LEVEL MSB 0 - 100
17H	0aaa_aaaaB	Par 11 LSB IN. LEVEL LSB
18H	0000_000aB	Par 12 MSB EF. LEVEL MSB 0 - 100
19H	0aaa_aaaaB	Par 12 LSB EF. LEVEL LSB
1AH	0000_000aB	Par 13 MSB DI. LEVEL MSB 0 - 100
1BH	0aaa_aaaaB	Par 13 LSB DI. LEVEL LSB
1EH	0000_000aB	Par 15 MSB DELAY R D.TIME H MSB 0 - 740

Table 29

MIDI CNT ASSIGN	CHORUS RATE	CHORUS LEVEL	MASTER LEVEL
0	0	0	100
1	0	0	100
2	0	0	100

* Table 12
PITCH SHIFT

Offset	Address	Description
00H	0000_1011B	algorithm 11
01H	0000_0000B	DUMMY
04H	0000_000aB	Par 2 MSB P.S. 1
05H	0aaa_aaaaB	Par 2 LSB
06H	0000_000aB	Par 3 MSB
07H	0aaa_aaaaB	Par 3 LSB
08H	0000_000aB	Par 4 MSB
09H	0aaa_aaaaB	Par 4 LSB
0AH	0000_000aB	Par 5 MSB
0BH	0aaa_aaaaB	Par 5 LSB
0CH	0000_000aB	Par 6 MSB
0DH	0aaa_aaaaB	Par 6 LSB
0EH	0000_000aB	Par 7 MSB
0FH	0aaa_aaaaB	Par 7 LSB
10H	0000_000aB	Par 8 MSB
11H	0aaa_aaaaB	Par 8 LSB
12H	0000_000aB	Par 9 MSB P.S. 2
13H	0aaa_aaaaB	Par 9 LSB
14H	0000_000aB	Par 10 MSB
15H	0aaa_aaaaB	Par 10 LSB
16H	0000_000aB	Par 11 MSB
17H	0aaa_aaaaB	Par 11 LSB
18H	0000_000aB	Par 12 MSB
19H	0aaa_aaaaB	Par 12 LSB
1AH	0000_000aB	Par 13 MSB
1BH	0aaa_aaaaB	Par 13 LSB
1CH	0000_0000B	Par 14 MSB
1DH	0000_0000B	Par 14 LSB
1EH	0000_000aB	Par 15 MSB P.S. 3
1FH	0aaa_aaaaB	Par 15 LSB
20H	0000_000aB	Par 16 MSB
21H	0aaa_aaaaB	Par 16 LSB
22H	0000_000aB	Par 17 MSB
23H	0aaa_aaaaB	Par 17 LSB
24H	0000_000aB	Par 18 MSB
25H	0aaa_aaaaB	Par 18 LSB
26H	0000_000aB	Par 19 MSB
27H	0aaa_aaaaB	Par 19 LSB
28H	0000_000aB	Par 20 MSB
29H	0aaa_aaaaB	Par 20 LSB
2AH	0000_000aB	Par 21 MSB P.S. 4
2BH	0aaa_aaaaB	Par 21 LSB
2CH	0000_000aB	Par 22 MSB
2DH	0aaa_aaaaB	Par 22 LSB
2EH	0000_000aB	Par 23 MSB
2FH	0aaa_aaaaB	Par 23 LSB
30H	0000_000aB	Par 24 MSB
31H	0aaa_aaaaB	Par 24 LSB
32H	0000_000aB	Par 25 MSB
33H	0aaa_aaaaB	Par 25 LSB
34H	0000_000aB	Par 26 MSB
35H	0aaa_aaaaB	Par 26 LSB
36H	0000_000aB	Par 27 MSB P.S.
37H	0aaa_aaaaB	Par 27 LSB
38H	0000_000aB	Par 28 MSB
39H	0aaa_aaaaB	Par 28 LSB
40H	0000_000aB	Par 32 MSB DIRECT
41H	0aaa_aaaaB	Par 32 LSB
42H	0000_000aB	Par 33 MSB
43H	0aaa_aaaaB	Par 33 LSB
48H	0000_000aB	Par 36 MSB MASTER
49H	0aaa_aaaaB	Par 36 LSB
50H	0000_000aB	Par 40 MSB MIDI CNT RECEIVE
51H	0aaa_aaaaB	Par 40 LSB RECEIVE
(OFF. AF. TOUCH. P. BEND. =0 - #31, #64 - #95)		
54H	0000_000aB	Par 42 MSB MIDI CNT ASSIGN
55H	0aaa_aaaaB	Par 42 LSB ASSIGN
58H	0000_000aB	Par 44 MSB MIDI CNT MIX H
59H	0aaa_aaaaB	Par 44 LSB MIX H
5AH	0000_000aB	Par 45 MSB MIDI CNT MIX L
5BH	0aaa_aaaaB	Par 45 LSB MIX L
5CH	0000_000aB	Par 46 MSB MIDI CNT MAX H

5DH	0aaa_aaaaB	Par 46 LSB	MAX H	LSB
5EH	0000_000aB	Par 47 MSB	MIDI CNT MAX L	MSB
5FH	0aaa_aaaaB	Par 47 LSB	MAX L	LSB
68H	0aaa_aaaaB	Name 1		
73H	0aaa_aaaaB	Name 12		
74H	0000_0000B	End Of Name		
75H	0000_0000B	END OF DATA		

Table 30

Offset	Address	Description
00H	0000_1100B	algorithm 12
01H	0000_0000B	DUMMY
04H	0000_000aB	Par 2 MSB P.S. L
05H	0aaa_aaaaB	Par 2 LSB
06H	0000_000aB	Par 3 MSB
07H	0aaa_aaaaB	Par 3 LSB
08H	0000_000aB	Par 4 MSB
09H	0aaa_aaaaB	Par 4 LSB
0AH	0000_000aB	Par 5 MSB
0BH	0aaa_aaaaB	Par 5 LSB
0CH	0000_000aB	Par 6 MSB
0DH	0aaa_aaaaB	Par 6 LSB
12H	0000_000aB	Par 9 MSB
13H	0aaa_aaaaB	Par 9 LSB
14H	0000_000aB	Par 10 MSB
15H	0aaa_aaaaB	Par 10 LSB
16H	0000_000aB	Par 11 MSB
17H	0aaa_aaaaB	Par 11 LSB
18H	0000_000aB	Par 12 MSB
19H	0aaa_aaaaB	Par 12 LSB
1AH	0000_000aB	Par 13 MSB
1BH	0aaa_aaaaB	Par 13 LSB
1EH	0000_000aB	Par 15 MSB P.S. R
1FH	0aaa_aaaaB	Par 15 LSB
20H	0000_000aB	Par 16 MSB
21H	0aaa_aaaaB	Par 16 LSB
22H	0000_000aB	Par 17 MSB
23H	0aaa_aaaaB	Par 17 LSB
24H	0000_000aB	Par 18 MSB
25H	0aaa_aaaaB	Par 18 LSB
26H	0000_000aB	Par 19 MSB
27H	0aaa_aaaaB	Par 19 LSB
28H	0000_000aB	Par 20 MSB
29H	0aaa_aaaaB	Par 20 LSB
2AH	0000_000aB	Par 21 MSB
2BH	0aaa_aaaaB	Par 21 LSB
2CH	0000_000aB	Par 22 MSB
2DH	0aaa_aaaaB	Par 22 LSB
2EH	0000_000aB	Par 23 MSB
2FH	0aaa_aaaaB	Par 23 LSB
30H	0000_000aB	Par 24 MSB
31H	0aaa_aaaaB	Par 24 LSB
32H	0000_000aB	Par 25 MSB
33H	0aaa_aaaaB	Par 25 LSB
36H	0000_000aB	Par 27 MSB MASTER
37H	0aaa_aaaaB	Par 27 LSB
40H	0000_000aB	Par 32 MSB MIDI CNT RECEIVE
41H	0aaa_aaaaB	Par 32 LSB RECEIVE
(OFF. AF. TOUCH. P. BEND. =0 - #31, #64 - #95)		
48H	0000_000aB	Par 36 MSB MIDI CNT ASSIGN
49H	0aaa_aaaaB	Par 36 LSB ASSIGN

* Table 13
STEREO PITCH SHIFT

Offset	Address	Description
00H	0000_1100B	algorithm 12
01H	0000_0000B	DUMMY
04H	0000_000aB	Par 2 MSB P.S. L
05H	0aaa_aaaaB	Par 2 LSB
06H	0000_000aB	Par 3 MSB
07H	0aaa_aaaaB	Par 3 LSB
08H	0000_000aB	Par 4 MSB
09H	0aaa_aaaaB	Par 4 LSB
0AH	0000_000aB	Par 5 MSB
0BH	0aaa_aaaaB	Par 5 LSB
0CH	0000_000aB	Par 6 MSB
0DH	0aaa_aaaaB	Par 6 LSB
12H	0000_000aB	Par 9 MSB
13H	0aaa_aaaaB	Par 9 LSB
14H	0000_000aB	Par 10 MSB
15H	0aaa_aaaaB	Par 10 LSB
16H	0000_000aB	Par 11 MSB
17H	0aaa_aaaaB	Par 11 LSB
18H	0000_000aB	Par 12 MSB
19H	0aaa_aaaaB	Par 12 LSB
1AH	0000_000aB	Par 13 MSB
1BH	0aaa_aaaaB	Par 13 LSB
1EH	0000_000aB	Par 15 MSB P.S. R
1FH	0aaa_aaaaB	Par 15 LSB
20H	0000_000aB	Par 16 MSB
21H	0aaa_aaaaB	Par 16 LSB
22H	0000_000aB	Par 17 MSB
23H	0aaa_aaaaB	Par 17 LSB
24H	0000_000aB	Par 18 MSB
25H	0aaa_aaaaB	Par 18 LSB
26H	0000_000aB	Par 19 MSB
27H	0aaa_aaaaB	Par 19 LSB
28H	0000_000aB	Par 20 MSB
29H	0aaa_aaaaB	Par 20 LSB
2AH	0000_000aB	Par 21 MSB
2BH	0aaa_aaaaB	Par 21 LSB
2CH	0000_000aB	Par 22 MSB
2DH	0aaa_aaaaB	Par 22 LSB
2EH	0000_000aB	Par 23 MSB
2FH	0aaa_aaaaB	Par 23 LSB
30H	0000_000aB	Par 24 MSB
31H	0aaa_aaaaB	Par 24 LSB
32H	0000_000aB	Par 25 MSB
33H	0aaa_aaaaB	Par 25 LSB
36H	0000_000aB	Par 27 MSB MASTER
37H	0aaa_aaaaB	Par 27 LSB
40H	0000_000aB	Par 32 MSB MIDI CNT RECEIVE
41H	0aaa_aaaaB	Par 32 LSB RECEIVE
(OFF. AF. TOUCH. P. BEND. =0 - #31, #64 - #95)		
48H	0000_000aB	Par 36 MSB MIDI CNT ASSIGN
49H	0aaa_aaaaB	Par 36 LSB ASSIGN

50H	0000_000aB	Par 40 MSB	MIDI CNT MIN H	MSB	Table31
51H	0aaa_aaaaB	Par 40 LSB	MIN H	LSB	
52H	0000_000aB	Par 41 MSB	MIN L	MSB	
53H	0aaa_aaaaB	Par 41 LSB	MIN L	LSB	
54H	0000_000aB	Par 42 MSB	MIDI CNT MAX H	MSB	
55H	0aaa_aaaaB	Par 42 LSB	MAX H	LSB	
56H	0000_000aB	Par 43 MSB	MAX L	MSB	
57H	0aaa_aaaaB	Par 43 LSB	MAX L	LSB	
68H	0aaa_aaaaB	Name 1			
73H	0aaa_aaaaB	Name 12			
74H	0000_0000H	End Of Name			
75H	0000_0000B	END Of Data			

Table 31

MIDI CNT ASSIGN 0	P. S. L FINE	0 - 1250 (-1250 - +1250)
	MASTER LEVEL	0 - 100
		MIDI CNT MIN L / MAX L
		DUMMY (IGNORED IF RECEIVED)

* Table 14
STEREO FLANGER

Offset	Address	Description
00H	0000_1101B	algorithm 13
01H	0000_0000B	DUMMY
04H	0000_000aB	Par 2 MSB FLANGER MODE MSB 0 - 1
05H	0aaa_aaaaB	Par 2 LSB MODE LSB (1,2)
06H	0000_000aB	Par 3 MSB RATE MSB 0 - 100
07H	0aaa_aaaaB	Par 3 LSB RATE LSB
08H	0000_000aB	Par 4 MSB DEPTH MSB 0 - 100
09H	0aaa_aaaaB	Par 4 LSB DEPTH LSB
0AH	0000_000aB	Par 5 MSB MANUAL MSB 0 - 100
0BH	0aaa_aaaaB	Par 5 LSB MANUAL LSB
0CH	0000_000aB	Par 6 MSB RESONANCE MSB 0 - 100
0DH	0aaa_aaaaB	Par 6 LSB RESONANCE LSB
0EH	0000_000aB	Par 7 MSB MOD. PHASE MSB 0 - 180
0FH	0aaa_aaaaB	Par 7 LSB MOD. PHASE LSB
12H	0000_000aB	Par 9 MSB GATE ON/OFF MSB 0 - 1
13H	0aaa_aaaaB	Par 9 LSB OK/OFF LSB (OFF, ON)
14H	0000_000aB	Par 10 MSB RATE MSB 0 - 100
15H	0aaa_aaaaB	Par 10 LSB RATE LSB
1EH	0000_000aB	Par 15 MSB MASTER LEVEL MSB 0 - 100
1FH	0aaa_aaaaB	Par 15 LSB LEVEL LSB
2AH	0000_000aB	Par 21 MSB MIDI CNT RECEIVE MSB 0 - 66
2BH	0aaa_aaaaB	Par 21 LSB RECEIVE LSB
		(OFF, AF, TOUCH, P. BEND, =0 - =31, =64 - =95)
36H	0000_000aB	Par 27 MSB MIDI CNT ASSIGN MSB 0 - 4
37H	0aaa_aaaaB	Par 27 LSB ASSIGN LSB
40H	0000_000aB	Par 32 MSB MIDI CNT MIX MSB
41H	0aaa_aaaaB	Par 32 LSB MIX LSB
48H	0000_000aB	Par 36 MSB MIDI CNT MAX MSB
49H	0aaa_aaaaB	Par 36 LSB MAX LSB
68H	0aaa_aaaaB	Name 1
73H	0aaa_aaaaB	Name 12
74H	0000_0000H	End Of Name
75H	0000_0000B	END Of Data

Table 32

MIDI CNT ASSIGN 0	FLANGER RATE	0 - 100
1	GATE ON/OFF	0 - 1
2	GATE ON/OFF (TREG)	0 - 1
3	GATE RATE	0 - 100
4	MASTER LEVEL	0 - 100

* Table 15
STEREO PHASER

Offset	Address	Description
00H	0000_1101B	algorithm 14
01H	0000_0000B	DUMMY
04H	0000_000aB	Par 2 MSB PHASER MODE MSB 0 - 3
05H	0aaa_aaaaB	Par 2 LSB MODE LSB (1 - 4)
06H	0000_000aB	Par 3 MSB RATE MSB 0 - 100
07H	0aaa_aaaaB	Par 3 LSB RATE LSB
08H	0000_000aB	Par 4 MSB DEPTH MSB 0 - 100
09H	0aaa_aaaaB	Par 4 LSB DEPTH LSB
0AH	0000_000aB	Par 5 MSB MANUAL MSB 0 - 100
0BH	0aaa_aaaaB	Par 5 LSB MANUAL LSB
0CH	0000_000aB	Par 6 MSB RESONANCE MSB 0 - 100
0DH	0aaa_aaaaB	Par 6 LSB RESONANCE LSB
0EH	0000_000aB	Par 7 MSB MOD. PHASE MSB 0 - 180
0FH	0aaa_aaaaB	Par 7 LSB MOD. PHASE LSB
12H	0000_000aB	Par 9 MSB MASTER LEVEL MSB 0 - 100
13H	0aaa_aaaaB	Par 9 LSB LEVEL LSB
1EH	0000_000aB	Par 15 MSB MIDI CNT RECEIVE MSB 0 - 66
1FH	0aaa_aaaaB	Par 15 LSB RECEIVE LSB
		(OFF, AF, TOUCH, P. BEND, =0 - =31, =64 - =95)
2AH	0000_000aB	Par 21 MSB MIDI CNT ASSIGN MSB 0 - 2
2BH	0aaa_aaaaB	Par 21 LSB ASSIGN LSB
36H	0000_000aB	Par 27 MSB MIDI CNT MIX MSB 0 - 100
37H	0aaa_aaaaB	Par 27 LSB MIX LSB
40H	0000_000aB	Par 32 MSB MIDI CNT MAX MSB 0 - 100
41H	0aaa_aaaaB	Par 32 LSB MAX LSB
68H	0aaa_aaaaB	Name 1
73H	0aaa_aaaaB	Name 12
74H	0000_0000H	End Of Name
75H	0000_0000B	END Of Data

Table 33

MIDI CNT MIX/MAX	
MIDI CNT ASSIGN 0 - PHASER RATE	0 - 100
1 - PHASER DEPTH	0 - 100
2 - MASTER LEVEL	0 - 100

* Table 16
VOCODER

Offset	Address	Description
00H	0000_1111B	algorithm 15
01H	0000_0000B	DUMMY
04H	0000_000aB	Par 2 MSB VOCODER VO. CHR. 1 MSB 0 - 100
05H	0aaa_aaaaB	Par 2 LSB VO. CHR. 1 LSB
06H	0000_000aB	Par 3 MSB VO. CHR. 2 MSB 0 - 100
07H	0aaa_aaaaB	Par 3 LSB VO. CHR. 2 LSB
08H	0000_000aB	Par 4 MSB VO. CHR. 3 MSB 0 - 100
09H	0aaa_aaaaB	Par 4 LSB VO. CHR. 3 LSB
0AH	0000_000aB	Par 5 MSB VO. CHR. 4 MSB 0 - 100
0BH	0aaa_aaaaB	Par 5 LSB VO. CHR. 4 LSB
12H	0000_000aB	Par 9 MSB VO. CHR. 5 MSB 0 - 100
13H	0aaa_aaaaB	Par 9 LSB VO. CHR. 5 LSB
14H	0000_000aB	Par 10 MSB VO. CHR. 6 MSB 0 - 100
15H	0aaa_aaaaB	Par 10 LSB VO. CHR. 6 LSB
16H	0000_000aB	Par 11 MSB VO. CHR. 7 MSB 0 - 100
17H	0aaa_aaaaB	Par 11 LSB VO. CHR. 7 LSB
18H	0000_000aB	Par 12 MSB HI F. MIX MSB 0 - 100
19H	0aaa_aaaaB	Par 12 LSB HI F. MIX LSB
1EH	0000_000aB	Par 15 MSB CHORUS PRE DELAY MSB 0 - 60
1FH	0aaa_aaaaB	Par 15 LSB PRE DELAY LSB
20H	0000_000aB	Par 16 MSB RATE MSB 0 - 100
21H	0aaa_aaaaB	Par 16 LSB RATE LSB
22H	0000_000aB	Par 17 MSB DEPTH MSB 0 - 100
23H	0aaa_aaaaB	Par 17 LSB DEPTH LSB
2AH	0000_000aB	Par 21 MSB V. S. THRESHOLD MSB 0 - 100

2BH	0aaa_aaaaB	Par 21 LSB	THRESHOLD	LSB	
36H	0000_000aB	Par 27 MSB	MASTER	LEVEL	MSB 0 - 100
37H	0aaa_aaaaB	Par 27 LSB		LEVEL	LSB
68H	0aaa_aaaaB	Name 1			
73H	0aaa_aaaaB	Name 12			
74H	0000_0000B	End Of Name			
75H	0000_0000B	END Of Data			

* Table 17
ROTARY

Offset	Address	Description
00H	0001_0000B	algorithm 16
01H	0000_0000B	DUMMY
04H	0000_000aB	Par 2 MSB ROTARY DRIVE MSB 0 - 100
05H	0aaa_aaaaB	Par 2 LSB DRIVE LSB
06H	0000_000aB	Par 3 MSB SPEED MSB 0 - 100
07H	0aaa_aaaaB	Par 3 LSB SPEED LSB
08H	0000_000aB	Par 4 MSB LO RATE S MSB 0 - 100
09H	0aaa_aaaaB	Par 4 LSB LO RATE S LSB
0AH	0000_000aB	Par 5 MSB LO RATE F MSB 0 - 100
0BH	0aaa_aaaaB	Par 5 LSB LO RATE F LSB
0CH	0000_000aB	Par 6 MSB HI RATE S MSB 0 - 100
0DH	0aaa_aaaaB	Par 6 LSB HI RATE S LSB
0EH	0000_000aB	Par 7 MSB HI RATE F MSB 0 - 100
0FH	0aaa_aaaaB	Par 7 LSB HI RATE F LSB
12H	0000_000aB	Par 9 MSB LO RISE T MSB 0 - 100
13H	0aaa_aaaaB	Par 9 LSB LO RISE T LSB
14H	0000_000aB	Par 10 MSB HI RISE T MSB 0 - 100
15H	0aaa_aaaaB	Par 10 LSB HI RISE T LSB
16H	0000_000aB	Par 11 MSB LO LEVEL MSB 0 - 100
17H	0aaa_aaaaB	Par 11 LSB LO LEVEL LSB
18H	0000_000aB	Par 12 MSB HI LEVEL MSB 0 - 100
19H	0aaa_aaaaB	Par 12 LSB HI LEVEL LSB
1AH	0000_000aB	Par 13 MSB SEPARAT. MSB 0 - 100
1BH	0aaa_aaaaB	Par 13 LSB SEPARAT. LSB
1EH	0000_000aB	Par 15 MSB X. S. THRESHOLD MSB 0 - 100
1FH	0aaa_aaaaB	Par 15 LSB THRESHOLD LSB
2AH	0000_000aB	Par 21 MSB MASTER LEVEL MSB 0 - 100
2BH	0aaa_aaaaB	Par 21 LSB LEVEL LSB
36H	0000_000aB	Par 27 MSB MIDI CNT RECEIVE MSB 0 - 66
37H	0aaa_aaaaB	Par 27 LSB RECEIVE LSB (OFF. AF. TOUCH. P. BEND. =0 - =31, =64 - =95)
40H	0000_000aB	Par 32 MSB MIDI CNT ASSIGN MSB 0 - 3
41H	0aaa_aaaaB	Par 32 LSB ASSIGN LSB
48H	0000_000aB	Par 36 MSB MIDI CNT MIN MSB Table 34
49H	0aaa_aaaaB	Par 36 LSB MIN LSB
50H	0000_000aB	Par 40 MSB MIDI CNT MAX MSB
51H	0aaa_aaaaB	Par 40 LSB MAX LSB
68H	0aaa_aaaaB	Name 1
73H	0aaa_aaaaB	Name 12
74H	0000_0000B	End Of Name
75H	0000_0000B	END Of Data

Table 34

MIDI CNT ASSIGN	ROTARY DRIVE	0	100
0	ROTARY DRIVE	0	100
1	ROTARY SPEED	0	1
2	ROTARY SPEED (TREG)	0	1
3	MASTER LEVEL	0	100

* Table 18
KEYBOARD MULTI 1

Offset	Address	Description
00H	0001_0001B	algorithm 17
01H	0000_0000B	DUMMY
02H	0000_000aB	Par 1 MSB EFFECT ON/OFF MSB
03H	0bcd_0000B	Par 1 LSB ON/OFF LSB
		a : EQUALIZER OFF/OX 0 / 1
		b : DELAY OFF/OX 0 / 1
		c : CHORUS OFF/OX 0 / 1
		d : REVERB OFF/OX 0 / 1
04H	0000_000aB	Par 2 MSB EQ LOW EQ MSB 0 - 24
05H	0aaa_aaaaB	Par 2 LSB LOW EQ LSB (-12--12dB)
06H	0000_000aB	Par 3 MSB MID FREQ MSB 0 - 12
07H	0aaa_aaaaB	Par 3 LSB MID FREQ LSB (250Hz-4kHz)
08H	0000_000aB	Par 4 MSB MID EQ MSB 0 - 24
09H	0aaa_aaaaB	Par 4 LSB MID EQ LSB (-12--12dB)
0AH	0000_000aB	Par 5 MSB HIGH EQ MSB 0 - 24
0BH	0aaa_aaaaB	Par 5 LSB HIGH EQ LSB (-12--12dB)
0CH	0000_000aB	Par 6 MSB LPF MSB 0 - 11
0DH	0aaa_aaaaB	Par 6 LSB LPF LSB (500Hz-THRU)
0EH	0000_000aB	Par 7 MSB LEVEL MSB 0 - 24
0FH	0aaa_aaaaB	Par 7 LSB LEVEL LSB (-12--12dB)
12H	0000_000aB	Par 9 MSB DELAY D. TIME H MSB 0 - 800
13H	0aaa_aaaaB	Par 9 LSB D. TIME H LSB
14H	0000_000aB	Par 10 MSB D. TIME L MSB
15H	0aaa_aaaaB	Par 10 LSB D. TIME L LSB
16H	0000_000aB	Par 11 MSB FEEDBACK MSB 0 - 100
17H	0aaa_aaaaB	Par 11 LSB FEEDBACK LSB
18H	0000_000aB	Par 12 MSB LEVEL MSB 0 - 100
19H	0aaa_aaaaB	Par 12 LSB LEVEL LSB
1EH	0000_000aB	Par 15 MSB CHORUS PRE DELAY MSB 0 - 60
1FH	0aaa_aaaaB	Par 15 LSB PRE DELAY LSB
20H	0000_000aB	Par 16 MSB RATE MSB 0 - 100
21H	0aaa_aaaaB	Par 16 LSB RATE LSB
22H	0000_000aB	Par 17 MSB DEPTH MSB 0 - 100
23H	0aaa_aaaaB	Par 17 LSB DEPTH LSB
2AH	0000_000aB	Par 21 MSB REVERB REV TIME MSB 0 - 199
2BH	0aaa_aaaaB	Par 21 LSB REV TIME LSB (0.1-20.0s)
2CH	0000_000aB	Par 22 MSB PRE DELAY MSB 0 - 100
2DH	0aaa_aaaaB	Par 22 LSB PRE DELAY LSB
2EH	0000_000aB	Par 23 MSB LPF MSB 0 - 11
2FH	0aaa_aaaaB	Par 23 LSB LPF LSB (500Hz-THRU)
30H	0000_000aB	Par 24 MSB LEVEL MSB 0 - 100
31H	0aaa_aaaaB	Par 24 LSB LEVEL LSB
36H	0000_000aB	Par 27 MSB MASTER LEVEL MSB 0 - 100
37H	0aaa_aaaaB	Par 27 LSB LEVEL LSB
40H	0000_000aB	Par 32 MSB MIDI CNT RECEIVE MSB 0 - 66
41H	0aaa_aaaaB	Par 32 LSB RECEIVE LSB (OFF. AF. TOUCH. P. BEND. =0 - =31, =64 - =95)
48H	0000_000aB	Par 36 MSB MIDI CNT ASSIGN MSB 0 - 3
49H	0aaa_aaaaB	Par 36 LSB ASSIGN LSB
50H	0000_000aB	Par 40 MSB MIDI CNT MIN MSB 0 - 100 Table 35
51H	0aaa_aaaaB	Par 40 LSB MIN LSB
54H	0000_000aB	Par 42 MSB MIDI CNT MAX MSB 0 - 100
55H	0aaa_aaaaB	Par 42 LSB MAX LSB
68H	0aaa_aaaaB	Name 1
73H	0aaa_aaaaB	Name 12
74H	0000_0000B	End Of Name
75H	0000_0000B	END Of Data

Table 35

MIDI CNT ASSIGN	DELAY LEVEL	0	100
0	DELAY LEVEL	0	100
1	CHORUS RATE	0	100
2	REVERB LEVEL	0	100
3	MASTER LEVEL	0	100

* Table 19
KEYBOARD MULTI 2

Offset	Address	Description
00H	0001_0010B	algorithm 18
01H	0000_0000B	DUMMY
02H	0000_000aB	Par 1 MSB EFFECT ON/OFF MSB
03H	0bcd_0000B	Par 1 LSB ON/OFF LSB
		a : PHASER OFF/ON 0 / 1
		b : EQUALIZER OFF/ON 0 / 1
		c : CHORUS OFF/ON 0 / 1
		d : REVERB OFF/ON 0 / 1
04H	0000_000aB	Par 2 MSB PHASER MODE MSB 0 - 3
05H	0aaa_aaaaB	Par 2 LSB MODE LSB (1 - 4)
06H	0000_000aB	Par 3 MSB RATE MSB 0 - 100
07H	0aaa_aaaaB	Par 3 LSB RATE LSB
08H	0000_000aB	Par 4 MSB DEPTH MSB 0 - 100
09H	0aaa_aaaaB	Par 4 LSB DEPTH LSB
0AH	0000_000aB	Par 5 MSB MANUAL MSB 0 - 100
0BH	0aaa_aaaaB	Par 5 LSB MANUAL LSB
0CH	0000_000aB	Par 6 MSB RESONANCE MSB 0 - 100
0DH	0aaa_aaaaB	Par 6 LSB RESONANCE LSB
0EH	0000_000aB	Par 7 MSB STEP MSB 0 - 100
0FH	0aaa_aaaaB	Par 7 LSB STEP LSB
12H	0000_000aB	Par 9 MSB EQ LOW EQ MSB 0 - 24
13H	0aaa_aaaaB	Par 9 LSB LOW EQ LSB (-12--+12dB)
14H	0000_000aB	Par 10 MSB MID FREQ MSB 0 - 12
15H	0aaa_aaaaB	Par 10 LSB MID FREQ LSB (250Hz-4kHz)
16H	0000_000aB	Par 11 MSB MID EQ MSB 0 - 24
17H	0aaa_aaaaB	Par 11 LSB MID EQ LSB (-12--+12dB)
18H	0000_000aB	Par 12 MSB HIGH EQ MSB 0 - 24
19H	0aaa_aaaaB	Par 12 LSB HIGH EQ LSB (-12--+12dB)
1AH	0000_000aB	Par 13 MSB LEVEL MSB 0 - 24
1BH	0aaa_aaaaB	Par 13 LSB LEVEL LSB (-12--+12dB)
1EH	0000_000aB	Par 15 MSB CHORUS PRE DELAY MSB 0 - 60
1FH	0aaa_aaaaB	Par 15 LSB PRE DELAY LSB
20H	0000_000aB	Par 16 MSB RATE MSB 0 - 100
21H	0aaa_aaaaB	Par 16 LSB RATE LSB
22H	0000_000aB	Par 17 MSB DEPTH MSB 0 - 100
23H	0aaa_aaaaB	Par 17 LSB DEPTH LSB
2AH	0000_000aB	Par 21 MSB REVERB REV TIME MSB 0 - 199
2BH	0aaa_aaaaB	Par 21 LSB REV TIME LSB (0.1-20.0s)
2CH	0000_000aB	Par 22 MSB PRE DELAY MSB 0 - 200
2DH	0aaa_aaaaB	Par 22 LSB PRE DELAY LSB
2EH	0000_000aB	Par 23 MSB LPF MSB 0 - 10
2FH	0aaa_aaaaB	Par 23 LSB LPF LSB (500Hz-THRU)
30H	0000_000aB	Par 24 MSB LEVEL MSB 0 - 100
31H	0aaa_aaaaB	Par 24 LSB LEVEL LSB
36H	0000_000aB	Par 27 MSB MASTER LEVEL MSB 0 - 100
37H	0aaa_aaaaB	Par 27 LSB LEVEL LSB
40H	0000_000aB	Par 32 MSB MIDI CNT RECEIVE MSB 0 - 66
41H	0aaa_aaaaB	Par 32 LSB RECEIVE LSB (OFF. AF. TOUCH, P. BEND, =0 - =31, =64 - =95)
48H	0000_000aB	Par 36 MSB MIDI CNT ASSIGN MSB 0 - 5
49H	0aaa_aaaaB	Par 36 LSB ASSIGN LSB
50H	0000_000aB	Par 40 MSB MIDI CNT MIN MSB 0 - 100 Table36
51H	0aaa_aaaaB	Par 40 LSB MIN LSB
54H	0000_000aB	Par 42 MSB MIDI CNT MAX MSB 0 - 100
55H	0aaa_aaaaB	Par 42 LSB MAX LSB
68H	0aaa_aaaaB	Name 1
71H	0aaa_aaaaB	Name 12
74H	0000_0000B	End Of Name
75H	0000_0000B	END Of Data

Table 36

MIDI CNT ASSIGN	0	PHASER RATE	0	100
	1	PHASER DEPTH	0	100
	2	PHASER STEP	0	100
	3	CHORUS RATE	0	100
	4	REVERB LEVEL	0	100
	5	MASTER LEVEL	0	100

* Table 20
RHODES

Offset	Address	Description
00H	0001_0011B	algorithm 19
01H	0000_0000B	DUMMY
02H	0000_000aB	Par 1 MSB EFFECT ON/OFF MSB
03H	0bcd_e000B	Par 1 LSB ON/OFF LSB
		a : EQUALIZER OFF/ON 0 / 1
		b : PHASER OFF/ON 0 / 1
		c : CHORUS OFF/ON 0 / 1
		d : PANNING OFF/ON 0 / 1
		e : REVERB OFF/ON 0 / 1
04H	0000_000aB	Par 2 MSB EQ LOW EQ MSB 0 - 24
05H	0aaa_aaaaB	Par 2 LSB LOW EQ LSB (-12--+12dB)
06H	0000_000aB	Par 3 MSB MID FREQ MSB 0 - 12
07H	0aaa_aaaaB	Par 3 LSB MID FREQ LSB (250Hz-4kHz)
08H	0000_000aB	Par 4 MSB MID EQ MSB 0 - 24
09H	0aaa_aaaaB	Par 4 LSB MID EQ LSB (-12--+12dB)
0AH	0000_000aB	Par 5 MSB HIGH EQ MSB 0 - 24
0BH	0aaa_aaaaB	Par 5 LSB HIGH EQ LSB (-12--+12dB)
0CH	0000_000aB	Par 6 MSB LPF MSB 0 - 10
0DH	0aaa_aaaaB	Par 6 LSB LPF LSB (500Hz-THRU)
0EH	0000_000aB	Par 7 MSB LEVEL MSB 0 - 24
0FH	0aaa_aaaaB	Par 7 LSB LEVEL LSB (-12--+12dB)
12H	0000_000aB	Par 9 MSB PHASER RATE MSB 0 - 100
13H	0aaa_aaaaB	Par 9 LSB RATE LSB
14H	0000_000aB	Par 10 MSB DEPTH MSB 0 - 100
15H	0aaa_aaaaB	Par 10 LSB DEPTH LSB
16H	0000_000aB	Par 11 MSB MANUAL MSB 0 - 100
17H	0aaa_aaaaB	Par 11 LSB MANUAL LSB
18H	0000_000aB	Par 12 MSB RESONANCE MSB 0 - 100
19H	0aaa_aaaaB	Par 12 LSB RESONANCE LSB
1EH	0000_000aB	Par 15 MSB N.S. THRESHOLD MSB 0 - 100
1FH	0aaa_aaaaB	Par 15 LSB THRESHOLD LSB
20H	0000_000aB	Par 16 MSB RELEASE MSB 0 - 100
21H	0aaa_aaaaB	Par 16 LSB RELEASE LSB
22H	0000_000aB	Par 17 MSB LEVEL MSB 0 - 100
23H	0aaa_aaaaB	Par 17 LSB LEVEL LSB
2AH	0000_000aB	Par 21 MSB CHORUS PRE DELAY MSB 0 - 60
2BH	0aaa_aaaaB	Par 21 LSB PRE DELAY LSB
2CH	0000_000aB	Par 22 MSB RATE MSB 0 - 100
2DH	0aaa_aaaaB	Par 22 LSB RATE LSB
2EH	0000_000aB	Par 23 MSB DEPTH MSB 0 - 100
2FH	0aaa_aaaaB	Par 23 LSB DEPTH LSB
36H	0000_000aB	Par 27 MSB PANNING RATE MSB 0 - 100
37H	0aaa_aaaaB	Par 27 LSB RATE LSB
38H	0000_000aB	Par 28 MSB DEPTH MSB 0 - 100
39H	0aaa_aaaaB	Par 28 LSB DEPTH LSB
3AH	0000_000aB	Par 29 MSB MOD. WAVE MSB 0 - 1
3BH	0aaa_aaaaB	Par 29 LSB MOD. WAVE LSB (TRI, SQR)
40H	0000_000aB	Par 32 MSB REVERB REV TIME MSB 0 - 199
41H	0aaa_aaaaB	Par 32 LSB REV TIME LSB (0.1-20.0s)
42H	0000_000aB	Par 33 MSB PRE DELAY MSB 0 - 200
43H	0aaa_aaaaB	Par 33 LSB PRE DELAY LSB
44H	0000_000aB	Par 34 MSB LPF MSB 0 - 10
45H	0aaa_aaaaB	Par 34 LSB LPF LSB (500Hz-THRU)
46H	0000_000aB	Par 35 MSB LEVEL MSB 0 - 100
47H	0aaa_aaaaB	Par 35 LSB LEVEL LSB
48H	0000_000aB	Par 36 MSB MASTER LEVEL MSB 0 - 100
49H	0aaa_aaaaB	Par 36 LSB LEVEL LSB
50H	0000_000aB	Par 40 MSB MIDI CNT RECEIVE MSB 0 - 66
51H	0aaa_aaaaB	Par 40 LSB RECEIVE LSB (OFF. AF. TOUCH, P. BEND, =0 - =31, =64 - =95)
54H	0000_000aB	Par 42 MSB MIDI CNT ASSIGN MSB 0 - 7
55H	0aaa_aaaaB	Par 42 LSB ASSIGN LSB
58H	0000_000aB	Par 44 MSB MIDI CNT MIN MSB 0 - 100 Table37
59H	0aaa_aaaaB	Par 44 LSB MIN LSB
6CH	0000_000aB	Par 46 MSB MIDI CNT MAX MSB 0 - 100
6DH	0aaa_aaaaB	Par 46 LSB MAX LSB
68H	0aaa_aaaaB	Name 1
71H	0aaa_aaaaB	Name 12
74H	0000_0000B	End Of Name
75H	0000_0000B	END Of Data

Table 37

MIDI CNT MIN/MAX			
MIDI CNT ASSIGN	0	PHASER RATE	0 - 100
	1	PHASER DEPTH	0 - 100
	2	K.S. LEVEL	0 - 100
	3	CHORUS RATE	0 - 100
	4	PANNING RATE	0 - 100
	5	PANNING DEPTH	0 - 100
	6	REVERB LEVEL	0 - 100
	7	MASTER LEVEL	0 - 100

* Table 21
GUITAR MULTI

Offset Address	Description
00H: 0001_0100B	algorithm 20
01H: 0000_0000B	DUMMY
02H: 0000_000aB	Par 1 MSB EFFECT ON/OFF MSB
03H: 0bcd_efg0B	Par 1 LSB ON/OFF LSB
	a : COMPRESSOR OFF/ON 0 / 1
	b : OD/DS OFF/ON 0 / 1
	c : EQUALIZER OFF/ON 0 / 1
	d : DELAY OFF/ON 0 / 1
	e : CHORUS OFF/ON 0 / 1
	f : REVERB OFF/ON 0 / 1
	g : LINE DRIVER OFF/ON 0 / 1
04H: 0000_000aB	Par 2 MSB COMP. SUSTAIN MSB 0 - 100
05H: 0aaa_aaaaB	Par 2 LSB SUSTAIN LSB
06H: 0000_000aB	Par 3 MSB ATTACK MSB 0 - 100
07H: 0aaa_aaaaB	Par 3 LSB ATTACK LSB
08H: 0000_000aB	Par 4 MSB LEVEL MSB 0 - 100
09H: 0aaa_aaaaB	Par 4 LSB LEVEL LSB
12H: 0000_000aB	Par 9 MSB OD/DS MODE MSB 0 - 3
13H: 0aaa_aaaaB	Par 9 LSB MODE LSB (OD TURBO OFF-DS TURBO ON)
14H: 0000_000aB	Par 10 MSB DRIVE MSB 0 - 100
15H: 0aaa_aaaaB	Par 10 LSB DRIVE LSB
16H: 0000_000aB	Par 11 MSB LEVEL MSB 0 - 100
17H: 0aaa_aaaaB	Par 11 LSB LEVEL LSB
1EH: 0000_000aB	Par 15 MSB EQ LOW EQ MSB 0 - 24
1FH: 0aaa_aaaaB	Par 15 LSB LOW EQ LSB (-12--12dB)
20H: 0000_000aB	Par 16 MSB MID FREQ MSB 0 - 12
21H: 0aaa_aaaaB	Par 16 LSB MID FREQ LSB (250Hz-4kHz)
22H: 0000_000aB	Par 17 MSB MID EQ MSB 0 - 24
23H: 0aaa_aaaaB	Par 17 LSB MID EQ LSB (-12--12dB)
24H: 0000_000aB	Par 18 MSB HIGH EQ MSB 0 - 24
25H: 0aaa_aaaaB	Par 18 LSB HIGH EQ LSB (-12--12dB)
26H: 0000_000aB	Par 19 MSB LEVEL MSB 0 - 24
27H: 0aaa_aaaaB	Par 19 LSB LEVEL LSB (-12--12dB)
2AH: 0000_000aB	Par 21 MSB V.S. THRESHOLD MSB 0 - 100
2BH: 0aaa_aaaaB	Par 21 LSB THRESHOLD LSB
2CH: 0000_000aB	Par 22 MSB RELEASE MSB 0 - 100
2DH: 0aaa_aaaaB	Par 22 LSB RELEASE LSB
2EH: 0000_000aB	Par 23 MSB LEVEL MSB 0 - 100
2FH: 0aaa_aaaaB	Par 23 LSB LEVEL LSB
36H: 0000_000aB	Par 27 MSB DELAY D. TIME H MSB 0 - 1200
37H: 0aaa_aaaaB	Par 27 LSB D. TIME H LSB
38H: 0000_000aB	Par 28 MSB D. TIME L MSB
39H: 0aaa_aaaaB	Par 28 LSB D. TIME L LSB
3AH: 0000_000aB	Par 29 MSB FEEDBACK MSB 0 - 100
3BH: 0aaa_aaaaB	Par 29 LSB FEEDBACK LSB
3CH: 0000_000aB	Par 30 MSB LEVEL MSB 0 - 100
3DH: 0aaa_aaaaB	Par 30 LSB LEVEL LSB
40H: 0000_000aB	Par 32 MSB CHORUS MODE MSB 0 - 2
41H: 0aaa_aaaaB	Par 32 LSB MODE LSB (MONO-STEREO)
42H: 0000_000aB	Par 33 MSB RATE MSB 0 - 100
43H: 0aaa_aaaaB	Par 33 LSB RATE LSB
44H: 0000_000aB	Par 34 MSB DEPTH MSB 0 - 100
45H: 0aaa_aaaaB	Par 34 LSB DEPTH LSB
46H: 0000_000aB	Par 35 MSB FEEDBACK MSB 0 - 100
47H: 0aaa_aaaaB	Par 35 LSB FEEDBACK LSB
48H: 0000_000aB	Par 36 MSB REVERB REV TIME MSB 0 - 199
49H: 0aaa_aaaaB	Par 36 LSB REV TIME LSB (0.1 - 20.0s)
4AH: 0000_000aB	Par 37 MSB PRE DELAY MSB 0 - 200
4BH: 0aaa_aaaaB	Par 37 LSB PRE DELAY LSB
4CH: 0000_000aB	Par 3A MSB LPF MSB 0 - 10

4DH: 0aaa_aaaaB	Par 3B LSB LPF LSB (500Hz-THRU)
4EH: 0000_000aB	Par 39 MSB LEVEL MSB 0 - 100
4FH: 0aaa_aaaaB	Par 39 LSB LEVEL LSB
50H: 0000_000aB	Par 40 MSB LINE DR. MODE MSB 0 - 1
51H: 0aaa_aaaaB	Par 40 LSB MODE LSB (1,2)
54H: 0000_000aB	Par 42 MSB MASTER LEVEL MSB 0 - 100
55H: 0aaa_aaaaB	Par 42 LSB LEVEL LSB
58H: 0000_000aB	Par 44 MSB MIDI CNT RECEIVE MSB 0 - 66
59H: 0aaa_aaaaB	Par 44 LSB RECEIVE LSB
	(OFF. AF. TOUCH. P. BEND. =0 - =31, =64 - =95)
5CH: 0000_000aB	Par 46 MSB MIDI CNT ASSIGN MSB 0 - 5
5DH: 0aaa_aaaaB	Par 46 LSB ASSIGN LSB
60H: 0000_000aB	Par 48 MSB MIDI CNT MIR MSB 0 - 100 Table 38
61H: 0aaa_aaaaB	Par 48 LSB MIN LSB
64H: 0000_000aB	Par 50 MSB MIDI CNT MAX MSB 0 - 100
65H: 0aaa_aaaaB	Par 50 LSB MAX LSB
68H: 0aaa_aaaaB	Name 1
73H: 0aaa_aaaaB	Name 12
74H: 0000_0000B	End Of Name
75H: 0000_0000B	END Of Data

Table 38

MIDI CNT MIN/MAX			
MIDI CNT ASSIGN	0	OD/DS DRIVE	0 - 100
	1	K.S. LEVEL	0 - 100
	2	DELAY LEVEL	0 - 100
	3	CHORUS RATE	0 - 100
	4	REVERB LEVEL	0 - 100
	5	MASTER LEVEL	0 - 100

* Table 22
VOCAL MULTI

Offset Address	Description
00H: 0001_0101B	algorithm 21
01H: 0000_0000B	DUMMY
02H: 0000_000aB	Par 1 MSB EFFECT ON/OFF MSB
03H: 0bcd_e000B	Par 1 LSB ON/OFF LSB
	a : LIMITER OFF/ON 0 / 1
	b : ENHANCER OFF/ON 0 / 1
	c : DELAY OFF/ON 0 / 1
	d : CHORUS OFF/ON 0 / 1
	e : REVERB OFF/ON 0 / 1
04H: 0000_000aB	Par 2 MSB LIMITER THRESHOLD MSB 0 - 100
05H: 0aaa_aaaaB	Par 2 LSB THRESHOLD LSB
06H: 0000_000aB	Par 3 MSB RATIO MSB 0 - 3
07H: 0aaa_aaaaB	Par 3 LSB RATIO LSB (2:1-10:1)
08H: 0000_000aB	Par 4 MSB RELEASE MSB 0 - 100
09H: 0aaa_aaaaB	Par 4 LSB RELEASE LSB
0AH: 0000_000aB	Par 5 MSB LEVEL MSB 0 - 100
0BH: 0aaa_aaaaB	Par 5 LSB LEVEL LSB
12H: 0000_000aB	Par 9 MSB ENHANCER SENS MSB 0 - 100
13H: 0aaa_aaaaB	Par 9 LSB SENS LSB
14H: 0000_000aB	Par 10 MSB LOW MIX MSB 0 - 100
15H: 0aaa_aaaaB	Par 10 LSB LOW MIX LSB
16H: 0000_000aB	Par 11 MSB HIGH MIX MSB 0 - 100
17H: 0aaa_aaaaB	Par 11 LSB HIGH MIX LSB
1EH: 0000_000aB	Par 15 MSB V.S. THRESHOLD MSB 0 - 100
1FH: 0aaa_aaaaB	Par 15 LSB THRESHOLD LSB
20H: 0000_000aB	Par 16 MSB RELEASE MSB 0 - 100
21H: 0aaa_aaaaB	Par 16 LSB RELEASE LSB
2AH: 0000_000aB	Par 21 MSB DELAY D. TIME H MSB 0 - 1000
2BH: 0aaa_aaaaB	Par 21 LSB D. TIME H LSB
2CH: 0000_000aB	Par 22 MSB D. TIME L MSB
2DH: 0aaa_aaaaB	Par 22 LSB D. TIME L LSB
2EH: 0000_000aB	Par 23 MSB FEEDBACK MSB 0 - 100
2FH: 0aaa_aaaaB	Par 23 LSB FEEDBACK LSB
30H: 0000_000aB	Par 24 MSB LEVEL MSB 0 - 100
31H: 0aaa_aaaaB	Par 24 LSB LEVEL LSB

36H	0000_000aB	Par 27 MSB	CHORUS	PRE DELAY	MSB	0 - 60
37H	0aaa_aaaaB	Par 27 LSB		PRE DELAY	LSB	
38H	0000_000aB	Par 28 MSB		RATE	MSB	0 - 100
39H	0aaa_aaaaB	Par 28 LSB		RATE	LSB	
3AH	0000_000aB	Par 29 MSB		DEPTH	MSB	0 - 100
3BH	0aaa_aaaaB	Par 29 LSB		DEPTH	LSB	
40H	0000_000aB	Par 32 MSB	REVERB	REV TIME	MSB	0 - 199
41H	0aaa_aaaaB	Par 32 LSB		REV TIME	LSB	(0.1-20.0s)
42H	0000_000aB	Par 33 MSB		PRE DELAY	MSB	0 - 200
43H	0aaa_aaaaB	Par 33 LSB		PRE DELAY	LSB	
44H	0000_000aB	Par 34 MSB		LPF	MSB	0 - 10
45H	0aaa_aaaaB	Par 34 LSB		LPF	LSB	(500Hz, THRU)
46H	0000_000aB	Par 35 MSB		LEVEL	MSB	0 - 100
47H	0aaa_aaaaB	Par 35 LSB		LEVEL	LSB	
48H	0000_000aB	Par 36 MSB	MASTER	LEVEL	MSB	0 - 100
49H	0aaa_aaaaB	Par 36 LSB		LEVEL	LSB	
50H	0000_000aB	Par 40 MSB	MIDI CNT RECEIVE	MSB	0 - 66	
51H	0aaa_aaaaB	Par 40 LSB	RECEIVE	LSB		
(OFF. AF. TOUCH, P. BEND, #0 - #31, #64 - #95)						
54H	0000_000aB	Par 42 MSB	MIDI CNT ASSIGN	MSB	0 - 3	
55H	0aaa_aaaaB	Par 42 LSB	ASSIGN	LSB		
58H	0000_000aB	Par 44 MSB	MIDI CNT MIX	MSB	0 - 100	Table39:
59H	0aaa_aaaaB	Par 44 LSB	MIX	LSB		
5CH	0000_000aB	Par 46 MSB	MIDI CNT MAX	MSB	0 - 100	
5DH	0aaa_aaaaB	Par 46 LSB	MAX	LSB		
68H	0aaa_aaaaB	Name 1				
73H	0aaa_aaaaB	Name 12				
74H	0000_0000B	End Of Name				
75H	0000_0000B	END Of Data				

Table 39

MIDI CNT MIN/MAX			
MIDI CNT ASSIGN	DELAY	LEVEL	
0			0 - 100
1	CHORUS RATE		0 - 100
2	REVERB LEVEL		0 - 100
3	MASTER LEVEL		0 - 100

* Table 23
STEREO ENHANCER

Offset	Address	Description
00H	0001_0110B	algorithm 22
01H	0000_0000B	DUMMY
02H	0000_000aB	Par 1 MSB EFFECT ON/OFF MSB
03H	0bc0_0000B	Par 1 LSB ON/OFF LSB
a : LIMITER OFF:ON 0 / 1		
b : ENHANCER OFF:ON 0 / 1		
c : X. SUPPRESSOR OFF:ON 0 / 1		
04H	0000_000aB	Par 2 MSB LIMITER THRESHOLD MSB 0 - 100
05H	0aaa_aaaaB	Par 2 LSB THRESHOLD LSB
06H	0000_000aB	Par 3 MSB RATIO MSB 0 - 3
07H	0aaa_aaaaB	Par 3 LSB RATIO LSB (2.1, 20.1)
08H	0000_000aB	Par 4 MSB RELEASE MSB 0 - 100
09H	0aaa_aaaaB	Par 4 LSB RELEASE LSB
0AH	0000_000aB	Par 5 MSB LEVEL MSB 0 - 100
0BH	0aaa_aaaaB	Par 5 LSB LEVEL LSB
12H	0000_000aB	Par 9 MSB ENHANCER SESS MSB 0 - 100
13H	0aaa_aaaaB	Par 9 LSB SESS LSB
14H	0000_000aB	Par 10 MSB LOW MIX MSB 0 - 100
15H	0aaa_aaaaB	Par 10 LSB LOW MIX LSB
16H	0000_000aB	Par 11 MSB HIGH MIX MSB 0 - 100
17H	0aaa_aaaaB	Par 11 LSB HIGH MIX LSB
1EH	0000_000aB	Par 15 MSB X.S. THRESHOLD MSB 0 - 100
1FH	0aaa_aaaaB	Par 15 LSB THRESHOLD LSB
20H	0000_000aB	Par 16 MSB RELEASE MSB 0 - 100
21H	0aaa_aaaaB	Par 16 LSB RELEASE LSB
2AH	0000_000aB	Par 21 MSB MASTER LEVEL MSB
2BH	0aaa_aaaaB	Par 21 LSB LEVEL LSB
68H	0aaa_aaaaB	Name 1

* Table 24
2CH MIXER

Offset	Address	Description
00H	0001_0110B	algorithm 23
01H	0000_0000B	DUMMY
04H	0000_000aB	Par 2 MSB CH 1 LOW EQ MSB 0 - 24
05H	0aaa_aaaaB	Par 2 LSB LOW EQ LSB (-12--12dB)
06H	0000_000aB	Par 3 MSB MID FREQ MSB 0 - 12
07H	0aaa_aaaaB	Par 3 LSB MID FREQ LSB (250Hz-4kHz)
08H	0000_000aB	Par 4 MSB MID EQ MSB 0 - 24
09H	0aaa_aaaaB	Par 4 LSB MID EQ LSB (-12--12dB)
0AH	0000_000aB	Par 5 MSB HIGH EQ MSB 0 - 24
0BH	0aaa_aaaaB	Par 5 LSB HIGH EQ LSB (-12--12dB)
0CH	0000_000aB	Par 6 MSB XS THRES. MSB 0 - 100
0DH	0aaa_aaaaB	Par 6 LSB XS THRES. LSB
0EH	0000_000aB	Par 7 MSB XS RELE. MSB 0 - 100
0FH	0aaa_aaaaB	Par 7 LSB XS RELE. LSB
12H	0000_000aB	Par 9 MSB REV LEVEL MSB 0 - 100
13H	0aaa_aaaaB	Par 9 LSB REV LEVEL LSB
14H	0000_000aB	Par 10 MSB DLY LEVEL MSB 0 - 100
15H	0aaa_aaaaB	Par 10 LSB DLY LEVEL LSB
16H	0000_000aB	Par 11 MSB CHO LEVEL MSB 0 - 100
17H	0aaa_aaaaB	Par 11 LSB CHO LEVEL LSB
18H	0000_000aB	Par 12 MSB PAN MSB 0 - 100
19H	0aaa_aaaaB	Par 12 LSB PAN LSB
1AH	0000_000aB	Par 13 MSB LEVEL MSB 0 - 100
1BH	0aaa_aaaaB	Par 13 LSB LEVEL LSB
1EH	0000_000aB	Par 15 MSB CH 2 LOW EQ MSB 0 - 24
1FH	0aaa_aaaaB	Par 15 LSB LOW EQ LSB (-12--12dB)
20H	0000_000aB	Par 16 MSB MID FREQ MSB 0 - 12
21H	0aaa_aaaaB	Par 16 LSB MID FREQ LSB (250Hz-4kHz)
22H	0000_000aB	Par 17 MSB MID EQ MSB 0 - 24
23H	0aaa_aaaaB	Par 17 LSB MID EQ LSB (-12--12dB)
24H	0000_000aB	Par 18 MSB HIGH EQ MSB 0 - 24
25H	0aaa_aaaaB	Par 18 LSB HIGH EQ LSB (-12--12dB)
26H	0000_000aB	Par 19 MSB XS THRES. MSB 0 - 100
27H	0aaa_aaaaB	Par 19 LSB XS THRES. LSB
28H	0000_000aB	Par 20 MSB XS RELE. MSB 0 - 100
29H	0aaa_aaaaB	Par 20 LSB XS RELE. LSB
2AH	0000_000aB	Par 21 MSB REV LEVEL MSB 0 - 100
2BH	0aaa_aaaaB	Par 21 LSB REV LEVEL LSB
2CH	0000_000aB	Par 22 MSB DLY LEVEL MSB 0 - 100
2DH	0aaa_aaaaB	Par 22 LSB DLY LEVEL LSB
2EH	0000_000aB	Par 23 MSB CHO LEVEL MSB 0 - 100
2FH	0aaa_aaaaB	Par 23 LSB CHO LEVEL LSB
30H	0000_000aB	Par 24 MSB PAN MSB 0 - 100
31H	0aaa_aaaaB	Par 24 LSB PAN LSB
32H	0000_000aB	Par 25 MSB LEVEL MSB 0 - 100
33H	0aaa_aaaaB	Par 25 LSB LEVEL LSB
36H	0000_000aB	Par 27 MSB REVERB REV TIME MSB 0 - 199
37H	0aaa_aaaaB	Par 27 LSB REV TIME LSB (0.1-20.0s)
38H	0000_000aB	Par 28 MSB PRE DELAY MSB 0 - 200
39H	0aaa_aaaaB	Par 28 LSB PRE DELAY LSB
3AH	0000_000aB	Par 29 MSB LPF MSB 0 - 10
3BH	0aaa_aaaaB	Par 29 LSB LPF LSB (500Hz-THRU)
3CH	0000_000aB	Par 30 MSB LEVEL MSB 0 - 100
3DH	0aaa_aaaaB	Par 30 LSB LEVEL LSB
40H	0000_000aB	Par 32 MSB DL TAP L D. TIME R MSB 0 - 1200
41H	0aaa_aaaaB	Par 32 LSB D. TIME R LSB
42H	0000_000aB	Par 33 MSB D. TIME L MSB
43H	0aaa_aaaaB	Par 33 LSB D. TIME L LSB
44H	0000_000aB	Par 34 MSB LEVEL MSB 0 - 100
45H	0aaa_aaaaB	Par 34 LSB LEVEL LSB
48H	0000_000aB	Par 36 MSB DL TAP R D. TIME R MSB 0 - 1200
49H	0aaa_aaaaB	Par 36 LSB D. TIME R LSB
4AH	0000_000aB	Par 37 MSB D. TIME L MSB
4BH	0aaa_aaaaB	Par 37 LSB D. TIME L LSB
4CH	0000_000aB	Par 38 MSB LEVEL MSB 0 - 100
4DH	0aaa_aaaaB	Par 38 LSB LEVEL LSB
50H	0000_000aB	Par 40 MSB DL TAP L D. TIME R MSB 0 - 1200

51H: 0aaa_aaaaB	Par 40 LSB	D.TIME H	LSB
52H: 0000_000aB	Par 41 MSB	D.TIME L	MSB
53H: 0aaa_aaaaB	Par 41 LSB	D.TIME L	LSB
54H: 0000_000aB	Par 42 MSB	FEEDBACK	MSB 0 - 100
55H: 0aaa_aaaaB	Par 42 LSB	FEEDBACK	LSB
56H: 0000_000aB	Par 43 MSB	LEVEL	MSB 0 - 100
57H: 0aaa_aaaaB	Par 43 LSB	LEVEL	LSB
58H: 0000_000aB	Par 44 MSB	DELAY LPF	MSB 0 - 10
59H: 0aaa_aaaaB	Par 44 LSB	DELAY LPF	LSB (500Hz-THRU)
5CH: 0000_000aB	Par 46 MSB	CHORUS PRE DELAY	MSB 0 - 60
5DH: 0aaa_aaaaB	Par 46 LSB	CHORUS PRE DELAY	LSB
60H: 0000_000aB	Par 48 MSB	RATE	MSB 0 - 100
61H: 0aaa_aaaaB	Par 48 LSB	RATE	LSB
62H: 0000_000aB	Par 49 MSB	DEPTH	MSB 0 - 100
63H: 0aaa_aaaaB	Par 49 LSB	DEPTH	LSB
64H: 0000_000aB	Par 50 MSB	MASTER LEVEL	MSB 0 - 100
65H: 0aaa_aaaaB	Par 50 LSB	MASTER LEVEL	LSB
68H: 0aaa_aaaaB	Name 1		
73H: 0aaa_aaaaB	Name 12		
74H: 0000_0000B	End Of Name		
75H: 0000_0000B	END OF Data		

* Table 25
REVERB1 - REVERB2

Offset	Address	Description
00H: 0001_1000B	algorithm 24	
01H: 0000_0000B	DUMMY	
04H: 0000_000aB	Par 2 MSB	REVERB 1 REV TIME MSB 0 - 199
05H: 0aaa_aaaaB	Par 2 LSB	REVERB 1 REV TIME LSB (0.1-20.0s)
06H: 0000_000aB	Par 3 MSB	PRE DELAY MSB 0 - 200
07H: 0aaa_aaaaB	Par 3 LSB	PRE DELAY LSB
08H: 0000_000aB	Par 4 MSB	HF DAMP MSB 0 - 9
09H: 0aaa_aaaaB	Par 4 LSB	HF DAMP LSB (0.1-1.0)
12H: 0000_000aB	Par 9 MSB	LPF MSB 0 - 10
13H: 0aaa_aaaaB	Par 9 LSB	LPF LSB (500Hz-THRU)
14H: 0000_000aB	Par 10 MSB	HPF MSB 0 - 11
15H: 0aaa_aaaaB	Par 10 LSB	HPF LSB (THRU-1kHz)
16H: 0000_000aB	Par 11 MSB	LEVEL MSB 0 - 100
17H: 0aaa_aaaaB	Par 11 LSB	LEVEL LSB
1EH: 0000_000aB	Par 15 MSB	REVERB 2 REV TIME MSB 0 - 199
1FH: 0aaa_aaaaB	Par 15 LSB	REVERB 2 REV TIME LSB (0.1-20.0s)
20H: 0000_000aB	Par 16 MSB	PRE DELAY MSB 0 - 200
21H: 0aaa_aaaaB	Par 16 LSB	PRE DELAY LSB
22H: 0000_000aB	Par 17 MSB	HF DAMP MSB 0 - 9
23H: 0aaa_aaaaB	Par 17 LSB	HF DAMP LSB (0.1-1.0)
2AH: 0000_000aB	Par 21 MSB	LPF MSB 0 - 10
2BH: 0aaa_aaaaB	Par 21 LSB	LPF LSB (500Hz-THRU)
2CH: 0000_000aB	Par 22 MSB	HPF MSB 0 - 11
2DH: 0aaa_aaaaB	Par 22 LSB	HPF LSB (THRU-1kHz)
2EH: 0000_000aB	Par 23 MSB	LEVEL MSB 0 - 100
2FH: 0aaa_aaaaB	Par 23 LSB	LEVEL LSB
36H: 0000_000aB	Par 27 MSB	OUTPUT MODE MSB 0 - 1
37H: 0aaa_aaaaB	Par 27 LSB	OUTPUT MODE LSB (MONOx2, STEREO)
40H: 0000_000aB	Par 32 MSB	DIRECT LEVEL L MSB 0 - 100
41H: 0aaa_aaaaB	Par 32 LSB	DIRECT LEVEL L LSB
42H: 0000_000aB	Par 33 MSB	LEVEL R MSB 0 - 100
43H: 0aaa_aaaaB	Par 33 LSB	LEVEL R LSB
4BH: 0000_000aB	Par 36 MSB	MASTER LEVEL L MSB 0 - 100
4CH: 0aaa_aaaaB	Par 36 LSB	MASTER LEVEL L LSB
4DH: 0000_000aB	Par 37 MSB	LEVEL R MSB 0 - 100
4EH: 0aaa_aaaaB	Par 37 LSB	LEVEL R LSB
5AH: 0aaa_aaaaB	Name 1	
73H: 0aaa_aaaaB	Name 12	
74H: 0000_0000B	End Of Name	
75H: 0000_0000B	END OF Data	

* Table 26
GATE - REVERB

Offset	Address	Description
00H: 0001_1001B	algorithm 25	
01H: 0000_0000B	DUMMY	
04H: 0000_000aB	Par 2 MSB	GATE REV GATE TIME MSB 0 - 39
05H: 0aaa_aaaaB	Par 2 LSB	GATE TIME LSB (5 - 200)
06H: 0000_000aB	Par 3 MSB	PRE DELAY MSB 0 - 200
07H: 0aaa_aaaaB	Par 3 LSB	PRE DELAY LSB
08H: 0000_000aB	Par 4 MSB	LPF MSB 0 - 10
09H: 0aaa_aaaaB	Par 4 LSB	LPF LSB (500Hz-THRU)
0AH: 0000_000aB	Par 5 MSB	HPF MSB 0 - 11
0BH: 0aaa_aaaaB	Par 5 LSB	HPF LSB (THRU-1kHz)
0CH: 0000_000aB	Par 6 MSB	LEVEL MSB 0 - 100
0DH: 0aaa_aaaaB	Par 6 LSB	LEVEL LSB
12H: 0000_000aB	Par 9 MSB	REVERB REV TIME MSB 0 - 199
13H: 0aaa_aaaaB	Par 9 LSB	REVERB REV TIME LSB (0.1-20.0s)
14H: 0000_000aB	Par 10 MSB	PRE DELAY MSB 0 - 200
15H: 0aaa_aaaaB	Par 10 LSB	PRE DELAY LSB
16H: 0000_000aB	Par 11 MSB	HF DAMP MSB 0 - 9
17H: 0aaa_aaaaB	Par 11 LSB	HF DAMP LSB (0.1-1.0)
1EH: 0000_000aB	Par 15 MSB	LPF MSB 0 - 10
1FH: 0aaa_aaaaB	Par 15 LSB	LPF LSB (500Hz-THRU)
20H: 0000_000aB	Par 16 MSB	HPF MSB 0 - 11
21H: 0aaa_aaaaB	Par 16 LSB	HPF LSB (THRU-1kHz)
22H: 0000_000aB	Par 17 MSB	LEVEL MSB 0 - 100
23H: 0aaa_aaaaB	Par 17 LSB	LEVEL LSB
2AH: 0000_000aB	Par 21 MSB	OUTPUT MODE MSB 0 - 1
2BH: 0aaa_aaaaB	Par 21 LSB	OUTPUT MODE LSB (MONOx2, STEREO)
36H: 0000_000aB	Par 27 MSB	DIRECT LEVEL L MSB 0 - 100
37H: 0aaa_aaaaB	Par 27 LSB	DIRECT LEVEL L LSB
38H: 0000_000aB	Par 28 MSB	LEVEL R MSB 0 - 100
39H: 0aaa_aaaaB	Par 28 LSB	LEVEL R LSB
40H: 0000_000aB	Par 32 MSB	MASTER LEVEL L MSB 0 - 100
41H: 0aaa_aaaaB	Par 32 LSB	MASTER LEVEL L LSB
42H: 0000_000aB	Par 33 MSB	LEVEL R MSB 0 - 100
43H: 0aaa_aaaaB	Par 33 LSB	LEVEL R LSB
68H: 0aaa_aaaaB	Name 1	
73H: 0aaa_aaaaB	Name 12	
74H: 0000_0000B	End Of Name	
75H: 0000_0000B	END OF Data	

* Table 27
CHORUS - REVERB

Offset	Address	Description
00H: 0001_1010B	algorithm 26	
01H: 0000_0000B	DUMMY	
04H: 0000_000aB	Par 2 MSB	CHORUS PRE DELAY MSB 0 - 60
05H: 0aaa_aaaaB	Par 2 LSB	PRE DELAY LSB
06H: 0000_000aB	Par 3 MSB	RATE MSB 0 - 100
07H: 0aaa_aaaaB	Par 3 LSB	RATE LSB
08H: 0000_000aB	Par 4 MSB	DEPTH MSB 0 - 100
09H: 0aaa_aaaaB	Par 4 LSB	DEPTH LSB
0AH: 0000_000aB	Par 5 MSB	LEVEL MSB 0 - 100
0BH: 0aaa_aaaaB	Par 5 LSB	LEVEL LSB
12H: 0000_000aB	Par 9 MSB	REVERB REV TIME MSB 0 - 199
13H: 0aaa_aaaaB	Par 9 LSB	REVERB REV TIME LSB (0.1-20.0s)
14H: 0000_000aB	Par 10 MSB	PRE DELAY MSB 0 - 200
15H: 0aaa_aaaaB	Par 10 LSB	PRE DELAY LSB
16H: 0000_000aB	Par 11 MSB	HF DAMP MSB 0 - 9
17H: 0aaa_aaaaB	Par 11 LSB	HF DAMP LSB (0.1-1.0)
18H: 0000_000aB	Par 12 MSB	LOW LEVEL MSB 0 - 24
19H: 0aaa_aaaaB	Par 12 LSB	LOW LEVEL LSB (12-120dB)
1AH: 0000_000aB	Par 13 MSB	H1 LEVEL MSB 0 - 24
1BH: 0aaa_aaaaB	Par 13 LSB	H1 LEVEL LSB (12-120dB)
1EH: 0000_000aB	Par 15 MSB	LPF MSB 0 - 10
1FH: 0aaa_aaaaB	Par 15 LSB	LPF LSB (500Hz-THRU)
20H: 0000_000aB	Par 16 MSB	HPF MSB 0 - 11

21H: 0aaa_aaaaB	Par 16 LSB	HPF	LSB (THRU-1kHz)	57H: 0aaa_aaaaB	Par 43 LSB	LEVEL R	LSB
22H: 0000_000aB	Par 17 MSB	LEVEL	MSB 0 - 100				
23H: 0aaa_aaaaB	Par 17 LSB	LEVEL	LSB	68H: 0aaa_aaaaB	Name 1		
2AH: 0000_000aB	Par 21 MSB	OUTPUT	MODE MSB 0 - 1	73H: 0aaa_aaaaB	Name 12		
2BH: 0aaa_aaaaB	Par 21 LSB	MODE	LSB (M0x2, STEREO)	74H: 0000_0000B	End Of Name		
				75H: 0000_0000B	END Of Data		
36H: 0000_000aB	Par 27 MSB	DIRECT	LEVEL L MSB 0 - 100				
37H: 0aaa_aaaaB	Par 27 LSB		LEVEL L LSB				
38H: 0000_000aB	Par 28 MSB		LEVEL R MSB 0 - 100				
39H: 0aaa_aaaaB	Par 28 LSB		LEVEL R LSB				
40H: 0000_000aB	Par 32 MSB	MASTER	LEVEL L MSB 0 - 100				
41H: 0aaa_aaaaB	Par 32 LSB		LEVEL L LSB				
42H: 0000_000aB	Par 33 MSB		LEVEL R MSB 0 - 100				
43H: 0aaa_aaaaB	Par 33 LSB		LEVEL R LSB				
68H: 0aaa_aaaaB	Name 1						
73H: 0aaa_aaaaB	Name 12						
74H: 0000_0000B	End Of Name						
75H: 0000_0000B	END Of Data						

* Table 28
DELAY - REVERB

Offset	Address	Description
00H:	0001_1011B	algorithm 27
01H:	0000_0000B	DUMMY
04H:	0000_000aB	Par 2 MSB DL TAP L D.TIME H MSB 0 - 1200
05H:	0aaa_aaaaB	Par 2 LSB D.TIME H LSB
06H:	0000_000aB	Par 3 MSB D.TIME L MSB
07H:	0aaa_aaaaB	Par 3 LSB D.TIME L LSB
08H:	0000_000aB	Par 4 MSB LEVEL MSB 0 - 100
09H:	0aaa_aaaaB	Par 4 LSB LEVEL LSB
12H:	0000_000aB	Par 9 MSB DL TAP R D.TIME H MSB 0 - 1200
13H:	0aaa_aaaaB	Par 9 LSB D.TIME H LSB
14H:	0000_000aB	Par 10 MSB D.TIME L MSB
15H:	0aaa_aaaaB	Par 10 LSB D.TIME L LSB
16H:	0000_000aB	Par 11 MSB LEVEL MSB 0 - 100
17H:	0aaa_aaaaB	Par 11 LSB LEVEL LSB
1EH:	0000_000aB	Par 15 MSB DL TAP C D.TIME H MSB 0 - 1200
1FH:	0aaa_aaaaB	Par 15 LSB D.TIME H LSB
20H:	0000_000aB	Par 16 MSB D.TIME L MSB
21H:	0aaa_aaaaB	Par 16 LSB D.TIME L LSB
22H:	0000_000aB	Par 17 MSB FEEDBACK MSB 0 - 100
23H:	0aaa_aaaaB	Par 17 LSB FEEDBACK LSB
24H:	0000_000aB	Par 18 MSB LEVEL MSB 0 - 100
25H:	0aaa_aaaaB	Par 18 LSB LEVEL LSB
2AH:	0000_000aB	Par 21 MSB DELAY LPF MSB 0 - 10
2BH:	0aaa_aaaaB	Par 21 LSB LPF LSB (300Hz-THRU)
36H:	0000_000aB	Par 27 MSB REVERB REY TIME MSB 0 - 199
37H:	0aaa_aaaaB	Par 27 LSB REY TIME LSB (0.1-20.0s)
38H:	0000_000aB	Par 28 MSB PRE DELAY MSB 0 - 100
39H:	0aaa_aaaaB	Par 28 LSB PRE DELAY LSB
3AH:	0000_000aB	Par 29 MSB HF DAMP MSB 0 - 9
3BH:	0aaa_aaaaB	Par 29 LSB HF DAMP LSB (0.1-1.0)
3CH:	0000_000aB	Par 30 MSB LOW LEVEL MSB 0 - 24
3DH:	0aaa_aaaaB	Par 30 LSB LOW LEVEL LSB (-12--12dB)
3EH:	0000_000aB	Par 31 MSB HI LEVEL MSB 0 - 24
3FH:	0aaa_aaaaB	Par 31 LSB HI LEVEL LSB (-12--12dB)
40H:	0000_000aB	Par 32 MSB LPF MSB 0 - 10
41H:	0aaa_aaaaB	Par 32 LSB LPF LSB (300Hz-THRU)
42H:	0000_000aB	Par 33 MSB HPF MSB 0 - 11
43H:	0aaa_aaaaB	Par 33 LSB HPF LSB (THRU-1kHz)
44H:	0000_000aB	Par 34 MSB LEVEL MSB 0 - 100
45H:	0aaa_aaaaB	Par 34 LSB LEVEL LSB
48H:	0000_000aB	Par 36 MSB OUTPUT MODE MSB 0 - 1
49H:	0aaa_aaaaB	Par 36 LSB MODE LSB (M0x2, STEREO)
56H:	0000_000aB	Par 40 MSB DIRECT LEVEL L MSB 0 - 100
57H:	0aaa_aaaaB	Par 40 LSB LEVEL L LSB
58H:	0000_000aB	Par 41 MSB LEVEL R MSB 0 - 100
59H:	0aaa_aaaaB	Par 41 LSB LEVEL R LSB
5AH:	0000_000aB	Par 42 MSB MASTER LEVEL L MSB 0 - 100
5BH:	0aaa_aaaaB	Par 42 LSB LEVEL L LSB
5CH:	0000_000aB	Par 43 MSB LEVEL R MSB 0 - 100

MIDI Implementation Chart

Function ***		Transmitted	Recognized	Remarks
Basic Channel	Default Changed	1 - 16 1 - 16	1 - 16 1 - 16	Memorized * 1
Mode	Default Messages Altered	x x *****	OMNI ON/OFF x	Memorized
Note Number	True Voice	x *****	x x	
Velocity	Note ON Note OFF	x x	x x	
After Touch	Key's Ch's	x x	x * 2	* 3
Pitch Bender		x	* 2	* 3
Control Change	0 - 31	x	* 2	* 3
	64 - 95	x	* 2	* 3
Prog Change	True #	x *****	0 - 127 0 - 127	
System Exclusive		○	○	Parameter value
System Common	Song Pos Song Sel Tune	x x x	x x x	
System Real Time	Clock Commands	x x	x x	
Aux Messages	Local ON/OFF All Notes OFF Active Sense Reset	x x x x	x x x x	
Notes	* 1 Basic channel is common to transmitting/receiving but not exclusive to one of them. * 2 Can be set manually to ○ or x, and permanently memorized. * 3 Made controllable by specifying one particular parameter. The value of parameter is to be determined by entering data.			

Mode 1 : OMNI ON, POLY
 Mode 3 : OMNI OFF, POLY

Mode 2 : OMNI ON, MONO
 Mode 4 : OMNI OFF, MONO

○ : Yes
 x : No

■ How to read a MIDI Implementation Chart

○ : MIDI data that can be transmitted or received.

× : MIDI data that cannot be transmitted or received.

● Basic Channel

The MIDI channel for transmitting (or receiving) MIDI data can be specified over this range. The MIDI channel setting is remembered even when the power is turned off.

● Mode

Most recent keyboard use mode 3 (omni off, poly).

Reception : MIDI data is received only on the specified channels, and played polyphonically.

Transmission : All MIDI data is transmitted on the specified MIDI channel.

* "Mode" refers to MIDI Mode messages.

● Note Number

This is the range of note numbers that can be transmitted (or received). Note number 60 is middle C (C4).

● Velocity

This is the range over which velocity can be transmitted (or received) by Note On and Note Off messages.

● Aftertouch

Key's : Polyphonic Aftertouch

Ch's : Channel Aftertouch

● Pitch Bender

The bender range setting of each Tone determines the range of pitch change caused by Pitch Bender messages. When set to 0, Pitch Bender messages will be ignored.

● Control Change

This indicates the control numbers that can be transmitted (or received), and what they will control. For details, refer to the MIDI implementation.

● Program Change

The program numbers in the chart indicate the actual data. (This is one less than the Pitch and Tone program numbers.)

● Exclusive

Exclusive message reception can be turned On/Off.

● Common, Real time

These MIDI messages are used to synchronize sequencers and rhythm machines. The SE-50 does not use these messages.

● Aux messages

Mainly, these messages are of the type used to prevent problems, such as Active Sensing (Checks whether MIDI cable is in proper condition or not); and All Notes Off (Message which terminates the sounding of all notes).

SPECIFICATIONS

SE - 50:STEREO EFFECTS PROCESSOR

● Patch Memories

User's Memories	100
Preset Memories	28

● Signal Processing

A/D Convertor	16bit
D/A Convertor	16bit

● Sampling Frequency

48kHz/32kHz(set every algorithm)

● Rated Input Level

- 20/+4dBm

● Input Impedance

1M Ω

● Rated Output Level

- 20/+4dBm

● Output Load Impedance

More than 50k Ω

● Frequency Response

20Hz to 20kHz(±1dB) (Sampling Frequency:48kHz)
20Hz to 15kHz(±1dB) (Sampling Frequency:32kHz)

● Residual Noise

Less than - 95dBm (IHF - A)
(LEVEL Switch: - 20dBm, THRU)

● Input Channel

2

● Input Gain

- 20dB to +12dB

(0dBm=0.775Vrms)

● Output Channel

2

● Controls

«Front Panel»

INPUT LEVEL Knobs L (MONO)/R
NUMBER Buttons UP/DOWN
PARAMETER Buttons UP/DOWN
VALUE Buttons UP/DOWN
WRITE Button
EXIT Button

UTILITY Button

EFFECT Button

POWER Switch

«Rear Panel»

LEVEL Switch

● Display

16 - letters, 2 - lines LCD (back lit)

● Indicator

Overload L/R

Effect On/Off

Utility

● Jacks

INPUT Jacks L(MONO)/R

OUTPUT Jacks L(MONO)/R

EFFECT REMOTE Jack

NUMBER SHIFT Jack

MIDI Connectors (IN, OUT)

AC Adaptor Jack

● Power

12V AC (BOSS BRB - 120, 220, 240)

● Current Draw

1A

● Dimensions

218(W) × 44(H) × 235(D) mm
8 - 5/8"(W) × 1 - 3/4"(H) × 9 - 5/16"(D)

● Weight

1.6kg / 3lb 9oz

● Accessories

AC Adaptor:BOSS BRB - 120, 220, 240

Foot Rubber × 4

Owner's Manual

● Options

Rack Mount Adaptor..... RAD - 50

* The RAD - 10 Rack Mount Adapter cannot be used for this unit.

Foot Switch.....FS - 5L, FS - 5U

Insert Cable.....PCS - 31(Roland)
(1/4" - Phone Plug(Stereo) ↔ 1/4" - Phone Plug(Mono) × 2)

Foot Controller.....FC - 100MK II (Roland)

RRC to MIDI Converter.....RMC - 1(Roland)

Expression Pedal.....EV - 5(Roland), EV - 10

*The specifications for this product are subject to change without prior notice, in the interest of improvement.

Index

【1,2,3.....】

2CH MIXER77

【A】

AC Adaptor Jack 8
AMBIENCE31
Aftertouch Message93
Algorithm17
Altering an Existing Effects Program17
Altering the Name of Effects Program21
Ambience31

【C】

CHORUS+REVERB85
Composition of Effects Programs17
Compressor68
Control Change Message93
Copying an Effects Program19

【D】

DELAY+REVERB87
Data Reception(Bulk Load) 103
Data Transmission(Bulk Dump) 102
Delay 37,39,41,58,69,73,78,87
Delay Tap39,78
Direct Level26
Display 7

【E】

EFFECT Button 7
EFFECT REMOTE Jack 8
EXIT Button 7
Early Reflection23
Early Reflection Delay23
Effect Off Mode15
Effect On/Off15
Enhancer72,75
Equalizer58
Exclusive Message93

【F】

Factory Preset 108
Flanger50
Foot Controller 100,105
Foot Switch13,15

【G】

GATE REVERB+REVERB83
GATE REVERB33,83
GUITAR MULTI68
Gate50
Gate Reverb33,83

【H】

HALL 125
HALL 227
HF Damp24
High - pass Filter24

【I】

INPUT JACK L(MONO)/R 7
Input Level 7,12
Input Level Knob 7

【K】

KEYBOARD MULTI 158
KEYBOARD MULTI 261

【L】

Late Reflection23
Level Switch 8,12
Limiter72,75
Line Driver70
Low - pass Filter24

【M】

MIDI Channel92,95
MIDI Control98
MIDI IN Connector 8
MIDI Implementation121
MIDI Implementation Chart134
MIDI OUT Connector 8
MULTI DELAY37
MULTI TAP DELAY39
MULTI PITCH SHIFTER45
Making the Connection10
Master Level26

【N】

NUMBER Button 7

NUMBER SHIFT Jack 8
 Noise Suppressor.....55,57,65,69,73,76,77

【O】

OMNI92,95
 OUTPUT JACK L(MONO)/R 8
 OVERDRIVE/DISTORTION.....68
 Overload Indicator.....12

【P】

PARAMETER Button 7,19
 PITCH SHIFTER.....45,48
 PLATE.....30
 Panning65
 Parameter.....19
 Performance Screen11
 Phaser52,61,64
 Pitch Bender Message.....93
 Pre Delay23
 Preset Data 108
 Program Change Map 96,116
 Program Change Message.....93,96
 Program Number.....12

【R】

REVERB1+REVERB2.....81
 RHODES64
 ROOM28
 ROTARY.....56
 Range of Program Numbers Selectable With Foot - switch14
 Reverb.....23
 Reverb Time23
 Reverberation23
 Rotary56

【S】

SPACE CHORUS43
 ST. PITCH SHIFTER.....48
 STEREO DELAY41
 STEREO ENHANCER.....75
 STEREO FLANGER50
 STEREO PHASER.....52
 STEREO REVERB.....35
 Space Chorus43
 Super Chorus55
 System Data..... 108

【U】

UTILITY Button..... 7

【V】

VALUE Button..... 7,19
 VOCAL MULTI72
 VOCODER54

【W】

WRITE Button 7,20
 Write Procedure20

Index to the Unit's Functions

Use the following as a quick guide to explanations about things you would like to do with the unit.

《Connections》	Connect with a mixer's Send/Return	10,80
	Connect with a keyboard	10
	Connect with a guitar	11
	Set the Level Switch	10,11,12
《Before Outputting Any Sound》		
	Turn on the power	11
	Adjust the Input Level	12
《Program Numbers》	Select an Effects Program (Effects Number) from the panel	12
	Select an Effects Program (Effects Number) using a foot - switch	13
	Select an Effects Program (Effects Number) while in the process of making settings for an Effects Program	12
	Set the range for changes in Program Number using a foot - switch	14
《Effects On/Off》	Turn Effects On/Off from the panel	15
	Turn Effects On/Off with a foot - switch	15
	Set the mode for switching Effects On/Off	15
	Set the unit so no sound is output when Effects are Off (Even Direct sound not output)	15
《Effects Programs》	Revise an existing Effects Program to create a different one	17
	Create a completely new Effects Program	18
	Copy Effects Programs to other locations (Program Numbers)	19
	Make changes in the parameters for an Effects Program	19
	Store an Effects Program in memory when it's completed (Write Procedure)	20
	Change the order in which Effects Programs are stored (Rearrange the order of Program Numbers)	21
	Change the name of an Effects Program	21
《MIDI Settings》	Set the MIDI channel	95
	Set the unit to the OMNI Mode	95
	Remotely change Program Numbers on the SE - 50 using an external MIDI device	96
	Make settings for the Program Change Map	96
	Remotely manipulate parameters in the SE - 50 using an external MIDI device (MIDI Control)	98
	Make settings for MIDI Control	98
	Use a foot controller (FC - 100MK II)	100

《Transmission/Reception of Data》

Types of data that can be transmitted 101
Connections needed to save SE - 50 data onto a sequencer..... 101
Connections needed to receive data previously stored in a sequencer 101
Connections needed to copy data to another SE - 50 102
Transmit data (Bulk Dump)..... 102
Receive data (Bulk Load) 103

《Others》

Restore the Factory Presets 108
Review the types of data that can be restored to their Factory Presets..... 108

MEMO

Information

●When you need repair service, call your local Roland Service Station or the authorized Roland distributor in your country as shown below.

U. S. A.

Roland Corp US
7200 Dominion Circle
Los Angeles, CA. 90040 - 3647
U. S. A.
☎ (213)685 - 5141

CANADA

Roland Canada Music Ltd.
(Head Office)
13880 Mayfield Place
Richmond B. C., V6V 2E4
CANADA
☎ (604)270 - 6626

Roland Canada Music Ltd.
9425 Transcanadienne
Service Rd. N.,
St Laurent, Quebec H4S 1V3
CANADA
☎ (514)335 - 2009

Roland Canada Music Ltd.
346 Watline Avenue.
Mississauga, Ontario L4Z 1X2
CANADA
☎ (416)890 - 6488

AUSTRALIA

Roland Corporation
(Australia) Pty. Ltd.
(Head Office)
38 Campbell Avenue
Dee Why West, NSW 2099
AUSTRALIA
☎ (02)982 - 8266

Roland Corporation
(Australia) Pty. Ltd.
(Melbourne Office)
50 Garden Street
South Yarra, Victoria 3141
AUSTRALIA
☎ (03)241 - 1254

NEW ZEALAND

Roland Corporation (NZ) Ltd.
97 Mt. Eden Road, Mt. Eden.
Auckland 3
NEW ZEALAND
☎ (09)398 - 715

UNITED KINGDOM

Roland(UK)Ltd
Amalgamated Drive
West Cross Centre, Brentford,
Middlesex TW8 9EZ.
UNITED KINGDOM
☎ (81)568 - 4578

WEST GERMANY

Roland Elektronische
Musikinstrumente
Handelsgesellschaft mbH.
Oststrasse 96,
2000 Norderstedt
WEST GERMANY
☎ 040/52 60 090

BELGIUM/HOLLAND/ LUXEMBOURG

Roland Benelux N. V.
Houtstraat 1
B - 2431 Oevel - Westerlo
BELGIUM
☎ 014 - 58 45 35

DENMARK

Roland Scandinavia A/S
Langebrogade 6
Box 1937
DK - 1023 Copenhagen K.
DENMARK
☎ 31 - 95 31 11

SWEDEN

Roland Scandinavia A/S
DanvikCenter 28 A. 2 tr.
S - 131 30 Nacka,
SWEDEN
☎ 08 - 702 00 20

NORWAY

Roland Scandinavia
Avd. Norge
Lilleakerveien 2
Postboks 95 Lilleaker
N - 0216 Oslo 2
NORWAY
☎ 02 - 73 00 74

FINLAND

Fazer Musik Inc.
Länsituulentie
POB 169
SF - 02101 Espoo
FINLAND
☎ 0 - 43 50 11

ITALY

Roland Italy S. P. A.
Viale delle Industrie 8
20020 ARESE MILANO
ITALY
☎ 02 - 93581311

SPAIN

Roland Electronics
de España S. A.
Bolivia 239
08020 Barcelona
SPAIN
☎ 93 - 308 - 1000

SWITZERLAND

Musitronic AG
Gerberstrasse 5, CH - 4410
Liestal
SWITZERLAND
☎ 061/921 16 15

Roland CK (Switzerland) AG
Hauptstrasse 21
CH - 4456 Tenniken
SWITZERLAND
☎ 061/98 60 55
Repair Service by Musitronic AG

FRANCE

Musikengro
102, Avenue Jean - Jaures
69007 Lyon Cedex 07
FRANCE
☎ (7)858 - 54 60

Musikengro
(Paris Office)
Centre Region Parisienne
41 rue Charles - Fourier.
94400 Vitry s/Seine
FRANCE
☎ (1)4680 86 62

AUSTRIA

E. Dematte & Co.
Neu - Rum Siemens - Strasse 4
A - 6021 Innsbruck Box 591
AUSTRIA
☎ 43(05222)63 45 1

GREECE

V. Dimitriadis & Co Ltd.
2 Fidiou Str. GR 106 78
Athens
GREECE
☎ 3620130

PORTUGAL

Casa Cuius Instrumentos
Musicais Lda.
Rua de Santa Catarina 131
Porto
PORTUGAL
☎ 02 - 38 44 56

HUNGARY

Intermusica Ltd.
Warehouse Area 'DEPO'
Budapest, P.O. Box 3,
2045 Torokbalint
Budapest
HUNGARY
☎ 1868905

BRAZIL

Oliver do Brazil S.A.
Instrumentos Musicais
Av. Cecl. No.578
Centro Empresarial
Tambore - Barueri - SP.
CEP - 06400
BRAZIL
☎ (011)709 - 1267

 Roland®

10990

UPC 10990



10990