

# Roland

DIGITAL SAMPLER

---

# S-760

OWNER'S MANUAL  
(Advanced Operation)  
(Basic Operation)

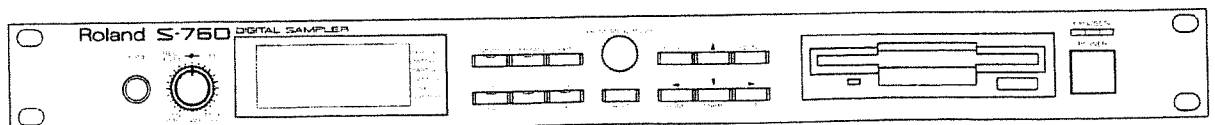



# Digital Sampler Roland S-760

---

## Owner's Manual: Advanced Operation

### Introduction

Thank you for purchasing the Roland S-760 Digital Sampler. In order to take full advantage of the S-760 and to enjoy long years of trouble-free use, please read this manual carefully.

# How to use the owner's manuals

The S-760 comes with two manuals which are organized as follows. In order to avoid unnecessary problems please first read the "Basic operation" manual to understand the basic concepts and operating procedures of the S-760. The "Advanced operation" manual explains how to take further advantage of the S-760's more advanced capabilities such as sound editing, and you can read each section as necessary.

## Basic Owner's manual

### Chapter 1. Before you begin

This chapter explains the preparations necessary for use, such as making connections, starting up and shutting down, and making a backup of the system disk.

### Chapter 2. Play the S-760

This chapter explains how to load sounds and play them.

### Chapter 3. Sample and create a sound

This chapter explains the procedure of sampling a sound, using the equalizer to modify it, and playing it.

### Chapter 4. Save your sounds

Sound data is lost when the power is turned off. This chapter explains how to save it.

### Chapter 5. Starting up the system from a hard disk

In addition to starting up the S-760 system from a floppy disk, it is also possible to start up from a hard disk. This chapter explains the procedure.

### Chapter 6. Convenient ways to start up the system

You can choose the disk drive from which the S-760 will be started up, or start up with different settings. This chapter explains the procedure.

### Chapter 7. Operations

This chapter explains the 6 modes, about the display, how to use the buttons, and how to assign names, etc.

### Chapter 8. How the S-760 is organized

This chapter explains how the S-760 works — how a sound is organized, how sound data and other data is managed, and about the audio signal flow.

### Chapter 9. Using MIDI to select sounds

Program Change Messages from an external MIDI controller can be used to select Patches, Performances, or Volumes. This chapter explains the procedure.

## Advanced Owner's manual

### Chapter 1. Sound editing procedure

There are various ways to edit sounds. This chapter explains the procedure.

### Chapter 2. Sound data compatibility

This chapter explains how S-760 sound data is compatible with S-770/750 (SYS-772 Version 2.0) or SP-700 sound data.

### Chapter 3. Parameters

This chapter explains each parameter.

### Chapter 4. Interrelated parameters

This chapter explains parameters (such as Volume and Output) which must be understood in their relation to the entire structure of sound.

### Chapter 5. Command/List displays

This chapter explains the Command and List displays.

### Chapter 6. Complex procedures

This chapter explains the more difficult or complex procedures.

### Chapter 7. Appendices

This chapter provides useful supplementary information on SCSI, troubleshooting and error messages, and parameter lists.

**\* The explanations in this manual include various illustrations of the LCD display. Please be aware that the factory preset data (sound names, etc.) will not necessarily be identical to the data shown in these LCDs.**

# Contents

How to use the operating manuals	0-2	Patch Mode	3-13
<b>Chapter 1 How to edit sounds</b>		Methods of Editing a Patch	3-13
How sound is output	1-2	Patch Common	3-13
When the square indicator is at a Mode position	1-2	Patch Split	3-16
When the square indicator is not displayed	1-3	Patch Control	3-18
How to access and read the display pages	1-4	Patch Quick Sampling display	3-21
Patch editing	1-5	Partial Mode	3-22
In Performance mode	1-5	How to Edit the Partials	3-22
How to access the display	1-5	Partial Common	3-22
Limitations of this editing method	1-5	Partial SMT (Partial Sample Mix Table)	3-24
In Patch mode	1-6	Partial TVF (Time Variant Filter)	3-28
How to access the display	1-6	Partial TVA (Time Variant Amplifier)	3-34
Limitations of this editing method	1-6	Partial LFO (Low Frequency Oscillator)	3-39
Partial editing	1-7	Partial Quick Sampling display	3-41
In Performance mode	1-7	Sample mode	3-42
How to access the display	1-7	Operations in Sample mode	3-42
Limitations of this editing method	1-8	Sampling display	3-42
In Patch mode	1-8	Sampling Execute display	3-46
How to access the display	1-8	Sampling Execute display (during sampling)	3-46
Limitations of this editing method	1-9	Sampling Stop display	3-47
In Partial mode	1-9	Loop & Smoothing displays	3-48
How to access the display	1-9	Smoothing	3-50
Limitations of this editing method	1-9	Auto Truncate/Normalize display	3-50
Sample editing/Output jacks used for editing	1-10	Time Stretch display	3-51
Sample editing	1-10	Digital Filter display	3-52
Output jacks used for editing	1-10	Compress/Expand display	3-53
		Rate Convert display	3-55
		Bit Convert display	3-56
		Truncate display	3-57
		Cut & Splice display	3-58
		Area Erase display	3-59
		Insert display	3-60
		Mixing display	3-62
		Combine display	3-64
		Wave Graph display	3-66
		About Loop Mode	3-68
		Disk Mode	3-70
		Disk Load	3-70
		Disk Save	3-72
		Disk Copy	3-75
		Disk Delete	3-79
		Disk Utility	3-82
		Save System	3-85
		Optimize	3-86
		Convert Load	3-88
		System Mode	3-91
		System Parameter	3-91
		System SCSI	3-93
		MIDI Control	3-96
		MIDI Volume Dump	3-97
		MIDI Sample Dump	3-99
		MIDI EQ Control	3-100
		System Volume ID	3-103
		Load/Save System Parameters	3-104
<b>Chapter 2 Sound data compatibility</b>			
Parameters that have been added/ modified/deleted	2-2		
Compared to the S-770/750	2-2		
Compared to the SP-700	2-3		
Saving to a different-format disk	2-4		
About samples	2-5		
Samples greater than 18 Mbytes	2-5		
Sampling frequency	2-5		
Master frequency	2-5		
<b>Chapter 3 Explanation of parameters</b>			
Performance mode	3-2		
Performance Play display	3-2		
Performance Equalizer display	3-4		
MIDI Filter display	3-5		
Module Monitor	3-7		
MIDI Monitor	3-7		
Quick Load display	3-8		
Quick Load Select display	3-9		
Performance Quick Sampling display	3-10		
Quick Edit display	3-11		

## Chapter 4 Explanation of parameters requiring caution

Output assignments	4-2
Basic concepts of sound output	4-2
System Output Mode	4-2
System Output Assign	4-5
Three output assigns	4-6
Part output assign settings	4-6
Patch output assign settings	4-6
Partial output assign settings	4-7
Pan	4-8
Level/Pitch	4-9
Level	4-9
Pitch	4-10

## Chapter 5 Explanation of Command/List displays

Copy/Delete/Initialize/Disk	5-2
Copy/Delete/Initialize	5-2
About the screen in each command display	5-2
Procedure	5-3
Cautions for Copy	5-3
Cautions for Delete	5-3
Cautions for Initialize	5-4
Disk	5-4
Performance commands	5-5
Edit Patch	5-5
Listen Delete	5-5
Performance Utility	5-6
Channel Converter	5-6
Copy MIDI Filter/Equalizer	5-6
Patch commands	5-7
Edit Partial	5-7
Rename Partials	5-7
Partial commands	5-8
Edit Sample	5-8
Template	5-8
Registering a User Set	5-8
Sample commands	5-9
Set Stereo/Mono	5-9
Sound list displays	5-10
About the sound list display screen	5-10
Selecting a sound	5-11
Changing the order of the sounds	5-11
Naming a sound	5-11
Specifying program numbers	5-11
Cautions for the Patch list display	5-12
Cautions for the Partial list display	5-12
Cautions for the Sample list display	5-12
Disk Mode list displays	5-13
Select Target display	5-13

Volume ID display	5-13
Specifying a Volume ID	5-13
Making a Volume ID list	5-13
Select Drive display	5-14
Selecting the Current Drive	5-14
Assigning a name to a drive	5-14
Making the S-760 recognize a drive (Scan)	5-15
Select Area display	5-15

## Chapter 6 Procedures requiring explanation

How to use Quick Load	6-2
Registering a sound in the list	6-2
Using the Quick Load function	6-3
Automatically loading a Volume at start-up	6-4
How to avoid saving unwanted sounds (Listen Delete)	6-5
Upgrading to a new version of the system (System Dump)	6-6
Procedure for upgrading to a new version of the system	6-6
Recording procedure for the System Dump function	6-6
Loading procedure for the System Dump function	6-7
Recording sound data to a MIDI sequencer (Volume Dump)	6-8
Samples for which Volume Dump can be used	6-8
Recording procedure for Volume Dump	6-9
Loading procedure for Volume Dump	6-10
Sample Dump	6-12
Transmission procedure for wave data	6-12
Reception procedure for wave data	6-12
Checking procedure after reception	6-13
Controlling sounds via MIDI	6-14
Using MIDI to control the sound of a Patch	6-14
Using Velocity to control the SMT	6-15
Using MIDI to control the SMT	6-16
Various methods of sampling	6-18
Performance Quick Sampling	6-18
Patch Quick Sampling	6-18
Partial Quick Sampling	6-18
Sampling	6-18
Sampling techniques	6-19
Marking the sample	6-19
Making loop settings in the Sampling display	6-20
Creating a Patch (Patch Split)	6-21
How to view the graphic display	6-21
Making Split settings from the front panel	6-21
Making Split settings from a MIDI keyboard	6-22
Part Split and Positional Crossfade	6-24
Positional Crossfade setup procedure	6-24
Creating a Volume ID list	6-25
Preview function	6-26
The Preview function in the Performance Play display	6-26
The Preview function in other displays	6-27

**Chapter 7 Appendices**

---

ABOUT SCSI ..... 7-2

    What is SCSI? ..... 7-2

    Device Number (SCSI ID) ..... 7-2

    Connectors and Cables ..... 7-3

    Terminator ..... 7-4

    Terminator Power ..... 7-4

    How to Connect the SCSI Chain ..... 7-5

    Format ..... 7-5

Startup/shutdown for system  
with a second S-760 or S-770/750/SP-700 ..... 7-6

TROUBLESHOOTING ..... 7-8

    PROBLEMS WITH THE SOUND ..... 7-8

    PROBLEMS WITH DRIVES ..... 7-11

    VARIOUS OTHER PROBLEMS ..... 7-12

ERROR MESSAGES ..... 7-14

PARAMETER LISTS ..... 7-16

TEMPLATE PRESET LIST ..... 7-21

MIDI Implementation Chart ..... 7-22

Specifications ..... 7-23

Index ..... 7-26

MEMO





# *Chapter 1*

## **How to edit sounds**

---

There are various ways to edit sounds, and how the S-760 produces sound will depend on which of these ways you use. In this chapter we will first explain how sound is output, how to select the various displays, and the meaning of the displays. Then we will explain the concepts of sound data editing, and the necessary procedure.

# How sound is output

The S-760 does not necessarily produce sound in the same way in every display page. For example in the Performance Play display, it outputs the sound of the entire Performance (multi-timbral output). However if you press MODE and then select the Patch Mode display from the Mode menu, the S-760 will output not the entire Performance, but only the individual Patch selected in that display (Performance parameters such as Equalizer will all be ignored).

In this way, the way in which sound is produced will differ from display to display. The square mode indicator in the right edge of the display indicates how sound is currently being output.

- \* **Actually, the sound output method is affected not only by the display page but also by the way in which you arrived at that display page. For details, please read this chapter carefully.**

## When the square indicator is at a Mode position

### PERFORM:

Sound will be output with the settings of the entire Performance. (All parameters from Performance to Sample are valid.) The square indicator will appear in this location in the various Performance mode displays, and also when the Select Performance page is displayed, etc.

- \* **The MIDI channels used are those specified for each Part. The Part Output Assign will determine the output jacks.**

### PATCH:

Sound will be output for the individual Patch that is currently selected. (Performance parameters are ignored.) The square indicator will appear in this location in the various Patch mode displays, and in the Select Patch display, etc.

- \* **Any MIDI channel can be used, since the S-760 will be in Omni On mode. The Patch Output Assign settings will determine the output jacks.**

### PARTIAL:

Sound will be output for the individual Partial that is currently selected. (Performance and Patch parameters will be ignored.) The square indicator will appear in this location in the various Partial mode displays, and in the Select Partial display, etc.

- \* **Any MIDI channel can be used, since the S-760 will be in Omni On mode. The Partial Output Assign settings will determine the output jacks.**

### SAMPLE:

Sound will be output for the individual Sample that is currently selected. (Performance, Patch and Partial settings will be ignored.) The square indicator will appear in this location in the various Sample mode displays, and in the Select Sample display, etc.

- \* **Any MIDI channel can be used, since the S-760 will be in Omni On mode. The sound will always be output from the Stereo 1 jacks (Individual 1 and 2).**

---

## When the square indicator is not displayed

No sound will be output. In the various Disk mode displays, the Quick Load display, and the Sampling display, the square indicator will not appear.

**\* Also, there will be no sound output while a command such as Copy is being executed.**

# How to access and read the display pages

In addition to the square indicator, there is also a triangle pointing to the right. This indicates the mode to which the current display page belongs.

Depending on how you arrived at the display page, there may also be a plus symbol. If from COMMAND you open the Disk mode display or a sound editing display (such as Patch), this will indicate the mode from which you arrived at the current display page.

**\* If from COMMAND you open one of the above display pages, an asterisk "\*" will be displayed at the left of the display page name.**

For example, suppose that there was a display page such as the following.

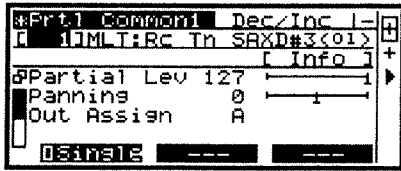

Since this is the Partial Common display, a right-pointing triangle is displayed at the position of PARTIAL.

Since the square indicator is displayed at PERFORM, the sound of the entire performance will be output.

There are plus symbols displayed at PERFORM and PATCH. This indicates that in order to open the Partial Common display, you went through Performance mode and Patch mode. In other words, in Performance mode you pressed COMMAND and selected Edit Patch to enter Patch mode; then you pressed COMMAND and selected Edit Partial to enter Partial mode; and finally you pressed the Value knob and selected the Partial Common display.

# Patch editing

---

There are two ways to edit a Patch.

## In Performance mode

You can edit the parameters of the Patch assigned to a Part while listening to the entire Performance. This allows you to fine-tune the sound of a Patch assigned to a Part so that it fits in with the other sounds of the Performance.

This method of editing is similar to your being able to edit some of the parameters of a Patch assigned to a part in the Performance Play display.

## How to access the display

1. Press MODE. The Mode Menu display will appear.
2. Select F1:Performance. The Performance mode display will appear.
3. Press COMMAND. The Performance Command Menu display will appear.
  - \* In the Quick Load display, COMMAND cannot be used.
4. Select 1:Edit Patch. The Patch mode display will appear.

### Note!

Even if you access the display in this way, if none of the Parts in the selected Performance have Patches assigned to them (for example, when a Performance has been initialized), you must use the "Patch Mode" editing method explained below, rather than this "Performance Mode" editing method.

Simply accessing the edit display does not tell you which method should be used. This is determined by the location of the square indicator at the right side of the display (i.e., how the sound is being output).

If the square indicator is at PERFORM, use the "Performance Mode" editing method.

If the square indicator is at PATCH, use the "Patch Mode" editing method.

## Limitations of this editing method

You can edit only those Patches which are assigned to a Part. In the Performance Play display, you will have to first assign the Patches you wish to edit to a Part.

The MIDI channel to play the Patch being edited is specified by the MIDI channel setting for the Part to which that Patch is assigned. If your MIDI keyboard is set to a different channel, or if the MIDI channel for that Part is turned Off, that Patch will not sound. Before you edit, make the appropriate MIDI channel settings in the Performance Play display.

All parameters from Performance to Sample are valid, but some of the Patch parameters (Level, Output Assign, and Pan) are ignored (Advanced Operation p.4-2). Even if you edit these parameters, the sound output will be determined by the Performance parameters, and the actual sound will not match your settings.

---

## In Patch mode

You can edit Patch parameters while listening to an individual Patch. Parameters from Patch to Sample are valid, but Performance parameters will be ignored.

### How to access the display

1. Press MODE. The Mode Menu display will appear.
2. Select F2:Patch. The Patch Mode display will appear.

### Limitations of this editing method

You can edit any Patch in internal memory.

Any MIDI channel can be used to play the Patch being edited.

# Partial editing

There are three ways to edit a Partial.

## In Performance mode

You can edit the parameters of a Partial used by a Patch which is assigned to a Part while listening to the sound of the entire Performance. This allows you to fine-tune the sound of a Partial used by a Patch assigned to a Part so that it fits in with the other sounds of the Performance.

### How to access the display

1. Press MODE. The Mode Menu display will appear.
2. Select F1:Performance. The Performance Mode display will appear.
3. Press COMMAND. The Performance Command Menu display will appear.
  - \* In the Quick Load display, COMMAND cannot be used.
4. Select 1:Edit Patch. The Patch Mode display will appear.
5. Press COMMAND. The Patch Command Menu display will appear.
6. Select 1:Edit Partial. The Partial Mode display will appear.

### Note!

Even if you access the display in this way, if none of the Parts in the selected Performance have Patches assigned to them (for example, when a Performance has been initialized), you must use the "Patch Mode" editing method explained below, rather than this "Performance Mode" editing method.

Also, if a Partial has not been assigned to any key in the Split of the selected Patch (for example, when a Patch has been initialized), you must use the "Partial Mode" editing method explained below, rather than this "Performance Mode" editing method.

Simply accessing the edit display does not tell you which method should be used. This is determined by the location of the square indicator at the right side of the display (i.e., how the sound is being output).

If the square indicator is at PERFORM, use the "Performance Mode" editing method.

If the square indicator is at PATCH, use the "Patch Mode" editing method.

If the square indicator is at PARTIAL, use the "Partial Mode" editing method.

---

## Limitations of this editing method

You can edit only those Partials which are used by a Patch which is assigned to a Part (i.e., Partials which are assigned to the keys by Patch Split).

Before you edit a Partial, you must assign it to the keyboard in the Patch Split display.

You can play the Partial on the MIDI channel of the Part to which the Patch using that Partial is assigned. If your MIDI keyboard is transmitting on a different MIDI channel or if the MIDI channel of the Part is turned Off, that Partial will not sound.

Before you begin editing, make the appropriate MIDI channel settings in the Performance Play display.

You can also select the Partial to be edited from your MIDI keyboard (by Note messages).

When editing, play the same key to check the sound.

You can choose whether to simultaneously edit all Partials used by the Patch (Global Edit) or to edit only the currently selected Partial (Single Edit). This choice is made by the Edit Mode setting (Advanced Operation p.3-24).

All parameters from Performance to Sample are valid, but some Partial parameters (Level, Output Assign, and Pan) are ignored (Advanced Operation p.4-2). Even if you edit these parameters, the way in which the sound is output will be affected by the Performance parameters or the Patch parameters, and the actual sound will not match your settings.

## In Patch mode

You can edit the parameters of a Partial used in a Patch while listening to the sound of the individual Patch. This allows you to fine-tune the Partial to fit in with the Patch.

## How to access the display

1. Press MODE. The Mode Menu display will appear.
2. Select F2:Patch. The Patch Mode display will appear.
3. Press COMMAND. The Patch Command Menu display will appear.
4. Select 1:Edit Partial. The Partial Mode display will appear.

### Note!

Even if you access the display in this way, if the Partial has not been assigned to any key in the Split of the selected Patch (for example, when a Patch has been initialized), you must use the "Partial Mode" editing method explained below, rather than this "Patch Mode" editing method.

Simply accessing the edit display does not tell you which method should be used. This is determined by the location of the square indicator at the right side of the display (i.e., how the sound is being output).

If the square indicator is at PATCH, use the "Patch Mode" editing method.

If the square indicator is at PARTIAL, use the "Partial Mode" editing method.



---

## Limitations of this editing mode

Only Partials used by the selected Patch (i.e., Partials assigned to the keyboard by Patch Split) can be edited. Before you begin, assign the Partial to the keyboard in the Patch Split display.

Any MIDI channel can be used to play the Partial being edited.

You can use your MIDI keyboard (Note messages) to select the Partial to edit. While editing, play the same key to check the sound.

You can choose whether to simultaneously edit all Partials used by the Patch (Global edit) or to edit only the currently selected Partial (Single edit). This choice is made by the Edit Mode setting (Advanced Operation p.3-24).

All parameters from Patch to Sample are valid, but some Partial parameters (Level, Output Assign, and Pan) are ignored (Advanced Operation p.4-2). Even if you edit these parameters, the way in which the sound is output will be affected by the Patch parameters, and the actual sound will not match your settings.

## In Partial mode

You can edit Partial parameters while listening to the sound of the individual Partial. The Partial and Sample parameters will be valid, and the Performance and Patch parameters will be ignored.

## How to access the display

1. Press MODE. The Mode Menu display will appear.
2. Select F3:Partial. The Partial Mode display will appear.

## Limitations of this editing method

You can edit any Partial in internal memory.

You can use any MIDI channel to play the Partial being edited.

The Editing Mode (Advanced Operation p.3-24) will always be "Single Edit", so that only the currently selected Partial will be edited.

Your MIDI keyboard (Note messages) cannot be used to select the Partial to edit.

# Sample editing/Output jacks used for editing

---

## Sample editing

Regardless of how the display was accessed, you can always edit Sample parameters while listening to the sound of an individual Sample. Parameters from Performance to Partial will be ignored.

## Output jacks used for editing

During editing, the output assign parameters at each level of sound data will be sometimes valid and sometimes ignored, depending on various things. For this reason you may sometimes have to reconnect the output jacks.

To avoid having to do this, you can set the System Output Mode to "Mix" (Advanced Operation p.3-92). All sound will be output from the Stereo 1 jacks (Individual 1 and 2).

When you finish editing, restore the previous settings.

# *Chapter 2*

## **Sound data compatibility**

---

The S-760 is able to load and play sound data from the S-770/750 (SYS-772 Version 2.0) or the SP-700. However the parameter structure of S-760 sound data is somewhat different from that of S-770/750 or SP-700 data. The sound data capacity and sampling frequency have also been extended. When loading or saving sound data between disks of different formats, there are several things you should be aware of.

# Parameters that have been added/modified/deleted

## Compared to the S-770/750

The following sound parameters of the S-760 have been added, modified or deleted in comparison to the S-770/750 (SYS-772 Version 2.0). In the table below, "Loaded Value" indicates the value of the parameter that will be set when S-770/750 (SYS-772 Version 2.0) data is loaded into the S-760.

**Parameters marked by an asterisk "\*" are also found on the S-770/750 (SYS-772 Version 2.0), but the range of settings has been extended.**

**Parameters marked by two asterisks "\*\*" have been deleted on the S-760.**

Sound	Parameter	Loaded value
Performance	Part Pan (Parts 1—32)	0
	Part Output Assign	A
	Pan Receive Switch (Ch 1-16)	On
	High Frequency (EQ1-8)	6.0 k
	High Gain (EQ1-8)	0
	Low Frequency (EQ1-8)	120
	Low Gain (EQ1-8)	0
Patch	*Patch Output Assign	the value in SYS-772 Version 2.0
	Resonance Offset	0
	Attack Time Offset	0
	Release Time Offset	0
	**Patch Stereo Mix	ignored
Partial	*Partial Output Assign	the value in SYS-772 Version 2.0
	*Sample Pan (Component 1-4)	the value in SYS-772 Version 2.0
	TVF Release Velocity Sensitivity	0
	TVA Release Velocity Sensitivity	0
	** Partial Stereo Mix	ignored

**\* When S-770/750 (SYS-772 Version 2.0) sounds are loaded into the S-760, the parameters which have been added will always have their initial values. Edit these parameters and save the data to the S-760's hard disk.**

## Compared to the SP-700

The following sound parameters have been modified/deleted in comparison to the SP-700. In the table below, "Loaded Value" indicates the value of the parameter that will be set when SP-700 data is loaded into the S-760.

**Parameters marked by an asterisk "\*" have been deleted on the S-760.**

Sound	Parameter	Loaded value
Performance	Pan Receive Switch (Ch1-16)	Note 1
Patch	*Aftertouch LFO Pan Depth	ignored
	*Modulation LFO Pan Depth	ignored
	*Control Change LFO Pan Depth	ignored
Partial	Sample Pan (Component 1-4)	Note 2
	*LFO Pan Modulation Depth	ignored

**Note 1: The SP-700 has the same parameter, but the range of setting is different. When loaded into the S-760, this parameter will be loaded as "On" for SP-700 data of "C" or "D". When turned "Off" on the SP-700, this parameter will be loaded as "Off".**

**Note 2: The SP-700 has the same parameter, but the range of setting is different. When loaded into the S-760, the value will be as set in the SP-700. However if the SP-700 setting was "LF+" or "LF-", the display will indicate "(LF+)" or "(LF-)" but the result will be the same as for a setting of "0".**

## Saving to a different-format disk

---

Although parameters have been added, modified, or deleted, it is still possible to save S-760 sound data to a hard disk which has been formatted for the 770/750 (SYS-772 Version 2.0) or SP-700. Conversely, it is also possible to save 770/750 (SYS-772 Version 2.0) or SP-700 sound data to a hard disk which has been formatted for the S-760. However you must keep in mind the following points.

Suppose you create sound data on the S-760 and save it to hard disk. When you then load that sound data into the S-770/750 (SYS-772 Version 2.0), edit it, and then save (overwrite) it on the same hard disk, all parameters added on the S-760 will have their initial values. You should use a different name when saving sound data edited on the S-770/750 (SYS-772 Version 2.0).

When you load SP-700 sound data into the S-760, parameters whose setting range has been modified on the S-760 (Pan Receive Switch and Sample Pan) will sometimes be loaded with values different from the SP-700 values. If these parameters are edited on the S-760 and saved (overwrite) on an SP-700 hard disk, the data in the hard disk will have the values edited by the S-760. However if you do not edit a parameter whose range of settings was changed, the data in the hard disk will still have the SP-700 values even if you overwrite the old data.

When saving on an floppy disk, all data is erased before saving, regardless of the disk format.

If sounds created on the S-770/750 (SYS-772 Version 2.0) and saved on a floppy disk are edited on the S-760, the data size will expand by the size of the parameters added on the S-760. This means that even if a sound fit on a single S-770/750 floppy disk, it may require two floppy disks after it has been loaded, edited, and saved by an S-760. On the other hand, there may be cases when a sound created on the S-760 occupies two floppy disks, but only the first disk is loaded when you load it into the S-770/750. In either case, the sound data is loaded or saved correctly, so there is no problem.

# About samples

---

## Samples greater than 18 Mbytes

The S-760 can be expanded to a maximum of 32 Mbytes of wave memory. This means that when using Mono sampling or the Sample mode functions Combine (Advanced Operation p.3-64) or Insert (Advanced Operation p.3-60), it is possible to create samples larger than 18 Mbytes.

However the S-770/750 (SYS-772 Version 2.0) and SP-700 cannot execute Disk Copy or Disk Delete operations on samples larger than 18 Mbytes. If you attempt to execute these operations, the S-770/750/SP-700 will malfunction. In the worst case, it may even delete all data on disk. The lengths of an 18 Mbyte sample at each sampling frequency are as follows. Be sure to check the sample length in the Sampling display. (Sample lengths in all displays other than the Sampling display are shown for 44.1 kHz.)

### 18 Mbytes

48/44.1 kHz	204.5 sec
32 kHz	307.0 sec
24/22.05 kHz	409.4 sec
16 kHz	614.1 sec

## Sampling frequency

The range of possible sampling frequencies has been extended on the S-760. If a sample recorded at 32/16 kHz using the S-760 is loaded into the S-770/750/SP-700, it will be handled as a 48 kHz sample and will not be sounded at the correct pitch. Use the Sample parameter Coarse Tune (Advanced Operation p.3-25) and Fine Tune (Advanced Operation p.3-25) to lower the pitch.

## Master frequency

The range of possible Master Frequencies (Advanced Operation p.3-91) has been extended on the S-760. If the master frequency is 32 kHz, playing back a 44.1/48 kHz sample will not sound the correct pitch. Use the Sample parameter Coarse Tune (Advanced Operation p.3-25) to raise the pitch. In this case, the pitch range will be less than two octaves above the Original Key of the sample.

---

# MEMO



# Chapter 3

## Explanation of parameters

---

This chapter explains the displays in the 6 modes.

In the explanatory text,

**Volume** indicates a Volume parameter,

**Perform** indicates a Performance parameter,

**Patch** indicates a Patch parameter,

**Partial** indicates a Partial parameter,

**Sample** indicates a Sample parameter,

**System1** indicates a System parameter saved on the system disk,

and **System2** indicates a System parameter saved in the system backup memory inside the S-760.

**Disk** indicates a Disk parameter.

# Performance mode

## Performance Play display

This is the display used when you play the S-760. It allows you to view/edit the status of each Part. You can also view/edit some of the parameters of the Patch assigned to each Part.

### Performance Select

Select a Performance.

#### Part

**(Part)**

Select the Part display. There are 32 Parts.

#### Ch

**(MIDI channel)**  **[-(Off)], [1] — [16]**

This specifies the MIDI receive channel

#### P#

**(Patch number)**

This is the Patch number

#### Patch Name

**(Patch select)**

This selects the Patch. When Off is selected, no Patch will be assigned to that Part.

#### [Lev]

**(Part Level)**  **[0] — [127]**

This parameter sets the level of the Part (Advanced Operation p.4-9).

#### [Pan]

**(Part Pan)**  **[L32] — [0] — [R32]**

This parameter sets the pan position of the Part (Advanced Operation p.4-8).

#### [Out]

**(Part Output Assign)**  **[ ( ) ], [A] — [D], [1] — [8]**

This parameter sets the output assignment of the Part (Advanced Operation p.4-2).

The parameters from Lev to Release in pages 3 through 6 are Patch parameters. They edit the Patch assigned to the Part (Advanced Operation p.3-2 and p.3-3).

#### Lev

**(Patch Level)**  **[0] — [127]**

This parameter sets the level of the Patch (Advanced Operation p.4-9).

#### Pan

**(Patch Pan)**  **[L32] — [0] — [R32]**

This parameter sets the Pan position of the Patch (Advanced Operation p.4-8).

#### Out

**(Patch Output Assign)**  **[A], ([B]) — ([D]), ([1]), ([2]), [3] — [8], [-P-]**

This parameter sets the output assignment of the Patch (Advanced Operation p.4-2).

\* Depending on the System setting Output Mode, the selections indicated as ([ ]) may not be possible.

<b>Pri</b>	<b>(Patch Priority)</b> <input type="checkbox"/> Patch	<b>[Off], [On]</b>
	Normally, when the maximum simultaneously note capability (24 notes) is exceeded, a currently sounding note is turned off to make way for the newly requested note (last-note priority). In such cases, Patches whose Priority setting is On will continue to sound.	
	<b>* If Patch Priority is turned on for all Patches, the assignment scheme will be "first-note priority", and later notes will not sound.</b>	
<b>Oct</b>	<b>(Octave Shift)</b> <input type="checkbox"/> Patch	<b>[-2] — [2]</b>
	This parameter shifts (in octaves) the MIDI note numbers that are received by a Patch.	
<b>Cor</b>	<b>(Patch Coarse Tune)</b> <input type="checkbox"/> Patch	<b>[-48] — [48]</b>
	This parameter adjusts the pitch of a Patch in semitones (Advanced Operation p.4-9).	
<b>Fin</b>	<b>(Patch Fine Tune)</b> <input type="checkbox"/> Patch	<b>[-50] — [50]</b>
	This parameter adjust the pitch of a Patch in 1-cent steps (1 cent is 1/100th of a semitone).	
<b>A.F</b>	<b>(Analog Feel)</b> <input type="checkbox"/> Patch	<b>[0] — [127]</b>
	This parameter creates slight irregularities in pitch each time the Patch is played (i.e., for each note that is played), providing a more natural feeling characteristic of acoustic instruments or analog synthesizers.	
<b>C.Off</b>	<b>(Cutoff Offset)</b> <input type="checkbox"/> Patch	<b>[-63] — [63]</b>
<b>Reso</b>	<b>(Resonance Offset)</b> <input type="checkbox"/> Patch	<b>[-63] — [63]</b>
	These parameters adjust the overall cutoff frequency and resonance for all Partials used by the Patch (Advanced Operation p.3-28).	
	<b>* When the TVF Filter Mode is Off, these settings have no effect (Advanced Operation p.3-28).</b>	
<b>Velocity</b>	<b>(Velocity Sense Offset)</b> <input type="checkbox"/> Patch	<b>[-63] — [63]</b>
	This parameter adjusts the overall TVF and TVA Velocity Curve Sensitivity for all Partials used by the Patch (Advanced Operation p.3-31, p.3-36).	
<b>Attack</b>	<b>(Attack Time Offset)</b> <input type="checkbox"/> Patch	<b>[-63] — [63]</b>
<b>Release</b>	<b>(Release Time Offset)</b> <input type="checkbox"/> Patch	<b>[-63] — [63]</b>
	These parameters adjust the overall Attack Time (Time 1) and Release Time (Time 4) for the TVA envelopes for all Partials used by the Patch (Advanced Operation p.3-37, p.3-38).	
<b>L.P</b>	<b>(Lower Key Point)</b> <input type="checkbox"/> Perform	<b>[A0] — [C8]</b>
<b>U.P</b>	<b>(Upper Key Point)</b> <input type="checkbox"/> Perform	<b>[A0] — [C8]</b>
	These parameters specify the key range of the Part.	
<b>L.W</b>	<b>(Lower Fade Width)</b> <input type="checkbox"/> Perform	<b>[0] — [86]</b>
<b>U.W</b>	<b>(Upper Fade Width)</b> <input type="checkbox"/> Perform	<b>[0] — [86]</b>
	These parameters are effective when positional crossfades are used. They specify the range over which the sound is faded from L.P and U.P.	

<b>F1 Q-Samp</b>	<b>(Performance Quick Sampling)</b> This button opens the Performance Quick Sampling display (Advanced Operation p.3-10).
<b>F2 ← Kbd</b> <b>F3 Kbd →</b>	<b>(keyboard display area switch)</b> <b>(keyboard display area switch)</b> In page 8, the Part keyboard range is displayed graphically, and these buttons select the displayed area. The marked key is C4.
<b>F4 1stPage</b>	<b>(first page)</b> This button moves to the first page of the display.
<b>F5 ← Page</b> <b>F6 Page →</b>	<b>(previous page)</b> <b>(next page)</b> These buttons select pages.

## Performance Equalizer display

Here you can make settings for the equalizers for each output jack.

### Performance Select

Select the Performance.

<b>H.F</b>	<b>(High Frequency)</b> <b>Perform</b> [750] — [18k] This parameter sets the high frequency at which the signal will be boosted or cut.
<b>H.G</b>	<b>(High Gain)</b> <b>Perform</b> [-12] — [+12] This parameter sets the amount by which the signal will be boosted or cut in the high range.
<b>L.F</b>	<b>(Low Frequency)</b> <b>Perform</b> [16] — [600] This parameter sets the low frequency at which the signal will be boosted or cut.
<b>L.G</b>	<b>(Low Gain)</b> <b>Perform</b> [-12] — [+12] This parameter sets the amount by which the signal will be boosted or cut in the low range.

- \* **Some equalizer settings can cause the sound to distort. If so, adjust the equalizer settings.**
- \* **The equalizer parameters can also be controlled by Control Change messages (#1-95) received on the control channel (Advanced Operation p.3-100).**

**F1 (Edit Mode) [Indiv], [Stereo]**

This button selects the edit mode.

Indivi : Each of the 8 equalizers will be edited individually.

Stereo : Equalizers which are paired for stereo output will be edited together.

**F2 (EQ on/off switch) [EQ On], [Bypass]**

By switching the EQ between On/Bypass, you can check the settings.

**\* This setting is not a parameter, and is valid only in the Performance Equalizer display. If you do not wish to use the equalizers, set all the Gain parameters to 0.**

## MIDI Filter display

Here you can make settings that determine the types of MIDI messages received for each MIDI channel, how notes are sounded (Phase Lock), and how dynamics are affected by note-on velocity (Velocity Curve Type).

### Performance Select

This selects the Performance.

**Ch (--)** (MIDI channel) [1] — [16]

This indicates the MIDI channel at the cursor position.

<b>Prog</b>	(Program change) <input type="checkbox"/> Perform	[o],[-]
<b>Bend</b>	(Pitch bend) <input type="checkbox"/> Perform	[o],[-]
<b>Mod</b>	(Modulation) <input type="checkbox"/> Perform	[o],[-]
<b>Hold</b>	(Hold) <input type="checkbox"/> Perform	[o],[-]
<b>A.T</b>	(Aftertouch) <input type="checkbox"/> Perform	[-], [C],[P]
<b>Vol</b>	(Volume) <input type="checkbox"/> Perform	[o],[-]
<b>Pan</b>	(Pan) <input type="checkbox"/> Perform	[o],[-]

These settings turn on/off reception of the corresponding MIDI message. "o" is on, and "-" is off.

For A.T, you can specify the type of Aftertouch as well as turning reception on/off.

There are two types of Aftertouch message. Channel Aftertouch messages have the same effect on all notes for the MIDI channel they are received on. Polyphonic Aftertouch messages apply independently to individual notes.

- [-] : Aftertouch messages will not be received.
- [C] : Channel Aftertouch messages will be received.
- [P] : Polyphonic Aftertouch messages will be received.

- \* The range over which Pitch Bend messages will change the pitch can be set in the Patch Control display (Advanced Operation p.3-18).
- \* Settings in the Patch Control display will determine the effect that Modulation and Aftertouch messages will have (Advanced Operation p.3-18).
- \* When a Hold message is received, the sound of the Patch will be sustained.
- \* When a Volume or Pan message is received, the level or pan position of the Part will change.
- \* You can use MIDI messages to control the tonal character of a Patch. For details, refer to Advanced Operation p.3-18.

**P.L** (Phase Lock)  Perform [0], [-]  
This parameter turns Phase Lock on/off. Phase Lock is a function that reduces any possible time lag between notes of Parts being played on the same MIDI channel.

- \* When Phase Lock is turned on, notes will be delayed until all currently-requested notes for Parts receiving the same MIDI channel are ready to sound. This means that sometimes there will be a time lag from when a Note-on message is received until the note is sounded. Turn this parameter on if necessary.

**Vel** (Velocity Curve Type)  Perform [-],[1] — [7]  
This parameter specifies the type of Velocity Curve.

- \* This parameter will determine how the velocity (keyboard playing dynamics) of the incoming note-on messages will affect the sound. When this is set to [-] (off), the velocity of the note-on message will apply just as it is received.

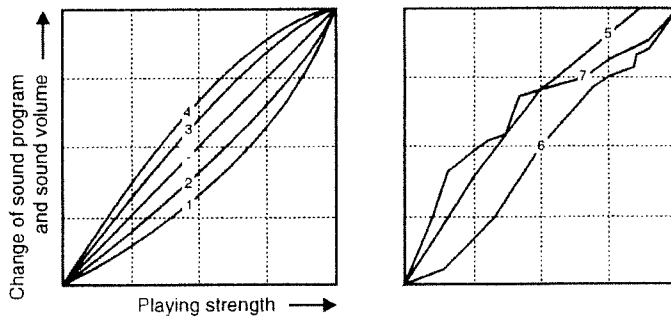

**All** (All)  
If you move the cursor to the "\*" of All and press S1/DEC or S2/INC, identical parameter settings will be made for all MIDI channels.

## Module Monitor

This monitor display shows the number of voices being used. When notes are being prematurely cut off during a performance, you can use this display to check the number of voices being used.

- V** **(voice)**  
Square indicators are displayed to show the number of voices used for all MIDI channels.
- Ch.1 — 16** **(MIDI channel)**  
A bar graph indicates the number of voices used for each MIDI channel.

## MIDI Monitor

The MIDI messages being received at the MIDI IN connector are shown in this display in realtime as hexadecimal data. If you are having MIDI-related problems, use this display to determine whether the problem is with the MIDI controller or with the S-760.

- Ch** **(MIDI channel)** **[1] — [16], [All]**  
This specifies the MIDI channel to be monitored.
- Trig** **(Trigger)** **[Note Off],[Note On],[Poly After],  
[Ctrl],[Program],[Ch After],[Bender],[Sys.Com&Ex]**  
This specifies the type of MIDI message which will start the monitor.

[Note Off]	Note-off messages (8n kk vv / 9n kk 00)
[Note On]	Note-on messages (9n kk vv)
[Poly After]	Polyphonic Aftertouch messages (An kk vv)
[Ctrl]	Control Change messages (Bn kk vv)
[Program]	Program Change messages (Cn pp)
[Ch After]	Channel Aftertouch messages (Dn vv)
[Bender]	Bender messages (En ll mm)
[Sys.Com&Ex]	System Common messages, Exclusive messages (F0 ... F7)

To execute the Trigger function, press F1 W.Trig.

- Stat** **(Status)**  
This displays the status of the received messages.
- Data** **(Data)**  
This displays the data of the received messages.
- F1 W.Trig** **(Wait Trigger)**  
When you press F1, the display will show "Waiting for Trigger". When the type of MIDI message you specify as the Trigger is received, the MIDI Monitor will start.
- F2 Clear** **(Clear Display)**  
This button clears all MIDI data shown in the display.

**F3 RTMOn/Off (Realtime Message on/off)**  
 This specifies whether or not Realtime messages will be monitored.

## Quick Load display

The Quick Load function allows you to register the sounds you use frequently, and load them quickly from this display without having to change the Current Drive setting.

**\* For the procedure of registering a sound in the Quick Load List, refer to Advanced Operation p.6-2.**

**<Target>** (Target) [Volume],[Performance],[Patch]  
 This indicates the type of sound data for quick loading or for registering in the Quick Load List. The Target will change each time you press F1.

**Number**  
 This indicates the number of the sound at the cursor location.

**Sound name** [System1]  
 This displays the Quick Load sound list.

**\* This list of sounds is a System parameter. If you turn the power off without Save System, the data will be lost.**

**Sound data size**  
 This indicates the size of the sound data in seconds (at 44.1 kHz).

**SCSI ID Number** [System1]  
 The SCSI ID of the drive in which the sound is saved is displayed in square brackets [ ]. When you register a sound in the Quick Load List, the SCSI ID of that drive is also registered automatically.

**Int** (Internal memory free area)  
 This indicates the amount of free internal memory in seconds (at 44.1 kHz).

**F1** (Target) [Volume],[Perform],[Patch]  
 Select the desired type of sound data.

**F3 Load** (Load)  
 Load the sound data at the cursor location.

**F4 SortABC** (Alphabetical sort)  
 Sort the sound list in alphabetical order.

**F5 Delete** (Delete)  
 Delete the sound at the cursor location from the sound list.



---

## Quick Load Select display

When you move the cursor to a sound name in the Quick Load display and press S1/DEC(Select), this display will appear, allowing you to register a sound in the Quick Load List (Advanced Operation p.6-2).

- TG**                    **(Target)**  
This displays the Target you selected in the Quick Load display. The Target cannot be changed in this display. You must set it in the Quick Load display.
- ID**                    **(Volume ID)**  
By specifying a Volume ID, you can restrict the sounds displayed in the Quick Load Select display.
- CD**                    **(Current Drive)**  
Specify the drive which contains the sound you wish to register.
- Int**                    **(Internal memory free area)**  
This indicates the amount of free internal memory in seconds (at 44.1 kHz).
- Sound data size**  
This indicates the size of the sound data in seconds (at 44.1 kHz).
- Program number**  
If the Target is Volume, this displays the program number of the Volume.
- F3 Select**            **(Select)**  
This registers the sound at the cursor location in the list. You will then return to the Quick Load display.

---

## Performance Quick Sampling display

- Patch**                    **Name (Patch Select)**  
Select the Patch you wish to create by sampling.
- ( )                    **(Part number)**                    [1] — [32]  
Specify the Part to which the Patch created by Performance Quick Sampling will be assigned.
- \* If you select a Part which is turned off (i.e., to which a Patch is not assigned), the lowest-numbered Patch which contains no data will be automatically selected. It is also possible to specify a Part, and then to later specify the Patch to which Partials will be assigned.
- [ ]                    **(Note number) [A0] — [C8]**  
Select the note number to which the Partial will be assigned.  
If Patch Select is set to a Patch which is already split, the note number settings you make here (parameters such as Partial Select and Lower Key Point) will be displayed.  
If you wish to re-do the Patch split settings in this display, specify the note number to which the Partial will be assigned.
- \* When F4 is set to MIDISel, you can press a note on your MIDI keyboard to specify this note number.
- Partial Name**                    **(Partial Select)**   
Select the Partial to assign to the note number.
- [L:]                    **(Lower Key Point)**                     [A0] — [C8]  
[U:]                    **(Upper Key Point)**                     [A0] — [C8]
- Specify the note range for which the Partial selected in Partial Select will sound.
- \* [L:] is the lower limit and [U:] is the upper limit of the note range.
  - \* It is not possible to set the Lower Key Point above the Upper Key Point, or to set the Upper Key Point below the Lower Key Point.
- Typ**                    **(Assign Type)**                     [Poly],[Mono], [Exc1] — [Exc16]  
Specify how notes will be sounded when more than one note number is requested at one time (Advanced Operation p.3-17).
- F1 Smpling**                    **(Performance Quick Sampling)**  
The Sampling display will appear (Advanced Operation p.3-42). This is the same sampling display as for Sample mode.
- \* In the case of Quick sampling, "\*" will be displayed before and after the display name, to indicate that this is not the normal sampling display. The procedure is the same as for the normal sampling display, so refer to Advanced Operation p.3-42.

- 
- F2 MoveSet**           **(Move Set)**  
 You can change split settings in the Performance Quick Sampling display. This moves the Lower Key Point and Upper Key Point to the correct position, and finalizes the split settings.
- \* If you wish to change the split settings to narrow the note range for a Patch which is already split across the entire keyboard or to change the split Assign Type, then adjust the Lower Key Point, Upper Key Point, and Assign Type, and press F2 MoveSet.**
- F3 Q-Edit**           **(Quick Edit)**  
 The Quick Edit display will appear (Advanced Operation p.3-11). This allows you to directly edit some of the Partial/Sample parameters.
- F4**                   **(MIDI switch)**                                 **[MIDISel],[MIDIOff]**  
 This determines how MIDI messages are received from an external MIDI controller.
- MIDISel   : Note-on messages from an external MIDI controller can be used to specify note numbers.  
 MIDIOff   : MIDI messages will be ignored for the purposes of specifying note numbers for the split. If the note which receives a Note-on message is already split, its Partial will sound.
- F5 ← Kbd**           **(keyboard display select)**  
**F6 Kbd →**           **(keyboard display select)**  
 These buttons move the keyboard display area in the direction indicated by the arrow. The triangle at each end of the graphic indicates whether part of the keyboard display is hidden. If the triangle is visible, part of the keyboard in that direction is hidden.

## Quick Edit display

From the Quick Sampling display in each mode, you can directly edit some of the Partial parameters and Sample parameters.

- [ ]**                   **(Note number)**                                 **[A0] — [C8]**  
 In the case of Performance/Patch Quick Edit, you can Quick Edit the Partial assigned to the note number you specify here.
- \* If F4 is set to MIDISel, you can use your MIDI keyboard to specify the note number.**

---

<b>Partial</b>	(Partial select) <input type="checkbox"/> Patch In the case of Performance/Patch Quick Edit, the Partial assigned to the selected note number will be displayed. In the case of Partial Quick Edit, you can select the Partial you wish to Quick Edit.
<b>Pitch KF</b>	(Pitch Key Follow) <input type="checkbox"/> Partial (Advanced Operation p.3-24)
<b>Pitch Cor</b>	(Sample Coarse Tune) <input type="checkbox"/> Partial (Advanced Operation p.3-25)
<b>Pitch Fin</b>	(Sample Fine Tune) <input type="checkbox"/> Partial (Advanced Operation p.3-25)
<b>TVF Fil</b>	(Filter Mode) <input type="checkbox"/> Partial (Advanced Operation p.3-28)
<b>TVF Cut</b>	(Cutoff Frequency) <input type="checkbox"/> Partial (Advanced Operation p.3-28)
<b>TVF Res</b>	(Resonance) <input type="checkbox"/> Partial (Advanced Operation p.3-28)
<b>TVA Lev</b>	(Partial Level) <input type="checkbox"/> Partial (Advanced Operation p.3-28)
<b>TVA Rel</b>	(Envelope Time 4) <input type="checkbox"/> Partial (Advanced Operation p.3-28)
<b>TVA Vel</b>	(Velocity Curve Type) <input type="checkbox"/> Partial (Advanced Operation p.3-34)
<b>Key</b>	(Original Key) <input type="checkbox"/> Sample (Advanced Operation p.3-42)

Refer to each item for details.

\* Changes in the value of each parameter made in the Quick Edit display are linked with parameter values in each level.

<b>F1</b>	(Loop Mode) <input type="checkbox"/> Sample (Advanced Operation p.3-68)
<b>F2</b>	(Edit Point) (Advanced Operation p.3-66)
<b>F3 L.Lock/Unlk</b>	(Loop Length Lock) (Advanced Operation p.3-49)
<b>F4</b>	(MIDI switch) (Advanced Operation p.3-17)

\* In the case of Partial Quick Edit, this will not be displayed.

<b>F6 Loop</b>	Loop (Advanced Operation p.3-48)
----------------	----------------------------------

Refer to each item for details.

# Patch Mode

---

This is the mode used for editing Patches.

A Patch is created by setting the necessary parameters for playing a maximum of 88 Partials which are assigned (split) to the 88 keys.

How the pitch, level and cutoff frequency of the filter are affected by control messages (Control Change, Pitch Bend, Aftertouch, etc.) from a MIDI controller (such as a master keyboard) can also be determined in this mode.

## Methods of Editing a Patch

There are two ways to edit a Patch:

- 1: This method allows you to edit the Patch assigned to a Part while listening to the entire Sound program of the Performance.
- 2: This method allows you to edit a Patch while listening only to the Patch Sound program itself.

See Advanced Operation p.1-5 for details.

## Patch Common

This determines the settings related to the entire Patch, such as how the Patch should sound when playing.

### Indications

[ ]

#### (Patch Select)

This changes the Patch to be edited.

In the case of 1(In Performance mode) ( Advanced Operation p.1-5):

Only the Patch which is assigned to the Part can be selected.

The currently selected Part is shown in parentheses "( )" to the right of the Patch name. While editing, you can check the sound by playing the external MIDI controller. The MIDI channel to be used is the same as that for the Part.

In the case of 2(In Patch mode) ( Advanced Operation p.1-6):

Any Patch in the internal memory can be selected.

There is no parentheses "( )" indication to the right of the Patch name.

While editing, you can check the sound by playing the external MIDI controller. Since the OMNI ON condition is active, any MIDI channel from 1 to 16 can be used.

### Patch Level

(Patch Level)

[0] — [127]

This determines the sound volume of the Patch. No sound is output when this parameter is set to 0( Advanced Operation p.4-9).

<b>Panning</b>	(Patch Panning) <input type="text" value="Patch"/> [L32] — [0 (Center)] — [R32]
	This determines the pan setting when using the stereo out jacks. This pan setting of the Partial (included in the Patch) moves the entire sound to the left or right (Advanced Operation p.4-8).
<b>Output Assign</b>	(Patch Output Assign) <input type="text" value="Patch"/> [A], ([B]) — ([D]), ([1]), ([2]), [3] — [8], [-P- (Partial)]
	This determines from which jack the Patch is output (Advanced Operation p.4-2). When this is set to [-P-] (Partial), the Output Assign setting for the Partial is active.
	<b>* It may happen that the jack indicated in parentheses ( ) may not be set according to the Output Mode setting of the System parameters. (Advanced Operation p.4-2)</b>
<b>Priority</b>	(Patch Priority) <input type="text" value="Patch"/> [Off], [On]
	When receiving note messages exceeding the maximum polyphony of the S-760, this determines whether the voices of the sounds being used for each Patch will be allowed to decay naturally or be abruptly cut off. The maximum polyphony of the S-760 is 24 voices. There may be a shortage of voices if you layer many samples or use the S-760 as a multi-timbral sound source. When this happens, the voices currently sounding are cut off one by one as new notes are played (last note priority); however, the Patches whose priority has been set to On will continue to sound. If you are concerned about the number of available voices when using the S-760 as a multi-timbral sound source, set the priority of Patches used for melody and bass lines to On. In this way, the most important parts (the melody and bass lines in this case) continue to sound even though some backing chords may be cut off unexpectedly.
	<b>* When the priority settings of all Patches are on, the earlier played sounds have priority and recently played notes (the ones which exceed the 24-voice limit) are ignored.</b>
<b>Oct Shift</b>	(Octave Shift) <input type="text" value="Patch"/> [-2] — [2]
	This shifts the received MIDI note number up or down (in octave units) and sounds the Patch accordingly.
<b>Coarse Tune</b>	(Patch Coarse Tune) <input type="text" value="Patch"/> [-48] — [48]
	This determines the pitch (in semi-tones) at which the Patch is sounded.
	<b>* The sound range of each sample can be up to two octaves higher than the original key (Advanced Operation p.3-42). Even when a pitch setting greater than two octaves is determined by tuning or pitch modulation, the sound can go no higher than the two octave limit.</b>
<b>Fine Tune</b>	(Patch Fine Tune) <input type="text" value="Patch"/> [-50] — [50]
	This determines the fine pitch setting of the Patch. The value is adjusted up or down in 1-cent steps (1 cent is equivalent to 1/100 of a semi-tone).
<b>Analog Feel</b>	(Analog Feel) <input type="text" value="Patch"/> [0] — [127]
	This provides a subtle, pitch modulation when playing. Higher values create a minute modulation of the Pitch each time a Patch sounds (for each sound), allowing you to obtain a warmer, more natural sound-like that of an analog synthesizer. This is also useful for adding thickness and depth to string sounds, especially when playing chords.

<b>Program #</b>	<b>(Program Number)</b> <input type="text" value="Patch"/> [1] — [128] This determines the program number when changing the Patch in the Performance Mode.  * See Basic Operation p.9-2 for changing Patches via MIDI.
<b>Caution!</b>	
Do not assign the same program number to several Patches. When the same program number is set to different Patches, the Patch with the lowest list number indicated in the Select Patch page has priority.	
<b>Cutoff Offs</b>	<b>(Cutoff Offset)</b> <input type="text" value="Patch"/> [-63] — [63] This adjusts the cutoff setting for the entire Patch. This value is added to the cutoff frequency ( Advanced Operation p.3-28) of each Partial being used by the Patch. If the cutoff frequency of the Partial has already been set to 127, setting this parameter to a positive value will not change the actual value any further.  * <b>When the TVF Filter Mode ( Advanced Operation p.3-28) is off, the setting of the Cutoff Offset becomes inactive.</b>
<b>Reso Offs</b>	<b>(Resonance Offset)</b> <input type="text" value="Patch"/> [-63] — [63] This affects the entire sound of the Patch. This value is added to the resonance value of each Partial being used by the Patch. ( Advanced Operation p.3-28) If the resonance of the Partial has already been set to 127, setting this parameter to a positive value will not change the actual value any further.  * <b>When the TVF Filter mode (Advanced Operation p.3-28) is off, the setting of the Resonance Offset becomes inactive.</b>
<b>Attack Offs</b>	<b>(Attack Time Offset)</b> <input type="text" value="Patch"/> [-63] — [63] This affects the entire TVA envelope attack time (the Time 1 parameter) of each Partial being used by the Patch. ( Advanced Operation p.3-37)
<b>ReleaseOffs</b>	<b>(Release Time Offset)</b> <input type="text" value="Patch"/> [-63] — [63] This affects the entire TVA envelope release time (the Time 4 parameter) of each Partial being used by the Patch ( Advanced Operation p.3-38).
<b>V-Sens Offs</b>	<b>(Velocity Sense Offset)</b> <input type="text" value="Patch"/> [63] — [-63] This affects the entire TVF and TVA Velocity Curve Sense value ( Advanced Operation p.3-31, p.3-36) of each Partial being used by the Patch.

## Patch Split

From this page you can assign Partials (and the range over which they will sound) to the 88 keys of the keyboard. The assignment of each single Partial is referred to as a "split" and a maximum of 88 Partials can be split over the keyboard. You can also assign splits by using a MIDI keyboard.

\* See Advanced Operation p.6-21 for information on how to set the split.

### Indications

[ ]

#### (Patch Select)

This changes the Patch to be edited.

[ ]

#### (Note Number)

[A0] — [C8]

Specify the note number you wish to assign to the Partial. If a MIDI keyboard is connected and F1 (MIDI switch) is set to MIDISel, you can also press a note on your MIDI keyboard to set this note number.

\* If you wish to specify a continuous range of more than one note number, the note number specified here can be any note in that range.

If in Patch Select you have selected a Patch which is already split, specifying a note number here will cause the parameter settings such as Partial Select and Lower Key Point to be displayed for each split area.

\* If F1 (MIDI switch) is set to MIDIOff, the Note Number cannot be selected by external MIDI keyboard.

### Partial Name

(Partial Select)

[---(Off)],[1] — [255]

This selects the Partial to be assigned to the note number.

[L:]

(Lower Key Point)

[A0] — [C8]

[U:]

(Upper Key Point)

[A0] — [C8]

This determines the range over which the Partial can be played. The sound range is from the key number of the lower key point (L.P) to the key number of the upper key point (U.P).

\* It is impossible to set the lower key point higher than the upper key point, or vice versa.



Typ

(Assign Type) **Patch****[Poly], [Mono], [Exc1] — [Exc16]**

This determines how the Partial's will sound when several notes are played simultaneously.

**Poly**

In this setting, successively played sounds of the same note number are layered. For example, when repeatedly playing a sound with a long decay, such as a crash cymbal, the individual sounds are layered, and subsequently played sounds do not cut off previous ones.

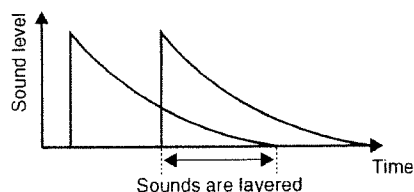
**Mono**

In this setting, successively played sounds of the same note number are sounded individually. The last sound played cuts off the previous sound when repeatedly playing a sound with a long decay.

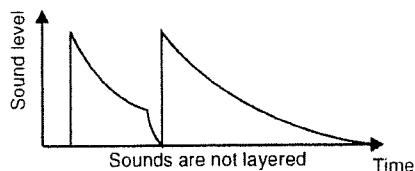
**Exc1 — Exc16 (Exclusive 1 — 16)**

In this setting, the sounds of Partial's set to the same EXC number are sounded individually, regardless of the note number played. This setting is useful when there are Partial's which you don't want to sound at the same time, such as a closed high-hat and open high-hat. In such a case, set these Partial's to the same Exclusive number (1 — 16).

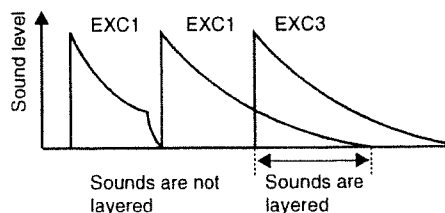

F1

**(MIDI switch)****[MIDI Sel], [MIDI Set], [MIDI Off]**

This specifies how MIDI messages will be received from an external MIDI controller. You can use a MIDI controller to check split settings or to actually make split settings.

- MIDI Sel : Note-on messages from an external MIDI controller will specify note numbers.
- MIDI Set : When a Note-on message from an external MIDI controller are received, the Partial selected in the Partial Select display will be split.
- MIDI Off : MIDI messages will be ignored for the purposes of specifying splits or note numbers. If you wish to make split settings from the front panel, set MIDI Off. If the key which receives the Note-on message is already split, its Partial will sound.

---

**F2** (Split mode) [1Key], [O.W], [Move]  
 This sets the split mode.

- 1Key : The Split will consist only of the specified single key.
- O.W : The Partial will be split to the area specified by the Lower Key Point (Advanced Operation p.3-16) and Upper Key Point (Advanced Operation p.3-16). If you attempt to split it to an area in which a Patch is already split, it will be overwritten.
- Move : Use this setting when you wish to modify the split area of a Partial which is already split. The Partial will be re-split to the area specified by the Lower Key Point and Upper Key Point.

**F3 Set** (Set)  
 This finalizes the split settings.

**F5** (keyboard display switch)  
**F6** (keyboard display switch)

These switches move the keyboard display in the direction of the arrow. A triangular indicator may be shown at either side of the keyboard display to indicate that part of the keyboard display is hidden.

\* For details on split settings, refer to Advanced Operation p.6-21.

## Patch Control

This determines the effects to be applied when receiving MIDI messages such as Pitch bend, Control Change or Aftertouch.

**Indications**  
 [ ]

(Patch Select)  
 This changes the Patch to be edited.

**SMT C.Sel** (Sample Mix Table Control Select)  Patch [Off (off)], [Bend (Pitch bend)], [A.T (aftertouch)], [Mod (modulation)], [Ctrl (Control Change)]

This determines the type of MIDI message which controls the SMT. (Advanced Operation p.3-24)

\* The SMT is controlled either with Velocity or MIDI messages. Velocity and MIDI messages cannot control the SMT at the same time. You must select either of them with SMT V. Ctrl in the Partial (Advanced Operation p.3-23). When the SMT is being controlled with Velocity, it cannot be controlled with MIDI messages.

\* The Control number (when setting to Ctrl) can be set by the Control Select parameter.

**SMT C.Sens** (Sample Mix Table Control Sense)  [-63] — [0] — [63]  
This sets the depth of the effect when controlling the SMT by the Control message selected in the Sample Mix Table Control Select parameter.

**\* The greater the value, the deeper the effect becomes. There is no effect at 0. The effect is inverted (reversed) when this is set to a negative value.**

**Ctrl Sel** (Control Select)  [0] — [95]  
This determines the Control number of the Ctrl (Control Change) parameter which controls pitch, TVF, TVA and LFO. It also determines the Control Number when "Ctrl" is set in the Control Select parameter of the Sample Mix Table. In this case, the Sample Mix Table is also controlled together with the pitch, TVF, TVA and LFO by the Control Number set here.

**\* When 7 (Main Volume), 10 (Pan) or 64 (Damper (Hold1)) is selected, the S-760 will receive Volume, Pan or Hold messages even if the Vol, Pan or Hold in the MIDI Filter of the Performance is set to OFF, and will control the pitch, TVF or SMT etc. in the Patch.**

**\* Some of the Control Numbers (above #64) function as an on/off control. A value of 0 corresponds to Off, and a value of 127 corresponds to On. (This differs depending on the MIDI transmission function of the connected MIDI controller, such as in the case of a switch-type controller like a footswitch.)**

**Bend-Up** (Pitch Bend Up Range)  [0] — [48]  
This determines how far the pitch will be raised when the Pitch Bender is at its maximum positive position. One step corresponds to a rise in pitch of one semi-tone.

**Bend-Down** (Pitch Bend Down Range)  [0] — [48]  
This determines how far the pitch will be lowered when the Pitch Bender is at its maximum negative position. One step corresponds to a lowering of the pitch by one semi-tone.

### Bend (Pitch Bend)

**Bend TVF Control** (Bend TVF Control)  [-63] — [63]  
This changes the TVF cutoff frequency by Pitch Bend messages.

**Bend TVA Control** (Bend TVA Control)  [-63] — [63]  
This changes the TVA level by Pitch Bend messages.

## A.T (Aftertouch)

- A.T Pitch Control** (Aftertouch Pitch Control)  Patch [-48] — [48]  
This determines the range over which pitch (in semi-tone steps) is to be controlled by Aftertouch messages.
- A.T TVF Control** (Aftertouch TVF Control)  Patch [-63] — [63]  
This controls the TVF cutoff frequency by Aftertouch messages.
- A.T TVA Control** (Aftertouch TVA Control)  Patch [-63] — [63]  
This controls the TVA level by Aftertouch messages.
- A.T LFO Rate Control** (Aftertouch LFO Rate Control)  Patch [-63] — [63]  
This controls the LFO rate by Aftertouch messages.
- A.T LFO Pitch Depth** (Aftertouch LFO Pitch Depth)  Patch [-63] — [63]  
This controls the depth of the vibrato (the periodic pitch change) as modulated by the LFO, via Aftertouch messages.
- A.T LFO-TVF Depth** (Aftertouch LFO TVF Depth)  Patch [-63] — [63]  
This controls the depth of the filter sweep effect (the movement of the TVF cutoff frequency) as modulated by the LFO, via Aftertouch messages.
- A.T LFO-TVA Depth** (Aftertouch LFO TVA Depth)  Patch [-63] — [63]  
This controls the depth of the tremolo (the periodic change of the sound level) as modulated by the LFO, via Aftertouch messages.

## Mod (Modulation)

- Mod LFO Rate Control** (Modulation LFO Rate Control)  Patch [-63] — [63]  
This controls the LFO rate by Modulation messages.
- Mod LFO-Pitch Depth** (Modulation LFO Pitch Depth)  Patch [-63] — [63]  
This controls the depth of the vibrato (the periodic pitch change) as modulated by the LFO, via Modulation messages.
- Mod LFO-TVF Depth** (Modulation LFO TVF Depth)  Patch [-63] — [63]  
This controls the depth of the filter sweep effect (the movement of the TVF cutoff frequency) as modulated by the LFO, via Modulation messages.
- Mod LFO-TVA Depth** (Modulation LFO TVA Depth)  Patch [-63] — [63]  
This controls the depth of the tremolo (the periodic change of the sound level) as modulated by the LFO, via Modulation messages.

## Ctrl (Control Change)

- Ctrl Pitch Control** (Control Change Pitch Control)  [-48] — [48]  
This determines the range over which pitch (in semi-tone steps) is to be controlled by Control Change messages.
- Ctrl TVF Control** (Control Change TVF Control)  [-63] — [63]  
This controls the TVF cutoff frequency by Control Change messages.
- Ctrl TVA Control** (Control Change TVA Control)  [-63] — [63]  
This controls the TVA level by Control Change messages.
- Ctrl LFO Rate Control** (Control Change LFO Rate Control)  [-63] — [63]  
This controls the LFO rate by Control Change messages.
- Ctrl LFO Pitch Depth** (Control Change LFO Pitch Depth)  [-63] — [63]  
This controls the depth of the vibrato (periodic pitch change) as modulated by the LFO, via Control Change messages.
- Ctrl LFO-TVF Depth** (Control Change LFO TVF Depth)  [-63] — [63]  
This controls the depth of the filter sweep effect (the movement of the TVF cutoff frequency) as modulated by the LFO, via Control Change messages.
- Ctrl LFO-TVA Depth** (Control Change LFO TVA Depth)  [-63] — [63]  
This controls the depth of the tremolo (the periodic change of the sound level) as modulated by the LFO, via Control Change messages.

## Patch Quick Sampling display

In this display you can sample to create Sample, Partial, and Patch data. For details refer to Advanced Operation p.6-18.

# Partial Mode

Partials are edited in this mode.

Settings such as moving the pan position of the sample left and right in the stereo image, or mixing several samples (up to a maximum of four) by velocity can be set here. It is also possible here to edit the Sound program, sound level and vibrato with the TVF, TVA and LFO parameters.

## How to Edit the Partials

Editing of the Partials is done in the following three ways:

- 1 This method allows you to edit the Partial being used by a Patch assigned to a Part while listening the Sound program of the entire Performance.
- 2 This method allows you to edit the Partial being used by a Patch while listening to the Sound program of the Patch itself.
- 3 This method allows you to edit the Partial while listening to the Sound program of the Partial itself.

\* See **Advanced Operation p.1-7** for details.

## Partial Common

This determines the settings of the output and the settings related to pan and pitch.

### Indications

[ ]

#### (Partial Select)

This changes the Partial to be edited.

In the case of editing with 1(In Performance mode) ( Advanced Operation p.1-7)

Only the Partial being used by the Patch assigned to the Part can be selected.

While editing, you can check the sound by playing the external MIDI controller. The MIDI channel to be used is the same as that for the Part.

The Partial to be edited can be changed also by the external MIDI controller (by note messages).

For example, it is possible to change the Partial for editing by playing the note C4, which selects the Partial assigned to the key C4.

In the case of editing with 2(In Patch mode) ( Advanced Operation p.1-8)

Only the Partial being used by the currently selected Patch can be selected.

While editing, you can check the sound by playing the external MIDI controller. Since the OMNI ON condition is active, any MIDI channel from 1—16 can be used.

The Partial to be edited can be changed also by the external MIDI controller (by note messages).

For example, it is possible to change the Partial for editing by playing the note C4, which selects the Partial assigned to the key C4.

In the case of editing with 3(In Partial mode) ( Advanced Operation p.1-9)

Any Partial in the internal memory can be selected.

While editing, you can check the sound by playing the external MIDI controller. Since the OMNI ON condition is active, any MIDI channel from 1—16 can be used.

An external MIDI controller (note messages) cannot be used to change the Partial which is to be edited.

<b>Partial Lev</b>	(Partial Level) <input type="checkbox"/> Partial	[0] — [127]
	This adjusts the sound volume of the entire Partial(Advanced Operation p.4-9).	
<b>Panning</b>	(Partial Panning) <input type="checkbox"/> Partial	[L32] — [0 (Center)] — [R32]
	This determines the pan setting of the entire Partial(Advanced Operation p.4-8).	
<b>Out Assign</b>	(Partial Output Assign) <input type="checkbox"/> Partial	[A], ([B]) — ([D]), ([1]), ([2]), [3] — [8]
	This determines the jack from which each Partial is output. This parameter becomes active when the Output Assign parameter of the Patch is set to "P."	
	* It may happen sometimes that the jack indicated in parentheses "( )" may not be set according to the Output Mode setting of the system.	
	* See Advanced Operation p.4-2 for details on the actual output configuration.	
<b>Coarse Tune</b>	(Partial Coarse Tune) <input type="checkbox"/> Partial	[-48] — [0] — [48]
	This adjusts the pitch of the entire Partial in semi-tone units(Advanced Operation p.4-9).	
	* A setting of +48 results in a pitch setting four octaves higher.	
	* The sounding range of each sample can be up to two octaves higher than the original key . Even when a pitch setting greater than two octaves is determined by the tuning or pitch modulation, the sound can go no higher than the two octave limit.	
<b>Fine Tune</b>	(Partial Fine Tune) <input type="checkbox"/> Partial	[-50] — [0] — [50]
	This finely adjusts the pitch of the entire Partial in 1-cent units (1/100 of a semi-tone).	
	* A change of 50 cents equals 1/2 of a semi-tone.	
<b>SMT V.Ctrl</b>	(SMT Velocity Control) <input type="checkbox"/> Partial	[Off], [On]
	This determines whether the Sample Mix Table is controlled by velocity or not. When this is set to Off, the SMT can be controlled by MIDI messages determined by the SMT C.Sel parameter ( Advanced Operation p.3-18). When this is set to On, the SMT can be controlled by velocity.	
	* The SMT is controlled either by velocity or MIDI messages. It cannot be simultaneously controlled by both velocity and MIDI messages.	
	* When the Partial Common page is opened with 3(In Partial mode) method, even if this parameter is turned off, how the sound is output is determined by the velocity that controls the SMT. The parameter value set here does not affect the output of the sound, but it will when the unit is returned to a mode such as the Performance mode.	

- F1 (Edit Mode)[Single], [Global]**  
 This determines the Edit Mode.  
 There are two modes in the Edit Mode: Single (Single Edit mode) and Global (Global Edit mode). The Partials to be edited differ between Single and Global.
- Single : In this mode, only the Partials which are currently selected can be edited.
  - Global : In this mode, all the Partial parameters, which are used by the currently selected Patch, can be simultaneously edited to the same value.
- In case of 1 (In Performance mode) and 2(In Patch mode) ( Advanced Operation p.1-7)**
- Either Single Edit Mode or Global Edit Mode can be selected.
- In case of 3 (In Partial mode) (Advanced Operation p.1-9)**
- There is no choice; only the Single Edit Mode can be selected.

## Partial SMT (Partial Sample Mix Table)

This determines the range over which samples in the Partial can be sounded by changes in velocity. This also determines how the sound of the sample is panned to the left or right, or how several samples are mixed and switched by velocity messages.

### Indications

- [ ] **(Partial Select)**  
 This selects the Partial for editing.

### Sample Name

- (Sample Select) [Partial]**  
 This assigns a maximum of four samples to the Partial. (Four samples are assigned to sections 1-4, referred to as components. How the sample sounds can be set for each component.)  
 No sample is assigned when this is set to Off.  
 Stereo samples are automatically assigned to components 1 and 2, and components 3 and 4 by moving the cursor to \*|1| or \*|3| at the left in the display and pressing S1/DEC or S2/INC. Press S1/DEC to search for samples from 512 to 1 and press S2/INC to search for samples from 1 to 512.
- \* Press S1/DEC(List) to call up the a Select sample page, and enable selection of samples. Press F3 (Set Off) when setting a sample to off.
  - \* Stereo samples received by MIDI Sample Dump ( Advanced Operation p.3-99) cannot be retrieved. Execute the Set Stereo command ( Advanced Operation p.5-9) to retrieve them.

- K.F (Pitch Key Follow) [Partial] [-16/8] — [-8/8] — [Off] — [Norm] — [16/8]**  
 This sets the relationship between the note number (key position) of the Partial to be used and the pitch which actually sounds.  
 This can be set over a range of 32 steps.
- \* The pitch of each sample is changed relative to the original key ( Advanced Operation p.3-42) of each Sample.



- 16/8 When the note number is increased by one octave, the actual pitch increases by two octaves.
- Norm(8/8) When the note number is increased by one octave, the pitch increases by one octave (the normal pitch change in semi-tone units).
- Off(0/8) The pitch doesn't change even though the note number is changed.
- 8/8 When the note number is increased by one octave, the actual pitch decreases by one octave.
- 16/8 When the note number is increased by one octave, the pitch decreases by two octave.

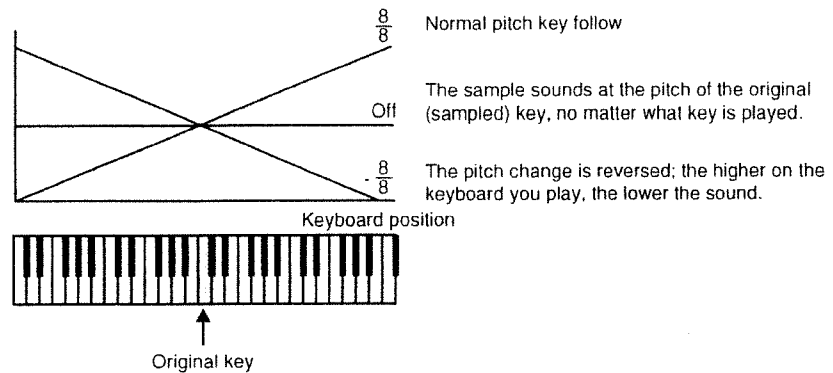

C.T

(Sample Coarse Tune)  [-48] — [48]

This determines the pitch of the sample to be used, in semi-tone units.

- \* A setting of +48 results in a pitch change four octaves higher.
- \* The sounding range of each sample can be up to two octaves higher than the original key (Advanced Operation p.3-42). Even when a pitch setting greater than two octaves is determined by the tuning or pitch modulation, the sound can go no higher than the two octave limit.

F.T

(Sample Fine Tune)  [-50] — [50]

This determines the fine pitch setting of the sample to be used, in 1-cent steps (1/100 of a semi-tone).

- \* A setting of 50 cents results in a pitch change of 1/2 of a semi-tone.

**Pan** (Sample Pan) Partial [L32] — [0 (Center)] — [R32], [Rnd], [Ky +], [Ky -], [Alt]

This determines the pan setting for each sample.  
 The stereo position is fixed at the center at 0, the far left at L32, and far right at R32.  
 The stereo position changes irregularly at Random (Rnd).  
 The stereo position changes according to the notes played on the keyboard (note number) when it is set to Ky + or Ky -. When this is set to Ky +, the higher up on the keyboard that you play, the further the sound is shifted to the right; when set to Ky -, the higher the notes played on the keyboard, the further left the sound is shifted.

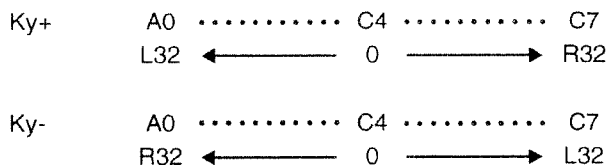

In the Alt (Alternate) setting, the stereo position of sound is shifted hard left and hard right (i.e., L32, R32, L32, etc.) each time a key is played.

**\* When moving the cursor to the component number \*[1] or \*[3] to select the stereo sample by using S1/DEC or S2/INC, this is set automatically to L32, R32.**

**\* See Advanced Operation p.4-8 for further information on the actual pan output.**

**Level** (Sample Level) Partial [0] — [127]

This determines the sound volume of each sample.

**\* See Advanced Operation p.4-9 for details on the actual sound volume output.**

**V.L** (Velocity Low Point) Partial [1] — [126]

This determines the lowest limit of the velocity for which the sample will sound.

**V.H** (Velocity High Point) Partial [2] — [127]

This determines the highest limit of the velocity for which the sample will sound.

**F.L** (Fade Width Low) Partial [0] — [125]

This determines the width of the area over which the sound level is faded from the velocity low point.

**F.H** (Fade Width High) Partial [0] — [125]

This determines the width of the area over which the sound level is faded from the velocity high point.

When playing the keyboard, the strength at which you play the keys (velocity value) is indicated by the down arrow mark at the top of the graphic display. Use this as a standard when setting the velocity value or fade width.

You can use the Velocity Range and the Fade Width settings of the sample Mix Table to simultaneously output the sounds of different samples, or to have samples (such as the loud and soft samples of the same sound) be played independently, depending on how hard the keyboard is played (velocity).

F1

**(Edit Mode)**

**[Single], [Global]**

This determines the Edit Mode(Advanced Operation p.3-24).

**Effects Possible with the SMT**

Layer (layering several sounds)

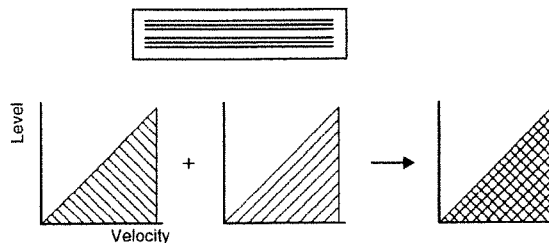

Velocity switch (sounding different samples separately depending on playing strength)

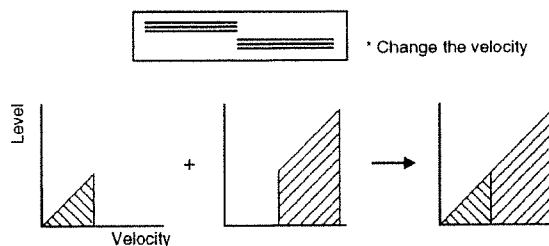

\* Change the velocity

Velocity mix (change the mix ratio of several samples by playing strength)

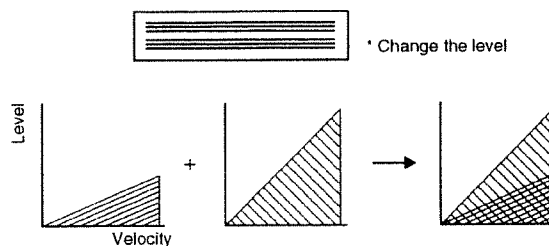

\* Change the level

Velocity crossfade (change the sound balance of several samples by playing strength)

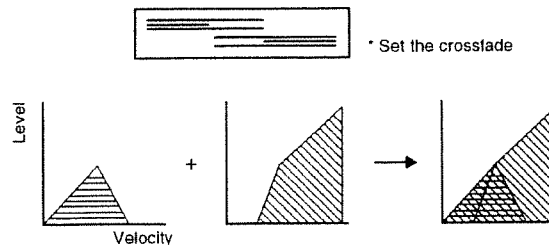

\* Set the crossfade

\* The SMT is normally controlled by velocity messages, however, it is also possible to control it by MIDI messages such as pitch bend and aftertouch. See Patch Control (Advanced p.3-18) for details.

---

## Partial TVF (Time Variant Filter)

This page is like the VCF section of an analog synthesizer, and it lets you control the timbre change over time by applying a common filter to four samples combined in the Sample Mix Table.

### Indications

[ ]

#### (Partial Select)

This determines the Partial to be edited.

### Filter Mode

(Filter Mode)

[Off], [LPF], [BPF], [HPF]

This determines the type of the filter.

Off (Off) : Samples are sounded or passed without being filtered. The pitch envelope is inactive at this time.

LPF (Low Pass Filter) : This lets frequencies lower than the set cutoff frequency pass, and cuts out the higher frequency elements.

BPF (Band Pass Filter) : This lets frequencies in a certain specified frequency band pass through without filtering. Higher resonance settings result in a narrower frequency band width.

HPF (High Pass Filter) : This lets frequencies higher than the set cutoff frequency pass, and cuts out the lower frequency elements.

### Cutoff Freq

(Cutoff Frequency)

[0] — [127]

This determines the cutoff frequency of the entire TVF.

This sets the frequency point at which the filter begins cutting out overtone elements. The smaller the value of the low pass filter, the more the overtone elements are cut, and the sound becomes close to a sine wave. (No sound is output if this setting is too low.) On the other hand, the timbre becomes light and sharp for higher values, since the high pass filter cuts out the low frequencies.

The cutoff setting can be changed in realtime by the envelope, messages from each controller, or a modulation source such as the LFO.

### Resonance

(Resonance)

[0] — [127]

This determines the resonance of the cutoff frequency.

The greater the value, the more the overtone elements around the cutoff frequency are emphasized; the timbre changes, taking on some of the characteristics of a synthesizer. Extremely high values result in oscillation.

**Cutoff KF** (Cutoff Frequency Key Follow) Partial [-63] — [63]

This changes the cutoff frequency relative to the key follow point, and lets you change the timbre of the sound according to what range of the keyboard (note data) you play. When this is set to 0, the cutoff cannot be controlled by key follow; the cutoff frequency remains at the setting which was made in the Cutoff Freq parameter.

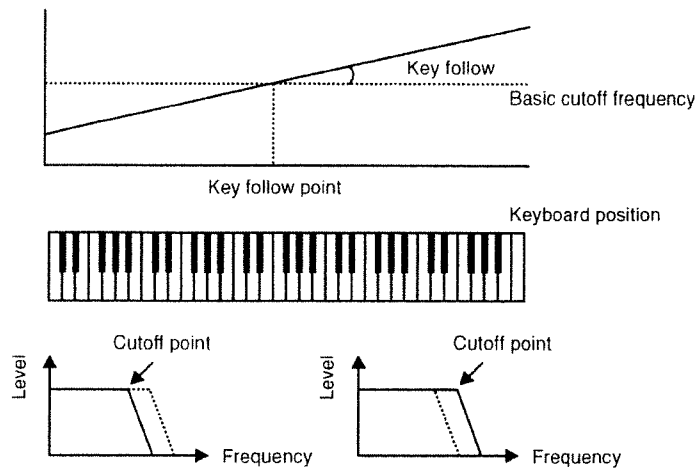

**KF Point** (Key Follow Point) Partial [A0] — [C8]

This determines the key used for the center of the key follow effect. The two independent parameters controlled by key follow (cutoff frequency and envelope time) are both affected by the Key Follow Point set here.

**Vel-Curve** (Velocity Curve Type) Partial [1] — [4]

This selects the curve which corresponds to the velocity value and the cutoff frequency. When this is set to "1," velocity has no effect on the cutoff frequency.

X axis : Velocity  
Y axis : Cutoff frequency

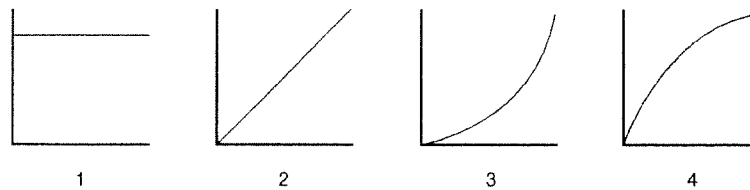

**Vel-C.Sens**

**(Velocity Curve Sense) Partial [-63] — [63]**

This determines the depth and polarity (positive/negative) of the velocity curve. A curve effect can be gained by setting the velocity curve to higher values close to 63; in other words, the cutoff frequency increases for high velocity values. Setting this close to 0 results in little change in the cutoff frequency, even with high velocity. With negative values, the effect becomes reversed; in other words, the cutoff frequency decreases for high velocity values.

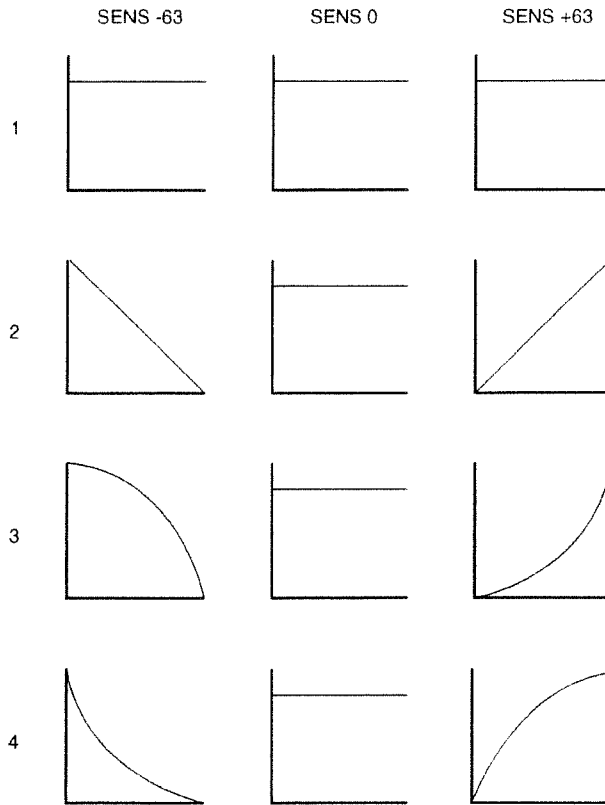

**Envelope-TVF Depth (Envelope TVF Depth) Partial [-63] — [63]**

This determines the depth of the envelope when changing the TVF cutoff frequency by the envelope. The envelope has the greatest effect at 63, has no effect at 0, and creates a reverse effect for negative values.

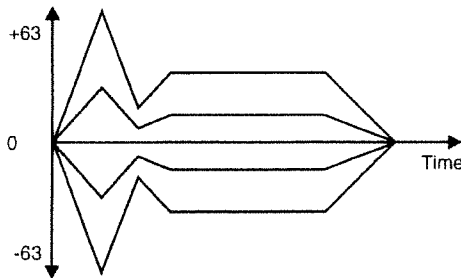

**Envelope-Vel Sens (Envelope Velocity Sense) Partial [-63] — [63]**

This determines how responsive the depth of the envelope is (in changing TVF cutoff frequency and pitch) to velocity data.

The envelope is most responsive to velocity at 63, has no effect at 0, and creates a reverse effect for negative values.

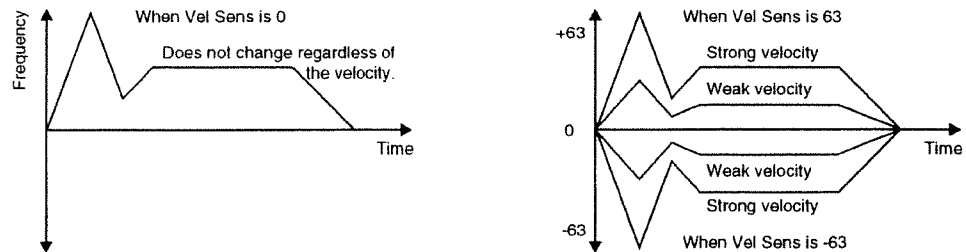

**Envelope-Pitch Depth (Envelope Pitch Depth) Partial [-63] — [63]**

Not only the cutoff frequency, but also the pitch can be changed by the TVF envelope. Set the effect depth in this parameter when changing pitch by the TVF envelope.

The envelope has the greatest effect at 63, has no effect at 0, and creates a reverse effect for negative values. When the set value is 63 and the envelope level is set to 127, the pitch rises two octaves. When the set value is -63, and the envelope level is set to 127, the pitch goes down four octaves.

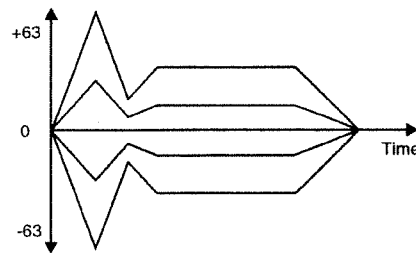

**Time-Vel Sens** (Time Velocity Sense) **Partial** [-63] — [63]

This determines the degree to which velocity affects the Time 1 length of the envelope. When this is set to a positive value, Time 1 becomes shorter as the velocity value increases (the envelope attack becomes faster). When this is set to a negative value, Time 1 becomes longer as the velocity value increases (the envelope attack becomes slower).

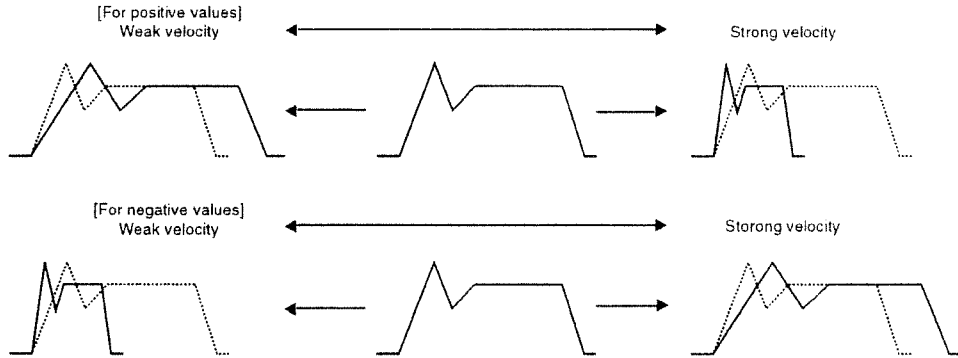

**Time-Key Follow** (Envelope Time Key Follow) **Partial** [-63] — [63]

This changes the envelope time (from Time 1 to 4) relative to the key follow point. When this is set to a positive value, the higher on the keyboard that you play (in other words, the greater the note number), the faster the attack of the envelope. When this is set to a negative value, the higher on the keyboard that you play (in other words, the greater the note number), the slower the attack of the envelope. The envelope time cannot be changed by the key follow when this is set to 0.

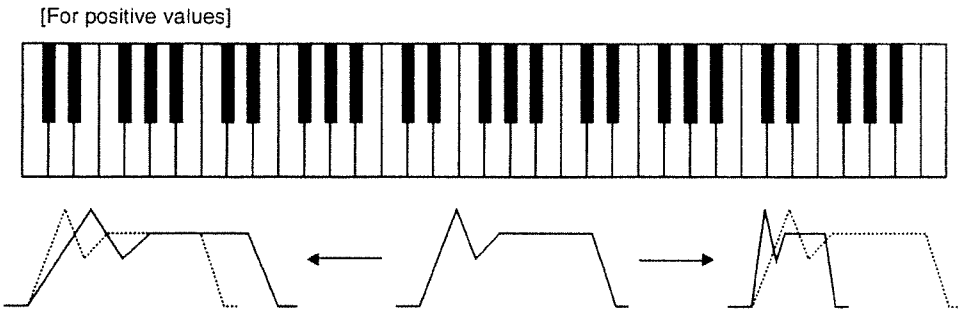



**R. Velo Sens**

**(Release Velocity Sense) Partial [-63] — [63]**

The release time (Time 4), can be changed by the speed at which you release your fingers from the keys (release velocity). The greater the value, the more pronounced the effect becomes. Setting this to a negative value creates a reverse effect.

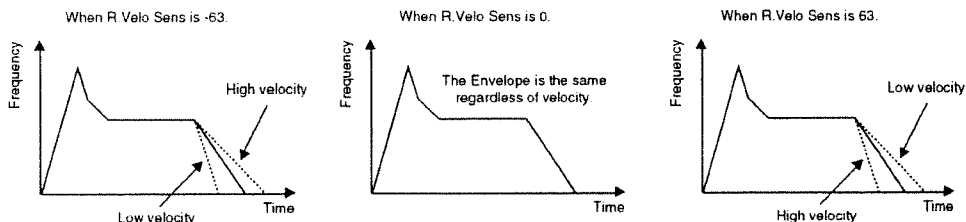

**\* When the release velocity is 64, the release time becomes the same as set in the Time 4 parameter.**

**TVF Envelope**

The Y axis in the graphic display indicates the cutoff frequency and the X axis indicates the time from the note on.

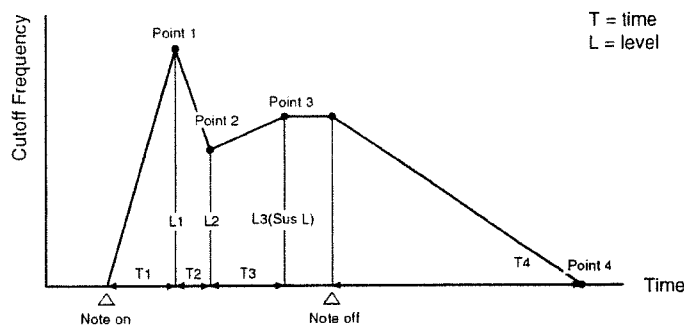

- Time 1**      **(Envelope Time 1) Partial [0] — [127]**  
This determines the time which it takes from when the key is pressed until Point 1.
- Level 1**      **(Envelope Level 1) Partial [0] — [127]**  
This determines the cutoff frequency level of Point 1.
- Time 2**      **(Envelope Time 2) Partial [0] — [127]**  
This determines the time which it takes from Point 1 to Point 2.
- Level 2**      **(Envelope Level 2) Partial [0] — [127]**  
This determines the cutoff frequency level of Point 2.
- Time 3**      **(Envelope Time 3) Partial [0] — [127]**  
This determines the time which it takes from Point 2 to Point 3.
- Level 3**      **(Envelope Level 3) Partial [0] — [127]**  
This determines the cutoff frequency level of Point 3 (sustain level).

**Time 4** (Envelope Time 4)  Partial [0] — [127]  
This determines the time which it takes from when the key is released until Point 4.

**Level 4** (Envelope Level 4)  Partial [0] — [127]  
This determines the cutoff frequency level of Point 4.

\* In addition to the TVF envelope, the TVA envelope of the currently selected Partial is also indicated in the graphic display. It is easier and more efficient to edit the TVF envelope while also seeing how it might affect or be affected by the TVA envelope.

\* Level 4 of the TVF envelope is linked with the level at the note on (the level before Point 1).

**F1** (Edit Mode)[Single], [Global]  
This determines the Edit Mode(Advanced Operation p.3-24).

## Partial TVA (Time Variant Amplifier)

This display is like the VCA section of an analog synthesizer, and it controls the sound volume change over time by passing the four samples combined in the Sample Mix Table through a common amplifier.

**Indications**  
[ ]

(Partial Select)  
This determines the Partial to be edited.

**Vel-Curve** (Velocity Curve Type)  Partial [1] — [4]  
This selects the curve which corresponds to the velocity value and the sound level.  
When this is set to "1," velocity has no effect on the level.  
X axis : Velocity  
Y axis : Sound level

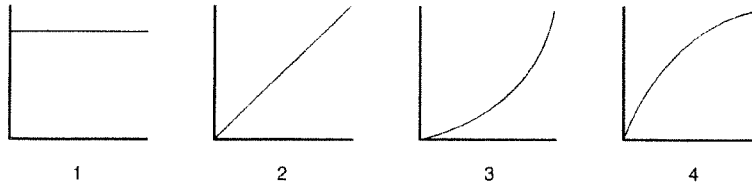

**Vel-C.Sens**

**(Velocity Curve Sense)** Partial [-63] — [63]

This determines the depth of the velocity curve.

The curve effect which was set in the Velocity Curve parameter can be gained at a setting of 0 here. The effect is emphasized for positive values, and becomes weaker for negative values.

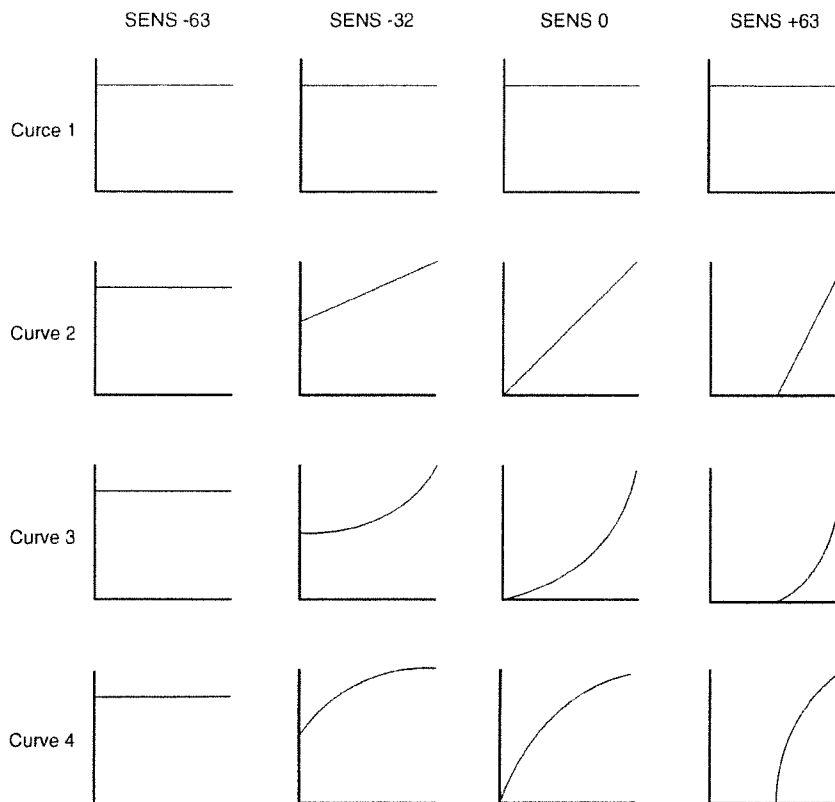

**Level KF**

**(Level Key Follow)** Partial [-63] — [63]

This changes the sound volume relative to the key follow point, and lets you change the timbre of the sound according to what range of the keyboard (note data) you play.

When this is set to 0, the sound level cannot be controlled by key follow.

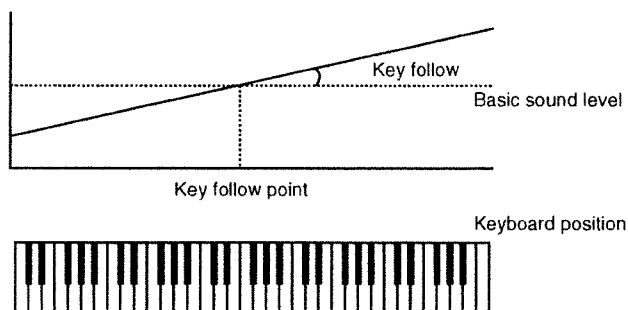

**KF Point**

**(Key Follow Point)** Partial [A0] — [C8]

This determines the key used for the center of the key follow effect.

The two independent parameters controlled by key follow (level and envelope time) are both affected by the Key Follow Point set here.

**Time-Vel Sens** (Time Velocity Sense) **Partial** [-63] — [63]

This determines the degree to which velocity affects the the Time 1 length of the envelope. When this is set to a positive value, Time 1 becomes shorter as the velocity value increases (the envelope attack becomes faster). When this is set to a negative value, Time 1 becomes longer as the velocity value increases (the envelope attack becomes slower).

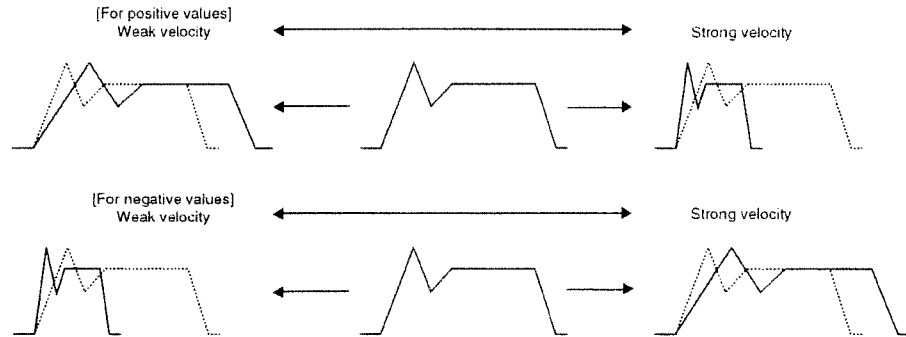

**Time-Key Follow** (Time Key Follow) **Partial** [-63] — [63]

This changes the envelope time (from Time 1 to 4) relative to the key follow point. When this is set to a positive value, the higher on the keyboard that you play (in other words, the greater the note number), the faster the attack of the envelope. When this is set to a negative value, the higher on the keyboard that you play (in other words, the greater the note number), the slower the attack of the envelope. The envelope time cannot be changed by the key follow when this is set to 0.

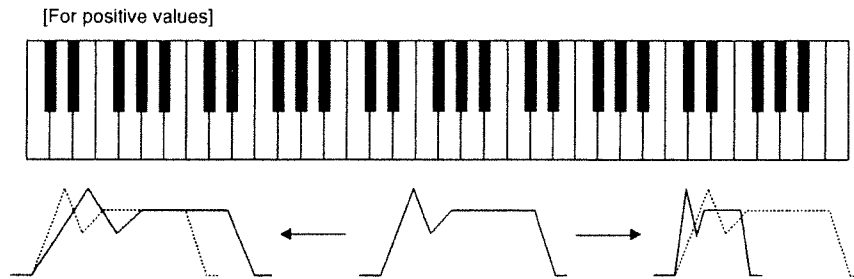

**R. Velo Sens**

**(Release Velocity Sense) Partial [-63] — [63]**

The release time (Time 4), can be changed by the speed at which you release your fingers from the keys (release velocity). The greater the value, the more pronounced the effect becomes. Setting this to a negative value creates a reverse effect.

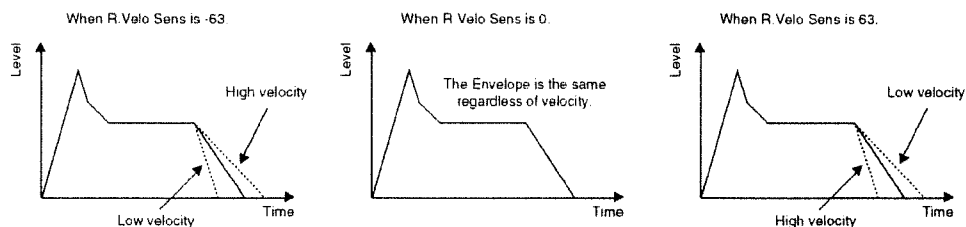

\* When the release velocity is 64, the release time becomes the same as set in the Time 4 parameter.

**TVA Envelope**

The Y axis in the graphic display indicates the level and the X axis indicates the time from the note on.

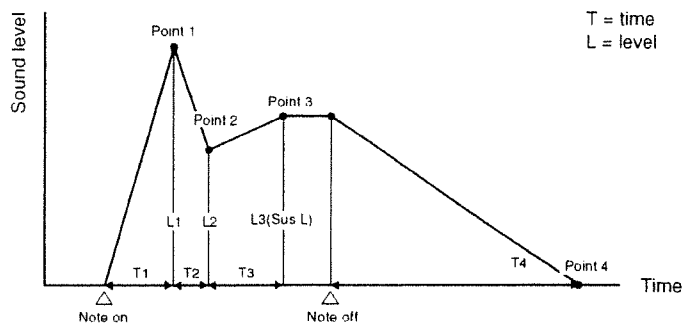

**Time 1**

**(Envelope Time 1) Partial [0] — [127]**

This determines the time which it takes from when the key is pressed until Point 1.

**Level 1**

**(Envelope Level 1) Partial [0] — [127]**

This determines the sound level of Point 1.

**Time 2**

**(Envelope Time 2) Partial [0] — [127]**

This determines the time which it takes from Point 1 to Point 2.

**Level 2**

**(Envelope Level 2) Partial [0] — [127]**

This determines the sound level of Point 2.

**Time 3**

**(Envelope Time 3) Partial [0] — [127]**

This determines the time which it takes from Point 2 to Point 3.

**Level 3**

**(Envelope Level 3) Partial [0] — [127]**

This determines the sound level of Point 3 (sustain level).

Time 4 (Envelope Time 4) **Partial** [0] — [127]

This determines the time which it takes for Level 3 to reach 0, from the time the key is released.

**\* In addition to the TVA envelope, the TVF envelope of the currently selected Partial is also indicated in the graphic display. It is easier and more efficient to edit the TVA envelope while also seeing how it might affect or be affected by the TVF envelope.**

**\* Level 4 of the envelope is fixed to 0.**

F1 (Edit Mode) **Single**, **Global**

This determines the Edit Mode(Advanced Operation p.3-24).

## Partial LFO (Low Frequency Oscillator)

The LFO is an oscillator which constantly outputs a very low frequency waveform. LFO modulation can be applied to pitch, the TVF or the TVA.

### Indications

[ ]

#### (Partial Select)



This determines the Partial to be edited.

### Waveform

(Waveform)  Partial

[Sin], [Tri], [SwUP], [SwDW], [Squ], [B. UP], [B.DW]

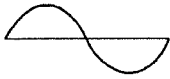
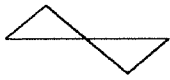
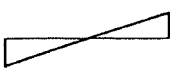
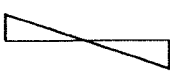
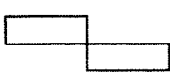
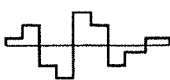
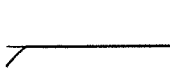
This selects the type of LFO waveform.

Sin	Sine		Sine wave
Tri	Triangle		Triangle wave
SwUP	Saw Up		Saw wave (up)
SwDW	Saw Down		Saw wave (down)
Squ	Square		Square wave
Rnd	Random		Sample and hold (the LFO value is converted once for every cycle)
B. UP	Bend Up		It stays at the same level, once the wave reaches the specific value.
B. DW	Bend Down		It stays at the same level, once the wave reaches the specific value.

\* An effect similar to a pitch envelope can be created by applying LFO to the pitch and using "B. UP" or "B. DW" for the LFO waveform type.

\* When "B.UP" or "B.DW" is selected, set the Key Sync (Advanced Operation p.3-40) to ON. If it is set to OFF, no effect will be obtained.

**Rate** (LFO Rate)  Partial  Partial [0] — [127]

This determines the speed of the LFO.  
The greater the value, the faster the LFO speed.

**Rate-Detune** (LFO Rate Detune)  Partial  Partial [0] — [127]

This makes subtle changes to the LFO rate each time a key is played.  
The greater the value, the greater the range of the rate variation becomes.

**\* This parameter is especially effective when playing chords with a string Sound program, since the speed of each sound's vibrato can be changed, making it sound richer and much more natural.**

**Delay** (LFO Delay)  Partial  Partial [0] — [127]

This sets the time (0.01—22 sec) that it takes from the time the key is pressed (key on) until the LFO effect is applied.

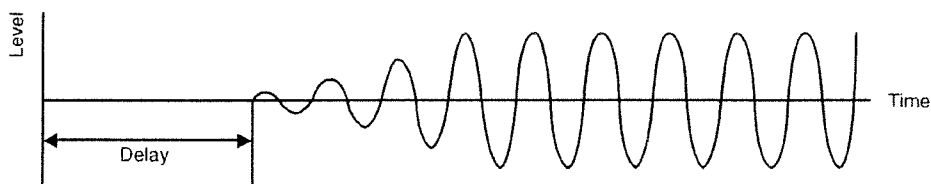

**Delay-Key Follow** (Delay Key Follow)  Partial  Partial [0] — [63]

The LFO delay time becomes shorter the higher in the key range that you play, with the C4 key (middle C, or note number 60) as the standard.

**Key Sync** (Key Sync)  Partial  Partial [Off], [On]

When this is set to On, the LFO phase can be started from 0 at the key on.

**\* When "B.UP" or "B.DW" is selected with the Waveform ( Advanced Operation p.3-39), set the Key Sync to ON. If it is set to OFF, no effect will be created.**

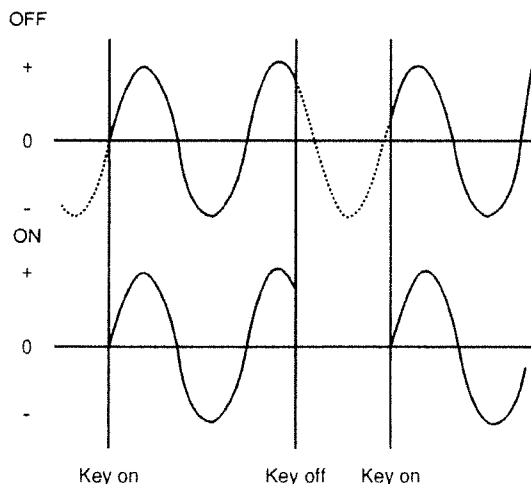



---

<b>Pitch Depth</b>	<b>(Pitch Modulation Depth)</b> <input type="checkbox"/> Partial <b>[-63] — [63]</b> This determines the depth of the LFO pitch modulation. The pitch can be changed periodically, creating a vibrato effect. The LFO waveform phase becomes reversed when this is set to a negative value.
<b>TVF Depth</b>	<b>(TVF Modulation Depth)</b> <input type="checkbox"/> Partial <b>[-63] — [63]</b> This determines the depth of the LFO filter modulation. The timbre of the sound can be changed periodically and a filter sweep effect can be created. The LFO waveform phase becomes reversed when this is set to a negative value.
<b>TVA Depth</b>	<b>(TVA Modulation Depth)</b> <input type="checkbox"/> Partial <b>[-63] — [63]</b> This determines the depth of the LFO amplifier modulation. The sound volume can be changed periodically, creating a tremolo effect. The LFO waveform phase becomes reversed when this is set to a negative value.
<b>F1</b>	<b>(Edit Mode)[Single], [Global]</b> This determines the Edit Mode(Advanced Operation p.3-24).

## Partial Quick Sampling display

In this display you can sample to create Sample and Partial data. For details refer to Advanced Operation p.6-18.

# Sample mode

In this mode you can sample a sound and edit it in various ways to create a Sample, the basic unit of sound data.

## Operations in Sample mode

The basic procedure in Sample mode is as follows.

1. Select the desired sample in Sample (Sample Select). Or, create a new sample.
2. Use S1/DEC and S2/INC or the Value knob to set the value of each parameter.
3. Press a function button to execute a command.

F3 Exec (Execute) will rewrite the sample with the specified settings.

F5 Recover (Recover) will restore the data to the condition it was in before the command was executed (Advanced Operation p.3-93).

F6 W.Graph (Wave Graph) will show a graphic display of the waveform.

\* There are also parameters which are set using the function buttons.

\* By pressing F4 SmpInfo (Sample Information), you can check or set the following parameters.

- Sample (Sample Select) : Select the desired Sample for editing.
- Orig Key (Original Key) : Specify the note number that will playback the Sample at the pitch it was recorded at.
- Sampling Rate (Sampling Rate) : This displays the sampling rate.
- Wave Length (Wave Length) : This displays the time length of the sample.
- Remaining (Remaining Time) : This displays the amount of free internal memory in seconds at 44.1 kHz.

## Sampling display

The S-760 allows you to record sounds from an external source as digital data. The recorded sound is called a Sample, and is the smallest unit of sound data.

### Sample

#### (Sample Select)

Select the sample you wish to record.

- \* When you record a sample, you must specify a Sample Name. It is not possible to record a sample without specifying a name.
- \* If you record a stereo sample, an ending of -L/-R will automatically be added to the sample name. This ending cannot be erased except by executing the Set Mono command (Advanced Operation p.5-9).

### Orig Key

(Original Key) Sample [A0] — [C8]

This parameter specifies the note number at which the sample will be played back at the sampled pitch.

<b>Sampling Mode</b>	<b>(Sampling Mode)</b>	<b>[Stereo],[Mono]</b>
	This specifies whether samples will be recorded in stereo or in mono.	
<b>Sampling Freq</b>	<b>(Sampling Frequency)</b>	<b>[48],[44.1],[32],[24],[22.05],[16]kHz</b>
	Select the sampling frequency.	
<b>Sampling Time</b>	<b>(Sampling Time)</b>	
	Specify the time over which the sample will be recorded.	
	<p><b>* If you select a Sample which has no wave data, the Sampling Time will be set to the maximum possible time.</b></p> <p><b>* The maximum time you can select will depend on the available amount of internal memory and on the sampling frequency. If you have plenty of internal memory, you should set the Sampling Time generously. Later, you can use the Truncate command (Advanced Operation p.3-57) to delete unneeded portions of the wave data, leaving only the minimum data necessary.</b></p>	
<b>[ ]</b>	<b>(EQ on/off switch)</b>	<b>[EQ On], [Bypass]</b>
	This specifies whether or not the equalizers will be used to input signal.	
<b>H.F Input-L</b>	<b>(High Frequency Input L)</b>	<b>[750] — [18k]</b>
<b>H.F Input-R</b>	<b>(High Frequency Input R)</b>	<b>[750] — [18k]</b>
	Specify the high frequency range at which the input signal will be boosted or cut.	
<b>H.G Input-L</b>	<b>(High Gain Input L)</b>	<b>[-12] — [+12]</b>
<b>H.G Input-R</b>	<b>(High Gain Input R)</b>	<b>[-12] — [+12]</b>
	Specify the amount (in decibels) by which the input signal will be boosted or cut in the high frequency range.	
<b>L.F Input-L</b>	<b>(Low Frequency Input L)</b>	<b>[16] — [600]</b>
<b>L.F Input-R</b>	<b>(Low Frequency Input R)</b>	<b>[16] — [600]</b>
	Specify the low frequency range at which the input signal will be boosted or cut.	
<b>L.G Input-L</b>	<b>(Low Gain Input L)</b>	<b>[-12] — [+12]</b>
<b>L.G Input-R</b>	<b>(Low Gain Input R)</b>	<b>[-12] — [+12]</b>
	Specify the amount (in decibels) by which the input signal will be boosted or cut in the low frequency range.	
	<p><b>* Some equalizer settings can cause the sound to distort. If so, adjust the equalizer settings, or adjust the input level using the recording level knob or the Digital Attenuator (Advanced Operation p.3-44).</b></p>	

<b>Input</b>	<p><b>(Input)</b>    <b>When Mode is Mono</b>        : [Analog],[Digital-L],[Digital-R]                           <b>When Mode is Stereo</b>        : [Analog],[Digital]</p> <p>This specifies whether you will be sampling from the analog input or from the digital input.</p> <p><b>* If the Power Sampling Expansion (OP-760-1) is not installed, digital input cannot be selected.</b></p>
<b>Digital ATT</b>	<p><b>(Digital attenuator)</b>                                [-12],[-9],[-6],[-3],[0],[+3],[+6],[+9],[+12],[+18],[+24]dB</p> <p>This adjusts the gain of the input signal.</p> <p><b>* Normally you should leave this set at [0], and adjust the gain of the input signal using the recording level knob.</b></p> <p><b>* When equalizer settings etc. cause the input signal to be distorted, set this to negative [-] settings. When the input signal is low, set this to positive [+] settings.</b></p>
<b>Normalize</b>	<p><b>(Normalize)</b>    [On],[Off]</p> <p>Specify whether or not the Normalize function will be performed automatically immediately after sampling.</p> <p><b>* The Normalize function rewrites the wave data, expanding it to a full 16 bits of dynamic range. It is also possible to normalize the wave data after sampling.</b></p>
<b>Trigger-Type</b>	<p><b>(Trigger type)</b>    [OneWay],[Auto],[Manual],[Prev]</p> <p>This selects the sampling method.</p> <p>OneWay : When the Sampling Start command is given, sampling will begin. Pre-trigger settings will be ignored.</p> <p>Auto : When the Sampling Start command is given, sampling will begin retroactive to the Pre-trigger length.</p> <p>Manual : When the Start Switch is pressed, sampling will begin retroactive to the Pre-trigger length.</p> <p>Prev : When the Start Switch is pressed, sampling will begin retroactive to the length of the Sampling Time. Pre-trigger settings will be ignored.</p>
<b>Trigger-Source</b>	<p><b>(Trigger source)</b>    [Level],[MIDI]</p> <p>When the Trigger Type is Auto or OneWay, this setting determines what will be the trigger to start sampling.</p>
<b>P-Trg</b>	<p><b>(Pre-trigger)</b>    [ .00] — [ .10]</p> <p>This specifies the pre-trigger length. This allows you to record wave data that was input even before the threshold was reached.</p> <p><b>* When you are using Auto or Manual sampling, this allows you to capture the complete sound even if the sampled sound has a gradual attack.</b></p> <p><b>* If the Trigger type is OneWay or Prev, this cannot be set.</b></p>
<b>Threshold</b>	<p><b>(Sampling threshold)</b>    [0] — [127]</p> <p>When the Trigger Source is Level, this specifies the volume level at which sampling will begin. When the input signal reaches this level, sampling will automatically start.</p> <p><b>* With a setting of [0], sampling will start at the instant F1 Start is pressed.</b></p> <p><b>* If the Trigger Type is Manual or Prev, this cannot be set.</b></p>

- LEFT** (Level indicator L)  
**RIGHT** (Level indicator R)
- These monitor the input signal levels. Adjust the recording level knob so that the bar level indicator at the far right does not light.
- \* Remember that even small amounts of distortion in a sample will cause noise.
- F1 New** (New sample)
- Press this switch to automatically give an appropriate name to the sample being newly created and assign it to the lowest-numbered Sample which contains no wave data.
- \* Names are assigned according to the following principles (About sound data names, Basic Operation p.3-10).  
 If the selected sample contains no wave data and has no name, a name of "NEW:Unnamed" will be assigned.  
 If the selected sample contains wave data and also has a name, the assigned name will consist of that sample name with the System Name (Basic Operation p.8-4) appended to it.  
 If the selected sample contains no wave data and has a name, the name will not be changed.
  - \* Be aware that in the case of a sample which has only a name and no wave data, pressing F1 New may cause the name to be rewritten. In general, you should use the ASCII display to assign a name before sampling.
- F2 MonOn/Off** (Monitor on/off switch) [On],[Off]
- This specifies whether the input sound will be output from Stereo Out 1 and the headphone jack. When turned on, the sound being sampled can be monitored from Stereo Out 1 or headphones.
- F3 Ready** (Ready switch)
- When you have completed preparations for sampling, press this switch. The Sampling Execute display will appear.
- \* Be aware that if the sample you are recording already contains wave data, pressing F3 Ready will erase the wave data.
  - \* If you press this switch without specifying a sample name, a message will ask whether or not you wish to accept the automatically-assigned name. (Please set name. How about this name?) Select one of the following.
    - Yes : A name will automatically be assigned, and the Sampling Execute display will appear.
    - No : You will return to the Sampling display. Please specify a name for the sample.

---

## Sampling Execute display

In this display you can begin sampling with the method you specified in the Sampling page.

### F1 Start

#### (Sampling Start switch)

When this switch is pressed, sampling will begin.

- \* Depending on the settings for Trigger Type and Trigger Source, the display will indicate "Wait Trigger". In this case, sampling will begin when the specified trigger is received.
- \* The sampling time indicator at the left side of the display indicates the time elapsed since sampling began.

### F3 Cancel

#### (Cancel)

When this switch is pressed, you will exit the Sampling Execute display and return to the Sampling display, so that you can make parameter settings again.

## Sampling Execute display (during sampling)

### F2 Mark

#### (Mark switch)

During sampling, you can press this switch to place a temporary mark in the sample at that point. Two marks can be placed. When recording a phrase sample, this can be a convenient way to indicate the approximate location of an edit point or a loop point.

- \* The Mark[--] indication in the upper right of the display will show how many marks have been assigned.

### F3 Stop

#### (Sampling Stop Switch)

You can press this switch to stop sampling at a point earlier than the specified Sampling Time.

- \* The sample recorded up to the time the switch was pressed remains valid.
- \* If you press EXIT during sampling, the sampling will be canceled. In this case, be aware that the sample recorded up to that time will be discarded.

## Sampling Stop display

When sampling is complete, the monitor sound will turn off, and the display will indicate "Now Working". Then, the sampled wave will be displayed. Use a MIDI keyboard etc. to check the sound you sampled. When sampling ends, the S-760 detects soundless areas at the beginning and end of the sample, and automatically sets these as the Start Point and Release Loop End Point.

### F1 Point

#### (Point)

This switch is effective only if you have assigned a mark in the sample. You can use the mark(s) to select an editing range in the sample just recorded. The options will alternate each time you press F1 Point, and will be indicated by a black rectangle above the wave display. The options differ depending on whether you have specified one or two marks. Select one of the options as a region for editing.

If one mark was specified : [Start-End], [Start-Mark], [Mark-End]

If two marks were specified : [Start-End], [Start-Mark1], [Mark1-Mark2], [Mark2-End]

- \* If no marks were specified as the sample was recorded, F1 Point will have no effect, and will not be displayed.
- \* If you press F3 Next or EXIT to leave the Sampling Execute display, the mark locations will be lost.
- \* You can use your MIDI keyboard to check the sound of the selected area.

### F2 Retry

#### (Retry)

When you make a mistake while sampling, press this switch to retry sampling with the current settings. The previous sample will be discarded.

### F3 Next

#### (Next)

If you wish to continue recording the next sample, press this switch.

### F5

#### (Loop Mode)

[FWD], [1Shot]

This switch selects the Loop Mode.

- \* In the Loop display, you can select Loop Modes other than FWD and 1Shot (Advanced Operation p.3-48).

### F6 Loop

#### (Loop)

This switch directly opens the Loop display (Advanced Operation p.3-48).

- \* Here you can edit the sample range specified in F1 Point.

## Loop & Smoothing displays

A Loop display and a Smoothing display are provided separately. Details of each display are as follows.

### Loop

When sampling sustaining instruments such as violin or trumpet, it is obviously impractical to record a sample as long as the longest note you might possibly play. However this means that when you hold a note down for longer than the sample was recorded, the sample will playback to the end and then the sound will stop. To prevent this and to allow you to play arbitrarily long notes, you can loop a portion of the wave data to be played back continuously, in order to create a sustaining sound.

[ ]

**(Sample number)**

This is the sample number.

**Start**

**(Start point)**

**[Start],[ST&LP]**

Move the cursor to Start and press S1/DEC and S2/INC to specify whether the Start Point and the Loop Start Point will be the same value.

- Start : Independently edit the Start Point and the Loop Start Point.
- ST&LP : Edit the Start Point and the Loop Start Point to the same value.

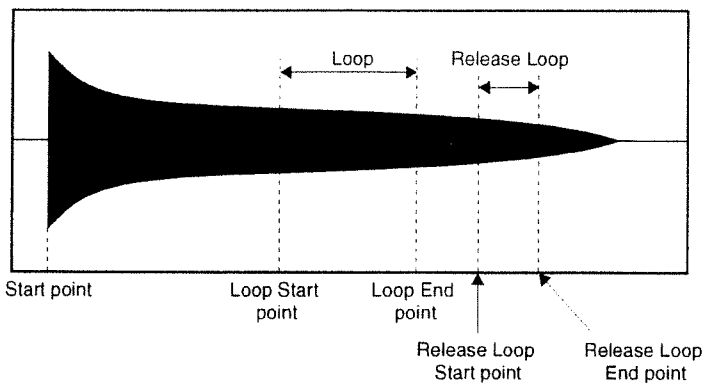

**Start**

**(Start point)**  [0]-

Specify the point in the wave data from which data will be read.

[ ]

**(Loop mode)**  **[Forward], [Fwd+R], [OneShot], [Fwd+One], [Alt], [RevOne], [Rev]**

This specifies the Loop Mode (Advanced Operation p.3-68). There are seven possibilities.

**Loop**

**(Loop Start Point)**  [0]-

This specifies the point at which the loop will start.

**Fine**

**(Loop Start Fine Point)**  [0] — [255]

This is a fine adjustment of the Loop Start Point in units smaller than those used for the Start point.



---

<b>End</b>	<b>(Loop End Point)</b> <input type="text" value="Sample"/> <b>[4]-</b> This specifies the point at which the loop will end.										
<b>Tune</b>	<b>(Loop Tuning)</b> <input type="text" value="Sample"/> <b>[-50] — [50]</b> This is a fine adjustment of the pitch within the loop in units of 1 cent (1/100th of a semitone).  <b>* When a sample having an unsteady pitch is looped, the pitch before the loop may sometimes not match the pitch within the loop. In such cases you can use this parameter to make the pitches match.</b>										
<b>RLoop</b>	<b>(Release Loop Start Point)</b> <input type="text" value="Sample"/> <b>[14]-</b> This specifies the point at which the Release Loop will be started.										
<b>Fine</b>	<b>(Release Loop Start Fine Point)</b> <input type="text" value="Sample"/> <b>[0] — [255]</b> This is a fine adjustment of the Release Loop Start Point in units smaller than those used for the Start point.										
<b>End</b>	<b>(Release Loop End Point)</b> <input type="text" value="Sample"/> <b>[18]-</b> This specifies the point at which the Release Loop will end.										
<b>Tune</b>	<b>(Release Loop Tuning)</b> <input type="text" value="Sample"/> <b>[-50] — [50]</b> This is a fine adjustment of the pitch within the release loop in units of 1 cent (1/100th of a semitone).  <b>* You can move the cursor to the "*" in the left edge of the display and press S1/DEC and S2/INC to search for and set each point automatically.</b>										
<b>F1 Stereo/Mono</b>	<b>(Edit mode)</b> This specifies whether a stereo sample will be edited in mono or in stereo.  <b>* In Stereo mode, the -L and -R samples will be simultaneously edited to the same values. It is not possible to edit a mono sample without -L/-R in stereo mode.</b>										
<b>F2</b>	<b>(Key On Mode)</b> <b>[KeyStr], [KeyLp], [KeyEnd], [KeyR-L], [KeyR-E]</b> This setting is valid only while the Loop display is open. It allows you to specify the point from which the sound will begin when you play the sample to check your loop settings.  <table border="0" style="margin-left: 2em;"> <tr> <td>KeyStr</td> <td>: The sample will be played normally with the specified loop mode.</td> </tr> <tr> <td>KeyLp</td> <td>: The sample will be played only in the loop area.</td> </tr> <tr> <td>KeyEnd</td> <td>: The sample will be played from the Loop End Point to the end of the data.</td> </tr> <tr> <td>KeyR-L</td> <td>: The sample will be played only in the Release Loop area.</td> </tr> <tr> <td>KeyR-E</td> <td>: The sample will be played from the Release End Point to the end of the data.</td> </tr> </table>	KeyStr	: The sample will be played normally with the specified loop mode.	KeyLp	: The sample will be played only in the loop area.	KeyEnd	: The sample will be played from the Loop End Point to the end of the data.	KeyR-L	: The sample will be played only in the Release Loop area.	KeyR-E	: The sample will be played from the Release End Point to the end of the data.
KeyStr	: The sample will be played normally with the specified loop mode.										
KeyLp	: The sample will be played only in the loop area.										
KeyEnd	: The sample will be played from the Loop End Point to the end of the data.										
KeyR-L	: The sample will be played only in the Release Loop area.										
KeyR-E	: The sample will be played from the Release End Point to the end of the data.										
<b>F3 L.Lock/Unlk</b>	<b>(Loop Length Lock)</b> When L.Lock is selected, you can adjust only the position of the loop without affecting the length from the Loop Point to the Loop End Point, or the length from the Release Loop Point to the Release Loop End Point.										

---

---

## Smoothing

When extremely complex waveforms are looped, it is sometimes difficult to get rid of pops or clicks. In such cases, you can use the Smoothing function to crossfade the beginning and end of the two loops to create a smoothly looped sample.

### Loop-Smoothing Length

(Loop Smoothing Length)

### R-Loop-Smoothing Length

(Release Loop Smoothing Length)

Specify the length over which the Loop Start Points and Loop End Points of the Loop and Release Loop will be smoothed.

## Auto Truncate/Normalize display

The Auto Truncate function deletes unnecessary data from before the Start Point and after the Release Loop End Point, rewriting the wave data.

The Normalize function rewrites the wave data to expand it to a full 16 bits of dynamic range.

Both Auto Truncate and Normalize can be executed simultaneously for more than one sample.

### F1 AllOn/Off

(Mark All On/Off switch)

This specifies whether or not all samples will be marked.

**\* When only one side of a stereo sample has been marked, this will automatically add marks to the other side as well.**

### F2

(Edit mode)

[Tr/Nm], [Trun], [Norm]

This selects the editing operation(s) that will be executed on the selected sample.

Tr/Nm : Truncate and Normalize will be executed.

Trun : Only Truncate will be executed.

Norm : Only Normalize will be executed.

### F5 Fade On/Off

(Fade On/Off switch)

When the Loop Mode is OneShot, this specifies whether or not the End Point will automatically be faded. When this is turned on, the End Point will be faded in order to eliminate click noise at the end point.

**\* For Auto Truncate, the fade range is fixed. It is not possible to specify the range. If you wish to set the fade range, open the Truncate display (Advanced Operation p.3-57), edit the fade area, and execute Truncate.**

**\* Auto Truncate and Normalize will be applied to all marked samples. Since the Recover Function cannot be used with these functions, it is not possible to restore the data to the state before execution.**

## Time Stretch display

This function rewrites the wave data to compress/expand the time length of the sample without affecting the pitch.

<b>From</b>	<b>(From)</b>	
<b>To</b>	<b>(to)</b>	
<b>Length</b>	<b>(Length)</b>	Specify the beginning point, end point, and length of the area to be Time Stretched.
		<b>* When Length is modified, the To parameter will change. Length allows you to check the time length of the area to be Time Stretched.</b>
<b>Ratio</b>	<b>(Ratio)</b>	[25] — [400]%
		This specifies how time will be compressed/expanded relative to the original time.
		<b>* With a setting of 100%, there will be no change.</b>
<b>Fade</b>	<b>(Fade Length)</b>	[20] — [2000]
		This specifies the fade area used when executing Time Stretch. In order to compress/expand the waveform without changing the pitch, part of the waveform must be cut out and crossfaded. This setting determines the length of the fade.
		<b>* When Mode is set to Auto, Fade cannot be set.</b>
<b>Mode</b>	<b>(Time Stretch Mode)</b>	[Manual],[Auto]
		Select the Time Stretch Mode.
	Manual	: Time Stretch will be executed according to the specified Fade settings.
	Auto	: Time Stretch will be executed with Fade settings made automatically. Your Fade settings will be ignored.
<b>Coarse</b>	<b>(Pitch Shift Coarse)</b>	[-48] — [48]
<b>Fine</b>	<b>(Pitch Shift Fine)</b>	[-50] — [50]
		These will be set automatically to prevent the pitch from being changed when Time Stretch is executed.
<b>Length</b>	<b>(Length)</b>	
		This displays the length of the specified area after Time Stretch is executed.
<b>Total.L</b>	<b>(Total Length)</b>	
		This displays the length of the entire wave data after Time Stretch is executed.
<b>F1</b>	<b>(Set Point)</b>	[SetStr],[SetLp],[SetEnd],[SetR-E]
		When the cursor is at the From/To position, this switch inserts the value of the point displayed at F1 into From/To (Time Stretch display page 1). Each time you press F1, the points will alternate as follows.
	Cursor at From	: [SetStr],[SetLp]
	Cursor at To	: [SetEnd],[SetR-E]

**F1 Search** (Search Switch)  
 This switch automatically determines the Fade value. When this is used, the Fade setting will be given the detected value (Time Stretch display page 2).

**F2** (Key On Mode) [KeyStr],[KeyLp],[KeyEnd],[KeyR-L],[KeyR-E],[KeyF-T],[KeyTo]  
 This setting is valid only while the Time Stretch display is open. It allows you to specify the point from which the sound will begin when you play the sample to check the loop settings.

- KeyF-T : The sound will be played between From and To.
- KeyTo : The sound will be played from To until the end of the data.

## Digital Filter display

The wave data will be rewritten according to the filter settings made in this display, modifying the sound.

The TVF parameters of a Partial have a common effect on all four samples combined by the SMT, and the TVF envelope can be used to create time-varying changes in tonal character. The TVF in a Partial is a filter that operates while you play, and does not actually rewrite or modify the wave data of the sample. In contrast, this Digital Filter directly rewrites the wave data in order to modify the sound.

**Filter Mode** (Filter Mode) [LPF],[HPF],[+Emphasis],[-Emphasis]  
 Select the type of filter.

- LPF : Frequencies lower than the cutoff frequency will be passed, and higher frequencies will be cut.
- HPF : Frequencies higher than the cutoff frequency will be passed, and lower frequencies will be cut.
- +Emphasis : The high frequencies will be emphasized.  
 For sample data received via Sample Dump (Advanced Operation p.3-99) from a different manufacturer's sampler or from a computer, executing +Emphasis will add an emphasis to the high frequencies which can sometimes improve the sound quality. Also after executing Rate Convert (Advanced Operation p.3-55), executing +Emphasis can sometimes improve the sound quality.
- Emphasis : The high frequencies will be deemphasized.  
 When transmitting sample data via Sample Dump (Advanced Operation p.3-99) to a different manufacturer's sampler or to a computer, the high range of the received data may sometimes be emphasized excessively. In such cases, execute -Emphasis before transmitting the data to minimize any loss in sound quality between the source and destination.

**Cutoff Freq** (Cutoff Frequency) ([D.C cut]),[0.1] — [10.0]  
 Specify the cutoff frequency.

- \* When the Filter Mode is +Emphasis or -Emphasis, this setting is ignored.
- \* When the Filter Mode is HPF, you can select [D.C cut]. When [D.C cut] is selected, only the direct current portion will be cut. In this case, the Resonance setting will be ignored.
- \* When this parameter is set to 10.0, Cutoff Frequency will be half the sampling frequency of the current Sample.

**Resonance**      **(Resonance)**      **[0] — [127]**  
Specify the resonance at the cutoff frequency.

**\* When the Filter Mode is +Emphasis or -Emphasis, this setting is ignored.**

**Level**      **(Level)**      **[0] — [127]**  
Specify the overall volume level.

## Compress/Expand display

In this display you can directly rewrite the sample's wave data to compress/expand the level.

The compression/expansion settings are shown graphically in the right of the display. The graphical display is linked to the parameters of this display (Threshold, Ratio), and the lines of the graph will change as you adjust the parameters.

The vertical lines of the graph indicate output level, and the horizontal axis indicates input level. Threshold is determined by the vertical axis. Press F6 W.Graph and check the level of the sample as you make Threshold Level settings.

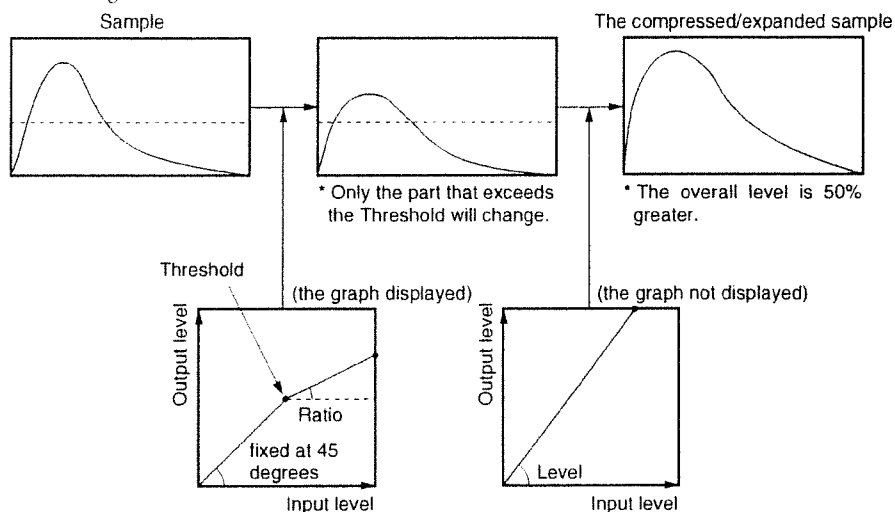

**T.H**      **(Threshold Level)**      **[0] — [100]%**  
Specify the input level at which compression or expansion will begin.

**Ratio**      **(Ratio)**      **[0] — [1000]%**  
Specify the compression ratio or expansion ratio.

**Level**      **(Level)**      **[0] — [1000]%**  
Specify the compression ratio or expansion ratio for the entire compressed or expanded waveform.

**Attack**      **(Attack Time)**      **[0] — [127]**  
Specify the time delay from when the input level rises above the threshold to when compression/expansion begins.

**Release**

**(Release Time)** [0] — [127]

Specify the time delay from when the input level falls below the threshold to when compression/expansion ends.

**\* About Attack/Release times**

**When the Threshold is set to a given value, the Ratio is 50%, and the Attack/Release Times are set to 127, the waveform will be affected as follows.**

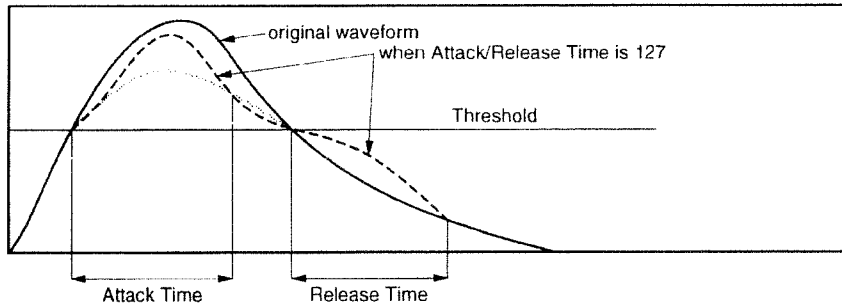

The release section will have the opposite effect as Ratio. In this case, since Ratio is set to compression, the release section will be expanded.

**F1 NomOff/After (Normalize On/Off switch)**

Specify whether or not Normalization will be performed.

NomOff : Normalization will not be performed.

After : After Compress/Expand is executed, normalization will automatically be performed.

## Rate Convert display

This function rewrites the wave data to convert the sampling rate of a sample. This allows you to match the sampling frequencies of two samples you wish to use with the Insert command (Advanced Operation p.3-60) or the Combine command (Advanced Operation p.3-64), or to convert a sample to a lower sampling frequency to conserve memory.

<b>Rate</b>	<b>(New Sampling Rate)</b>	<b>[48],[44.1],[32],[30],[24],[22.05],[16],[15]</b>
	Specify the sampling frequency to be the result of the Rate Convert operation.	
<b>Coarse</b>	<b>(Pitch Shift Coarse)</b>	<b>[-48] — [48]</b>
	The Rate Convert operation can simultaneously modify both the sampling frequency and the pitch. Specify the pitch change (in half-steps) which will result from the Rate Convert operation.	
<b>Fine</b>	<b>(Pitch Shift Fine)</b>	<b>[-50] — [50]</b>
	Specify a fine adjustment in cents (1/100 of a semi-tone) to the pitch which will result from the Rate Convert operation.	
<b>Length</b>	<b>(Length)</b>	
	This displays the length of the wave data which will result from the Rate Convert operation. The value is displayed in seconds at a sampling frequency of 44.1 kHz.	
<b>F1 Correct</b>	<b>(Correct switch)</b>	
	This switch automatically detects the pitch of the selected sample.	
	* <b>The detected pitch will be displayed in "Coarse [ ]" and "Fine [ ]" as a Key Number and Cents (1/100th of a semi-tone). For example, a display of [C_4],[-10] indicates a pitch 10 cents lower than C4.</b>	

## Bit Convert display

In this display you can rewrite the wave data by converting the bits or thinning out the data. This can be used to purposefully lower the quality of the sample in order to create unique effects.

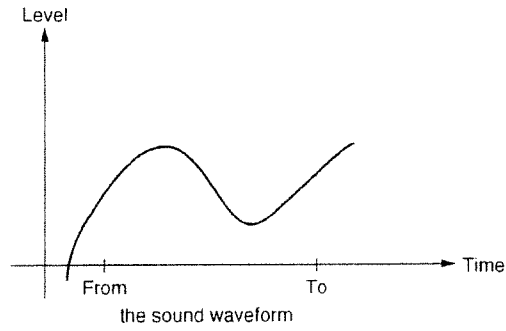

↓ Sampling

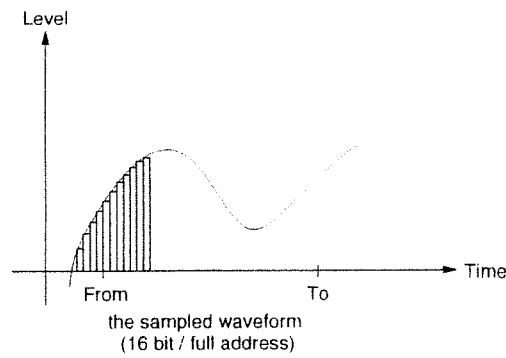

↓ Bit conversion

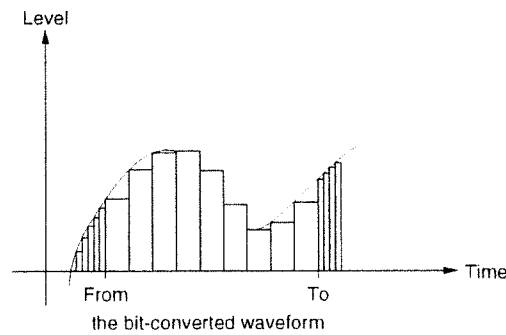

**From**  
**To**

**(From)**  
**(To)**  
Specify the beginning and end of the range which will be bit-converted.



- Bit** (Bit) [Off],[1] — [15]bit  
Specify the number of bits into which the sample data will be converted. With a setting of [Off] the data will not be converted.
- Skip Address** (Skip Address) [Off],[2] — [32]step  
Specify the interval at which the sample data will be thinned when read.
- F1** (Set Point) [SetStr],[SetLp],[SetEnd],[SetR-E]  
When the cursor is at From/To, the value of the point displayed in F1 will be inserted for From/To. Each time you press F1, the points will alternate as follows.
- Cursor located at From : [SetStr],[SetLp]  
Cursor located at To : [SetEnd],[SetR-E]
- F2** (Key On Mode) [KeyStr],[Key-Lp],[KeyR-L],[KeyR-E],[KeyF-T],[KeyTo]  
This setting is valid only while the Bit Convert display is open. It allows you to specify the point from which the sound will begin when you play the sample to check the loop settings.

## Truncate display

This function cuts away unwanted sections of the wave data to reduce its size, leaving only the section of the sample between From and To.

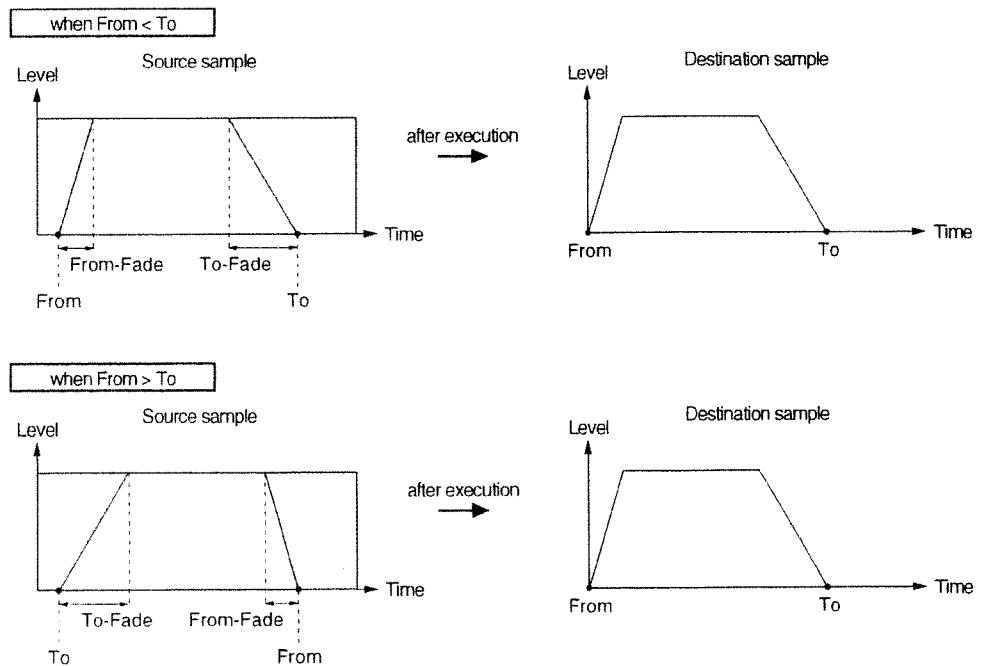

**From** (From)  
**From-Fade** (From Fade)

- To** (To)  
**To-Fade** (To Fade)  
 Specify the starting position, ending position, and the fade ranges for each.
- \* For this operation, you can also specify a fade area for the Truncate Start position. The Auto Truncate function (Advanced Operation p.3-50) does not allow you to specify a fade area for the Truncate Start position.
- F1** (Set point) [SetStr],[SetLp],[SetEnd],[SetR-E]  
 When the cursor is at the From/To location, the value of the point displayed in F1 will be inserted for From/To. Each time you press F1, the points will alternate as follows.
- Cursor located at From : [SetStr],[SetLp]  
 Cursor located at To : [SetEnd],[SetR-E]
- F2** (Key On Mode) [KeyStr],[Key-Lp],[KeyR-L],[KeyR-E],[KeyF-T],[KeyTo]  
 This setting is valid only while the Truncate display is open. It allows you to specify the point from which the sound will begin when you play the sample to check the loop settings.

## Cut & Splice display

This function cuts away the portion of the sample between From and To, and joins the ends.

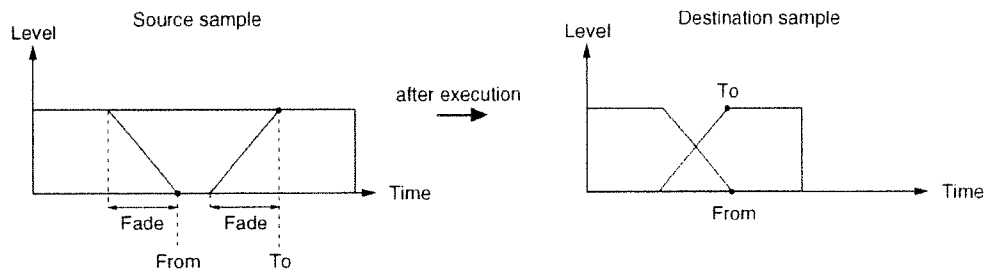

\* Cannot execute if From > To.

- From** (From)  
**To** (To)  
**Fade** (Fade)
- Specify the start, end, and fade area of the section to which the Cut & Splice operation will apply.
- \* It is not possible to execute Cut & Splice if From is greater than To.
  - \* The Fade area will be the same for both From and To.

**F1 (Set point)** **[SetStr],[SetLp],[SetEnd],[SetR-E]**  
 When the cursor is at the From/To location, the value of the point displayed in F1 will be inserted for From/To. Each time you press F1, the points will alternate as follows.

Cursor located at From : [SetStr],[SetLp]  
 Cursor located at To : [SetEnd],[SetR-E]

**F2 (Key On Mode)** **[KeyStr],[Key-Lp],[KeyEnd],[KeyR-L],[KeyR-E],[KeyF-T],[KeyTo]**  
 This setting is valid only while the Cut & Splice display is open. It allows you to specify the point from which the sound will begin when you play the sample to check the loop settings.

## Area Erase display

This function erases the sample between From and To, creating a region of silence.

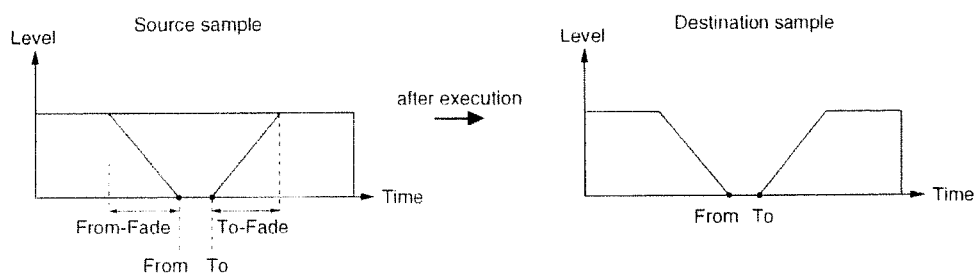

\* Cannot execute if From > To.

**From (From)**  
**From-Fade (From Fade)**  
**To (To)**  
**To-Fade (To Fade)**  
 For the data to which Area Erase will be applied, specify the starting position, ending position, and the fade ranges for each.

\* It is not possible to execute the operation if From is greater than To.

**F1 (Set point)** **[SetStr],[SetLp],[SetEnd],[SetR-E]**  
 When the cursor is at the From/To location, the value of the point displayed in F1 will be inserted for From/To. Each time you press F1, the points will alternate as follows.

Cursor located at From : [SetStr],[SetLp]  
 Cursor located at To : [SetEnd],[SetR-E]

**F2 (Key On Mode)** **[KeyStr],[Key-Lp],[KeyEnd],[KeyR-L],[KeyR-E],[KeyF-T],[KeyTo]**  
 This setting is valid only while the Area Erase display is open. It allows you to specify the point from which the sound will begin when you play the sample to check the loop settings.

## Insert display

With this function, the wave data between From and To of Source Sample S2 is inserted between From and To of Source Sample S1, creating a new sample.

when From (S1) < To(S1), From (S2) < To (S2)

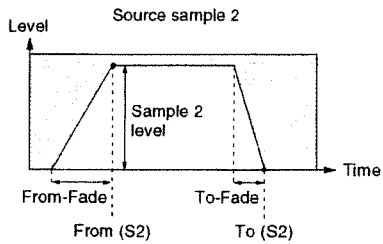
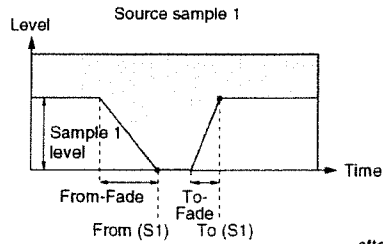

after execution

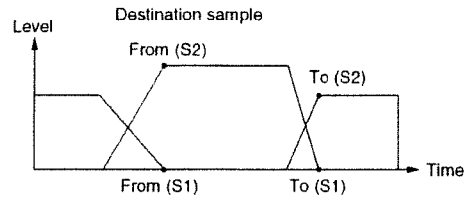

\* Cannot execute if From (S1) > To (S1).

when From (S1) < To(S1), From (S2) > To (S2)

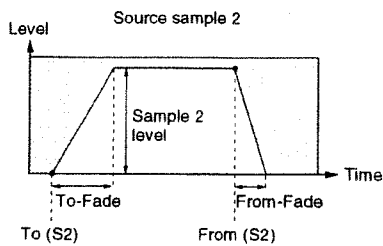
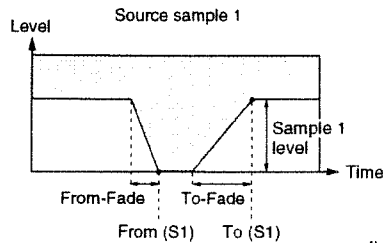

after execution

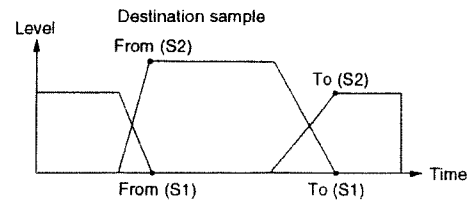

\* Cannot execute if From (S1) > To (S1).

### Dest Sample

#### (Destination Sample)

Select the sample to be newly created as a result of the Insert command.

---

<b>No.</b>	<b>(Sample number)</b> This is the number of the Source sample. Both source samples S1/S2 are displayed. You can also use S1/DEC and S2/INC or the Value knob to select the source samples.
<b>Source Sample</b>	<b>(Source Sample)</b> Select source samples S1 and S2.
<b>From From-Fade</b>	<b>(From)</b> <b>(From Fade)</b> Specify the insert starting positions and fade areas for source samples S1/S2.  <b>* The Insert function does not allow you to specify the fade area for source sample S2.</b>
<b>To To-Fade</b>	<b>(To)</b> <b>(To Fade)</b> Specify the insert end positions and fade areas for source samples S1/S2.  <b>* The Insert function does not allow you to specify the fade area for source sample S2.</b>  <b>* It is not possible to execute the operation if S1's From is greater than To.</b>
<b>Level</b>	<b>(Sample Level)</b> <span style="float: right;"><b>[0] — [127]</b></span> Specify the volume level of source samples S1/S2.
<b>F1</b>	<b>(Set point)</b> <span style="float: right;"><b>[SetStr],[SetLp],[SetEnd],[SetR-E]</b></span> When the cursor is at the From/To location, the value of the point displayed in F1 will be inserted for From/To. Each time you press F1, the points will alternate as follows.  Cursor located at From     : [SetStr],[SetLp] Cursor located at To       : [SetEnd],[SetR-E]
<b>F2</b>	<b>(KeyOn Mode)</b> <span style="float: right;"><b>[KeyStr],[Key-Lp],[KeyEnd],[KeyR-L], [KeyR-E],[KeyFT1],[KeyFT2]</b></span> This setting is valid only while the Insert display is open. It allows you to specify the point from which the sound will begin when you play the sample to check the loop settings.  KeyFT1     : Play source sample S1 from From to To. KeyFT2     : Play source sample S2 from From to To.

---

## Mixing display

With this function, the wave data between From and To of Source Sample S1 is mixed with the wave data between From and To of Source Sample S2, creating a new sample.

when From (S1) < To(S1), From (S2) < To (S2)

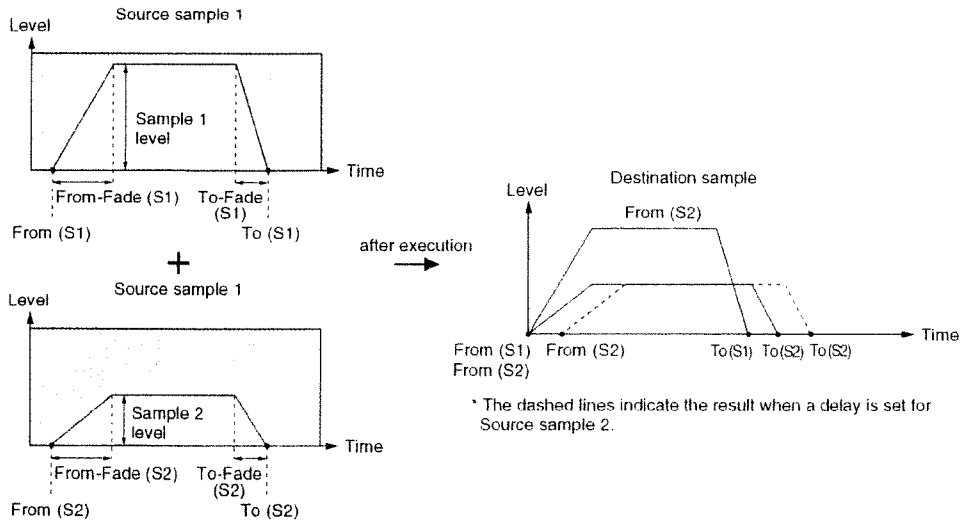

when From (S1) < To(S1), From (S2) > To (S2)

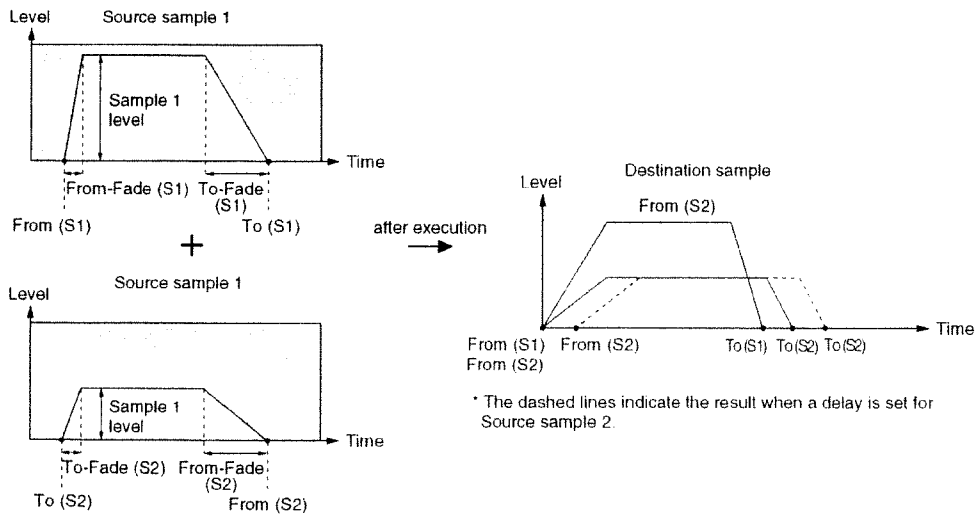

**Dest Sample**

**(Destination Sample)**

Select the sample to be newly created as a result of the Mixing command.

**No.**

**(Sample number)**

---

<b>Source Sample</b>	<b>(Source Sample)</b> Select and display source samples S1 and S2.
<b>From</b>	<b>(From)</b>
<b>From-Fade</b>	<b>(From Fade)</b>
<b>To</b>	<b>(To)</b>
<b>To-Fade</b>	<b>(To Fade)</b> Specify the start and end positions and the fade areas for the sections of source samples S1 and S2 to be mixed.
	<b>* For the Mixing command, there are no restrictions on the area settings of From or To.</b>
<b>Level</b>	<b>(Sample Level)</b> [0] — [127] Set the volume levels for source samples S1/S2.
<b>F1</b>	<b>(Set point)</b> [SetStr],[SetLp],[SetEnd],[SetR-E] When the cursor is at the From/To location, the value of the point displayed in F1 will be inserted for From/To. Each time you press F1, the points will alternate as follows.  Cursor located at From : [SetStr],[SetLp] Cursor located at To : [SetEnd],[SetR-E]
<b>F2</b>	<b>(Key On Mode)</b> [KeyStr],[Key-Lp],[KeyEnd], [KeyR-L],[KeyR-E],[KeyFT1],[KeyFT2] This setting is valid only while the Mixing display is open. It allows you to specify the point from which the sound will begin when you play the sample to check the loop settings.
<b>Delay</b>	<b>(Delay)</b> You can delay the start point of the S2 source sample when Mixing is executed.

---

## Combine display

With this function, the wave data between the beginning and To of Source Sample S2 is joined to the wave data between To and the end of Source Sample S1, creating a new sample.

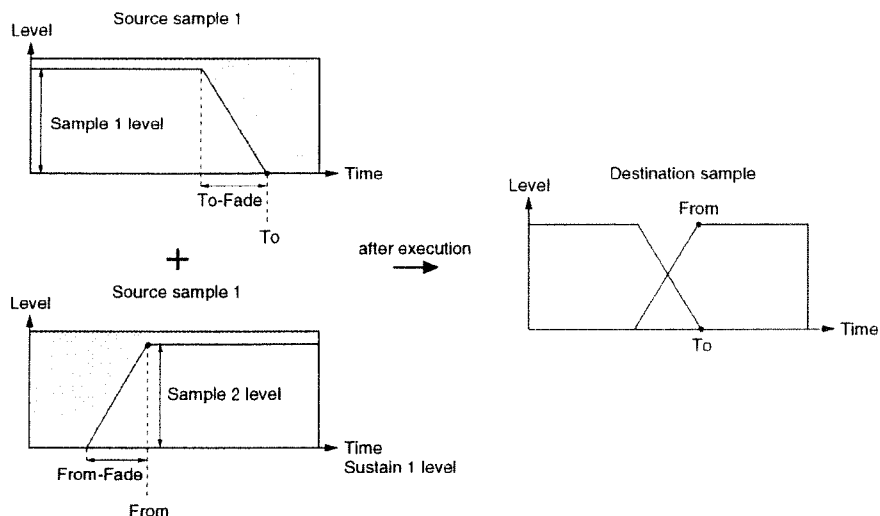

- Dest Sample**      **(Destination Sample)**  
 Select the sample to be newly created as a result of the Combine command.
- No.**                **(Sample number)**
- Source Sample**   **(Source Sample)**  
 Select and display source samples S1 and S2.
- From**              **(From)**  
 Specify the start for Combining source sample S2.
- To**                  **(To)**  
**To-Fade**         **(To Fade)**  
 Specify the end and the fade area for Combining source sample S1.
- Level**              **(Sample Level)**                                 **[0] — [127]**  
 Set the volume levels for source samples S1/S2.



**F1 (Set point)** [SetStr],[SetLp],[SetEnd],[SetR-E]  
 When the cursor is at the From/To location, the value of the point displayed in F1 will be inserted for From/To. Each time you press F1, the points will alternate as follows.

Cursor located at From : |SetStr|,|SetLp|  
 Cursor located at To : |SetEnd|,|SetR-E|

**F2 (Key On Mode)** [KeyStr],[Key-Lp],[KeyEnd],[KeyR-L]  
 [KeyR-E],[KeyFT1],[KeyFT2]  
 This setting is valid only while the Combine display is open. It allows you to specify the point from which the sound will begin when you play the sample to check the loop settings.

### (Caution)

**When one of the operations Truncate, Cut & Splice, or Area Erase are executed on a stereo sample, the L and R samples will be edited simultaneously.**

**When selecting a Destination sample for the Insert, Mixing, or Combine operations, if you select a sample which contains no wave data, that sample will become a mono sample. In order to select a stereo sample which has no wave data as the Destination sample, you must create a stereo dummy sample by stereo sampling in the Sampling display (Advanced Operation p.3-42).**

The new sample will be created as follows, depending on the choice of Destination sample and Source sample 1.

Dest	Source 1	Dest after executing
mono sample	mono sample	mono sample
mono sample	stereo sample	mono sample
stereo sample	mono sample	stereo sample
stereo sample	stereo sample	stereo sample

## Wave Graph display

This display allows you to graphically view the sample waveform as you edit the various points.

- P**            **(Point)**  
Specify the point of the wave data you wish to edit, such as the Start Point or Loop Point, etc.
- D**            **(Data)**  
This displays the data of the various points, such as the Start Point or Loop Point, etc. By editing this value, you can directly rewrite the wave.
- F1**           **(Graph)**  
This switch sets the display mode of the graphic.
- Point                    : This displays the waveform before and after the point selected for P, such as the Start Point or Loop Point, etc. You can use S1/DEC and S2/INC or the Value knob to move the time location of each point.
  - Loop                    : The left side displays the waveform up to the Loop End Point, and the right side displays the waveform from the Loop Point. You can use S1/DEC and S2/INC or the Value knob to move the various points and check the looping. When the Loop Mode is Alt, the waveform between the Loop End Point and Loop Point will be displayed together with the folded back waveform. Press F2 to specify whether you wish to edit the Loop End Point or the Loop Point.
  - R-Loop                 : The left side displays the waveform up to the Release Loop End Point, and the right side displays the waveform from the Release Loop Point. You can use S1/DEC and S2/INC or the Value knob to move the various points and check the looping. Press F2 to specify whether you wish to edit the Release Loop End Point or the Release Loop Point.
  - Samp1/Samp2           : When the Wave Graph display is opened from either the Insert display, the Mixing display, or the Combine display, F1 will select which source sample S1 or S2 is displayed.
- F2**            **(Edit Point)**  
Specify the point you wish to edit. Points and data can be edited for the point you specify here. Depending on the F1 settings, the range of selection will change as follows.
- F1 Point                : [Start],[ST&LP],[Loop],[End],[R-Loop],[R-End]
  - F1 Loop                 : [Loop],[End]
  - F1 R-Loop               : [R-Loop],[R-End]
  - F1 Sam1/Samp2         : [From],[To]

F3

**(Zoom)****[Zoom.X],[Zoom.Y],[Move.L]**

Specify Zoom In/Out for the time axis and the level axis.

**\* When you press the button, the cursor will move to the upper right of the display. In this location, specify the various values. Each time you press the button, the parameter to be set will change as follows.**

[Zoom.X] : This expands the waveform display in the direction of the time axis. Zoom can be set over the five levels of [1] -- [4] and [Max], and smaller numbers result in higher magnification. The black box in the upper part of the graph indicates what portion of the entire waveform is represented by the currently displayed area, and the current time is indicated by a white dot. When F1 is set to Point, [Max] displays the entire length of the wave data.

[Zoom.Y] : This expands the waveform display in the direction of the level axis. Zoom can be set over the six levels of [1] -- [5] and [Max], and smaller numbers result in higher magnification. With a setting of [Max] the entire level of the wave data is displayed. The black box at the right edge of the graph indicates what portion of the overall level is represented by the currently displayed area.

[Move.L] : When the level axis of the waveform display is magnified, part of the data may go off the screen and not be displayed. When this parameter is set to [On], the graph display area is adjusted as far as possible so that the current data point is displayed in the center of the screen. However if [Zoom.Y] is set to [Max], this will not function.

F5

**(Key On Mode)**

This setting is valid only while the Wave Graph display is open. It allows you to specify the point from which the sound will begin when you play the sample to check the loop settings. It operates in conjunction with the Key On Mode you specify in each editing display.

F6 L.Lock/Unlk

**(Loop Length Lock)**

When L.Lock is selected, you can adjust only the loop location without affecting the distance between the Loop Point and Loop End Point, or between the Release Loop Point and the Release Loop End Point.

**\* If the display mode is Loop or R-Loop, use F2 to select the point you wish to edit, then move the cursor to P and press S1/DEC or S2/INC to automatically search and set each point.**

**\* Depending on the display, there may be some parameters which cannot be edited or some function buttons which are not displayed.**

## About Loop Mode

Here we will explain about the various types of loop (Loop Mode, Advanced Operation p.3-48).

### Forward (Forward):

When the data has been read from the Start point to the Loop End point, it will then be repeatedly read in the forward direction from the Loop Start point to the Loop End point.

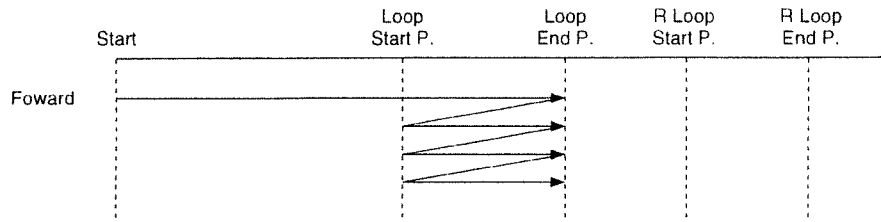

### Fwd+R (Forward + Release):

When the data has been read from the Start point to the Loop End point, it will then be repeatedly read in the forward direction from the Loop Start point to the Loop End point. When a Note-off message is received, the data will be read to the Release Loop End point, and then repeatedly read in the forward direction from the Release Loop Start point to the Release Loop End point.

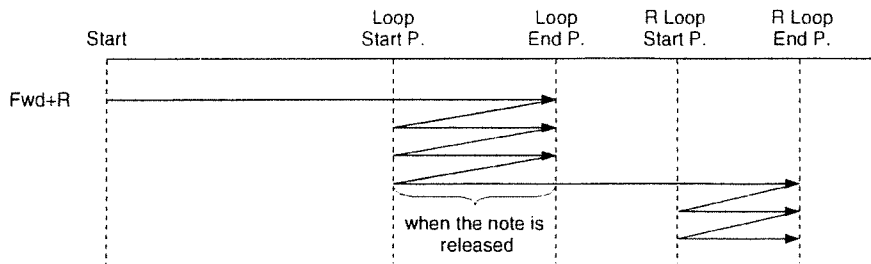

### OneShot (One Shot):

The data will be read only once from the Start point to the Loop End point.

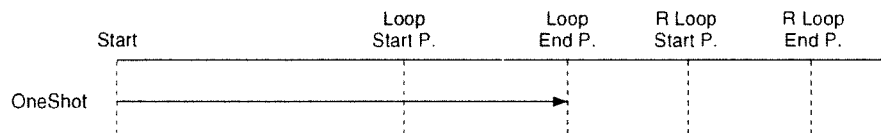

### Fwd+One (Forward + One-shot):

When the data has been read from the Start point to the Loop End point, it will be repeatedly read in the forward direction from the Loop Start point to the Loop End point. When a Note-off message is received, the data will be read once from the Loop Start point to the Release Loop End point.

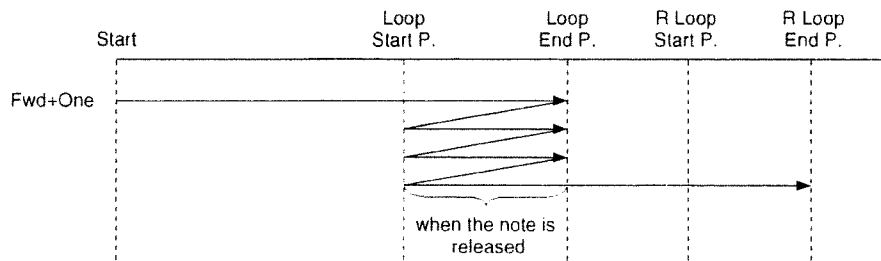

.....

**Alt (Alternate):**

When the data has been read from the Start point to the Loop End point, reading will fold back from the Loop End point and go back and forth between the Loop End point and the Loop Start point.

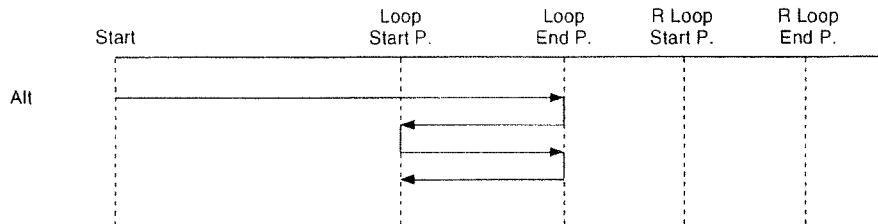

**RevOne (Reverse One Shot):**

The data will be read only once from the Loop End point to the Start point in the reverse direction.

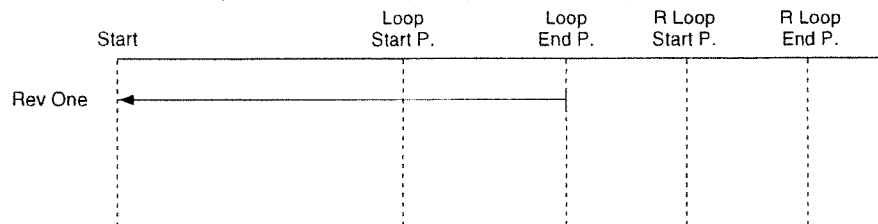

**Rev (Reverse):**

When the data has been read from the Loop End point to the Start point, it will be repeatedly read in the reverse direction from the Loop Start point to the Start point.

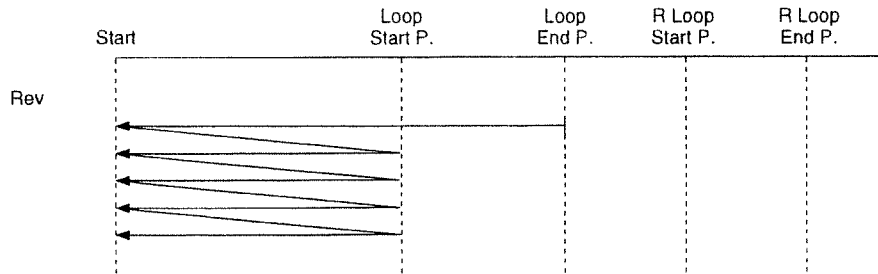

.....

# Disk Mode

In the Disk Mode, sound data can be transferred (with load/save operations) between drives, the sound data in the drive can be copied/deleted, and the drive can be formatted.

## Caution!

The maximum memory capacity of a drive which can be used with the S-760 is 600 megabytes. For example, if an 800-megabyte hard disk is formatted, it works as a 600-megabyte hard disk; the remaining 200 megabytes cannot be used at all.

## Caution!

Remove the magneto-optical disk, CD-ROM disk or tape ONLY when the busy indication of the drive is off. Removing a disk while the indicator is still lit may damage the disk and render it unusable.

# Disk Load

The sound data is read in from the current drive to the internal memory of the S-760.

## Indications

TG

(Target)

[Volm (Volume)], [Pfm (Performance)], [Pach (Patch)],  
[Prtl (Partial)], [Samp (Sample)], [PrPM (Partial parameter)],  
[PaPM (Patch parameter)], [PfPM (Performance parameter)]

This selects the type of the sound data to be loaded.

When selecting Volm, Pfm, Pach or Prtl, sound data of the lower levels are also loaded at the same time.

When PrPM, PaPM or PfPM is selected, only each parameter itself is loaded; lower level sound data is not loaded.

\* Press S1/DEC(List) to call up the Select Target page, and enable selection of the Target. (Advanced Operation p.5-13)

ID:

(Volume ID)

With the enormous amounts of data that can be saved to a hard disk or magneto-optical disk, it becomes difficult to find the sound data you want. Because of this, the S-760 lets you classify the sound data for each Volume using the first three letters of the name. The first three letters are called the Volume ID (Basic Operation p.8-4).

Assign a Volume ID to the sound data to be loaded so that only the sound data which has the assigned Volume ID can be indicated in the list (shown in the Disk Load page). By determining the Volume ID, sound data can be easily found.

Set this to All in order to indicate all the sound data in the list.

\* Pressing S1/DEC(List) calls up the Volume ID page, and the Volume ID can be determined (Advanced Operation p.5-13).

<b>CD</b>	<p><b>(Current Drive)</b> The current drive is the drive which is selected at present for transferring of the sound data. Select the drive which has the sound data that is to be loaded.</p> <ul style="list-style-type: none"> <li>* Data cannot be loaded from the streaming tape drive. A "Can't Execute" message is displayed when trying to load.</li> <li>* A "Can't Communicate" message is displayed when selecting "No Drive" (selecting a SCSI ID for a drive that has not been connected). And a "SCSI ID Error" message is displayed when selecting "S-760 Self". Select only connected drives.</li> <li>* Pressing S1/DEC(List) calls up the Select Drive page, and the current drive can be changed (Basic Operation p.2-7).</li> <li>* Make sure to execute the Scan Command (Basic Operation p.2-7) when replacing the disk or when the connected drive cannot be recognized.</li> </ul>
<b>Number</b>	<p><b>(Number)</b> Scroll through the list by moving the cursor to the number and pressing S1/DEC or S2/INC, or Value knob.</p> <ul style="list-style-type: none"> <li>* When the cursor is at the 100s position, the list scrolls in units of 100, and when the cursor is at the 1s position, the list scrolls in single units.</li> </ul>
<b>f</b>	<p><b>(Amount of Files)</b> The amount of the files of the sound data (selected by the Target) in the current drive is displayed.</p>
<b>Sound program</b>	<p><b>(Sound Program to be Loaded)</b> The names of the various sound data in the current drive are listed. Mark the sound data to be loaded and execute the load operation. The mark alternately appears and disappears each time S1/DEC is pressed after moving the cursor to the name. Press F1 in order to mark all the sound data. Press F1 again in order to release all marks.</p> <ul style="list-style-type: none"> <li>* Marks are all cancelled when changing the Target.</li> <li>* The sound data at the cursor position is loaded when no other data is marked.</li> </ul> <p>Execute the load operation after marking the sound data to be loaded.</p>
<b>Time</b>	<p><b>(Capacity of the Sound Data)</b> The capacity of the sound data is indicated in seconds (at a standard of 44.1kHz). This displayed capacity of the sound data could be less than or greater than the actual capacity. Refer to the section "Correction for Time Indication" for details(Advanced Operation p.3-87).</p>
<b>PG#</b>	<p><b>(Program Number)</b> When the Volume is set by the Target, the program number of the Volume is indicated. When the Target is a Performance or Patch, the applicable program number cannot be displayed.</p>

- 
- Int.** (Remaining Capacity of Internal Memory)  
The remaining memory capacity of internal memory is indicated in seconds (at a standard of 44.1kHz). Since the capacity (time) of the Sound program to be loaded is also indicated by the second, you can easily determine whether it can be loaded or not. If there isn't enough internal memory left, the wave data can only be partially loaded.
- F1 All On/Off** (Mark All On/Off)  
All marks are added or deleted.
- F2 VollInfo** (Volume Information)  
This displays Volume information (the volume name and number of sounds) for the internal memory. The amount of wave memory installed in the S-760 is also displayed.
- F3 Load** (Load)  
This loads the marked sound data to the internal memory.

\* See Basic Operation p.8-8 for information on precautions to take when loading.

### Caution!

The error message "Error Wave Memory Full" is indicated when trying to load sound data which is greater than the memory capacity of the internal memory, or when loading sound data to the remaining memory and the capacity of the data exceeds the remaining memory. In such a case, only part of the sound data can be loaded. A "Directory Full" message is indicated when trying to load beyond the maximum permissible number of sound data items of the internal memory. (The sound data cannot be loaded).

## Disk Save

This saves the sound data in the internal memory of the S-760 to the current drive.

\* If, for some reason, the power to the S-760 is cut off, all sound data currently in the internal memory will be lost. Make it a habit to regularly and often save important sound data.

### Indication

**TG** (Target) [Volm (Volume)], [Pfom (Performance)],  
[Pach (Patch)], [Prtl (Partial)], [Samp (Sample)]

This selects the type of the sound data to be saved.

When selecting Volm, Pfom, Pach or Prtl, the sound data of lower levels are also saved at the same time.

\* Pressing S1/DEC(List) calls up the Select Target page, and the Target can be selected. (Advanced Operation p.5-13)



- ID:**                   **(Volume ID)**  
 With the enormous amounts of data that can be saved to a hard disk or magneto-optical disk, it becomes difficult to find the sound data you want. Because of this, the S-760 lets you classify the sound data for each Volume using the first three letters of the name. The first three letters are called the Volume ID (Basic Operation p.8-4).  
 Unlike the ID in the Disk Load page, the Volume ID of the sound data to be saved can be changed to the determined Volume ID, while saving.  
 When saving the Volume ID of the current Volume memory without changing, set it to "Thr."
- \* **Pressing S1/DEC(List) calls up the Volume ID page, and the Volume ID can be selected. (Advanced Operation p.6-25)**
- CD**                   **(Current Drive)**  
 The current drive is the drive which is selected at present for transferring of the sound data. Select the drive to which the sound data is to be saved.
- \* **Data cannot be saved to the CD-ROM drive or streaming tape drive. A "Can't Execute" message is displayed when trying to save.**
  - \* **A "Can't Communicate" message is displayed when selecting "No Drive" (selecting a SCSI ID for a drive that has not been connected). And a "SCSI ID Error" message is displayed when selecting "S-760 Self". Select only connected drives.**
  - \* **Pressing S1/DEC(List) calls up the Select Drive page, and the current drive can be changed (Basic Operation p.2-7).**
  - \* **Make sure to execute the Scan Command (Basic Operation p.2-7) when replacing the disk or when the connected drive cannot be recognized.**
- Number**               **(Number)**  
 Scroll through the list by moving the cursor to the number and pressing S1/DEC or S2/INC, or Value knob.
- \* **When the cursor is at the 100s position, the list scrolls in units of 100, and when the cursor is at the 1s position, the list scrolls in single units.**
- f**                       **(Amount of Files)**  
 The amount of the files of the sound data (selected by the Target) in the internal memory is displayed.

**Sound Program (Sound Program to be Saved)**

The names of the various sound data in the internal memory are listed.

Mark the sound data to be saved and execute the save operation. The mark alternately appears and disappears each time S1/DEC is pressed after moving the cursor to the name. Press F1 in order to mark all the sound data. Press F1 again in order to release all marks.

- \* **Marks are all cancelled when changing the Target or the Volume ID.**
- \* **The sound data at the cursor position is saved when no other data is marked.**
- \* **Sound data of 0 seconds cannot be saved.**

**Time (Capacity of the Sound Data)**

The capacity of the sound data is indicated in seconds (at a standard of 44.1kHz).

- \* **Sound data of 0 seconds cannot be saved.**

**Dsk (Remaining Capacity of the Current Drive)**

The remaining capacity of the current drive is indicated in seconds (at a standard of 44.1kHz).

You can easily check whether the data can be saved or not since the capacity (time) of the sound data to be saved is also indicated in seconds. When there is not enough memory remaining in the current drive, only part of the wave data can be saved.

**F1 All On/Off (Mark All On/Off)**

When the ID (Volume ID) is set to Thr, all the marks will be added or erased.

**F2 VollInfo (Volume Information)**

This displays volume information (the volume name and number of sounds) for the internal memory. The amount of wave memory installed in the S-760 is also displayed.

**F3 Save (Save)**

The marked sound data is saved to the current drive.

- \* **See Basic Operation p.8-9 for information on precautions to take when saving.**

**Caution!**

The error message, "Disk Memory Full," is indicated when trying to save sound data which has memory capacity exceeding the remaining memory capacity of the destination current drive. Only part of the sound data can be saved to the current drive.

A "Directory Full" message is indicated when trying to save beyond the maximum permissible number of sound data items of the current drive. (This sound data cannot be saved.)

## Disk Copy

This operation lets you copy sound data between SCSI devices, such as a hard disk.

The following four patterns are available, depending on the type of the objective drive.

**\* The display automatically changes when selecting the objective drive by the source drive or the destination drive.**

- 1 The sound data is copied from the hard disk/magneto-optical disk to the hard disk/optical disk.
- 2 The sound data is copied (backed-up) from the hard disk/magneto-optical disk to the streaming tape drive.  
A "Backup to Tape" message is indicated.
- 3 The sound data backed up to the streaming tape drive is copied (recovered) to the hard disk/magneto-optical disk. A "Recover from Tape" message is indicated.
- 4 The sound data backed up to the streaming tape drive is copied from the streaming tape drive to the streaming tape drive. A "Copy Tape to Tape" message is indicated.

### Indications

TG

(Target)

[Volm (Volume)], [Pform (Performance)], [Pach (Patch)],  
[Prtl (Partial)], [Samp (Sample)]

This selects the type of sound data to be copied.

When selecting Volm, Pform, Pach or Prtl, the lower level sound data are also copied at the same time.

However, this setting becomes inactive when the streaming tape drive is set for the source drive or the destination drive.

**\* Pressing S1/DEC(List) calls up the Select Target page, and the Target can be selected. (Advanced Operation p.5-13)**

ID:

(Volume ID)

With the enormous amounts of data that can be saved to a hard disk or magneto-optical disk, it becomes difficult to find the sound data you want. Because of this, the S-760 lets you classify the sound data for each Volume using the first three letters of the name. The first three letters are called the Volume ID (Basic Operation p.8-4).

Assign a Volume ID to the sound data to be copied so that only the sound data which has the assigned Volume ID can be indicated in the list (shown in the Disk Copy page). By determining the Volume ID, sound data can be easily found.

Set this to All in order to indicate all the sound data in the list.

However, this setting becomes inactive when the streaming tape drive is set for the source drive or the destination drive.

**\* Pressing S1/DEC(List) calls up the Volume ID page, and the Volume ID can be selected. (Advanced Operation p.5-13)**

- Source Drive**      **(Source Drive)**  
This selects the original drive to be copied.  
Select the drive which has the sound data you wish to copy.
- \* **The floppy disk drive cannot be selected.**
  - \* **A "Can't Communicate" message is displayed when selecting "No Drive" (selecting a SCSI ID for a drive that has not been connected). And a "SCSI ID Error" message is displayed when selecting "S-760 Self". Select only connected drives.**
  - \* **This source drive changes linking with the current drive (CD) of other page.**
  - \* **The select drive page opens when pressing S1/DEC(List), and the source drive can be changed.**
  - \* **Make sure to execute the Scan Command (Basic Operation p.2-7) when replacing the disk/tape or when the connected drive cannot be recognized.**
- Destin Drive**      **(Destination drive)**  
This selects the destination drive of the copy.  
Select the drive to which the sound data is copied.
- \* **The floppy disk drive cannot be selected.**
  - \* **A "Can't Communicate" message is displayed when executing the disk copy operation with "No Drive" (selecting a SCSI ID for a drive that has not been connected). And a "SCSI ID Error" message is displayed when executing the disk copy operation with "S-760 Self". Select only connected drives.**
  - \* **Pressing S1/DEC(List) calls up the Select Drive page, and the destination drive can be changed**  
.
  - \* **Make sure to execute the Scan Command (Basic Operation p.2-7) when replacing the disk/tape or when the connected drive cannot be recognized.**
- Number**              **(Number)**  
Scroll through the list by moving the cursor to the number and pressing S1/DEC or S2/INC, or Value knob.  
However, the list is not displayed and not scrolled when the streaming tape drive is set for the source drive or the destination drive.
- \* **When the cursor is at the 100s position, the list scrolls in units of 100, and when the cursor is at the 1s position, the list scrolls in single units.**
- f**                      **(Amount of Files)**  
The amount of the files of the sound data (selected by the Target) in the source drive is displayed.  
However, the list is not displayed when the streaming tape drive is set for the source drive or the destination drive.

---

<b>Sound program</b>	<p><b>(Sound Program to be Copied)</b>  The names of the various sound data in the source drive are listed.  However, the list is not displayed when the streaming tape drive is set for the source drive or the destination drive.  Mark the sound data to be copied and execute the copy operation. The mark alternately appears and disappears each time S1/DEC is pressed after moving the cursor to the name. Press F1 in order to mark all the sound data. Press F1 again in order to release all marks.  Execute the copy after marking the sound data to be copied.  The sound data is copied from the source drive to the destination drive by pressing F3 Copy.</p> <ul style="list-style-type: none"> <li>* <b>Marks are all cancelled when changing the Target.</b></li> <li>* <b>The sound data at the cursor position is copied when no other data is marked.</b></li> <li>* <b>When there is unassigned sound data in the source drive (sound data which is not assigned to any Performance, Patch or Partial; see Basic Operation p.8-10, examples 1-3), the unassigned sound data cannot be copied to the destination drive, even by setting the Target to the Volume, and marking all Volumes by pressing F1 to execute the disk copy.  In order to copy the unassigned sound data, copy all sound data by changing the Target one by one: Sample, Partial, Patch, Performance, Volume.  Or, back up the sound data to the streaming tape drive then recover from the tape to the destination drive.</b></li> </ul>
<b>Time</b>	<p><b>(Capacity of the sound data)</b>  The capacity of the sound data is indicated in seconds (at a standard of 44.1kHz).  However, it is not displayed when the streaming tape drive is set for the source drive or the destination drive.</p> <ul style="list-style-type: none"> <li>* <b>This displayed capacity of the sound data could be less than or greater than the actual capacity. Refer to the section "Correction for Time Indication" for details(Advanced Operation p.3-87).</b></li> </ul>
<b>PG#</b>	<p><b>(Program Number)</b>  When the Volume is set by the target, the program number of the Volume is indicated. When the target is a Performance or Patch, the program number of the Performance or Patch is not displayed.  However, the list is not displayed when the streaming tape drive is set for the source drive or the destination drive.</p>
<b>Dsk</b>	<p><b>(Remaining Capacity of the Destination Drive)</b>  The remaining capacity of the destination drive is indicated in seconds (at a standard of 44.1kHz).  However, it is not displayed when the streaming tape drive is set for the destination drive.</p>
<b>F1 All On/Off</b>	<p><b>(Mark All On/Off)</b>  This adds or releases all marks.  However, it cannot be executed when the streaming tape drive is set for the source drive or the destination drive.</p>

---

**F3 Copy**

**(Copy)**

This copies the marked sound data to the destination drive.  
However, all sound data is backed up/recovered/copied to the destination drive when the streaming tape drive is set for the source drive or the destination drive.

**\* When the streaming tape drive is set for the source drive or the destination drive, or when copying a large amount of sound data, such as that of a magneto-optical disk, the copy operation may take quite a long time.**

**Caution!!**

**When the streaming tape drive is selected for the Source Drive or the Destination Drive:**  
All sound data in internal memory of the S-760 is lost when executing the backup, recover, or copy operations by pressing F3 (Copy). Therefore, save the necessary sound data before executing these operations by pressing F3 (Copy).

**Caution!!**

**When backing up from a hard disk/magneto-optical disk to the streaming tape drive:**  
All sound data in the hard disk/magneto-optical disk are backed up to the tape.  
For example, there are 60 megabytes of sound data in the 100-megabyte hard disk. If you back up this disk, the 60 megabytes of sound data is not backed up alone, but the total 100-megabyte capacity of the hard disk is backed up as well.  
Therefore, you should make sure that the capacity (length) of the tape you are using is the same or greater than the capacity of the hard disk/magneto-optical disk.  
Keep in mind that if there is already sound data in the tape to be used, these sound data will all be lost. (Only one set of backup data can be copied to one tape.)

**Caution!!**

**When recovering from the streaming tape drive to the hard disk/magneto-optical disk:**  
All sound data in the tape is recovered to the hard disk/magneto-optical disk.  
Therefore it is necessary to recover to a hard disk/magneto-optical disk which has the same or greater capacity than the sound data in the tape.  
However, when recovering to a hard disk/magneto-optical disk which has more capacity than the sound data in the tape, the capacity that can be used on the hard disk/magneto-optical disk will only be the same as the capacity of the sound data in the tape.  
For example, there are 150 megabytes of sound data in the tape, and this data is recovered to a 200-megabyte hard disk. In this condition, the 200-megabyte hard disk functions as a 150-megabyte hard disk, and the remaining 50 megabytes cannot be used at all.  
Keep in mind that if there is already sound data in the hard disk to be used, this sound data will all be lost.

**Caution!!**

**When copying from the streaming tape drive to the streaming tape drive:**  
All sound data in the original tape is copied to the destination tape.  
Therefore, it is necessary to copy to a destination tape which has the same or greater capacity than the sound data in the original tape.  
Keep in mind that if there is already sound data in the destination tape to be used, this sound data will all be lost (only one set of backup data can be copied to one tape).

**Concerning the tape which can be used (Streaming Tape Drive)**

Make sure to use 4-mm data grade DDS DAT cassette tapes. We recommend that you use Maxell HS-4/60, FUJI FILM DG-60M or SONY DG-60 M.

**\* Do not use audio DAT tape for data backup purposes.**

The relation between the length and the capacity of the tape is shown below.

Length (meter)	Time (minute)	Capacity (Mbyte)
23	45	About 490
30	60	About 670
45	90	About 1000
60	120	About 1350

**\* The maximum capacity of the drive which can be used for the S-760 is 600 megabytes.**

It is unnecessary to format the newly purchased tape or the tape which was already used by other device, since the S-760 automatically formats the tape.

## Disk Delete

This deletes the sound data in the current drive.

### Indication

TG

(Target) [Volm (Volume)], [PfoM (Performance)], [Pach (Patch)],  
[Prtl (Partial)], [Samp (Sample)]

This selects the type of the sound data to be deleted.

When selecting Volm, PfoM, Pach or Prtl, the lower level sound data is also deleted at the same time.

**\* Pressing S1/DEC(List) calls up the Select Target page, and the Target can be selected. (Advanced Operation p.5-13)**

ID:

**(Volume ID)**

With the enormous amounts of data that can be saved to a hard disk or magneto-optical disk, it becomes difficult to find the sound data you want. Because of this, the S-760 lets you classify the sound data for each Volume using the first three letters of the name. The first three letters are called the Volume ID (Basic Operation p.8-4).

Assign a Volume ID to the sound data to be deleted so that only the sound data which has the assigned Volume ID can be indicated in the list (shown in the Disk Delete page). By determining the Volume ID, sound data can be easily found.

Set this to All in order to indicate all the sound data in the list.

**\* Pressing S1/DEC(List) calls up the Volume ID page, and the Volume ID can be selected. (Advanced Operation p.5-13)**

- 
- CD**                   **(Current Drive)**  
The current drive is the drive which is selected at present for transferring of the data. Select the drive which has the sound data you wish to delete.
- \* **The sound data in the CD-ROM drive or streaming tape drive cannot be deleted. A "Can't Execute" message is displayed if you attempt to delete the data.**
  - \* **A "Can't Communicate" message is displayed when selecting "No Drive" (selecting a SCSI ID for a drive that has not been connected). And a "SCSI ID Error" message is displayed when selecting "S-760 Self". Select only connected drives.**
  - \* **Pressing S1/DEC(List) calls up the Select Drive page, and the current drive can be selected (Basic Operation p.2-7).**
  - \* **Make sure to execute the Scan Command (Basic Operation p.2-7) when replacing the disk or when the connected drive cannot be recognized.**
- Number**               **(Number)**  
Scroll through the list by moving the cursor to the number and pressing S1/DEC or S2/INC, or Value knob.
- \* **When the cursor is at the 100s position, the list scrolls in units of 100, and when the cursor is at the 1s position, the list scrolls in single units.**
- (Amount of Files)**  
The amount of the files of the sound data (selected by the Target) in the current drive is displayed.
- Sound Program**      **(Sound Program to be Deleted)**  
The names of the various sound data in the current drive are listed.  
Mark the sound data to be deleted and execute the delete operation. The mark alternately appears and disappears each time S1/DEC is pressed after moving the cursor to the name. Press F1 in order to mark all the sound data. Press F1 again in order to release all marks.  
Execute the delete operation after marking the sound data to be deleted.  
The sound data is deleted by pressing F3 (Delete).
- \* **Marks are all cancelled when changing the Target.**
  - \* **The sound data at the cursor position is deleted when no other data is marked.**
- Time**                   **(Capacity of the Sound Data)**  
The capacity of the sound data is indicated in seconds (at a standard of 44.1kHz).
- \* **This displayed capacity of the sound data could be less than or greater than the actual capacity. Refer to the section "Correction for Time Indication" for details(Advanced Operation p.3-87).**
- PG#**                   **(Program Number)**  
When the Volume is set by the target, the program number of the Volume is indicated. When the target is a Performance or Patch, the program number of the Performance or the Patch cannot be displayed.



- Dsk**                   **(Remaining Capacity of the Current Drive)**  
The remaining capacity of the current drive is indicated in seconds (at a standard of 44.1kHz).
- F1 All On/Off**       **(Mark All On/Off)**  
This adds or releases all marks.
- F2 Norm/Fast**       **(Setting the Fast Delete Mode)** **System2**  
The way of deleting sound data differs depending on the settings (on/off) of the Fast Delete Mode for SCSI (Advanced Operation p.3-95).
- Norm       : The Fast Delete Mode is set to off.  
              This function checks whether the sound data to be deleted is used for other sound data or not, and if it is not used, then it deletes only that unused sound data.
- Fast        : The Fast Delete Mode is set to on.  
              This deletes all sound data without checking whether the sound data to be deleted is used for other sound data or not. In this way, the delete operation can be performed much faster.
- F3 Delete**           **(Delete)**  
This deletes all marked sound data.
- \* **Deleting a large amount of sound data, such as that of a magneto-optical disk, may take quite a long time.**

### Caution!

When executing Disk Delete, different from the Delete Command (Advanced Operation p.5-2), the name of a sound will be retained in a 'Select' of data one level higher that uses sound data even after being disk-deleted.

For example, when a Partial is disk-deleted, the name of the Partial deleted remains within the Split Partial Select in all the Patches that use that Partial.

Similarly, when a Patch is disk-deleted, the name in the Part Patch Select will remain. This applies to the Sample Select of the SMT where the Sample is disk-deleted.

That is, you must be aware that the Disk Delete function cannot automatically delete (turn off) the name in a Select Parameter of sound data one level higher.

## Disk Utility

These operations are used to format and park the heads the hard disk or magneto-optical disk. Keep in mind that some of the commands in this page change the data in the drive.

### Indications

**TG** (Target) [Volm (Volume)], [Pfom (Performance)], [Pach (Patch)], [Prtl (Partial)], [Samp (Sample)]  
This selects the type of the sound data whose name or program number will be changed.

- \* Pressing S1/DEC(List) calls up the Select Target page, and the Target can be selected. (Advanced Operation p.5-13)

**ID:** (Volume ID)  
With the enormous amounts of data that can be saved to a hard disk or magneto-optical disk, it becomes difficult to find the sound data you want. Because of this, the S-760 lets you classify the sound data for each Volume using the first three letters of the name. The first three letters are called the Volume ID (Basic Operation p.8-4).  
Assign a Volume ID to the sound data whose name or program number is to be changed so that only the sound data which has the assigned Volume ID can be indicated in the list (shown in the Disk Utility page). By determining the Volume ID, sound data can be easily found.  
Set this to All in order to indicate all the sound data in the list.

- \* Pressing S1/DEC(List) calls up the Volume ID page, and the Volume ID can be selected. (Advanced Operation p.5-13)

**CD** (Current Drive)  
The current drive is the drive which is selected at present for transferring of the data. Select the drive containing the sound data whose name or program number is to be changed, or the drive which will be formatted.

- \* Editing and executing of commands cannot be done for the CD-ROM drive or the streaming tape drive. A "Can't Execute" message is displayed when attempting to execute commands.
- \* Pressing S1/DEC(List) calls up the Select Drive page, and the current drive can be selected (Basic Operation p.2-7).
- \* Make sure to execute the Scan Command (Basic Operation p.2-7) when replacing the disk or when the connected drive cannot be recognized.
- \* A "Can't Communicate" message is displayed when selecting "No Drive" (selecting a SCSI ID for a drive that has not been connected). And a "SCSI ID Error" message is displayed when selecting "S-760 Self". Select only connected drives.

<b>Number</b>	<p><b>(Number)</b>  Scroll through the list by moving the cursor to the number and pressing S1/DEC or S2/INC, or Value knob.</p> <p><b>* When the cursor is at the 100s position, the list scrolls in units of 100, and when the cursor is at the 1s position, the list scrolls in single units.</b></p>
<b>f</b>	<p><b>(Amount of Files)</b>  The amount of the files of the sound data (selected by the Target) in the current drive is displayed.</p>
<b>Sound program</b>	<p><b>(Sound Program in the current drive)</b>  The names of the various sound data in the current drive are listed.  This function can be used to change the name of the sound data.  Move the cursor to the sound data whose name to be changed, then call up the ASCII page by pressing S2/INC(Name). The name can then be changed.  This can also be used to change the order of the sound data in the current drive.  To do this, move the cursor to the sound data whose order is to be changed, and press S1/DEC(Get). Scroll through the List using the Cursor buttons (up/down) and move the cursor to the destination for the sound data (the sound data will be inserted at the position just before the sound data that is highlighted with the cursor).  The order of the sound data is changed by pressing S1/DEC(Ins).</p> <p><b>* There is no need to save here, since the data in the current drive is rewritten directly.</b></p>
<b>Time</b>	<p><b>(Capacity of the Sound Data)</b>  The capacity of the sound data is indicated in seconds (at a standard of 44.1kHz).</p> <p><b>* This displayed capacity of the sound data could be less than or greater than the actual capacity. Refer to the section "Correction for Time Indication" for details(Advanced Operation p.3-87).</b></p>
<b>PG#</b>	<p><b>(Program Number)</b> <input type="checkbox"/> Disk                    [--- (off)], [65] — [128]</p> <p>When the Volume is set with the Target, the program number of the Volume can be determined. When the Target is a Performance or Patch, the program number of the Performance or Patch cannot be displayed.</p> <p><b>* There is no need to save here, since the data in the current drive is rewritten directly.</b></p> <p>This program number of the Volume is used to determine the Volume to be changed (loaded) by program change messages over the control channel when the Control Mode (Advanced Operation p.***) of the MIDI parameters is set to  Perf/Vol .</p> <p>The program number of the Volume is also used when determining the Volume to be read in at the powering on the S-760 (Initial Volume). (Advanced Operation p.3-94)</p> <p><b>* Up to 128 Volumes can be saved to a hard disk, and the program numbers can be determined for up to 64 Volumes out of 128 volumes. Set the program numbers of Volumes that are not to be changed (loaded) to "---" (off).</b></p> <p>See Basic Operation p.8-6 for details.</p>

**Caution!**

Do not assign the same program number to several different Volumes; when the same program number is set, the Volume that the S-760 retrieves first has priority. All Volumes in the current drive can be indicated in the list by setting the Volume ID to "All." This lets you easily check whether or not the same program number is set to several Volumes, when setting the program number. It is recommended that you don't set the program number for each Volume ID, since it takes time to check these.

**Int. (Remaining Capacity of internal memory)**

The remaining capacity of internal memory is indicated in seconds (at a standard of 44.1kHz).

**F1 ParkHds (Park Heads)**

This function safely parks the heads of all connected SCSI hard disks and magneto-optical disks. Hard disk drives have heads which track along the surface of the disks, which constantly rotate at an extremely high speed allowing the heads to read data from, and write data to, the hard disk at any time. However, since the heads are continually touching the surface of the disks, the disks could be damaged if the drive is jarred or moved suddenly. This is why it is necessary to move the heads to a safe position, off the disk surface, in order to protect the disks when moving the disk drive. This is called "parking the heads." All the heads of the hard disk and the magneto-optical disk drive on a SCSI chain can be parked simultaneously from the S-760 when executing the Park Heads command (Basic Operation p.1-7). Execute the F2 Restart command, when accessing the hard disk or magneto-optical disk after executing the Park Heads operation.

**F2 Restart (Restart)**

This starts up (or re-engages) the hard disk or magneto-optical disk whose heads were parked.

- \* Be sure to execute the Scan Command (Basic Operation p.2-7) after executing the Restart Command.

**F3 Format (Format)**

This formats the hard disk and magneto-optical disk in the current drive.

- \* There is no need to format a hard disk/magneto-optical disk which is used by an S-770/750 or SP-700, or the hard disk which is used by an S-550/W-30.

**Caution!**

Be careful when initializing or formatting, since all data will be lost. Lost sound data cannot be recovered.

- \* Commands cannot be executed for the CD-ROM drive and the streaming tape drive.
- \* The maximum memory capacity of a drive which can be used with the S-760 is 600 megabytes. This means for example, that even if you format an 800-megabyte hard disk, it functions only as a 600-megabyte hard disk; the remaining 200 megabytes cannot be used at all.

---

## Save System

This saves the system program and system parameters to disk. The parameters saved together with the program are as follows.

- Quick Load list
- Mark list
- Template list
- Volume ID list

\* For details on System parameters, refer to Basic Operation p.8-7.

### Caution!

It is not possible to save to a disk which is formatted by the S-770/750 (SYS-772 Version 2.0) or SP-700. For details refer to Basic Operation p.5-2.

## CD

### (Current Drive)

The current drive is the drive which is selected at present for transferring of the system data. Select the drive to which the system data is to be saved.

- \* Data cannot be saved to the CD-ROM drive or streaming tape drive. A "Can't Execute" message is displayed when trying to save.
- \* A "Can't Communicate" message is displayed when selecting "No Drive" (selecting a SCSI ID for a drive that has not been connected). And a "SCSI ID Error" message is displayed when selecting "S-760 Self". Select only connected drives.
- \* Pressing S1/DEC(List) calls up the Select Drive page, and the current drive can be changed (Basic Operation p.2-7).
- \* Make sure to execute the Scan Command (Basic Operation p.2-7) when replacing the disk or when the connected drive cannot be recognized.

---

## Optimize

This function is used to optimize the sound data in the current drive, or re-sort the sound data into alphabetical order, or re-calculate the capacity (time) of the sound data.

The sound data in the drive are sorted by the optimize function according to the best order for retrieval. When this is done, the time it takes to execute each command (Load, Save, Copy, Delete, etc.) in the Disk Mode becomes slightly shorter.

### Caution!

If wave memory has not been expanded, attempting to execute the Optimize function will result in a display of "Can't Execute", and execution will be cancelled. Please expand the wave memory.

### Indications

#### CD

#### (Current Drive)

The current drive is the drive which is selected at present for transferring the data. Select the drive which has the sound data to be optimized.

- \* **The sound data in the CD-ROM drive or the streaming tape drive cannot be optimized. A "Can't Execute" message is displayed when attempting to optimize.**
- \* **A "Can't Communicate" message is displayed when selecting "No Drive" (selecting a SCSI ID for a drive that has not been connected). And a "SCSI ID Error" message is displayed when selecting "S-760 Self". Select only connected drives.**
- \* **Pressing S1/DEC(List) calls up the Select Drive page, and the current drive can be selected (Basic Operation p.2-7).**
- \* **Make sure to execute the Scan Command (Basic Operation p.2-7) when replacing the disk or when the connected drive cannot be recognized.**

#### [Options]

#### (Options)

The function of the marked option is also executed together when executing Optimize.

The mark alternately appears and disappears each time S1/DEC(Mark) is pressed after moving the cursor. Press F1 in order to mark all the options. Press F1 again in order to release all marks on the options.

#### 1 Sort in Alphabetical Order (Alphabetical Sort)

All the sound data (from Volume to sample) in the current drive are rearranged into alphabetical order.

## 2 Correction for Time Indication

The capacity of the sound data in the current drive is indicated by the time indication (second) in each display (Load, Copy, Delete, Utility) of the Disk Mode. This is due to the fact that this time value is also saved for reference purposes when saving sound data (from Volumes to samples) to the drive.

However, if you save the sound data of the same name after having saved sound data into a drive (overwrite), or copy a part of the sound data with the Disk Copy function, or delete a part of the sound data with Disk Delete, or save sound data after Listen Delete. The actual time will differ from the time written on the drive (time written when the sound data has been saved for the first time).

You can re-calculate this time for the current drive and then have the corrected time properly indicated by executing this option.

### Caution!

The time (in seconds) of the sound data is also indicated in the Quick Load page.

However, the correct time is not indicated even when executing this option, since the Sound program list in this page is of the System parameters.

For example, when registering the Sound program name to the Sound program list of the Quick Load function from a drive whose time is not accurate, the indicated time remains inaccurate. In this case, execute the option to correct the time, and register the Sound program again.

In order to prevent this from happening, execute this option to correct the time, then register the Sound program name to the Sound program list of the Quick Load function.

F1 All On/Off

(Mark All On/Off)

This adds or deletes all marks.

F3 Optimiz

(Optimize)

This executes the Optimize function.

When the option is marked, its function is also executed together.

### Caution!

This will erase all the sound data in the internal memory and therefore opens the confirmation message screen.

Pressing F1 (Yes) will erase Sound Data and execute the Optimize function.

Pressing F3 (No) will cancel the Optimize function.

- \* Before executing the Optimize function, be sure to save necessary sound data. (Basic Operation p.4-4)
- \* For large amounts of data as commonly contained on a magneto-optical disk, it takes quite a long time to optimize (especially when executing the options as well).

---

## Convert Load

A CD-ROM disk for the S-550/W-30 can be read into (convert loaded) the S-760 and then used.

**\*It is not possible to Convert Load floppy disk data.**

Since the sound data of the S-550/W-30 is structured differently and has different parameters, it cannot be loaded to the S-760 as it is. However, by executing the Convert Load operation, a portion of the parameters can be automatically converted by the S-760 and used, leaving the wave data unchanged. Convert Load can be used on the sound units of Patch and Tone.

**\* The Sound program might be changed slightly by executing Convert Load since the parameter structure, the playback frequency and the analog circuits are different.**

**Compatible disks for the Convert Load operation are as follows:**

- CD-ROM disk for the S-550, W-30 (option: USV-1 (discontinued), USV-2, CD50CD01)
- CD-ROM disk (L-CD1) supplied with the Roland CD-5.
- Hard disk which contains sound data used for the S-550 or W-30.

**\* The sound data created by the S-760 cannot be used for these Roland Samplers: S-50/330/550, W-30.**

### Indications

TG

**(Target)[Pach (Patch to Patch)],[Tone (Tone to Partial)]**

This selects the type of the sound data to be convert loaded.

- Pach : The Patch of the S-550/W30 is convert loaded to the Internal memory as a Patch for the S-760. The lower level sound data are also convert loaded at the same time.
- Tone : The Tone of the S-550/W30 is convert loaded to the Internal memory as the Partial for S-760. The lower level sound data are also convert loaded at the same time.

**\* When convert loading from the CD-ROM drive, it takes a little time to make each setting.**

Ar

**(Area Number)**

This selects the area number when convert loading from a CD-ROM drive or hard disk.

**\* Pressing S1/DEC(List) calls up the Select Area page, and the area can be changed.**



- 
- CD**                   **(Current Drive)**  
 The current drive is the drive which is selected at present for transferring the data. Select the SCSI device which contains the sound data to be convert loaded.
- \* **Sound data cannot be loaded from the streaming tape drive. A "Can't Execute" message appears when attempting to load.**
  - \* **A "Can't Communicate" message is displayed when selecting "No Drive" (selecting a SCSI ID for a drive that has not been connected). And a "SCSI ID Error" message is displayed when selecting "S-760 Self". Select only connected drives.**
  - \* **Pressing S1/DEC(List) calls up the Select Drive page, and the current drive can be selected (Basic Operation p.2-7).**
  - \* **Make sure to execute the Scan Command (Basic Operation p.2-7) when inserting/replacing the CD-ROM disk or when the connected drive cannot be recognized in the Convert Load page.**
- Sound program**   **(Sound Program to be Convert Loaded)**  
 The names of the various sound data in the current drive are listed.  
 Mark the sound data to be convert loaded and execute the convert load operation. The mark alternately appears and disappears each time S1/DEC is pressed after moving the cursor to the name. Press F1 in order to mark all the sound data. Press F1 again in order to release all marks.
- \* **Marks are all cancelled when changing the Target.**
  - \* **The sound data at the cursor position is convert loaded when no other data is marked.**
- Execute the convert load operation after marking the sound data to be convert loaded.  
 The sound data is convert loaded to the internal memory by pressing F3 (ConvLD).
- Capacity of Tone**   **(Capacity of Tone)**  
 The capacity of the Tone is indicated in seconds (at a standard of 44.1kHz), when the Tone is selected with the Target.  
 This is not indicated when the Patch is selected with the Target.
- Int.**                   **(Remaining Capacity of internal Memory)**  
 The remaining capacity of internal memory is indicated in seconds (at a standard of 44.1kHz). When sound units from Tone to Partial are set with the Target, the Tone capacity to be convert loaded is also indicated in seconds. Check whether convert load can be executed or not. The wave data can only be partially loaded when there is not enough memory left in the internal memory.
- F1 All On/Off**       **(Mark All On/Off)**  
 This adds or deletes all marks.
-

**F3 ConvLD**

**(Convert Load)**

This convert loads the marked sound data.

The name of the convert-loaded sound data becomes as shown below:

Patch P11 : name /  
P12 : name \  
Partial T11 : name  
Sample T11 : name

\* The "/" at the end of the Patch name indicates the 1st Tone and "\" indicates the 2nd Tone.

The characters "P11" or "T11" are added automatically to the Volume ID, or "/" or "\" are added automatically to the end of the name. Change the name in the ASCII page (Basic Operation p.7-12) as needed. When entering the Volume IDs continuously, you can enter them individually from the ASCII page, or enter them all together in the System Volume ID page (Advanced Operation p.3-103).

**Caution!**

The error message, "Error Wave Memory Full," is indicated when trying to convert load sound data which has a greater amount of memory than the memory capacity of the internal memory, or when trying to convert load the sound data to the remaining memory and it exceeds the capacity. In such a case, the sound data can only be partially convert loaded. A "Directory Full" message appears when trying to convert load beyond the maximum permissible number of sound data items of the internal memory. (The sound data cannot be convert loaded.)

The sound data (CD-ROM disk) of other manufacturers can be convert loaded.

- \* Since the S-760 automatically scans CD-ROM disks, the Convert Load (A) page is called up when a CD-ROM disk of another manufacturer is inserted into the CD-ROM drive.
- \* Make sure to execute the Scan Command (Basic Operation p.2-7) when inserting or replacing the CD-ROM disk in the convert load page or when the connected drive cannot be recognized.

Since the structure of the sound data and the parameter structure are different, a portion of the parameters is automatically converted by the S-760 and convert loaded as Patches. Therefore, some Sound programs may differ from the original one depending on the programs. In such case, edit the parameters after convert loading. The sound may also be slightly different because of differences in the playback frequency or the analog circuits.

See Advanced Operation p.3-88, since all operations (excepting the ones shown below) are the same as those in the Convert Load (S) pages.

**Indications  
Part**

**(Partition)**

This selects the partition in the CD-ROM disk.

**Vol**

**(Volume)**

This selects the Volume in the CD-ROM disk.

# System Mode

In this mode, the general or global operating settings of the S-760 are made (such as for receiving and transmitting data with external devices), and the System parameters are loaded/saved.

## Caution!

**Be sure to save the system parameters since they are lost if you turn the power off without saving them.** System parameters can be classified in two groups, depending on the destination to which they are saved. For details refer to Basic Operation p.8-7.

## System Parameter

The global settings of the S-760 are made from this page.

### Indications

#### Wave Memory

(Wave Memory)

You can check the entire capacity of the wave memory .

#### Master-Freq

(Master Frequency) System2 [48], [44.1], [32] kHz

This determines the system clock of the S-760.

**\* Depending on the Master Frequency settings, there may be times in which you must be careful about sound data compatibility with the S-770/750 (SYS-772 Version 2.0) or SP-700. For details refer to Advanced Operation p.2-2.**

#### Master -Tune

(Master Tune) System 2 [-50] — [50] (cent)

This adjusts the overall pitch of the S-760.

A change in pitch of 50 cents equals 1/2 of a semi-tone.

#### Master - Level

(Master Level) System 2 [0] — [127]

This adjusts the overall sound level of the S-760. This adjusts the sound level of all stereo output jacks A—D (individual output jacks 1—8). (Advanced Operation p.4-9)

#### LCD Contrast

(LCD contrast) System2 [-50] — [50]

This sets the brightness of the LCD.

- 
- Controller** (Controller) System 2 [Panel+LCD], [Mouse+CRT], [RC100+CRT]  
 This selects the display device and auxiliary controller by which the S-760 will be operated.
- Panel+LCD : Operate using only the S-760.
  - Mouse+CRT : A mouse and CRT display etc. can be connected for operation.
  - RC100+CRT : A mouse and a separately sold RC100 remote controller (out of production) and a CRT display etc. can be connected for operation.
- After making settings, press F3 Exec.
- \* If the separately sold Power Sampling Expansion (OP-760-1) has not been installed, it is not possible to select Mouse+CRT or RC100+CRT.
  - \* If you select either Mouse+CRT or RC100+CRT, the LCD will not be used for display.
- Output - Mode** (Output Mode) System 2 [4st], [Mix], [1st+6 outs], [8 outs]  
 This determines how the stereo output jacks A—D (individual output jacks 1—8) should be used(Advanced Operation p.4-2).
- Output-Assign C/D (Output Assign C/D)** System 2 [A/B], [C/D]  
 This specifies the output jack from which the output of equalizer C and D (individual 5-8) will be output. If you change C/D → A/B, the sound that was specified for output from C/D will be output from A/B. For details refer to Advanced Operation p.4-2.
- Digital Booster** (Digital booster) System 2 [-6], [0], [+6], [+12] dB  
 This boosts or cuts the analog/digital output.
- \* The initial value is [-6]. If you wish to playback a sound sampled with a wide dynamic range at its original level, multiple simultaneously notes will result in distortion. Normally you will set this at [-6] to avoid this problem. If you set this to [0], the sound will be output at the level at which it was sampled. If you wish to especially emphasize individual notes, set this to [0]-[+12].
- Time Display** (Time Display) System 2 [Off],[On]  
 The capacity (in seconds) of the Performance, Patch, Partial, and Samples are indicated in the Select Performance page, Select Patch page, Select Partial page, Select Sample page or each command page (for the Performance, Patch, Partial, or Sample). Set it to Off if you wish to shorten the waiting time for these pages to be opened. Normally, though, set this to On.

**Recover Function** (Recover function) System2 [On], [Off]

This sets the Recover Function of Sampling mode on or off.

- \* When this is set on, executing a command in Sample mode will preserve the original state of the sample before the command was executed. This allows you to restore the original sample if you do not like the results of executing the command.
- \* When this is set off, it will not be possible to restore the original sample, but the execution speed of each command will be a bit faster.

**Preview-Note#** (Preview note number) System2 [A0] — [C8]

**Preview-Velocity** (Preview velocity) System2 [0] — [127]

**Preview-Mode** (Preview mode) System2 [Single], [Chord]

This sets the note number, velocity, and preview mode of the Preview function. For details refer to Advanced Operation p.6-26.

Single : Each time you press the Volume knob, note numbers [1] — [4] will be sounded in succession.

Chord : Each time you press the Volume knob, note numbers [1] — [4] will be sounded in unison.

**F1 VolInfo** (Volume Information)

This displays Volume information (the Volume name and number of sounds) for the internal memory. The amount of wave memory installed in the S-760 is also displayed.

## System SCSI

The S-760 features built-in SCSI ports, and they are used to transfer the sound data between the S-760 and the drive (such as a CD-ROM and a hard disk). The SCSI relationships are determined in this page.

### Indications

**S-760 Self SCSI ID** (S-760 Self SCSI ID Number) System 2 [0] — [7]

This determines the SCSI ID number of the S-760.

- \* Normally, this should be set to 7.
- \* This parameter only becomes active when the power is turned off and then on again.

- Initial Drive** (Initial Drive SCSI ID Number) System 2 [SCSI:0] — [SCSI:7],[Floppy]  
 This sets the drive which becomes the current drive when turning on the S-760.
- \* Do not set this to the streaming tape drive or the S-760 itself.
  - \* This parameter only becomes active when the power is turned off and then on again.
  - \* Be sure to insert the CD-ROM disk before turning on the S-760. Use the disk which is designed specifically for the S-770/750/SP-700. (Insert the CD-ROM disk for the S-550/W-30 from the Convert Load page). Do not set it to the hard disk which is used for the S-550/W-30.
  - \* A maximum of 7 drives can be connected. Set the SCSI ID numbers for each drive and the S-760 (0—7). Be sure not to assign the same SCSI ID number to different devices when connecting the devices. This could result in some problems ( Advanced Operation p7-2).
  - \* Refer to the owner's manual of each connected device for information on setting the SCSI ID number of the drive.
- Initial Volume** (Initial Volume) System 2 [Off], [65] — [128]  
 This determines which Volume should be loaded when turning on the S-760. No Volume is loaded when turning on the power if this is set to off. Program numbers 65—128 are the program numbers of the Volume, and the Volume whose program number is specified here will be loaded automatically when you turn on the power. The correspondence between the Volume and the program number is determined by PG# in the Disk Utility page ( Advanced Operation p.3-83). From which drive the Volume is to be loaded is determined by the Initial Drive parameter in the System SCSI page ( Advanced Operation p.3-94).
- \* Do not set the Initial Drive to the streaming tape drive or "S-760 Self." Data cannot be loaded with these settings.  
**Be sure to insert the CD-ROM disk before turning on the S-760 when setting this to the CD-ROM drive. Data cannot be loaded if the disk is not inserted. Use a disk which is specially designed for the S-770/750/SP-700. (Data cannot be loaded from CD-ROM disks for the S-550/W-30.)**  
**Also, data cannot be loaded from a hard disk used for the S-550/W-30.**
- Boot Drive** (Boot Drive) System2 [Default], [Floppy], [SCSI:0] — [SCSI:7]  
 This selects the drive from which the system program will be loaded to start up the S-760. For details refer to Basic Operation p.5-3.
- [Default] : If the system disk is inserted in the floppy disk drive, the S-760 will start up using that system. If it is not inserted, the SCSI devices will be checked for systems starting with the lowest numbered SCSI ID. The S-760 will start up using the first system it finds.
  - [Floppy] : The system program will be loaded from system disk in the floppy disk drive. It cannot load from SCSI devices.
  - [SCSI:0] — [SCSI:7] : The system will be loaded from the drive with the SCSI ID you specify here. If the number specified here is the same as the SCSI ID of the S-760 itself, the result will be the same as if [Default] was specified.

**Fast Delete Mode (Fast Delete Mode) System 2 [Off], [On]**

This sets the Fast Delete Mode when executing the Disk Delete function ( Advanced Operation p.3-8).

**Off** : This sets the Fast Delete Mode to Off. It deletes after checking the dependent relationships of the sound data. This setting makes the delete operation extremely time consuming; it could take up to an entire day to delete the data.

**On** : This sets the Fast Delete Mode to On. This setting allows the data to be deleted at high speed, ignoring the relationships of the sound data.

**\* The delete function of the internal memory ( Advanced Operation p.5-2) always checks the data relationships, regardless of this setting.**

#### The Relationships of the Sound Data

When executing the Disk Delete function, not only the selected sound data, but also the lower level sound data are deleted at the same time. For example, when deleting a Performance, the Patches, Partials and Samples being used by the Performance are all deleted.

The way that the S-760 handles sound data, several higher level sound data programs or categories can share the same lower level sound data. For example, two Performances can use the same Patch.

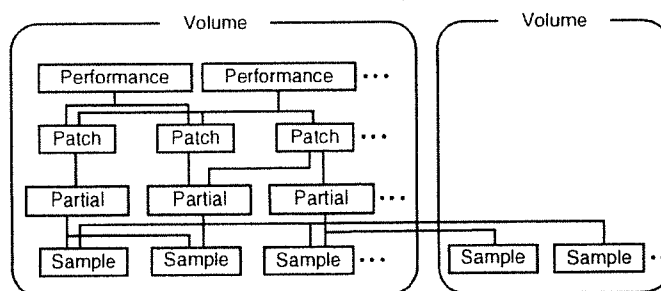

When deleting the sound data in such a condition, the Sound programs of other sound data might be destroyed, since other sound data might be using its lower level sound data. In order to prevent such problems from occurring, the S-760 can automatically check through all the level relationships of the data before deleting the sound data with the Fast Delete Mode parameter.

When the Fast Delete Mode is set to ON, all applicable sound data (including the lower level sound data) are deleted without checking the relationships of the sound data. In this case, the sound data can be deleted quickly; however, if you delete sound data that is shared by several different higher level categories, the higher level categories will be destroyed.

When the Fast Delete Mode is set to Off, the lower level sound data is not deleted and the Sound program of other sound data is not destroyed, even when other sound data is using the same lower level sound data, since relationships of the sound data is checked.

**\* When the sound data is controlled in Volume units (except when several high level sound data are using the same lower sound data), depending on the Volume ID, the operation can be performed efficiently by setting the Fast Delete Mode to on.**

**On the other hand, make sure to check the relationships of the sound data before deleting by setting the Fast Delete Mode to Off, when one sound data is used by several Volumes ( Basic Operation p.8-3).**

**Overwrite Switch (Overwrite Switch) System 2 [On], [Off]**

This determines whether or not the System will prompt you before performing the overwrite operation. When the Overwrite Switch is set to Off, a message appears prompting you to confirm whether you wish to overwrite (delete the old data and replace it) or not. This message appears if, while loading or saving sound data or while copying data to disk (except with streaming tape drive), sound data of the same name already exists in the destination (Internal memory when loading, current drive when saving, or destination drive when copying to disk).

- F1 (Yes) : All data is overwritten.
- F2 (No) : Sound data of the same name is not transferred. (Only sound data with different names are transferred).
- F53(Cancel): The Load, Save and Disk Copy operations are aborted.

**\* The Copy function for sound data of the internal memory ( Advanced Operation p.5-2) always checks whether same named data exists or not, regardless of this setting. When data of the same name exists, a message appears in the page, prompting you to confirm the operation.**

When the Overwrite Switch is set to On, the overwrite operation is performed even when data of the same name exists. (No message prompting you for confirmation appears.)

## MIDI Control

The MIDI controls can be set in this page.

### Indications

**Control Channel (Control Channel) System 2 [Off], [1] — [16]**

This determines the control channel.

While the MIDI channel controls operations for each Part, the control channel here, on the other hand, controls operations for the entire S-760. The master level value is changed by control change data (#7: volume), the master tune value is changed by the RPN of the control change data, each parameter setting of the equalizer is changed by control change data (#1—95), and Program Change data.

- \* See Basic Operation p.9-2 for details of changing Sound programs by using MIDI.
- \* Do not set the control channel to the same value as the Part channel. If they are set to the same channel, the program change of the control channel has priority and the Patch of the Part cannot be changed.
- \* Control Change messages received on the control channel are irrelevant to settings of the MIDI Filter in a Performance.



<b>Control Mode</b>	<b>(Control Mode)</b> <span style="border: 1px solid black; padding: 0 2px;">System2</span>	<b>[Perf Only], [Perf/Vol]</b>
	Program Change messages received on the Control channel can select Performances or load Volumes. This setting determines which sounds will be selected by Program Change messages.	
	If Perf Only is selected, only Performances will be selected. If a Program Change of 65 or higher is received, the Performance which has a program number corresponding to "the program number minus 64" will be selected.	
	If Perf/Vol is selected, program numbers 1-64 will select Performances. When a program number 65-128 is received, a Volume will be loaded from Current Drive.	
	For details refer to Basic Operation p.9-2.	
<b>MIDI Out/Thru</b>	<b>(MIDI Out/Thru switch)</b> <span style="border: 1px solid black; padding: 0 2px;">System2</span>	<b>[Out], [Thru]</b>
	The S-760 uses the same connector for MIDI OUT and MIDI THRU. This setting specifies how the connector will function.	

## MIDI Volume Dump

The data of the Volume (including that of the Performances down to the Partial's being used by the Volume except wave data) in the internal memory and the System data of the internal memory are transmitted as MIDI Exclusive data from this display page. Wave (or sample) data cannot be transmitted. Conditions for receiving of Exclusive data are also set here.

### Indications

<b>Device ID</b>	<b>(Device ID Number)</b> <span style="border: 1px solid black; padding: 0 2px;">System 2</span>	<b>[0] — [31]</b>
	This determines the device ID number for the Exclusive data transfer or Sample dump. When several S-760s coexist in the same system, the Exclusive data and wave data can be transmitted and received among the devices whose device IDs numbers match. Set the device ID number of the S-760 different than the MIDI channel.	
	<b>* This device ID number is also indicated in the MIDI Sample Dump page, and it can be used also for transmitting and receiving wave data. ( Advanced Operation p.3-99)</b>	
<b>Exclusive RX</b>	<b>(System Exclusive Receiving Switch)</b> <span style="border: 1px solid black; padding: 0 2px;">System 2</span>	<b>[Off], [On]</b>
	This determines the condition of Exclusive data reception and wave data reception by Sample dump. Exclusive data or wave data is received in the Performance Mode (except from the Quick Load page) when this is set to On.	

**Interval**

**(Capacity Partition of the Volume Dump) [16] — [128], [All]**

The maximum data of one Volume (from Performances to Partials) is about 250 kilobytes. Some sequencers which record Exclusive data cannot record 250 kilobytes of data at once. For such sequencers, it is necessary to divide the Exclusive data of the Volume into amounts that it can handle simultaneously. This parameter determines how much (in kilobytes) of the Exclusive Volume data is to be sent in a single transmission. When this is set to "All," all Exclusive data in the Volume is transmitted at once.

- \* For MIDI sequencers that are capable of recording all Volume data at once, set the Interval to "All."
- \* When executing the Volume Dump by dividing up the data of the Volume, the message "Continue Volume Dump function?" appears each time the set amount of data has been transmitted. You can select here whether to continue the Volume Dump or not.  
Press F1 (Yes) to transmit all the data.  
Press F3 (Cancel) to abort the Volume dump operation in the middle.

**Caution!**

Make sure to make a note of the order of disks or files made when dividing the data and recording it to a MIDI Sequencer. If you are using disks, write the order down on the disk label and name the files properly. When you reload the data from the MIDI Sequencer to the S-760, the sound will not be output properly unless the data is loaded in the correct order (the same order as when it was recorded).

**F2 SysDump**

**(System Dump)**

The System data of the groups, the Quick Load, the Volume ID, the Mark Set and the Template in internal memory are transmitted as MIDI Exclusive data.

The setting of the Interval doesn't matter here since System data is transmitted in a single operation.

**F3 VolDump (Volume Dump)**  
 The Volume data is transmitted as MIDI Exclusive data. The data divided up and transmitted in separate "packets" according to the Interval setting.

**Using MIDI Sequencers with System Dump or Volume Dump**

Only MIDI Sequencer capable of recording MIDI Exclusive data can be used with System Dump or Volume Dump.

When using the Volume Dump function, set the amount of data to be transmitted at once with the Interval parameter above, considering the capacity of the MIDI Sequencer (how much data it can record at once) and the capacity of the Volume to be recorded.

- \* Refer the owner's manual of your MIDI Sequencer for more information on the points above.
- \* For the MIDI Sequencer , we recommend that you use the Roland MC-50 or MC-50MKII. When the capacity of Volume exceeds 128k byte, set the Interval to 128 and record it into MC-50 or MC-50MKII Sequencer.

## MIDI Sample Dump

The wave data is transmitted by Sample Dump of the MIDI Universal Exclusive Messages in this page. The wave data, which includes the loop point and the loop mode, is transmitted to the Sampler which corresponds to the MIDI Sample Dump Standard (wave data from other samplers can also be received). This also sets the receiving of the wave data by the Sample Dump.

- \* The sound quality may be affected when transferring the wave data between the S-760 and another manufacturer's sampler when using the Sample Dump Standard.

### Indications

[ ]

**(Sample Select)**

This selects the sample (wave data) to be transmitted.

### Device ID

**(Device ID Number)** System 2 [0] — [31]

This determines the device ID number of the Exclusive or Sample Dump.

When several S-760s coexist in the same system, the Exclusive data and wave data can be transmitted and received among the devices whose device IDs numbers match. Set the device ID number of the S-760 different than the MIDI channel.

- \* This device ID number is also indicated in the MIDI Volume Dump page, and it can be used also for transmitting and receiving Exclusive data. ( Advanced Operation p.3-97)

### Exclusive RX

**(System Exclusive Receiving Switch)** System 2 [Off], [On]

This determines the condition of Exclusive data reception and wave data reception by Sample dump.

Exclusive data or wave data is received in the Performance Mode (except from the Quick Load page) when this is set to On.

**F3 SmpDump**

**(Sample Dump)**

This starts the transmission of the Sample (wave data).

- \* **The Sample Dump Standard transfers only the data which affects or determines how the wave data is read, such as the actual wave data itself and the start/loop/end points. Since other parts of the data such as the sample name, the way the samples are combined (their soundable range and how they are to be sounded), and the envelope settings for the filter and amplifier, etc. are not transmitted, you must make these settings individually on the received sampler after using Sample Dump to transmit the data.**

The S-760 tries first to transmit the wave data by the handshaking method. When the receiving sampler does not support the handshaking method, the S-760 automatically transmits the data using the one-way method. However, even when using the one-way method, it is necessary to connect the MIDI OUT of the receiving unit with the MIDI IN of the transmitting unit in order for the receiving unit to send out a "data request" message. Therefore, connect two MIDI cables, as is done for the handshaking method .

- \* **Receiving is executed in the same way as transmitting.**

## MIDI EQ Control

Each parameter setting of the equalizer of the Performance can be controlled by the control change data (#1—95), which is received over the control channel.

The correspondence between each parameter of the equalizer and the control change data is set in this page.

- \* **The original function of the control number which is selected by the cursor is indicated at the top right of the display.**

## Indications

**H.F**

**(High Frequency)** System 2

**[Off], [1] — [95]**

This determines which control number of the control change data is to control the High Frequency parameter of the equalizer.

It can be controlled by "7" (main volume), and the master level ( Advanced Operation p.3-91) can also be controlled at the same time.

Set this to Off when not controlling the High Frequency.

**H.G**                    **(High Gain)** **System 2**                    **[Off], [1] — [95]**  
 This determines which control number of the control change data is to control the High Gain parameter of the equalizer.  
 It can be controlled by "7" (main volume), and the master level ( Advanced Operation p.3-91) can also be controlled at the same time.  
 Set this to Off when not controlling the High Gain.

**L.F**                    **(Low Frequency)** **System 2**                    **[Off], [1] — [95]**  
 This determines which control number of the control change data is to control the Low Frequency parameter of the equalizer.  
 It can be controlled by "7" (main volume), and the master level ( Advanced Operation p.3-91) can also be controlled at the same time.  
 Set this to Off when not controlling the Low Frequency.

**L.G**                    **(Low Gain)** **System 2**                    **[Off], [1] — [95]**  
 This determines which control number of the control change data is to control the Low Gain parameter of the equalizer.  
 It can be controlled by "7" (main volume), and the master level ( Advanced Operation p.3-91) can also be controlled at the same time.  
 Set this to Off when not controlling the Low Gain.

**\* The control channel is set in the MIDI Control page ( Advanced Operation p.3-97).**

**\* Control Change messages received on the Control Channel are irrelevant to settings of the MIDI Filter in a Performance.**

**The correspondence between the control number and the parameter (factory settings)**

	<b>L.G</b>	<b>L.F</b>	<b>H.G</b>	<b>H.F</b>
EQ-1	16	70	24	78
EQ-2	17	71	25	79
EQ-3	18	72	26	80
EQ-4	19	73	27	81
EQ-5	20	74	28	82
EQ-6	21	75	9	83
EQ-7	22	76	30	84
EQ-8	23	77	31	85

The control data affect the following parameter values.

Data	L.G/H.G	H.F	L.F
0 — 5	-12dB	750	16
6 — 10	-11dB	1.0k	20
11 — 15	-10dB	1.3k	24
16 — 20	-9dB	1.5k	28
21 — 25	-8dB	1.8k	32
26 — 30	-7dB	2.0k	36
31 — 35	-6dB	2.3k	40
36 — 40	-5dB	2.5k	48
41 — 46	-4dB	3.0k	56
47 — 51	-3dB	3.5k	64
52 — 56	-2dB	4.0k	72
57 — 61	-1dB	5.0k	80
62 — 66	0dB	6.0k	120
67 — 71	1dB	7.0k	160
72 — 76	2dB	8.0k	200
77 — 81	3dB	9.0k	240
82 — 87	4dB	10k	280
88 — 92	5dB	11k	320
93 — 97	6dB	12k	360
98 — 102	7dB	13k	400
103 — 107	8dB	14k	440
108 — 112	9dB	15k	480
113 — 117	10dB	16k	520
118 — 122	11dB	17k	560
123 — 127	12dB	18k	600

## System Volume ID

With the enormous amounts of data that can be saved to a hard disk or optical disk, it becomes difficult to find the sound data you want. Because of this, the S-760 lets you classify the sound data for each Volume using the first three characters of the name. The first three letters are called the Volume ID.

In the System Volume ID page, the Volume ID is added at the beginning of the name (the ID Area) of the sound data (Volume, Performance, Patch, Partial and sample) in the internal memory.

**\* See Basic Operation p.8-4 for more information on the Volume ID and managing the sound data.**

### Indications

#### Volume Name

(Volume Name)

The Volume name of the internal memory is indicated.

#### Volume ID

(Volume ID)

This determines the Volume ID that is to be assigned to the sound data.

#### Determining the Sound Data

After selecting the Volume ID to be assigned with the Volume ID parameter, determine the sound data to which the Volume ID will be assigned by marking the sound data.

Move the cursor to the sound data to which the Volume ID will be assigned, then press S1/DEC(Mark) to mark it.

Press F1 in order to mark all the sound data when adding Volume IDs to all sound data.

Press F1 again to release all marks.

Volume  
Performance  
Patch  
Partial  
Sample

**\* If the Volume ID of the sample has been changed (remember that the Volume ID is a part of the name), the wave data of the changed sample cannot be loaded, even by executing the Volume Dump function. See Advanced Operation p.6-8 for details.**

**\* When none of the sound data is marked, the Volume ID is added to the sound data at the cursor position.**

#### F1 All On/ff

(Mark All On/Off)

All the marks of the sound data from Volume to sample are added or released.

#### F3 Exec

(Execute)

The specified Volume ID is added to the marked sound data.

---

## Load/Save System Parameters

This function loads/saves the System parameters between the S-760 System Backup memory and Internal memory.

**\* For details on System parameters, refer to Basic Operation p.8-7.**

The following parameters are loaded/saved.

- System Parameter display parameters
- System SCSI display parameters
- System MIDI display parameters

### F1 LoadPRM

#### **(Load System Parameters)**

This switch loads the System parameters from the System Backup memory into Internal memory. If you have modified the System parameter settings and not yet saved them to System Backup memory, loading allows you to restore the previous settings.

### F3 SavePRM

#### **(Save System Parameters)**

If the settings in System Backup memory are different than the current System parameter settings, the display will read "SysPRM are Edited". As necessary, save the System parameters to System backup memory.

**\* If you turn the power off without saving, the settings will all be lost.**



# Chapter 4

## Explanation of parameters requiring caution

---

Sounds consist of a hierarchical structure of data, from Performance to Sample. In each level, there are some parameters which have similar effects. These parameters affect each other to determine the final result.

In this chapter we will explain the process by which various parameters determine the output jack from which sound is finally output, the final pan position that results, the final resulting level, and the final resulting pitch.

# Output assignments

## Basic concepts of sound output

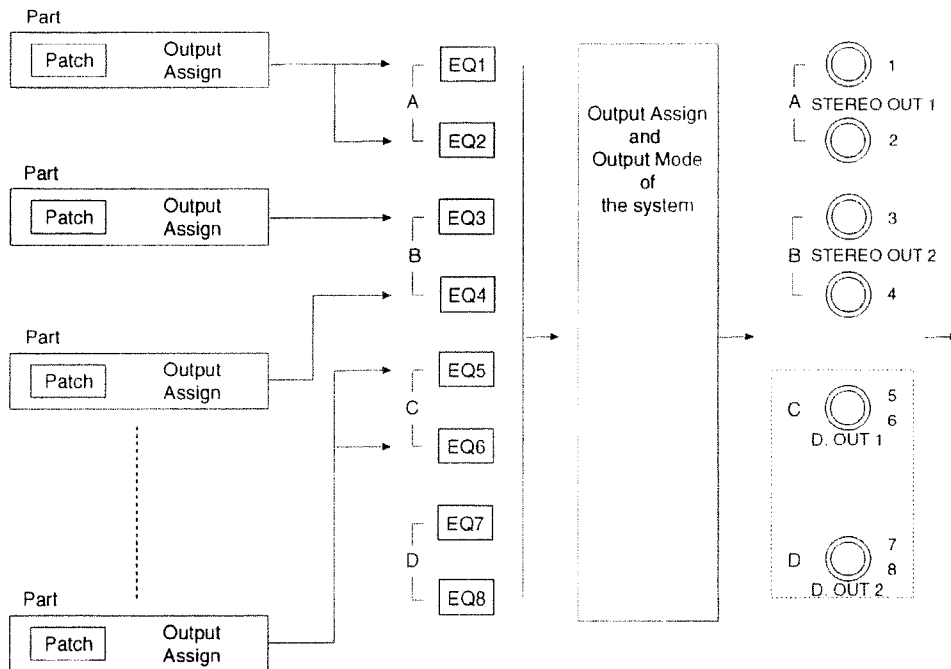

The Output Assign settings of each Part select the equalizer (A — D/1 — 8) to which the sound of each Patch is sent.

After passing through the equalizer, the System Output Mode and Output Assign parameters select the output jack to which the sound is sent.

## System Output Mode

The System Output Mode settings allow you to use the output jacks as follows.

- \* If the separately sold Power Sampling Expansion (OP-760-1) is not installed, there are four output jacks (stereo A and B: STEREO OUT 1 and 2), so the references in the following explanation to sound being output from stereo C and D (individual 5—8) are not applicable. (However if the Output Mode is "Mix", it will be output from Stereo A.) If the sound is not output, you can set the System Output Assign to Stereo A and B.
- \* For installation of the Power Sampling Expansion (OP-760-1), please consult a Roland Service Station or your dealer.

**4 Stereo**

Each Patch/Partial will be output in stereo.

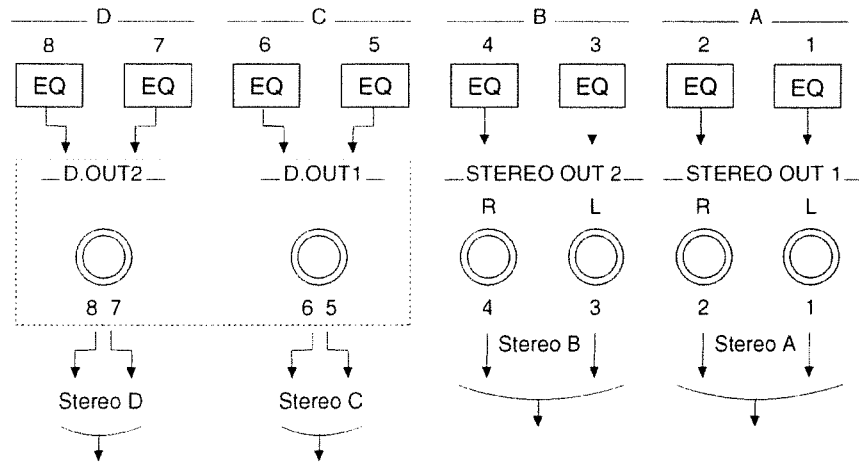

Each is output in stereo.

**Mix**

Other outputs are mixed with Stereo A and output as a single stereo pair. The various equalizers will be mixed. The single stereo pair will be output from both Stereo A (STEREO OUT 1) and Stereo C (D.OUT 1).

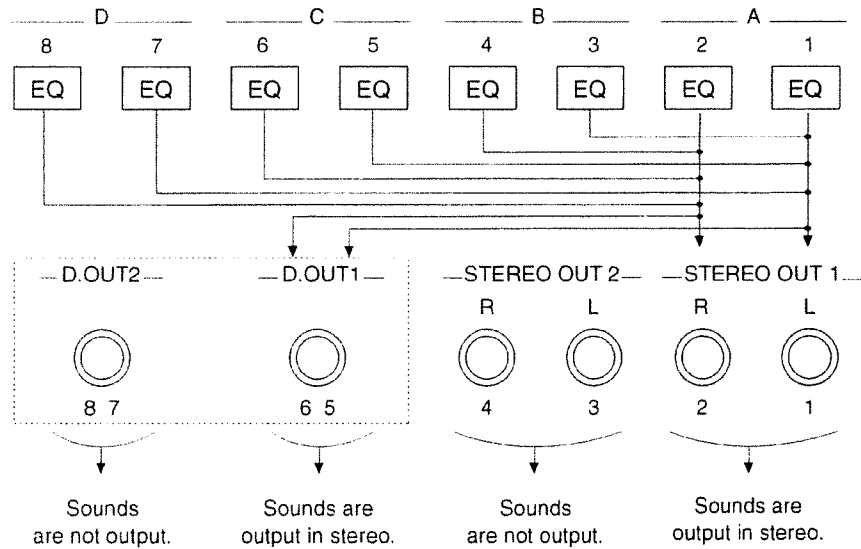

**1 Stereo + 6 Out**

Each Patch/Partial will be output to stereo or individual.

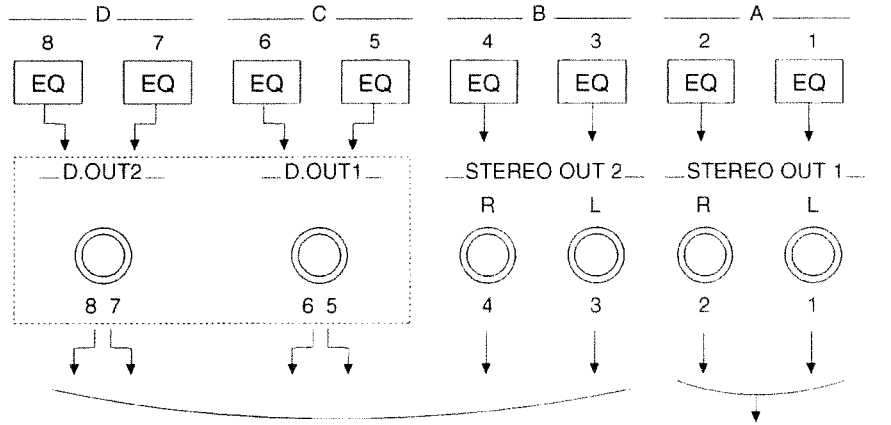

Each Patch/Partial is output independently.

Sounds are output in stereo.

**8 Out**

Each Patch/Partial will be output independently.

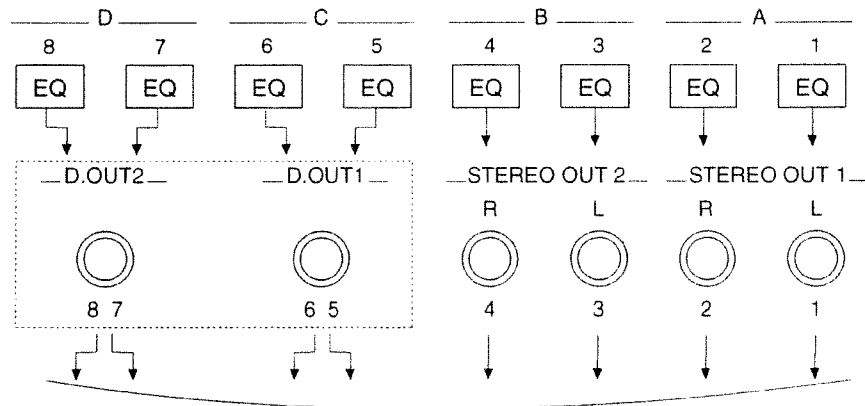

Each Patch/Partial is output independently.

In this way, the output jacks can be used in two ways: as Stereo outputs or Individual outputs. When used as stereo outputs, you can specify a Pan setting (Advanced Operation p.4-8).

If a jack is not connected, the sound that was to have been output from that jack will not be output from any jack. However in the following cases, it will be output from other jacks.

1. When the System Output Mode is set either to 4 Stereo, Mix, or 1 Stereo + 6 Out, if the R jack of STEREO OUT 1 is not connected the sound will be mixed into the L jack and output as a mono signal.
2. When the System Output Mode is set to 8 out, if the Individual Output 2 jack is not connected the sound will be mixed with Individual Output 1.

### System Output Assign

If the Power Sampling Expansion (OP-760-1) is not installed, sound specified for output from stereo C and D will not be output. You can set the System Output Assign to output the sound from Stereo A and B.

The output assign settings work in the following way.

#### When set to C/D

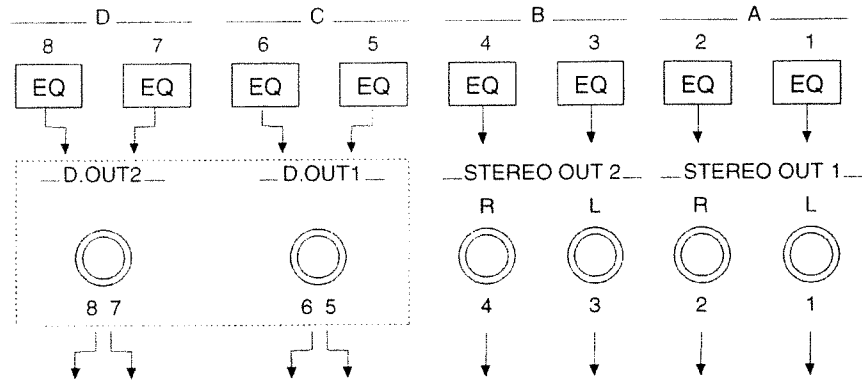

#### When set to A/B

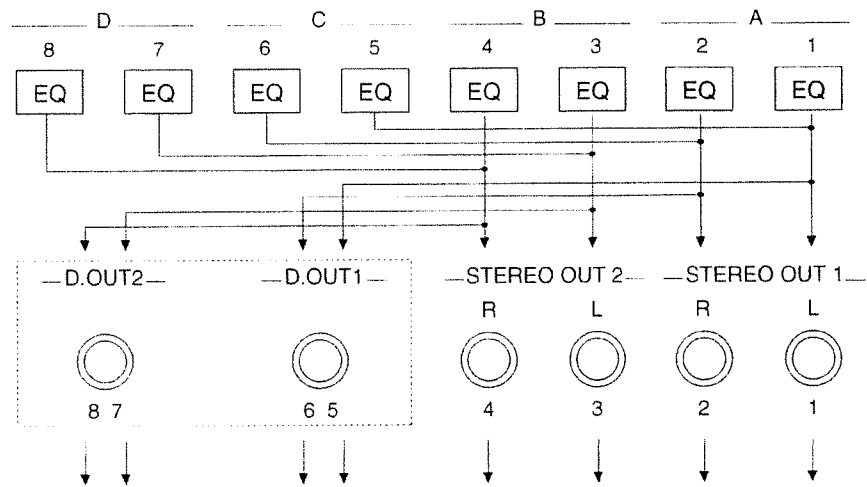

In this case, the sound specified for output from stereo C and D will be mixed into Stereo 1 and 2. Also, if the Power Sampling Expansion is installed, the mixed Stereo A and B output can also be output from stereo C and D.

---

## Three output assigns

The output assign settings of each Part determine which equalizer the sound of each Patch will be sent to. Actually, there are Output Assign settings not only for the Part, but also for the Patch and Partial. This means that some of these settings will be either valid or ignored.

In general, the output assign settings of the Part will take priority. However by giving priority to the output assign setting of lower level data, the sound can be output with the output assign settings of the Patch or the Partial.

### Part output assign settings

- ( ) : Use this setting when you want the sound to be output according to the output assign settings of the Patch or Partial. The output assign settings of the Patch will be displayed in the parentheses ( ).
- A—D : The Patch will be output in stereo from A—D. The output assign settings of the Patch and Partial will be ignored.
  - \* **If the output assign of the Patch is set to 1—8, the Patch will be output in stereo, but the L and R signals will be mixed.**
  - \* **If the output assign of the Patch is set to -P- while the output assign of the Partial is set to 1—8, the Patch will be output in stereo but the L and R signals will be mixed.**
- 1—8 : The Patch will be output individually from 1—8. The output assign settings of the Patch and Partial will be ignored.

### Patch output assign settings

Each of the following settings will be valid when the output assign of the Part is set to ( ).

- \* **The range of output assign settings for the Patch will depend on the System Output Mode. In this section, we will assume that the Output Mode has been set to 4 Stereo.**
- P- : Each Partial will be output according to the output assign setting of each Partial used by the Patch. For Patches such as drum sets in which each key has a different sound (Partial), this is the best setting to use.
- A—D : The Patch will be output in stereo from A—D.
- 1—8 : The Patch will be output individually from 1—8.

---

## Partial output assign settings

Each of the following settings will be valid when the output assign of the Part is set to ( ) and the output assign of the Patch is set to -P-. The output setting you make here will be used.

**\* The range of output assign settings for the Partial will depend on the System Output Mode. In this section, we will assume that the Output Mode has been set to 4 Stereo.**

A—D : Each Partial will be output in stereo from A—D according to the output assign settings of each Partial used in the Patch.

1—8 : Each partial will be output individually from 1—8 according to the output assign settings of each Partial used in the Patch.

# Pan

When outputting in stereo, the Pan settings will determine the stereo position of the sound. You can also assign the output destination for each Patch or Partial.

Pan position is determined by the following parameters.

- Partial SMT Sample Pan
- Partial Panning
- Patch Panning
- Part Pan

The output assign determines whether or not the sound will be stereo. The various output assign settings determine whether or not the pan settings will be valid, as shown in the following table.

Part	Patch	Partial	resulting Pan
A—D	A—D	A—D, 1—8	all Pan settings valid
A—D	1-8	A—D, 1—8	only Part Pan settings valid
A—D	-P-	A—D	all Pan settings valid
A—D	-P-	1—8	only Part Pan settings valid
1—8	A—D, 1—8, -P-	A—D, 1—8	all Pan settings ignored
( )	A—D	A-D, 1—8	all Pan settings valid
( )	1—8	A-D, 1—8	all Pan settings ignored
( )	-P-	A-D	all Pan settings valid
( )	-P-	1—8	all Pan settings ignored

- \* If all the Pan settings of each level are valid, the Pan values will be added. The sum of the Pan values cannot exceed L32/R32.
- \* If you wish to make only the Pan settings of the Part valid, you can set the output assign of the Patch to 1—8.



# Level/Pitch

## Level

Volume level is determined by the following parameters in each level.

- Partial SMT Level
- Partial Level
- Patch Level
- Part Level
- System Master Level
- Volume knob

\* The Volume knob controls only the volume of STEREO OUT 1 (Individual 1 and 2). If you wish to adjust the level of all output jacks, adjust the System Master Level.

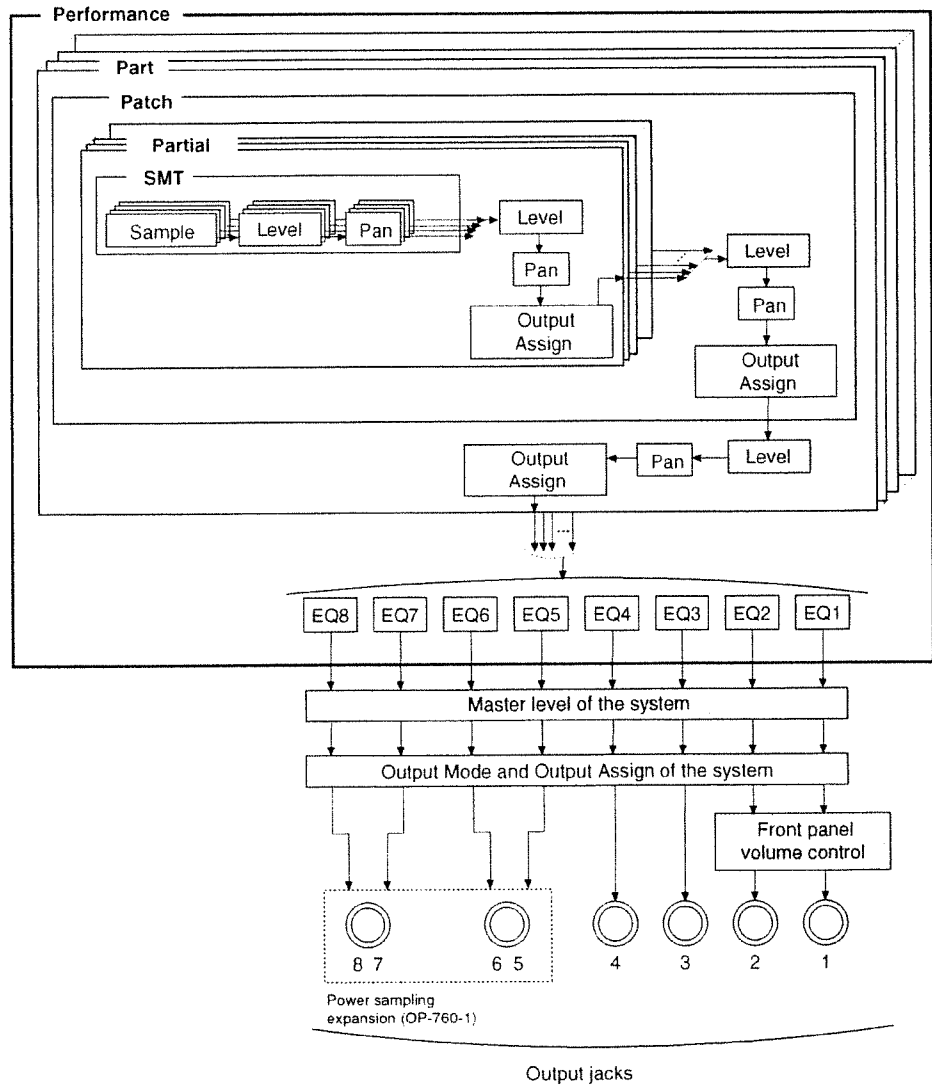

---

## Pitch

The pitch that actually results when you play a note is determined by the following parameters in each level.

- Sample Original Key
- Partial SMT Pitch Key Follow
- Partial SMT Coarse Tune
- Partial SMT Fine Tune
- Partial Coarse Tune
- Partial Fine Tune
- Partial Envelope Pitch Depth
- Patch Octave Shift
- Patch Coarse Tune
- Patch Fine Tune
- Patch Analog Feel
- System Master Tune

The range of pitch is limited to two octaves above the Original Key of the sample. If the sum of pitch-related parameters other than Patch Octave Shift exceeds this upper limit, the pitch will always be sounded two octaves above the original key.'

**\* Pitch can change depending on the Master Frequency settings. For details refer to Advanced Operation p.2-5.**

# Chapter 5

## Explanation of Command /List displays

---

Each mode allows you to use various commands. This chapter will explain the commands that are common to each mode, and the commands unique to each mode. The S-760 often allows you to select sounds or disk drives etc. from a list. This chapter will also explain these various List displays.

In the explanatory text,

**Volume** indicates a Volume parameter,

**Perform** indicates a Performance parameter,

**Patch** indicates a Patch parameter,

**Partial** indicates a Partial parameter,

**Sample** indicates a Sample parameter,

**System1** indicates a System parameter saved on the system disk,

and **System2** indicates a System parameter saved in the system backup memory inside the S-760.

**Disk** indicates a Disk parameter.

# Copy/Delete/Initialize/Disk

These commands are found in each mode, and except for Disk, the procedure is the same. Before executing one of these commands, please read the corresponding notes of caution.

## Copy/Delete/Initialize

### About the screen in each command display

**TG (Target)**

Select the type of sound data you wish to deal with.

**[ ] (Number)**

This displays the number of the sound data at the cursor location.

**Sound list**

Select the desired sound data.

**Sound data size**

This indicates the sound data size in seconds (at 44.1 kHz).

**Program number**

If the Target is a Performance Parameter or a Patch Parameter, this indicates the program number.

**Int (internal memory free area)**

This indicates the size of the internal memory free area in seconds (at 44.1 kHz).

**F1 AllOn/Off (Mark All On/Off switch)**

This allows you to mark or unmark all sounds.

**F2 VolInfo (Volume Information)**

This indicates the Volume Name, the number of Performances/Patches/Partials/Samples in internal memory, and the amount of wave memory.

**F3 Copy/Delete/Initial**

This button executes the indicated command.

## Procedure

1. In TG (Target), specify the desired type of sound data.
2. In the sound data list, mark the desired sound data.
3. Press F3 to execute the command.

- \* You can use your MIDI keyboard to check the sound at the cursor location.
- \* If not even one sound is marked, the command will apply to the sound at the cursor location.
- \* You can use F1 (Mark All On/Off switch) to mark or unmark all sounds.
- \* Commands cannot be executed on unnamed sounds.
- \* Commands must be executed on groups of sound data of the same type.

## Cautions for Copy

This operation copies sounds in internal memory, but lower-level sound data is not copied. Except for samples, only parameters are copied.

Sounds will be copied to vacant numbers in the sound list. If you copy repeatedly, the last two characters in the sound name will be set to AA, AB, AC, etc.

The number of sounds that internal memory can hold is limited (64 Performances, 128 Patches, 255 Partials, 512 Samples). It is not possible to copy if this number would be exceeded. Before you execute the Copy operation, press F2 VolInfo to check the number of sounds in internal memory.

When you copy Performance parameters or Patch parameters, the program number of the copied Performance or Patch will be the same as the original. Reset the program number in the Performance or Patch Select display.

## Cautions for Delete

This operation deletes sounds in internal memory, and also deletes lower-level sound data. Regardless of the Fast Delete Mode settings (Advanced Operation p.3-95), this operation always checks the dependency of sound data (unlike the Disk Delete function), so that sound data used by other sounds will not be deleted.

When you delete a Volume, all sounds in internal memory (including sound data not used by any sound) will be deleted.

When you press F3 Delete to execute the delete operation, a message will ask for confirmation (Are you sure?). To execute the delete operation, press F1 Yes. To cancel without deleting, press F3 No.

When you delete a Performance or Patch, the program number of the deleted Performance or Patch will be the same as the list number. Reset the program number in the Performance or Patch Select display.

### **Cautions for Initialize**

This operation initializes sound data in internal memory, but lower-level sound data is not initialized.

For the initialized parameter values, refer to Advanced Operation p.7-16. In particular, be aware that the parameters Patch Select, Partial Select, and Sample Select are turned off, so there will be no sound. The name of an initialized sound will consist of spaces. For sound data of the next higher level that uses that sound, the Select parameter will also be set to a name consisting of spaces.

When you initialize a Performance or Patch, the program number of the initialized Performance or Patch will be the same as the list number. Reset the program number in the Performance or Patch Select display.

### **Disk**

This accesses the various displays of Disk Mode. For details, please refer to Advanced Operation p.3-70.

# Performance commands

---

## Edit Patch

This access the various displays of Patch Mode. For details, please refer to Advanced Operation p.1-5, p.3-13.

## Listen Delete

Using the Listen Delete function, all Partials for keys that were not played even once can be turned off for each Split in a Patch. By using this function before saving, you can avoid saving unnecessary sound data (Partials that were not played even once, and the Samples used by those Partials), thus conserving hard disk space.

### Performance

Select the Performance to which Listen Delete will be applied.

### Prt( ) (Part number)

### [ ] (Patch name)

When the cursor is at Ignore-Part, that Part number and Patch name will be displayed.

### Ignore-Part (Parts to which Listen Delete will not apply)

Mark the Parts to which you do not wish to apply Listen Delete.

### Ignore-MIDI (MIDI channels which will not be used by Listen Delete)

Mark the MIDI channels which you do not wish to be used by Listen Delete.

### F3 Start (Start)

Start the Listen Delete operation. For details, refer to Advanced Operation p.6-5.

### Caution!

While Listen Delete is being executed, you can play a MIDI controller as usual, but you will not be able to load Volumes using Program Change messages. However you will be able to select Patches/Performances by Program Change messages. Even if different Patch/Performances are selected, the Listen Delete operation will continue. In this case, Listen Delete will apply to both the previous and the newly-selected Patches.

---

## Performance Utility

This contains two commands: Channel Converter and Copy MIDI Filter/Equalizer.

### Channel Converter

This command changes the MIDI channel of a Part to the specified MIDI channel.

#### Performance

Select the Performance whose MIDI channel you wish to modify.

#### Prt ( ) (Part number)

#### [ ] (Patch name)

When the cursor is at the MIDI channel of the Part, its part number and Patch name will be displayed.

#### Part MIDI channel [1]-[16],[Off]

This displays the MIDI channel of the Part. This can also be edited.

#### Control Ch (MIDI Control channel) [1] — [16],[Off]

MIDI Control Channel can be edited.

#### Converter [ ] — [ ] (converter) [off], [1] — [16]

Specify the MIDI channel to be converted and the resulting MIDI channel.

When you specify the MIDI channel to be converted, a round mark will appear at the corresponding MIDI channel of the Part.

#### F1 Prt01-/17- (Part Change) [Prt01-],[Prt17-]

Select the Parts to be displayed.

#### F3 Exec (Execute)

Change the MIDI channel.

### Copy MIDI Filter/Equalizer

This command copies a Performance's MIDI Filter and Equalizer settings to another Performance.

#### Performance

Select the copy source Performance.

#### Mark Parameter (Mark Parameter)

Mark the parameters you wish to copy.

#### Copy to (copy destination Performance) [1]-[64],[All]

Select the copy destination Performance.

#### F1 (Mark All On/Off switch)

This switch will mark/unmark all parameters.

#### F3 Copy (Copy)

Copy the marked parameters.



# Patch commands

## Edit Partial

This command accesses the various displays of Partial mode. For details, refer to Advanced Operation p.1-7, p.3-22.

## Rename Partial

This command renames all Partials used by a Patch selected in the Patch Mode display to the same name as the Patch.

**\* The Rename Partial display cannot be accessed for unnamed Patches.**

**[ ] (Patch name)**

This displays the Patch name.

**F1 Yes (yes)**

Execute the Rename Partial operation.

**F3 No (no)**

Cancel the Rename Partial operation.

# Partial commands

---

## Edit Sample

This command accesses the various displays of Sample mode. For details, refer to Advanced Operation p.1-10, p.3-42.

## Template

This command rewrites the TVF/TVA parameters of the Partial selected in the Partial Mode display to a set of previously specified parameter values. By rewriting the TVF/TVA parameters to settings close to the values you want, you can edit Partials more efficiently.

There are two types of template; preset and user set, and there are 10 of each type. Press F1 to switch the display.

Preset templates are set at the factory, and cannot be rewritten by the user.  
User Set templates can contain your own TVF/TVA parameter settings as a template.

**\* For the contents of each preset (the TVF/TVA parameter values), refer to Advanced Operation p.7-21.**

To execute the Template operation, move the cursor to Preset or User Set, and press S1/DEC(Select).

## Registering a User Set

1. In the Partial TVF/TVA display, select a Partial.
2. Have TVF/TVA parameter settings already made.
3. Open the Template display.
4. Press F1 to select the User Set display.
5. Move the cursor to the left arrow of [Set], and press S1/DEC(Set).
6. The data will be registered as a User Set. The User Set will be given the name of that Partial.
7. Up to 10 User Sets can be registered, so repeat steps 1 to 6 if desired.

**\* User Set data is a System parameter. If you turn the power off without saving, the data will be lost (Basic Operation p.8-7).**

# Sample commands

---

## Set Stereo/Mono

This command creates one stereo sample from two mono samples, or two mono samples from one stereo sample.

Stereo samples received via MIDI sample dump are handled as two mono samples, and can not be searched for as stereo samples in the Partial SMT display. You must execute the Set Stereo command to make them a stereo sample.

Source1 (Source Sample 1)  
Source2 (Source Sample 2)

Select the samples to which the command will apply. You can use your MIDI keyboard to check the sound at the cursor location.

**\* When executing Set Mono, select a stereo sample for Source Sample 1.**

### F1 Mono (Set Mono)

Execute the Set Mono command. The stereo sample will be converted to a mono sample, and the -L/-R at the end of the sample name will be erased.

### F3 Stereo (Set Stereo)

Execute the Set Stereo command. The two mono samples will be converted to stereo samples, and -L/-R will be added to the end of the sample names.

**\* If the Source Samples 1 and 2 have a different wave data size (in seconds), the Set Stereo command cannot be executed.**

**\* It is not possible to create a stereo sample using two of the same sample.**

When you execute the command, a display will ask for confirmation.

F1 Yes : Execute the command.  
F3 No : Cancel the command.

# Sound list displays

Move the cursor to the sound name, press S1/DEC(List), and a sound name list display will appear. There are sound name list displays for each type of data, from Performance to Sample, and each of these list displays can be used to select sounds. In addition to selecting sounds, these list displays allow you to change the order of the listed sounds, change the name of sounds, and specify program numbers. The procedure is the same for each list display.

## About the sound list display screen

### <Target> (Target)

This indicates the selected type of sound data.

### [ ] (Number)

This indicates the number of the sound at the cursor location.

### Name (Sound name) / / /

A list of the sounds is displayed here. Select the desired sound.

- \* **When you move the cursor to a sound name, that sound will be temporarily selected, and you can check the sound by playing your MIDI keyboard or by using the Preview function.**
- \* **If you press S2/INC(Name), the ASCII display will appear, allowing you to assign a name.**

### Time (size of the sound data)

This displays the size of the sound data in seconds (at 44.1 kHz)

- \* **If sound data sizes are displayed, you will have to wait longer for the sound list display to appear. If you do not require the data size to be displayed, turn off the System parameter Time Display (Advanced Operation p.3-92).**

### PG# (Program number)

If the Target is Performance or Patch, this displays/sets the program number.

### Key (Original key)

In a Sample list display, this displays/sets the original key.

### F1 Renum (Renum)

If the Target is Performance or Patch, this rewrites the program numbers of the sound data to the numbers of the sound data as shown in the list display.

### F2 SortABC (Alphabetical sort)

This alphabetically sorts the sounds shown in the list display.

**F3 Blank/Set Off/--- (Blank/set Off/---)**

The function of F3 will differ even in identical displays, depending on how the display was accessed.

When you wish to create a new sound, you can press F3 Blank to select a sound that contains no data. You will return to the previous display.

When you do not wish to assign a Patch to a Part, a Partial to a Patch Split, or a Sample to a Partial SMT, press F3 Set Off. You will return to the previous display.

If the sample list display has been accessed from the Sample Dump display, F3 will be displayed as "---", and will have no function.

**F4 SortPG# (Program number sort)**

When the Target is Performance or Patch, this function sorts the order of the sounds displayed in the list display according to their program numbers.

## Selecting a sound

Move the cursor to the sound name, and press S1/DEC(Sel).

To select a sound which contains no data, press F3 Blank.

If you do not wish to assign a Patch to a Part, or to assign a Partial to a Patch Split, press F3 Set Off.

In either case, you will return to the previous display.

## Changing the order of the sounds

Press F2 SortABC. The sounds will be sorted in alphabetical order.

If the Target is Performance or Patch, you can press F4 SortPG# to sort the sounds in the order of their program numbers.

## Naming a sound

Move the cursor to the sound name, and press S2/DEC(Name). The ASCII display will appear, and you can assign a name.

**\* It is possible to rename a Sample, but in this case you will no longer be able to use the Volume Dump function (Advanced Operation p.6-8).**

## Specifying program numbers

If the Target is Performance or Patch, you can move the cursor to the program number and specify the program number.

You can also press F1 Renum to rewrite the program numbers of each sound to the number at which it appears in the list display.

**\* Do not specify the same program number for more than one sound (Basic Operation p.9-2).**

---

## Cautions for the Patch list display

The <Target> display and the function of F3 will be different depending on whether you have opened the list display from the Performance Play display in order to select a Patch to assign to a Part, or whether you have opened the list display from the Patch Mode display in order to select a Patch to edit.

When selecting a Patch to assign to a Part : <Target> = Part#1-Part#32, F3 = Set Off  
When selecting a Patch to edit : <Target> = Patch, F3 = Blank

Also, if you have entered Patch Edit via a command, you will be able to select only Patches which are assigned to a Part. Patches which cannot be selected will be displayed in parentheses ( ).

## Cautions for the Partial list display

The function of F3 will be different depending on whether you have opened the list display from the Patch Split display in order to select a Partial to assign to a Patch, or whether you have opened the list display from the Partial Mode display in order to select a Partial to edit.

When selecting a Partial to assign to a Patch : F3 = Set Off  
When selecting a Partial to edit : F3 = Blank

Also, if you have entered Partial Edit via a command, you will be able to select only Partials which are assigned to a Patch. Partials which cannot be selected will be displayed in parentheses ( ).

## Cautions for the Sample list display

The <Target> display and the function of F3 will be different depending on whether you have opened the list display from the Partial SMT display in order to select a Sample to assign to a Component, or whether you have opened the list display from the Sample Mode display in order to select a Sample to edit.

When selecting a Sample to assign to a Component : <Target> = No.1-No.4, F3 = Set Off  
When selecting a Sample to edit : <Target> = Sample, F3 = Blank

**\* If you have opened the Sample list display from the Sample Dump display, F3 will be displayed as "---" and will have no function.**

# Disk Mode list displays

## Select Target display

In the Disk Mode or Command display, move the cursor to TG (Target), and press S1/DEC(List) to open the Select Target display.

Here you can select the type of sound data on which a command will be executed.

## Volume ID display

In the Quick Load, Disk Mode, or System Volume ID displays, move the cursor to ID (Volume ID), and press S1/DEC(List) to open the Volume ID display.

A list of Volume IDs will appear, and you can scroll using the cursor buttons (up/down). Specifying the volume ID lets you search more efficiently for sound data. You can also register a new Volume ID in the list, or delete a Volume ID from the list.

## Specifying a Volume ID

Move the cursor to the desired Volume ID, and press S1/DEC(Sel). The Volume ID will be selected, and you will return to the previous display.

If you want all sounds to be displayed regardless of their Volume ID (in displays such as Disk Load, etc.), press F2 All.

In the Disk Save display, the Volume ID of the sound being saved will be rewritten to the Volume ID specified here. If you wish to save the sound with its current Volume ID, press F2 Thru.

In this way, the function of F2 depends on how the display was accessed.

**\* If you access this display from the System Volume ID display, F2 will appear as "---", and will have no function.**

## Making a Volume ID list

1. When you load a sound, its Volume ID will automatically be added to the list if the list does not already contain it.
2. If you wish to register a new Volume ID, press F3 Make. The ASCII display will appear, allowing you to specify a Volume ID. Press F3 CR to finalize (Basic Operation p.3-14).
3. After specifying the Volume IDs, press F1 SortABC (Alphabetical sort). The Volume IDs in the list will be sorted alphabetically.

**\* Up to 200 Volume IDs can be registered.**

**\* The Volume ID list is a System parameter. If you turn the power off without Save System, the data will be lost (Basic Operation p.8-7).**

## Select Drive display

In the Quick Load or Disk Mode displays, move the cursor to CD (Current Drive) and press S1/DEC(List) to open the Select Drive display.

This allows you to change the Current Drive or Source/Destination Drive, and to assign a name to a drive. Here you can also make the S-760 recognize SCSI devices which are connected to it.

\* A circular indicator is displayed at the left of the Current Drive.

## Selecting the Current Drive

A list of the drives connected to the S-760 will be displayed. Move the cursor to the desired drive and press S1/DEC(Sel). The Current Drive will change, and the previous display will reappear.

### Note!

Square brackets "[ ]" are displayed at the right of the drive name. This area is used only when a PIONEER six-disk CD-ROM drive (model number DRM-604X) is connected. The number displayed here indicates the disk (1-6) from which sounds will be loaded.

## Assigning a name to a drive

A list of the drives connected to the S-760 will be displayed. The drives will be displayed as follows.

### Unformatted:

A hard disk or magneto-optical disk that has not yet been formatted is connected. Please format this disk (Basic Operation p.4-3).

### Formatted:

A formatted hard disk or magneto-optical disk is connected.

### CD-ROM DRIVE:

A CD-ROM drive is connected.

### TapeStreamer:

A tape streamer is connected.

### S-760 Self:

This is the S-760 itself.

### No Drive:

A drive is not connected.

### [FloppyDisk]:

This is the S-760's internal floppy disk drive.



To assign a name, move the cursor to the desired drive, and press S2/INC(Name). The ASCII display will appear, and you can specify a name for the drive.

- \* It is not possible to assign a name to a CD-ROM drive, tape streamer, or floppy disk.
- \* The name you specify here is written directly to the disk, so there is no need to save it.

### Making the S-760 recognize a drive (Scan)

This command makes the S-760 recognize a connected drive. When you change disks or tapes, or if you turn on/off the power of a drive after the S-760 power is turned on, or if there is any other circumstance that prevents the S-760 from recognizing a drive, press F3 Scan to execute the Scan command.

### Select Area display

In the Convert Load (S) display, move the cursor to Ar (Area number), and press S1/DEC(List) to open the Select Area display.

This selects the S-550/W-30 sound data area.

Move the cursor to Area Number, and use S1/DEC and S2/INC or the Value knob to scroll the list. Move the cursor to the desired Area Number, and press S1/DEC(Sel) to select it. You will return to the Convert Load (S) display.

- \* A circular indicator will be displayed at the left of the currently selected Area name.

MEMO

# *Chapter 6*

**Procedures  
requiring explanation**

---

# How to use Quick Load

First you must register the names of sounds (Volumes, Performances, Patches) in the Quick Load list. Then you can Quick Load sounds from the list.

## Registering a sound in the list

1. Open the Quick Load display.  
Press MODE.  
Select F1:Performance.  
Press the Value knob.  
Select 5:Quick Load.
2. Press F1 to specify the type of sound you wish to register. Each time you press F1 the <Target> will change, and a list of each type of sound will be displayed.
  - \* **There are three lists; Volume, Performance and Patch.**
  - \* **With the factory settings, there are not sounds registered in Quick Load List.**
3. Move the cursor to the sound name in the list which you want to register. The list number will be displayed in square brackets [ ] in the upper left of the display.
4. Press S1/DEC(Select). The Quick Load Select display will appear.  
The sounds in the current drive will be displayed.
  - \* **In this display it is not possible to change the TG (Target). If you wish to change it, return to step 2.**
5. If you wish to change the Current Drive, move the cursor to CD and press S1/DEC(List). The Select Drive display will appear and you can change the Current Drive.
  - \* **Only sounds in a SCSI device can be registered in the list. It is not possible to register sounds from a floppy disk.**
6. If necessary, you can specify the Volume ID as you search for a sound. Move the cursor to ID and press S1/DEC(List). The Volume ID display will appear, and you can specify the Volume ID (Advanced Operation p.6-25).
7. Move the cursor to the sound you wish to register, and press F3 Select or S1/DEC(Select).  
The sound will be registered in the Quick Load list, and you will return to the Quick Load display.
  - \* **If you wish to quit without registering, press EXIT.**

8. Repeat these steps to create a list. Up to 32 sound names can be registered in each list.

\* The Quick Load List is a system parameter (Basic Operation p.8-7). If you turn the power off without saving, the list contents will be lost.

#### Note

The SCSI ID number is displayed in the square brackets "[ ]" at the right of the sound name. This indicates the SCSI ID of the SCSI device in which that sound is saved. When you register sound names in the Quick Load List, the SCSI ID is also registered. This SCSI ID number determines the drive from which the sound will be quick loaded.

## Using the Quick Load function

1. Go to the Quick Load display.

Press MODE.  
Select F1:Performance.  
Press the Value knob.  
Select 5:Quick Load.

2. Press F1 to specify the type of sound you wish to load. Each time you press F1 the <Target> will change, and a list of each type of sound will appear.

3. Move the cursor to the name of the sound you wish to load.

4. Press F3 Load. The sound will be loaded into internal memory.

\* Int: indicates the number of seconds (at 44.1 kHz) of free area in internal memory. The size of the sound data is also displayed, allowing you to check whether or not you will be able to load the data. If there is insufficient free area, the wave data will be loaded incompletely.

# Automatically loading a Volume at start-up

You can specify that a Volume be automatically loaded from the Current Drive (Initial Drive) when the S-760 is started up.

1. Go to the Disk Utility display.  
Press MODE.  
Select F5:Disk.  
Press the Value knob.  
Select 5:Utility.
2. Set TG to "Volm" and ID to "All", so that all Volumes in the drive will be displayed.
3. For CD, specify the drive which contains the Volume you wish to load.
  - \* **It is not possible to automatically load a Volume from floppy disk.**
4. The program number of the Volume is displayed so you can check the Program number of the Volume you wish to load.
  - \* **You can edit the program numbers in this display. Do not set more than one Volume to the same program number. If identical program numbers exist, the S-760 will load the first Volume it finds. Volumes for which you do not want to set a program number should be turned off (--).**
5. Go to the first page of the System SCSI display.  
Press MODE.  
Select F6:System.  
Press the Value knob.  
Select 2:SCSI.  
Select the first page.
6. In Initial Drive, specify the drive that contains the Volume you wish to load.
7. In Initial Volume, specify the program number of the Volume you wish to load.
8. Go to the Load/Save System Parameter display.  
Press the Value knob.  
Select 5:LD/SV SysPRM.
9. Press F3 SavePRM. The system parameters will be saved in the system backup memory.
  - \* **Initial Drive and Initial Volume are system parameters. If you turn the power off without saving, the data will be lost (Basic Operation p.8-7).**
10. The next time the S-760 is started up, the specified Volume will automatically be loaded.
  - \* **If the automatically-loaded Volume is on a removable disk drive (such as a magneto-optical disk), be sure to insert the disk before turning on the S-760.**

# How to avoid saving unwanted sounds (Listen Delete)

The Listen Delete function allows you to turn off all Partials whose notes were not played even once, for entire Splits in a Patch. By using this function and then saving, you can avoid saving unnecessary sound data (i.e., Partials whose keys were not played even once, and the Samples used by those Partials), thereby conserving hard disk space.

1. Go to the Performance Play display, and select the Performance and Part Patches to which you want to apply the Listen Delete function.
2. Go to the Listen Delete display.  
Press COMMAND.  
Select 6: Listen Delete.
3. Mark the Parts or MIDI channels to which you do not want to apply the Listen Delete function.
4. Press F3 Start. The F3 display will change to Stop, and the S-760 will wait for Note-on messages from a MIDI controller. The display will indicate "Wait for Note On".
5. Operate your MIDI controller to transmit Note-on messages to the S-760. The display will indicate "Now logging".
6. When you finish transmitting Note-on messages, press F3 Stop.
7. If you wish to continue Listen Delete, press F1 GoOn. The display will again indicate "Now logging" and you will return to step 5. If you wish to cancel Listen Delete, press F2 Cancel. If you wish to execute Listen Delete, press F3 Exec.
8. If you press F3 Exec, the Target Patch display will appear, allowing you to select the Patches for which to execute Listen Delete.

- |            |   |
|------------|---|
| F1 All     | : Listen Delete will be executed on Patches for which Note-on messages were input. In addition, Listen Delete will also be executed on all Patches in internal memory for which not even one Note-on message was input. In this case, the Partial in the Split will be initialized instead of being turned off. |
| F2 Sounded | : Listen Delete will be executed on Patches for which Note-on messages were input. If the result of Listen Delete is that the Partials for all keys in the Split are turned off, that Patch will be initialized.  |
| F3 Cancel  | : Listen Delete will be canceled.   |

9. Save the sound data on which Listen Delete was executed.

\* Patches you wish to save must be assigned to a Part (Basic Operation p.8-9).

# Upgrading to a new version of the system (System Dump)

## Procedure for upgrading to a new version of the system

To upgrade to a new version of the system program, you must use the Save System operation to save it to floppy disk or hard disk. However in this case since the system program and the system parameters (Basic Operation p.8-7) are saved together, the system parameter settings will be rewritten to the factory settings. To avoid this, use the following procedure.

1. Use the System Dump function to record the system parameter data from internal memory into a MIDI sequencer, and save it to disk.
2. Start up the S-760 with the new version system disk.
3. Load the system parameter data from your MIDI sequencer into the S-760.
4. Execute the Save System function to save the system to a floppy disk or hard disk.

\* For details on the System Dump function, refer to the following explanation.

## Recording procedure for the System Dump function

This function transmits the system parameters of internal memory as a MIDI Exclusive message. You will need to use a MIDI sequencer that is capable of recording MIDI Exclusive messages.

\* The system parameters transmitted by the System Dump function are the Quick Load List, Volume ID List, Mark List, and the Template User Set.

\* We recommend that you use a Roland MC-50 or MC-50 MKII as the MIDI sequencer.

1. Using a MIDI cable, connect the S-760 MIDI OUT/THRU to the MIDI IN of your MIDI sequencer.
2. Go to the MIDI Control display.  
Press MODE.  
Select F6: System  
Press the Value knob.  
Select 3: MIDI.  
Go to page 1.
3. Set MIDI Out/Thru to Out.
4. Go to the Volume Dump display on page 2.
5. Specify the Device ID (Device ID Number).

\* If you forget the Device ID number, you will no longer be able to load the data into the S-760. Write it on the label of your disk.



6. Start recording on your MIDI sequencer.
  - \* **Do not forget the tempo setting used for recording. Write it on the label of your disk.**
7. Press F2 SysDump. The display will indicate "Now Working", and the system will be dumped.
8. When System Dump is complete, the display will indicate "Complete". Stop recording on your MIDI sequencer.
9. Save the recorded data to disk.

## Loading procedure for the System Dump function

1. Use a MIDI cable to connect the S-760 MIDI IN to the MIDI OUT of your MIDI sequencer.
2. Go to the Volume Dump display.
  - Press MODE.
  - Select F6:System.
  - Press the Value knob.
  - Select 3:MIDI.
  - Go to page 2.
3. Set the Device ID (Device ID Number) to the same setting as used when recording the data.
4. Turn Exclusive RX (Exclusive Receive Switch) On.
5. Go to the Performance Play display.
  - Press MODE.
  - Select F1:Performance.
  - Press the Value knob.
  - Select 1:Perform Play.
  - \* **Exclusive data can be received in any Performance mode display except Quick Load.**
  - \* **Stop playing the S-760. The S-760 receives exclusive data when not being played.**
6. Playback your MIDI sequencer. The exclusive data will be loaded.
  - \* **Playback your MIDI sequencer at the same tempo as (or a bit slower than) when you recorded the data.**
  - \* **If you stop playback on your MIDI sequencer during this process, the exclusive data will not be loaded correctly. In such a case, play the data once again from the beginning.**

# Recording sound data to a MIDI sequencer (Volume Dump)

If the only SCSI device connected to the S-760 is a CD-ROM drive, you will be able to load and edit sounds, but will be able to save them only to floppy disk.

By using the Volume Dump function, a Volume in internal memory can be recorded on a MIDI sequencer as MIDI Exclusive data. (Only the sound data parameters will be recorded, not the wave data.) This exclusive data can later be played back from the MIDI sequencer to load it back into the S-760's internal memory. At the same time, the samples (wave data) used by that Volume will be loaded from the drive in which they are.

## Samples for which Volume Dump can be used

Samples used in the Volume must meet the following requirements. Check these points before you record the data to a MIDI sequencer.

1. The samples must be loaded into internal memory from a single CD-ROM disk or a single drive.
  - \* If sounds have been loaded from more than one CD-ROM or more than one disk drive, samples (wave data) cannot be loaded.
2. You may not change the name of the samples. You may not use the following operations which affect sample names.
  - Modifying names (including Volume IDs) in the Select Sample display (Advanced Operation p.3-42).
  - Executing the Set Stereo/Mono command in the Set Stereo/Mono display (Advanced Operation p.5-9).
  - Modifying the Volume ID of samples in the System Volume ID display (Advanced Operation p.3-103).
3. Samples loaded into internal memory via MIDI Sample Dump, by Convert Load, or by sampling cannot be used.
  - \* Such samples are not on CD-ROM or in a drive, so they cannot be loaded.

---

## Recording procedure for Volume Dump

This procedure transmits Volume data (only parameters) from internal memory as MIDI Exclusive data. You must use a MIDI sequencer capable of recording MIDI Exclusive data.

1. Use a MIDI cable to connect the MIDI OUT/THRU of the S-760 to the MIDI IN of your MIDI sequencer.
2. Go to the MIDI Control display.  
Press MODE.  
Select F6: System.  
Press the Value knob.  
Select 3: MIDI.  
Go to page 1.
3. Set MIDI Out/Thru to Out.
4. Go to page 2 of the Volume Dump display.
5. Set Device ID (Device ID Number).  
  
**\* If you forget the Device ID Number, you will be unable to load the data back into the S-760. Write it on the disk label.**
6. Set Interval to specify the amount of Exclusive data to be transmitted at one time (Advanced Operation p.3-98).  
  
**\* Set this according to the amount of data your MIDI sequencer is able to record at one time.**
7. Start recording on your MIDI sequencer.  
  
**\* Do not forget the tempo used for recording. Write it on the disk label.**
8. Press F3 VolDump. The display will indicate "Now Working", and Volume Dump will be executed.  
  
**\* If the Exclusive data for the Volume is being transmitted in segments, use the following procedure.**  
**When transmission ends, you will be asked "Continue Volume Dump Function?"**  
**Stop recording on your MIDI sequencer.**  
**Save the recorded data to disk.**  
**Delete the recorded data from the memory of your MIDI sequencer.**  
**Start recording on your MIDI sequencer once again.**  
**Press F1 Yes. Volume Dump will continue.**  
  
**\* If you forget the order of the disks or files that were recorded, you will be unable to reload it correctly. Make a note on the disk label.**
9. When System Dump is completed, the display will indicate "Complete". Stop recording on your MIDI sequencer.
10. Save the recorded data to disk.

---

## Loading procedure for Volume Dump

1. Connect the drive on which the samples used by the Volume are saved, and turn on the power of the S-760.
  - \* **For a CD-ROM drive, insert the CD-ROM which contains the samples used by the Volume.**
2. Use a MIDI cable to connect the S-760's MIDI IN to your sequencer's MIDI OUT.
3. Go to the Disk Load display.
  - Press MODE.
  - Select F5:Disk.
  - Press the Value knob.
  - Select 1:Load.
4. Specify the connected drive as the Current Drive.
  - Move the cursor to CD (Current Drive) and press S1/DEC(List).
  - Move the cursor to the desired drive, and press S1/DEC(Set).
5. Go to the Volume Dump display.
  - Press MODE.
  - Select F6:System.
  - Press the Value knob.
  - Select 3:MIDI.
  - Go to page 2.
6. Set the Device ID to the same setting as used when recording.
7. Set the Exclusive Receive Switch to On.
8. Go to the Performance Play display.
  - Press MODE.
  - Select 1:Performance.
  - Press the Value knob.
  - Select 1:Perform Play.
  - \* **Exclusive data can be received in any Performance mode display except Quick Load.**
  - \* **Stop playing the S-760. The S-760 receives Exclusive data while not being played.**

9. Playback your MIDI sequencer. The Exclusive data will be loaded.

- \* **Playback your MIDI sequencer at the same tempo as (or a bit slower than) when you recorded the data.**
- \* **If you stop playback on your MIDI sequencer during this process, the exclusive data will not be loaded correctly. In such a case, play the data once again from the beginning.**
- \* **If the Exclusive data is split over two or more disks or files, load them in the correct order.**

10. When all Exclusive data has been loaded, the display will indicate "Requested to Load Wave Data by Exclusive Command", and the wave data will be automatically loaded from the drive.

# Sample dump

---

The MIDI Universal Exclusive message Sample Dump allows wave data to be transmitted and received via MIDI. The S-760 is able to exchange wave data (with loop point and loop mode data) with another sampler which conforms to the Sample Dump Standard.

**\* Sample names and parameters such as keyboard range and filter/amplitude envelopes are not transmitted. You must set these parameters manually after the data is received.**

## Transmission procedure for wave data

1. Use two MIDI cables to connect the MIDI IN of each device to the MIDI OUT of the other device.
2. Go to the MIDI Control display.  
Press MODE.  
Select F6: System.  
Press the Value knob.  
Select 3: MIDI.  
Go to page 1.
3. Set MIDI Out/Thru to Out.
4. Go to the Sample Dump display on page 3.
5. Set the Device ID number to match the Device ID number of the receiving sampler.
6. Select the sample you wish to transmit.
7. Press F3 SmpDump. Data transmission will begin.

## Reception procedure for wave data

1. Use two MIDI cables to connect the MIDI IN of each device to the MIDI OUT of the other device.
2. Go to the MIDI Control display.  
Press MODE.  
Select F6: System.  
Press the Value knob.  
Select 3: MIDI.  
Go to page 1.
3. Set MIDI Out/Thru to Out.
4. Go to the Sample Dump display on page 3.

- 
5. Set the Device ID number to match the Device ID number of the transmitting sampler.
    - \* For some devices, this setting is called "Unit Number" or "Channel" instead of "Device ID Number". Refer to the owner's manual for your device.
    - \* For some devices, the number can be set over a range of 0—31, and for others, a range of 1—32. In such cases, "0" corresponds to "1", and "31" corresponds to "32".
  6. Set the Exclusive Receive Switch to On.
  7. Go to the Performance Play display.
    - Press MODE.
    - Select F1:Performance.
    - Press the Value knob.
    - Select 1:Perform Play.
    - \* **Reception will stop while a command such as Load is being executed.**
  8. Make the appropriate settings on the transmitting sampler, and transmit the data.

## Checking procedure after reception

1. Go to the Select Sample display.
  - Press MODE.
  - Select F3:Partial.
  - Press the Value knob.
  - Select 2:SMT.
  - Move the cursor to the sample name and press S1/DEC(List).
2. Scroll the list to find the name of the sample that was received.
  - Received samples will have a name of " :MIDI Smp\*\*\*" where \*\*\* is a three digit number.
  - \* **There is no distinction of mono/stereo for data received via Sample Dump. The S-760 handles stereo data as two individual samples.**  
**In order for these two samples to be handled as stereo data, you can use the Set Stereo command (Advanced Operation p.5-9) to modify the name. (-L/-R will be added to the end of the name.) If the samples are not handled as stereo samples, they will not be part of the automatic search for stereo samples in the Partial SMT display (Advanced Operation p.3-24).**
  - \* **The Volume Dump cannot be correctly executed for samples received via Sample Dump.**

# Controlling sounds via MIDI

When using MIDI to control the Hold effect, changes in volume or pan, or changes in pitch, check the MIDI Filter settings of the Performance (Advanced Operation p.3-5). If you wish to control the pitch, also check the Bend Range (up/down) of the Patch (Advanced Operation p.3-19).

This section will explain how to control the sound of a Patch and how to control the SMT (Sample Mix Table).

## Using MIDI to control the sound of a Patch

You can use MIDI Pitch Bend messages, Aftertouch messages, Modulation messages (Control Change message #1), or other Control Change messages (#0—95) to control the sound of a Patch.

1. Go to the MIDI Filter display.  
Press MODE.  
Select F1:Performance.  
Press the Value knob.  
Select 3:MIDI Filter.
2. Make settings so that the type of message with which you want to control the sound of the Patch will be received (Advanced Operation p.3-5).  
  
**\* When using Control Change messages, be aware that control messages for Hold (#64), Volume (#7) and Pan (#10) will affect not only the Patch but also the Hold function, and affect Part level and Part pan. If you do not want to affect the Hold function, Part level or Part pan, make settings so that these messages are not received. Even if you turn off reception for Hold (#64), Volume (#7) and Pan (#10), these messages will still affect the Patch.**
3. Go to the Patch Control display.  
  
**\* There are two ways to edit a Patch, and the way to access the editing display will depend on which of these ways you use. For details refer to Advanced Operation p.1-5.**
4. Go to page 3 and page 4, and make settings for Pitch Bend messages, Aftertouch messages, Modulation messages, and Control Change messages (#0—95) to specify what aspects of the sound will be controlled.
5. When using Control Change messages (#0—95), use Ctrl Sel (Control Select) in page 1 to specify which control number will be used.
6. Go to the Performance Play display.  
Press MODE.  
Select F1:Performance.  
Press the Value knob.  
Select 1:Perform Play.
7. While playing, transmit MIDI messages from a MIDI controller to the S-760.



---

## Using Velocity to control the SMT

1. Go to page 2 of the Partial Common display.
  - \* **There are three ways to edit Partials, and the way to access the editing display will depend on which of these ways you use. For details refer to Advanced Operation p.1-7.**
2. If you want the same SMT settings for all Partials used by the Patch, edit the settings from the Edit Partial display opened via the Command Menu. If you press F1 and set the Edit Mode to Global Edit, all Partials will be edited to the same value. If you wish to edit Partials independently, set the Edit Mode to Single Edit.
3. Turn SMT V.Ctrl (SMT Velocity Control) on.
4. Go to page 4 or page 5 of the Partial SMT display.
  - Press the Value knob.
  - Select 2:SMT.
5. Make SMT settings (Advanced Operation p.3-24).
  - \* **Play your MIDI controller (transmit note messages) to check the settings.**
6. If you wish to make settings for all Partials used in the Patch, select a different Partial and repeat steps 1—5.
7. Go to the Performance Play display.
  - Press MODE.
  - Select F1:Performance.
  - Press the Value knob.
  - Select 1:Perform Play.
8. Play your MIDI controller.

---

## Using MIDI to control the SMT

You can use MIDI Pitch Bend messages, Aftersustain messages, Modulation messages (Control Change #1), or other Control Change messages (#0—95) to control the SMT.

1. Go to the MIDI Filter display.
  - Press MODE.
  - Select F1:Performance.
  - Press the Value knob.
  - Select 3:MIDI Filter.
2. Make settings so that the messages to control the SMT will be received (Advanced Operation p.3-5).
  - \* **When using Control Change messages, be aware that control messages for Hold (#64), Volume (#7) and Pan (#10) will affect not only the SMT but also the Hold function, and affect Part level and Part pan. If you do not want to affect the Hold function, Part level or Part pan, make settings so that these messages are not received. Even if you turn off reception for Hold (#64), Volume (#7) and Pan (#10), these messages will still affect the SMT.**
3. Go to page 1 of the Patch Control display.
  - \* **There are two ways to edit a Patch, and the way to access the editing display will depend on which of these ways you use. For details refer to Advanced Operation p.1-5.**
4. Set SMT C.Sel (SMT Control Select) to the MIDI message you wish to use to control it.
5. If you specify Ctrl (Control Change messages), set Ctrl Sel (Control Select) to specify the control number.
6. Set SMT C.Sens (SMT Control Sensitivity) to specify the depth of the effect.
  - \* **With a setting of 0, SMT will not be controlled.**
7. Go to page 4 or 5 of the Partial SMT display.
  - There are three ways to edit Partials, and the way to access the editing display will depend on which of these ways you use. For details refer to Advanced Operation p.1-7.
  - For now, do your editing in the Partial SMT display accessed from the Command menu. In the Partial SMT display accessed from the Mode Menu, it is not possible to check the results of SMT control via MIDI.
8. If you want the same SMT settings for all Partials used by the Patch, press F1 to set the Edit Mode to Global Edit so that all Partials will be edited to the same value. If you wish to edit Partials independently, set the Edit Mode to Single Edit.

9. Make SMT settings (Advanced Operation p.3-24).

**\* Play your MIDI controller (transmit note messages) to check the settings. At this point, SMT is still being controlled by velocity.**

10. To make settings for all Partial used by the Patch, select Partial and repeat SMT settings.

11. Go to page 2 of the Partial Common display.

Press the Value knob.

Select 1:Common.

Go to page 2.

12. Press F1 to set Edit Mode to Global so that all Partial used in the Patch will be set to the same value.

13. Turn SMT V.Ctrl (SMT Velocity Control) off. At this point, MIDI messages can be used to control SMT.

14. Go to the Performance Play display.

Press MODE.

Select F1:Performance.

Press the Value knob.

Select 1:Perform Play.

15. While playing your MIDI controller, transmit the MIDI messages you specified to the S-760.

**\* If you wish to re-do SMT settings, return to step 7. However since the SMT is being controlled not by velocity but by a different MIDI message, you will need to transmit note messages and the MIDI messages used for control from your MIDI controller.**

# Various methods of sampling

There are various methods of sampling, and each has their own characteristics. Use the method most appropriate for your situation.

## Performance Quick Sampling

When Performance Quick Sampling is executed, Sample/Partial/Patch data is automatically created, and that Patch automatically assigned to a Part. Patch Split and Part Split settings can also be made. This is convenient for uses such as phrase sampling, where you do not need to make fine adjustments to the sound, or complex loop mode settings.

## Patch Quick Sampling

When Patch Quick Sampling is executed, Sample/Partial/Patch data is automatically created. Patch Split settings can also be made. This method is convenient when you wish to create many Patches and use one Performance as a multi-timbral sound source, or use one Patch with two or more Performances.

## Partial Quick Sampling

When Partial Quick Sampling is executed, Sample/Partial data is automatically created, and Samples can be assigned to Components. When you wish to use the SMT to switch between samples by Velocity, or switch between sounds by key or keyboard area (as for a Drum Part), it is convenient to use this method to create many Partials beforehand.

## Sampling

When Sampling is executed, only a Sample is created. This allows you to perform various edits on the Sample, such as making fine adjustments in tonal character, setting complex looping modes, or directly rewriting the wave data of the Sample.

# Sampling techniques

## Marking the sample

While sampling is being executed, you can assign marks to indicate desired points in the sample. While you record the sample, you can assign marks to indicate approximate locations for Loop Start point or Loop End point. This will make it easier for you when you later edit the various points.

1. Open the Sampling display.

**\* There are four methods of Sampling, and the way in which you access the display will depend on the method you choose.**

2. Name the sample.

Move the cursor to Sample Name, and press S2/INC(Name).  
Assign the Sample Name (Basic Operation p.7-12).

3. Press F3 Ready. The Sampling Execute display will appear.

4. Press F1 Start. Sampling will begin.

5. During sampling, press F2 Mark when you want to mark the current time. Up to two marks can be assigned.

**\* The number of marks is indicated by "x:" in "Mark [--]" in the upper right of the display.**

6. When sampling ends, the wave data of the sample will be displayed.

7. Press F1 Point to select the area on which editing operations for Loop Mode or Loop Start Point, etc. will be executed.

**\* The area to be edited will change each time you press F1 Point, and this will be indicated by the black rectangle above the wave display. The area to be edited will depend on the number of marks you have assigned. You can use a MIDI keyboard to check the sound of each area. Select one of the areas from the following choices.**

When 1 mark was assigned : [Start-End], [Start-Mark], [Mark-End]

When 2 marks were assigned : [Start-End], [Start-Mark1], [Mark1-Mark2], [Mark2-End]

**\* If you press F3 Next or EXIT to leave the Sampling Execute display, the mark locations will be lost.**

**\* If you have not assigned any marks, the F1 Point switch will have no effect and will not be displayed. The entire area of the sample will be the edited area.**

## Making loop settings in the Sampling display

If during sampling, you have assigned marks to specify an area as the editing area, you can make loop settings without leaving the Sampling display. This allows you to avoid having to open the Loop & Smoothing display.

1. In the display immediately before sampling, press F6 Loop. For a just-recorded sample, this will open the Loop display. If you have marked the sample, the Loop display will open for the area selected as the editing area.
  - \* **The parameters editable in the Loop & Smoothing display (Advanced Operation p.3-48) are somewhat different, but parameters common to the Loop display and the Loop & Smoothing display are linked.**
  - \* **The area selected as the editing area will be indicated by a black rectangle in the upper part of the Loop display.**
  - \* **If you press EXIT, you will return to the display immediately after sampling. There you can remake settings to specify the edit area.**
2. Specify the Loop Mode (Advanced Operation p.3-68).
3. Select the Key On Mode (Advanced Operation p.3-49) depending on the point you wish to edit.
4. As necessary, set F3 (Loop Length Lock). When set to L.Lock, you can move the various points without affecting the length of the loop.
5. Set the various points that determine how the wave data is read.
  - Start/ST&LP : Specify the point at which playback will begin. ST&LP specifies the same point as the Start point and the Loop Start point.
  - Loop/Fine/Tune : Specify the point at which to begin looping. Fine allows you to make fine adjustments to the start point. Tune allows you to adjust the pitch of the looped area.
  - R-Loop/Fine/Tune : Specify the point at which to begin the Release Loop. Fine allows you to make fine adjustments to the start point. Tune allows you to adjust the pitch of the looped area.
  - \* **If you move the cursor to the "\*" in the left edge of the display and press S1/DEC or S2/INC, the Loop Start point, Loop End point, Release Loop Start point, and Release Loop End point will be automatically found, and assigned as the settings for each point.**
6. If necessary, press F1 Trun to execute the Truncate function.
  - \* **If you have specified a loop, the sampled data before the Start point and after the Release End point is unnecessary. By deleting the unnecessary data you can conserve wave memory.**
7. Press EXIT. You will return to the display immediately after sampling.

# Creating a Patch (Patch Split)

One or more Partials are arranged on the keyboard to create a Patch. The arrangement of a Partial on an area of the keyboard is called a Split. Up to 88 Partials can be split on the keyboard.

\* If you want the sound to change depending on the key or keyboard area (such as for Drum parts), create Partials beforehand, and split them in a Patch.

## How to view the graphic display

The graphic display indicates the split status for the Partial and Assign Type of the specified note number. If the split occupies two or more consecutive note numbers, the status of these note numbers will also be displayed. Note numbers to which Partials or Assign Types identical to the specified note number are assigned will also be displayed.

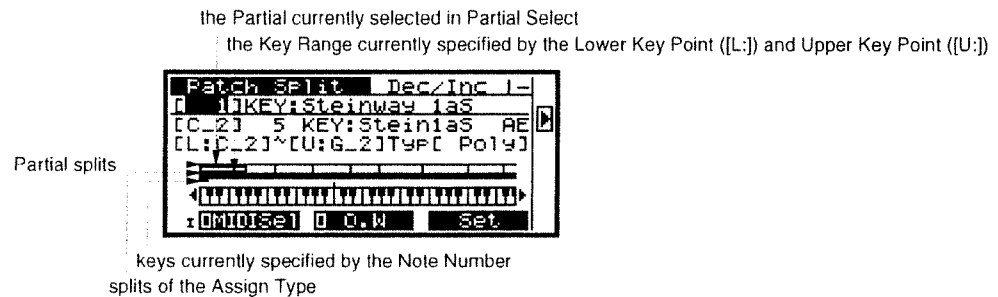

## Making Split settings from the front panel

1. Open the Patch Split display.

\* There are two methods of Patch editing, and the way in which you access the display will depend on the method you choose. For details, refer to Advanced Operation p.1-5.

2. Name the Patch.

Move the cursor to Patch Name, and press S2/INC(Name).  
Assign a Patch name (Basic Operation p.7-12).

3. Press F2 to select the Split Mode.

1Key : Split the Partial to just one key.

O.W : Split the Partial to the area specified by Lower Key Point (Advanced Operation p.3-16) and Upper Key Point (Advanced Operation p.3-16).

Move : Use this when you wish to modify the split area of a Partial which is already split. The Partial will be re-split to the area specified by Lower Key Point and Upper Key Point.

\* If an already-split Partial is to be re-split to a narrower area than before, simply resetting the [L:]/[U:] values will not change the split area. In such cases you must move the actual [L:]/[U:] locations, and use them to re-split the Partial to the correct location.

3. Move the cursor to [ ] (Note Number) (Advanced Operation p.3-16), and specify the note number to which you wish to assign a Partial or which you wish to turn off.
  - \* If you wish to specify a range of consecutive note numbers, any note number in this range will do.
  - \* In the case of a Patch for which split settings have already been made, specifying a note number will cause the Partial to be displayed for each split area. However it will not be displayed for a Split Mode of 1Key.
4. Select the Partial you wish to assign.
  - Move the cursor to Partial Name, and press S1/DEC(List).
  - Select a Partial.
  - \* If you wish to turn off a Partial which is already split, press F3 SetOff.
6. Set [L:] (Lower Key Point) and [U:] (Upper Key Point) to specify the area to which the selected Partial will be split.
  - \* This is also valid when the Split Mode is 1Key. In this case, the operation is the same as when Split Mode is O.W. The Partial will be split to the area specified by [L:]/[U:].
7. Set the Assign Type (Advanced Operation p.3-17).
8. Press F3 Set. The split will be finalized.
9. Repeat steps 3--8 to make split settings.
  - \* If the split areas (note numbers) overlap, the later-specified split will have priority. It is not possible for splits to overlap and sound together.
10. Play your MIDI keyboard to check the split settings.

## Making Split settings from a MIDI keyboard

1. Open the Patch Split display.
  - \* There are two methods of Patch editing, and the way in which you access the display will depend on the method you choose. For details, refer to Advanced Operation p.1-5.
2. Name the Patch.
  - Move the cursor to Patch Name, and press S2/INC(Name).
  - Assign a Patch name (Basic Operation p.7-12).
3. Press F1 to set the MIDI switch to MIDISet.



- 
4. Select the Partial you wish to assign.  
Move the cursor to Partial Name, and press S1/DEC(List).  
Select a Partial.  
  
**\* If you wish to turn off a Partial which is already split, press F3 SetOff.**
  5. Set the Assign Type (Advanced Operation p.3-17).
  6. Press the key(s) on your MIDI keyboard to which you want to assign the selected Partial or which you want to turn off. If the desired area consists of two or more note numbers, press each of the corresponding notes on your keyboard.
  7. Repeat steps 3 to 6 to make split settings.  
  
**\* If the split areas (note numbers) overlap, the later-specified split will have priority. It is not possible for splits to overlap and sound together.**
  8. Press F1 to set the MIDI switch to MIDISel or MIDIOff.
  9. Play your MIDI keyboard to check the split settings.

# Part Split and Positional Crossfade

You can specify the keyboard range for a Patch assigned to a Part. Positional Crossfade is a method of fading the edges of the keyboard range for each Part and combining several Parts so that playing up or down the keyboard will smoothly change to a different sound. This method allows you to soften the boundaries between keyboard areas, or mix different sounds.

## Positional Crossfade setup procedure

Beforehand, you will need to create several Patches.

1. Open the Performance Play display.  
Press MODE.  
Select F1:Performance.  
Press the Value knob.  
Select 1:Perform Play.
  2. For the Parts you wish to positionally crossfade, set the MIDI channels to the same setting.
  3. Assign Patches to the Parts you wish to positionally crossfade.
  4. Press F6 several times to open the Performance Play 7 display.
  5. Make settings for L.P (Lower Key Point) and U.P (Upper Key Point) so that the keyboard ranges overlap for the Parts you wish to positionally crossfade.
  6. Make settings for L.W (Lower Fade Width) and U.W (Upper Fade Width) so that the overlapping areas are faded.
  7. Press F6 to open the Performance Play 8 display. The Part keyboard ranges will be displayed graphically, so you can check your settings. By pressing F2 or F3 you can move the region displayed by the graphic.
- \* Since the MIDI channels of the Parts are the same, receiving a Program Change message will cause each Part to switch to the same Patch, and the cross-faded effect you created will be lost. To avoid this, make settings so that Program Change messages will select Performances (Advanced Operation p.9-4).

# Creating a Volume ID list

---

When you load a sound in the Quick Load display or the Disk Load display, or name a newly sampled sound, the Volume ID of the name will be registered in the Volume ID List. Here we will explain how to create a new Volume ID and register it in the list.

1. Open the System Volume ID display.  
Press MODE.  
Select F6:System.  
Press the Value knob.  
Select 4:Volume ID.
2. Move the cursor to Volume ID and press S1/DEC(List). The Select Volume ID display will appear.  
  
**\* The Volume ID list can hold up to 200 Volume IDs.**
3. If you wish to assign a new Volume ID to a sound, use the following procedure.  
Press F3 Make. The ASCII display will appear.  
Specify the new Volume ID.  
Press F3 CR. You will return to the Select Volume ID display.
4. If you wish to delete a Volume ID from the list, use the following procedure.  
Move the cursor to the Volume ID you wish to delete.  
Press S2/INC(Del).
5. Press F1 SortABC. The Volume IDs displayed in the list will be sorted in alphabetical order.
6. Move the cursor to the Volume ID which you wish to give your sound, and press S1/DEC(Sel). You will return to the System Volume ID display.  
  
**\* This list is a System parameter. It is not a list displayed by directly searching the contents of a drive. If you turn the power off without saving, the contents of the list will be lost. Execute Save System (Basic Operation p.1-8) to save the data.**

# Preview function

The S-760 has a Preview function that allows you to hear the currently selected sound merely by pressing the Volume knob, even if a MIDI keyboard is not connected. Here's how to make settings for the Preview function and use it.

1. Open the System Parameter display page 5.  
Press MODE.  
Select F6: System.  
Press the Value knob.  
Select 1: System PRM.  
Move to page 5.
2. Specify the Preview-Note# (Preview Note Number). These are the note numbers that will sound when you press the Volume knob.  
  
**\* You can specify four note numbers [1] — [4].**
3. Specify the Preview-Velocity (Preview Velocity). This determines the velocity of the notes that will sound when you press the Volume knob. Set the velocity for each of the four note numbers [1] — [4].
4. Specify the Preview-Mode (Preview Mode).  
  
Single : Each time you press the Volume knob, the four note numbers [1] — [4] will be sounded successively.  
Chord : Each time you press the Volume knob, the four note numbers [1] — [4] will be sounded simultaneously.

## The Preview function in the Performance Play display

When the cursor is located at Performance Select, the Patch assigned to Part 1 will sound. Patches assigned to Parts that have the same MIDI channel as Part 1 will also sound.

When the cursor is in a location to specify a Part (i.e. at Part Number, Patch number, or Patch Select etc.), the Patch of the specified Part at the cursor location will sound. Patches assigned to Parts that have the same MIDI channel as the specified Part will also sound.

If Performance Play display page 8 is open, the Patch of the displayed Part will sound. Patches assigned to Parts that have the same MIDI channel as the displayed Part will also sound.

---

## The Preview function in other displays

In Patch/Partial/Sample modes, the Patch/Partial/Sample selected by Patch Select, Partial Select or Sample Select will sound. If a sound list is open, the Patch/Partial/Sample at the cursor location will sound.

If you use the Preview function in the Sampling display, remember that the sample will be sounded not at its Original Key but with the note numbers specified by the Preview Note Number.

**\* Depending on settings such as Patch Split (Advanced Operation p.6-21) and Part Split (Advanced Operation p.6-24), the note numbers specified by Preview Note Number may not be assigned for the selected Patch or Partial, and in this case there will be no sound. Check the split settings.**

MEMO



# *Chapter 7*

**Appendices**

---

# ABOUT SCSI

The S-760 is capable of transferring large amounts of sound data (including wave data) to and from external SCSI devices.

## What is SCSI?

SCSI (Small Computer System Interface) is a data communication standard which allows high-speed transmission and reception of large amounts of data.

Check the following points when connecting a CD-ROM drive and hard disk to the S-760.

Device number of the connected device (SCSI ID)  
Connector and cable  
Terminator  
Power source of the terminator  
Format

- \* Refer to the included leaflet "SCSI Devices Compatible with the S-760" for a list of the SCSI devices (CD-ROM drives, hard disk drives and optical disk drives) which can be connected to the S-760 SCSI port.
- \* You should realize that the maximum capacity of a drive which can be used by the S-760 is 600 megabytes. For example, even if you format an 800-megabyte hard disk, it will function as a hard disk of only 600 megabytes. The remaining 200 megabytes will not be used at all.

## Device Number (SCSI ID)

Up to eight devices can be connected by SCSI. The connected devices are recognized by device numbers 0-7. From the perspective of SCSI, the S-760's Internal memory has an independent device number. A device number is referred to on the S-760 as the SCSI ID.

The Internal memory is set to a default device number of 7 at the factory. The remaining seven device numbers are used for connected SCSI devices.

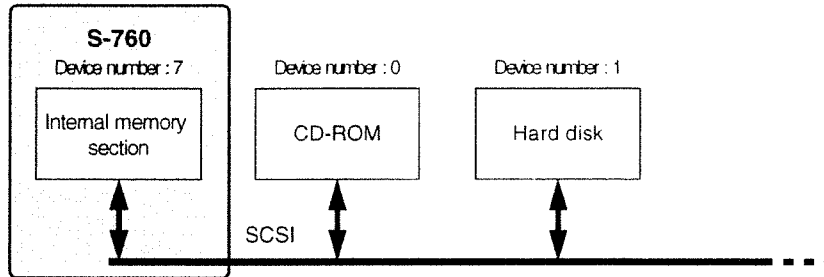

- \* The ID number of each SCSI device is set on each device. Refer to the owner's manual for each of the connected devices for details.
- \* Do not assign the same device number to several devices. If several devices have the same number, they will fail to function properly.



## Connectors and Cables

There are some SCSI-compatible devices with two connectors (or ports) and some with only one. You can easily create a SCSI network (called a SCSI chain) by connecting devices one by one using special cables. However, a device which has only one connector can only be connected as the first or last device in a SCSI chain.

- \* When creating a SCSI chain, the cable used should be as short as possible; the total length of the connected cables must be less than 6.5 meters. The network does not function well if the total length is more than that.



Devices with only one connector are connected as the first or last device in the chain.

There are several types of SCSI connectors depending on the shape and the number of pins of the connector. The SCSI connector of the S-760 has one D-Sub 25-pin connector. SCSI connectors for SCSI devices are available in full-pitch 50 and halfpitch 50 configurations. Check the shape and the number of pins on the SCSI connector and on the cable to be used. Use only high-quality cables which conform to the SCSI standard.

- \* **Optional SCSI cables available from Roland are listed below.**  
C-5025-6:full-pitch 50 pin and D-Sub 25 pin  
C-5050-3:full-pitch 50 pin and full-pitch 50 pin

### Caution!

The RS-232C type connector is used for 25-pin SCSI connectors. Never use improper cables or connect an incompatible unit to the SCSI port, as these can cause problems.

## Terminator

A terminator is a resistor installed in the SCSI devices which are at the ends of the chain. Terminators installed on devices in the middle of the chain must be removed.

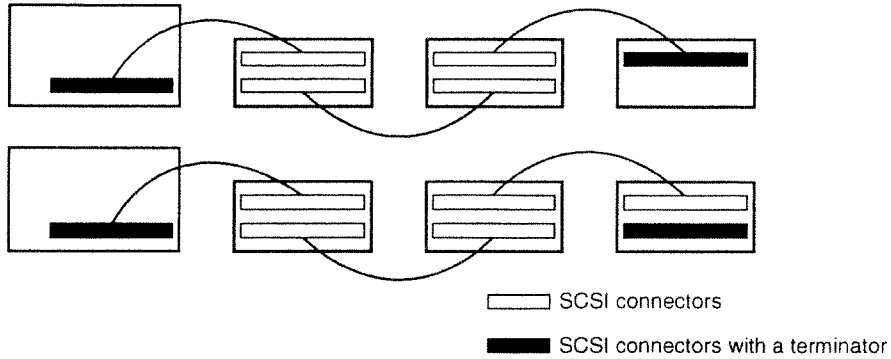

There are two types of terminators; external and internal. The external type is inserted into the SCSI connector of the SCSI device. The internal type is installed in the main controller board of the SCSI device. There are some SCSI devices with internal types that allow you to use DIP switches to turn the terminator on and off.

The terminator of the S-760 is an internal type.

Terminators are usually installed in SCSI devices which can only be connected at the end of a chain (devices with one connector). Refer to the owner's manual of your device for information on installing/removing (turning on/off) the terminator.

**\* There are some SCSI devices which have built-in terminators. Do not install an external terminator on such a device.**

## Terminator Power

Terminators are installed in the devices at both ends of a SCSI chain. These must be powered by a 5-volt power source.

The S-760 provides for the supply of power to its internal terminator. Additionally, it sends out power on the SCSI bus (for use by external SCSI devices). Therefore, no additional settings need be made to any of the SCSI devices in the SCSI chain.

---

## How to Connect the SCSI Chain

Generally, the order in which the SCSI devices (including the S-760) are connected does not matter, as long as you consider whether they contain terminators or not, and that all the SCSI devices are powered on. However, it is recommended that you put those SCSI devices with terminator DIP switches in the middle of the chain. This is simply because their terminators are easily turned on and off.

## Format

When connecting external devices (except a CD-ROM drive or streaming tape backup), disks or cartridges which have been newly purchased or have been used for something else, must be formatted by the S-760 so that data can be stored on them. (External SCSI devices which have been used by the S-770/750 or SP-700 can be used without being formatted.)

The S-760 can format the disks in the current drive (the presently selected disk drive for transferring data to and from the S-760) via SCSI. See Basic Operation p.4-3 for details.

- \* **There is a compatibility problem of the sound data for external SCSI devices used by S-770/750s or SP-700s. See Advanced Operation p.2-2 for details.**
- \* **The format systems differ between the S-760 and personal computers. Therefore, even if these are part of the same SCSI chain, it is impossible for the two devices to share the same area within a disk or to check the data in the other's disk.**

# Startup/shutdown for system with a second S-760 or S-770/750/SP-700

If your system includes a S-770/750 (SYS-772 Version 2.0) or SP-700, or a second S-760, use the following procedure for startup and shutdown.

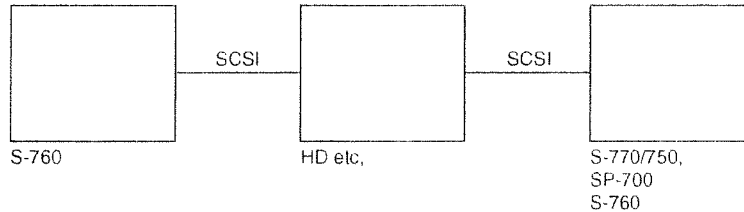

## Startup

**Before you turn the power on, make sure of the following points.**

Are the SCSI IDs and terminators of the SCSI devices set correctly? (Advanced Operation p.7-2)

Are the SCSI devices, audio equipment, and MIDI equipment connected correctly? (Basic Operation p.1-4)

Is the volume of your amp/speaker system turned down?

1. Turn on the power of the terminated SCSI device.
2. Turn on the power of the non-terminated SCSI devices.
  - \* **Wait a while until all drives have started up. Even if you do not plan to use a device, make sure that the power is turned on for all connected SCSI devices.**
3. For SCSI devices that require removable media such as a CD-ROM, a magneto-optical disk, or a tape streamer, insert the disk or tape.
4. Turn on the power of the S-760, S-770/750 or SP-700. The order does not matter.
  - \* **Some of the system parameters are different between the S-760 and the S-770/750 (SYS-772 Version 2.0). For this reason, the S-760 system program cannot start up the S-770/750. Nor can the S-760 be started up using SYS-772 Version 2.0.**  
**If you are using a hard disk or magneto-optical disk as a startup disk, you will have to start up either the S-760 or the S-770/750 from the system disk.**  
**The SP-700 does not require a system disk, so this problem will not occur.**
5. Execute the Scan command on each of the S-760, S-770/750 and SP-700-700.
  - Press MODE.
  - Select F5:Disk.
  - Press the Value knob.
  - Select 1:Load.
  - Move the cursor to CD, and press S1/DEC(List).
  - Press F3 Scan.
  - \* **For details on the Scan commands of the S-770/750 or SP-700, refer to their operating manuals.**

6. Open the Performance Play display.  
Press MODE.  
Select F1:Performance.  
Press the Value knob.  
Select 1:Perform Play.
7. Turn on the power of your MIDI devices.
8. Turn on the power of your audio devices. Raise the volume to an appropriate level.

## Shutdown

**Before you turn the power off, make sure of the following points.**

Have you saved all necessary sound data and system data? (Basic Operation p.4-2)

**\* For saving on the S-770/750 and SP-700, refer to their owner's manuals.**

Is the volume of your amp/speaker system turned down?

1. Before you turn the power off, execute the Park Head command to park the heads of the connected SCSI devices.  
Press MODE.  
Select F5:Disk.  
Press the Value knob.  
Select 5:Utility.  
Press F1 ParkHds.  
  
  - \* **When the Park Head operation is finished, the display will show "Complete".**
  - \* **If a S-770 is connected, park the heads of the S-770 internal hard disk as well.**
2. Turn off the power of your audio devices.
3. Turn off the power of your MIDI devices.
4. Turn off the power of your SCSI devices.  
  
  - \* **After turning off the power of a SCSI device, wait about 30 seconds before moving it.**
  - \* **The heads of the hard disks etc. remain parked until the next time the power is turned on. The next time the power is turned on they will automatically be unparked.**
5. Turn off the power of the S-760 and S-770/750 or SP-700. The order does not matter.

# TROUBLESHOOTING

The following provides some solutions for a range of problems that could possibly be encountered while using the S-760.

## PROBLEMS WITH THE SOUND

### Sound Not Produced

**Have you checked to make sure that all audio and MIDI cables are connected properly?**

**Are you sure that the volume on your amplifier or mixer is not turned down too low?**

**Have you checked the settings affecting the volume produced by the S-760?**

Once again, check through the following items(Advanced Operation p.4-9).

Position of the Volume knob.

System setting for the Master Level .

Part Level set for each of the Parts .

Patch Level set for each of the Patches .

Partial Level set for each of the Partials .

Sample Level set for each of the Samples .

**Are the MIDI channels matched properly?**

Check the channels you have set for the connected MIDI controller, and the receive channels you have set for each of the Parts. The settings in effect on the S-760 can be checked from the Performance Play page (Advanced Operation p.3-2). You should also check to see if MIDI messages are being properly received, by checking the MIDI indicator, and the MIDI monitoring page (Advanced Operation p.3-7).

**Have you selected the appropriate output jacks? (Advanced Operation p.4-2)**

Check the settings you have for the Output Mode/Output Assign , and the output assignments in effect for Performances/Patches/Partials .

**Are you sure Exclusive messages are not being received?**

The unit cannot produce sound while it is receiving Exclusive messages. You may want to turn OFF the System Exclusive reception switch (Advanced Operation p.3-97), if you are certain that there is no need to receive such messages.

**Did you make sure the size (in seconds) of the sound data you loaded was not too large to fit in the available space at the Internal Memory?**

If the data was too large, it most likely was impossible to load all of the sample itself. However, the Performance/Patch/Partial will have been loaded, and as a result their names are displayed. To see if this is the case, check the size of the sound data from the select Sound program page. Is it "0" seconds?

**Have you performed a Listen Delete? (Advanced Operation p.5-5).**

The Patch might have been initialized.

## Pitch Is Strange

Check through the following items(Advanced Operation p.4-10).

**Could the Master Tune setting have strayed?**

**Have you checked to make sure the settings you have made for Octave Shift and Coarse Tune/Fine Tune for each of the Patches are appropriate?**

**Could you have Analog Feel for any of the Patches set to the maximum?**

**Do you possibly have inappropriate settings made for Pitch Key Follow for any of the Partials?**

**Do you possibly have inappropriate settings made for Coarse Tune/Fine Tune for any of the Partials?**

**Do you possibly have inappropriate settings made for Sample Coarse Tune/Fine Tune for any of the Partials?**

**Are you sure you have the appropriate settings made for Envelope Pitch Depth for each of the Partials?**  
The pitch will change in accord with the settings for the TVF envelope (Advanced Operation p.3-31).

**Could a pitch bend still be in effect?**

On occasion, when playing a sequencer and a reset has not been performed, the pitch could remain changed (the pitch remains high and does not return to normal).

## The Expected Effect Is Not Obtained From A Control Message (Pitch Bender, Modulation, Aftertouch, or others such as Breath)

**Could it be because you have the reception switch in the MIDI Filter page ( Advanced Operation p.3-5) turned OFF?**

Check to see if you have the settings for controllers set correctly for every Patch ( Advanced Operation p.3-18).

## Velocity Not Expressed As Expected

Check to make sure the controller you have connected actually provides control over Velocity.

**Are you sure you have made the correct settings for the Velocity Curve ( Advanced Operation p.3-6) in the MIDI Filter page?**

**Could you possibly have inappropriate settings made for Velocity Sens Offset ( Advanced Operation p.3-15) for any of the Patches?**

**Could you possibly have inappropriate settings made for the TVA and TVF Velocity Curve/Velocity Curve Sens ( Advanced Operation p.3-29, p.3-34) for any of the Partials?**

**Could you possibly have inappropriate settings made for Velocity Sens & Level Key Follow ( Advanced Operation p.3-31, p.3-35) for the TVA and TVF Envelope/Envelope Time for any of the Partials?**

### No Patch selection via Program Change Message

Check through the following items(Basic Operation p.9-2).

**Could you possibly have the channels for any of the Parts set incorrectly?**

If the channel is set to the same number as the Control Channel, Patch changes cannot be obtained .

**Do you have Program Changes turned ON in the MIDI Filter page ?**

**Could you possibly have the same Program Number assigned to several Patches ?**

**Have you made a Patch change while Performance Play page is open?**

You need to be in one of the above pages. Sound changes cannot be made from pages within the Edit mode (Patch or Partial Mode pages), nor can they be made from the various other pages (such as the Command, ASCII, or Select pages).

### No Volume, or Performance selection via Program Change Messages

Check through the following items(Basic Operation p.9-2).

**Could you possibly have the Control Channel set incorrectly?**

**Are you sure you have made the correct settings for the Control Mode ?**

**Could you possibly have the Volume's Program Number set to OFF (---), or have the same Program Number assigned to more than one Volume?**

**Could you possibly have the same Program Number assigned to several Performances ?**

**Have you made a change in the sound while Performance Play page is open?**

Sound changes cannot be made from pages within the Edit mode (Patch or Partial Mode pages), nor can they be made from the various other pages (such as the Command, ASCII, or Select pages).

### Sounds Are Left Out

The S-760 is only capable of playing a maximum of 24 voices at the same time. Sounds in excess of this will not be played. Check on the number of voices being used from the Module Monitor page (Advanced Operation p.3-7).

Could the Assign Type (Advanced Operation p.3-17) for the sound which has not been sounded possibly be at "Exc1" through "16," or be set to "Mono"? If the Assign Type is set to anything other than "Poly," sounds that were sounding will be canceled out when other affiliated Partials start sounding.

Have you excessively employed Positional Crossfades (Advanced Operation p.6-24) or Velocity Crossfades (Advanced Operation p.3-27).

Maximum polyphony will be reduced considerably within all crossfade regions.



## The Timing Of Sounds Is Off

**Have you made the setting for Phase Lock (Advanced Operation p.3-6), when you have identical channel settings for a multiple number of Parts which are being sounded together?**

Do you have a number of MIDI devices connected between the S-760 and the controller, linked by means of MIDI THRU? You should be aware that if any unit is placed too far down the line in a MIDI chain, you will not only encounter delays in sound production, but errors in the data content could also occur. Try using a MIDI Thru Box instead.

**Could you have possibly made inappropriate settings for the Key Follow for the TVA and TVF Envelope Time, and other Envelope settings for any of the Partials (Advanced Operation p.3-32, p.3-36)?**

Note that the length of a particular piece of data will change when the pitch is changed for playback. As a result, it will take a little longer for the attack portion to be realized with pitches that are lower than the original key; and conversely, the attack of higher pitched sounds will be faster. So some variances in the timing of the attack should be expected, depending on the sound. If you wish, you can correct such variances to some extent by splitting the sound into separate, independent Partials. However, you can eliminate most problems entirely by listening to and carefully adjusting each of the notes, so as to achieve just the right timing (as you input them by means of Step Recording into a sequencer).

## PROBLEMS WITH DRIVES

### Commands Directed To A Drive (Load/Save/Copy/Delete) Do Not Work

Check all settings related to SCSI (including SCSI IDs), and check that cables, terminators, and all other elements of your SCSI chain are configured appropriately. For details, refer to "About SCSI" (Advanced Operation p.7-2).

Did you change the disk or tape in a drive? After every change to another disk or tape, or at any other time when the drive is no longer recognized, you should always execute the Scan command from the Select Drive page.

Are you sure the drive you have selected is capable of performing the command you requested? A CD-ROM drive or streaming tape backup device will not accept certain commands.

### Other Sound Data Was Corrupted When Sound Data Was Deleted From A Disk

**Did you have the Fast Delete Mode ON?**

If you inadvertently erase lower region sound data that is used by more than one upper region sound, all of such upper region sound data (that using the data that was erased) will be corrupted. When the Fast Delete mode is OFF, you can check the sound data's relationship with other data before performing a deletion from the disk. This way, you can proceed without adversely affecting other sounds and their sound data (Advanced Operation p.3-95).

Although A Patch Was Deleted To Create Free Space,

---

### The Available Space Reading For The Current Drive Has Not Changed

The reason for this could be that you have the Fast Delete Mode OFF (Advanced Operation p.3-95), and the sample associated with the Patch is also used by some other Patch. In situations such as this, the samples on the drive will not be erased, so the available space reading for the drive will not change.

**\* If you should switch the Fast Delete Mode ON, and then carry out the deletion, you will obtain an increase in the amount of available space, but you also risk destroying other sound data. The best policy to follow when you need to create free space is to have the Fast Delete Mode OFF, then carefully select for deletion from the disk only those Patches which you have confirmed will not adversely affect other sound data.**

### Quick Load Cannot Be Carried Out

Check to make sure that the SCSI ID number of the sound is matched with the SCSI ID of the drive on which the sound is contained. Care should be taken with CD-ROM drives and magneto-optical disks, since the disk on which the sound is located could have been inserted into a different drive, and as a result, can't be loaded. As a solution, either change the SCSI ID number of the drive containing the sound, or reinsert the disk and execute the Scan command.

### Parameters Added For The S-760 Have Reverted To Their Defaults When Sharing Sound Data On A Hard Disk Also Used With The S-770/750

Although you can share a hard disk between the S-760 and the S-770/750 (SYS-772 Version 2.0), certain restrictions apply. For details, see Advanced Operation p.2-2.

## VARIOUS OTHER PROBLEMS

### Power Accidentally Turned Off During Editing

All data located in internal memory that had not been saved will be lost.  
(There is no way that it can be restored.)

As a precaution against such accidents, try to save your data frequently, and at regular intervals.

### Power Accidentally Turned Off While Saving To Hard Disk

All data that was stored on the hard disk will be corrupted. In certain cases, all sound data on the drive will have been destroyed, so an initialization will not be sufficient; you will need to start over by reformatting the disk.

---

## **Exclusive Data Cannot Be Recorded/Loaded During A Volume Dump/System Dump**

**Have you checked to make sure the sequencer you are using is capable of recording Exclusive data?**

**If loading, do you have the Device ID set to the same number as you did when recording?**

**If loading, are you playing the MIDI sequencer at the same tempo (or slower) you used when recording?**

**If loading, do you have the Performance Play page open?**

With this page open, cancel play or whatever command that was given.

**Are you following the same disk order that was used when recording, while you are loading (performing a Volume Dump)?**

**If carrying out a Volume Dump, have you changed the name of any of the samples?**

Any samples which have been given different names will not be loaded.

**If loading (carrying out a Volume Dump), do you have the drive containing the samples to be loaded selected as the current drive?**

**If carrying out a Volume Dump, do you have an appropriate setting made for the amount of data to be sent in each transmission packet (Interval)?**

For further information about Volume Dumps/System Dumps, see Advanced Operation p.6-6.

# ERROR MESSAGES

The following provides explanation for the unit's Error Messages (such as SCSI ID Errors), and provides some solutions for them.

## **SPC Hardware Error**

The LSI governing SCSI is faulty.

## **Target ID Error**

SCSI ID Error

Self ID Error

The SCSI ID settings are in error. Check and reset if necessary.

## **SCSI Device Error**

A futile attempt has been made to save/copy/delete data on a CD-ROM drive. Or, a load/save/delete has been attempted with respect to a streaming tape backup device.

Such procedures cannot be performed with the above types of drives.

## **Can't Communicate**

Either "No Drive" is selected as the current drive, or the SCSI cable has been disconnected, and as a result communication with the drive is impossible. Check the settings and connections, then execute the Scan command from the Select Drive page.

## **Arbitration Failed**

## **Bus Free Waiting**

## **Interrupt Error**

## **Phase Error**

## **Check Condition**

## **Busy Status**

## **Status Error**

## **Message Error**

## **No\_define sense**

Satisfactory communications with the SCSI drive could not be achieved. Check the connections, then execute the Scan command from the Select Drive page.

## **Not Formatted**

The SCSI drive has not been formatted for use with the S-760, SP-700 or S-770/750. If the error has appeared for a drive which you are certain has been formatted for the S-760, SP-700 or S-770/750 (excluding streaming tape backup devices), check the connections, then execute the Scan command from the Select Drive page.

## **MEDIUM ERROR**

Abnormalities have been found in the media in the SCSI device. The drive may be usable after it has been reformatted (initialization is not sufficient).

## **HARDWARE ERROR**

The SCSI drive is faulty. Please contact the manufacturer of the device for advice.

## **ILLEGAL REQUEST**

## **ABORTED COMMAND**

A command sent by the S-760 to the SCSI drive is apparently not supported by that drive, and as a result was rejected. Any SCSI drive that presents this problem cannot be used with the S-760 system.

**Caddy not inserted****NO DISK**

No media has been inserted into a removable-media drive (CD-ROM or magneto-optical disk drive). Insert a disk.

**WRITE PROTECT**

The disk is set so it cannot be written onto.

**NOT READY**

The SCSI drive is not ready for operation.

**TOC reading**

The CD-ROM drive is getting ready for operation (it is reading the TOC (Table of Contents)).

**HD MODE ERROR****CD MODE ERROR****Not 512 byte/sector**

The media in the SCSI drive is not configured to have sectors that are 512 bytes in size. The S-760 can only work with media having 512-byte sectors.

**NOT DATA DISK**

An audio CD has mistakenly been inserted into a CD-ROM drive.

**Canceled**

Execution of the command has been canceled.

**File Not Found**

The selected file (sound data) does not exist.

**No Name****Please Rename**

Either the file (sound data) does not yet have a name, or an existing file already has the same name. Supply a new name for the file.

**Not S550/W-30 Disk**

An unsuccessful Convert Load was attempted using an HD/CD-ROM disk that is not compatible with the S-550 or W-30.

**No Data/Wrong Data**

There is no data on the tape in the streaming tape backup device.

**End of Tape**

The end of the tape in the streaming device tape backup unit has been reached.

**Directory Full**

During loading or saving, the maximum permissible number of sound data items has been exceeded, for either Volume Memory or a SCSI drive. Loading/saving cannot be carried out once the maximum number has been exceeded.

**Disk Memory Full**

During a save process, the unit found that there was insufficient free space on the hard disk/magneto-optical disk.

**Wave Memory Full**

During loading, the unit found that there was insufficient free space in the wave memory.

**Can't Execute**

The requested command could not be carried out.

# PARAMETER LISTS

## System Parameters

Group	Parameter		Display	Values	Page
System Parameter	Master Frequency		Master-Freq	44.1KHz, 48KHz, 32KHz	System PRM
	Master Tune		Master-Tune	-50 — 50	
	Master Level		Master-Level	0 — 127	
	LCD Contrast		LCD-Contrast	-50 — 50	
	Controller		Controller	Panel+LCD, Mouse+CRT, RC100+CRT	
	Output Mode		Output-Mode	4st, MIX, 1st+6outs, 8outs	
	Output Assign C/D		Output-Assign C/D	A/B, C/D	
	Digital Booster		Digital-Booster	-6, 0, +6, +12	
	Time Display		Time-Display	Off, On	
	Recover Function		Recover-Function	Off, On	
	Preview Note Number		Preview-Note #	A0 — C8	
	Preview Velocity		Preview-Vel	0 — 127	
	Preview Mode		Preview-Mode	Single, Chode	
	S-760 self SCSI ID		S-760 Self SCSI ID	0 — 7	System SCSI
	Initial Drive SCSI ID		Initial-Drive	SCSI: 0 — 7, Floppy	
	Initial Volume		Initial-Volume	Off, 65 — 128	
	Boot Drive		Boot-Drive	Default, Floppy, SCSI: 0 — 7	
	Fast Delete Mode		Fast Delete Mode	Off, On	
	Overwrite Sw		Overwrite Switch	Off, On	
	Control Channel		Control Channel	Off, 1 — 16	MIDI Control
Control Mode		Control Mode	Perf Only, Perf/Vol		
MIDI Out/Thru		MIDI Out/Thru	Out, Thru		
EQ 1 — 8	High Frequency	H. F	Off, C. Chg 1 — 95	MIDI EQ Control	
	High Gain	H. G	Off, C. Chg 1 — 95		
	Low Frequency	L. F	Off, C. Chg 1 — 95		
	Low Gain	L. G	Off, C. Chg 1 — 95		
Device ID		Device ID	0 — 31	Volume Dump/ Sample Dump	
System Exclusive Reception		Exclusive RX	Off, On		
Quick Load	Volume List (Up to 32)	Volume Name	Name	Volume Name	Quick Load
		Drive Number	Drv	0 — 7	
	Performance List (Up to 32)	Performance Name	Name	Performance Name	
		Drive Number	Drv	0 — 7	
	Patch List (Up to 32)	Patch Name	Name	Patch Name	
		Drive Number	Drv	0 — 7	
Volume ID	Volume ID List (Up to 200)		List	The first three lettes of the sound neme	Select Volume ID
Mark Set	Mark Set List (Up to 20)		[1] — [20]	Page Name	Mark Set
Template	User Set List (Up to 10)		User set	Parital Name	Template

### Disk Parameters

Parameter	Display	Values	Page
Disk Name	Disk Name	12 letters	Select Drive
Program Number of Volume	PG #	— — —, 65 — 128	Disk Utility

### Volume Parameters

Parameter	Display	Values	Page
Volume Name	Volume Name	15 letters (Volume ID+Name)	System Volume ID

### Performance Parameters

	Parameter	Display	Values	Initial Values	Page
Part 1 — 32	Performance Name	Performance Name	15 (ID+ Name)	space	Perform Play
	Part Channel	Ch	1 — 16,	1 — 16 - (Part 1 — 16) - (Part 17 — 32)	
	Patch Select	Patch Name	Off, 1 — 128	Off	
	Part Level	[Lev]	0 — 127	127	
	Part Pan	[Pan]	L32 — 0 — R32	0	
	Part Output Assign	[Out]	( ), A — D, 1 — 8	A	
	Lower Key Point	L.P	A0 — C8	A0	
	Upper Key Point	U.P	A0 — C8	C8	
	Lower Fade Width	L.W	0 —	0	
Channel 1 — 16	Upper Fade Width	U.W	0 —	0	MIDI Filter
	Program Change Reception	Prog	—, <input type="radio"/>	<input type="radio"/>	
	Pitch Bend Reception	Bend	—, <input type="radio"/>	<input type="radio"/>	
	Modulation Reception	Mod	—, <input type="radio"/>	<input type="radio"/>	
	Hold Reception	Hold	—, <input type="radio"/>	<input type="radio"/>	
	Aftertouch Reception	A.T	—, C, P	C	
	Volume Reception	Vol	—, <input type="radio"/>	<input type="radio"/>	
	Pan Reception	Pan	—, <input type="radio"/>	<input type="radio"/>	
EQ 1 — 8	Phase Lock	P.L	—, <input type="radio"/>	—	Perform EQ
	Velocity Curve Type	Vel	—, 1 — 7	—	
	High Frequency	H. F	750 — 18K	6.0k	
	High Gain	H. G	-12 — +12	0	
EQ 1 — 8	Low Frequency	L. F	16 — 600	120	Perform EQ
	Low Gain	L. G	-12 — +12	0	
Program Number		PG #	1 — 64	1 — 64 (Performance 1 — 64)	Select Perform

**Patch Parameters**

Parameter		Display	Values	Initial Values	Page
Patch Name		Patch Name	15 letters (ID+ Name) space		Common
Patch Level		Patch Level (Lev)	0 — 127	127	
Patch Panning		Panning (Pan)	L32 — 0 — R32	0	
Patch Output Assign		Out Assign (Pri)	A, (B) — (D), (1), (2) — P — 3 — 8, — P —		
Patch Priority		Priority (Pri)	Off, On	Off	
Octave Shift		Oct Shift (Oct)	-2 — 2	0	
Patch Coarse Tune		Coarse Tune (Coar)	-48 — 48	0	
Patch Fine Tune		Fine Tune (Fin)	-50 — 50	0	
Analog Feel		Analog Feel (A, F)	0 — 127	0	
Patch Program Number		Program # (PG #)	0 — 127	0	
Cutoff Offset		Cutoff Offs (C, Off)	-63 — 63	0	
Resonance Offset		Reso Offs (Reso)	-63 — 63	0	
Attack Time Offset		Attack Offs (Attack)	-63 — 63	0	
Release Time Offset		Release Offs (Release)	-63 — 63	0	
Velocity Sens Offset		V-Sens Offs (Vel)	-63 — 63	0	
A0 — C8	Partial Select	Partial Name	Off, 1 — 255	Off	Split
	Lower Key Point	L	A0 — C8	A0	
	Upper Key Point	U	A0 — C8	C8	
	Assign Type	Typ.	Poly, Mono, Exc1 — Exc16	Poly	
SMT Control Select		SMT C. Sel	Off, Bend, A, 1, Mod, Ctrl	Off	Control
SMT Control Sens		SMT C. Sens	-63 — 63	0	
Control Select		Ctrl Select	0 — 95	2	
Bender	Pitch Bend Up Range	Bend-Up	0 — 48	2	
	Pitch Bend Down Range	Bend-Down	0 — 48	2	
	TVF Control	Bend, TVF Control	-63 — 63	0	
	TVA Control	Bend, TVA Control	-63 — 63	0	
Aftertouch	Pitch Control	A, T, Pitch Control	-48 — 48	0	
	TVF Control	A, T, TVF Control	-63 — 63	0	
	TVA Control	A, T, TVA Control	-63 — 63	0	
	LFO Rate Control	A, T, LFO Rate Control	-63 — 63	0	
	LFO Pitch Depth	A, T, LFO-Pitch Depth	-63 — 63	0	
	LFO TVF Depth	A, T, LFO-TVF Depth	-63 — 63	0	
	LFO TVA Depth	A, T, LFO-TVA Depth	-63 — 63	0	
Modulation	LFO Rate Control	Mod, LFO Rate Control	-63 — 63	0	
	LFO Pitch Depth	Mod, LFO-Pitch Depth	-63 — 63	0	
	LFO TVF Depth	Mod, LFO-TVF Depth	-63 — 63	0	
	LFO TVA Depth	Mod, LFO-TVA Depth	-63 — 63	0	
Control Change	Pitch Control	Ctrl, Pitch Control	-48 — 48	0	
	TVF Control	Ctrl, TVF Control	-63 — 63	0	
	TVA Control	Ctrl, TVA Control	-63 — 63	0	
	LFO Rate Control	Ctrl, LFO Rate Control	-63 — 63	0	
	LFO Pitch Depth	Ctrl, LFO-Pitch Depth	-63 — 63	0	
	LFO TVF Depth	Ctrl, LFO-TVF Depth	-63 — 63	0	
	LFO TVA Depth	Ctrl, LFO-TVA Depth	-63 — 63	0	



**Partial Parameters**

Parameter		Display	Values	Initial Values	Page	
Partial Name		Partial Name	15 letters (ID+ Name)	space	Prtl Common	
Partial Level		Partial Lev	0 — 127	127		
Partial Panning		Panning	L32 — 0 — R32	0		
Partial Output Assing		Out Assign	A, (B) — (D), (1), (2) 3 — 8	A		
Partial Coarse Tune		Coarse Tune	-48 — 48	0		
Partial Fine Tune		Fine Tune	-50 — 50	0		
SMT Velocity Control		SMT V. Ctrl	Off, On	On		
TVF	SMT Component 1 — 4	Sample Select	Sample Name	Off, 1 — 512	Off	Prtl SMT
		Pitch Key Follow	K, F	-16/8 — -8/8 — Off — Norm — 16/8	Norm	
		Sample Coarse Tune	C, T	-48 — 48	0	
		Sample Fine Tune	F, T	-50 — 50	0	
		Sample Pan	Pan	L32 — 0 — R32, Rnd, Ky+, Ky-, Alt	0	
		Sample Level	Lev	0 — 127	127	
		Velocity Low Point	V, L	1 — 126	1	
		Velocity High Point	V, H	2 — 127	127	
		Fade Width Low	F, L	0 — 125	0	
		Fade Width High	F, H	0 — 125	0	
		Filter Mode	Filter Mode	Off, LPF, BPF, HPF	Off	Partial TVF
		Cutoff Frequency	Cutoff Freq	0 — 127	127	
		Resonance	Resonance	0 — 127	0	
		Cutoff Frequency Key Follow	Cutoff KF	-63 — 63	0	
		Key Follow Point	KF Point	A0 — C8	C4	
		Velocity Curve Type	Vel-Curve	1 — 4	2	
		Velocity Curve Sens	Vel-C. Sens	-63 — 63	0	
		Envelope TVF Depth	Envelope-TVF Depth	-63 — 63	63	
		Envelope Velocity Sens	Envelope-Vel Sens	-63 — 63	0	
		Envelope Pitch Depth	Envelope-Pitch Depth	-63 — 63	0	
		Time Velocity Sens	Time-Vel Sens	-63 — 63	0	
		Time Key Follow	Time-Key Follow	-63 — 63	0	
		Release Velocity Sens	R. Velo Sens	-63 — 63	0	
		Envelope Time 1	Time1	0 — 127	0	
		Envelope Level 1	Level1	0 — 127	127	
		Envelope Time 2	Time2	0 — 127	10	
		Envelope Level 2	Level2	0 — 127	127	
		Envelope Time 3	Time3	0 — 127	10	
	Envelope Level 3	Level3	0 — 127	127		
	Envelope Time 4	Time4	0 — 127	0		
	Envelope Level 4	Level4	0 — 127	0		

PARAMETER LISTS

	Parameter	Display	Values	Initial Values	Page
TVA	Velocity Curve Type	Vel-Curve	1 — 4	2	Partial TVA
	Velocity Curve Sens	Vel-C.Sens	-63 — 63	0	
	Level Key Follow	Level KF	-63 — 63	0	
	Key Follow Point	KF Point	A0 — C8	C4	
	Release Velocity Sens	R. Vel Sens	-63 — 63	0	
	Envelope Time 1	Time1	0 — 127	1	
	Envelope Level 1	Level1	0 — 127	127	
	Envelope Time 2	Time2	0 — 127	10	
	Envelope Level 2	Level2	0 — 127	127	
	Envelope Time 3	Time3	0 — 127	10	
	Envelope Level 3	Level3	0 — 127	127	
LFO	Waveform	Waveform	Sin, Tri, SwUP, swDW, Squ, Rnd, B. Up, B. DW	Sin	Partial LFO
	LFO Rate	Rate	0 — 127	102	
	LFO Rate Detune	Rate-Detune	0 — 127	0	
	LFO Delay	Delay	0 — 127	0	
	Delay Key Follow	Delay-Key Follow	0 — 63	0	
	Key Sync	Key Sync	Off, On	On	
	Pitch Modulation Depth	Pitch Depth	-63 — 63	0	
	TVF Modulation Depth	TVF Depth	-63 — 63	0	
TVA Modulation Depth	TVA Depth	-63 — 63	0		

Sample Parameters

Parameter	Display	Values	Page
Sample Name	Name	15 letters (Volume ID+Name)	Select Sample
Original Key	Key	A0 — C8	
Loop Mode	Loop	Forward, Fwd+R, OneShot, Fwd+One, Alt, Rev One, Rev	
Start Point	Start	0 —	
Loop Start Point	Loop	0 —	
Loop Start Fine Point	Loop, Fine	0 — 225	
Loop End Point	Loop, End	4 —	Loop & Smoothing
Loop Tuning	Loop, Tune	-50 — 50	
Release Loop Start Point	R Loop	14 —	
Release Loop Start Fine Point	R Loop, Fine	0 — 225	
Release Loop End Point	R Loop, End	18 —	
Release Loop Tuning	R Loop, Tune	-50 — 50	

# TEMPLATE PRESET LIST

A : Organ  
 B : Piano  
 C : Brass/Wind  
 D : Compress  
 E : Percussion Long  
 F : Percussion Short  
 G : Velocity Strings  
 H : Velocity Perc.  
 I : TVF Sweep Up/Down  
 J : TVF Sweep Down

## TVF

	A	B	C	D	E	F	G	H	I	J
Filter Mode	Off	Off	Off	Off	Off	Off	Off	Off	LPF	LPF
Cutoff Freq	70	70	70	70	70	70	70	70	50	50
Resonance	20	20	20	20	20	20	20	20	20	20
Cutoff KF	0	0	0	0	0	0	0	0	0	0
KF Point	C4	C4	C4	C4	C4	C4	C4	C4	C4	C4
Vel-Curve	2	2	2	2	2	2	2	2	2	2
Vel-C.Sens	0	0	0	0	0	0	0	0	0	0
Envelope-TVF Depth	63	63	63	63	63	63	63	63	63	63
Envelope-Vel Sens	0	0	0	0	0	0	0	0	0	0
Envelope-Pitch Depth	0	0	0	0	0	0	0	0	0	0
Time-Vel Sens	0	0	0	0	0	0	60	63	0	0
Time-Key Follow	0	10	0	0	0	0	0	0	0	0
R.Velo Sens	0	0	0	0	0	0	0	0	0	0
Time1	0	0	6	0	0	0	40	15	64	0
Level1	127	127	80	127	127	127	127	127	127	127
Time2	0	10	6	0	0	0	0	0	0	0
Level2	127	80	127	127	127	127	127	127	127	127
Time3	0	75	20	5	90	30	0	40	80	80
Level3	127	0	110	48	0	0	127	0	0	0
Time4	0	10	10	10	90	30	40	40	40	40
Level4	0	0	0	0	0	0	0	0	0	0

## TVA

	A	B	C	D	E	F	G	H	I	J
Vel-Curve	2	2	2	2	2	2	2	2	2	2
Vel-C.Sens	0	0	0	0	0	0	0	0	0	0
Level KF	0	0	0	0	0	0	0	0	0	0
KF Point	C4	C4	C4	C4	C4	C4	C4	C4	C4	C4
Time-Vel Sens	0	0	0	0	0	0	60	63	0	0
Time-Key Follow	0	10	0	0	0	0	0	0	0	0
R.Velo Sens	0	0	0	0	0	0	0	0	0	0
Time1	0	0	6	0	0	0	40	15	0	0
Level1	127	127	80	127	127	127	127	127	127	127
Time2	0	10	6	0	0	0	0	0	0	0
Level2	127	80	127	127	127	127	127	127	127	127
Time3	0	75	20	5	90	30	0	40	0	0
Level3	127	0	110	48	0	0	127	0	127	127
Time4	0	10	10	10	90	30	40	40	40	40

MIDI Implementation Chart

Function...		Rtransmitted	Recognized	Remarks
Basic Channel	Default	X	1—16, OFF *3	
	Changed	X	1—16, OFF *3	
Mode	Default	X	3	
	Messages	X	X	
	Altered	*****	X	
Note Number	True Voice	X	21—108	
		*****	21—108	
Velocity	Note ON	X	○	
	Note OFF	X	○	
After Touch	Key's Ch's	X	○ *1	
		X	X*	
Pitch Bend		X	○ *1	
Control Change	0—95	X	○	* 2
	1	X	○ *1	Modulation
	6, 38	X	○	Data entry
	7	X	○ *1	Volume
	10	X	○ *1	Pan
	64	X	○ *1	Hola 1
	100, 101	X	○	RPN LSB, MSB
Prog Change	True #	X *****	0—127 *1	
System Exclusive		X *1	X *1	
System Common	Song Pos	X	X	
	Song Sel	X	X	
	Tune	X	X	
System Real Time	Clock Commands	X X	X X	
Aux Messages	Local ON/OFF	X	X	
	All Notes OFF	X	○ (123—127)	
	Active Sense	X	○	
	Reset	X	X	
Notes		*1 ○ or X selectable. *2 optional setting. *3 multiple basic setting can be made.		

# Specifications

## S-760: DIGITAL SAMPLER

### Maximum Poliphony

24 voice

### Sampling Method

DI(Differential Interpolation)synthesis

### Sampling Frequency

48KHz,44.1KHz,32KHz,24KHz,22.05KHz,16KHz

### Data Format

16 bit linear

### Signal Processing

A/D Conversion : 16-bit  
D/A Conversion : 18-bit  
Internal Processing : 24-bit linear

### Disk Drive

3.5"Floppy Disk Drive(2HD/2DD)

### External Media Interface

SCSI connector : 1

### Display

160 x 64 dots(backlit LCD)

### Effects

2 band equalizer : 8

### Wave Memory

RAM : 2Mbytes(maximum installed:32Mbytes)

### Internal Memory

Volume : 1  
Performance : 64  
Patch : 128  
Partial : 255  
Sample : 512

### Connectors

Headphone jack(stereo) : 1  
Stereo input jack : 1  
(L(mono): 1, R: 1)  
Stereo output jacks : 2  
(INDIVIDUAL OUTPUT jacks: 4)  
MIDI connectors : IN,OUT/THRU  
SCSI connectors : 1  
AC inlet : 1

**Frequency Response (A/D — D/A)**

Sampling frequency 48KHz : 10Hz-23.4KHz(+0/-3dB)  
Sampling frequency 44.1KHz : 10Hz-21.5KHz(+0/-3dB)  
Sampling frequency 32KHz : 10Hz-15.5KHz(+0/-3dB)

**Residual Noise Level(IHF-A Type)**

Stereo output 1 or Individual output 1-2  
less than -100dBm (all volume MAX)  
Stereo output 2 or Individual output 3-4  
less than -100dBm

**Input Level(rec level MAX)**

-15dBm

**Maximum Output Level**

+15dBm

**Output Impedance**

1.6k $\Omega$

**Power Supply**

AC117V,AC230V or AC240V(50/60Hz)

**Power Consumption**

AC117V,AC230V or AC240V:25W

**Dimensions:**

482(W) x 362.3(D) x 44.8(H)mm  
19(W) x 14-5/16(D) x 1-13/16(H)inches  
(EIA-1U rack mount type)

**Weight**

4.2kg  
9 lbs 5 oz

**Included Items**

Owner's Manual : 2  
The list of SCSI compatible devices for S-760" : 1  
3.5 inch(2HD)System Disk : 1  
3.5 inch(2HD)Sound Disk : 1  
MIDI Cable : 1

---

**Options**

Memory Expander : SIM72-8(8Mbyte)  
: SIM72-16(16Mbyte)

SCSI cable : C-5025-6(full-pitch 50pin and D-Sub 25pin)  
: C-5050-6(full-pitch 50pin and full-pitch 50pin)

## CD-ROM disks

for S-770/750/SP-700 : L-CD series,L-CDP series,RS-1,USV-3,DS-60711,C50CD02,PSEL-1  
for S-550/W-30(Convert Load necessary)  
: USV-2,C50CD01

MIDI cable : MSC-15/25/50

**\* In the interest of product development, the specifications and/or appearance of this unit are subject to change without prior notice.**

# Index

- A**
- Alphabetical Sort (Disk) ..... Advanced 3-86
  - Alphabetical Sort (Performance) ..... Advanced 5-10
  - Alphabetical Sort (Partial) ..... Advanced 5-10
  - Alphabetical Sort (Patch) ..... Advanced 5-10
  - Alphabetical Sort (Sample) ..... Advanced 5-10
  - Alternate (Loop Mode) ..... Advanced 3-69
  - Analog Feel ..... Advanced 3-14
  - Area (Number) ..... Advanced 3-88
  - Area Erase ..... Advanced 3-59
  - ASCII Keyboard ..... Basic 7-12
  - Assign Type ..... Advanced 3-17
  - Auto Truncate ..... Advanced 3-50
- B**
- Bit Convert ..... Advanced 3-56
  - Boot Drive ..... Advanced 3-94
  - Bypass (Equalizer) ..... Basic 3-13, Advanced 3-5
- C**
- CD-ROM Disk ..... Basic 1-2, Basic 2-10
  - CD-ROM Drive ..... Basic 1-2, Advanced 7-2
  - Channel (Part) ..... Advanced 3-2
  - Channel Aftertouch ..... Advanced 3-6
  - Channel Converter ..... Advanced 5-6
  - Clear (MIDI Monitor) ..... Advanced 3-7
  - Coarse Tune (Partial) ..... Advanced 3-23
  - Coarse Tune (Patch) ..... Advanced 3-14
  - Coarse Tune (Sample) ..... Advanced 3-25
  - COMMAND button ..... Basic 7-7
  - Combine ..... Advanced 3-64
  - Component ..... Advanced 3-24
  - Compress/Expand ..... Advanced 3-53
  - Control Channel ..... Basic 9-2, Advanced 3-96
  - Control Mode ..... Basic 9-2, Advanced 3-97
  - Controller ..... Advanced 3-92
  - Convert Load ..... Advanced 3-88
  - Copy ..... Advanced 5-2
  - Copy MIDI Filter/EQ ..... Advanced 5-6
  - Current Drive ..... Basic 2-7
  - Cursor ..... Basic 7-5
  - Cutoff Frequency (Partial) ..... Advanced 3-28
  - Cutoff Frequency Key Follow ..... Advanced 3-29
  - Cut & Splice ..... Advanced 3-58
- D**
- Delay Vibrato ..... Advanced 3-40
  - Delete ..... Advanced 5-2
  - Delete (Quick Load) ..... Advanced 3-8
  - Delete (Volume ID) ..... Advanced 6-25
  - Device ID ..... Advanced 3-97
  - Device Number (SCSI ID) ..... Advanced 7-2
  - Digital Attenuator ..... Advanced 3-44
  - Digital Booster ..... Advanced 3-92
  - Digital Filter ..... Advanced 3-52
  - Disk Copy ..... Advanced 3-75
  - Disk Delete ..... Advanced 3-79
  - Disk Load ..... Advanced 3-70
  - Disk Save ..... Advanced 3-72
  - Disk Utility ..... Advanced 3-82
- E**
- Edit ..... Basic 7-2
  - Edit Mode (Equalizer) ..... Advanced 3-5
  - Edit Mode (Partial) ..... Advanced 3-24
  - Emphasis (Digital Filter) ..... Advanced 3-52
- F**
- Equalizer ..... Advanced 3-5
  - EXIT ..... Basic 7-6
- F**
- Fast Delete Mode ..... Advanced 3-95
  - Filter Mode (Partial) ..... Advanced 3-28
  - Fine Tune (Patch) ..... Advanced 3-14
  - Fine Tune (Partial) ..... Advanced 3-23
  - Fine Tune (Sample) ..... Advanced 3-25
  - Format ..... Advanced 3-84
  - Forward (Loop Mode) ..... Advanced 3-68
  - Forward + One Shot (Loop Mode) ..... Advanced 3-68
  - Forward + Release (Loop Mode) ..... Advanced 3-68
  - Function buttons ..... Basic 7-5
- G**
- Global Edit (Partial) ..... Advanced 3-24
- H**
- Hard Disk ..... Basic 1-2, Basic 5-3
- I**
- Individual Edit (Equalizer) ..... Advanced 3-5
  - Individual Output ..... Advanced 3-92, Advanced 4-4
  - Initial Drive ..... Advanced 3-94
  - Initial Volume ..... Advanced 3-94
  - Initialize ..... Advanced 5-2
  - Insert ..... Advanced 3-60
  - Insert Mode ..... Basic 7-13
  - Internal Memory ..... Basic 8-5
  - Interval (Volume Dump) ..... Advanced 3-98
- J**
- Jump ..... Basic 7-8
- K**
- Key On Mode ..... Advanced 3-49
  - Key Sync (LFO) ..... Advanced 3-40
- L**
- LCD Contrast ..... Advanced 3-91
  - Level (Part) ..... Advanced 3-2
  - Level (Partial) ..... Advanced 3-23
  - Level (Patch) ..... Advanced 3-13
  - Level (Sample) ..... Advanced 3-26
  - LFO Delay ..... Advanced 3-40
  - LFO Rate ..... Advanced 3-40
  - Listen Delete ..... Advanced 5-5, Advanced 6-5
  - Load (Sound Data) ..... Basic 8-8, Advanced 3-70
  - Load (System) ..... Basic 8-7, Advanced 3-104
  - Loop ..... Advanced 3-48
  - Lower Case Letter (NAME) ..... Basic 7-13
- M**
- Mark Set ..... Basic 7-8
  - Mark Switch ..... Advanced 3-46
  - Master Frequency ..... Advanced 3-91
  - Master Level ..... Advanced 3-91
  - Master Tune ..... Advanced 3-91
  - Maximum Polyphony ..... Basic 0-3, Advanced 3-14
  - Memory Expander ..... Basic 1-3
  - MIDI Channel (Control) ..... Advanced 3-96
  - MIDI Channel (Part) ..... Advanced 3-2
  - MIDI Filter ..... Advanced 3-5
  - MIDI Monitor ..... Advanced 3-7



MIDI Switch ..... Advanced 3-17  
 Mixing ..... Advanced 3-62  
 Mode ..... Basic 7-2  
 Module Monitor ..... Advanced 3-7

**N**

Normalize ..... Advanced 3-44

**O**

Octave Shift (Patch) ..... Advanced 3-14  
 Optimize ..... Advanced 3-86  
 Original Key ..... Advanced 3-42  
 Output Assign (Part) ..... Advanced 3-2, Advanced 4-6  
 Output Assign (Partial) ..... Advanced 3-23, Advanced 4-6  
 Output Assign (Patch) ..... Advanced 3-14, Advanced 4-6  
 Output Assign C/D ..... Advanced 3-92, Advanced 4-5  
 Output Mode ..... Basic 3-13, Advanced 3-92  
 One Shot (Loop Mode) ..... Advanced 3-68  
 Overwrite Mode ..... Basic 8-12  
 Overwrite Switch ..... Basic 8-12, Advanced 3-96

**P**

Page Box ..... Basic 7-5  
 Page Mark ..... Basic 7-5  
 Pan (Part) ..... Advanced 3-2  
 Pan (Partial) ..... Advanced 3-23  
 Pan (Patch) ..... Advanced 3-14, Advanced 4-8  
 Pan (Sample) ..... Advanced 3-26  
 Park Heads ..... Advanced 3-84  
 Part ..... Advanced 3-2  
 Part Split ..... Advanced 6-24  
 Partial ..... Basic 8-2, Advanced 3-22  
 Patch ..... Basic 8-2, Advanced 3-13  
 Patch Priority ..... Advanced 3-14  
 Patch Split ..... Advanced 3-16, Advanced 6-21  
 Performance ..... Basic 8-2, Advanced 3-2  
 Phase Lock ..... Advanced 3-6  
 Pitch Bend ..... Advanced 3-19  
 Pitch Key Follow ..... Advanced 3-24  
 Polyphonic Aftertouch ..... Advanced 3-6  
 Positional Crossfade ..... Advanced 6-24  
 Power Sampling Expansion (OP-760-1) ..... Basic 1-5  
 Preset (Template) ..... Advanced 5-8  
 Preview Function ..... Advanced 3-93, Advanced 6-26  
 Previous Sampling ..... Advanced 3-44  
 Program Change ..... Basic 9-2, Advanced 3-97  
 Program Number (Patch) ..... Basic 9-2, Advanced 3-15  
 Program Number (Performance) ..... Basic 9-4, Advanced 5-10  
 Program Number (Volume) ..... Basic 9-5, Advanced 3-83  
 Program Number Sort (Patch) ..... Advanced 5-10  
 Program Number Sort (Performance) ..... Advanced 5-10

**Q**

Quick Edit ..... Advanced 3-11  
 Quick Load ..... Advanced 3-8, Advanced 6-2  
 Quick Sampling (Patch) ..... Advanced 3-21, Advanced 6-18  
 Quick Sampling (Partial) ..... Advanced 3-41, Advanced 6-18  
 Quick Sampling (Performance) ..... Advanced 3-10

**R**

Rate Convert ..... Advanced 3-55  
 Recover Function ..... Advanced 3-93  
 Release Loop ..... Advanced 3-48  
 Rename Partials ..... Advanced 5-7  
 Resonance (Partial) ..... Advanced 3-28  
 Restart ..... Advanced 3-84

Reverse (Loop Mode) ..... Advanced 3-69  
 Reverse One shot (Loop Mode) ..... Advanced 3-69

**S**

Sample ..... Basic 8-2, Advanced 3-42  
 Sample Dump ..... Advanced 3-99, Advanced 6-12  
 Sample Mix Table (SMT) ..... Advanced 3-24  
 Sampling Frequency ..... Advanced 3-43  
 Save (Sound Data) ..... Basic 8-9, Advanced 3-72  
 Save (System) ..... Basic 8-7, Advanced 3-85  
 Scan ..... Basic 2-7  
 SCSI ..... Advanced 7-2  
 SCSI Chain ..... Advanced 7-3  
 SCSI ID (Device Number) ..... Advanced 7-2  
 Set Stereo/Mono (Sample) ..... Advanced 5-9  
 Single Edit (Partial) ..... Advanced 3-24  
 Smoothing ..... Advanced 3-50  
 Sound Data ..... Basic 8-2  
 Split Mode ..... Advanced 3-18  
 Stereo Edit (Equalizer) ..... Advanced 3-5  
 Stereo Output ..... Advanced 3-92, Advanced 4-4  
 Streaming Tape Backup Device ..... Advanced 3-75  
 System (Program & Parameter) ..... Basic 8-7  
 System Backup Memory ..... Basic 8-7, Advanced 3-104  
 System Dump ..... Advanced 3-98, Advanced 6-6  
 S-770/750 ..... Basic 1-2, Advanced 7-6  
 SP-700 ..... Basic 1-2, Advanced 7-6  
 SYS-772 Version 2.0 ..... Basic 1-2, Advanced 7-6

**T**

Template ..... Advanced 5-8  
 Terminator ..... Advanced 7-4  
 Threshold ..... Advanced 3-45  
 Time Display ..... Advanced 3-92  
 Time Key Follow (TVA) ..... Advanced 3-36  
 Time Key Follow (TVF) ..... Advanced 3-32  
 Time Stretch ..... Advanced 3-51  
 Time Velocity Sens (TVA) ..... Advanced 3-36  
 Time Velocity Sens (TVF) ..... Advanced 3-32  
 Trigger Source ..... Advanced 3-44  
 Truncate ..... Advanced 3-57  
 TVA Envelope (Partial) ..... Advanced 3-37  
 TVF Envelope (Partial) ..... Advanced 3-33

**U**

Upper Case Letter (NAME) ..... Basic 7-13  
 User Set (Template) ..... Advanced 5-8

**V**

Velocity Crossfade ..... Advanced 6-24  
 Velocity Curve Sens (TVA) ..... Advanced 3-35  
 Velocity Curve Sens (TVF) ..... Advanced 3-30  
 Velocity Curve Type (MIDI Filter) ..... Advanced 3-6  
 Velocity Curve Type (TVA) ..... Advanced 3-34  
 Velocity Curve Type (TVF) ..... Advanced 3-29  
 Velocity Mix ..... Advanced 3-27  
 Velocity Switch ..... Advanced 3-27  
 Volume ..... Basic 8-2  
 Volume Dump ..... Advanced 6-8  
 Volume ID ..... Basic 8-4, Advanced 3-103

**W**

Wait Trigger (MIDI Monitor) ..... Advanced 3-7  
 Waveform (LFO) ..... Advanced 3-39  
 Wave Memory ..... Basic 1-3, Basic 8-5

.....

# MEMO

.....

---

# SCSI compatible devices for S-760

## S-760 に接続できる SCSI 機器

---

The following devices can be connected to the S-760 by using the SCSI interface.

ローランドで、動作確認を行った機種として、次のものがあります。

---

In order to connect a SCSI device to the S-760, you will need to have the appropriate SCSI cable. The SCSI connector on the S-760 is the DB-25 type. You should check the shape of the connector on your SCSI device and count the number of pins it has to make sure you obtain the right SCSI cable. Refer to the section "About SCSI" of the S-760's owner's manual (Advanced Operation).

Note that you will not to use any SCSI driver software that may have been supplied with your SCSI device.

SCSI 機器と S-760 を接続するには、SCSI ケーブルが必要です。

S-760 の SCSI コネクターは、D-SUB 25 ピンです。SCSI 機器を S-760 に接続するには、その SCSI 機器の SCSI コネクターの形状とピン数をご確認の上、SCSI ケーブルをご用意いただくことになります。S-760 の取扱説明書 (応用編) の「SCSI について」をご覧ください。

また、SCSI 機器に付属されている、SCSI ドライバーなどのソフトウェアは、使用する必要はありません。

The operation of the following products listed below have been checked by Roland.

下記のリストは、ローランドで動作確認をしたものです。

### ●CD-ROM drives

TEXEL CORPORATION  
DM-5024 (double speed/2 倍速)

APPLE COMPUTER, INC.  
AppleCD 300 (double speed/2 倍速)

TOSHIBA CORPORATION  
XM-3300A (Japan only/日本国内のみ)  
XM-3400A (Japan only/日本国内のみ)  
(double speed/2 倍速)

関東電子 (株) (LOGITEC)  
LCD-M500 (Japan only/日本国内のみ)  
(double speed/2 倍速)

CHINON (CHINON AMERICA,INC)  
CDX-535 (USA only/USAのみ)  
(double speed/2 倍速)

ヤノ電器 (株)  
CD295C (Japan only/日本国内のみ)  
(double speed/2 倍速)

PIONEER ELECTRONIC CORPORATION  
DRM-604X (six-disk/6連)

SONY CORPORATION (Hardware Manufacturer)  
CDU561-02 (double speed/2 倍速)

ROLAND CORPORATION  
CD-5

### ●Magneto-Optical drives

{5 inch}

SONY CORPORATION  
RMO-S550

ROLAND CORPORATION  
MO-7

Available removable disks/使用できるディスク  
Sony Corporation  
EDM-1DA1 (512 Byte/Sector)  
Seiko/Epson Corporation  
EPM-C51 (512 Byte/Sector)

MAXTOR CORPORATION  
TAHITI-2

Available removable disks/使用できるディスク  
MAXOPTIX Corporation  
1 Gigabyte (512 Byte/Sector)  
650 Megabyte (512 Byte/Sector)

KUBOTA CORPORATION  
TAHITI-1000S (Japan only/日本国内のみ)

Available removable disks/使用できるディスク  
KUBOTA Corporation  
C1000-512 (512 Byte/Sector)  
C650-512 (512 Byte/Sector)

RICOH COMPANY, LTD.  
RS-9200EX (Japan only/日本国内のみ)

Available removable disks/使用できるディスク  
RICOH Company, Ltd.  
ROD-5064F (512 Byte/Sector)

<3.5 inch>

SONY CORPORATION \*  
RMO-S350  
RMO-S360

RICOH COMPANY, LTD. \*  
RS-3100EX (Japan only/日本国内のみ)

MIDORI ELECTRONICS CO., LTD. \*  
OMC-120 (Japan only/日本国内のみ)

ヤノ電器 (株) \*  
MO128C (Japan only/日本国内のみ)

\* In most cases, any magneto-optical disk of a capacity 128 MBytes single-sided can be used with 3.5 inch magneto-optical drive.

\* 3.5 inch の光磁気ディスク・ドライブでは、128 MByte single-sided のディスクであれば、基本的にすべて使用できます。

## ●Hard Disk drives

In most cases, any hard disk of a capacity less than 600 megabytes can be used with S-760. Although you can use hard disks that are larger than 600 megabytes. So, for example, with an 800 megabytes disk, you would have 600 megabytes of usable, and 200 megabytes that must remain idle.

You can also use removable-media hard disk drives ( SyQuest 44 megabytes and 88 megabytes disks) .

容量が 600 メガバイト以下のハード・ディスクであれば、基本的にすべて使用できます。600 メガバイトより容量の大きいハード・ディスクも使用できますが、使用できる容量は 600 メガバイトまでです。たとえば、800 メガバイトのハード・ディスクの場合、600 メガバイトまで使用でき、残りの 200 メガバイトは、一切使用できません。また、リムーバブル式のハード・ディスク (SyQuest タイプの 44 メガバイトと 88 メガバイト) も使用できます。

## ●Streaming Tape drives

<4 mm DAT>

WangDAT (Hardware Manufacturer) \*  
1300

ARCHIVE (Hardware Manufacturer) \*  
4360XT

Roland CORPORATION \*  
DDS-80 (Japan only/日本国内のみ)

\* We recommend you to use data-grade DDS DAT cassettes.

\* データ・グレード DDS DAT のカセットを使用することを推奨します。



# Roland

DIGITAL SAMPLER

# S-760

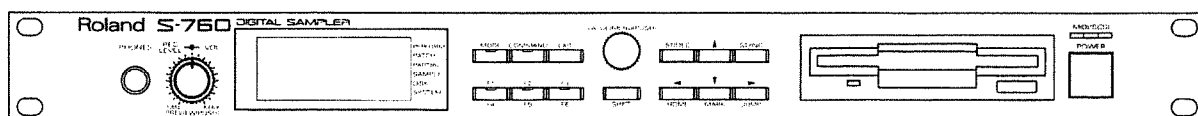
OWNER'S MANUAL  
(Basic Operation)



	<b>CAUTION</b> RISK OF ELECTRIC SHOCK DO NOT OPEN	
<b>ATTENTION</b> RISQUE DE CHOC ELECTRIQUE NE PAS OUVRI		
<p><b>CAUTION:</b> TO REDUCE THE RISK OF ELECTRIC SHOCK, DO NOT REMOVE COVER (OR BACK). NO USER-SERVICEABLE PARTS INSIDE. REFER SERVICING TO QUALIFIED SERVICE PERSONNEL.</p>		



The lightning flash with arrowhead symbol, within an equilateral triangle, is intended to alert the user to the presence of uninsulated "dangerous voltage" within the product's enclosure that may be of sufficient magnitude to constitute a risk of electric shock to persons.



The exclamation point within an equilateral triangle is intended to alert the user to the presence of important operating and maintenance (servicing) instructions in the literature accompanying the product.

INSTRUCTIONS PERTAINING TO A RISK OF FIRE, ELECTRIC SHOCK, OR INJURY TO PERSONS.

## IMPORTANT SAFETY INSTRUCTIONS SAVE THESE INSTRUCTIONS

**WARNING** - When using electric products, basic precautions should always be followed, including the following:

1. Read all the instructions before using the product.
2. Do not use this product near water — for example, near a bathtub, washbowl, kitchen sink, in a wet basement, or near a swimming pool, or the like.
3. This product should be used only with a cart or stand that is recommended by the manufacturer.
4. This product, either alone or in combination with an amplifier and headphones or speakers, may be capable of producing sound levels that could cause permanent hearing loss. Do not operate for a long period of time at a high volume level or at a level that is uncomfortable. If you experience any hearing loss or ringing in the ears, you should consult an audiologist.
5. The product should be located so that its location or position does not interfere with its proper ventilation.
6. The product should be located away from heat sources such as radiators, heat registers, or other products that produce heat.
7. The product should be connected to a power supply only of the type described in the operating instructions or as marked on the product.
8. The power-supply cord of the product should be unplugged from the outlet when left unused for a long period of time.
9. Care should be taken so that objects do not fall and liquids are not spilled into the enclosure through openings.
10. The product should be serviced by qualified service personnel when:
  - A. The power-supply cord or the plug has been damaged; or
  - B. Objects have fallen, or liquid has been spilled onto the product; or
  - C. The product has been exposed to rain; or
  - D. The product does not appear to operate normally or exhibits a marked change in performance; or
  - E. The product has been dropped, or the enclosure damaged.
11. Do not attempt to service the product beyond that described in the user-maintenance instructions. All other servicing should be referred to qualified service personnel.

For the USA

### GROUNDING INSTRUCTIONS

This product must be grounded. If it should malfunction or breakdown, grounding provides a path of least resistance for electric current to reduce the risk of electric shock.

This product is equipped with a cord having an equipment-grounding conductor and a grounding plug. The plug must be plugged into an appropriate outlet that is properly installed and grounded in accordance with all local codes and ordinances.

**DANGER:** Improper connection of the equipment-grounding conductor can result in a risk of electric shock. Check with a qualified electrician or serviceman if you are in doubt as to whether the product is properly grounded. Do not modify the plug provided with the product — if it will not fit the outlet, have a proper outlet installed by a qualified electrician.

For the U.K.

**IMPORTANT:** THE WIRES IN THIS MAINS LEAD ARE COLOURED IN ACCORDANCE WITH THE FOLLOWING CODE.

BLUE	: NEUTRAL
BROWN	: LIVE

As the colours of the wires in the mains lead of this apparatus may not correspond with the coloured markings identifying the terminals in your plug, proceed as follows:

The wire which is coloured BLUE must be connected to the terminal which is marked with the letter N or coloured BLACK.  
The wire which is coloured BROWN must be connected to the terminal which is marked with the letter L or coloured RED.

The product which is equipped with a THREE WIRE GROUNDING TYPE LINE PLUG must be grounded.

# Attention all S-760 users

Depending on the version of S-760 system software and whether or not the Power Sampling Expansion (OP-760-1) has been installed, the available functions and operation procedures will be different. The way in which you read the manuals will depend on your setup.

With the S-760 (Ver.1), two manuals are included: "Basic Operation" and "Advanced Operation".

With the S-760 Ver.2, the above two manuals and an additional manual titled "S-760 Ver.2/OP-760-1" are included.

With the OP-760-1, one manual is included: "S-760 Ver.2/OP-760-1" .

These manuals contain the following contents.

## [Basic Operation]

This manual explains basic ideas and operation of the S-760 Ver.1. It explains how to operate the unit using its LCD display and the front panel buttons.

## [Advanced Operation]

This manual explains more advanced uses, such as how to edit S-760 Ver.1 sounds. It explains how to operate the unit using its LCD display and the front panel buttons.

## [S-760 Ver.2 / OP-760-1]

This manual explains the functions and parameters which were added/modified in S-760 System Software Ver.2, and the functions and operation of the OP-760-1 which is available as an option for the S-760. Refer to this manual for how to operate the unit using a CRT display and mouse.

## Caution!

**The functions of the OP-760-1 are available only when the S-760 is started up using S-760 System Software Ver.2. If you start up using Ver.1, you will not be able to use the OP-760-1 even if it is installed.**

Note the following points applicable to your system, and read the appropriate sections of each manual.

### ■ If you upgraded from Ver.1 to Ver.2

Start up the S-760 using the Ver.2 system disk.

You will be able to use the functions of S-760 System Software Ver.2, but the functions of the OP-760-1 will not be available.

### ■ If you previously owned an S-760 (Ver.1) and newly purchased an OP-760-1

Start up the S-760 using the system disk (Ver.2) included with the OP-760-1. You will be able to use all the functions of S-760 System Software Ver.2 and the OP-760-1. Refer to "S-760 Ver.2/OP-760-1".

### ■ If you purchased an S-760 (Ver.1) and an OP-760-1 together

Start up the S-760 using the system disk (Ver.2) included with the OP-760-1. You will be able to use all the functions of S-760 System Software Ver.2 and the OP-760-1. Refer to "Basic Operation" and "S-760 Ver.2/OP-760-1." As necessary, refer to "Advanced Operation."

### ■ If you purchased an S-760 Ver.2 by itself

Refer to "Basic Operation" and "S-760 Ver.2/OP-760-1." As necessary, refer to "Advanced Operation." You will be able to use the functions of S-760 System Software Ver.2, but not the functions of the OP-760-1.

### ■ If you purchased an S-760 Ver.2 and an OP-760-1 together

Refer to "Basic Operation" and "S-760 Ver.2/OP-760-1." As necessary, refer to "Advanced Operation." The system disk for the S-760 Ver.2 and the system disk (Ver.2) included with the OP-760-1 are identical. You may use either of them to start up the S-760. You will be able to use all the functions of the S-760 System Software Ver.2 and the OP-760-1.

### ■ If you previously owned an S-760 Ver.2 and newly purchased an OP-760-1

Refer to "S-760 Ver.2/OP-760-1." The system disk for the S-760 Ver.2 and the system disk (Ver.2) included with the OP-760-1 are identical. You may use either of them to start up the S-760. You will be able to use all the functions of the S-760 System Software Ver.2 and the OP-760-1.

Please be aware of the following points as well.

### ■ Start up / shut down procedure

Start up using the system disk (Ver.2). To start up/shut down, refer to "Starting up and shutting down" (Basic Operation p.1-6).

If you wish to start up from a hard disk rather than from a floppy disk, refer to "Starting up from a hard disk" (Basic Operation p.5-1).

Ver.1 users should refer to the following item "How to upgrade from Ver.1 to Ver.2."

If you have installed an OP-760-1 and wish to use a CRT and mouse, make connections before startup (Ver.2 p.2-3). For details on how to switch to CRT display and mouse operation, refer to "Operation using the CRT display and mouse / RC-100" (Ver.2 p.3-1).

### ■ Backing up the system disk

The system disk (Ver.2) is very important, and you should make a backup and keep the original disk in a safe place. For details refer to "Backing up the System Disk" (Basic Operation p.1-8).

### ■ Attention S-760 Ver.1 users

#### ● How to upgrade from Ver.1 to Ver.2

If you start up using the Ver.2 system disk, you will be able to use the functions of S-760 System Software Ver.2. However the system program and system parameters are always saved together. If when you were using the Ver.1 system disk you modified the system parameters from their factory settings and then saved them, the system parameters will return to their factory settings when you start up using the Ver.2 system disk.

For details on upgrading, refer to "Upgrading to a new version of the system" (Advanced Operation p.6-6). There are two types of system parameters, so also refer to "Loading/Saving the system" (Basic Operation p.8-7).

### Caution!

The display screen structure differs between Ver.1 and Ver.2. For this reason, screen mark lists saved in Ver.1 (system parameter) cannot be used in Ver.2. Even if you follow the procedure in "Upgrading to a new version of the system" to load system dumped data, the mark list data will be unrecognized by Ver.2. If you wish to keep the mark list data you saved, you will have to write it down and re-input it after upgrading. Other data which is system dumped (the quick load list, the volume ID list, the user set template list) can be used by Ver.2

#### ● Sound data compatibility between Ver.1 and Ver.2

Some sound parameters have been added/modified in Ver.2, but all sounds created on the S-760 Ver.1 can be used just as they are in Ver.2. For details refer to "Functions added/modified in Ver.2" (Ver.2 p.1-1).

Please be aware that the sections "Sound data compatibility" (Advanced Operation p.2-1) and "PARAMETER LISTS" (Advanced Operation p.7-16) were written for Ver.1.



# Digital Sampler Roland S-760

---

## Owner's Manual: Basic Operation

### Introduction

Thank you for purchasing the Roland S-760 Digital Sampler. In order to take full advantage of the S-760 and to enjoy long years of trouble-free use, please read this manual carefully.

---

Copyright © 1993 ROLAND CORPORATION

All rights reserved. No part of this publication may be reproduced in any form without the permission of ROLAND CORPORATION.

# How to use the owner's manuals

---

The S-760 comes with two manuals which are organized as follows. In order to avoid unnecessary problems please first read the "Basic operation" manual to understand the basic concepts and operating procedures of the S-760. The "Advanced operation" manual explains how to take further advantage of the S-760's more advanced capabilities such as sound editing, and you can read each section as necessary.

## Basic Owner's manual

### Chapter 1. Before you begin

This chapter explains the preparations necessary for use, such as making connections, starting up and shutting down, and making a backup of the system disk.

### Chapter 2. Play the S-760

This chapter explains how to load sounds and play them.

### Chapter 3. Sample and create a sound

This chapter explains the procedure of sampling a sound, using the equalizer to modify it, and playing it.

### Chapter 4. Save your sounds

Sound data is lost when the power is turned off. This chapter explains how to save it.

### Chapter 5. Starting up the system from a hard disk

In addition to starting up the S-760 system from a floppy disk, it is also possible to start up from a hard disk. This chapter explains the procedure.

### Chapter 6. Convenient ways to start up the system

You can choose the disk drive from which the S-760 will be started up, or start up with different settings. This chapter explains the procedure.

### Chapter 7. Operations

This chapter explains the 6 modes, about the display, how to use the buttons, and how to assign names, etc.

### Chapter 8. How the S-760 is organized

This chapter explains how the S-760 works — how a sound is organized, how sound data and other data is managed, and about the audio signal flow.

### Chapter 9. Using MIDI to select sounds

Program Change Messages from an external MIDI controller can be used to select Patches, Performances, or Volumes. This chapter explains the procedure.

## Advanced Owner's manual

### Chapter 1. Sound editing procedure

There are various ways to edit sounds. This chapter explains the procedure.

### Chapter 2. Sound data compatibility

This chapter explains how S-760 sound data is compatible with S-770/750 (SYS-772 Version 2.0) or SP-700 sound data.

### Chapter 3. Parameters

This chapter explains each parameter.

### Chapter 4. Interrelated parameters

This chapter explains parameters (such as Volume and Output) which must be understood in their relation to the entire structure of sound.

### Chapter 5. Command/List displays

This chapter explains the Command and List displays.

### Chapter 6. Complex procedures

This chapter explains the more difficult or complex procedures.

### Chapter 7. Appendices

This chapter provides useful supplementary information on SCSI, troubleshooting and error messages, and parameter lists.

**\* The explanations in this manual include various illustrations of the LCD display. Please be aware that the factory preset data (sound names, etc.) will not necessarily be identical to the data shown in these LCDs.**

# Main features

---

## High-capacity sound data handling

- D-Sub 25 pin SCSI connector is standard, allowing SCSI-compatible devices such as CD-ROM drives, magneto-optical disk drives, and hard disks to be connected for high-speed loading, saving and searching of sound data.
- The sound data of the S-760 is compatible with the Roland S-770/750 (SYS-772 Version 2.0) Digital Sampler and the Roland SP-700 Sample Player, allowing you to make use of the vast sound libraries available for these instruments. You can use sound data from CD-ROM, magneto-optical disks, hard disks, and floppy disks. It is also possible to use S-550/W-30 sounds via the Convert Load operation (CD-ROM, hard disk).
- Quick Load function is provided so that you can register frequently-used sounds for easy loading, shortening the time required to find the sound you want from massive sound libraries such as on a CD-ROM disk.
- 2 Mbyte of wave memory (RAM) is standard, and separately sold memory expander modules (SIM72-8, SIM72-16) can be installed to increase the wave memory to a maximum of 32 Mbytes. For wave memory installation (Basic Operation, p.1-3), please consult a Roland Service Station or your dealer.
- Sounds saved on hard disk etc. can be copied to a SCSI-compatible tape streamer, allowing sounds to be backed up on DDS (digital data storage) tapes.
- Sampling frequencies up to 48 kHz can be used, allowing long and high quality stereo sampling.

## Versatility for live performance

- Up to 24 simultaneous notes can be produced and sent from the two sets of stereo outputs. Patches can be assigned to the desired output.

## User-friendly operation

- The Mark/Jump feature allows you to move directly to the desired page.
- Operating procedures are consistent and intuitive, allowing you to enjoy sampling without requiring excessive background knowledge.
- No complex settings are required before or after sampling. You can also sample while using the equalizer to adjust or modify sounds.
- When a separately sold Power Sampling Expansion (OP-760-1) has been installed, you can connect a mouse and CRT for more visual operation. This also provides you with one digital input and two digital outputs, for loss-free sampling and playback. For installation of the Power Sampling Expansion, please consult a Roland Service Station or your dealer.

## A full complement of editing functions

- Each output has an independent 2-band equalizer, for adjusting or modifying sounds.
- Sounds can be created just as on a synthesizer, with parameters such as TVF, TVA and LFO to modify the sample data.
- The Sample Mix Table (SMT) allows you to use velocity to control up to 4 sample mix ratios.
- Polyphonic Aftertouch is also received, for sensitive expressiveness in performance.
- Positional Crossfade allows you to create smooth splits across the keyboard.
- The Listen Delete function allows you to turn off, by Splits in a Patch, each Partial that was not used during a performance. By executing this function before saving to hard disk etc., you can avoid saving unneeded sound data and save memory.

# Precautions

---

## Power Supply

- All data in the internal memory of the S-760 is erased once the power has been turned off. therefore, you should be careful not to inadvertently press the power switch or disconnect the power plug from the outlet. Also, be sure to save important data regularly (and often)!
- Before connecting this unit to other devices, turn off the power to all units; this will help prevent damage or malfunction.
- Do not use this unit on the same power circuit with any device that will generate line noise; an electric motor or variable lighting system for example.

## Placement

- Using the unit near power amplifiers (or other equipment containing large power transformers) may induce hum.
- This device may interfere with radio and television reception. Do not use this device in the vicinity of such receivers.
- Observe the following when using the unit's disk drive. For further details, refer to "Before Using Disks".
- Do not place the unit near devices that produce a strong magnetic field (eg., loudspeakers).
- Install the unit on a solid, level surface.
- Do not move the unit or subject it to vibration while the drive is operating.

## Maintenance

- For everyday cleaning wipe the unit with a soft, dry cloth or one that has been slightly dampened with water. To remove stubborn dirt, use a mild, non-abrasive detergent. Afterwards, be sure to wipe the unit thoroughly with a soft, dry cloth.
- Never use benzene, thinners, alcohol or solvents of any kind, to avoid the possibility of discoloration and/or deformation.

## Additional Precautions

- Protect the unit from strong impact.
- Never strike or apply strong pressure to the LCD display.
- A small amount of heat will radiate from the unit during normal operation.
- Before using the unit in a foreign country, consult with qualified service personnel.

## Before Using Disks

- Install the unit on a solid, level surface in an area free from vibration. If the unit must be installed at an angle, be sure the installation falls within the specified range: upward; 20°, downward; 20°.
- Avoid using the unit in areas of high humidity (eg., condensation). High levels of humidity can adversely affect the operation of the drive and/or damage floppy disks. When the unit has been transported, allow it to warm to room temperature before operating.
- To insert a disk, push it gently but firmly into the drive — it will click into place. To remove a disk, press the EJECT button firmly. Do not use excessive force to remove a disk which is lodged in the drive.

## Handling Floppy Disks

- Floppy disks contain a magnetic storage medium (much like magnetic recording tape). Please observe the following when handling floppy disks:
- Never touch the magnetic medium inside the disk.
- Do not subject floppy disks to temperature extremes (eg., direct sunlight in an enclosed vehicle). Recommended temperature range: 10 to 50°C.
- Do not expose floppy disks to strong magnetic fields, such as those generated by loudspeakers.
- Floppy disks contain a 'write protect' tab which can protect the disk from accidental erasure. It is recommended that the tab be kept in the 'PROTECT' position and moved to the 'WRITE' position only when you wish to write new data onto the disk.

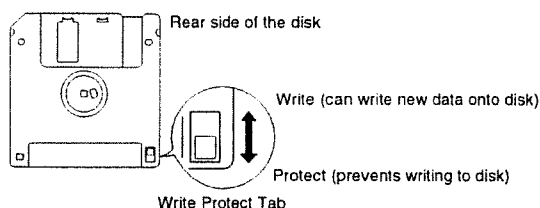

- Never attempt to remove a floppy disk from the drive while the drive is operating (the indicator is brightly lit); damage could result to both the disk and the drive.
- Remove any floppy disk from the drive before powering up or down.
- All important data should be copied onto backup disk(s). This provides a complete duplicate of the data should the original disk(s) be lost or damaged.
- The identification label should be firmly fixed to the disk. Should the label come loose while the disk is in the drive, it may be difficult to remove the disk.

## About Use With SCSI Devices

- Be sure that the Busy and/or SCSI indicators are not lit when removing the disk or the tape. The disk or tape may be damaged if you attempt to remove it while the indicator is lit.
- Carefully read the manual of the SCSI device (a hard disk drive, for example) connected to the S-760.
- Roland is not responsible for any damage or loss of data caused by damage to the unit during operation.

## Turning Off the Power/Transporting the S-760

- Although the S-760 does not include a hard disk, if a SCSI - equipped data storage device (such as hard disk drive, etc.) has been connected, always save the data and properly park the head(s) of the device before turning off the power. Also be sure to park the head(s) when moving the SCSI device. See Basic Operation p.1-7 for more information on turning off the power.

\* **Keep the original shipping box and packing materials and use them when transporting the unit.**

\* **Be very careful whenever you move or need to ship the S-760 and any SCSI devices, since they are precision electronic devices. You need to be sure they will be protected from any excessive shock.**

# Front and rear panel

## Front panel

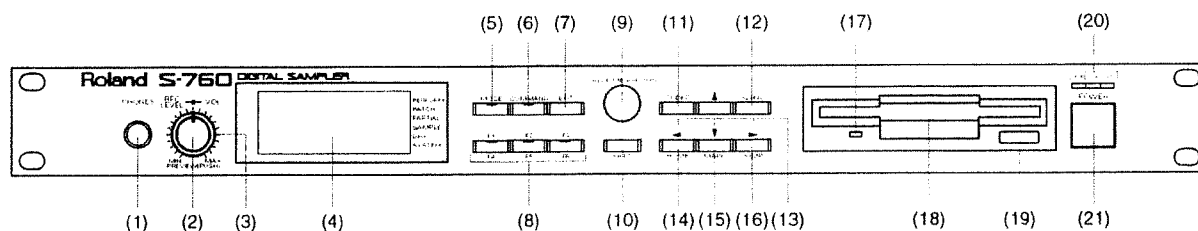

### (1) Headphone jack

A set of stereo headphones can be connected to this jack. This jack outputs the same signal as the rear panel STEREO OUT 1 (Individual Out 1, 2).

### (2) Volume control

This knob has two functions. It adjusts the volume of STEREO OUT 1 (Individual Out 1, 2) and the headphones. It does not affect the volume of other outputs. If you press the volume knob, the currently selected sound will be played even if no MIDI controllers are connected (the Preview function).

### (3) Recording Level control

This knob adjusts the recording level when you record a sample. For stereo sampling, it adjusts both L and R simultaneously.

### (4) LCD display

This display provides various information in each mode.

### (5) MODE

Press this button to select modes of the S-760. A mode menu display will appear. The currently selected mode is indicated at the right of the LCD (Basic Operation p.7-5).

### (6) COMMAND

If this button is pressed when the indicator is lit green, the Command Menu page will appear, and the indicator will light red.

### (7) EXIT

Press this button to return to the previous page.

### (8) Function buttons (F1—F6)

Use these buttons to execute commands, etc. The function of each button is displayed in the lower part of each page, and the indicators will light green to indicate buttons which can be used.

### (9) Value knob

This knob has two functions. When the knob is rotated, the value of the parameter at the cursor location will be increased or decreased. When the knob is pressed, a menu display will appear, allowing you to select pages in the current mode.

### (10) SHIFT

When the Shift button is pressed, function buttons F1—F3 will select functions F4—F6. There are other buttons as well which change their function in this way. For such buttons, the shifted function is printed in blue under the button. While or after the Shift button is pressed, the indicator will light red.

### (11) S1/DEC

This button is used to decrease the value of a parameter, or to select sounds in a list page. The function will depend on the cursor location, and will be displayed in the upper right of the LCD.

### (12) S2/INC

This button is used to increase the value of a parameter. The function will depend on the cursor location, and will be displayed in the upper right of the LCD.

### (13) Cursor buttons

These buttons move the cursor displayed in the LCD. If the display has two or more pages, cursor movement will also switch pages.

### (14) HOME

When this button is pressed while holding the Shift button, the cursor will move to the home position.

### (15) MARK

When this button is pressed while holding the Shift button, the Mark page will appear.

**(16) JUMP**

When this button is pressed while holding the Shift button, the Jump page will appear, allowing you to jump directly to previously-specified pages.

**(17) Disk drive indicator**

When the disk drive is operating, this indicator will light more brightly.

**(18) Disk drive**

This is a 3.5 inch 2HD/2DD floppy disk drive.

**(19) Eject button**

Press this button to eject the floppy disk.

**(20) MIDI/SCSI indicator**

This indicator lights green when MIDI data is being received, and lights red when a SCSI device is being accessed.

**(21) Power switch**

## Rear panel

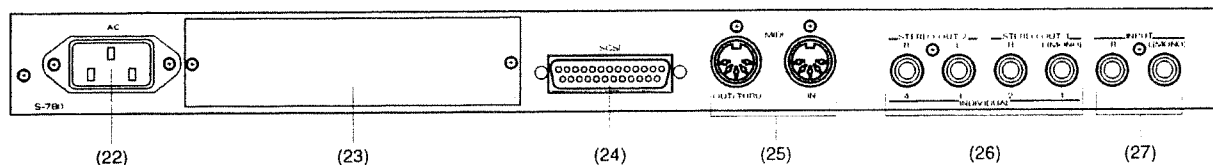

### (22) AC inlet

Connect the included power cable to this inlet.

### (23) Power Sampling Expansion installation port

A separately sold Power Sampling Expansion (OP-760-1) can be installed here. For installation, please consult a Roland Service Station or your dealer.

### (24) SCSI connector

Separately sold SCSI devices such as CD-ROM drives or hard disks can be connected here.

### (25) MIDI connectors

MIDI devices can be connected here.

**IN** : This connector receives MIDI data. Connect MIDI devices such as sequencers or keyboards here to play the S-760.

**OUT/THRU** : System Parameter settings determine whether this connector will function as an OUT or as a THRU connector (Advanced Operation, p.3-97). If OUT is selected, this connector will transmit mainly MIDI Exclusive data. If THRU is selected, this connector will re-transmit the data that was received at MIDI IN. With the factory settings, OUT is selected.

### (26) Output jacks

These are analog audio output jacks (2 stereo or 4 individual). A separately sold Power Sampling Expansion (OP-760-1) can be installed to provide digital audio outputs (2 stereo or 4 individual). For details on the audio outputs, refer to Basic Operation p.3-11 and Advanced Operation p.4-2.

### (27) Input jacks

These jacks input the audio signal when recording a sample. For mono sampling, use the L(MONO) jack.



# Contents

How to use the owner's manuals .....	0-2
Main features .....	0-3
Precautions .....	0-4
Front and rear panel .....	0-6

## Chapter 1. Before you begin

Setups using the S-760 .....	1-2
For those not using the S-770/750 (SYS-772 Version 2.0) or SP-700 .....	1-2
For S-770/750 (SYS-772 Version 2.0) or SP-700 users .....	1-2
About wave memory .....	1-3
Making connections .....	1-4
Basic connections .....	1-4
Connecting audio equipment .....	1-4
Connecting MIDI equipment .....	1-4
Connecting SCSI devices .....	1-5
Connecting a mouse, CRT display, and digital audio devices .....	1-5
Starting up and shutting down .....	1-6
Starting up .....	1-6
Starting up from floppy disk .....	1-6
Shutting down .....	1-7
Backing up the System Disk .....	1-8

## Chapter 2. Play the S-760

Loading sounds from floppy disk .....	2-2
Playing the S-760 from a MIDI keyboard .....	2-4
Selecting sounds .....	2-5
Selecting Patches .....	2-5
Selecting Performances .....	2-5
Loading sounds from a SCSI device .....	2-7
Selecting the current drive .....	2-7
Making the S-760 recognize SCSI devices (Scan command) .....	2-7
Wave Memory space .....	2-8
The convenient Quick Load function .....	2-8
Automatically loading a Volume at start-up .....	2-9
Sound libraries usable with the S-760 .....	2-10

## Chapter 3. Create a sound from a sample

Preparations and precautions for sampling .....	3-2
Performance Quick Sampling .....	3-3
What is Performance Quick Sampling? .....	3-3
Specify the Part and Patch .....	3-3
Basic procedure .....	3-4
Record a sample .....	3-4
About sound data names .....	3-10
1. If the Performance and Patch are unnamed .....	3-10
2. If the Performance is unnamed and the Patch is named .....	3-10
3. If the Performance is named and the Patch is unnamed .....	3-10
4. If both the Performance and the Patch are named .....	3-10
About NEW: Unnamed .....	3-10

Equalizer and output jacks .....	3-11
Adjusting/Modifying sounds with the equalizer .....	3-11
Mix all sounds for output .....	3-13
Preparations for saving .....	3-14
Assign the same Volume ID to all sounds .....	3-14
Name all sounds .....	3-15
Assign Patches to Parts .....	3-15

## Chapter 4. Save your sounds (Save)

Before you save .....	4-2
Regarding sound data .....	4-2
Regarding disks .....	4-2
Formatting .....	4-3
Saving to floppy disk .....	4-4
Saving to SCSI device .....	4-6
Convenient automatic formatting .....	4-7

## Chapter 5. Starting up from a hard disk

Starting up from a hard disk .....	5-2
1. Hard disks usable as a start-up device .....	5-2
2. Saving the system to a hard disk .....	5-2
3. Setting the Boot Drive / Initial Drive .....	5-3
4. Saving the System Parameters .....	5-4
5. Starting up from a hard disk .....	5-4

## Chapter 6. Convenient ways to start-up

Convenient ways to start-up .....	6-2
-----------------------------------	-----

## Chapter 7. Operation

Six operation modes .....	7-2
How each mode is organized .....	7-3
How to view the screen .....	7-5
Page .....	7-5
The mode and audio output status, etc. ....	7-5
Function Buttons .....	7-5
How to open a display .....	7-6
Opening a mode display .....	7-6
Opening a command display .....	7-7
Opening a list display .....	7-7
Directly opening a display (Jump) .....	7-8
Opening/marking a display for marking .....	7-8
Jumping to a display .....	7-8
About SHIFT .....	7-9
Modifying settings .....	7-10
Using the Value knob to modify a value .....	7-10
Using S1/DEC and S2/INC to modify a value .....	7-10
Using the function buttons to modify a value .....	7-11
Assigning names .....	7-12
Opening an ASCII display .....	7-12
1. When the cursor is located at the ASCII keyboard .....	7-13
2. When the cursor is located at a name .....	7-13

---

## **Chapter 8. How the S-760 is organized**

How sounds are organized	8-2
How sound data is interdependent	8-3
About the Volume ID and sound data management	8-4
What is the Volume ID?	8-4
Using the Volume ID	8-4
Managing sound data	8-4
Internal memory structure	8-5
Number of sounds	8-6
Loading/Saving the system	8-7
The System (program and parameters)	8-7
System parameters	8-7
Loading sound data	8-8
Clear	8-8
Overwrite	8-8
Error messages	8-8
Saving sound data	8-9
Sounds that can be saved	8-9
Sounds not included in any Volume	8-10
Example 1	8-10
Example 2	8-11
Example 3	8-12
Overwrite	8-12
Error messages	8-13
Signal flow	8-14

## **Chapter 9. Using MIDI to select sounds**

Selecting Patches	9-2
Selecting Performances	9-4
Loading Volumes	9-5

# *Chapter 1*

## **Before you begin**

---

The S-760 has a powerful range of capabilities, but unless connections and various settings have been made correctly, you will not be able to take advantage of them. Before you turn the power on, please read this chapter. This will help you avoid unnecessary problems and frustration.

## Setups using the S-760

The S-760 has a built-in floppy disk drive, so that it is possible to play sounds with just the S-760 alone. However for more efficient editing and in order to manage a wider variety of sounds, it is also possible to put together a system combining the S-760 with SCSI devices.

- \* For more about SCSI devices, refer to "About SCSI" (Advanced Operation p.7-2).
- \* For a list of usable SCSI devices, refer to the separate sheet "SCSI devices compatible with the S-760".

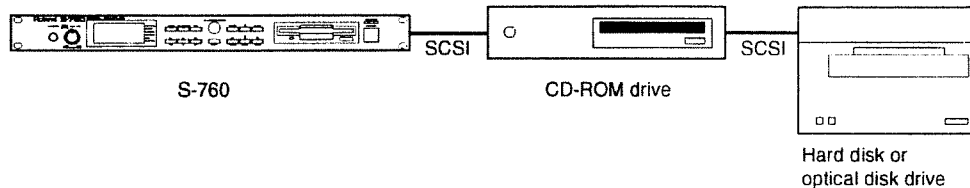

Sounds from a CD-ROM drive, hard disk or magneto-optical disk can be loaded and played. Sound data can be modified and saved on a floppy disk, hard disk or magneto-optical disk.

- \* For the sound libraries that can be used in a CD-ROM drive, refer to "Sound libraries usable with the S-760 (Basic Operation p.2-10)".

## For those not using the S-770/750 (SYS-772 Version 2.0) or SP-700

Floppy disks, hard disks and magneto-optical disks which are being used for the first time must be formatted for the S-760 (Basic Operation p.4-3).

## For S-770/750 (SYS-772 Version 2.0) or SP-700 users

Sounds on CD-ROM, hard disks and magneto-optical disks which you used on the S-770/750 (SYS-772 Version 2.0) or SP-700 can be used just as they are on the S-760. It is not necessary to reformat them.

- \* In the case of S-760 sounds, some parameters have been expanded or deleted relative to S-770/750 (SYS-772 Version 2.0) or SP-700 sounds. This means that you should be careful when saving S-760 sounds to a hard disk or magneto-optical disk which is also used by a S-770/750 (SYS-772 Version 2.0) or SP-700. For details, refer to "Sound data compatibility" (Advanced Operation p.2-2).
- \* It is not possible to save the S-760 system (programs and parameters) on a hard disk or magneto-optical disk which is being used by an S-770/750 (SYS-772 Version 2.0) or SP-700. For details, see "Starting up from a hard disk" (Basic Operation p.5-2).
- \* If you wish to share a hard disk or magneto-optical disk between two S-760 units or between an S-760 and an S-770/750 (SYS-772 Version 2.0) or SP-700, refer to "Startup/shutdown for system with a second S-760 or S-770/750/SP-700" (Advanced Operation, p.7-6).

# About wave memory

---

The S-760 comes with 2 Mbytes of wave memory for loading wave data. When loading wave data from a SCSI device, this may not be enough to accommodate larger sounds or setups. In this case, expand the wave memory.

For expansion memory, please use only Roland SIM72-8 (8 Mbyte RAM) or SIM72-16 (16 Mbyte RAM) Memory Expander modules. The memory can be expanded to up to 32 Mbytes.

There are four ways to expand the memory. Choose the method appropriate for your situation.

2 M (standard memory) + 8M = 10M  
2 M (standard memory) + 16M = 18M  
2 M (standard memory) + 8M + 16M = 26M  
16M + 16M = 32M

**\* When two SIM72-16 modules are installed, the 2 Mbyte standard memory shipped with the unit will not be used.**

For expansion memory installation, be sure to consult a Roland Service Station or your dealer.

**\* You can verify the amount of installed memory in the Wave Memory Check during start-up, or in the System Parameter display (Advanced Operation, p.3-91).**

# Making connections

---

## Basic connections

In order to use the S-760, you will need at least the following equipment.

- MIDI controller (keyboard, sequencer, etc.)
- a mixer/amplifier and speaker system, or a set of headphones

In order to make the most efficient use of the S-760, you will need the following equipment.

- SCSI device(s) (CD-ROM drive, hard disk, magneto-optical disk, etc.)

In the explanations given in this manual, we will assume that your setup consists of an S-760 + CD-ROM drive + hard disk / magneto-optical disk + MIDI keyboard.

- \* **Before making connections, make sure that the power is turned off for all devices. If power is on when connections are made, the speakers or other devices could be damaged.**

## Connecting audio equipment

The S-760 has four jacks to output audio, and you can freely decide which jacks to use. The audio output used is determined by the System parameters Output Mode and Output Assign C/D and by the Performance/Patch/Partial Output Assign parameters. For details on audio output, refer to Basic Operation p.3-11 or Advanced Operation p.4-2.

With the factory settings, the System parameter Output Mode is set to "4 Stereo", and the Output Assign C/D parameter is set to "C/D". When sound data is loaded from the included floppy disk etc., the Output Assign of each part is set to "Stereo A".

For now, connect the STEREO OUT 1 jacks to the inputs of your mixer/amplifier system.

- \* **If you are using headphones, connect them to the front panel Phones jack. Headphone volume is adjusted by the Volume knob.**
- \* **The headphones will carry the same signal as the STEREO OUT 1 outputs.**
- \* **The S-760 is designed to achieve maximum dynamic range when the Volume knob is set to MAX. Set the S-760 volume to MAX and adjust the final volume at the mixer or amplifier.**

## Connecting MIDI equipment

The S-760 produces sound in response to messages received from an external MIDI device. Use a MIDI cable to connect the MIDI OUT connector of a MIDI keyboard or sequencer to the MIDI IN connector of the S-760.

If you wish to control another MIDI device from the same MIDI keyboard or sequencer, connect the S-760's MIDI OUT/THRU to the MIDI IN of the other device so that it receives the same data stream (the MIDI THRU function).

With the factory settings, the MIDI OUT/THRU connector is set to OUT, so you will need to set it to THRU (Advanced Operation, p.3-97).

---

## Connecting SCSI devices

CD-ROM drives, hard disks, magneto-optical disks etc. can be connected to the SCSI connector. For details on connecting and on how to make settings for the SCSI devices, refer to "About SCSI" (Advanced Operation p.7-2) and to the manual for each device.

The SCSI drives usable with the S-760 are listed in the separate sheet "SCSI devices compatible with the S-760".

**\* In the following explanation, we will assume that you have set the SCSI ID number of your CD-ROM drive to 0, and the SCSI ID number of your hard disk or magneto-optical disk to 1.**

## Connecting a mouse, CRT display, and digital audio devices

If the separately sold Power Sampling Expansion (OP-760-1) has been installed, you have the following possibilities.

1. In addition to operating the unit from the front panel, a mouse and CRT display (digital RGB, 200-line) / television with an S-Video input / television with a video input and separately sold RC-100 Remote Controller (discontinued) can be connected. This allows you to see a large number of parameters at a glance and use the mouse for more efficient visual editing.

**\* When the unit is operated via mouse and CRT display etc., the LCD will be blank.**

2. Digital audio equipment can be connected to the digital input and the two digital outputs, allowing sampling and playback without loss of sound quality.

**\* The S-760's digital in/out (COAXIAL) is compatible with Mode II (consumer equipment) of the AES/EBU digital audio interface format.**

For installation of the Power Sampling Expansion (OP-760-1), please consult a Roland Service Station or your dealer.

# Starting up and shutting down

---

## Starting up

In order to start up, the S-760 system (program and parameter data) must be loaded when power is turned on. The system can be loaded in two ways: from a floppy disk, or from a SCSI device such as a hard disk or magneto-optical disk onto which the system was previously saved (Basic Operation p.2-7).

With the factory settings, the system will be loaded from floppy disk (see Boot Drive parameter, Advanced Operation p.3-94).

## Starting up from floppy disk

1. Make sure that connections (audio, MIDI, SCSI) are correctly made, and that the volume of the audio system is turned down. Also make sure that the SCSI ID numbers and terminators are correctly set for all SCSI devices (Advanced Operation p.7-2).
2. Turn on the power of the terminated SCSI device.
3. Turn on the power of the unterminated SCSI devices.
  - \* Even if you will not be using a certain SCSI device, you must turn on the power of all connected SCSI devices.
  - \* If your system includes SCSI devices which require a disk or tape to be inserted (such as CD-ROM drives, magneto-optical disks, SCSI tape streamers, etc.), insert the disk or tape after step 3 (i.e, after turning the SCSI device power on). If the disk or tape is inserted after the S-760 power is turned on, the S-760 will not be able to recognize that SCSI device. In this case, you will have to execute the Scan command so that the device will be recognized (Basic Operation p.2-7).
4. Turn on the S-760 power. The display will show "Please Insert System Disk", and the floppy disk drive indicator will blink.
5. Insert the S-760 system disk into the disk drive. The display will show "System Loading", and the system will be loaded.
  - \* If you have inserted a disk other than the S-760 system disk, such as a sound disk, the display will show "Not S-760 System disk, Please Change Disk".
6. When start-up is complete, the Performance Play display will appear.

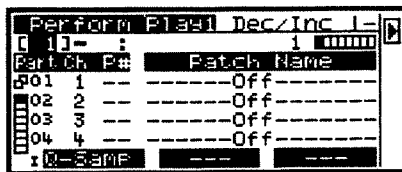

7. Turn on the power of your MIDI and audio equipment.



## Shutting down

1. Save all sounds and system parameters which you wish to keep (Basic Operation p.4-4, p.8-7).

\* If you turn the power off without saving your data, it will be lost.

2. Remove the floppy disk from the disk drive.

\* Do not remove the floppy disk while the disk drive is operating (the indicator will be brightly lit).

3. Execute the Park Heads command to park the heads of the SCSI devices.

Press MODE. The Mode Menu display will appear.

Move the cursor to F5:Disk, and press S1/DEC(Open). The Disk Mode display will appear.

Press the Value knob. The Disk Menu display will appear.

Move the cursor to 5:Utility, and press S1/DEC(Open). The Disk Utility display will appear.

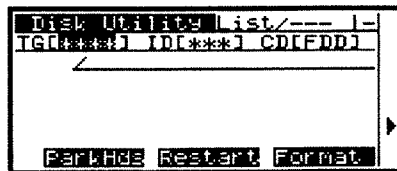

Press F1 ParkHds. The Park Heads command will be executed. When the heads have been parked, the display will indicate "Complete".

\* If SCSI devices are not connected, the display will indicate "Can't Communicate".

4. Turn down the volume of your audio equipment, and turn off the power of the audio equipment, MIDI equipment, and SCSI devices. Avoid moving a SCSI device for approximately 30 seconds after its power is turned off.

5. Turn off the power of the S-760.

# Backing up the System Disk

The S-760 cannot be used without a system disk. Make a backup copy of the included system disk, and store the original disk in a safe place (Basic Operation p.0-5).

Obtain a new 2HD floppy disk, and follow the procedure given below.

1. Press MODE. The Mode Menu display will appear.
2. Move the cursor to F5:Disk and press S1/DEC(Open). The Disk Mode display will appear.
3. Press the Value knob. The Disk Menu display will appear.
4. Move the cursor to 6:Save System, and press S1/DEC(Open). The Save System display will appear, and the System Program version will be displayed.

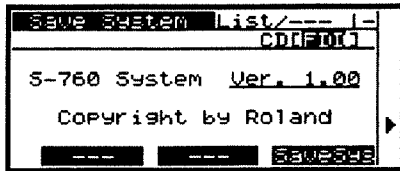

5. With its protect tab in the WRITE position, insert a 2HD floppy disk into the floppy disk drive.
  - \* It is not possible to backup the system on a 2DD floppy disk. If you attempt to backup the system on a 2DD floppy disk, the display will show "2HD FD, Please!". Insert a 2HD floppy disk.
  - \* If you backup the system on a floppy disk that has been previously used by an S-770/750 etc., all data that was on the disk will be lost.
6. Make sure that CD (Current Drive) is set to FDD.

\* If not, follow the procedure below.

Press S1/DEC(List). The Select Drive display will appear.

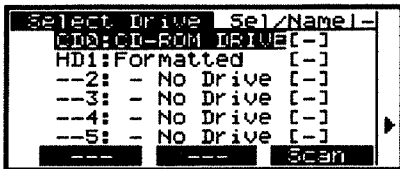

Move the cursor to FDD:[Floppy Disk] and press S1/DEC(Sel). You will return to the Save System display.

7. Press F3 SaveSys. The display will show "Now Saving System", and the system will be saved to floppy disk.
  - \* **If the floppy disk is not formatted, you will be asked "Current Drive is not formatted. Do you need to format?" Press F1 Yes. After the floppy disk is formatted, the system will automatically be saved. If you wish to cancel the operation press F3 NO.**
8. After the system has been saved, the display will show "Complete".
9. Press the eject button, remove the floppy disk from the disk drive, and set the protect tab to PROTECT.
  - \* **The S-760 system disk contains both the System Program and the System Parameters (Basic Operation p.8-7).**
  - \* **It is also possible to save the S-760 system program and system parameters on a SCSI device such as a hard disk (Basic Operation p.5-2).**

---

# MEMO

# Chapter 2

## Play the S-760

---

After being started up, the S-760 is still not able to produce sound. In order to produce sound, sound data must be loaded into internal memory from the included sound disk (floppy disk), from CD-ROM sound libraries (Basic Operation p.2-10) or from S-770/750 (SYS-772 Version 2.0) or SP-700 sound data disks.

Or, you can sample sounds with the S-760 and create new sounds (Basic Operation p.3-3).

# Loading sounds from floppy disk

In this section we will explain how to load sounds (a Volume) from the included floppy disk.

1. When the S-760 has been started up correctly, the Performance Play display will appear.
  - \* With the factory settings, the floppy disk drive is selected as the "Current Drive" — the drive currently selected by the S-760 to use when reading and writing data (see Initial Drive parameter, Advanced Operation p.3-94).
2. Remove the S-760 system disk and insert the included sound disk into the disk drive.
3. Press COMMAND. The Performance Command menu display will appear.
4. Move the cursor to 5:Disk and press S1/DEC(Select). The Disk Mode display will appear.
5. Press the Value knob. The Disk Menu display will appear.
6. Move the cursor to 1:Load and press S1/DEC(Open). The Disk Load display will appear.
  - \* Instead of pressing S1/DEC(Open) you can also press the Value knob once again to get the Disk Load display.

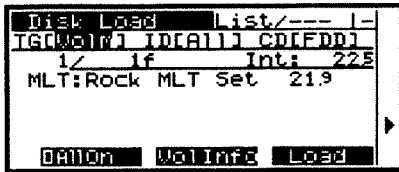

7. Make sure that TG (Target) is set to Volm (Volume).  
If not, set TG to Volm as follows.  
Move the cursor to TG and press S1/DEC(List). The Select Target display will appear.  
Move the cursor to Volume and press S1/DEC(Select). TG will be set to Volm and you will return to the Disk Load display.

8. Make sure that CD (Current Drive) is set to FDD (Floppy Disk Drive).

If not, set CD to FDD as follows.

Move the cursor to CD and press S1/DEC(List). The Select Drive display will appear.

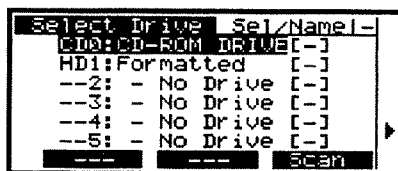

Move the cursor to FDD:[Floppy Disk] and press S1/DEC(Sel). CD will be set to FDD and you will return to the Disk Load display.

9. Move the cursor to the Volume names displayed, and press S1/DEC(Mark) to mark the sounds you wish to load.

If you press S1/DEC(Mark) once more the mark will disappear.

**\* A floppy disk can accommodate only one Volume, but devices such as hard disks can store many Volumes. By marking two or more Volumes, you can load all necessary data in a single operation.**

10. Press F3 Load. The Volume will be loaded into internal memory.

11. When loading is complete, the display will show "Complete".

# Playing the S-760 from a MIDI keyboard

After loading a Volume of sounds, play your MIDI keyboard to hear the S-760's sounds.

1. Press MODE. The Mode Menu display will appear.
2. Move the cursor to F1:Performance and press S1/DEC(Open). The Performance Play display will appear.
  - \* You can also press F1 Perform to get the Performance Play display.
  - \* If a different display of Perform mode appears, use the following procedure.  
Press the Value knob. The Performance Menu display will appear.  
Move the cursor to 1.Perform Play and press S1/DEC(Open).

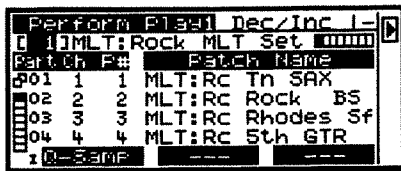

Part	Ch	P#	Patch Name
01	1	1	MLT:RC Tn SAX
02	2	2	MLT:RC Rock BS
03	3	3	MLT:RC Rhodes Sf
04	4	4	MLT:RC 5th GTR

3. Set the MIDI channel of your MIDI keyboard to the Ch (MIDI channel) setting for Part 1. Or move the cursor to the MIDI channel for Part 1 and use S1/DEC(Dec) and S2/INC(Inc) or the Value knob to change the setting to the MIDI channel of your keyboard.
4. Play your MIDI keyboard and you will hear the sound (the Patch) assigned to Part 1.
  - \* By setting your MIDI keyboard to the MIDI channels for the other Parts, you can hear the Patches assigned to each of the other Parts.

There are a total of 32 Parts. Use the cursor buttons (up/down) to scroll the display to the other Parts. The box-shaped markers (Page Box) at the left of the display indicate the number of Part pages. The one displayed in reverse video is the currently displayed page. If you move the cursor to the page mark on the page box, you can use S1/DEC(Prev) and S2/INC(Next) or the Value knob to move by page. For the S-760, a set of data that specifies the sounds (Patches) played by each of these 32 Parts is known as a "Performance".



# Selecting sounds

## Selecting Patches

Here's how to select a different Patch for Part 1 to hear a different sound.

1. Move the cursor to the Patch Name for Part 1, and press S1/DEC(List). The Select Patch display will appear.

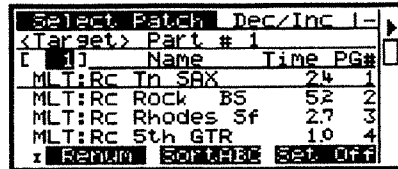

[ ]	Name	Time	PG#
1	MLT:RC Tr SAX	24	1
2	MLT:RC Rock BS	52	2
3	MLT:RC Rhodes Sf	27	3
4	MLT:RC 5th GTR	10	4
z	RENUM	SOFTABC	Set Off

2. When the cursor is located on "[ ]" (the Patch number in the top line of the list is displayed), you can use the Value knob or S1/DEC(Dec) and S2/INC(Inc) to scroll the list. When the cursor is located in the list, you can also scroll by pressing and holding the cursor buttons (up/down).
3. Move the cursor to the Patch name you wish to select. When you move the cursor to the Patch name and press the Value knob, the selected Patch will be played so you can check the sound. (This is known as the "Preview function".) You can also play your MIDI keyboard to check the sound.
4. Press S1/DEC(Select). The Patch will change and you will return to the Performance Play display.

\* If the cursor is located at P# (Patch number) in the Performance Play display, you can also change Patches using the Value knob or S1/DEC(Dec) and S2/INC(Inc).

## Selecting Performances

Here's how to select Performances.

1. Move the cursor to the Performance name (second line from the top of the display) and press S1/DEC(List). The Select Performance display will appear.

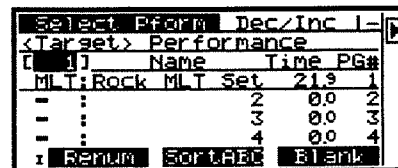

[ ]	Name	Time	PG#
1	MLT:Rock MLT Set	21.9	1
2	- :	0.0	2
3	- :	0.0	3
4	- :	0.0	4
z	RENUM	SOFTABC	Blank

2. When the cursor is located on "[ ]" (the Performance number in the top line of the list is displayed), you can use the Value knob or S1/DEC(Dec) and S2/INC(Inc) to scroll the list. When the cursor is located in the list, you can also scroll by pressing and holding the cursor buttons (up/down).
3. Move the cursor to the Performance name you wish to select.
  - \* **As when selecting Patches, you can use the Volume knob or your MIDI keyboard to check the sounds in the Performance.**
4. Press S1/DEC(Select). The Performance will change and you will return to the Performance Play display.
  - \* **If the cursor is located at the Performance number in the Performance Play display, you can also change Performances using the Value knob or S1/DEC(Dec) and S2/INC(Inc).**

# Loading sounds from a SCSI device

---

In the preceding sections we have explained how to load and play sounds from a floppy disk, but it is also possible to load sounds from a CD-ROM drive or other device. The procedure is the same as for a floppy disk, but be aware of the following points.

## Selecting the current drive

Set the desired drive to the current drive.

1. In the Disk Load display, move the cursor to CD (Current Drive) and press S1/DEC(List). The Select Drive display will appear.



2. Move the cursor to the desired drive and press S1/DEC(Sel). The current drive will be set to the drive you specified, and the Disk Load display will reappear.

## Making the S-760 recognize SCSI devices (Scan command)

When the S-760 starts up, it recognizes the SCSI devices which are connected. However some SCSI devices (removable media devices) need to have a disk or tape inserted (such as CD-ROM drives etc.). If you insert or exchange the disk or tape after startup, you will need to execute the Scan command to make the S-760 recognize that SCSI device.

1. In the Disk Load display, move the cursor to CD (Current Drive) and press S1/DEC(List). The Select Drive display will appear.
2. Press F3 Scan to execute the Scan command.
3. After executing, press EXIT to return to the Disk Load display.

---

## Wave Memory space

The S-760 comes with 2 Mbytes of Wave memory. (At a sampling frequency of 44.1 kHz, this is 22.5 seconds.) Some sounds in CD-ROM sound libraries etc. are too large to be loaded unless wave memory has been expanded. Unless the wave memory has been expanded, you will be able to load only Patches of less than 22.5 seconds. If you have already loaded some sounds, the free area will be less than 2 Mbytes, so you will be even more restricted in the Patches you can load. For your reference, the Disk Load display shows the number of seconds of "Int" (free area of internal memory) and the area occupied by each sound.

**\* If you wish to expand the wave memory (Basic Operation p.1-3), consult a Roland Service Station or your dealer.**

**\* When you load a sound into free area of internal memory, a message of "Clear Internal Memory Befor Loading?" will appear. Press one of the following function buttons.**

- F1 Yes : Erase (clear) all sounds in internal memory and load the new sound.**
- F2 No : Load the new sound into free memory. If free memory is insufficient, loading will be incomplete.**
- F3 Cancel : The Load operation will be canceled.**

When loading a Patch, set TG (Target) to "Patch" before loading.

1. Move the cursor to "TG" (Target) and press S1/DEC(List). The Select Target display will appear.
  2. Move the cursor to "Patch" and press S1/DEC(Select). Target will be set to Patch and the Disk Load display will reappear.
- \* Simply loading a Patch does not enable you to play it. In the Performance Play display you must select the Select Patch page and assign that Patch to a Part. For details refer to the explanation of "Selecting Patches" in Basic Operation p.2-5.**

## The convenient Quick Load function

In addition to loading sounds from the Disk Load display, you can also load sounds using the very convenient Quick Load function. This function allows you to register your frequently-used sounds so that you can find them immediately without searching through the huge number of sounds which may be on a CD-ROM or other SCSI device. Since you can also specify the SCSI ID, you will not have to change the Current Drive setting even when loading from a SCSI device.

For details on Quick Load, see p.6-2 of Advanced Operation.

---

## Automatically loading a Volume at start-up

It is possible to automatically load a specified Volume (Initial Volume, Advanced Operation p.3-94) from the Initial Drive (Advanced Operation p.3-94) when the S-760 is started up. For details please refer to Advanced Operation p.6-4.

- \* **It is not possible to automatically load a Volume from floppy disk.**

# Sound libraries usable with the S-760

---

The following sound libraries (CD-ROM) can be used with the S-760.

- \* **The S-760 comes with 2 Mbytes of Wave memory. (At a sampling frequency of 44.1 kHz, this is 22.5 seconds.) Some sounds in sound libraries are too large to be loaded unless wave memory has been expanded. If you wish to expand the wave memory (Basic Operation p.1-3), consult a Roland Service Station or your dealer.**

Roland, "Preview" (CD-ROM included with the Roland SP-700)  
Roland, L-CD series  
Roland, L-CDP series  
PROSONUS, RS-1  
Optical Media International, USV-3  
Roland + Northstar, DS-60711  
Club50, C50CD02  
PSEL, PSEL-1

The parameter structure of the data in the above CD-ROMs is identical to that of the S-770/750 (SYS-772 Version 2.0).

In addition to these, sounds from floppy disks, hard disks, and magneto-optical disks used by the S-770/750 (SYS-772 Version 2.0) or SP-700 can also be used.

- \* **For details on compatibility between S-760 sound data and SYS-772 Version 2.0 / SP-700 sound data, refer to Advanced Operation p.2-2.**

In addition, you can use the Convert Load operation to use data from hard disks or sound libraries (CD-ROMs) used by the S-550/W-30 (Advanced Operation p.3-88)

- \* **It is not possible to Convert Load from a floppy disk.**

USV-1 (discontinued)  
USV-2  
C50CD01  
L-CD1 (CD-ROM included with Roland CD-5)

S-50 sound data cannot be used directly. If you wish to use S-50 sounds, Convert Load them into the S-550/W-30. Save them as S-550/W-30 data, and then Convert Load them into the S-760. It is not possible to Convert Load S-760 sound libraries into the S-550/W-30.

## Caution!

Sounds such as in the previously mentioned sound libraries are sampled at a sampling frequency of 48, 44.1, 24, or 22.05 kHz. When playing these sounds on the S-760, some settings of the Master Frequency may cause the pitch to change. For details refer to Advanced Operation p.2-5.

# Chapter 3

## Create a sound from a sample

---

This chapter will explain how you can record a sample from an audio source such as CD or DAT and create a sound. We will explain the process of sampling, using the equalizer to correct or modify the sound, and how to output it from stereo output 1. Finally we will save the newly created data.

# Preparations and precautions for sampling

---

In order to make available sufficient memory area for sampling, we will delete all sound data from internal memory.

1. In the Performance Play display, press COMMAND. The Performance Command Menu display will appear.
2. Move the cursor to 3:Delete, and press S1/DEC(Select). The Delete display will appear.

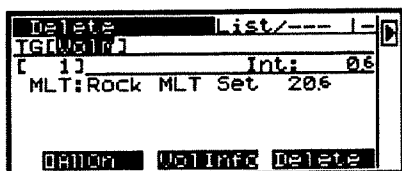

3. Make sure that TG (Target) is set to Volm (Volume).
  - \* If not, perform the following procedure.  
Move the cursor to TG, and press S1/DEC(List). The Select Target display will appear. Move the cursor to Volume, and press S1/DEC(Select). TG will be set to Volm, and you will return to the Delete display.
4. Move the cursor to the Volume name, and press S1/DEC(Mark). The Volume will be marked.
5. Press F3 Delete. A display will ask for confirmation.
  - F1 Yes : Delete the data.
  - F3 No : Cancel the Delete operation.
6. When the data has been deleted, the display will indicate "Complete".

## Warning!

Sampling from a copyrighted CD or tape etc. for commercial purposes such as music production, performance or broadcast is prohibited by law except for personal use.



# Performance Quick Sampling

---

There are several ways of sampling, and you can use the method most suited to your situation (Advanced Operation p.6-18). In this explanation, we will use Performance Quick Sampling as an example as we explain the ideas and procedure of sampling.

## What is Performance Quick Sampling?

First, read the section in Basic Operation p.8-2 "How sound are organized", so that you understand the various types of sound data used by the S-760.

When you sample a sound using this method, the S-760 automatically creates Sample, Partial and Patch data, and assigns the Patch to the specified Part. In addition, you can assign Partials to the keyboard area you specify. If you wish, you can assign the same Partial to the entire keyboard, or you can sample several times and create a split-type Patch. The major Partial parameters (Pitch, TVF, TVA) can be edited immediately after sampling (the Quick Edit function).

In this way, Performance Quick Sampling provides an easy way to make various setting as you sample.

## Specify the Part and Patch

When using Performance Quick Sampling, the important things to decide are which Part the sampled Patch will be assigned, and which Patch you will be creating.

There are 32 Parts in a Performance, and you can use any Part you like.

When you specify a Part, the Sampled Partials will be assigned to the Patch which is assigned to that Part. If a Patch is not yet assigned to that Part, the Sampled Partials will be assigned to the lowest-numbered unused Patch in internal memory. And then the Patch will be assigned to the specified Part. This is the usual procedure. You are also free to specify the Patch to which the Sampled Partials will be assigned even after you specify the Part.

These two choices (choosing the Part and the Patch) allow you to do things like the following.

You can keep sampling repeatedly without changing the specified Part and Patch, so that two or more Partials are split over the Patch for that Part.

Or, you can keep changing the specified Part and Patch while you sample, so that different Patches are assigned to different Parts.

## Basic procedure

Here's the basic procedure of what you will be doing in each display.

1. Make the connections necessary for sampling.
2. In the Performance Play display, select a Performance.
3. In the Performance Quick Sampling display, specify the Part and Patch.
4. In the Sampling display, sample a sound.
5. Listen to the recorded sample. If you like it, proceed to the next step. If not, use the Retry command to return to step 4.
6. In the Split display, specify how the Partial will be assigned to the keyboard.
7. In the Quick Edit display, edit that Partial.
8. Repeat steps 3 to 7.
9. If you have been repeatedly sampling in order to make splits for a Patch, you can change split settings in the Performance Quick Sampling display.

### Caution!

You will play a MIDI keyboard to hear the results, but be aware that the way in which sound is produced will depend on the S-760 display. The square indicator in the right edge of the display indicates the audio output status of the S-760. For details, refer to Advanced Operation p.4-2 "How sound is output".

## Record a sample

### Make connections

1. Connect the source you wish to sample to the rear panel input jacks. If you are recording a stereo sample, be carefully not to reverse the L/R orientation. If you are recording a mono sample, use the L jack. In this example we will be recording a stereo sample.
  - \* **The S-760 supports only line-level connections. Microphones cannot be connected directly. If you wish to connect a mic, use a mixer to raise the level first.**
  - \* **Sampling from a digital audio input is possible only if the separately sold Power Sampling Expansion (OP-760-1) is installed.**

### Select a Performance

2. Go to the Performance Play display.
  - Press MODE. The Mode Menu display will appear.
  - Move the cursor to F1:Performance, and press S1/DEC(Open). The Performance Mode display will appear.
  - Press the Value knob. The Performance Menu display will appear.
  - Move the cursor to 1:Perform Play, and press S1/DEC(Open). The Performance Play display will appear.
3. While holding SHIFT press HOME. The cursor will move to the [ ] (Performance number) at the upper left of the display.
  - \* When you do this, the cursor will move to the home position.**
4. Rotate the Value knob to select a Performance.
  - \* You can select from a list if you wish. Move the cursor to the Performance name, and press S1/DEC(List) to get the Select Performance display. Move the cursor to the Performance name, and press S1/DEC(Sel) to select.**
5. Set the MIDI channel of your keyboard to match the MIDI channel of the Part to which you will assign your new Patch.

### Specify the Part and Patch

6. Press F1 Q-Samp. The Performance Quick Sampling display will appear.



7. The Part number will be displayed in the parentheses ( ) in the right edge of the second line of the display, and the cursor will be located there. Use S1/DEC and S2/INC or the Value knob to select the Part to which the Patch you are about to create (by sampling) will be assigned.
8. The second line of the display shows the number and name of the Patch. Move the cursor to select the Patch you will create by sampling. The procedure is the same as when selecting a Performance.
  - \* If a Patch is already assigned to the Part and you select a different Patch to sample, the previous Patch will no longer be assigned to a Part.**

### Sample the sound

9. Press F1 Smpling. The Sampling display will appear.

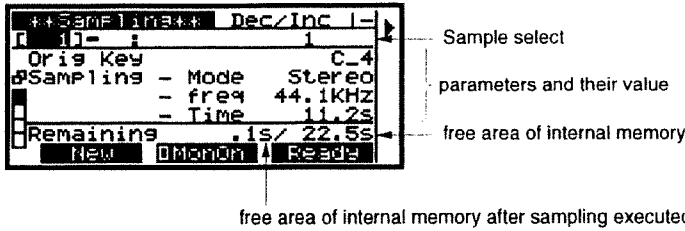

- \* In the Quick Sampling display, "\*\*\*" will appear on each side of the display name, indicating that this is not the usual sampling display.
10. The Sample number and name are shown in the second line of the display. Move the cursor to select the Sample you wish to create. The procedure is the same as when selecting a Performance.
- \* If a sample already exists, the lowest-numbered Sample in internal memory which contains no wave data will be selected. This sample may or may not be automatically named. For details, refer to Basic Operation p.3-10 "About sound data names".
  - \* If you have selected a Sample for which wave data exists, be aware that this data will be erased before a new sample is recorded.
11. Move the cursor to the Sample name, and press S2/INC(Name). The ASCII display will appear. Assign a name to the sample. For the procedure, refer to Basic Operation p.7-12.
- \* You must give a name to the sample. If you proceed with sampling without doing so, the sample will be named NEW:Unnamed, and you will later have to individually rename each piece of sound data. For details refer to Basic Operation p.3-10 "About sound data names".

12. The factory settings of each parameter are as follows (Advanced Operation p.3-42). Modify the settings as necessary.

\* Since we are recording a stereo sample, set the Sampling-Mode to Stereo.

Orig Key	C_4
Sampling-Mode	Stereo
Sampling-Freq	44.1 kHz
Sampling-Time	maximum possible sampling time (for 2 Mbyte of wave memory, 11.2 sec)
H.F Input-L/R	6.0 k
H.G Input-L/R	0
L.F Input-L/R	120
L.G Input-L/R	0
Input	Analog
Digital ATT	0
Normalize	Off
Trigger-Type	OneWay
Trigger-Source	Level
Threshold	0

13. Use the Recording Level knob to adjust the input level.

\* Make sure that the F2 display is MonOn (monitor on). If it reads MonOff (monitor off), press F2 to set it to MonOn. The display will change each time you press the button.

\* While listening to the audio you wish to sample, make settings so that the level meters move as far as possible. However if the level meters reach the top, clipping level has been reached and the sampled sound will be distorted.

\* It is not possible to further amplify the audio being input for sampling. If the level is still too low when the Recording Level knob is turned to MAX, increase the output volume of your audio device.

14. Press F3 Ready.

\* If the Sample you have selected for recording already contains wave data, the wave data will automatically be erased.

\* If you have not yet named the sample, a message will appear. (Please set Name. How about this name?) If you are satisfied with a name of NEW:Unnamed, press F1 Yes. If not, press F3 No. Return to step 11 and specify a name.

15. Press F1 Start, and play your audio source. The display will indicate "Start (Cancel=EXIT)", and sampling will begin.

**To end sampling**

Press F3 Stop. The sample recorded up to that point will be valid.

**To cancel sampling**

Press EXIT. The sample recorded up to that point will be discarded. You will return to the Performance Quick Sampling display.

16. When you have finished sampling, the monitor audio will stop, and the display will indicate "Now Working". Then, the sampled wave will be displayed.

**Check the sampled results**

17. Play your MIDI keyboard to check the sound you sampled. You can also press the Volume knob to hear the sampled sound without playing a MIDI keyboard (the Preview function).

If the sampled sound is ok, proceed to the next step.

If you wish to try again, press F2 Retry. Now you can sample again with the same settings. The sampled wave data will automatically be erased.

- \* **The note number, velocity, and preview mode for the Preview function can be specified by System parameters (Advanced Operation p.3-93).**

**Assign the Partial to the keyboard**

18. If the sampled sound is ok, press EXIT. The Split display will appear, and the Split status of the Patch you are creating (sampling) will appear.

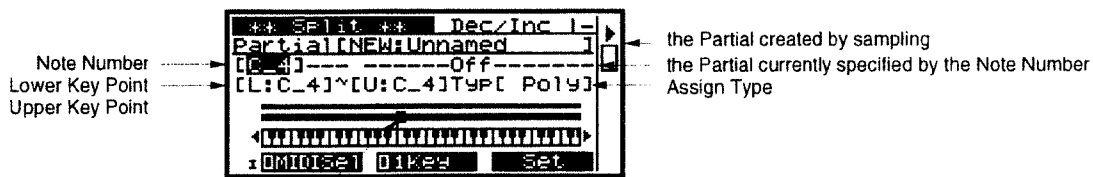

C4 display

- \* **In the case of the Quick Sampling display, "\*\*\*" will be displayed at each side of the display name to indicate that this is not the normal Split display.**

19. Specify how the sampled Partial will be assigned to the keyboard.

**If you wish to assign the Partial to 1 key**

Make sure that the F2 display is indicating 1Key. If it is set to O.W (Overwrite), press F2 to select 1Key. The display will alternate each time you press the button. Move the cursor to the | ] (key number) in the third line of the display. Use S1/DEC and S2/INC or the Value knob to specify the key number to which the Partial will be assigned.

- \* **Key Number will display the Original Key which you specified in the Sampling display. If you modify the key number, the Original Key of the sample will be rewritten to the newly specified key number.**

- \* **You can also use your MIDI keyboard to specify the Key Number. Make sure that the F1 display indicates MIDISel. If it is set to MIDIOff, press F1 to make it read MIDISel. The display will alternate each time you press the button.**

### If you wish to assign the Partial to 2 or more keys

Move the cursor to [L: ] (Lower Key Point) and [U: ] (Upper Key Point) in the fourth line of the display. Use S1/DEC and S2/INC or the Value knob to specify the range of key numbers to which the Partial will be assigned.

**\* When you specify the range of key numbers, the Original Key of the sample will not change.**

If you assign a Partial to a key number which is already assigned to a different Partial, the later-assigned Partial will take priority.

You can switch the keyboard display by holding SHIFT and pressing F5 or F6. The C4 key number is indicated by a mark.

20. Press F3 Set. The Partial will be assigned to the specified key number(s), and the Patch will be assigned to the specified Part. You will then return to the Performance Quick Sampling display.

**\* If you wish to delete the Sample or Partial data you sampled, press EXIT.**

### Quick Edit a Partial

21. Press F3 Q-Edit. The Quick Edit display will appear.

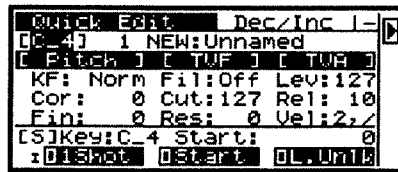

Modify the settings as necessary (Advanced Operation p.3-11).

22. Press EXIT. You will return to the Performance Quick Sampling display.

### Record more samples

23. Press EXIT. You will return to the Performance Play display.  
 24. Repeat steps 5 through 23 to create a Patch.

### Modify the Split settings

25. Go to the Performance Quick Sampling display.  
 In the Performance Play display, press F1 Q-Samp.

Modify the settings as necessary (Advanced Operation p.3-11).

**\* Even if you modify the Key Number, the Original Key of the sample will not change.**

26. Press EXIT. You will return to the Performance Play display.

## About sound data names

When Performance Quick Sampling is used, each level of sound data that is created will be automatically named. The following will explain how names are assigned.

### 1. If the Performance and Patch are unnamed

The name specified in the Sampling display (including NEW:Unnamed) will be assigned to the Performance, Patch, Partial and Sample.

**\* If a name of NEW:Unnamed is assigned, subsequent samples will be automatically renamed with the last two characters as AA, AB, AC, etc. to distinguish each sample.**

### 2. If the Performance is unnamed and the Patch is named

The Sampling display will show a name identical to the Patch name. The Partial and Sample will be given a name identical to the Patch. The Performance will not be named.

### 3. If the Performance is named and the Patch is unnamed

The Sampling display will show a name identical to the Performance name. The Patch, Partial and Sample will be given a name identical to the Performance.

### 4. If both the Performance and the Patch are named

The Sampling display will show a name identical to the Patch name. The Partial and Sample will be given the same name as the Patch. The Performance name will not change.

## About NEW: Unnamed

The S-760 manages sound data by name. Although you are free to name a sound as NEW:Unnamed, it is likely that this will result in conflicts with other identically-named data on disk. Since in such cases the previous data is erased (overwritten) when the new data is saved, this will cause problems in data management (Basic Operation p.8-12). If data is sampled with a name of NEW:Unnamed, you will later have to rename sounds one by one. It is highly recommended that you assign a name before you begin sampling.



# Equalizer and output jacks

There are 8 equalizers (A--D, or 1--8) in a Performance. The Output Assign settings of each Part determine the Equalizer through which each Patch is sent. The System parameters Output Mode and Output Assign determine the output jack from which the output of each Equalizer is sent.

In this example, we will assign a different Equalizer to each of two Patches, and mix these sounds for stereo output from the STEREO OUT 1 jacks. First you will need to make two stereo patches.

\* For details on output assignments refer to **Advanced Operation p.4-2**.

## Adjusting/Modifying sounds with the equalizer

1. Go to the Performance Play display.  
Press MODE. The Mode menu will open.  
Move the cursor to F1:Performance, and press S1/DEC(Open). The Performance Mode display will appear.  
Press the Value knob. The Performance Menu display will appear.  
Move the cursor to 1:Perform Play, and press S1/DEC(Open). The Performance Play display will appear.

2. Assign Patch 1 to Part 1, and Patch 2 to Part 2.

\* Refer to **Basic Operation p.2-5, "Selecting Patches"**.

3. A box-shaped mark (the Page Box) is displayed in the upper right of the LCD. This indicates how many pages there are in the horizontal direction. The area displayed in reverse video indicates the currently displayed page. Go to the second page in the horizontal direction.  
While holding SHIFT, press F6.

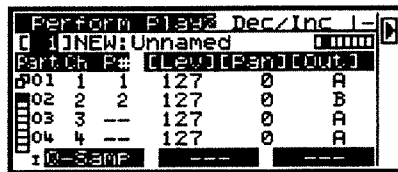

The screenshot shows the Performance Play display with a table of patch assignments. The table has columns for Patch #, Part, EQ, and Output. The current page is 2 of 3, indicated by a box in the top right corner.

Part	Ch	P#	EQ	Out
01	1	1	127	0 A
02	2	2	127	0 B
03	3	--	127	0 A
04	4	--	127	0 A

At the bottom of the screen, it says "10 SMP --- ---".

\* You can back up to the previous page by holding SHIFT and pressing F5.

4. Move the cursor to [Out]. Set the Part 1 Output Assign to A, and the Part 2 Output Assign to B.

\* There is an "Out" display in page 3 as well, but this refers to the Patch's Output Assign. Here you need to modify the [Out] setting in page 2.

5. Since you have set the Part 2 Output Assign to B, Patch 2 will be output in stereo from the STEREO OUT 2 output jacks. Since STEREO OUT 2 is not connected to an amplifier or mixer yet, you will need to make these connections at this time, using the following procedure.

\* Since the Output Assign of Part 1 is A, it will be output in stereo from the STEREO OUT 1 jacks.

\* In general, each equalizer corresponds to each output jack.

6. Go to the System Parameter display page 1.

Press MODE. The Mode Menu display will appear.

Move the cursor to F6:System, and press S1/DEC(Open). The System Mode display will appear.

Press the Value knob. The System Menu display will appear.

Move the cursor to 1:System PRM, and press S1/DEC(Open). The System Parameter display will appear.

Move the cursor to the page mark, and rotate the Value knob to the left to open page 1.

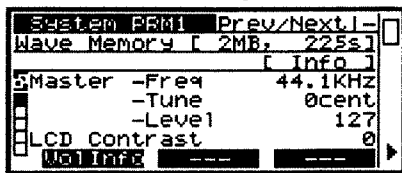

7. Move the cursor to Master-Level (Master Level), and rotate the Value knob to the left to lower the output level of the entire S-760.

\* For details of Master Level, refer to Advanced Operation p.3-91.

8. Lower the input level of the connected amplifier or mixer.

9. Connect STEREO OUT 2 to your amplifier or mixer.

10. When connections have been made, raise the Master Level of the S-760 and the input level of your amplifier or mixer.

11. Go to the Performance Equalizer display.

Press MODE. The Mode Menu display will appear.

Move the cursor to F1:Performance, and press S1/DEC(Open). The Performance Mode display will appear.

Press the Value knob. The Performance Menu display will appear.

Move the cursor to 2:Perform EQ, and press S1/DEC(Open). The Performance Equalizer display will appear.

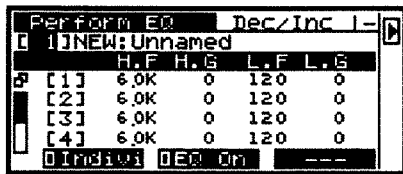

12. Since we want to output the Patch in stereo, we will also make the equalizer settings in stereo. Press F1 to set the F1 display to Stereo.
  - \* Each time you press F1, the display will alternate between Indivi and Stereo.
13. Move the cursor to the Equalizer A and B parameters and make settings. The parameters are as follows.
 

H.F (High Frequency)	This sets the frequency at which the high range of the signal will be boosted or cut.
H.G (High Gain)	This sets the amount (in decibels) of boost or cut for the high range.
L.F (Low Frequency)	This sets the frequency at which the low range of the signal will be boosted or cut.
L.G (Low Gain)	This sets the amount (in decibels) of boost or cut for the low range.
14. While playing your MIDI keyboard, check the equalizer settings.
  - \* Switch the transmit channel of your MIDI keyboard between the MIDI channels of Part 1 and Part 2.
15. When you press F2, the equalizers will be bypassed. Compare the equalized and original sounds to check that you have made the appropriate equalizer settings.
  - \* Each time you press F2, the F2 display will alternate between EQ On and Bypass.

## Mix all sounds for output

The Patch for Part 1 is output in stereo from STEREO OUT 1, and the Patch for Part 2 is output from STEREO OUT 2. Now we will make settings so that the two Patches are mixed and output from STEREO OUT 1.

1. Open the System Parameter display page 3. Press MODE. The Mode Menu display will appear. Move the cursor to F6:System, and press S1/DEC(Open). The System Mode display will appear. Press the Value knob. The System Menu display will appear. Move the cursor to 1:System PRM, and press S1/DEC(Open). The System Parameter display will appear. Move the cursor to the page mark, and rotate the Value knob to open page 3.

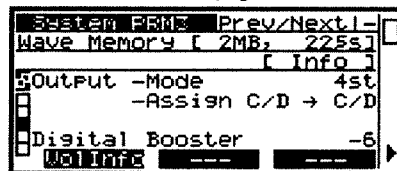

2. Move the cursor to Output-Mode (Output Mode), and rotate the Value knob to set it to MIX (mix).
  - \* With the factory settings, Output Mode is set to 4st (4 stereo).

# Preparations for saving

Sampled and edited sounds will be lost when the power is turned off, so you need to save them. However not all sounds in internal memory are necessarily saved. Before you save data, you will need to do the following.

\* For details on saving, refer to Basic Operation p.8-7. For the Save procedure, refer to Basic Operation p.4-4.

## Assign the same Volume ID to all sounds

You need to assign the same Volume ID to all the sound data you have created by sampling.

\* The Volume ID is a name that makes it easier to search for and manage sound data. Normally, this is an abbreviation of a sound name. For details on the Volume ID, refer to Basic Operation p.8-4.

1. Open the System Volume ID display.  
Press MODE. The Mode Menu display will appear.  
Move the cursor to F6:System, and press S1/DEC(Open). The System Mode display will appear.  
Press the Volume knob. The System Menu display will appear.  
Move the cursor to 4:Volume ID, and press S1/DEC(Open). The System Volume ID display will appear.

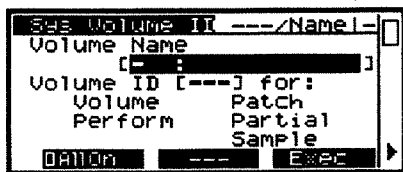

2. Move the cursor to Volume Name, and press S2/INC(Name). The ASCII display will appear. Assign a name to the Volume. The three characters before the colon ":" are the Volume ID, and the following 12 characters are the name. Here we will specify both the Volume ID and the name.  
For the procedure, refer to Basic Operation p.7-12.
3. The Volume ID you specify will be displayed in Volume ID [ ].  
  
\* The System parameters contain a list of Volume IDs. Newly created Volume IDs are automatically added to this list. If you turn the power off without saving, this data will be lost (Basic Operation p.8-7).
4. Press F1 to mark all types of sound data.  
  
\* Each time you press F1, the mark will alternately appear and disappear.
5. Press F3 Exec. All sounds will be assigned the Volume ID you specified. When the operation is complete, the display will indicate "Complete".

---

## Name all sounds

Unnamed sounds cannot be saved. For details on assigning names, refer to Basic Operation p.7-12 "Assigning names".

## Assign Patches to Parts

Patches which are not assigned to a Part will not be saved. You must assign each Patch to a Part. For the procedure, refer to Basic Operation p.2-5 "Selecting Patches".

**\* In actuality, not only Patches, but also Partials must be assigned to Patches. For details, refer to Basic Operation p.3-8.**

---

# MEMO



# *Chapter 4*

## **Save your sounds (Save)**

---

Sounds you sampled or edited will be lost when the power is turned off, so be sure to save important data to a floppy disk or hard disk. In this section we will explain how to save data as an entire Volume.

# Before you save

---

Before you save a Volume, check the following points.

## Regarding sound data

1. Is the same Volume ID specified for all sounds (Basic Operation p.8-4)? Unless the same Volume ID is specified, it will be difficult to keep track of the data among the vast quantity of other data on the disk.
2. Have all sounds been named (Basic Operation p.8-9)? Unless names have been assigned, the data cannot be saved.
3. Are the Patches you wish to save assigned to Parts (Basic Operation p.8-9)? Unless they have been assigned, they cannot be saved.

## Regarding disks

1. Floppy disks / hard disks / magneto-optical disks that have been newly purchased or that were used by other computers etc. must be formatted by the S-760 before they can be used to store sound data. When a disk is formatted, any data which may have been on that disk will be lost. Refer to the procedure in "Formatting" to format the disk.
2. Floppy disks or hard disks etc. used by the S-770/750 (SYS-772 Version 2.0) or SP-700 can be used without reformatting. However when you save S-760 sound data, there are some things you should be aware of regarding the disks and sound data compatibility. Before saving please be sure to read "Sound Data Compatibility" (Advanced Operation p.2-2).



# Formatting

- \* Since the S-760 and personal computers use different formats, it is not possible for these devices to share disks or recognize each other's data.

Before formatting a floppy disk or a magneto-optical disk, you must first set the protect tab of the disk to the WRITE position.

1. Press MODE. The Mode Menu display will appear.
2. Move the cursor to F5:Disk and press S1/DEC(Open). The Disk Mode display will appear.
3. Press the Value knob. The Disk Menu display will appear.
4. Move the cursor to 5:Utility and press S1/DEC(Open). The Disk Utility display will appear.

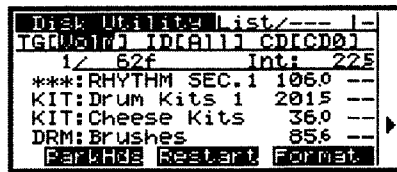

5. Move the cursor to CD (Current Drive) and press S1/DEC(List). The Select Drive display will appear.

- \* If you are formatting a floppy disk or a magneto-optical disk, insert the disk. If you insert a magneto-optical disk, be sure to press F3 Scan to make the S-760 recognize the magneto-optical disk.

6. Move the cursor to the drive you wish to format and press S1/DEC(Sel). The current drive will change, and you will return to the Disk Utility display.
7. Press F3 Format. The current drive will be formatted.

- \* In the case of a floppy disk which has already been formatted, a message will appear for confirmation.

F1 Yes : Format the disk.  
F3 No : Cancel without formatting.

- \* In the case of a SCSI device which has already been formatted, a messages will appear, allowing you to select either formatting or initialization (press F1 Yes twice).

F1 Yes : Initialize (erase) all sounds and the system, restoring the disk to the condition it was in when formatted. This takes less time than formatting.  
F2 No : Format the disk.  
F3 Cancel : Cancel initialization/formatting.

# Saving to floppy disk

A floppy disk of either 2DD or 2HD type can store one Volume per disk. If the volume does not fit on a single disk, the data can be divided across two or more disks.

1. Press MODE. The Mode Menu display will appear.
2. Move the cursor to F5:Disk and press S1/DEC(Open). The Disk Mode display will appear.
3. Press the Value knob. The Disk Menu display will appear.
4. Move the cursor to 2:Save and press S1/DEC(Open). The Disk Save display will appear.

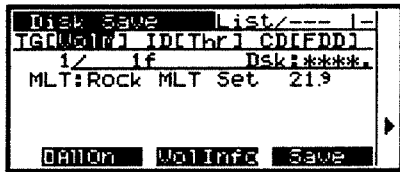

5. Make sure that TG (Target) is set to Volm (Volume).
  - \* If not, perform the following procedure.  
Move the cursor to TG and press S1/DEC(List). The Select Target display will appear.  
Move the cursor to Volume and press S1/DEC(Select). You will return to the Disk Save display.
6. Make sure that ID (Volume ID) is set to Thr.
  - \* If not, perform the following procedure.  
Move the cursor to ID and press S1/DEC(List). The Volume ID display will appear. Press F2 Thru. You will return to the Disk Save display.
7. With the protect tab set in the WRITE position, insert a formatted floppy disk into the floppy disk drive.
8. Move the cursor to CD (Current Drive) and press S1/DEC(List). The Select Drive display will appear.  
Move the cursor to FDD:[Floppy Disk] and press S1/DEC(Sel). You will return to the Disk Save display.
9. Move the cursor to Volume Name and press S1/DEC(Mark). Mark the sounds you wish to save.
  - \* If you press S1/DEC(Mark) once again, the mark will disappear.

---

10. Press F3 Save. A message will ask you to confirm, and the number of sounds you wish to save and the number of floppy disks required will be displayed. Make sure you have the required number of floppy disks.

**\* It is not possible to mix 2DD and 2HD floppy disks.**

**\* To cancel the saving operation, press F3 No.**

11. Press F1 Yes. The Volume will be saved.

**\* If you save sound data to a floppy disk which already contains S-760 or SYS-772 Version 2.0 sound data, a message will ask for confirmation. Be aware that if you press F1 Yes and save the data, all sound data previously on that disk will be lost.**

**\* If the amount of sound data is too great to be saved on a single disk, a message of "Please Change Disk" will appear. Remove the first disk, insert another one, and press F1 Yes.**

**\* If the second or subsequent disk is not formatted, a message of "Current Drive is not formatted. Do you need to format?" will appear. Press F1 Yes. After the floppy disk is formatted, the sound data will be continued to be saved.**

**\* Mark the labels of each floppy disk with the order that the data was saved. When you later load the data, insert the disks in the same order.**

12. When saving is complete, a message of "Complete" will appear. Remove the disk and set the protect tab to the PROTECT position.

## Saving to SCSI device

---

Until step 6 the procedure is the same as "Saving to floppy disk".

7. Move the cursor to CD (Current Drive) and press S1/DEC(List). The Select Drive display will appear.

Move the cursor to the SCSI device you wish to use for saving and press S1/DEC(Sel). You will return to the Disk Save display.

**\* It is not possible to save to a CD-ROM drive or to a tape streamer.**

8. Move the cursor to Volume Name and press S1/DEC(Mark) to mark the sounds you wish to save.

**\* If you press S1/DEC(Mark) once again, the mark will disappear.**

9. Press F3 Save to save the Volume.

**\* In the System settings, there is an Overwrite Switch parameter (Basic Operation p.8-12, Advanced Operation p.3-96). With the factory settings, this is turned Off. When this is Off, if the SCSI device to which you are saving data already contains sound data with identical names to the sound data you are attempting to save, the numbers of the identically-named sound data will be displayed and you will be asked whether or not it is ok to overwrite the existing sound data. Select one of the following.**

**F1 Yes : Save all the sound data, overwriting the old identically-named data.**

**F2 No : Do not save identically-named data, but do save the uniquely-named data.**

**F3 Cancel : Cancel the operation without saving.**

10. When saving is complete, the display will indicate "Complete".

**\* If you attempt to save sound data that is larger than the free area in the current drive, an error message of "Disk Memory Full" will appear. The sound data will be saved only partially.**

**\* If you attempt to save more (numbers of) sound data than the current drive can accommodate, a message of "Directory Full" will appear, and those sounds will not be saved.**

# Convenient automatic formatting

---

The preceding explanation described how to format by specifying in the Disk Utility display the disk drive to be formatted.

In addition to this method, it is also possible to automatically format a disk which has never been formatted by the S-760. In the Disk Save display when you press F3 Save, or in the Save System display when you press F3 SaveSys, a message of "Current Drive is not formatted. Do you need to format?" will appear. Press F1 Yes and the disk will automatically be formatted, and then the sound data or system will be saved.

**\* Disks which have already been formatted by the S-760 or used in the S-770/750 (SYS-772 Version 2.0) or S-700 cannot be reformatted in this way. In order to reformat them, you must first backup the sound data and then use the previously described procedure to format them. (All data on the disk will be lost.)**

---

# MEMO



# *Chapter 5*

## **Starting up from a hard disk**

---

# Starting up from a hard disk

The S-760 system (program and parameters) can be saved to a SCSI device such as a hard disk or a magneto-optical disk so that the SCSI device can be used as the start-up disk. In this chapter, we will explain how the S-760 can be started up from a connected hard disk, and how to specify that hard disk for reading and writing data. Use the following procedure.

- \* It is not possible to use a CD-ROM drive or a SCSI tape streamer as the start-up device.
- \* The S-760 cannot be started up using SYS-772 Version 2.0. Even if you save SYS-772 Version 2.0 to a hard disk or connect a hard disk which was being used as a S-770/750 start-up disk, the S-760 will not start-up.

## 1. Hard disks usable as a start-up device

You will need to save the S-760 system to a hard disk or magneto-optical disk formatted by the S-760. However it is not possible to save the system on a hard disk or magneto-optical disk already formatted by the S-770/750 (SYS-772 Version 2.0) or the SP-700, since the system parameters are different.

If you absolutely want to save the S-760 system on such a disk, you will have to reformat that disk on the S-760. If you do this, all data that was on that disk will be lost, so be sure to make a backup before formatting.

- \* For details of formatting, see Basic Operation p.4-3.

## 2. Saving the system to a hard disk

1. Press MODE. The Mode Menu display will appear.
2. Move the cursor to F5:Disk and press S1/DEC(Open). The Disk Mode display will appear.
3. Press the Value knob. The Disk Menu display will appear.
4. Move the cursor to 6:Save System and press S1/DEC(Open). The Save System display will appear.

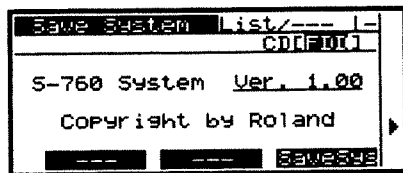

5. Set CD (Current Drive) to the hard disk on which you want to save the system. Press S1/DEC(List). The Select Drive display will appear. Move the cursor to the desired hard disk drive, and press S1/DEC(Sel). You will return to the Save System display.



6. Press F3:SaveSys (Save System). Saving will be executed.

\* If you attempt to save onto a hard disk drive or magneto-optical disk already formatted by the S-770/750 (SYS-772 Version 2.0) or the SP-700, a message of "Can't Execute. This Drive is S-770/SP-700 format!" will appear. The system cannot be saved on such a disk. Press F2 OK.

\* If the hard disk/magneto-optical disk has not been formatted by the S-760, a message of "Current Drive is not formatted. Do you need to format?" will appear. Press F1 Yes. After formatting, saving will be done automatically. If you wish to cancel, press F3 NO.

7. When the system has been saved, the display will indicate "Complete".

### 3. Setting the Boot Drive / Initial Drive

You can specify the disk drive from which the system will be started up (the Boot Drive) and the disk which will be used to read and write data (the Initial Drive).

1. Press MODE. The Mode Menu display will appear.

2. Move the cursor to F6:System and press S1/DEC(Open). The System Mode display will appear.

3. Press the Value knob. The System Menu display will appear.

4. Move the cursor to 2:SCSI and press S1/DEC(Open). The System SCSI display will appear.

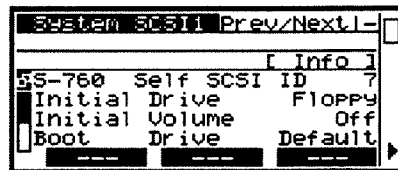

5. Move the cursor to Initial Drive and specify the disk for reading and writing data. In this example, the SCSI ID of the hard disk is 1, so set SCSI:1.

6. Move the cursor to Boot Drive and specify the disk from which the system will be started up. In this example, the SCSI ID of the hard disk is 1, so set SCSI:1.

\* Depending on the Boot Drive setting, if you turn the S-760 on with a floppy disk inserted, it may start up from the floppy rather than from the hard disk. In this case, remove the floppy disk before turning the S-760 on. For details refer to Basic Operation "Convenient ways to start-up" (Basic Operation p.6-2).

---

## 4. Saving the System Parameters

Parameters such as Boot Drive or Initial Drive are known as System parameters. System parameter settings are lost when the power is turned off, so you need to save them to the System Backup memory inside the S-760.

**\* System parameters can be broadly divided into two groups by where they are saved: those which are saved in the System Backup memory inside the S-760, and those which are saved on the System disk. For details refer to Basic Operation p.8-7.**

1. Press the Value knob. The System Menu display will appear.
2. Move the cursor to 5:LD/SV SysPRM and press S1/DEC(Open). The Load/Save System Parameter display will appear.

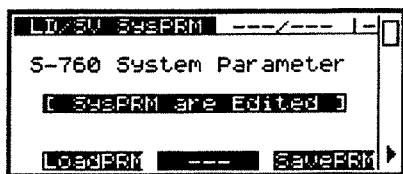

**\* If you have edited the System parameters and not yet saved them, a message of "[SysPRM are Edited]" will appear. This message will disappear when the data is saved.**

3. Press F3 SavePRM (Save System Parameters). The System parameters will be saved. From the next time the S-760 is started up, the specified Boot Drive and Initial Drive will be in effect.

## 5. Starting up from a hard disk

Turn off the power as explained in Basic Operation "Shutting down" (p.1-7).

1. In the same way as in "Starting up from floppy disk", turn on the power of each SCSI device.
2. Turn on the power of the S-760. The system will be loaded from hard disk (the Boot Drive).
3. When the S-760 has started up correctly, the Performance Play display will appear.
4. Turn on the power of your MIDI devices and audio devices.



## *Chapter 6*

### **Convenient ways to start-up**

---

# Convenient ways to start-up

---

We have already explained how to start up from either the floppy disk or the hard disk, as specified by the Boot Drive setting (Basic Operation p.5-3). It is also possible to modify the settings when starting up the S-760.

If you turn the power on while pressing MODE, the Setup Menu display will appear.

**\* The MODE indicator will blink.**

Use the cursor buttons and Value Knob, or S1/DEC(Dec) and S2/INC(Inc) to modify the setting. The following parameters can be modified.

**\* All of these are parameters which are saved in the system backup memory inside the S-760.**

When you finish making settings, press EXIT. The settings will be saved into the S-760 system backup memory, and the S-760 will start up as usual.

1. Self SCSI ID            [SCSI: 0]—[SCSI: 7]  
The SCSI ID of the S-760 itself can be changed.

2. Boot Drive            [Default], [Floppy], [SCSI: 0]—[SCSI: 7]  
You can select the drive from which the system (program and parameters) will be loaded.

**Default:**

If the system disk is inserted into the floppy disk drive, that system will be started up. If it is not inserted, each SCSI drive will be checked in sequence (starting with 0) to see whether it contains a system. The S-760 will start up with the first system it finds. If none of the SCSI devices contain a system, a message of "Please Insert System Disk" will appear, prompting you to insert a floppy disk (system).

**Floppy:**

The system will be started up only from a floppy disk (system).

**SCSI: 0—SCSI: 7:**

The system will be started up from the drive with the SCSI ID you specify. If there is no system in the specified drive, each SCSI drive will be checked in sequence (starting with 0) to see whether it contains a system. The S-760 will start up with the first system it finds.

If none of the SCSI drives contain a system, the floppy disk drive will be checked to see if the system disk is inserted. If so, the S-760 will start up from the floppy. If not, a message of "Please Insert System Disk" will appear, prompting you to insert a floppy disk (system).

**\* If the ID you specify here is the same as the S-760's Self SCSI ID, the result will be the same as if Default had been selected.**

---

3. Controller [Panel+LCD], [Mouse+CRT], [RC-100+CRT]

You can select how you wish to operate the S-760.

**Panel+LCD:**

The S-760 can be operated using only by its own front panel.

**Mouse+CRT:**

The S-760 can be operated using a mouse and a CRT display. The LCD display will not be used.

**RC100+CRT:**

The S-760 can be operated using a mouse and a separately sold RC100 remote controller (discontinued) and a CRT display. The LCD display will not be used.

**\* If the separately sold Power Sampling Expansion (OP-760-1) is not installed, this parameter cannot be set to Mouse+CRT or RC100+CRT. If it is installed, you can select from the three settings.**

4. LCD Contrast [-50]—[50]

This parameter adjusts the brightness of the LCD.

MEMO

# *Chapter 7*

**Operation**

---

# Six operation modes

---

In the S-760, the parameters that determine how a sound is produced are organized in a hierarchy. The operating procedures are organized correspondingly.

## 1. Performance mode

In this mode you can actually play the S-760 from a MIDI sequencer or MIDI keyboard, etc. You can edit Performances, and can also select the Performance Command Menu to edit Patches, Partials, and Samples. By sampling while in Performance mode, you can automatically create Patches, Partials and Samples.

## 2. Patch mode

This is the mode in which you edit individual Patches. From the Patch Command Menu, you can also edit Partials and Samples. By sampling while in Patch mode you can automatically create Patches, Partials and Samples.

## 3. Partial mode

This is the mode in which you edit individual Partials. From the Partial Command Menu, you can also edit Samples. By sampling while in Partial mode, you can automatically create Partials and Samples.

## 4. Sample mode

This is the mode in which you sample, or edit individual samples.

## 5. Disk mode

This is the mode in which you save and load sounds to a floppy disk drive or SCSI device, or save the system (program and parameters).

## 6. System mode

This is the mode in which you make settings affecting the entire system, such as input/output, MIDI, and SCSI.

- \* **When playing the S-760, make sure that Performance Play display in the Performance mode is selected.**
- \* **There are several ways to edit Patches/Partials. Refer to "How to edit sounds" (Advanced Operation p.1-2).**



# How each mode is organized

Each mode consists of several displays, organized by function.

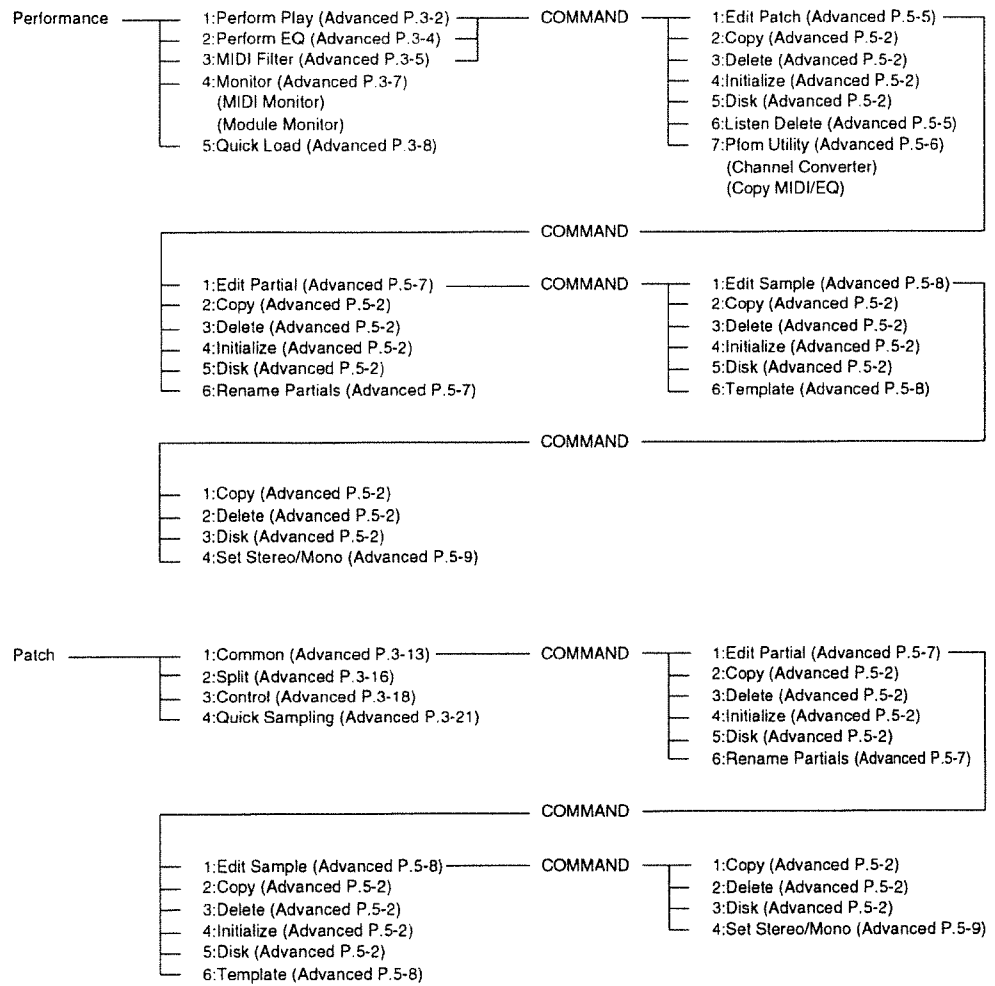

How each mode is organized

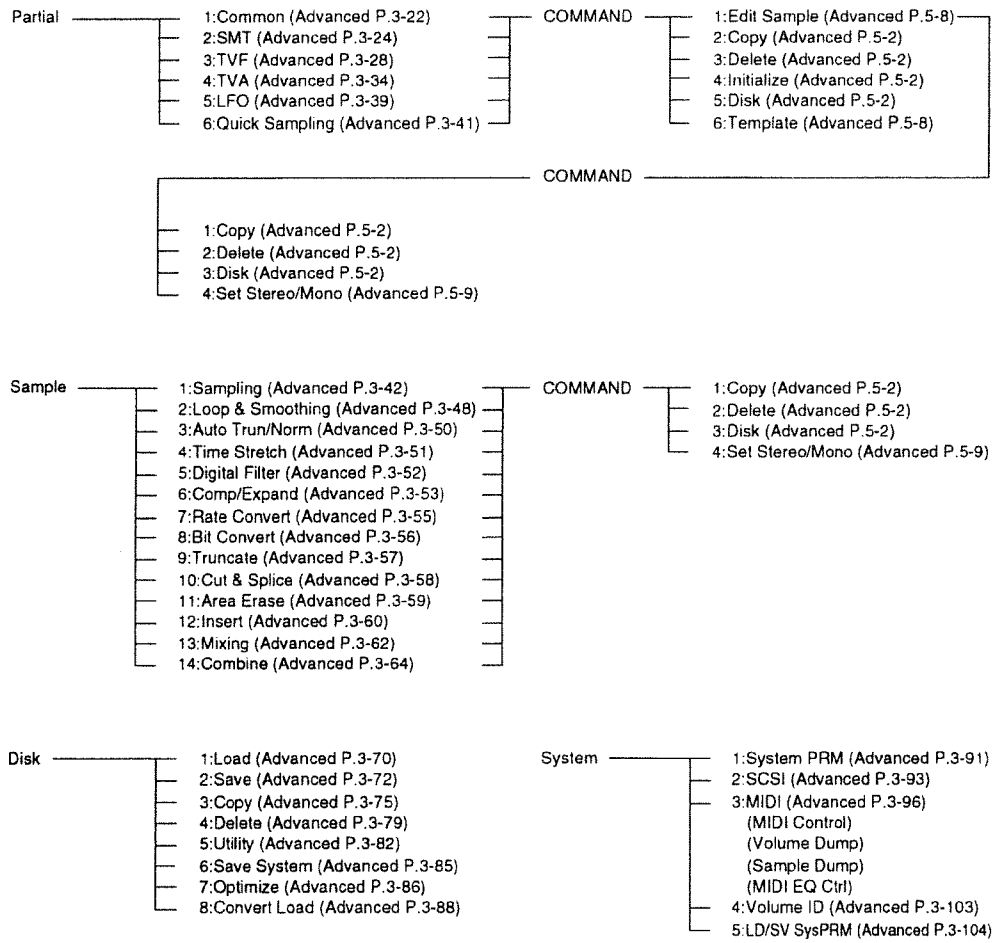

# How to view the screen

The following information appears in the screen.

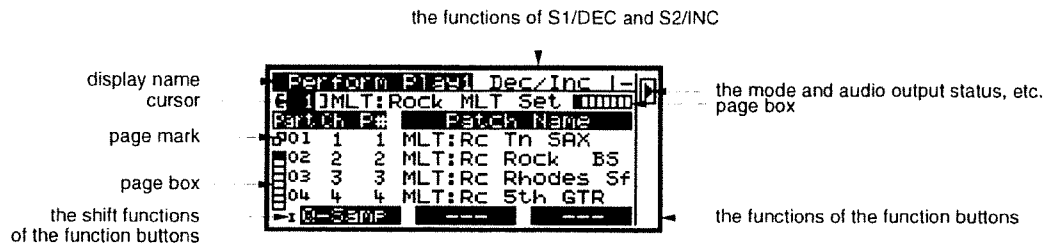

## Page

Some displays consist of several pages, and a page box will appear in the left or right edge of the screen. The boxes indicate the number of pages, and the box displayed in reverse video indicates the current page. For pages in the vertical direction, a page mark will be displayed in addition to the boxes.

## The mode and audio output status, etc.

The triangle pointing right indicates the mode of the currently opened page.

When you arrived at a disk mode or sound edit page via a command, a plus sign indicates the mode you passed through so that you can tell which mode you were originally in.

The square indicates how the S-760 will output sound.

For details refer to Advanced Operation p.1-4.

## Function Buttons

The function of the function buttons is displayed in the lower line of the display. The method of display depends on the type. Function buttons displayed as "—" cannot be used (the indicator will also be unlit). For some screens, the function buttons may have three or more functions. In such cases, the lower left of the screen will show "I". When SHIFT is pressed, different functions will be accessed and the display will show "II".

### 1. Select a mode

Select a mode in the Mode Menu display.

### 2. Execute a command

Execute a command such as Load or Save.

### 3. Modify settings

Modify setting related to the display (select a target within the display, or change the edit mode). The setting will change each time you press the function button, and the current setting will be displayed. In this case the display will have a square for the first letter.

# How to open a display

---

To open the desired display, use the following procedure.

## Opening a mode display

1. Press MODE. The Mode Menu will appear. The currently selected mode will be marked by a circle.
2. Move the cursor to the desired mode and press S1/DEC(Open).
  - \* **The last-selected screen within that mode will appear.**
  - \* **To move the cursor, use the cursor buttons or the Value knob.**
3. If you wish to open a different display, press the Value knob. The menu display of the selected mode will appear. The currently selected display will be marked by a circle.
4. Move the cursor to the desired display and press S1/DEC(Open). The desired display will open.
5. Some displays consist of two or more pages, so move the cursor to select pages.
  - \* **Horizontal pages can be switched as follows, depending on the display. Press a function button while holding SHIFT.**
    - F4 1stPage : return to the first page**
    - F5 ← Page : move to the previous page**
    - F6 Page → : move to the next page**
  - \* **For vertical pages, move the cursor to the page mark and use S1/DEC or S2/INC, or the Value knob to select pages.**
    - S1/DEC(Prev) : move to the previous page**
    - S2/INC(Next) : move to the next page**
6. To return to the previous display, press EXIT.

---

## Opening a command display

When you want to execute a command (such as loading sound data) in a display of one of the modes Performance, Patch, Partial or Sample, open a command display. When the COMMAND indicator is lit green, you can execute a command.

1. Press COMMAND. The COMMAND indicator will light red, and the Command Menu display will appear.
2. Move the cursor to desired command and press S1/DEC(Select). The Command display will appear.
  - \* For details on executing each command, refer to the explanation of each command (Advanced Operation p.5-2).
3. If you wish to cancel a command without executing, press EXIT. You will return to the previous display.

## Opening a list display

When you want to select sounds or drives from a list, open a list display. List displays can be opened when the S1/DEC function is List. The S1/DEC function will be List when the cursor is in the following locations.

1. In Performance, Patch, Partial or Sample mode when the cursor is located on a Performance/Patch/Partial/Sample sound name
2. In the Disk Mode display when the cursor is located on a drive selection such as CD (Current Drive).
3. In the Quick Load display when the cursor is located on CD (Current Drive).

If you wish to cancel the selection of a sound or drive, press EXIT. You will return to the previous display.

## Directly opening a display (Jump)

In addition to the methods described above, you can use the Jump function to go directly to the desired display. By marking frequently-used displays or displays reached by a complicated path, you can operate the S-760 more efficiently. You must first mark the display to which you wish to jump.

### Opening/marking a display for marking

1. Open the display you wish to mark.
  - \* ASCII displays and list displays cannot be marked.
2. While holding SHIFT press MARK. The Mark display will appear.

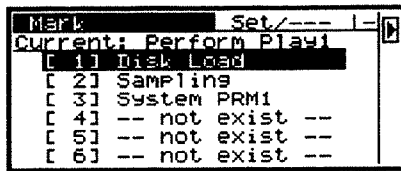

3. Move the cursor to the mark number you wish to use. Use the cursor buttons to scroll.
  - \* Up to 20 displays can be marked.
4. Press S1/DEC(Set). The display will be marked.
5. Press EXIT. The previous display will reappear.

The list of marked displays is a system parameter. If you turn the power off without saving this data to a system disk, it will be lost (Basic Operation p.8-7).

### Jumping to a display

1. While holding SHIFT press JUMP. The Jump display will appear.

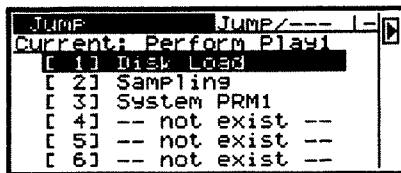

2. Move the cursor to the number of the display to jump to. Use the cursor buttons to scroll.
3. Press S1/DEC(Jump). The desired display will appear.
  - \* To cancel, press EXIT.

# About SHIFT

---

Some buttons change their function while SHIFT is pressed (the indicator will light). These functions are printed in blue on the lower part of the button. You may either press the button while holding SHIFT or press the button after pressing SHIFT.

**\* If you press a function button while pressing SHIFT, that function will be executed each time you press the function button. If you press a function button after pressing SHIFT, that function will be executed once and will then exit.**

The following buttons change their function.

## **Function buttons (F4—F6)**

In some displays the function buttons have three or more functions. In such cases, a Roman numeral will appear in the lower left of the display to distinguish them.

## **HOME**

The cursor will move to the home position. In many cases, home position is the upper left of the display.

## **MARK**

The Mark display will open.

## **JUMP**

The Jump display will open.

# Modifying settings

---

## Using the Value knob to modify a value

Move the cursor to the parameter you wish to modify and rotate the Value knob to the right to increase the value (parameter value) or to the left to decrease it.

**\* If the function of S1/DEC and S2/INC is other than Dec/Inc or -100/+100, rotating the Value knob will not affect the value.**

## Using S1/DEC and S2/INC to modify a value

The functions of S1/DEC and S2/INC will depend on the display and the cursor position. The function is displayed at the upper right of the screen. They have the following functions. When "---" is displayed the buttons will have no effect.

Dec/Inc	: decrease/increase by the smallest division the value of the parameter indicated by the cursor
-100/+100	: scroll sound list by hundreds.
Open/---	: select modes.
Select/---	: select sounds, etc.
Mark/---	: mark sounds, etc.
List/Name	: display a list of sounds or drives, or modify a name
Prev/Next	: switch pages vertically
Type/Del	: in an ASCII display input or delete characters
O.W/---	: in an ASCII display switch character input modes
INS/---	: in an ASCII display switch character input modes
Search ← / →	: in the Partial SMT display or Sample Loop & Smoothing display, automatically find stereo samples
Get/Name	: in the Disk Utility display, select the sounds you want to rearrange, or rename sound
Ins/Cancel	: in the Disk Utility display, modify the order or sounds or cancel them
Jump/---	: jump to the specified screen
Set/---	: in the Mark display, set a mark
Sel/Name	: in the Select Drive display, select a drive or modify a name
Sel/Del	: in the Volume ID List display, select or delete a Volume ID
List/---	: in the Disk Mode display, display a list of the Targets or Volume IDs or drives.
---/Name	: In the System Parameter display, modify the volume name.



---

## Using the function buttons to modify a value

When the first letter of a function button has a square box, it can be used to modify a setting related to that screen.

# Assigning names

---

## Opening an ASCII display

If you wish to name a sound or drive, get the following display, move the cursor to the name and set the function of S2/INC to Name. Press S2/INC to get the ASCII display.

**\* The following displays are examples. It is usually possible to open ASCII displays from other displays as well.**

### **Volume**

In the System Volume ID display, move the cursor to the Volume name

### **Performance**

In the Performance Play display, move the cursor to the Performance name.

### **Patch**

In the Patch Common display, move the cursor to the Patch name.

### **Partial**

In the Partial Common display, move the cursor to the Partial name.

### **Sample**

In the Sampling display, move the cursor to the Sample name.

**\* If you modify the sample name, the Volume Dump function will no longer be usable. For details refer to Advanced Operation p.6-8.**

### **Drive**

In the Disk Load display, move the cursor to CD (Current Drive) and press S1/DEC(List). The Select Drive display will open, so move the cursor to the drive which you want to rename.

**\* It is not possible to name floppy disks, CD-ROM drives, or tape streamers.**

### **Sound names in a disk drive**

Move the cursor to a sound name in the Disk Utility display.

**\* The TG (Target) settings will determine the types of sounds.**

There are the following two ways of assigning a name.

**\* Names can be assigned up to 12 characters long.**

## 1. When the cursor is located at the ASCII keyboard

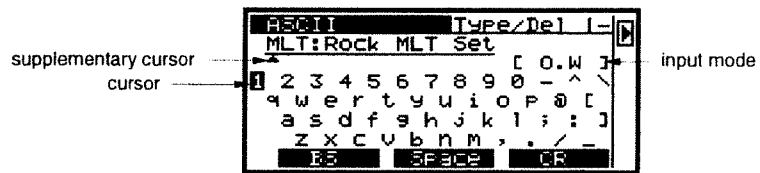

Move the supplementary cursor to the location where you wish to input the name, move the cursor to the character you wish to input and press S1/DEC(Type).

### Moving the supplementary cursor

Use the Value knob to move the supplementary cursor.

### Switching between lowercase and uppercase letters

This will shift each time you press SHIFT. For uppercase letters the indicator will light.

### Deleting characters

Move the supplementary cursor to the character you wish to delete and press S2/INC(Del).

### Switching input mode

There are two input modes.

[O.W] : The character at the supplementary cursor will be overwritten.

[INS] : The character will be inserted at the supplementary cursor location, and subsequent characters will be moved backwards.

Move the cursor to the [ ] position and press S1/DEC to switch.

### Finalizing the name

When you finish entering the name, press F3 CR. The name will be finalized and you will return to the previous display.

### Cancelling your input

Press EXIT. The name will remain as it was previously specified.

## 2. When the cursor is located at a name

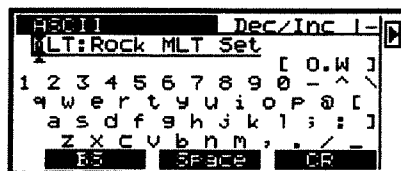

Move the cursor to the location where you wish to input, and press S1/DEC or S2/INC or use the Value knob to input characters.

### Deleting characters

Move the cursor to the right side of the character you wish to delete and press F1 BS.

---

# MEMO



## *Chapter 8*

**How the S-760 is organized**

---

# How sounds are organized

Sounds are organized as follows.

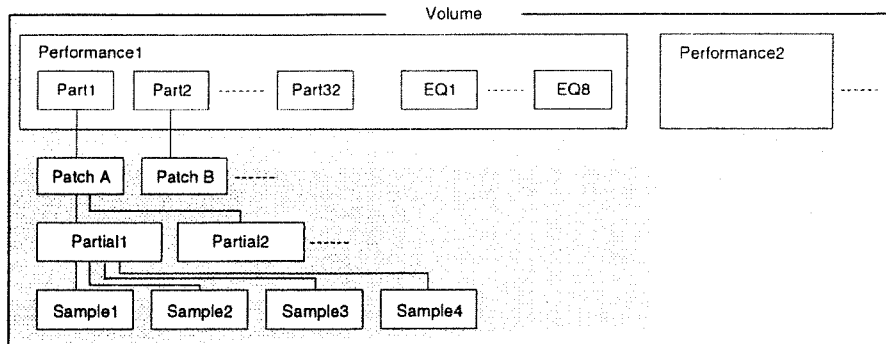

## 1. Samples

A "Sample" is the smallest unit of sound data — wave data with its associated parameters such as loop points. When a sound is loaded, the samples used in that sound are automatically loaded into wave memory.

## 2. Partials

Up to four Samples can be combined to create one sound, and this is referred to as a "Partial".

## 3. Patches

Partials are assigned to the 88-note keyboard (note numbers 21 (A0) to 108 (C8)) and various performance-related parameters added to create a "Patch".

## 4. Performances

Patches are assigned to up to 32 Parts, and given settings for MIDI channel, volume level, and keyboard range so that each Patch can be used as an independent MIDI sound source. Such a setup is called a "Performance". For each output jack you can specify settings for EQ, Patch mixing, and MIDI data handling. Performances are the largest unit of sound data.

## 5. Volumes

Internal memory holds the various types of sound data listed above. The totality of all sound data in internal memory is called a "Volume".

**\* Patches, Performances and Volumes can be selected by Program Change messages from an external MIDI controller (Basic Operation p.9-2).**

# How sound data is interdependent

---

1. When a sound is loaded or saved, all lower levels of sound data are loaded or saved together with it.

For example when a Volume is loaded, all Performances, Patches, Partials and Samples used in that Volume are also loaded.

2. The names of the lower-level data specify which lower-level data is used by the higher-level data.

For example if several Parts in a certain Performance specify Patch A by name. It may seem as though more than one Patch A exists, but actually only one Patch A exists as data. Thus, there is no need to create multiple copies of Patch A.

3. When a certain piece of lower-level sound data is used by two or more higher-level sounds, editing and saving the lower-level sound data will affect all higher-level sounds which use that lower-level sound data.

This is because a single copy of the lower-level data is being used by several higher-level sounds. If you wish to avoid this, copy the lower-level data before editing it, change the name, change the upper-level data to use the newly-named lower data, and then save it.

Since all sound data is kept track of by its name, the renamed data will be treated as a separate piece of data even though it may be identical to the data with the old name.

In this way, lower-level sound data is always affected by upper-level sound data. When executing operations such as Load, Save and Disk Delete etc., always be aware of possible dependencies, and check whether it is ok to execute the operation for lower levels of data as well. (See "Fast Delete Mode" in Advanced Operation p.3-95, and "Overwrite Switch" in Basic Operation p.8-12).

# About the Volume ID and sound data management

---

## What is the Volume ID?

When large amounts of sound data are saved in a disk, the interdependent relationships of "which Partials and Samples are used by which Patch" can become very complicated. Although all data is kept track of by name, a Volume ID is assigned to each Volume to help manage large amounts of data.

For example, suppose that there was a sound data name "GTR:E.Guitar-L".

The first 3 characters of the name are the Volume ID, and are treated as part of the sound name. Even if there is an otherwise identically named sound, it will be handled as a separate sound if the Volume ID is different.

- \* **It is a good idea to use abbreviations of instrument names etc. as the Volume ID. In this example, GTR is used as an abbreviation for Guitar, indicating the type of sound.**
- \* **For details on how to specify the Volume ID, refer to Basic Operation p.3-14.**
- \* **When you record a stereo sample or copy a sound, the last three characters of the name are automatically added as -L, -R, AA, AB, etc. to indicate this.**

## Using the Volume ID

In the Disk Mode display, you can specify a Volume ID for the sounds you wish to have displayed. This allows you to quickly find the desired sound. This is especially useful when high-capacity disks are used to store a large number of sounds (Advanced Operation p.6-25).

## Managing sound data

In order to avoid complicated interdependence between sound data, use the same Volume ID for all sounds in the Volume and save all the data as one Volume.



# Internal memory structure

In order to produce sound, System parameters, sound data parameters, and wave data must be loaded into internal memory.

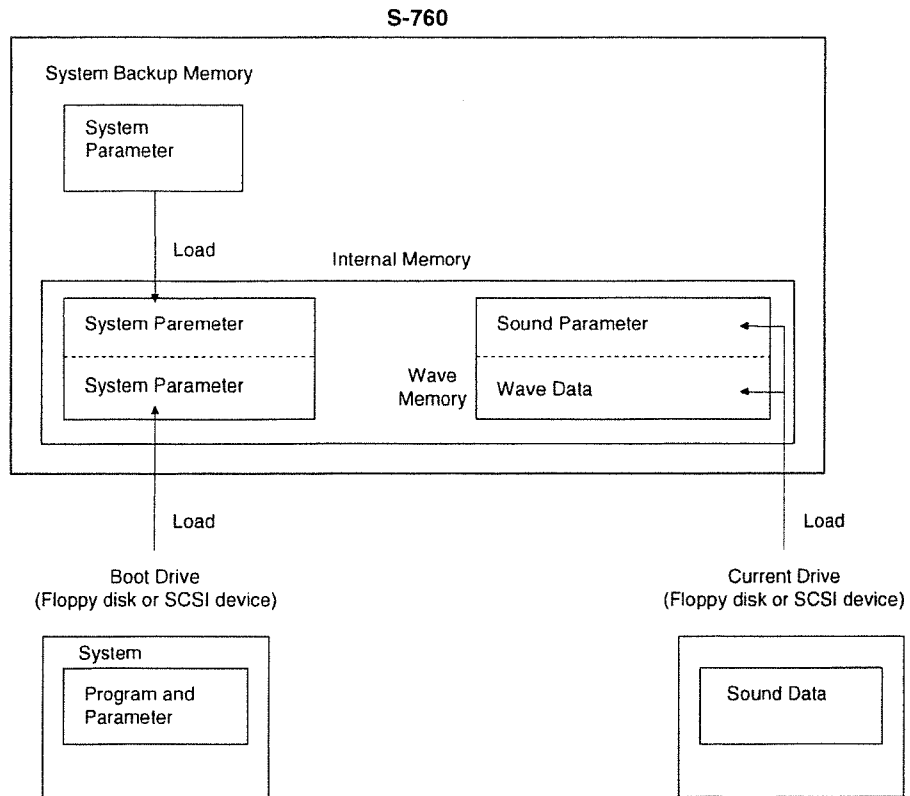

When the system starts up, the system (program and parameters) is loaded from the Boot Drive (floppy disk drive or SCSI device), and other system parameters are loaded from the system backup memory inside the S-760.

**\* For details on the Boot Drive, refer to Basic Operation p.5-3.**

**\* System parameters can be classified into two groups. One of these is stored in system backup memory. For details, refer to Basic Operation p.8-7.**

After the system has started up, sounds (sound data parameters and wave data) are loaded from the Current Drive (floppy disk drive or SCSI device), and now the S-760 is finally able to produce sound.

**\* For details on the Current Drive, refer to Basic Operation p.2-7.**

The memory into which the system and sounds are loaded is called Internal Memory. Sound data can be broadly divided into parameters and wave data. Wave data is loaded into Wave Memory.

**\* When the S-760 is shipped, it has 2 Mbytes of wave memory. You can install separately sold memory expanders (SIM72-8 or SIM72-16) to expand the wave memory to a maximum of 32 Mbytes (Basic Operation p.1-3).**

When the power is turned off, the system and sounds in internal memory will be lost, so save this data if necessary. The method of saving will depend on the type of data, so please read the following items carefully.

---

## Number of sounds

Internal memory (lost when the power is turned off) and floppy disks or SCSI devices can contain a maximum of the following numbers of each type of data.

Type of sound data	Internal memory / floppy disk	Hard disk etc.
Volume	1	128
Performance	64	512
Patch	128	1024
Partial	255	4096
Sample	512	8192

# Loading/Saving the system

---

## The System (program and parameters)

This data is saved on the system disk (floppy disk, hard disk, or magneto-optical disk). To save it, use the save operation in the Disk Mode item Save System. The following parameters are saved.

- Quick Load list (Advanced Operation p.6-2)**
- Mark list (Basic Operation p.7-8)**
- Template list (Advanced Operation p.5-8)**
- Volume ID list (Advanced Operation p.6-25)**

The system program and system parameters are always loaded or saved together. It is not possible to save just the system parameters along, but since they are always saved (overwritten) together with the system program, this is not a problem.

However when upgrading to a new version of the system program, the system parameter settings will be rewritten to the factory settings. In this situation, use the System Dump function to transmit system parameter settings as a MIDI Exclusive data, and record this data on a MIDI sequencer. For details refer to Advanced Operation p.6-6.

## System parameters

System parameters are saved in system backup memory inside the S-760. To save it, use the System Mode item Load/Save System Parameters. This data includes the parameters of the following displays.

- System Parameter display (Advanced Operation p.3-91)**
- System SCSI display (Advanced Operation p.3-93)**
- System MIDI display (Advanced Operation p.3-96)**

When the system is started up, this data is loaded from the system backup memory into internal memory, but you can also reload it again after startup (Advanced Operation p.3-104). If you have edited it but not yet saved it, this allows you to recover the previous settings.

# Loading sound data

---

## Clear

If internal memory already contains sound data, a message will ask whether you want to erase all that sound data before loading new data (Clear Internal Memory Before Loading?). Select one of the following.

- Yes : Erase all sound data from internal memory before loading.
- No : Load into free area of internal memory. If there is insufficient free memory, the data will be loaded incompletely.
- Cancel : The Load operation will be canceled.

## Overwrite

When loading into the free area of internal memory, you can choose to be asked whether or not identically-named sound data should be overwritten by the newly loaded data (Same Name! Overwrite?). This is determined by the System Parameter Overwrite Switch (Advanced Operation p.3-96).

- Off : A message will ask whether it is ok to overwrite (Same Name! Overwrite?).
  - F1 Yes : All the specified sound data will be loaded, and identically-named data will be overwritten.
  - F2 No : Identically-named data will not be loaded, and only differently-named sound data will be loaded.
  - F3 Cancel: The Load operation will be canceled.
- On : No message will be displayed. All sound data will be loaded, and identically-named sound data will be overwritten.

## Error messages

If wave memory is insufficient, a message of "Wave Memory Full" will appear and the data will be loaded incompletely for some sounds. Either expand the wave memory (Basic Operation p.1-3) or load only the necessary Volume/Performances/Patches.

If you exceed the number of sounds that can be loaded into internal memory (Basic Operation p.8-6), a message of "Directory Full" will appear, and the data will be loaded incompletely for some sounds. Load only the necessary Performances/Patches.

# Saving sound data

## Sounds that can be saved

When you save a Volume, all Performances used in that Volume will be saved. At the same time, all Patches, Partials, and Samples used by those Performances will also be saved. At this time, only the following data will be saved.

- Performances** : Those that have a name.
- Patches** : Those that have a name, and are assigned to a Part in the Performance.
- Partials** : Those that have a name, and are used by a Patch of a Part.
- Samples** : Those that have a name, and are used by a Partial used by a Patch of a Part.

\* Patches which are not assigned to a Part, and the Partials and Samples in such Patches cannot be saved as a Volume. Nor can they be handled by the Volume Dump function (Advanced Operation p.6-8).

\* Even if they have a name, sounds with a data size of 0 seconds cannot be saved.

As an example, let us suppose that a volume contains 20 named Patches and 1 named Performance. Patches 1—10 are assigned to Parts of a Performance, and Patches 11—20 are not assigned to a Part. Even if we save the entire Volume, Patches 11—20 and the Partials and Samples used in these Patches will not be saved.

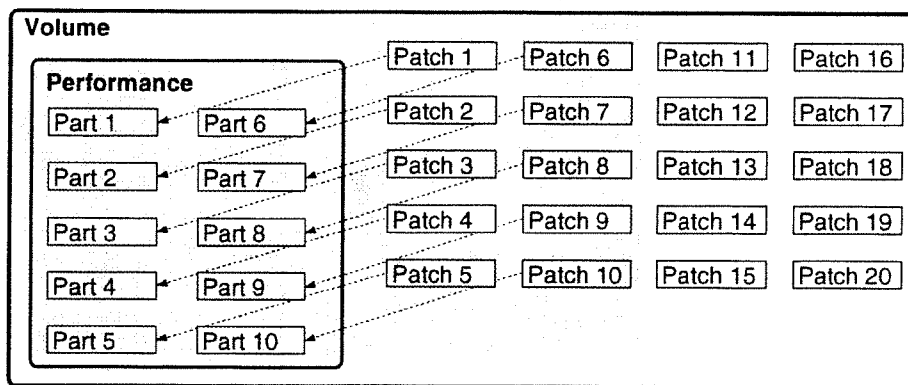

Assign Patches 11—20 to an unused Part if you wish to save them. (Turn the MIDI channel off for unused Parts.) When using MIDI Program Change messages to select Patches, you must save the Patches you wish to use.

## Sounds not included in any Volume

When a Volume is saved, the names of all sounds used in that Volume are written into the Volume. When a Volume is loaded, all sounds written in the Volume are loaded. This means that when saving to a hard disk or other SCSI device, the following situations can occur.

- \* When saving to a floppy disk, the following situations cannot occur since all previous sound data is always erased before saving.

### Example 1

Suppose that you saved a Volume that contained four Performances. Later, you created a fifth Performance (with the identical Volume ID), and saved that Performance by itself to the same hard disk. The next time you load that Volume, the fifth Performance will not be loaded.

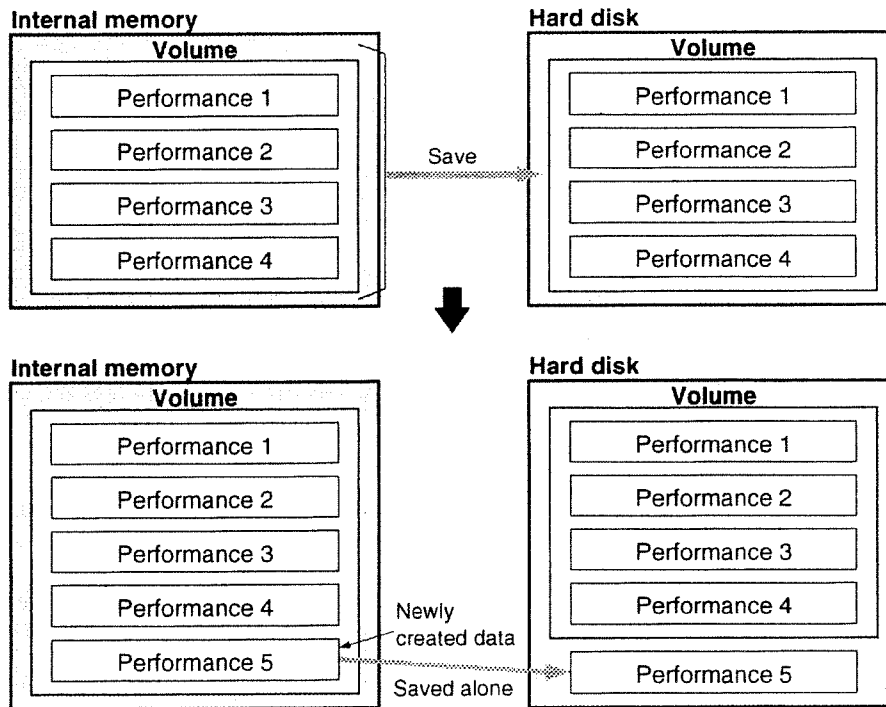

Since the fifth Performance was saved later by itself, it was not written into the previously-saved Volume. Thus, that Performance does not belong to any Volume. You will have to re-save the Volume with the five Performances, overwriting the previous Volume.

## Example 2

Suppose that you loaded a Volume with two Performances from a hard disk. Later, you used the Delete Command (Advanced Operation p.5-2) to delete the second Performance, and saved that Volume (overwriting the old data). The second Performance on the hard disk is not deleted.

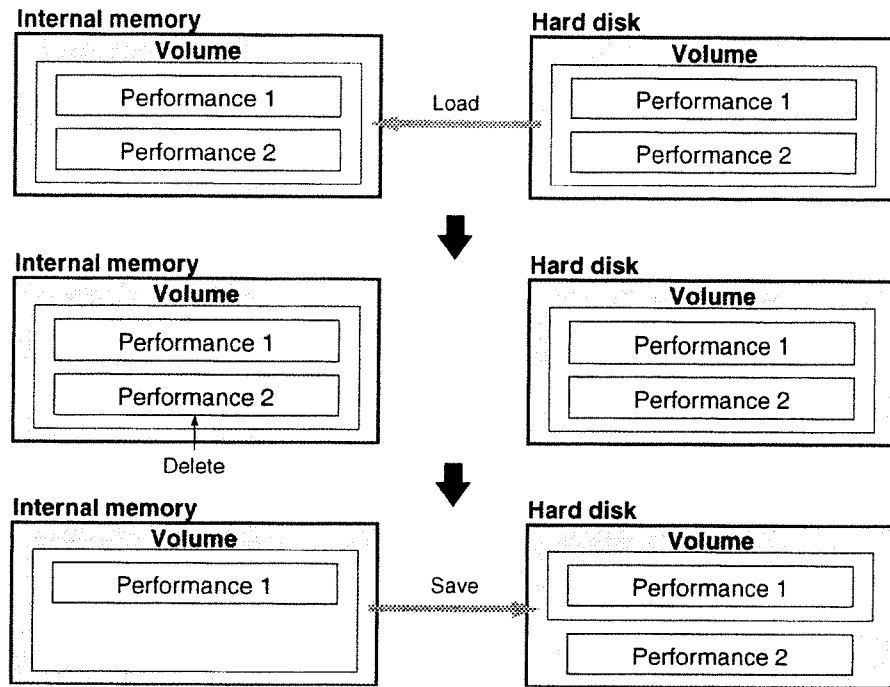

When the Volume was saved, all sound data names making up that Volume were written in the Volume data, so only the name of the first Performance was written.

However since the second Performance was not deleted from the hard disk, it now no longer belongs to any Volume (as long as it is not used by another Volume).

If the Performance is not needed, delete it in the Disk Delete display (Advanced Operation p.3-79).

### Example 3

Suppose that you loaded a Volume containing one Performance from a hard disk. Later, you modified the name of that Performance and saved that Volume (overwriting the old data). The Performance of the old name is not deleted.

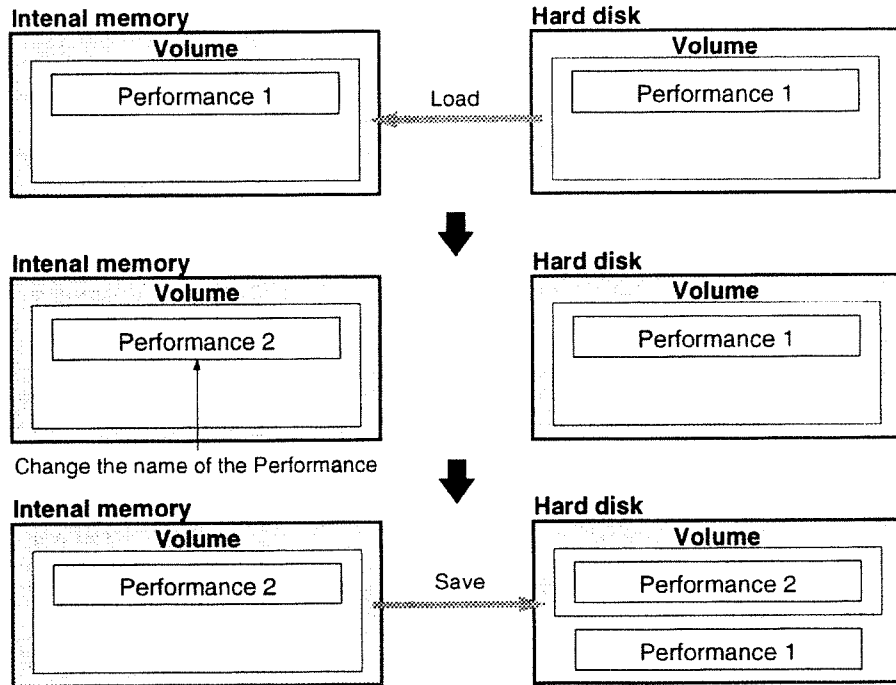

Unless it is being used by a different Volume, that Performance is now no longer used by any Volume. If the Performance is not needed, delete it in the Disk Delete display (Advanced Operation p.3-79).

## Overwrite

When saving to a SCSI device such as a hard disk, you have the option of being asked whether it is ok to rewrite the sound data if identically-named sound data already exists (Same Name! Overwrite?). The System parameter Overwrite Switch determines whether this message will appear (Advanced Operation p.3-96).

- Off : A message will ask whether it is ok to overwrite (Same Name! Overwrite?).
- F1 Yes : All the specified sound data will be saved, and identically-named data will be overwritten.
- F2 No : Identically-named data will not be saved, and only differently-named sound data will be saved.
- F3 Cancel: The Save operation will be canceled.
- On : No message will be displayed. All sound data will be saved, and identically-named sound data will be overwritten.



---

## Error messages

If the capacity of the hard disk etc. is exceeded, a message of "Disk Memory Full" will appear, and some sounds will be saved incompletely. Delete unneeded sound data in the Disk Delete display (Advanced Operation p.3-79).

If the number of sounds (Basic Operation p.8-6) that can be saved on a hard disk etc. is exceeded, a message of "Directory Full" will appear, and some sounds will be saved incompletely. Delete unneeded sound data in the Disk Delete display (Advanced Operation p.3-79).

# Signal flow

The S-760 receives MIDI messages at the MIDI IN connector and produces sound. The following diagram shows the signal flow from when a MIDI message is received to when sound is produced.

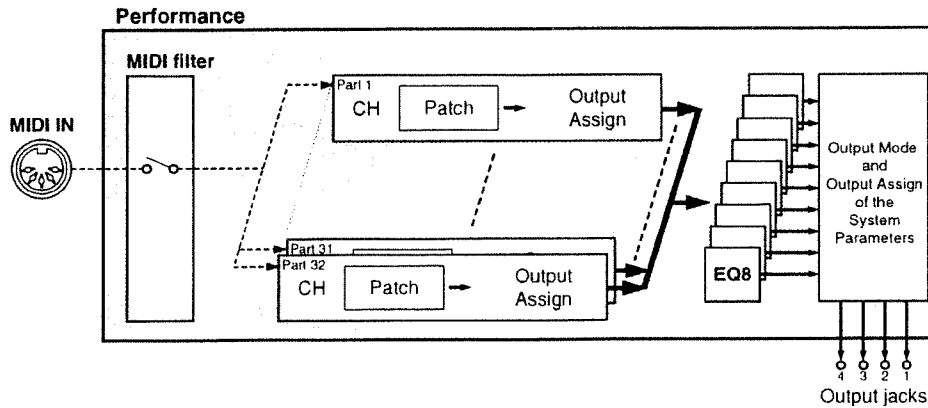

MIDI messages received at the MIDI IN connector pass through the MIDI Filter (Advanced Operation p.3-5), which can be set to determine which messages are received. For example, if you do not want the volume to change, you can specify that incoming MIDI Volume messages be ignored.

The received MIDI messages are sent to the Part for the corresponding MIDI channel, and will sound the Patch of that Part.

The S-760 can produce up to 24 simultaneous notes. (Each sample counts as a note, including notes in the Release stage.) If more than 24 notes are requested at once, the notes which actually sound will be determined by the Patch Priority settings (Advanced Operation p.3-14).

# Chapter 9

## Using MIDI to select sounds

---

Program Change messages from an external MIDI controller can be used to select Patches, Performances, or Volumes.

To select sounds, make sure that the Performance Play display is selected. If a different display is selected, you may not be able to select sounds.

### **Caution!**

**When sequencer song data created for the SP-700 is used to play the S-760, be aware of the following.**

The internal memory of the SP-700 is divided into two parts; Volume A memory and Volume B memory. However the S-760 has only one internal memory. This means that if the song data created for the SP-700 contains MIDI messages (such as Bank Select messages, etc.) which switch the Volume Memory, the S-760 may not sound correctly. In such cases you will need to modify the song data appropriately for the S-760.

# Selecting Patches

---

Program Change messages received on the channel of each Part can select Patches.

Program numbers 1—128 can select Patches. The Patch with the Program Number matching the incoming Program Number will be selected.

**\* You can specify independently for each MIDI channel whether or not Program Change messages will be received. If you wish to select Patches, set Program Change messages to be received.**

1. Select the Performance Play display.

Press MODE.

Select F1:Performance.

Press the Value knob.

Select 1:Perform Play.

2. Set the MIDI channel for each Part.

**\* Do not set the channel of a Part to the same channel as the Control Channel. If they are the same, Program Change messages will be applied to the Control Channel only, and will not select Patches for a Part.**

**\* When a Program Change message is received, the corresponding Patch will be selected for all Parts receiving that channel. If you have set two or more Parts to receive the same channel, with each Part using a different Patch so as to create splits or positional crossfades, select the Performance via the Control Channel.**

3. Move the cursor to the Patch name and press S1/DEC(List). The Select Patch display will appear.

4. Specify the program number for each Patch.

**\* Do not specify the same program number for two or more Patches. If you do, the lower-numbered Patch will be given priority.**

**\* If you modify the program numbers, be aware of how they correspond with the program numbers in sequencer data, etc.**

**\* It is possible to set the Patch program numbers so that they are the same as the Patch number (see the Renumber command, Advanced Operation p.5-10).**

5. Select the MIDI Filter 1 display.

Press the Value knob.

Select 3:MIDI Filter.

Select page 1.

6. Set the Prog (program change message receive switch) for each MIDI channel. With "o" displayed, program change messages will be received. When set to "-" (off), they will not be received.

**\* If you move the cursor to All and press S1/DEC S2/INC or the same value will be set for all channels.**

---

**7. Select the Performance Play display.**

Press the Value knob.

Select 1:Perform Play.

**8. Using a MIDI keyboard etc., transmit a Program Change message on the same MIDI channel as a Part channel to select Patches.**

# Selecting Performances

---

Program Change messages received on the Control Channel can select Performances. Program numbers 1—64 can be used to select Performances. The Performance with the Program Number matching the incoming Program Number will be selected.

**\* When program numbers 65—128 are received, a Volume will be loaded from the Current Drive (when Control Mode is set to Perf/Vol).**

1. Select the MIDI Control display.  
Press MODE.  
Select F6:System.  
Press the Value knob.  
Select 3:MIDI.  
Select page 1.
2. Specify the Control Channel.  
  
**\* Do not set the Control Channel to the same channel as a Part. If they are the same, Program Change messages will be applied to the Control Channel only, and will not select Patches for a Part.**
3. Select the Performance Play display.  
Press MODE.  
Select F1:Performance.  
Press the Value knob.  
Select 1:Perform Play.
4. Move the cursor to the Performance name and press S1/DEC(List). The Select Performance display will appear.
5. Set the Performance Number.  
  
**\* Do not specify the same program number for more than one Performance. If you do so, the lower-numbered Performance will be given priority.**  
  
**\* If you modify the program numbers, be aware of how they correspond with the program numbers in sequencer data, etc.**  
  
**\* It is possible to set the Performance program numbers so that they are the same as the Performance number (see the Renumber command, Advanced Operation p.5-10).**
6. Press EXIT. You will return to the Performance Play display.
7. Using a MIDI keyboard etc., transmit a Program Change message on the same MIDI channel as the Control channel to select Performances.

# Loading Volumes

---

Program Change messages received on the Control channel can load Volumes from the Current Drive. Program numbers 65—128 are used to load Volumes.

## Note!

**When MIDI messages are used to load a Volume, all sounds in internal memory will be erased before the Volume is loaded. Also, no sounds can be played while loading is in progress.**

1. Select the MIDI Control display.  
Press MODE.  
Select F6:System.  
Press the Value knob.  
Select 3:MIDI.  
Select page 1.
2. Specify the Control Channel.
  - \* **Do not set the Control Channel to the same channel as a Part. If they are the same, Program Change messages will be applied to the Control Channel only, and will not select Patches for a Part.**
3. Set the Control Mode to Perf/Vol.  
The Volume with the Program Number matching the incoming Program Number will be selected.
  - \* **If the Current Drive is a floppy disk, Volumes will not be loaded even when Program Change messages are received.**
  - \* **If the Control Mode is set to Perf only, Volumes will not be loaded.**
4. Select the Disk Utility display.  
Press MODE.  
Select F5:Disk.  
Press the Value knob.  
Select 5:Utility.
5. Set TG (Target) to Volm (Volume).
6. Set ID (Volume ID) to All.
7. Move the cursor to PG# (Program Number) and specify the program number.
  - \* **Do not set the same program number for more than one Volume. If you do so, the first Volume found by the S-760 will be loaded.**
  - \* **The sixty-four program numbers 65—128 can be used for Volumes. Volumes for which you do not wish to specify a program number should be turned off (—).**
  - \* **If you modify the program numbers, be aware of how they correspond with the program numbers in sequencer data etc.**

MIDI Switch ..... Advanced 3-17  
 Mixing ..... Advanced 3-62  
 Mode ..... Basic 7-2  
 Module Monitor ..... Advanced 3-7

**N**

Normalize ..... Advanced 3-44

**O**

Octave Shift (Patch) ..... Advanced 3-14  
 Optimize ..... Advanced 3-86  
 Original Key ..... Advanced 3-42  
 Output Assign (Part) ..... Advanced 3-2, Advanced 4-6  
 Output Assign (Partial) ..... Advanced 3-23, Advanced 4-6  
 Output Assign (Patch) ..... Advanced 3-14, Advanced 4-6  
 Output Assign C/D ..... Advanced 3-92, Advanced 4-5  
 Output Mode ..... Basic 3-13, Advanced 3-92  
 One Shot (Loop Mode) ..... Advanced 3-68  
 Overwrite Mode ..... Basic 8-12  
 Overwrite Switch ..... Basic 8-12, Advanced 3-96

**P**

Page Box ..... Basic 7-5  
 Page Mark ..... Basic 7-5  
 Pan (Part) ..... Advanced 3-2  
 Pan (Partial) ..... Advanced 3-23  
 Pan (Patch) ..... Advanced 3-14, Advanced 4-8  
 Pan (Sample) ..... Advanced 3-26  
 Park Heads ..... Advanced 3-84  
 Part ..... Advanced 3-2  
 Part Split ..... Advanced 6-24  
 Partial ..... Basic 8-2, Advanced 3-22  
 Patch ..... Basic 8-2, Advanced 3-13  
 Patch Priority ..... Advanced 3-14  
 Patch Split ..... Advanced 3-16, Advanced 6-21  
 Performance ..... Basic 8-2, Advanced 3-2  
 Phase Lock ..... Advanced 3-6  
 Pitch Bend ..... Advanced 3-19  
 Pitch Key Follow ..... Advanced 3-24  
 Polyphonic Aftertouch ..... Advanced 3-6  
 Positional Crossfade ..... Advanced 6-24  
 Power Sampling Expansion (OP-760-1) ..... Basic 1-5  
 Preset (Template) ..... Advanced 5-8  
 Preview Function ..... Advanced 3-93, Advanced 6-26  
 Previous Sampling ..... Advanced 3-44  
 Program Change ..... Basic 9-2, Advanced 3-97  
 Program Number (Patch) ..... Basic 9-2, Advanced 3-15  
 Program Number (Performance) ..... Basic 9-4, Advanced 5-10  
 Program Number (Volume) ..... Basic 9-5, Advanced 3-83  
 Program Number Sort (Patch) ..... Advanced 5-10  
 Program Number Sort (Performance) ..... Advanced 5-10

**Q**

Quick Edit ..... Advanced 3-11  
 Quick Load ..... Advanced 3-8, Advanced 6-2  
 Quick Sampling (Patch) ..... Advanced 3-21, Advanced 6-18  
 Quick Sampling (Partial) ..... Advanced 3-41, Advanced 6-18  
 Quick Sampling (Performance) ..... Advanced 3-10

**R**

Rate Convert ..... Advanced 3-55  
 Recover Function ..... Advanced 3-93  
 Release Loop ..... Advanced 3-48  
 Rename Partials ..... Advanced 5-7  
 Resonance (Partial) ..... Advanced 3-28  
 Restart ..... Advanced 3-84

Reverse (Loop Mode) ..... Advanced 3-69  
 Reverse One shot (Loop Mode) ..... Advanced 3-69

**S**

Sample ..... Basic 8-2, Advanced 3-42  
 Sample Dump ..... Advanced 3-99, Advanced 6-12  
 Sample Mix Table (SMT) ..... Advanced 3-24  
 Sampling Frequency ..... Advanced 3-43  
 Save (Sound Data) ..... Basic 8-9, Advanced 3-72  
 Save (System) ..... Basic 8-7, Advanced 3-85  
 Scan ..... Basic 2-7  
 SCSI ..... Advanced 7-2  
 SCSI Chain ..... Advanced 7-3  
 SCSI ID (Device Number) ..... Advanced 7-2  
 Set Stereo/Mono (Sample) ..... Advanced 5-9  
 Single Edit (Partial) ..... Advanced 3-24  
 Smoothing ..... Advanced 3-50  
 Sound Data ..... Basic 8-2  
 Split Mode ..... Advanced 3-18  
 Stereo Edit (Equalizer) ..... Advanced 3-5  
 Stereo Output ..... Advanced 3-92, Advanced 4-4  
 Streaming Tape Backup Device ..... Advanced 3-75  
 System (Program & Parameter) ..... Basic 8-7  
 System Backup Memory ..... Basic 8-7, Advanced 3-104  
 System Dump ..... Advanced 3-98, Advanced 6-6  
 S-770/750 ..... Basic 1-2, Advanced 7-6  
 SP-700 ..... Basic 1-2, Advanced 7-6  
 SYS-772 Version 2.0 ..... Basic 1-2, Advanced 7-6

**T**

Template ..... Advanced 5-8  
 Terminator ..... Advanced 7-4  
 Threshold ..... Advanced 3-45  
 Time Display ..... Advanced 3-92  
 Time Key Follow (LVA) ..... Advanced 3-36  
 Time Key Follow (TVF) ..... Advanced 3-32  
 Time Stretch ..... Advanced 3-51  
 Time Velocity Sens (TVA) ..... Advanced 3-36  
 Time Velocity Sens (TVF) ..... Advanced 3-32  
 Trigger Source ..... Advanced 3-44  
 Truncate ..... Advanced 3-57  
 TVA Envelope (Partial) ..... Advanced 3-37  
 TVF Envelope (Partial) ..... Advanced 3-33

**U**

Upper Case Letter (NAME) ..... Basic 7-13  
 User Set (Template) ..... Advanced 5-8

**V**

Velocity Crossfade ..... Advanced 6-24  
 Velocity Curve Sens (LVA) ..... Advanced 3-35  
 Velocity Curve Sens (TVF) ..... Advanced 3-30  
 Velocity Curve Type (MIDI Filter) ..... Advanced 3-6  
 Velocity Curve Type (TVA) ..... Advanced 3-34  
 Velocity Curve Type (TVF) ..... Advanced 3-29  
 Velocity Mix ..... Advanced 3-27  
 Velocity Switch ..... Advanced 3-27  
 Volume ..... Basic 8-2  
 Volume Dump ..... Advanced 6-8  
 Volume ID ..... Basic 8-4, Advanced 3-103

**W**

Wait Trigger (MIDI Monitor) ..... Advanced 3-7  
 Waveform (LFO) ..... Advanced 3-39  
 Wave Memory ..... Basic 1-3, Basic 8-5



MEMO

## Information

When you need repair service, call your local Roland Service Station or the authorized Roland distributor in your country as shown below.

### ARGENTINA

**Instrumentos Musicales S.A.**  
Florida 638  
(1005) Buenos Aires  
ARGENTINA  
TEL: (01) 394 4029

### BRAZIL

**Roland Brasil Ltda.**  
R. Coronel Octaviano da Silveira  
203 05522-010  
Sao Paulo BRAZIL  
TEL: (011) 843 9377

### CANADA

**Roland Canada Music Ltd. (Head Office)**  
5480 Parkwood Way Richmond  
B. C. V6V 2M4 CANADA  
TEL: (604) 270 6626

**Roland Canada Music Ltd. (Toronto Office)**  
Unit 2, 109 Woodbine Downs  
Blvd, Etobicoke, ON  
M9W 6Y1 CANADA  
TEL: (416) 213 9707

### MEXICO

**Casa Veerkamp, s.a. de c.v.**  
Av. Toluca No. 323 Col. Olivar de  
los Padres 01780 Mexico D.F.  
MEXICO  
TEL: (525) 668 04 80

**La Casa Wagner de  
Guadalajara s.a. de c.v.**  
Av. Corona No. 202 S.J.  
Guadalajara, Jalisco Mexico  
C.P.44100 MEXICO  
TEL: (03) 613 1414

### PANAMA

**Productos Superiores, S.A.**  
Apartado 655 - Panama 1  
REP. DE PANAMA  
TEL: 26 3322

### U. S. A.

**Roland Corporation U.S.**  
7200 Dominion Circle  
Los Angeles, CA. 90040-3696,  
U. S. A.  
TEL: (0213) 685 5141

### VENEZUELA

**Musicland Digital C.A.**  
Av. Francisco de Miranda,  
Centro Parque de Cristal, Nivel  
C2 Local 20 Caracas  
VENEZUELA  
TEL: (02) 285 9218

### AUSTRALIA

**Roland Corporation  
Australia Pty. Ltd.**  
38 Campbell Avenue  
Dee Why West, NSW 2099  
AUSTRALIA  
TEL: (02) 982 8266

### NEW ZEALAND

**Roland Corporation (NZ)  
Ltd.**  
97 Mt. Eden Road, Mt. Eden,  
Auckland 3, NEW ZEALAND  
TEL: (09) 3098 715

### HONG KONG

**Tom Lee Music Co., Ltd.  
Service Division**  
22-32 Pun Shan Street, Tsuen  
Wan, New Territories, HONG  
KONG  
TEL: 2415 0911

### INDONESIA

**PT CITRARAMA  
BELANTIKA**  
Kompleks Perkantoran Duta  
Merlin Blok E No.6—7  
Jl. Gajah Mada No.3—5, Jakarta  
10130,  
INDONESIA  
TEL: (021) 3850073

### KOREA

**Cosmos Corporation  
Service Station**  
261 2nd Floor Nak-Won Arcade  
Jong-Ro ku, Seoul, KOREA  
TEL: (02) 742 8844

### MALAYSIA

**Bentley Music SDN BHD**  
No.142, Jalan Bukit Bintang 55100  
Kuala Lumpur, MALAYSIA  
TEL: (03) 2443333

### PHILIPPINES

**G.A. Yupangco & Co. Inc.**  
339 Gil I. Puyat Avenue  
Makati, Metro Manila 1200,  
PHILIPPINES  
TEL: (02) 899 9801

### SINGAPORE

**Swee Lee Company  
BLOCK 231,  
Bain Street #03-23  
Bras Basah Complex,  
SINGAPORE 0718  
TEL: 3367886**

### CRISTOFORI MUSIC PTE LTD

335, Joo Chiat Road SINGAPORE  
1542  
TEL: 3450435

### TAIWAN

**Siruba Enterprise (Taiwan)  
Co., LTD.**  
Room. 5, 9fl. No. 112 Chung Shan  
N.Road Sec.2 Taipei, TAIWAN,  
R.O.C.  
TEL: (02) 561 3339

### THAILAND

**Theera Music Co., Ltd.**  
330 Veeng Nakorn Kasem, Soi 2,  
Bangkok 10100, THAILAND  
TEL: (02) 2248821

### BAHRAIN

**Moon Stores**  
Bad Al Bahrain Road,  
P.O.Box 20077  
State of BAHRAIN  
TEL: 211 005

### IRAN

**TARADIS**  
Mir Emad Ave. No. 15, 10th street  
P. O. Box 15875/4171 Teheran,  
IRAN  
TEL: (021) 875 6524

### ISRAEL

**Halilit P. Greenspoon &  
Sons Ltd.**  
8 Rotzif Ha'aliya Hashnya St.  
Tel-Aviv-Yafa ISRAEL  
TEL: (03) 6823666

### JORDAN

**AMMAN Trading Agency**  
Prince Mohammed St. P. O. Box  
825 Amman 11118 JORDAN  
TEL: (06) 641200

### KUWAIT

**Easa Husain Al-Yousifi**  
P.O. Box 126 Safat 13002  
KUWAIT  
TEL: 5719499

### LEBANON

**A. Chahine & Fils**  
P.O. Box 16-5857 Gergi Zeidan St.  
Chahine Building, Achrafieh  
Beirut, LEBANON  
TEL: (01) 335799

### OMAN

**OHI Electronics &  
Trading Co. LLC**  
P. O. Box 889 Muscat  
Sultanate of OMAN  
TEL: 706 010

### QATAR

**Badie Studio & Stores**  
P.O.Box 62,  
DOHA QATAR  
TEL: 423554

### SAUDI ARABIA

**SAF Music Center**  
Al-Khobar 31952, P. O. Box 1366  
SAUDI ARABIA  
TEL: (03) 898 3311

### Abdul Latif S. Al-Ghamdi

**Trading Establishment**  
Al-Tamimi Commercial And  
Residential Center Al-Khobar  
Dharran Highway W/ Hamood St.  
P. O. Box 3631 Al-Khobar  
31952 SAUDI ARABIA  
TEL: (03) 898 2332

### SYRIA

**Technical Light & Sound  
Center**  
Khaled Ebn Al Walid St  
P.O.Box 13520  
Damascus - SYRIA  
TEL: (011) 2235 384

### TURKEY

**Barkat Sanayi ve Ticaret**  
Siraselvier Cad. Guncy Ishani No.  
86/6 Taksim, Istanbul TURKEY  
TEL: (0212) 2499324

### U.A.E.

**Zak Electronics & Musical  
Instruments Co.**  
Zabed Road, Al Sherouq Bldg.,  
No. 14, Grand Floor DUBAI  
U.A.E.  
P.O. Box 8050 DUBAI, U.A.E.  
TEL: (04) 360715

### EGYPT

**Al Fanny Trading Office**  
9, Ebn Hagar At Askalany Street,  
Ard El Goll, Heliopolis, Cairo,  
11341 EGYPT  
TEL: (02) 4171828  
(02) 4185531

### MAURITIUS

**Philanne Music Center**  
4th Floor Noll, Happy World  
House Sir William Newton Street  
Port Luis MAURITIUS  
TEL: 242 2986

### REUNION

**FO - YAM Marcel**  
25 Rue Jules Mermet ZL  
Chaudron - BP79 97491  
Ste Clotilde REUNION  
TEL: 28 29 16

### SOUTH AFRICA

**That Other Music Shop  
(PTY) Ltd.**  
11 Melle Street (Cnr Melle and  
Juta Street)  
Braamfontein 2001  
Republic of SOUTH AFRICA  
TEL: (011) 403 4105

**Paul Bothner (PTY) Ltd.**  
17 Werdmuller Centre Claremont  
7700  
Republic of SOUTH AFRICA  
TEL: (021) 64 4030

### AUSTRIA

**E. Dematte & Co.**  
Neu-Rum Siemens-Strasse 4  
A-6040 Innsbruck P.O.Box 83  
AUSTRIA  
TEL: (0512) 26 44 260

### BELGIUM/HOLLAND/ LUXEMBOURG

**Roland Benelux N. V.**  
Houtstraat 1 B-2260 Gevel-  
Westerlo BELGIUM  
TEL: (014) 575811

### CYPRUS

**Radex Sound Equipment  
Ltd.**  
17 Diagorou St., P.O.Box 2046,  
Nicosia CYPRUS  
TEL: (02) 453 426  
(02) 466 423

### DENMARK

**Roland Scandinavia A/S**  
Langebrogade 6 Post Box 1937  
DK-1023 Copenhagen K,  
DENMARK  
TEL: 32 95 3111

### FRANCE

**Guillard Musiques Roland**  
ZAC de Rosarge Les Echets 01700  
MIRIBEL FRANCE  
TEL: 7226 5060

**Guillard Musiques Roland  
(Paris Office)**  
1923 rue Léon Geoffroy 94400  
VITRY-SUR-SEINE FRANCE  
TEL: (1) 4680 86 62

### FINLAND

**Roland Scandinavia As,  
Filial Finland**  
Lauttasaaarentie 54 B  
Fin-00201 Helsinki, FINLAND  
P. O. Box No. 109  
TEL: (0) 682 4020

### GERMANY

**Roland Elektronische  
Musikinstrumente**  
**Handelsgesellschaft mbH.**  
Oststrasse 96, 22844 Norderstedt,  
GERMANY  
TEL: (040) 52 60090

### GREECE

**V. Dimitriadis & Co. Ltd.**  
20, Alexandras St. & Bouboulinas  
54 St. 106 82 Athens, GREECE  
TEL: (011) 8232415

### HUNGARY

**Intermusica Ltd.**  
Warehouse Area 'DEPO' PL83  
11-2046 Torokbalint, HUNGARY  
TEL: (01) 1868905

### IRELAND

**The Dublin Service Centre  
Audio Maintenance  
Limited**  
11 Brunswick Place Dublin 2  
Republic of IRELAND  
TEL: (01) 677522

### ITALY

**Roland Italy S. p. A.**  
Viale delle Industrie, 8  
20020 Arese Milano, ITALY  
TEL: (02) 93581311

### NORWAY

**Roland Scandinavia Avd.  
Kontor Norge**  
Lilleakerveien 2 Postboks 95  
Lilleaker N-0216 Oslo  
NORWAY  
TEL: 273 0074

### POLAND

**P. P. H. Brzostowicz Marian**  
61-502 Poznan, ul. Filarecka 11,  
TEL: (061) 332 665  
03-624 Warszawa, ul. Blokowa32,  
TEL: (02) 679 44 19

### PORTUGAL

**Caius - Tecnologias Audio e  
Musica, Lda.**  
Rue de Catarina 131  
4000 Porto, PORTUGAL  
TEL: (02) 38 4456

### RUSSIA

**PETROSHOP**  
Vershavskoe, Shosse, 27-1  
Moscow, RUSSIA  
TEL: 095 901 0892

### INVASK Limited

Lenina Str. 13-342  
Krasnogorsk 143400,  
Moscow Region, RUSSIA  
TEL: 095 564 61 44

### SPAIN

**Roland Electronics  
de España, S. A.**  
Calle Bolivia 239 08020 Barcelona,  
SPAIN  
TEL: (93) 308 1000

### SWEDEN

**Roland Scandinavia A/S**  
Danvik Center 28 A, 2 tr.  
S-131 30 Nacka SWEDEN  
TEL: (08) 702 0020

### SWITZERLAND

**Roland (Switzerland) AG  
Musitronic AG**  
Gerberstrasse 5, CH-4410 Liestal,  
SWITZERLAND  
TEL: (061) 921 1615

### UNITED KINGDOM

**Roland (U.K.) Ltd., Swansea  
Office**  
Atlantic Close, Swansea  
Enterprise Park SWANSEA  
West Glamorgan SA7 9FL,  
UNITED KINGDOM  
TEL: (01792) 702701



This product complies with the requirements of European Directive 89/336/EEC.

For Europe

### Bescheinigung des Herstellers/Importeurs

Hiermit wird bescheinigt, daß der/die/das

Digital Sampler S-760

(Gerät, Typ, Bezeichnung)

in Übereinstimmung mit den Bestimmungen der BMPT-AmtsblVfg 243/1991, 46/1992 funk-entstört ist.

Der vorschriftsmäßige Betrieb mancher Geräte (z. B. Meßsender) kann allerdings gewissen Einschränkungen unterliegen. Beachten Sie deshalb die Hinweise in der Bedienungsanleitung.

Dem Zentralamt für Zulassungen im Fernmeldewesen wurde das Inverkehrbringen dieses Gerätes angezeigt und die Berechtigung zur Überprüfung der Serie auf die Einhaltung der Bestimmungen eingeräumt.

Roland Corporation

4-16 Dojimahama 1-Chome Kita-ku Osaka 530 Japan

(Name und Anschrift des Herstellers/Importeurs)

For Germany

### FEDERAL COMMUNICATIONS COMMISSION RADIO FREQUENCY INTERFERENCE STATEMENT

This equipment has been tested and found to comply with the limits for a Class B digital device, pursuant to Part 15 of the FCC Rules. These limits are designed to provide reasonable protection against harmful interference in a residential installation. This equipment generates, uses, and can radiate radio frequency energy and, if not installed and used in accordance with the instructions, may cause harmful interference to radio communications. However, there is no guarantee that interference will not occur in a particular installation. If this equipment does cause harmful interference to radio or television reception, which can be determined by turning the equipment off and on, the user is encouraged to try to correct the interference by one or more of the following measures:

- Reorient or relocate the receiving antenna.
- Increase the separation between the equipment and receiver.
- Connect the equipment into an outlet on a circuit different from that to which the receiver is connected.
- Consult the dealer or an experienced radio/TV technician for help.

Unauthorized changes or modification to this system can void the users authority to operate this equipment.  
This equipment requires shielded interface cables in order to meet FCC class B Limit.

For the USA

### CLASS B

### NOTICE

This digital apparatus does not exceed the Class B limits for radio noise emissions set out in the Radio Interference Regulations of the Canadian Department of Communications.

### CLASSE B

### AVIS

Cet appareil numérique ne dépasse pas les limites de la classe B au niveau des émissions de bruits radioélectriques fixés dans le Règlement des signaux parasites par le ministère canadien des Communications.

For Canada

 Roland®

---

**70120245**

UPC 70120245



10981