

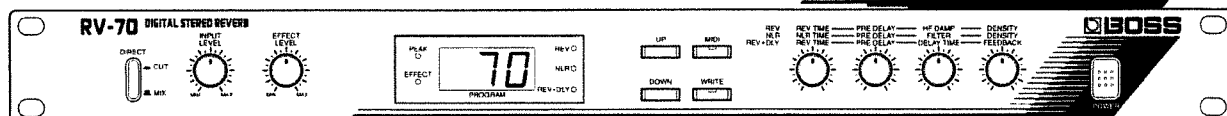



RV-70 DIGITAL STEREO REVERB

Owner's Manual



	CAUTION RISK OF ELECTRIC SHOCK DO NOT OPEN	
ATTENTION: RISQUE DE CHOC ELECTRIQUE NE PAS OUVRI		
<p>CAUTION: TO REDUCE THE RISK OF ELECTRIC SHOCK, DO NOT REMOVE COVER (OR BACK). NO USER-SERVICEABLE PARTS INSIDE. REFER SERVICING TO QUALIFIED SERVICE PERSONNEL.</p>		



The lightning flash with arrowhead symbol, within an equilateral triangle, is intended to alert the user to the presence of uninsulated "dangerous voltage" within the product's enclosure that may be of sufficient magnitude to constitute a risk of electric shock to persons.



The exclamation point within an equilateral triangle is intended to alert the user to the presence of important operating and maintenance (servicing) instructions in the literature accompanying the product.

INSTRUCTIONS PERTAINING TO A RISK OF FIRE, ELECTRIC SHOCK, OR INJURY TO PERSONS.

IMPORTANT SAFETY INSTRUCTIONS SAVE THESE INSTRUCTIONS

WARNING - When using electric products, basic precautions should always be followed, including the following:

1. Read all the instructions before using the product.
2. Do not use this product near water — for example, near a bathtub, washbowl, kitchen sink, in a wet basement, or near a swimming pool, or the like.
3. This product should be used only with a cart or stand that is recommended by the manufacturer.
4. This product, either alone or in combination with an amplifier and headphones or speakers, may be capable of producing sound levels that could cause permanent hearing loss. Do not operate for a long period of time at a high volume level or at a level that is uncomfortable. If you experience any hearing loss or ringing in the ears, you should consult an audiologist.
5. The product should be located so that its location or position does not interfere with its proper ventilation.
6. The product should be located away from heat sources such as radiators, heat registers, or other products that produce heat.
7. The product should be connected to a power supply only of the type described in the operating instructions or as marked on the product.
8. The power-supply cord of the product should be unplugged from the outlet when left unused for a long period of time.
9. Care should be taken so that objects do not fall and liquids are not spilled into the enclosure through openings.
10. The product should be serviced by qualified service personnel when:
 - A. The power-supply cord or the plug has been damaged; or
 - B. Objects have fallen, or liquid has been spilled onto the product; or
 - C. The product has been exposed to rain; or
 - D. The product does not appear to operate normally or exhibits a marked change in performance; or
 - E. The product has been dropped, or the enclosure damaged.
11. Do not attempt to service the product beyond that described in the user-maintenance instructions. All other servicing should be referred to qualified service personnel.

For the USA

This product may be equipped with a polarized line plug (one blade wider than the other) . This is a safety feature. If you are unable to insert the plug into the outlet, contact an electrician to replace your obsolete outlet. Do not defeat the safety purpose of the plug.

For Canada

For Polarized Line Plug

CAUTION: TO PREVENT ELECTRIC SHOCK, MATCH WIDE BLADE OF PLUG TO WIDE SLOT, FULLY INSERT.

ATTENTION: POUR ÉVITER LES CHOCs ÉLECTRIQUES, INTRODUIRE LA LAME LA PLUS LARGE DE LA FICHE DANS LA BORNE CORRESPONDANTE DE LA PRISE ET POUSSER JUSQU' AU FOND.

For the U.K.

WARNING: THE APPARATUS MUST BE EARTHED

IMPORTANT: THE WIRES IN THIS MAINS LEAD ARE COLOURED IN ACCORDANCE WITH THE FOLLOWING CODE.
GREEN-AND-YELLOW: EARTH, BLUE: NEUTRAL, BROWN: LIVE

As the colours of the wires in the mains lead of this apparatus may not correspond with the coloured markings identifying the terminals in your plug, proceed as follows:

The wire which is coloured GREEN-AND-YELLOW must be connected to the terminal in the plug which is marked by the letter E or by the safety earth symbol  or coloured GREEN or GREEN-AND-YELLOW.

The wire which is coloured BLUE must be connected to the terminal which is marked with the letter N or coloured BLACK.

The wire which is coloured BROWN must be connected to the terminal which is marked with the letter L or coloured RED.

The product which is equipped with a THREE WIRE GROUNDING TYPE LINE PLUG must be grounded.

Introduction

We'd like to take a moment to thank you for purchasing the BOSS RV-70 Digital Stereo Reverb. In order to fully realize the potential of the RV-70, and to ensure years of trouble-free operation, please take the time to read this manual thoroughly.

MAIN FEATURES

High-Quality Effects

Advanced digital processing (16-bit, 44.1 kHz sampling) and the AF Method produce effects on par with studio-grade equipment.

The AF (Adaptive Focus) Method :

A BOSS original technique that significantly reduces quantization noise by combining multiple samples to optimally match signal levels through analog-to-digital conversion.

199 Memory Locations

The RV-70 can store up to 199 different effects patches in memory. These memory locations can be accessed directly from the unit's panel or via MIDI.

Simple Operation

The RV-70's controls and panel layout make it very easy to create the effects you want.

Stereo Output

The RV-70's inputs and outputs allow you to take full advantage of stereo input signals.

MCR-8 Control

Connecting a Roland MCR-8 Multi Controller (optional) allows you to access the RV-70's full range of parameters - some of which are not even accessible via the unit's front panel.

CONTENTS

MAIN FEATURES	3	SETTING A PROGRAM CHANGE MAP	22
IMPORTANT NOTES	5	RESTORING THE FACTORY DEFAULTS - INITIALIZATION ..	23
PANEL DESCRIPTIONS	6	BEFORE CALLING FOR SERVICE	24
MAKING THE CONNECTION	7	USING A MCR-8 TO OPERATE THE RV-70	25
POWERUP AND STANDBY	8	Connecting the MCR-8	25
Turning On the Power	8	Initial Settings	25
Outputting Direct Sounds	8	Initial Settings for the RV-70	25
Adjusting the Input Level	8	Initial Settings for the MCR-8	25
Adjusting the Effect Level	8	Operating the RV-70 with the MCR-8	26
Switching Effects On and Off	9	Switching Program Numbers	26
SELECTING EFFECTS	10	Changing Effect Settings	26
Effect Structure	10	Canceling Changes	26
EDITING EFFECTS SETTINGS	11	Storing Changes - The Write Operation	26
A Handy Tip for Editing Effects	11	Copying Effect Settings	26
How to Edit an Effect	11	Functions of Parameters Accessed with the MCR-8 ...	27
How to Cancel Changes	12	<Parameters Shared by All Effect Types>	27
Storing Changes - The Write Operation	13	<REVERB> <REVERB+DELAY>	28
Copying Effect Settings	14	<NLR>	30
Effect Knob Functions	14	MIDI Implementation Chart	32
USING MIDI	16	SPECIFICATIONS	33
About MIDI	16		
The Exchange of MIDI Data	16		
About MIDI Connectors	16		
MIDI Channels	16		
MIDI Messages Recognized by the RV-70	17		
CHANNEL MESSAGES	17		
Program Change Messages	17		
Control Change Messages	17		
SYSTEM MESSAGES	17		
Exclusive Messages	17		
So What Can You Do with MIDI on the RV-70?	18		
1. Switching Program Numbers	18		
2. Sending Data	18		
Setting the MIDI Send/Receive Channel	19		
Setting the Omni Mode	19		
Sending Data (Bulk Dump)	20		
Making the Connections	20		
Storing Data in a Sequencer	20		
Copying Data to Another RV-70	20		
Transmitting Data	20		
Receiving Data (Bulk Load)	21		
Making the Connections	21		
Sending Data Stored in a Sequencer to the RV-70	21		
Receiving Data	21		

IMPORTANT NOTES

In addition to the items listed under Safety Precautions on page 2, please read and adhere to the following:

[Power Supply]

- When making any connections with other devices, always turn off the power to all equipment first; this will help prevent damage or malfunction.
- Do not use this unit on the same power circuit with any device that will generate line noise, such as a motor or variable lighting system.

[Placement]

- Using the unit near power amplifiers (or other equipment containing large transformers) may induce hum.
- This unit may interfere with radio and television reception. Do not use this unit in the vicinity of such receivers.

[Maintenance]

- For everyday cleaning wipe the unit with a soft, dry cloth (or one that has been slightly dampened with water). To remove stubborn dirt, use a mild neutral detergent. Afterwards, be sure to wipe the unit thoroughly with a soft, dry cloth.
- Never use benzene, thinners, alcohol or solvents of any kind, to avoid the risk of discoloration and/or deformation.

[Memory Backup]

- The unit contains a battery which maintains the contents of memory while the main power is off. The expected life of this battery is 5 years or more. However, to avoid the unexpected loss of memory data, it is strongly recommended that you change the battery every 5 years. Please be aware that the actual life of the battery will depend on the physical environment (especially temperature) in which the unit is used. When it is time to change the battery, consult with qualified service personnel.
- When the battery becomes weak, the following message will appear in the display. Please change the battery as soon as possible to avoid the loss of memory data.



- Please be aware that the contents of memory may at times be lost; when the unit is sent for repairs or when by some chance a malfunction has occurred. Important data should be stored in another MIDI device (eg. a sequencer), or settings written down on paper. During repairs, due care is taken to avoid the loss of data. However, in certain cases (such as when circuitry related to memory itself is out of order), we regret that it may be impossible to restore the data.

[Additional Precautions]

- Protect the unit from strong impact.
- Never strike or apply strong pressure to the display.
- A small amount of heat will radiate from the unit during normal operation.
- Before using the unit in a foreign country, consult with qualified service personnel.

PANEL DESCRIPTIONS

Front Panel

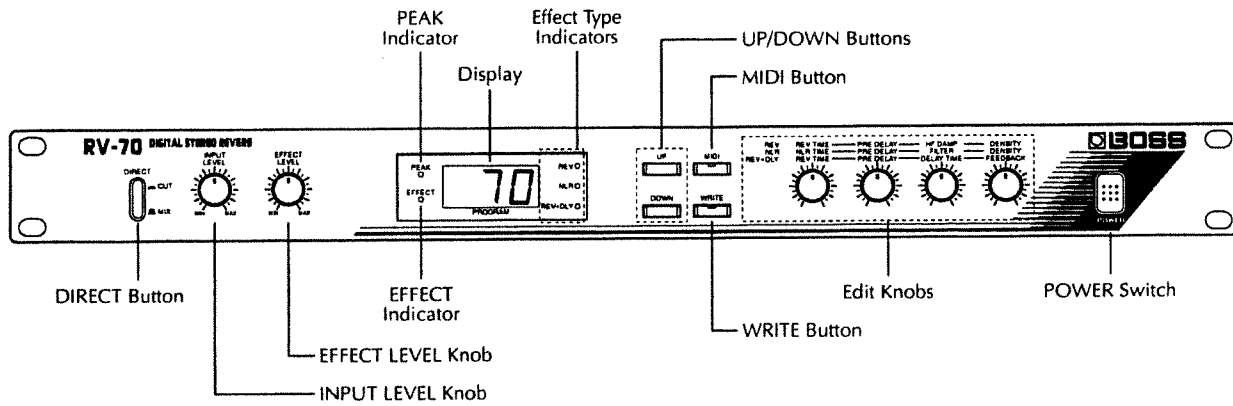

Rear Panel

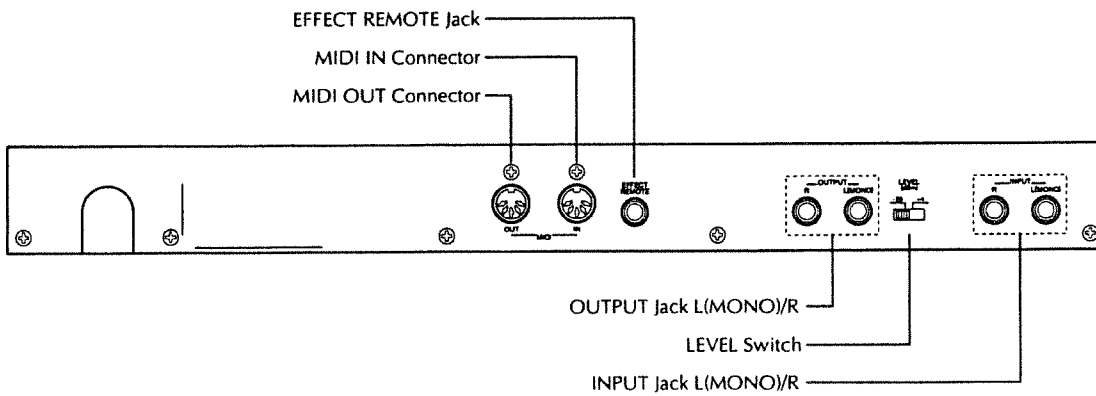

MAKING THE CONNECTION

The type of connection you need depends on what you want to achieve with the RV-70. Read on for details.

** Before making any connections, be sure all the equipment in your system is turned off and that all volume levels are at zero; this will help prevent damage, malfunction or electric shock.*

** If you're connecting the RV-70 to a monaural device, use the L (MONO) jack only.*

Mixer Send/Return

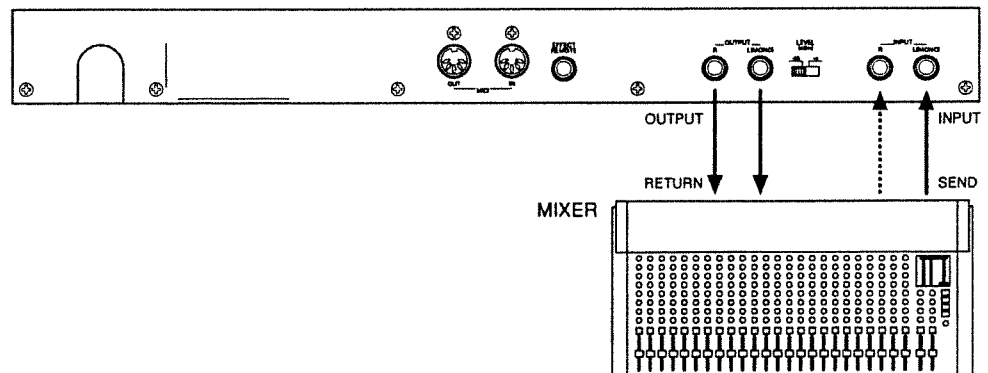

** Set the [LEVEL] switch to match the input/output level of the mixer you are using.*

Connecting a Keyboard

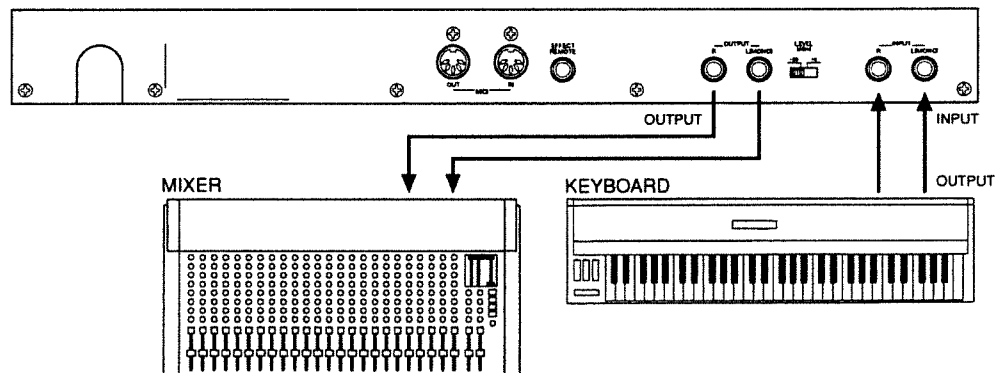

** Normally, the [LEVEL] switch should be set to "-20 dBm."*

POWERUP AND STANDBY

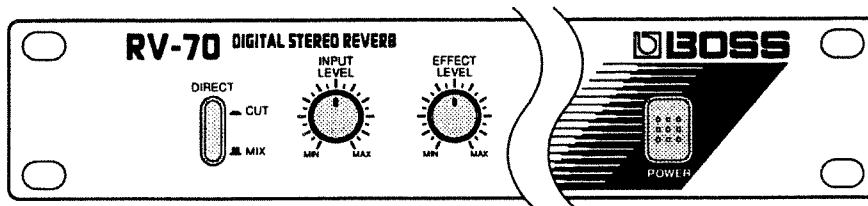

Turning On the Power

After making sure that all external devices are properly connected, press the [POWER] switch to turn on the RV-70.

The RV-70 will be ready in a second or two and the display will indicate the selected Program Number (memory location 1 to 199).

- * After you've turned on all the other devices in your system, set the volume controls to appropriate levels.
- * The RV-70 contains a special circuitry protection function which will mute the output stage for a second or two after power-up.
- * When you turn on the RV-70 the last Program Number selected will be selected again.

Outputting Direct Sounds

The [DIRECT] button determines which output mode is selected:

CUT: Only effects sounds are output.

MIX: Direct sounds and effects sounds are mixed and output.

Adjusting the Input Level

Use the [INPUT LEVEL] knob to adjust the level of the input signal. When set properly, the PEAK indicator will light only during input signal peaks (the loudest moments).

- * The PEAK indicator lights 6 dB below the clipping point (the level at which distortion becomes audible).

Adjusting the Effect Level

Use the [EFFECT LEVEL] knob to adjust the output level of effects. Rotating the knob clockwise increases the effect level.

- * No effects are output when the knob is rotated completely counterclockwise (to MIN).

Switching Effects On and Off

If you have an optional BOSS FS-5L pedal switch connected to the EFFECT REMOTE jack, each press of the pedal will switch the effects (effect output) on and off.

The EFFECT indicator (on the front panel) lights when the effects are turned on.

*** Effects are always on when no pedal switch is connected.**

*** When effects are turned off and the [DIRECT] button is set to "CUT," there is no output from the RV-70.**

*** When using an FS-5L pedal switch (optional), set the POLARITY switch as shown.**

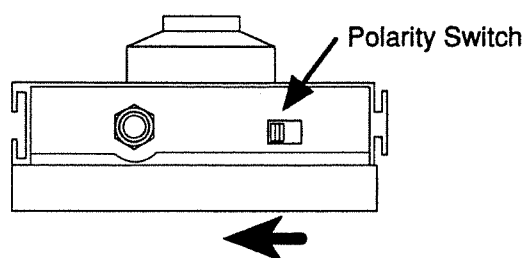

SELECTING EFFECTS

Use the panel buttons ([UP]/[DOWN]) to select the Program Number that corresponds to the desired effect. Effects are assigned to Program Numbers ranging from 1 to 199.

** You can also switch effects (Program Numbers) with an external MIDI device. Check out “Switching Program Numbers” on p. 18 for an explanation on how to do this.*

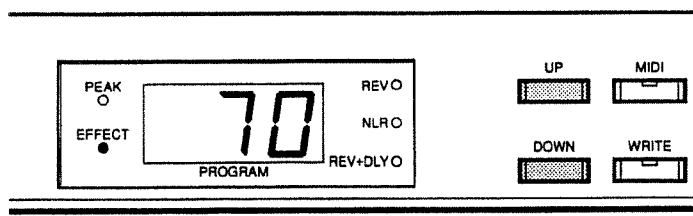

Use the [UP] and [DOWN] buttons to select the desired Program Number.

The display shows the Program Number you've selected.

[UP]: Increases the Program Number.

[DOWN]: Decreases the Program Number.

You can change the Program Number rapidly by holding down the [UP] (or [DOWN]) button and pressing the [DOWN] (or [UP]) button.

Effect Structure

The RV-70 contains three main types of effects. The Effect Type LEDs (REV, NLR and REV+DLY) light to show you the particular type of effect you've selected.

REVERB (REV)

Reverb (reverberation) is the effect produced by multiple reflections of sound in an enclosed space. For example, if you clap your hands outdoors, you just hear the clap. But when you clap your hands in a church, for example, there is a lingering 'wash' of sound called the reverberation or reverb. The sound of the reverb depends on the size of the space (room, hall, etc.), and on the shape and material of the reflecting surfaces (such as the walls, floor and ceiling).

All these elements are digitally simulated in the RV-70.

NON-LINEAR (NLR)

These are digitally generated (artificial) reverbs. They can sound very different from naturally occurring types of reverb.

REVERB+DELAY (REV+DLY)

These types of sounds combine reverb with a delayed input signal. This produces sounds with 'echo-like' qualities.

IMPORTANT!

Even when the Effect Type LEDs and Effect knob settings (the four knobs on the right) are the same, the actual sound heard may vary. This is because the structure of the parameters for creating the effect may be changed beforehand. When choosing a specific effect, be sure to check the actual sound of the effect as you select the Program Number.

EDITING EFFECTS SETTINGS

It's easy to alter effects settings (in any way you like) and then store the results at a specific Program Number. This section explains how to make and store these changes.

A Handy Tip for Editing Effects

The effects stored in the RV-70 are grouped into three types, which are shown by the Effect Type LEDs. However, even when the Effect Type LEDs and Effect knob settings are the same, the actual sound produced may be different.

If you want to create a particular effect, one very handy technique is to first select the effect (Program Number) that is closest to the sound you have in mind. Then you can alter (edit) the settings to create exactly what you need.

How to Edit an Effect

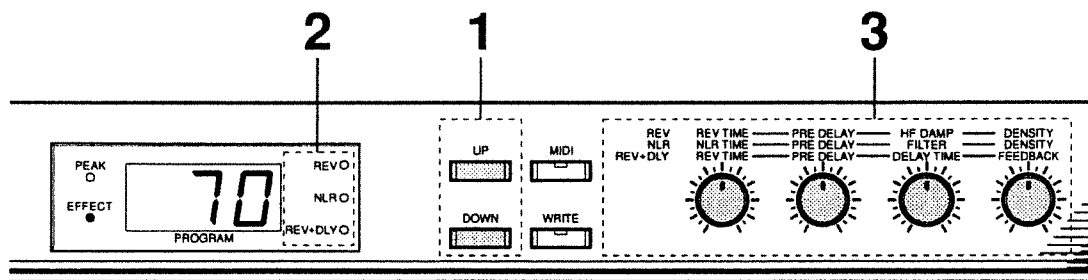

1. Use the [UP] and [DOWN] buttons to choose a Program Number (effect) that sounds similar to the effect you want to create.
2. Check the Effect Type LEDs to determine the effect type used by the Program Number that you've selected.
3. Change the parameter settings by slowly rotating the appropriate Effect knobs. A dot (.) lights in the display to show that you are currently in the process of editing. After momentarily displaying the value (0 to 100, for example) that you've selected with the Effect knobs, the display reverts to the Program Number.

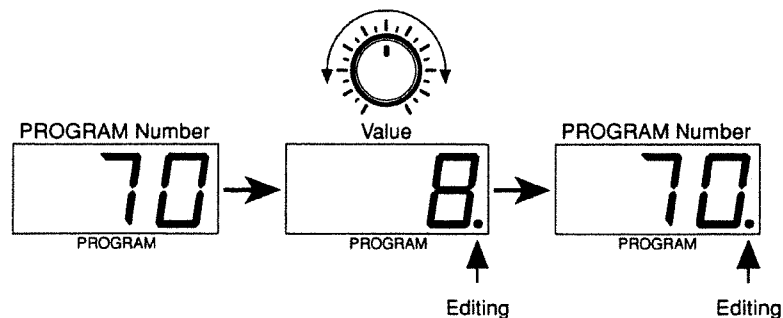

The functions of the four Edit knobs vary according to the effect type selected. See "Effect Knob Functions" on p. 14 for a full description.

4. Repeat steps 3 and 4 to create the effect you want.

When you're ready to store the effect you've made, follow the procedure described in "Storing Changes - The Write Operation" on p. 13.

If You're Using the MCR-8...

If you hook up an MCR-8 (optional), you can change and store more parameters than you can using just the Edit knobs. Check out "Changing Effect Settings" on p. 26 for more details.

If You're Using System Exclusive (SysEx) Messages...

The RV-70 can use SysEx messages to switch algorithms or vary parameters that cannot be changed with the Edit knobs. "MIDI Implementation" is a publication (sold separately) that describes MIDI in detail. This document can be obtained at your nearest Roland Service Station.

How to Cancel Changes

If you have not yet carried out the Write operation, you can cancel any editing you have done and return to the original settings. The following procedure describes how to do this.

1. Press the [UP] or [DOWN] button.

The Program Number flashes in the display.

** If you want to continue making changes, continue rotating the Edit knobs. This returns you to the editing mode.*

2. Press [UP] or [DOWN] again.

The Program Number changes and the RV-70 returns to the standard mode. Once you have returned to this mode, all previous edits will be canceled.

Storing Changes - The Write Operation

If you want to store the new settings that you've made, you need to perform the Write operation.

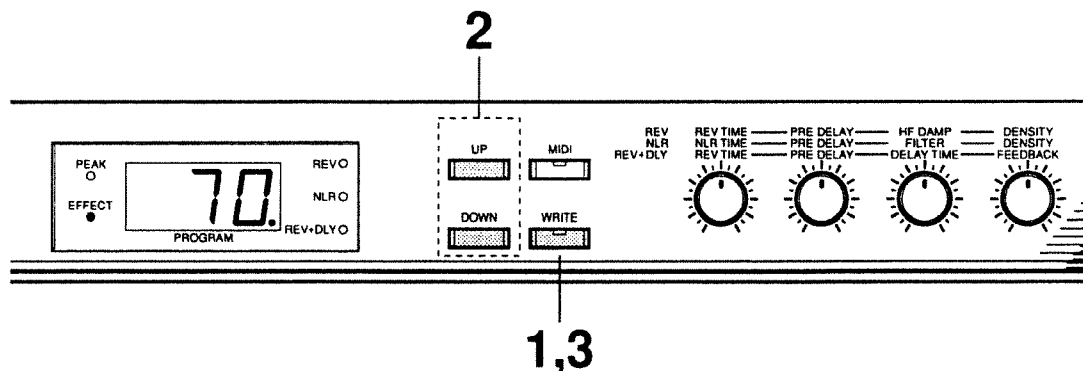

- 1.** Press the [WRITE] button.
The button indicator starts to flash and the Program Number display appears.
- 2.** Use the [UP] and [DOWN] buttons to select the Program Number where you want to store the new effect.

** If you store the changes in a different Program Number, the contents of the original Program Number remain unchanged.*

** If you want to store the changes in the same Program Number, you don't need to choose another Program Number as the destination. In other words, you can skip step 2 and go right on to step 3.*

** If you want to cancel the Write operation and continue making changes, rotate one of the Effect knobs. The indicator on the [WRITE] button goes out and the editing mode is reselected.*
- 3.** Press the [WRITE] button again.
The changes you've made are stored in the selected Program Number. The new effect is automatically selected and ready for use.

Copying Effect Settings

You can easily copy the settings of one Program Number to another.

** Rotating any of the Effect knobs while copying stops the copying process; the RV-70 reverts to the editing mode.*

- 1.** Use the [UP] and [DOWN] buttons to select the Program Number that is to serve as the source for copying.
- 2.** Press the [WRITE] button.
The button indicator starts to flash, and the Program Number that is the destination for copying appears in the display.
- 3.** Use the [UP] and [DOWN] buttons to select the Program Number to serve as the copy destination.
- 4.** Press the [WRITE] button again.
The settings for the source Program Number are copied to the destination Program Number. After the data has been copied, the RV-70 automatically moves to the destination Program Number.

Effect Knob Functions

The functions of the Effect knobs vary according to the selected effect type:

REVERB

REVERB TIME

This parameter adjusts the length (duration) of the reverb effect. A higher setting results in a longer reverb time.

PRE DELAY

This parameter adjusts the time interval before output of the reverb effect starts. A higher setting results in a longer time interval.

HF DAMP

This parameter adjusts the amount of attenuation for HF damping (damping of the high-frequency sounds in the reverb effect). A higher value results in greater high-frequency damping and therefore a darker sound.

DENSITY

This parameter adjusts the density of the initial reflected sound. A higher setting results in greater density for a thicker sound.

NON-LINEAR

NLR TIME

This parameter adjusts the length (duration) of the reverb effect. A higher setting results in a longer reverb time.

PRE DELAY

This parameter adjusts the time interval before output of the reverb effect starts. A higher setting results in a longer time interval.

FILTER

This parameter adjusts the quality of the reverb effect by varying the amount of input signal that is passed through the bandpass filter (BPF). When set to "0," none of the sound is filtered. A higher value results in more sound being passed through the filter, up to a maximum of "100" (all sound is filtered).

DENSITY

This parameter adjusts the density of the initial reflected sound. A higher setting results in greater density, for a thicker sound.

REVERB+DELAY

REVERB TIME

This parameter adjusts the length (duration) of the reverb effect. A higher setting results in a longer reverb time.

PRE DELAY

This parameter adjusts the time interval before output of the reverb effect starts. A higher setting results in a longer time interval.

DELAY TIME

This parameter adjusts the delay time, which is the interval or time lag before the sound is heard. A higher setting results in a longer delay.

FEEDBACK

This parameter adjusts the amount of feedback for the delayed sound. A higher setting results in more feedback loops for the delayed sound.

USING MIDI

The RV-70 is equipped with MIDI terminals. Using these terminals to receive data from an external MIDI device makes it possible to switch Program Numbers and change effect settings remotely.

About MIDI

MIDI is the acronym for "Musical Instrument Digital Interface." It is an industry-wide standard that allows for data (such as that representing the music played, or for changes in sounds used) to be exchanged among various instruments and computers. As long as they are MIDI compatible, all devices, regardless of model or manufacturer, can exchange whatever performance data they are both equipped to 'understand.'

MIDI converts every 'performance event' into MIDI data. When received by another instrument, this stream of MIDI data can be used to "play" it, as if that instrument itself were being played.

The Exchange of MIDI Data

About MIDI Connectors

In carrying out the exchange of MIDI data, the three connectors shown below are used. MIDI cables can be routed from these connectors in varying ways depending on the kind of setup you have in mind.

MIDI IN: Receives data from another MIDI device.

MIDI OUT: Transmits data originating in the unit.

MIDI THRU: Sends out an exact copy of the data received at MIDI IN.

** The RV-70 has MIDI IN and MIDI OUT ports.*

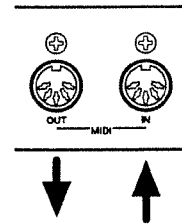

MIDI Channels

In MIDI communications, a single cable simultaneously carries different streams of performance information for a multiple number of MIDI devices. This is possible thanks to the concept of MIDI channels.

MIDI channels are in some ways similar to the channels on a television set. On a TV, a variety of programs broadcast from different stations can be viewed by switching channels. This is because the information on any particular channel is conveyed only when the receiver is set to the same channel that is being used for transmission.

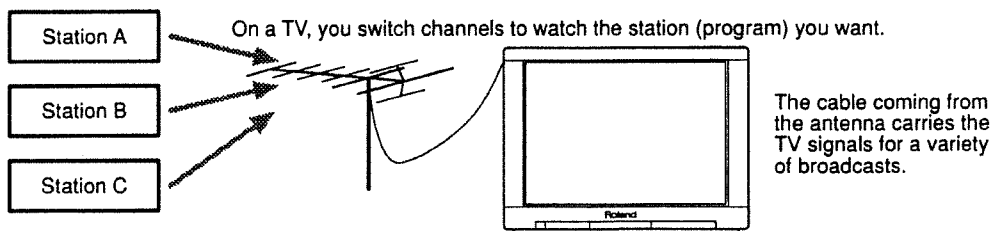

The channels available with MIDI range from 1 through 16. When a musical instrument (the receiver) is set so its channel matches the MIDI channel used by the transmitting device, the MIDI data is successfully 'communicated.'

** When the Omni Mode is set to ON, MIDI data arriving on any channel will be received, regardless of any MIDI channel settings that exist. If you do not need to have channel-specific MIDI control over anything, the Omni Mode can be set to ON.*

MIDI Messages Recognized by the RV-70

In order to convey the great variety of expression possible with music, the MIDI standard contains a large range of data 'types' (messages). MIDI messages can be divided into two main types: messages that are handled on each channel (Channel messages); and messages that are handled independently of channels (System messages).

CHANNEL MESSAGES

These messages are used to convey the events of a performance. In most circumstances, they alone are sufficient for providing the range of control needed. The specific results obtained by the various MIDI message of this type are determined by the settings on the unit receiving them.

Program Change Messages

These messages are used for conveying information about changes to another sound. Sounds are changed using Program Change Numbers, numbered from 1 through 128.

Control Change Messages

Control Change messages serve in enhancing the expressiveness of a performance. Every available function can be identified by its own Control Number. The functions which are available for control can vary widely depending on the MIDI device being used.

SYSTEM MESSAGES

System messages include Exclusive messages, messages used for synchronizing the performance of multiple units, and other messages employed for diagnostic purposes. The RV-70 supports the use of Exclusive messages.

Exclusive Messages

Exclusive messages handle information related to a unit's own unique sounds, or other device-specific information. Generally, such messages can only be exchanged between devices of the same model by the same manufacturer.

Exclusive messages can be employed to save the settings for Effects Programs into a sequencer, or for transferring such data to another RV-70.

MIDI Implementation Chart

MIDI has made it possible for a wide range of musical instruments to communicate with each other, but that doesn't necessarily mean that the many types of data will all be understood. If communication between two connected MIDI devices is to be successful, it must take place using only the types of data that they have in common.

It is for this reason that every owner's manual — for all kinds of MIDI devices — always includes a MIDI Implementation Chart as a quick reference to the types of MIDI messages it is capable of handling. You should compare the MIDI Implementation Charts for any two devices in order to find out which types of data can be exchanged. Since these charts are standardized, you can place them so they overlap. This way you can easily compare the receiving device with the transmitting device.

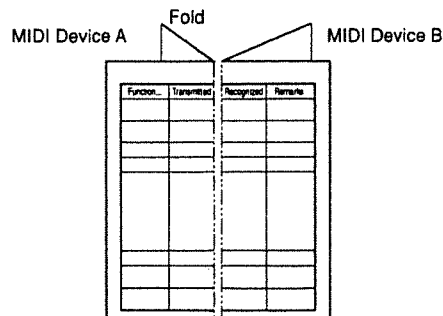

** For detailed information on MIDI data of the RV-70, a separate "MIDI Implementation document" is available at any Roland Service Station.*

So What Can You Do with MIDI on the RV-70?

Here's what you can do when the RV-70 is connected to an external MIDI device.

1. Switching Program Numbers

You can use MIDI Program Change messages to switch Program Numbers on the RV-70 by sending tone switching messages from an external MIDI device.

After making the connections shown below, you can select a Program Number on an external MIDI device and simultaneously send out the corresponding Program Change message to the RV-70. The Program Number on the RV-70 changes according to the message received.

** When the Omni mode is set to "ON," Program Change messages are received without regard to the MIDI channel selected for the RV-70. When set to "OFF," the RV-70 only receives messages on the selected MIDI channel.*

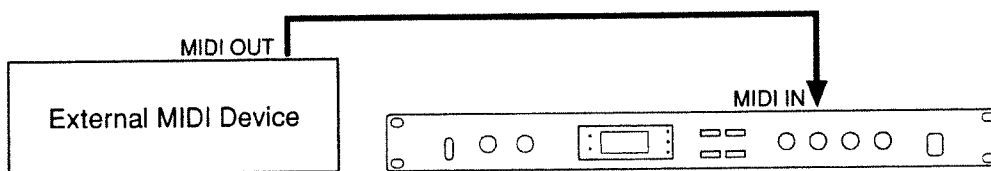

Performing MIDI Mapping

Performing MIDI mapping makes it possible to switch to Program Numbers higher than 128. For details, see "Setting a Program Change Map" on p. 22.

2. Sending Data

You can use System Exclusive ("SysEx") messages to send the contents of effects stored in the RV-70 to another MIDI device. This makes it possible to configure another RV-70 in the same way as the first, or store effect settings in a sequencer (for example).

Setting the MIDI Send/Receive Channel

Here's how to set the MIDI channel for transmitting MIDI data.

** The "device ID" that is set when handling SysEx messages is the same as the MIDI send/receive channel.*

** The MIDI channel on the RV-70 is set to "1" when shipped from the factory.*

1. Press the [MIDI] button once.
The button indicator will light and the number of the current MIDI send/receive channel appears in the display.
2. Use the [UP] and [DOWN] buttons to select the MIDI send/receive channel.
3. Press the [MIDI] button three times.
The button indicator will go out and the new MIDI send/receive channel has been stored.

Setting the Omni Mode

When the Omni mode is set to "ON," the RV-70 can receive data on any MIDI channel, no matter what the actual MIDI send/receive channel setting may be.

** Even when the Omni mode has been enabled, SysEx messages are received only on the selected MIDI send/receive channel (device ID).*

** The Omni mode is set to "ON" when the RV-70 is shipped from the factory.*

1. Press the [MIDI] button twice.
The button indicator will light and the current Omni mode setting appears in the display.
2. Use the [UP] and [DOWN] buttons to select the Omni mode setting.

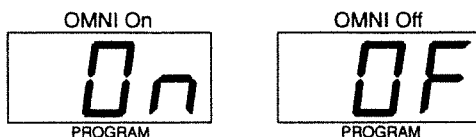

Omni On: Data on all MIDI channels is received, regardless of the MIDI channel setting.

Omni Off: Only data on the selected MIDI channel is received.

3. Press the [MIDI] button twice.
The button indicator goes out and the RV-70 returns to the normal play mode.

Sending Data (Bulk Dump)

You can send RV-70 data to another RV-70 or to some other external MIDI device. This transmission is carried out on the MIDI channel (device ID) selected as the MIDI send/receive channel.

Making the Connections

Storing Data in a Sequencer

Make the connections as shown below and set up the sequencer for receiving SysEx messages.

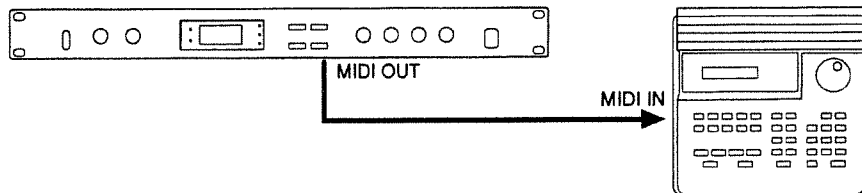

** Refer to the owner's manual for the sequencer for information on how to operate it.*

Copying Data to Another RV-70

Make the connections as shown below and make sure the sending RV-70 and receiving RV-70 are set to the same MIDI channel (device ID).

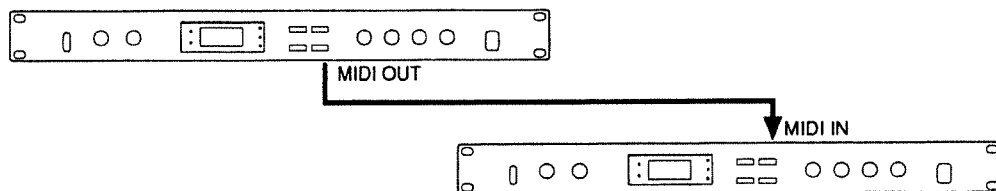

Transmitting Data

1. While in the standard play mode, press the **[MIDI]** button once.
The button indicator will light and the number of the current MIDI send/receive channel appears in the display.
2. Use the **[UP]** and **[DOWN]** buttons to select the MIDI send/receive channel.
The data will be sent on the MIDI channel (device ID) that you select here.
3. Press the **[WRITE]** button.
The button indicator will start to flash and the following message appears in the display:



4. Press the **[WRITE]** button again.
The display starts to flash and data transmission (bulk dump) begins. When the transmission is complete, the RV-70 returns to the standard play mode.

Receiving Data (Bulk Load)

Making the Connections

Sending Data Stored in a Sequencer to the RV-70

Make the connections as shown below. Set the RV-70 to the same MIDI channel (device ID) that was used when the data was stored in the sequencer.

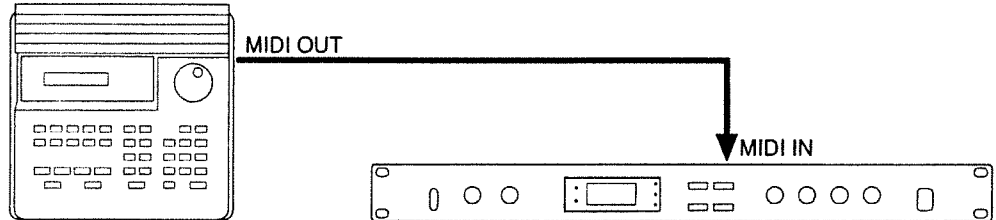

** Refer to the owner's manual for the sequencer for information on how to operate it.*

Receiving Data

SysEx messages, including bulk load data, can be received at any time. The following message appears when data is being received.



** All functions of the RV-70 are unavailable while the unit is receiving SysEx messages.*

** The RV-70 receives only SysEx messages on the matching MIDI channel (device ID).*

SETTING A PROGRAM CHANGE MAP

When the RV-70 received Program Change messages sent from an external MIDI device, the Program Number on the RV-70 changes. You can make settings that determine which Program Number is selected when these messages are received.

- 1.** Switch off the power.
- 2.** While holding down the [UP] and [MIDI] buttons, switch the power back on. "PC" appears in the display and the [MIDI] button indicator lights.
- 3.** Use the [UP] and [DOWN] buttons to select the Program Change number to be received.
- 4.** Press the [WRITE] button (the button indicator will light).
- 5.** Use the [UP] and [DOWN] buttons to select the Program Number on the RV-70 that you want to link with the Program Change number you selected in step 3. The [WRITE] button indicator starts to flash.
- 6.** Press the [WRITE] button.
The settings you've made are stored in memory. When complete, the [WRITE] button indicator goes out and the [MIDI] button indicator will light.
- 7.** Repeat steps 3 to 6 to link all the Program Numbers necessary.

When you've finished making the settings, turn the power off and then on again.

RESTORING THE FACTORY DEFAULTS - INITIALIZATION

If you wish, you can return any or all of the stored Program Number settings to their factory defaults, i.e., the settings as they were when the RV-70 was brand new. This process is called "initializing."

- 1.** Switch off the power.
- 2.** While holding down the [DOWN] and [WRITE] buttons, switch the power back on. "FL" appears in the display and the [WRITE] button indicator lights.
- 3.** Use the [UP] and [DOWN] buttons to select the Program Number you wish to initialize.

The [WRITE] button indicator begins to flash.

1 to *199* : Only the settings for the Program Number shown in the display are initialized.

RL : All Program Numbers are initialized to their factory defaults.

- 4.** Press the [WRITE] button.
The selected Program Number is initialized. When the initialization is complete, the [WRITE] button indicator lights continuously.
- 5.** If you want to initialize another Program Number, repeat steps 3 and 4.

When you've finishing initializing all the Program Numbers you want, turn the power off and then on again.

BEFORE CALLING FOR SERVICE

If your RV-70 is not functioning properly, or you suspect there is a problem somewhere, check the following items. If you are still unable to correct the problem, contact your Roland retailer or nearest Roland Service Center.

No Sound

- * Is all the equipment hooked up correctly? (P. 7)
- * Are the connected amps or mixers turned on and levels set properly?
- * Is the DIRECT button set properly?
- * Is the INPUT LEVEL knob set appropriately? (P. 8)
- * Is the EFFECT LEVEL knob set appropriately? (P. 8)
- * Are the connection cables in good repair?

Sound Is Distorted (the PEAK Indicator Lights Often)

- * Is the INPUT LEVEL knob adjusted properly? (P. 8)
- * Is the LEVEL switch (on the rear panel) set to match the connected instrument? (P. 7)
- * Is the output level of the connected equipment set too high?

Cannot Obtain Expected Changes in Program Numbers

- * First make sure the MIDI channels on your units match.
If changes to unintended Program Numbers occur, recheck the settings for the Program Change Map. (p. 22)

USING A MCR-8 TO OPERATE THE RV-70

The Roland MCR-8 Multi Controller (optional) can be used to control the RV-70. With it you can change some parameter settings that cannot be accessed by RV-70 panel operations. Here's how to connect and use the MCR-8.

At the end of this manual is a panel diagram that shows the relationships between MCR-8 controls and parameters. Please refer to this figure while operating the MCR-8.

Connecting the MCR-8

This figure illustrates how to connect the MCR-8 to the RV-70.

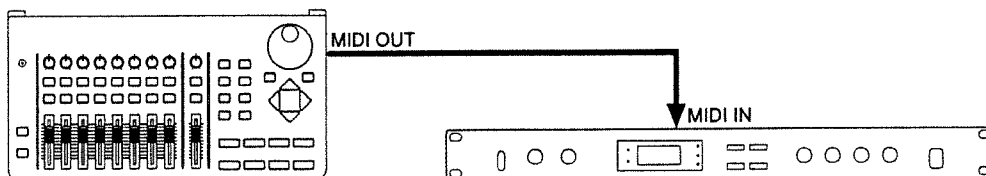

Initial Settings

Before controlling the RV-70 with an MCR-8, you first need to make some initial settings.

Initial Settings for the RV-70

MIDI Channel

Set the RV-70 and the MCR-8 to the same MIDI channel. When you turn on the power, the MIDI channel for the MCR-8 is set to "16," so set the MIDI channel for the RV-70 to "16" as well. See "Setting the MIDI Send/Receive Channel" on p. 19 for a description of this procedure.

*** The MIDI channel for the MCR-8 can be changed during power up. If you've changed the MIDI channel on the MCR-8, make sure that the RV-70 is set to the same MIDI channel.**

MCR-8 Receive Switch

When the RV-70 is connected to the MCR-8, you must turn on the MCR-8 Receive switch.

*** When shipped, the MCR-8 Receive switch is set to "off."**

1. While in the standard play mode, press the [MIDI] button three times.
The button indicator will light and the display shows the current settings for the MCR-8 Receive switch.
2. Use the [UP] and [DOWN] buttons to make the settings for the MCR-8 Receive switch.

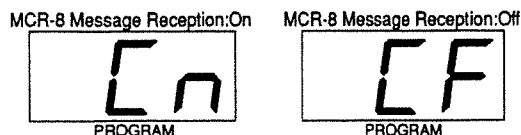

3. Press the [MIDI] button.
The button's indicator goes out and the RV-70 returns to the standard play mode.

Initial Settings for the MCR-8

Mode Switch

When using the MCR-8 to operate the RV-70, set the Mode switch on the MCR-8 to "Mode 4."

Computer Switch

When using the MCR-8 to operate the RV-70, set the COMPUTER switch on the MCR-8 to "MIDI."

Operating the RV-70 with the MCR-8

This figure illustrates how to operate the MCR-8.

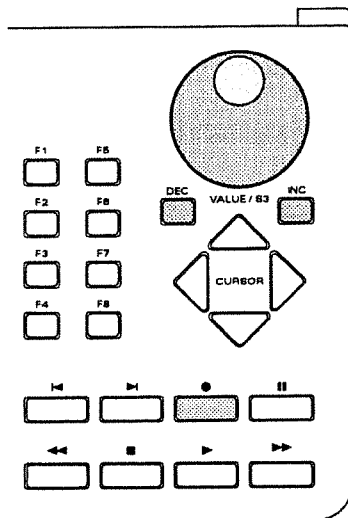

Switching Program Numbers

You can use the [UP (INC)] and [DOWN (DEC)] buttons on the MCR-8 to switch Program Numbers. This works just like the [UP] and [DOWN] buttons on the RV-70.

You can also change the Program Number by rotating the dial on the MCR-8. The Program Number changes when you call up the desired Program Number and push the dial.

** You can change the Program Number rapidly by holding down the [UP (INC)] (or [DOWN (DEC)]) button and pressing the [DOWN (DEC)] (or [UP (INC)]) button.*

Changing Effect Settings

In addition to the parameters that you can work with using the Edit knobs on the RV-70, the MCR-8 lets you control parameters that cannot be accessed from the front panel. The method of operation is just like that when using the RV-70 alone.

** For a full description, check out "Functions of Parameters Accessed with the MCR-8" on p. 27.*

Canceling Changes

You can't use the [UP (INC)] and [DOWN (DEC)] buttons on the MCR-8 to cancel changes. These buttons work just like the [UP] and [DOWN] buttons on the RV-70.

Storing Changes - The Write Operation

You can use the [WRITE (REC)] button on the MCR-8 to store changes you have made, just as with the [WRITE] button on the RV-70.

Copying Effect Settings

You can use the MCR-8 to copy Program Number settings by following the same procedure as for the RV-70 alone.

Functions of Parameters Accessed with the MCR-8

<Parameters Shared by All Effect Types>

ALGORITHM

You can use some of S1 and S2 to select the ALGORITHM. The ALGORITHM parameters are allocated as follows for each of the effect types.

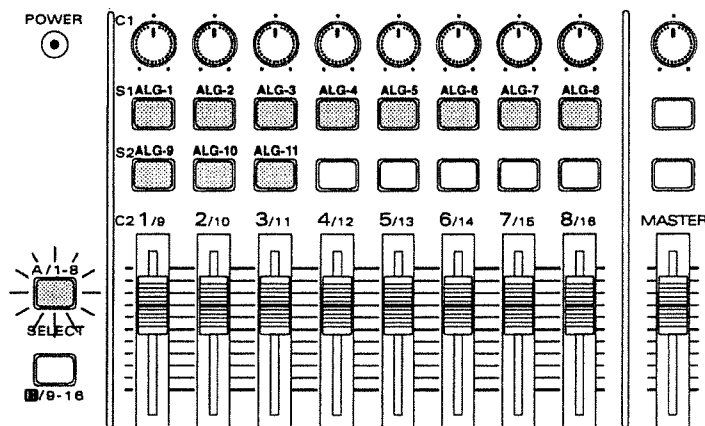

ALG-1/S1-1:	<REVERB>	ROOM1
ALG-2/S1-2:	<REVERB>	ROOM2
ALG-3/S1-3:	<REVERB>	ROOM3
ALG-4/S1-4:	<REVERB>	HALL1
ALG-5/S1-5:	<REVERB>	HALL2
ALG-6/S1-6:	<REVERB>	GARAGE
ALG-7/S1-7:	<NON-LINEAR>	NON-LINEAR
ALG-8/S1-8:	<REVERB+DELAY>	ROOM-SERIES
ALG-9/S2-1:	<REVERB+DELAY>	HALL-SERIES
ALG-10/S2-2:	<REVERB+DELAY>	ROOM-PARALLEL
ALG-11/S2-3:	<REVERB+DELAY>	HALL-PARALLEL

EQUALIZER

This is a three-band, parametric equalizer. In the low and high ranges, you can also switch between 'peaking' and 'shelving' types of EQ.

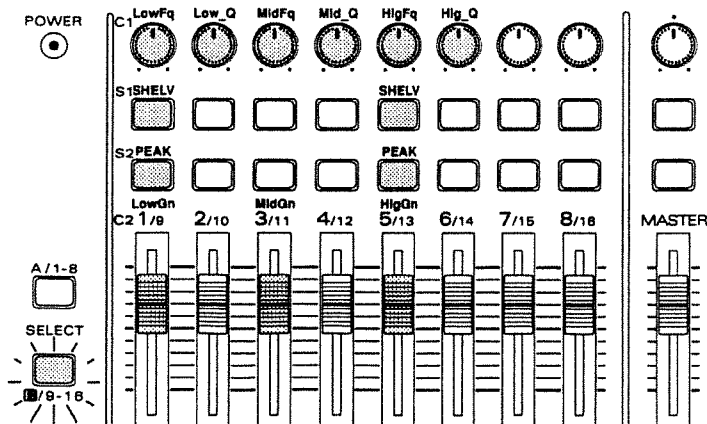

- LowFq /C1-9** [Low EQ Frequency]
This parameter adjusts the central frequency when adjusting the sound in the low range.
- LowGn /C2-9** [Low EQ Gain]
This parameter adjusts the gain (amount of boost and cut) for the low range.
- Low_Q /C1-10** [Low EQ Q]
This parameter adjusts the range for the central frequency set with "Low EQ Frequency" that is applied by the equalizer. The higher the setting, the narrower the range.
- SHELV /S1-9** [SHELVING]
PEAK /S2-9 [PEAKING]
This parameter switches between low equalizer shelving and peaking.
** When "SHELVING" is selected here, "Low EQ Q" has no effect.*
- MidFq /C1-11** [Mid EQ Frequency]
This parameter adjusts the central frequency when adjusting the sound in the middle range.
- MidGn /C2-11** [Mid EQ Gain]
This parameter adjusts the gain (amount of boost/cut) for the middle range.
- Mid_Q /C1-12** [Mid EQ Q]
This parameter adjusts the range for the central frequency set with "Mid EQ Frequency" that is applied by the equalizer. The higher the setting, the narrower the range.
- HigFq /C1-13** [High EQ Frequency]
This parameter adjusts the central frequency when adjusting the sound in the high range.
- HigGn /C2-13** [High EQ Gain]
This parameter adjusts the gain (amount of boost and cut) for the high range.
- Hig_Q /C1-14** [High EQ Q]
This parameter adjusts the range for the central frequency set with "High EQ Frequency" that is applied by the equalizer. The higher the setting, the narrower the range.
- SHELV /S1-13** [SHELVING]
PEAK /S2-13 [PEAKING]
This parameter switches between high equalizer shelving and peaking.
** When "SHELVING" is selected here, "High EQ Q" has no effect.*

<REVERB> <REVERB+DELAY>

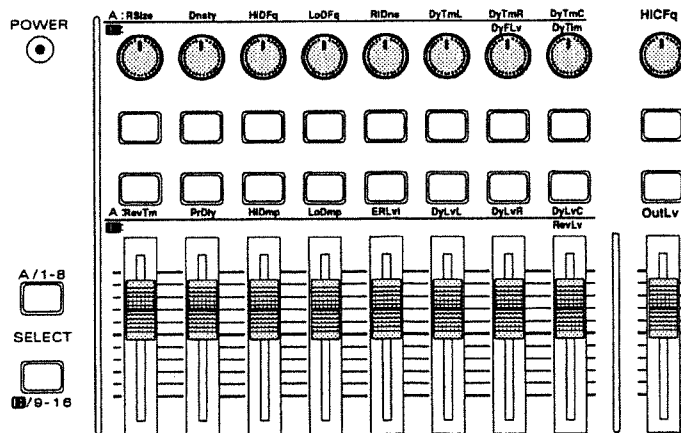

- RSize /C1-1** [Room Size]
This parameter adjusts the size of the simulated room.
- RevTm /C2-1** [Reverb Time]
This parameter adjusts the duration of the reverberations.

Dnsty /C1-2	[Density] This parameter adjusts the density of the reverb effect. A higher setting results in greater density, for a thicker sound.
PrDly /C2-2	[Pre Delay] This parameter adjusts the delay time of the reverberations in relation to the direct sound.
HiDFq /C1-3	[HF Damp <Frequency>] This parameter adjusts the base frequency for HF damping (high-range damping of the reverb effect). Frequencies above the base frequency are attenuated.
HiDmp /C2-3	[HF Damp <Gain>] This parameter adjusts the amount of attenuation for HF damping. When set to "0," there is no HF damping.
LoDFq /C1-4	[LF Damp <Frequency>] This parameter adjusts the base frequency for LF damping (low-range damping of the reverb effect). Frequencies below the base frequency are damped.
LoDmp /C2-4	[LF Damp <Gain>] This parameter adjusts the amount of attenuation for LF damping. When set to "0," there is no LF damping.
RIDns /C1-5	[Release Density] This parameter adjusts the ratio at which the density of the reverb effect increases over time. A higher value produces greater density.
ERLvl /C2-5	[Early Reflection Level] This parameter adjusts the volume of the initial reflected sound.
RevLv /C2-16	[Reverb Level] This parameter adjusts the volume of the reverb.
DyTmL /C1-6	[Delay Time Left]
DyLvL /C2-6	[Delay Level Left]
DyTmR /C1-7	[Delay Time Right]
DyLvR /C2-7	[Delay Level Right]
DyTmC /C1-8	[Delay Time Center]
DyLvC /C2-8	[Delay Level Center]
	These parameters adjust the respective delay times and volume levels for output to the left, right, and center of the stereo spectrum.
DyFLv /C1-15	[Delay Feedback Level] This parameter adjusts the amount of feedback for the delayed sound. A higher setting results in more feedback loops for the delayed sound.
DyTim /C1-16	[Delay Time Scale] This parameter controls the overall delay time output to the left, right, and center of the stereo spectrum.
	* The following parameters can be used only when the effect type is "REVERB+DELAY."
	RevLv [Reverb Level]
	DyTmL [Delay Time Left]
	DyLvL [Delay Level Left]
	DyTmR [Delay Time Right]
	DyLvR [Delay Level Right]
	DyTmC [Delay Time Center]
	DyLvC [Delay Level Center]
	DyFLv [Delay Feedback Level]
	DyTim [Delay Time Scale]
HiCFq /C1-MASTER	[High Cut Filter Frequency] This parameter adjusts the frequency at which the high-cut filter (which cuts off high frequencies) begins to work.
OutLv /C2-MASTER	[Output Level] This parameter adjusts the overall output level for the effect.

<NLR>

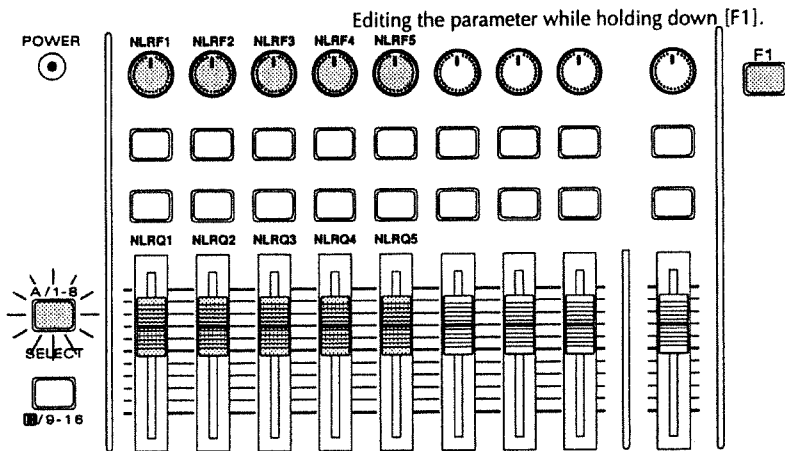
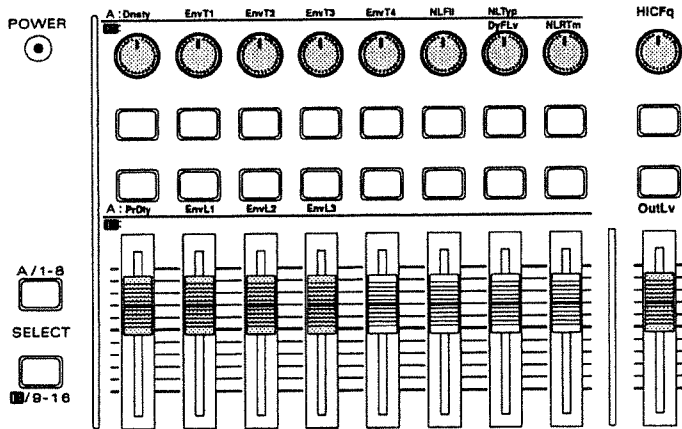

Dnsty /C1-1

[Density]

This parameter adjusts the density of the reverb effect. A higher setting results in greater density, for a thicker sound.

PrDly /C2-1

[Pre Delay]

This parameter adjusts the interval of delay before the reverb sound is output.

EnvT1 /C1-2

[Envelope Time1]

EnvL1 /C2-2

[Envelope Level1]

EnvT2 /C1-3

[Envelope Time2]

EnvL2 /C2-3

[Envelope Level2]

EnvT3 /C1-4

[Envelope Time3]

EnvL3 /C2-4

[Envelope Level3]

EnvT4 /C1-5

[Envelope Time4]

These parameters adjust the output levels at the respective points in time, as well as the time intervals before these points are reached.

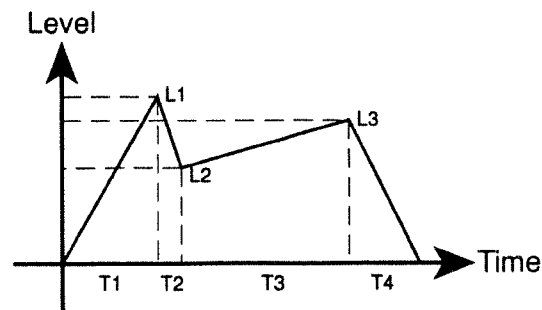

-
- NLFil** /C1-6 **[Non-linear Filter]**
 This parameter adjusts the quality of the reverb effect by varying the amount of input signal that is passed through the bandpass filter (BPF). When set to "0," none of the sound is filtered. A higher value results in more sound being passed through the filter, up to a maximum of "100" (all sound is filtered).
- NLTyp** /C1-7 **[Non-linear Type]**
 This parameter sets the panning (stereo location) for the reverb.
0: The reverb pans from the left channel to the right channel.
1: No panning.
2: The reverb pans from the right channel to the left channel.
- DyFLv** /C1-15 **[Delay Feedback Level]**
 This parameter adjusts the amount of feedback for the delayed sound. A higher setting results in more feedback loops for the delayed sound.
- NLRTm** /C1-16 **[Non-linear Time]**
 This parameter adjusts the length (duration) of the reverb effect.
- HiCFq** /C1-MASTER **[High Cut Filter Frequency]**
 This parameter adjusts the frequency at which the high-cut filter (which cuts off high frequencies) begins to take effect.
- OutLv** /C2-MASTER **[Output Level]**
 This parameter adjusts the output level for the effect.
- NLRF1** /[F1]+C1-1 **[Non-linear Filter 1]**
NLRF2 /[F1]+C1-2 **[Non-linear Filter 2]**
NLRF3 /[F1]+C1-3 **[Non-linear Filter 3]**
NLRF4 /[F1]+C1-4 **[Non-linear Filter 4]**
NLRF5 /[F1]+C1-5 **[Non-linear Filter 5]**
NLRQ1 /[F1]+C2-1 **[Non-linear Filter Q1]**
NLRQ2 /[F1]+C2-2 **[Non-linear Filter Q2]**
NLRQ3 /[F1]+C2-3 **[Non-linear Filter Q3]**
NLRQ4 /[F1]+C2-4 **[Non-linear Filter Q4]**
NLRQ5 /[F1]+C2-5 **[Non-linear Filter Q5]**
- These parameters divide the time over which the reverb is output into five sections, and adjust how the bandpass filter (BPF) is applied to each time slice. Filters 1 to 5 adjust the central frequency for the BPF. Q1 to Q5 adjust the range over which the BPF is applied, centering on the respective frequencies set with Filters 1 to 5. The higher the value, the narrower the range.

MIDI Implementation Chart

Function***		Transmitted	Recognized	Remarks
Basic Channel	Default Changed	1 - 16 1 - 16	1 - 16 1 - 16	Memorized
Mode	Default Messages Altered	x x *****	OMNI ON/OFF x x	Memorized
Note Number	True Voice	x *****	x x	
Velocity	Note ON Note OFF	x x	x x	
After Touch	Key's Ch's	x x	x x	
Pitch Bend		x	x	
Control Change	0 - 7	x	o *1	
	10	x	o *1	
	21	x	o *1	
	23 - 25	x	o *1	
	30	x	o *1	
	32	x	o *1	
	36	x	o *1	
	40 - 43	x	o *1	
	48 - 82	x	o *1	
	88	x	o *1	
	92	x	o *1	
96	x	o *1		
Prog Change	True #	x *****	o 0 - 127	Program Number 1 - 128
System Exclusive		o	o	
System Common	Song Pos Song Sel True	x x x	x x x	
System Real Time	Clock Commands	x x	x x	
AUX Messages	Local ON/OFF All Notes OFF Active Sense Reset	x x x x	x x x x	
Notes	*1: Reception possible if MCR-8 receive switch is turned on, either through Exclusive data or manually. (Used to alter parameter values in the RV-70 — not defined by MIDI specs.)			

Mode 1 : OMNI ON, POLY
Mode 3 : OMNI OFF, POLY

Mode 2 : OMNI ON, MONO
Mode 4 : OMNI OFF, MONO

o : Yes
x : No

SPECIFICATIONS

RV-70 : Digital Stereo Reverb

Signal Processing

AD Conversion : 16 bit linear 128 times oversampling
 $\Delta\Sigma$ modulation Adaptive Focus Method
DA Conversion : 16 bit linear 8 times oversampling

Sampling Frequency

44.1 kHz

Program Memories

199 (User Area)

Nominal Input Level

+4 / -20 dBm (selectable with LEVEL Switch)

Input Impedance

470 k Ω (LEVEL Switch : -20 dBm)
470 k Ω (LEVEL Switch : +4 dBm)

Nominal Output Level

+4 / -20 dBm (same as Nominal Input level)

Output Impedance

2.6 k Ω (LEVEL Switch : -20 dBm)
2.6 k Ω (LEVEL Switch : +4 dBm)

Recommended Load Impedance

26 k Ω or greater

Dynamic Range

120 dB or greater (direct)
90 dB or greater (effect)

Controls

DIRECT Button
INPUT LEVEL Knob
EFFECT LEVEL Knob
UP/DOWN Buttons
MIDI Button
WRITE Button
Edit Knobs x4
POWER Switch
LEVEL Switch

Display

7 segments, 2 characters (LED)

Indicators

PEAK Indicator
EFFECT Indicator
Effect Type Indicators x3

Connectors

INPUT Jacks L(MONO),R
OUTPUT Jacks L(MONO),R
EFFECT REMOTE Jack
MIDI Connectors (IN,OUT)

Power Supply

AC 117 V, AC 230 V or AC 240 V

Power Consumption

6.5 W (AC 117 V, AC 230 V, AC 240 V)

Dimensions

482 (W) x 165 (D) x 44 (H) mm
19 (W) x 6-1/2 (D) x 1-3/4 (H) inches
(EIA-1U rack mount type)

Weight

2.2 kg / 4 lbs 14oz

Accessory













Owner's Manual













* 0 dBm = 0.775 Vrms













* In the interest of product development, the specifications and/or appearance of this unit are subject to change without prior notice.

<REVERB> <REVERB+DELAY>

POWER 



A : RSize            

A : ALG-1            

A : ALG-9            

A : RevTm            



HICFq 



 

OutLv 

 



 

WRITE   

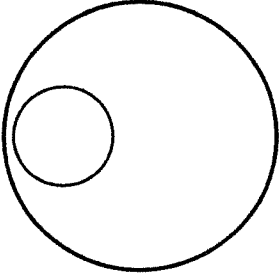

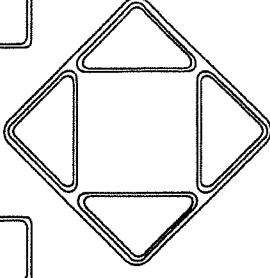
DOWN  



























  



A / 1-8 

SELECT 

B / 9-16 

A : RSize            

A : ALG-1            

A : ALG-9            

A : RevTm            

HICFq

OutLv

<NON-LINEAR>

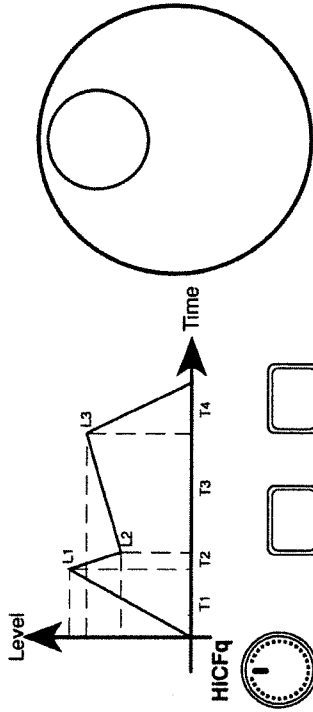

POWER

A : Dnsdy	EnvT1	EnvT2	EnvT3	EnvT4	NLFil	NLTyp	DyTim
B : LowFq	Low_Q	MidFq	Mid_Q	HigFq	Hig_Q	DyFLV	
A : ALG-1	ALG-2	ALG-3	ALG-4	ALG-5	ALG-6	ALG-7	ALG-8
B : SHELV				SHELV			
PEAK							
A : ALG-9	ALG-10	ALG-11					
B : PEAK							
PEAK							
A : PrDly	EnvL1	EnvL2	EnvL3	HigGn			
B : LowGn		MidGn					

A / 1-8 SELECT B / 9-16

DOWN UP

WRITE

OutLv

A : Dnsdy	EnvT1	EnvT2	EnvT3	EnvT4	NLFil	NLTyp	DyTim
B : LowFq	Low_Q	MidFq	Mid_Q	HigFq	Hig_Q	DyFLV	
A : ALG-1	ALG-2	ALG-3	ALG-4	ALG-5	ALG-6	ALG-7	ALG-8
B : SHELV				SHELV			
A : ALG-9	ALG-10	ALG-11					
B : PEAK				PEAK			
A : PrDly	EnvL1	EnvL2	EnvL3	HigGn			
B : LowGn		MidGn					

HICFq OutLv

<NON-LINEAR>

POWER



A: NLR01

NLR02

NLR03

NLR04

NLR05



Holding down

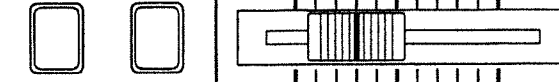
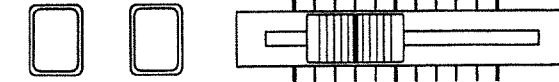
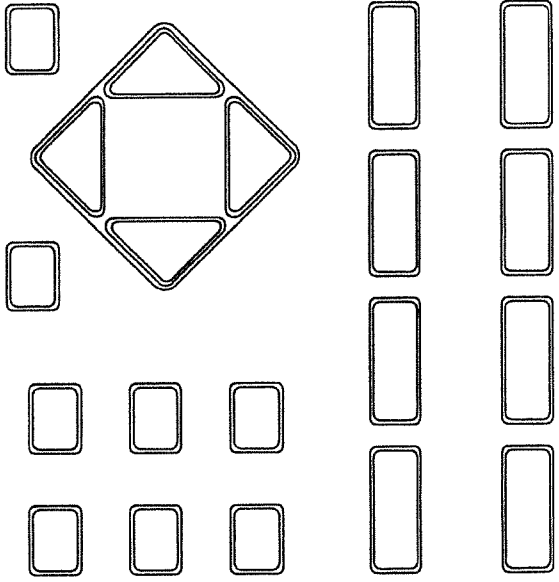

A: NLR01

NLR02

NLR03

NLR04

NLR05

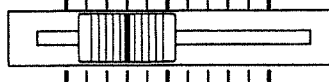
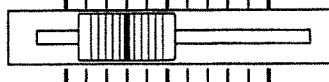
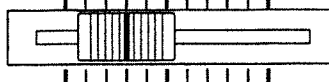
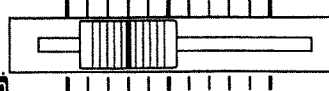

A/1-8



SELECT



B/9-16

A: NLR01

NLR02

NLR03

NLR04

NLR05



A: NLR01

NLR02

NLR03

NLR04

NLR05

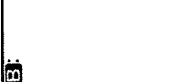

MEMO

Information

When you need repair service, call your local Roland Service Station or the authorized Roland distributor in your country as shown below.

U. S. A.

Roland Corporation US
7200 Dominion Circle
Los Angeles, CA. 90040-3696, U. S. A.
TEL: (213) 685-5141

CANADA

Roland Canada Music Ltd.
(Head Office)
5480 Parkwood Way
Richmond B. C., V6V 2M4
CANADA
TEL: (604) 270-6626

Roland Canada Music Ltd.

(Montreal Office)
9425 Transcanadienne
Service Rd. N., St Laurent,
Quebec H4S 1V3, CANADA
TEL: (514) 335-2009

Roland Canada Music Ltd.

(Toronto Office)
346 Watline Avenue,
Mississauga, Ontario L4Z 1X2, CANADA
TEL: (416) 890-6488

AUSTRALIA

Roland Corporation Australia Pty. Ltd.
38 Campbell Avenue
Dee Why West. NSW 2099
AUSTRALIA
TEL: (02) 982-8266

NEW ZEALAND

Roland Corporation (NZ) Ltd.
97 Mt. Eden Road, Mt. Eden,
Auckland 3, NEW ZEALAND
TEL: (09) 3098-715

UNITED KINGDOM

Roland (U.K.) Ltd.
Rye Close Ancells Business
Park Fleet, Hampshire GU13 8UY, UNITED KINGDOM
TEL: 0252-816181

Roland (U.K.) Ltd., Swansea Office

Atlantic Close, Swansea,
Enterprise Park, Swansea,
West Glamorgan SA79FJ,
UNITED KINGDOM
TEL: (0792) 700-139

IRELAND

The Dublin Service Centre Audio Maintenance Limited
11 Brunswick Place Dublin 2
Republic of Ireland
TEL: 010 353 1677322

ITALY

Roland Italy S. p. A.
Viale delle Industrie 8 20020
ARESE MILANO ITALY
TEL: 02-93581311

SPAIN

Roland Electronics de España, S. A.
Calle Bolivia 239 08020
Barcelona, SPAIN
TEL: 93-308-1000

GERMANY

Roland Elektronische Musikinstrumente Handelsgesellschaft mbH.
Oststrasse 96, 22844
Norderstedt, GERMANY
TEL: 040/52 60 090

FRANCE

Guillard Musiques Roland
ZAC de Rosarge Les Echets
01700
MIRIBEL FRANCE
TEL: (7) 226-50 60

Guillard Musiques Roland (Paris Office)

1923 rue Léon Geoffroy
94400 VITRY-SUR-SEINE
FRANCE
TEL: (1) 4680 86 62

BELGIUM/HOLLAND/LUXEMBOURG

Roland Benelux N. V.
Houtstraat 1 B-2260 Oevel-
Westerlo BELGIUM
TEL: (0032) 14-575811

DENMARK

Roland Scandinavia A/S
Langebrogade 6 Box 1937
DK-1023 Copenhagen K.
DENMARK
TEL: 31-95 31 11

SWEDEN

Roland Scandinavia A/S
Danvik Center 28 A, 2 tr.
S-131 30 Nacka SWEDEN
TEL: 08-702 00 20

NORWAY

Roland Scandinavia Avd. Kontor Norge
Lilleakerveien 2 Postboks 95
Lilleaker N-0216 Oslo 2
NORWAY
TEL: 22-73 00 74

FINLAND

Fazer Musik Inc.
Länsituulentie POB 169,
SF-02101 Espoo FINLAND
TEL: 0-43 50 11

SWITZERLAND

Roland CK (Switzerland) AG
Gerberstrasse 5, CH-4410
Liestal, SWITZERLAND
TEL: 061/921 16 15

AUSTRIA

E. Dematte & Co.
Neu-Rum Siemens-Strasse 4
A-6040 Innsbruck P.O.Box
83
AUSTRIA
TEL: (0512) 26 44 260

GREECE

V. Dimitriadis & Co. Ltd.
20, Alexandras Avn., GR
10682 Athens, GREECE
TEL: 01-8232415

PORTUGAL

Casa Caius Instrumentos Musicais Lda.
Rua de Santa Catarina 131
4000 Porto, PORTUGAL
TEL: 02-38 44 56

HUNGARY

Intermusica Ltd.
Warehouse Area 'DEPO'
Torokballint, Budapest
HUNGARY
TEL: (1) 1868905

ISRAEL

D.J.A. International Ltd.
11 Bar Giyora St., Tel Aviv
ISRAEL
TEL: 972-3-525-3834

CYPRUS

Radex Sound Equipment Ltd.
17 Diagorou St., P.O.Box
2046, Nicosia CYPRUS
TEL: 453426, 466423

U.A.E

Zak Electronics & Musical Instruments Co.
P.O. Box 8050
DUBAI, U.A.E
TEL: 9714-360715

KUWAIT

Easa Husain Al-Yousifi
P.O. Box 126 Safat 13002
KUWAIT
TEL: 965-5719499

LEBANON

A. Chahine & Fils
P.O. Box 16-5857
Beirut, LEBANON
TEL: 335799

TURKEY

Barkat Sanayi ve Ticaret
Siraselviler Cad. 86/6 Taksim
Istanbul, TURKEY
TEL: 212-2499324

EGYPT

Al Fanny Trading Office
9, Ebn Hagar Al Askalany
Street, Ard El Golf,
Heliopolis, Cairo, 11341
EGYPT
TEL: 2917803-665918

QATAR

Badie Studio & Stores
P.O.Box 62,
DOHA Qatar
TEL: 974 423554

BAHRAIN

Moon Stores
Bad Al Bahrain Road,
P.O.Box 20077
State of Bahrain
TEL: (0973) 211 005

BRAZIL

Roland Brasil Ltda.
R. Coronel Oaviano da
Silveira 203 05522-010
Sao Paulo BRAZIL
TEL: (011) 843-9377

MEXICO

Casa Veerkamp, s.a. de c.v.
Mesones No. 21 Col. Centro
MEXICO D.F. 06080
TEL: (5) 709-3716

La Casa Wagner de Guadalajara s.a. de c.v.

Av. Corona No. 202 S.J.
C.P.44100 Guadalajara,
Jalisco MEXICO
TEL: (36) 13-1414

VENEZUELA

Musicland Digital C.A.
Av. Francisco De Miranda,
Centro Parque de Cristal,
Nivel C2 Local 20 Caracas
VENEZUELA
TEL: (2)285-9218

PANAMA

Productos Superiores, S.A.
Apartado 655 - Panama 1
REP. DE PANAMA
TEL: 26-3322

ARGENTINA

Instrumentos Musicales S.A.
Florida 638
(1005) Buenos Aires
ARGENTINA
TEL: (1)394-4029

HONG KONG

Tom Lee Music Co., Ltd. Service Division
22-32 Pun Shan Street, Tsuen
Wan, New Territories,
HONG KONG
TEL: 415-0911

KOREA

Cosmos Corporation Service Station
261 2nd Floor Nak-Won
Arcade Jong-Ro ku, Seoul,
KOREA
TEL: (02) 742 8844

SINGAPORE

Swee Lee Company
BLOCK 231,
Bain Street #03-23
Bras Basah Complex,
Singapore 0718
TEL: 3367886

PHILIPPINES

G.A. Yupangco & Co. Inc.
339 Gil J. Puyat Avenue
Makati, Metro Manila 1200,
PHILIPPINES
TEL: 02 (817) 0013

THAILAND

Theera Music Co., Ltd.
330 Veeng Nakorn Kasem,
Soi 2, Bangkok 10100,
THAILAND
TEL: 2248821

MALAYSIA

Bentley Music SDN BHD
No.142, Jalan Bukit Bintang
55100 Kuala Lumpur,
MALAYSIA
TEL: (03) 2443333

INDONESIA

PT CITRARAMA BELANTIKA
Kompleks Perkantoran Duta
Merlin Blok E No.6—7
Jl. Gajah Mada No.3—5,
Jakarta 10130,
INDONESIA
TEL: (021) 3850073

TAIWAN

Siruba Enterprise (Taiwan) Co., LTD.
Room. 5, 9fl. No. 112 Chung
Shan N.Road Sec.2 Taipei,
TAIWAN, R.O.C.
TEL: (02) 571-5860

SOUTH AFRICA

That Other Music Shop (PTY) Ltd.
11 Melle Street (Cnr Melle
and Juta Street)
Braamfontein 2001
Republic of South Africa
TEL: 27 11 403-4105

Paul Bothner (PTY) Ltd.

17 Werdmuller Centre
Claremont 7700
Republic of South Africa
TEL: 212-64-4030

No. Preset Name	Algorithm	No. Preset Name	Algorithm
101 STUDIO #2	<REVERB>ROOM2	151 REPEAT REVERB	<REV+DLY>ROOM-SERIES
102 STUDIO #3	<REVERB>HALL1	152 REBOUND	<REV+DLY>HALL-PARALLEL
103 GUITAR HOUSE #1	<REVERB>ROOM1	153 HOOFBAT	<REV+DLY>HALL-PARALLEL
104 GUITAR HOUSE #2	<REVERB>ROOM1	154 EVH RIFFS	<REV+DLY>ROOM-SERIES
105 BRIGHT BOOTH	<REV+DLY>ROOM-PARALLEL	155 WHOLE LOTTA REV	<REV+DLY>ROOM-SERIES
106 CHURCH	<REVERB>HALL1	156 POPPING REVERB	<REV+DLY>HALL-SERIES
107 SMALL CHURCH	<REVERB>HALL1	157 DELAY -> REVERB	<REV+DLY>HALL-SERIES
108 MEDIUM CHURCH	<REVERB>HALL1	158 ECHOPREX	<REV+DLY>HALL-SERIES
109 BIG CHURCH	<REVERB>HALL1	159 LEFT DOOR REFLECTION	<REV+DLY>ROOM-SERIES
110 HARD WALL CHURCH	<REVERB>HALL1	160 BOUNCE DELAY	<REV+DLY>ROOM-PARALLEL
111 CATHEDRAL #1	<REVERB>HALL1	161 LONG DENSE ER	<REV+DLY>HALL-SERIES
112 CATHEDRAL #2	<REVERB>HALL2	162 SPRING	<REV+DLY>HALL-SERIES
113 HUGE CATHEDRAL	<REVERB>ROOM1	163 CAVE	<REV+DLY>ROOM-PARALLEL
114 WARM CORRIDOR	<REVERB>GARAGE	164 DEEP CAVE	<REVERB>ROOM3
115 DRUM	<REVERB>ROOM1	165 BOOMY CAVE	<REVERB>HALL1
116 DEBBIE DRUMS	<REVERB>HALL2	166 LONG CAVE	<REVERB>ROOM1
117 CRIES DRUMS	<REVERB>HALL2	167 CAN	<REVERB>GARAGE
118 DENSE DRUM	<REVERB>ROOM3	168 WASHBOWL	<REVERB>ROOM2
119 TECHNO DRUM	<REVERB>ROOM1	169 LOBBY	<REVERB>ROOM2
120 ROCK KICK #1	<REVERB>ROOM1	170 THEATER #1	<REVERB>ROOM3
121 ROCK KICK #2	<REVERB>ROOM1	171 THEATER #2	<REVERB>ROOM3
122 KICK GATE #1	< N L R >NON-LINEAR	172 STADIUM #1	<REVERB>HALL2
123 SNARE	<REVERB>ROOM1	173 STADIUM #2	<REVERB>HALL1
124 ROCK SNARE	<REVERB>ROOM1	174 STADIUM ANNOUNCE	<REV+DLY>ROOM-PARALLEL
125 TECHNO SNARE	<REVERB>ROOM1	175 CANNON	<REV+DLY>HALL-PARALLEL
126 BIG SNARE #1	<REVERB>ROOM1	176 FALLIN' ECHO	<REV+DLY>HALL-SERIES
127 BIG SNARE #2	<REVERB>ROOM1	177 FOREVER	<REV+DLY>HALL-PARALLEL
128 BIG SNARE #3	<REVERB>ROOM1	178 IT'S DELAY	<REV+DLY>HALL-SERIES
129 CRACK SNARE	<REVERB>ROOM1	179 ANALOG DELAY	<REV+DLY>HALL-SERIES
130 SWEET SNARE	<REVERB>ROOM1	180 KARAOKE #1	<REV+DLY>HALL-SERIES
131 CHOIR NON-LINEAR	< N L R >NON-LINEAR	181 KARAOKE #2	<REV+DLY>ROOM-SERIES
132 BRIGHT BRASS	<REVERB>GARAGE	182 SIMPLE NON-LINEAR	< N L R >NON-LINEAR
133 METAL HORN	< N L R >NON-LINEAR	183 GO RIGHT NON-LINEAR	< N L R >NON-LINEAR
134 SLOW BALLADE GUITAR	<REV+DLY>ROOM-SERIES	184 GO LEFT NON-LINEAR	< N L R >NON-LINEAR
135 RICH REVERB	<REVERB>HALL1	185 SLOW ATTACK NON-LINEAR	< N L R >NON-LINEAR
136 LIGHT WEIGHT REVERB	<REVERB>ROOM3	186 NON ATTACK NON-LINEAR	< N L R >NON-LINEAR
137 DARK SPACE	<REVERB>HALL2	187 DENSE NON-LINEAR	< N L R >NON-LINEAR
138 LONG HIGH TAIL REVERB	<REVERB>ROOM3	188 SUBMARINE	< N L R >NON-LINEAR
139 HIGH CUT REVERB	<REVERB>ROOM2	189 G NOTE FILTER	< N L R >NON-LINEAR
140 FOLLOW ME	<REVERB>ROOM2	190 DEEP BREATHING	< N L R >NON-LINEAR
141 PANNING DELAY REVERB	<REVERB>GARAGE	191 SPIRAL	< N L R >NON-LINEAR
142 DOUBLING NON-LINEAR	< N L R >NON-LINEAR	192 TWIN PEAKS	< N L R >NON-LINEAR
143 BASIC DELAY REVERB	<REV+DLY>ROOM-SERIES	193 FORGET	< N L R >NON-LINEAR
144 STEREO DELAY REVERB	<REV+DLY>ROOM-SERIES	194 MASHED DELAY	< N L R >NON-LINEAR
145 PING PONG	<REV+DLY>ROOM-SERIES	195 PING	< N L R >NON-LINEAR
146 TRIPLET DELAY	<REV+DLY>HALL-PARALLEL	196 FLAM NON-LINEAR	< N L R >NON-LINEAR
147 WARM DELAY REV	<REV+DLY>ROOM-SERIES	197 DOPPLER	< N L R >NON-LINEAR
148 LUSH DELAY	<REV+DLY>HALL-SERIES	198 DO UP	< N L R >NON-LINEAR
149 SLAPVERB	<REV+DLY>ROOM-PARALLEL	199 HH -> CRASH	< N L R >NON-LINEAR
150 SPARKLING	<REV+DLY>ROOM-SERIES		

No. Preset Name	Algorithm	No. Preset Name	Algorithm
1 140 PLATE	<REVERB>ROOM2	51 CONFERENCE ROOM	<REVERB>ROOM1
2 AIR PLATE	<REVERB>ROOM2	52 BALLROOM	<REVERB>HALL1
3 VOCAL PLATE	<REVERB>ROOM1	53 POWER ROOM	<REVERB>ROOM3
4 BRIGHT PLATE	<REVERB>ROOM1	54 ROOM WITH DELAY	<REV+DLY>ROOM-PARALLEL
5 SHORT PLATE	<REVERB>ROOM1	55 CONCERT HALL #1	<REVERB>HALL1
6 WARM PLATE	<REVERB>ROOM2	56 CONCERT HALL #2	<REVERB>ROOM1
7 RICH PLATE	<REVERB>ROOM1	57 SIMPLE SMALL HALL	<REVERB>HALL1
8 DARK DENSE PLATE	<REVERB>ROOM2	58 SMALL HALL	<REVERB>ROOM1
9 STRINGS PLATE	<REVERB>ROOM2	59 SHORT HALL	<REVERB>ROOM1
10 BRASS PLATE	<REVERB>ROOM1	60 MEDIUM HALL #1	<REVERB>HALL2
11 SOFT AMBIENCE	<REVERB>ROOM1	61 MEDIUM HALL #2	<REVERB>HALL1
12 REFLECT AMBIENCE	<REVERB>ROOM1	62 LARGE HALL	<REVERB>HALL1
13 DRUM AMBIENCE	<REVERB>ROOM3	63 LONG HALL	<REVERB>HALL2
14 SHORT AMBIENCE	<REVERB>HALL2	64 WIDE HALL	<REVERB>ROOM2
15 NARROW AMBIENCE	<REVERB>HALL1	65 DEEP HALL	<REVERB>HALL2
16 ROOM AMBIENCE	<REVERB>ROOM1	66 GOTHIC HALL	<REVERB>HALL2
17 MID AMBIENCE	< N L R >NON-LINEAR	67 DRUM HALL	<REVERB>HALL2
18 NICE SIZZLE ROOM	<REVERB>ROOM1	68 STRINGS HALL #1	<REVERB>HALL2
19 CLEAR ROOM	<REVERB>ROOM1	69 STRINGS HALL #2	<REVERB>ROOM1
20 LOCKER ROOM	<REVERB>ROOM1	70 GUITAR HALL	<REVERB>GARAGE
21 DARK ROOM	<REVERB>ROOM2	71 PIANO HALL	<REVERB>ROOM1
22 MEDIUM ROOM	<REVERB>ROOM1	72 LONG TAIL HALL	<REVERB>ROOM1
23 MEDIUM BRIGHT ROOM	<REVERB>ROOM1	73 COARSE HALL	<REVERB>GARAGE
24 SIZZLE ROOM #1	<REVERB>ROOM1	74 REFLECTIVE HALL	<REVERB>HALL2
25 SIZZLE ROOM #2	<REVERB>ROOM1	75 LIGHT HALL	<REVERB>HALL2
26 LITTLE ROOM #1	<REVERB>ROOM1	76 WARM MID HALL	<REVERB>HALL1
27 LITTLE ROOM #2	<REVERB>ROOM1	77 BRIGHT MID HALL	<REVERB>HALL1
28 ORCHESTRA ROOM	<REVERB>ROOM1	78 BRIGHT LARGE HALL	<REVERB>HALL1
29 SHORT ROOM	<REVERB>ROOM1	79 OCEAN HALL	<REVERB>HALL1
30 CLOSET ROOM	<REVERB>ROOM1	80 WARM HALL	<REVERB>GARAGE
31 TILED ROOM	<REVERB>ROOM1	81 RICH HALL	<REVERB>HALL1
32 MEDIUM REFLECT ROOM	<REVERB>ROOM2	82 HALL WITH DELAY	<REV+DLY>HALL-PARALLEL
33 SMALL REFLECT ROOM	<REVERB>ROOM2	83 LARGE CHAMBER	<REVERB>HALL2
34 LARGE REFLECT ROOM	<REVERB>ROOM2	84 SMALL CHAMBER	<REVERB>HALL2
35 VOCAL ROOM	<REVERB>ROOM1	85 JAZZ CHAMBER	<REVERB>ROOM1
36 BRASS ROOM	<REVERB>GARAGE	86 BIG CHAMBER	<REVERB>HALL2
37 DRUM ROOM	<REVERB>ROOM1	87 CLASSICAL #1	<REVERB>ROOM1
38 WOOD ROOM	<REVERB>HALL1	88 CLASSICAL #2	<REVERB>ROOM1
39 KITCHEN ROOM	<REVERB>ROOM2	89 GARAGE	<REVERB>GARAGE
40 DENSE ROOM	<REVERB>ROOM3	90 LARGE GARAGE	<REVERB>GARAGE
41 WARM ROOM #1	<REVERB>ROOM3	91 WAREHOUSE	<REVERB>GARAGE
42 WARM ROOM #2	<REVERB>ROOM2	92 BOOMY WAREHOUSE	<REVERB>GARAGE
43 SMALL ROOM #1	<REVERB>ROOM2	93 MEDIUM GYM	<REVERB>ROOM1
44 SMALL ROOM #2	<REVERB>ROOM3	94 SMALL GYM	<REVERB>ROOM3
45 SHORT SMALL ROOM	<REVERB>GARAGE	95 BIG GYM	<REVERB>ROOM1
46 DISTANCE ROOM	<REVERB>ROOM3	96 MUSIC CLUB	<REVERB>HALL2
47 GOODBY ROOM	<REVERB>ROOM2	97 LIVE HOUSE	<REVERB>ROOM3
48 BATHROOM	<REVERB>GARAGE	98 NIGHT CLUB	<REVERB>HALL2
49 SMALL BATHROOM	<REVERB>GARAGE	99 DISCO	<REVERB>ROOM3
50 BIG BATHROOM	<REVERB>GARAGE	100 STUDIO #1	<REVERB>HALL1

For Nordic Countries

Apparatus containing Lithium batteries

ADVARSEL!

Lithiumbatteri - Eksplosjonsfare ved feilagtig håndtering.
Udskiftning må kun ske med batteri af samme fabrikat og type.
Levér det brugte batteri tilbage til leverandøren.

VARNING!

Explosionsfara vid felaktigt batteribyte.
Använd samma batterityp eller en ekvivalent typ som rekommenderas av apparattillverkaren.
Kassera använt batteri enligt fabrikantens instruktion.

ADVARSEL!

Lithiumbatteri - Eksplosjonsfare.
Ved utskifting benyttes kun batteri som anbefalt av apparatfabrikanten.
Brukt batteri returneres apparatleverandøren.

VAROITUS!

Paristo voi räjähtää, jos se on virheellisesti asennettu.
Vaihda paristo ainoastaan laitevalmistajan suosittelemaan tyyppiin. Hävitä käytetty paristo valmistajan ohjeiden mukaisesti.

For Germany

Bescheinigung des Herstellers/Importeurs

Hiermit wird bescheinigt, daß der/die/das

DIGITAL STEREO REVERB RV-70

(Gerät, Typ, Bezeichnung)

in Übereinstimmung mit den Bestimmungen der BMPT-A AmtsbVfg 243/1991 funk-entstört ist. Der vorschriftsmäßige Betrieb mancher Geräte (z. B. Meßsender) kann allerdings gewissen Einschränkungen unterliegen. Beachten Sie deshalb die Hinweise in der Bedienungsanleitung.

Dem Zentralamt für Zulassungen im Fernmeldewesen wurde das Inverkehrbringen dieses Gerätes angezeigt und die Berechtigung zur Überprüfung der Serie auf die Einhaltung der Bestimmungen eingeräumt.

Roland Corporation

4-16 Dojimahama 1-Chome Kita-ku Osaka 530 Japan

(Name und Anschrift des Herstellers/Importeurs)

For the USA

FEDERAL COMMUNICATIONS COMMISSION RADIO FREQUENCY INTERFERENCE STATEMENT

This equipment has been tested and found to comply with the limits for a Class B digital device, pursuant to Part 15 of the FCC Rules. These limits are designed to provide reasonable protection against harmful interference in a residential installation. This equipment generates, uses, and can radiate radio frequency energy and, if not installed and used in accordance with the instructions, may cause harmful interference to radio communications. However, there is no guarantee that interference will not occur in a particular installation. If this equipment does cause harmful interference to radio or television reception, which can be determined by turning the equipment off and on, the user is encouraged to try to correct the interference by one or more of the following measures:

- Reorient or relocate the receiving antenna.
- Increase the separation between the equipment and receiver.
- Connect the equipment into an outlet on a circuit different from that to which the receiver is connected.
- Consult the dealer or an experienced radio/TV technician for help.

Unauthorized changes or modification to this system can void the users authority to operate this equipment.
This equipment requires shielded interface cables in order to meet FCC class B Limit.

For Canada

CLASS B

NOTICE

This digital apparatus does not exceed the Class B limits for radio noise emissions set out in the Radio Interference Regulations of the Canadian Department of Communications.

CLASS B

AVIS

Cet appareil numérique ne dépasse pas les limites de la classe B au niveau des émissions de bruits radioélectriques fixés dans le Règlement des signaux parasites par le ministère canadien des Communications.

 Roland®

70349834

UPC 70349834



18981

RV-70

 **BOSS**