





RP101

Roland Digital Piano
Owner's Manual

Roland®

WARNING: To reduce the risk of fire or electric shock, do not expose this apparatus to rain or moisture.

	CAUTION RISK OF ELECTRIC SHOCK DO NOT OPEN	
ATTENTION: RISQUE DE CHOC ELECTRIQUE NE PAS OUVRIR		
CAUTION: TO REDUCE THE RISK OF ELECTRIC SHOCK, DO NOT REMOVE COVER (OR BACK). NO USER-SERVICEABLE PARTS INSIDE. REFER SERVICING TO QUALIFIED SERVICE PERSONNEL.		



The lightning flash with arrowhead symbol, within an equilateral triangle, is intended to alert the user to the presence of uninsulated "dangerous voltage" within the product's enclosure that may be of sufficient magnitude to constitute a risk of electric shock to persons.



The exclamation point within an equilateral triangle is intended to alert the user to the presence of important operating and maintenance (servicing) instructions in the literature accompanying the product.

INSTRUCTIONS PERTAINING TO A RISK OF FIRE, ELECTRIC SHOCK, OR INJURY TO PERSONS.

IMPORTANT SAFETY INSTRUCTIONS SAVE THESE INSTRUCTIONS

WARNING - When using electric products, basic precautions should always be followed, including the following:

1. Read these instructions.
2. Keep these instructions.
3. Heed all warnings.
4. Follow all instructions.
5. Do not use this apparatus near water.
6. Clean only with a dry cloth.
7. Do not block any of the ventilation openings. Install in accordance with the manufacturers instructions.
8. Do not install near any heat sources such as radiators, heat registers, stoves, or other apparatus (including amplifiers) that produce heat.
9. Do not defeat the safety purpose of the polarized or grounding-type plug. A polarized plug has two blades with one wider than the other. A grounding type plug has two blades and a third grounding prong. The wide blade or the third prong are provided for your safety. If the provided plug does not fit into your outlet, consult an electrician for replacement of the obsolete outlet.
10. Protect the power cord from being walked on or pinched particularly at plugs, convenience receptacles, and the point where they exit from the apparatus.
11. Only use attachments/accessories specified by the manufacturer.
12. Use only with the cart, stand, tripod, bracket, or table specified by the manufacturer, or sold with the apparatus. When a cart is used, use caution when moving the cart/apparatus combination to avoid injury from tip-over.
13. Unplug this apparatus during lightning storms or when unused for long periods of time.
14. Refer all servicing to qualified service personnel. Servicing is required when the apparatus has been damaged in any way, such as power-supply cord or plug is damaged, liquid has been spilled or objects have fallen into the apparatus, the apparatus has been exposed to rain or moisture, does not operate normally, or has been dropped.



For the U.K.

IMPORTANT: THE WIRES IN THIS MAINS LEAD ARE COLOURED IN ACCORDANCE WITH THE FOLLOWING CODE.

BLUE: NEUTRAL
BROWN: LIVE

As the colours of the wires in the mains lead of this apparatus may not correspond with the coloured markings identifying the terminals in your plug, proceed as follows:
The wire which is coloured BLUE must be connected to the terminal which is marked with the letter N or coloured BLACK.
The wire which is coloured BROWN must be connected to the terminal which is marked with the letter L or coloured RED.
Under no circumstances must either of the above wires be connected to the earth terminal of a three pin plug.



Before using this unit, carefully read the sections entitled: "IMPORTANT SAFETY INSTRUCTIONS," "USING THE UNIT SAFELY" (p. 4), and "Important Notes" (p. 7). These sections provide important information concerning the proper operation of the unit. Additionally, in order to feel assured that you have gained a good grasp of every feature provided by your new unit, owner's manual should be read in its entirety. The manual should be saved and kept on hand as a convenient reference.



Copyright © 2007 ROLAND CORPORATION

All rights reserved. No part of this publication may be reproduced in any form without the written permission of ROLAND CORPORATION.







USING THE UNIT SAFELY

INSTRUCTIONS FOR THE PREVENTION OF FIRE, ELECTRIC SHOCK, OR INJURY TO PERSONS

About  WARNING and  CAUTION Notices

 WARNING	Used for instructions intended to alert the user to the risk of death or severe injury should the unit be used improperly.
 CAUTION	Used for instructions intended to alert the user to the risk of injury or material damage should the unit be used improperly. * Material damage refers to damage or other adverse effects caused with respect to the home and all its furnishings, as well to domestic animals or pets.

About the Symbols

	The  symbol alerts the user to important instructions or warnings. The specific meaning of the symbol is determined by the design contained within the triangle. In the case of the symbol at left, it is used for general cautions, warnings, or alerts to danger.
	The  symbol alerts the user to items that must never be carried out (are forbidden). The specific thing that must not be done is indicated by the design contained within the circle. In the case of the symbol at left, it means that the unit must never be disassembled.
	The  symbol alerts the user to things that must be carried out. The specific thing that must be done is indicated by the design contained within the circle. In the case of the symbol at left, it means that the power-cord plug must be unplugged from the outlet.

ALWAYS OBSERVE THE FOLLOWING

WARNING

Do not disassemble or modify

Do not disassemble or modify this device.





Do not repair or replace parts

Never attempt to repair this device or replace parts. If repair or part replacement should become necessary, you must contact your dealer or a Roland service center.



Do not use or store in the following types of locations

- Locations of extremely high temperature (such as in direct sunlight, near heating equipment, or on a device that generates heat) 
- Near moisture (such as in a bathroom, near a sink, or on a wet floor) or in locations of high humidity 
- Locations exposed to rain
- Locations of excessive dust
- Locations subject to heavy vibration

Do not place in an unstable location

Do not place this device on an unstable stand or a tilted surface. You must place it in a stable and level location. 

Connect the power cord to an outlet of the correct voltage

You must connect the power cord to an AC outlet of the correct voltage as marked on the device. 

WARNING

Use only the included power cord

You must use only the power cord included with the device. Do not use the included power cord with any other device. 

Do not bend the power cord or place heavy objects on it

Do not bend the power cord excessively, or place heavy objects on the power cord. Doing so will damage the power cord, and may cause short circuits or faulty connections, possibly resulting in fire or electrical shock. 

Do not share an outlet with an unreasonable number of other devices

Do not connect excessive numbers of electrical devices to a single power outlet. In particular, when using a power strip, exceeding the rated capacity (watts/amps) of the power strip may cause heat to be generated, possibly melting the cable. 

Avoid extended use at high volume

This device, either by itself or used in conjunction with headphones, amps, and/or speakers, is capable of producing volume levels that can cause permanent hearing damage. If you experience impaired hearing or ringing in your ears, immediately stop using the device and consult a medical specialist. 

⚠ WARNING

Do not insert foreign objects

Never allow foreign objects (flammable objects, coins, wires, etc.) to enter this device. This can cause short circuits or other malfunctions.



Turn off the power if an abnormality or malfunction occurs

If any of the following should occur, immediately turn off the power, disconnect the power cord from the AC outlet, and contact your dealer or a service center to have the device serviced.



- The power cord is damaged
- The device produces smoke or an unusual smell
- A foreign object enters the device, or liquid spills into the device
- The device becomes wet (by rain, etc.)
- An abnormality or malfunction occurs in the device

Do not allow children to use without supervision

In households with children, take particular care against tampering. If children are to use this device, they must be supervised or guided by an adult.



Do not drop or subject to strong impact

Do not drop this device or subject it to strong impact.



Do not use overseas

If you wish to use this device overseas, please contact your dealer or a service center.



Do not place containers of water on the device

Do not place containers of water (such as a flower vase) or drinks on the device. Nor should you place containers of insecticide, perfume, alcoholic liquids, nail polish, or spray cans on the device. Liquids that spill into the device may cause it to malfunction, and may cause short circuits or faulty operation.



⚠ CAUTION

Place in a well ventilated location

When using this device, ensure that it is placed in a well ventilated location.



Grasp the plug when connecting or disconnecting the power cord

When connecting or disconnecting the power cord to/from an AC outlet or the device itself, you must grasp the plug, not the cord.



Periodically wipe the dust off the power cord plug

From time to time, you should unplug the power cord from the AC outlet and use a dry cloth to wipe the dust off of it. You should also unplug the power cord from the AC outlet if you will not be using the device for an extended period of time. Dust or dirt that accumulates between the power cord plug and the AC outlet can cause a short circuit, possibly resulting in fire.



Manage cables for safety

Ensure that the connected cables are organized and managed in a safe manner. In particular, place the cables out of reach of children.



Do not stand or place heavy objects on this device

Do not stand on this device, or place heavy objects on it.



Do not connect or disconnect the power cord with wet hands

Do not connect or disconnect the power cord to the device or AC outlet while holding the power cord plug with wet hands.



Cautions when moving this device

When moving this device, please check the following cautions. Then, make sure that at least two persons work together in lifting and carrying the device, all the while making sure to keep it level. When doing so, be careful not to pinch your hands or drop the device on your feet.



- Check whether the screws fastening the device to its stand have become loose. If they are loose, tighten them firmly.
- Disconnect the power cord.
- Disconnect external devices.
- Raise the adjuster of the stand (p. 15).
- Close the lid.
- Remove the music rest.

USING THE UNIT SAFELY

CAUTION

Unplug the power cord from the AC outlet before cleaning

Before you clean the device, turn off the power and unplug the power cord from the AC outlet (p. 12).



If there is a possibility of lightning strike, disconnect the power cord from the AC outlet

If there is a possibility of lightning strike, immediately turn off the power and disconnect the power cord from the AC outlet.



Cautions when opening/closing the lid

Be careful when opening/closing the lid so you do not get your fingers pinched (p. 12). Adult supervision is recommended whenever small children use the unit.



Keep small items out of the reach of children

To prevent small items such as the following from being swallowed accidentally, keep them out of the reach of children.



- Included items
 - Screws for assembling the stand
 - Wing nut for headphone hook
 - Removed parts
 - Music rest attachment screws
-

Important Notes

In addition to the items listed under "IMPORTANT SAFETY INSTRUCTIONS" and "USING THE UNIT SAFELY" on pages 3 and 4–6, please read and observe the following:

Power Supply

- Do not connect this unit to same electrical outlet that is being used by an electrical appliance that is controlled by an inverter (such as a refrigerator, washing machine, microwave oven, or air conditioner), or that contains a motor. Depending on the way in which the electrical appliance is used, power supply noise may cause this unit to malfunction or may produce audible noise. If it is not practical to use a separate electrical outlet, connect a power supply noise filter between this unit and the electrical outlet.
- Before connecting this unit to other devices, turn off the power to all units. This will help prevent malfunctions and/or damage to speakers or other devices.
- Although the LEDs are switched off when the POWER switch is switched off, this does not mean that the unit has been completely disconnected from the source of power. If you need to turn off the power completely, first turn off the POWER switch, then unplug the power cord from the power outlet. For this reason, the outlet into which you choose to connect the power cord's plug should be one that is within easy reach and readily accessible.

Placement

- Using the unit near power amplifiers (or other equipment containing large power transformers) may induce hum. To alleviate the problem, change the orientation of this unit; or move it farther away from the source of interference.
- This device may interfere with radio and television reception. Do not use this device in the vicinity of such receivers.
- Noise may be produced if wireless communications devices, such as cell phones, are operated in the vicinity of this unit. Such noise could occur when receiving or initiating a call, or while conversing. Should you experience such problems, you should relocate such wireless devices so they are at a greater distance from this unit, or switch them off.
- Do not expose the unit to direct sunlight, place it near devices that radiate heat, leave it inside an enclosed vehicle, or otherwise subject it to temperature extremes. Also, do not allow lighting devices that normally are used while their light source is very close to the unit (such as a piano light), or powerful spotlights to shine upon the same area of the unit for extended periods of time. Excessive heat can deform or discolor the unit.

- When moved from one location to another where the temperature and/or humidity is very different, water droplets (condensation) may form inside the unit. Damage or malfunction may result if you attempt to use the unit in this condition. Therefore, before using the unit, you must allow it to stand for several hours, until the condensation has completely evaporated.
- Do not allow rubber, vinyl, or similar materials to remain on the unit for long periods of time. Such objects can discolor or otherwise harmfully affect the finish.
- Do not allow objects to remain on top of the keyboard. This can be the cause of malfunction, such as keys ceasing to produce sound.
- Do not paste stickers, decals, or the like to this instrument. Peeling such matter off the instrument may damage the exterior finish.

Maintenance

- To clean the unit, use a dry, soft cloth; or one that is slightly dampened. Try to wipe the entire surface using an equal amount of strength, moving the cloth along with the grain of the wood. Rubbing too hard in the same area can damage the finish.
- If water droplets should adhere to this device, immediately wipe them off using a soft dry cloth.
- Never use benzine, thinners, alcohol or solvents of any kind, to avoid the possibility of discoloration and/or deformation.
- The pedals of this unit are made of brass. Brass eventually darkens as the result of the natural oxidization process. If the brass becomes tarnished, polish it using commercially available metal polisher.

Repairs and Data

- Please be aware that all data contained in the unit's memory may be lost when the unit is sent for repairs. Important data should always be backed up in another MIDI device (e.g., a sequencer), or written down on paper (when possible). During repairs, due care is taken to avoid the loss of data. However, in certain cases (such as when circuitry related to memory itself is out of order), we regret that it may not be possible to restore the data, and Roland assumes no liability concerning such loss of data.

Important Notes

Additional Precautions

- Please be aware that the contents of memory can be irretrievably lost as a result of a malfunction, or the improper operation of the unit. To protect yourself against the risk of losing important data, we recommend that you periodically save a backup copy of important data you have stored in the unit's memory in another MIDI device (e.g., a sequencer).
- Unfortunately, it may be impossible to restore the contents of data that was stored in the unit's memory once it has been lost. Roland Corporation assumes no liability concerning such loss of data.
- Use a reasonable amount of care when using the unit's buttons, knobs, or other controls; and when using its jacks and connectors. Rough handling can lead to malfunctions.
- When connecting / disconnecting all cables, grasp the connector itself—never pull on the cable. This way you will avoid causing shorts, or damage to the cable's internal elements.
- A small amount of heat will radiate from the unit during normal operation.
- To avoid disturbing your neighbors, try to keep the unit's volume at reasonable levels. You may prefer to use headphones, so you do not need to be concerned about those around you (especially when it is late at night).
- When you need to transport the unit, pack it in shock-absorbent material. Transporting the unit without doing so can cause it to become scratched or damaged, and could lead to malfunction.
- Do not apply undue force to the music rest while it is in use.
- Some connection cables contain resistors. Do not use cables that incorporate resistors for connecting to this unit. The use of such cables can cause the sound level to be extremely low, or impossible to hear. For information on cable specifications, contact the manufacturer of the cable.
- Before opening or closing the keyboard lid, always make sure that no pets or other small animals are located on top of the instrument (in particular, they should be kept away from the keyboard and its lid). Otherwise, due to the structural design of this instrument, small pets or other animals could end up getting trapped inside it. If such a situation is encountered, you must immediately switch off the power and disconnect the power cord from the outlet. You should then consult with the retailer from whom the instrument was purchased, or contact the nearest Roland Service Center.

Contents

USING THE UNIT SAFELY	4	Changing Various Settings	32
Important Notes	7	Tuning to Other Instruments' Pitches (Master Tuning)	32
Main Features	10	Lowering/Raising the Standard Pitch	32
Panel Descriptions	11	Setting the Standard Pitch to 440.0 Hz	32
Control Panel	11	Setting the Standard Pitch to 442.0 Hz	32
Rear Panel	11	Changing the Temperament	33
Before You Start Playing	12	Setting the Tonic	33
Connecting the Pedal Cord	12	Changing the Damper Pedal's Resonance	
Connecting the Power Cord	12	(Damper Resonance)	34
Opening/Closing the Lid	12	Setting the Tuning Curve (Stretch Tuning)	34
Setting Up the Music Rest	12	Disabling Everything Except Piano Play (Panel Lock)	35
Connecting Headphones	13	Using the V-LINK function	35
Using the Headphone Hook	13	Remembering the Settings Even when the Power is	
Turning the Power On and Off	14	Turned Off (Memory Backup)	36
Adjusting the Sound's Volume	14	Restoring the Original Default Settings (Factory Reset) ..	36
About the Pedals	14	Connecting External Devices	37
About the Adjuster	15	Connecting to Audio Equipment	37
Enjoying the Internal Songs	16	Connecting MIDI Devices	38
Performance	17	What's MIDI?	38
Performing with a Variety of Sounds	17	MIDI Send Channel Settings	38
Playing Two Sounds Together (Dual Play)	18	Switching Local Control On and Off	39
Adjusting the Volume Balance in Dual Play		Sending Recorded Performance Data to a MIDI	
(Dual Balance)	19	Device (Composer Out)	40
Changing the Brightness of the Sound (Brilliance)	20	Connecting to a Computer	40
Adding Reverberation to the Sound (Reverb)	21	Appendices	41
Changing the Depth of the Reverb Effect	21	Troubleshooting	41
Adjusting the Keyboard Touch (Key Touch)	22	Tone List	42
Transposing the Key of the Keyboard (Transpose)	23	Internal Song List	43
Splitting the Keyboard Into Two Sections for Four-Hand		Easy Operation List	44
Performances (Twin Piano)	24	MIDI Implementation Chart	46
Changing the Way in Which the Sound is Heard		Main Specifications	47
(Twin Piano Mode)	25	Index	48
Using Metronome	26		
Sounding the Metronome	26		
Changing the Beat of Metronome	26		
Changing the Metronome Volume	27		
Changing the Metronome Tempo	27		
Recording Your Performance	30		
Recording	30		
Playing Back the Recorded Performance	31		
Erasing Recorded Performances	31		

Main Features

Thank you, and congratulations on your choice of the Roland Digital Piano RP101.

To ensure that you obtain the maximum enjoyment and take full advantage of the RP101's functionality, please read this owner's manual carefully.

Piano Sounds with Rich Resonance and Wide Expressive Range

- This instrument features a piano sound generator that utilizes stereo sampling, so it is capable of faithfully recreating the sound of a high-quality concert grand piano, realistically reproducing even the finest details, including the sound of the hammers striking the strings. With a maximum polyphony of 64 notes, it has ample capability even for performances that make full use of pedaling.

The Playing Feel of a Grand Piano

- The PHA alpha II keyboard gives you a weighty playing feel in the low register while becoming lighter in the high register, replicating the authentic feel of a piano.
- The pedal position is detected smoothly, allowing you to vary the effect by the changing the depth to which you press the pedal. You can take advantage of the way in which subtle differences in pedaling will affect the sound.

A Compact Cabinet that Fits Anywhere

- The newly designed cabinet projects a sense of elegant craftsmanship. It can be placed nearly anywhere, and does not occupy excessive space.
- In addition to a sliding keyboard lid that stores inside the instrument, there's a headphone hook for conveniently storing your headphones when not using them.

Functionality to Assist Your Practicing

- With metronome and recorder functions, as well as 65 built-in songs, you can experience the kind of piano lessons that are possible only with digital pianos.

Panel Descriptions

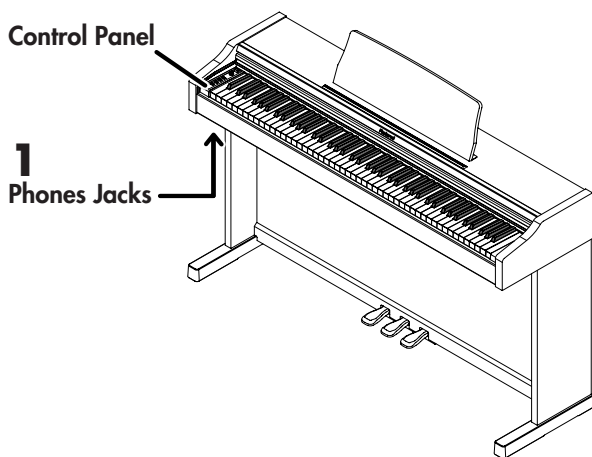

- 1 Phones Jacks**
You can connect headphones to these jacks (p. 13).
- 2 Pedal Connector**
Connect the pedal cord to this connector (p. 12).

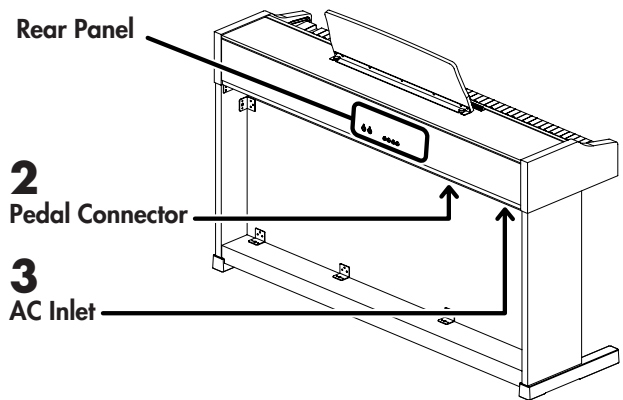

- 3 AC Inlet**
Connect the supplied power cord here (p. 12).

Control Panel

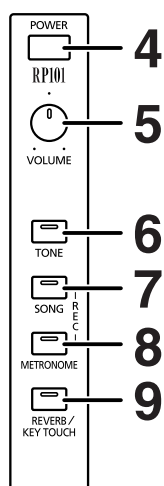

- 4 [POWER] Switch**
Turns the power on/off (p. 14).
- 5 [VOLUME] Knob**
Adjusts the overall volume level (p. 14).
- 6 [TONE] Button**
Used to choose the tone played by the keyboard (p. 17).
- 7 [SONG] Button**
Plays the internal songs (p. 16) or the song you recorded (p. 31). If you simultaneously press the [SONG] button and [METRONOME] button, you'll enter recording-standby mode (p. 30).
- 8 [METRONOME] Button**
Turns the metronome on/off (p. 26).
- 9 [REVERB/KEY TOUCH] Button**
Adds reverberation to the sound (p. 21).
Modifies the playing feel of the keyboard (p. 22).

Rear Panel

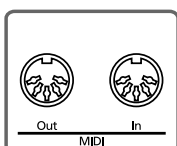

10

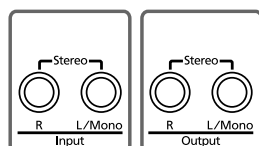

11

12

- 10 MIDI Out/In Connectors**
Connect to external MIDI devices to exchange performance data (p. 38).
- 11 Input Jacks**
These jacks can be connected to another sound generating device or an audio device, so that the sound of that device will be output from the RP101's speakers (p. 37).

- 12 Output Jacks**
Allows you to output the piano's sound to sound reinforcement equipment to obtain a more powerful sound. These can also be connected to a tape recorder or other recording device to record a performance (p. 37).

Before You Start Playing

Connecting the Pedal Cord

1. Connect the pedal cord to the Pedal connector on the bottom panel of the RP101, at the rear.

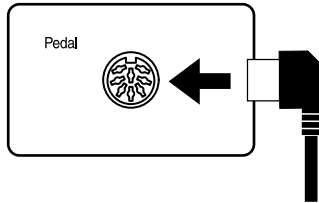

Connecting the Power Cord

1. Insert the included power cord into the AC inlet on the bottom panel of the RP101, at the rear.
2. Plug the power cord into a power outlet.

NOTE

Be sure to use the supplied power cord.

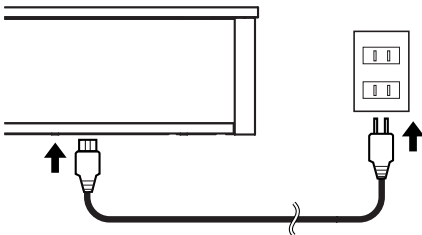

Opening/Closing the Lid

To open the lid, use both hands to lift it lightly, and slide it away from yourself.

To close the lid, pull it gently toward yourself, and lower it softly after it has been fully extended.

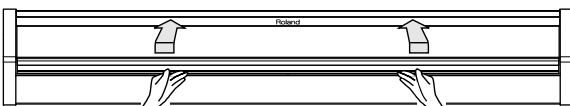

NOTE

When opening and closing the lid, be careful not to let your fingers get caught. If small children will be using the RP101, adult supervision should be provided.

NOTE

If you need to move the piano, make sure the lid is closed first to prevent accidents.

Setting Up the Music Rest

1. Insert the included music rest attachment screws into the screw holes on top of the RP101, and tighten the screws slightly (in two places).

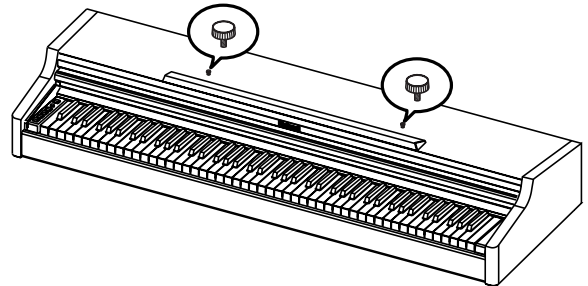

2. Put the music rest between the screws and the RP101's body.

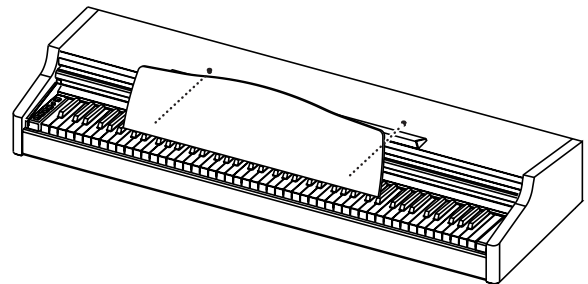

3. While supporting the music rest with one hand, secure it in place by turning the screws.

When attaching the music rest, support it firmly with one hand to make sure that you don't drop it. Be careful, so you don't get your fingers pinched.

4. To remove the music rest, support it with one hand while loosening the screws.

After removing the music rest, don't forget to retighten the screws.

NOTE

Do not apply excessive force to the installed music rest.

NOTE

Be sure to use the supplied screws for attaching the music rest.

NOTE

Before moving the RP101, be sure to remove the music rest to prevent accidents.

Connecting Headphones

The RP101 has two jacks for plugging in headphones. This allows two people to listen through headphones simultaneously, making it very useful for lessons and when performing piano pieces for four hands. Additionally, this allows you to play without having to worry about bothering others around you, even at night.

1. Plug the headphones into the Phones jack located at the bottom left of the piano.

Connecting headphones will automatically mute the sound from the internal speakers. The headphone volume is adjusted by the [VOLUME] knob of the RP101 (p. 14).

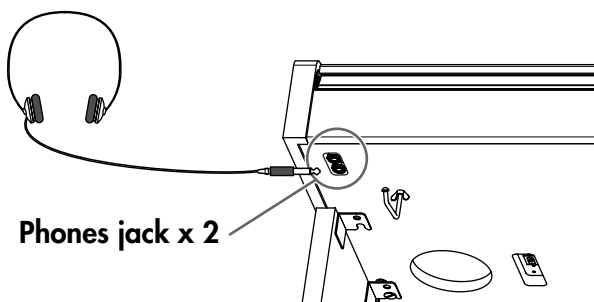

NOTE

Use Stereo headphones.

Some notes on using headphones

- To prevent damage to the cord, handle the headphones only by the headset or the plug.
- Connecting the headphones when the volume of connected equipment is turned up may result in damage to the headphones. Lower the volume on the RP101 before plugging in the headphones.
- Listening at excessively high volume levels will not only damage the headphones, but may also cause hearing loss. Use the headphones at a moderate volume level.

Using the Headphone Hook

Whenever you are not using the headphones, you can hang them on the headphone hook at the lower left of the RP101.

Attaching the Headphone Hook

Press and twist the headphone hook included with the RP101 into the hole in the bottom of the RP101 (refer to the figure below). Turn the wing nut of headphone hook to secure the headphone hook.



Before You Start Playing

Turning the Power On and Off

NOTE

Once the connections have been completed, turn on power to your various devices in the order specified. By turning on devices in the wrong order, you risk causing malfunction and/or damage to speakers and other devices.

1. To turn the power on, turn the [VOLUME] knob all the way down, and then press the [POWER] switch.

The power will turn on, and the indicator of the [TONE] button will light.

After a few seconds, you will be able to play the keyboard to produce sound.

Use the [VOLUME] knob to adjust the volume.

NOTE

This unit is equipped with a protection circuit. A brief interval (a few seconds) after power up is required before the unit will operate normally.

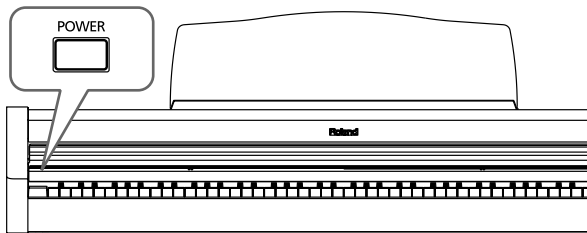

Turning the Power Off

1. To turn the power off, turn the [VOLUME] knob all the way to the left, and press the [POWER] switch.

The indicators for all buttons will go out, and the power will turn off.

NOTE

If you need to turn off the power completely, first turn off the [POWER] switch, then unplug the power cord from the power outlet. Refer to "Power Supply" (p. 7).

Adjusting the Sound's Volume

1. Turn the [VOLUME] knob to adjust the overall volume.

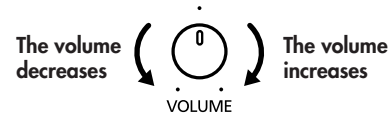

About the Pedals

The pedals perform the following operations. You'll use them mainly when playing piano.

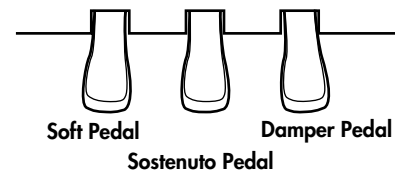

Damper Pedal (right pedal)

While this pedal is held down, notes will be sustained for an extended time even if you release your fingers from the keyboard.

On an acoustic piano, holding down the damper pedal will cause the strings for notes other than the ones you actually play to vibrate in sympathy with what you've played, producing a rich resonance. The RP101 simulates this sympathetic vibration (damper resonance).

NOTE

You can change the amount of resonance applied with the damper pedal. Refer to "Changing the Damper Pedal's Resonance (Damper Resonance)" (p. 34).

Sostenuto Pedal (center pedal)

This pedal sustains only the sounds of the keys that were already played when you pressed the pedal.

Soft Pedal (left pedal)

This pedal is used to make the sound softer.

About the Adjuster

If you feel that the pedal is unstable (for example if you've moved the RP101 to a different location), you can adjust the adjuster located on the bottom of the pedals as follows.

- Turn the adjuster to lower it until the adjuster is in firm contact with the floor. The pedal may be damaged if there is a gap between the adjuster and the floor. In particular, when you've placed the RP101 on carpet, you must turn the adjuster until it is pressing firmly against the floor.

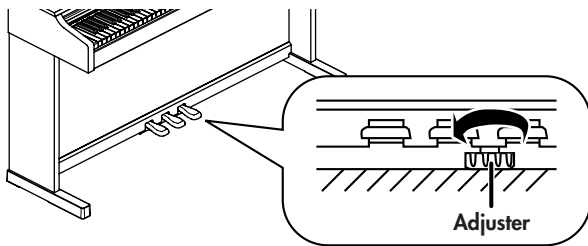

MEMO

If the adjuster is difficult to turn, have one person lift either the left or right side of the stand to make it easier for another person to turn the adjuster and make the adjustment.

NOTE

After adjusting the adjuster, press the pedals, and if the front board moves, turn the adjuster further so that it makes firm contact with the floor.

NOTE

Always readjust the adjuster after moving the piano.

Enjoying the Internal Songs

The RP101 comes with 65 piano songs onboard.

The songs are played back continuously in sequence.

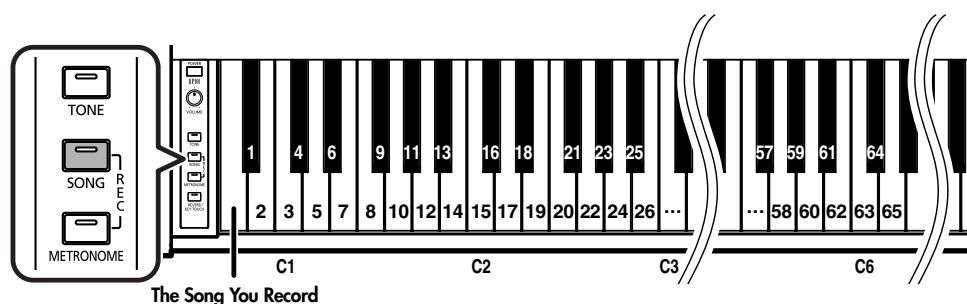

1. While holding down the [SONG] button, press the key that corresponds to the song you wish to hear.

The built-in songs are assigned consecutively, starting with the B \flat 0 key.

* The song you record (p. 30) is assigned to the leftmost key (A0) of the keyboard.

The song will begin playing when you press the key. When the selected song has finished playing, the next song will begin playing.

When the last song has finished playing, playback will begin again from the first song. However, if you've recorded a song, that song will play before the first built-in song begins playing.

Stopping the playback

2. Press the [SONG] button, getting the button to go dark.

Playback will stop.

The next time you press the [SONG] button, the song you selected most recently by pressing a key will play.

- You can change the tempo of the song while it plays. The procedure is the same as in "Changing the Metronome Tempo" (p. 27).
- You can make the metronome (p. 26) sound while the song plays.
- If you turn on the metronome and then play back a song, a count will be sounded before the song begins playing. A count will be sounded again before playback continues to the next song.



For more details, refer to "Internal Song List" (p. 43).



When you play back an internal song, the reverb effect will automatically be turned on (the button's indicator lights).



You can also play back a song by simply pressing the [SONG] button. In this case, playback will begin with the song you selected most recently by pressing a key.



If there is a song you've recorded, the [TONE] button's indicator will blink while you hold down the [SONG] button.



If there's no song that you've recorded, the first of the built-in songs will play when you press the [SONG] button and then the A0 key.

Performance

Performing with a Variety of Sounds

The RP101 contains 17 different internal tones.

You can also select a tone by pressing the [TONE] button and a key to which a tone is assigned.

The “Grand Piano” tone is selected when the instrument is turned on.

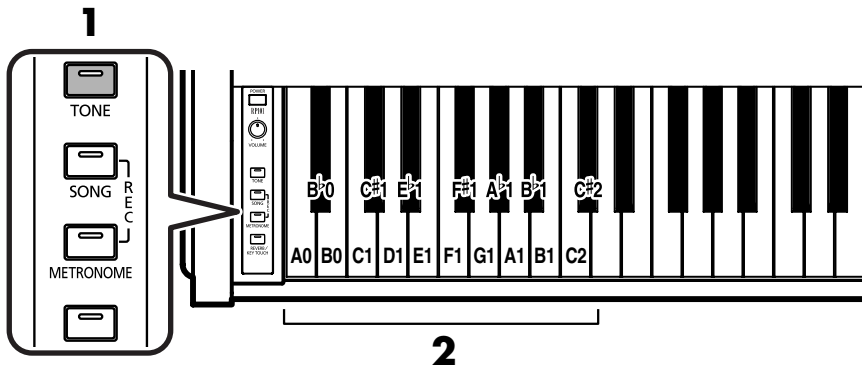

1. Press the [TONE] button.

The button’s indicator will blink.

2. Press a key to which a tone is assigned.

The [TONE] button’s indicator will change from blinking to lit.

Keys to which tones are assigned: A0–C♯2 keys

The tone you’ve selected is heard when you finger the keyboard.

Tone	Key Pressed	Tone
Grand Piano	A0	
	B♭0	Slow Strings
Mellow Piano	B0	
Honky-tonk	C1	
	C♯1	Strings
Harpichord	D1	
	E♭1	Choir
Coupled Harpichord	E1	
Electric Piano1	F1	
	F♯1	Church Organ 1
Electric Piano2	G1	
	A♭1	Church Organ 2
Vibraphone	A1	
	B♭1	Organ Flute
Piano + Strings	B1	
Piano + Choir	C2	
	C♯2	Rotary Organ



For more details, refer to “Tone List” (p. 42).



You can also switch sounds by holding down the [TONE] button and pressing a key to which a sound is assigned.



While you’re selecting a sound, playing the keyboard won’t produce sound.

Playing Two Sounds Together (Dual Play)

Simultaneously playing two tones when one key is pressed is called "Dual play."

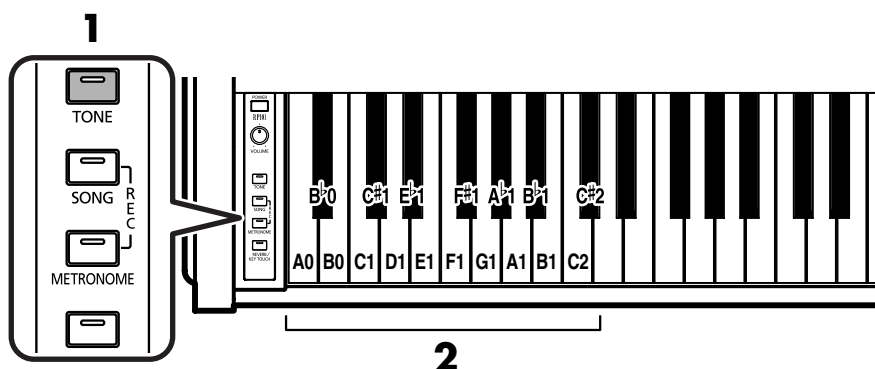

1. Press the [TONE] button.

The button's indicator will blink.

2. Simultaneously press a white key and black key to which tones are assigned.

The [TONE] button's indicator will change from blinking to lit.

The black keys are assigned to sounds that are suitable for layering with the sounds assigned to white keys.

Tone	Key Pressed	Tone
Grand Piano	A0	
	B♭0	Slow Strings
Mellow Piano	B0	
Honky-tonk	C1	
	C♯1	Strings
Harpichord	D1	
	E♭1	Choir
Coupled Harpichord	E1	
Electric Piano1	F1	
	F♯1	Church Organ 1
Electric Piano2	G1	
	A♭1	Church Organ 2
Vibraphone	A1	
	B♭1	Organ Flute
Piano + Strings	B1	
Piano + Choir	C2	
	C♯2	Rotary Organ

3. To cancel Dual play, press the [TONE] button and then press a key to which a sound is assigned.

MEMO

You can also switch sounds by holding down the [TONE] button and simultaneously pressing two keys to which sounds are assigned.

MEMO

You can also use Dual Play by combining tones that are assigned to two white keys or two black keys.

NOTE

The sounds assigned to the B1 and C2 keys are actually combinations of two sounds. The sounds assigned to these keys can't be combined with the sounds of other keys.

■ Adjusting the Volume Balance in Dual Play (Dual Balance)

You can change the volume balance between the two layered sounds in Dual play.

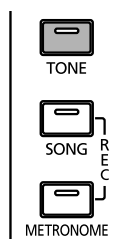

While holding down the [TONE] button...

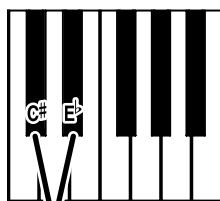

Press the "C#" or "E \flat " keys of any octave above C#3.

When using Dual play, the tones are handled as follows according to the combination of keys you pressed.

White key and black key	White key and white key, or black key and black key
White key: Tone 1	Left key: Tone 1
Black key: Tone 2	Right key: Tone 2

1. Hold down the [TONE] button and press the "C#" or "E \flat " keys of any octave above C#3.

The volume balance changes.

- Hold down the [TONE] button and press the "C#" key of any octave above C#3 to lower the volume of the Tone 2.
- Holding down the [TONE] button and pressing the "E \flat " key of any octave above C#3 raises the volume of the Tone 2.

2. To return to the original volume balance, hold down the [TONE] button and press both the "C#" and "E \flat " keys of any octave above C#3 simultaneously.



You can adjust the dual balance in 9 steps.



You can also adjust the dual balance by using the "C#" and "E \flat " keys of any octave above C#3.

Changing the Brightness of the Sound (Brilliance)

You can adjust the brightness of the sound.

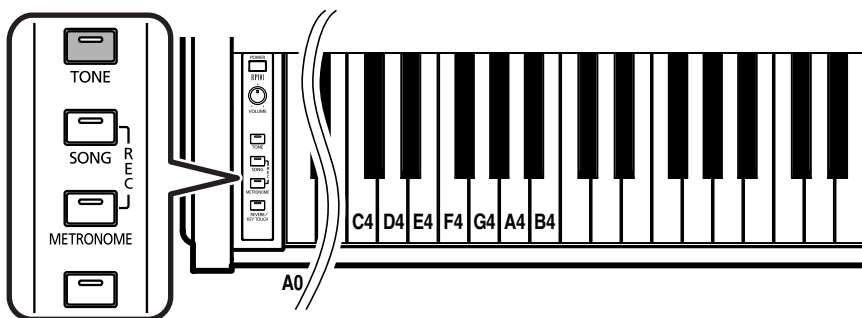

1. Hold down the [TONE] button and press one of the keys from "C4" to "B4" to adjust the brightness of the sound.

Key Pressed	Setting	Explanation
C4	-3	Mellow sound (three levels).
D4	-2	
E4	-1	
F4	0	Normal sound.
G4	+1	Bright sound (three levels).
A4	+2	
B4	+3	

MEMO

You can use the Memory Backup function to store this setting in internal memory (p. 36).

MEMO

This is set to "0" when the RP101 is shipped from the factory.

Adding Reverberation to the Sound (Reverb)

By applying the reverb effect you can produce a pleasant reverberation, making it sound as though you were performing in a concert hall.

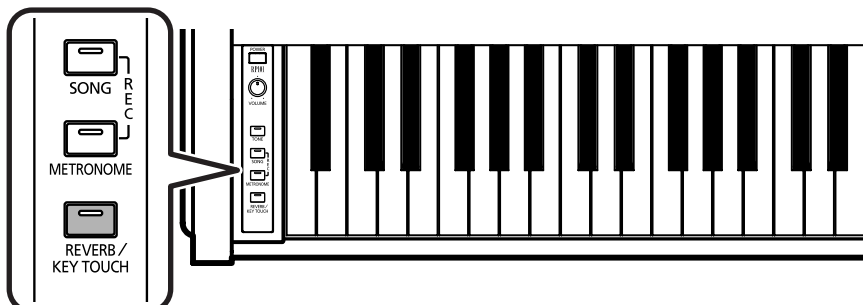

1. Press the [REVERB/KEY TOUCH] button.

The button's indicator will light, and a reverb effect will be applied to the sound.

To cancel the reverb effect, press the [REVERB/KEY TOUCH] button, getting its indicator to go dark.

■ Changing the Depth of the Reverb Effect

The amount (depth) of the reverb effect can be set to any of eight levels.

1. Hold down the [REVERB/KEY TOUCH] button and press the "C#" or "E \flat " key.

Pressing the "C#" key as you hold down the [REVERB/KEY TOUCH] button reduces the amount of reverb effect applied. Holding down the [REVERB/KEY TOUCH] button and pressing the "E \flat " key increases the reverb effect.

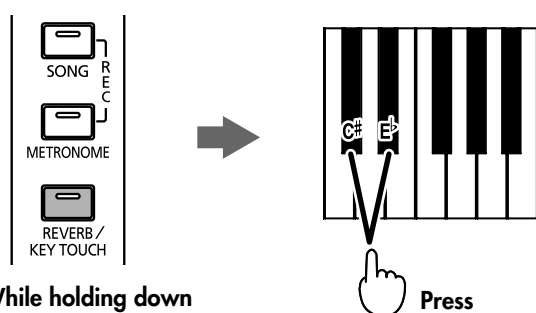

While holding down the [Reverb/Key Touch] button...

2. To restore the reverb depth to its factory-set state, hold down the [REVERB/KEY TOUCH] button and press the "C#" and "E \flat " keys simultaneously.



You can use the Memory Backup function to store this setting in internal memory (p. 36).



When you play back an internal song, the reverb effect will automatically be turned on (the button's indicator lights).



You can change the Depth of the Reverb Effect by pressing any "C#" or "E \flat " key.



This is set to "4" when the RP101 is shipped from the factory.

Adjusting the Keyboard Touch (Key Touch)

You can adjust the touch (playing feel) of the keyboard.

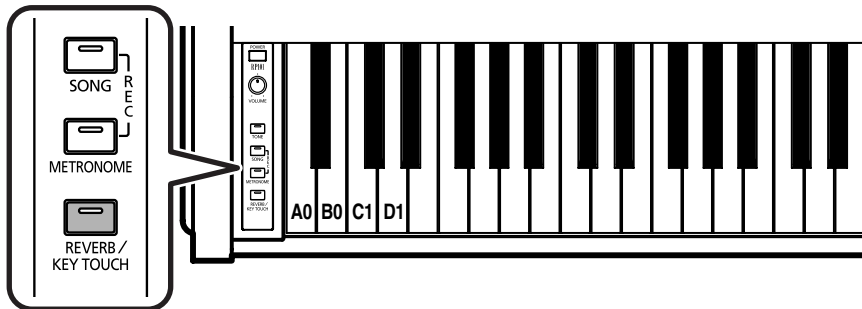

1. Hold down the [REVERB/KEY TOUCH] button and press either the "A0," "B0," "C1," or "D1" key.

The feel of the keyboard will change.

Key Pressed	Setting	Explanation
A0	Light	Fortissimo (ff) can be produced by playing less strongly than usual, making the keyboard feel lighter. This setting makes it easy to play, even for children.
B0	Medium	This allows you to play using the most natural touch. This is the closest to the touch of an acoustic piano.
C1	Heavy	Fortissimo (ff) cannot be produced unless you play more strongly than usual, making the keyboard feel heavier. Dynamic fingering adds even more feeling to what you play.
D1	Fixed	Sounds at a fixed volume, regardless of your keyboard playing strength.



You can use the Memory Backup function to store this setting in internal memory (p. 36).



This is set to "Medium" when the RP101 is shipped from the factory.

Transposing the Key of the Keyboard (Transpose)

By using the “Transpose function,” you can transpose your performance without changing the notes you play. For example, even if the song is in a difficult key with numerous sharps (\sharp) or flats (\flat), you can transpose it to a key that is easier for you to play.

When accompanying a vocalist, you can easily transpose the pitch to a range that is comfortable for the singer, while still playing the notes as written (i.e., with the same fingering positions).

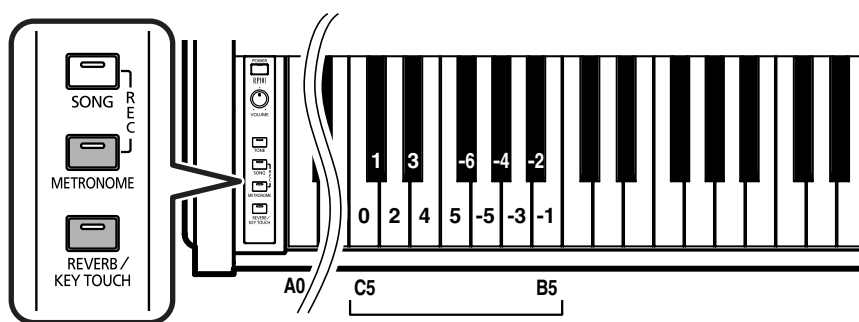

While holding down
two buttons...

Press

1. Hold down the [METRONOME] and [REVERB/KEY TOUCH] buttons, and press the key for the note you want to set as the tonic.

Keys for Setting the Transposition: C5–B5

The keyboard will be transposed.

The available range is -6–0–5 (semitone steps).

For example, if you want the E pitch to sound when you play the C key, hold down the [METRONOME] and [REVERB/KEY TOUCH] buttons and press the E5 key.

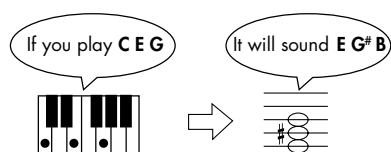

To cancel the transposition, hold down the [METRONOME] and [REVERB/KEY TOUCH] buttons and press the “C5” key (transposition 0).



This is set to “0” when the instrument is turned on.



This setting returns to the original value (0) when you turn off the power.

Splitting the Keyboard Into Two Sections for Four-Hand Performances (Twin Piano)

You can divide the keyboard into two separate sections, allowing two people to perform in the same registers.

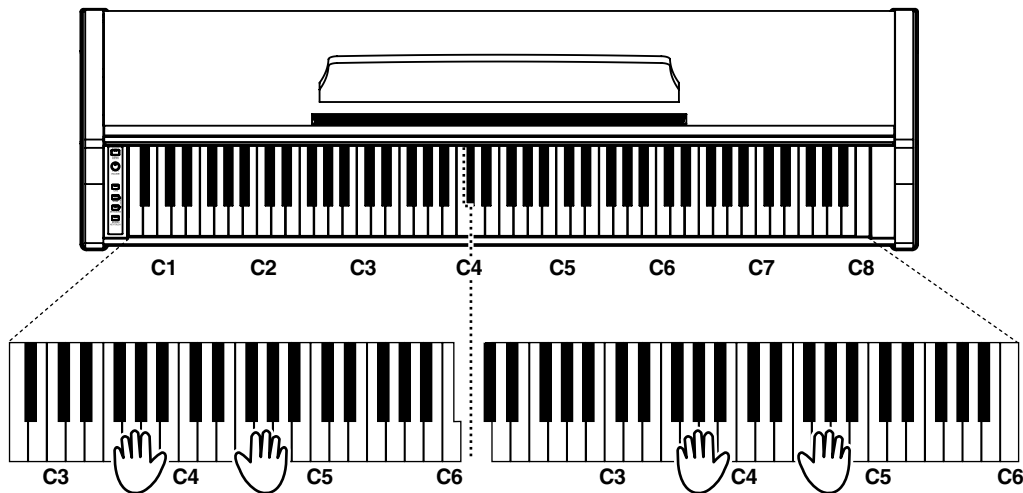

1. While holding down the [TONE] button and press the "C8" key.

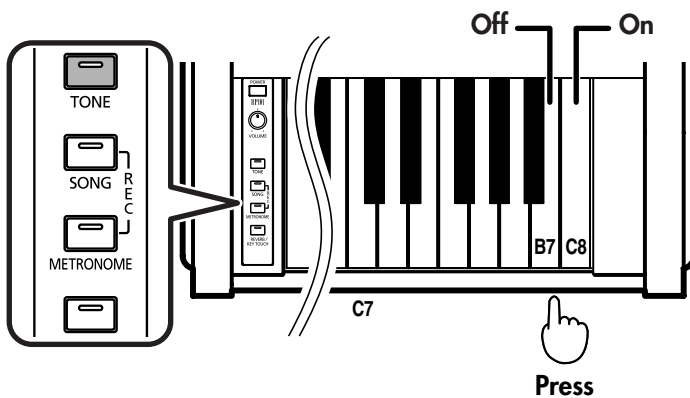

NOTE

The damper resonance function is not operational in Twin Piano Mode.

The keyboard is divided into two separate sections, and the pitch changes.

The right pedal now functions as the damper pedal for the right keyboard section, and the left pedal functions as the damper pedal for the left keyboard section.

2. To exit the function, hold down the [TONE] button and press the "B7" key.

■ Changing the Way in Which the Sound is Heard (Twin Piano Mode)

You can choose one of two ways in which the sound will be produced.

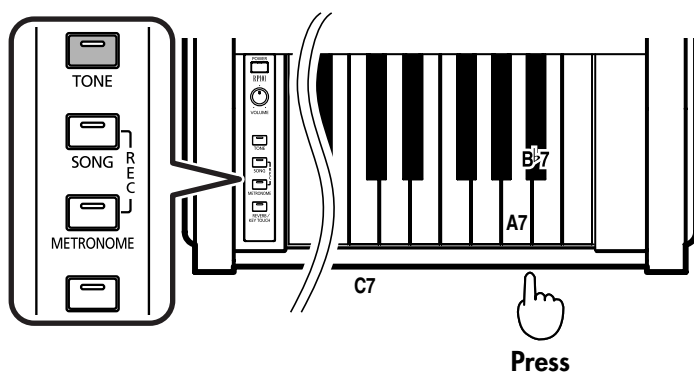

1. While holding down the [TONE] button, press the A7 or B \flat 7 key to specify how the sound is to be produced.

Key Pressed	Setting	Explanation
A7	1	Notes played in the keyboard's right zone will be heard more loudly from the right speaker than from the left speaker. Conversely, notes played in the keyboard's left zone will be heard more loudly from the left speaker than from the right speaker.
B \flat 7	2	Notes played in the keyboard's right zone will be heard only from the right speaker. Notes played in the keyboard's left zone will be heard only from the left speaker.

MEMO

You can use the Memory Backup function to store this setting in internal memory (p. 36).

MEMO

This is set to "1" when the RP101 is shipped from the factory.

NOTE

If you set Twin Piano mode to "2," reverb will no longer be applied when you turn on Twin Piano mode.

NOTE

For some sounds, the sound may not be split even if you set Twin Piano mode to "2."

MEMO

When you change the Twin Piano mode setting, Twin Piano will automatically be turned on.

Using Metronome

■ Sounding the Metronome

The RP101 features a built-in metronome.

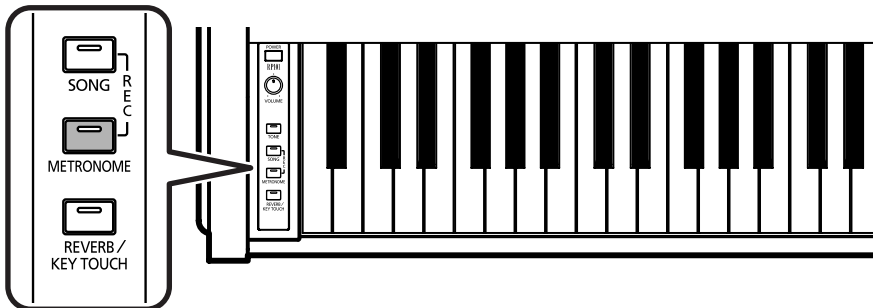

Starting the metronome

1. Press the [METRONOME] button, getting its indicator to light.

The metronome will sound.

The button flashes in red and green in time with the beat selected at that time. The button lights in red on the downbeats, and in green on weak beats.

Stopping the metronome

2. Once again press the [METRONOME] button, getting the button to go dark.

The metronome will stop.

■ Changing the Beat of Metronome

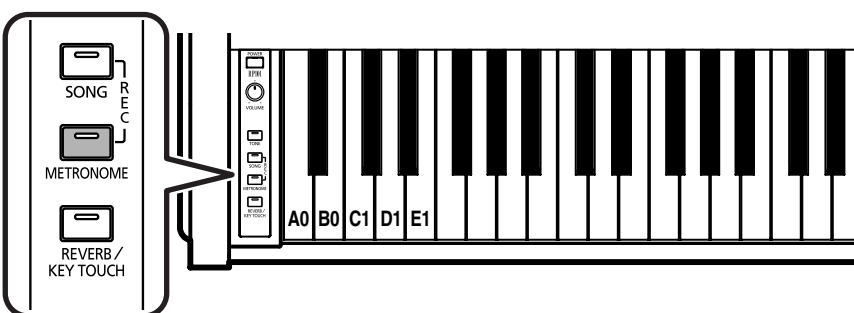

1. Hold down the [METRONOME] button and press either the "A0," "B0," "C1," "D1," or "E1" key.

Key Pressed	A0	B0	C1	D1	E1
Beat	Weak beats only (0/4)	2/4	3/4	4/4	6/4



The beat is set to "weak beats only" when the power is turned on. When the beat is set to "weak beats only," the [METRONOME] button only flashes in green.

■ Changing the Metronome Volume

The volume of the metronome can be adjusted, with eight volume levels available.

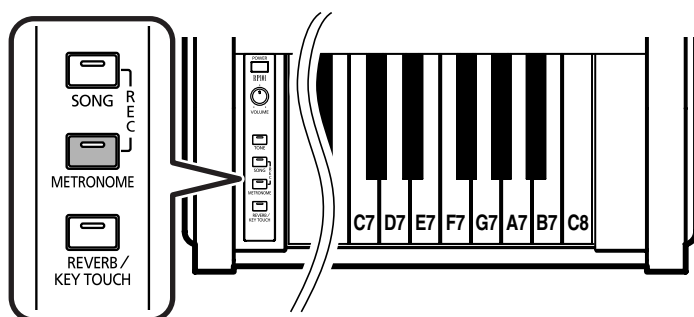

1. Hold down the [METRONOME] button and press a white key in the "C7" to "C8" range.

Key Pressed	C7	D7	E7	F7	G7	A7	B7	C8
Volume	0	1	2	3	4	5	6	7

■ Changing the Metronome Tempo

Changing the Tempo in Single Beat Increments

1. Hold down the [METRONOME] button and press the "C#" or "E \flat " key.

The metronome tempo changes.

Hold down the [METRONOME] button and press the "C#" key to slow down the tempo; continue pressing for consecutive decreases.

Hold down the [METRONOME] button and press the "E \flat " key to increase the tempo; continue pressing for consecutive increases.

If you hold down the [METRONOME] button and simultaneously press the "C#" key and "E \flat " key, the tempo will return to the standard tempo ($\text{♩} = 108$) or the original tempo of the selected song.

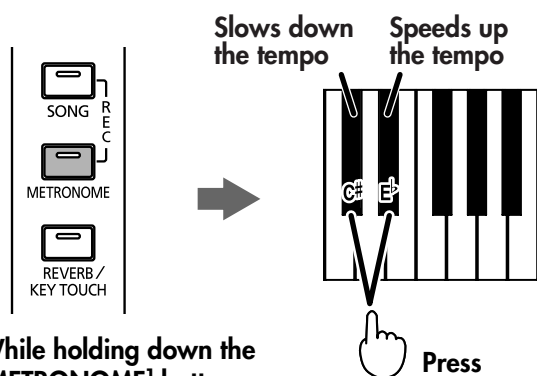

While holding down the [METRONOME] button...



This is set to "3" when the instrument is turned on.



When the metronome volume is set to "0," the metronome sound does not play.



You can change the tempo by pressing any "C#" or "E \flat " key.



The range available when adjusting the tempo of the metronome is: $\text{♩} = 20\text{--}250$.



Some of the built-in songs have a tempo and time signature that are based on eighth notes or half notes, such as 3/8 or 2/2. Immediately after you've played back one of these songs, the tempo will be based on eighth notes or half notes.

Selecting the Preset Tempo

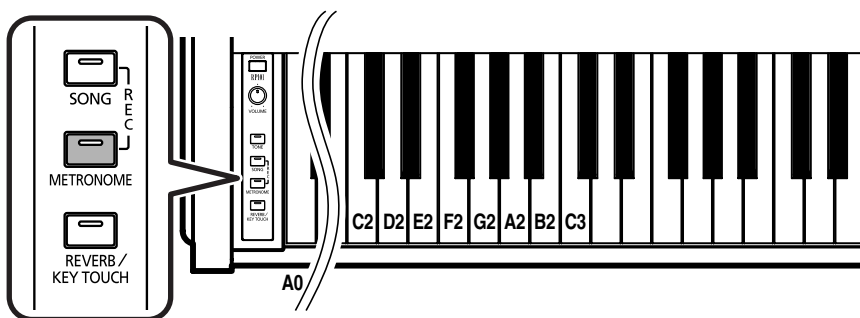

1. Hold down the [METRONOME] button and press the white keys in the "C2" to "C3" range.

The metronome tempo changes.

Key Pressed	C2	D2	E2	F2	G2	A2	B2	C3
Tempo	60	72	84	96	108	120	138	160

Setting the Tempo Value

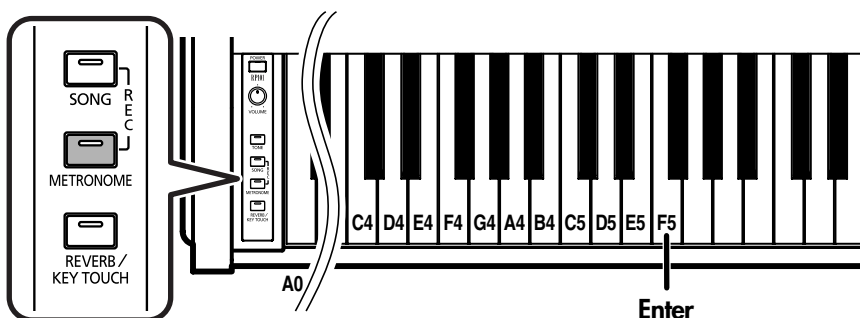

1. Hold down the [METRONOME] button and press the white keys in the "C4" to "E5" range.

The tempo can be adjusted in a range of ♩ = 20–250.

Key Pressed	C4	D4	E4	F4	G4	A4	B4	C5	D5	E5	F5
Tempo	1	2	3	4	5	6	7	8	9	0	Enter

2. Press the "F5" key to set that tempo.

Example: Setting the Tempo to ♩ = 120

While holding down the [METRONOME] button, press the "C4 (1)" key, the "D4 (2)" key, and the "E5 (0)" key, in that sequence, then press the "F5" key to set the tempo.

Example: Setting the Tempo to ♩ = 86

While holding down the [METRONOME] button, press the "C5 (8)" key and the "A4 (6)" key in that sequence, then press the "F5" key to set the tempo.

Setting the Tempo According to the Interval a Key is Pressed as you Hold Down the [METRONOME] Button (Tap Tempo)

You can set the tempo according to the interval a key is pressed as you hold down the [METRONOME] button. This function is called "Tap Tempo." This feature allows you to set the tempo you have in mind quickly and easily, without indicating the tempo numerically.

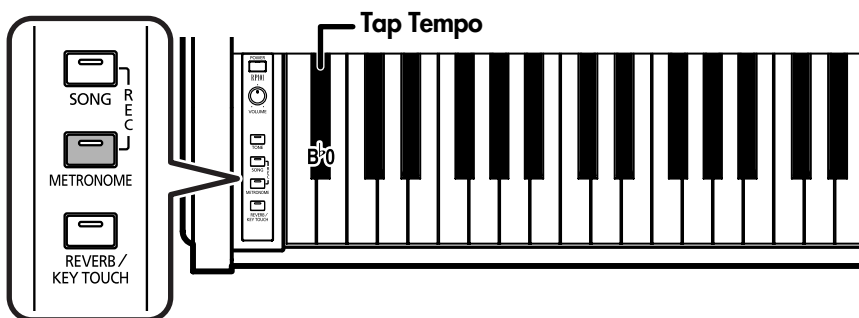

1. Hold down the [METRONOME] button and press the "B ♭ 0" key at least twice.

The tempo is set to the interval between presses of the key.

Recording Your Performance

You can record your own performance.

Listening to the playback of your recorded performance can be a helpful way for you to evaluate your own playing.

You can also sound a count before recording starts.

This is called “count-in recording,” and allows you to match the timing of the count so that your performance will begin smoothly.

NOTE

The RP101 always saves the newly recorded song and erases the previously recorded song. If you want to keep a song you’ve recorded, you should send the recorded song data to a MIDI device or computer (p. 40).

Recording

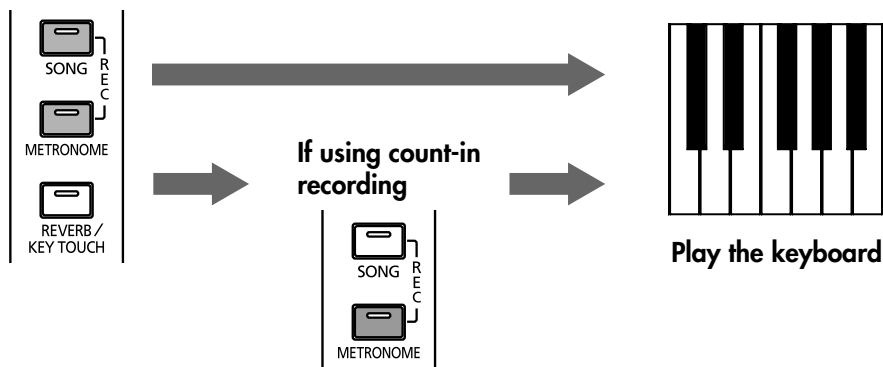

Set the tempo and time signature of the metronome before you record (p. 26, p. 27).

1. Hold down the [SONG] button and press the [METRONOME] button.

The [SONG] button’s indicator will light, and the [METRONOME] button’s indicator will blink orange. This is called “recording-standby mode.”

If you want to use count-in recording

2. Press the [METRONOME] button.

The [METRONOME] button’s indicator will change from blinking to lit. A two-measure count will sound. The [SONG] button will blink while the count-in is sounding. After the count-in, recording begins.

When recording begins, the [SONG] button’s indicator will change from blinking to lit.

If not using count-in recording

2. Play the keyboard to start recording.

When recording begins, the [METRONOME] button’s indicator will change from blinking to lit.

3. When you’ve finished recording, press the [SONG] button or the [METRONOME] button.

When you press the button, the indicators for all buttons will blink, and the recorded performance (song) will be saved in internal memory.

NOTE

You can’t select tones or make detailed settings, such as those for key touch or master tuning, while you’re recording or while you’re in recording-standby mode.

MEMO

While recording or in recording-standby mode, you can press the [REVERB/KEY TOUCH] button to turn reverb on/off (p. 21).

MEMO

If a recorded song has been saved, the [TONE] button’s indicator will blink while you press the [SONG] button.

NOTE

After you’ve finished recording, don’t turn off the power until all indicators have stopped blinking.

Playing Back the Recorded Performance

Playing back the song immediately after you've stopped recording

1. Press the [SONG] button.

The song you recorded will play back.

Playing back the recorded song after you've played other internal songs

1. Hold down the [SONG] button and press the "A0" key.

The recorded performance will play back.

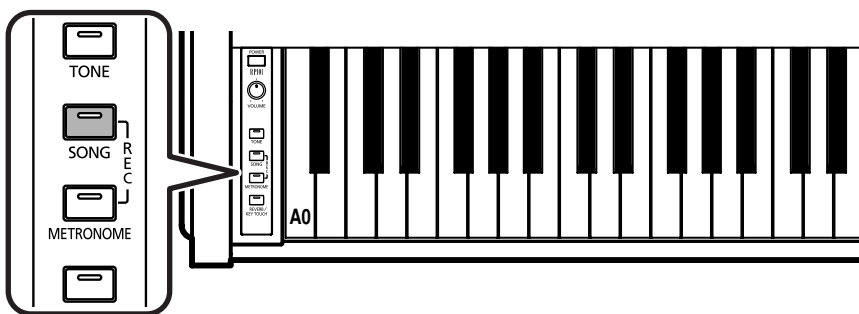

MEMO

Some of the built-in songs have a tempo and time signature that are based on eighth notes or half notes, such as 3/8 or 2/2. If you record your own performance immediately after playing back one of these songs, the tempo of the music that's recorded will be based on eighth notes or half notes.

Erasing Recorded Performances

1. Hold down the [SONG] button and press the [TONE] button.

The recorded performance is erased.

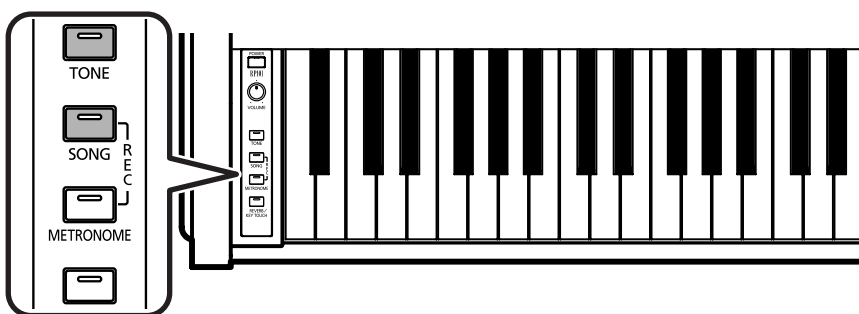

MEMO

If a recorded song has been saved, the [TONE] button's indicator will blink while you press the [SONG] button.

Changing Various Settings

Tuning to Other Instruments' Pitches (Master Tuning)

In situations such as when playing ensemble with other instruments, you can tune the RP101's standard pitch to the pitch of another instrument. The standard pitch generally refers to the pitch of the note that's played when you finger the middle A key. This tuning of all the instruments to a standard pitch is called "tuning."

You can set the standard pitch anywhere in a range of 415.3 Hz to 466.2 Hz.

This is set to "440.0 Hz" when the RP101 is shipped from the factory.



You can use the Memory Backup function to store this setting in internal memory (p. 36).

■ Lowering/Raising the Standard Pitch

1. While holding down the [METRONOME] and [REVERB/KEY TOUCH] buttons, press the "C # 1" note to lower the standard pitch, or the "E ♭ 1" note to raise it.

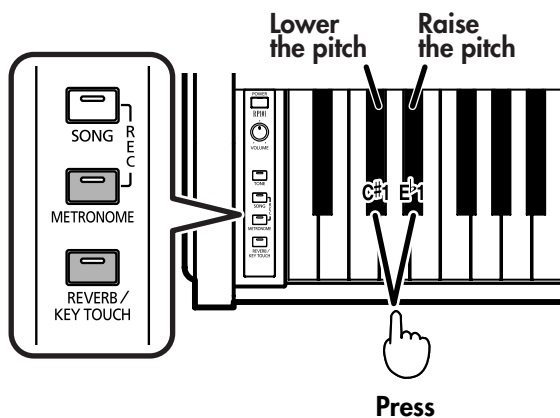

Each time you press the "C # 1" key, the pitch will fall by 0.1 Hz. If you continue holding the key, the pitch will continue falling.

Each time you press the "E ♭ 1" key, the pitch will rise by 0.1 Hz. If you continue holding the key, the pitch will continue rising.

■ Setting the Standard Pitch to 440.0 Hz

The standard pitch will be set to 440.0 Hz. This is the most commonly used setting. The A4 (Middle A) key will sound at 440.0 Hz.

1. While holding down the [METRONOME] and [REVERB/KEY TOUCH] buttons, press the "C1" key on the keyboard.

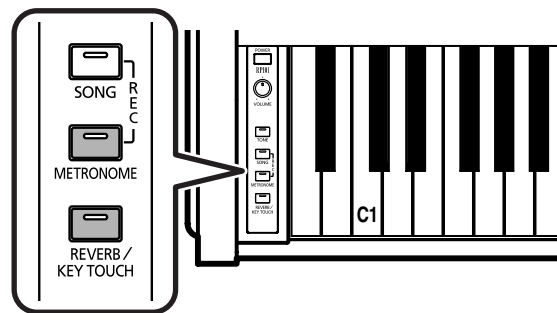

■ Setting the Standard Pitch to 442.0 Hz

The standard pitch will be set to 442.0 Hz. This setting is often used for concert pianos. The A4 (Middle A) key will sound at 442.0 Hz.

1. While holding down the [METRONOME] and [REVERB/KEY TOUCH] buttons, press the "D1" key on the keyboard.

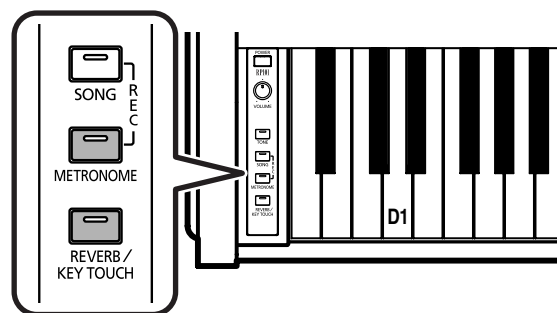

You can confirm the pitch of A4 by holding down the [METRONOME] and [REVERB/KEY TOUCH] buttons and pressing either the A0, B ♭ 0, or B0 key.

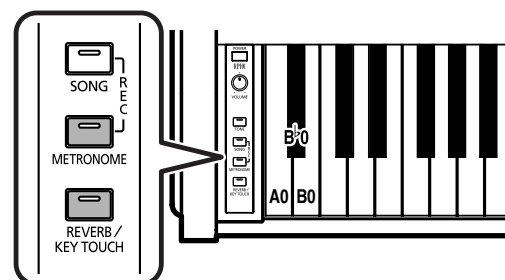

Changing the Temperament

You can play classical styles such as Baroque using historic temperaments (tuning methods).

Today, compositions are generally created with equal temperament in mind and are played using equal temperament. However in past ages of classical music, a variety of temperaments were used. Playing a composition with its original tuning lets you enjoy the sonorities of the chords that the composer originally intended.

This is set to "Equal" when the instrument is turned on.

1. While holding down the [METRONOME] and [REVERB/KEY TOUCH] buttons, press the appropriate key (F3–B3) on the keyboard.

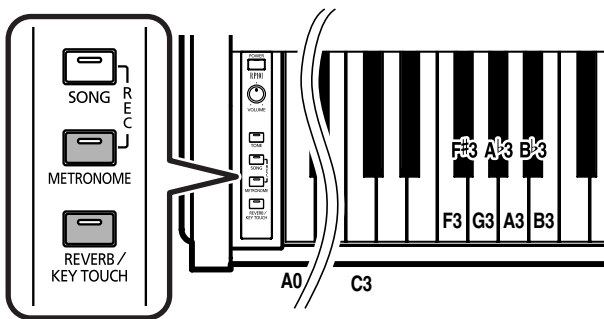

You can choose from among the seven temperaments described below.

Key Pressed	Temperament/Qualities
F3	Equal In this tuning, each octave is divided into twelve equal steps. Every interval produces about the same amount of slight dissonance.
F # 3	Just Major This tuning eliminates ambiguities in the fifths and thirds. It is unsuited to playing melodies and cannot be transposed, but is capable of beautiful sonorities.
G3	Just Minor The Just tunings differ from major and minor keys. You can get the same effect with the minor scale as with the major scale.
A ♭ 3	Kirnberger This is an improvement of the Mean Tone and Just tunings that provides a high degree of freedom of modulation. Performances are possible in all keys (third method).
A3	Mean Tone This scale makes some compromises in just intonation, enabling transposition to other keys.

Key Pressed	Temperament/Qualities
B ♭ 3	Pythagorean This tuning, devised by the philosopher Pythagoras, eliminates dissonance in fourths and fifths. Dissonance is produced by third-interval chords, but melodies are euphonious.
B3	Werckmeister This temperament combines the Mean Tone and Pythagorean tunings. Performances are possible in all keys (first method, number three).

Setting the Tonic

When playing with tuning other than equal temperament, you need to specify the tonic note for tuning the song to be performed (that is, the note that corresponds to C for a major key or to A for a minor key).

If you choose an equal temperament, there's no need to select a tonic note.

1. While holding down the [METRONOME] and [REVERB/KEY TOUCH] buttons, press the tonic (root) of the key (C4–B4).

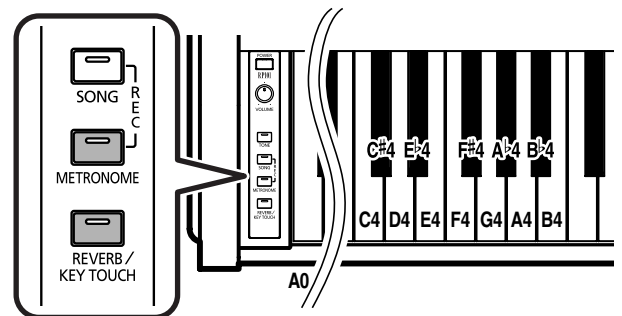

NOTE

When performing in ensemble with other instruments, be aware that depending on the key, there may be some shifting of the pitch. Tune the RP101 to the standard pitch of the other instruments.

Changing Various Settings

Changing the Damper Pedal's Resonance (Damper Resonance)

On an acoustic piano, depressing the damper pedal makes the notes you play resonate with other strings, adding rich reverberations and fatness to the sound. The damper pedal on the RP101 recreates this resonance (damper resonance) when depressed.

You can select from eight levels of depth for the resonant sound (resonance level).

MEMO

You can use the Memory Backup function to store this setting in internal memory (p. 36).

MEMO

This is set to "4" when the RP101 is shipped from the factory.

NOTE

This setting is enabled only with the piano tones. You cannot set this for other tones.

1. While holding down the [REVERB/KEY TOUCH] buttons and press the appropriate key (C2–C3) on the keyboard.

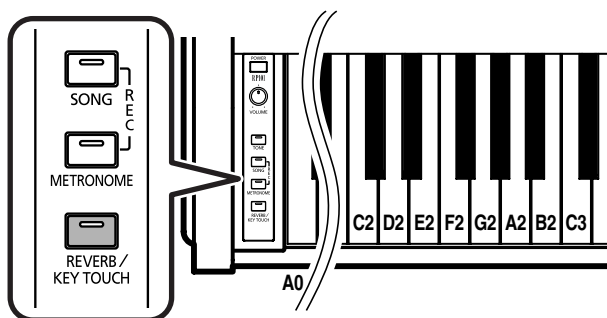

Key Pressed	C2	D2	E2	F2	G2	A2	B2	C3
Depth of Effect	Off	1	2	3	4	5	6	7

Larger values will produce a deeper effect.

Setting the Tuning Curve (Stretch Tuning)

A piano is generally tuned to a pitch with a lower bass range and a higher treble range than equal temperament. This special tuning method for pianos is called "Stretch Tuning."

NOTE

This effect works only with the piano tones.

MEMO

Stretch Tuning is set to On when the instrument is turned on.

1. While holding down the [METRONOME] and [REVERB/KEY TOUCH] buttons, the "D2" note to turn the setting On, or press the "C2" note to turn the setting Off.

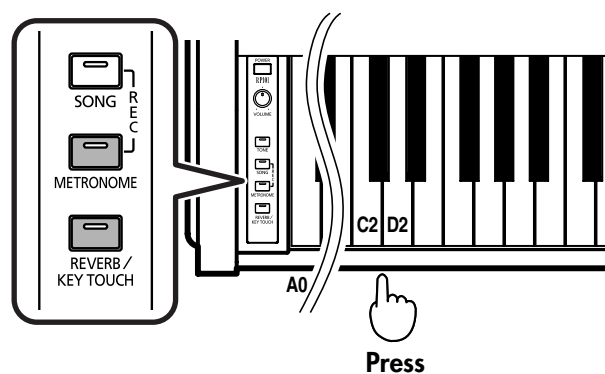

Key Pressed	Setting	Explanation
C2	Off	This is the standard tuning curve. This is the right choice when using Dual play (p. 18), or when playing in ensemble with other instruments.
D2	On	This tuning curve expands the bass and treble ends somewhat. It is suitable for performances such as piano solos.

Disabling Everything Except Piano Play (Panel Lock)

The “Panel Lock” function locks the RP101 in a state where only piano performance can be used, and all buttons will be disabled. This prevents the settings from being inadvertently modified even if children press the buttons accidentally.

NOTE

In the Panel Lock state, only the grand piano sound can be played.

1. Turn the volume to the minimum, and press the [POWER] switch to turn off the power.
2. Hold down the [TONE] button and press the [POWER] switch to turn on the power.

Continue holding down the [TONE] button until the panel indicator lights.

While holding down the [TONE] button, press the [POWER] switch.

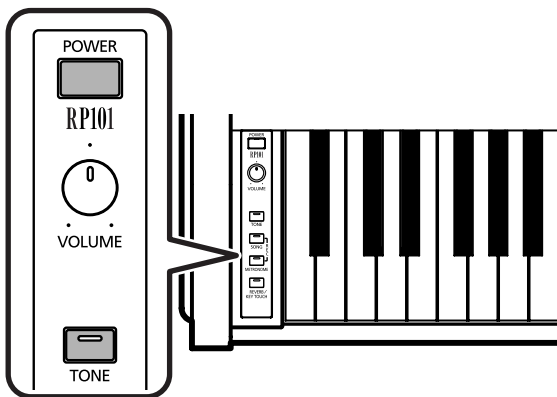

All buttons are disabled.

Adjust the volume by using the [VOLUME] knob.

When you play the keyboard, the grand piano sound will be heard.

To defeat the Panel Lock function, turn the volume down to the minimum, and turn on the power once again.

Using the V-LINK function

Connecting the RP101 to a V-LINK compatible image device allows you to control the images with the RP101.

V-LINK

V-LINK (**V-LINK**) is a function that allows music and images to be performed together. By using MIDI to connect two or more V-LINK compatible devices, you can easily enjoy a wide range of visual effects that are linked to the expressive elements of a music performance.

How to Use the V-LINK

MEMO

V-LINK is set to Off when the instrument is turned on.

1. While holding down the [METRONOME] and [REVERB/KEY TOUCH] buttons, the “A ♭ 7” note to turn the setting On, or press the “G7” note to turn the setting Off.

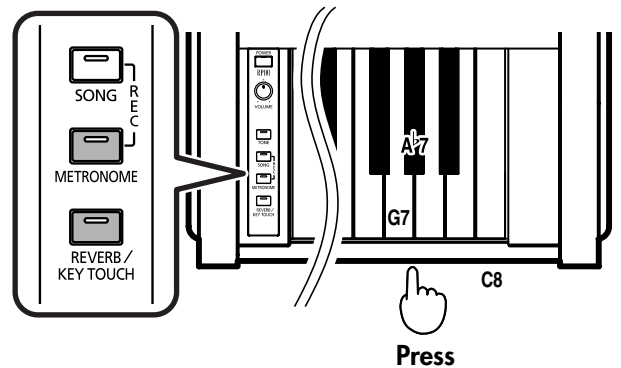

Key Pressed	Setting	Explanation
G7	Off	The V-LINK function is switched off.
A ♭ 7	On	The V-LINK function is switched on. You can control images using the twelve keys at the left end of the keyboard.

NOTE

While V-LINK is switched on, no sound is produced when you press any of the twelve keys at the left end of the keyboard.

All button indicators light up when the V-LINK function is on.

Remembering the Settings Even when the Power is Turned Off (Memory Backup)

Normally, the settings of the various variations will revert to their default values when the power is turned off. However, you can specify that the various settings will be remembered even when the power is turned off.

This function is called "Memory Backup."

Stored Settings

- Brilliance (p. 20)
- Reverb On/Off, Depth of the Reverb (p. 21)
- Damper Resonance (p. 34)
- Key Touch (p. 22)
- Twin Piano Mode (p. 25)
- Master Tuning (p. 32)

1. While holding down the [SONG] button and [METRONOME] button, hold down the A0 key for approximately five seconds.

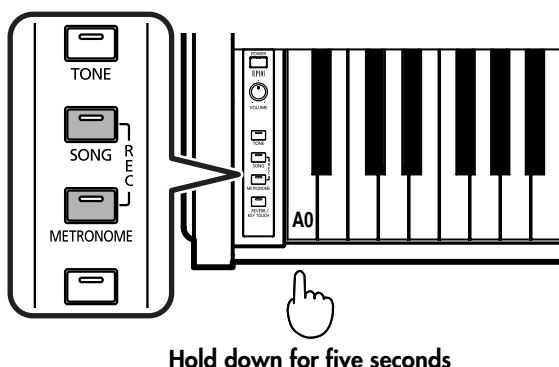

The indicators of all buttons will blink several times. When memory backup has been completed, the RP101 will return to its previous state.

Restoring the Original Default Settings (Factory Reset)

The memory backup settings can be restored to the original default condition. This operation is referred to as "Factory Reset."

1. While holding down the [SONG] button and [METRONOME] button, hold down the C8 key for approximately five seconds.

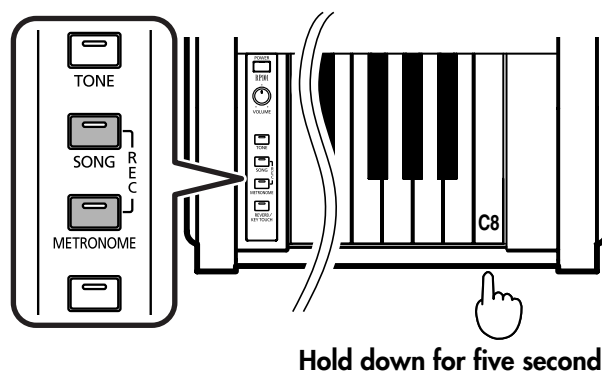

2. When the indicators of all buttons start blinking, switch off the power, then turn it back on again.

NOTE

Executing this operation will not erase the recorded performance. When you want to erase the recorded performance, refer to "Erasing Recorded Performances" (p. 31).

Connecting External Devices

Connecting to Audio Equipment

You can connect audio devices to play the sound of the RP101 through the speakers of your audio system, or to record your performance on a tape recorder or other recording device. When connecting, please use an audio cable with a standard phone plug (sold separately).

Connection Examples

NOTE

To prevent malfunction and/or damage to speakers or other devices, always turn down the volume, and turn off the power on all devices before making any connections.

NOTE

Some connection cables contain resistors. Do not use cables that incorporate resistors for connecting to this unit. The use of such cables can cause the sound level to be extremely low, or impossible to hear. For information on cable specifications, contact the manufacturer of the cable.

Playing the sound of the RP101 through the speakers of an audio system/Recording the performance of the RP101 on a recording device

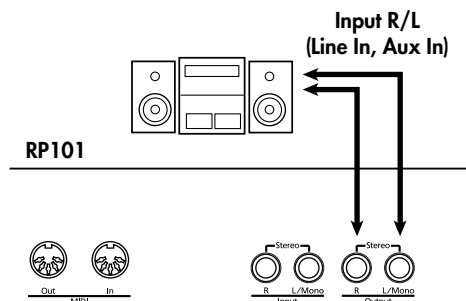

○ Use the following procedure when turning on the power.

1. Turn on the power of the RP101.
2. Turn on the power of the connected device.
3. Adjust the volume of each device.

When Recording RP101 Performances on a Recording Device

4. Start recording with the connected device.
5. Perform on the RP101.
6. When the performance ends, stop recording on the connected equipment.

Playing the sound of an audio device through the speakers of the RP101

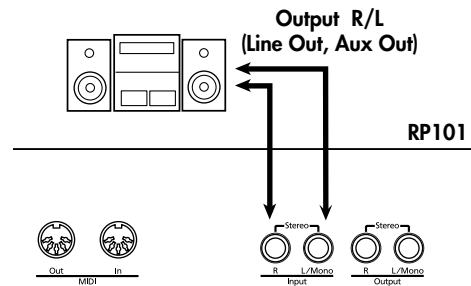

○ Use the following procedure when turning on the power.

1. Turn on the power of the connected device.
2. Turn on the power of the RP101.
3. Adjust the volume of each device.

NOTE

You cannot use the RP101 to adjust the volume of the connected sound generating device.

Turning off the power

1. Set the volume of the RP101 and of the connected devices to the minimum position.
2. Turn off the power of the RP101.
3. Turn off the connected equipment.

Connecting External Devices

Connecting MIDI Devices

By connecting an external MIDI device and exchanging performance data, you can control the performances on one device from the other. For instance, you can output sound from the other instrument or switch tones on the other instrument.

■ What's MIDI?

MIDI stands for Musical Instrument Digital Interface, an international standard which allows performance information to be communicated among electronic musical instruments and computers.

The RP101 provides MIDI connectors, which allow performance data to be exchanged with external devices. When these connectors are used to connect the RP101 to external devices, an even wider range of possibilities becomes available.

Connection Examples

NOTE

To prevent malfunction and/or damage to speakers or other devices, always turn down the volume, and turn off the power on all devices before making any connections.

Playing the RP101 from a MIDI sequencer/Recording an RP101 performance on a MIDI sequencer

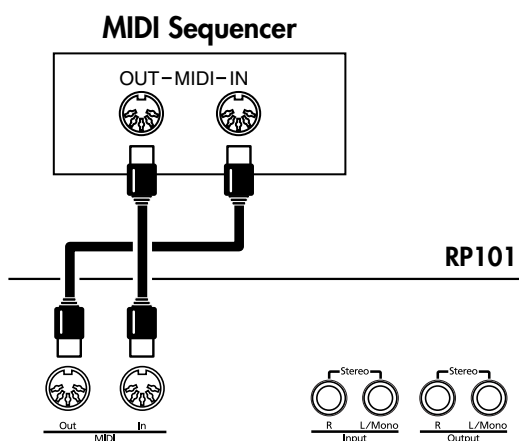

MEMO

Set Local Off if you have connected the RP101 to a MIDI sequencer. Refer to "Switching Local Control On and Off" (p. 39). Also set your MIDI sequencer to MIDI Thru mode (so that messages received at MIDI IN will be re-transmitted without change from MIDI OUT). For details, refer to the owner's manual of your MIDI sequencer.

Perform on the RP101 to play a MIDI sound module

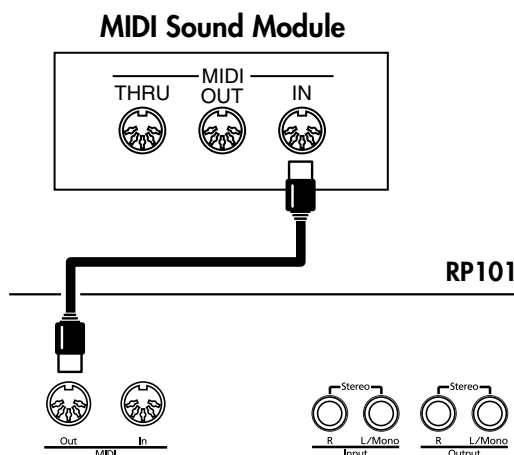

■ MIDI Send Channel Settings

MIDI features sixteen MIDI channels, numbered 1–16. Simply connecting a cable is not enough for communication to take place. The connected devices must be set to use the same MIDI channels. Otherwise, no sound will be produced, and no sounds can be selected.

MEMO

The RP101 receives all channels 1–16.

When the RP101 is turned on, Channel "1" is selected.

1. While holding down the [METRONOME] and [REVERB/KEY TOUCH] buttons, press the appropriate key (C6–E \flat 7) on the keyboard.

The MIDI transmit channel will switch to the number that corresponds to the note you pressed.

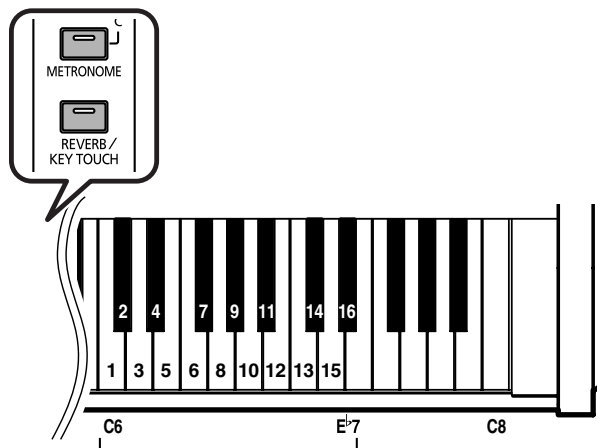

■ Switching Local Control On and Off

When connecting a MIDI sequencer, set Local Control to "OFF."

As illustrated, information describing what has been played on the keyboard is passed to the internal sound generator over two different routes, (1) and (2). As a result, you hear overlapping or intermittent sounds. To prevent this from happening, route (1) must be severed, by setting the unit to what is known as "Local Off."

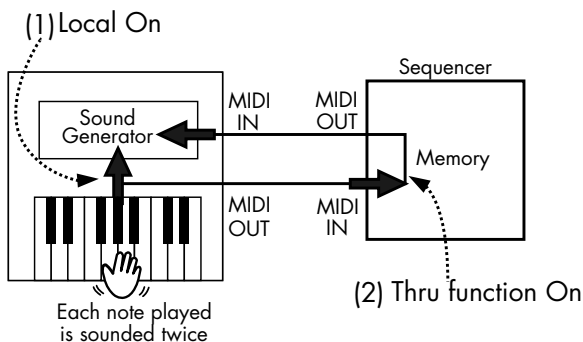

Local Control ON

The keyboard and the internal sound generator are in a linked state.

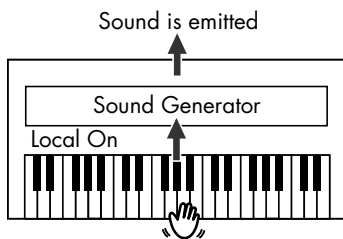

Local Control OFF

The keyboard and the internal sound generator are in an unlinked state. No sound will be produced by the keyboard when it is played.

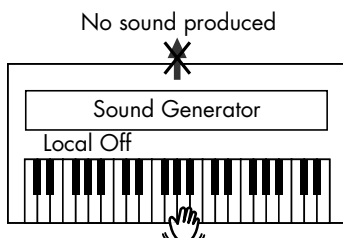

MEMO

Local On is set when the power is switched on.

1. While holding down the [METRONOME] and [REVERB/KEY TOUCH] buttons, the "C8" note to turn the setting On, or press the "B7" note to turn the setting Off.

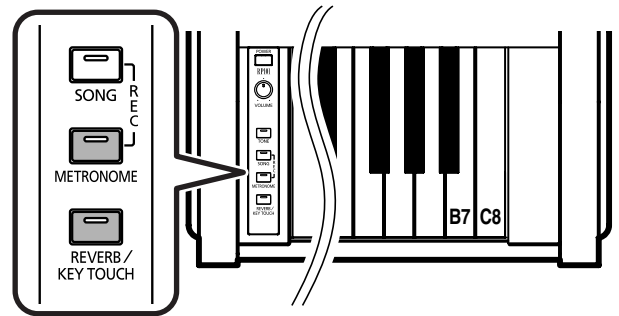

Key Pressed	Value
B7	Off
C8	On

MEMO

When a Roland MT series instrument is connected, it is not necessary to make the Local Off setting. MT units transmit Local Off messages when their power is switched on. If you turn on the power in the order of the RP101 → MT series, Local Off will be set automatically.

Connecting External Devices

■ Sending Recorded Performance Data to a MIDI Device (Composer Out)

When Composer Out is active, you can send performance data recorded with the RP101 to a connected MIDI device or computer.



When you turn on the power, this is set to "Off."

1. While holding down the [METRONOME] button and [REVERB/KEY TOUCH] button, press the F7 or F # 7 key to switch Composer Out on/off.

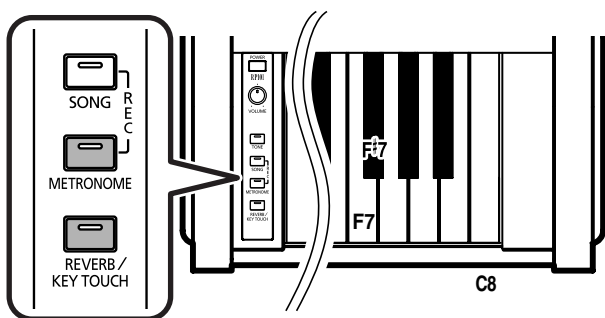

Key Pressed	Value
F7	Off
F # 7	On

If Composer Out is turned on, the song data will be sent to a connected MIDI device or computer when you play back a recorded song.

Connecting to a Computer

You can use a USB MIDI interface cable (sold separately) to connect the RP101 to your computer.

You can connect the RP101 to a computer that has other sequencer software installed, and then play performances from the software through the RP101.

Connection Examples

NOTE

To prevent malfunction and/or damage to speakers or other devices, always turn down the volume, and turn off the power on all devices before making any connections.

NOTE

In order to make connections to your computer, you must install "MIDI driver" software on your computer. For details, refer to the owner's manual for your MIDI interface.

Use a USB MIDI interface cable to connect the USB connector of your computer to the MIDI connectors of the RP101.

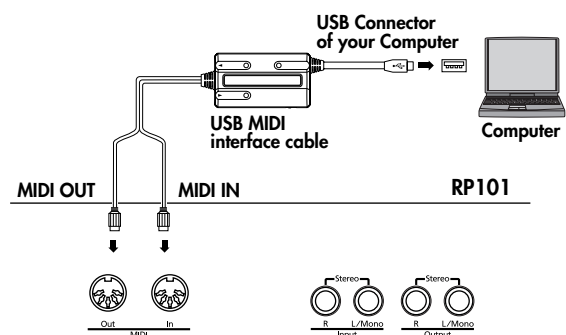

Troubleshooting

If you think there's a problem, read this first.

Case	Cause/Remedy
The power doesn't come on	Is the power cord connected and plugged in correctly? (p. 12)
The button doesn't work	Is the panel locked? (p. 35) Turn the power off, then back on.
No sound is heard	Is the volume level of the RP101 turned all the way down? (p. 14)
	Are headphones plugged in? (p. 13) Has a plug remained connected to the Phones jack? Plugging headphones or other plugs into the headphone jack stops sounds from playing through the speakers.
	Is Local Off selected? When Local Control is set to Off, no sound is produced by playing the keyboard. Set Local Control to "On" (p. 39).
	Is V-LINK switched on? While V-LINK is switched on, no sound is produced when you press any of the twelve keys at the left end of the keyboard (p. 35).
No sound is heard (when a MIDI instrument is connected)	Have all devices been switched on?
	Are the MIDI cables connected correctly?
	Does the MIDI channel match the connected instrument? (p. 38)
Sounds are heard twice (doubled) when the keyboard is played	Is the RP101 in Dual play? (p. 18)
	When the RP101 is connected to an external sequencer, set it to the Local OFF mode (p. 39). Alternatively, the sequencer could be set so its MIDI Thru feature is OFF.
Tone doesn't change	Is the panel locked? (p. 35) Turn the power off, then back on.
Not all played notes are sounded	The maximum number of notes that the RP101 can play simultaneously is 64. Frequent use of the damper pedal when playing along with a song may result in performance data with too many notes, causing some notes to drop out.
The tuning or pitch of the keyboard or song is off	Have you set Transpose? (p. 23)
	Are the settings for the "Temperament" (p. 33) and "Stretch Tuning" (p. 34) correct?
	Is the setting for the "Master Tuning" correct? (p. 32)
Depressing a pedal has no effect, or the pedal effect doesn't stop	Is the pedal connected correctly? Make sure the pedal cord is securely connected to the pedal jack on the bottom of the unit, at the rear (p. 12).
The pedal rattles	Adjust the adjuster underneath the pedal so that the adjuster presses firmly against the floor surface (p. 15).

Case	Cause/Remedy
In the upper range, the sound changes abruptly beyond a certain key	On an acoustic piano, notes in the upper one and a half octaves of the keyboard continue to sound until they decay naturally, regardless of the damper pedal. There is a difference in the timbre as well. Roland pianos faithfully simulate such characteristics of the acoustic piano. On the RP101, the range that is unaffected by the damper pedal will change depending on the Transpose setting.
A High-pitched whine is produced	When listening through headphones: Some of the more flamboyant and effervescent piano tones feature an ample high-end component, which may make the sound appear to have metallic reverberation added. Since this reverberation becomes particularly audible when supplemented by heavy reverb, you may be able to diminish the problem by reducing the amount of reverb applied to the sound.
	When listening through speakers: Here, a different cause (such as resonance produced by the RP101) would be suspect. Consult your Roland dealer or nearest Roland Service Center.
The bass range sounds odd, or there is a vibrating resonance	When listening through speakers: Playing at loud volumes may cause instruments near the RP101 to resonate. Resonance can also occur with fluorescent light tubes, glass doors, and other objects. In particular, this problem occurs more easily when the bass component is increased, and when the sound is played at higher volumes. Use the following measures to suppress such resonance.
	<ul style="list-style-type: none"> • Place speakers so they are 10–15 cm from walls and other surfaces. • Reduce the volume. • Move the speakers away from any resonating objects.
The volume level of the instrument connected to Input jacks is too low	When listening through headphones: Here, a different cause would be suspect. Consult your Roland dealer or nearest Roland Service Center.
	Could you be using a connection cable that contains a resistor? Use a connection cable that does not contain a resistor.

Tone List

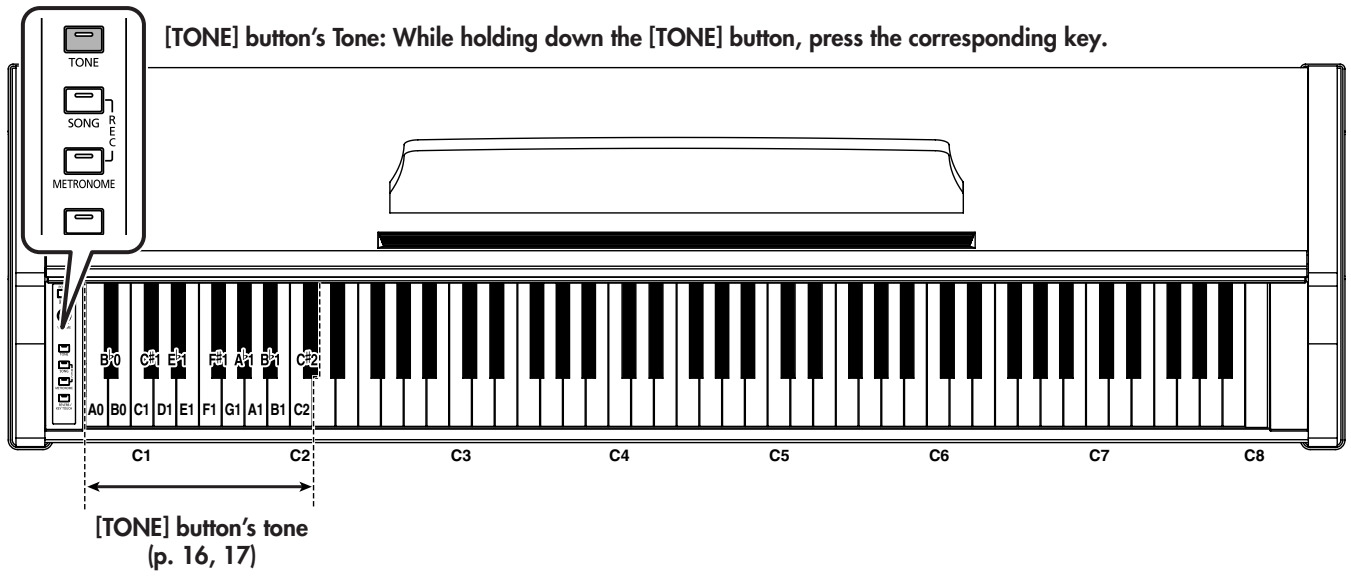

Tone	Key Pressed	Tone
Grand Piano	A0	
	B \flat 0	Slow Strings
Mellow Piano	B0	
Honky-tonk	C1	
	C \sharp 1	Strings
Harpichord	D1	
	E \flat 1	Choir
Coupled Harpichord	E1	
Electric Piano1	F1	
	F \sharp 1	Church Organ 1
Electric Piano2	G1	
	A \flat 1	Church Organ 2
Vibraphone	A1	
	B \flat 1	Organ Flute
Piano + Strings	B1	
Piano + Choir	C2	
	C \sharp 2	Rotary Organ

Internal Song List

Song No.	Key	Song Name
1	B \flat 0	La Fille aux Cheveux de Lin
2	B0	La Campanella
3	C1	Hungarian Rag
4	C \sharp 1	Scherzo No.2
5	D1	Sonate No.15
6	E \flat 1	Liebesträume 3
7	E1	Étude, op.10-3
8	F1	Je te veux
9	F \sharp 1	Valse, op.64-1
10	G1	Golliwog's Cakewalk
11	A \flat 1	Fantaisie-Impromptu
12	A1	Arabesque 1
13	B \flat 1	An der schönen, blauen Donau
14	B1	Auf Flügeln des Gesanges
15	C2	Mazurka No.5
16	C \sharp 2	Gymnopédie 1
17	D2	Étude, op.25-1
18	E \flat 2	Clair de Lune
19	E2	Étude, op.10-5
20	F2	Dr. Gradus ad Parnassum
21	F \sharp 2	Grande Valse Brillante
22	G2	La prière d'une Vierge
23	A \flat 2	Course en Troïka
24	A2	To The Spring
25	B \flat 2	Valse, op.64-2
26	B2	Radetzky Marsch
27	C3	Träumerei
28	C \sharp 3	Moments Musicaux 3
29	D3	Prélude, op.28-15
30	E \flat 3	Harmonious Blacksmith
31	E3	Ungarische Tänze 5
32	F3	Türkischer Marsch (Beethoven)
33	F \sharp 3	Nocturne No.2
34	G3	Frühlingslied

Song No.	Key	Song Name
35	A \flat 3	Präludium
36	A3	Jägerlied
37	B \flat 3	Menuet Antique
38	B3	Für Elise
39	C4	Türkischer Marsch (Mozart)
40	C \sharp 4	Ständchen
41	D4	Humoreske
42	E \flat 4	Blumenlied
43	E4	Alpenglöckchen
44	F4	Menuett G dur (Beethoven)
45	F \sharp 4	Venezianisches Gondellied
46	G4	Alpenabendröte
47	A \flat 4	Farewell to the Piano
48	A4	Brautchor
49	B \flat 4	Battle of Waterloo
50	B4	Wiener Marsch
51	C5	Le Coucou
52	C \sharp 5	Menuett G dur (Bach)
53	D5	Spinnerlied
54	E \flat 5	Gavotte
55	E5	Heidenröslein
56	F5	Zigeuner Tanz
57	F \sharp 5	La Cinquantaine
58	G5	Csikos Post
59	A \flat 5	Dolly's Dreaming Awakening
60	A5	La Violette
61	B \flat 5	Fröhlicher Landmann
62	B5	Sonatine op.36-1 (Clementi)
63	C6	Sonatine op.20-1 (Kuhlau)
64	C \sharp 6	Sonatine No.5 (Beethoven)
65	D6	Fly Flee

* All rights reserved. Unauthorized use of this material for purposes other than private, personal enjoyment is a violation of applicable laws.

Easy Operation List

■ Tone Settings

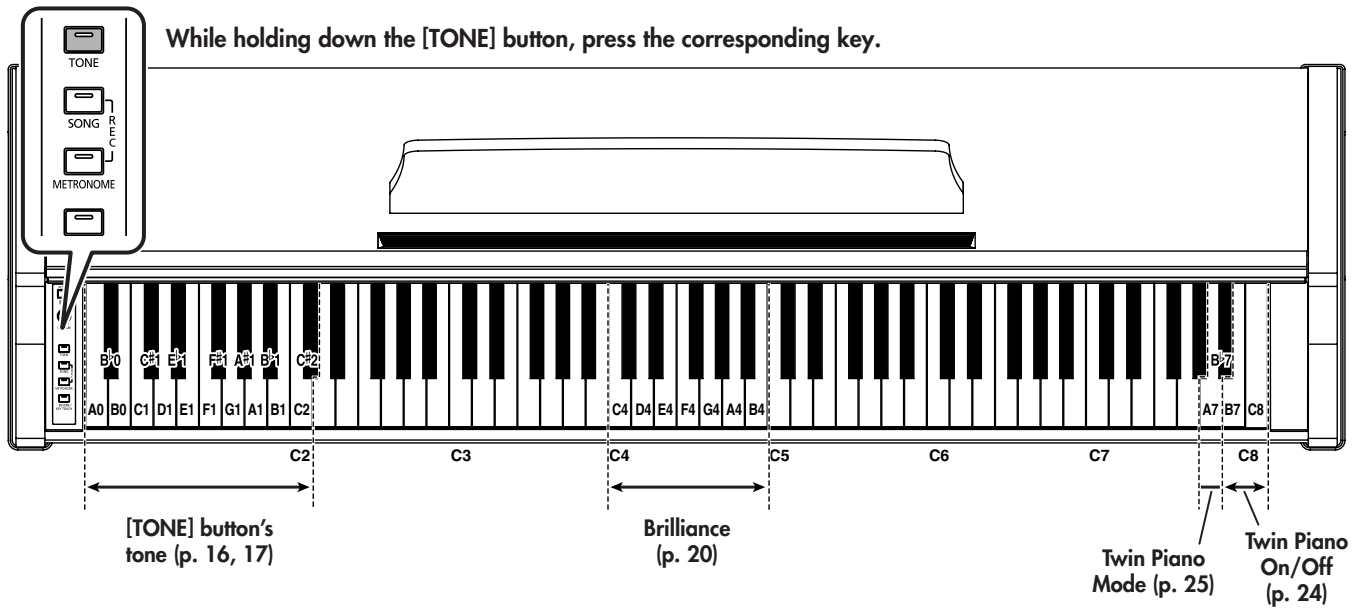

■ Metronome Settings

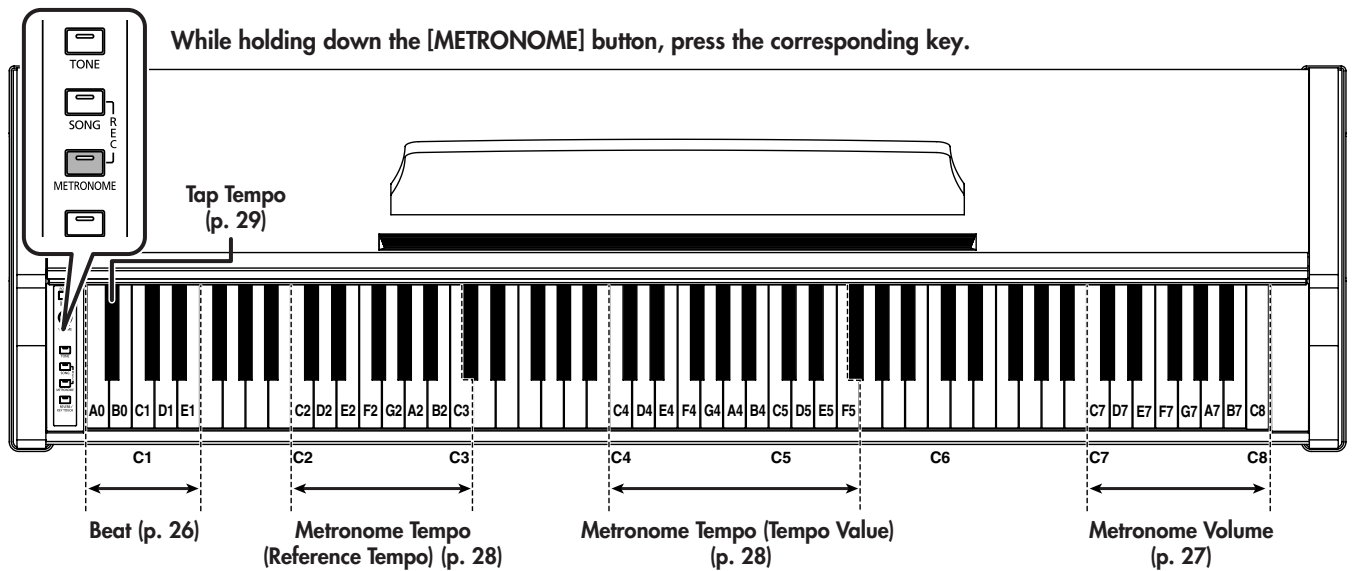

■ Key Touch/Damper Resonance Settings

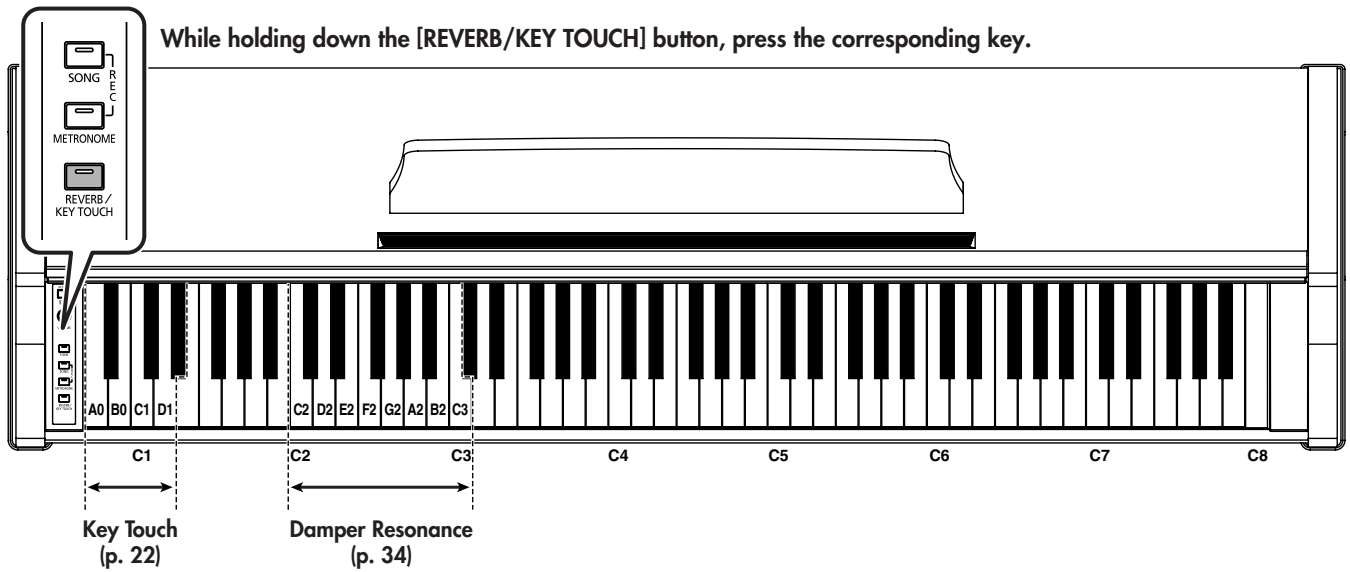

■ Other Settings

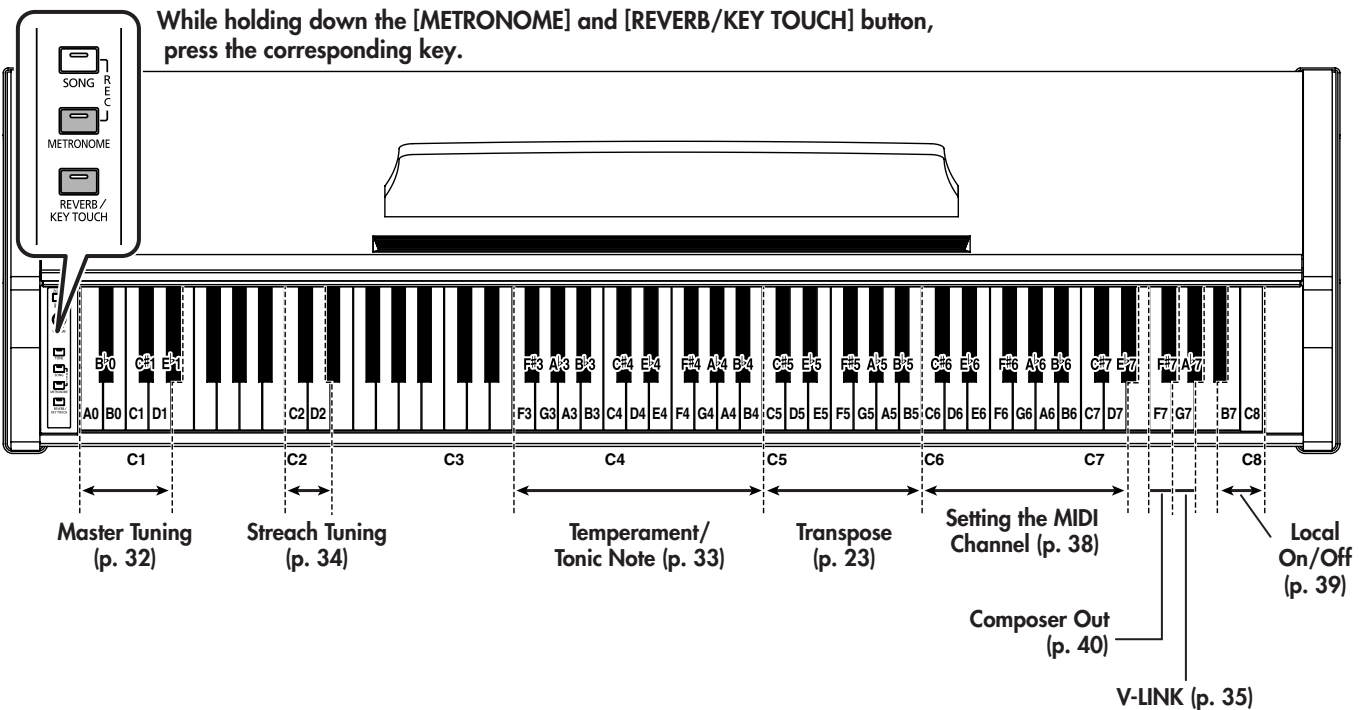

DIGITAL PIANO

Date : Jan. 1, 2007

Model RP101

MIDI Implementation Chart

Version : 1.00

Function...	Transmitted	Recognized	Remarks
Basic Channel Default Changed	1 1-16	1 1-16	
Mode Default Messages Altered	Mode 3 x *****	Mode 3 x	
Note Number : True Voice	15-113 *****	0-127 15-113	
Velocity Note ON Note OFF	O x 8n v=64	O x	
After Touch Key's Ch's	x x	x x	
Pitch Bend	x	x	
Control Change 6, 38 7 11 64 66 67 91 100, 101	O x x O O O O O	O O O O O O O O	Data entry Volume Expression Hold 1 Sostenuto Soft Effect 1 (Reverb) RPN LSB, MSB
Prog Change : True Number	0-119 *****	O 0-119	
System Exclusive	O	O	
System Common : Song Pos : Song Sel : Tune	x x x	x x x	
System Real Time : Clock : Commands	x x	x x	
Aux Message : All sound off : Reset all controllers : Local Control : All Notes OFF : Active Sense : Reset	x x x x O x	x O O O (123-127) O x	
Notes			

Mode 1 : OMNI ON, POLY Mode 2 : OMNI ON, MONO
 Mode 3 : OMNI OFF, POLY Mode 4 : OMNI OFF, MONO

O : Yes
 X : No

Main Specifications

Keyboard	
Keyboard	88 keys, PHA alpha II keyboard
Touch Sensitivity	Light, Medium, Heavy, Fixed
Keyboard Modes	Whole, Dual (volume balance adjustable), Twin piano
Sound Generator	
Max. Polyphony	64 voices
Tones	17 tones
Temperament	7 types, selectable tonic
Stretched Tuning	On/Off
Master Tuning	415.3–466.2 Hz (adjustable in increments of 0.1 Hz)
Transpose	-6→+5 (in semitones)
Effects	Reverb (8 levels), Damper Resonance (only for piano tones, 7 levels, Off)
Recorder	
Track	1 track
Number of songs stored	1 song
Number of notes stored	Approx. 5000 notes
Controls	Song Select, All Song Play/Stop, Rec
Tempo	Quarter note = 20 to 250
Resolution	120 ticks per quarter note
Metronome	
Beat	0/4, 2/4, 3/4, 4/4, 6/4
Volume	8 levels
Others	
Preset Songs	65 songs
Rated Power Output	25 W x 2
Speakers	12 cm x 2
Control	Volume
Pedals	Damper (half-pedal recognition), Soft (half-pedal recognition), Sostenuto
Other Functions	Panel Lock, V-LINK
Connectors	AC inlet, Pedal connector, Input jacks (L/Mono, R), Output jacks (L/Mono, R), MIDI connectors (In, Out), Phones jack (Stereo) x 2
Power Supply	AC 115 V, AC 117 V, AC 220 V, AC 230 V, AC 240 V (50/60 Hz)
Power Consumption	47 W
Dimensions (including piano stand)	1387 (W) x 400 (D) x 995 (H) mm (with Music Rest) 54-5/8 (W) x 15-3/4 (D) x 39-3/16 (H) inches 1387 (W) x 400 (D) x 808 (H) mm (without Music Rest) 54-5/8 (W) x 15-3/4 (D) x 31-13/16 (H) inches
Weight (including the dedicated stand)	46 kg / 102 lbs
Accessories	Owner's manual, Power Cord, Headphones Hook, Music Rest, Music Rest attachment screws

* In the interest of product improvement, the specifications and/or appearance of this unit are subject to change without prior notice.

Index

- A**
AC Inlet 11–12
Adjuster 15
Audio Equipment 37
- B**
Beat 26
Brilliance 20
- C**
Composer Out 40
Computer 40
Control Panel 11
Count-in Recording 30
- D**
Damper Pedal 14
Damper Resonance 14, 34
Dual Balance 19
Dual Play 18–19
- E**
Erasing
 Recorded Performance 31
- F**
Factory Reset 36
- H**
Headphone Hook 13
Headphones 13
- I**
Input Jack 11, 37
Internal Song 16
- K**
Key Touch 22
- L**
Lid 12
Local Control 39
Local Off 39
Local On 39
- M**
Master Tuning 32
Memory Backup 36
Metronome 26
 Beat 26
 Tempo 27–29
 Volume 27
[METRONOME] Button 11, 23, 26–30, 32–36, 38–40
MIDI 38
MIDI Channel 38
MIDI Connector 11, 38
MIDI Devices 38
Music Rest 12
- O**
Output Jack 11, 37
- P**
Panel Lock 35
Pedal 14
Pedal Connector 11–12
Pedal Cord 12
Phones Jack 11, 13
Playing Back
 Internal Song 16
 Recorded Performance 31
Power 14
Power Cord 12
[POWER] Switch 11, 14, 35
- R**
Rear Panel 11
Recording 30
Reverb 21
 Depth 21
[REVERB/KEY TOUCH] Button ... 11, 21–23, 32–35, 38–40
- S**
Soft Pedal 14
[SONG] Button 11, 16, 30–31, 36
Sostenuto Pedal 14
Standard Pitch 32
Stretch Tuning 34
- T**
Tap Tempo 29
Temperament 33
Tempo 27
Tone 17
Tone 1 19
Tone 2 19
[TONE] Button 11, 17–20, 24–25, 31, 35
Tonic 33
Transpose 23
Tuning 32
Tuning Curve 34
Twin Piano 24
Twin Piano Mode 24–25
- V**
V-LINK 35
Volume 14
 Metronome 27
[VOLUME] Knob 11, 14



This product complies with the requirements of European Directives EMC 89/336/EEC and LVD 73/23/EEC.

For EU Countries

For the USA

FEDERAL COMMUNICATIONS COMMISSION RADIO FREQUENCY INTERFERENCE STATEMENT

This equipment has been tested and found to comply with the limits for a Class B digital device, pursuant to Part 15 of the FCC Rules. These limits are designed to provide reasonable protection against harmful interference in a residential installation. This equipment generates, uses, and can radiate radio frequency energy and, if not installed and used in accordance with the instructions, may cause harmful interference to radio communications. However, there is no guarantee that interference will not occur in a particular installation. If this equipment does cause harmful interference to radio or television reception, which can be determined by turning the equipment off and on, the user is encouraged to try to correct the interference by one or more of the following measures:

- Reorient or relocate the receiving antenna.
- Increase the separation between the equipment and receiver.
- Connect the equipment into an outlet on a circuit different from that to which the receiver is connected.
- Consult the dealer or an experienced radio/TV technician for help.

This device complies with Part 15 of the FCC Rules. Operation is subject to the following two conditions:

- (1) This device may not cause harmful interference, and
- (2) This device must accept any interference received, including interference that may cause undesired operation.

Unauthorized changes or modification to this system can void the users authority to operate this equipment.
This equipment requires shielded interface cables in order to meet FCC class B Limit.

For Canada

NOTICE

This Class B digital apparatus meets all requirements of the Canadian Interference-Causing Equipment Regulations.

AVIS

Cet appareil numérique de la classe B respecte toutes les exigences du Règlement sur le matériel brouilleur du Canada.

For EU Countries



- UK** This symbol indicates that in EU countries, this product must be collected separately from household waste, as defined in each region. Products bearing this symbol must not be discarded together with household waste.
- DE** Dieses Symbol bedeutet, dass dieses Produkt in EU-Ländern getrennt vom Hausmüll gesammelt werden muss gemäß den regionalen Bestimmungen. Mit diesem Symbol gekennzeichnete Produkte dürfen nicht zusammen mit dem Hausmüll entsorgt werden.
- FR** Ce symbole indique que dans les pays de l'Union européenne, ce produit doit être collecté séparément des ordures ménagères selon les directives en vigueur dans chacun de ces pays. Les produits portant ce symbole ne doivent pas être mis au rebut avec les ordures ménagères.
- IT** Questo simbolo indica che nei paesi della Comunità europea questo prodotto deve essere smaltito separatamente dai normali rifiuti domestici, secondo la legislazione in vigore in ciascun paese. I prodotti che riportano questo simbolo non devono essere smaltiti insieme ai rifiuti domestici. Ai sensi dell'art. 13 del D.Lgs. 25 luglio 2005 n. 151.
- ES** Este símbolo indica que en los países de la Unión Europea este producto debe recogerse aparte de los residuos domésticos, tal como está regulado en cada zona. Los productos con este símbolo no se deben depositar con los residuos domésticos.
- PT** Este símbolo indica que nos países da UE, a recolha deste produto deverá ser feita separadamente do lixo doméstico, de acordo com os regulamentos de cada região. Os produtos que apresentem este símbolo não deverão ser eliminados juntamente com o lixo doméstico.
- NL** Dit symbool geeft aan dat in landen van de EU dit product gescheiden van huishoudelijk afval moet worden aangeboden, zoals bepaald per gemeente of regio. Producten die van dit symbool zijn voorzien, mogen niet samen met huishoudelijk afval worden verwijderd.
- DK** Dette symbol angiver, at i EU-lande skal dette produkt opsamles adskilt fra husholdningsaffald, som defineret i hver enkelt region. Produkter med dette symbol må ikke smides ud sammen med husholdningsaffald.
- NO** Dette symbolet indikerer at produktet må behandles som spesialavfall i EU-land, iht. til retningslinjer for den enkelte regionen, og ikke kastes sammen med vanlig husholdningsavfall. Produkter som er merket med dette symbolet, må ikke kastes sammen med vanlig husholdningsavfall.

- SE** Symbolen anger att i EU-länder måste den här produkten kasserars separat från hushållsavfall, i enlighet med varje regions bestämmelser. Produkter med den här symbolen får inte kasserars tillsammans med hushållsavfall.
- FI** Tämä merkintä ilmaisee, että tuote on EU-maissa kerättävä erillään kotitalousjätteistä kunkin alueen voimassa olevien määräysten mukaisesti. Tällä merkinnällä varustettuja tuotteita ei saa hävittää kotitalousjätteiden mukana.
- HU** Ez a szimbólum azt jelenti, hogy az Európai Unióban ezt a terméket a háztartási hulladéktól elkülönítve, az adott régióban érvényes szabályozás szerint kell gyűjteni. Az ezzel a szimbóllummal ellátott termékeket nem szabad a háztartási hulladék közé dobni.
- PL** Symbol oznacza, że zgodnie z regulacjami w odpowiednim regionie, w krajach UE produktu nie należy wyrzucać z odpadami domowymi. Produktów opatrzonych tym symbolem nie można utylizować razem z odpadami domowymi.
- CZ** Tento symbol udává, že v zemích EU musí být tento výrobek sbírán odděleně od domácího odpadu, jak je určeno pro každý region. Výrobky nesoucí tento symbol se nesmí vyhazovat spolu s domácím odpadem.
- SK** Tento symbol vyjadruje, že v krajinách EÚ sa musí zber tohto produktu vykonávať oddelene od domového odpadu, podľa nariadení platných v konkrétnej krajine. Produkty s týmto symbolom sa nesmú vyhazovať spolu s domovým odpadom.
- EE** See sümbol näitab, et EL-i maades tuleb see toode olemprügist eraldi koguda, nii nagu on igas piirkonnas määratletud. Selle sümboliga märgitud tooteid ei tohi ära visata koos olmeprügiga.
- LT** Šis simbolis rodo, kad ES šalyse šis produktas turi būti surenkamas atskirai nuo buitinių atliekų, kaip nustatyta kiekviename regione. Šiuo simboliu paženklinoti produktai neturi būti išmetami kartu su buitiniems atliekomis.
- LV** Šis simbols norāda, ka ES valstīs šo produktu jāievāc atsevišķi no mājsaimniecības atkritumiem, kā noteikts katrā reģionā. Produkta ar šo simbolu nedrīkst izmest kopā ar mājsaimniecības atkritumiem.
- SI** Ta simbol označuje, da je treba proizvod v državah EU zbirati ločeno od gospodinskih odpadkov, tako kot je določeno v vsaki regiji. Proizvoda s tem znakom ni dovoljeno odlagati skupaj z gospodinskimi odpadki.
- GR** Бхфь фп уэмвилл дзлоней ыфи уфйт чосет фэт ЕЕ. фп рспьн бхфь рсЭрей нб ухллЭрефбий оешейуфь брь фб пйкйбкь брпсЯммбфб, узмшнб ме фз нимпиеуб фэт кьне респнчЮт. Фб рспьнфб рпх иЭспн бхфь фп уэмвилл ден рсЭрей нб брпсЯрфпнфбий мбжЯ ме фб пйкйбкь брпсЯммбфб.

Roland®



* 0 4 5 6 4 7 7 8 - 0 2 *

04564778 07-04-2N