

Owner's Manual

Before using this unit, carefully read the sections entitled: "USING THE UNIT SAFELY" and "IMPORTANT NOTES" (separate sheet).

These sections provide important information concerning the proper operation of the unit. Additionally, in order to feel assured that you have gained a good grasp of every feature provided by your new unit, Owner's manual should be read in its entirety. The manual should be saved and kept on hand as a convenient reference.

* The "Mini Guide" on the back of the RC-20XL provides a simple explanation of use. You can use it as a reminder of operational procedures.

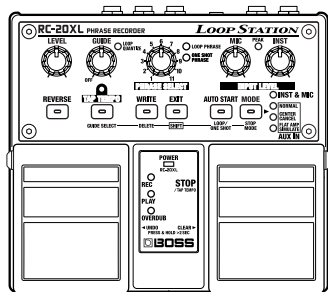

Main Uses

Here are some ways in which the RC-20XL can be used. You can use your own creativity to come up with other ways to enjoy using the RC-20XL.

■ "Sound On Sound" performance

New "sound on sound" possibilities let you combine performances not only of guitar, but also vocals, percussion, and drum pads.  p. 12

■ Create loop phrases

You can record phrases from a sampling CD or MD, and overdub guitar or vocals.  p. 14

■ Switch loops while you perform live

Multiple R&B or techno phrase loops can be stored, and selected successively while you perform (**Phrase Shift**).  p. 24

■ As a phrase trainer

Play your guitar while playing back phrases recorded from a CD or MD  p. 18

Practice at a different tempo without changing the pitch.  p. 21

Erase the guitar solo or vocal when recording, to create "minus-one" data for practicing (**Center Cancel**)  p. 20

■ As a backing device

Phrase trainer with a pedal that lets you start/stop or select phrases (One-shot Playback).  p. 22

■ Special effects during a live performance

Reverse-playback of a recorded phrase.  p. 26

Contents

Main features	3
Panel Descriptions	4
Front Panel.....	4
Rear Panel	7
Installing batteries	8
Making connections	9
Turning the power on/off	10
Important <Caution when turning off the power>	11
Recording a guitar or vocal performance to create a loop phrase	12
Recording a phrase from CD/MD to create a loop phrase	14
Playing/overdubbing along with a saved phrase	18
Using the RC-20XL for practicing—Phrase Trainer	20
Creating minus-one data	20
Practicing at a different tempo.....	21
Playing back in various ways	22
Playing a phrase only once (One-shot Playback).....	22
Selecting the Method of Stopping Playback (Stop Mode)	23
Using the pedal to switch phrases (Phrase Shift).....	24
When connecting two FS-5U.....	25
Play back a phrase backward (Reverse Playback)	26
Saving or deleting a phrase	28
About memory	28
Saving a phrase	29
Erasing a saved phrase (Delete).....	31
Write Protect mode.....	31
About the tempo and time signature	32
What is Loop Quantize?.....	32
Setting the tempo	33
Setting the time signature	34
About the guide tone	35
Troubleshooting	36
Specifications	38
Index	39

Main features

■ Simple and reliable loop play

The new “**loop quantize**” function automatically adjusts the timing of the loop end. This makes it easy for anyone to create looped phrases of an accurate length.

■ Up to 16 minutes of extended phrase recording

You can save up to eleven different loop phrases for a total of 16 minutes of recording.

■ Overdubbing undo/redo capability

If you make a mistake in overdubbing, you can cancel the action and restore the data to its condition before the overdub (undo). And if after undoing the overdub you decide that you want to use it after all, you can cancel the undo and restore the data to the state it was in right after the overdub (redo).

■ Control the phrase tempo in real time

The tempo of a phrase can be controlled in real time without affecting its pitch. A phrase recorded into internal memory can be made to match the tempo of a live performance, opening up new possibilities during a gig.

This feature is also useful when you wish to slow down the tempo of a guitar phrase to learn and practice it.

■ Dedicated mic input for vocalists

Since the INST jack and MIC jack can be used simultaneously, you can create new sound-on-sound performances that combine guitar, vocals, and percussion.

■ Selectable playback method to match your purpose

You can switch each loop phrase individually to one-shot playback.

You can also choose the mode used to stop playback to suit your needs, for example by fading out or stopping playback immediately upon reaching the end.

■ Easily record audio signals from a CD or MD

It's easy to record audio signals from a CD or MD connected to the AUX IN jack.

Since the vocal or guitar solo can be erased from the audio signal while it is being recorded, it's also easy to create minus-one data.

■ Pedal design for hands-free operation

You can use the pedals to start/stop the performance, switch phrases, and set the tempo without taking your hands off of your guitar.

Panel Descriptions

Front Panel

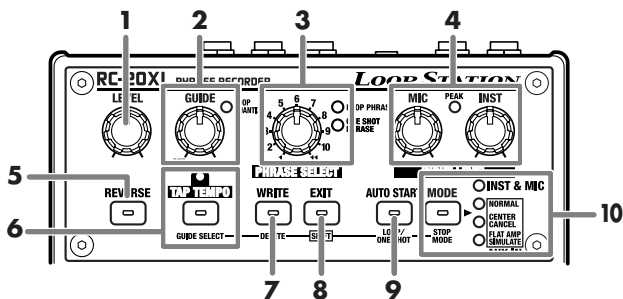

1

LEVEL Knob

This knob adjusts the play volume of the phrase.

* This knob does not adjust the input level from the INST/MIC/AUX IN jacks or the volume of the guide tone.

2

GUIDE Knob

This knob adjusts the volume of the guide tone that sounds according to the tempo while a phrase is being recorded or played.

LOOP QUANTIZE Indicator

This indicator lights when the Loop Quantize function (p. 32) is activated.

3

PHRASE SELECT Knob

This knob selects the phrase track that will be saved or played.

LOOP PHRASE Indicator

This indicator will light if a phrase has been saved in the selected track.

* The flashing light indicates there is not enough memory for recording or overdubbing (temporary memory; p. 28).

* The light flashes rapidly to indicate there is not enough memory to save the phrase.

* The light flashes rapidly while the loop phrase is read from memory. Be careful not to turn off the power while this light is flashing rapidly.

ONE SHOT PHRASE Indicator

This indicator will light if a one shot phrase has been saved in the selected track.

* The flashing light indicates there is not enough memory for recording or overdubbing (temporary memory; p. 28).

* The light flashes rapidly to indicate there is not enough memory to save the phrase.

* The light flashes rapidly while the one shot phrase is read from memory. Be careful not to turn off the power while this light is flashing rapidly.

When both the LOOP PHRASE indicator and ONE SHOT indicator are flashing

* If these indicators are flashing before recording, it indicates that there is insufficient memory for recording, so you will not be able to record.

* If the indicators flash after recording, it indicates that there is insufficient memory to undo (p. 6) the recording, so you may not be able to execute the undo.

4

MIC Knob

This knob adjusts the input level from the MIC jack.

INST Knob

This knob adjusts the input level from the INST jack.

PEAK Indicator

This indicator will light when the level of the input is excessively high.

5

REVERSE Button

Turn this button on (indicator lit) when you want the phrase to play back in reverse (p. 26).

6

TAP TEMPO Button

This button is used to set the tempo or time signature.

The indicator will light to indicate the current tempo and time signature (red on the first beat, green on subsequent beats).

- **Tempo**

Specify the tempo by the interval at which you press the button (p. 33).

- **Time signature**

When you press and hold the button for two seconds or longer, it will switch to time signature setting mode. Then press the button the number of times that is equivalent to the numerator of the desired time signature (p. 34).

- When this button is pressed while the SHIFT (EXIT) button is held down, it functions as the GUIDE SELECT button, allowing you to switch the guide sound (p. 35).

7

WRITE Button

- This button is used to save a recorded phrase into internal memory (p. 29).
- When this button is pressed while the SHIFT (EXIT) button is held down, it functions as the DELETE button, allowing you to delete the phrase on the selected track (p. 31).

8

EXIT (SHIFT) Button

This button is used to halt a phrase save or delete operation.

This is also used as a SHIFT button for switching the functions of other buttons.

9

AUTO START Button

- Turn this button on (indicator lit) if you want recording to begin simultaneously when the performance begins.
- When this button is pressed while the SHIFT (EXIT) button is held down, it functions as the LOOP/ONE SHOT button, allowing you to switch between phrase playback and one-shot playback for phrases saved to the selected track (p. 22).

** You cannot switch anything if there is no phrase saved (both the LOOP PHRASE and ONE SHOT PHRASE indicators are off). The unit remains set to loop playback.*

10

MODE Button

This button selects the recording method.

- When this button is pressed while the SHIFT (EXIT) button is held down, it functions as the STOP MODE button, allowing you to select the stop mode (p. 23).

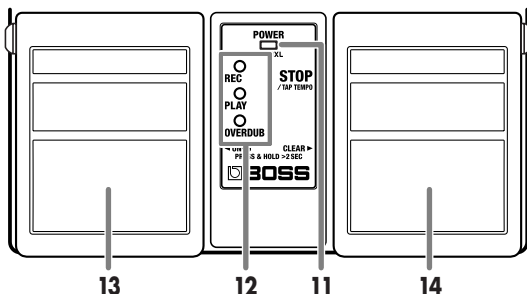

11

POWER Indicator

This indicator will light when the power is on.

** When the batteries run down, the POWER indicator will become dim. When this occurs, please replace them with new batteries.*

12

REC Indicator

This indicator will light during recording.

PLAY Indicator

This indicator will light while a phrase is playing.

OVERDUB Indicator

This indicator will light during overdubbing.

13

Left Pedal

- Provides for switching among phrase recording, playback, and overdubbing.
A phrase track in which no phrase is recorded: recording → playback → overdubbing
A phrase track in which a phrase has been recorded: playback → overdubbing
- You can undo the most recent overdub by holding down the pedal for at least two seconds. When you undo an overdub, the OVERDUB indicator flashes.
- By holding down the pedal for at least two seconds after an undo, you can restore (redo) the cancelled overdub to its condition before the undo. When you redo an overdub, the OVERDUB indicator flashes.

14

Right Pedal

- This stops recording, playback, and overdubbing of the phrase.
- You can set the tempo to the timing at which you press the pedal.
- If you press and hold the pedal for two seconds or longer, the unsaved phrase will be deleted (clear; p. 28).

Rear Panel

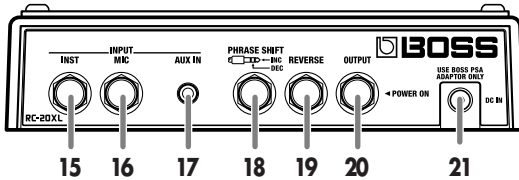

15

INST Jack

A guitar or other instrument can be connected to this jack.

16

MIC Jack

Accepts connection of a microphone. Used when you wish to record a vocal or instrumental performance via a microphone.

17

AUX IN Jack

Connect to the headphones jack of a CD or MD.

18

PHRASE SHIFT Jack

If you wish to use a pedal to switch the phrase track, connect a pedal switch (sold separately; e.g., FS-5U) to this jack.

** You can connect two FS-5U pedals using the special connection cable (the optional Roland PCS-31) (p. 25).*

19

REVERSE Jack

If you wish to use a pedal to play back the phrase in reverse, connect a pedal switch (sold separately; e.g., FS-5U) to this jack.

20

OUTPUT Jack

Connect a guitar amp or monitor speaker to this jack.

** If you are using batteries, the power will be turned on when you insert a plug (for connection to an amp or speaker) into the this jack.*

NOTE: Do not connect headphones to this jack. Doing so may damage the headphones.

21

AC Adaptor Jack

Connect an AC adaptor (sold separately; BOSS PSA series) to this jack.

Installing batteries

Insert the included batteries as shown in the diagram, being careful to observe the correct polarity.

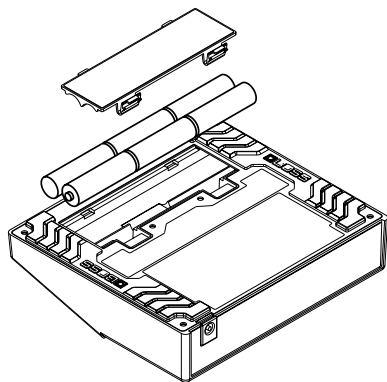

NOTE

- Batteries are supplied with the unit. The life of these batteries may be limited, however, since their primary purpose was to enable testing.
- When turning the unit upside-down, get a bunch of newspapers or magazines, and place them under the four corners or at both ends to prevent damage to the buttons and controls. Also, you should try to orient the unit so no buttons or controls get damaged.
- When turning the unit upside-down, handle with care to avoid dropping it, or allowing it to fall or tip over.
- Be sure to observe the correct + (positive) and - (negative) orientation of the batteries.
- When the batteries run down, the POWER indicator will become dim. When this occurs, please replace them with new batteries as soon as possible.
If the power is turned off while you are recording or overdubbing, all of the saved data may be lost (p. 11).
- When replacing the batteries, use six R6/LR6 (AA) batteries.
- Do not mix new batteries with previously used batteries or batteries of a different type. Doing so may cause battery leakage.
- The running time may be shorter depending on the type of batteries you use.

MEMO

Expected battery life under continuous use:

Carbon: 6 hours

Alkaline: 16 hours

These figures will vary depending on the actual conditions of use.

Making connections

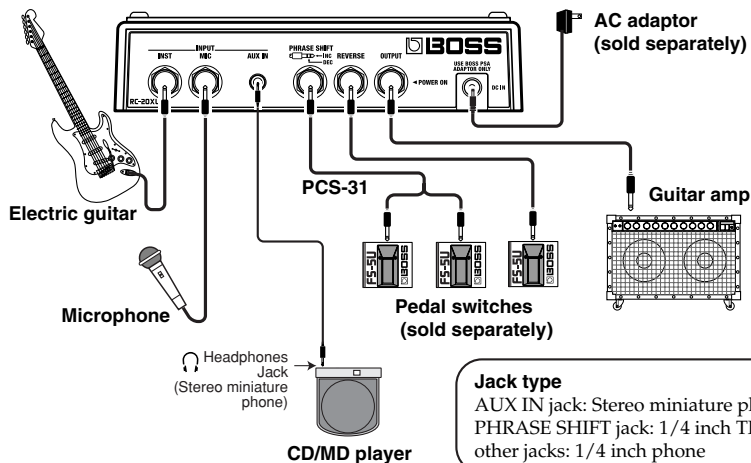

Jack type

AUX IN jack: Stereo miniature phone
PHRASE SHIFT jack: 1/4 inch TRS phone
other jacks: 1/4 inch phone

- * To prevent malfunction and/or damage to speakers or other devices, always turn down the volume, and turn off the power on all devices before making any connections.
- * Use a cable from Roland to make the connection. If using some other make of connection cable, please note the following precautions.
 - Some connection cables contain resistors. Do not use cables that incorporate resistors for connecting to this unit. The use of such cables can cause the sound level to be extremely low, or impossible to hear. For information on cable specifications, contact the manufacturer of the cable.
- * The use of an AC adaptor is recommended as the unit's power consumption is relatively high. Should you prefer to use batteries, please use the alkaline type.
- * If you are using batteries, the power will be turned on when a connector plug for your amp or speaker is inserted into the OUTPUT jack.
- * For details on installing the batteries, refer to "Installing batteries" (p. 8).
- * For details on pedal switches that can be connected to the PHRASE SHIFT jack and REVERSE jack, refer to p. 24, 26.
- * Do not connect headphones to the OUTPUT jack. Doing so may damage the headphones.

* *Howling could be produced depending on the location of microphones relative to amp. This can be remedied by:*

1. Changing the orientation of the microphone(s).
2. Relocating microphone(s) at a greater distance from speakers.
3. Lowering volume levels.

* *If the amp and microphone are close together, the sound played back from the amp may be picked up by the microphone. If you record or overdub in such a state, the amp playback picked up by the microphone will also be recorded. You should separate the amp and microphone so that the playback from the amp is not picked up by the microphone.*

Turning the power on/off

Once the connections have been completed, turn on power to your various devices in the order specified. By turning on devices in the wrong order, you risk causing malfunction and/or damage to speakers and other devices.

When turning the power on: Turn on the power of the amp or mixer **last**.

When turning the power off: Turn off the power of the amp or mixer **first**.

* *Always make sure to have the volume level turned down before switching on power. Even with the volume all the way down, you may still hear some sound when the power is switched on, but this is normal, and does not indicate a malfunction.*

* *If you are using batteries, the indicator will become darker when the batteries run down. Please replace the batteries as soon as possible.*



When turning on the power while a recorded track is being selected (the LOOP PHRASE or ONE SHOT PHRASE indicator is lit), the indicators on the front panel flash in a sequential order, and the LOOP PHRASE or ONE SHOT PHRASE indicator flashes rapidly for a few seconds.

Important <Caution when turning off the power>

Before you turn off the power, make sure that the following conditions are met.

All saved data may be lost if the power is turned off inappropriately.

- You must not be playing/recording/overdubbing a phrase
(The REC, PLAY, and OVERDUB indicators must not be lit)
- The WRITE indicator or EXIT indicator must not be lit
- The LOOP PHRASE or ONE SHOT PHRASE indicator is not flashing rapidly

If you are using batteries, the power will be turned off automatically when the connector plug to your amp or speaker is unplugged from the OUTPUT jack. Before unplugging this connector, make sure you check for the above states.

To avoid problems, select an empty phrase track whenever possible, and turn off/on the power.

Recording a guitar or vocal performance to create a loop phrase



On the RC-20XL, the process of recording an additional performance while a recorded performance plays back is called **overdubbing**.

The performance from an instrument or microphone connected to the INST jack or MIC jack can be recorded to create a loop phrase. This lets you enjoy new types of sound-on-sound playing that combine guitar, percussion, or drum pad performances.

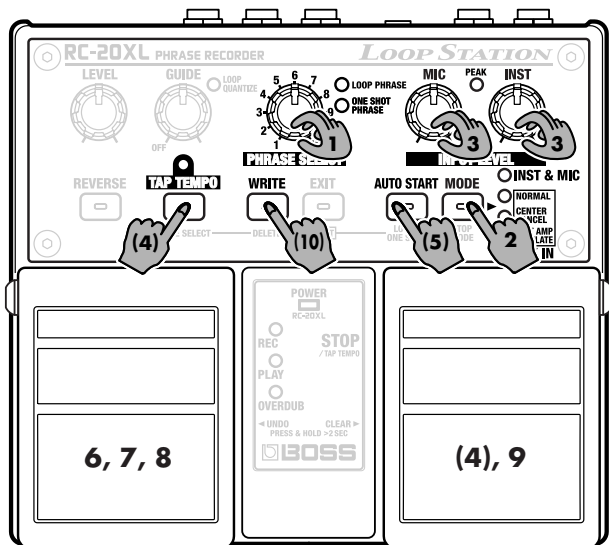

1. Select an empty phrase track
2. Select the recording method
3. Adjust the recording level
4. (Tempo setting) ← If you are recording to a tempo
5. (Auto Start setting) ← If you wish to start recording when the performance begins
6. Start recording
7. Stop recording, and start playback
8. Start/stop overdubbing
9. Stop playback
10. (Save the phrase) ← If you wish to save the phrase

1. Turn the PHRASE SELECT knob to select an empty phrase track 1–11.

If there are any empty phrase tracks, both the LOOP PHRASE and ONE SHOT PHRASE indicators remain off.

If there are no empty phrase tracks, or when the LOOP PHRASE and ONE SHOT PHRASE indicators flash, indicating that the memory is full, delete any unnecessary phrases to free up some memory (p. 31).

2. Press the MODE button to get the INST & MIC indicator to light.

3. While you produce sound on your microphone or instrument, turn the MIC knob or INST knob to adjust the recording level.

Adjust the volume so that the PEAK indicator lights occasionally.

4. Set the tempo by pressing the TAP TEMPO button or the right pedal several times in time with the tempo of the phrase you wish to record.

* For details on setting the tempo, refer to “Setting the tempo” (p. 33).

* If you are recording a phrase of a time signature other than 4/4, you must also set the time signature (p. 34).

5. If you want recording to begin the moment you start playing, turn the AUTO START button on (indicator lit).

6. Press the left pedal to begin recording.

If Auto Start is on, recording will begin the moment you start playing.

If you have specified the tempo, recording will begin one measure after you press the left pedal.

If you have not specified the tempo, recording will begin the moment you press the left pedal.

* If the internal memory is used up, recording or overdubbing may stop before you are finished. If this occurs, erase unnecessary phrases (p. 31), and try the operation again.

7. Press the left pedal to stop recording.

Simultaneously, the recorded phrase will begin playing.

* Regardless of the timing at which you press the left pedal, the length of the phrase will be automatically adjusted in units of a measure, so that the loop phrase can be created correctly (Loop Quantize p. 32). This means that a certain amount of time may be required from when you press the left pedal until recording stops.

* The minimum length of time required for a loop phrase is approximately 1.5 seconds. If the phrase you've recorded is shorter than that, the length of the phrase will be adjusted automatically, and then recording will stop (p. 37).

8. If you wish to overdub onto the phrase, press the left pedal.

Each time you press the left pedal, the playback and overdubbing modes will alternate.

9. When you are finished with playback or overdubbing, press the right pedal.

10. Press the WRITE button, getting the indicator to start flashing. To save the data in the same phrase track, press the WRITE button once again.

If you wish to save the data to a different phrase track, press the WRITE button (so its indicator is flashing), use the PHRASE SELECT knob to select the desired save destination, then press the WRITE button once again.

* For details on saving, refer to “Saving a phrase” (p. 29).

Recording a phrase from CD/MD to create a loop phrase

You can create a loop phrase by recording a performance from a CD or MD connected to the AUX IN jack. For example, you can record phrases from a sampling CD and overdub guitar or vocal onto it, or even record an entire song from an audio CD and use it for practicing.

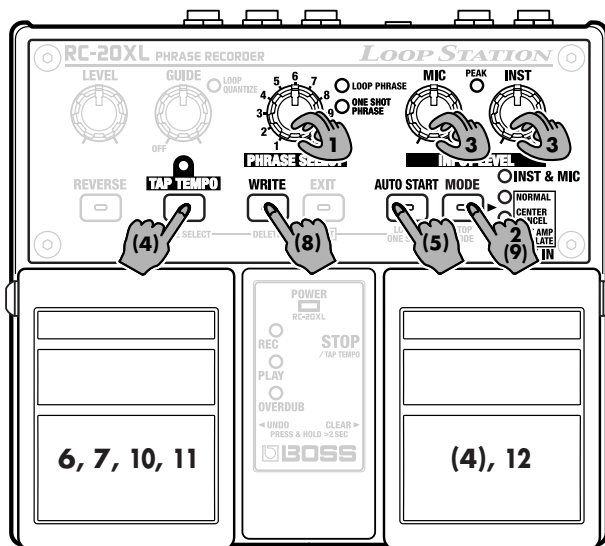

1. Select an empty phrase track
2. Select the recording method
3. Adjust the recording level
4. (Tempo setting) ←If you are recording to a tempo
5. (Auto Start setting)←If you wish to start recording when the performance begins
6. Start recording
7. Stop recording, start playback
8. (Save the phrase) ←If you wish to keep the phrase
9. (Select the overdubbing method)←If you wish to change the overdubbing method
10. Start playback
11. Start/stop overdubbing
12. Stop playback

1. Turn the PHRASE SELECT knob to select an empty phrase track 1–11.

If there are any empty phrase tracks, both the LOOP PHRASE and ONE SHOT PHRASE indicators remain off.

If there are no empty phrase tracks, or when the LOOP PHRASE and ONE SHOT PHRASE indicators flash, indicating that the memory is full, delete any unnecessary phrases to free up some memory (p. 31).

2. Press the MODE button to select the recording method.**• NORMAL+FLAT AMP SIMULATE**

Apply the Flat Amp Simulator effect to the sound being recorded.

• CENTER CANCEL+FLAT AMP SIMULATE

Sounds localized at the center will be erased, and then the Flat Amp Simulator effect will be applied to the sound being recorded.

* *If an effect such as reverb has been applied to the sounds localized at the center, it may not be possible to erase the sound completely.*

• NORMAL

The performance from the CD or MD will be recorded as is.

• CENTER CANCEL

Sounds localized at the center (such as vocals or guitar solo) will be erased from the sound being recorded.

The Flat Amp Simulator effect

Guitar amps are designed with a frequency response that is optimized for guitar playing. For this reason, when a phrase recorded from CD or MD is played back through a guitar amp, the low-frequency and high-frequency ranges will be emphasized in comparison to the mid-range. The Flat Amp Simulator compensates the frequency response during recording, so that the recorded (i.e., non-guitar) performance will sound correct when played through your guitar amp.

3. While playing back the CD/MD, use the volume control of the CD/MD player to adjust the recording level.

Adjust the volume so that the PEAK indicator lights occasionally.

4. If you set the tempo before recording, press the TAP TEMPO button or the right pedal several times in time with the tempo of the phrase you wish to record.

* *For details on setting the tempo, refer to “Setting the tempo” (p. 33).*

* *If you are recording a phrase of a time signature other than 4/4, you must also specify the time signature (p. 34).*

5. To have recording start simultaneously with playback of a CD or MD, set the AUTO START button to ON (with the indicator lit).

When AUTO START button is on, stop the CD/MD player for now, and put it in playback-ready mode.

6. Press the left pedal to begin recording.

If the AUTO START button is on, recording will begin the moment the CD/MD begins to play.

If the AUTO START button is off, recording will begin the moment you press the left pedal. Listen to the sound of the CD/MD, and press the left pedal at the appropriate time.

* *If the internal memory is used up, recording or overdubbing may stop before you are finished. If this occurs, erase unnecessary phrases (p. 31), and try the operation again.*

7. Press the left pedal to stop recording.

Simultaneously, the recorded phrase will begin playing. The tempo of the phrase will also be set automatically.

* *The automatic tempo setting is calculated with a time signature of 4/4. If you are recording a phrase whose time signature is different, you must specify the time signature before recording (p. 34).*

* *The minimum length of time required for a loop phrase is approximately 1.5 seconds. If the phrase you've recorded is shorter than that, the length of the phrase will be adjusted automatically, and then recording will stop (p. 37).*

8. Press the WRITE button, getting the indicator to start flashing. When you do so, playback will stop automatically. To save the data in the same phrase track, press the WRITE button once again.

If you wish to save the data in a different phrase track, press the WRITE button (so its indicator is flashing), use the PHRASE SELECT knob to select the desired save destination, and then press the WRITE button once again.

* *For details on saving, refer to "Saving a phrase" (p. 29).*



We recommend that you save the phrase at this point. If you are not content with the results of subsequent overdubbing, you can then cancel only the overdubbing.

9. Press the MODE button to select how overdubbing will occur.

As you did in step 2, select the overdubbing method. If you wish to overdub a performance from guitar or mic, select INST & MIC.

10. Press the left pedal to begin playback.

11. When you wish to overdub (p. 12) along with the phrase, press the left pedal.

Each time you press the left pedal, you will switch between playback and overdubbing modes.

- **To cancel (undo) the most recently recorded overdub, hold down the left pedal for at least two seconds. When you undo an overdub, the OVERDUB indicator flashes.**

* *You cannot undo if the unit only has a slight amount of memory left (the OVERDUB indicator does not flash even if the left pedal is held down for two seconds or more).*

- **To restore (redo) a cancelled overdub, hold down the left pedal again for at least two seconds. When you redo an overdub, the OVERDUB indicator flashes.**
- **To undo all overdubbed sounds (clear), hold down the right pedal for at least two seconds. Cleared overdubs cannot be restored.**

* *If the internal memory is used up, overdubbing may stop before you are finished. If this occurs, erase unnecessary phrases (p. 31), and try the operation again.*

12. To stop playback and overdubbing, press the right pedal.

<CAUTION>

- Unauthorized recording, distribution, sale, lending, public performance, broadcasting, or the like, in whole or in part, of a work (musical composition, video, broadcast, public performance, or the like) whose copyright is held by a third party is prohibited by law.
- Do not use this unit for purposes that could infringe on a copyright held by a third party. We assume no responsibility whatsoever with regard to any infringements of third-party copyrights arising through your use of this unit.
- Use of the Sound Library for RC-20XL (Sample Phrase CD) supplied with this product for any purpose other than private, personal enjoyment without the permission of the copyright holder is prohibited by law. Additionally, this data must not be copied, nor used in a secondary copyrighted work without the permission of the copyright holder.

Playing/overdubbing along with a saved phrase

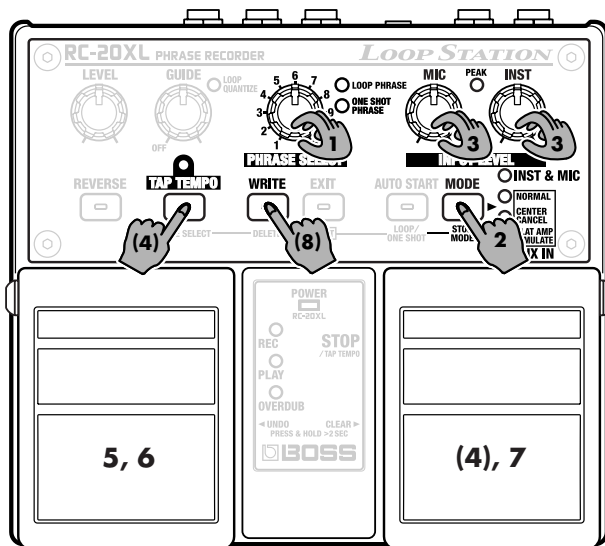

1. Select a phrase track
2. Select the recording method
3. Adjust the recording level
4. (Adjust the tempo)
5. Start playback
6. Start/stop overdubbing
7. Stop playback
8. (Save the phrase)

-
1. Turn the **PHRASE SELECT** knob to select the phrase track in which the desired phrase is saved.

The LOOP PHRASE or ONE SHOT PHRASE indicator flashes rapidly while the phrase is read from memory.

-
2. Press the **MODE** button to get the INST & MIC indicator to light.

3. Turn the MIC knob or INST knob to adjust the recording level.

4. If necessary, press the TAP TEMPO button several times to set the tempo.

You can also set the tempo by pressing the right pedal instead of the TAP TEMPO button.

- * For details on setting the tempo, refer to “Setting the tempo” (p. 33).
 - * It is not possible to adjust the tempo beyond a certain limit.
-

5. Press the left pedal to begin playback.

6. When you wish to overdub along with the phrase, press the left pedal.

Each time you press the left pedal, you will switch between playback and overdubbing modes.

- **To cancel (undo) the most recently recorded overdub, hold down the left pedal for at least two seconds. When you undo an overdub, the OVERDUB indicator flashes.**
 - * You cannot undo if the unit only has a slight amount of memory left (the OVERDUB indicator does not flash even if the left pedal is held down for two seconds or more).
 - **To restore (redo) a cancelled overdub, hold down the left pedal again for at least two seconds. When you redo an overdub, the OVERDUB indicator flashes.**
 - **To undo all overdubbed sounds (clear), hold down the right pedal for at least two seconds. Cleared overdubs cannot be restored.**
 - * If the internal memory is used up, overdubbing may stop before you are finished. If this occurs, erase unnecessary phrases (p. 31), and try the operation again.
-

7. When you are finished playing or overdubbing, press the right pedal.

8. Press the WRITE button, getting the indicator to start flashing. To save the data in the same phrase track, press the WRITE button once again.

If you wish to save the data in a different phrase track, press the WRITE button (so its indicator is flashing), use the PHRASE SELECT knob to select the desired save destination, and then press the WRITE button once again.

- * For details on saving, refer to “Saving a phrase” (p. 29).
 - * If you continue looping in Overdub mode, unwanted noise will also be recorded repeatedly. You should use Overdub mode only while recording a phrase.
-

Using the RC-20XL for practicing—Phrase Trainer

When recording a song from CD or MD, you can erase vocals or guitar solos that locate at the center of the sound field. This function makes it easy to create “minus-one” data for practicing.

You can also adjust the tempo while the phrase plays back. Changing the tempo of the song will not affect the pitch. This is convenient when you wish to slow down the tempo for practicing.

Creating minus-one data

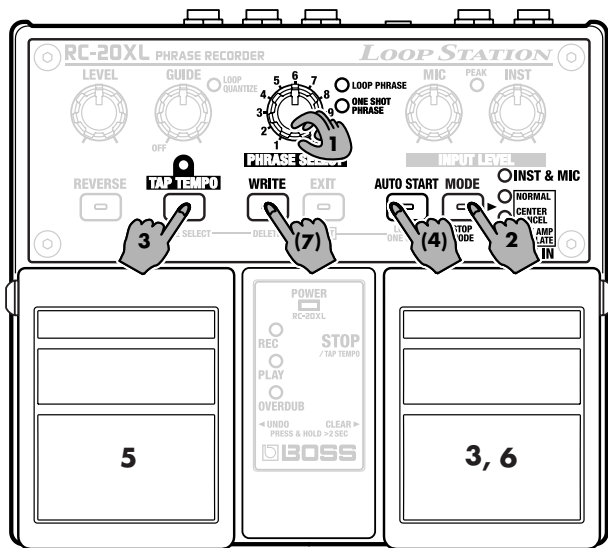

1. Turn the PHRASE SELECT knob to select an empty phrase track 1–11.

If there are any empty phrase tracks, both the LOOP PHRASE and ONE SHOT PHRASE indicators remain off.

If there are no empty phrase tracks, or when the LOOP PHRASE and ONE SHOT PHRASE indicators flash, indicating that the memory is full, delete any unnecessary phrases to free up some memory (p. 31).

2. Press the MODE button to select the recording method.

If you wish to play the recorded phrase through a monitor speaker, select “CENTER CANCEL.” If you wish to play through a guitar amp, select “CENTER CANCEL+FLAT AMP SIMULATE.”

* *If an effect such as reverb has been applied to the sounds localized at the center, it may not be possible to erase the sound completely.*

3. If you set the tempo before recording, press the TAP TEMPO button or the right pedal several times in time with the tempo of the phrase you wish to record.

4. If you want recording to begin at the moment the performance starts, turn the AUTO START button on (indicator lit).

5. Press the left pedal to start recording.

* *If the internal memory is used up, recording or overdubbing may stop before you are finished. If this occurs, erase unnecessary phrases (p. 31), and try the operation again.*

6. Press the right pedal to stop recording.

When recording ends, the tempo of the phrase will be assigned automatically.

* *The automatic tempo setting is calculated with a time signature of 4/4. If you are recording a phrase whose time signature is different, you must set the time signature before recording (p.34).*

7. Press the WRITE button, getting the indicator to start flashing. To save the data in the same phrase track, press the WRITE button once again.

If you wish to save the data in a different phrase track, press the WRITE button (so its indicator is flashing), use the PHRASE SELECT knob to select the desired save destination, and then press the WRITE button once again.

* *For details on saving, refer to “Saving a phrase” (p. 29).*

Practicing at a different tempo

To change the tempo while the phrase is playing, press the TAP TEMPO button several times at the desired interval.

The tempo of the phrase will change temporarily.

* *For details on changing the tempo, refer to “Setting the tempo” (p. 33).*

* *It is not possible to adjust the tempo beyond a certain limit.*



If you wish to keep the modified tempo, save the phrase (p. 29).

Playing back in various ways

Playing a phrase only once (One-shot Playback)

Phrases saved to Phrase Tracks 1–11 are initially set to loop playback (with the LOOP PHRASE indicator lit), but **you can switch the phrase settings to one-shot playback by holding down the SHIFT (EXIT) button and pressing the LOOP/ONE SHOT (AUTO START) button.**

This feature is handy when, for example, you want to have one-shot playback of saved phrases used for playing live twin guitar solos or effects sounds.

- * *When you want to have One-Shot Playback remain in effect constantly, switch to One-Shot Playback, then save the phrase (“Saving a phrase” (p. 29)).*

Loop Playback

The phrase is played repeatedly from beginning to end until the right pedal is pressed.

One-Shot playback

The phrase plays one time from beginning to end and then stops automatically.

- * *Overdubbing is disabled when one-shot playback is in effect. When the left pedal is pressed during playback of the phrase, the phrase starts playing from the beginning again (retrigger playback).*
If you want to overdub, first switch to loop playback.

Selecting the Method of Stopping Playback (Stop Mode)

Phrases stops playing immediately when the right pedal is pressed during playback of the phrase, but you can set the phrase to stop playing after fading out or after the end of the phrase is reached.

You can use this function for natural-sounding fadeouts and to simplify stopping playback right at the end of the phrase.

- * *You cannot switch the stop mode during One-Shot playback. Pressing the right pedal immediately stops playback.*
- * *When you save a phrase after switching the stop mode, the stop mode is also saved at the same time (“Saving a phrase” (p. 29)).*

1. Hold down the SHIFT (EXIT) button and press the STOP MODE (MODE) button (continue to hold down the SHIFT button).

The flashing of the AUX IN indicators shows which stop mode is currently selected.

- **NORMAL indicator flashing:** Pressing the right pedal stops playback immediately.
- **CENTER CANCEL indicator flashing:** Playback stops after fadeout.
 - * *If the right pedal is pressed during overdubbing, overdub ends at that point.*
 - * *The PLAY indicator flashes until playback stops.*
 - * *You can still stop playback immediately by pressing the right pedal once again while the phrase is fading out.*
 - * *You cannot overdub while the phrase is fading out.*
- **FLAT AMP SIMULATE indicator flashing:** Playback stops after the phrase is played to the end.
 - * *If the right pedal is pressed during overdubbing, overdub ends at that point.*
 - * *The PLAY indicator flashes until playback stops.*
 - * *You can still stop playback immediately by pressing the right pedal once again until playback stops.*
 - * *You cannot overdub until playback stops.*

2. While continuing to hold down the SHIFT (EXIT) button, press the STOP MODE (MODE) button to switch the stop mode.

3. Release the SHIFT (EXIT) button.

Using the pedal to switch phrases (Phrase Shift)

While a phrase is playing, you can press a pedal switch connected to the PHRASE SHIFT jack to switch to the phrase track of the following number.

It is convenient to store the phrases in consecutive phrase tracks according to the order in which you intend to perform them.



If you prepare Intro, looped phrase, and Ending, you can use the Phrase Shift to play them back as a song.

1. Connect a pedal switch such as the FS-5U (sold separately) to the PHRASE SHIFT jack (p. 9).

- * Pedal switches made by another manufacturer may operate in the opposite way. Such pedal switches cannot be used.
- * If you are using the FS-5U, move the polarity switch toward the jack.
- * The FS-5L cannot be used.

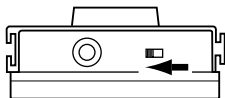

2. Turn the PHRASE SELECT knob to select the phrase that you wish to play first.

- * If the phrase has not been saved, it will be deleted when you switch to a different phrase. For more on saving phrases, refer to "Saving a phrase" (p. 29).

3. Press the left pedal to begin playing the phrase.

4. When you want to switch phrases, press the pedal switch.

The PLAY indicator flashes the same count as the number for the phrase to be played next, then flashes rapidly, and repeats this pattern.

The unit switches to the phrase with the next number (or, if that is empty, the phrase after that) at the timing used in returning to the start of the loop.

When the phrase is switched, the PLAY indicator flashes the same count as the number for the phrase currently being played, then remains lit, and repeats this pattern.

- * When the number of the next phrase to be played back matches the phrase number indicated by the PHRASE SELECT knob, the PLAY indicator flashes rapidly, then remains lit when the phrases are switched.
- You can advance to any phrase while the current phrase is playing by pressing the pedal switch the corresponding number of times.
 - * Empty phrase tracks are disregarded. For example, when you press the pedal switch one time while the Number 1 phrase is playing, if Number 2 is empty, the unit will switch to Number 3.

- When you switch to a phrase set to **One-Shot Playback**, the phrase is played to the end, and then playback stops.
- If you use **Phrase Shift** during **One-Shot Playback**, the phrase is played to the end, then the unit switches to the next phrase.



The unit may not switch to the next phrase if you carry out Phrase Shift while the end of the phrase is approaching. Use Phrase Shift while there is still ample time to carry it out.



After carrying out the switch operation, you cannot change the tempo or switch to Reverse Playback until the phrases are switched.

5. Press the right pedal to stop playback.

When you start playback again, the phrase selected with the PHRASE SELECT knob will play.



You can also use Phrase Shift with the PHRASE SELECT knob.

If, while a phrase is playing back, you turn the PHRASE SELECT knob to select the phrase track that will be played next, the next phrase will begin at the moment that the currently playing phrase returns to the loop start.

When connecting two FS-5U

You can connect two FS-5U pedals using the special connection cable (the optional Roland PCS-31).

- Pressing the FS-5U to which the plug with the white stripe has been connected switches phrase tracks as follows: 1→2→3...11→1... (switches to the next higher track number).
- Pressing the FS-5U to which the plug with the red stripe has been connected switches phrase tracks as follows: 11→10→9...1→11... (switches to the previous lower track number).

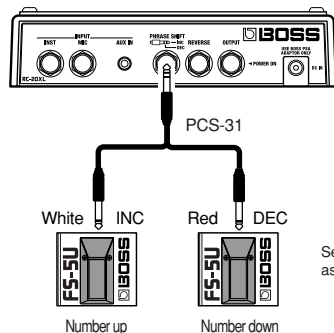

Set the polarity switch as shown in the figure.

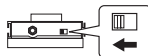

Play back a phrase backward (Reverse Playback)

Playing a recorded phrase from the end toward the beginning is called “reverse playback.” The result is similar to playing a tape in reverse.

By pressing the REVERSE button, lighting its indicator, you can use reverse playback. To return to normal playback, extinguish the indicator.

Since this can produce unexpected results, it may be useful as a gimmick during a live performance.

- * *If you save a phrase with the REVERSE button turned on, the state of the button will also be memorized. If you will always want a certain phrase to play back in reverse, you should save it with the REVERSE button turned on. (“Saving a phrase” (p. 29))*
- * *If you overdub onto a phrase that plays back in reverse, the sound you’ve overdubbed is recorded as being for normal playback.*
- * *When you switch to reverse playback while playback is in progress, the phrase begins to play in the opposite direction, starting from the point in the loop that maintains the loop’s duration. This allows you to switch to reverse playback at any point in the phrase you like without changing the duration of the loop.
Example: When you switch to reverse playback one measure from the start of the phrase, reverse playback then starts one measure from the end of the phrase.*
- * *You cannot switch to Reverse Playback under the following conditions.*
 - *While phrases are being switched (while the PLAY indicator is flashing)*
 - *While changing the tempo (while the LOOP PHRASE or ONE SHOT PHRASE indicator is flashing)*



You can also control reverse playback by using the pedal switch instead of the REVERSE button.

Connect a pedal switch such as the FS-5U (sold separately) to the REVERSE jack (p. 9).

- * *Pedal switches made by some other manufacturer may operate in the opposite way. Such pedal switches cannot be used.*
- * *If you are using the FS-5U, move the polarity switch toward the jack.*
- * *The FS-5L cannot be used.*

MEMO

Saving or deleting a phrase

About memory

The memory of the RC-20XL is divided into two areas: phrase tracks 1–11 and temporary memory.

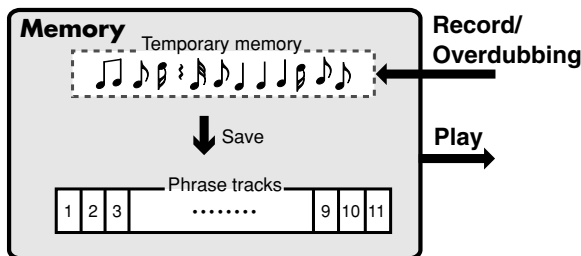

A phrase that you record or overdub is first stored in temporary memory. The phrase stored in temporary memory is temporary, and will be erased when the following operations occur.

- When you turn off the power
- When you select a different phrase track

Before you perform any of these operations, make sure to save the phrase in a phrase track if you wish to keep it (p. 29).

If the overdubbing produces a phrase that you like, save it to the phrase track before using the next procedure. Once the data is saved to the phrase tracks, it can be called up anytime afterwards.



If you wish to erase (**clear**) only the phrase in temporary memory, press and hold the right pedal for two seconds or longer.

What is a phrase track?

A phrase track is an area of internal memory in which phrases are stored. Phrases that are saved here will not be lost when the power is turned off. Also, phrases that are saved here can be selected at any time by using the PHRASE SELECT knob. The phrases that can be saved in phrase tracks 1–11 can have a maximum total length of 16 minutes.



You can only change the playback tempo (p. 33) of phrases saved to the phrase tracks. To change the playback tempo of a phrase stored in temporary memory immediately following overdubbing or recording, save it to a phrase track.

Saving a phrase

When you have finished recording/overdubbing, or after you have edited the tempo or other settings of a phrase, you can save it.



All phrases that have not been saved are lost when you turn off the power or select a different phrase track.

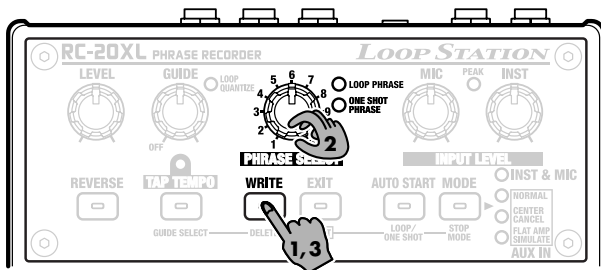

1. Press the WRITE button, getting the indicator to start flashing.

The RC-20XL will be ready to save.

* To copy the data, select the copy-source phrase track, and press the WRITE button.

2. Use the PHRASE SELECT knob to select the unused or empty track.

- * It is not possible to save to a phrase track that already contains a phrase (the LOOP PHRASE or ONE SHOT PHRASE indicator will be lit).
- * The LOOP PHRASE and ONE SHOT PHRASE indicators flash when there is not enough memory to save the phrase.

3. Press the WRITE button once again to save the phrase. To cancel this operation, press EXIT button.

While the data is being saved, the indicator will light. When saving is complete, the indicator goes out.

- * Depending on the length of the phrase, it may take some time for the save to be completed.
- * If you decide not to save, press the EXIT button. However, if you have turned the PHRASE SELECT knob to select another phrase track, the recorded phrase will be lost when you press the EXIT button, and you will switch to the selected phrase.

<CAUTION>

- Never turn off the RC-20XL's power while the WRITE indicator or the EXIT indicator is lit. Doing so will cause all data saved in the phrase tracks to be lost.
- Please be aware that the contents of memory can be irretrievably lost as a result of a malfunction, or the improper operation of the unit. To protect yourself against the risk of losing important data, we recommend that you periodically save a backup copy of important data you have stored in the unit's memory on an MD, or other device.
- During repairs, due care is taken to avoid the loss of data. However, in certain cases (such as when circuitry related to memory itself is out of order), we regret that it may not be possible to restore the data.
- Unfortunately, it may be impossible to restore the contents of data that was stored in the unit's memory once it has been lost. Roland Corporation assumes no liability concerning such loss of data.

Erasing a saved phrase (Delete)

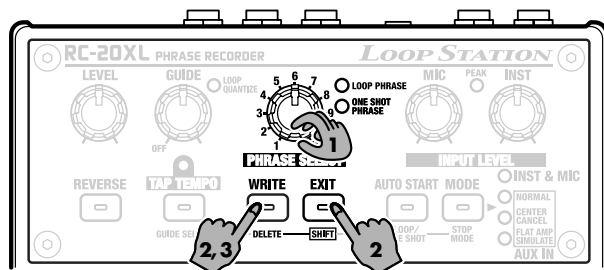

1. Turn the PHRASE SELECT knob to select the phrase track that you wish to delete.
2. Simultaneously press the SHIFT (EXIT) button and the DELETE (WRITE) button to get both indicators to flash.
The RC-20XL will be ready to delete the data.
3. Press the DELETE (WRITE) button to delete the data.
To cancel this operation, press the EXIT button.

The indicator will be lit while the data is being deleted, and will go out when the deletion is complete.



Never turn off the RC-20XL's power while the WRITE indicator or the EXIT indicator is lit. Doing so will cause all data saved in the phrase tracks to be lost.

* It is not possible to delete all phrase tracks in one operation.

Write Protect mode

You can temporarily prevent phrases from being saved or erased. This condition is called "Write Protect mode."

To select Write Protect mode, hold down the WRITE button as you turn on the power. Confirm that all four indicators to the right of the MODE button are lit, then release the button.

This setting will be cleared when you turn off the power, so the next time power is turned on, you will once again be able to save or erase phrases.

About the tempo and time signature

The RC-20XL allows you to set the tempo and time signature separately for each phrase. These settings also determine how the guide tone will play, and how loop quantization will occur. This means that if the tempo and time signature are correctly set before recording, it will be easy to create a correct loop phrase.

- * *The default time signature is 4/4. If you are recording a phrase with a 4/4 time signature, it is not necessary to set the time signature.*

What is Loop Quantize?

The timing at which you stop recording the phrase is very important in order to create an accurately looped phrase. When using devices other than the RC-20XL, it was necessary to become skilled at operating the pedal, through much practice.

The RC-20XL, however, has Loop Quantize function that automatically corrects the length of the phrase by referring to the information in the Tempo settings so that an accurately looped phrase can be created even if recording is stopped at a slightly inaccurate timing.

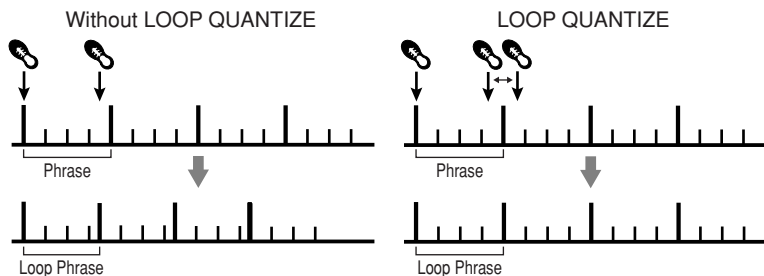

- * *Loop Quantize is valid only when you have set the tempo before recording (the LOOP QUANTIZE indicator will be lit). If you have not set the tempo before recording, or during overdubbing, the Loop Quantize function is not active (LOOP QUANTIZE indicator extinguished).*

About automatic tempo settings

When a phrase is recorded without a specific tempo setting, the tempo is then set automatically after the recording is finished.

- * *The automatic tempo setting calculates the tempo premised on recording with a time signature (beat) of 4/4 and four beats per measure. If you are recording phrases with other beats, set the beat using the procedure on p. 34 before recording.*

Setting the tempo

If you are recording a performance from an instrument or microphone connected to the INST or MIC jacks, set the tempo before recording.

You can change the tempo for playing back the stored phrase.

- * If you change the playback tempo, then store the phrase, the modified tempo will be stored. If you do not save it, the tempo change will be lost.

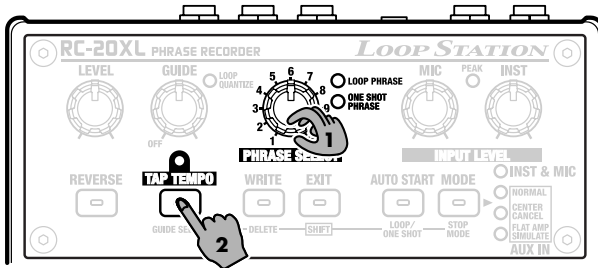

1. Turn the PHRASE SELECT knob to select the phrase track you wish to use.

If you are recording a new phrase, select the track you wish to record.

2. Press the TAP TEMPO button several times at the desired tempo.

The tempo will be set according to the intervals at which you press the button.

- * The tempo can also be set by pressing the right pedal instead of the TAP TEMPO button. However, the right pedal cannot be used while a phrase is playing.
- * You cannot set the tempo for phrases that are looped over an interval shorter than the minimum recording time (approximately 1.5 seconds).
- * If you wish to record a new phrase at the same tempo and time signature as the previously-selected phrase, press the TAP TEMPO button / right pedal once.
- * By starting recording without setting the tempo, you can create a loop phrase without using the Loop Quantize function.



You can only change the playback tempo of phrases saved to the phrase tracks. To change the playback tempo of a phrase stored in temporary memory immediately following overdubbing or recording, save it to a phrase track (p. 29).

Setting the time signature

If you are recording a phrase with a time signature of other than 4/4, set the correct time signature before recording.

- * It is not possible to change the time signature after recording.
- * It is not possible to set a time signature whose denominator is anything other than 4.

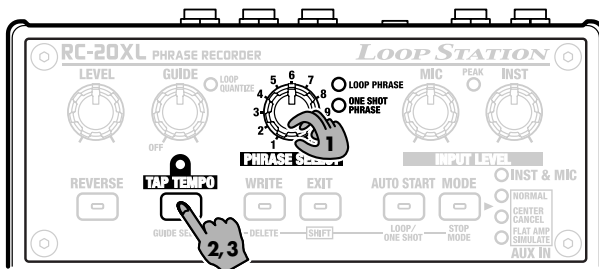

- 1. Turn the PHRASE SELECT knob to select the phrase track you wish to record.**
- 2. Press and hold the TAP TEMPO button for two seconds or longer.**
The indicator will flash, then go out, and you will be able to set the time signature.
- 3. Press the TAP TEMPO button as many times as the time signature you wish to set.**
When you have finished setting the time signature, the indicator will flash, and you will automatically return to the state in which you can make tempo settings.



If you hold down the TAP TEMPO button to set the beat immediately after setting the tempo, the action of the button being pressed is interpreted as setting the tempo, and you may end up inadvertently changing the tempo as a result. Be sure to leave a brief interval between setting the tempo and setting the beat.

About the guide tone

A guide tone will sound while you are playing or recording a phrase.

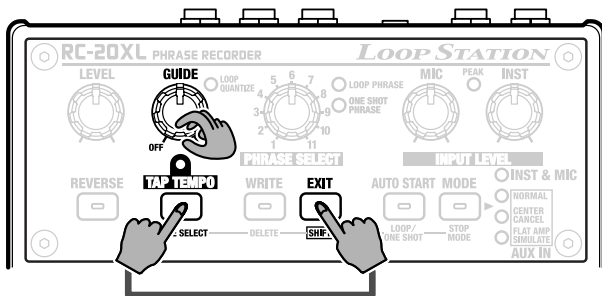

Changing the sound of the guide tone

The volume of the guide tone can be adjusted with the GUIDE knob.

If you do not wish to hear the guide tone, turn the GUIDE knob to the OFF position.

If you wish to change the sound of the guide tone, hold down the SHIFT (EXIT) button and press the GUIDE SELECT (TAP TEMPO) button several times.

Each time you press the GUIDE SELECT (TAP TEMPO) button, the guide tone will change (eight types).

* When you save a phrase (p. 29), the currently selected guide tone will also be remembered.



The guide tone will not be heard when you record a phrase for which no tempo has been set. However, the tempo will be calculated automatically when you have finished recording, and the guide tone will play during playback.

Troubleshooting

Power does not turn on

- **Is an amp or speaker connected to the OUTPUT jack?**
 - If you are using batteries, the power will not turn on unless an amp or speaker is connected to the OUTPUT jack. Check the connections (p. 9).
- **Have the batteries run down?**
 - Install new batteries (p. 8).
- **Is the correct AC adaptor (sold separately) connected?**
 - Check the connections once again (p. 9).

No sound/not loud enough

- **Have the connections to other devices been made correctly?**
 - Check the connections once again (p. 9).
- **Has the volume been turned down on the connected guitar amp or other device?**
 - Check the settings of the connected device.
- **Could you be using a connection cable that contains a resistor?**
 - Use a connection cable that does not contain a resistor.

Recorded/overdubbed sound cannot be heard or is too quiet

→ Use the LEVEL knob to adjust the volume.

Guide tone cannot be heard/is not loud enough

- Use the GUIDE knob to adjust the volume.
- The guide tone will sound when:
 - you've set the tempo before recording to an empty phrase
 - you play back a phrase

Recording/overdubbing ends prematurely

→ You have run out of memory. Delete unneeded phrases (p. 31), and perform the recording/overdubbing once again.

Recording does not end immediately when you press the pedal

→ Since the phrase length is adjusted automatically when you record with Loop Quantize or record a phrase that is shorter than the minimum recording time (approximately 1.5 seconds), recording may not stop immediately after you press the pedal.

Recording begins immediately even though the Auto Start function is on

→ If there is a significant amount of noise (for example due to distortion), that noise may be enough to trigger the beginning of recording. Reduce the noise (for example by lowering the distortion level).

The LOOP PHRASE or ONE SHOT PHRASE indicator flashes even though there should be time remaining for recording

→ In the situations listed below, temporary memory for overdubbing (p. 28) is allocated separately from the phrase. Since any calculation of available recording time must take such temporary memory into account, the LOOP PHRASE or ONE SHOOT PHRASE indicator may flash.

- When a phrase is selected
- When the playback tempo is changed
- When a phrase is saved

Recorded a short phrase, but the length of the phrase has changed

→ The minimum length of time required for a loop phrase is approximately 1.5 seconds. If the phrase you've recorded is shorter than that, the length is automatically multiplied by a factor of two, four, eight, or more until it reaches an acceptable length.

Unable to switch to Reverse Playback

→ You cannot switch to Reverse Playback under the following conditions.

- While phrases are being switched (while the PLAY indicator is flashing)
- While changing the tempo (while the LOOP PHRASE or ONE SHOT PHRASE indicator is flashing)

Unable to change the playback tempo

→ You cannot change the playback tempo under the following conditions.

- If the phrase has not been saved
- If you are using overdubbing
- While phrases are being switched (while the PLAY indicator is flashing)
- While you are setting the tempo for phrases that are looped over an interval shorter than the minimum recording time (approximately 1.5 seconds).

Automatically set tempo is odd

→ When a phrase shorter than the minimum recording time (approximately 1.5 seconds) is recorded with more than five beats set, the guide sound may play half the beats. If this occurs, record the phrase over again with the recording lasting twice as long.

Specifications

Nominal Input Level

INST:	-20 dBu (variable)
MIC:	-40 dBu (variable)
AUX IN:	-10 dBu

Input Impedance

INST:	1 M Ω
MIC:	1 k Ω
AUX IN:	47 k Ω

Nominal Output Level

OUTPUT: -20 dBu

Output Impedance

1 k Ω

Recommended Load Impedance

10 k Ω or greater

Internal Memory

Recording time: 16 min. (max.)
Maximum number of saved phrases:
11 phrases (max.)

Controls

REC/PLAY/OVERDUB Pedal,
STOP/TAP TEMPO Pedal,
INST Knob, MIC Knob,
PHRASE SELECT Knob, GUIDE Knob,
LEVEL Knob, REVERSE Button,
TAP TEMPO Button, WRITE Button,
EXIT Button, AUTO START Button,
MODE Button

Indicators

POWER (serves also as battery check indicator), REC, PLAY, OVERDUB, PEAK, LOOP QUANTIZE, LOOP PHRASE, ONE SHOT PHRASE, TAP TEMPO, REVERSE, WRITE, EXIT, AUTO START, MODE, INST & MIC, NORMAL, CENTER CANCEL, FLAT AMP SIMULATE

Connectors

INST Jack (1/4 inch phone type)
MIC Jack (1/4 inch phone type)
AUX IN Jack (Stereo miniature phone type)
PHRASE SHIFT Jack (1/4 inch TRS phone type)
REVERSE Jack (1/4 inch phone type)
OUTPUT Jack (1/4 inch phone type)
AC Adaptor Jack

Power

DC 9V: Dry battery (R6/LR6 (AA) type) x 6
AC Adaptor (PSA-series)

Power Consumption

120 mA (9 V max.)

* Expected battery life under continuous use:
Carbon: 6 hours
Alkaline: 16 hours
These figures will vary depending on the actual conditions of use.

Dimensions

173 (W) x 158 (D) x 57 (H) mm
6-13/16 (W) x 6-1/4 (D) x 2-1/4 (H) inches

Weight

1.2 kg / 2 lbs 11 oz (including batteries)

Accessories

Owner's Manual
Leaflet ("USING THE UNIT SAFELY,"
"IMPORTANT NOTES," and "Information")
Dry battery (AA type) x 6
Sound Library for RC-20XL (Sample
Phrase CD)

Options

AC Adaptor (PSA-series)
Foot Switch (FS-5U)

- * 0 dBu = 0.775 Vrms
- * In the interest of product improvement, the specifications and/or appearance of this unit are subject to change without prior notice.

Index

A

AUTO START 13, 16, 21

B

Batteries 8

C

CENTER CANCEL 15, 20

Clear 17, 19, 28

Connections 9

D

Delete 31

E

Erasing

 Data saved in the phrase tracks 31

 Only the phrase in temporary memory 28

F

FLAT AMP SIMULATE 15, 20

Flat Amp Simulator 15

G

Guide tone 35

L

Loop Playback 22

Loop Quantize 13, 32

LOOP/ONE SHOT 5, 22

M

Minimum length of recording time 37

Minus-one data 20

O

One-shot Playback 22

Overdubbing 12–13, 17

P

Pedal 24

Phrase Shift 24

Phrase track 28

Phrase Trainer 20

Playback 13, 17

Playing 19

Power 10

R

Recording

 From a device connected to the AUX IN
 jack 14

 From a device connected to the INST jack
 or MIC jack 12

Redo 6, 17, 19

Retrigger playback 22

Reverse Playback 26

S

Saving 29

Sound-on-sound 12

STOP MODE 5

Stop Mode 23

T

TAP TEMPO 21, 33

Tempo 21, 32

Temporary memory 28

Time signature 32, 34

U

Undo 6, 17, 19

W

Write Protect mode 28, 31



This product complies with the requirements of European Directive 89/336/EEC.

For EU Countries

FEDERAL COMMUNICATIONS COMMISSION RADIO FREQUENCY INTERFERENCE STATEMENT

For the USA

This equipment has been tested and found to comply with the limits for a Class B digital device, pursuant to Part 15 of the FCC Rules. These limits are designed to provide reasonable protection against harmful interference in a residential installation. This equipment generates, uses, and can radiate radio frequency energy and, if not installed and used in accordance with the instructions, may cause harmful interference to radio communications. However, there is no guarantee that interference will not occur in a particular installation. If this equipment does cause harmful interference to radio or television reception, which can be determined by turning the equipment off and on, the user is encouraged to try to correct the interference by one or more of the following measures:

- Reorient or relocate the receiving antenna.
- Increase the separation between the equipment and receiver.
- Connect the equipment into an outlet on a circuit different from that to which the receiver is connected.
- Consult the dealer or an experienced radio/TV technician for help.

This device complies with Part 15 of the FCC Rules. Operation is subject to the following two conditions:

- (1) This device may not cause harmful interference, and
- (2) This device must accept any interference received, including interference that may cause undesired operation.

Unauthorized changes or modification to this system can void the users authority to operate this equipment.
This equipment requires shielded interface cables in order to meet FCC class B Limit.

For Canada

NOTICE

This Class B digital apparatus meets all requirements of the Canadian Interference-Causing Equipment Regulations.

AVIS

Cet appareil numérique de la classe B respecte toutes les exigences du Règlement sur le matériel brouilleur du Canada.



BOSS Corporation

G6017384