

 Roland

MIDI INTELLIGENT ARRANGER

PRO-E

Owner's Manual

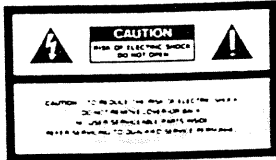

The lightning flash with arrowhead symbol, within an equilateral triangle, is intended to alert the user to the presence of uninsulated "dangerous voltage" within the product's enclosure that may be of sufficient magnitude to constitute a risk of electric shock to persons.



The exclamation point within an equilateral triangle is intended to alert the user to the presence of important operating and maintenance (servicing) instructions in the literature accompanying the product.

ADVARSEL!

Lithiumbatteri. Eksplosionsfare.
Udskiftning må kun foretages af en sagkyndig.
og som beskrevet i servicemanual.

WARNING!

Lithiumbatteri. Explosionsrisk.
Får endast bytas av behörig servicetekniker.
Se instruktioner i servicemanualen.

ADVARSEL!

Lithiumbatteri. Fare for eksplosion.
Må bare skiftes av kvalifisert tekniker som
beskrevet i servicemanualen.

VAROITUS!

Lithiumparisto. Rajahdysvaara.
Pariston saa vaihtaa ainoastaan
alan ammottimies.

IMPORTANT SAFETY INSTRUCTIONS

WARNING When using electric products, basic precautions should always be followed, including the following:

- 1 Read all the instructions before using the product.
- 2 To reduce the risk of injury, close supervision is necessary when a product is used near children.
- 3 Do not use this product near water— for example, near a bathtub, washbowl, kitchen sink, in a wet basement, or near a swimming pool, or the like.
- 4 This product should be used only with a cart or stand that is recommended by the manufacturer.
- 5 This product, either alone or in combination with an amplifier and headphones or speakers, may be capable of producing sound levels that could cause permanent hearing loss.
Do not operate for a long period of time at a high volume level or at level that is uncomfortable. If you experience any hearing loss or ringing in the ears, you should consult an audiologist.
- 6 The product should be located so that its location or position does not interfere with its proper ventilation.
- 7 The product should be located away from heat sources such as radiators, heat registers or other products that produce heat.
- 8 The product should avoid using in where it may be effected by dust.
- 9 The product should be connected to a power supply only of the type described in the operating instructions or as marked on the product.
- 10 The power-supply cord of the product should be unplugged from the outlet when left unused for a long period of time.
- 11 Do not tread on the power-supply cord.
- 12 Do not pull the cord but hold the plug when unplugging.
- 13 When setting up with any other instruments, the procedure should be followed in accordance with instruction manual.
- 14 Care should be taken so that objects do not fall and liquids are not spilled into the enclosure through openings.
- 15 The product should be serviced by qualified service personnel when:
 - A The power-supply cord or the plug has been damaged; or
 - B Objects have fallen, or liquid has been spilled into the product; or
 - C The product has been exposed to rain; or
 - D The product does not appear to operate normally or exhibits a marked change in performance; or
 - E The product has been dropped, or the enclosure damaged.
- 16 Do not attempt to service the product beyond that described in the user-maintenance instructions. All other servicing should be referred to qualified service personnel.

SAVE THESE INSTRUCTIONS

NOTICE

This digital apparatus does not exceed the Class B limits for radio noise emission set out in the Radio Interference Regulations of the Canadian Department of Communications.

AVIS

Cet appareil numérique ne dépasse pas les limites de la classe B au niveau des émissions de bruits radio-électriques fixés dans le Règlement des signaux parasites par le Ministère canadien des Communications.

WARNING

THIS APPARATUS MUST BE EARTH GROUNDED.

The three conductors of the mains lead attached to this apparatus are identified with color as shown in the table below, together with the matching terminal on the UK type power plug. When connecting the mains lead to a plug, be sure to connect each conductor to the correct terminal, as indicated.

"This instruction applies to the product for United Kingdom."

MAINS LEADS		PLUG
Conductor	Color	Mark on the matching terminal
Live	Brown	Red or letter L
Neutral	Blue	Black or letter N
Grounding	Green-Yellow	Green, Green-Yellow, letter E or symbol

Bescheinigung des Herstellers / Importeurs

Hiermit wird bescheinigt, daß der/die/das
ROLAND PRO-E INTELLIGENT ARRANGER
(Gerät Typ Bezeichnung)

in Übereinstimmung mit den Bestimmungen der
Amtsbl. Vfg. 1046 / 1984

(Administrativbeleg)

Funk-entstört ist

Der Deutschen Bundespost wurde das Inverkehrbringen dieses Gerätes
angezeigt und die Berechtigung zur Überprüfung der Serie auf Einhaltung
der Bestimmungen eingeräumt

Roland Corporation Osaka Japan

Name des Herstellers / Importeurs

RADIO AND TELEVISION INTERFERENCE

Warning This equipment has been verified to comply with the limits for a Class B computing device pursuant to Subpart J of Part 15 of FCC rules. Operation with non-certified or non-verified equipment is likely to result in interference to radio and TV reception.

The equipment described in this manual generates and uses radio frequency energy. If it is not installed and used properly (that is, in strict accordance with our instructions), it may cause interference with radio and television reception.

This equipment has been tested and found to comply with the limits for a Class B computing device in accordance with the specifications in Subpart J of Part 15 of FCC Rules. These rules are designed to provide reasonable protection against such a interference in a residential installation. It does not guarantee that the interference will not occur in a particular installation. If this equipment does cause interference to radio or television reception, which can be determined by turning the equipment on and off, the user is encouraged to try to correct the interference by the following measures:

- Disconnect other devices and their input/output cables one at a time. If the interference stops, it is caused by either the other device or its I/O cable.
- These devices usually require Roland designed shielded I/O cables. For Roland devices, you can obtain the proper shielded cable from your dealer. For non-Roland devices, contact the manufacturer or dealer for assistance.
- If your equipment does cause interference to radio or television reception, you can try to correct the interference by using one or more of the following measures:
 - Turn the TV or radio antenna until the interference stops.
 - Move the equipment to one side or the other of the TV or radio.
 - Move the equipment farther away from the TV or radio.
 - Plug the equipment into an outlet that is on a different circuit than the TV or radio. (That is, make certain the equipment and the radio or television set are on circuits controlled by different circuit breakers or fuses.)
 - Consider installing a radio/television antenna with coaxial cable lead-in between the antenna and TV.
- If necessary, you should consult your dealer or an experienced radio/television technician for additional suggestions. You may find helpful the following booklet prepared by the Federal Communications Commission:
 - How to Identify and Resolve Radio-TV Interference Problems.

This booklet is available from the U.S. Government Printing Office, Washington, D.C. 20540. Stock No. 048-000-00345-4.

FEATURES

- The PRO-E is a 32 partial, polyphonic synthesized arranger complete with a 37-note, dynamic keyboard.
- The PRO-E uses Roland's Linear Arithmetic Synthesis (LA sound)
- The LCD (Liquid Crystal Display) provides information and directions to the player while programming the many features of the PRO-E making operation quicker and easier.

Thank you for purchasing the Roland PRO-E Intelligent Arranger.

The PRO-E is an easy-to-operate arranger instrument that anyone can use.

It gives you the benefit of Roland's superior digital technology.

The PRO-E uses the same Linear Arithmetic synthesis used by our D-series professional synthesizers. The 128 tones, 33 Special Effects plus 4 Effect mixtures and 30 percussion sounds of the PRO-E offer you an excellent natural range of sound.

The musical functions of the PRO-E add the fantastic modern musical sounds of other instruments to your keyboard playing.

This Owner's Manual is written to help you have many years of musical enjoyment with your PRO-E.

- [1] BALANCE section
(See page 21)
- [2] REVERB EFFECT section
(See page 45)
- [3] MEMORY CARD section
(See page 77)
- [4] COMPOSER section
(See page 71)
- [5] MODE/TRACK section
- [6] ARRANGER section
(See page 24)
- [7] STYLE/TONE SELECT section
(See page 27)
- [8] FUNCTION section
(See page 49)
- [9] MIDI button
(See page 85 & MIDI Manual)
- [10] PARAMETER button
- [11] CURSOR button
- [12] TRANSPOSE button
(See page 48)
- [13] MELODY INTELLIGENCE
(See page 44)
- [14] MIDI MESSAGE LED
(See page 85 & MIDI Manual)
- [15] TEMPO LEDs
(See page 29)
- [16] DISPLAY WINDOW (LCD)
- [17] MASTER VOLUME control
(See page 13)
- [18] FADE IN/OUT section
(See page 47)
- [19] SOUND EFFECTS section
(See page 40)
- [20] ARRANGER LOOP buttons
(See page 31)
- [21] USER PROGRAM buttons (Bank
& Number) (See page 60)
- [22] ADVANCED ARRANGER
button (See page 26)
- [23] FILL-IN buttons
(See page 26)
- [24] BREAK MUTE/TAP TEMPO
button (See pages 27/29)
- [25] INTRO/ENDING button
(See page 30)
- [26] START/STOP button
- [27] TEMPO/FUNCTION Dial
(See page 47)
- [28] PITCH BEND/MODULATION
Lever (See page 44)
- [29] AC Socket
- [30] POWER SWITCH
- [31] MEMORY/STYLE CARD slot
- [32] MIDI Sockets
- [33] FOOTSWITCH Socket
- [34] Stereo OUT Sockets
- [35] Headphone Socket

CONTENTS

PANEL DESCRIPTION	3
FEATURES	5
IMPORTANT NOTES	8
THE CARE OF YOUR PRO-E ...	9
CONNECTIONS	10
OPERATION	
POWER ON	12
MASTER VOLUME	13
KEYBOARD MODES	
SOLO Mode	14
LOWER Mode	14
SOLO/LOWER Mode	14
MANUAL BASS Mode	15
SOLO/MANUAL BASS Mode ..	15
LOWER/MANUAL BASS Mode	15
TONE SELECT	
SOLO TONE SELECT	17
LOWER TONE SELECT	18
MANUAL BASS TONE SELECT	19
TONE BALANCE	
SOLO BALANCE	21
LOWER BALANCE	22
MANUAL BASS BALANCE ..	22
ARRANGER SECTION	
ARRANGER Mode	25
ADVANCED ARRANGER ...	26
VARIATION	26
FILL-IN	26
BREAK MUTE	27
HOLD	27
MUSIC STYLE SELECT	27
STARTING THE STYLE	28
TEMPO LEDs	29
TEMPO CONTROL	29
TAP TEMPO	29
SYNC START	30
INTRO/ENDING	30
STOPPING THE STYLE	30
SYNC STOP	30
ARRANGER LOOP	31
STYLE VOLUME BALANCE ...	
ACCOMPANIMENT BALANCE	33
ACCOMP BASS BALANCE ...	35
ACCOMP DRUM BALANCE ..	36
SOLO/ARRANGER Mode	
LOWER/ARRANGER Mode ..	37
MANUAL DRUMS Mode	37
MANUAL DRUM SOUNDS AND KEY ASSIGNMENT	
SOUND EFFECTS Mode	40
SOUND EFFECTS AND KEY ASSIGNMENT	41
SOUND EFFECTS PAD ASSIGNMENT	43
SOUND EFFECTS VOLUME BALANCE	43
PITCH BENDER/ MODULATION	44
MELODY INTELLIGENCE ..	44
REVERB EFFECT	
REVERB ON/OFF	45

REVERB TYPE	45
REVERB PART ASSIGN	46
FADE	47
OUT	47
IN	47
TEMPO/FUNCTION DIAL ...	47
TRANSPOSE	48
FUNCTIONS	
MASTER TUNE	49
FOOTSWITCH ASSIGN	50
PITCH BENDER RANGE	51
OCTAVE RANGE	51
SOLO	52
LOWER	52
MANUAL BASS	53
ACCOMP 1/2/3 BALANCE	
ENABLE	53
ACCOMP/MANUAL BASS	
BALANCE ENABLE	54
SOUND EFFECTS Style sync .	54
ARRANGER CHORD	
INTELLIGENCE	55
PLAY INTELLIGENT	
CHORDS	56
INTERNAL MEMORY	
protection	59
USER PROGRAMS	60
FACTORY PRESET USER	
PROGRAMS 11 to 18	61
WRITING A PANEL	
CONFIGURATION	69
LOADING FACTORY USER	
PROGRAMS INTO THE	
PRO-E	70
COMPOSER	71
RECORDING A SONG	72
PUNCH IN RECORD	74
TRACK ERASE	75
PLAYING BACK A SONG	76
MEMORY CARD	77
WRITING DATA ONTO THE	
CARD	77
LOADING DATA FROM THE	
CARD INTO THE PRO-E	80
ERROR MESSAGES	82
STYLE CARD	83
PLAYING STYLES FROM	
THE CARD	83
ERROR MESSAGES	83
DEMO SONGS	84
MIDI CONTROL	85
CONNECTIONS	85
MIDI MESSAGE LED	85
128 TONES AVAILABLE BY	
EXTERNAL MIDI	
PROGRAM CHANGE	89
MIDI FUNCTION, VALUES	
AND CHANNELS	90
CHANGING MIDI VALUES	
AND CHANNELS	92
IF YOUR PRO-E FAILS TO	
OPERATE	93
DEFAULT SETTING (Prg. 0) ..	94
SPECIFICATIONS	95
PANEL SETTING MEMO	96
MIDI IMPLEMENTATION	97

IMPORTANT NOTES

- The appropriate power supply for the instrument is shown on its name plate. Please make sure that the line voltage in your country meets the requirements
- Use only the AC cord provided.
- Please do not use the same socket used for any noise generating device (such as a motor, variable lighting system).
- It is normal for this unit to become hot while being operated.
- If the unit is not to be used for a long period of time, unplug the AC cord from the socket.
- Disconnect the AC cord immediately in the event of an electrical storm.
- Before setting up this keyboard with other MIDI devices, turn this keyboard off along with all other units.
- Be sure to connect the MIDI cables securely. If the MIDI cable is disconnected while the Arranger is being played, various troubles will occur (e.g. the note may continue to sound).
- Static electricity may cause the built-in computer to malfunction. Should this occur, simply reset the instrument by turning the power switch off and then after a few seconds, back on.
- This instrument might not operate correctly if turned on immediately after being turned off. If this happens, simply turn it off and after a few seconds later, turn it on again.
- Operating the PRO-E near a neon light, fluorescent lamp, TV or CRT display, may cause noise interference. If so, change the position of the instrument.
- To avoid risk of electric shock, do not perform any servicing. Refer all servicing to qualified service personnel.

THE CARE OF YOUR PRO-E

To ensure the best use and full enjoyment of your PRO-E, please read this guide carefully and thoroughly.

ROOM LOCATION

Avoid using this instrument in excessive heat or humidity conditions or where it may be affected by direct sunlight or dust and avoid places subject to high vibrations.

CABINET CARE

Use a soft dry cloth for dusting. To remove fingerprints or dulling film, use a soft cloth slightly dampened with water and a little mild detergent. Immediately wipe dry with a soft cloth. Do not use solvents such as paint thinners.

CONNECTIONS:

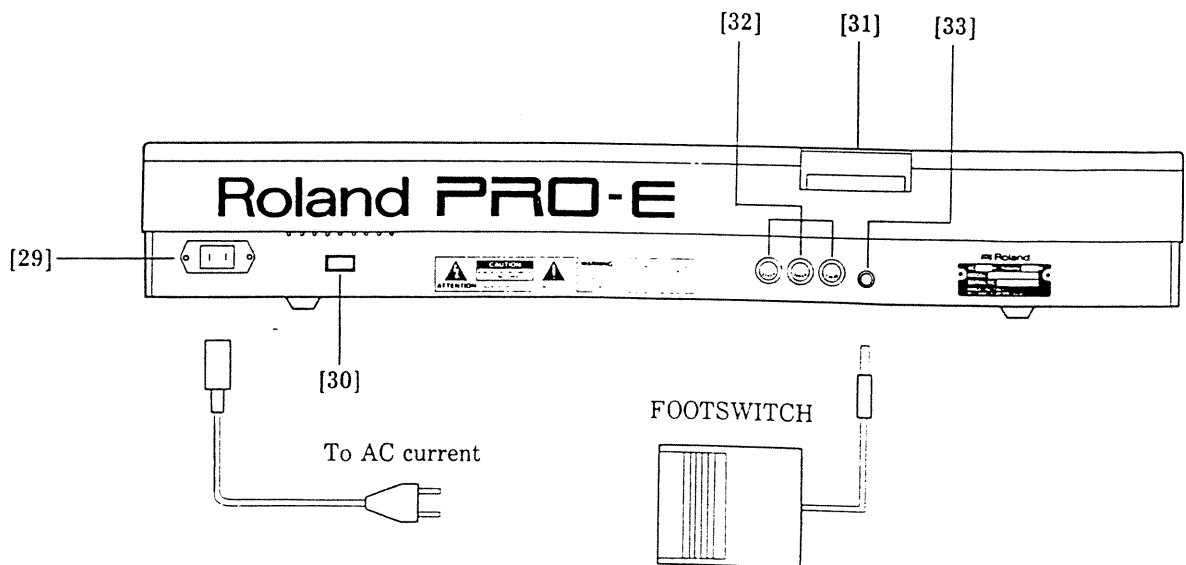
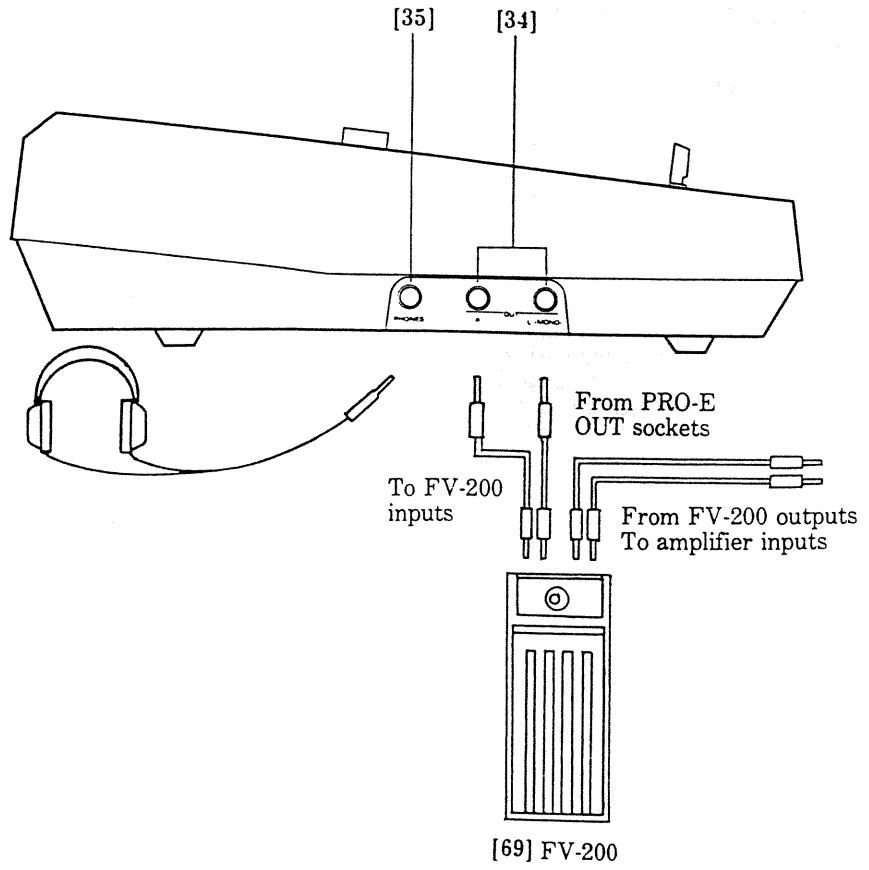

- (29) AC Socket
To connect with household AC current, use the AC power cord supplied with your PRO-E.
- (30) POWER Switch
- (31) Memory Card Slot
Insert optional Memory Card or Music Style Card here.
See MEMORY CARD and STYLE CARD.
- (32) MIDI Sockets
See MIDI CONTROL
- (33) FOOTSWITCH Socket
Using the optional footswitch (DP-2/DP-6), various functions can be controlled by the foot.
See FOOTSWITCH ASSIGN
- (34) Stereo OUT Sockets
These sockets are used to amplify the sound of the PRO-E. When connecting to a Mono amplifier, always use the «L (mono)» OUT socket.
- (35) Headphones (PHONES) Socket
For your playing convenience, connect a set of standard stereo headphones (RH-12/RH-100) into this socket and you can play and practice in private. The Master Volume control will adjust the headphones overall volume.
- (69) FV-200 Stereo Expression Pedal
See page 13 for details.

OPERATION

POWER ON

Press the Power On/Off switch on the rear panel of the PRO-E [30].

The display window [16] will respond with:

This is shown for a few seconds.

ROLAND PRO-E
INTELL. ARRANGER

After a few seconds the display changes to:

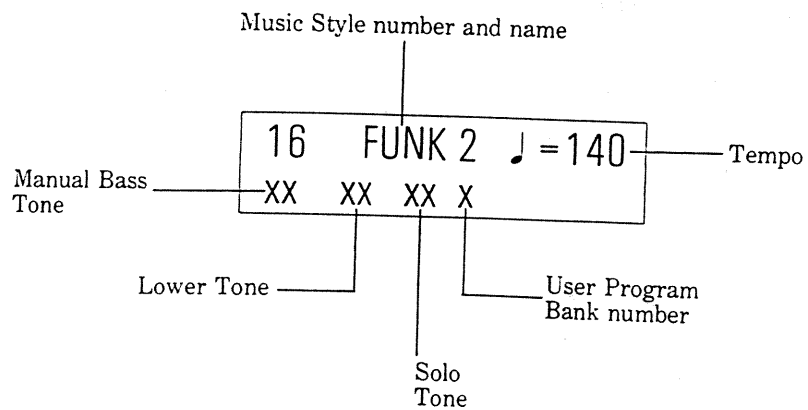

Throughout this text, this will be referred to as the Master Display.

MASTER VOLUME

Make sure that the MASTER VOLUME control [17] is turned to the central position.

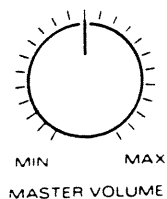

The Master Volume control enables the overall volume of the PRO-E to be raised (rotating the control clockwise) or lowered (rotating the control counterclockwise). This control will also control the overall volume when using headphones.

<REFERENCE>

When connecting to external amplification, an optional stereo expression pedal (FV-200) can be used to control the overall volume. See the following illustration for connecting procedures.

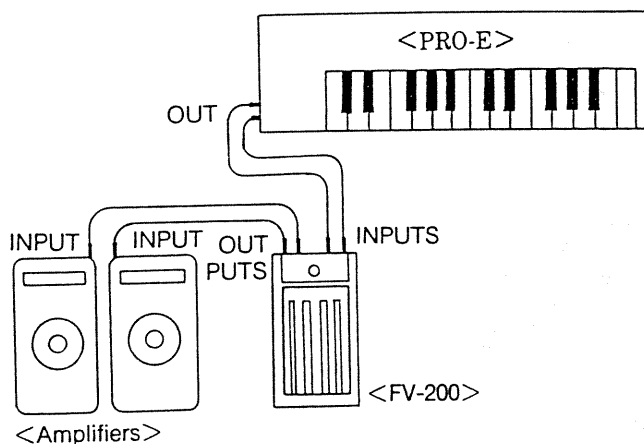

1. Be sure to turn the PRO-E and any other amplification system Off.
2. Connect the PRO-E to the FV-200 by inserting a couple of shielded cords into the PRO-E OUT and the FV-200 INPUT sockets.
3. Connect the FV-200 to an amplification system with two additional shielded cords inserted into the FV-200 OUTPUT sockets.
4. Turn the switches of all instruments ON and adjust the Master Volume control of the PRO-E.
5. Make sure that the overall volume is controlled by the foot pedal.

KEYBOARD MODES

The instrument can be played in eleven different keyboard modes:

SOLO
LOWER
SOLO/LOWER
ARRANGER
SOLO/ARRANGER
LOWER/ARRANGER
MANUAL BASS
SOLO/MANUAL BASS
LOWER/MANUAL BASS
MANUAL DRUMS
SOUND EFFECTS

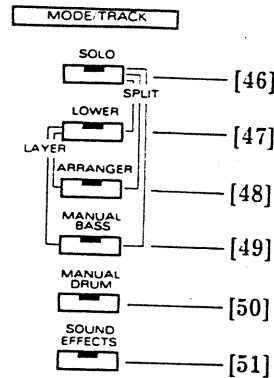

SOLO Mode

To play in SOLO Mode, press the SOLO button [46] (Orange LED lights) in the MODE/TRACK section. The 37-note keyboard can now be played as a Solo synthesizer using the Solo tone already preset. To select a different Solo tone, see TONE SELECT.

LOWER Mode

To play in the LOWER Mode, press the Lower button [47] (Orange LED lights). The keyboard can now be played as a synthesizer using the LOWER tone already preset. To select a different LOWER tone, see TONE SELECT.

SOLO/LOWER Mode

To play in the SOLO/LOWER Mode, press SOLO and LOWER buttons simultaneously (both Orange LEDs light). The keyboard can now be played in a «Split» condition. One tone on the right-hand side of the keyboard and a different tone for the left.

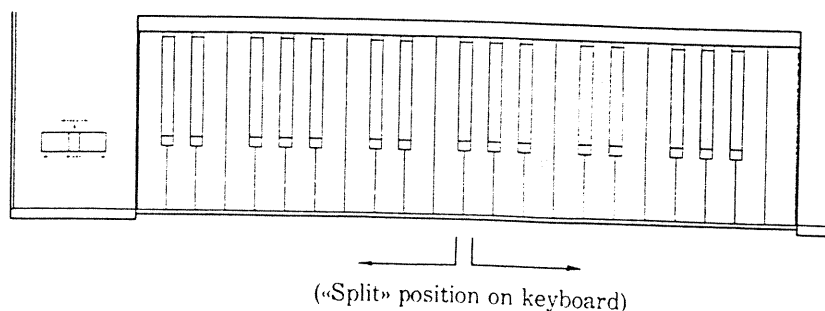

With both the SOLO and LOWER (Orange LEDs lit), the keyboard will now be split between the F#2 and G2 keys in the second octave. The tone now sounding from the bottom note to and including F#2 will be known as the Lower. The tone now sounding from and including the G2 key upwards is known as the Solo. To select a different SOLO or LOWER tone, see TONE SELECT.

MANUAL BASS Mode

To play in the MANUAL BASS Mode, press the MANUAL BASS button [49] (Orange LED lights). The keyboard will now play the Manual Bass tone already selected, in the correct Bass pitch. To select a different MANUAL BASS tone, see TONE SELECT.

SOLO/MANUAL BASS Mode

To play in the SOLO/MANUAL BASS Mode, press the SOLO and MANUAL BASS buttons simultaneously (both Orange LEDs will light). The keyboard again can now be played in a «Split» condition. The SOLO tone played on the right-hand side of the keyboard and the MANUAL BASS tone played on the left. To select a different SOLO or MANUAL BASS tone, see TONE SELECT.

LOWER/MANUAL BASS Mode

To play in the LOWER/MANUAL BASS Mode, press the LOWER and MANUAL BASS buttons simultaneously (both orange LEDs will light). The keyboard will now be in a «Layered» condition, that is if a chord is played both the LOWER and MANUAL BASS tones will sound together. However, the MANUAL BASS will now play «monophonically» (only one note can be played at one time). The MANUAL BASS note heard will be the Root note of the chord played. To select a different LOWER or MANUAL BASS tone, see TONE SELECT.

* In all the above modes, all of the 37 keys can be played dynamically, that is the harder you play the key the louder the tone will sound.

TONE SELECT

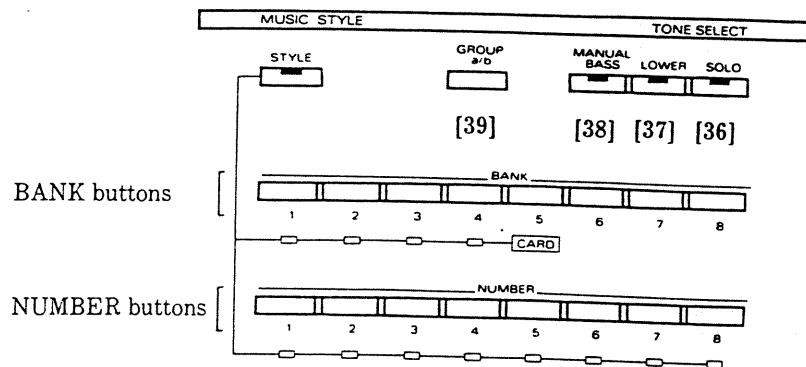

Any one of the 128 different tones can be selected for the Solo, Lower and Manual Bass by using the BANK and NUMBER Buttons. Tone selection can be carried out while playing in any keyboard mode. Tones can also be selected while the Arranger is playing or stopped.

- * See the PRO-E Sound List card included with this manual for the complete list of internal change and MIDI Program Change numbers of all 128 tones.

SOLO TONE SELECT

To select the Solo tone, press the SOLO button [36] in the TONE SELECT section (LED lights). The display will indicate the tone in use:

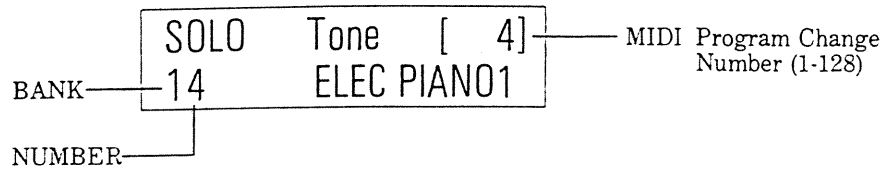

To change any of the 128 tones, select either Group a or b by pressing the GROUP a/b button [39], then press a BANK button for the first digit and a NUMBER button for the second.

Example: To select 51a FANTASY tone

Press BANK button 5 and then NUMBER button 1.

The display will respond with:

The diagram shows a rectangular display box containing the text "SOLO Tone [33]" on the top line and "51 FANTASY" on the bottom line.

After a few seconds the Master Display will return.

Example: To select 48b BRASS SECT1 tone

Press GROUP a/b button [39], press BANK button 4 and then NUMBER button 8. The display will respond with:

The diagram shows a rectangular display box containing the text "SOLO Tone [96]" on the top line and "48b BRASS SECT1" on the bottom line.

After a few seconds the display will revert to the Master Display.

LOWER TONE SELECT

To select a different tone for the Lower, press the LOWER button [37] in the TONE SELECT section (LED lights). The display will indicate the LOWER tone in use:

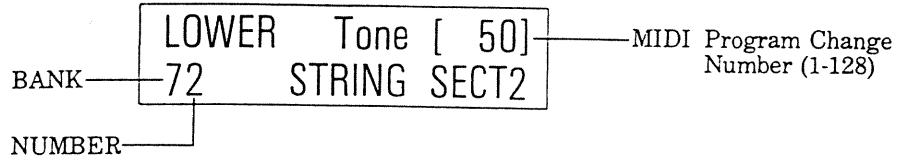

To change any of the 128 tones, select either Group a or b by pressing the GROUP a/b button, then press a BANK button for the first digit and a NUMBER button for the second.

Example: To select 17a ELEC PIANO4 tone

Press BANK button 1 and then NUMBER button 7.

The display will respond with:

The diagram shows a rectangular display box containing the text "LOWER Tone [7]" on the top line and "17 ELEC PIANO4" on the bottom line.

After a few seconds the display will revert to the Master Display.

MANUAL BASS TONE SELECT

To select the Manual Bass tone, press the MANUAL BASS button [38] in the TONE SELECT section (LED lights). The display will indicate the MANUAL BASS tone in use:

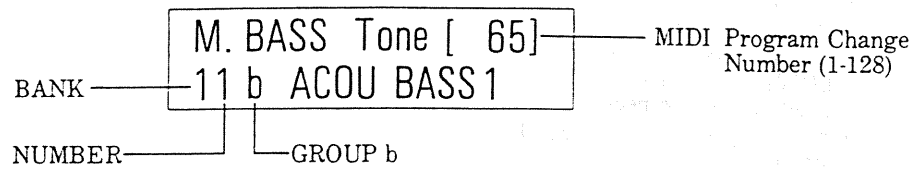

To change any of the 128 tones, select either Group a or b by pressing the GROUP a/b button, then press a BANK button for the first digit and a NUMBER button for the second.

Example: To select 15b SLAP BASS 1 tone

Ensure that Group b appears to the right of the Manual Bass tone number in the display, press BANK button 1 and then NUMBER button 5. The display will respond with:

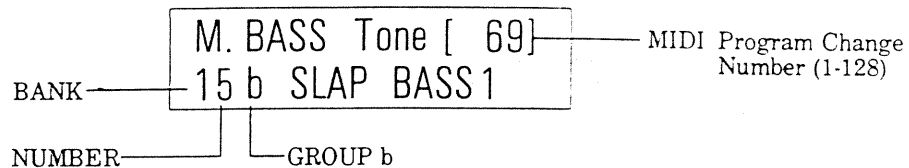

After a few seconds the display will revert to the Master Display

<Notes On Tone Selecting>

- * After pressing the SOLO, LOWER or MANUAL BASS SELECT button, the display will continue to show that tone condition until a selection using the BANK, NUMBER (or GROUP a/b) buttons is made.
- * Selecting either SOLO, LOWER or MANUAL BASS keyboard mode will automatically light the SOLO, LOWER or MANUAL BASS Tone Select button respectively.
- * The procedures (pressing BANK, NUMBER and GROUP a/b buttons) can be carried out in any order you wish).
- * On selecting either SOLO, LOWER or MANUAL BASS tones, if the Group, BANK or the NUMBER is the same as the previous tone, there is no need to press that button.
- * If the LED of the desired Select button is lit, there is no need to press that button again before pressing BANK, NUMBER and GROUP a/b buttons, simply press the two numbers (plus GROUP a/b if necessary) of the particular tone you require.
- * The SOLO, LOWER and MANUAL BASS tone select procedures are the same with or without the Style playing.
- * Changing the MANUAL BASS tone will not affect the preset Accomp Bass tone played by the ARRANGER.

TONE BALANCE

The volumes of SOLO, LOWER and MANUAL BASS tones can be controlled by the buttons “▷” and “◁” in the BALANCE section [1].

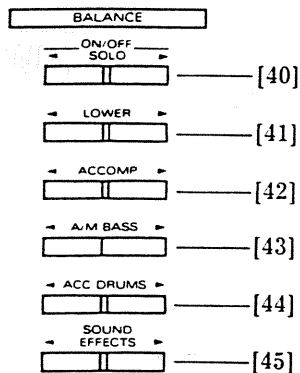

SOLO BALANCE

To adjust the volume of the SOLO tone, press either SOLO “▷” button or “◁” button [44]. The display will respond with:

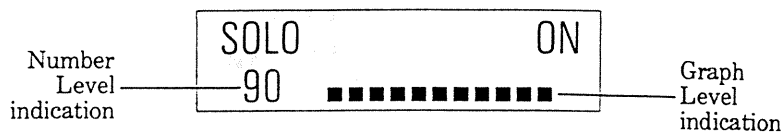

Press either SOLO “▷” button to increase or “◁” button to decrease the volume.

Pressing either SOLO “▷” or “◁” buttons will cause the number and graph indication to increase or decrease.

To quickly turn off the Solo tone, press SOLO “▷” and “◁” buttons simultaneously. The display will respond with:

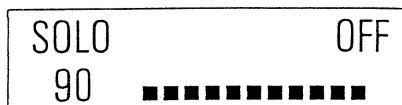

To turn the Solo tone on again, press SOLO “▷” and “◁” buttons again simultaneously.

LOWER BALANCE

To adjust the volume of the LOWER tone, press either LOWER "▷" button or "◁" button [41]. The display will respond with:

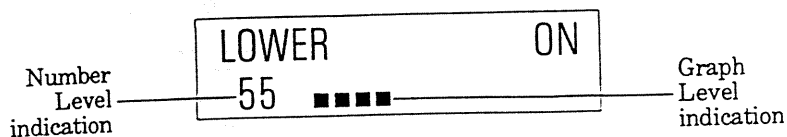

Press either LOWER "▷" button to increase or "◁" button to decrease the volume.

Pressing either LOWER "▷" or "◁" buttons will cause the number and graph indication to increase or decrease.

To quickly turn off the LOWER tone, press LOWER "▷" and "◁" buttons simultaneously. The display will respond with:

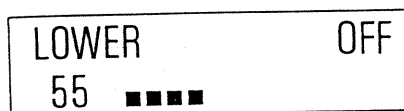

To turn on again the LOWER tone, press LOWER "▷" and "◁" buttons again simultaneously.

* In the above balance procedures, after a few seconds if neither "▷" or "◁" button is pressed, the Master Display will return.

MANUAL BASS BALANCE

Accomp and Manual Bass volume can both be adjusted in one operation.

Press either A/M BASS "▷" or "◁" button [43] and the display will respond with:

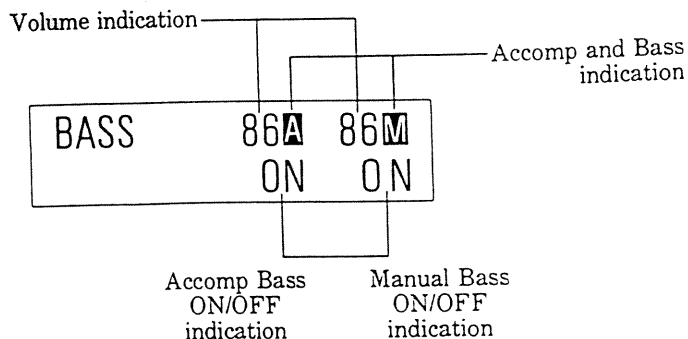

To adjust the volume of both the Accomp and Manual Bass, press either A/M BASS "▷" button to increase or "◁" button to decrease both volumes.

Pressing either A/M BASS "▷" or "◁" buttons will cause both Volume indication numbers to increase or decrease.

To quickly turn off both the Accomp and Manual Bass tone, press A/M BASS "▷" and "◁" buttons simultaneously. The display will respond with:

BASS	86 ^A	86 ^M
	OFF	OFF

To turn on again both the Accomp and Manual Bass tone, press A/M BASS "▷" and "◁" buttons again simultaneously.

To adjust the volume of the Manual Bass tone (M) separately requires the Accomp Bass balance function to be disabled. (See ACCOMP BASS BALANCE ENABLE in FUNCTIONS).

With the Accomp Bass Balance function turned off, pressing either A/M BASS "▷" or "◁" button the display will respond with:

BASS	86	86 ^M
	ON	ON

Accomp Bass balance function turned off

Press either A/M BASS "▷" button to increase or "◁" button to decrease the Manual Bass Volume.

Pressing either A/M BASS "▷" or "◁" buttons will cause the Manual Bass Volume indication number to increase or decrease but will not affect the volume condition of the Accomp Bass.

To quickly turn off just the Manual Bass tone, press A/M BASS "▷" and "◁" buttons simultaneously. The display will respond with:

BASS	86 ^M	86
	OFF	ON

To turn on again in the Manual Bass tone, press A/M BASS "▷" and "◁" buttons again simultaneously.

* In the above balance procedures, after a few seconds if neither "▷" or "◁" button is pressed, the Master Display will return.

ARRANGER SECTION

Your PRO-E is also equipped with a unique built-in ARRANGER section with a total of 32 Music Styles.

Each Music Style includes a Drum track, Bass line and Orchestral accompaniment and preset tempo. You can select between the basic Style (original) and Variation (see VARIATION). The Arranger supplies the Orchestral Accompaniment with a choice of simple or Advanced arrangements (see ADVANCED ARRANGER). HOLD automatically holds the notes you play until new notes are played (see HOLD).

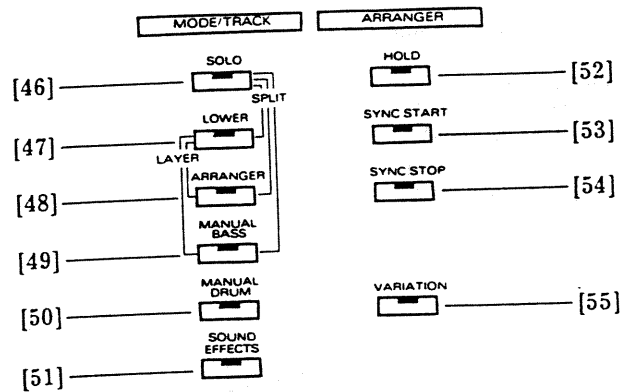

ARRANGER Mode

To play in the Arranger mode, press the ARRANGER button [48] in the MODE/TRACK section (Orange LED lights). This will introduce orchestral accompaniment from chords played on the keyboard. The display will indicate the chord and type that is played. For example:

```
16  FUNK 2  ♩ =140  
XX XX XX X F  Ma
```

Arranger Chord and Type
Indication

The chords recognized on the PRO-E are as follows:

- Major (Ma)
- Minor (mi)
- Seventh (7)
- Minor seventh (mi7)
- Major seventh (Ma7)
- Minor seventh b5th (0)
- Diminished (Dim)
- Augmented (Aug)
- Suspended fourth (Su4)
- Suspended seventh (Su7)

If notes are played which cannot be recognized as one of the above chord types by the PRO-E, the root of the chord along with asterisks will appear in the display:

```
16  FUNK 2  ♩ =140  
XX XX XX X G#***
```

Unrecognized
Chord Type

The Arranger can be played either by conventional chords or by using CHORD INTELLIGENCE. CHORD INTELLIGENCE enables you to play chords with just a finger or two. The CHORD INTELLIGENCE system lets you play major, minor, seventh, minor seventh, major seventh, minor seventh b5th, diminished, augmented, suspended fourth and suspended seventh chords. The CHORD INTELLIGENCE is always OFF when the PRO-E is switched on. To turn this feature ON, see ARRANGER CHORD INTELLIGENCE in FUNCTIONS.

ADVANCED ARRANGER

Each Music Style includes two types of arrangements - Simple and Advanced. Pressing the ADVANCED ARRANGER button [22] will select between the two arrangements. (LED will light when the Advanced arrangement is selected).

VARIATION

Pressing the VARIATION button [55] (LED lights) will give a variation to each part of the Music Style (Drum track, Bass line and accompaniment).

To return to the basic (original) Style, press the VARIATION button once more (LED is turned Off).

FILL-IN

While playing the basic (original) Style, a Fill-in can be inserted by pressing the FILL-IN «TO ORIGINAL» button [23]. This will result in a one measure fill-in and on completion will return to the basic Style.

While playing in the Variation, pressing the FILL-IN «TO VARIATION» button will result in a one measure fill-in and then on completion will return to the Variation.

If playing in the basic (original) Style and the FILL-IN «TO VARIATION» button is pressed, a one measure fill-in will occur and on completion will automatically proceed into the Variation of the Style (VARIATION LED lights). Likewise if playing in the Variation of a Style and the FILL-IN «TO ORIGINAL» button is pressed, a one measure fill-in will occur and on completion will automatically return to play the original Style (VARIATION LED is turned off).

- * If either of the FILL-IN buttons are pressed within the 1st and 3rd beats (1st and 2nd on Waltz 3/4 Styles and 1st only on Polka 2/4 Style), the fill-in will be performed for the remainder of that measure. If either of the FILL-IN buttons are pressed within the 4th beat (3rd on Waltz Styles), this operation will be interpreted as a preselection of the fill-in to start at the downbeat of the next measure.

The Fill-in to Variation/Original can be performed by the optional footswitch (See FOOTSWITCH ASSIGN in FUNCTIONS). When using the footswitch the Fill-in will be automatic. When playing in the original style, pressing the footswitch will introduce the Fill-in To Variation. When playing in the Variation of the Style, pressing the footswitch will introduce the Fill-in To Original.

BREAK MUTE

While playing the style in any of the Arrangements, pressing the BREAK MUTE/TAP TEMPO button [24] will result in a one measure (bar) (silent) break (four beats in a 4/4 Style, three in a 3/4 Style and two in a 2/4 Style).

* If the button is pressed within the 1st and 3rd beats (1st and 2nd on Waltz 3/4 Styles and 1st only on 2/4 Styles), the break will be performed for the remainder of that measure. If the button is pressed within the 4th beat (3rd on Waltz Styles and 2nd on 2/4 Styles), this operation will be interpreted as a preselection of the break to start at the downbeat of the next measure).

* The Break Mute feature can also be operated from the optional foot-switch (see FOOTSWITCH ASSIGN in FUNCTIONS).

HOLD

Pressing the HOLD button [52] in the ARRANGER section (LED lights) will activate a memory circuit which will continue to play the chord after the keys are released. It will memorize and hold the notes until the next note(s) is played.

MUSIC STYLE SELECT

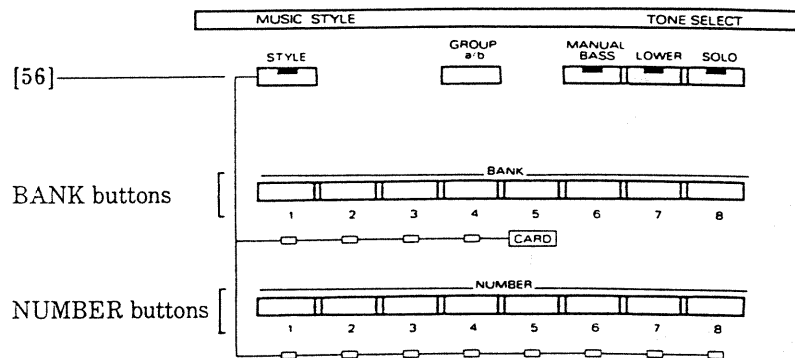

The instrument will automatically select 16 FUNK 2 when it is turned on. To select a different Music Style from the 32 in the MUSIC STYLE TABLE, press the STYLE button [56] in the STYLE SELECT section (LED lights), then press a BANK button for the first digit and NUMBER button for the second. The display will indicate the new Style selected.

Example:

To select 44 CHA CHA Style

Ensure that the STYLE select LED is lit, press BANK button 4 and then NUMBER button 4. The display will respond with the new Style and preset tempo:

44	CHACHA	♩ = 140
XX	XX	XX

- * The above procedure (pressing BANK and NUMBER buttons) can be carried out in any order you wish.
- * On selecting a new Style, if the BANK or the NUMBER is the same as the previous Style, there is no need to press that button.
- * A new Style can be selected WITHOUT stopping the Style already playing by simply pressing the appropriate BANK and NUMBER buttons.
- * With this operation, the new Style will not be played in the Styles preset tempo, but will follow the tempo set by the previous Style.

Additional Styles can be obtained from optional Music Style Cards available from your Roland dealer. To select the additional Styles, see MUSIC STYLE CARD.

STARTING THE STYLE

The Style can be started in three ways:

1. Press the START/STOP button [26] and the Style will start immediately.
2. Press the SYNC START button [53] (see SYNC START) (LED lights). Then press a key on the keyboard. The Style will automatically start.
3. Press the INTRO/ENDING button [25]. The Style will begin with a musical «introduction», length of which depends on the Style selected.

TEMPO LEDs

While the Style is playing, the Tempo LEDs [15] to the left of the display will visually count out the tempo set, the downbeat (first beat) of the measure flashes red, while the remaining three beats flash green. When using a Waltz (3/4) Style, the first beat flashes red, while the following two beats, flash green (the fourth not being used). When using a POLKA (2/4) style, the first beat flashes red, while the second beat flashes green (the third and fourth not being used). When the Style is stopped, the first LED (red) will visually flash the beat of the tempo set.

Each Style contains different lengths of patterns, two, three, four, six, eight measures etc. To assist the player, the TEMPO LEDs will also indicate the beginning of each pattern by all four LEDs (one red and three green) flashing together.

TEMPO CONTROL

To change the tempo, use the TEMPO/FUNCTION Dial [27] located beneath the display. Turn the Dial counterclockwise to decrease and clockwise to increase the tempo. The numbers at the top-right of the display will indicate the tempo in BPM (beats per minute).

Example: $\text{♩} = 140$. This means that 140 quarter notes (crotchets) will be played within one minute.

The TEMPO range available is from 20 to a maximum of 250.

TAP TEMPO

The tempo of a Style can also be set by using the TAP TEMPO feature just like the tapping of a Conductors baton in an Orchestra.

While the Style is stopped (START/STOP LED off), press the BREAK MUTE/TAP TEMPO button [24] in the tempo you wish the Style to play - Four beats for 4/4 Styles, three beats for 3/4 (Waltz) Styles, two beats for 2/4 (Polka) style, the Tempo LEDs will flash accordingly. The Tempo number in the display will automatically change to the tempo set and the Style can now be started in any of the above three ways.

- * The Tap Tempo procedure will only operate when the Style is stopped. When the Style is playing, pressing the BREAK MUTE/TAP TEMPO button will result in a one measure break (see BREAK MUTE).
- * The Tap Tempo feature can also be operated from the optional foot-switch (see FOOTSWITCH ASSIGN IN FUNCTIONS).

SYNC START

Pressing the SYNC START button [53] will synchronize the start of the Style when a key is played on the keyboard. The SYNC START button can also be selected before pressing the INTRO/ENDING button (INTRO/ENDING LED will begin to flash); pressing a key will now start the Style with an "introduction".

- * Sync Start can be used along with Sync Stop for some interesting effects (see SYNC STOP).

INTRO/ENDING

Without the Style playing, pressing the INTRO/ENDING button [25] will start the Style which will begin with a musical "introduction", length of which depends on the Style selected.

When the INTRO/ENDING button is pressed with the Style playing, a musical "ending" will begin at the next downbeat, the length of which depends on the Style selected.

- * INTRO and ENDING can also be operated from the optional foot-switch (see FOOTSWITCH ASSIGN in FUNCTIONS).

STOPPING THE STYLE

The Style can be stopped in three ways:

1. Press the START/STOP button and the Style will stop immediately.
2. Press the INTRO/ENDING button. At the next downbeat the Style will perform a musical "ending", the length of which depends on the Style selected.
3. Press the SYNC STOP button [54] (LED lights). Now when the keys are released the Style will stop immediately (see SYNC STOP).

SYNC STOP

When the SYNC STOP button [54] is pressed (LED lit), the Style will stop immediately the keys are released. The style can then be started in any of the three ways above.

- * The Sync Stop feature will operate even if the HOLD button is lit.
- * The Sync Stop feature can be used along with the Sync Start for some interesting effects (see SYNC START).

NOTE: The drum track of each Style can also be used alone with the above features - Start and Stop, Variation, Intro/Ending, Fill-in, Break Mute and Tap Tempo.

ARRANGER LOOP

The Arranger Loop is a Real Time sequencer which allows a chord progression played with Arranger to be recorded in Real Time and played back repeatedly in Real Time without stopping the Style. What is recorded is only the chord progression so other features Style select, Fill-In, Break Mute, melody, etc. must be performed again on playback.

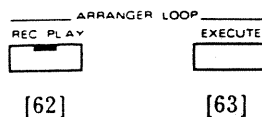

1. While playing the style, press REC/PLAY button [62] (Red LED starts to flash. Arranger Loop is now in ready condition for recording).
 2. When you wish to start the recording press the Arranger Loop EXECUTE button [63]. (Red LED of REC/PLAY button will light constantly).
 3. When you wish to stop recording, press REC/PLAY button once more. Red LED will now change to green and will flash. Arranger Loop is now in ready condition for loop play.
 4. When you wish the Arranger Loop play to start, press EXECUTE button. (Green LED lights constantly.) Loop play will begin on the next downbeat. The Arranger Loop will play repeatedly till stopped.
- * If you wish to go direct from loop record to loop play, just press EXECUTE button after recording. Again loop play will begin on the next downbeat.
5. To stop the Arranger Loop play, press the REC/PLAY button one more time (REC/PLAY green LED will be turned off).
- * The last sequence recorded in the Arranger Loop can be played back again and again even after the Style has been stopped or even if the PRO-E has been switched off and on. Just press REC/PLAY button twice (green LED flashing) and then press EXECUTE.

- * Arranger Loop recording and play can be performed while the style is playing or stopped. To record loop immediately when style is started, press REC/PLAY button, press EXECUTE, then press START/STOP. To play loop immediately before style is started, press REC/PLAY button twice, press EXECUTE, then press START/STOP.
- * The Arranger Loop can record up to approx. 32 measures.
- * If the REC/PLAY or EXECUTE button is pressed in the middle of the measure, the REC/PLAY will be turned off (LED not lit). On play of that particular Loop, the whole of that measure will be played.
- * If the Style is stopped during Loop record, the REC/PLAY will be turned off (LED not lit). On play of that particular Loop, the whole of the measure, when the Style was stopped, will be played.
- * The EXECUTE procedure can be carried out by the optional footswitch (See FOOTSWITCH ASSIGN in FUNCTIONS).

STYLE VOLUME BALANCE

While stopped or while playing, the volumes of each section of the Style (Accomp, Accomp Bass and Drums) can be modified by using the appropriate “▷” and “◁” buttons in the BALANCE section.

ACCOMPANIMENT BALANCE

The Arrangement is divided into three sections - Accompaniment 1, 2 & 3. The Accompaniment 3 is the basic (simple) Arrangement (ADVANCED ARRANGER LED off) and Accompaniments 1 and 2 are the Advanced Arrangements (ADVANCED ARRANGER LED lit). The volumes of these different sections can be adjusted in one operation, press either ACCOMP “▷” or “◁” button [42]. The display will respond with:

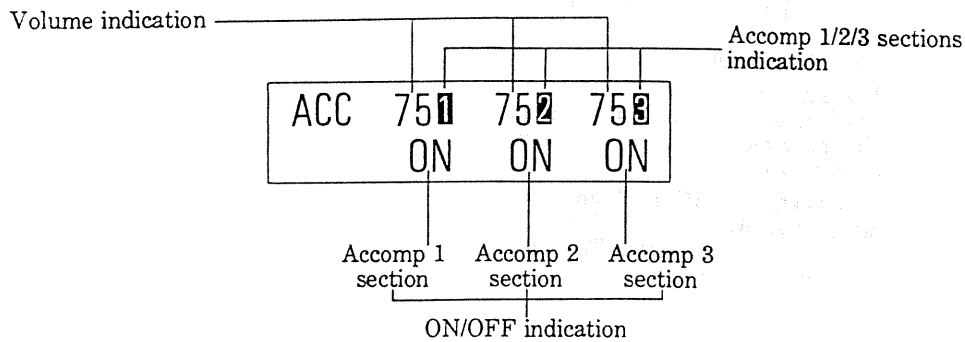

Press either ACCOMP “▷” button to increase or “◁” button to decrease all three volumes.

Pressing either ACCOMP “▷” or “◁” buttons will cause all three Volume indication numbers to increase or decrease.

To quickly turn off all three Accomp sections, press ACCOMP “▷” and “◁” buttons simultaneously. The display will respond with:

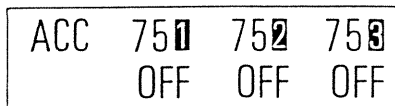

To turn on again all three Accomp sections, press ACCOMP "▷" and "◁" buttons again simultaneously.

To adjust or turn OFF/ON separately the volume of Accomp 1, 2 or 3, the other sections that you don't wish to change must be disabled (See ACCOMP 1/2/3 BALANCE ENABLE in FUNCTIONS).

With the Accomp sections balance functions not required turned off, for example — Accomp 2 & 3, pressing either ACCOMP button, "▷" or "◁" button, the display will respond with:

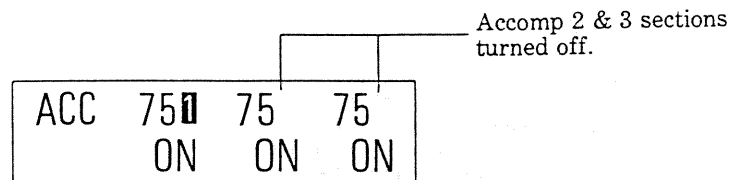

Press either ACCOMP "▷" button to increase or "◁" button to decrease the volume of Accomp 1.

Pressing either ACCOMP "▷" or "◁" buttons will cause the Accomp 1 Volume indication number to increase or decrease.

To quickly turn off the Accomp 1 section, press ACCOMP "▷" and "◁" buttons simultaneously. The display will respond with:

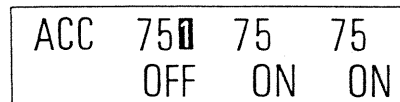

To turn on again the Accomp 1 section, press ACCOMP "▷" and "◁" buttons again simultaneously.

To adjust or turn OFF/ON the volumes of Accomp 2 & 3 sections, follow the same procedure as above for Accomp 1 section, ensuring that the Accomp section you do not wish to change has been disabled in FUNCTIONS.

ACCOMP BASS BALANCE

Accomp and Manual Bass volume can both be adjusted in one operation.

To adjust the volume of the Accomp Bass tone (A) separately requires the Manual Bass balance function to be disabled. (See MANUAL BASS BALANCE ENABLE in FUNCTIONS).

With the Manual Bass Balance function turned off, pressing either A/M BASS "▷" or "◁" button [43] the display will respond with:

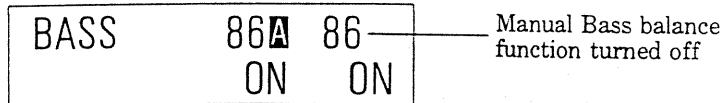

Press either A/M BASS "▷" button to increase or "◁" button to decrease the Accomp Bass volume.

Pressing either A/M BASS "▷" or "◁" buttons will cause the Accomp Bass Volume indication number to increase or decrease but will not affect the volume indication of the Manual Bass.

To quickly turn off just the Accomp Bass tone, press A/M BASS "▷" and "◁" buttons simultaneously. The display will respond with:

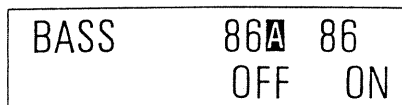

To turn on again the Accomp Bass tone, press A/M BASS "▷" and "◁" buttons again simultaneously.

* In the above balance procedures, after a few seconds if neither "▷" or "◁" button is pressed, the Master Display will return.

ACCOMP DRUM BALANCE

To adjust the volume of the accompaniment drums requires only one operation (similarly to Solo and Lower), press either ACC DRUMS "▷" button or "◁" button [44]. The display will respond with:

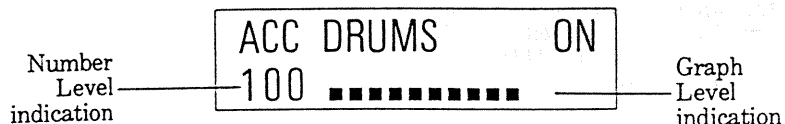

Press either ACC DRUMS "▷" button to increase or "◁" button to decrease the volume.

Pressing either ACC DRUMS "▷" or "◁" buttons will cause the number and graph indication to increase or decrease.

To quickly turn off the Drums, press ACC DRUMS "▷" and "◁" buttons simultaneously. The display will respond with:

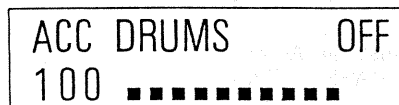

To turn the Drums on again, press the ACC DRUMS "▷" and "◁" buttons again simultaneously.

* In the above balance procedures, after a few seconds if neither "▷" or "◁" button is pressed, the Master Display will return.

SOLO/ARRANGER Mode

To play in the SOLO/ARRANGER Mode, press the SOLO and ARRANGER buttons simultaneously (both Orange LEDs will light). The keyboard will now be in a 'Split' condition, that is a SOLO tone can be played on the right-hand side of the keyboard and the Arranger played on the left.

With both the SOLO and ARRANGER Orange LEDs lit, the keyboard will now be split between the F#2 and G2 keys in the second octave. The keys from the bottom note to and including F#2 will be used to play the Arranger. The tone now sounding from and including the G2 key upwards is known as the Solo. To select a different SOLO tone or Music Style, see TONE SELECT.

* In this mode, only the keys to the right of the 'split' can be played dynamically.

LOWER/ARRANGER Mode

To play in the LOWER/ARRANGER Mode, press the LOWER and ARRANGER buttons simultaneously (both orange LEDs will light). The keyboard will now be in a 'Layered' condition, that is when a chord is played both the LOWER tone and ARRANGER will sound together.

- * In the above mode, all of the 37 keys can be played dynamically, but this will only affect the Lower tones. However, interesting effects can be obtained.
- * When using INTRO/ENDING, the Lower Mode will be temporarily cancelled.

MANUAL DRUMS Mode

To play the keyboard in Manual drums mode, press the MANUAL DRUMS button [50] in the MODE/TRACK section (orange LED lights). Now all the 30 drum instruments can be played manually from the keyboard. All the drum instruments can be played dynamically, that is the harder you play any key the louder the drum will sound.

Underneath, at the front section of the keyboard, you will find the names of the instrument each key represents. Each of these instruments can be played without or in conjunction with the Music Style.

When the MANUAL DRUM button is pressed with the Style playing, the Accomp and Accomp Bass will be cancelled. Manual drums can then be played along with the Style rhythm. If the HOLD button was pressed (LED lit) prior to pressing the MANUAL DRUM button, the chord playing of the Style will remain and cannot be changed until the ARRANGER button in the Mode is pressed.

To cancel the Manual Drums, just press any other button in the MODE/TRACK section.

The assignment of the drum sounds are shown in the following illustration. The number represents the MIDI note number.

MANUAL DRUM SOUNDS AND KEY ASSIGNMENT

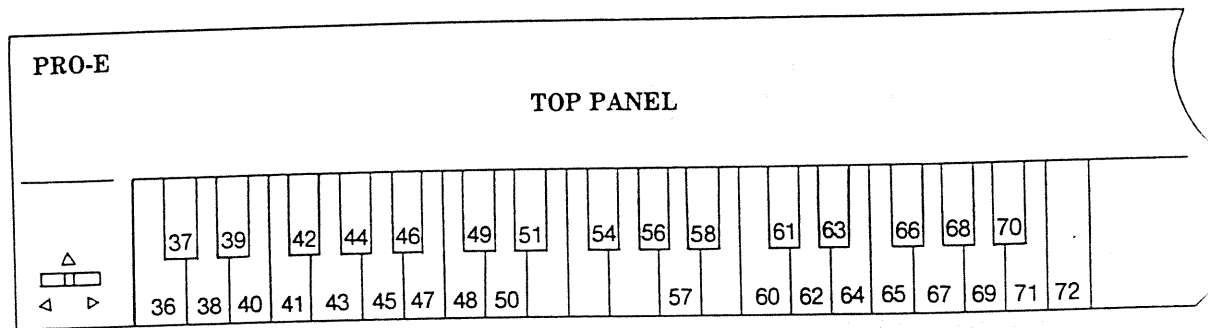

- 36: Acou BD (Acoustic Bass Drum)
- 37: Rim Shot
- 38: Acou SD (Acoustic Snare Drum)
- 39: Hand Clap
- 40: Elec SD (Electric Snare Drum)
- 41: Acou Low Tom (Acoustic Low Tom)
- 42: Clsd Hi Hat (Closed Hi-Hat)
- 43: Acou Low Tom (Acoustic Low Tom)
- 44: Open Hi Hat2
- 45: Acou Mid Tom (Acoustic Medium Tom)
- 46: Open Hi Hat1
- 47: Acou Mid Tom (Acoustic Medium Tom)
- 48: Acou Hi Tom (Acoustic High Tom)
- 49: Crash Cym (Crash Cymbal)
- 50: Acou Hi Tom (Acoustic High Tom)
- 51: Ride Cym (Ride Cymbal)
- 54: Tambourine
- 56: Cowbell
- 57: Quijada (N° 57 & N° 73 on rx)
- 58: Claves (N° 58 & N° 75 on rx)
- 60: High Bongo
- 61: Low Bongo
- 62: Mt High Conga (Muted High Conga)
- 63: High Conga
- 64: Low Conga
- 65: High Timbale
- 66: Low Timbale
- 67: High Agogo
- 68: Low Agogo
- 69: Cabasa
- 70: Maracas
- 71: Smba Whis S (Samba Whistle Short)
- 72: Smba Whis L (Samba Whistle Long)

The volume balance of the Manual Drums is affected only by playing dynamically from the keyboard (The Manual Drums volume cannot be adjusted by the ACC DRUMS volume balance).

<Reference>

Stereo Balance of the Drum sounds.

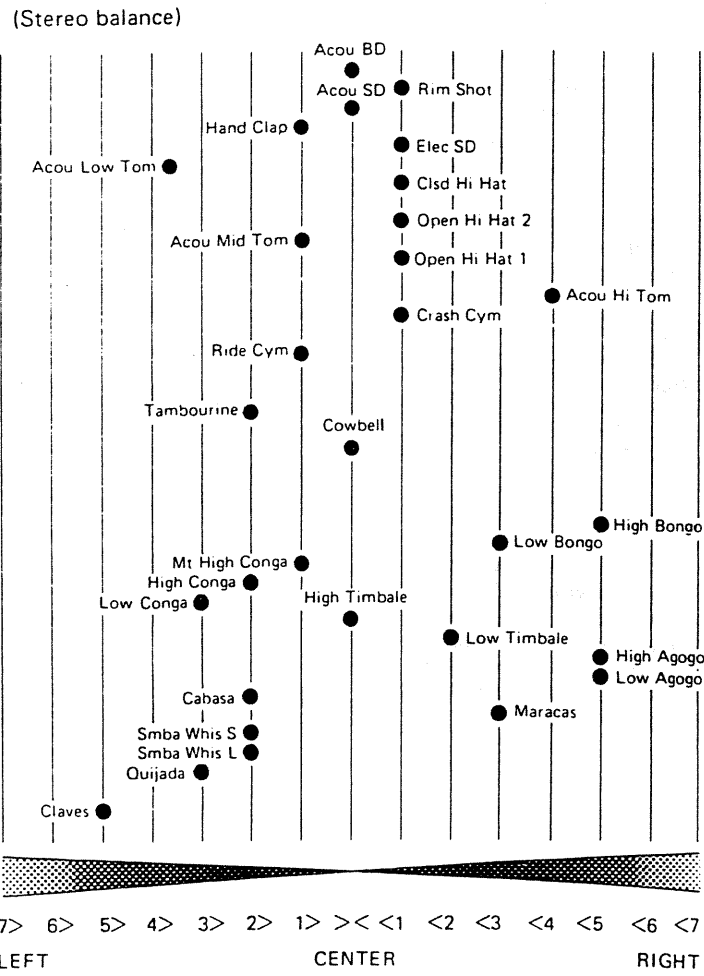

SOUND EFFECTS Mode

The PRO-E features 33 Stereo Sound Effects plus 4 Effect Mixtures. The Sound Effects can be used alone or as effect to accompany a song.

To play the keyboard in the Sound Effects Mode, press the SOUND EFFECTS button [51] in the MODE/TRACK section (orange LED lights). The keys from the lowest C up to and including G #3 will produce 33 different Sound Effects. The four uppermost keys (A3~C4) will produce a mixture of different effects. Each of the Effects can be dynamically played.

Each sound can be heard briefly by quickly pressing the key. However to hear the full effect, press and hold the key. Each effect is in stereo and on certain effects the sound travels from one side to the other (Train, Helicopter, etc).

Each Sound Effect can be held, even if you release the key by pressing the HOLD button [57] in the SOUND EFFECTS section while the key is played (LED will light). To cancel the Effect, press the HOLD button again (LED turned off).

A total of four different Sound Effects (four keys) can be played at one time (except the top four notes which are already 4 Effect Mixtures). This way, interesting sounds effects can be made. The assignement of the Sound Effects are shown in the following illustration. The number represents the MIDI note number.

SOUND EFFECTS AND KEY ASSIGNMENT

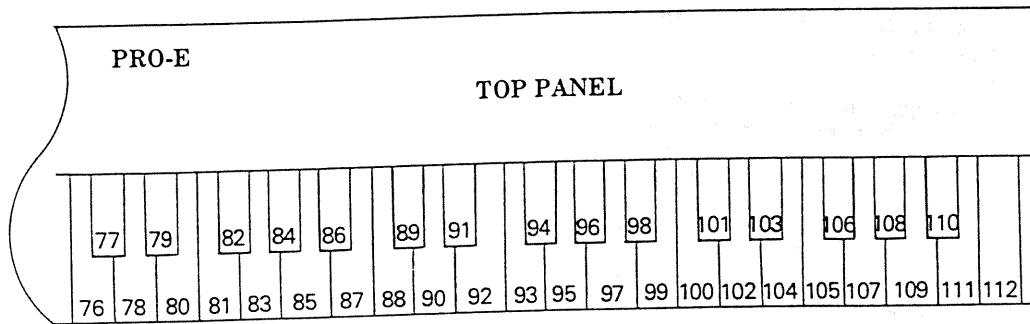

- 76: Laughing
 - 77: Screaming
 - 78: Punch
 - 79: Heartbeat
 - 80: Footsteps 1
 - 81: Footsteps 2
 - 82: Applause
 - 83: Creaking
 - 84: Door
 - 85: Scratch
 - 86: Windchime
 - 87: Engine
 - 88: Car Skid
 - 89: Car Pass
 - 90: Crash
 - 91: Siren
 - 92: Train
 - 93: Jet
 - 94: Helicopter
 - 95: Starship
 - 96: Pistol
 - 97: Machine Gun
 - 98: Laser Gun
 - 99: Explosion
 - 100: Dog
 - 101: Horse Gallop
 - 102: Birds
 - 103: Rain
 - 104: Thunder
 - 105: Wind
 - 106: Waves
 - 107: Stream
 - 108: Bubble
 - 109: Storm
 - 110: War
 - 111: Thriller
 - 112: Wonderland
- } Mixtures

The Sound Effects can also be played from the 12 Sound Effects 'pads' (buttons) a~l in the SOUND EFFECTS section. The Sound Effects printed above the pads are the sound preset from the factory. However, any of the 37 Sound Effects played from the keyboard can be assigned to any of the 12 pads.

To assign a particular Sound Effect from the keyboard to the pads, press the key which contains the desired Sound Effect and while holding the key, press any one of the 12 pads (a~l) you wish to assign the Effect to. When that particular pad is played, the factory set Effect will now be cancelled and the newly assigned Effect will be heard.

- * The assigning of Sound Effects from the keys to the pads can be carried out again and again. However, turning the instrument off will erase any assignment you have made to the pads. If you wish to save any assignments you have made, these can be recorded into the User Programs.
- * Unlike the keys, the pads cannot be played dynamically, pressing a pad will give the full volume of that effect.
- * The Sound Effects played from the pads can be held by the same procedure as the keys by pressing the HOLD button while pressing a pad.
- * The Sound Effects are made up of the following sounds:
 - a) Continuous sound (Sustained sounds - Rain, Stream, etc).
 - b) Interrupted sound (Rhythmic sounds - Footsteps, Gun Shot, etc.)

The interrupted sounds can be synchronized to the Style tempo. Raising the tempo will increase the speed of certain effects or how often the effect is played. The tempo synchronization is ON when the PRO-E is turned on, to turn OFF the Style sync, see SOUND EFFECTS Style sync in FUNCTIONS.

SOUND EFFECTS PADS ASSIGNMENT

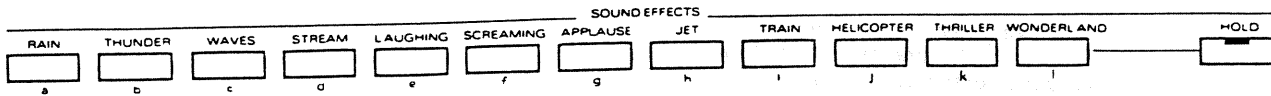

SOUND EFFECTS VOLUME BALANCE

To adjust the volume of the SOUND EFFECTS, press either SOUND EFFECT "▷" button or "◁" button [45]. The display will respond with:

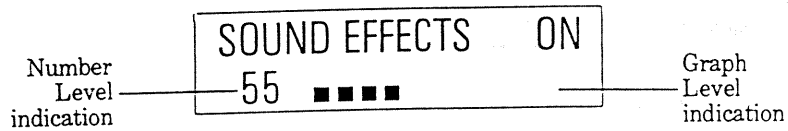

Press either SOUND EFFECTS "▷" button to increase or "◁" button to decrease the volume.

Pressing either SOUND EFFECTS "▷" or "◁" buttons will cause the number and graph indication to increase or decrease.

To quickly turn off the SOUND EFFECTS volume, press LOWER "▷" and "◁" buttons simultaneously. The display will respond with:

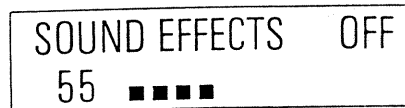

To turn on again the volume of the SOUND EFFECTS, press the SOUND EFFECTS "▷" and "◁" buttons again simultaneously.

- * After a few seconds if neither "▷" or "◁" button is pressed, the Master Display will return.
- * The volume change of the continuous SOUND EFFECTS (Applause, Rain etc.) will not take effect until these particular Sound Effects have begun to re-loop.

PITCH BENDER/ MODULATION LEVER

By moving the Pitch Bender/Modulation lever [28], bending of the 128 tones can be obtained. Moving the lever to the right raises the pitch and moving the lever to the left lowers the pitch of the note. If the lever is released (central position), the note returns to normal pitch. This lever can be used to give a guitar bending effect or the sliding of the trombone and is used often in modern synthesizer playing.

The range of the Pitch (when the lever is moved left or right) can be adjusted (see Pitch Bender Range in FUNCTIONS).

Pushing the same lever away from you will add modulation (vibrato/tremolo) to the each tone. Releasing the lever will cancel the modulation effect.

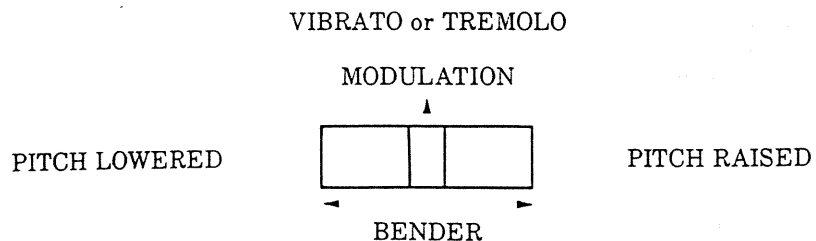

MELODY INTELLIGENCE

Pressing the MELODY INTELLIGENCE button [28] (LED lit) automatically adds a musical counter-melody note to single-note melodies. MELODY INTELLIGENCE will only function when in ARRANGER or SOLO/ARRANGER Mode or in ARRANGER LOOP Mode. The feature operates with or without the Style playing. The harmonizing notes added to the melody are programmed by the type of chord that you play on the keyboard when in either SOLO or SOLO/ARRANGER mode.

MELODY INTELLIGENCE will only function while a note(s) is played in the Solo section together with a recognized Chord in the Arranger section or held with the HOLD feature.

Pressing the same button again will turn off MELODY INTELLIGENCE (LED turned off).

REVERB EFFECT

The PRO-E also has a Digital Reverb unit built-in. The Reverb feature can be assigned (turned On/Off) for certain parts of the keyboard (see REVERB PART ASSIGN). There is also a choice of Reverb types (see REVERB TYPE).

The Reverb will be set up as follows when the instrument is turned on.

REVERB — On (LED on)
REVERB PART ASSIGN

- SOLO part YES
- LOWER part YES
- DRUMS part YES
- SOUND EFFECTS part YES

REVERB TYPE — Room 2

REVERB ON/OFF

To turn off the Reverb effect completely, press the ON/OFF button [58] in the REVERB section (LED off). Pressing the same button again will turn on the Reverb effect (LED on).

REVERB TYPE

To change the type of Reverb effect, press and hold the TYPE button [59] in the REVERB section. The display will respond with:

REVERB type 2 = Room 2

While continuing to hold the TYPE button, press the CURSOR button, the number to the left of the display will start to flash. Using the TEMPO/FUNCTION Dial [27], turn clockwise or counterclockwise to select the desired Reverb Type.

The eight types of Reverb effect available are as follows:

- 1 = Room 1
- 2 = Room 2
- 3 = Hall 1 (turn-on setting)
- 4 = Hall 2
- 5 = Plate 1
- 6 = Plate 2
- 7 = Delay 1
- 8 = Delay 2

The display will indicate the Reverb effect chosen.

REVERB PART ASSIGN

To control the REVERB on/off for individual parts of the keyboard, press and hold the REVERB TYPE button [59]. The display will respond with:

REVERB type 2 = Room 2

Using the TEMPO/FUNCTION Dial [27], turn the Dial clockwise or counterclockwise, until the part you wish to change appears in the display.

To turn off the Reverb effect for the SOLO tones, turn the Dial until the following display appears:

SOLO part	
REVERB	ON

While continuing to hold the TYPE button, press the CURSOR button, the ON/OFF will start to flash. Turn ON or OFF using the Dial. The display will indicate the ON/OFF setting.

To change the Reverb assign for the other parts, follow the same procedure as for the SOLO part.

LOWER part	
REVERB	ON

MANUAL BASS part	
REVERB	ON

DRUMS part	
REVERB	ON

SOUND EFFCT part	
REVERB	ON

Releasing the REVERB TYPE button will return the display to the Master Display.

* REVERB ON/OFF and REVERB TYPE can be recorded into the USER PROGRAMS.

FADE

This feature [18] enables the whole sound (Style, Tone, etc.) to fade in or out.

FADE OUT

To fade out press the FADE OUT button [61] (LED starts to flash). The fade out will start from the maximum volume selected by the Master Volume control and fade to "0" volume. When fade out is completed the LED of the FADE OUT button will light constantly.

To place the PRO-E in the playing mode again press the FADE OUT button once more (LED will be turned off).

- * When the fade out is completed (LED lit constantly) turning the Master Volume control to 0 will cancel the FADE OUT button (LED off).
- * Fade out can also be enabled by the footswitch (see FOOTSWITCH ASSIGN).

FADE IN

To fade in press the FADE IN button [60] (LED starts to flash). The fade in will immediately start from 0 volume and will continue to the maximum volume set by the Master Volume control. When fade in is completed, the LED of the FADE IN will be turned off.

- * Fade in can be enabled during the fade out, the fade in will start at the volume level of fade out when the FADE IN button was pressed.
- * Likewise, the fade out can be enabled during the fade in, the fade out will start at the volume of fade in when the FADE OUT button was pressed.

TEMPO/FUNCTION DIAL

When the Master Display is showing, this control [27] is used to adjust the tempo of the Style.

When the MIDI button is pressed, this control is used to select the function and by moving the Cursor (pressing CURSOR button) to the Values /Channels (flashing) it is then used to modify the data.

When the PARAMETER button is pressed, this control is used to select the function and by moving the Cursor (pressing CURSOR button) to specific data (flashing) it is then used to modify the data.

TRANPOSE

The Transpose feature lets you play in one key and hear the music in another key. STANDARD pitch C (0 shift) is always selected when the instrument is turned on.

To Transpose the PRO-E, press the TRANPOSE button [12] and hold: After one second the display will change to:

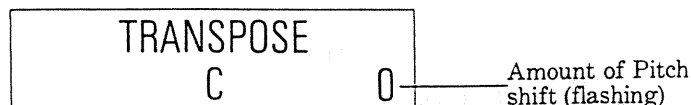

Rotate the TEMPO/FUNCTION Dial clockwise to raise the pitch and counterclockwise to lower the pitch. The display will indicate which key the PRO-E has been changed to and the pitch shift change. If the PRO-E has been transposed, upon releasing the TRANPOSE button the LED will be lit. If no changes in Pitch have been made (in C, 0 shift), the LED will not light.

By switching On and OFF the Transpose feature (LED ON and OFF) it is possible to switch quickly between Standard Pitch and the newly selected pitch.

To return the PRO-E permanently to Standard Pitch (C) perform again the above procedure, rotating the TEMPO/FUNCTION Dial until the display indicates «C 0».

The possible keys and related pitch shift that are selectable are:

C \emptyset shift (Standard Pitch)

C \sharp - 11 shift	C \sharp + 1 shift
D - 10 shift	D + 2 shift
E \flat - 9 shift	E \flat + 3 shift
E - 8 shift	E + 4 shift
F - 7 shift	F + 5 shift
F \sharp - 6 shift	F \sharp + 6 shift
G - 5 shift	G + 7 shift
G \sharp - 4 shift	A \flat + 8 shift
A - 3 shift	A + 9 shift
B \flat - 2 shift	B \flat + 10 shift
B - 1 shift	B + 11 shift

Upon the release of the TRANPOSE button the display will return to the Master Display.

* TRANPOSE range settings can be recorded into the USER PROGRAMS.

FUNCTIONS

(See page 90 for CHANGING MIDI CHANNELS and FUNCTIONS)

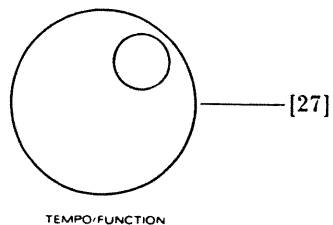
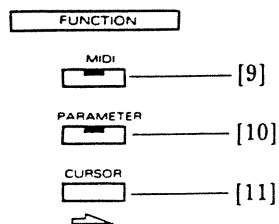

MASTER TUNE

The Master Tune feature enables you to slightly raise or lower the pitch of your PRO-E. This feature is extremely useful when playing with other instruments that may not exactly match the pitch of the PRO-E.

To change the Master Tune, press the PARAMETER button [10] (LED lights), rotate the TEMPO/FUNCTION Dial [27] until the display responds with:

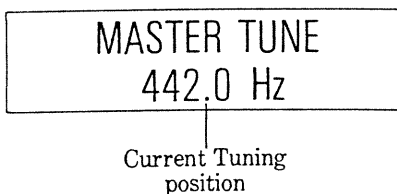

Press the CURSOR button [11], the current tuning position number will begin to flash. Lower or higher the tuning position by rotating the TEMPO/FUNCTION Dial counterclockwise or clockwise. The display will indicate the tuning position change.

The selectable Master Tune range is from 427.5 Hz to 452.6 Hz. "442.0 Hz" being the Standard Master Tune.

To exit the Master Tune operation, press the PARAMETER button once more, LED will be turned off and the Master Display will return.

* Any changes of Master Tune made will be remembered even after the instrument is switched off.

FOOTSWITCH ASSIGN

With the optional footswitch, certain functions of the PRO-E can be controlled by the foot. The input socket [33] for the footswitch is located on the rear panel.

The Sustain function for the footswitch is always set when the instrument is turned on.

To select the different footswitch functions, press the PARAMETER button [10] (LED lights), rotate the TEMPO/FUNCTION Dial until the display responds with:

FOOT SWITCH to =
SUSTAIN

Current Assigned
Function

Press the CURSOR button [11], the current assigned function will begin to flash. Rotating the TEMPO/FUNCTION Dial will 'scroll' through and select the different functions. The possible footswitch functions are as follows:

SUSTAIN
FILL-IN TO ORIGINAL/FILL-IN TO
VARIATION (FO/FV)
TAP TEMPO/BREAK MUTE
(TAP TMP/BRK MUTE)
INTRO/ENDING
STYLE START/STOP
FADE OUT
PUNCH IN
ARRANGER LOOP EXECUTE
(ARR. LOOP EXECUTE)

The display will indicate the function selected.

PITCH BENDER RANGE

This feature enables you to set the range of Pitch Bender (when using the Pitch Bend Lever).

The PRO-E selects a Pitch Bender range of 2 when it is turned on. Moving the lever to the right will raise the pitch by two semitones and moving the lever to the left will lower the pitch by two semitones.

To change the range of the Pitch Bender, press the PARAMETER button [10], rotate the TEMPO/FUNCTION Dial until the display responds with:

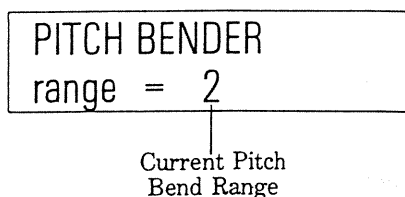

Press the CURSOR button [11], the current Pitch Bend range will begin to flash. Lower or higher the Pitch Bend range by rotating the TEMPO/FUNCTION Dial counterclockwise or clockwise. The display will indicate the Pitch Bend range. The selectable range is from the following:

- 1 = one semitone
- 2 = one tone (turn-on position)
- 3 = one and a half tones
- 4 = two tones
- 5 = two and a half tones
- 6 = three tones
- 7 = three and a half tones
- 8 = twelve semitones (octave)

* Any changes of the Pitch Bend range made will be remembered even after the instrument is switched off.

To exit the Pitch Bend range operation press the PARAMETER button once more, LED will be turned off and the Master Display will return.

OCTAVE RANGE

The octave position of the SOLO, LOWER and MANUAL BASS parts is appropriately set when the PRO-E is turned on. However this can be changed between a range of 5 octaves (-2 to 3).

SOLO OCTAVE Change

When the PRO-E is turned on, the Octave position of the Solo part is always set to "1". To change the Octave position, press the PARAMETER button [10], rotate the TEMPO/FUNCTION Dial until the display responds with:

SOLO part octave = 1	Current Octave Position
-------------------------	----------------------------

Press the CURSOR button [11], the current Octave position will begin to flash. Lower or higher the Octave position by rotating the TEMPO/FUNCTION Dial counterclockwise or clockwise. The display will indicate the change in Octave position.

To exit this operation, press the PARAMETER button once more, LED will be turned off and the Master Display will return.

LOWER OCTAVE Change

When the PRO-E is turned on, the Octave position of the Lower part is always set to "1". To change the Octave position, press the PARAMETER button [10], rotate the TEMPO/FUNCTION Dial until the display responds with:

LOWER part octave = 1	Current Octave Position
--------------------------	----------------------------

Press the CURSOR button [11], the current Octave position will begin to flash. Lower or higher the Octave position by rotating the TEMPO/FUNCTION Dial counterclockwise or clockwise. The display will indicate the change in Octave position.

To exit this operation, press the PARAMETER button once more, LED will be turned off and the Master Display will return.

MANUAL BASS OCTAVE Change

When the PRO-E is turned on, the Octave position of the Manual Bass part is always set to “-1”. To change the Octave position, press the PARAMETER button [10], rotate the TEMPO/FUNCTION Dial until the display responds with:

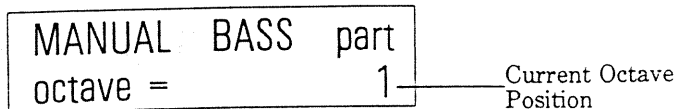

Press the CURSOR button [11], the current Octave position will begin to flash. Lower or higher the Octave position by rotating the TEMPO/FUNCTION Dial counterclockwise or clockwise. The display will indicate the change in Octave position.

To exit this operation, press the PARAMETER button once more, LED will be turned off and the Master Display will return.

ACCOMP 1/2/3 BALANCE

The Accomp. 1/2/3 Balances are always enabled when the instrument is turned on. To disable 1,2,3 or any combination, press the PARAMETER button, rotate the TEMPO/FUNCTION Dial until the following display shows:

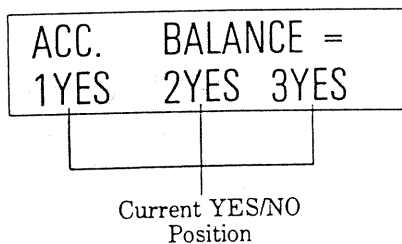

Press the CURSOR button [11] repeatedly until the section 1, 2 or 3 begins to flash. Turn the feature ON or OFF by rotating the TEMPO/FUNCTION Dial counterclockwise or clockwise. The display will indicate the change.

To exit this operation, press the PARAMETER button once more, LED will be turned of and the Master Display will return.

ACCOMP/MANUAL BASS BALANCE

Both the Accomp Bass and Manual Bass Balances are always enabled when the instrument is turned on. To disable either the Accomp or Manual Bass, press the PARAMETER button [10], rotate the TEMPO/FUNCTION Dial until the following display shows:

BASS BALANCE =
acc YES man YES

Current YES/NO
Position

Press the CURSOR button [11] repeatedly until the section ACCOMP (acc) or MANUAL (man) begins to flash. Turn the feature YES or NO by rotating the TEMPO/FUNCTION Dial counterclockwise or clockwise. The display will indicate the change.

To exit this operation, press the PARAMETER button once more, LED will be turned off and the Master Display will return.

SOUND EFFECTS Style sync

The SOUND EFFECTS style sync is always ON when the PRO-E is turned on, to turn this feature OFF, press the PARAMETER button [10]. Rotate the TEMPO/FUNCTION Dial until the display responds with:

SOUND EFFECTS
Style sync = OFF

Current ON/OFF
Position

Press the CURSOR button [11], the current ON/OFF position will begin to flash. Turn the feature ON or OFF by rotating the TEMPO/FUNCTION Dial counterclockwise or clockwise. The display will indicate the change.

To exit this operation, press the PARAMETER button once more, LED will be turned off and the Master Display will return.

ARRANGER CHORD INTELLIGENCE

The Arranger can be played either by conventional chords or by using CHORD INTELLIGENCE. CHORD INTELLIGENCE enables you to play chords with just a finger or two. The CHORD INTELLIGENCE system lets you play major, minor, seventh, minor seventh, major seventh, minor seventh b5th, diminished, augmented, suspended fourth and suspended seventh chords. The CHORD INTELLIGENCE is always OFF when the PRO-E is switched on, to turn this feature ON, press the PARAMETER button [10], rotate the TEMPO/FUNCTION Dial until the display responds with:

ARRANGER chord intelligence = OFF — Current ON/OFF Position

Press the CURSOR button [11], the current ON/OFF position will begin to flash. Turn the feature ON or OFF by rotating the TEMPO/FUNCTION Dial counterclockwise or clockwise. The display will indicate the change.

To exit this operation, press the PARAMETER button once more, LED will be turned off and the Master Display will return.

PLAYING INTELLIGENT CHORDS

● Major Chords (Ma)

Playing just one key in the lower section of the keyboard will produce the Major chord of the same name; that is, playing C will give you C Major; G will give you G Major, etc.

C major

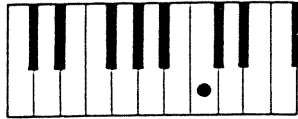

C

G major

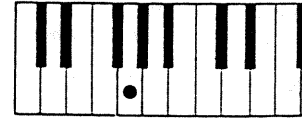

G

● Minor Chords (mi)

Minor Chords are formed by playing the one-note chord with an added note a minor third higher (three keys to the right).

Cm

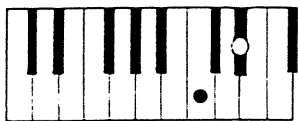

C Eb

E \flat m

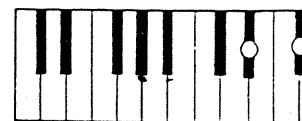

E \flat G \flat

● Seventh Chords (7)

Two-note seventh chords can be formed by playing the one-note Major chord along with the note a whole step (two keys) to the left.

F7

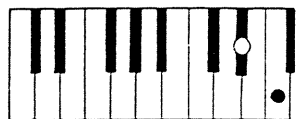

E \flat F

B \flat 7

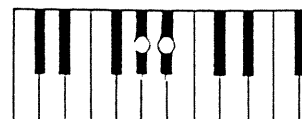

A \flat B \flat

● Minor Seventh Chords (mi7)

Minor seventh chords are formed by playing the two notes that program a minor chord and then adding another note two keys to the left.

Cm7

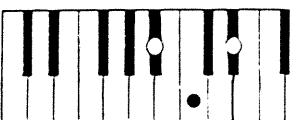

B \flat C E \flat

E \flat m7

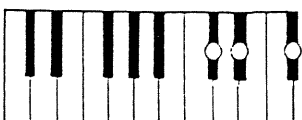

D \flat E \flat G \flat

● Major Seventh Chords (Ma7)

Major seventh chords can be formed by playing the one-note Major chord along with the note immediately to the left.

CMa7

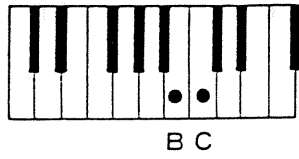

A^bMa7

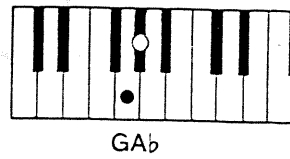

● Minor Seventh b5th Chords (0)

Minor seventh b5th chords are played as four-note chords

Cm7^b5

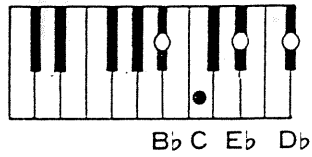

Gm^b5

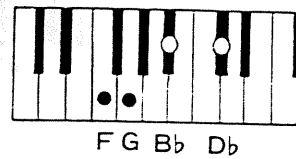

● Diminished Chords (Dim)

Diminished chords are played as three-note chords.

Bdim

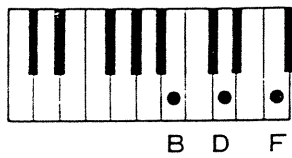

Cdim

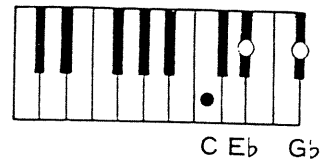

● Augmented Chords (Aug)

Augmented chords are played as three-note chords.

Caug

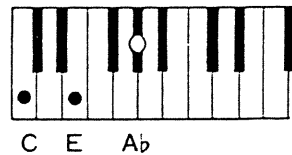

Faug

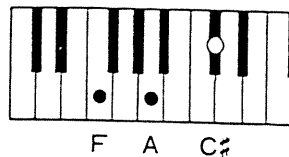

● **Suspended Fourth Chords (Su4)**

Suspended fourth chords are played as three-note chords.

Csu4

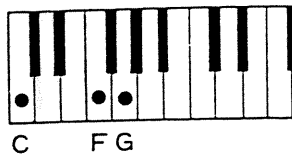

Fsu4

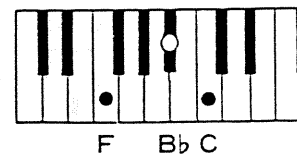

● **Suspended Seventh Chords (Su7)**

Suspended seventh chords are played as four-note chords.

Csu7

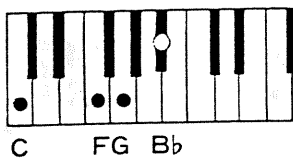

Fsu7

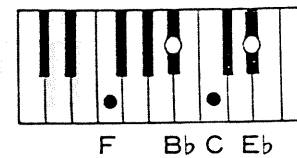

- * Without turning off the CHORD INTELLIGENCE, chords can still be played in the conventional way as well as the easy way described above.
- * PITCH BENDER/OCTAVE range, SOUND EFFECTS Style sync/CHORD INTELLIGENCE ON/OFF settings can all be recorded into the USER PROGRAMS

INTERNAL MEMORY Protection

To safeguard any loss in internal data, the Internal Memory of the PRO-E is always protected when the instrument is turned on. To turn off the protection and enable writing of new data, press the PARAMETER button [10], rotate the TEMPO/FUNCTION Dial until the display responds with:

INTERNAL MEMORY protection = ON	Current ON/OFF Position
------------------------------------	----------------------------

Press the CURSOR button [11], the current ON/OFF position will begin to flash. Turn the protection ON or OFF by rotating the TEMPO/FUNCTION Dial counterclockwise or clockwise. The display will indicate the change.

To exit this operation, press the PARAMETER button once more, LED will be turned off and the Master Display will return.

USER PROGRAMS

One of the advantages of the PRO-E is its ability to produce a wide variety of instrumental tones and effects. Normally, changing from one tone or effect to another involves activating several buttons. However, with Roland's digital technology, 48 User Programs provided on the instrument enable you to record 48 complete panel registrations of your choice which are recallable at the touch of a button.

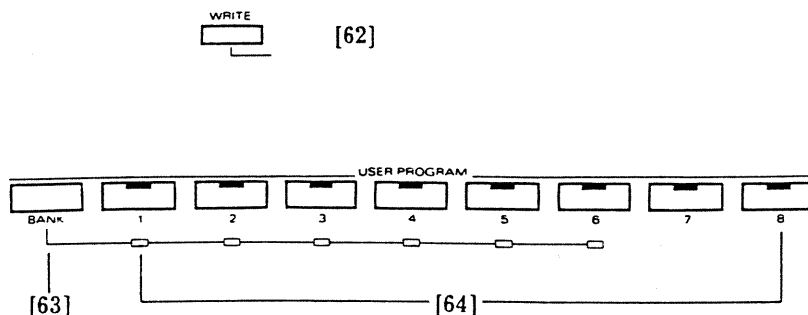

The following functions can be recorded into the User Programs:

- Solo Tone
- Lower Tone
- Manual Bass Tone
- Nine Volume Balances
- Style
- Tempo
- Variation
- Advanced Arranger
- Hold
- Sync Start
- Sync Stop
- Reverb
- Reverb Type
- Sound Effect pads
- Melody Intelligence
- Transpose
- Footswitch assign
- Pitch Bend range
- Solo Octave
- Lower Octave
- Manual Bass Octave
- Accomp 1/2/3 Balance Enable
- Accomp/Manual Bass Balance Enable
- Sound Effects Style sync
- Chord Intelligence
- All MIDI Functions

The PRO-E will arrive with 8 factory User Programs in BANK 1 (repeated in Bank 2~6) preset with the following configurations:

**FACTORY PRESET
USER PROGRAM 11 (Bank 1 - Number 1)**

Solo Tone - 44b
Lower Tone - 34b
Manual Bass Tone - 17b

Balance Solo - 100 ON
Lower - 100 ON
Accomp 1 - 75 ON
Accomp 2 - 75 ON
Accomp 3 - 75 ON
Accomp Bass - 90 ON
Manual Bass - 90 ON
Accomp Drums - 90 ON
Sound Effects - 90 ON

Style - 32 **BIG BAND**
Tempo - 140
Variation - OFF
Advanced Arranger - ON
Hold - ON
Sync Start - OFF
Sync Stop - OFF
Reverb - ON
Reverb Type - HALL 1
Melody Intelligence - OFF

Sound Effect pad a - RAIN
Sound Effect pad b - THUNDER
Sound Effect pad c - WAVES
Sound Effect pad d - STREAM
Sound Effect pad e - LAUGHING
Sound Effect pad f - SCREAMING
Sound Effect pad g - APPLAUSE
Sound Effect pad h - JET
Sound Effect pad i - TRAIN
Sound Effect pad j - HELICOPTER
Sound Effect pad k - THRILLER
Sound Effect pad l - WONDERLAND

Transpose - 0 OFF
Footswitch assign - SUSTAIN
Pitch Bend range - 2
Solo Octave - 1
Lower Octave - 1
Manual Bass Octave: -1
Accomp 1 Balance Enable - YES
Accomp 2 Balance Enable - YES
Accomp 3 Balance Enable - YES

Accomp Bass Balance Enable - YES
Manual Bass Balance Enable - YES
Sound Effects Style sync - ON
Chord Intelligence - OFF

MIDI FUNCTIONS

Solo part MIDI Ch = 4 ON
Solo rx limit low = C0 upp = C8
Solo rx note shift = 0
Lower part MIDI Ch = 3 ON
Lower rx limit low = C0 upp = C8
Lower rx note shift = 0
Accomp 1 part MIDI Ch = 5 ON
Accomp 1 rx limit low = C0 upp = C8
Accomp 1 rx note shift = 0
Accomp 2 part MIDI Ch = 6 ON
Accomp 2 rx limit low = C0 upp = C8
Accomp 2 rx note shift = 0
Accomp 3 part MIDI Ch = 7 ON
Accomp 3 rx limit low = C0 upp = C8
Accomp 3 rx note shift = 0
Accomp Bass part MIDI Ch = 8 ON
A. Bass rx limit low = C0 upp = C8
A. Bass rx note shift = 0
Manual Bass part MIDI Ch = 2 ON
M. Bass rx limit low = C0 upp = C8
M. Bass rx note shift = 0
Drums part MIDI Ch = 10 ON
Drums rx limit low = C0 upp = C8
Drums rx note shift = 0
Sound Effect part MIDI Ch = 11 ON
Sound Effect rx limit low = C0 upp = C8
Sound Effect rx note shift = 0
RX Only part MIDI Ch = 9 ON
RX Only rx limit low = C0 upp = C8
RX Only note shift = 0
Note To Arranger MIDI Ch = 1 ON
Note To A. limit low = C0 upp = B2
MIDI SOFT THRU For Local = ON
Style PRG Change MIDI Ch = 10 ON
Style-Tone PRG C rx/tx = ON
MIDI Real Time rx/tx = ON
MIDI Volume CC 7 rx/tx = ON
MIDI VELOCITY rx = 127 ON

**FACTORY PRESET
USER PROGRAM 12 (Bank 1 - Number 2)**

Solo Tone - 28b
Lower Tone - 64b
Manual Bass Tone - 11b

Balance Solo - 100 ON
Lower - 100 ON
Accomp 1 - 75 ON
Accomp 2 - 75 ON
Accomp 3 - 75 ON
Accomp Bass - 90 ON
Manual Bass - 90 ON
Accomp Drums - 90 ON
Sound Effects - 90 ON

Style - 23 16 BEAT 1
Tempo - 75
Variation - OFF
Advanced Arranger - ON
Hold - ON
Sync Start - OFF
Sync Stop - OFF
Reverb - ON
Reverb Type - HALL 1
Melody Intelligence - OFF

Sound Effect pad a - RAIN
Sound Effect pad b - THUNDER
Sound Effect pad c - WAVES
Sound Effect pad d - STREAM
Sound Effect pad e - LAUGHING
Sound Effect pad f - SCREAMING
Sound Effect pad g - APPLAUSE
Sound Effect pad h - JET
Sound Effect pad i - TRAIN
Sound Effect pad j - HELICOPTER
Sound Effect pad k - THRILLER
Sound Effect pad l - WONDERLAND

Transpose - 0 OFF
Footswitch assign - SUSTAIN
Pitch Bend range - 2
Solo Octave - 1
Lower Octave - 1
Manual Bass Octave: -1
Accomp 1 Balance Enable - YES
Accomp 2 Balance Enable - YES
Accomp 3 Balance Enable - YES

Accomp Bass Balance Enable - YES
Manual Bass Balance Enable - YES
Sound Effects Style sync - ON
Chord Intelligence - OFF

MIDI FUNCTIONS

Solo part MIDI Ch = 4 ON
Solo rx limit low = C0 upp = C8
Solo rx note shift = 0
Lower part MIDI Ch = 3 ON
Lower rx limit low = C0 upp = C8
Lower rx note shift = 0
Accomp 1 part MIDI Ch = 5 ON
Accomp 1 rx limit low = C0 upp = C8
Accomp 1 rx note shift = 0
Accomp 2 part MIDI Ch = 6 ON
Accomp 2 rx limit low = C0 upp = C8
Accomp 2 rx note shift = 0
Accomp 3 part MIDI Ch = 7 ON
Accomp 3 rx limit low = C0 upp = C8
Accomp 3 rx note shift = 0
Accomp Bass part MIDI Ch = 8 ON
A. Bass rx limit low = C0 upp = C8
A. Bass rx note shift = 0
Manual Bass part MIDI Ch = 2 ON
M. Bass rx limit low = C0 upp = C8
M. Bass rx note shift = 0
Drums part MIDI Ch = 10 ON
Drums rx limit low = C0 upp = C8
Drums rx note shift = 0
Sound Effect part MIDI Ch = 11 ON
Sound Effect rx limit low = C0 upp = C8
Sound Effect rx note shift = 0
RX Only part MIDI Ch = 9 ON
RX Only rx limit low = C0 upp = C8
RX Only note shift = 0
Note To Arranger MIDI Ch = 1 ON
Note To A. limit low = C0 upp = B3
MIDI SOFT THRU For Local = ON
Style PRG Change MIDI Ch = 10 ON
Style-Tone PRG C rx/tx = ON
MIDI Real Time rx/tx = ON
MIDI Volume CC 7 rx/tx = ON
MIDI VELOCITY rx = 127 ON

FACTORY PRESET
USER PROGRAM 13 (Bank 1 - Number 3)

Solo Tone - 67b
Lower Tone - 44
Manual Bass Tone - 16b

Balance Solo - 100 ON
Lower - 100 ON
Accomp 1 - 75 ON
Accomp 2 - 75 ON
Accomp 3 - 75 ON
Accomp Bass - 90 ON
Manual Bass - 90 ON
Accomp Drums - 90 ON
Sound Effects - 90 ON

Style - 15 FUNK 1
Tempo - 104
Variation - OFF
Advanced Arranger - ON
Hold - ON
Sync Start - OFF
Sync Stop - OFF
Reverb - ON
Reverb Type - HALL 1
Melody Intelligence - OFF

Sound Effect pad a - RAIN
Sound Effect pad b - THUNDER
Sound Effect pad c - WAVES
Sound Effect pad d - STREAM
Sound Effect pad e - LAUGHING
Sound Effect pad f - SCREAMING
Sound Effect pad g - APPLAUSE
Sound Effect pad h - JET
Sound Effect pad i - TRAIN
Sound Effect pad j - HELICOPTER
Sound Effect pad k - THRILLER
Sound Effect pad l - WONDERLAND

Transpose - 0 OFF
Footswitch assign - SUSTAIN
Pitch Bend range - 2
Solo Octave - 1
Lower Octave - 1
Manual Bass Octave: -1
Accomp 1 Balance Enable - YES
Accomp 2 Balance Enable - YES
Accomp 3 Balance Enable - YES

Accomp Bass Balance Enable - YES
Manual Bass Balance Enable - YES
Sound Effects Style sync - ON
Chord Intelligence - OFF

MIDI FUNCTIONS

Solo part MIDI Ch = 4 ON
Solo rx limit low = C0 upp = C8
Solo rx note shift = 0
Lower part MIDI Ch = 3 ON
Lower rx limit low = C0 upp = C8
Lower rx note shift = 0
Accomp 1 part MIDI Ch = 5 ON
Accomp 1 rx limit low = C0 upp = C8
Accomp 1 rx note shift = 0
Accomp 2 part MIDI Ch = 6 ON
Accomp 2 rx limit low = C0 upp = C8
Accomp 2 rx note shift = 0
Accomp 3 part MIDI Ch = 7 ON
Accomp 3 rx limit low = C0 upp = C8
Accomp 3 rx note shift = 0
Accomp Bass part MIDI Ch = 8 ON
A. Bass rx limit low = C0 upp = C8
A. Bass rx note shift = 0
Manual Bass part MIDI Ch = 2 ON
M. Bass rx limit low = C0 upp = C8
M. Bass rx note shift = 0
Drums part MIDI Ch = 10 ON
Drums rx limit low = C0 upp = C8
Drums rx note shift = 0
Sound Effect part MIDI Ch = 11 ON
Sound Effect rx limit low = C0 upp = C8
Sound Effect rx note shift = 0
RX Only part MIDI Ch = 9 ON
RX Only rx limit low = C0 upp = C8
RX Only note shift = 0
Note To Arranger MIDI Ch = 1 ON
Note To A. limit low = C0 upp = B3
MIDI SOFT THRU For Local = ON
Style PRG Change MIDI Ch = 10 ON
Style-Tone PRG C rx/tx = ON
MIDI Real Time rx/tx = ON
MIDI Volume CC 7 rx/tx = ON
MIDI VELOCITY rx = 127 ON

**FACTORY PRESET
USER PROGRAM 14 (Bank 1 - Number 4)**

Solo Tone - 22b
Lower Tone - 84
Manual Bass Tone - 11b

Balance Solo - 100 ON
Lower - 80 ON
Accomp 1 - 75 ON
Accomp 2 - 75 ON
Accomp 3 - 75 ON
Accomp Bass - 90 ON
Manual Bass - 90 ON
Accomp Drums - 90 ON
Sound Effects - 90 ON

Style - 42 BOSSA N
Tempo - 120
Variation - OFF
Advanced Arranger - OFF
Hold - ON
Sync Start - OFF
Sync Stop - OFF
Reverb - ON
Reverb Type - HALL 1
Melody Intelligence - OFF

Sound Effect pad a - RAIN
Sound Effect pad b - THUNDER
Sound Effect pad c - WAVES
Sound Effect pad d - STREAM
Sound Effect pad e - LAUGHING
Sound Effect pad f - SCREAMING
Sound Effect pad g - APPLAUSE
Sound Effect pad h - JET
Sound Effect pad i - TRAIN
Sound Effect pad j - HELICOPTER
Sound Effect pad k - THRILLER
Sound Effect pad l - WONDERLAND

Transpose - 0 OFF
Footswitch assign - START/STOP
Pitch Bend range - 2
Solo Octave - 1
Lower Octave - 1
Manual Bass Octave: -1
Accomp 1 Balance Enable - YES
Accomp 2 Balance Enable - YES
Accomp 3 Balance Enable - YES

Accomp Bass Balance Enable - YES
Manual Bass Balance Enable - YES
Sound Effects Style sync - ON
Chord Intelligence - OFF

MIDI FUNCTIONS

Solo part MIDI Ch = 1 ON
Solo rx limit low = C0 upp = C8
Solo rx note shift = 0
Lower part MIDI Ch = 2 OFF
Lower rx limit low = C0 upp = C8
Lower rx note shift = 0
Accomp 1 part MIDI Ch = 5 ON
Accomp 1 rx limit low = C0 upp = C8
Accomp 1 rx note shift = 0
Accomp 2 part MIDI Ch = 6 ON
Accomp 2 rx limit low = C0 upp = C8
Accomp 2 rx note shift = 0
Accomp 3 part MIDI Ch = 7 ON
Accomp 3 rx limit low = C0 upp = C8
Accomp 3 rx note shift = 0
Accomp Bass part MIDI Ch = 8 ON
A. Bass rx limit low = C0 upp = C8
A. Bass rx note shift = 0
Manual Bass part MIDI Ch = 3 ON
M. Bass rx limit low = C0 upp = C8
M. Bass rx note shift = 0
Drums part MIDI Ch = 10 ON
Drums rx limit low = C0 upp = C8
Drums rx note shift = 0
Sound Effect part MIDI Ch = 11 ON
Sound Effect rx limit low = C0 upp = C8
Sound Effect rx note shift = 0
RX Only part MIDI Ch = 9 ON
RX Only rx limit low = C0 upp = C8
RX Only note shift = 0
Note To Arranger MIDI Ch = 2 ON
Note To A. limit low = C0 upp = C8
MIDI SOFT THRU For Local = OFF
Style PRG Change MIDI Ch = 10 ON
Style-Tone PRG C rx/tx = ON
MIDI Real Time rx/tx = ON
MIDI Volume CC 7 rx/tx = ON
MIDI VELOCITY rx = 127 ON

FACTORY PRESET
USER PROGRAM 15 (Bank 1 - Number 5)

Solo Tone - 68
Lower Tone - 21
Manual Bass Tone - 12b

Balance Solo - 100 ON
Lower - 100 ON
Accomp 1 - 75 ON
Accomp 2 - 75 ON
Accomp 3 - 75 ON
Accomp Bass - 90 ON
Manual Bass - 90 ON
Accomp Drums - 90 ON
Sound Effects - 90 ON

Style - 12 ROCK 2
Tempo - 133
Variation - ON
Advanced Arranger - ON
Hold - ON
Sync Start - OFF
Sync Stop - OFF
Reverb - ON
Reverb Type - HALL 1
Melody Intelligence - OFF

Sound Effect pad a - RAIN
Sound Effect pad b - THUNDER
Sound Effect pad c - WAVES
Sound Effect pad d - STREAM
Sound Effect pad e - LAUGHING
Sound Effect pad f - SCREAMING
Sound Effect pad g - APPLAUSE
Sound Effect pad h - JET
Sound Effect pad i - TRAIN
Sound Effect pad j - HELICOPTER
Sound Effect pad k - THRILLER
Sound Effect pad l - WONDERLAND

Transpose - 0 OFF
Footswitch assign - START/STOP
Pitch Bend range - 2
Solo Octave - 1
Lower Octave - 1
Manual Bass Octave: -1
Accomp 1 Balance Enable - YES
Accomp 2 Balance Enable - YES
Accomp 3 Balance Enable - YES

Accomp Bass Balance Enable - YES
Manual Bass Balance Enable - YES
Sound Effects Style sync - ON
Chord Intelligence - OFF

MIDI FUNCTIONS

Solo part MIDI Ch = 4 ON
Solo rx limit low = C0 upp = C8
Solo rx note shift = 0
Lower part MIDI Ch = 3 ON
Lower rx limit low = C0 upp = C8
Lower rx note shift = 0
Accomp 1 part MIDI Ch = 5 ON
Accomp 1 rx limit low = C0 upp = C8
Accomp 1 rx note shift = 0
Accomp 2 part MIDI Ch = 6 ON
Accomp 2 rx limit low = C0 upp = C8
Accomp 2 rx note shift = 0
Accomp 3 part MIDI Ch = 7 ON
Accomp 3 rx limit low = C0 upp = C8
Accomp 3 rx note shift = 0
Accomp Bass part MIDI Ch = 8 ON
A. Bass rx limit low = C0 upp = C8
A. Bass rx note shift = 0
Manual Bass part MIDI Ch = 2 ON
M. Bass rx limit low = C0 upp = C8
M. Bass rx note shift = 0
Drums part MIDI Ch = 10 ON
Drums rx limit low = C0 upp = C8
Drums rx note shift = 0
Sound Effect part MIDI Ch = 11 ON
Sound Effect rx limit low = C0 upp = C8
Sound Effect rx note shift = 0
RX Only part MIDI Ch = 9 ON
RX Only rx limit low = C0 upp = C8
RX Only note shift = 0
Note To Arranger MIDI Ch = 1 ON
Note To A. limit low = C0 upp = C8
MIDI SOFT THRU For Local = OFF
Style PRG Change MIDI Ch = 10 ON
Style-Tone PRG C rx/tx = ON
MIDI Real Time rx/tx = ON
MIDI Volume CC 7 rx/tx = ON
MIDI VELOCITY rx = 127 ON

**FACTORY PRESET
USER PROGRAM 16 (Bank 1 - Number 6)**

Solo Tone - 42
Lower Tone - 14
Manual Bass Tone - 11b

Balance Solo - 100 ON
Lower - 80 ON
Accomp 1 - 75 ON
Accomp 2 - 75 ON
Accomp 3 - 75 ON
Accomp Bass - 90 ON
Manual Bass - 90 ON
Accomp Drums - 90 ON
Sound Effects - 90 ON

Style - 31 SWING
Tempo - 130
Variation - OFF
Advanced Arranger - OFF
Hold - OFF
Sync Start - OFF
Sync Stop - OFF
Reverb - ON
Reverb Type - HALL 1
Melody Intelligence - OFF

Sound Effect pad a - RAIN
Sound Effect pad b - THUNDER
Sound Effect pad c - WAVES
Sound Effect pad d - STREAM
Sound Effect pad e - LAUGHING
Sound Effect pad f - SCREAMING
Sound Effect pad g - APPLAUSE
Sound Effect pad h - JET
Sound Effect pad i - TRAIN
Sound Effect pad j - HELICOPTER
Sound Effect pad k - THRILLER
Sound Effect pad l - WONDERLAND

Transpose - 0 OFF
Footswitch assign - START/STOP
Pitch Bend range - 2
Solo Octave - 1
Lower Octave - 1
Manual Bass Octave: -1
Accomp 1 Balance Enable - YES
Accomp 2 Balance Enable - YES
Accomp 3 Balance Enable - YES

Accomp Bass Balance Enable - YES
Manual Bass Balance Enable - YES
Sound Effects Style sync - ON
Chord Intelligence - ON

MIDI FUNCTIONS

Solo part MIDI Ch = 1 ON
Solo rx limit low = C0 upp = C8
Solo rx note shift = 0
Lower part MIDI Ch = 2 ON
Lower rx limit low = C0 upp = C8
Lower rx note shift = 0
Accomp 1 part MIDI Ch = 5 ON
Accomp 1 rx limit low = C0 upp = C8
Accomp 1 rx note shift = 0
Accomp 2 part MIDI Ch = 6 ON
Accomp 2 rx limit low = C0 upp = C8
Accomp 2 rx note shift = 0
Accomp 3 part MIDI Ch = 7 ON
Accomp 3 rx limit low = C0 upp = C8
Accomp 3 rx note shift = 0
Accomp Bass part MIDI Ch = 8 ON
A. Bass rx limit low = C0 upp = C8
A. Bass rx note shift = 0
Manual Bass part MIDI Ch = 3 ON
M. Bass rx limit low = C0 upp = C8
M. Bass rx note shift = 0
Drums part MIDI Ch = 10 ON
Drums rx limit low = C0 upp = C8
Drums rx note shift = 0
Sound Effect part MIDI Ch = 11 ON
Sound Effect rx limit low = C0 upp = C8
Sound Effect rx note shift = 0
RX Only part MIDI Ch = 4 ON
RX Only rx limit low = C0 upp = C8
RX Only note shift = 0
Note To Arranger MIDI Ch = 2 OFF
Note To A. limit low = C0 upp = C8
MIDI SOFT THRU For Local = OFF
Style PRG Change MIDI Ch = 10 ON
Style-Tone PRG C rx/tx = ON
MIDI Real Time rx/tx = ON
MIDI Volume CC 7 rx/tx = ON
MIDI VELOCITY rx = 127 OFF

FACTORY PRESET
USER PROGRAM 17 (Bank 1 - Number 7)

Solo Tone - 28
 Lower Tone - 14
 Manual Bass Tone - 11b

Balance Solo - 100 ON
 Lower - 80 ON
 Accomp 1 - 75 ON
 Accomp 2 - 75 ON
 Accomp 3 - 75 ON
 Accomp Bass - 90 ON
 Manual Bass - 90 ON
 Accomp Drums - 90 ON
 Sound Effects - 90 ON

Style - 35 WALTZ 1
 Tempo - 182
 Variation - OFF
 Advanced Arranger - ON
 Hold - ON
 Sync Start - OFF
 Sync Stop - OFF
 Reverb - ON
 Reverb Type - HALL 1
 Melody Intelligence - OFF

Sound Effect pad a - RAIN
 Sound Effect pad b - THUNDER
 Sound Effect pad c - WAVES
 Sound Effect pad d - STREAM
 Sound Effect pad e - LAUGHING
 Sound Effect pad f - SCREAMING
 Sound Effect pad g - APPLAUSE
 Sound Effect pad h - JET
 Sound Effect pad i - TRAIN
 Sound Effect pad j - HELICOPTER
 Sound Effect pad k - THRILLER
 Sound Effect pad l - WONDERLAND

Transpose - 0 OFF
 Footswitch assign - START/STOP
 Pitch Bend range - 2
 Solo Octave - 1
 Lower Octave - 1
 Manual Bass Octave: -1
 Accomp 1 Balance Enable - YES
 Accomp 2 Balance Enable - YES
 Accomp 3 Balance Enable - YES

Accomp Bass Balance Enable - YES
 Manual Bass Balance Enable - YES
 Sound Effects Style sync - ON
 Chord Intelligence - ON

MIDI FUNCTIONS

Solo part MIDI Ch = 1 ON
 Solo rx limit low = C0 upp = C8
 Solo rx note shift = 0
 Lower part MIDI Ch = 2 OFF
 Lower rx limit low = C0 upp = C8
 Lower rx note shift = 0
 Accomp 1 part MIDI Ch = 5 ON
 Accomp 1 rx limit low = C0 upp = C8
 Accomp 1 rx note shift = 0
 Accomp 2 part MIDI Ch = 6 ON
 Accomp 2 rx limit low = C0 upp = C8
 Accomp 2 rx note shift = 0
 Accomp 3 part MIDI Ch = 7 ON
 Accomp 3 rx limit low = C0 upp = C8
 Accomp 3 rx note shift = 0
 Accomp Bass part MIDI Ch = 8 ON
 A. Bass rx limit low = C0 upp = C8
 A. Bass rx note shift = 0
 Manual Bass part MIDI Ch = 3 OFF
 M. Bass rx limit low = C0 upp = C8
 M. Bass rx note shift = 0
 Drums part MIDI Ch = 10 ON
 Drums rx limit low = C0 upp = C8
 Drums rx note shift = 0
 Sound Effect part MIDI Ch = 11 ON
 Sound Effect rx limit low = C0 upp = C8
 Sound Effect rx note shift = 0
 RX Only part MIDI Ch = 4 ON
 RX Only rx limit low = C0 upp = C8
 RX Only note shift = 0
 Note To Arranger MIDI Ch = 2 ON
 Note To A. limit low = C0 upp = C8
 MIDI SOFT THRU For Local = OFF
 Style PRG Change MIDI Ch = 10 ON
 Style-Tone PRG C rx/tx = ON
 MIDI Real Time rx/tx = ON
 MIDI Volume CC 7 rx/tx = ON
 MIDI VELOCITY rx = 127 OFF

**FACTORY PRESET
USER PROGRAM 18 (Bank 1 - Number 8)**

Solo Tone - 66b
Lower Tone - 55
Manual Bass Tone - 17b

Balance Solo - 100 ON
Lower - 100 ON
Accomp 1 - 75 ON
Accomp 2 - 75 ON
Accomp 3 - 75 ON
Accomp Bass - 90 ON
Manual Bass - 100 ON
Accomp Drums - 90 ON
Sound Effects - 90 ON

Style - 21 8 BEAT 1
Tempo - 70
Variation - OFF
Advanced Arranger - ON
Hold - ON
Sync Start - OFF
Sync Stop - OFF
Reverb - ON
Reverb Type - HALL 1
Melody Intelligence - OFF

Sound Effect pad a - RAIN
Sound Effect pad b - THUNDER
Sound Effect pad c - WAVES
Sound Effect pad d - STREAM
Sound Effect pad e - LAUGHING
Sound Effect pad f - SCREAMING
Sound Effect pad g - APPLAUSE
Sound Effect pad h - JET
Sound Effect pad i - TRAIN
Sound Effect pad j - HELICOPTER
Sound Effect pad k - THRILLER
Sound Effect pad l - WONDERLAND

Transpose - 0 OFF
Footswitch assign - SUSTAIN
Pitch Bend range - 2
Solo Octave - 1
Lower Octave - 1
Manual Bass Octave: -1
Accomp 1 Balance Enable - YES
Accomp 2 Balance Enable - YES
Accomp 3 Balance Enable - YES

Accomp Bass Balance Enable - YES
Manual Bass Balance Enable - YES
Sound Effects Style sync - ON
Chord Intelligence - OFF

MIDI FUNCTIONS

Solo part MIDI Ch = 1 ON
Solo rx limit low = F#5 upp = B6
Solo rx note shift = 0
Lower part MIDI Ch = 1 ON
Lower rx limit low = C4 upp = F5
Lower rx note shift = 0
Accomp 1 part MIDI Ch = 5 ON
Accomp 1 rx limit low = C0 upp = C8
Accomp 1 rx note shift = 0
Accomp 2 part MIDI Ch = 6 ON
Accomp 2 rx limit low = C0 upp = C8
Accomp 2 rx note shift = 0
Accomp 3 part MIDI Ch = 7 ON
Accomp 3 rx limit low = C0 upp = C8
Accomp 3 rx note shift = 0
Accomp Bass part MIDI Ch = 8 ON
A. Bass rx limit low = C0 upp = C8
A. Bass rx note shift = 0
Manual Bass part MIDI Ch = 1 ON
M. Bass rx limit low = C3 upp = B3
M. Bass rx note shift = -12
Drums part MIDI Ch = 10 ON
Drums rx limit low = C0 upp = C8
Drums rx note shift = 0
Sound Effect part MIDI Ch = 1 ON
Sound Effect rx limit low = C7 upp = C8
Sound Effect rx note shift = 6
RX Only part MIDI Ch = 9 ON
RX Only rx limit low = C0 upp = C8
RX Only note shift = 0
Note To Arranger MIDI Ch = 1 ON
Note To A. limit low = C0 upp = B2
MIDI SOFT THRU For Local = ON
Style PRG Change MIDI Ch = 10 ON
Style-Tone PRG C rx/tx = OFF
MIDI Real Time rx/tx = ON
MIDI Volume CC 7 rx/tx = ON
MIDI VELOCITY rx = 127 ON

WRITING A PANEL CONFIGURATION

A total of 48 User Programs can be used - 6 Banks of 8 numbers

1. Set all the recordable functions you wish to record into a User Program.
2. Press the WRITE button [62] and hold. The display will respond with:

WRITE PANEL IN
USER PROGRAM ?

While pressing the WRITE button:

3. Press and hold the BANK button [63] in the USER PROGRAMS section (LED of current BANK number will light)
4. Press the BANK number 1~6 (BANK LED will light)
5. While keeping the WRITE button pressed, release the BANK button.
6. Press the USER PROGRAM number 1~8 (USER PROGRAM number LED will light) and the display will confirm and indicate:

OK !!
SAVE COMPLETE

When the WRITE button is released, the Master Display will return and show the recorded USER BANK number.

* If the Internal Memory Protection parameter is in ON position when the WRITE button was pressed, the display will indicate:

INTERNAL MEMORY
PROTECTED !!

To enable a USER PROGRAM to be recorded, set the Internal Memory Protection parameter to OFF position (See INTERNAL MEMORY Protection in FUNCTIONS), and perform the above procedures 2~6 again.

* If the BANK button LED you wish to use lights, there is no need to press that button again, simply release the BANK button and perform procedure 6.

To record another User Program, follow the same procedures as above. The User Program contents will be retained until they are further changed. Turning the instrument off will not erase a recorded User Program.

However, if you wish to record more than 48 User Program configurations, the User Programs already recorded can be saved onto an optional memory card. (see MEMORY CARD).

To activate any of the User Programs:

1. Press the BANK button [63] and hold (LED of current BANK will light).
2. Press the BANK number button 1~6 (LED will light).
3. Release the BANK button
4. Press the USER PROGRAM number button 1~ 8 (LED will light)

The panel setting in that particular program will be recalled and the display will indicate next to the Solo tone number, the number of the USER BANK in use. To cancel a User Program, press the same User Program button a second time (the button of the LED lit). The program will now be cancelled and the panel registration before selecting a User Program will return. This is called User Program 0.

LOADING FACTORY USER PROGRAMS INTO THE PRO-E

If you wish to reset the factory preset User Programs (1-48):

1. Turn the PRO-E off.
2. Press the WRITE button [62] and hold it.
3. Turn the PRO-E back on.

The display will respond with:

FACTORY	SET	UP
LOADED	!	!

NOTE: This procedure will erase any current User Programs AND songs contained in the Composer memory. To retain the current User Programs and songs, follow the procedure - «WRITING DATA ONTO THE CARD».

COMPOSER

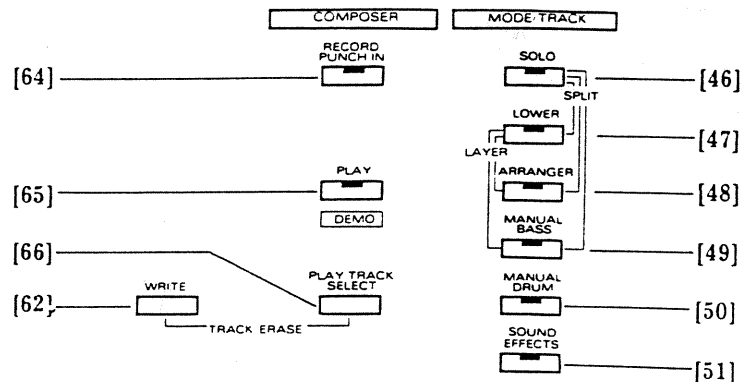

The COMPOSER is a unique «six track sequencer» that can record and store three complete songs for playback at any time.

In addition to the six tracks recording chord and note information, the Composer can also record the following functions:

Tone change
(SOLO, LOWER, MANUAL BASS)
Balance Change
(SOLO, LOWER, ACCOMP 1/2/3,
ACCOMP/MANUAL BASS,
ACCOMP DRUMS,
SOUND EFFECTS)
Style
Tempo
Variation ON/OFF
Advanced Arranger ON/OFF
Hold ON/OFF
Fill-In to Original
Fill-In to Variation
Break Mute
Intro/Ending
Sync Start ON/OFF
Sync Stop ON/OFF
Sound Effects (from key or pad)

User Program 1~48
Pitch Bend
Modulation
Sustain (using the optional footswitch)
Reverb ON/OFF
Reverb Type
Melody Intelligence ON/OFF
Sound Effect pads a~l assign
Transpose
Footswitch assign
Pitch Bend range
Octave range
Accomp 1/2/3 Balance enable
Acc/Man Bass Balance enable
Sound Effects Style sync ON/OFF
Chord Intelligence ON/OFF
All MIDI Parameters

Accompaniment and melody can be recorded simultaneously, but if recording separately, we suggest that the accompaniment be recorded first.

The maximum amount of chord changes recordable in one measure is 96. The minimum length of melody notes that can be recorded in one measure is a sixty-fourth note triplet (♩)

All events recorded in the Composer will be retained until they are changed. Turning the instrument off will not erase a recorded track or song.

However, if you wish to record more than three songs, the songs already recorded in the Composer can be saved onto an optional memory card (see MEMORY CARD).

RECORDING A SONG

1. Stop the Style if already playing.
2. Press and hold the RECORD/PUNCH IN button [64] in the Composer section. The display will respond with:

RECORD SONG x — SONG 1, 2 or 3
SELECT TRACK

3. Select the desired Song 1, 2 or 3 by rotating the TEMPO/FUNCTION Dial. The display will show the song change.

Upon releasing the RECORD/PUNCH IN button, the LED will light red, the LED of the keyboard mode previously selected will light red and the Master Display will return.

- * If the Internal Memory Protection parameter is in ON position when the RECORD/PUNCH IN button was pressed, the display will indicate:

INTERNAL MEMORY
PROTECTED !!

To enable a Song to be recorded, set the Internal Memory Protection parameter to OFF position (See INTERNAL MEMORY Protection in FUNCTIONS), and perform the above procedures 2 & 3 again.

Tracks can be recorded separately - SOLO, LOWER, MANUAL BASS, ARRANGER, MANUAL DRUMS, SOUND EFFECTS and also in the same combination as in Keyboard Modes - SOLO/LOWER, SOLO/MANUAL BASS, SOLO/ARRANGER and LOWER/MANUAL BASS.

To record (ensure RECORD/PUNCH IN LED is ON):

4. Press the desired track or tracks (red LEDs will light)
5. Press START/STOP, recording begins.

NOTE: If the RECORD LED turns off immediately after pressing the START button, the total memory capacity has been reached. In this case use the «Track Erase» function to erase tracks previously recorded which are not needed or to «free» empty tracks.

6. To stop recording press START/STOP button again (RECORD/PUNCH IN LED will be turned off).
7. If you wish to record on a second track and hear the other(s) playing back (when Multi-Track recording for example), press RECORD/PUNCH IN button (LED lit), press the desired track(s) for recording (red LED lights of the track button). Then press the PLAY button [65] (green LED lights), the LED of the tracks already recorded in will now light green).

Follow the procedures 5 & 6.

* If you do not wish to hear a PLAY track on Multi-recording, press and hold the PLAY TRACK SELECT button and press the track you wish to mute (green LED of play track will be turned off). If the track you disabled on playback is the same as the keyboard mode selected, the LED will light orange. To enable the track to play again on playback, press and hold the PLAY TRACK SELECT button and press the track you wish to play (green LED of play track will be turned back on).

* To record in the Arranger track, the Style you wish to use in the recording should be selected before starting. Further selections can be made during recording.

* To record on SOLO, LOWER, MANUAL BASS tracks, the tone you wish to use in the recording should be selected before starting. Further selections can be made during recording.

The recording can be started in three ways:

- a) Press the START/STOP button. The rhythm and recording starts immediately.
- b) Press the SYNC START button (LED lights). Then press a note on the keyboard (in the accompaniment section of the keyboard when recording in 'Split' mode - SOLO/LOWER, SOLO/ARRANGER, SOLO/MANUAL BASS). Rhythm and recording will begin automatically.

c) Press the INTRO/ENDING button and the recording will start with the "introduction" to the rhythm selected.

* The Intro can also be selected with the SYNC START function. Press the INTRO/ENDING button **after pressing** the SYNC START button (Sync Start LED begins to flash). Then play a note on the keyboard. The recording will begin with the "introduction".

The Song Composer will inform you when you are approaching the full memory capacity of the song you are recording by flashing the RECORD LED. This occurs when only 10% of the memory is remaining.

* When the total memory capacity is reached, recording will be automatically switched off. The rhythm will automatically be switched off and RECORD LED will be turned off.

* To record on the same song, both on previously recorded track(s) or on empty track(s), it will be necessary to use the «Track Erase» function to erase the track(s) previously recorded or «free» the empty tracks.

To record another song (three songs are possible), follow procedures 2 & 3 in «RECORDING A SONG», then follow procedures 4~7.

NOTE: Using the PITCH BENDER/MODULATION LEVER, TEMPO CHANGE and BALANCE features on record will use up a lot of the song memory.

NOTE: Although FADE IN/OUT can be used during recording, it will not be recorded in the Song.

NOTE: Recording can either be made from the keyboard (PRO-E) itself or from external keyboard/device via MIDI. The transmitted MIDI channel must be the same as the channel of the keyboard mode related to the track being recorded.

PUNCH IN RECORD

Punch In recording can be performed in any of the tracks already recorded.

1. Press the RECORD/PUNCH IN button [64], and the PLAY button [65], press the track button you wish to Punch-In (Red and green LEDs will flash alternately).

2. Press the START/STOP button.

NOTE: If the RECORD LED turns off immediately after pressing the START button, the total memory capacity has been reached. In this case use the «Track Erase» function to erase tracks previously recorded which are not needed or to «free» empty tracks.

3. At the point you wish to Punch-in, press the REC/PUNCH IN button (LED of Punch-in track will light red constantly)

4. Press START/STOP when Punch-in recording is finished.

TRACK ERASE

To erase any recorded track completely:

1. Press and hold the PLAY TRACK SELECT button [66]
2. Press and hold the WRITE button [62]. Display will show:

TRACK ERASE
SELECT TRACK

All tracks LEDS will flash red.

3. While holding PLAY TRACK SELECT and WRITE BUTTONS, just press the button of the track you wish to erase. LED of track erased will be turned off.

* If the Internal Memory Protection parameter is in ON position when the track button was pressed, the display will indicate:

INTERNAL MEMORY
PROTECTED !!

To enable the track to be erased, set the Internal Memory Protection parameter to OFF position (See INTERNAL MEMORY Protection in FUNCTIONS), and perform the above procedures 2 & 3 again.

PLAYING BACK A SONG

To play back the current song.

1. Press the PLAY button (LED lights).
2. Press START/STOP button, playback will start.

— or —

Press the SYNC START button, then press a note in the lower section of the keyboard.

Each keyboard mode can be played during Composer playback. Just select the keyboard mode (LED will flash green and orange alternately).

Playback and rhythm will automatically stop after the final measure of the song, or the song can be stopped at any time by pressing the START/STOP button (PLAY LED is turned off).

If you wish the song to playback repeatedly, press the PLAY button one more time (LED will start to flash). To cancel the "loop" feature press the PLAY button again until the LED lights constantly.

To playback one of the other two songs:

1. Press PLAY [65] button and hold, the display will respond with.

PLAY SONG X SELECT TRACK	—	SONG 1,2 or 3
-----------------------------	---	---------------

2. Select the desired Song - 1, 2 or 3 by rotating the TEMPO/FUNCTION Dial. The display will show the song change.

Upon releasing the PLAY button, the LED will light, and the Master Display will return.

3. Follow the "PLAYING BACK A SONG" procedures above.

* If you wish to load and play Composer Songs already recorded on the optional Memory card, see MEMORY CARD and follow the "PLAYING BACK A SONG", procedures above.

MEMORY CARD

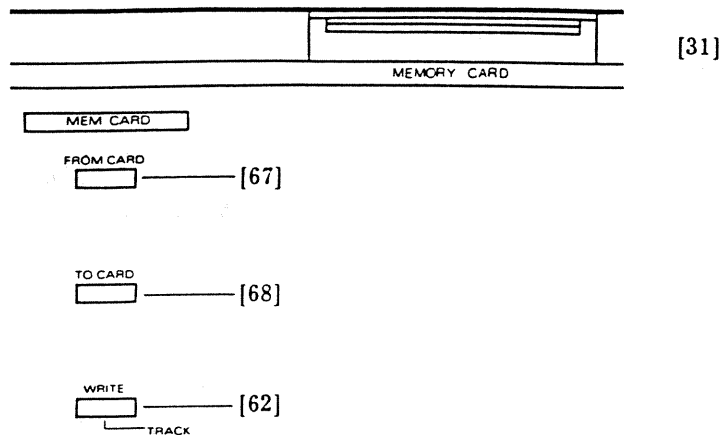

An optional Memory Card (M-256D, M-256E) is available from your Roland dealer.

With the Memory Card, 3 songs recorded in Composer and/or 48 USER PROGRAMS can be "written" and stored onto the card (To Card) making it possible to record additional songs or panel configurations in the PRO-E internal memory.

The data stored onto the card can then be "loaded" and returned to the PRO-E (From Card) for playback at any time.

The Composer songs can be loaded either separately to 3 positions in the card or all 3 simultaneously or they can be loaded along with the User Programs.

WRITING DATA ONTO THE MEMORY CARD

To "write" and store data onto the Memory Card:

1. Insert the Memory Card into the MEMORY CARD SLOT [31] with the label facing upwards.
2. Make sure that the PROTECT switch of the Memory Card is set to OFF position.
3. Press and hold the TO CARD button [68] in the MEM CARD section. The display will respond with:

SONGS/USER PROG
TO MEMORY CARD

Stores all Composer songs and User Programs TO the Card

4. While holding the TO CARD button, moving the TEMPO/FUNCTION Dial will show and select the following TO CARD writing operations:

USER PROGRAMS TO MEMORY CARD

Stores all User Programs TO the Card.

INT ALL SONGS TO CARD SONGS

Stores all Composer songs TO the Card

INT SONG TO CARD SONG	1 X
--------------------------	--------

Stores Composer Song 1 TO the Card position (1, 2 or 3). Press CURSOR button and rotate TEMPO/FUNCTION Dial to select position 1, 2 or 3.

INT SONG TO CARD SONG	2 X
--------------------------	--------

Stores Composer Song 2 TO the Card position (1, 2 or 3). Press CURSOR button and rotate TEMPO/FUNCTION Dial to select position 1, 2 or 3.

INT SONG TO CARD SONG	3 X
--------------------------	--------

Stores Composer Song 3 TO the Card position (1, 2 or 3). Press CURSOR button and rotate TEMPO/FUNCTION Dial to select position 1, 2 or 3.

* If the CURSOR button has been pressed while showing any of the above displays, press once more to see other displays.

5. While holding the TO CARD button, press the WRITE button [62]. If the card has not been used before, the display will respond with:

ILLEGAL CARD !!
WRITE AGAIN ?

6. While holding the TO CARD button, press the WRITE button once more. The display will respond with:

OK !!
SAVE COMPLETE

The selected writing operation has now been executed. After releasing both buttons, the Master Display will return.

* To protect the data (Songs and User Programs) stored on the card, set the PROTECT switch to ON before removing the card.

The same contents of the Card can be loaded in the same sequence (separately or together) into the PRO-E.

**LOADING DATA FROM THE
MEMORY CARD INTO THE PRO-E**

To "write" and load data into the
PRO-E:

1. Insert the Memory Card into the
MEMORY CARD SLOT [31] with
the label facing upwards.
2. Press and hold the FROM CARD
button [67] in the MEM CARD sec-
tion.
The display will respond with:

SONGS/USER PROG
FROM MEMORY CARD

Loads all Composer songs and
User Programs FROM the Card.

3. While holding the FROM CARD
button, moving the TEMPO/
FUNCTION Dial will show and se-
lect the following Card loading ope-
rations:

USER PROGRAMS
FROM MEMORY CARD

Loads all User Programs FROM
the Card to PRO-E.

INT ALL SONGS
FROM CARD SONGS

Loads all songs FROM
the Card to PRO-E

INT SONG 1
FROM CARD SONG X

Loads Song X (1, 2 or 3) FROM the
Card to Composer Song 1. Press the
CURSOR button and rotate
TEMPO/FUNCTION Dial to select
Card Song 1, 2 or 3.

INT SONG 2
FROM CARD SONG X

Loads Song X (1, 2 or 3) FROM the
Card to Composer Song 2. Press the
CURSOR button and rotate
TEMPO/FUNCTION Dial to select
Card Song 1, 2 or 3.

INT SONG 3
FROM CARD SONG X

Loads Song X (1, 2 or 3) FROM the
Card to Composer Song 3. Press the
CURSOR button and rotate
TEMPO/FUNCTION Dial to select
Card Song 1, 2 or 3.

If the CURSOR button has been pressed while showing any of the above displays, press once more to see other displays.

4. While holding the FROM button, press the WRITE button [62]. The display will respond with:

OK !!
SAVE COMPLETE

The selected loading operation has now been executed. After releasing both buttons, the Master Display will return.

- * If the Internal Memory Protection parameter is in ON position when the WRITE button was pressed, the display will indicate:

INTERNAL MEMORY
PROTECTED !!

To enable loading of the selected operation, set the Internal Memory Protection parameter to OFF position (See INTERNAL MEMORY Protection in FUNCTIONS), and perform the procedure 4 again.

<Reference>

If desired, the "factory preset" User Program settings can be reloaded into the PRO-9. To reload the factory User Program settings, see **LOADING FACTORY USER PROGRAMS INTO THE PRO-E.**

ERROR MESSAGES

If any of the (write/load) procedures have not been carried out correctly, the following Error messages will be displayed:

DISPLAY	REASON	REMEDY
CARD NOT READY	<ul style="list-style-type: none"> - The card has not been inserted. 	<ul style="list-style-type: none"> - Insert card and repeat procedure.
ILLEGAL CARD !!	<ul style="list-style-type: none"> - The card is new. - The battery has not been inserted. - The card has been programmed on other Roland instruments. - The card now in the MEMORY CARD slot is a Style Card. 	<ul style="list-style-type: none"> - Press the WRITE button again. - Insert battery and repeat procedure. - If you wish to erase the data on the card, press the WRITE button again. - Insert a Memory Card M-256D or M-256E and repeat procedure.
MEMORY CARD PROTECTED !	<ul style="list-style-type: none"> - The Protect switch is set to the ON position. 	<ul style="list-style-type: none"> - Set the Protect switch to the OFF position and repeat procedure.
SAVE NOT POSSIBLE !!	<ul style="list-style-type: none"> - The Card now in the MEMORY CARD slot is a ROM Card. 	<ul style="list-style-type: none"> - Insert a RAM Card and repeat procedure.
WRITE ERROR FOR CARD	<ul style="list-style-type: none"> - When the written data showed irregularities. 	<ul style="list-style-type: none"> - Repeat procedure and if the result is the same, change the Card
CHECK CARD BATTERY !!	<ul style="list-style-type: none"> - The battery inside the card is below its charge limit. 	<ul style="list-style-type: none"> - Renew the Card battery and repeat procedure.

STYLE CARD

Additional Styles are available from optional Music Style Cards available from your Roland dealer.

PLAYING STYLES FROM THE CARD

To play Styles from the Music Style Card:

1. Insert Style Card into MEMORY CARD slot [31].
2. Press CARD button in the STYLE SELECT section.
3. Press one of the NUMBER buttons 1-8. The number, name and preset tempo of the card Style selected will appear in the display.

Example:

C1 M'TOWN ♩ = 132
XX XX XX

To START/STOP, and select: VARIATION, ADVANCED ARRANGER ON/OFF, FILL-IN, INTRO/ENDINGS, TAP TEMPO/BREAK MUTE, follow the same procedures as were used for the built-in Styles.

- * Inserting a Music Style Card into the PRO-E will not erase the built-in Styles.
- * Do not remove the Music Style Card when a Style from the card is playing.

ERROR MESSAGES

If any of the above procedures were not carried out correctly, the Error messages below will be displayed.

DISPLAY	REASON	REMEDY
<div style="border: 1px solid black; padding: 10px; width: fit-content; margin: auto;">CARD NOT READY</div>	– The Music Style Card has not been inserted.	– Insert card and repeat procedure.
<div style="border: 1px solid black; padding: 10px; width: fit-content; margin: auto;">MEMORY CARD PROTECTED !</div>	– The Card now in the card slot is not a Music Style Card.	– Insert a Music Style Card and repeat procedure.

DEMO SONGS

Inside the PRO-E is stored 5 Demo Songs which can be played to experience the excellent qualities of the instrument's tones and Music Styles and effects and to demonstrate how effectively Songs can be recorded into the PRO-E's six-track Composer.

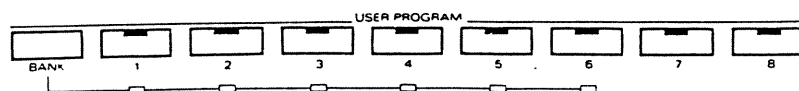

1. Press and hold the PLAY/DEMO button [65].
2. Press USER PROGRAM buttons 1~5 to hear Demo Songs 1~5 separately.

— or —

Press USER PROGRAM button 6 to hear all Demo Songs in sequence.

3. Press the START/STOP button [26].

* While the Demo Songs are being performed, the PRO-E cannot be played and no MIDI message can be received.

* The Demo Songs data cannot be sent out through MIDI OUT.

4. To stop playing any Demo Song, press again the START/STOP button [26].

Following is a list of the Demo Songs and composers.

Demo 1 - «TIME OUT» by:
Luigi Bruti/Roberto Lanciotti © 1989
Demo 2 - «YAH YAH» by:
Dave Smith © 1989
Demo 3 - «PASADENA» by:
Luigi Bruti © 1989
Demo 4 - «MY RADIO» by:
Luigi Bruti/Roberto Lanciotti © 1989
Demo 5 - «YUPPIE» by:
Luigi Bruti © 1988

MIDI CONTROL

M.I.D.I. is the acronym for Musical Instrument Digital Interface.

MIDI is a standardized interface by which all digital musical instruments also equipped with MIDI connections can exchange data. This means that the PRO-E can be used as a MIDI control keyboard - to control other MIDI devices (keyboard, sequencer, etc.) or as a MIDI sound source (to be controlled by other MIDI devices).

CONNECTIONS

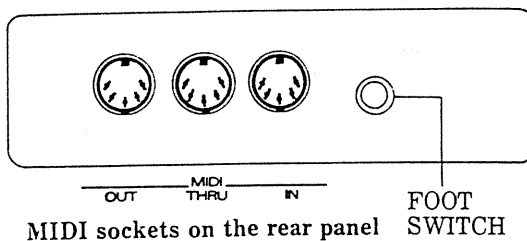

Switch off the PRO-E and all other MIDI devices.

There are three MIDI sockets on the rear panel of the PRO-E as follows:

- MIDI OUT socket
Use this socket for sending MIDI signals from the PRO-E to control external MIDI devices.
 - MIDI THRU socket
The exact copy of the signal fed into the MIDI IN is sent out through this socket.
 - MIDI IN socket.
Use this socket for feeding MIDI signals from an external MIDI device to control the PRO-E.
- * The signal fed into the MIDI IN is not sent out through MIDI OUT.
- * When connecting, switch off the PRO-E and all other MIDI devices.
- * Do not connect more than 3 MIDI devices through the MIDI THRU sockets. Use the optional MIDI THRU box (MM-4) in this case.

MIDI MESSAGE LED

This LED [14] is lit every time a MIDI message (Note On/Off, Program Change, Pitch Bend, etc.) is operative.

External MIDI Connections

The PRO-E can be played (triggered) from the following MIDI equipped instruments. To connect the instrument to the PRO-E, use a standard MIDI cable and connect from the MIDI OUT & MIDI IN sockets of the instrument to the MIDI IN & MIDI OUT sockets of the PRO-E respectively. By using a factory preset User Program, all MIDI parameters needed for each connection will be automatically set. If you should still experience any difficulty playing the PRO-E from a particular instrument, refer to the MIDI section of both Owner's Manuals or see your local Roland Dealer.

Example 1: Connection of the PRO-E with MIDI Piano

a) **Press User Program No. 11** (press BANK and User Program 1 buttons simultaneously, then press User Program 1 button).

- Arranger played from Piano keyboard (notes C0-B2)
- Play actual sound from Piano keyboard (notes C3 - C8) (Ensure volume of Piano keyboard is turned up)
- Solo "Trombone 2" or Lower "Clarinet 2" from PRO-E keyboard.

b) **Press User Program No. 12** (press BANK and User Program 1 buttons simultaneously, then press User Program 2 button).

- Arranger played from Piano keyboard (notes C0-B3)
- Play actual sound from Piano keyboard (notes C4-C8)
- Solo "Sax 2" or Lower "Shakuhachi" from PRO-E keyboard.

c) **Press User Program No. 18** (press BANK and User Program 1 buttons simultaneously, then press User Program 8 button).

- Multi Split Example
- Turn Piano keyboard volume to Zero
- Arranger played from Piano keyboard (notes C0-B2)
- Manual Bass "Fretless 1" from Piano keyboard (C3-B3)
- Lower "Soundtrack " from Piano Keyboard (C4-F5)
- Solo "Whistle 2" played from Piano keyboard (notes F#5-B6)
- Sound Effects from Piano keyboard (C7-C8)

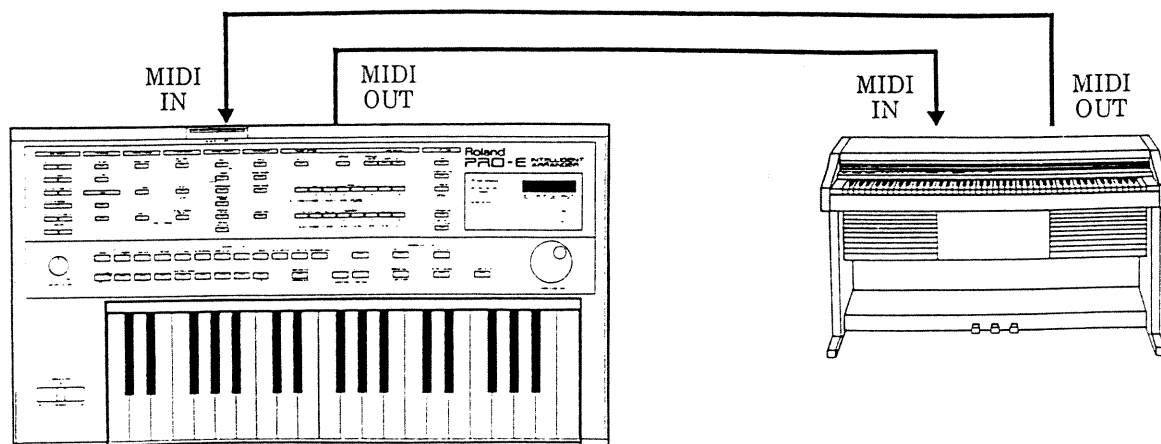

Example 2: Connection of PRO-E with MIDI Synthesizer

Press User Program No. 13 (press BANK and User Program 1 buttons simultaneously, then press User Program 3 button)

- Arranger played from Synth keyboard (notes C0-B3)
- Play actual sound from Synth keyboard (notes C4-C8)
(Ensure volume of Synth keyboard is turned up)
- Solo "Bottle Blow" or Lower "Syn Brass 4" from PRO-E keyboard.

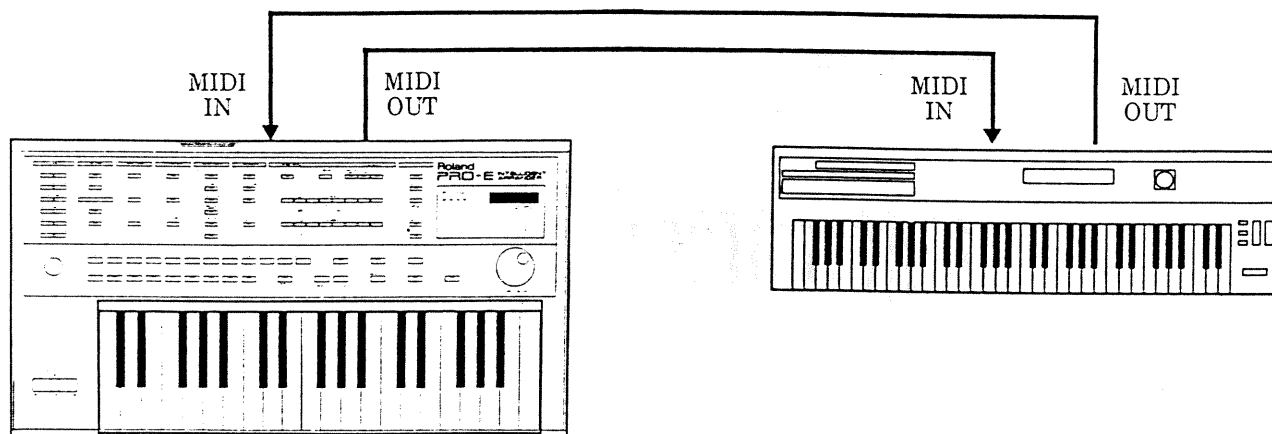

Example 3: Connection of PRO-E with MIDI Organ

Press User Program No. 14 press BANK and User Program 1 buttons simultaneously, then press User Program 4 button).

- Arranger played from Organ keyboard (notes C0-C8)
- Solo "Flute 2" played from Upper Organ keyboard (notes C0-C8)
- Lower "Guitar 1" from PRO-E keyboard.
- Manual Bass "Acou Bass 1" from Organ pedalboard.
- If you do not wish to hear the tone of the Organ keyboards turn the volume to Zero.

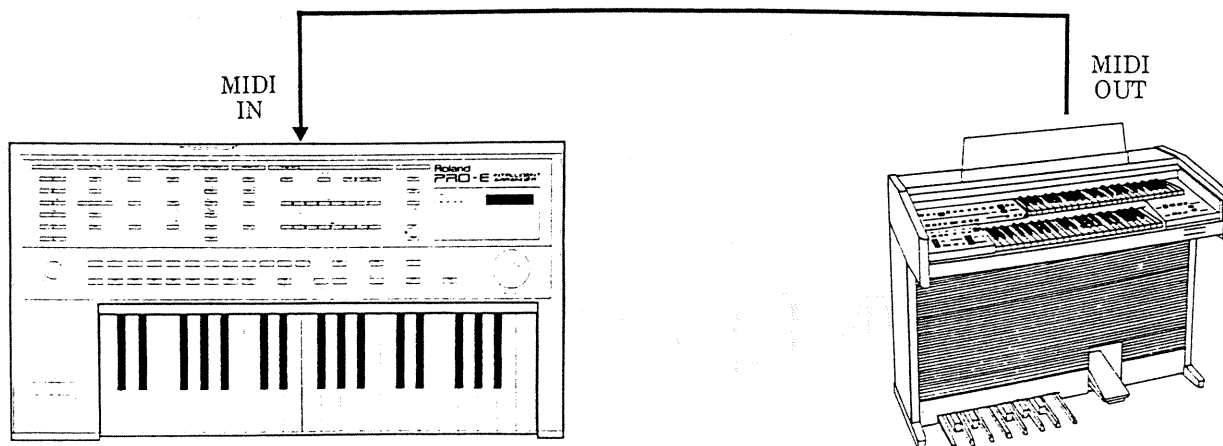

Example 4: Connection of PRO-E with MIDI Guitar

Press User Program No. 15 (press BANK and User Program 1 buttons simultaneously, then press User Program 5 button).

- Arranger played from Guitar.
- Solo "Square Wave" from PRO-E keyboard.
- Lower "Elec Organ 1" from PRO-E keyboard.

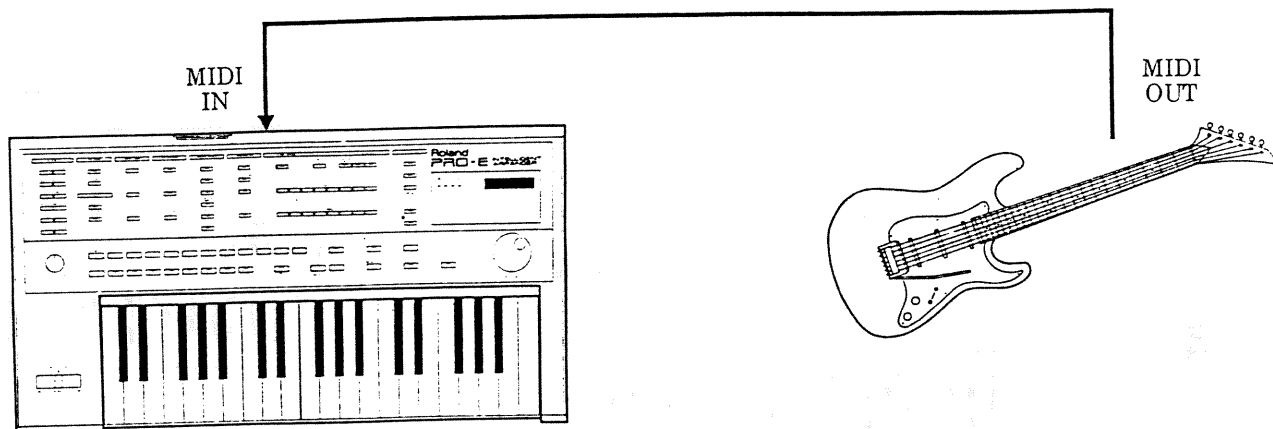

Example 5: Connection of PRO-E with MIDI Accordion

a) Press User Program No. 16 (press BANK and User Program 1 buttons simultaneously, then press User Program 6 button).

- Solo "Syn Brass 2" and Mono section from right Accordion keyboard (notes C0-C8)
- Lower "Elec Piano 1" from left Accordion Chord buttons.
- Bass "Acou Bass 1" from left Accordion Bass buttons.

b) Press User Program No. 17 (press BANK and User Program 1 buttons simultaneously, then press User Program 7 button).

- Arranger played from left Accordion Chord buttons.
- Solo "Accordion" and Mono section from right Accordion keyboard (notes C0-C8)

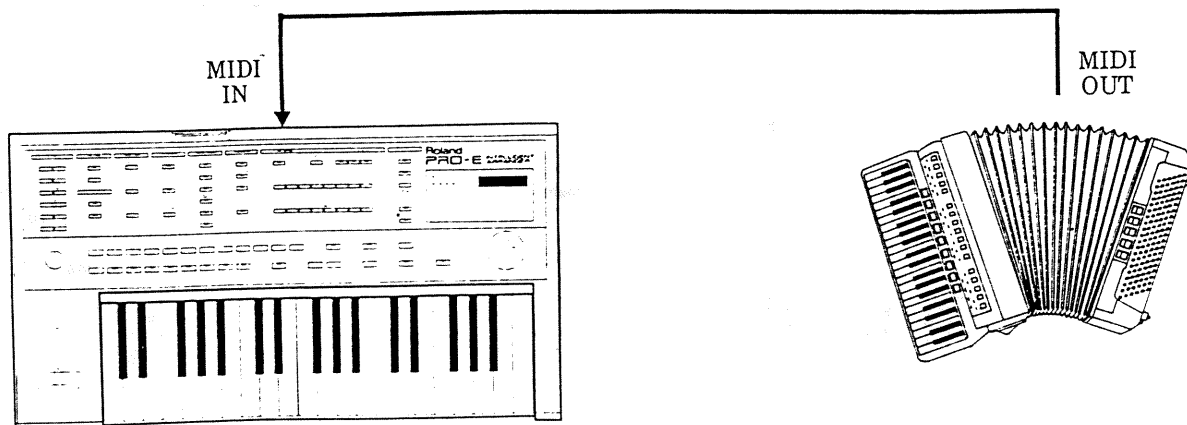

128 TONES AVAILABLE BY
EXTERNAL MIDI PROGRAM
CHANGE

When using an external MIDI device
to control the sound source within the
PRO-E, a total of 128 tones can be
played.

The 128 tones available are:

Tone Name	Prog-No.	HP-Prog.	Tone Name	Prog-No.	HP-Prog.
Acou Piano 1	001	A11	Acou Bass 1	065	B11
Acou Piano 2	002	A12	Acou Bass 2	066	B12
Acou Piano 3	003	A13	Elec Bass 1	067	B13
Elec Piano 1	004	A14	Elec Bass 2	068	B14
Elec Piano 2	005	A15	Slap Bass 1	069	B15
Elec Piano 3	006	A16	Slap Bass 2	070	B16
Elec Piano 4	007	A17	Fretless 1	071	B17
Honkytonk	008	A18	Fretless 2	072	B18
Elec Org 1	009	A21	Flute 1	073	B21
Elec Org 2	010	A22	Flute 2	074	B22
Elec Org 3	011	A23	Piccolo 1	075	B23
Elec Org 4	012	A24	Piccolo 2	076	B24
Pipe Org 1	013	A25	Recorder	077	B25
Pipe Org 2	014	A26	Pan Pipes	078	B26
Pipe Org 3	015	A27	Sax 1	079	B27
Accordion	016	A28	Sax 2	080	B28
Harpsi 1	017	A31	Sax 3	081	B31
Harpsi 2	018	A32	Sax 4	082	B32
Harpsi 3	019	A33	Clarinet 1	083	B33
Clavi 1	020	A34	Clarinet 2	084	B34
Clavi 2	021	A35	Oboe	085	B35
Clavi 3	022	A36	Engl Horn	086	B36
Celesta 1	023	A37	Bassoon	087	B37
Celesta 2	024	A38	Harmonica	088	B38
Syn Brass 1	025	A41	Trumpet 1	089	B41
Syn Brass 2	026	A42	Trumpet 2	090	B42
Syn Brass 3	027	A43	Trombone 1	091	B43
Syn Brass 4	028	A44	Trombone 2	092	B44
Syn Bass 1	029	A45	Fr Horn 1	093	B45
Syn Bass 2	030	A46	Fr Horn 2	094	B46
Syn Bass 3	031	A47	Tuba	095	B47
Syn Bass 4	032	A48	Brs Sect 1	096	B48
Fantasy	033	A51	Brs Sect 2	097	B51
Harmo Pan	034	A52	Vibe 1	098	B52
Chorale	035	A53	Vibe 2	099	B53
Glasses	036	A54	Syn Mallet	100	B54
Soundtrack	037	A55	Windbell	101	B55
Atmosphere	038	A56	Glock	102	B56
Warm Bell	039	A57	Tube Bell	103	B57
Funny Vox	040	A58	Xylophone	104	B58
Echo Bell	041	A61	Marimba	105	B61
Ice Rain	042	A62	Koto	106	B62
Oboe 2001	043	A63	Sho	107	B63
Echo Pan	044	A64	Shakuhachi	108	B64
Doctor Solo	045	A65	Whistle 1	109	B65
Schooldaze	046	A66	Whistle 2	110	B66
Bellsinger	047	A67	Bottleblow	111	B67
Square Wave	048	A68	Breathpipe	112	B68
Str Sect 1	049	A71	Timpani	113	B71
Str Sect 2	050	A72	Melodic Tom	114	B72
Str Sect 3	051	A73	Deep Snare	115	B73
Pizzicato	052	A74	Elec Perc 1	116	B74
Violin 1	053	A75	Elec Perc 2	117	B75
Violin 2	054	A76	Taiko	118	B76
Cello 1	055	A77	Taiko Rim	119	B77
Cello 2	056	A78	Cymbal	120	B78
Contrabass	057	A81	Castanets	121	B81
Harp 1	058	A82	Triangle	122	B82
Harp 2	059	A83	Orche Hit	123	B83
Guitar 1	060	A84	Telephone	124	B84
Guitar 2	061	A85	Bird Tweet	125	B85
Elec Gtr 1	062	A86	One Note Jam	126	B86
Elec Gtr 2	063	A87	Water Bells	127	B87
Sitar	064	A88	Jungle Tune	128	B88

* "HP-Prog." stands for the Program
Change numbers transmitted by the
Roland HP Piano series and other si-

MIDI FUNCTION VALUES AND CHANNELS

Pressing the MIDI button [9] (LED lights) and rotating the TEMPO/FUNCTION Dial will show the MIDI functions/channels and their current/default value in the display and enable any changes you wish to make.

DISPLAY	CHANGEABLE VALUES
BASIC USER PRG C Midi Ch = 12 ON	MIDI Channel 1-16 TX (Transmit) & RX (Receive) Channel ON/OFF Recorded as Global Parameter (not in User Program)
SOLO part Midi Ch = 4 ON	MIDI Channel 1-16 TX (Transmit) & RX (Receive) Channel ON/OFF
SOLO rx limit low=C 0 upp=C 9	C0 to C9 Lower and Upper
SOLO rx note shift = 0	-96 to +96 RX (Receive)
LOWER part Midi Ch = 3 ON	MIDI Channel 1-16 TX (Transmit) & RX (Receive) Channel ON/OFF
LOWER rx limit low=C 0 upp=C 9	C0 to C9 Lower and Upper
LOWER rx note shift = 0	-96 to +96 RX (Receive)
ACCOMP1 part Midi Ch = 5 ON	MIDI Channel 1-16 TX (Transmit) & RX (Receive) Channel ON/OFF
ACCOMP1 rx limit low=C 0 upp=C 9	C0 to C9 Lower and Upper
ACCOMP1 rx note shift = 0	-96 to +96 RX (Receive)
ACCOMP2 part Midi Ch = 6 ON	MIDI Channel 1-16 TX (Transmit) & RX (Receive) Channel ON/OFF
ACCOMP2 rx limit low=C 0 upp=C 9	C0 to C9 Lower and Upper
ACCOMP2 rx note shift = 0	-96 to +96 RX (Receive)
ACCOMP3 part Midi Ch = 7 ON	MIDI Channel 1-16 TX (Transmit) & RX (Receive) Channel ON/OFF
ACCOMP3 rx limit low=C 0 upp=C 9	C0 to C9 Lower and Upper
ACCOMP3 rx note shift = 0	-96 to +96 RX (Receive)
ACCOMP BASS part Midi Ch = 8 ON	MIDI Channel 1-16 TX (Transmit) & RX (Receive) Channel ON/OFF
A. BASS rx limit low=C 0 upp=C 9	C0 to C9 Lower and Upper
A. BASS rx note shift = 0	-96 to +96 RX (Receive)

DISPLAY	CHANGEABLE VALUES
MANUAL Bass part Midi Ch= 2 ON	MIDI Channel 1-16 TX (Transmit) & RX (Receive) Channel ON/OFF
M. BASS rx limit low=C 0 upp=C 9	C0 to C9 Lower and Upper
M. BASS rx note shift= 0	-96 to +96 RX (Receive)
DRUMS part Midi Ch= 10 ON	MIDI Channel 1-16 TX (Transmit) & RX (Receive) Channel ON/OFF
DRUMS rx limit low=C 0 upp=C 9	C0 to C9 Lower and Upper
DRUMS rx note shift= 0	-96 to +96 RX (Receive)
EFFECT part Midi Ch= 11 ON	MIDI Channel 1-16 TX (Transmit) & RX (Receive) Channel ON/OFF
EFFECT rx limit low=C 0 upp=C 9	C0 to C9 Lower and Upper
EFFECT rx note shift= 0	-96 to +96 RX (Receive)
RX ONLY part Midi Ch= 9 ON	MIDI Channel 1-16 RX (Receive) Channel Only ON/OFF
RX ONLY limit low=C 0 upp=C 9	C0 to C9 Lower and Upper
RX ONLY note shift= 0	-96 to +96 RX (Receive)
NOTE TO ARRANGER Midi Ch= 1 ON	MIDI Channel 1-16 RX (Receive) Channel Only ON/OFF
NOTE TO A. limit low=C 0 upp=C 9	C0 to C9 Lower and Upper
MIDI SOFT THRU FOR LOCAL = ON	ON/OFF
STYLE PRG CHANGE Midi Ch= 10 ON	MIDI Channel 1-16 TX (Transmit) & RX (Receive) Channel ON/OFF
STYLE-TONE PRG C rx/tx = ON	ON/OFF TX (Transmit) & RX (Receive)
MIDI REAL TIME rx/tx = OFF	ON/OFF TX (Transmit) & RX (Receive) START = FAH, STOP = FCH, TIME CLOCK = FSH
MIDI VOLUME CC 7 rx/tx QN	TX (Transmit) & RX (Receive) ON/OFF Volume Control Change 07
MIDI VELOCITY rx 127 ON	0 ~ 127 ON/OFF RX (Receive)
DATA DUMP = ALL PRESS WRITE	ALL, USER P, SONG 1, SONG 2, SONG 3, SONGS

- * MIDI CLOCK is to be ON when you wish to play other MIDI-equipped rhythm machines or sequencers at the same tempo with the PRO-E.
- * MIDI VOLUME (MIDI Control Change 7) is a MIDI message that controls the volume. When using external MIDI-equipped devices (sequencers, synthesizers, etc.), the volume of each part of the PRO-E is controlled by its MIDI Channel as well as the total volume of all parts.

CHANGING VALUES AND CHANNELS

To change the MIDI Channel of each part for transmitting and receiving MIDI data, press the MIDI button [9] (LED lights) and rotate the TEMPO/FUNCTION Dial until the part you require appears in the display.

Press the CURSOR button [11] to select the value you wish to edit. Edit the value by rotating the TEMPO/FUNCTION Dial [27]. The display will indicate the change.

To exit the MIDI operations, press the MIDI button once more. The Master Display will return.

- * The changes you make in MIDI functions will be erased if the instrument is switched off (except the MIDI Global functions). However any changes in all MIDI functions can be recorded in the 48 User Programs and further can be saved onto a Memory Card. (See USER PROGRAMS & MEMORY CARD).

As was explained above, the PRO-E itself delivers a lot of musical capability, however the capabilities increase when external MIDI equipment is used. An additional Part (RX ONLY part) is available (which cannot be played with the PRO-E alone) with 128 tones available for selection when the PRO-E is controlled by external MIDI devices such as the MC/PR series sequencers. Then the PRO-E will perform most 9-part orchestrations.

See MIDI IMPLEMENTATION CHART for details on the MIDI data which the PRO-E can transmit and receive (recognize).

IF YOUR PRO-E FAILS TO OPERATE:

- Make sure that the AC cord is firmly plugged into the AC socket [29] on the rear panel. Also check that the AC wall outlet is not faulty. Plug in a lamp or radio to test the wall outlet.
- Be sure the ON/OFF switch [30] (located on the rear of the panel) is ON.
- In the event the instrument is still inoperable, your Roland technician or dealer is best qualified to provide you with competent service. Do not attempt any adjustments or repairs by yourself.
- When the display responds with a different indication from any explained in this manual, refer to "ERROR MESSAGES".

<Reference>

The PRO-E will always select the following features, when it is turned on (These are often called the Default settings or User Program 0):

**FACTORY PRESET
USER PROGRAM 0 and Default Setting (Banks 2-6)**

<p>Solo Tone - 14 Lower Tone - 73 Manual Bass Tone - 11b</p> <p>Balance Solo - 100 ON Lower - 80 ON Accomp 1 - 75 ON Accomp 2 - 75 ON Accomp 3 - 75 ON Accomp Bass - 90 ON Manual Bass - 90 ON Accomp Drums - 90 ON Sound Effects - 90 ON</p> <p>Style - 16 FUNK 2 Tempo - 110 Variation - OFF Advanced Arranger - ON Hold - OFF Sync Start - OFF Sync Stop - OFF Reverb - ON Reverb Type - HALL 1 Melody Intelligence - OFF</p> <p>Sound Effect pad a - RAIN Sound Effect pad b - THUNDER Sound Effect pad c - WAVES Sound Effect pad d - STREAM Sound Effect pad e - LAUGHING Sound Effect pad f - SCREAMING Sound Effect pad g - APPLAUSE Sound Effect pad h - JET Sound Effect pad i - TRAIN Sound Effect pad j - HELICOPTER Sound Effect pad k - THRILLER Sound Effect pad l - WONDERLAND</p> <p>Transpose - 0 OFF Footswitch assign - SUSTAIN Pitch Bend range - 2 Solo Octave - 1 Lower Octave - 1 Manual Bass Octave: -1 Accomp 1 Balance Enable - YES Accomp 2 Balance Enable - YES Accomp 3 Balance Enable - YES</p>	<p>Accomp Bass Balance Enable - YES Manual Bass Balance Enable - YES Sound Effects Style sync - ON Chord Intelligence - OFF</p> <p>MIDI FUNCTIONS</p> <p>Solo part MIDI Ch = 4 ON Solo rx limit low = C0 upp = C8 Solo rx note shift = 0 Lower part MIDI Ch = 3 ON Lower rx limit low = C0 upp = C8 Lower rx note shift = 0 Accomp 1 part MIDI Ch = 5 ON Accomp 1 rx limit low = C0 upp = C8 Accomp 1 rx note shift = 0 Accomp 2 part MIDI Ch = 6 ON Accomp 2 rx limit low = C0 upp = C8 Accomp 2 rx note shift = 0 Accomp 3 part MIDI Ch = 7 ON Accomp 3 rx limit low = C0 upp = C8 Accomp 3 rx note shift = 0 Accomp Bass part MIDI Ch = 8 ON A. Bass rx limit low = C0 upp = C8 A. Bass rx note shift = 0 Manual Bass part MIDI Ch = 2 ON M. Bass rx limit low = C0 upp = C8 M. Bass rx note shift = 0 Drums part MIDI Ch = 10 ON Drums rx limit low = C0 upp = C8 Drums rx note shift = 0 Sound Effect part MIDI Ch = 11 ON Sound Effect rx limit low = C0 upp = C8 Sound Effect rx note shift = 0 RX Only part MIDI Ch = 9 ON RX Only rx limit low = C0 upp = C8 RX Only note shift = 0 Note To Arranger MIDI Ch = 1 ON Note To A. limit low = C0 upp = B3 MIDI SOFT THRU For Local = OFF Style PRG Change MIDI Ch = 10 ON Style-Tone PRG C rx/tx = ON MIDI Real Time rx/tx = ON MIDI Volume CC 7 rx/tx = ON MIDI VELOCITY rx = 127 ON</p>
--	---

SPECIFICATIONS

Keyboard:

37 keys velocity sensitive

Sound Source System:

LA Digital Synthesis

Built-in Effect:

33 PCM Sound Effects, 30 PCM Drum sounds, Digital Reverb (8 types: Hall 1-2 etc.)

Panel Switch/Control:

VOLUME:

Master Volume Control

BALANCE:

Solo, Lower, Accomp 1/2/3, A/M Bass, Acc Drums, Sound Effects

FUNCTION:

Transpose, Master Tune, Footswitch (8 modes), Pitch Bender Range, Octave Range, Accomp 1/2/3, Balance enable, Accomp/Manual Bass Balance enable, Sound Effects Style sync, Arranger Chord Intelligence, Internal Memory Protection

MIDI - 10 instrumental sections, MIDI channel changeable

COMPOSER:

Record (Punch In) and Play (Six Tracks)

3 songs (1 song: approx. 200 measures)

ARRANGER:

Advanced, Hold, Sync Start, Sync Stop

STYLE/TONE SELECT:

Bank 1-4, Number 1-8, Card, Tempo Dial, Variation for each Style

TONE SELECT:

Solo, Lower, Manual Bass

MEMORY CARD:

From Card, To Card, Write

REVERB:

On/Off, Part Assign (Yes/No), Type (8 types)

Real Time Switches:

Fill-in (To Original, To Variation), Intro/Ending, Tap Tempo/Break Mute, Advanced Arranger, Start/Stop, Melody Intelligence, User Program Bank 1~6, Number 1 ~8, Write, Demo, Pitch Bender/Modulation Lever

Display:

16 characters × 2 lines (LCD back-lit)

Rear Panel Terminal:

MIDI (OUT, THRU, IN)

Footswitch

Side Panel Terminal

STEREO OUT (Right, Left/Mono)

Headphones

Power Amplifier:

5 W × 2 (stereo)

Power Consumption: 20W

Dimensions:

649mm(W) × 100mm(H) × 347mm (D)

Weight: kg 8

Options:

Stereo Expression Pedal (FV-200)

Memory Card (M-256D, M-256E)

Style Card (RXN-E20)

USER PROGRAM PANEL SETTING MEMO

Please write your User Program panel settings on the memo below so you will have a written record of them.

MODEL: ROLAND PRO-E INTELLIGENT ARRANGER

SONG TITLE:

DATE:

<p>Solo Tone - Lower Tone - Manual Bass Tone -</p> <p>Balance Solo - Lower - Accomp 1 - Accomp 2 - Accomp 3 - Accomp Bass - Manual Bass - Accomp Drums - Sound Effects -</p> <p>Style - Tempo - Variation - Advanced Arranger - Hold - Sync Start - Sync Stop - Reverb - Reverb Type - Melody Intelligence -</p> <p>Sound Effect pad a - Sound Effect pad b - Sound Effect pad c - Sound Effect pad d - Sound Effect pad e - Sound Effect pad f - Sound Effect pad g - Sound Effect pad h - Sound Effect pad i - Sound Effect pad j - Sound Effect pad k - Sound Effect pad l -</p> <p>Transpose - Footswitch assign - Pitch Bend range - Solo Octave - Lower Octave - Manual Bass Octave - Accomp 1 Balance Enable - Accomp 2 Balance Enable -</p>	<p>Accomp 3 Balance Enable - Accomp Bass Balance Enable - Manual Bass Balance Enable - Sound Effects Style sync - Chord Intelligence -</p> <p>MIDI FUNCTIONS</p> <p>Solo part MIDI Ch = Solo rx limit low = upp = Solo rx note shift = Lower part MIDI Ch = Lower rx limit low = upp = Lower rx note shift = Accomp 1 part MIDI Ch = Accomp 1 rx limit low = upp = Accomp 1 rx note shift = Accomp 2 part MIDI Ch = Accomp 2 rx limit low = upp = Accomp 2 rx note shift = Accomp 3 part MIDI Ch = Accomp 3 rx limit low = upp = Accomp 3 rx note shift = Accomp Bass part MIDI Ch = A. Bass rx limit low = upp = A. Bass rx note shift = Manual Bass part MIDI Ch = M. Bass rx limit low = upp = M. Bass rx note shift = Drums part MIDI Ch = Drums rx limit low = upp = Drums rx note shift = Sound Effect part MIDI Ch = Sound Effect rx limit low = upp = Sound Effect rx note shift = RX Only part MIDI Ch = RX Only rx limit low = upp = RX Only note shift = Note To Arranger MIDI Ch = Note To A. limit low = upp = MIDI SOFT THRU For Local = Style PRG Change MIDI Ch = Style-Tone PRG C rx/tx = MIDI Real Time rx/tx = MIDI Volume CC 7 rx/tx = MIDI VELOCITY rx =</p>
---	--

If you require additional USER PROGRAM SETTING MEMO pages, photocopying of this page is permitted.

 Roland

MIDI INTELLIGENT ARRANGER

PRO-E

MIDI IMPLEMENTATION

Roland Exclusive Messages

1 Data Format for Exclusive Messages

Roland's MIDI implementation uses the following data format for all exclusive messages (type IV):

Byte	Description
F0H	Exclusive status
41H	Manufacturers ID (Roland)
DEV	Device ID
MDL	Model ID
CMD	Command ID
(BODY)	Main data
F7H	End of exclusive

MIDI status: F0H, F7H

An exclusive message must be flanked by a pair of status codes, starting with a Manufacturers-ID immediately after F0H (MIDI version 1.0).

Manufactures-ID: 41H

The Manufactures-ID identifies the manufacturer of a MIDI instrument that triggers an exclusive message. Value 41H represents Roland's Manufactures-ID.

Device-ID: DEV

The Device-ID contains a unique value that identifies the individual device in the multiple implementation of MIDI instruments. It is usually set to 00H-0FH, a value smaller by one than that of a basic channel, but value 00F-1FH may be used for a device with multiple basic channels.

Model-ID: MDL

The model-ID contains a value that uniquely identifies one model from another, different models, however, may share an identical Model-ID if they handle similar data.

The Model-ID format may contain 00H in one or more places to provide an extended data field. The following are examples of valid Model-IDs, each representing a unique model:

01H
02H
03H
00H, 01H
00H, 00H, 01H

Command-ID: CDM

The Command-ID indicates the function of an exclusive message. The Command-ID format may contain 00H in one or more places to provide an extended data field. The following are examples of valid Model-IDs, each representing a unique function:

01H
02H
03H
00H, 01H
00H, 00H, 01H

Main data: BODY

This field contains a message to be exchanged across an interface. The exact data size and contents will vary with the Model-ID and Command-ID.

2 Address - mapped Data Transfer

Address mapping is a technique for transferring messages conforming to the data format given in Section 1. It assigns a series of memory-resident records--waveform and tone data, switch status, and parameters, for example--to specific locations in a machine-dependent address space, thereby allowing access to data residing at the address a message specifies. Address-mapped data transfer is therefore independent of models and data categories.

One-way transfer procedure (See Section 3 for details)

This procedure is suited for the transfer of a small amount of data. It sends out an exclusive message completely independent of a receiving device status.

Connection Diagram

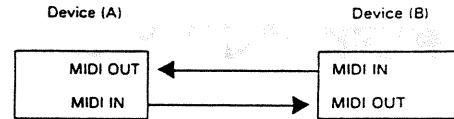

Connection at point 2 is essential for «Request data» procedures (See Section 3).

3 One-way Transfer Procedure

This procedure sends out data all the way until it stops when the messages are so short that answer backs need not be checked.

For long messages, however, the receiving device must acquire each message in time with the transfer sequence, which inserts intervals of at least 20 milliseconds in between.

Types of Messages

Message	Command ID
Request data 1	RQ1 (11H)
Data set 1	DT1 (12H)

Request data 1: RQ1 (11H)

This message is sent out when there is no need to acquire data from a device at the other end of the interface. It contains data for the address and size that specify designation and length, respectively, of data required. On receiving an RQ1 message, the remote device checks its memory for the data address and size that satisfy the request.

If it finds them and is ready for communication, the device will transmit a «Data set 1 (DT1)» message, which contains the requested data. Otherwise, the device will send out nothing.

Byte	Description
F0H	Exclusive status
41H	Manufacturers ID (Roland)
DEV	Device ID
MDL	Model ID
11H	Command ID
aaH	Address MSB
.	.
.	.
.	.
.	.
.	LSB
ssH	Size MSB
.	.
.	.
.	.
.	LSB
sum	Check sum
F7H	End of exclusive

- The size of the requested data does not indicate the number of bytes that will make up a DT1 message, but represents the address fields where the requested data resides.
- Some models and data are subject to limitations in data format used for a single transaction. Requested data, for example, may have a limit in length or must be divided into predetermined address fields before it is exchanged across the interface.

MODEL PRO-E MIDI Implementation

1. TRANSMITTED DATA

- The same number of bytes comprises address and size data, which, however, vary with the Model ID.
- The error checking process uses a checksum that provides a bit pattern where lower seven bits are zero when values for an address, size, and that checksum are summed.

Data set 1: DT1 (12H)

This message corresponds to the actual data transfer process. Because every byte in the data is assigned a unique address, a DT1 message can convey the starting address (es) of one or more data as well as a series of data formatted in an address-dependent order.

Although the MIDI standards inhibit non-real time messages from interrupting an exclusive one, some devices support a «soft-through» mechanism for such interrupts. To maintain compatibility with such devices, Roland limited the DT1 to 256 bytes so that an excessively long message is sent out in separate segments.

Byte	Description
FOH	Exclusive status
41H	Manufacturers ID (Roland)
DEV	Device ID
MDL	Model ID
12H	Command ID
aaH	Address MSB
.	.
.	.
.	.
.	.
.	LSB
ddH	Data
.	.
.	.
.	.
sum	Check sum
F7H	End of exclusive

- A DT1 message is capable of providing only the valid data among those specified by an RQ1 message.
- Some models and data are subject to limitations data format used for a single transaction. Requested data for example, may have a limit in length or must be divided into predetermined address fields before it is exchanged across the interface.
- The number of bytes comprising address data varies from one Model-ID to another.
- The error checking process uses a checksum that provides a bit pattern where lower seven bits are zero when values for an address, size and that checksum are summed.

Example of Message Transactions

- Device A sending data to Device B
Transfer of a DT1 message is all that takes place.

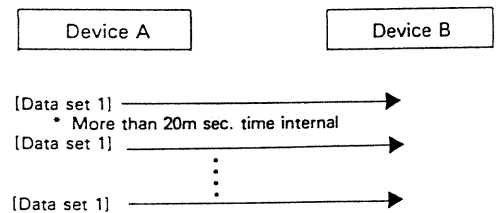

- Device B requesting data from Device A
Device B sends an RQ1 message to Device A. Checking the message, Device A sends a DT1 message back to Device B.

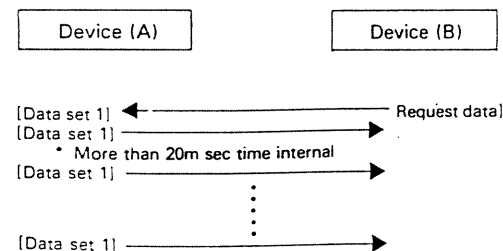

■ Note event

Note off

Status	Second	Third
8nH	kkH	wvH
9nH	kkH	00H

kkH: Note number 0CH – 78H (12 – 120)
wvH: Velocity 00H

Note on

Status	Second	Third
9nH	kkH	wvH

kkH: Note number 0CH – 78H (12 – 120)
wvH: Velocity 1H – 7FH (1 – 127)

■ Control Change

Continuous controller (7 bits)

Status	Second	Third
BnH	mmH	wvH

Modulation mmH = 01H
Volume: mmH = 07H
Hold 1 mmH = 40H
wvH = 0H – 7FH (0 – 127)
wvH = 0H – 7FH (0 – 127)
wvH = 0H – 3FH (0 – 63) OFF
wvH = 40H – 7FH (64 – 127) ON

■ Program Change

Status	Second
cnH	ppH

Patch Program Change

Section: Solo, Lower, Accompaniment 1, Accompaniment 2, Accompaniment 3, Accompaniment Bass, Manual Bass, RX only.
ppH: program number 0H – 7FH (0 + 127)

Style Program Change

ppH: program number 0H – 54H (0 – 84)

User Program change

ppH: program number 0H – 30H (0 – 47, 48 = default power on setting)

BANK 1	0 ROCK 1	1 ROCK 2	2 DISCO 1	3 DISCO 2	4 FUNK 1	5 FUNK 2	6 BALLAD	7 S. ROCK
VAR. OF BANK 1	8	9	10	11	12	13	14	15
BANK 2	16 8 BEAT 1	17 8 BEAT 2	18 16 BEAT 1	19 16 BEAT 2	20 REGGAE	21 BOOGIE	22 ROCK	23 DIXIE
VAR. OF BANK 2	24	25	26	27	28	29	30	31
BANK 3	32 SWING	33 B. BAND	34 SHUFF.	35 COUNTRY	36 WALTZ 1	37 WALTZ 2	38 POLKA	39 MARCH
VAR. OF BANK 3	40	41	42	43	44	45	46	47
BANK 4	48 BAROQ.	49 BOSSAN	50 RHUMBA	51 CHACHA	52 SALSA	53 TANGO	54 SAMBA	55 FUSION
VAR. OF BANK 4	56	57	58	59	60	61	62	63
BANK C	64 (C1)	65 (C2)	66 (C3)	67 (C4)	68 (C5)	69 (C6)	70 (C7)	71 (C8)
VAR. OF BANK C	72	73	74	75	76	77	78	79
	80 FILL TO VARI	81 FILL TO ORIG.	82 INTRO	83 ENDING	84 BREAK MUTE			

■ Pitch Bender

<u>Status</u>	<u>Second</u>	<u>Third</u>
EnH	IIH	mmH

IIH: 0H-7FH (0-127)
mmH: 0H-7FH (0-127)

■ Channel mode Message

<u>Status</u>	<u>Second</u>	<u>Third</u>
BnH	mmH	vvH

mmH = local control 122
vvH = 0, local control OFF
vvH = 127, local control ON

■ Real Time Messages

<u>Status</u>	
F8H	timing clock
FAH	start
FCH	stop

■ Created Message

System exclusive

<u>Status</u>	
FOH:	System Exclusive
F7H:	EOX (End of System Exclusive)

See "3. EXCLUSIVE COMMUNICATIONS" for details.

2. RECOGNIZED DATA

■ Note event

Note off

<u>Status</u>	<u>Second</u>	<u>Third</u>
8nH	kkH	vvH
9nH	kkH	00H

kkH: Note number OCH-6CH (12-108)
vvH: ignored

Note on

<u>Status</u>	<u>Second</u>	<u>Third</u>
9nH	kkH	vvH

kkH: Note number OCH-78H (12-120)
vvH: Velocity 1H-7FH (1-127)

■ Control Change

Continuous controller (14 bits)

<u>Status</u>	<u>Second</u>	<u>Third</u>
BnH	mmH	vvH

Modulation mmH = 01H
Volume: mmH = 07H
Panpot mmH = 0AH
Expression mmH = 0BH

vvH = 0H-7FH (0-127)
vvH = 0H-7FH (0-127)
vvH = 0H-7FH (0-127)
vvH = 0H-7FH (0-127)

Continuous controller (7 bits)

<u>Status</u>	<u>Second</u>	<u>Third</u>
BnH	mmH	vvH

Hold 1 mmH = 40H
vvH = 0H-3FH (0-63) OFF
vvH = 40H-7FH (64-127) ON

■ Program Change

<u>Status</u>	<u>Second</u>
CnH	ppH

Patch Program Change
Section: Solo, Lower, Accompaniment 1, Accompaniment 2, Accompaniment 3,
Accompaniment Bass, Manual Bass, RX only.
ppH: program number 0H-7FH (0-127)

Style Program Change
ppH: program number 0H-54H (0-84)

User Program change
ppH: program number 0H-30H (0-47, 48 = default power on set)

BANK 1	0 ROCK 1	1 ROCK 2	2 DISCO 1	3 DISCO 2	4 FUNK 1	5 FUNK 2	6 BALLA
VAR. OF BANK 1	8	9	10	11	12	13	14
BANK 2	16 8 BEAT 1	17 8 BEAT 2	18 16 BEAT 1	19 16 BEAT 2	20 REGGAE	21 BOOGIE	22 ROCK
VAR. OF BANK 2	24	25	26	27	28	29	30
BANK 3	32 SWING	33 B. BAND	34 SHUFF.	35 COUNTRY	36 WALTZ 1	37 WALTZ 2	38 POLK.
VAR. OF BANK 3	40	41	42	43	44	45	46
BANK 4	48 BAROO.	49 BOSSAN	50 RHUMBA	51 CHACHA	52 SALSA	53 TANGO	54 SAME
VAR. OF BANK 4	56	57	58	59	60	61	62
BANK C	64 (C1)	65 (C2)	66 (C3)	67 (C4)	68 (C5)	69 (C6)	70 (C7)
VAR. OF BANK C	72	73	74	75	76	77	78
	80 FILL TO VARI	81 FILL TO ORIG.	82 INTRO	83 ENDING	84 BREAK MUTE		

■ Pitch Bender

<u>Status</u>	<u>Second</u>	<u>Third</u>
EnH	IIH	mmH

IIH: 0H-7FH (0-127)
mmH: 0H-7FH (0-127)

■ Channel mode Message

<u>Status</u>	<u>Second</u>	<u>Third</u>
BnH	mmH	00H

mmH: All notes Off 7BF (123)
Omni Off 7CH (124)
Omni On 7DH (124)
Mono On 7EH (124)
Poly On 7FH (128)

Recognized as only All Notes Off.
PRO-E does not change mode, but remains in mode 3 (Poly).

■ Real Time Messages

<u>Status</u>	
F8H	timing clock
FAH	start
FCH	stop

■ System exclusive

<u>Status</u>	
FOH:	System Exclusive
F7H:	EOX (End of System Exclusive)

3. EXCLUSIVE COMMUNICATIONS

Model-ID # is 22 H

■ One way communication

Request RQ1 11H

When the RQ1 received contains a start address listed in Parameter base a address size is 1 or more, PRO-E sends the corresponding data.
PRO-E won't transmit RQ1 in the default mode.

Byte	Description
F0H	Exclusive status
41H	Roland-ID
DEV	Device-ID
22 H	Model-ID
11H	Command-ID (RQ1)
aaH	Address MSB *3-1
aaH	Address
aaH	Address LSB
ssH	Size MSB
ssH	Size
ssH	Size LSB
sum	Checksum
F7H	EDX (End of Exclusive)

Data Set DT1 12H

When the DT1 contains a start address as defined in RQ1 above, PRO-E stores the data into a memory location.

PRO-E sends this message upon receiving RQ1 in the default mode.

Notes:

3-1 Address & size should be the address where data exist.

4. ADDRESS MAPPING OF USERS PROGRAMS AND COMPOSER DATA

Addresses are shown in Hexa-decimal, while numbers are given in 7 bits.

Address	MSB	LSB
binary	Oaaa aaaa	Obbb bbbb
7bit Hex	AA	BB
		Occc cccc
		CC

The actual address of users programs and composer data is the sum of the start address of each block and one or more offset address.

■ User programs and composer base address accessible on Unit # 10

Start address	Description
00 61 7F	User programs area
01 40 00	Composer area (Song*1)
02 40 00	Composer area (Song*2)
03 40 00	Composer area (Song*3)
04 40 00	Style card (bank*1)
05 40 00	Style card (bank*2)
06 40 00	Style card (bank*3)
07 40 00	Style card (bank*4)

■ User programs area

Offset address	Size	Description
00 00	00 00 50	User program # 11 * 4-1
01 20	00 00 50	User program # 12 * 4-1
01 70	00 00 50	User program # 12 * 4-1
- -	- -	- -
1D 30	00 00 50	User program # 68 * 4-1

■ Composer data area

Offset address	Size	Description
00 00	00 40 00	Song # 1 * 4-1
00 00	00 40 00	Song # 2 * 4-1
00 00	00 40 00	Song # 3 * 4-1

■ Style card data area

Offset address	Size	Description
00 00	00 40 00	Bank # 1 * 4-1
00 00	00 40 00	Bank # 2 * 4-1
00 00	00 40 00	Bank # 3 * 4-1
00 00	00 40 00	Bank # 4 * 4-1

Notes

* 4-1 User programs and composer data must be sent/received in NIBBLES

BIT 7 : 0
 BIT 6 : 0
 BIT 5 : 0
 BIT 4 : 0
 BIT 3 : --
 BIT 2 : 5 data
 BIT 1 :
 BIT 0 : --

LSB NIBBLE must be sent/received first. Data are packed in 256 bytes (1 byte contains only 1 nibble) data pack.

■ User program structure

Offset address	Description
00 00H	Solo Volume on/off (bit 7), volume (bit 6-0) (0-100)
00 01H	Lower Volume on/off (bit 7), volume (bit 6-0) (0-100)
00 02H	Acc1 Volume on/off (bit 7), volume (bit 6-0) (0-100)
00 03H	ManBass Volume on/off (bit 7), volume (bit 6-0) (0-100)
00 04H	Acc Drums Volume on/off (bit 7), volume (bit 6-0) (0-100)
00 05H	Sound Effect Volume on/off (bit 7), volume (bit 6-0) (0-100)
00 06H	Acc2 Volume on/off (bit 7), volume (bit 6-0) (0-100)
00 07H	Acc3 Volume on/off (bit 7), volume (bit 6-0) (0-100)
00 08H	Acc Bass Volume on/off (bit 7), volume (bit 6-0) (0-100)
00 09H	Solo Voice Bank (bit 6,5,4,3) Number (bit 2,1,0)
00 0AH	Lower Voice Bank (bit 6,5,4,3), Number (bit 2,1,0)
00 0BH	ManBass Voice Bank (bit 6,5,4,3), Number (bit 2,1,0)
00 0CH	Style Bank (bit 5,4,3), Number (bit 2,1,0) (bank 0-3=internal styles; bank 4=card styles)
00 0DH	Sound Effect 1 (76-112)
00 0EH	Sound Effect 2 (76-112)
00 0FH	Sound Effect 3 (76-112)
00 10H	Sound Effect 4 (76-112)
00 11H	Sound Effect 5 (76-112)
00 12H	Sound Effect 6 (76-112)
00 13H	Sound Effect 7 (76-112)
00 14H	Sound Effect 8 (76-112)
00 15H	Sound Effect 9 (76-112)
00 16H	Sound Effect 10 (76-112)
00 17H	Sound Effect 11 (76-112)
00 18H	Sound Effect 12 (76-112)
00 1AH	Rx Velocity on/off (bit 7), velocity value (bit 6-0)
00 1BH	Tempo in B.P.M. (20-250)
00 1CH	MIDI lower limit Solo (12-120)
00 1DH	upper limit Solo (12-120)
00 1EH	shift Solo (-96, +96)
00 1FH	lower limit Lower (12-120)
00 20H	upper limit Lower (12-120)
00 21H	shift Lower (-96, +96)
00 22H	lower limit Accomp.1 (12-120)
00 23H	upper limit Accomp.1 (12-120)
00 24H	shift Accomp.1 (-96, +96)
00 25H	lower limit Accomp.2 (12-120)
00 26H	upper limit Accomp.2 (12-120)
00 27H	shift Accomp.2 (-96, +96)
00 28H	lower limit Accomp.3 (12-120)
00 29H	upper limit Accomp.3 (12-120)
00 2AH	shift Accomp.3 (-96, +96)
00 2BH	lower limit Accomp. Bass (12-120)
00 2CH	upper limit Accomp. Bass (12-120)
00 2DH	shift Accomp. Bass (-96, +96)
00 2EH	lower limit Manual Bass (12-120)
00 2FH	upper limit Manual Bass (12-120)
00 30H	shift Manual Bass (-96, +96)
00 31H	lower limit Drums (12-120)
00 32H	upper limit Drums (12-120)
00 33H	shift Drums (-96, +96)
00 34H	lower limit Effect (12-120)
00 35H	upper limit Effect (12-120)
00 36H	shift Effect (-96, +96)
00 37H	lower limit RXonly (12-120)
00 38H	upper limit RXonly (12-120)
00 39H	shift RXonly (-96, +96)
00 3AH	lower limit Note to Arranger (12-120)
00 3BH	upper limit Note to Arranger (12-120)
00 3DH	lower Octave (bit 7-4), (-2, +3 two complement)
	solo octave (bit 3-0) (-2, +3 two complement)
00 3EH	Foot Switch (bit 6-4), (-2, +3 two complement)
	Man Bass Octave (bit 3-0) (-2, +3 two complement)
00 3FH	Midi on/off (bit 7), channel Solo (bit 3-0)
00 40H	Midi on/off (bit 7), channel Lower (bit 3-0)
00 41H	Midi on/off (bit 7), channel Acc1 (bit 3-0)
00 42H	Midi on/off (bit 7), channel Acc2 (bit 3-0)
00 43H	Midi on/off (bit 7), channel Acc3 (bit 3-0)
00 44H	Midi on/off (bit 7), channel Acc Bass (bit 3-0)
00 45H	Midi on/off (bit 7), channel Man Bass (bit 3-0)
00 46H	Midi on/off (bit 7), channel Drums (bit 3-0)
00 47H	Midi on/off (bit 7), channel Sound Effect (bit 3-0)
00 48H	Midi on/off (bit 7), channel RX Only (bit 3-0)
00 49H	Midi on/off (bit 7), channel Note to Arr (bit 3-0)
00 4AH	Midi on/off (bit 7), channel Style Prg. Ch. (bit 3-0)
00 4BH	Transposer (bit 7-3) (-11, +11 two complement)
00 4CH	Pitch Bend Range (bit 2-0)

00	4BH	Transposer (bit 7-3) Pitch Bend Range (bit 2-0)	(-11, +11 two complement)		String request for all user program F0-41-10-22-11-00-61-7F-00-30-00-70-F7	USER ALL
00	4CH	accompaniment bass Volume on/off manual bass Volume on/off style/tone prog. ch.: Rx/Tx/On/Off midi Soft Thru on/off accompaniment 3 Volume on/off accompaniment 2 Volume on/off accompaniment 1 Volume on/off	(bit 7), (bit 6), (bit 5), (bit 3), (bit 2), (bit 1), (bit 0)		String request for song # 1 F0-31-10-22-11-01-40-00-00-40-00-7F-F7	SONG # 1
00	4DH	midi Rx/Tx Real Time on/off midi Rx/Tx volume Control Change (07) on/off Reverb. Type	(bit 7), (bit 6), (bit 5,4,3)		String request for song # 2 F0-41-10-22-11-02-40-00-00-40-00-7E-F7	SONG # 2
00	4EH	sound effect drums Sync on/off (1 = 96th or 0 = fixed clock) arranger Chord intelligence on/off	(bit 0)		String request for song # 3 F0-41-10-22-11-03-40-00-00-40-00-7D-F7	SONG # 3
00	4FH	Sync Start Sync Stop Reverb ON/OFF arranger Hold advanced Arranger Variation Melody Intelligence on/off Transposer on/off	(bit 7), (bit 6), (bit 5), (bit 4), (bit 3), (bit 2), (bit 1), (bit 0)		String request for style Card (Bank # 1) F0-41-10-22-11-04-40-00-00-40-00-7C-F7	STYLE CARD BANK # 1
					String request for style Card (Bank # 2) F0-41-10-22-11-04-40-00-00-40-00-7B-F7	STYLE CARD BANK # 2
					String request for style Card (Bank # 3) F0-41-10-22-11-06-40-00-00-40-00-7A-F7	STYLE CARD BANK # 3
					String request for style Card (Bank # 4) F0-41-10-22-11-07-40-00-00-40-00-79-F7	STYLE CARD BANK # 4

Notes

* 6-2 The content of address 0011H and 0012H are the same.

DUMP REQUEST EXAMPLES

START SYS.EXC. - ROLAND-UNIT # - MODEL # - RQ1 - aa3 - aa2 - aa1 -
ss3 - ss2 ss1 - CHECKSUM-END SYS

F0-41-10-22-11-00-61-7F-00-00-50-50-F7	USER PROGRAM # 11
F0-41-10-22-11-00-62-4F-00-00-50-7F-F7	USER PROGRAM # 12
F0-41-10-22-11-00-63-1F-00-00-50-2E-F7	USER PROGRAM # 13
F0-41-10-22-11-00-63-6F-00-00-50-5E-F7	USER PROGRAM # 14
F0-41-10-22-11-00-64-3F-00-00-50-0D-F7	USER PROGRAM # 15
F0-41-10-22-11-00-65-0F-00-00-50-3C-F7	USER PROGRAM # 16
F0-41-10-22-11-00-65-5F-00-00-50-6C-F7	USER PROGRAM # 17
F0-41-10-22-11-00-66-2F-00-00-50-1B-F7	USER PROGRAM # 18
F0-41-10-22-11-00-66-7F-00-00-50-4B-F7	USER PROGRAM # 21
F0-41-10-22-11-00-67-4F-00-00-50-7A-F7	USER PROGRAM # 22
F0-41-10-22-11-00-68-1F-00-00-50-29-F7	USER PROGRAM # 23
F0-41-10-22-11-00-68-6F-00-00-50-59-F7	USER PROGRAM # 24
F0-41-10-22-11-00-69-3F-00-00-50-08-F7	USER PROGRAM # 25
F0-41-10-22-11-00-6A-0F-00-00-50-37-F7	USER PROGRAM # 26
F0-41-10-22-11-00-6A-5F-00-00-50-67-F7	USER PROGRAM # 27
F0-41-10-22-11-00-6B-2F-00-00-50-16-F7	USER PROGRAM # 28
F0-41-10-22-11-00-6B-7F-00-00-50-46-F7	USER PROGRAM # 31
F0-41-10-22-11-00-6C-4F-00-00-50-75-F7	USER PROGRAM # 32
F0-41-10-22-11-00-6D-1F-00-00-50-24-F7	USER PROGRAM # 33
F0-41-10-22-11-00-6D-6F-00-00-50-54-F7	USER PROGRAM # 34
F0-41-10-22-11-00-6E-3F-00-00-50-03-F7	USER PROGRAM # 35
F0-41-10-22-11-00-6E-8F-00-00-50-32-F7	USER PROGRAM # 36
F0-41-10-22-11-00-6F-5F-00-00-50-62-F7	USER PROGRAM # 37
F0-41-10-22-11-00-70-2F-00-00-50-11-F7	USER PROGRAM # 38
F0-41-10-22-11-00-70-7F-00-00-50-41-F7	USER PROGRAM # 41
F0-41-10-22-11-00-71-4F-00-00-50-70-F7	USER PROGRAM # 42
F0-41-10-22-11-00-72-1F-00-00-50-1F-F7	USER PROGRAM # 43
F0-41-10-22-11-00-72-6F-00-00-50-4F-F7	USER PROGRAM # 44
F0-41-10-22-11-00-73-3F-00-00-50-7E-F7	USER PROGRAM # 45
F0-41-10-22-11-00-74-0F-00-00-50-2D-F7	USER PROGRAM # 46
F0-41-10-22-11-00-74-5F-00-00-50-5D-F7	USER PROGRAM # 47
F0-41-10-22-11-00-75-2F-00-00-50-0C-F7	USER PROGRAM # 48
F0-41-10-22-11-00-75-7F-00-00-50-3C-F7	USER PROGRAM # 51
F0-41-10-22-11-00-76-4F-00-00-50-6B-F7	USER PROGRAM # 52
F0-41-10-22-11-00-77-1F-00-00-50-1A-F7	USER PROGRAM # 53
F0-41-10-22-11-00-77-6F-00-00-50-4A-F7	USER PROGRAM # 54
F0-41-10-22-11-00-78-3F-00-00-50-79-F7	USER PROGRAM # 55
F0-41-10-22-11-00-79-0F-00-00-50-28-F7	USER PROGRAM # 56
F0-41-10-22-11-00-79-5F-00-00-50-58-F7	USER PROGRAM # 57
F0-41-10-22-11-00-7A-2F-00-00-50-07-F7	USER PROGRAM # 58
F0-41-10-22-11-00-7A-7F-00-00-50-37-F7	USER PROGRAM # 61
F0-41-10-22-11-00-7B-4F-00-00-50-66-F7	USER PROGRAM # 62
F0-41-10-22-11-00-7C-1F-00-00-50-15-F7	USER PROGRAM # 63
F0-41-10-22-11-00-7C-6F-00-00-50-45-F7	USER PROGRAM # 64
F0-41-10-22-11-00-7D-3F-00-00-50-74-F7	USER PROGRAM # 65
F0-41-10-22-11-00-7E-0F-00-00-50-23-F7	USER PROGRAM # 66
F0-41-10-22-11-00-7E-5F-00-00-50-53-F7	USER PROGRAM # 67
F0-41-10-22-11-00-7F-2F-00-00-50-02-F7	USER PROGRAM # 68

MIDI IMPLEMENTATION CHART

FUNCTION		TRANSMITTED	RECOGNIZED	REMARKS
Basic	Default	2-3-4-5-6-7-8 10-11-12	2-3-4-5-6-7-8 9-10-11-12	1=NOTE TO ARR. 8=ACC. BASS 2=MAN. BASS 9=RX ONLY 3=LOWER 10=STYLE 4=SOLO P. CHANGE 5=ACCOMP.1 10=DRUMS 6=ACCOMP.2 11=SOUND EFF. 7=ACCOMP.3 12=USER PROG.
Channel	Changed	1-16, OFF	1-16, OFF	
Mode	Default Message Altered	MODE 3 × *****	MODE 3 × ×	
Note Number	True voice	0-120 *****	0-127 12-120	
Velocity	Note ON Note OFF	○ ×	○* ×	
After Touch	Key's Ch's	× ×	× ×	
Pitch Bender		○	○	
Control Change	1 7 10 11 12-63 64 65-121	○ ○* × × × ○* ×	○ ○* ○ ○ × ○ ×	MODULATION PART VOLUME PAN POT EXPRESSION HOLD 1
Program Change	True #	0-127 *****	0-127 0-127	STYLE PATTERN 0-84 USER PROGRAMS 0-48
System Exclusive		○	○	
System Common	: Song Pos. : Song Sel : Tune	× × ×	× × ×	
System Real Time	: Clock : Commands	○* ○*	○* ○*	
Aux Messages	: Local ON/OFF : All Notes OFF : Active Sense : Reset	○ × ○ ×	× ○ (123-127) ○ ×	
Notes	* can be set ○ or × MANUALLY			

Mode 1 : OMNI ON, POLY
Mode 2 : OMNI OFF, POLY

Mode 3 : OMNI ON, MONO
Mode 4 : OMNI OFF, MONO

○ : Yes
× : No

 **Roland**[®]