

MV-8800

PRODUCTION STUDIO

Appendices

Contents

Troubleshooting	3
Error Messages.....	10
Shortcut Keys	11
Glossary	12
Preset Patches and Algorithm List.....	14
Effect Block.....	16
About MIDI.....	65
MIDI Implementation	66
Specifications	76

Mixer Block Diagram



Copyright © 2006 ROLAND CORPORATION

All rights reserved. No part of this publication may be reproduced in any form without the written permission of ROLAND CORPORATION.

Roland International Web Site: <http://www.Roland.com>

Troubleshooting

If the system does not operate as you expect, please check the following points first. If this does not resolve the problem, please contact the nearest Roland service center.

■ Problems with the power supply

Problem	Cause
Power does not turn on	<ul style="list-style-type: none"> ● Is the MV-8800's AC power cord correctly connected to an AC outlet and to the MV-8800's power inlet?

■ Problems with the sound

Problem	Cause
No sound / Volume is too low	<ul style="list-style-type: none"> ● Are the audio cables connected correctly?
	<ul style="list-style-type: none"> ● Could an audio cable be broken?
	<ul style="list-style-type: none"> ● Has power to the connected amp and/or speakers been switched on? Could their volume be turned down?
	<ul style="list-style-type: none"> ● Could the volume have been turned down by the MASTER knob or PHONES knob?
No sound when you strike the velocity pads	<ul style="list-style-type: none"> ● Could multi-timbre sampler mode be on? <ul style="list-style-type: none"> → If multi-timbre sampler mode is on, the internal sound generator will not sound. If you want to play sounds by striking the velocity pads, access the MIDI screen (Screen Guide; p. 177), and turn the Multi Timbre Sampler Mode setting Off.
	<ul style="list-style-type: none"> ● You don't hear sounds after creating a new project <ul style="list-style-type: none"> → When you create a new project, the newly created project will not immediately play sounds unless you copy instruments, audio phrases, or pattern settings from the currently selected project. When you create a new project, use the CREATE NEW PROJECT screen (Screen Guide; p. 166) to make the appropriate settings in Copy From Current Project. If you want to play new sounds in your new project, start by preparing your sounds. <ul style="list-style-type: none"> ☞ IMPORT screen (Screen Guide; p. 219), SAMPLING screen (Screen Guide; p. 209)
	<ul style="list-style-type: none"> ● A specific velocity pad doesn't produce sound <ul style="list-style-type: none"> → Use the PAD BANKS popup (Screen Guide; p. 5) to check whether a sound (partial, audio phrase, or pattern) is assigned to that velocity pad and to other pad banks. If you want to newly assign a sound, make the desired assignment. <ul style="list-style-type: none"> • Assigning a partial <ul style="list-style-type: none"> ☞ PATCH QUICK ASSIGN popup (Screen Guide; p. 216) • Assigning an audio phrase <ul style="list-style-type: none"> ☞ AUDIO PHRASE QUICK ASSIGN popup (Screen Guide; p. 214) • Assigning a pattern <ul style="list-style-type: none"> ☞ ASSIGN TO PAD popup (Screen Guide; p. 100)
	<ul style="list-style-type: none"> ● Could the volume be turned down by the MASTER knob or PHONES knob?
	<ul style="list-style-type: none"> ● Could the fixed velocity level value be set to a low value? <ul style="list-style-type: none"> → If [FIXED VELOCITY] is lit, the sound will play at the velocity value specified by the Fixed Velocity Level setting in the PAD screen (Screen Guide; p. 174), regardless of how strongly you actually strike the pad.
	<ul style="list-style-type: none"> ● Does the performance data of the track have an appropriate output destination? <ul style="list-style-type: none"> → In the SONG screen or PATTERN screen, the sounds played by the pads are determined by the type of the current track. In the TRACK PARAMETER popup (Screen Guide; p. 11–15), set the Output Assign or MIDI parameter to the part number or MIDI channel you want the track to play.

Troubleshooting

■ Problems with the sound (continued)

Problem	Cause
A specific part of an instrument does not sound, or is too low in volume	<ul style="list-style-type: none"> ● Is the appropriate patch loaded into the part? → In the INSTRUMENTS screen (Screen Guide; p. 114), check the Patch value.
	<ul style="list-style-type: none"> ● Could the part be muted (silenced)? → In the MIXER (INSTRUMENTS PART) screen (Screen Guide; p. 236), turn the Mute setting Off.
	<ul style="list-style-type: none"> ● Could the part volume level be turned down? → In the MIXER (INSTRUMENTS PART) screen (Screen Guide; p. 236), increase the Level.
	<ul style="list-style-type: none"> ● Is the part output assign setting appropriate? → In the MIXER (INSTRUMENTS PART) screen (Screen Guide; p. 236), check the Output value. If you want the sound to be output from master out, choose Mix.
A specific partial does not sound, or is too low in volume	<ul style="list-style-type: none"> ● Could the partial's volume level be turned down? → In the PARTIAL EDIT screen (Screen Guide; p. 125), increase the Level.
	<ul style="list-style-type: none"> ● Is the partial's output assign setting appropriate? → In the PARTIAL EDIT screen (Screen Guide; p. 125), check the Output Assign value. If you want the sound to be output from master out, choose Mix.
	<ul style="list-style-type: none"> ● Could the SMT switch be turned off? → In the PARTIAL EDIT (SMT) screen (Screen Guide; p. 141), turn the Sw setting On.
	<ul style="list-style-type: none"> ● Could the SMT volume level be lowered? → In the PARTIAL EDIT (SMT) screen (Screen Guide; p. 141), raise the Level.
A specific audio phrase does not sound, or is too low in volume	<ul style="list-style-type: none"> ● Could the audio phrase's volume level be turned down? → In the AUDIO PHRASE EDIT screen (Screen Guide; p. 155), increase the Level.
A specific audio track does not sound, or is too low in volume	<ul style="list-style-type: none"> ● Could the audio track mixer be muted (silenced)? → In the MIXER (AUDIO TRACK) screen (Screen Guide; p. 235), turn the Mute setting Off.
	<ul style="list-style-type: none"> ● Could the audio track mixer volume be lowered? → In the MIXER (AUDIO TRACK) screen (Screen Guide; p. 235), increase the Level.
	<ul style="list-style-type: none"> ● Is the audio track mixer's output assign setting appropriate? → In the MIXER (AUDIO TRACK) screen (Screen Guide; p. 235), check the Output value. If you want the sound to be output from master out, choose Mix.
Sound is interrupted	<ul style="list-style-type: none"> ● Could more than 64 notes have been played simultaneously? → In the PARTIAL EDIT (SMT) screen (Screen Guide; p. 141), use the partial's SMT settings to turn the Sw to Off for samples you're not using. → In the INSTRUMENTS screen (Screen Guide; p. 114), adjust the VoRsv value for the parts that you don't want to be interrupted.
Volume of the device connected to the ANALOG INPUT jacks (MIC/LINE or PHONO) is too low	<ul style="list-style-type: none"> ● Could you be using a cable that has a built-in resistor? → Use a cable that does not contain a built-in resistor (such as one from the Roland PCS series).
	<ul style="list-style-type: none"> ● Could the input sensitivity have been lowered by the SENS knob?
	<ul style="list-style-type: none"> ● Could the input mixer volume be lowered? → In the MIXER (AUX/FX/AUDIO PHRASE/INPUT) screen (Screen Guide; p. 237), raise the Level.
Can't input sound from a device connected to ANALOG INPUT (PHONO)	<ul style="list-style-type: none"> ● Could a different device be connected to the ANALOG INPUT (MIC/LINE) jacks? → If cables are connected to the ANALOG INPUT (MIC/LINE) jacks, sound cannot be input from a device connected to the ANALOG INPUT (PHONO) jacks. You must disconnect the cables from the ANALOG INPUT (MIC/LINE) jacks.
	<ul style="list-style-type: none"> ● Is the input mixer's input source setting appropriate? → In the GLOBAL screen (Screen Guide; p. 173), set the Input Select setting to Analog.

■ Problems with the sound (continued)

Problem	Cause
Sound is distorted	<ul style="list-style-type: none"> ● Could you be using an effect that distorts the sound? → In the EFFECTS screen (Screen Guide; p. 229), check the MFX (multi-effect) settings.
	<ul style="list-style-type: none"> ● Could the volume of a specific part be too high? → In the MIXER (INSTRUMENTS PART) screen (Screen Guide; p. 236), decrease the Level.
	<ul style="list-style-type: none"> ● Could the volume of a specific audio track be too high? → In the MIXER (AUDIO TRACK) screen (Screen Guide; p. 235), decrease the Level.
	<ul style="list-style-type: none"> ● Could the MASTER knob be set to an excessively high volume?
	<ul style="list-style-type: none"> ● Does the sound distort when a large number of notes are played simultaneously? → If the overall volume of the entire sampler is raised, distortion may occur when a large number of notes are played simultaneously. In the GLOBAL screen (Screen Guide; p. 173), lower the Sampler Output Gain.
	<ul style="list-style-type: none"> ● Is the sound distorted even if you lower the output level settings in the mixer? → It is possible that the sound was recorded in a distorted condition because the input level was too high during recording. In this case, you'll have to re-record the material.
Pitch is wrong	<ul style="list-style-type: none"> ● Is the overall tuning of the entire MV-8800 incorrect? → In the GLOBAL screen (Screen Guide; p. 173), check the Master Tune.
	<ul style="list-style-type: none"> ● Is the pitch incorrect for just a specific patch? → In the PATCH EDIT screen (Screen Guide; p. 118), check the Coarse and Fine settings.
	<ul style="list-style-type: none"> ● Is the pitch incorrect for just a specific partial? → In the PARTIAL EDIT screen (Screen Guide; p. 125), check the Pitch Coarse and Pitch Fine settings. → In the PARTIAL EDIT (SMT) screen (Screen Guide; p. 141), check the Pitch KF, Tune Coarse, and Tune Fine settings.
	<ul style="list-style-type: none"> ● Could you have changed the playback pitch for a specific audio phrase? → In the AUDIO PHRASE EDIT screen (Screen Guide; p. 155), check the Coarse Tune and Fine Tune settings.
	<ul style="list-style-type: none"> ● Could you have changed the playback pitch for a specific audio event? → In the AUDIO EVENT PARAMETER popup (Screen Guide; p. 28), check the Coarse Tune and Fine Tune settings.
	<ul style="list-style-type: none"> ● Could the pitch be incorrect because of a pitch bend message received from an external MIDI device?
When you play legato from a low range of the keyboard to a high range, the pitch does not rise all the way	<ul style="list-style-type: none"> ● The sample you're using for legato performance has exceeded the upper pitch limit at which it can be played. → In the PATCH EDIT (SOLO/PORTAMENTO) screen (Screen Guide; p. 122), turn the Legato Retrigger setting On.
A partial consisting of two or more samples doesn't sound like a single note when you play legato from a low range of the keyboard to a high range	<ul style="list-style-type: none"> ● The respective sample has exceeded the upper pitch limit at which it can be played. → In the PATCH EDIT (SOLO/PORTAMENTO) screen (Screen Guide; p. 122), turn the Legato Retrigger setting On.
When you play in a high range of the keyboard, the playback pitch is incorrect, or noise is heard	<ul style="list-style-type: none"> ● The sample has exceeded the upper pitch limit at which it can be played. → This problem occurs in pitch ranges that would not normally be used. This is not a malfunction.

Troubleshooting

■ Problems with effects

Problem	Cause
An effect is not applied	<ul style="list-style-type: none"> ● Could the effect be turned off (disabled)? <ul style="list-style-type: none"> → In the EFFECTS screen (Screen Guide; p. 229), turn on (enable) the effect that you want to use.
	<ul style="list-style-type: none"> ● Are the various settings of the effect appropriate? <ul style="list-style-type: none"> → Check the settings in the EFFECTS EDIT screen (Screen Guide; p. 231).
	<ul style="list-style-type: none"> ● Could the send level of the signal from each part or audio track be turned down? <ul style="list-style-type: none"> → In each MIXER screen, check the DlyCho Send or Reverb Send settings. <ul style="list-style-type: none"> ☞ MIXER (AUDIO TRACK) screen (Screen Guide; p. 235) MIXER (INSTRUMENTS PART) screen (Screen Guide; p. 236) MIXER (AUX/FX/AUDIO PHRASES/INPUT) screen (Screen Guide; p. 237)
	<ul style="list-style-type: none"> ● Is the MFX (multi-effect) routing appropriate? <ul style="list-style-type: none"> → In the EFFECTS screen (Screen Guide; p. 229), check the Routing setting.

■ Problems with sampling

Problem	Cause
Can't sample	<ul style="list-style-type: none"> ● Is there free space in wave memory? <ul style="list-style-type: none"> → Check the Wave Memory status. <ul style="list-style-type: none"> ☞ SAMPLING screen (Screen Guide; p. 209), RESAMPLING screen (Screen Guide; p. 209) → If there are unused samples, delete them. <ul style="list-style-type: none"> ☞ SAMPLE MANAGER screen (Screen Guide; p. 169)
	<ul style="list-style-type: none"> ● Have you made the appropriate settings to initiate sampling? <ul style="list-style-type: none"> → In the SAMPLING screen (Screen Guide; p. 209), check the Start Trigger setting.
Sampling ends prematurely	<ul style="list-style-type: none"> ● Could you be running out of wave memory? <ul style="list-style-type: none"> → Check the Wave Memory status. <ul style="list-style-type: none"> ☞ SAMPLING screen (Screen Guide; p. 209), RESAMPLING screen (Screen Guide; p. 209) → If there are unused samples, delete them. <ul style="list-style-type: none"> ☞ SAMPLE MANAGER screen (Screen Guide; p. 169)
	<ul style="list-style-type: none"> ● Could you have made settings to stop sampling? <ul style="list-style-type: none"> → In the SAMPLING screen (Screen Guide; p. 209), check the Stop Trigger setting.
When a sample is assigned to a partial or audio phrase and played, it is lower in volume than when it was originally sampled	<ul style="list-style-type: none"> ● The overall volume of the sampler is lowered to prevent distortion from occurring in the output due to filter settings (or other causes) when large numbers of notes are played simultaneously. <ul style="list-style-type: none"> → As appropriate for the sound you're using or the number of simultaneously played notes, you can adjust the GLOBAL screen (Screen Guide; p. 173) Sampler Output Gain setting to a suitable value.
Noise or distortion is heard in the sampled sound	<ul style="list-style-type: none"> ● Is the input sensitivity set appropriately? <ul style="list-style-type: none"> → Use the SENS knob to adjust the input sensitivity so that the level meter moves within a range of -12–0 dB.

■ Problems with the sequencer

Problem	Cause
Can't play back	<ul style="list-style-type: none"> ● Could the [PLAY] indicator be blinking? → In the SYNC screen (Screen Guide; p. 81), check the Sync Mode setting.
Can't change the tempo during playback	<ul style="list-style-type: none"> ● Could the tempo track be turned on? → In the SONG PARAMETER screen (Screen Guide; p. 79), turn the Tempo Track "Off."
Can't record on a MIDI track	<ul style="list-style-type: none"> ● Is there free space in sequence memory? → Check the Sequence Memory status. ☞ SONG screen (Screen Guide; p. 8), PATTERN screen (Screen Guide; p. 91) → Use the DATA THIN popup (Screen Guide; p. 42) to thin out unneeded performance data. ● Could the Multi-Timbre Sampler Mode be on? → If Multi-Timbre Sampler Mode is on, you won't be able to record a performance in the sequencer. Go to the MIDI screen (Screen Guide; p. 177) and turn the Multi Timbre Sampler Mode setting Off.
Can't record on an audio track	<ul style="list-style-type: none"> ● Is there free space in wave memory? → Check the Remain status. ☞ SONG screen (Screen Guide; p. 8), PATTERN screen (Screen Guide; p. 91) → If there are unused samples, delete them. ☞ SAMPLE MANAGER screen (Screen Guide; p. 169) ● Is the recording mode appropriate? → In the RECORDING PARAMETER (AUDIO) popup (Screen Guide; p. 19), check the Rec Mode setting.
MIDI data that should exist is not displayed	<ul style="list-style-type: none"> ● Are the view filter settings appropriate? ● In the EVENT LIST screen or PIANO ROLL EDIT screen, have you selected the track that you want to view? → Specify the current track as the track whose MIDI data you want to view.
The sounds switch unexpectedly	<ul style="list-style-type: none"> ● Could unwanted program changes have been entered? → In the EVENT LIST screen (Screen Guide; p. 23), delete the unwanted program changes.
After playback, you no longer hear the sound	<ul style="list-style-type: none"> ● Could control change messages have lowered the volume? ● Could you be using the mute control track? → In the TRACK PARAMETER popup (Screen Guide; p. 11–16), check the Mute Control setting of each track. → Check the Mute Control Track settings of each song or pattern. ☞ SONG PARAMETER screen (Screen Guide; p. 79) PATTERN PARAMETER popup (Screen Guide; p. 99)
Notes are delayed or interrupted	<ul style="list-style-type: none"> ● Could the number of simultaneous notes have exceeded 64? → Try reducing the number of simultaneously played notes. Depending on the structure of a partial, some partials may use eight samples (four stereo samples). If you use such a partial, eight notes of polyphony are actually being used for each note you play. Also, sounds that have an extended release may still be using processing power even after the release has become inaudible to the ear, and this will mean that the performance data can differ from the actual number of notes being played. ● Could you be using sounds that use a significant amount of LFO? → Try using other sounds. LFO processing places a significant load on the processor, so making extensive use of LFO will increase the overall processing load on the MV-8800, and may also affect the timing accuracy of the notes themselves. ● Could data be concentrated at the beginning of beats in the sequence data? → Offset the data by one or two ticks so that the data does not occur at the identical timing. If you step-recorded your song data, or if you realtime-recorded it from a keyboard and then quantized it, the data will tend to be concentrated at the beginning of beats. This will cause a large amount of data to be sent to the MV-8800 at once, and may cause processing of notes to be delayed.

Troubleshooting

■ Problems with the sequencer (continued)

Problem	Cause
Notes are delayed or interrupted (continued)	<ul style="list-style-type: none"> ● Is there a program change at the point where the playback becomes sluggish? <ul style="list-style-type: none"> → Change the location of the program change data. If a program change is inserted during a song, a certain amount of processing time is required to switch patches, and this may cause the playback to become sluggish.
	<ul style="list-style-type: none"> ● Is there a system exclusive message at the point where the playback becomes sluggish? <ul style="list-style-type: none"> → Change the location of the system exclusive data. Since a system exclusive message contains a large amount of data, it places a significant processing load on the sequencer and sound generator module. Either change the location of the data, or use a control change instead (if it is feasible to substitute a control change for the system exclusive message).
	<ul style="list-style-type: none"> ● Is there a large amount of aftertouch or other data at the point where the playback become sluggish? <ul style="list-style-type: none"> → Change the location of the data. → Use the DATA THIN popup (Screen Guide; p. 42) to thin out unneeded data. If there is unneeded data, delete that data. If you are recording data from a keyboard that transmits aftertouch, it is easy to inadvertently input large amounts of aftertouch data without realizing it. Such large amounts of data will place an excessive processing load on the sequencer and sound generator.

■ Problems with MIDI

Problem	Cause
No sound from a connected MIDI device	<ul style="list-style-type: none"> ● Is the MIDI cable connected correctly?
	<ul style="list-style-type: none"> ● Could the MIDI cable be broken? <ul style="list-style-type: none"> → Use a different MIDI cable.
	<ul style="list-style-type: none"> ● Does the MIDI track's output assignment match the MIDI receive channel setting of your MIDI device? <ul style="list-style-type: none"> → In the TRACK PARAMETER popup (Screen Guide; p. 11), check the MIDI setting.
MIDI keyboard does not operate correctly when connected via MIDI	<ul style="list-style-type: none"> ● On your MIDI keyboard, could the Soft Thru setting be enabled? <ul style="list-style-type: none"> → Disable the Soft Thru setting, and then connect your MIDI keyboard.
When pitch bend messages are received via MIDI, the pitch of the patch does not rise all the way	<ul style="list-style-type: none"> ● For a sample used by a patch, could you have exceeded the upper limit of the pitch at which that sample can be played? <ul style="list-style-type: none"> → In the PATCH EDIT screen (Screen Guide; p. 118), adjust the Bend Range Up setting.
An external MIDI device does not synchronize to MIDI clock or MTC data transmitted from the MV-8800	<ul style="list-style-type: none"> ● Is the MIDI cable connected correctly?
	<ul style="list-style-type: none"> ● Could the MIDI cable be broken?
	<ul style="list-style-type: none"> ● Have you made the appropriate settings for transmitting MIDI clock or MTC messages? <ul style="list-style-type: none"> → In the SYNC screen (Screen Guide; p. 81), check the Sync Mode or Frame Rate settings.
	<ul style="list-style-type: none"> ● Have you made the appropriate settings on your external device so that it will synchronize to incoming MIDI clock and MTC messages? <ul style="list-style-type: none"> → Check the synchronization settings on your external device.
The MV-8800 does not synchronize to the MIDI clock or MTC data transmitted from an external MIDI device	<ul style="list-style-type: none"> ● Is the sequencer set to play back? <ul style="list-style-type: none"> → Press [SONG].
	<ul style="list-style-type: none"> ● Is the MIDI cable connected correctly?
	<ul style="list-style-type: none"> ● Could the MIDI cable be broken?
	<ul style="list-style-type: none"> ● Have you made the appropriate settings on the MV-8800 so that it will synchronize to incoming MIDI clock or MTC messages? <ul style="list-style-type: none"> → In the SYNC screen (Screen Guide; p. 81), check the Sync Mode and Frame Rate settings.

■ **Problems with the internal hard disk**

Problem	Cause
Project contents are not saved correctly	<ul style="list-style-type: none"> ● Did you save the project? → Save all data needed for your song as a “project” on the hard disk.
Can't correctly read data from the hard disk	<ul style="list-style-type: none"> ● Did you perform the Shutdown operation? → Make sure to save your work, and be sure to perform the Shutdown operation in order to power down safely.
	<ul style="list-style-type: none"> ● Could you have turned off the power while the hard disk was operating?
	<ul style="list-style-type: none"> ● Could you have subjected the hard disk to a strong impact? → Format the hard disk.  DISK UTILITY screen (Screen Guide; p. 193)

■ **Problems with the internal CD-RW drive**

Problem	Cause
Can't read a disc	<ul style="list-style-type: none"> ● Could you be using a CD-R or CD-RW disc that has not yet been finalized?
	<ul style="list-style-type: none"> ● Is the disc in a format that the MV-8800 is able to read? → The MV-8800 is able to read discs of the following formats. <ul style="list-style-type: none"> • Audio CD • ISO9660 format CD-ROM • Roland S-700 series CD-ROM library • AKAI MPC2000/2000XL CD-ROM library • AKAI S1000/3000 CD-ROM library
An audio CD created on the MV-8800 won't play in a conventional CD player	<ul style="list-style-type: none"> ● Could you be using a CD-RW disc? → If you create an audio CD using a CD-RW disc, it may not be playable by a conventional CD player. You will be able to play it using the MV-8800's CD Player function.
Can't write to a CD-R/RW disc	<ul style="list-style-type: none"> ● Are you using a blank (empty) CD-R/RW disc?

■ **Other problems**

Problem	Cause
Varying the strength with which you strike the velocity pads does not affect the volume (velocity)	<ul style="list-style-type: none"> ● Could the [FIXED VELOCITY] indicator be lit? → Press [FIXED VELOCITY] again so the indicator is turned off.
You hear the same sound regardless of which velocity pad you strike	<ul style="list-style-type: none"> ● Could the [MULTILEVEL] indicator be lit? → Press [MULTILEVEL] again so the indicator is turned off.

Error Messages

Message	Content
Can't create more audio track.	No further audio tracks can be created.
Can't create more MIDI track.	No further MIDI tracks can be created.
Can't delete current Song.	You cannot delete the song that you are currently working on.
Can't delete current Project.	You cannot delete the project you are currently working on.
Can't delete last one track.	You cannot delete the last track of the song.
CD-R/RW disc full.	There is insufficient space on the CD-R/RW disc (audio files cannot be added).
Cue Sheet is Full.	No more than 99 songs can be registered to the cue sheet.
Current Project is protected.	The project you are currently working on is write-protected.
Current Project is protected. Saving Project is not performed before.	The current project cannot be saved since it is write-protected. Do you want to load without saving the current project?
Disk full.	There is no free space on the disk. Writing or editing is not possible.
Disk not ready.	No disk is inserted.
File name duplicate.	The file name is a duplicate. Editing is not possible.
File not found.	The file was not found.
File read error.	The file could not be read.
File write error.	The file could not be written.
Invalid file name.	The file name is inappropriate. Please change it to an appropriate name.
MIDI buffer full.	An extremely large amount of MIDI data was received faster than it could be processed.
MIDI offline.	There is a problem with the MIDI cable connection (MIDI IN). Alternatively, the MIDI cable was disconnected during transmission.
Mixdown Mode.	The MV-8800 is in Mixdown mode.
Marker memory full.	No more Marker can be stored.
No space to add more MIDI Clips.	No more MIDI clips can be stored.
No more Song numbers.	No more songs can be created.
No more Sample numbers.	No more samples can be stored (no further sampling or recording is possible).
No region selected.	No editing region has been selected.
Operation Failed.	The operation could not be completed successfully for some reason.
Preview unsupported drive.	The data from the floppy disk cannot be previewed.
Preview unsupported file.	This file cannot be previewed.
Selected Project is too large.	The project cannot be loaded (there is not enough wave memory to load it).
Sequence memory full.	No more song performance data can be recorded/edited.
Unformatted disk.	The disc/disk is of an unknown type (it cannot be used on the MV-8800).
Unknown disc.	
Unsupported file format.	The MV-8800 cannot handle this file.
Wave memory full.	No more samples can be stored (no further sampling or recording is possible).
Write Protected.	The disk is write-protected.

Shortcut Keys

Here's a list of convenient operations you can perform by simultaneously pressing multiple buttons or by using a button together with the VALUE dial.

Shortcut	Explanation
[SHIFT] + [SHUTDOWN]	Access the SAVE PROJECT popup
[SHIFT] + [V-LINK]	Access the V-LINK screen (Screen Guide; p. 179)
[SHIFT] + [AUTO PUNCH]	Access the AUTO PUNCH popup (Screen Guide; p. 49)
[SHIFT] + LOOP [ON]	Access the LOOP popup (Screen Guide; p. 48)
[SHIFT] + [JUMP]	Access the JUMP popup (Screen Guide; p. 60)
[SHIFT] + [ASSIGNABLE SLIDER]	Access the ASSIGNABLE SLIDER screen (Screen Guide; p. 182)
[SHIFT] + [ROLL]	Access the PAD ROLL INTERVAL popup
[SHIFT] + MEAS [▶▶]	Forward in steps of one beat
[SHIFT] + MEAS [◀◀]	Rewind in steps of one beat
[SHIFT] + VALUE dial	Increment/decrement a parameter value in steps of ten
[JUMP] + VALUE dial	Change the sequencer time location in one-tick steps
[SHIFT] + [INC]	Increment a parameter value in steps of ten
[SHIFT] + [DEC]	Decrement a parameter value in steps of ten
[JUMP] + CURSOR [▲]	Erase the data in the specified range.
[JUMP] + CURSOR [▶]	Move the data in the specified range.
[JUMP] + CURSOR [▼]	Paste the data to the current location.
[JUMP] + CURSOR [◀]	Access the AUDIO EVENT PARAMETER popup (Screen Guide; p. 28)
[SHIFT] + [EXIT]	Switch the operation screen (VGA/LCD).
[SHIFT] + [1]	Set to Step Time ♪ (30).
[SHIFT] + [2]	Set to Step Time ♪ (60).
[SHIFT] + [3]	Set to Step Time ♪ (80).
[SHIFT] + [4]	Set to Step Time ♪ (120).
[SHIFT] + [5]	Set to Step Time ♪ (160).
[SHIFT] + [6]	Set to Step Time ♪ (240).
[SHIFT] + [7]	Set to Step Time ♪ (320).
[SHIFT] + [8]	Set to Step Time ♪ (480).
[SHIFT] + [9]	Set to Step Time ♪ (960).

AKAI MPC 2000 (XL), S1000, S3000

The AKAI MPC2000, MPC2000XL, S1000 and S3000 are products of Pro Audio Japan KK. You can load the sound data used for these devices (.SND, .A1S, and .A3S files), enabling previous assets to be utilized as is.

Audio Phrase

Sample of a certain length. Performances of several measures can be used just as they are as recorded data by being played repeatedly on sequencers.

Audio Track

Area in sequencer enabling storage of audio phrase performances and direct recording of audio input from external sources.

BPM

BPM stands for Beats Per Minute. Referring to the number of beats (generally the number of quarter notes) per minute, it is an indicator of the tempo (speed).

CD-R

Short for **Compact Disc Recordable**. This is a system for reading and writing discs in the same format as that used for CDs (CD-ROMs and music CDs). A specialized CD-R drive allows one-time only writing of discs. However, as long as the data has not been finalized and there is sufficient capacity remaining on the disc, the CD-R drive can be used for multiple additions to, and changes in the material. Sometimes they are referred to as "Write Once CD," "CD-Write Once," or something similar.

CD-RW

Short for **Compact Disc ReWritable**. This is a system allowing creation of discs that can be read using the same format as regular CDs (CD-ROMs and Music CDs). While resembling the CD-R system in that it uses a special CD-RW drive, these discs can be rewritten any number of times.

Compressor

An effect that suppresses volume fluctuations. When the input signal exceeds a specified level (threshold), the gain is reduced as the input signal rises, thus suppressing signal overload. The same algorithm can also be used as a limiter (an effect that instantaneously suppresses peaks). Of the effects in this system, only the compressor included in guitar multi simulates a compact compressor for guitar, and works differently from a limiter. (It suppresses signal overloads, and also evens out the volume by raising low-level signals.)

COSM

Stands for **Composite Object Sound Modeling**. This is "a technology which combines multiple sound models to create new sounds," which was first used on the Roland's VG-8 V-Guitar System. For example, sounds created on the VG-8 are the result of a variety of sound models (elements) such as the pickup, the body of the guitar, the guitar amp, mic, and speaker etc.

Cue Sheet

Data including song sequence and detailed time information settings recorded to audio CDs. Audio CDs are created according to these cue sheets, which are written to the CD-R/RW discs.

Current Song

The song currently being recorded, played back, or edited is referred to as the current song.

Current Track

The currently selected track used as the material being worked upon.

DIMM

Memory built into the MV-8800. The unit is shipped from the factory with a 128 MB DIMM installed. DIMMs can be switched (Owner's Manual; p. 323) for up to 512 MB of memory.

Dynamics (effect)

Effects that compressor expand the range of volume changes. These effects are used to reduce noise when recording to tape, or to increase the dynamic range of a tape or wireless mic. Dynamics effects provided on this system include Enhancer, Expander, Compressor, and Limiter.

DSP

An abbreviation for **Digital Signal Processing**. Technology that uses dedicated circuitry or software calculations to process digitized audio or video signals in order to implement the functionality of a mixer, filter, or effect processor. By extension, DSP is also used to collectively refer to effect devices and effect functionality that uses such technology.

Expander

An effect that increases (by a fixed ratio) the difference in loud and soft volume levels, by making low-level signals softer, and high-level signals louder.

Frame

Similar to the individual frames in a roll of movie film, the numerous still pictures that are displayed in rapid succession to create a moving video image are also known as "frames." About thirty of these frames are shown each second. When hard disk recorders, sequencers, and other such equipment are synchronized with video, it is generally assumed that there should be one frame every 1/30th of a second.

IEC

The signals that are transferred via the digital output of this device comply with the IEC60958 and IEC958 (consumer) formats.

Limiter

An effect that works similarly to a compressor. When the input signal rises beyond a specified level (threshold), a limiter instantly lowers the gain to limit the output level. The degree of compression is specified by the Ratio. In general, ratios of 1:10 or less are referred to as compression, in distinction to limiting.

MIDI Track

Section in sequencer for storing MIDI data.

MMC

MMC is an acronym for **MIDI Machine Control**. This is rule that defines how MIDI system exclusive message can be used to control multiple recording devices from a single device. The MV-8800 supports MMC. In addition to song play back, stop and fast-forward, you can also select the tracks for recording, etc.

MTC

MTC stands for **MIDI Time Code**. This is a group of messages which are transmitted and received between MIDI devices to synchronize their operation. Unlike MIDI Clock messages, MTC specifies an absolute time. Like SMPTE time code, MTC also supports a variety of frame rates. If you wish to use MTC to synchronize the operation of two devices, both devices must be set to the same frame rate.

Patch

Patches are “sound sets.” On the MV-8800, patch sounds are sounded at preprogrammed timing (sequencer playback), or are played using the velocity pads.

Partial

These are the separate, individual sounds from which patches are composed. Partials are samples (waveform data) processed with the application of a variety of parameters, assigned note numbers, and sounded.

Program File

Program files used with the AKAI MPC2000, MPC2000XL, S1000 and S3000 correspond to patches used with the MV-8800.

PS/2 Mouse

Mouse that can be connected to the connector used with PS/2 computers developed by IBM in the U.S. In the future, users will be able to carry out tasks on the MV-8800 using a PS/2 mouse.

RSS

RSS stands for **Roland Sound Space**. This is an effect which allows a sound source to be placed in three-dimensional space when played back on a conventional stereo system. The sound can be placed not only in front of the listener, but also directly to the side, above, below, and behind the listener.

S-700 series

Generic name for the S-750/770 and S-760 sequencers sold by Roland.

Sample

The waveform data (sound material) that the MV-8800 needs to produce sounds.

Sampling

The process of capturing and loading sounds using a sampler.

SCMS

SCMS stands for **Serial Copy Management System**. This is a function that protects the rights of copyright holders by prohibiting recording via a digital connection for more than two generations. When digital connections are made between digital recorders that implement this function, SCMS data will be recorded along with the audio data. Digital audio data which contains this SCMS data cannot again be recorded via a digital connection.

Shutdown

In order to turn the power off safely, you must first make sure that the performance has been saved to hard disk, and that the hard disk heads are parked. This procedure is referred to as Shutdown.

SMF

SMF stands for Standard MIDI File, the standard file format for handling MIDI music data.

SMPTE time code

This is a signal format defined by the American organization SMPTE (Society of Motion Picture and Television Engineers) which is used to synchronize the operation of video or audio devices. SMPTE specifies “hours:minutes:seconds:frames” to indicate the address of each frame of a video image. For this reason, there are a variety of frame rates.

SMT

The Sample Mix Table is collective data including levels, pan, and tuning information for up to four audio data files (samples).

Song

This is recorded data containing information (events) in the MV-8800’s performances along the time axis with recorded data for instrument and effect settings. Data called “sequencer data” is stored within these songs.

TOC

Short for Table of Contents. This is the region on the CD-R disc that handles information such as song times, end times, sequence, and so on. Although the songs on a disc and their playing time can be displayed when an audio CD is placed in a CD player, this is because they can be read automatically from the TOC. The TOC is recorded differently than music data, with its main characteristic being disc access, such as the ability to go to the start of any song instantly.

USB

Universal Serial Bus is a serial interface specification. “USB mass storage class” is supported on the MV-8800, so it can be recognized by the connected computer as an externally connected hard disk.

Velocity

ne of the sound expression parameters, velocity is used to express the relative strength of the sound. With the MV-8800, the value of this parameter changes according to the force used in tapping the velocity pads or in playing the keys of an externally connected keyboard.

VGA

VGA stands for Video Graphics Array. Although this refers to the 640 x 480 dot graphics system capable of showing 16 colors developed by IBM in the U.S., a VGA-compatible mode permitting display of many colors at high resolution has been developed by other companies. Presently, VGA has come to mean only an indication of the resolution rather than referring to the graphics system.

Preset Patches and Algorithm List

Effect Preset Patch List

■ MFX preset library

Library number	Library name	Algorithm	Library number	Library name	Algorithm
P001	01>Iso&Fltr	Isolator & Filter	P023	23>MicModel	Mic.Modeling
P002	02>Ct.Cancel	Center Canceler	P024	24>Vocoder10	10 Band Vocoder
P003	03>Comp&Etc.	St.Dynamics Processor	P025	25>AnlgBass1	Analog Modeling Bass
P004	04>Rev&Gate	Reverb & Gate	P026	26>AnlgBass2	Analog Modeling Bass
P005	05>TapeEcho	Tape Echo 201	P027	27>AnlgBass3	Analog Modeling Bass
P006	06>EZ Delay	EZ Delay	P028	28>AnlgBass4	Analog Modeling Bass
P007	07>Delay RSS	Delay RSS	P029	29>AnlgBass5	Analog Modeling Bass
P008	08>AnalogD&C	Analog Delay & Chorus	P030	30>AnlgBass6	Analog Modeling Bass
P009	09>StDigiCho	Digital Chorus	P031	31>AnlgBass7	Analog Modeling Bass
P010	10>4bton Cho	4 Button Chorus 320	P032	32>AnlgBass8	Analog Modeling Bass
P011	11>Flange325	Vintage Flanger 325	P033	33>AnlgBass9	Analog Modeling Bass
P012	12>FlgBOSSx2	2 x BOSS Flanger	P034	34>AnlgBass10	Analog Modeling Bass
P013	13>Pitch-Sft	Stereo Pitch Shifter	P035	35>MAD COMP	St.Dynamics Processor
P014	14>80sPhaser	80s Phaser	P036	36>AIR Vocal	Vocal Multi
P015	15>2xAutoWah	Stereo Auto Wah	P037	37>AutoWah90	Stereo Auto Wah
P016	16>2xDistort	Stereo Distortion	P038	38>YOU MOVE!	Analog Delay&Chorus
P017	17>Records	Phonograph	P039	39>SPACY RSS	Delay RSS
P018	18>RadioTune	Radio Modeling	P040	40>FunkyBsWh	Stereo Auto Wah
P019	19>Lo-FiProc	Lo-Fi Processor	P041	41>GateRev09	Reverb & Gate
P020	20>GuitarMlt	Guitar Multi	P042	42>OLDSAMPLR	Lo-Fi Processor
P021	21>VocalMlt	Vocal Multi	P043	43>NICEPhase	80's Phaser
P022	22>VoTrans	Voice Transformer	P044	44>MPS WIDE	Stereo Pitch Shifter

■ Delay/Chorus preset library

Library number	Library name	Algorithm	Library number	Library name	Algorithm
P01	01>Delay	Delay	P02	02>Chorus	Chorus

■ Reverb preset Library

Library number	Library name	Algorithm	Library number	Library name	Algorithm
P01	01>Reverb	Reverb	P03	03>SRV Hall	SRV Hall
P02	02>SRV Room	SRV Room	P04	04>SRV Plate	SRV Plate

■ Mastering Tool Kit preset library

Library number	Library name	Algorithm	Library number	Library name	Algorithm
P01	Mixdown	Mastering Tool Kit	P14	RockBand	Mastering Tool Kit
P02	PreMastr	Mastering Tool Kit	P15	Orchestr	Mastering Tool Kit
P03	LiveMix	Mastering Tool Kit	P16	LoBoost	Mastering Tool Kit
P04	PopMix	Mastering Tool Kit	P17	Brighten	Mastering Tool Kit
P05	DanceMix	Mastering Tool Kit	P18	DJsVoice	Mastering Tool Kit
P06	JinglMix	Mastering Tool Kit	P19	PhoneVox	Mastering Tool Kit
P07	HardComp	Mastering Tool Kit	P20	Cassette	Mastering Tool Kit
P08	SoftComp	Mastering Tool Kit	P21	Phono	Mastering Tool Kit
P09	ClnComp	Mastering Tool Kit	P22	D4R-Set 1	Mastering Tool Kit
P10	DnceComp	Mastering Tool Kit	P23	D4R-Set 2	Mastering Tool Kit
P11	OrchComp	Mastering Tool Kit	P24	D4R-Set 3	Mastering Tool Kit
P12	VocalComp	Mastering Tool Kit	P25	D4R-Set 4	Mastering Tool Kit
P13	Acoustic	Mastering Tool Kit	P26	D4R-Set 5	Mastering Tool Kit

Algorithm List

	Algorithm	Effect block						
01	Isolator & Filter	3 Band Isolator	Filter	Low Booster				
02	Center Canceler	Center Canceler	3 Band EQ					
03	St.Dynamics Processor	Comp/Limiter	Enhancer	3 Band EQ	Noise Suppressor			
04	Reverb & Gate	3 Band EQ	Reverb + Gate					
05	Tape Echo 201	Tape Echo						
06	EZ Delay	EZ Delay						
07	Delay RSS	Delay RSS						
08	Analog Delay & Chorus	Analog Delay	Analog Chorus					
09	Digital Chorus	Digital Chorus						
10	4 Button Chorus 320	4 Button Chorus						
11	Vintage Flanger 325	Vintage Flanger						
12	2 x BOSS Flanger	Stereo Flanger						
13	Stereo Pitch Shifter	Stereo Pitch Shifter						
14	80s Phaser	Stereo Phaser						
15	Stereo Auto Wah	Stereo Auto Wah						
16	Stereo Distortion	Stereo Distortion	3 Band EQ	Noise Suppressor				
17	Phonograph	Phonograph						
18	Radio Modeling	Radio Modeling						
19	Lo-Fi Processor	Bit/Rate Down	Filter	Noise Suppressor				
20	Guitar Multi	Comp/Sustainer	Auto Wah	Drive	Guitar Amp	Noise Suppressor	Delay	Chorus/ Flanger
21	Vocal Multi	Noise Suppressor	Limiter/De-esser	Enhancer	3 Band EQ	Pitch Shifter	Delay	Chorus
22	Voice Transformer	Voice Transformer	3 Band EQ	Simple Delay				
23	Mic.Modeling	Mic Modeling Link	Mic Modeling (Ch A)	Mic Modeling (Ch B)				
24	10 Band Vocoder	Vocoder	Stereo Delay	Chorus				
25	Analog Modeling Bass	Synth Common	Synth LFO	Virtual VOC + Ring	Cirtual VCF	Virtual VCA	Delay	Chorus/ Flanger

01 Isolator & Filter

Isolator (3 Band Isolator)

This effect separates the input sound into three frequency bands, High, Mid, and Low, and cuts or extracts them.

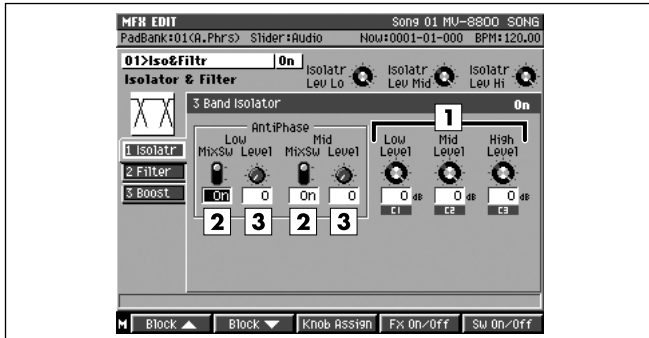

1 Low Level, Mid Level, High Level

Value: -60 dB–4 dB

These cut (or increase) each frequency band. At -60 dB, the sound becomes inaudible. 0 dB is equivalent to the input level of the sound.

2 AntiPhase Low MixSw, AntiPhase Mid MixSw

Value: Off, On

This turns the Anti-Phase function on and off for the low and mid frequency ranges. When turned on, the counter-channel of stereo sound is inverted and added to the signal.

3 AntiPhase Low Level, AntiPhase Mid Level

Value: 0–100

This sets the Anti-Phase level for the low and mid frequency ranges. The level setting allows you to achieve the effect of extracting only a particular part. (This is effective only for stereo source.)

MEMO

- In this algorithm, the functions of the machines that make up the basics for remix artists and pro DJs have been minutely analyzed and reproduced. Whereas with ordinary equalizers, some sound is still audible even when the gain is turned all the way down, the Isolator completely cuts off the sound. By turning this on and off and changing each level in realtime, you can get the effect of having the sound of particular parts appear and disappear.

Filter

These filters allow you to modify the frequency response of the input sound widely and give sound a style.

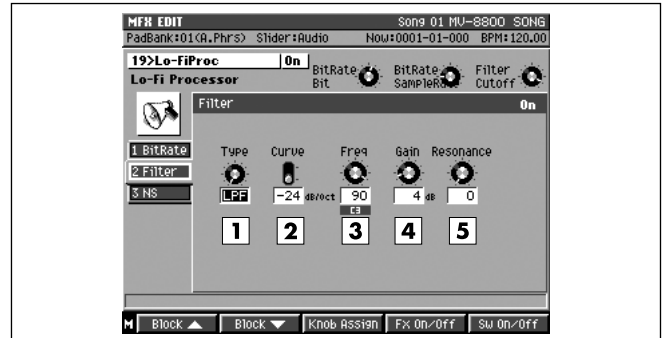

1 Type

Sets the type of filter used.

Value	Explanation
LPF	Low pass filter. Passes frequencies below the cutoff frequency.
BPF	Band pass filter. Passes frequencies near the cutoff frequency.
HPF	High pass filter. Passes frequencies above the cutoff frequency.
BEF	Band eliminate filter. Passes frequencies other than those near the cutoff frequency.

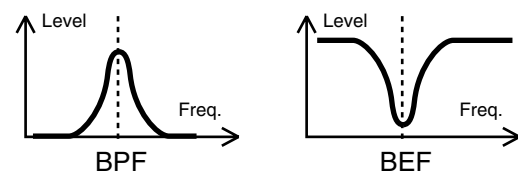
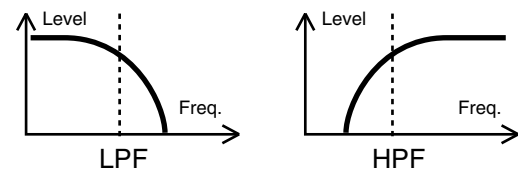

2 Curve

Value: -12 dB/oct, -24 dB/oct

Sets the filter's attenuation slope (-24 dB per one octave: steep; -12 dB per one octave: shallow).

3 Freq (Cutoff Frequency)

Value: 0–100

Sets the filter's cutoff frequency. Set this closer to zero, the cutoff frequency becomes lower; set closer to 100, the cutoff frequency becomes higher.

4 Gain

Value: 0–24 dB

This compensates for the volume dropped in the cut frequency range with some filters. The level of compensation increases as the value is increased, and raise the volume.

5 Resonance

Value: 0–100

Sets the filter's resonance level. Raising the setting increases resonance near the cutoff frequency, giving the sound a special characteristic.

NOTE

- If the resonance value is raised too much, loud strange sound (known as oscillation) begins to appear. Take care not to allow this sound to damage your ears or your playback equipments.

Boost (Low Booster)

This emphasizes the bottom to create a heavy bass sound.

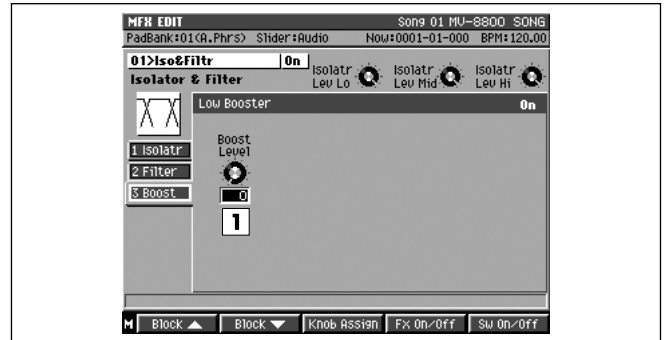
**1 Boost Level**

Value: 0–100

Increasing this value gives you a heavier low end. (Depending on the Isolator and filter settings this effect may be hard to distinguish.)

02 Center Canceler

Center (Center Canceler)

This cuts sounds in the center of the stereo field (such as vocals).

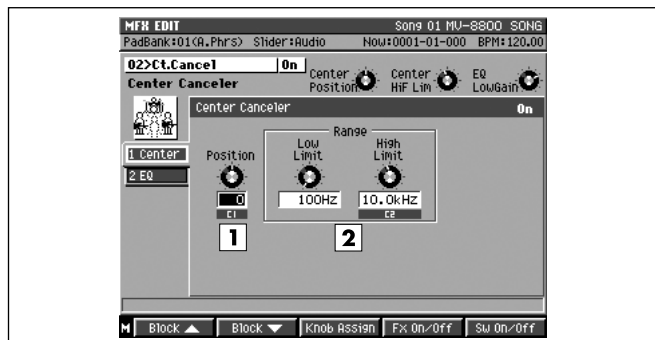

1 Position (Cancel Position)

Value: -50–50

This is for finer adjustment of the cut position. Adjust this so that the sound is cut fully.

2 Range

These set the upper and lower limits of the frequency range to be cut. When “Thru” is selected, the frequencies to be cut are not limited.

Value	Explanation
Low Limit	Thru, 20–2000 Hz
High Limit	1.0–20.0 kHz, Thru

MEMO

- Although you can get a similar effect by using the Anti-Phase function in Algorithm 01 Isolator & Filter (p. 16), this algorithm differs in that you can specify the upper and lower frequency limits of the effect. This is especially effective when cutting vocals, for example.

NOTE

- This has no effect if the input sound is monaural. Additionally, even in stereo, the result of cutting may differ depending on the particular recording.

EQ (3 Band EQ)

This equalizer works in three frequency ranges: Low, Midrange, and High. You can set the frequencies and boost or cut the level.

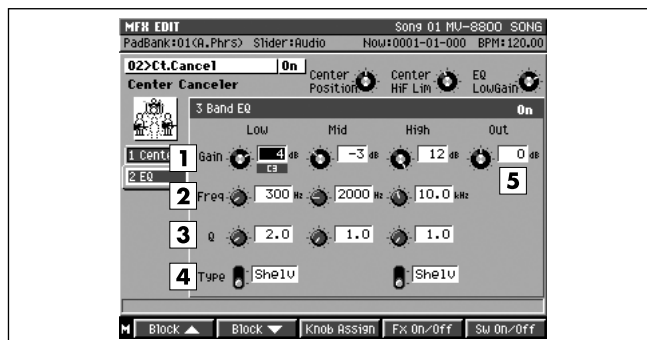

1 Gain

Sets the gain (boost or cut) of the equalizer.

Parameter	Value
Low Gain	-12–12 dB
Mid Gain	
High Gain	

2 Freq

Sets the reference for the frequency range to be boost or cut. With the peaking-type equalizer, this means the center frequency; with the shelving-type equalizer, this becomes the cutoff frequency.

Parameter	Value
Low Freq	20–2000 Hz
Mid Freq	200–8000 Hz
High Freq	1.4–20.0 kHz

3 Q

This sets the bandwidth of the sound that is boost or cut. As the frequency value becomes bigger the bandwidth becomes narrower (refer to “Type” parameter).

MEMO

- This has no effect on the shelving-type equalizer.

Parameter	Value
Low Q	0.3–16.0
Mid Q	
High Q	

4 Type

This switches the Low or High EQ curve characteristics.

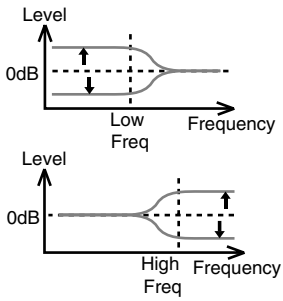
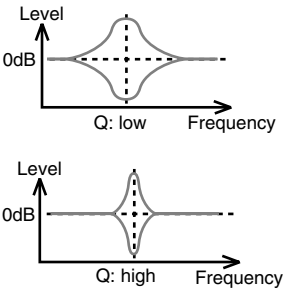
Value	Explanation
Shelv	<p>Shelving-type</p> 
Peak	<p>Peaking-type</p> 

5 Out Level

Value: -12–12 dB

Sets the output volume.

03 St. Dynamics Processor

Comp (Comp/Limiter)

This effect is able to use as a compressor, which controls inconsistencies in sound levels by suppressing high sound levels while lifting weaker signals, or as a limiter that prevents the signal from reaching exceedingly high levels.

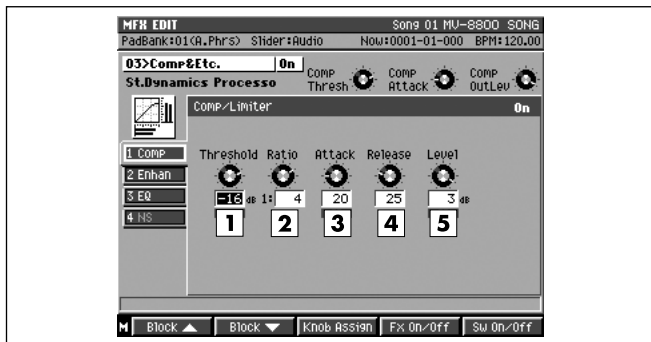

- 1 Threshold**
Value: -60–0 dB
Sets the volume level at which the compression begins.
- 2 Ratio**
Value: 1:1.5, 1:2, 1:4, 1:100
Sets the “source sound:output sound” compression ratio.
- 3 Attack**
Value: 0–100
Sets the time after the sound volume is crossed the threshold level until compression begins.
- 4 Release**
Value: 0–100
Sets the time for compression to stop after the sound falls back under the threshold level.
- 5 Output Level**
Value: -60–12 dB
Sets the output volume.

MEMO

- When used as a limiter, set the Ratio to 100:1 with a short release time. If the volume exceeds the threshold level, the sound is suppressed instantly detected as the excess input.

Enhan (Enhancer)

This effect regulates the high-end overtones, clarifying the sound and the sound contour.

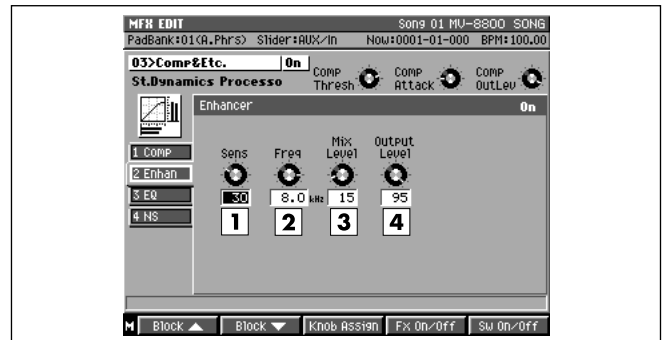

- 1 Sens**
Value: 0–100
Sets the degree to which the Enhancer is applied.
- 2 Freq**
Value: 1.0–10.0 kHz
Sets the lower limit of the frequencies to which the enhancement effect is added.
- 3 Mix Level**
Value: 0–100
Sets the level of the overtones produced by the Enhancer that is mixed in with the source sound.
- 4 Output Level**
Value: 0–100
Sets the output volume.

NS (Noise Suppressor)

This suppresses noise (such as background noise and hum from mics) when no sound is being played. The noise suppressor watches at the input level at the top of the chain of effects, and when there is no input, turns down any output at the end.

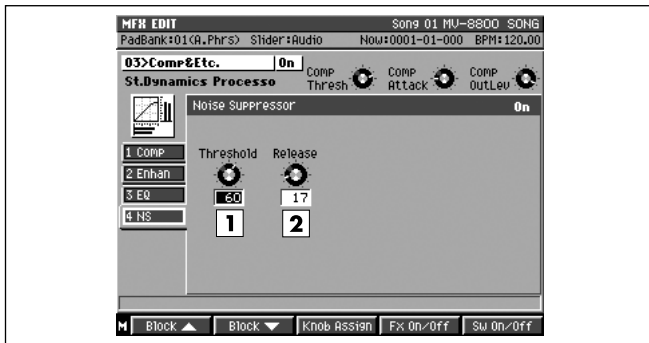

1 Threshold

Value: 0–100

Sets the volume level at which starts muting. Set the value higher when there is a lot of noise, and if there is less noise, decrease the value.

2 Release

Value: 0–100

Sets the time from when the muting starts until the volume reaches 0.

MEMO

- If the threshold level is set too low, the effect is lost; when set too high, even the sounds you want will be muted. In addition, if the release time is set too long, the releasing noise becomes audible; when set too short, it sounds unnatural. Set these to suitable point for the input noise conditions at the time.

Other effect blocks



- EQ (3 Band EQ) (p. 18)

04 Reverb & Gate

Reverb

This is a high-quality digital reverb. Imbues sound with reverberations, making it seem as if it were being played in a hall.

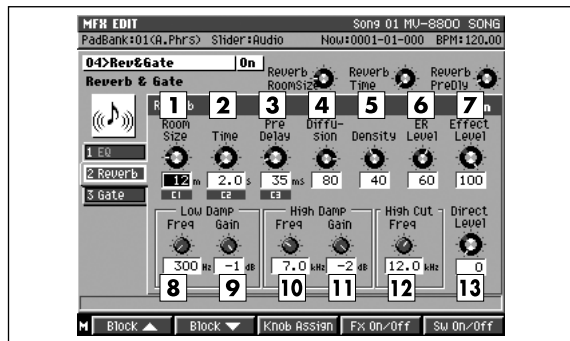

1 Room Size

Value: 5–40 m

Sets the size of the room. For example, the setting “10m” gives you reverb as it would sound in a single space 10 meters wide.

2 Time

Value: 0.1–32 sec

Sets the reverb time in seconds.

3 Pre Delay

Value: 0–200 msec

Sets the delay time between the source sound and the point at which the reverb sound is started. This indicates distance from the source of the sound.

4 Diffusion

Value: 0–100

Increasing this value intensifies the sense of spatial width. This is effective when playing back in stereo.

5 Density

Value: 0–100

Increasing this value makes the reverb sound denser. For hall or garage sounds, make this thinner.

6 ER Level

Value: 0–100

Raising the value increases the volume of the early reflections.

MEMO

- Early reflections: The first sounds reflected directly from the walls and other surfaces. A sort of “patter” sound is audible at the beginning of the reverb sound.

7 Effect Level

Value: 0–100

Sets the volume of the reverb sound. Lower it to get a balance with the direct level.

8 Low Damp Freq

Value: 50–4000 Hz

Sets the upper frequency limit of the range to be damped by “Low Damp.” The Low Damp function damps the low frequency band of the reverb sound quicker than other bands, which makes for a clearer reverb effect.

9 Low Damp Gain

Value: -36–0 dB

Sets the degree of the Low Damp.

10 High Damp Freq

Value: 1–20 kHz

High Damp, by attenuating the higher frequencies first, makes the reverb sound more natural. Sets the lower frequency limit of the range to be dampened.

MEMO

- In the natural world, the high frequencies in reverberation die out quicker than other bands.

11 High Damp Gain

Value: -36–0 dB

Sets the degree of the High Damp.

MEMO

- By combining Low Damp and High Damp, you can indicate the qualities of the room such as surface material (or the sound absorption properties thereof.)

12 High Cut Freq

Value: 0.2–20 kHz

Upper band than this frequency of the reverb sound are gently cut to make the reverberation more stable. This does not make time-based changings.

13 Direct Level

Value: 0–100

Sets the volume of the source sound.

MEMO

- To make the gate settings easy when using the gate function to get special reverb effects, make reverb times longer. In such instances, instead of using Low Damp or High Damp to change the tone, do this with the High Cut frequency settings or through equalization at an earlier stage. To get sharp gate reverb, make the attack and release times extremely short, and set expression time to match the rhythm with the hold time setting. To get reverse reverb, make the attack time plenty long, and keep the release time short.

Gate

This shuts off the signal. It also provides the characteristic effect in gated reverb, which cuts off reverb sounds while they are still being produced, ducking reverb, and other such effects.

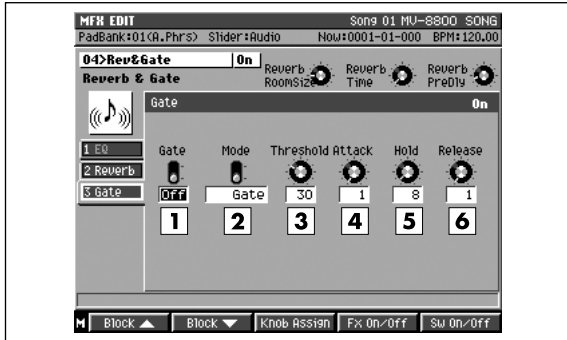

1 Gate (Gate Switch)

Value: Off, On

This turns on and off the gate function that cuts the output of the reverb sound based on the volume of the source sound.



- The effect block switch (press [F5](Fx On/Off) to change) is shared with the Reverb block. If you want to turn off only the Gate, turn the Gate switch Off.

2 Mode

Value	Explanation
Gate	(Gate Reverb) When the source volume falls below a certain level, the gate closes, giving the effect of the reverb sound being cut with a gate reverb.
Duck	(Ducking Reverb) When the source volume gets high enough, the gate closes, which gives a ducking reverb-type effect. Stop the reverb sound only when input loud sound so that prevent the play sound become unclear.

3 Threshold

Value: 0–100

Sets the input volume level at which starts closing the gate to cut the reverb sound.

4 Attack

Value: 1–100

Sets the time it takes the gate fully opens after being triggered.

5 Hold

Value: 1–100

Sets the time it takes the gate starts closing after the instant the source sound goes under the threshold level.

6 Release

Value: 1–100

Sets the time it takes the gate fully closes after passes by the hold time.

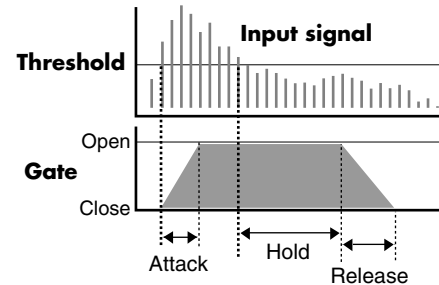

Other effect blocks



- EQ (3 Band EQ) (p. 18)

05 Tape Echo 201

Echo (Tape Echo 201)

This simulates the tape echo part of Roland's RE-201 Space Echo.

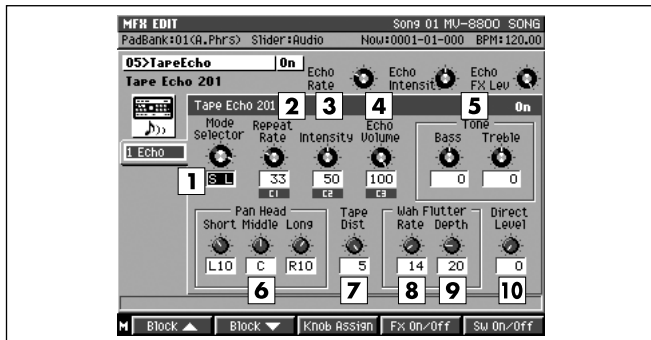

1 Mode Selector

The RE-201 had three playback heads to make different delay times (Short, Medium, and Long delay) at once. Use Modes Selector parameter to set the combination of playback heads to be used. For example, when you set “ML,” the middle and long heads are selected.

Value	Playback heads to be used
S	Short
M	Middle
L	Long
SM	Short and Middle
ML	Middle and Long
S L	Short and Long
SML	All heads

2 Repeat Rate

Value: 0–100

Sets the tape speed. This corresponds to the delay time in a contemporary delay effect. As the value is increased, the interval of the delay sounds is shortened.

3 Intensity

Value: 0–100

Sets the repeat times of the delayed sound. This is analogous to a contemporary delay’s feedback setting. Raising this value increases the number of repeats.

4 Echo Volume

Value: 0–100

Sets the volume of the echo sound. Lower it to get a balance with the direct level.

5 Bass/Treble

Value: -100–100

These are the echo sound’s bass and treble adjustments. When set to 0, they make no change to the sound.

6 Pan Head Short, Pan Head Middle, Pan Head Long

Value: L63–R63

These are the pan (left–right) settings for each of the heads for Short, Medium, and Long delay time. This parameter does not appear on the original RE-201.

7 Tape Dist.

Value: 0–5

This parameter adds the distortion characteristic of tape. It reproduces that subtle change in tone that can only be measured with equipments. The distortion gets more intense as the value is increased.

8 Wow/Flutter Rate

Value: 0–100

The wavering becomes more rapid the higher the Wow/Flutter rate is set.

MEMO

- The wavering of multiple pitches that appears from tape wear and irregularities in rotation is called wow and flutter. (This phenomenon is called “wow” when its occurs at slow rotation speeds, and “flutter” when the tape is run quickly.)

9 Wow/Flutter Depth

Value: 0–100

The wavering deepens as the Wow/Flutter depth setting is increased.

10 Direct Level

Value: 0–100

Sets the volume of the source sound.

MEMO

- Since the RE-201 SPACE ECHO has been released in 1974, a great number of fans are still using. This algorithm faithfully reproduces the sound of the original unit’s tape echo section based on the real unit and the data when it was developed. What’s more, it includes settings to express the sway caused by the motor, distortion, and panning for each of the three heads (something the original lacked). Now, you can easily get this warm, Lo-Fi echo sound, something different than the clear sound of today’s digital delays. You can change the repeat rate (tape speed) with the Realtime Effects knobs, and enjoy the realistic feeling of operating this vintage device.

Effect Block

10 High Damp Gain

Value: -36–0 dB

Sets the degree of the High Damp.

MEMO

- You can combine Low Damp and High Damp to elicit qualities such as the room's wall material (and sound absorbency thereof).

11 Feedback

Value: 0–100

Sets the repeat times for the delay sound. When set to 0, each delayed sound is played only once.

NOTE

- Increasing the value too highly may cause oscillation in the sound.

12 Direct Level

Value: 0–100

Sets the volume of the source sound.

Effect Block

11 High Damp Gain

Value: -36–0 dB

Sets the degree of the High Damp.

12 Feedback Level

Value: 0–100

Sets the repeat time for the delay sound. When set to 0, each delayed sound is played only once.

NOTE

- Increasing the value too highly may cause oscillation in the sound.

13 Direct Level

Value: 0–100

Sets the volume of the source sound.

Normally, you can really grasp the RSS effect by setting the monaural delay level to 0. With the L-R shift set to 0 (no shift), the RSS effect may be difficult to hear. The points to be aware of when synchronizing the delay to the song's tempo are the same as those in algorithm 06 EZ Delay (p. 25).

RSS (Roland Sound Space) is a special effects technology that allows you to play three-dimensional sounds with ordinary stereo speakers. RSS technology is used, in part, in this algorithm, which gives you the effect of having the sound placed right on either side of you (outside the field defined by the left and right speakers). (Some of Roland effects processors with dedicated RSS installed, you can freely control the direction, whether above, below, or behind, as well as the distance, near or far, that the sound apparently comes from.)

To have the RSS effect exhibited to the fullest extent, take note of the following points.

- It works best in rooms with little reverberation.
- Single-way speakers are most appropriate. Furthermore, coaxial or virtual coaxial speakers are also acceptable.
- On the sides, keep speakers as far away from walls as possible.
- Do not separate the left and right speakers too much.
- Listen from the optimal position, as shown below.



For Stereo Speakers

This sound is made to be played specifically through speakers. The proper effect cannot be obtained if listened to through headphones.

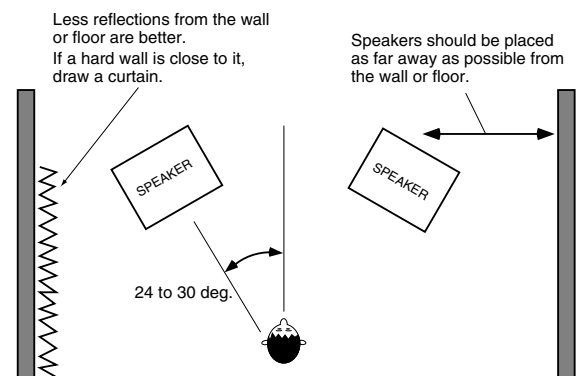

08 Analog Delay & Chorus

Delay (Virtual Analog Delay)

This effect simulates the compact analog delays used for guitars in the 1980s. This imparts the analog delay's characteristic mood, giving you that soft, velvety sound.

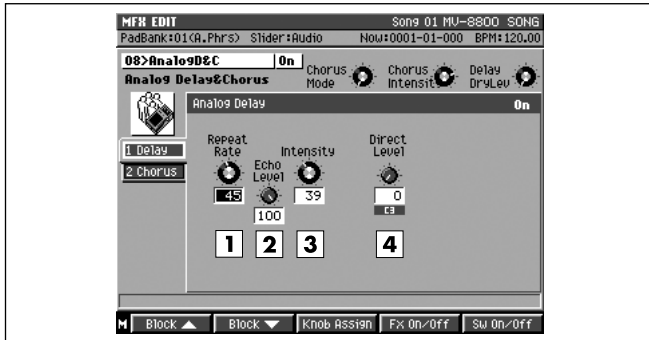

1 Repeat Rate

Value: 0–100

This corresponds to the delay time in a current delay effects unit. The higher the value selected, the shorter the interval of the delay sound.

2 Echo Level

Value: 0–100

Sets the volume of the delay sound.

3 Intensity

Value: 0–100

Sets the repeat time of the delayed sound. This is analogous to a current delay effect's feedback setting. Raising this value increases the number of repeats.

4 Direct Level

Value: 0–100

Sets the volume of the source sound.

MEMO

- This reproduces such parameters as the frequency response of the BOSS compact analog echo in the middle 80's. As it simulates the limitation of the performance of "BBD (analog IC)" as well, delay times are shorter than with other delay effects. Although the actual unit had no direct level setting, it is included in this algorithm in the interests of convenience.

Chorus (Virtual Analog Chorus)

This algorithm reproduces the sound of the BOSS CE-1 Chorus Ensemble. It adds a vibrating effect and breadth to the source sound.

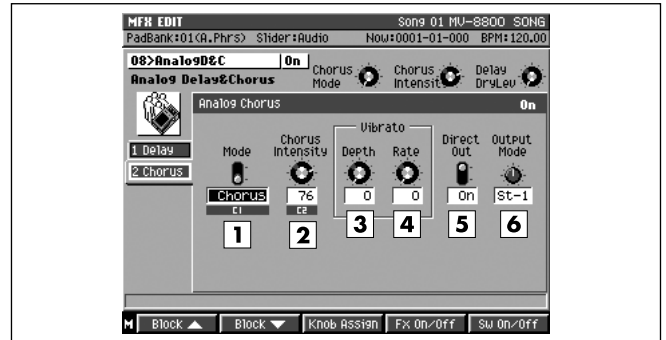

1 Mode (CE Mode)

Value: Chorus, Vibrato

This switches the sound between chorus and vibrato modes.

MEMO

- This algorithm faithfully reproduces the sound of the original CE-1 based on the specifications when it was developed. In Chorus mode (Chorus), you can get the effect of pitch vibrato chorus added to the source sound. In Vibrato mode (Vibrato), the waveform and rate of the wavering of the pitch differ from those of chorus. (Although later BOSS vibrato effects do not mix in the source sound, the CE-1 mixed the source sound when switched to vibrato as well.)

2 Chorus Intensity

Value: 0–100

When CE Mode is Chorus, this sets the pitch vibrato speed.

3 Vibrato Depth

Value: 0–100

When CE Mode is Vibrato, this sets the pitch vibrato depth.

4 Vibrato Rate

Value: 0–100

When CE Mode is Vibrato, this sets the pitch vibrato speed.

5 Direct Out

Value: Off, On

This switch determines whether or not the source sound (although monaural) is mixed in. On the original CE-1 this was fixed at On.

Effect Block

6 Output Mode

This switches the output format (mono/stereo). This includes two different stereo settings.

Value	Explanation
Mono	Output is monaural.
St-1(Stereo-1)	Chorus sound of the pitch vibration which phase is inverted between left and right is mixed with the source sound. This is a broader chorus, with a weaker feeling of placement.
St-2(Stereo-2)	The left output contains the source sound, and the right side has the wavering chorus sound.

MEMO

- The output mode was added to a later model, the CE-3. (The sounds of the CE-1 are reproduced by “Mono” and “St-1.”)

09 Digital Chorus

Chorus (Digital Chorus)

This effect gives the sound spatial breadth while adding vibrato.

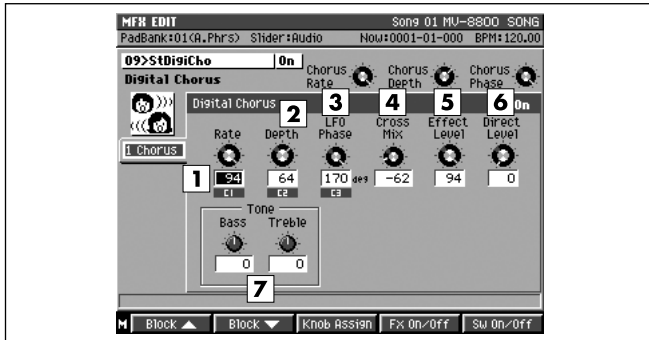

1 Rate

Value: 0–100

Sets the rate of the pitch vibrato.

2 Depth

Value: 0–100

Sets the depth of the pitch vibrato.

3 LFO Phase

Value: 0–180 deg

Sets the degrees of left and right phase shift in the Low Frequency Oscillator (LFO) that produces the pitch vibrato (see MEMO).

MEMO

- When setting the LFO phase, you can shift the timing of the rising and falling of the pitch in the left and right chorus sound. At 0 deg. (0 degree), the left and right pitches rise and fall together. At 180 degrees, they are completely opposite. Setting a slight shift, especially with monaural input, brings out the broadening effect.

4 Cross Mix

Value: -100–100

This inputs the left chorus sound into the right channel, and the right side chorus into the left, thereby creating a greater sense of breadth.

The plus setting makes the chorus sound return in normal phase, and the minus setting makes it return in inverted phase.

MEMO

- By setting a negative value for the Cross Mix as a “hidden flavor,” you can get stereo chorus that features a particular floating sensation.

5 Effect Level

Value: 0–100

Sets the volume of the chorus sound. This is ordinarily set to 100.

6 Direct Level

Value: 0–100

Sets the volume of the source sound.

7 Bass/Treble

Value: -100–100

These are the chorus bass and treble settings. When set to 0, they make no change to the sound.

10 4 Button Chorus 320

Chorus (4 Button Chorus: Virtual SDD-320)

This effect creates spatial breadth.

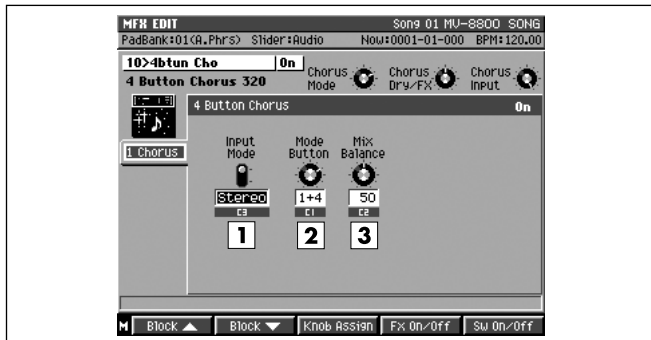

1 Input

Value: Mono, Stereo

This setting determines whether stereo source sound is converted to mono (Mono) or left as is (Stereo). (On the SDD-320, this was accomplished with the input jack connections.)

2 Mode Button

Value: 1–4, 1+4, 2+4, 3+4

The SDD-320 features four mode buttons for changing the effect. This setting determines which buttons are to be pressed. (“1+4” represents the condition when Buttons 1 and 4 are pressed simultaneously.)

3 Mix Balance

Value: 0–100

Sets the volume balance between the source sound and the effect sound. A setting of 50 gives you the same balance as that of the SDD-320. At 0 only the source sound is output, at 100 only the effect.

MEMO

- This effect changes subtly depending on the mode button settings. Try out each mode and select the most suitable one.
- The Roland SDD-320, released in 1979 and produced for eight years, was an remarkable analog effect that added spatial breadth. The panel featured only five buttons (four mode buttons and an OFF button), that allowed the user to switch the effects. Although a chorus-type effect, its special feature was the natural-sounding breadth it got without the heavy vibrato. This model still has a great number of fans like remix artist, and so on.

13 Stereo Pitch Shifter

Pitch (Stereo pitch shifter)

This effect changes the pitch of the source sound. The degrees of pitch shift can be set separately for each channel.

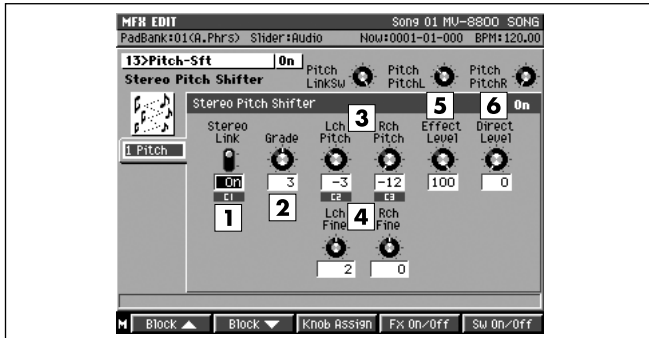

1 Stereo Link

Value: Off, On

This selects whether the pitch shift in left and right channels are to be linked or set independently. When set to “ON,” the right channel pitch shifter settings conform to those set for the left channel.

2 Grade

Value: 1, 2, 3, 4, 5

Sets the grade of the effect sound. The higher the value is set, the more natural-sounding can be obtained; however, this increases the delay from the source sound as well. Depending on the setting, you may be able to hear some disruption of drums and other parts, so select the suitable setting after listening to the sound at different settings.

3 Lch Pitch/Rch Pitch (Left/Right Channel Pitch)

Value: -12–12

These set the degrees of left and right pitch shift. You can adjust the pitch shift in semitones.

4 Lch Fine/Rch Fine (Left/Right Channel Fine Pitch)

Value: -100–100

These set the degrees of left and right pitch shift. You can adjust the pitch shift in cents (1/100 of a semitone) for minute adjustment of the pitch shift.

MEMO

- When Stereo Link is on, changes to the right channel settings are ignored.

5 Effect Level

Value: 0–100

Sets the volume of the effect.

6 Direct Level

Value: 0–100

Sets the volume of the source sound.

MEMO

- When simply changing the pitch of the source sound, set the direct level to 0.

14 80s Phaser

Phaser (Stereo Phaser)

This effect features two linked monaural phasers arranged in parallel.

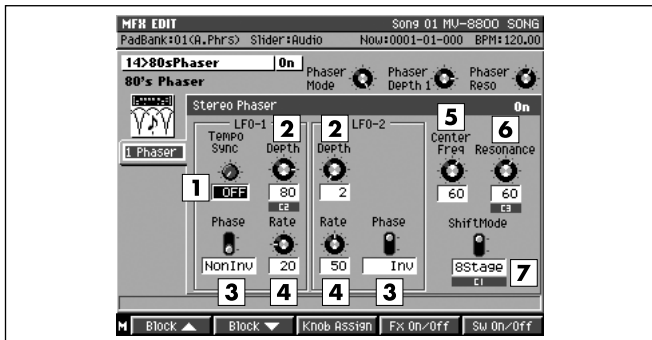

1 Tempo Sync

Value: OFF, ♪3, ♪, ♪♩, ♪3, ♪, ♪., ♪3, ♪, ♪., ♪3, ♪, ♪., ♪3, ♪, ♪.,

Set this when synchronizing the LFO1 Rate setting to the song tempo. When not synchronizing, set this "OFF." When you select the note, the LFO1 Rate setting is disabled, and the LFO1 Rate is set the note length corresponding to the song tempo.

MEMO

- If the length of the note is set longer (or shorter) than that of the possible range of the Rate settings by the change of song tempo, the Rate can not correspond to the note length. If "?" appears before the note symbol you set, it is because the upper (or lower) limit of the setting range has been exceeded, and that the synchronization is not correct. Furthermore, the precision of the Rate setting and song tempo differ. If left to develop over long periods, the two may gradually drift apart.

2 Depth

Value: 0–100

Sets the depth of the swelling sound.

3 Phase

Value: NonInv, Inv

Sets the phase of both left and right swelling. When set to "Normal" (NonInv), both are same phase; when set to "Invert" (Inv), the phase of right channel is inverted.

4 Rate

Value: 0–100

Sets the rate of the swelling sound. When Tempo Sync is active, this is not effective, and you cannot make this setting.

MEMO

- These are the LFO2 settings. The functions of these parameters are the same as those for LFO1 (however, there is no Tempo Sync function).

5 Center Freq

Value: 0–100

Sets the center frequency to which the phaser effect is applied. Increasing this value moves the effect point of the phaser into higher frequency ranges.

6 Resonance

Value: 0–100

Increasing this value gives a more distinctive sound to the effect.

NOTE

- Setting the Resonance value too high may result in extreme oscillation. Take care to prevent this sound from damaging your ears or your playback equipment.

7 Shift Mode

Value: 4Stage, 8Stage

This sets the number of stages in the pitch shift circuit (four (4STG) or eight (8STG)). Setting this to eight stages (8STG) increases the number of the frequency points that sound is canceled, giving a sharper effect.

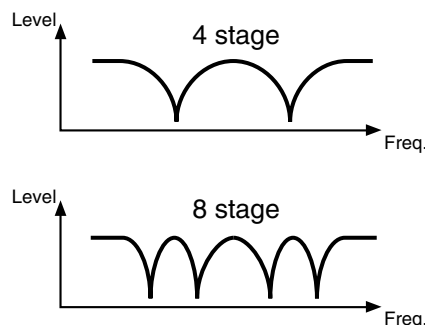

MEMO

- This algorithm reproduces the sound of the 2U rack-mount phasers of the early 1980s. Two monaural single-input, single output phasers are arranged in parallel. Two oscillators (LFO) which create the swelling sound installed into each phaser, allowing the creation of complex modulation patterns. The rates of the swelling sounds from LFO1 and LFO2 differ. LFO1 creates an extremely slow modulation, whereas that of LFO2 is faster. You can set the phase of each one independently, and by creating a large swell with LFO1 and a very short wavering with the phase inverted in LFO2, you can give the sound a feeling of great breadth.

16 Stereo Distortion

Distort (Stereo Distortion)

This is a virtual analog distortion that reproduces the sound of compact effects for guitars.

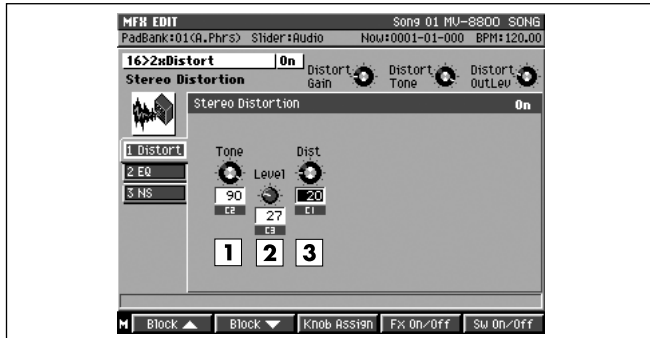

1 Tone

Value: 0–100

This adjusts the brightness of the sound. When this value is set high, the distortion is loud and bright.

2 Level

Value: 0–100

Sets the output volume. Distortion also increases the volume levels; you can use this parameter to control it.

3 Dist

Value: 0–100

Sets the degree of distortion. At the source sound with low volume levels, there may be no distortion, even with the value increased.

MEMO

- Two distortion units are linked and arranged in parallel (left and right) to make the algorithm stereo compatible. If you can't adjust the tone enough with the Tone control, use the equalizer at the next stage.

Other effect blocks



- EQ (3 Band EQ) (p. 18)
- NS (Noise Suppressor) (p. 21)

17 Phonograph

Phono (Phonograph)

This effect is like the sound of an analog record being played.

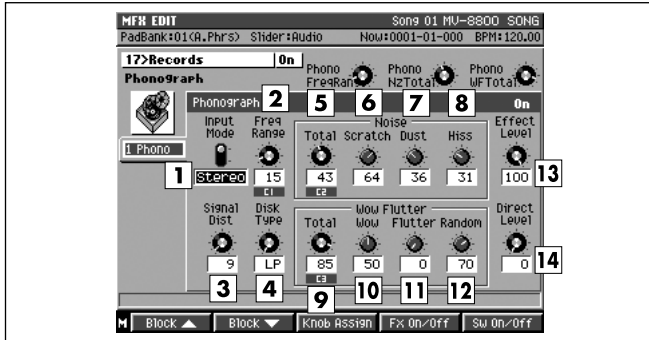

- 1 Input Mode**
Value: Mono, Stereo
Use this setting to select either a stereo or monaural record player for the effect.
- 2 Freq.Range**
Value: 0–100
Sets the frequency response of the record player. Lowering the value degrades the frequency characteristics, making the sound resemble that from an older system.
- 3 Signal Dist (Signal Distortion)**
Value: 0–100
Sets the degree of distortion. The higher the value is set, the more the sound is distorted.
- 4 Disk Type**
Sets the turntable rotation speed. This influences the cycles of scratches and noises being played.
- | Value | Explanation |
|-------|---------------|
| LP: | 33 1/3 r.p.m. |
| EP: | 45 r.p.m. |
| SP: | 78 r.p.m. |
- 5 Noise Total**
Value: 0–100
Total noise level.
- 6 Scratch**
Value: 0–100
Scratches on the record.
- 7 Dust**
Value: 0–100
Dust on the record.
- 8 Hiss**
Value: 0–100
Continuous hissing noise.
These settings add the typical record's noise. The noises increase as the values are raised. Set each of the Scratch, Dust, and Hiss noise levels to get a balance, the adjust the overall amount of noise with the Total Noise Level control.
- 9 Wow Flutter Total**
Value: 0–100
Total wow and flutter.
- 10 Wow**
Value: 0–100
Wow, long cycle rotational irregularity.
- 11 Flutter**
Value: 0–100
Flutter, short cycle rotational irregularity.
- 12 Random**
Value: 0–100
Random rotational irregularity.
These settings determine the rotational irregularities of the record player. Set each of the Wow, Flutter, and Random levels to get a balance, the adjust the overall depth of the effect with the Total Wow/Flutter control.
- 13 Effect Level**
Value: 0–100
Sets the volume of the effect sound. It is ordinarily set to 100.
- 14 Direct Level**
Value: 0–100
Sets the volume of the source sound. It is ordinarily set to 0. Raise this when you want to mix the source sound.

MEMO

- When reproducing the sound of old records such as SPs, you can make it sound more realistic by setting Input to "Mono." This effect continues to make the noises during the "record's silent parts." To quickly stop making this noise, press [F4](FX ON/OFF) to turn off the effect.

18 Radio Modeling

Radio (AM radio modeling)

This effect makes it sound like the source sound is being played from an AM radio.

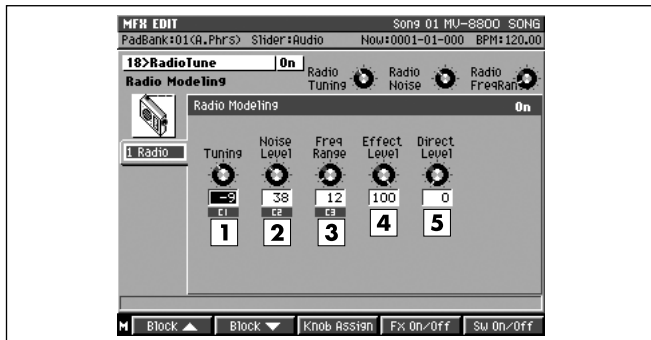

1 Tuning

Value: -50—+50

This setting adjusts the degree of noise that occurs when tuning a radio. A setting of 0 corresponds to exact tuning.

2 Noise Level

Value: 0–100

Sets the noise level.

3 Freq Range

Value: 0–100

Sets the frequency response of the radio. Lowering the value worsens the frequency characteristics, making the sound appear to be coming from a tiny radio speaker.

4 Effect Level

Value: 0–100

Sets the volume of the effect sound. It is ordinarily set to 100.

5 Direct Level

Value: 0–100

Sets the volume of the source sound. It is ordinarily set to 0. Raise this when you want to mix the source sound.

MEMO

- At any Noise Level setting beside 0, the radio noise continues even when there is no source sound.

NOTE

- Regarding the effect's algorithms for producing sounds, the following two effects algorithms include functions for synthesizing radio, record, and other such noises.

- 17 Phonograph
- 18 Radio Modeling

Note the following points when using effects with these parameters inserted only on specific tracks.

- If the phrase group levels (Screen Guide; p. 153) on tracks with the effect inserted are set individually to different levels, the level for the effect sound (noise) produced by the effect will also change accordingly. If this procedure creates any problems, try a workaround, such as by resampling to separate tracks and setting all phrase levels to 100.

19 Lo-Fi Processor

BitRate (Bit/Rate Down)

This algorithm changes the bit rate and sampling rate of the source sound to produce the lo-fi sound of the first generation of digital samplers. Arranged serially after Bit/Rate Down are a filter that alters the tone and a noise suppressor.

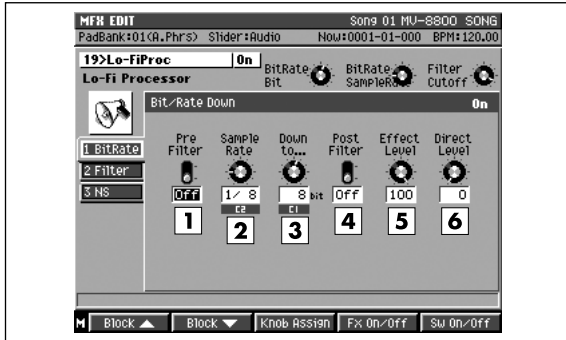

1 Pre Filter (Pre-Process Filter)

Value: Off, On

This is the switch of the filter placed before the Lo-Fi processing. When set “ON,” this suppresses the digital distortion by lowering sample rates.

2 Sample Rate

Value: Thru, 1/2–1/32

Sets the fraction of current sample rates to be used for processing. You set the Sample Rate parameter to “Thru” if no change is desired.

3 Down to...

Value: 16–1 bit

This setting is for reducing the bit count. When this is set to 16 bit, the bit count currently used is preserved.

4 Post Filter (Post-Process Filter)

Value: Off, On

This is the switch of the filter placed after the Lo-Fi processing. Like the pre-process filter. When set “ON,” this suppresses the digital distortion by lowering sample rates.

5 Effect Level

Value: 0–100

Sets the volume of the effect sound. It is ordinarily set to 100.

6 Direct Level

Value: 0–100

Sets the volume of the source sound. It is ordinarily set to 0. Raise this when you want to mix the source sound.

MEMO

- Both the pre-process and post-process filters are necessary components in general digital sound processing. These allow the suppression of digital distortion that occurs when the sample rate is lowered, or to allow distortion when turned off.
- Lo-Fi is a term derived from and opposite in meaning to Hi-Fi (high fidelity, i.e., reproduced sound that is extremely close to the original sound). Lo-Fi processing methods that “degrade sounds in a cool way” are currently often used with dance music.

Other effect blocks



- Filter (p. 16)
- NS (Noise Suppressor) (p. 21)

20 Guitar Multi

Comp (Comp/Sustainer)

This effect compresses the level of the signal by reducing the level of strong input signals and boosting low-level signals.

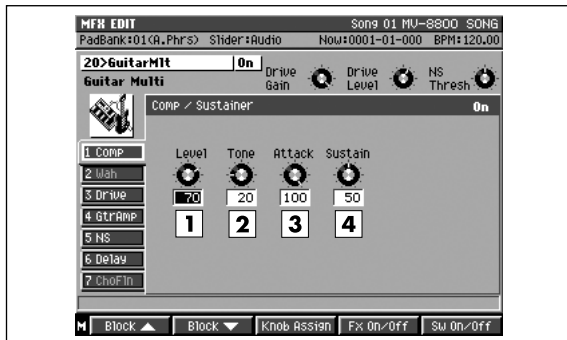

- 1 Output Level**
Value: 0–100
This adjusts the Compressor volume level.
- 2 Tone**
Value: 0–100
This adjusts the compressor tone.
- 3 Attack**
Value: 0–100
This adjusts the attack strength when the sound is input.
- 4 Sustain**
Value: 0–100
This adjusts the length of time that the compressor continues to raise and hold the level of weak input.

Wah (Auto Wah)

Wah is an effect created by the periodic change in a filter's frequency characteristics, giving a particular kind of tone change. You can get the wah effect by changing the volume of the input sound or by using cyclical time-based changes.

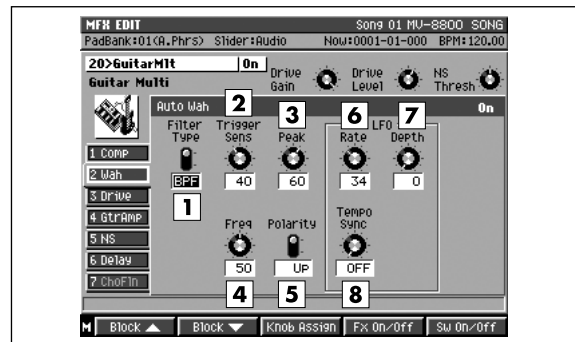

- 1 Filter Type**
Value: LPF, BPF
When set to BPF, the wah effect occurs within a narrow frequency range; setting this to LPF produces the wah effect over a wide range of frequencies.
- 2 Trigger Sens**
Value: 0–100
Sets the sensitivity level when wah is added through changes in the source sound volume. The wah effect is added at lower volumes as the volume increases. Set this to 0 if the wah effect is not to be added in response to changes in the volume of the input sound.
- 3 Peak**
Value: 0–100
This sets the amount of wah effect near the reference frequency. The range narrows as the value increases; lower the value to get the wah effect over a wider range.
- 4 Freq**
Value: 0–100
This sets the reference frequency for the wah effect (the frequency at which the wah starts).
- 5 Polarity**
Value: Down, Up
When the wah effect is added through changes in the source sound volume, this setting is for selecting whether the effect is to be added to the high frequencies (Up) or lower frequencies (Down).

4 Feedback Level

Value: 0–100

Sets the repeat times for the delay sound. When set to 0, each delayed sound is played only once. (if the Mode is “Alternate” (Alt), delayed sound in each channel are played only once.)

NOTE

- Increasing the value too highly may cause oscillation in the sound.

5 Effect Level

Value: 0–100

Sets the volume of the delay sound. Adjust this after getting a balance with the direct level.

6 Direct Level

Value: 0–100

Sets the volume of the source sound. It is ordinarily set to 100

MEMO

- The effect is abbreviated as “Delay” in the screen. Although the algorithm is similar to that of “06 EZ Delay”, functions are simplified, for example with the omission of High and Low Damp. Long delays of up to a maximum of 2.4 seconds are available in Monaural mode.

ChoFln (Chorus/Flanger)

This provides you with chorus or flanger effects to suit your needs. Chorus is an effect that adds breadth and fullness to the sound. The flanger gives you effect that is like a jet sound rising and falling.

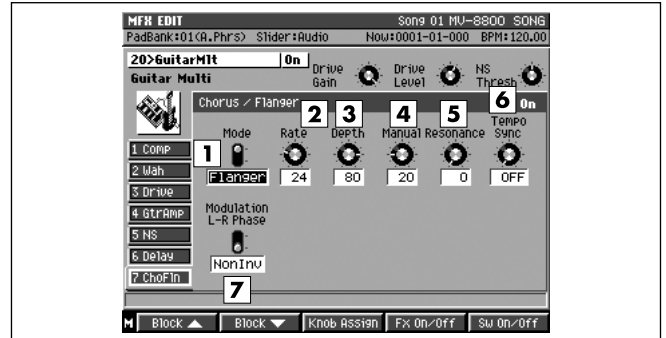
**1 Mode**

Value: Chorus, Flanger

This selects either the chorus or the flanger.

2 Rate

Value: 0–100

This sets the chorus or flanger modulation cycle time. This has no effect and cannot be set when Tempo Sync is in use.

3 Depth

Value: 0–100

This sets the chorus or flanger modulation depth.

4 Manual

Value: 0–100

When the effect mode is set to Flanger, this control sets the center frequency to which the effect is applied. The pitch of the flanger effect’s metallic sound is changed. This is disabled when set to Chorus mode.













5 Resonance

Value: 0–100

This sets the amount of reinforcement of the flanger effect. This setting is disabled when set to Chorus mode.

Effect Block

6 Tempo Sync

Value: OFF, , , , , , , , , , , , , ,
○ x1 – ○ x4

Set this when synchronizing the Rate setting to the song tempo. When not synchronizing, set this “OFF.” When you select the note, the Rate setting is disabled, and the Rate is set the note length corresponding to the song tempo.

MEMO

- If the length of the note is set longer (or shorter) than that of the possible range of the Rate settings by the change of song tempo, the Rate can not correspond to the note length. If “?” appears before the note symbol you set, it is because the upper (or lower) limit of the setting range has been exceeded, and that the synchronization is not correct. Furthermore, the precision of the Rate setting and song tempo differ. If left to develop over long periods, the two may gradually drift apart.

7 Modulation L-R Phase

Value: NonInv, Inv

This sets the phase when the chorus or flanger sound is mixed in with the source sound in the left and right channels. When this is set to NORM, the channels are in phase; when set to INV (inverted), the phases of left and right channels are inverted relative to each other.

Other effect blocks



- NS (Noise Suppressor) (p. 21)

21 Vocal Multi

LimDes (Limiter/De-esser)

You can use either the Limiter or De-esser functions of this effect. The limiter is an effect that compresses high-level signals, thereby preventing distortion. De-esser is an effect that cuts the sibilance in vocals, giving sounds a softer quality.

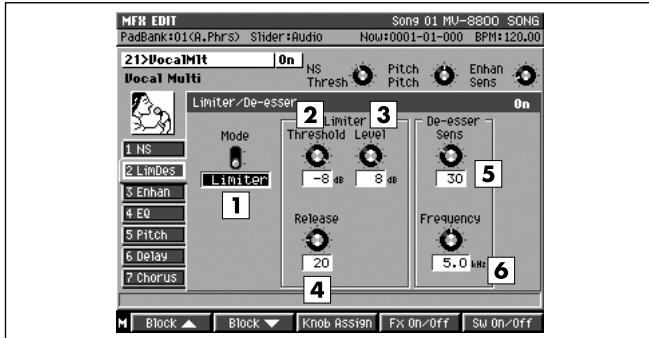

- 1 Mode**
Value: Limiter, De-esser
This determines whether the Limiter or De-esser function is used.
- 2 Limiter Threshold**
Value: -60–0 dB
This adjusts the level of the signal at which the Limiter begins to function (the threshold level).
- 3 Limiter Level**
Value: -60–12 dB
This sets the level of the signal passing through the Limiter.
- 4 Limiter Release**
Value: 0–100
This adjusts the time for the Limiter to stop functioning after the signal falls back under the threshold level.
- 5 De-esser Sens**
Value: 0–100
This adjusts the sensitivity of the de-esser effect based on the input level.
- 6 De-esser Frequency**
Value: 1.0–10.0 kHz
This adjusts the frequency to which the De-esser effect is applied. The effect works best at higher frequencies than that of the settings.

Pitch (Pitch Shifter)

This effect changes the pitch of the source sound.

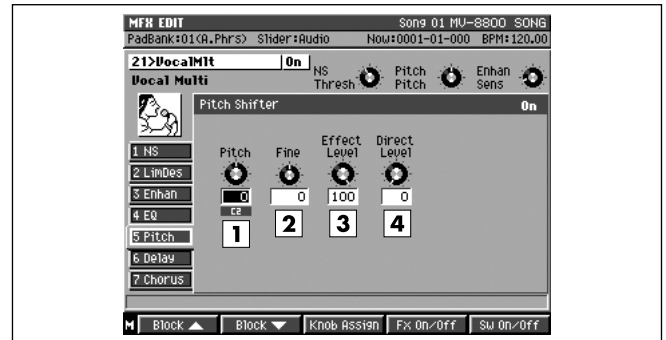

- 1 Pitch**
Value: -12–12
This adjusts the pitch in semitone (half-step) increments.
- 2 Fine**
Value: -100–100
This finely adjusts the pitch shift.
- 3 Effect Level**
Value: 0–100
This sets the volume of the pitch-shifted sound.
- 4 Direct Level**
Value: 0–100
This sets the volume of the direct sound.

Chorus

This effect adds breadth to the sound, making it “fatter.”

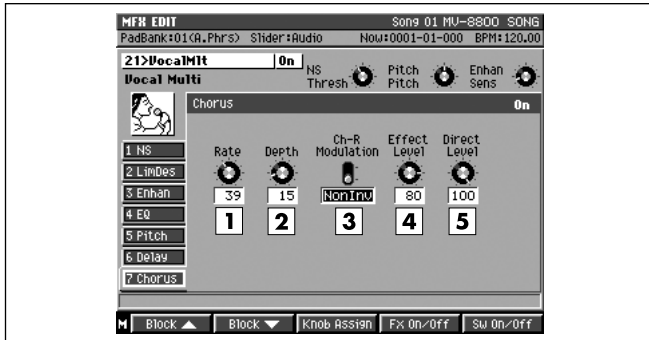

1 Rate

Value: 0–100

This sets the chorus modulation cycle time.

2 Depth

Value: 0–100

This sets the chorus modulation depth.

3 Ch-R Modulation (Right Channel Modulation Phase)

Value: NonInv, Inv

This is ordinarily set to NonInv. When set to Inv (Invert), the modulation (rising and falling sound) in the right channel is inverted against the left channel. This gives an effect in which the modulation in the left and right channels is reversed.

4 Effect Level (Effect Level)

Value: 0–100

This adjusts the chorus volume level.

5 Direct Level

Value: 0–100

This adjusts the volume level of the direct sound.

Other effect blocks



- NS (Noise Suppressor) (p. 21)
- Enhan (Enhancer) (p. 20)
- EQ (3 Band EQ) (p. 18)
- Delay (p. 44)

22 Voice Transformer

V.Trns (Voice Transformer)

This effect, by controlling the keynote (root tone) and the formant independently, lets you create a variety of voice characteristics.

- When inputting vocal sounds, do so for only one person at a time. The effect does not function properly with multiple voice input.
- Do not let the vocals from speakers enter the mic. This is the same as using multiple voices, so the effect does not function properly.
- We recommend using a unidirectional mic. Additionally, be sure to speak as closely to the mic as possible.

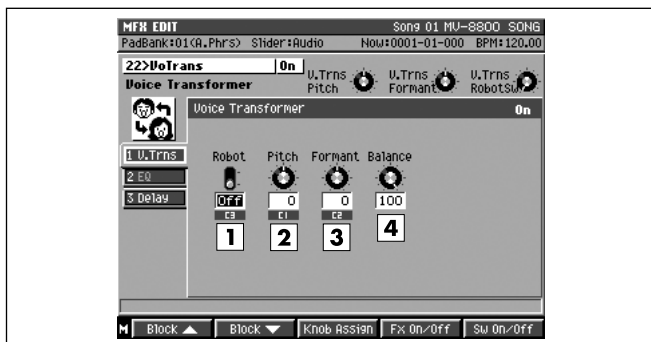

1 Robot (Robot Switch)

Value: Off, On

This switches the Robot function on and off. When this is switched on, all sounds are output at the same pitch, regardless of the input pitch, resulting in vocal sounds without any intonation.

2 Pitch

Value: -63–63

This adjusts the voice character pitch.

3 Formant

Value: -63–63

This adjusts the voice character formant.

4 Balance

Value: 0–100

The adjusts the volume balance of the voice character sound and the regular vocal sound.

Other effect blocks



- EQ (3 Band EQ) (p. 18)
- Delay (p. 44)

23 Mic Modeling

Link (Mic. Modeling Link)

This is the link switch for Channels A and B.

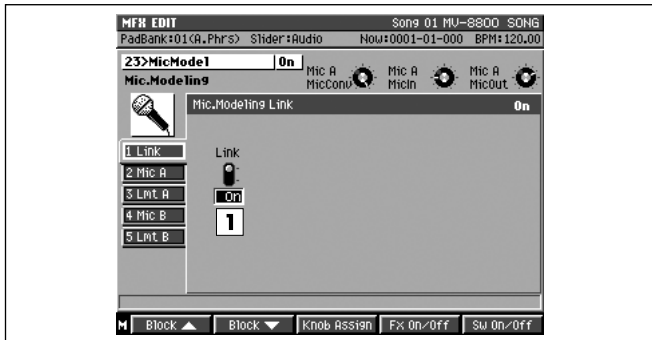

1 Link (Link Switch)

Value: Off, On

When set to Off, each of the two channels works independently as a mono channel equalizer. When set to On, both equalizer channels work simultaneously on Channel A. (The Channel B settings are disregarded.)

Mic (Mic Modeling)

This effect converts the characteristics of inexpensive, all-purpose mics to those of expensive, studio-quality mics (microphone → microphone conversion). It makes signals that have already been recorded in your Project sound as if the changes in sound quality were made through mic selection and placement. This also adds characteristics of microphones to instrument sounds recorded through line input (line → microphone conversion).

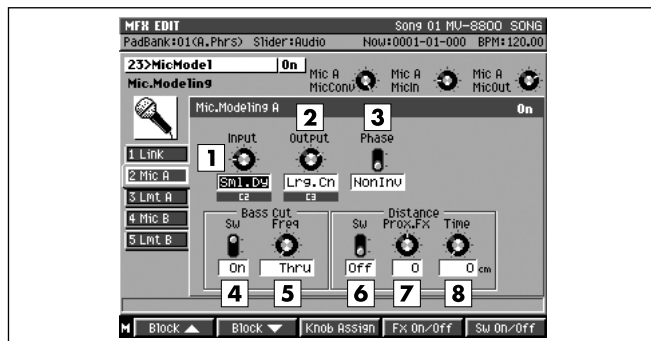

1 Input

This selects the mic used for recording.

Value	The type of mic to be used for recording
DR-20	Roland DR-20 (dynamic mic manufactured by Roland)
Sml.Dy	Small dynamic mic used for miking instruments, vocals, and the like
Hed.Dy	Headset-type dynamic mic
Min.Cn	Mini condenser mic
Flat	Line input
C3000B	AKG C3000B (condenser mic manufactured by AKG)

2 Output

This sets the mic to be modeled.

Value	he type of mic modeling
Sml.Dy	Dynamic mic for general use with instruments and vocals. Perfect for guitar amps and snare drums.
Voc.Dy	Dynamic mic especially known for use with vocals. Features exceptional midrange presence. For vocals.
Lrg.Dy	Dynamic mic with extended low range. For bass drums, toms, and similar applications.
Sml.Cn	Small condenser mic for use with instruments. Features a particularly fine high range. For use with metal percussion instruments and acoustic guitars.
Lrg.Cn	Flat-response condenser mic. For vocals, narration, live instruments, and the like.
Vnt.Cn	Vintage condenser mic. For vocals, instruments, and the like.
Flat	Mic with flat frequency response characteristics. Use this when you want the sound of a mic used for miking larger groups.

MEMO

- If you've set the Input parameter to "Min.Cn," the only choices for the Output parameter will be "Sml.Cn" and "Lrg.Cn".
- When a condenser-type mic is selected in TypeOut, low-range noise transmitted through the mic stand may be accentuated due to the mic's low range characteristics. In such instances, either cut out any unnecessary low end with bass cut filter, or equip the mic stand with an isolation mount (a mic holder with rubber or other shock absorbing material).

3 Phase

This selects the mic phase.

Value	Explanation
NonInv	In phase to the input.
Inv	Invented phase to the input.

4 Bass Cut Sw (Bass Cut Filter Switch)

Value: Off, On

This filter cuts out popping and other such noises as well as unneeded low end sounds. Switching this on creates a simulated bass cut filter. When turned off, the Freq setting is disabled.

5 Bass Cut Freq (Frequency)

Value: Thru, 20–2000 Hz

This adjusts the bass cut filter's cutoff frequency.

6 Distance Sw

Value: Off, On

Microphones tend to accentuate the low end the closer they are placed to the source sound. This is known as the proximity effect. Switching on this effect simulates frequency characteristics and timing differences that change with distance. When turned off, the ProxFx, Interval settings are disabled.

7 Prox.Fx (Proximity Effect)

Value: -12–12

Microphones tend to accentuate the low end the closer they are placed to the source sound. This effect simulates those qualities, and compensates for the low end characteristics that change with distance. Positive settings bring the mic closer to the source, and negative settings put the mic at a greater distance.

8 Time

Value: 0–3000 cm

This simulates the time difference that changes with distance from the source.

Lmt (Mic. Modeling Limiter)

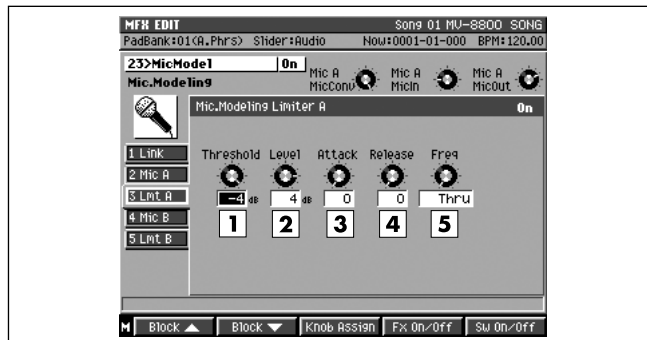

1 Threshold

Value: -60–0 dB

This sets the volume level at which the Limiter begins to work.

2 Output Level

Value: -60–24 dB

This sets the Limiter's output level.

3 Attack

Value: 0–100

This sets the time for the Limiter to begin working after the input level exceeds the threshold level.

4 Release

Value: 0–100

This sets the time for the effect to stop after the sound falls back under the threshold level.

5 Freq (Frequency)

Value: Thru, 20–2000 Hz

This adjusts the level detector cutoff frequency.

24 10 Band Vocoder

Vocodr

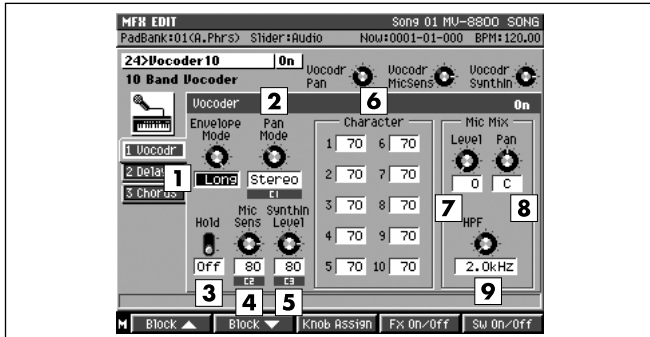

1 Envelope Mode

This setting determines the sound characteristics.

Each sound has its own unique envelope. This is what gives sounds their characteristic qualities. In distinguishing one sound from another, it is often the envelope of a sound that gives us one of our greatest clues.

Value	Explanation
Sharp:	The human voice will be emphasized.
Soft:	The instrumental sound will be emphasized.
Long:	A vintage sound with long decay will be produced.

2 Pan Mode

This determines how the vocoder's sound is positioned.

Value	Explanation
Mono	the components of each frequency band will be located in the center
Stereo	the odd-numbered frequency bands will be located at the left, and the even-numbered components at the right.
L >> R	the low frequency bands will be located increasingly toward the left, and the high frequency bands will be located increasingly toward the right.
R << L	the low frequency bands will be located increasingly toward the right, and the high frequency bands will be located increasingly toward the left.

3 Hold

Value: Off, On

This setting fixes the formants (p. 49) and determines whether or not the instrument sound is played.

This allows you to play instrument sounds with the same vocal formants as those of the sound input via the mic. If you set the Hold parameter to On and, for example, speak into the mic (e.g., "A-E-I-O-U"), the instrument sound is then played using the same formants as that in the Hold data received the instant the "E" is input.

4 Mic Sens.

Value:0–100

Adjust the input sensitivity of the mic.

5 SynthIn Level

Value:0–100

Adjust the input level of the instrument.

MEMO

- When using this, input the mic to the L channel and the instrument to the R channel.

6 Character 1-10

Value: 0–100

Adjust the volume of each frequency band. This setting adjusts the tone of the vocoder.

MEMO

- The central frequency bands for each channel are as shown below.

- Ch1 = 100.0 [Hz]
- Ch2 = 166.8 [Hz]
- Ch3 = 278.3 [Hz]
- Ch4 = 464.2 [Hz]
- Ch5 = 774.3 [Hz]
- Ch6 = 1.292 [kHz]
- Ch7 = 2.154 [kHz]
- Ch8 = 3.594 [kHz]
- Ch9 = 5.995 [kHz]
- Ch10 = 10.00 [kHz]

7 Mic Mix Level

Value: 0–100

Adjust the amount of the mic audio (L channel input) which has passed through the mic HPF that will be added to the output of the vocoder.

8 Mic Mix Pan

Value: L63–R63

Adjust the panning of the mic audio.

9 MicMix HPF

Value: Thru, 1.0–20.0 kHz

This adjusts the frequency at which the high pass filter (HPF) will begin to affect the mic audio.

With a setting of Thru, the HPF will not be applied.

25 Analog Modeling Bass

Common (Synth Common)

These are parameters related to overall control of the synthesizer.

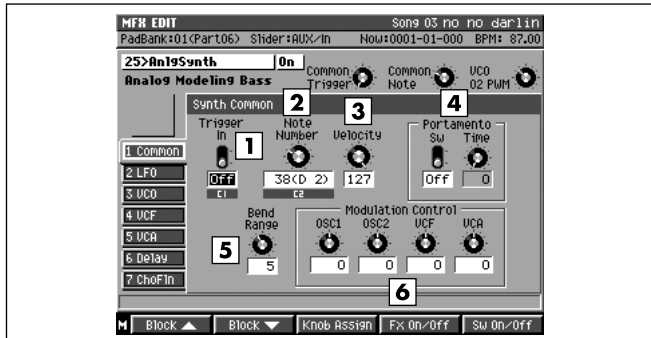

1 Trigger In

Value: Off, On

This turns the synthesizer sound on and Off. Setting this from “Off” to “On” corresponds to pressing a key on the keyboard.

2 Note Number

Value: 0 (C-1)–127 (G 9)

Sets which key is pressed (note number) and the strength or force at pressing key (velocity).

NOTE

- Near the upper and lower note number limits, pitches may not change, or the changes may be unstable (this changes with the conditions in each of the parameter settings).

3 Velocity

Value: 0–127

This sets the emphasis applied to sounds that are played in response to the force used in playing the keys (the velocity).

4 Portamento

• Sw (Switch)

Value: Off, On

This turns on and Off the portamento effect (the smooth gliding of the synthesizer sound from one pitch to another).

• Time (Portamento Time)

Value: 0–100

Sets the transition time for the portamento effect to change pitches. The elapsed time increases as the value is increased.

5 Bend Range

Value: 0–12

This specifies the range within which the pitch is changed when MIDI Pitch Bend Change messages are received. You can set this in semitone units, up to a maximum of one octave.

6 Modulation Control

Value: -100–100

You can add or subtract an Offset of up to 100 to or from the parameter values that have already been set when a MIDI Control Change message (modulation) is received.

OSC1: OSC1 (Vibrato)

OSC2: OSC2 (Vibrato)

VCF: VCF (Wah, Growl)

VCA: VCA (Tremolo)

LFO (Synth LFO)

The LFO is the oscillator that creates a swelling sound. By greatly increasing the values for parameters such as VCF vibrato (p. 55) and PWM depth (p. 56), you can get various kinds of vibrating sounds (periodic, cyclical changes) in tone and pitch.

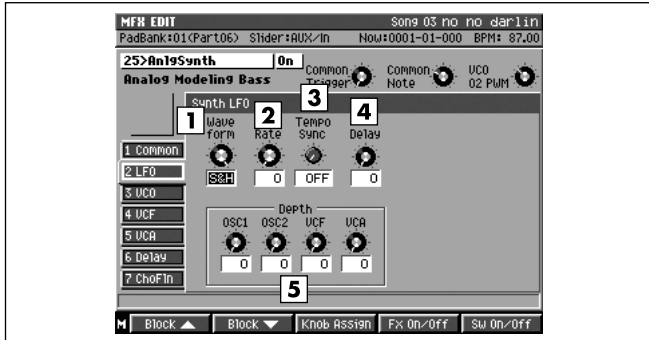



1 Waveform

Sets the waveform of the vibration.

Tri (Triangle wave) 

Sqr (Square wave) 

SAW (Sawtooth wave) 



S/H (Sample and Hold creates random change) 

2 Rate

Value: 0–100

Sets the rate of the vibration. When set to 0, the rate is approximately 0.1 Hz (10 seconds per cycle), and at a setting of 100, the rate is approximately 20 Hz (20 cycles per second). In Tempo Sync this is disabled, and you cannot make this setting.

3 Tempo Sync

Value: Off,  —  x4

This setting synchronizes the rate to the tempo of the song. When not synchronizing, set this “Off.” When you select the note, the rate setting is disabled, and the rate is set the note length corresponding to the tempo. When synchronizing to a song’s tempo.

MEMO

- If “?” appears before the note symbol you set, it is because the upper (or lower) limit of the setting range has been exceeded, and that the synchronization is not correct. Furthermore, the precision of the Rate setting and song tempo differ. If left to develop over long periods, the two may gradually drift apart.

4 Delay

Value: 0–100

Sets the elapsed time between the moment Trigger In turns “On” and the point at which the modulation from the LFO reaches the designated depth. As the value is increased, the elapsed time increases, gradually deepening the swelling.

5 Depth

• OSC1/OSC2

Value: 0–100

Sets the depth of the OSC1 or OSC2 vibrato (the cyclical change in pitch caused by the LFO).

• VCF

Value: 0–100

Sets the depth of the vibrating cutoff frequency by the LFO. As the value is increased, the cyclical tone change gets bigger.

• VCA

Value: 0–100

Sets the depth of the wavering volume (tremolo effect). As the value is increased, the variation in volume increases.

VCO (Virtual VCO + Ring)

This reproduces the VCO (Voltage Controlled Oscillator) virtually. It comprises two oscillators, OSC1 and OSC2, a noise generator, and ring modulator. Settings include those for the waveforms that are the basis of synthesizer sounds and pitch settings for the two oscillators.

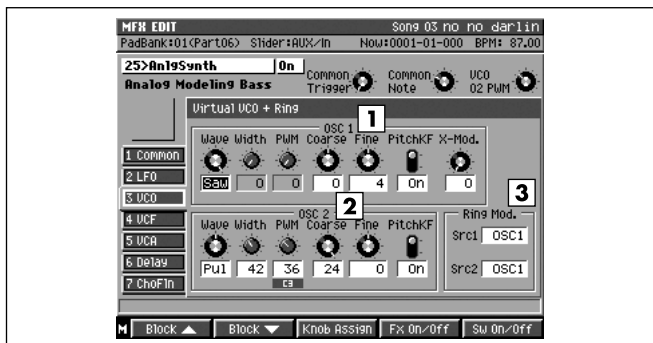

1 OSC1 (Oscillator 1)

• Wave

Sets the waveform for the sound produced by OSC1.

Value	Explanation
Tri	Triangle wave. A clear sound with few overtones.
Pul	Pulse wave. This sound varies depending on the settings in the following parameters (Width, PWM).
Saw	Sawtooth wave. A thick sound filled with overtones.

• Width

Value: 0–100

Sets the pulse width when the “pulse wave” (Pul) is selected for the OSC1 waveform. Increasing the value narrows the pulse width. This has no effect if the OSC1 waveform is not set to “pulse wave” (Pul).

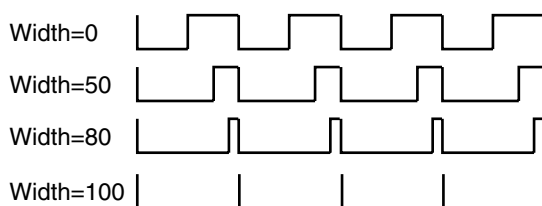

• PWM (Pulse Width Modulation)

Value: 0–100

When OSC1 Wave is set to “pulse wave” (Pul), this set the depth which the LFO vibrates the pulse width. This gives the characteristic cyclical change in tone. Increasing the value deepens the effect. This is effective only when the OSC1 waveform is set to “pulse wave” (Pul).

NOTE

- When both OSC1 Pulse Width and OSC1 Pulse Width Modulation settings are large, the periodic or cyclical sound may become inaudible.

• Coarse/Fine

Coarse Value: -24→+24

Fine Value: -100–100

Sets the pitch of the sound from OSC1. With 0 as the reference, coarse tuning adjusts the pitch in semitone increments, fine tuning in cents (1/100 of a semitone).

• PitchKF (Pitch Key Follow)

Value: Off, On

This setting determines whether the pitch of Oscillator 1 (hereafter OSC1) changes according to the Note Number in Common (On) or not (Off).

• X-Mod. (Cross Modulation)

Value: 0–100

Sets the depth of the OSC1 cross modulation effect (the modulation of the OSC1 pitch by oscillation from the OSC2). As the value is increased, the increased overtones make the sound more powerful.

2 OSC2 (Oscillator 2)

These are the settings for OSC2. The effect of these settings are the same as those in OSC1 (there is no cross modulation included in OSC2).

3 Ring Mod. (Ring Modulator)

• Src1 (Source 1)/Src2 (Source 2)

Value: OSC1, OSC2, Noise, ExtIn

You can select from two ring modulator inputs. Besides the oscillators OSC1 and OSC2, “Noise” or “ExtIn” (external input) may also be selected.

MEMO

- By multiplying the ring modulator’s two inputs each other, you can create sounds that include numerous overtones not found in either waveform. You can get metallic sounds unrelated to any sense of harmony. To play the VCO’s sounds (OSC1, OSC2, noise generator, and ring modulator), raise the volume level of each in the VCF mixer at the next stage. The synthesizer sounds are tuned to A4 (440.0 Hz). If you want to have A4 set to 442 Hz, set the Fine reference setting of OSC1 and OSC2 above not to ±0, but to +8.

VCF (Virtual VCF)

This reproduces, virtually, the VCF (Voltage Controlled Filter). The sounds from the VCO or input from external sources are processed with a filter that moves the cutoff frequency as needed, and creates brightness (or hardness) in the tone and changes in tone brightness over time. There is a mixer to set the input level from each of the sound generators at the input section of the VCF.

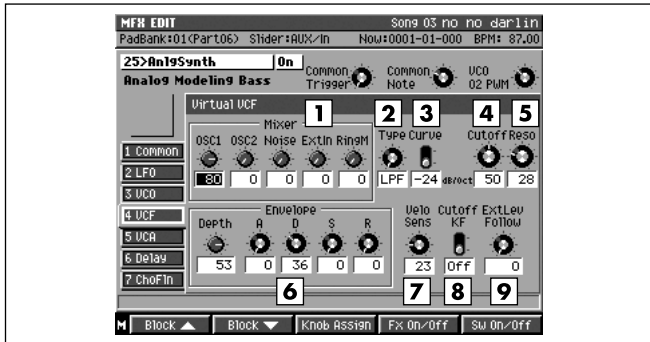

1 Mixer

- OSC1 (Oscillator 1)
- OSC2 (Oscillator 2)
- Noise
- ExtIn
- Ring M

Value: 0–100

Sets the input level to the VCF from each of the sound generators. Mute unneeded sounds by setting them to 0.

2 Type

Sets the type of filter used.

Value	Explanation
LPF	Low pass filter. Passes frequencies below the cut off frequency.
BPF	Band pass filter. Passes frequencies near the cut off frequency.
HPF	High pass filter. Passes frequencies above the cut off frequency.
BEF	Band eliminate filter. Passes frequencies other than those near the cut off frequency.

3 Curve

Value: -12 dB, -24 dB

Sets the filter's slope characteristics at the cutoff frequency (-24 dB at one octave: steep; -12 dB at one octave: shallow).

MEMO

- Some analog synthesizers featured -12 dB/octave, -24 dB/octave, or other slopes.

4 Cutoff (Cutoff Frequency)

Value: 0–100

Sets the filter's cutoff frequency. Set this closer to zero, the cutoff frequency becomes lower; set closer to 100, the cutoff frequency becomes higher.

This setting varies with the addition of changes from the envelope, LFO, and other changes.

5 Reso (Resonance)

Value: 0–100

Sets the filter's resonance level. Raising the setting increases resonance near the cutoff frequency, giving the sound a special characteristic.

NOTE

- If the resonance value is raised to much, extreme oscillation can arise. Take care not to allow this sound to damage your ears or your playback equipment.

6 Envelope

- Depth (Envelope Depth)

Value: -100–100

Sets the depth of the Filter Envelope (the function of changing the filter's frequency characteristics over time).

- A (Attack Time)

Value: 0–100

The elapsed time starting at the point Trigger In is switched "On" to the point at which the cutoff frequency reaches the peak value.

- D (Decay Time)

Value: 0–100

The elapsed time from the point at which the cutoff frequency reaches the peak value until reaching to the sustain level (next item).

- S (Sustain Level)

Value: 0–100

The level of the cutoff frequency after the decay time (previous item) is passed and until Trigger In is switched "Off."

Effect Block

- **R (Release Time)**

Value: 0–100

The elapsed time from when Trigger In is switched “Off” until the cutoff frequency return to the original (pre-attack) value.

MEMO

- These are the filter envelope settings. Select the contour through the attack, decay, sustain, and release, and set the degree of effect with the envelope depth. If a negative value is selected for the envelope depth, the envelope shape is inverted.

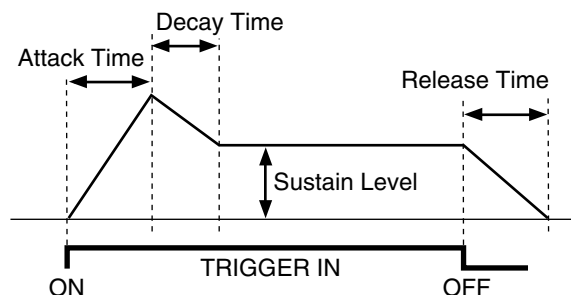

7 Velo Sens (Velocity Sens)

Value: 0–100

Sets the degree to which the cutoff frequency reflects the value of the Velocity in Common. As the value is increased, the cutoff frequency which follows the Velocity (the strength or force at pressing key) gets higher.

8 Cutoff KF (Cutoff Key Follow)

Value: Off, On

This setting determines whether the cutoff frequency changes according with the Note Number in Common (On) or not (Off).

9 Ext Lev Follow (External Level Follow)

Value: -100–100

Sets the degree to which the linked external input volume level changes the cutoff frequency. As the value is increased, you get an effect in which the tone changes more dynamically according to the rhythm of the input.

VCA (Virtual VCA)

This reproduces, virtually, the VCA (Voltage Controlled Amplifier).

Sounds from the VCF are amplified as they change over time, and the resulting amplified volume levels and changes are then output.

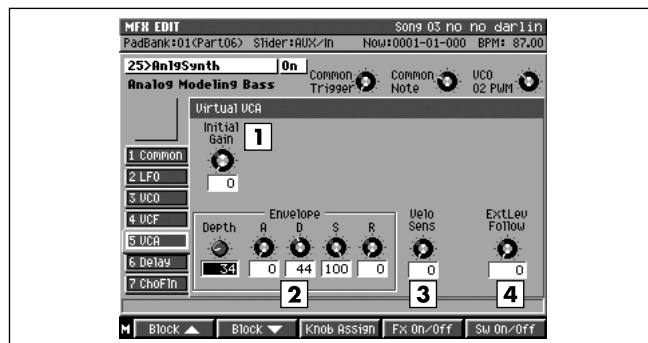

1 Initial Gain

Value: 0–100

Sets the reference volume. When set to any value except 0, sound plays even when the Trigger In is turned Off, with the volume increasing as the value is increased. (Volume changes based on the envelope, LFO, or other input are added to this volume level.) Thus, when setting Trigger In for regulation of sound expression, set this to 0, and regulate the volume with the envelope depth.

2 Envelope

- **Depth**

Value: 0–200

Sets the depth of the envelope (the function of changing the amplifier’s volume over time).

- **A (Attack Time)**

Value: 0–100

The elapsed time from when Trigger In is switched “On” to the point of maximum volume.

- **D (Decay Time)**

Value: 0–100

The elapsed time from the point of maximum volume until reaching the sustain level (next item).

- **S (Sustain Level)**

Value: 0–100

The volume level after passage of the decay time (previous item) up until Trigger In is switched “Off.”

- **R (Release Time)**

Value: 0–100

The elapsed time from when Trigger In is switched “Off” until the volume reaches its minimum value.

MEMO

- These are the volume envelope settings. Select the contour with attack, decay, sustain, and release, and set the degree of effect with the envelope depth.

3 Velo Sens (Velocity Sens)

Value: 0–100

This sets the degree to which the volume corresponds to the value of the Velocity in Common. As the value is increased, the volume level which follows the Velocity (the strength or force at pressing key) is increased.

4 Ext Lev Follow (External Level Follow)

Value: 0–100

Sets the degree to which changes in the tremolo effect are linked to and controlled by the external input volume level. As the value is increased, you get an effect in which the synthesizer sound is played intermittently according to the rhythm of the external input (such as drum phrases).

Delay

This digital delay can be switched between monaural and alternate modes (left and right channels mutually). The maximum delay of 2400 msec (2.4 seconds) provides long echoes, fat, or thick sounds.

MEMO

- You can also use this simply and effectively as a long delay machine by setting the VCF input to “ExtIn” (external input) and then raising only that.

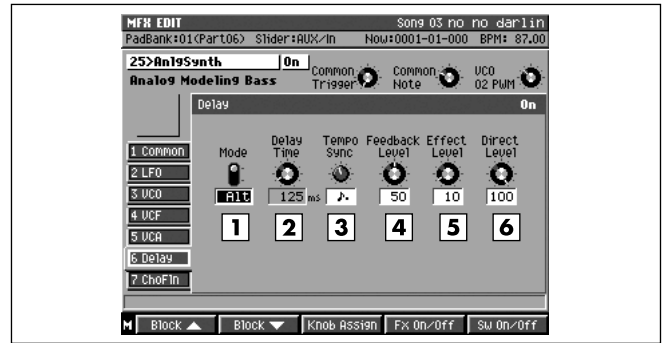

1 Mode

This switches the mode of the delay.

Value	Explanation
Mono (Monaural)	A single-input, single-output delay
ALT (Alternate)	A single-in, dual-out stereo delay in which the left and right outputs are alternated (alternated delay).

2 Delay Time

Sets the delay time, that is, the elapsed time between the source sound and the delay sound.

Mode	Value
Mono	1–2400 msec
Alt	1–1200 msec
If Tempo sync parameter is not off.	N/A

3 Tempo Sync

Value: Off, -

Set this when synchronizing the Delay Time to the song tempo. When not synchronizing, set this “Off.” When you select the note, the Delay Time is set to match the length of the note.

MEMO

- If “?” appears before the note symbol you set, it is because the upper (or lower) limit of the setting range has been exceeded, and that the synchronization is not correct. Furthermore, the precision of the Rate setting and song tempo differ. If left to develop over long periods, the two may gradually drift apart.

4 Feedback Level

Value: 0–100

Sets the repeat times for the delay sound. When set to 0, each delayed sound is played only once. (if the Mode is “Alt,” delayed sound in each channel are played only once.)

5 Effect Level

Value: 0–100

Sets the volume of the delay sound. Adjust this after getting a balance with the direct level.

6 Direct Level

Value: 0–100

Sets the volume of the source sound. It is ordinarily set to 100.

ChoFln (Chorus/Flanger)

This effect can select either a chorus effect, which adds spaciousness and a wavering effect to the sound, or a flanger effect, which adds a metallic undulation (rising and falling sound).

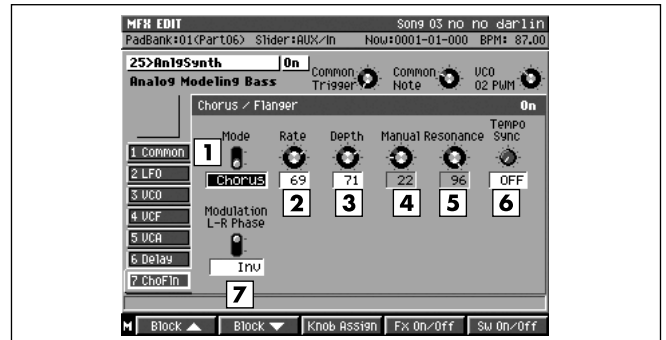

1 Mode

Value: Chorus, Flanger

This is used to select either the chorus or flanger. Setting this to “Chorus” adds an effect of spaciousness and wavering, and setting it to “Flanger” adds the flanger effect, a metallic undulation (rising and falling sound).

2 Rate

Value: 0–100

Sets the rate of the wavering and undulation of the chorus and flanger sounds. This is disabled in Tempo Sync, and you cannot make this setting.

3 Depth

Value: 0–100

Sets the depth of the wavering and undulation of the chorus and flanger sounds.

4 Manual

Value: 0–100

When the effect mode is switched to Flanger, this sets the center frequency for the effect, changing the pitch of the flanger’s metallic sound. This has no effect in Chorus mode.

5 Resonance

Value: 0–100

Sets the intensity of the flanger effect. This has no effect in Chorus mode.

6 Tempo Sync

Value: Off, $\frac{1}{2}$ – $\times 4$

Set this when synchronizing the Rate to the song tempo. When not synchronizing, set this “Off.” When you select the note, the Rate setting is disabled, and the Rate is set the note length corresponding to the tempo.

MEMO

- If “?” appears before the note symbol you set, it is because the upper (or lower) limit of the setting range has been exceeded, and that the synchronization is not correct. Furthermore, the precision of the Rate setting and song tempo differ. If left to develop over long periods, the two may gradually drift apart.

7 Modulation L-R Phase

Value: NonInv, Inv

This setting determines whether the timing of the pitch wavering and undulation (rise and fall) coincides (NonInv), or inverts (Inv).

MEMO

- The oscillator (LFO) used to create these chorus and flanger sounds separates from the common oscillator used by the synthesizer as a whole.

Reverb effect

Reverb

This is a basic reverb. Adds reverberation to the sound, modeling an acoustic space.

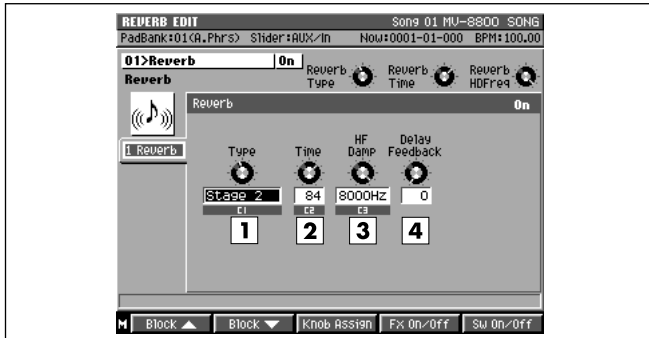

1 Type

This selects the reverb type.

Value	Explanation
Room 1	Short, high-density reverb
Room 2	Short, low-density reverb
Stage 1	Emphasis on heavy reverb component
Stage 2	Reverb with boosted early reflections
Hall 1	Clear, transparent reverb
Hall 2	Rich, full reverb
Delay	General delay
Pan-Delay	Delay sound with reflections shifted to the left and right

2 Time

Value: 0–127 sec

When Type is set to Room, Stage, or Hall, this sets the length of the reverberant sound.

When Type is set to Delay or Pan-Delay, this sets the delay time.

3 HF Damp (High Frequency Damp)

Value: 200–8000 Hz, Bypass

Adjusts the frequency above which the high-frequency content of the reverb sound will be cut, or “damped.” If you do not want to cut the high frequencies, set this parameter to Bypass.

4 Delay Feedback

Value: 0–127

Adjusts the amount of delay feedback when the Type setting is Delay or Pan-Delay.

SRV Room reverb SRV Hall Reverb SRV Plate Reverb

Room and Hall reverbs enable more precise modeling than that available with the basic reverb. Plate models the type of reverb that utilizes a metal sheet or plate.

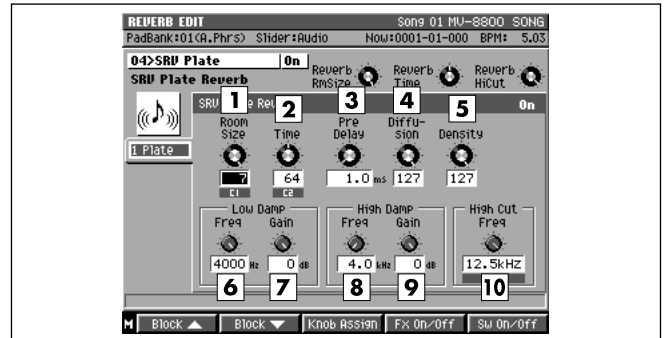

1 Room Size

Value: 5–40 m

Sets the size of the room. For example, the setting “10m” gives you reverb as it would sound in a single space 10 meters wide.

2 Time

Value: 0–127 sec

Sets the reverb time in seconds.

3 Pre Delay

Value: 0–200 msec

Adjusts the delay time from the direct sound until the chorus sound is heard.

4 Diffusion

Value: 0–100

Increasing this value intensifies the sense of spatial width. This is effective when playing back in stereo.

5 Density

Value: 0–100

Increasing this value makes the reverb sound denser. For hall or garage sounds, make this thinner.

6 Low Damp Freq

Value: 50–4000 Hz

Sets the upper frequency limit of the range to be damped by “Low Damp.” The Low Damp function damps the low frequency band of the delay sound quicker than other bands, which makes for a clearer delay effect

7 Low Damp Gain

Value: -36–0 dB

Sets the degree of the Low Damp.

8 High Damp Freq

Value: 1–20 kHz

High Damp, by attenuating the higher frequencies first, makes the delay sound more natural. Sets the lower frequency limit of the range to be dampened.

MEMO

- In the natural world, the high frequencies in echo die out quicker than other bands.

9 High Damp Gain

Value: -36–0 dB

Sets the degree of the High Damp.

MEMO

- You can combine Low Damp and High Damp to elicit qualities such as the room's wall material (and sound absorbency thereof).

10 High Cut Freq

Value: 0.2–20 kHz

Upper band than this frequency of the reverb sound are gently cut to make the reverberation more stable. This does not make time-based changings.

About MIDI

This section explains the basic concepts of MIDI, and how the MV-8800 handles MIDI messages.

What is MIDI

MIDI stands for **Musical Instrument Digital Interface**. It is a worldwide standard that allows electronic musical instruments and personal computer to exchange musical performance data and messages such as sound selections. Any MIDI-compatible device can transmit musical data (as appropriate for the type of device) to any other MIDI-compatible device, regardless of its manufacturer or model type.

MIDI connectors

MIDI messages (the data handled by MIDI) are transmitted and received using the following two types of connectors. The MV-8800 has two MIDI OUT connectors; A and B.

MIDI IN: This receives MIDI messages from external MIDI devices.

MIDI OUT A/B: This transmits MIDI messages from the MV-8800.

MIDI channels

MIDI is able to send information over a single MIDI cable independently to two or more MIDI devices. This is made possible by the concept of MIDI channels. You can think of MIDI channels as being somewhat similar in function to the channels on a television. By changing the channel of a TV set, you can view a variety of programs being transmitted by different broadcast stations. This is because data is received only from the transmitter whose channel is selected on the receiver.

In the same way, a MIDI device whose receive channel is set to "1" will receive only the data being transmitted by another MIDI device whose transmit channel is also set to "1."

MIDI messages

The MV-8800 uses the following types of MIDI message.

● Note messages:

These messages are used to play notes. On a keyboard, these messages transmit the key (note number) that was pressed, and how strongly it was pressed (velocity). On the MV-8800, these messages are used when you use a MIDI sound source to play the metronome sound.

● Control Change messages:

In general, these messages are used to transmit information such as vibrato, hold, and volume etc., that makes a performance more expressive. The various functions are differentiated by a controller number from 0–127, and the controller number is defined for each function. The functions that can be controlled on any given device will depend on that device.

On the MV-8800, these messages can be transmitted to external MIDI devices by ASSIGNABLE SLIDER function.

● Exclusive messages:

Unlike note messages and control change messages, exclusive messages are used to transmit settings that are unique to a particular device. On the MV-8800, they can be used to control MV-8800 mixer parameters, when it receives exclusive messages.

Exclusive messages intended for different units are distinguished by their Device ID, rather than by MIDI channel. When exclusive messages are to be transmitted or received, you must set the Device ID of both units to a matching setting.

MIDI Implementation Chart

MIDI allows a variety of electronic musical instruments to communicate with each other. However it is not necessarily the case that all devices will be able to communicate using all types of MIDI message. They can only communicate using those types of MIDI message that they have in common.

Each owner's manual for a MIDI device includes a MIDI Implementation Chart. This chart shows you at a glance the types of MIDI message that can be transmitted and received. By comparing the implementation charts of two devices, you will be able to see the types of message with which they will be able to communicate.

1. Receive Data (Sound Generator Section)

■ Channel Voice Messages

● Note off

Status	2nd byte	3rd byte
8nH	kkH	vvH
9nH	kkH	00H

n = MIDI channel number: 0H - FH (ch.1 - 16)
kk = note number: 00H - 7FH (0 - 127)
vv = note off velocity: 00H - 7FH (0 - 127)

● Note on

Status	2nd byte	3rd byte
9nH	kkH	vvH

n = MIDI channel number: 0H - FH (ch.1 - 16)
kk = note number: 00H - 7FH (0 - 127)
vv = note on velocity: 01H - 7FH (1 - 127)

● Polyphonic Key Pressure

Status	2nd byte	3rd byte
AnH	kkH	vvH

n = MIDI channel number: 0H - FH (ch.1 - 16)
kk = note number: 00H - 7FH (0 - 127)
vv = Polyphonic Key Pressure: 00H - 7FH (0 - 127)

● Control Change

If the corresponding Controller number is selected for the Common Control Change Number (PATCH EDIT (CONTROL) screen), the corresponding effect will occur.

○ Modulation (Controller number 1)

Status	2nd byte	3rd byte
BnH	01H	vvH

n = MIDI channel number: 0H - FH (ch.1 - 16)
vv = Modulation depth: 00H - 7FH (0 - 127)

○ Portamento Time (Controller number 5)

Status	2nd byte	3rd byte
BnH	05H	vvH

n = MIDI channel number: 0H - FH (ch.1 - 16)
vv = Portamento Time: 00H - 7FH (0 - 127)

* Controls Portamento Time parameter (PATCH EDIT(SOLO/PORTAMENTO)) of the part that corresponds to received MIDI channel number.

○ Volume (Controller number 7)

Status	2nd byte	3rd byte
BnH	07H	vvH

n = MIDI channel number: 0H - FH (ch.1 - 16)
vv = Volume: 00H - 7FH (0 - 127)

○ Panpot (Controller number 10)

Status	2nd byte	3rd byte
BnH	0AH	vvH

n = MIDI channel number: 0H - FH (ch.1 - 16)
vv = Panpot: 00H - 40H - 7FH (Left - Center - Right),

○ Expression (Controller number 11)

Status	2nd byte	3rd byte
BnH	0BH	vvH

n = MIDI channel number: 0H - FH (ch.1 - 16)
vv = Expression: 00H - 7FH (0 - 127)

○ Hold 1 (Controller number 64)

Status	2nd byte	3rd byte
BnH	40H	vvH

n = MIDI channel number: 0H - FH (ch.1 - 16)
vv = Control value: 00H - 7FH (0 - 127) 0-63 = OFF, 64-127 = ON

○ Portamento (Controller number 65)

Status	2nd byte	3rd byte
BnH	41H	vvH

n = MIDI channel number: 0H - FH (ch.1 - 16)
vv = Control value: 00H - 7FH (0 - 127) 0 - 63 = OFF, 64 - 127 = ON

* Controls Portamento Switch parameter (PATCH EDIT (SOLO/PORTAMENTO) screen) of the part that corresponds to received MIDI channel number.

○ Sostenuto (Controller number 66)

Status	2nd byte	3rd byte
BnH	42H	vvH

n = MIDI channel number: 0H - FH (ch.1 - 16)
vv = Control value: 00H - 7FH (0 - 127) 0 - 63 = OFF, 64 - 127 = ON

○ Legato Foot Switch (Controller number 68)

Status	2nd byte	3rd byte
BnH	44H	vvH

n = MIDI channel number: 0H - FH (ch.1 - 16)
vv = Control value: 00H - 7FH (0 - 127) 0 - 63 = OFF, 64 - 127 = ON

* Controls Legato Switch parameter (PATCH EDIT (CONTROL) screen) of the part that corresponds to received MIDI channel number.

○ Resonance (Controller number 71)

Status	2nd byte	3rd byte
BnH	47H	vvH

n = MIDI channel number: 0H - FH (ch.1 - 16)
vv = Resonance value (relative change): 00H - 40H - 7FH (-64 - 0 - +63),

* Controls the Filter Resonance Offset parameter (PATCH EDIT (CONTROL) screen) of the part that correspond to received MIDI channel number.

○ Release Time (Controller number 72)

Status	2nd byte	3rd byte
BnH	48H	vvH

n = MIDI channel number: 0H - FH (ch.1 - 16)
vv = Release Time value (relative change): 00H - 40H - 7FH (-64 - 0 - +63),

* Controls the Amplifier Release Offset parameter of the part that correspond to received MIDI channel number.

○ Attack time (Controller number 73)

Status	2nd byte	3rd byte
BnH	49H	vvH

n = MIDI channel number: 0H - FH (ch.1 - 16)
vv = Attack time value (relative change): 00H - 40H - 7FH (-64 - 0 - +63),

* Controls the Amplifier Attack Offset parameter (PATCH EDIT (CONTROL) screen) of the part that correspond to received MIDI channel number.

○ Cutoff (Controller number 74)

Status	2nd byte	3rd byte
BnH	4AH	vvH

n = MIDI channel number: 0H - FH (ch.1 - 16)
vv = Cutoff value (relative change): 00H - 40H - 7FH (-64 - 0 - +63)

* Controls the Filter Cutoff Offset parameter (PATCH EDIT (CONTROL) screen) of the part that correspond to received MIDI channel number.

○ Portamento control (Controller number 84)

Status	2nd byte	3rd byte
BnH	54H	kkH

n = MIDI channel number: 0H - FH (ch.1 - 16)

kk = source note number: 00H - 7FH (0 - 127)

- * A Note-on received immediately after a Portamento Control message will change continuously in pitch, starting from the pitch of the Source Note Number.
- * If a voice is already sounding for a note number identical to the Source Note Number, this voice will continue sounding (i.e., legato) and will, when the next Note-on is received, smoothly change to the pitch of that Note-on.
- * The rate of the pitch change caused by Portamento Control is determined by the Portamento Time value (PATCH EDIT (SOLO/PORTAMENTO) screen).

○ Effect 1 (Reverb Send Level) (Controller number 91)

Status	2nd byte	3rd byte
BnH	5BH	vvH

n = MIDI channel number: 0H - FH (ch.1 - 16)

vv = Reverb Send Level: 00H - 7FH (0 - 127)

○ Effect 3 (Chorus Send Level) (Controller number 93)

Status	2nd byte	3rd byte
BnH	5DH	vvH

n = MIDI channel number: 0H - FH (ch.1 - 16)

vv = Chorus Send Level: 00H - 7FH (0 - 127)

● Program Change

Status	2nd byte
CnH	ppH

n = MIDI channel number: 0H - FH (ch.1 - 16)

pp = Program number: 00H - 7FH (Pattern Library 001 - 128)

- * Program change that received each MIDI channel number will function as the patch change.

● Channel Pressure

Status	2nd byte
DnH	vvH

n = MIDI channel number: 0H-FH (ch.1-16)

vv = Channel Pressure: 00H-7FH (0-127)

● Pitch Bend Change

Status	2nd byte	3rd byte
EnH	llH	mmH

n = MIDI channel number: 0H - FH (ch.1 - 16)

ll, mm = Pitch Bend value: 00, 00H - 00, 40H - 7E, 7FH (-8192 - 0 - +8191)

■ Channel Mode Messages

● All Sound Off (Controller number 120)

Status	2nd byte	3rd byte
BnH	78H	00H

n = MIDI channel number: 0H-FH (ch.1-16)

- * When this message is received, all notes currently sounding on the corresponding channel will be turned off.

● Reset All Controllers (Controller number 121)

Status	2nd byte	3rd byte
BnH	79H	00H

n = MIDI channel number: 0H-FH (ch.1-16)

- * When this message is received, the following controllers will be set to their reset values.

Controller	Reset value
Pitch Bend Change	+/-0 (center)
Polyphonic Key Pressure	0 (off)
Channel Pressure	0 (off)
Modulation	0 (off)
Expression	127 (max)
Hold 1	0 (off)

● All Notes Off (Controller number 123)

Status	2nd byte	3rd byte
BnH	7BH	00H

n = MIDI channel number: 0H - FH (ch.1 - 16)

- * When All Notes Off is received, all notes on the corresponding channel will be turned off. However, if Hold 1 is ON, the sound will be continued until these are turned off.

● OMNI OFF (Controller number 124)

Status	2nd byte	3rd byte
BnH	7CH	00H

n = MIDI channel number: 0H - FH (ch.1 - 16)

- * The same processing will be carried out as when All Notes Off is received.

● OMNI ON (Controller number 125)

Status	2nd byte	3rd byte
BnH	7DH	00H

n = MIDI channel number: 0H - FH (ch.1 - 16)

- * The same processing will be carried out as when All Notes Off is received. OMNI ON will not be turned on.

● MONO (Controller number 126)

Status	2nd byte	3rd byte
BnH	7EH	mmH

n = MIDI channel number: 0H - FH (ch.1 - 16)

mm = mono number: 00H - 10H (0 - 16)

- * The same processing will be carried out as when All Notes Off is received.
- * The Mono Mode parameter (PATCH EDIT (SOLO/PORTAMENTO) screen) of the part that corresponds to received MIDI channel will be turned On.

● POLY (Controller number 127)

Status	2nd byte	3rd byte
BnH	7FH	00H

n = MIDI channel number: 0H - FH (ch.1 - 16)

- * The same processing will be carried out as when All Notes Off is received.
- * The Mono Mode parameter (PATCH EDIT (SOLO/PORTAMENTO) screen) of the part that corresponds to received MIDI channel will be turned Off.

■ System Realtime Message

● Active Sensing

Status
FEH

- * When Active Sensing is received, the unit will begin monitoring the intervals of all further messages. While monitoring, if the interval between messages exceeds 420 ms, the same processing will be carried out as when All Sounds Off, All Notes Off and Reset All Controllers are received, and message interval monitoring will be halted.

2. Data Transmission (Sound Generator section)

■ Channel Voice Messages

● Note off

Status	2nd byte	3rd byte
8nH	kkH	vvH

n = MIDI channel number: 0H - FH (ch.1 - 16)

kk = note number: 15H - 74H (21 - 116)

vv = note off velocity: 00H - 7FH (0 - 127)

● Note on

Status	2nd byte	3rd byte
9nH	kkH	vvH

n = MIDI channel number: 0H - FH (ch.1 - 16)

kk = note number: 15H - 74H (21 - 116)

vv = note on velocity: 01H - 7FH (1 - 127)

● Polyphonic Key Pressure

Status	2nd byte	3rd byte
AnH	kkH	vvH

n = MIDI channel number: 0H - FH (ch.1 - 16)

kk = note number: 15H - 74H (21 - 116)

vv = Polyphonic Key Pressure: 00H - 7FH (0 - 127)

● Control Change

* By selecting a controller number that corresponds to the setting of parameters of controllers (Assignable sliders), the MV-8800 can transmit any control change message.

○ Hold 1 (Controller number 64)

Status	2nd byte	3rd byte
BnH	40H	vvH

n = MIDI channel number: 0H - FH (ch.1 - 16)

vv = Control value: 00H - 7FH (0 - 127) 0-63 = OFF, 64-127 = ON

* Transmitted when the Foot Switch Assign parameter (PANEL screen) is set to Damper.

● Channel Pressure

Status	2nd byte
DnH	vvH

n = MIDI channel number: 0H - FH (ch.1 - 16)

vv = Channel Pressure: 00H - 7FH (0 - 127)

■ System Realtime Messages

● Active Sensing

Status
FEH

* This message is transmitted at intervals of approximately 250 msec.

* This message is not sent when the Tx Active Sensing parameter (MIDI screen) is Off.

3. Receive Data (Sequencer Section)

3.1 Messages recorded during recording

■ Channel Voice Messages

● Note Off

Status	2nd byte	3rd byte
8nH	kkH	vvH
9nH	kkH	00H

n=MIDI channel number:0H - FH (ch.1 - ch.16)

kk=note number: 00H - 7FH (0 - 127)

vv=note off velocity: 00H - 7FH (0 - 127)

* Not received when the Note parameter (RECORDING FILTER popup) is Off.

● Note on

Status	2nd byte	3rd byte
9nH	kkH	vvH

n=MIDI channel number:0H - FH (ch.1 - ch.16)

kk=note number: 00H - 7FH (0 - 127)

vv=note on velocity: 01H - 7FH (1 - 127)

* Not received when the Note parameter (RECORDING FILTER popup) is Off.

● Polyphonic Key Pressure

Status	2nd byte	3rd byte
AnH	kkH	vvH

n=MIDI channel number:0H - FH (ch.1 - ch.16)

kk=note number: 00H - 7FH (0 - 127)

vv=Polyphonic Aftertouch:00H - 7FH (0 - 127)

* Not received when the Poly Aftertouch parameter (RECORDING FILTER popup) is Off.

● Control Change

Status	2nd byte	3rd byte
BnH	kkH	vvH

n=MIDI channel number:0H - FH (ch.1 - ch.16)

kk=Control number: 00H - 78H (0 - 120)

vv=value: 00H - 7FH (0 - 127)

* Not received when the Control Change parameter (RECORDING FILTER popup) is Off.

● Program Change

Status	2nd byte
CnH	ppH

n=MIDI channel number:0H - FH (ch.1 - ch.16)

pp=Program number:00H - 7FH (prog.1 - prog.128)

* Not received when the Program Change parameter (RECORDING FILTER popup) is Off.

● Channel Pressure

Status	2nd byte
DnH	vvH

n=MIDI channel number:0H - FH (ch.1 - ch.16)

vv=Channel Aftertouch:00H - 7FH (0 - 127)

* Not received when the Channel Aftertouch parameter (RECORDING FILTER popup) is Off.

● Pitch Bend Change

Status	2nd byte	3rd byte
EnH	llH	mmH

n=MIDI channel number: 0H - FH (ch.1 - ch.16)

ll, mm=Pitch Bend value: 00, 00H - 00, 40H - 7F, 7FH (-8192 - 0 - +8191)

* Not received when the Pitch Bend parameter (RECORDING FILTER popup) is Off.

Channel Mode messages

* Not received when the Mode Message parameter (RECORDING FILTER popup) is Off.

Reset All Controller (Controller number 121)

Status	2nd byte	3rd byte
BnH	79H	00H

n=MIDI channel number: 0H - FH (ch.1 - ch.16)

Omni Off (Controller number 124)

Status	2nd byte	3rd byte
BnH	7CH	00H

n=MIDI channel number: 0H - FH (ch.1 - ch.16)

* The same processing will be done as when an All Note Off message is received.

Omni On (Controller number 125)

Status	2nd byte	3rd byte
BnH	7DH	00H

n=MIDI channel number: 0H - FH (ch.1 - ch.16)

* The same processing will be done as when an All Note Off message is received.

Mono (Controller number 126)

Status	2nd byte	3rd byte
BnH	7EH	mmH

n=MIDI channel number: 0H - FH (ch.1 - ch.16)

mm=mono number: 00H - 10H (0 - 16)

* The same processing will be done as when an All Note Off message is received.

Poly (Controller number 127)

Status	2nd byte	3rd byte
BnH	7FH	00H

n=MIDI channel number: 0H - FH (ch.1 - ch.16)

* The same processing will be done as when an All Note Off message is received.

System Common messages

Tune Request

Status
F6H

* Not received when the Tune Request parameter (RECORDING FILTER popup) is Off.

System Exclusive Messages

Status	Data byte	Status
F0H	iiH, ddH,, eeH	F7H

F0H:	System Exclusive message status
ii=ID number:	This is the ID number (manufacturer ID) that specifies the manufacturer whose exclusive message this is. Roland's manufacturer ID is 41H. ID numbers 7EH and 7FH are defined in an expansion of the MIDI standard as Universal Non-real-time messages (7EH) and Universal Realtime Messages (7FH).
dd,...., ee = data:	00H - 7FH (0 - 127)
F7H:	EOX (End of System Exclusive)

* Not received when the System Exclusive parameter (RECORDING FILTER popup) is Off.

* MIDI Machine Control and MIDI Time code is not recorded.(Refer to "3.3 Messages acknowledged for synchronization")

3.2 Messages not recorded during recording

Channel mode messages

All Sound Off (Controller number 120)

Status	2nd byte	3rd byte
BnH	78H	00H

n = MIDI channel number: 0H-FH (ch.1-16)

* The same processing will be done as when an All Note Off message is received.

Local On/Off (Controller number 122)

Status	2nd byte	3rd byte
BnH	7AH	vvH

n=MIDI channel number: 0H - FH (ch.1 - ch.16)

vv=Value: 00H, 7FH (Local Off, Local On)

All notes off (Controller number 123)

Status	2nd byte	3rd byte
BnH	7BH	00H

n=MIDI channel number: 0H - FH (ch.1 - ch.16)

* When an All Note Off message is received, all notes of the corresponding channel that are on will be sent Note Off's, and the resulting Note Off messages will be recorded.

3.3 Messages acknowledged for synchronization

System Common messages

MIDI Time Code Quater Frame Message

Status	2nd byte
F1H	mmH (= 0nnndddd)

nnn = Message type:
 0 = Frame count LS nibble
 1 = Frame count MS nibble
 2 = Seconds count LS nibble
 3 = Seconds count MS nibble
 4 = Minutes count LS nibble
 5 = Minutes count MS nibble
 6 = Hours count LS nibble
 7 = Hours count MS nibble

dddd = 4bit nibble data: 0H - FH (0 - 15)

If the upper and lower 4 bits of the count are combined, these bit fields are assigned as follows.

Frame Count	xxxxxyyy	(000)
	xxx Reserved	No. (0-29)
	yyyyy Frame	
Seconds Count	xyyyyyyy	
	xx	Reserved (00)
	yyyyyy	Seconds Count (0-59)
Minutes Count	xyyyyyyy	
	xx	Reserved (00)
	yyyyyy	Minutes Count (0-59)
Hour Count	xyzzzzzz	
	x	Reserved (00)
	yy	Time Code Type
		0 = 24 Frame/Sec
		1 = 25 Frame/Sec
		2 = 30 Frame/Sec (Drop Frame)
		3 = 30 Frame/Sec (Non Drop Frame)
	zzzzz	Hour Count

* Received when the Sync Mode parameter (SYNC or PATTERN SYNC screen) is set to Slave-MTC.

MIDI Implementation

● Song Position Pointer

Status	2nd byte	3rd byte
F2H	llH	mmH

mm, ll=value: 00, 00H - 7F, 7FH (0 - 16383)

* Received when Sync Mode parameter (SYNC or PATTERN SYNC screen) is set to Slave-MIDI.

■ System Realtime Messages

* Received when Sync Mode parameter (SYNC or PATTERN SYNC screen) is set to Slave-MIDI or Remote.

● Timing Clock

Status
F8H

● Start

Status
FAH

● Continue

Status
FBH

● Stop

Status
FCH

■ System Exclusive Message

● MIDI Time Code

○ Full Message

Status	Data byte	Status
F0H	7EH, dev, 01H, 01H, hrH, mnH, scH, frH	F7H

Byte	Description
F0H	Status of System Exclusive Message
7FH	Universal System Exclusive Real-time Header
Dev	Device ID (or 7FH)
01H	MIDI Time Code
01H	MIDI Time Code Full Message
hr	Type/Hour (0yyzzzzz) yy: Time Code Type 0=24 Frame/Sec 1=25 Frame/Sec 2=30 Frame/Sec (Drop) 3=30 Frame/Sec (Non-Drop) zzzzz: Hours (0-23)
mn	Minutes (0-59)
sc	Seconds (0-59)
fr	Frames (0-59)
F7H	EOX (End of System Exclusive message)

* Received when the Sync Mode parameter (SYNC or PATTERN SYNC screen) is set to Slave-MTC.

● MIDI Machine Control (MMC)

* Received when the MMC Mode parameter (SYNC or PATTERN SYNC screen) is Slave.

○ STOP (MCS)

Status	Data byte	Status
F0H	7FH, dev, 06H, 01H	F7H

Byte	Remarks
F0H	Exclusive status
7FH	Universal System Exclusive Realtime Header
dev	Device ID (or 7FH)
06H	MMC command message
01H	STOP (MCS)
F7H	EOX (End of Exclusive)

○ PLAY (MCS)

Status	Data byte	Status
F0H	7FH, dev, 06H, 02H	F7H

Byte	Remarks
F0H	Exclusive status
7FH	Universal System Exclusive Realtime Header
dev	Device ID (or 7FH)
06H	MMC Command Message
02H	PLAY (MCS)
F7H	EOX (End of System Exclusive message)

○ DEFERRED PLAY (MCS)

Status	Data byte	Status
F0H	7FH, dev, 06H, 03H	F7H

Byte	Remarks
F0H	Exclusive status
7FH	Universal System Exclusive Realtime Header
dev	Device ID (or 7FH)
06H	MMC command message
03H	DEFERRED PLAY (MCS)
F7H	EOX (End of Exclusive)

○ RECORD STROBE

Status	Data byte	Status
F0H	7FH, dev, 06H, 06H	F7H

Byte	Remarks
F0H	Exclusive status
7FH	Universal System Exclusive Realtime Header
dev	Device ID (or 7FH)
06H	MMC Command Message
06H	RECORD STROBE
F7H	EOX (End of System Exclusive message)

* When in the SONG or PATTERN screen, MV-8800 starts recording.

○ RECORD EXIT

Status	Data byte	Status
F0H	7FH, dev, 06H, 07H	F7H

Byte	Remarks
F0H	Exclusive status
7FH	Universal System Exclusive Realtime Header
dev	Device ID (or 7FH)
06H	MMC Command Message
07H	RECORD EXIT
F7H	EOX (End of System Exclusive message)

* When in the SONG or PATTERN screen, MV-8800 stops recording.

○ LOCATE (MCP)

Format1—LOCATE [I/F]

Status	Data byte	Status
F0H	7FH, dev, 06H, 44H, 02H, 00H, nnH	F7H

Byte	Remarks
F0H	Exclusive status
7FH	Universal System Exclusive Realtime Header
dev	Device ID (or 7FH)
06H	MMC Command Message
44H	LOCATE (MCP)
02H	number of Bytes
00H	"I/F" sub command
nnH	Information Filed (08H, 09H, 0AH, 0BH, 0CH, 0DH, 0EH, 0FH)
F7H	EOX (End of System Exclusive message)

* MV-8800 locates the selected time location stored to the Locator 0-7.

Format2—LOCATE [TARGET]

Status	Data byte	Status
F0H	7FH, dev, 06H, 44H, 06H, 01H, hrH, mnH, scH, frH, ffH	F7H

Byte	Remarks
F0H	Exclusive status
7FH	Universal System Exclusive Realtime Header
Dev	Device ID (or 7FH)
06H	MMC command message
44H	LOCATE (MCP)
06H	Byte count
01H	"TARGET" sub-Command
hrH	Standard Time Specification with subframes (type ff)
mnH	
scH	
frH	
ffH	
F7H	EOX (End of Exclusive)

4. Data transmission (Sequencer Section)

4.1 Messages transmitted during playing

Recorded messages are transmitted during playback.

4.2 Messages that are generated and transmitted

4.2.1 Messages Appearing When Synchronizing with Other Devices

When the Sync Mode parameter (SYNC or PATTERN SYNC screen) is set to Master. MV-8800 sends the following messages.

■ System Common Messages

● MIDI Time Code Quarter Frame Message

Status	2nd byte
F1H	mmH (= 0nnndddd)

nnn = Message type: 0 = Frame count LS nibble
 1 = Frame count MS nibble
 2 = Seconds count LS nibble
 3 = Seconds count MS nibble
 4 = Minutes count LS nibble
 5 = Minutes count MS nibble
 6 = Hours count LS nibble
 7 = Hours count MS nibble

dddd = 4bit nibble data: 0H - FH (0 - 15)

If the upper and lower 4 bits of the count are combined, these bit fields are assigned as follows.

Frame Count	xxxxyyyy	Reserved (000)
	xxx	Frame No. (0-29)
	yyyyy	
Seconds Count	xyyyyyyy	Reserved (00)
	xx	Seconds Count (0-59)
	yyyyyy	
Minutes Count	xyyyyyyy	Reserved (00)
	xx	Minutes Count (0-59)
	yyyyyy	
Hour Count	xyyzzzzz	Reserved (00)
	x	Time Code Type
	yy	0 = 24 Frame/Sec
		1 = 25 Frame/Sec
		2 = 30 Frame/Sec (Drop Frame)
		3 = 30 Frame/Sec (Non Drop Frame)
	zzzzz	Hour Count

* Sent when the MTC Output parameter (SYNC screen) is set to On.

● Song Position Pointer

Status	2nd byte	3rd byte
F2H	llH	mmH

ll, mm=value: 00, 00H - 7F, 7FH (0 - 16383)

* Sent when the MIDI Clock Output parameter (SYNC or PATTERN SYNC screen) is set to On.

MIDI Implementation

System Realtime Messages

Timing Clock

Status
F8H

* Sent when the SYNC Mode parameter (SYNC or PATTERN SYNC screen) is set to Slave-MIDI or Remote.

Start

Status
FAH

* Sent when the SYNC Mode parameter (SYNC or PATTERN SYNC screen) is set to Slave-MIDI or Remote.

Continue

Status
FBH

* Sent when the SYNC Mode parameter (SYNC or PATTERN SYNC screen) is set to Slave-MIDI or Remote.

Stop

Status
FCH

* Sent when the SYNC Mode parameter (SYNC or PATTERN SYNC screen) is set to Slave-MIDI or Remote.

System Exclusive Message

MIDI Time code

Status	Data Byte	Status
F0H	7FH, 7FH, 01H, 01H, hrH, mnH, scH, frH	F7H

Byte	Remarks
F0H	Exclusive status
7FH	Universal System Exclusive Realtime Header
7FH	Device ID
01H	sub-ID #1 (MIDI Time code)
01H	sub-ID #2 (Full Message)
hrH	hours and type: 0 yy zzzzz
	yy type:
	00 = 24 Flame/sec
	01 = 25 Flame/sec
	10 = 30 Flame/sec
	11 = 30 Flame/sec
	zzzzz: Hours (00 - 23)
mnH	Minutes (00 - 59)
scH	Seconds (00 - 59)
frH	Frames (00 - 29)
F7H	EOX (End of Exclusive)

* Sent when the MTC Output parameter (SYNC or PATTERN SYNC screen) is set to On.

MIDI Machine Control (MMC)

* Sent when the MMC Output parameter (SYNC or PATTERN SYNC screen) is set to On.

STOP (MCS)

Status	Data Byte	Status
F0H	7FH, 7FH, 06H, 01H	F7H

Byte	Remarks
F0H	Exclusive status
7FH	Universal System Exclusive Realtime Header
7FH	Device ID
06H	MMC command message
01H	STOP (MCS)
F7H	EOX (End of Exclusive)

DEFERRED PLAY (MCS)

Status	Data Byte	Status
F0H	7FH, 7FH, 06H, 03H	F7H

Byte	Remarks
F0H	Exclusive status
7FH	Universal System Exclusive Realtime Header
7FH	Device ID
06H	MMC command message
03H	DEFERRED PLAY (MCS)
F7H	EOX (End of Exclusive)

RECORD STROBE

Status	Data Byte	Status
F0H	7FH, 7FH, 06H, 06H	F7H

Byte	Description
F0H	Exclusive status
7FH	Universal System Exclusive Realtime Header
7FH	Device ID
06H	MMC Command Message
06H	RECORD STROBE
F7H	EOX (End of System Exclusive message)

RECORD EXIT

Status	Data Byte	Status
F0H	7FH, 7FH, 06H, 07H	F7H

Byte	Description
F0H	Exclusive status
7FH	Universal System Exclusive Realtime Header
7FH	Device ID
06H	MMC Command Message
07H	RECORD EXIT
F7H	EOX (End of System Exclusive message)

LOCATE (MCP)

Format2—LOCATE [TARGET]

Status	Data Byte	Status
F0H	7FH, 7FH, 06H, 44H, 06H, 01H, hrH, mnH, scH, frH, ffH	F7H

Byte	Remarks
F0H	Exclusive status
7FH	Universal System Exclusive Realtime Header
7FH	Device ID
06H	MMC command message
44H	LOCATE (MCP)
06H	Byte count
01H	"TARGET" sub-Command
hrH	Standard Time Specification with subframes (type ff)
mnH	
scH	
frH	
ffH	
F7H	EOX (End of Exclusive)

5. Appendices

● Decimal and Hexadecimal table (Hexadecimal number is shown with H.)

In MIDI documentation, data values and addresses/sizes of system exclusive messages etc. are expressed as hexadecimal values for each 7 bits.

the following table shows how these correspond to decimal numbers.

dec	hex	dec	hex	dec	hex	dec	hex
0	00H	32	20H	64	40H	96	60H
1	01H	33	21H	65	41H	97	61H
2	02H	34	22H	66	42H	98	62H
3	03H	35	23H	67	43H	99	63H
4	04H	36	24H	68	44H	100	64H
5	05H	37	25H	69	45H	101	65H
6	06H	38	26H	70	46H	102	66H
7	07H	39	27H	71	47H	103	67H
8	08H	40	28H	72	48H	104	68H
9	09H	41	29H	73	49H	105	69H
10	0AH	42	2AH	74	4AH	106	6AH
11	0BH	43	2BH	75	4BH	107	6BH
12	0CH	44	2CH	76	4CH	108	6CH
13	0DH	45	2DH	77	4DH	109	6DH
14	0EH	46	2EH	78	4EH	110	6EH
15	0FH	47	2FH	79	4FH	111	6FH
16	10H	48	30H	80	50H	112	70H
17	11H	49	31H	81	51H	113	71H
18	12H	50	32H	82	52H	114	72H
19	13H	51	33H	83	53H	115	73H
20	14H	52	34H	84	54H	116	74H
21	15H	53	35H	85	55H	117	75H
22	16H	54	36H	86	56H	118	76H
23	17H	55	37H	87	57H	119	77H
24	18H	56	38H	88	58H	120	78H
25	19H	57	39H	89	59H	121	79H
26	1AH	58	3AH	90	5AH	122	7AH
27	1BH	59	3BH	91	5BH	123	7BH
28	1CH	60	3CH	92	5CH	124	7CH
29	1DH	61	3DH	93	5DH	125	7DH
30	1EH	62	3EH	94	5EH	126	7EH
31	1FH	63	3FH	95	5FH	127	7FH

(*) Decimal values such as MIDI channel, bank select, and program change are listed as one(1) greater than the values given in the above table.

(*) A 7-bit byte can express data in the range of 128 steps. For data where greater precision is required, we must use two or more bytes. For example, two hexadecimal numbers aa bbH expression two 7-bit bytes would indicate a value of aa x 128 + bb.

(*) In the case of values which have a +/- sign, 40H=-64, 00H=0, 3FH=+63, so that the decimal expression would be 64 less than the value given in the above chart.

In the case of two types, 40 00H = -8192, 00 00H = 0, 3F 7FH = +8191.

(*) Data marked "nibbled" is expressed in hexadecimal in 4-bit units.

A value expressed as a 20byte nibble 0a 0bH has the value of a x 16 + b.

<Ex.1> What 5AH in decimal system?

5AH = 90 according to the above table.

<Ex.2> What in decimal system is 12034H in hexadecimal of every 7 bit?

12H = 18, 34H = 52 according to the above table. So 18 x 128 + 52 = 2356.

<Ex.3> What in decimal system is 0A 03 09 0D in nibble system?

0AH = 10, 03H = 3, 09H = 9, 0DH = 13 according to the above table.

So (10 x 16 + 3) x 16 + 9) x 16 + 3 = 41885.

<Ex.4> What in nibble system is 1258 in decimal system?

```

16) 1258
   78 ... 10
   4 ... 14
   0 ... 4
    
```

0 = 00H, 4 = 04H, 14 = 0EH, 10 = 0AH according to the above table. So it is 00 04 0E 0AH.

● Example of system exclusive message and Checksum calculation

On Roland system exclusive message (DT1), checksum is added at the end of transmitted data (in front of F7) to check the message is received correctly.

Value of checksum is defined by address and data (or size) of the system exclusive message to be transmitted.

○ How to calculate checksum (Hexadecimal number is shown with H.)

checksum is a value which lower 7 bit of the sum of address, size and checksum itself turns to be 0.

If the address of the system exclusive message to be transmitted is aa bb ccH and data or size is dd ee ffH,

aa + bb + cc + dd + ee + ff = sum
sum /128 = quotient and odd

When odd is 0, 0 = checksum
When odd is other than 0, 128 - odd = checksum.

■ MIDI Machine Control (MMC) Command, Information Field/Response Reference

● Command Recognized

Command	Action
01H STOP	STOP
02H PLAY	PLAY
03H DEFFERED PLAY	PLAY
06H RECORD STROBE	REC / PUNCH IN
07H RECORD EXIT	PUNCH OUT
44H 00H LOCATE I/F	LOCATE (Read Locator)
44H 01H LOCATE TARGET	LOCATE (Desired Time)

● Commands Transmitted

Command	Action
01H STOP	STOP
03H DEFFERED PLAY	PLAY
06H RECORD STROBE	REC/PUNCH IN
07H RECORD EXIT	PUNCH OUT
44H 01H LOCATE TARGET	LOCATE

MIDI Implementation

PRODUCTION STUDIO

Date : Aug. 25, 2006

Model MV-8800

MIDI Implementation chart (Sequencer section)

Version : 1.00

Function...	Transmitted	Recognized	Remarks
Basic channel: Default Changed	All channels x	All channels 1-16	There is no specific basic channel.
Mode: Default Message Altered	x x *****	x x x	
Note number: True voice	o 0-127	o 0-127	
Velocity: Note On Note Off	o o	o o	
Aftertouch Key's Channel's	o o	o *1 o *1	
Pitch bend	o	o *1	
Control change 0-119	o	o *1	
Program change True number	o *****	o *1 0-127	
System exclusive	o	o *1	
System common: Quarter frames Song position Song select Tune request	o *1 o *1 x o	o *1 *2 o *1 x o	
Real time: Clock Command	o *1 o *1	o *1 o *1	
Aux message: All sound off Reset all controller Local On/Off All note off Active sensing System reset	o o o o *3 o x	o *2 *3 *4 o *4 o *2 *3 o *2 *4 o *2 x	
Notes	*1 o x selectable. *2 Not stored when received. *3 It can be created and transmitted using EVENT LIST screen. *4 All currently sounding notes are turned off.		

Mode 1: OMNI ON, POLY
Mode 3: OMNI OFF, POLY

Mode 2: OMNI ON, MONO
Mode 4: OMNI OFF, MONO

o: Yes
x: No

PRODUCTION STUDIO

Date : Aug. 25, 2006

Model MV-8800

MIDI Implementation chart (Sound generator section)

Version : 1.00

Function...		Transmitted	Recognized	Remarks
Basic Channel:	Default Changed	1-16 1-16	1-16 1-16	Memorized
Mode:	Default Messages Altered	Mode 3 x *****	Mode 3 Mode 3, 4(M=1) x	*7
Note number:	True voice	o 21-116	o 0-127	
Velocity:	Note On Note Off	o o	o o	
Aftertouch	Key's Channel's	o o *3	o *1 o *1	
Pitch bend		x	o	
Control change		1 x 5 x 7 x 10 x 11 x 64 x *4 65 x 66 x 68 x 71 x 72 x 73 x 74 x 84 x 91 x 93 x 0 - 119 o *3 *5	o *1 o o *1 o *1 o *1 o *1 o o o o o o o o o o o *6	Modulation Portamento time Volume Panpot Expression Hold 1 Portamento Sostenuto Legato foot switch Resonance Release time Attack time Cutoff Portamento control General purpose effects 1 General purpose effects 3
Program change	True number	o *3 *****	o *1 0-127	Patch Library 1-128
System Exclusive		o *3	x	
System common:	Quarter frames Song position Song select Tune request	x x x x	x x x x	
System real time:	Clock Commands	x x	x x	
Aux messages:	All sound off Reset all controllers Local On/Off All notes off Active sensing System reset	o o *3 o o *3 o o	o *2 x x o *2 x x	
Notes	*1 o x is selectable. *2 All currently sounding notes are turned off. *3 Transmitted when V-LINK is On. *4 Transmitted when Foot Switch Type is "Damper." *5 Transmitted when the control number is assigned to Assignable Sliders. *6 Received when the control number is assigned to Common Control Change Number. *7 Recognized as M=1 even if M ≠ 1			

Mode 1: OMNI ON, POLY
Mode 3: OMNI OFF, POLY

Mode 2: OMNI ON, MONO
Mode 4: OMNI OFF, MONO

o: Yes
x: No

Specifications

● MV-8800: PRODUCTION STUDIO

Sampler Section			
Audio Data Format		16-bit linear	
Sampling Frequency		44.1 kHz (fixed)	
Maximum Polyphony		64 voices	
Parts		16 (Instruments) + 9 (Audio Tracks) + 1 (Audio Phrases)	
Wave Memory (RAM)		DIMM: 1 slot (168 pins, PC100 CL = 2 or PC133 CL = 3, 3.3 V, 128 M bytes, 256 M bytes, 512 M bytes) 128 M bytes (standard) Expandable up to 512 M bytes (replacement to 512 M bytes DIMM is required.)	
Maximum Sampling Time	with 128 M bytes DIMM (standard)	mono: 24 min. approx. (stereo: 12 min. approx.)	
	with 512 M bytes DIMM (expanded)	mono: 100 min. approx. (stereo: 50 min. approx.)	
Effects	Multi-effects (MFX)	1 (25 types)	
	Reverb	1 (2 types)	
	Chorus	1 (4 types)	
	Mastering Tool Kit	1 (only in the Mastering Mode)	
Sequencer Section			
Tracks	Song	MIDI tracks (1 MIDI channel per track)	128
		Audio tracks	8
		Pattern track	1
		Tempo track	1
		Mute Control Track	1
	Pattern	MIDI tracks (1 MIDI channel per track)	64
Audio track		1	
Mute Control Track		1	
Resolution		480 TPQN	
Tempo		5–300	
Note Capacity		approx. 150,000 notes	
Song Length		9,999 measures	
Recording Method		Event recording (Realtime/Step) Audio recording	
Others			
Project	Songs		16
	Patterns		500
	Patches		16 (per Song)
	Partials		96 (16 pads x 6 banks per Patch)
	Samples		9,999
	Audio Phrases		512 (16 pads x 32 banks)
	Patch Libraries		128
	MIDI Clips		100
	Multi-effects (MFX) Libraries		144 (Preset: 44, User: 100)
	Chorus Libraries		52 (Preset: 2, User: 50)
	Reverb Libraries		54 (Preset: 4, User: 50)
	Mastering Tool Kit Libraries		76 (Preset: 26, User: 50)
	Still Images (Photos) for Pix Jam Function		16
Signal Processing	AD Conversion	24 bits, 64 times oversampling	
	DA Conversion	24 bits, 128 times oversampling	
Frequency Response	MIC/Line Inputs	20 Hz–20 kHz (+0/-2 dB)	
Nominal Input Level	MIC/Line Inputs	-50+14 dBu (maximum +26 dBu: balanced, maximum +20 dBu: unbalanced)	
	Phono Inputs	-87--27 dBu	
Input Impedance	MIC/Line Inputs	40 k ohms	
	Phono Inputs	50 k ohms	

Others (continued)														
Nominal Output Level		+4 dBu (balanced)												
Output Impedance		600 ohms												
Recommended Load Impedance	Master Outputs	10 k ohms or greater												
	Headphones	8–600 ohms												
Residual Noise Level		-86 dBu or less (SENS: LINE, Phono Input Jacks: short-circuited, IHF-A Typ.)												
Display		Graphic 320 x 240 dots backlit LCD (Color)												
Pads		16 Pads, Velocity and Aftertouch sensitive												
Controllers	Effects Control Knobs	C1–C3												
	Mixer Sliders	1–8												
Hard Disk Drive		2.5 inches, 40 G bytes												
CD-R/RW Drive		Built-in type CD-DA, CD-ROM, CD-R, CD-RW												
Connectors	Phono Input Jacks	L, R (RCA phono type)												
	MIC/Line Input Jacks	L, R (1/4 inch TRS phone type)												
	Master Output Jacks	L, R (1/4 inch TRS phone type)												
	Headphone Jack	Stereo 1/4 inch phone type												
	Digital Out Connector A	Coaxial type												
	Digital Out Connector B	Optical type												
	MIDI Connectors	IN, OUT A, OUT B												
	USB Connector	supports file transfer (mass storage class)												
	VGA Out Connector	HD DB-15 type												
	PS/2 Mouse Connector	6-pin mini DIN type												
	Foot Switch Jack	1/4 inch phone type												
AC Inlet														
Power Supply		AC 115 V, AC 117 V, AC 220 V, AC 230 V, AC 240 V (50/60 Hz)												
Power Consumption		35 W												
Dimension		480 (W) x 482 (D) x 136 (H) mm 18-15/16 (W) x 19 (D) x 5-3/8 (H) inches												
Weight		9.0 kg / 19 lbs 14 oz												
Operating Temperature		5–40 degrees centigrade / 41–104 degrees Fahrenheit												
Accessories		Owner's Manual, Screen Guide, Appendices, Booklet "Content Discs," Content Discs (CD-ROM), Mouse (PS/2), Mouse Pad, Power Cord, Short Pin												
Options		Foot Switch: BOSS FS-5U Pedal Switch: DP-2												
File Format Compatibility	<table border="1" style="width: 100%; border-collapse: collapse;"> <thead> <tr> <th style="width: 20%;"></th> <th style="width: 50%;">Import</th> <th style="width: 30%;">Export</th> </tr> </thead> <tbody> <tr> <td>From CD-ROM</td> <td> audio CD .WAV/AIFF, ACIDized file S-700 (Sample, Partial, Patch) AKAI MPC2000 (Program file (.PGM), Sound file (.SND)) AKAI S1000/3000 (Program, Sample) SMF (format 0/1) Still Image (.BMP/JPG) MV-8000 Patch, MV-8000 Project (backup data) </td> <td></td> </tr> <tr> <td>To CD-R/RW</td> <td></td> <td> audio CD MV-8800 Project (backup data) </td> </tr> <tr> <td>PC/Mac via USB</td> <td> .WAV/AIFF, ACIDized file KAI MPC2000 (Program file (.PGM), Sound file (.SND)) SMF (format 0/1) Still Image (.BMP/JPG) MV-8000 Patch, MV-8000 Project </td> <td> MV-8800 Sample, Audio Phrase (in .WAV/AIFF) MV-8800 Song, Pattern (in SMF (format 1)) </td> </tr> </tbody> </table>			Import	Export	From CD-ROM	audio CD .WAV/AIFF, ACIDized file S-700 (Sample, Partial, Patch) AKAI MPC2000 (Program file (.PGM), Sound file (.SND)) AKAI S1000/3000 (Program, Sample) SMF (format 0/1) Still Image (.BMP/JPG) MV-8000 Patch, MV-8000 Project (backup data)		To CD-R/RW		audio CD MV-8800 Project (backup data)	PC/Mac via USB	.WAV/AIFF, ACIDized file KAI MPC2000 (Program file (.PGM), Sound file (.SND)) SMF (format 0/1) Still Image (.BMP/JPG) MV-8000 Patch, MV-8000 Project	MV-8800 Sample, Audio Phrase (in .WAV/AIFF) MV-8800 Song, Pattern (in SMF (format 1))
	Import	Export												
From CD-ROM	audio CD .WAV/AIFF, ACIDized file S-700 (Sample, Partial, Patch) AKAI MPC2000 (Program file (.PGM), Sound file (.SND)) AKAI S1000/3000 (Program, Sample) SMF (format 0/1) Still Image (.BMP/JPG) MV-8000 Patch, MV-8000 Project (backup data)													
To CD-R/RW		audio CD MV-8800 Project (backup data)												
PC/Mac via USB	.WAV/AIFF, ACIDized file KAI MPC2000 (Program file (.PGM), Sound file (.SND)) SMF (format 0/1) Still Image (.BMP/JPG) MV-8000 Patch, MV-8000 Project	MV-8800 Sample, Audio Phrase (in .WAV/AIFF) MV-8800 Song, Pattern (in SMF (format 1))												

* (0 dBu = 0.775 V rms)

* In the interest of product improvement, the specifications and/or appearance of this unit are subject to change without prior notice.

Mixer Block Diagram

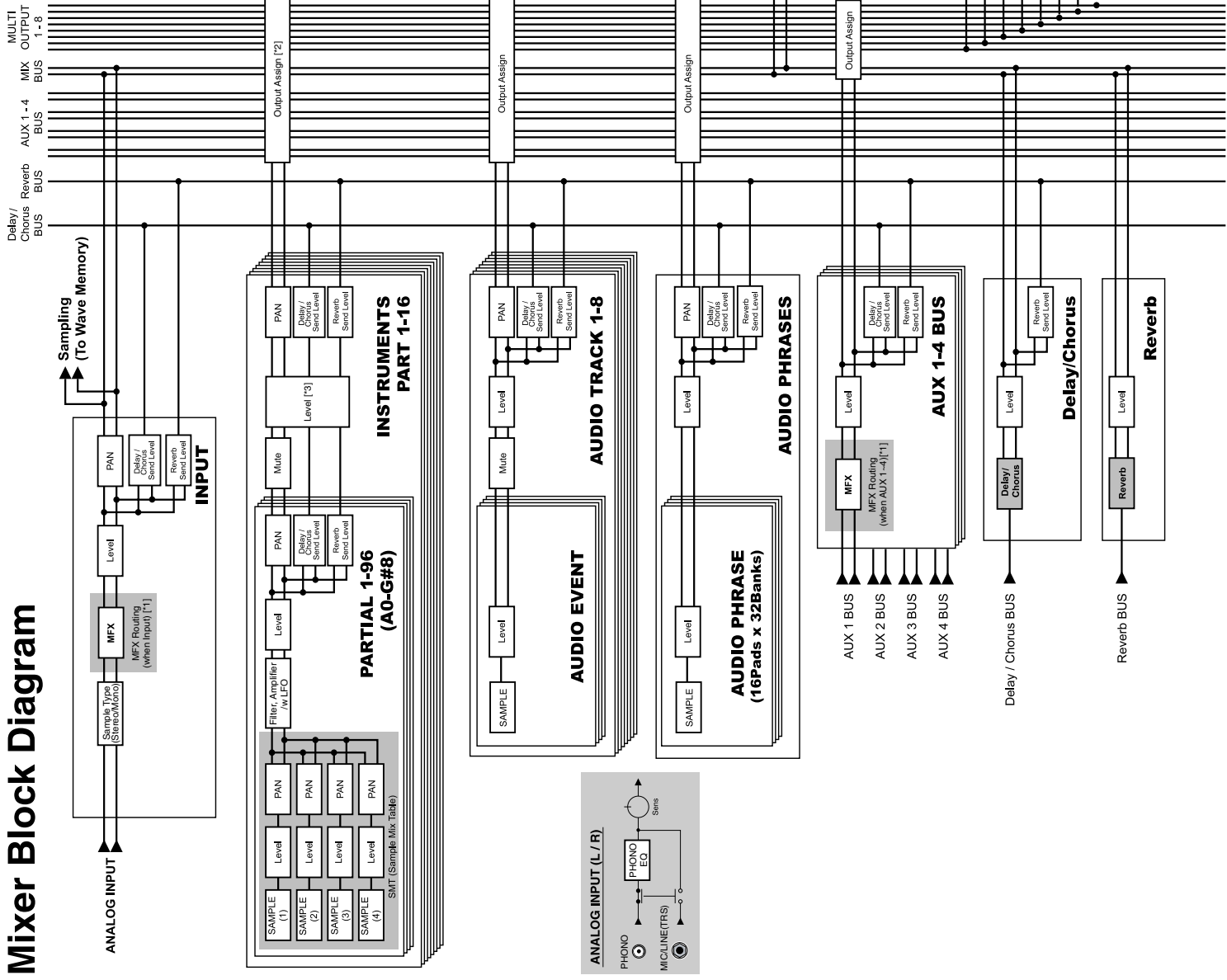

*1 Location of MFX can be set on Routing parameter in EFFECTS screen.
 You can select from Input, AUX 1-4 or Master.
 *2 In case Output parameter of the Instrument part is set to Partial, target of output follows to setting of Partial output.
 *3 Send level to Delay/Chorus and Reverb changes if part level parameter is changed.

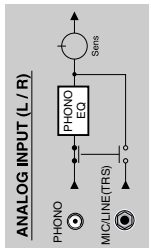



* 0 4 3 4 8 4 2 3 - 0 2 *

04348423

06-11-2N