



MIDI DIGITAL KEYBOARD RECORDER

MSQ-100

Owner's Manual



Warning – This equipment has been verified to comply with the limits for a Class B computing device, pursuant to Subpart J, of Part 15, of FCC rules. Operation with non-certified or non-verified equipment is likely to result in interference to radio and TV reception.”

The equipment described in this manual generates and uses radio-frequency energy. If it is not installed and used properly, that is, in strict accordance with our instructions, it may cause interference with radio and television reception.

This equipment has been tested and found to comply with the limits for a Class B computing device in accordance with the specifications in Subpart J, of Part 15, of FCC Rules. These rules are designed to provide reasonable protection against such a interference in a residential installation.

However, there is no guarantee that the interference will not occur in a particular installation. If this equipment does cause interference to radio or television reception, which can be determined by turning the equipment on and off, the user is encouraged to try to correct the interference by the following measure:

- Disconnect other devices and their input/output cables one at a time. If the interference stops, it is caused by either the other device or its I/O cable.

These devices usually require Roland designated shielded I/O cables. For Roland devices, you can obtain the proper shielded cable from your dealer. For non Roland devices, contact the manufacturer or dealer for assistance.

If your equipment does cause interference to radio or television reception, you can try to correct the interference by using one or more of the following measures:

- Turn the TV or radio antenna until the interference stops.
- Move the equipment to one side or the other of the TV or radio.
- Move the equipment farther away from the TV or radio.
- Plug the equipment into an outlet that is on a different circuit than the TV or radio. (That is, make certain the equipment and the radio or television set are on circuits controlled by different circuit breakers or fuses.)
- Consider installing a rooftop television antenna with coaxial cable lead-in between the antenna and TV.

If necessary, you should consult your dealer or an experienced radio/television technician for additional suggestions. You may find helpful the following booklet prepared by the Federal Communications Commission:

“How to Identify and Resolve Radio–TV Interference Problems”

This booklet is available from the U.S. Government Printing Office, Washington, D.C., 20402, Stock No. 004-000-00345-4.

1 Panel Description

1. Front Panel

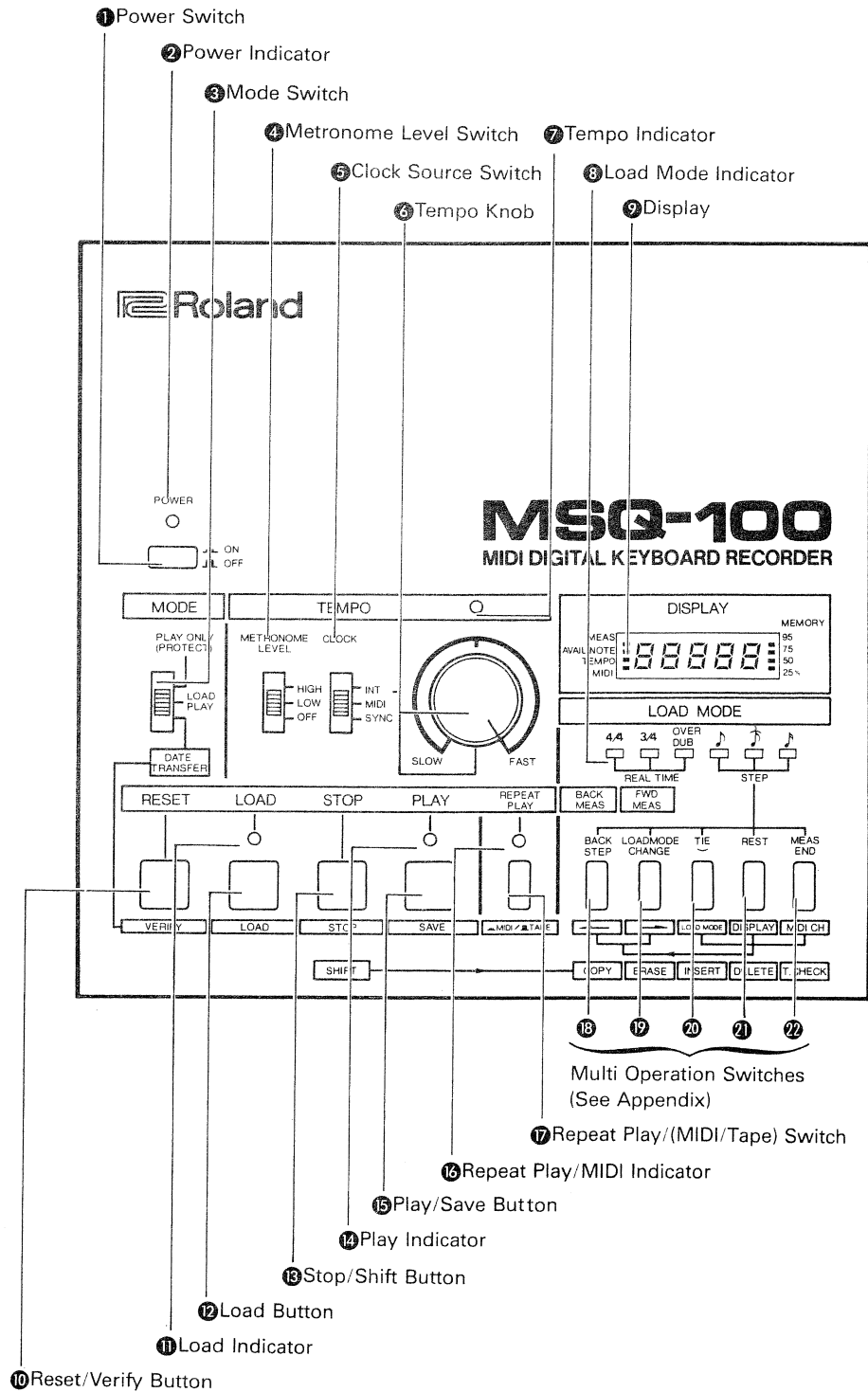

The Roland MSQ-100 Digital Keyboard Recorder is specially designed for polyphonic keyboards featuring MIDI.

Features

- Both Step Loading and Real Time Loading are possible.
- An Overdubbing function behaves like a Mix Down on recording equipment.
- Various edit functions are provided, allowing quick and easy data correction.
- The LCD is used for easy grasp of the current condition of the MSQ-100.
- A MIDI Channel Shift function makes it possible to change the MIDI Channel of the MSQ-100 (transmitter).
- The Start/Stop Jack offers a remote control option, for the start/stop function.
- Sync is possible by means of the DIN Sync or MIDI Clock.
- A Tape Interface function is included for saving the data in the MSQ-700's memory onto an ordinary audio tape.
- It is selectable whether or not to write Key Velocity (Dynamics) into memory.
- MSQ-100's memory capacity is 6100 single notes without velocity and 4900 single notes with velocity.

Contents

Features	P 4	4 Applications	P 24
Important Notes	P 5	1 DIN Sync	P 24
1 Panel Description	P 3	2 Real Time Loading (2)	P 24
1 Front Panel	P 3	3 Play (2)	P 25
2 Rear Panel		4 MIDI Channel Shift	P 25
«Function Switches»	P 6	5 Overdub (2)	P 26
2 Connection	P 8	a. Using one MSQ-100 and	
3 Operation	P 9	Sound Modules.	P 26
1 Load	P 9	b. Using two MSQ-100's.	P 27
a. Real Time Loading (1)	P 9	6 Channel Erase	P 28
«Metronome»		7 Sequencing a Rhythm Machine	
b. Step Loading	P 10	(with Dynamics).	P 28
2 Play (1)	P 14	5 Appendix	P 29
«Tempo Check»		6 Specifications	P 33
3 Overdub (1)	P 15		
4 Edit	P 16		
a. Copy	P 16		
b. Erase	P 17		
c. Insert	P 18		
d. Delete	P 18		
«Display»	P 19		
5 Data Transfer	P 20		
a. Saving data onto a tape.	P 20		
b. Transferring data by means of MIDI. .	P 23		

IMPORTANT NOTES

POWER SUPPLY

- The MSQ-100 uses an AC adaptor system. Be sure to use the supplied AC Adaptor. Using any other adaptor could cause malfunction or even break down.
- Do not turn the MSQ-100 on before connecting the AC Adaptor to it.
- This unit might not work properly if turned on immediately after being turned off. If this happens, simply turn it off, and turn it on again a few seconds later.
- Before setting up the MSQ-100 with an external synthesizer, be sure to turn both of them off.

LOCATION

- Using the MSQ-100 near a neon or fluorescent lamp may cause noise interference. If so, change the angle or position of the MSQ-100.
- Avoid using the MSQ-100 in extreme heat or humidity or where it may be affected by dust.

CLEANING

- Use a soft cloth and clean only with a mild detergent.
- Do not use solvents such as paint thinner.

OTHERS

- If the AC Adaptor is connected, turning the Power Switch off does not erase the data in memory, but about a day after the AC Adaptor is disconnected, its data will be completely erased. So it may be a good idea to save all data onto a cassette tape.
- Do not touch the Mode Switch ③ while the MSQ-100 is running. If you press it while loading, the data may be lost.
- To avoid accidental loss of the data, be sure to set the Mode Switch ③ to the Play Only (Protect) position when not loading, and while turning the unit on or off.

2. Rear Panel

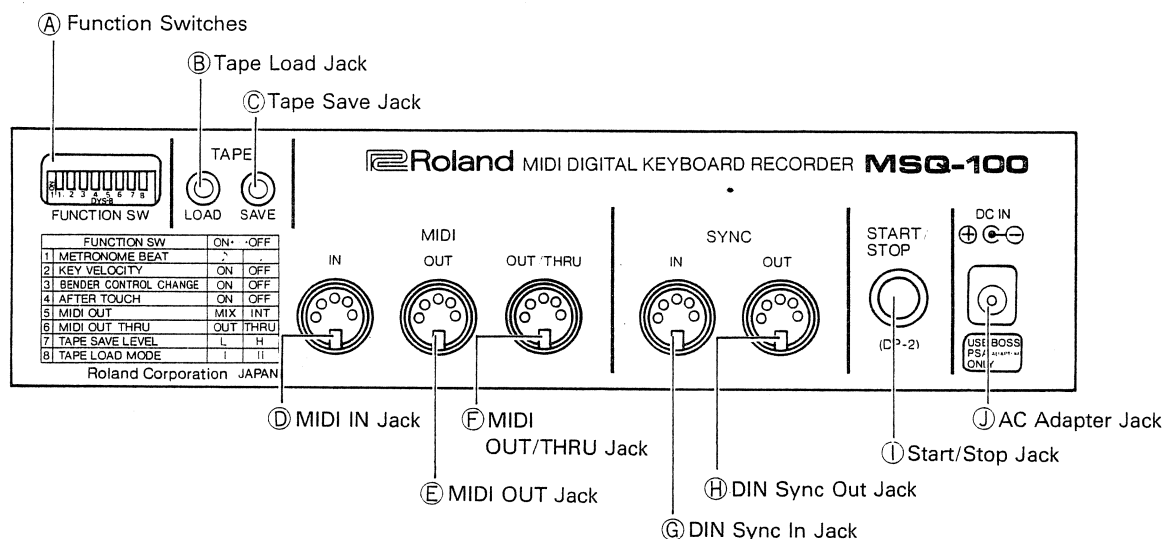

«Function Switches»

1. Metronome Beat Switch

(Do not touch this switch while the MSQ-100 is running.)

This selects the Metronome beat (♩ or ♪), for loading or playing.

2. Key Velocity Switch

(Do not touch this switch while the MSQ-100 is running.)

When this switch is set to ON, the Key Velocity information sent through MIDI is written into memory.

If you are using a Keyboard without the Key Velocity function (e.g. Juno-106), or do not want Key Velocity information to be written, turn this switch off. Thus, more notes can be loaded into the MSQ-100.

3. Bender/Control Change Switch

(Do not touch this switch while the MSQ-100 is running.)

With this switch on, Continuous Controller and/or Pitch Bender information received via MIDI, can be written into memory. Such information consumes much of the memory, thereby reducing the maximum number of notes to be loaded. So, do not turn this switch on, unless Bender or Continuous Controller information is needed to be written into memory.

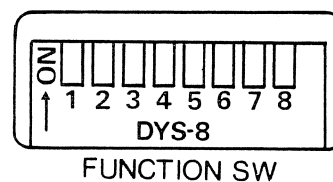

4. After Touch Switch

(Do not touch this switch while the MSQ-100 is running.)

When this switch set to ON, After touch information sent through MIDI can be written into memory. This, however, considerably reduces the memory capacity, so turn the switch off if you do not need After Touch information to be written into memory.

5. MIDI OUT Switch

(Do not touch this switch while the MSQ-100 is running.)

This switch can select the type of information sent from the MIDI OUT Jack of the MSQ-100.

When this switch is OFF (Internal), only the music data of the MSQ-100 is output.

e.g.) In a simple set up of one synthesizer and one MSQ-100, this switch is normally set to OFF.

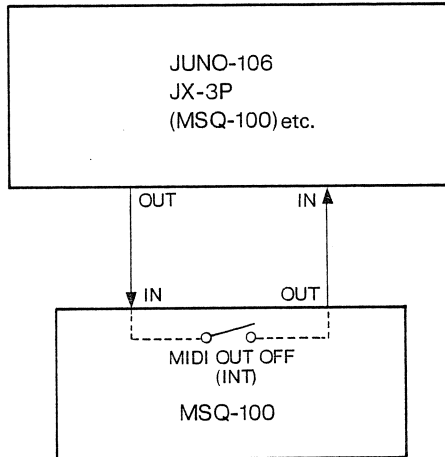

The HP-300/400 is an exceptional case. When controlling an external sound source, this switch would be on.

e.g.) When the MSQ-100 is set up between a Keyboard and Sound Module, this switch is normally set to ON. Otherwise the data cannot be sent from the keyboard to the Sound Module.

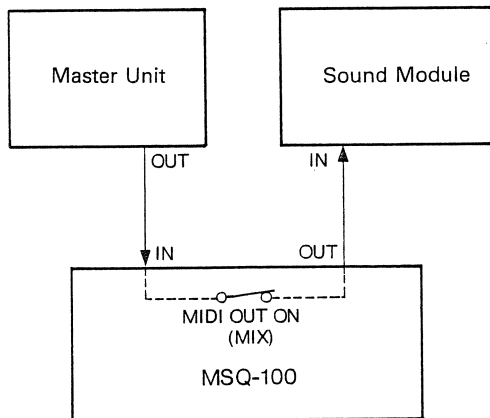

6. MIDI OUT/THRU Switch

(Do not touch this switch while the MSQ-100 is turned off.)

When this switch is set to ON, the MIDI OUT/THRU Jack serves as MIDI OUT. When OFF, it becomes a MIDI THRU (The signal fed into the MIDI IN Jack is output from this jack without being processed).

7. Tape Save Level Switch

(Do not touch this switch while the MSQ-100 is running.)

With this switch set to ON, a low Level Tape Save output is obtained. When it is set to OFF, a high Level Tape Save output (Line Level) is obtained.

8. Tape Load Mode Switch

(Do not touch this switch while the MSQ-100 is running.)

This switch selects the tone color in tape loading mode. Set it to mode II if using a normal tape recorder, and to I if a data recorder is used.

*To move the positions of these switches, use a thin implement such as the head of a ball-point pen, and do the job gently.

2 Connection

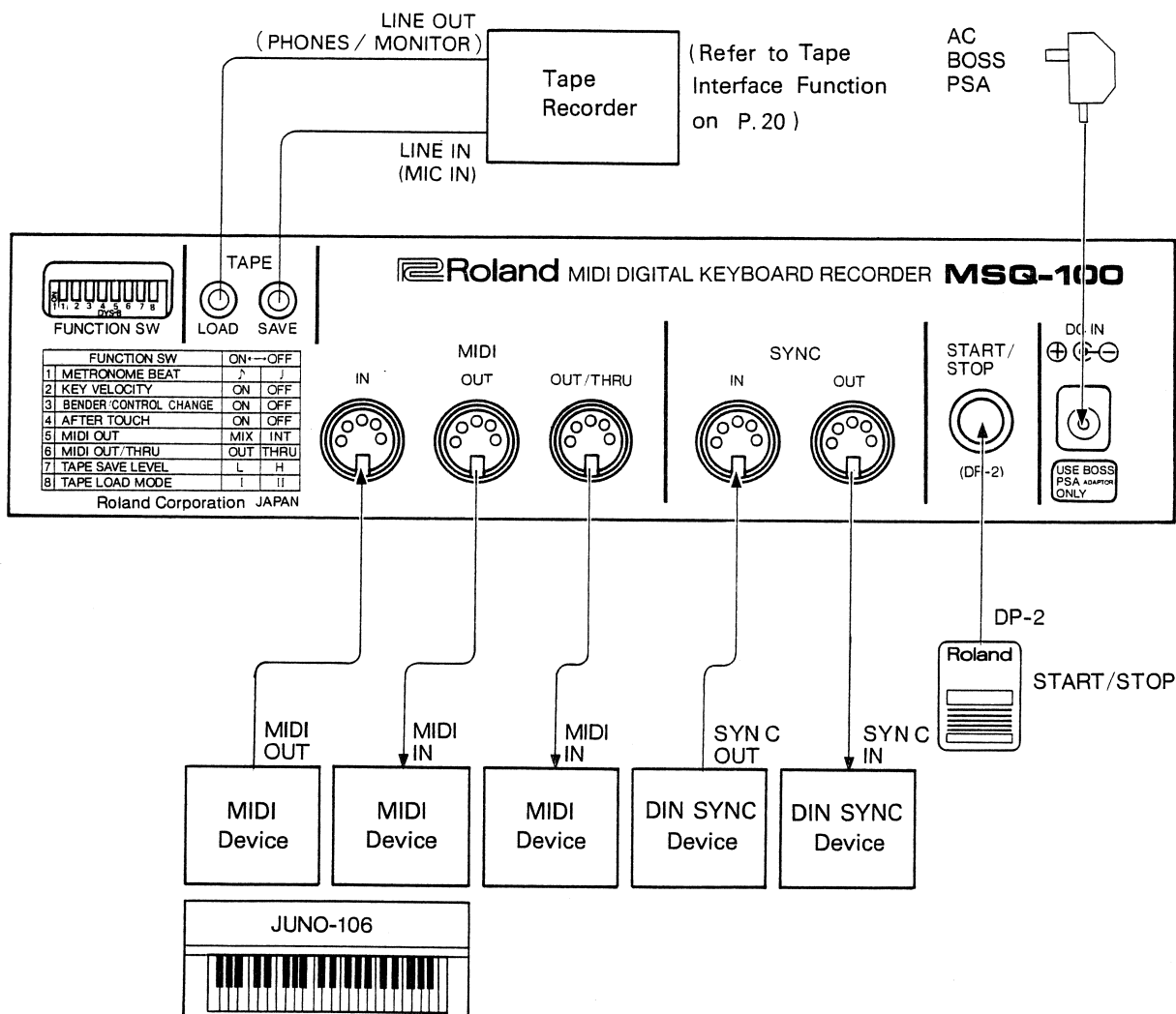

Keyboard with MIDI OUT	Sound Source with MIDI IN	Device with SYNC IN	Device with SYNC OUT
JUNO-106	JUNO-106	TR-606	TR-606
JX-3P	JX-3P	TR-808	TR-808
JP-6	JP-6	TR-909	
HP-300/400 *	HP-300/400 *	CR-8000	CR-8000
MKB-1000 *	MKS-10 *	MC-4	MC-4
	MKS-30 *	MSQ-700	MSQ-700
	TR-909 *	TB-303	JSQ-60
etc.	etc.	etc.	etc.

The device with "*" sends Key Velocity (Dynamics) information.
 The device with "*" receives Key Velocity (Dynamics) information.

Device sending Clock from MIDI OUT	Device receiving Clock from MIDI IN
TR-909	TR-909
MSQ-700	MSQ-700
PR-800	PR-800

3 Operation

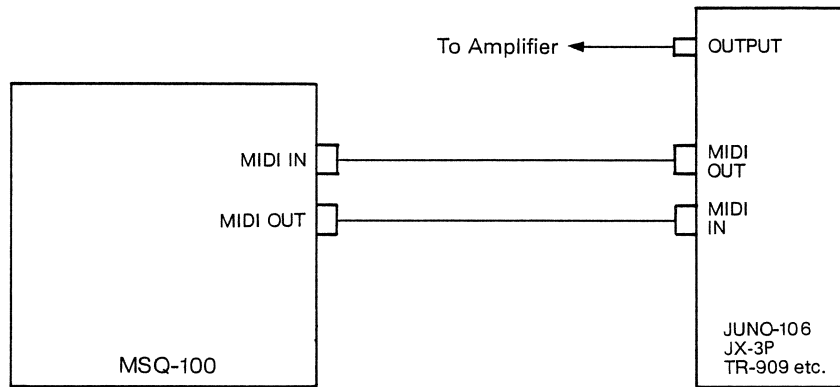

1. Load

In this manual, writing music data into memory is called "Loading". There are two methods of loading, Real Time Loading and Step Loading.

a Real Time Loading (1)

In this mode, what you play will be loaded exactly as it is played.

Normally, the performer plays to a metronome.

① Set the Mode Switch ③ to Load/Play (Protect off).

② While holding the Load Mode button ⑭, press ← ⑮ or → ⑯, selecting 4/4 or 3/4.

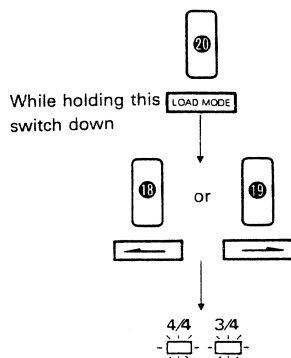

③ By using the Reset Key ⑩, Back Measure Button ⑰ and Forward Measure Button ⑱, go to the measure where you wish to start loading.

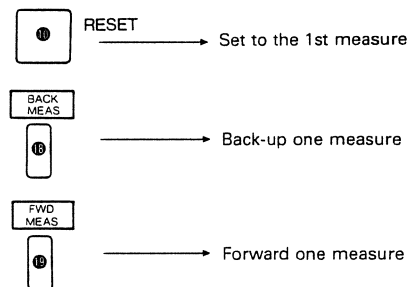

④ Set the Clock Source Switch to the Internal position.

* For sync to an external device, see "4 Applications, 2. Real Time Loading".

⑤ Set the Metronome Level Switch ④ to High or Low.

If you do not need the metronome sound at all, set it to off.

- ⑥ Press the Load Button 12
- The Load Indicator lights up and the Metronome will sound.
- Actual loading will start from the third measure. That is, what you have played before that will not be loaded, the first two bars being a tempo guide.

- * When the Display is in the Measure Mode, it will respond during the first 2 measures as shown below.

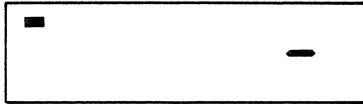

- ⑦ Press the Stop Key 13 when you have finished playing. The MSQ-100 runs up to the end of the measure then stops. The Load Indicator goes out.

b Step Time Loading

In this mode, pitches and key velocity can be loaded by playing the keyboard, and the timing value is loaded, step by step, by selecting a step time (♩, ♪, ♫).

e.g.)



- ① Find out the shortest note in the phrase, then represent the entire score using only multiples of this shortest timing value.

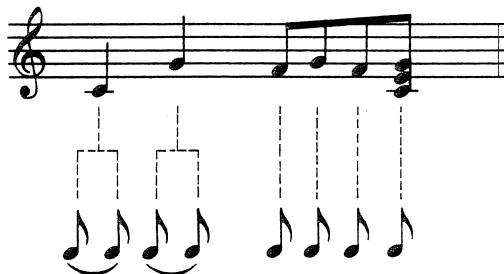

- ② Set the Mode Switch 3 to the Load/Play position (=Protect Off).

«Note»

- * If the whole memory capacity is used up during loading, the Display shows "FULL", and loading automatically stops. If this happens, the data will not be properly played.
- * If you press the Load Button with the Mode Switch 3 set to Protect, the Display Window Shows "PTEC" (protect), and loading is not possible.
Be sure to set the Mode Switch to Load/Play in loading mode.

- ③ While pressing the Load Mode Button, press the ← Button 18 or → Button 19 to set the Load Mode to the shortest timing value.
- In this example, select ♩.

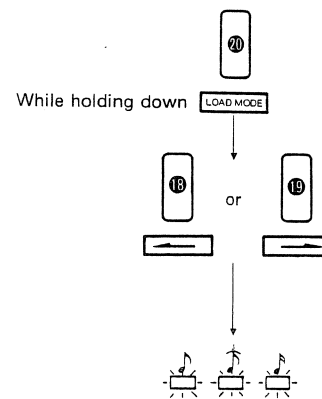

- ④ By using the Reset Button ⑩, Back Measure Button ⑬ and Forward Measure Button ⑭, go to the measure where you wish to start loading.
In this example, press the Reset Button to go to the very beginning.

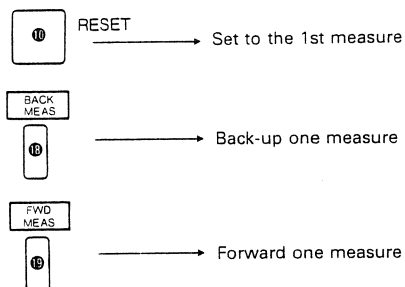

- ⑤ Press the Load Button ⑫.
The Load Indicator lights up and Step Loading starts.
From now on, the switches ⑬, ⑭, ⑮, ⑯ and ⑰ all work as shown in “* Multi Operation Buttons in Step Load mode.”

- ⑥ Load the music data by playing the instrument and using the switches ⑬, ⑭, ⑮, ⑯ and ⑰. A quarter note is considered to be a tie of two eighth notes, so press the Tie Button ⑳ after pressing a key.

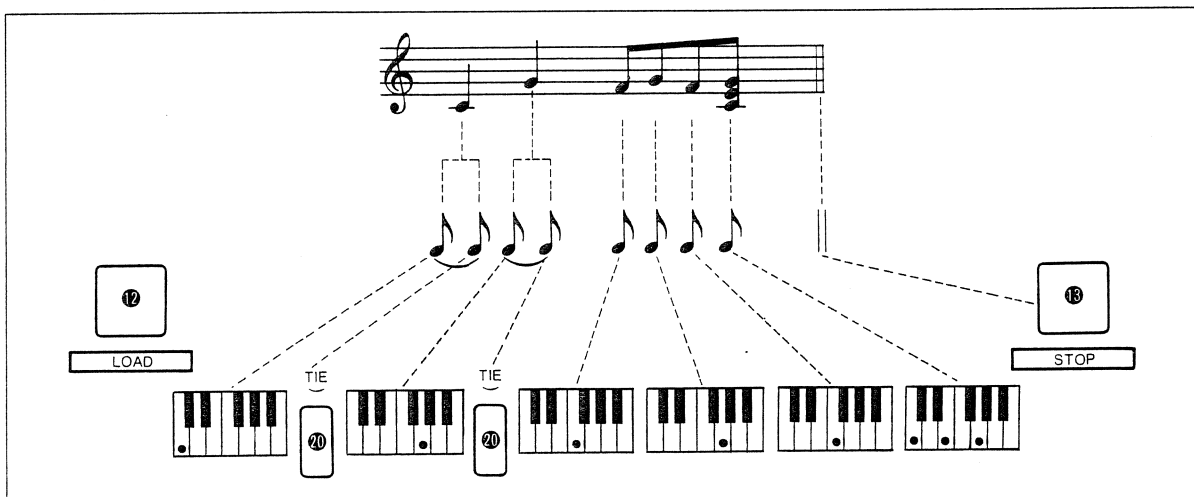

- ⑦ Press the Stop Button ⑬, if you have loaded the whole piece of music. Here, a bar line is automatically written.

*** Functions of Multi Operation Buttons in Step Load mode.**

- ⑬ Back Step
Press this Button, and the MSQ-100 will back up one step.
While this button is being used, the Display Window shows '←' (back) and any other operation is ignored.
- ⑭ Load Mode Change
Each time you press this button, the mode changes like

- ⑰ Tie
Press this button, and the note just played will become one step longer.
- ⑱ Rest
This button is used to write rests.
- ⑲ Measure End
This button is used to write bar lines.
This does not consume a step.

Loading a Tie (in ♪ mode)

Pressing the Tie Button will make the timing value one step longer.



Press them at precisely the same time. → Release the keys → Press the Tie Button three times.

Special Use of the Tie Button (in ♪ mode)

1) Legato

Load the first note in the usual way, and the next one by pressing the relevant key while holding the Tie Button down.



Release the key. → Press the Tie Button → Play D, E and F in non legato manner. → Release the Tie Button
 Keep the Tie Button held down.

2) Tie + Legato



Modify the score as shown left, then load in the same way as above.

* Each note, chord or rest is loaded as one step (= Shortest timing value set with the Load Mode Button).

* How you play the keyboard does not affect the timing value of each note, all the notes are loaded in the same length. Please note that the pitches are not loaded until all the Keys pressed are simultaneously released (please refer to "Note" below).

* If you wish to load a chord which cannot be pressed at the same time, switch on the Hold button on the keyboard (or the Damper Pedal), and play each key one after another, then switch off the Hold effect.

* If you do not write bar lines, later editing will be extremely difficult. Be sure to write a bar line at the end of each measure.

Note

If you want to load this figure  using the ♪ mode.

Play



Then release all the keys before you play



«Load Mode Change, Tie, Rest and Measure End Buttons»

(Starting with Load Mode = ♩)

e.g.)

To change the Load Mode from ♩ to ♪, press the Load Mode Change Button 19 twice. This is because the mode changes like ♩ → ♪ → ♩.

- * The shortest timing value is counted as one step, so if ♩ = 1 step, ♪ = 2 steps and ♫ = 4 steps. Likewise, if ♪ = 1 step, ♩ = 2 steps and ♫ = 4 steps.

By using this arithmetic, to load ♫ when ♩ = 1 step, there are four different ways as shown right.

These are 4 phases of expression from Tenuto to Staccato.

- * In Step Loading mode, only pitches and key velocity data can be loaded. If you wish to write patch numbers etc., later overdubbing will be required.
- * If the whole memory capacity is used up during loading, the MSQ-100 will automatically stop loading.

«Metronome»

The Metronome function is available in Real Time Loading or Play mode.

The beat of the Metronome can be set to either whole (♩) or half (♪) a beat.

- * The first beat of a measure has an accent.
- * The volume of the metronome can be selectable between High and Low with the Metronome Level Switch 4.

If you do not want the metronome at all, set it to OFF.

«Loading 1/16 Quint, Triplet and 1/32 note»

♩, ♪ and ♫ can be loaded into the MSQ-100, by changing the Load Mode from the usual ♩ ♪ ♫ to ♩ ♪ ♫.

- 1 Make sure that the MSQ-100 is in the Step Loading mode.
- 2 While holding the Reset Button down 10, press the Load Mode Change Button 19 down to select the desired timing value.
- 3 To go back to ♩ ♪ ♫ mode, simply press the Load Mode Change Button (without holding the Reset Button down).

2. Play (1)

- ① Set the Mode Switch ③ to Play Only or Load/Play.
- ② By using the Reset Button ⑩, Back Measure Button ⑬ and Forward Measure Button ⑭, go to the measure where you wish to start playing.

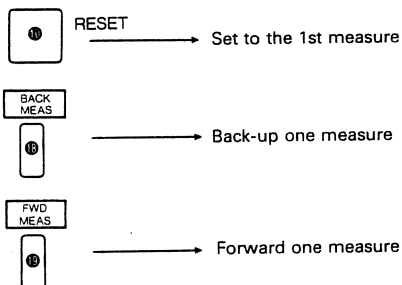

- ③ Set the Clock Source Switch ⑤ to the Internal position.
- * For Sync with an external device, refer to 3 Play (2) of ④ Applications.

«Tempo Check»

To see the current tempo of the MSQ-100, press the Tempo Check Button ⑳ while holding the Shift Button down. Then the Display will show the tempo, and the metronome will sound keeping the same tempo.

To cancel this mode, simply press the Reset Button ⑩ or Stop Button ⑬.

- * During this Tempo Check mode, the MSQ-100 does not output any music data, therefore the connected device (Sound Module) does not run. Thus, this mode can be effectively used during live performance for tempo adjustment of the next piece of music.

- ④ Press the Play Button ⑮. The Play Indicator lights up and the music data will be played.

* If you wish to play the same music data repeatedly, set the Repeat Play Switch ⑰ to ON. At the OFF position, play will automatically stop at the end of the music data.

- ⑤ To stop playing in the middle of the data, simply press the Reset Button ⑩, or the Stop Button ⑬.

(a) If you press the Reset Button ⑩, the MSQ-100 will immediately stop playing and go back to the 1st measure.

(b) If you press the Stop Button ⑬, the Play Indicator starts flashing, and the MSQ-100 keeps playing the music data up to the end of the measure, then it stops running.

- * If there is no more data following, pressing the Play Button ⑮ will cause the Display to show *End*. If so, press the Back Measure Button or Reset Button, then press the Play Button.

Tempo J =120

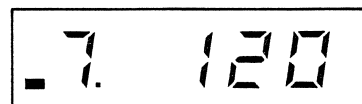

3. Overdub (1)

The overdub mode allows you to add more data on top of existing data. While listening to the existing data playing, you can overdub new data in real time.

- ① Set the Mode Switch ③ to Load/Play.
- ② By using the ← Button ⑮, → Button ⑯, and Mode Button ⑳, set the Load Mode to Overdub.

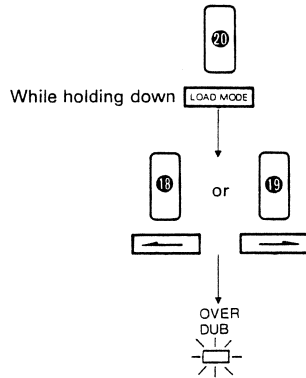

- ③ By using the Reset Button ⑩, Back Measure Button ⑮ and Forward Measure Button ⑯, go to the measure where you wish to start overdubbing.

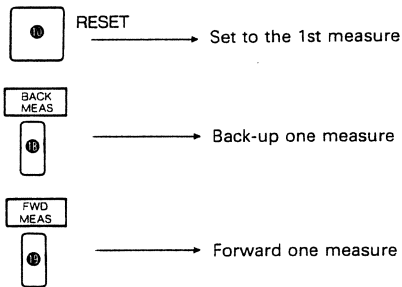

- ④ An Overdub can be done in exactly the same way as Real Time Loading, but note that the MSQ-100 stops at the end of the existing data. If you wish to stop overdubbing in the middle of the existing data, press the Stop Button ⑬, and the MSQ-100 will stop at the end of the measure. The rest of the music data will be retained.

* During this overdubbing, the new data and existing data are merged, becoming one complete new data. Therefore, it is not possible to separately delete any errors you have made in playing the keyboard. To correct an error, you need to delete the measure that contains the error, and insert the correct data there. (See "Edit" on P.16)

* It may be a good idea to save the base data before overdubbing onto a tape. In this way, even if you have made an error in overdubbing, you can simply load the data back into the MSQ-100 and try again. (Refer to "Data Transfer on P.20)

4. Edit

The MSQ-100 features the Edit functions of Copy, Erase, Insert and Delete.

* When the MSQ-100 is in the Edit mode the Display Window shows the measure number currently being edited.

If you wish to cancel the Edit mode, simply press the Stop Button 13.

a. Copy

The Copy function allows you to copy a measure of the existing music data.

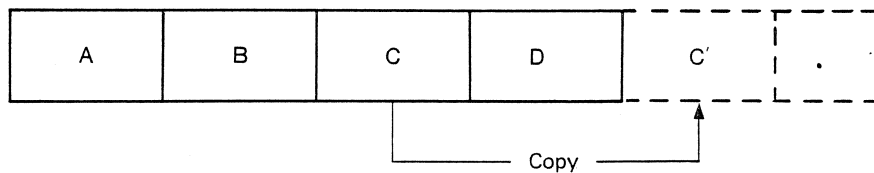

For instance, if you have loaded 4 measures, but wish to copy the 3rd measure to the end of the existing data (to the 5th measure), do as follows.

① Set the Mode Switch 3 to Load/Play.

② By using the Reset Button 10, Back Measure Button 18 and Forward Measure Button 19, assign the measure number to be copied (original measure).

In this example, assign the 3rd measure.

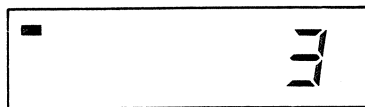
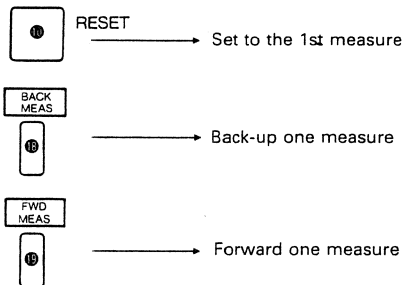

③ While holding the Shift Button down, press the Copy Button 13. Thus, the MSQ-100 is set to the Copy mode.

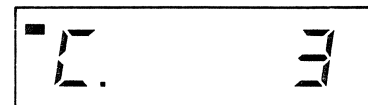
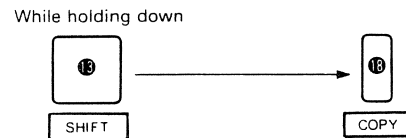

④ Press the Load Button 12, and the data of the measure shown in the Display will be copied to the end of the existing data. Then the display shows the next measure. In this example, 4 is displayed.

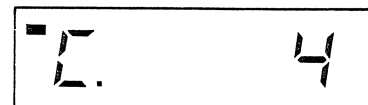

⑤ Pressing the Stop Button 13 or Reset Button 10 will cancel the Copy mode.

Example Operation

By repeating this procedure ④, as many measures as required can be copied.

* When the data to be copied (Original) consists of more than one measure, and also includes Bender effect, the copied data may not be played correctly.

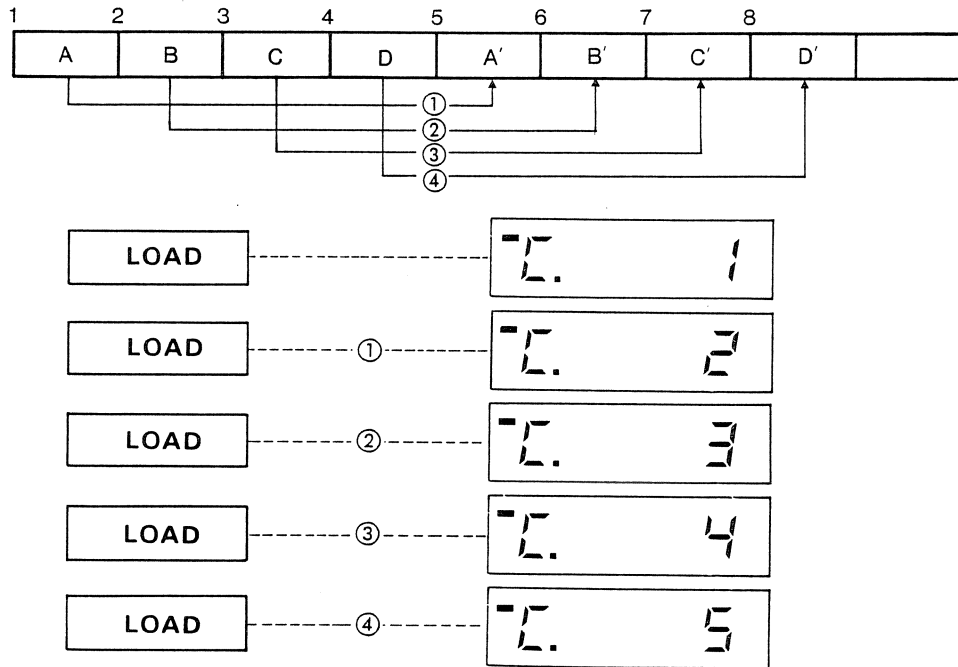

b. Erase

The Erase mode allows you to delete from any measure to the end of the data.

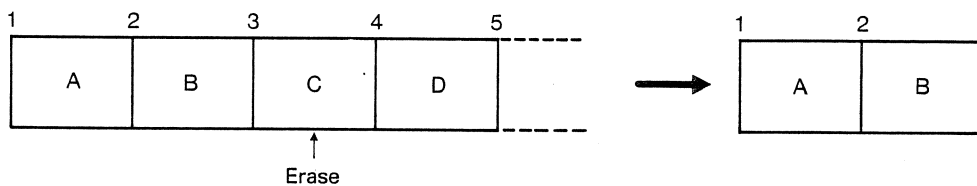

① Set the Mode Switch ③ to Load/Play.

② By using the Reset Button ⑩, Back Measure Button ⑪ and Forward Measure Button ⑫, go to the first measure of the data to be deleted.

③ While holding the Shift Button ⑬ down, press the Erase Button ⑭ to turn the MSQ-100 to the Erase mode.

While holding down

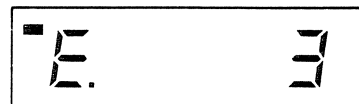
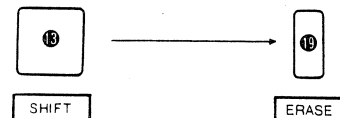
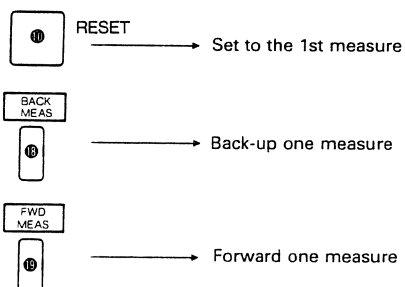

④ Press the Load Button ⑬, and the data is erased from the assigned measure (shown in the Display) to the end. Then the Erase mode is automatically cancelled.

c. Insert

The Insert mode allows you to insert a measure of music data into the existing data.

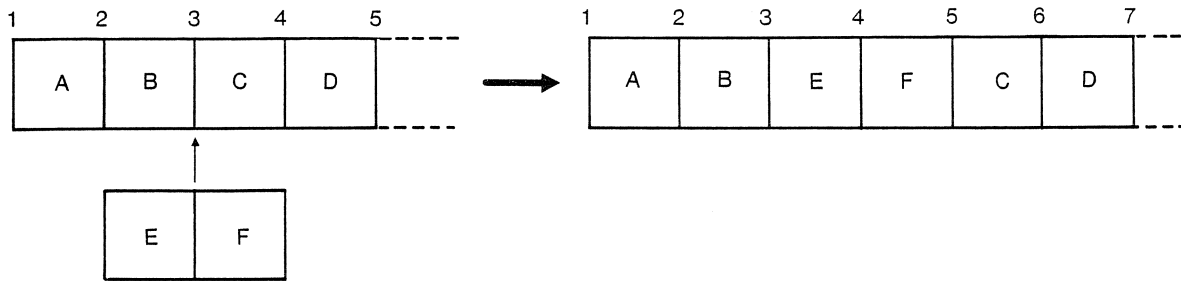

- ① Set the Mode Switch ③ to Load/Play.
- ② By using the ← Button ⑬, → Button ⑭ and the Load Mode Button ⑮, select any Load Mode you like except for Overdub.
- ③ By using the Reset Button ⑩, Back Measure Button ⑬ and Forward Measure Button ⑭, go to the measure where you wish to insert new data.

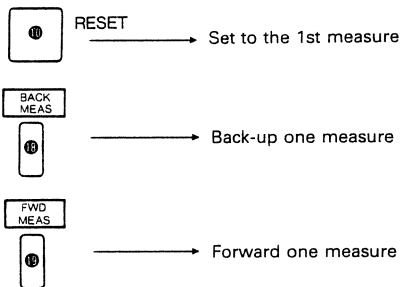

- ④ While holding the Shift Button ⑬ down, press the Insert Button ⑯, and the MSQ-100 is turned to the Insert mode.

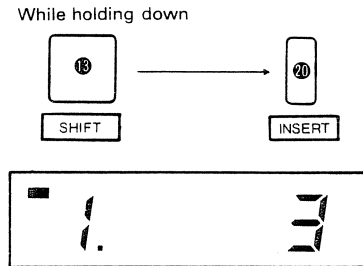

- ⑤ Press the Load Button ⑫, and write music data in the usual way, Step Load or Real Time Load (Depending on which Load Mode you have selected in procedure ②).
- ⑥ When you press the Stop Button to stop loading, the Insert mode is automatically cancelled.

d. Delete

The Delete mode allows you to delete any measure of the existing data.

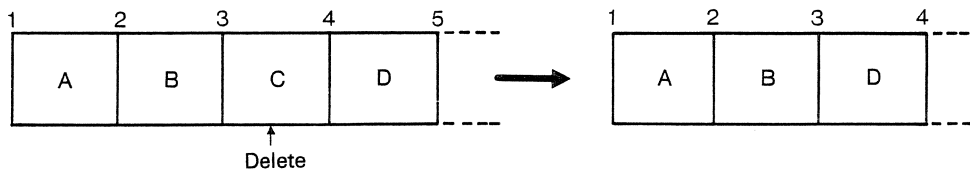

- ① Set the Mode Switch ③ to Load/Play.
- ② By using the Reset Button ⑩, Back Measure Button ⑬ and Forward Measure Button ⑭, go to the measure you wish to delete.

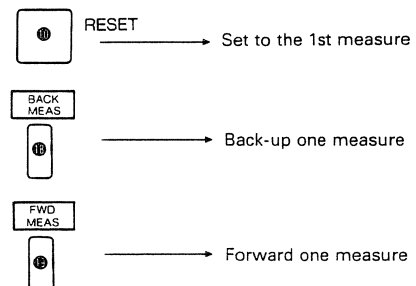

- ③ To turn the MSQ-100 to the Delete mode, press the Delete button ② while holding the Shift Button ⑬ down.

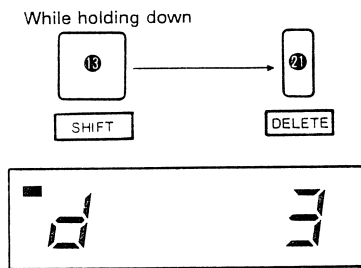

«Note»

* All the Edit operations are done measure by measure. Therefore, it is necessary to get to the beginning of the measure before setting the MSQ-100 to an Edit mode. It is not possible to set it to the Edit mode in the middle of a

- ④ Press the Load Button ⑫, and the measure will be deleted. If you wish to delete the next few measures, just press the Load Button as many times.

- ⑤ Press the Stop Button ⑬, or reset Button ⑩, and the Delete mode will be cancelled.

measure. (The display shows *HALF*.) If this happens, go to the beginning of the measure by using the Reset Button ⑩, Back Measure Button ⑬ or Forward Measure Button ⑭.

«Display»

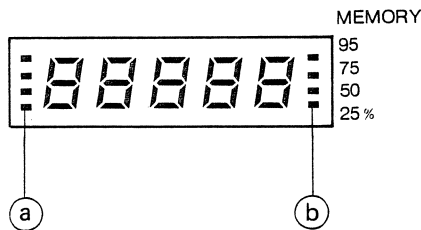

a. Display Mode Change

This function allows you to select any Display mode; Measure, Available Note, Tempo or MIDI Channel Shift.

While holding the Display Button ②, press the ← ⑬ or the → ⑭ Button, and the Display mode changes. The indicators ① show which one of the Display modes is currently chosen.

(1) Measure (MEAS)

In this mode, the measure currently loading, playing, and/ or being edited will be shown in the Display. When the MSQ-100 is first switched on, or turned to the Edit mode, the Measure mode is automatically selected.

(2) Available Note

The display shows how much more data can be loaded into the MSQ-100's memory. (This number, however, does not represent the exact number of notes available, so use it to roughly gauge memory consumption.)

(3) Tempo

The Display shows the tempo of the clock selected with the Clock source Switch ⑤. When the MSQ-100 is in wither MIDI or DIN Sync mode, if no external unit is connected to the MSQ-100, or the clock is extremely slow or stopped, the Display shows " *SL0* " (slow).

Turning the MSQ-100 to Tempo Check mode will automatically set it to this Tempo Display mode.

(4) MIDI Channel Shift

The number shown in the Display represents how much is to be added to, or subtracted from, the previous MIDI Channel number. When there is no alteration of the MIDI Channel number (Channel Shift number = 0), "—" is shown. (See 4. MIDI Channel Shift on P.25.)

b. Memory Indicators

These indicators ② show how much memory has been consumed so far, by percentage of 0, 25, 50, 75 and 95%.

* Regarding the Display response in Data Transfer mode, see "5. Data Transfer on P.20.

5. Data Transfer

The MSQ-100 features a Tape Interface function that allows you to save the data in memory onto a tape. Moreover, data transfer between two MSQ-100's is possible by means of MIDI.

a. Tape Interface Function

- Connection

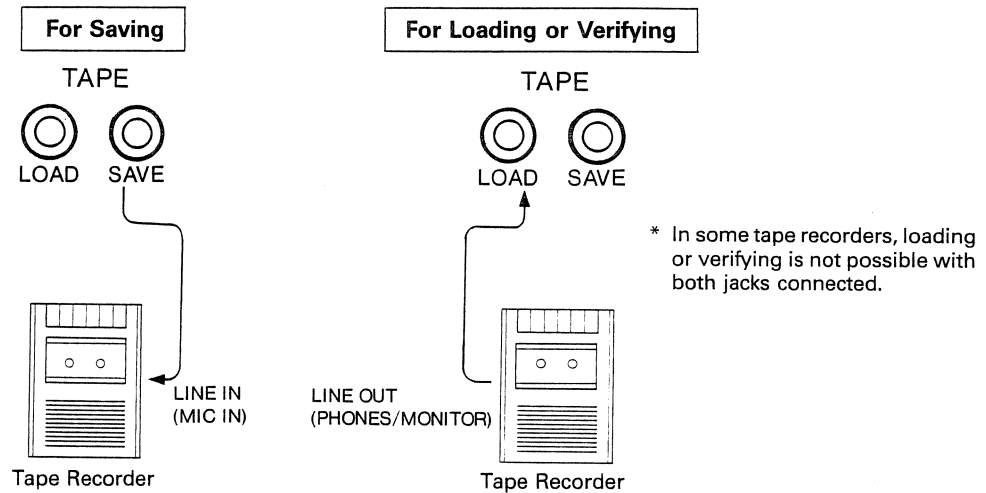

- * **Save** Recording the music data in memory onto a tape
- * **Verify** Ensuring that the data is properly saved
- * **Load** Calling the data saved on a tape into the memory

Please make it a rule to verify immediately after saving.

- * To leave Save, Load or Verify mode in the middle of the operation, just press the Stop Button **13**.

1 Save

- ① Set the Mode Switch **3** to Data Transfer, and the Repeat Play Switch **17** to Tape. The Display shows "TAPPE".
- ② Start tape recording.
- ③ Press the Save Button **15**.
The Display shows "5" (save) and a Pilot tone* will be heard. In about 5 seconds, data transfer will start. (During data transfer, Metronome will sound at a certain tempo.)

- * A Pilot tone is a high pitched sound heard before data transfer begins.

- ④ When data transfer is finished, the Display shows "5.G.O.O.D" (save good).
- ⑤ Stop the tape recorder and press the Stop Button **13** on the MSQ-100.

- * The data in the MSQ-100's memory can be retained even when the power is switched off, as long as the AC Adaptor is connected. If, however, the AC Adaptor is disconnected, the data in the memory will be lost in about a day. It may be a good idea to save the data you have made onto a tape to avoid accidental loss.

2) Verify

- ① Rewind the tape to the beginning of the data. If your tape recorder features a playback level control, set it to medium volume.
- ② Set the Mode Switch ③ to Data Transfer, and the Switch ⑰ to Tape. The Display shows "TAPPE".
- ③ Press the Verify Button. The display shows "V" (verify).
- ④ Play the tape recorder. When the head of the data is found, verification will begin. (During verification, the metronome will sound at a certain tempo.)
- ⑤ When verification is finished, the Display shows "VGOOD" (verification good). If "VERR" is shown instead, repeat the verification procedure. Please read "Notes on Verify and Load".
- ⑥ Stop the tape recorder, then press the Stop Button ⑱ on the MSQ-100.

3) Load

- ① Rewind the tape to the beginning of the data. If your tape recorder features a playback level control, set it to medium.
 - ② Set the Mode Switch ③ to Data Transfer and the Repeat Play Switch ⑰ to Tape. The Display shows "TAPPE".
 - ③ Press the Load Button. The Display shows "L" (load).
 - ④ Play the tape recorder. When the head of the data is found, the Display shows "L F" (data found), and loading will start. (During loading, the metronome will sound at a certain tempo.)
 - ⑤ When loading is completed, the Display will show "LGOOD" (loading good). If a Load Error "LERR" is indicated, repeat the load procedure. Please read "Notes on Verify and Load".
 - ⑥ Stop the tape recorder, and press the Stop Button ⑱ on the MSQ-100.
- * If loading or verification is not completed within a few minutes, there must be an error.

Notes on Verify and Load

If an error is indicated during the verify or load operation, repeat the operation, taking care of the following points.

(1) When to press the Button

Be sure to press the Verify Button ⑩, or Load Button ⑫, before data transfer begins.

(2) Level Adjustment

Adjust the playback level of the tape recorder. (The appropriate level varies depending on the type of tape recorder.)

(3) Connection

Be sure that the connections are all made correctly, and securely.

If your tape recorder has two kinds of IN/OUT jacks (i.e. MIC/LINE IN, EAR/LINE OUT, etc.), try using different ones this time.

Some tape recorders do not allow proper operation when both Save and Load connection are made at the same time, so make only the relevant connection.

(4) Tape you use

Use a high quality tape.

If it is possible, use a new tape. An old tape is more likely to have dropouts.

Use a tape shorter than a C-60. The one longer C-90 is too thin for a proper result in saving.

(5) Where to start saving

Run the tape for a while before actually saving, to avoid the head of the tape.

(6) Tape Recorder

Try using the same tape recorder for saving and loading, so that the possibility of error will be reduced.

Playback the data tape in the same track system as it was saved. If the data has been saved in monaural, it is no use playing it in stereo.

Clean and demagnetize the head of the tape recorder.

(7) Tape Load Mode

Change the position of the Tape Load Mode switch ⑨ in the Function Switches (A).

(8) Tape Save Level

Change the position of the Tape Save Level ⑧ in the Function Switches (A).

* If an error is still indicated, use a different tape recorder and repeat the procedure.

Preserving Data Tapes

Please do not keep the data tape in extreme heat, or humidity or near strongly magnetic units such as a speaker, or an amplifier.

b. Data Transfer through MIDI

Between two MSQ-100's, music data can be communicated by means of MIDI Exclusive messages.

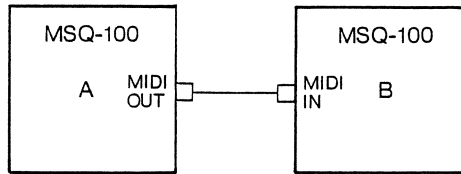

How to transfer data from A to B

- ① On both A and B, set the Mode Switches ③ to Data Transfer, and the Switch ⑰ to MIDI. The display shows "E L U" (Exclusive).
- ② Press the Load Button ⑫ on B (receiver). The Display will show "L" (load), and B will be in standby mode.
 - * When reading data is impossible, "L E R" (load error) will be indicated. If so, see if the connections have been correctly and securely made.
- ③ Press the Save Button ⑮ on A (transmitter). The Display will show "S" (save), and A will begin transfer.
- ④ When transfer is completed, A (transmitter) will show "S E D" (save end) in the Display Window, while the Display on B (receiver) shows "L E D" (load end).
- ⑤ Press the Stop Button of both units A and B. (This also applies to stopping transfer in the middle.)

4 Applications

1. DIN SYNC

The MSQ-100 can be perfectly synchronized with the device featuring the DIN Sync function.

a DIN SYNC IN Jack

Connect this jack to the SYNC OUT of the external device. Then set the Clock Source Switch ⑤ to SYNC. The MSQ-100 serves as a Slave unit (being controlled by an external unit), therefore the external unit controls the tempo, start/stop function, etc.

b DIN SYNC OUT

Connect this jack to the SYNC IN of the external device, then set the Clock Source Switch ⑤ to the proper position, depending on how the units are set up. If the MSQ-100 serves as a Master unit (controlling the external device), set the switch to the Internal position.

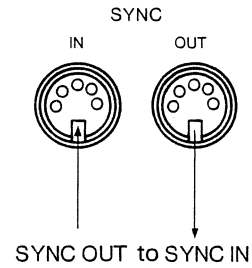

* When the MSQ-100 is a slave, and not playing, the Start signal sent from the external unit will always start the music data from the beginning.

2. Real Time Loading (2)

Even when the MSQ-100 is synchronized with an external device such as a rhythm machine or sequencer, the Real Time Load function is still available.

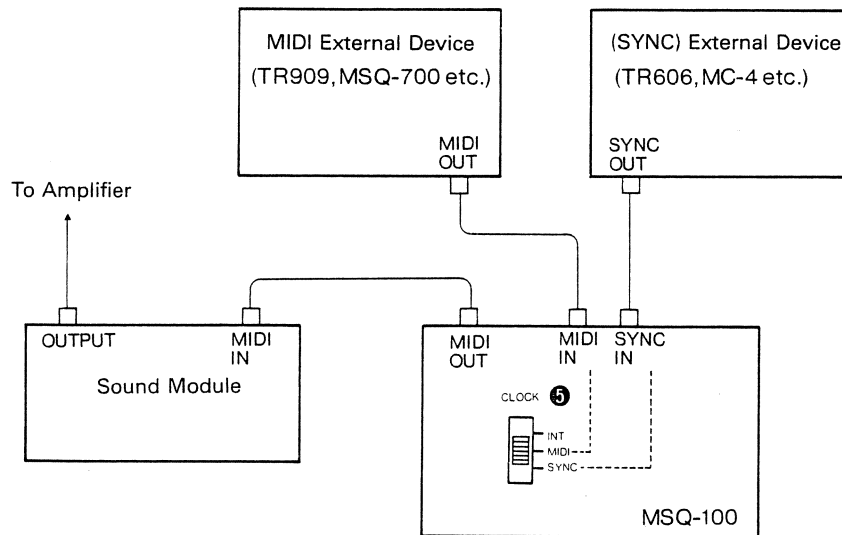

- ① Repeat the procedures ① to ③ of Real Time Loading (1).
- ② Select either MIDI or SYNC depending on the type of external device, by using the Clock Source Switch ⑤.
- ③ Press the Load Button ⑫. The Load Indicator lights up and the MSQ-100 is in the standby mode.
- ④ The moment the external device starts playing, loading automatically starts. That is, it is not the same as Real Time Loading (1) that gives two measures of metronome before the actual loading starts.
- ⑤ While the last measure of the music is being played, stop the external device. The MSQ-100 stops at the end of the measure, and the Load Indicator goes out.

3. Play (2)

You can playback the data loaded in the MSQ-100, while synchronized with an external device.

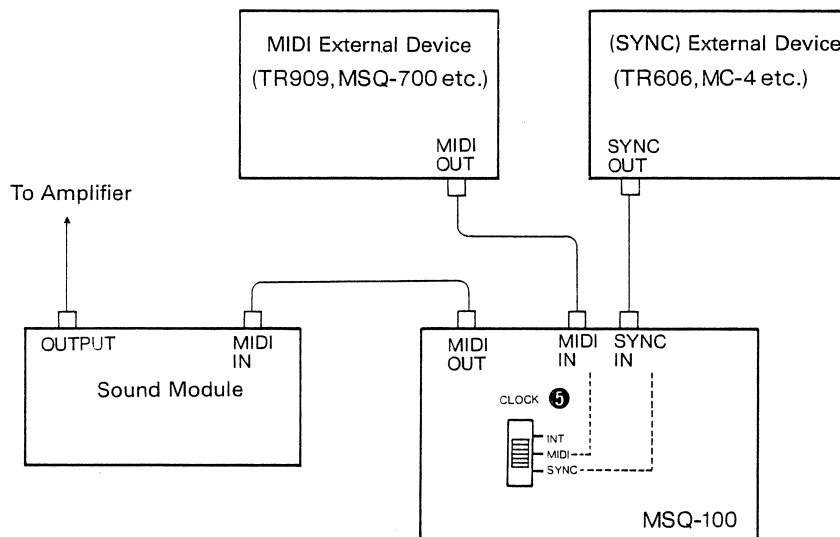

- ① Take the same procedures in ① and ② of Play (1).
- ② Select either MIDI or SYNC depending on the type of external device, with the Clock Source Switch.
- ③ The moment the external device starts playing, the Play Indicator lights up and the MSQ-100 starts playing the music data.
- ④ As soon as the external device stops, the MSQ-100 stops playing.

4. MIDI Channel Shift

This function makes it possible to use different MIDI Channels for loading the information received from the MIDI IN. If the MIDI OUT ⑤ of the Function Switches ① is set to the ON position (Mix), the information received from the MIDI IN will be transmitted from MIDI OUT on the new channel.

- ① Make sure the MSQ-100 is not running.
- ② Press the MIDI Channel Button **22**. The Display will show a number as long as the button is pressed down.
 - * The number shown in the Display means the number added to or subtracted from the current MIDI Channel number. In this manual, we call this the Channel Shift number.
 - * The Channel Shift number is zero right after power on, and the Display reacts as shown below.

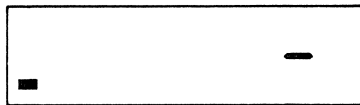

* If this new channel number happens to be less than zero, or bigger than 17 (such as -2, -5, 18 or 20 etc.), that will be ignored. Therefore, it is not transmitted or loaded.

• **Example**

Information is received on MIDI Channel 2. The number shown in the Display (Channel Shift number) is 5. → The new MIDI Channel is $2 + 5 = 7$.

Information is received on MIDI Channel 10. The number in the Display (Channel Shift) = -4 → The new MIDI Channel is $10 + (-4) = 6$.

- ③ While holding the MIDI Channel Button **22** down, press the **←** or **→** Button, to set a new channel number.

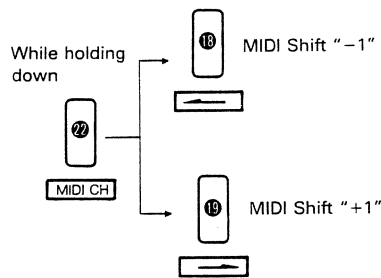

5. Overdub (2)

a. Using one MSQ-100 and Sound Modules

By changing the MIDI Channel, the MSQ-100 can work like a multitrack recorder.

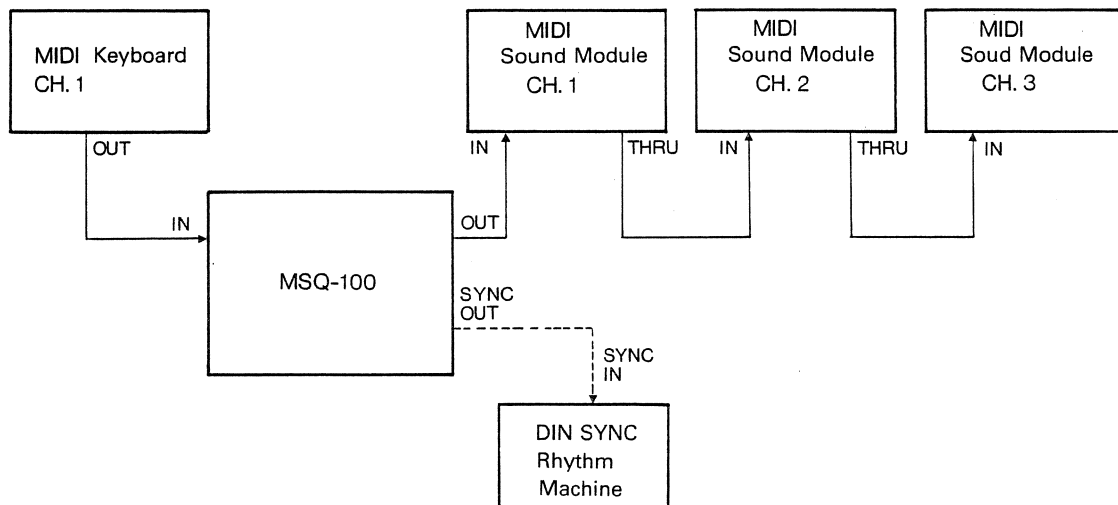

- ① Firstly, load the bass part on channel 1.
- ② Secondly, dub the chord backing part on channel 2. (MIDI Channel Shift number in the Display should be 1.)
- ③ Finally, dub the melody part on channel 3. (Channel Shift number is 2.)
- ④ Play the data. All bass, chord and melody parts will be simultaneously played, on channels 1,2 and 3.

b. Using 2 sets of MSQ-100's

Using 2 MSQ-100's allows advanced editing such as overdubbing in Step Loading mode.

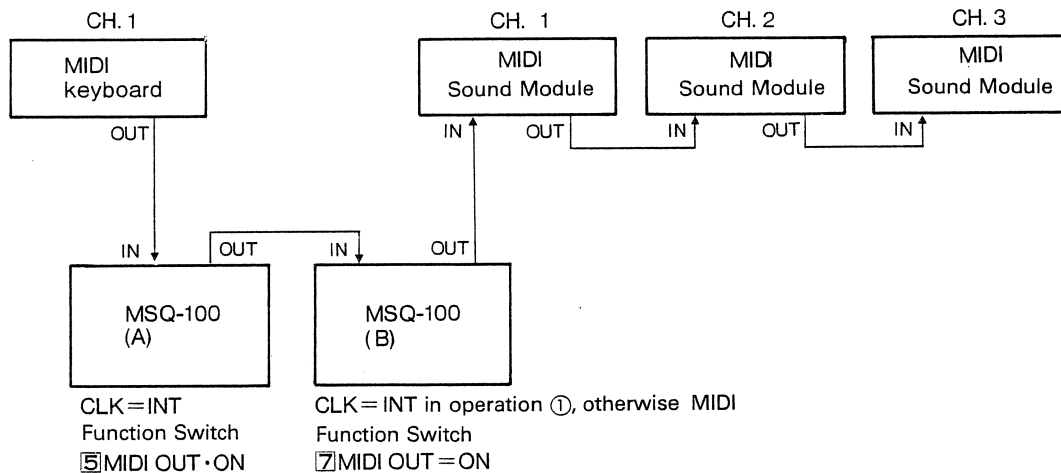

- ① Firstly load music data into B on channel 1.
- ② Secondly, set the MIDI Channel of A to 2.
- ③ Press the Reset Button of A, then load music data into A in Step Loading or Real Time Loading mode. If you load in Real Time Loading mode, B will be playing the music data loaded in procedure ①.
- ④ If the loading is completed, press the Reset Button ⑩, then the Play Button ⑮ of A. The MSQ-100's will start in sync.. Here, check if there is any loading mistake you have made.
- ⑤ Press the Reset Button ⑩ of A. Set B to Overdub mode, then press its Load Button ⑫ to turn it to standby mode. Now, press the Play Button of A, and the music data in A will be overdubbed onto that of B.
- ⑥ Repeat procedures ② to ⑤ with different MIDI Channels, and the final data will be obtained in B.

6. Channel Erase

If you happen to make an error while overdubbing using a new MIDI Channel number, the Channel Erase function can be effectively used, because this function allows you to erase the data on the Channel number you assign independently.

- ① Set the Mode Switch ③ to Load/Play.
- ② By using the Reset Button ⑩, the Back Measure Button ⑮ and the Forward Measure Button ⑯, go to the first measure of the data to be erased.

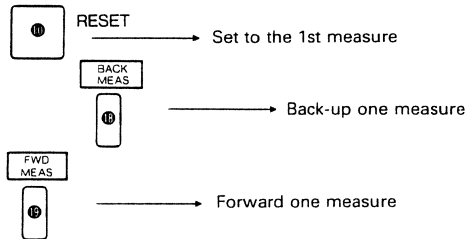

- ③ By using the MIDI Channel Button ⑳, the Left Arrow Button ⑬ and the Right Arrow Button ⑭, set an appropriate MIDI Channel Shift number to assign the MIDI Channel you wish to erase.

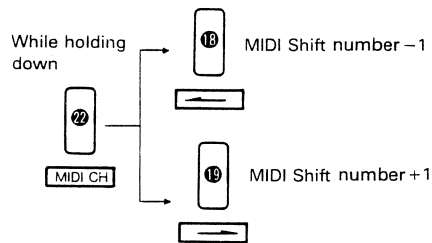

7. Sequencing a Rhythm Machine (with Dynamics)

By using the MSQ-100 with a MIDI rhythm machine that accepts Key Velocity information, Dynamics (such as the TR-909), a unique result can be obtained. That is, by loading rhythm data into the MSQ-100 by using a MIDI keyboard with

e.g.)

If you wish to delete the data on Channel 1, set the MIDI Channel Shift number to zero (the Display should show “—”).

If you wish to delete the data on Channel 10, set the MIDI Channel Shift number to 9.

- ④ While holding the Shift Button ⑬ down, press the Erase Button ⑰ to turn the unit to the Erase mode.

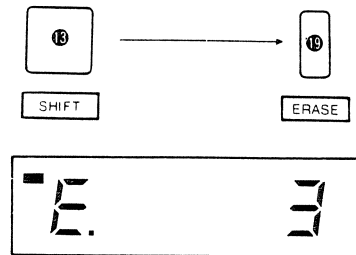

- ⑤ Press the MIDI Channel Button ⑳.
- ⑥ Press the Load Button ⑫, and the data is erased from the assigned measure to the end. Then the Erase mode is automatically cancelled.

the Key Velocity function (such as HP-300/400), rhythm with Dynamics can be played. Also, subtle nuances can be expressed through real time loading.

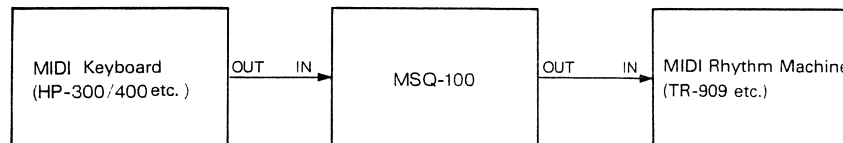

The Voices of the TR-909 correspond with the keyboard as shown below.

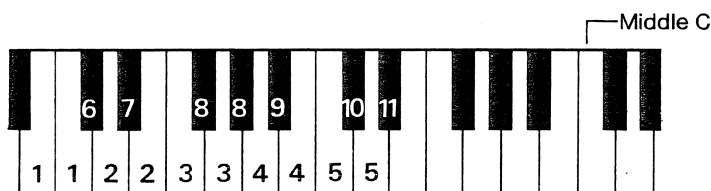

1. Bass Drum
2. Snare Drum
3. Low Tom
4. Mid Tom
5. High Tom
6. Rim Shot
7. Hand Clap
8. Hi Hat (Closed)
9. Hi Hat (Open)
10. Crash Cymbal
11. Ride Cymbal

5 Appendix

Appendix 1. Operation Table

1. Load/Play Mode

a. Load Mode

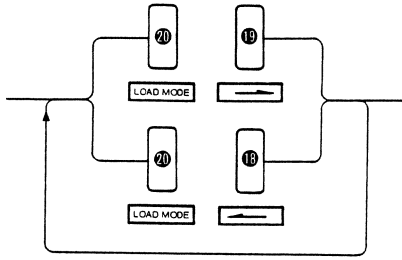

b. Display Mode

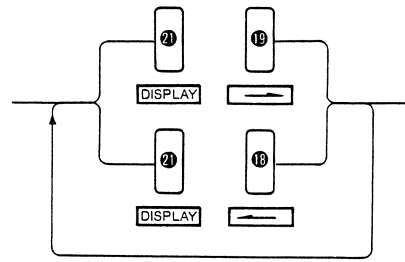

c. MIDI Channel Shift

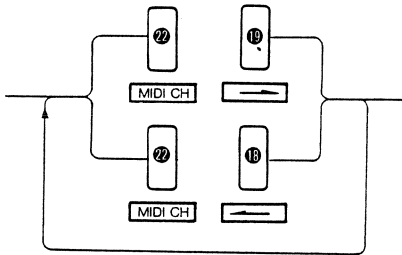

d. Measure Set

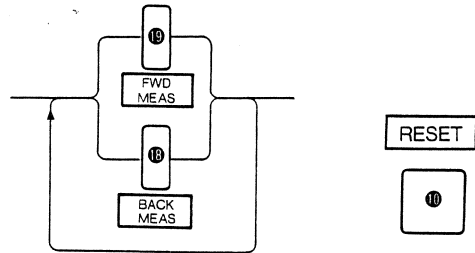

(Set the Measure)

(Go to the data head)

e. Load

① Real Time Load

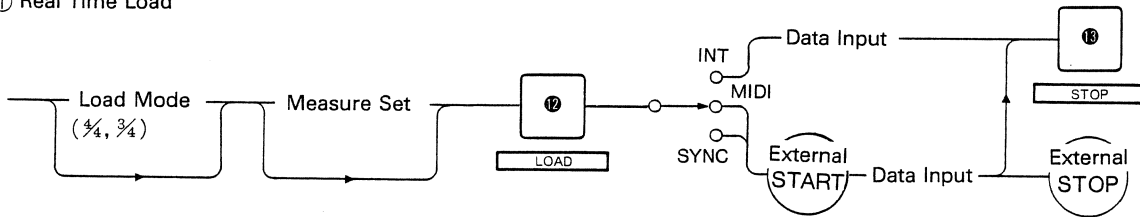

② Step Load

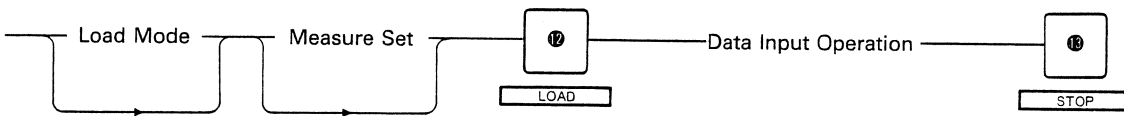

f. Play

① Play

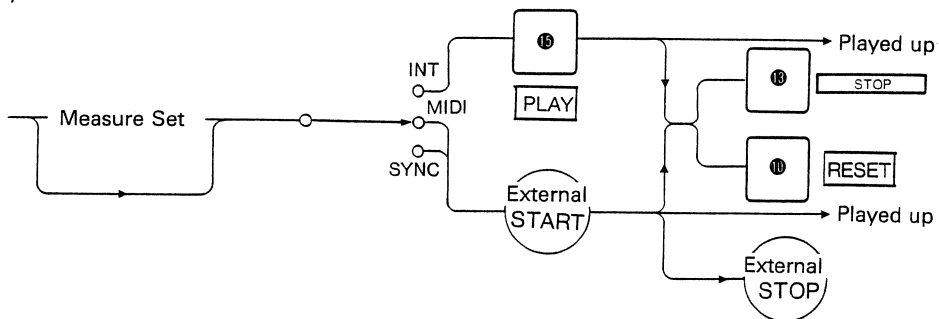

② Repeat

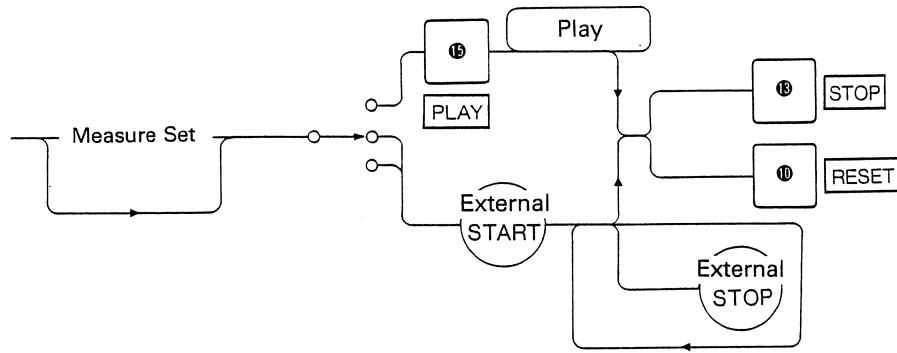

9. Edit

① Copy

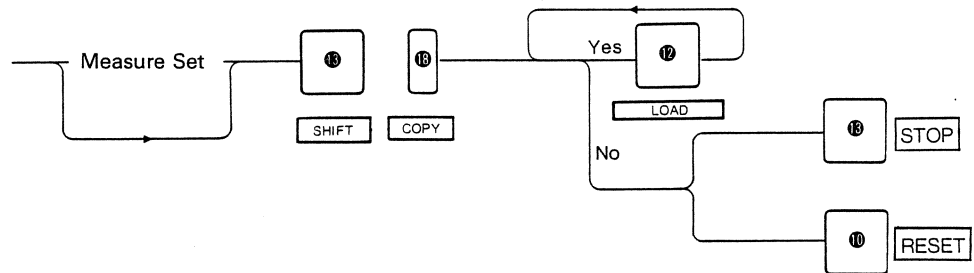

② Erase

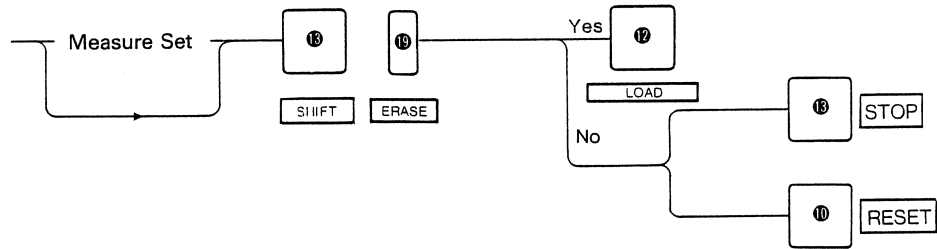

③ Insert

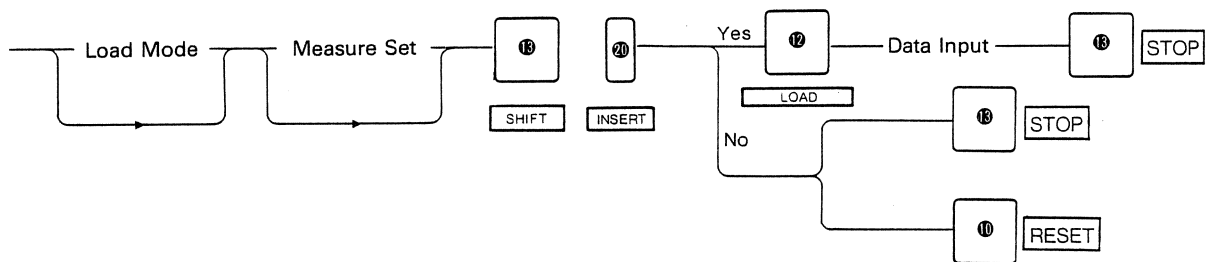

④ Delete

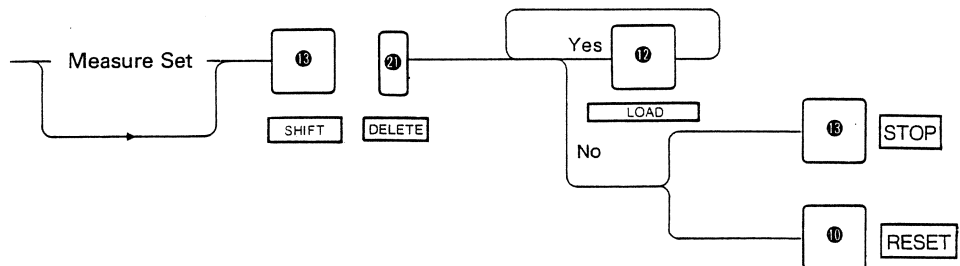

h. Overdub

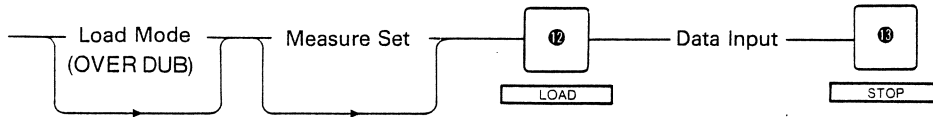

i. Tempo Check

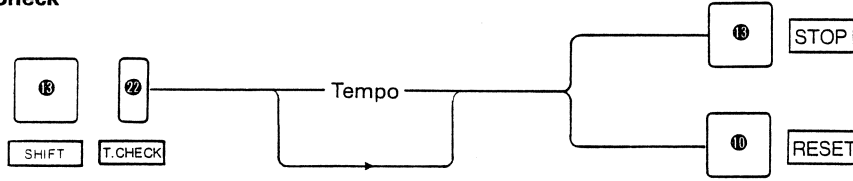

2. Data Transfer Mode

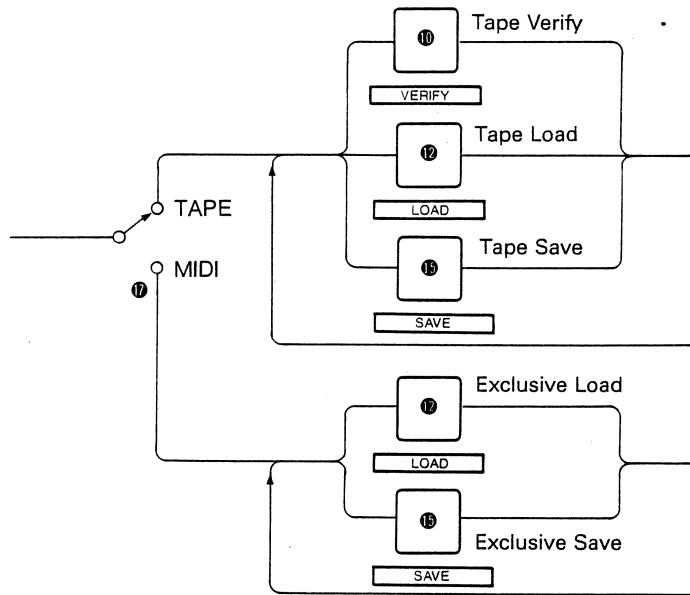

Appendix 2. Multi Operation Switches

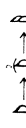
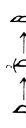
		When pressing each button on its own.				
		Step Load Mode	Play or Real Time Load Mode	Stop Mode		
18	SHIFT In Edit Mode (Press each button while holding the Shift Button 18 while in Stop Mode)	BACK STEP This button can back-up one step. If this button is pressed immediately after loading a bar line, the data will return to just before the bar line. (This does not back-up a step, as a bar line is not a step.)	BACK MEAS Pressing this button backs up one measure. *1 *2	BACK MEAS Pressing this button backs up one measure. *1 *2	18	
19	COPY Copy Mode	LOADMODE CHANGE The Load Mode changes as 	LOADMODE CHANGE The Load Mode changes as 	FWD MEAS Pressing this button advances one measure. *1	19	
20	ERASE Erase Mode	TIE () Press this to write Legato or Tie.	TIE () Press this to write Legato or Tie.		20	
21	INSERT Insert Mode	DELETE Delete Mode	DELETE Delete Mode		21	
22	MEAS END Press this to write a bar line.	T.CHECK Tempo Check Mode	MEAS END Press this to write a bar line.	MIDI CH While this button is held down, MIDI Channel Shift number is displayed.	22	

*1 If pressing the Back Button while holding the Forward Measure Button down, the forwarding operation will be done fast. Likewise, if pressing the Forward Measure Button while holding the Back Measure Button down, the back-up operation will be done fast.



*2 If you press the Back Measure Button at the first measure, the Display shows "  ", followed by the end of the data.

⑥ Specifications

● Memory Capacity

Approx. 6100 single notes without Key Velocity.

● Front Panel

Mode Switch (PLAY, LOAD/PLAY, DATA TRANSFER)
Metronome Level Switch (HIGH, LOW, OFF)
Clock Source Switch (INT, MIDI, SYNC)
Tempo Volume (♩ = 35 to 240)
Tempo Indicator
Reset/Verify Button
Load Button
Stop/Shift Button
Play/Save Button
Play Indicator
Repeat Play/(MIDI/TAPE) Button
Repeat Play/MIDI Indicator
Liquid Crystal Display
Load Mode Indicator
($\frac{4}{4}$, $\frac{3}{4}$, OVER DUB, ♩, ♪, ♫)
Back Measure/Back Step/  /Copy Button
Forward Measure/Forward Step/  /Erase Button
Tie/Load Mode/Insert Button
Rest/Display/Delete Button
Measure End/MIDI Channel Shift/Tempo Check Button

● Rear Panel

Function Switches (DIP Switches)

- ① Metronome Beat ♩ / ♪
- ② Key Velocity ON/OFF
- ③ Bender Control Change
- ④ After Touch ON/OFF
- ⑤ MIDI OUT MIX OUT/INT ONLY
- ⑥ MIDI OUT/THRU
- ⑦ Tape Save Level L/H
- ⑧ Tape Load Mode I/II

● Jacks

Tape Load Jack
Tape Save Jack (Tape Transfer Speed: 3200 baud)
MIDI IN
MIDI OUT
MIDI OUT/THRU
DIN SYNC IN
DIN SYNC OUT
Start/Stop Jack (DP-2)
DC IN Jack (PSA)

● Dimensions

266(W) × 233(D) × 57(H)
10 1/2(W) × 9 3/16(D) × 2 1/2(H) in (without projection)

● Weight

1.8kg/3lb.15oz.

● Power

9VDC 100mA

● Consumption

3W

● Accessories

AC Adapter PSA-120, 220 or 240
MIDI/Sync Cable (4ft. 11in.) × 2

● Option

DP-2 Pedal

MODEL MSQ-100 MIDI Implementation Chart

Date :
Version:1. 0

Function.....		Transmitted	Recognized dis en	Remarks
Basic Channel	Default Changed	all ch ×	all ch ×	Not BASIC ch
Mode	Default Messages Altered	3 × *****	× ×	mode not changed
Note Number	True voice	0-120 *****	0-127 0-120	
Velocity	Note ON Note OFF	○ 9n v=1-127 ○ 9n v=0, 8n	× ○* × ○*	n=0 - SF * velocity ON
After Touch	Key's Ch's	○ ○	× ○** × ○**	** after touch ON
Pitch Bender		○	× ○***	
Control Change	0- 63 64- 95 96-121	○ ○ ○	× ○*** ○ ○ × ○***	*** bender/cont ON
Prog Change	True #	○ *****	○ ○ 0-127	0-127
System Exclusive		○	○	For seq date
System Common	Song Pos Song Sel Tune	○ × ×	○ × ×	in STOP mode
System Real Time	Clock Commands	○ ○	○ MIDI clock mode ○ MIDI clock mode	
Aux Messages	Local ON/OFF All Notes OFF Active Sense Reset	× ○ (123) × ×	× ○ (123-127) × ×	
Notes	<p>When power up, OMNI OFF, POLY ON are sent in All channels. (1-16)</p> <p>Received voice messages are enabled or disabled being transmitted to MIDI OUT.</p>			

Mode 1 : OMNI ON, POLY
Mode 2 : OMNI OFF, POLY

Mode 2 : OMNI ON, MONO
Mode 4 : OMNI OFF, MONO

○ : Yes
× : No

1. RECOGNIZED RECEIVE DATA

1.1 Memorized messages while in LOAD mode

Status	Second	Third	Description	
1000 nnnn	Okkk kkkk	Ovvv vvvv	Note OFF	*1, 2
1001 nnnn	Okkk kkkk	0000 0000	Note OFF	*1
1001 nnnn	Okkk kkkk	Ovvv vvvv	Note ON	*1, 2
1010 nnnn	Okkk kkkk	Ovvv vvvv	Polyphonic Key Pressure	*3, 4
1011 nnnn	Occc cccc	Ovvv vvvv	Control Change	*3, 5
1100 nnnn	Oppp pppp		Program Change	*3
1101 nnnn	Ovvv vvvv		Channel Pressure	*3, 4
1110 nnnn	Ovvv vvvv	Ovvv vvvv	Pitch Wheel Change	*3, 6
1111 0000	0100 0001	0100 0010	Oxxx xxxx	
	1111 0111	(EDX)	Sequence Data (Exclusive message)	*7

1.2 Recognized only

Status	Second	Third	Description	
1011 nnnn	0111 1011	0000 0000	ALL NOTES OFF	*8
1011 nnnn	0111 1100	0000 0000	OMNI OFF	*9
1011 nnnn	0111 1101	0000 0000	OMNI ON	*9
1011 nnnn	0111 1110	0000 0000	MONO ON	*9
1011 nnnn	0111 1111	0000 0000	POLY ON	*9
1111 0010	Oppp pppp	Oppp pppp	Song Position Pointer	*10

1.3 Recognized messages for sync.

Status	Description	
1111 1000	Timing Clock	*11
1111 1010	Start	*11
1111 1011	Continue	*11
1111 1100	Stop	*11

- notes :
- *1 kkkkkk = 0 thru 120 (real), 0 thru 127 (recognized).
 - *2 When KEY VELOCITY switch is OFF, vvvvvv = 1000000
 - *3 Memorized while in REALTIME LOAD mode.
 - *4 When AFTER TOUCH switch on the rear panel is ON.
 - *5 cccccc = 0 thru 122 (BENDER/CONTROL CHANGE switch ON),
64 thru 95 (BENDER/CONTROL CHANGE switch OFF).
 - *6 When BENDER/CONTROL CHANGE switch is ON.
 - *7 When LOAD and VERIFY mode in MIDI.
 - *8 When all notes are not OFF, this unit creates OFF for all ON notes.
 - *9 Recognized as only an ALL NOTES OFF.
 - *10 While STOP mode.
 - *11 When the CLOCK switch is set to MIDI.

2. TRANSMITTED DATA

- 2.1 All memorized messages while in PLAY mode.
- 2.2 All received messages.
- 2.3 Created messages.

Status	Second	Third	Description	
1111 1000			Timing Clock	
1111 1010			Start	
1111 1011			Continue	
1111 1100			Stop	
1011 nnnn	0111 1011	Ovvv vvvv	ALL NOTES OFF	*2
1011 nnnn	0111 1100	Ovvv vvvv	OMNI OFF	*3
1011 nnnn	0111 1111	Ovvv vvvv	POLY ON	*3
1111 0010	Oppp pppp	Oppp pppp	Song Position Pointer	*4
1111 0000	0100 0111	0100 0010	Oxxx xxxx	
	1111 0111	(EDX)	Sequence Data (Exclusive messages)	*5

- notes :
- *1 When MIDI OUT switch is set to MIX.
(While in PLAY or OVER-DUB mode, received Mode Messages are not transmitted.)
 - *2 When all notes turn OFF.
 - *3 When at power up, these MODE MESSAGES are transmitted for all channels.
 - *4 When one of FWD MEAS, BACK MEAS or RESET is pressed.
 - *5 When SAVE mode in MIDI.

3. EXCLUSIVE MESSAGE for MSQ-100 sequence data

Byte	Description
a 1111 0000	Exclusive status
b 0100 0001	Roland ID #
c 0101 0111	function type
d 0111 0000	Data type = 7-8 conversion
e 0nnn nnnn	message #, 0 - 127
f 0xxx xxxx	Encoded data, 256 bytes max (See note)
	0... ..
g 0sss ssss	Check sum (encoded data only)
h 1111 0111	EDX

Note :
Each 8 bytes include encoded 7 data bytes as follows:
Check sum : f1 + f2 + + g = 0

Bit format of data to be encoded.

bit	7	6	5	4	3	2	1	0
byte of data								
first	1-7	1-6	1-5	1-4	1-3	1-2	1-1	1-0
second	2-7	2-6	2-5	2-4	2-3	2-2	2-1	2-0
third	3-7	3-6	3-5	3-4	3-3	3-2	3-1	3-0
4th	4-7	4-6	4-5	4-4	4-3	4-2	4-1	4-0
5th	5-7	5-6	5-5	5-4	5-3	5-2	5-1	5-0
6th	6-7	6-6	6-5	6-4	6-3	6-2	6-1	6-0
7th	7-7	7-6	7-5	7-4	7-3	7-2	7-1	7-0

Encoding Bit format for MIDI.

bit	7	6	5	4	3	2	1	0
byte of MIDI								
first	'0'	7-7	6-7	5-7	4-7	3-7	2-7	1-7
second	'0'	1-6	1-5	1-4	1-3	1-2	1-1	1-0
third	'0'	2-6	2-5	2-4	2-3	2-2	2-1	2-0
4th	'0'	3-6	3-5	3-4	3-3	3-2	3-1	3-0
5th	'0'	4-6	4-5	4-4	4-3	4-2	4-1	4-0
6th	'0'	5-6	5-5	5-4	5-3	5-2	5-1	5-0
7th	'0'	6-6	6-5	6-4	6-3	6-2	6-1	6-0
8th	'0'	7-6	7-5	7-4	7-3	7-2	7-1	7-0

* The sequence data is formatted as 'Q1' type data format.

4. 'Q1' type data format

A file of sequence data contains a [FCB], [TD] and [ED].

4.1 [FCB] File control block

This is the file control block which contains fixed 40 bytes total. It is sent under an exclusive message.

name	# of bytes	description
a) Header	1 byte	\$FD
b) Block Type	1 byte	'F' in ascii
c) Data type	2 bytes	'Q1' in ascii
d) File Name	30 bytes	'MSQ-100.0', 21. spaces
e) Conductor sw	1 byte	\$00, off
f) track num	1 byte	\$00, none of tracks
g) phrase num	2 bytes	\$01, \$00
h) time base	1 byte	\$78, time base = 120
i) tempo	1 byte	\$64, (no function)
j) EOB	2 byte	\$FE, \$FE

4.2 [PD] Phrase data block

This block contains actual sequence data with time values. If the data is long, it may be divided.

name	# of bytes	description
a) Header	1 byte	\$FD
b) Block type	1 byte	'P' in ascii
c) Phrase id #	2 bytes	\$00, \$00
d) data	n bytes	midi data with time
e) EOB	1 or 2 bytes	\$FE, (\$FE)

4.3 [ED] End block

This block is sent at the end of a file.

name	# of bytes	description
a) Header	1 byte	\$FD
b) Block type	1 byte	'E' in ascii
c) Data type	2 bytes	\$00, # \$00 (dummy)
d) EOB	2 bytes	\$FE, \$FE

5. Phrase data format

1st byte	2nd byte	3rd byte	4th byte
normal MIDI voice messages			
0 - 239	(\$80 - \$EF) *	0 - 127	0 - 127
time	midi status	Key #	vel
time overflow			
248 (\$F8)			
cpu status			
measure end	\$F9		
0 - 239			
time	MPU mark		
BPM change (beat per measure)			
0	\$FA	0	0 - 8 **
time	special func	BPM	# of beat
change internal format			
0	\$FA	1	0, 127 ***
time	special func	int format	switch
data end			
0	\$FC		
time	MPU mark		

note :

- * Same MIDI status will not be sent.
- ** 0 : data does not contain the MEASURE ENDS.
- *** 0 : set internal data format not to maintain NOTE ON VELOCITY.
- 127 : set internal data format to maintain NOTE ON VELOCITY.

Example

0	\$90	60	54	120	64	43		
t1=0	status	do	on	t2=120	mi	on		
2	60	0	\$F8	120	64	0		
t3=2	do	off	t=240	t4=120	mi	off		
118	\$F9	\$F8	\$F8	0	\$F9	\$17	\$FC	
t5=118	ME	t=240	t=240	t=0	ME	t=23	end	

t1 - t5 time value, ME: measure end
do, mi: name of note

Roland®

10192

UPC

10192



10981

Roland®