

Rhodes

MK-60

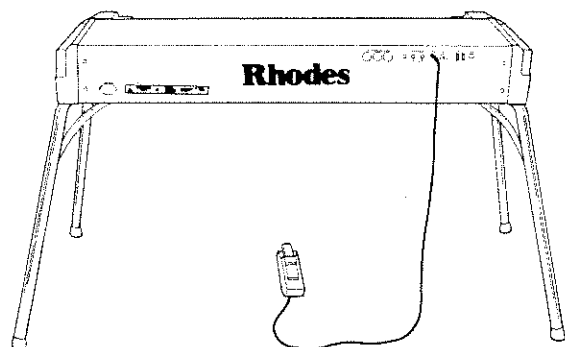

OWNER'S MANUAL

Thank you, and congratulations on your purchase of the Rhodes MK-60.

In order that you may better understand the full range of superior functions provided, and enjoy long reliable service, we recommend that you read this owner's manual in its entirety.

Since the MK-60 is equipped with MIDI connectors, it can be used in ensemble with other devices, or be played automatically. When wishing to make use of the unit's MIDI capabilities, first refer to the separate *MIDI APPLICATIONS*.

■ FEATURES

● S/A Process Sound Generation

S/A sound sources were developed in a striving for a much higher level of sensitivity and realism for sounds. It represents a uniquely new process for music synthesis, and relies on proprietary digital signal processing technology.

● Realistic Preset Sounds

Eight realistic tones are provided as presets: CLASSIC, SPECIAL, BLEND, CONTEMPORARY, PIANO 1 & 2, CLAVI, and VIBRAPHONE.

● Auto Bend Function

Allows a pitch change to be applied when the keyboard is played, thus providing more natural expression of the sound of string impact.

● Stretch (Tuning Curve)

When playing acoustic pianos, it is not only because of the differences in timbre that exist between different models that resonating chords sound different. It is also due to slight differences in their respective tuning curves. With the MK-60, for each preset tone you have a choice of two tuning curves that are available to best suit them.

● Effects

Tremolo, Chorus, and Equalizer are available as effects to be applied to your performances.

◇ Equalizer

Allows you to alter sound in a variety of ways.

The configuration provides two fixed type bands (BASS, TREBLE).

◇ Tremolo

An effect which applies periodic changes to sound volume, thus allowing you to obtain undulating-sounding, or other tremolo-like effects.

◇ Chorus

An effect used to add breadth and thickness to a sound.

● Light, Compact Design

The compact body, equipped with a 64-key keyboard, has been designed light so it can be transported easily. Moreover, the range of the keyboard expands readily — at a single touch it is shifted either above or below by an octave.

■ Making Connections and Powering Up

Make sure the power on both the MK-60 and the amplifier being connected is off. Also, volume should be set at a low level.

- ① Make the connections between the output jacks on the MK-60 and the input jacks (or line in) on the amplifier.
- ② Connect the supplied pedal to the MK-60's DAMPER jack.

Should you wish to use the pedal to turn on/off an effect or Auto Bend, connect the supplied pedal (or an optional Damper pedal) to the EFFECT CONTROL jack.

- ③ Push the MK-60's power switch to turn it on.
The unit cannot be operated for approximately 4 seconds after power has been turned on due to its circuitry protection feature.
- ④ Turn on the external amplifier's power, and adjust the volume to an appropriate level.

● Connections using mixer

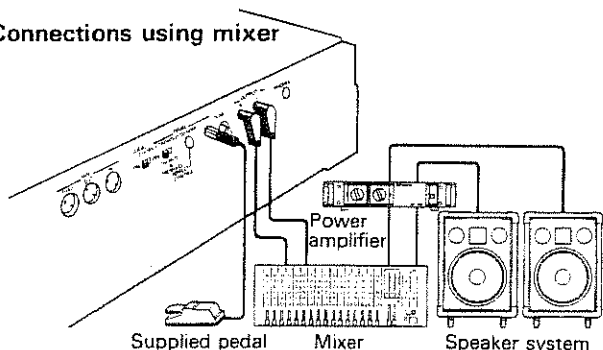

● Using headphones

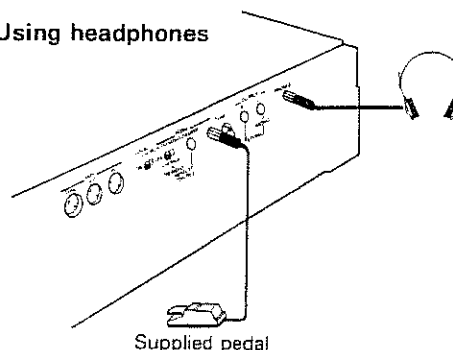

● Using one keyboard amplifier

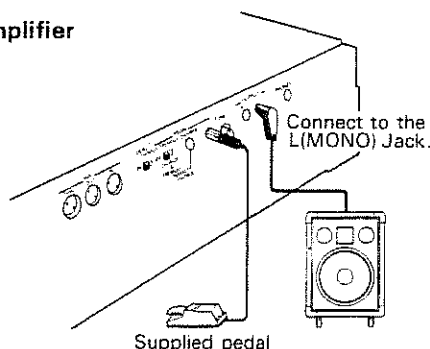

● Using two keyboard amplifiers

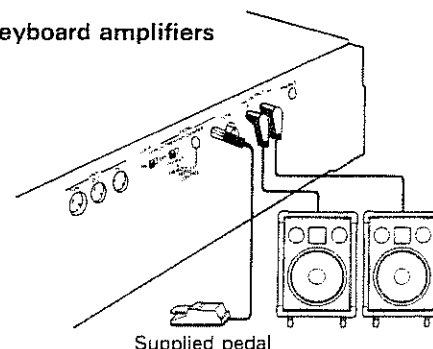

■ Tone Selection

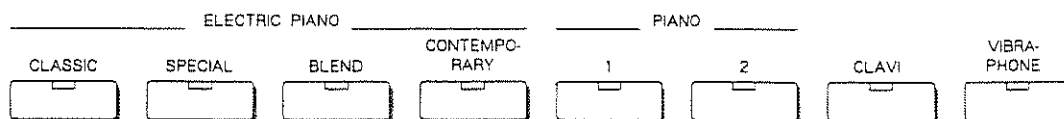

Press the button corresponding to the tone you wish to use in performance.

CLASSIC	An orthodox Rhodes sound, characterized by its fatness and duration. Realization made possible thanks to advice from Mr. Harold Rhodes.
SPECIAL	A simulation of the restructuring and processing very often carried out on the classic Rhodes. Features some growl in the lower range, good body in the mid-to-upper range, and a clear high end.
BLEND	With clean distortion in the lower range, it features a really sharp attack for the mid-to-upper range.
CONTEMPORARY	Synthesized electric piano. With a metallic-sounding upper range, it has a pleasant brilliance overall.
PIANO 1	The sound of a full concert grand piano.
PIANO 2	The sound of an electric grand piano.
CLAVI	The sound of the clavichord.
VIBRAPHONE	The sound of the vibraphone.

【Voice Preserve Function】

While the unit is emitting sound (while any key is depressed, or the damper pedal is down), the change in tone will not take place at the moment you press a tone button. Only afterwards, when no longer in a state of play (your fingers are not on the keys, and your foot is off the damper pedal) will the change in the tone take effect.

PANEL DESCRIPTIONS

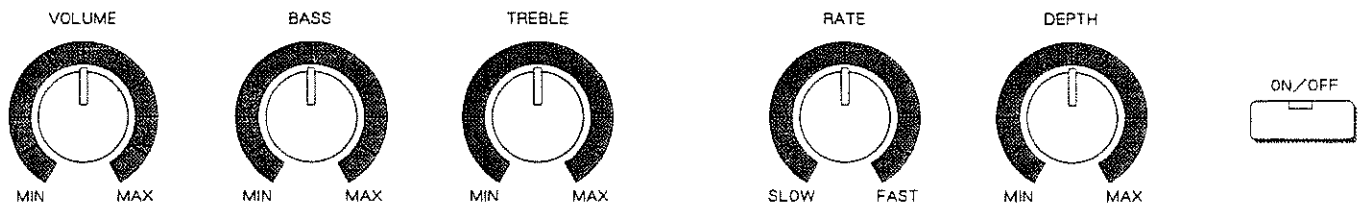

● VOLUME Knob

Adjusts the volume level of the sound output from the Output and Headphone jacks.

● BASS Knob

Adjusts the quality of sound in the lower range. When moved toward "MIN" the sound gets tighter and harder, and towards "MAX" it gets fatter.

● TREBLE Knob

Adjusts the quality of sound in the upper range. Moving it towards "MIN" gives a sound that is sweeter and more mellow; and towards "MAX" it gets more brilliant.

● TREMOLO ON/OFF Button

When pushed this button's indicator will light, thus enabling periodic changes in sound level (tremolo) to be applied. The tremolo for an externally connected MIDI device can be turned on or off as well. (Refer to MIDI APPLICATIONS, "On/Off Control of Chorus and Tremolo for an External MIDI Device.")

● TREMOLO RATE Knob

With TREMOLO ON/OFF switched "ON", this knob adjusts the rate of the tremolo effect; from the minimum at "SLOW" to the maximum at "FAST."

● TREMOLO DEPTH Knob

With TREMOLO ON/OFF switched "ON", this knob adjusts the depth of the tremolo effect. At "MIN" the effect is superficial, and it is the deepest at "MAX."

* The On/Off status of Tremolo with respect to each tone is stored in memory until power is turned off.

REAR PANEL

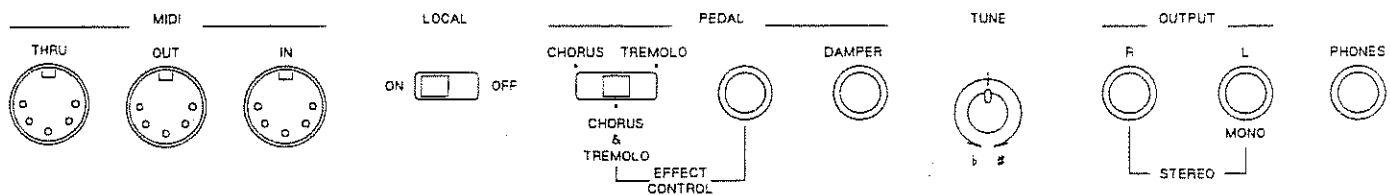

● PHONES Jack

The instrument's performance can also be listened to through stereo headphones. The most suitable headphones are those with an impedance of from 8 to 150 ohms. Their volume is adjusted using the Volume knob on the panel. Sound will also continue to be output from the Output jacks while headphones are in use.

● OUTPUT Jacks

Accept connection of an amplifier (or speakers equipped with amplification).

● TUNE Knob

Allows you to tune the unit so its pitch matches that of other instruments. When set to the center line, middle A = 440 Hz.

● DAMPER Pedal Jack

Accepts connection of the supplied pedal, or an optionally available Damper pedal. When the pedal is depressed, the sound will decay gradually. The effect is identical to that obtained with the right pedal on a piano.

● EFFECT CONTROL Jack

Accepts connection of the supplied pedal, or an optionally available Damper pedal. The internal effects can then be turned on or off by depressing the pedal.

● EFFECT CONTROL Switch

Provides for selection of the effect(s) that will be controlled using the pedal connected to the Effect Control jack.

CHORUS : Controls on/off of chorus.

TREMOLO : Controls on/off of tremolo.

CHORUS & TREMOLO : Simultaneous on/off control of both chorus and tremolo.

* The pedal connected to the Effect Control jack can also be used to turn Auto Bend (see page at right) on or off. To do so, have the switch set at the CHORUS & TREMOLO position, and hold down the CONTEMPORARY button while turning power on. Then, when the pedal is depressed, Auto Bend is turned on, and when it is released, Auto Bend is turned off.

* For explanation of the MIDI connectors and Local switch, refer to the separate "MIDI APPLICATIONS."

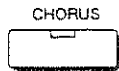

● CHORUS Button

When this button is pressed and its indicator is lit, you then can obtain the chorus effect. Chorus is an effect which adds breadth and thickness to a sound.

Two methods in which chorus can be applied are provided.

◆ Mode 1

Provides a stereo chorus effect. (A difference in the phase between L and R is produced.) Suitable when speakers are removed from each other, or in places with little reverberation. This is the mode that always prevails when power is turned on.

◆ Mode 2

Provides a chorus effect for the L channel only. Suitable when the two speakers are close together, or in places with a great deal of reverberation.

* The mode selection bears no relevance in cases where only output L (MONO) is being used.

□ Selecting the Mode

Press the CHORUS button for over 2 seconds, and a indicator for the CLASSIC or SPECIAL tone button will start blinking. While in this condition, press either CLASSIC to select Mode 1, or SPECIAL to select Mode 2.

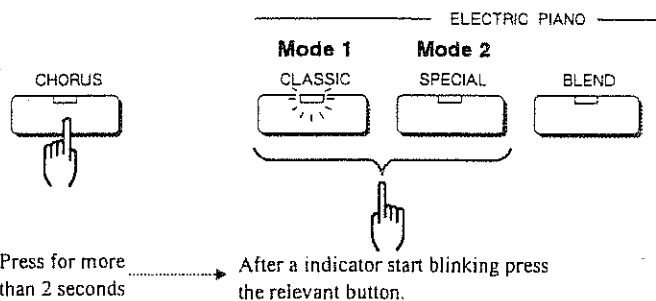

* The on/off status of chorus and the mode that has been selected, for each tone, are stored in memory until power is turned off.

* The chorus for an externally connected MIDI device can be turned on or off as well. (Refer to MIDI APPLICATIONS, "On/Off Control of Chorus and Tremolo for an External MIDI Device.")

● AUTO BEND Button

Press this button and its indicator will light, meaning that a pitch change will be obtained when the keyboard is played. Keys will sound at an altered pitch the instant they are pressed. Then following a natural curve, they return to the normal pitch. This is termed as Auto Bend, and is effective in expressing the natural sound of impact upon strings.

Eight separate settings are available for determining the manner in which pitch change will be obtained. The type of Auto Bend desired can be selected as shown below.

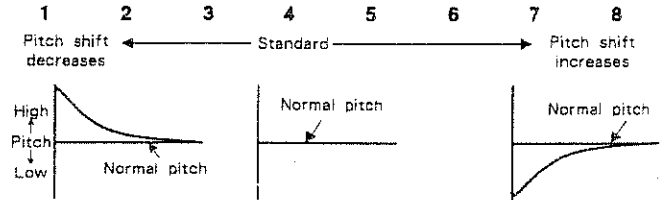

□ Selecting the Auto Bend Curve

Press the AUTO BEND button for more than 2 seconds, and one indicator of the tone buttons will start blinking. While in this condition, make your selection by pressing the button which corresponds to the curve desired.

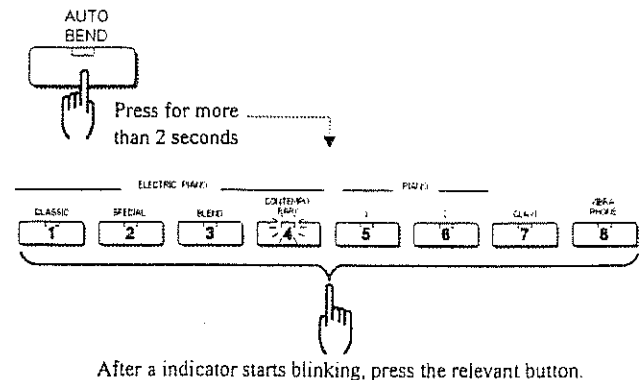

* The On/Off status of Auto Bend with respect to each tone is stored in memory until power is turned off.

* The pedal can also be used to turn Auto Bend on or off. (see EFFECT CONTROL Switch)

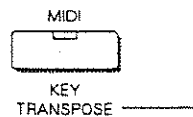
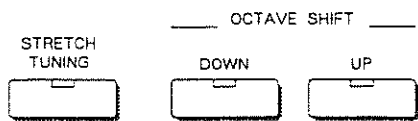

● STRETCH Button

When this button is pressed, and thus its indicator is lit, the pitch can be shifted with respect to the temperament.

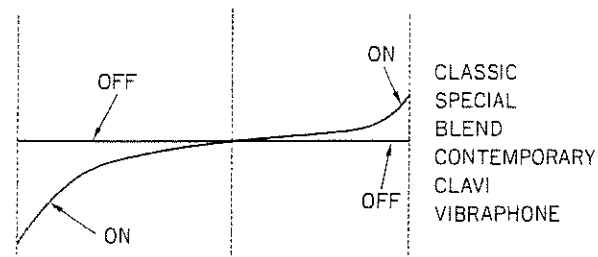
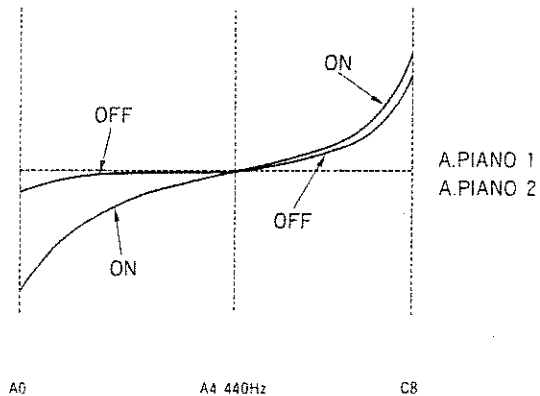

● OCTAVE SHIFT Buttons

When pressed, the DOWN button shifts the range of the keyboard downward by an octave. The UP button shifts the range of the keyboard upward by an octave.

To return to normal, press whichever button is lit, or press both at the same time.

● MIDI / KEY TRANSPOSE Button

Using this button, the pitch at which keys will sound can be shifted (transposed) upwards or downwards. This function thus allows you to play in a different key even though you use more familiar keys. After transposed, MIDI/KEY TRANSPOSE is lit.

□ Selecting the Amount of Transposition

The amount of change obtained by the transposition can be set in units of a semitone. When the MIDI/KEY TRANSPOSE button is pressed, it's indicator and that of the CLASSIC button will start blinking. While in this condition, press the buttons needed to make your selection.

With each press a 1 semitone shift downward is obtained. (For maximum of 6 times)

With each press a 1 semitone shift upward is obtained. (For maximum of 5 times)

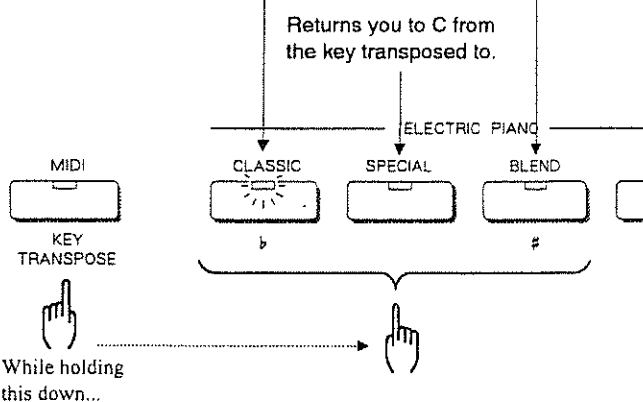

* You are unable to play while making settings for a transposition.

SPECIFICATIONS

Keyboard	64 Keys
Sound Source	S/A Process Maximum simultaneously producible tones: 16 (10 for CONTEMPORARY and CLAVI)
Preset Tones	CLASSIC, SPECIAL, BLEND, CONTEMPORARY, PIANO 1, PIANO 2, CLAVI, VIBRAPHONE
Effects	Equalizer, Tremolo, Chorus
Front Panel	Knobs: VOLUME, BASS, TREBLE, TREMOLO RATE, TREMOLO DEPTH Buttons: TREMOLO ON/OFF, CHORUS, AUTO BEND, STRETCH, OCTAVE SHIFT DOWN, OCTAVE SHIFT UP, MIDI/KEY TRANSPOSE Power Switch
Rear Panel	PHONES jack, 2 OUTPUT jacks, TUNE knob, DAMPER pedal jack, EFFECT CONTROL jack, EFFECT CONTROL switch, LOCAL ON/OFF switch, MIDI connectors (IN, OUT, THRU), AC inlet
Dimensions	1091 (W) x 475 (D) x 154 (H) mm 43-5/8" (W) x 19" (D) x 6-3/16" (H)
Weight	27 kg 59 lbs., 6 oz.
Power Consumption	18 W
Supplied Accessories	Owner's Manual, MIDI APPLICATIONS, Warranty Information, Pedal Unit, AC Cord Set
Options	Stand, Music Rack

The soundable range of the MK-60's keyboard is as shown below.

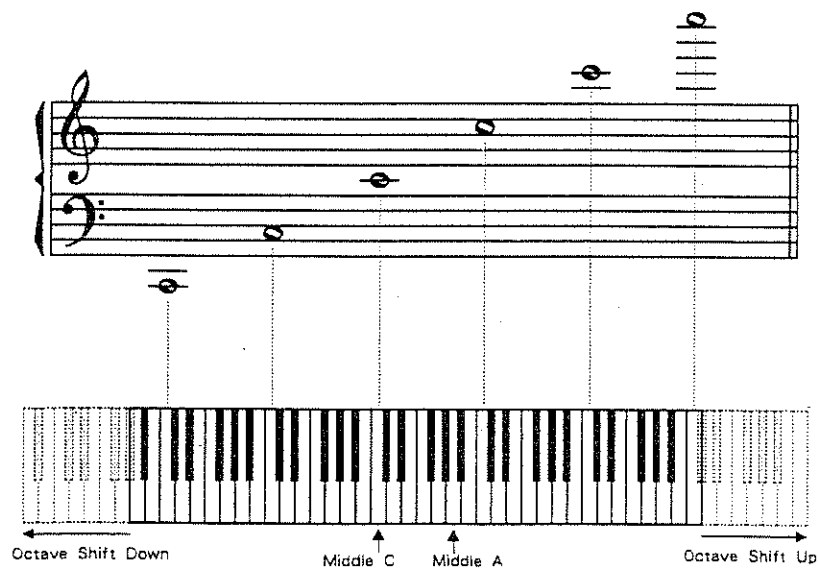

* The specifications for this product are subject to change without prior notice, in the interest of improvement.

■ IMPORTANT NOTES

In addition to the items listed under Safety Precautions, we request that you please read and adhere to the following.

[Concerning the power supply]

- Whenever you make any connections with other devices, always turn off the power to all equipment first. This will help in preventing malfunction, and damage to speakers.
- Do not force the unit to share the same power outlet as one used for distortion producing devices (such as motors, variable lighting devices). Be sure to use a separate power outlet.

[Concerning placement]

- Placing the unit near power amplifiers or other equipment containing large transformers may induce hum.
- Should the unit be operated nearby television or radio receivers, TV pictures may show signs of interference, and static might be heard on radios. In such cases, move the unit out of proximity with such devices.

[Maintenance]

- For everyday cleaning, wipe the unit with a soft dry cloth, or one that is dampened slightly. To remove dirt that is more stubborn, wipe using a mild, neutral detergent. Afterwards, make sure to wipe thoroughly with a soft cloth.
- Never apply benzene, thinners, alcohol or any like agents, to avoid the risk of discoloration and deformation.

[Other Precautions]

- Protect the unit from strong impact.
- A certain small amount of heat will be radiated from the unit, and thus should not be considered abnormal.
- Before using the unit in a foreign country, check first with your local Roland Service Station.

For West Germany

Bescheinigung des Herstellers/Importeurs

Hiermit wird bescheinigt, daß der/die/das

Rhodes MK-60

(Gerät. Typ. Bezeichnung)

in Übereinstimmung mit den Bestimmungen der

Amtsbl. Vfg 1046/1984

(Amtsblattverfügung)

funk-entstört ist.

Der Deutschen Bundespost wurde das Inverkehrbringen dieses Gerätes angezeigt und die Berechtigung zur Überprüfung der Serie auf Einhaltung der Bestimmungen eingeräumt.

Roland Corporation Osaka/Japan

Name des Herstellers/Importeurs

For the USA

RADIO AND TELEVISION INTERFERENCE

WARNING — This equipment has been verified to comply with the limits for a Class B computing device, pursuant to Subpart J, of Part 15, of FCC rules. Operation with non-certified or non-verified equipment is likely to result in interference to radio and TV reception.

The equipment described in this manual generates and uses radio frequency energy. If it is not installed and used properly, that is, in strict accordance with our instructions, it may cause interference with radio and television reception. This equipment has been tested and found to comply with the limits for a Class B computing device in accordance with the specifications in Subpart J, of Part 15, of FCC Rules. These rules are designed to provide reasonable protection against such a interference in a residential installation. However, there is no guarantee that the interference will not occur in a particular installation. If this equipment does cause interference to radio or television reception, which can be determined by turning the equipment on and off, the user is encouraged to try to correct the interference by the following measure:

- Disconnect other devices and their input/output cables one at a time. If the interference stops, it is caused by either the other device or its I/O cable. These devices usually require Roland designated shielded I/O cables. For Roland devices, you can obtain the proper shielded cable from your dealer. For non Roland devices, contact the manufacturer or dealer for assistance.

If your equipment does cause interference to radio or television reception, you can try to correct the interference by using one or more of the following measures.

- Turn the TV or radio antenna until the interference stops.
- Move the equipment to one side or the other of the TV or radio.
- Move the equipment farther away from the TV or radio.
- Plug the equipment into an outlet that is on a different circuit than the TV or radio. (That is, make certain the equipment and the radio or television set are on circuits controlled by different circuit breakers or fuses.)
- Consider installing a rooftop television antenna with coaxial cable lead-in between the antenna and TV. If necessary, you should consult your dealer or an experienced radiotelevision technician for additional suggestions. You may find helpful the following booklet prepared by the Federal Communications Commission: "How to Identify and Resolve Radio — TV Interference Problems"

This booklet is available from the U.S. Government Printing Office, Washington, D.C., 20402, Stock No. 004-000-00345-4.

For Canada

CLASS B



NOTICE

This digital apparatus does not exceed the Class B limits for radio noise emissions set out in the Radio Interference Regulations of the Canadian Department of Communications.

CLASSE B

AVIS

Cet appareil numérique ne dépasse pas les limites de la classe B au niveau des émissions de bruits radioélectriques fixés dans le Règlement des signaux parasites par le ministère canadien des Communications.

	CAUTION RISK OF ELECTRIC SHOCK DO NOT OPEN	
ATTENTION : RISQUE DE CHOC ELECTRIQUE NE PAS OUVRIR		
CAUTION: TO REDUCE THE RISK OF ELECTRIC SHOCK, DO NOT REMOVE COVER (OR BACK). NO USER-SERVICEABLE PARTS INSIDE. REFER SERVICING TO QUALIFIED SERVICE PERSONNEL.		



The lightning flash with arrowhead symbol, within an equilateral triangle, is intended to alert the user to the presence of un-insulated "dangerous voltage" within the product's enclosure that may be of sufficient magnitude to constitute a risk of electric shock to persons.



The exclamation point within an equilateral triangle is intended to alert the user to the presence of important operating and maintenance (servicing) instructions in the literature accompanying the product.

INSTRUCTIONS PERTAINING TO A RISK OF FIRE, ELECTRIC SHOCK, OR INJURY TO PERSONS.

IMPORTANT SAFETY INSTRUCTIONS

WARNING — When using electric products, basic precautions should always be followed, including the following:

1. Read all the instructions before using the product.
2. Do not use this product near water — for example, near a bathtub, washbowl, kitchen sink, in a wet basement, or near a swimming pool, or the like.
3. This product should be used only with a cart or stand that is recommended by the manufacturer.
4. This product, either alone or in combination with an amplifier and headphones or speakers, may be capable of producing sound levels that could cause permanent hearing loss. Do not operate for a long period of time at a high volume level or at a level that is uncomfortable. If you experience any hearing loss or ringing in the ears, you should consult an audiologist.
5. The product should be located so that its location or position does not interfere with its proper ventilation.
6. The product should be located away from heat sources such as radiators, heat registers, or other products that produce heat.
7. Avoid using the product where it may be effected by dust.
8. The product should be connected to a power supply only of the type described in the operating instructions or as marked on the product.
9. The power-supply cord of the product should be unplugged from the outlet when left unused for a long period of time.
10. Do not tread on the power-supply cord.
11. Do not pull the cord but hold the plug when unplugging.
12. When setting up with any other instruments, the procedure should be followed in accordance with instruction manual.
13. Care should be taken so that objects do not fall and liquids are not spilled into the enclosure through openings.
14. The product should be serviced by qualified service personnel when:
 - A. The power-supply cord or the plug has been damaged; or
 - B. Objects have fallen, or liquid has been spilled into the product; or
 - C. The product has been exposed to rain; or
 - D. The product does not appear to operate normally or exhibits a marked change in performance; or
 - E. The product has been dropped, or the enclosure damaged.
15. Do not attempt to service the product beyond that described in the user-maintenance instructions. All other servicing should be referred to qualified service personnel.

SAVE THESE INSTRUCTIONS

WARNING: THIS APPARATUS MUST BE EARTHED

For the U.K.

IMPORTANT: THE WIRES IN THIS MAINS LEAD ARE COLOURED IN ACCORDANCE WITH THE FOLLOWING CODE.
GREEN-AND-YELLOW: EARTH, BLUE: NEUTRAL, BROWN: LIVE

As the colours of the wires in the mains lead of this apparatus may not correspond with the coloured markings identifying the terminals in your plug proceed as follows:

The wire which is coloured GREEN-AND-YELLOW must be connected to the terminal in the plug which is marked by the letter E or by the safety earth symbol  or coloured GREEN or GREEN-AND-YELLOW.

The wire which is coloured BLUE must be connected to the terminal which is marked with the letter N or coloured BLACK.

The wire which is coloured BROWN must be connected to the terminal which is marked with the letter L or coloured RED.

The product which is equipped with a THREE WIRE GROUNDING TYPE AC PLUG must be grounded.

Rhodes

Copyright © 1989 by ROLAND CORPORATION

26035222 '89-8-83-125



Rhodes

MK-60

MIDI APPLICATIONS

Since the MK-60 is equipped with MIDI connectors, you can enjoy ensemble performances using external MIDI devices, or have it played automatically. Those wishing to employ MIDI should read this manual first.

■ Connecting MIDI Cables

MK-60 MIDI Connector

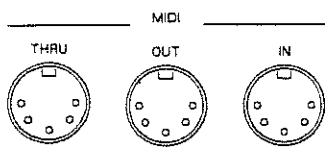

MIDI IN Connector

Provides for reception of MIDI information from other MIDI devices. When wishing to play the MK-60 using a separate keyboard or a sequencer, connect a cable between here and the MIDI OUT or MIDI THRU on such other devices.

MIDI OUT Connector

Provides for transmission of MIDI information to another MIDI device. When you want to play other devices by playing the MK-60, or record performances to a sequencer, connect a cable between here and the MIDI IN on such other devices.

MIDI THRU Connector

Transmits exactly the same MIDI data as received at MIDI IN.

● Setup using MIDI sound module

MIDI Sound Module
Roland MT-32, CM-64, D-110,
U-110, S-330, etc.

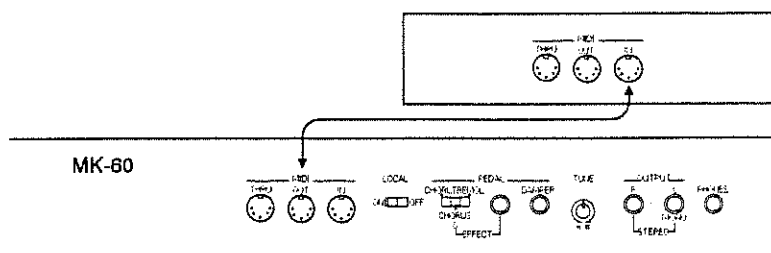

● Setup using Super MRC and MIDI sound module

MIDI Sequencer
Roland Super MRC

MIDI Sound Module
Roland MT-32, CM-64, D-110,
U-110, S-330, etc.

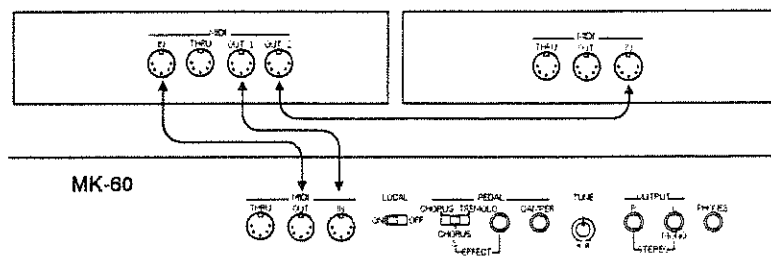

● Setup using the PR-100 and MIDI sound module

MIDI Sequencer
Roland PR-100

MIDI Sound Module
Roland MT-32, CM-64, D-110,
U-110, S-330, etc.

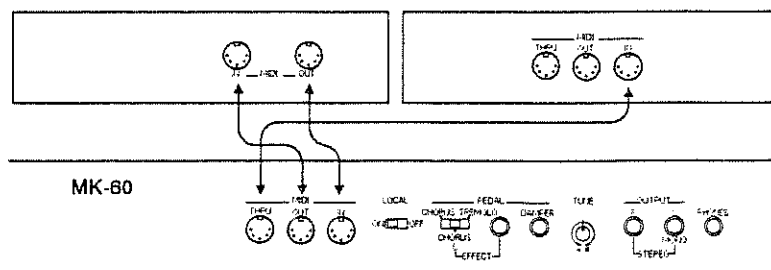

■ Setting the MIDI Channel

Whenever an external MIDI device is to be connected, and transmission/reception of MIDI information is to be carried out, you will need to have the channels on both transmitting and receiving devices set so they match.

On the MK-60, MIDI channels are set as follows:

«When wishing to transmit and receive on a single channel»

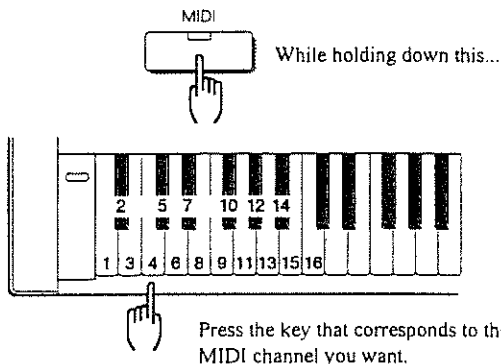

* Each time power is turned on, the unit is set to channel 1 (Omni Off).

«When wishing to set separate receive and transmit channels»

■ Setting the transmit channel

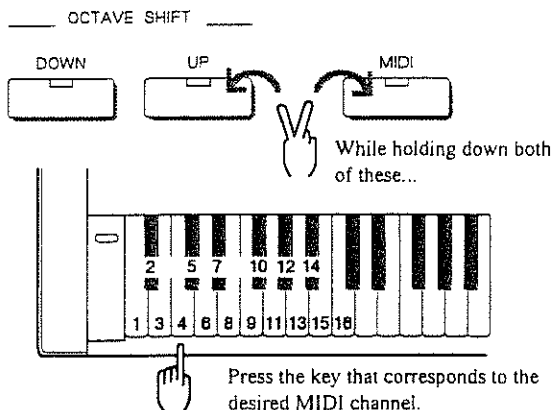

■ Setting the receive channel

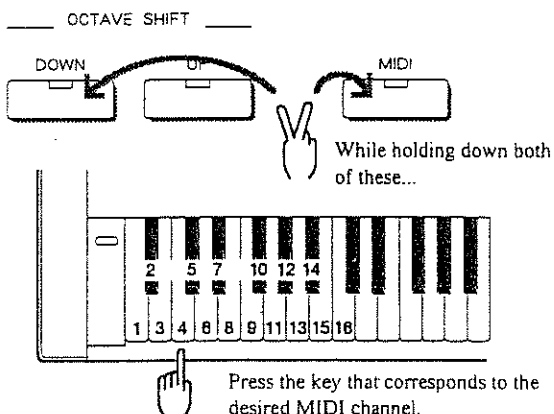

* Once a receive channel has been set, the unit enters the Omni Off mode.

■ Transmission of Program Changes

Program Changes are MIDI messages used to change tones. Any particular device can have a number (from 1 to 128) assigned to each tone. Through transmission or reception of this number in the form of a Program Change, you can produce the change to a different tone.

On the MK-60 a Program Change number (1 – 128) is specified in terms of its Group (A/B), Bank (1 – 8), and Number (1 – 8).

Program Change numbers and their equivalents when represented as Group/Bank/Number are shown in the chart below.

Group A									Group B										
		Number										Number							
Bank		1	2	3	4	5	6	7	8	Bank		1	2	3	4	5	6	7	8
1		1	2	3	4	5	6	7	8	1		65	66	67	68	69	70	71	72
2		9	10	11	12	13	14	15	16	2		73	74	75	76	77	78	79	80
3		17	18	19	20	21	22	23	24	3		81	82	83	84	85	86	87	88
4		25	26	27	28	29	30	31	32	4		89	90	91	92	93	94	95	96
5		33	34	35	36	37	38	39	40	5		97	98	99	100	101	102	103	104
6		41	42	43	44	45	46	47	48	6		105	106	107	108	109	110	111	112
7		49	50	51	52	53	54	55	56	7		113	114	115	116	117	118	119	120
8		57	58	59	60	61	62	63	64	8		121	122	123	124	125	126	127	128

To transmit Program Changes, do as follows:

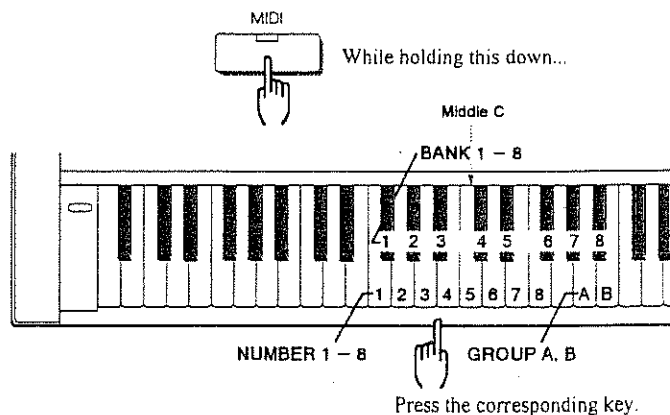

■ Tone Changes Made When Program Changes Are Received

When a Program Change number from 1 to 8 is received, change will be made to the tone which corresponds to that number.

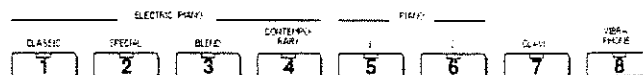

* Program Change numbers 9 through 128 are ignored.

■ On/Off Control of Chorus and Tremolo for an External MIDI Device

When any MIDI device connected to the MK-60's MIDI OUT is equipped with chorus or tremolo (capable of receiving and using chorus or tremolo messages), you can switch between on and off for such effects using the MK-60's panel.

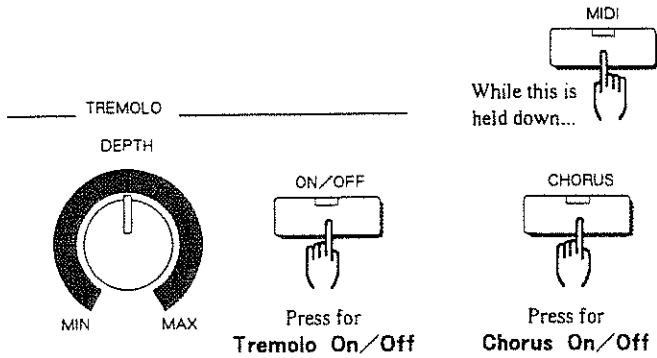

* At this time, Control Change No. 93 (chorus), or Control Change No. 92 (tremolo) is transmitted.

■ Setting to Omni On

When the setting shown below (Omni On) has been made, the unit will produce sound regardless of the channel the messages are received on.

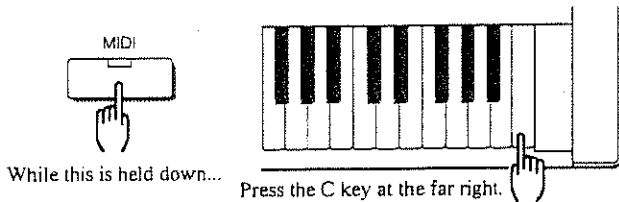

* Upon selection of a specific receive channel, the mode will revert to Omni Off.

■ Selection of Transmission / Reception Mode for Program & Control Changes

When power is turned on normally, using solely the power switch, all transmission/reception of Program Changes, and Control Changes Nos. 93 (chorus) and 92 (tremolo) will take place as explained so far, that is, in accord with the "standard mode." However, other modes are provided, and can be selected by turning power on in a different manner, as explained in the following.

- **When the VIB button is held down while turning on power:** Program Changes, and Control Changes Nos. 93 (chorus) and 92 (tremolo) are ignored if received.
- **When the CLAVI button is held down while turning on power:** In addition to the characteristics of the standard mode, when a tone change is made, its corresponding number (see illustration below) is transmitted as a Program Change. Also transmitted is the on/off status with respect to chorus and tremolo that pertains to that particular tone.



■ Selecting How All Notes Off Messages Are Handled

Ordinarily, when an All Notes Off message is received, the instrument will stop emitting sound for all keys that had been sounding. However, if the PIANO 2 button is held down while turning on power any All Notes Off messages received will be ignored.

■ Local On/Off

Using the switch on the rear panel, the MK-60 can easily be set to either Local On or Local Off.

Local On
The ordinary condition; the MK-60's keyboard and the internal sound source are linked together.

Local Off
In this condition, the keyboard and the internal sound source are not linked together, thus the MK-60's sound will not be heard when its keyboard is played.

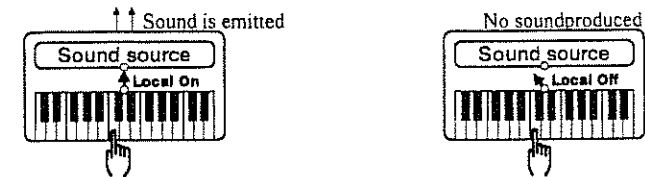

Local Off is effective to use when you wish only a connected module to be sounded, or when you have a MIDI sequencer connected.

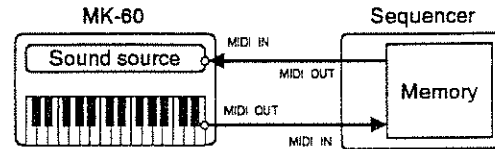

When the MK-60 and a sequencer are connected up as shown below, what is played on the MK-60 can be recorded into the sequencer. Later the sequencer can be played, thus playing the MK-60.

However, if you have the sequencer set to Soft Thru On (condition whereby any information received at its MIDI IN is transmitted from MIDI OUT), the MK-60 needs to be set to Local Off.

This is because if it is left at Local On, and the keyboard is played, one stream of signals from the keyboard directly sounds the internal source, along with another identical stream arriving via the sequencer. This type of redundancy can cause a tone to sound differently than it normally should, or cause certain notes to be left out.

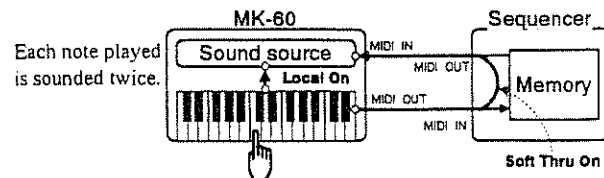

You should check how your sequencer is handling Soft Thru by referring to its manual, and then alter settings if necessary.

* Since the MK-60 receives and responds to any Local On/Off messages that may be received from an external MIDI device, you should take caution, since the position shown by the switch may not always reflect the actual status the unit has assumed.

MIDI Implementation Chart

Function ***		Transmitted	Recognized	Remarks
Basic Channel	Default Changed	1 1 - 16 each	1 1 - 16 each	
Mode	Default Messages Altered	Mode 3 Omni Off, Poly *****	Mode 3 ×	* 1
Note Number	True Voice	15 - 113 *****	0 - 127 15 - 113	
Velocity	Note ON Note OFF	○ × 9n v = 0	○ × 9n v = 0	v = 1 - 127
After Touch	Key's Ch's	× ×	× ×	
Pitch Bender		×	×	
Control Change	64	* 1	○	Hold 1 Tremolo Chorus
	92	* 1	* 2	
93	* 1	* 2		
	121	×	○	Reset All Controllers
Prog Change	True #	○ (0 - 127) *****	* 2 (0 - 7) 0 - 7	
System Exclusive		×	×	
System Common	Song Pos Song Sel Tune	× × ×	× × ×	
System Real Time	Clock Commands	× ×	× ×	
Aux Message	Local ON/OFF All Notes OFF Active Sense Reset	× × ○ ×	○ * 2 ○ ×	
Notes		* 1 When power on, transmitted to channel 1. * 2 Can be set o or x, when power is first applied.		

Mode 1 : OMNI ON, POLY
Mode 3 : OMNI OFF, POLY

Mode 2 : OMNI ON, MONO
Mode 4 : OMNI OFF, MONO

○ : Yes
× : No

1. TRANSMITTED DATA

■ Channel Voice Messages

● Note Off

<u>Status</u>	<u>Second</u>	<u>Third</u>
9nH	kkH	00H

n = MIDI channel number : 0H - FH (0 - 15) 0 = ch 1 15 = ch 16
kk = Note number : FH - 71H (15 - 113)

● Note On

<u>Status</u>	<u>Second</u>	<u>Third</u>
9nH	kkH	vvH

n : MIDI channel number : 0H - FH (0 - 15) 0 = ch 1 15 = ch 16
kk : Note number : FH - 71H (15 - 113)
vv : Velocity : 01H - 7FH (1 - 127)

* Note number's range can be changed by key transpose and octave shift.

● Control Change

○ Damper (Hold 1)

<u>Status</u>	<u>Second</u>	<u>Third</u>
BnH	40H	vvH

n = MIDI channel number : 0H - FH (0 - 15) 0 = ch 1 15 = ch 16
vv = Control value : 00H, 7FH (0, 127) 0 = OFF, 127 = ON

○ Tremolo

<u>Status</u>	<u>Second</u>	<u>Third</u>
BnH	5CH	vvH

n = MIDI channel number : 0H - FH (0 - 15) 0 = ch 1 15 = ch 16
vv = Control value : 00H, 7FH (0, 127) 0 = OFF, 127 = ON

* When the TREMOLO switch is pressed while the MIDI switch is being held down, the TREMOLO ON or OFF message is sent.

* If the power has been applied with the CLAVI switch being held down, pressing TREMOLO switch sends TREMOLO ON or OFF message. (MIDI Transmit and Receive mode3)

○ Chorus

<u>Status</u>	<u>Second</u>	<u>Third</u>
BnH	5DH	vvH

n = MIDI channel number : 0H - FH (0 - 15) 0 = ch 1 15 = ch 16
vv = Control value : 00H, 7FH (0, 127) 0 = OFF, 127 = ON

* When the CHORUS switch is pressed while the MIDI switch being held down, the CHORUS ON or OFF message is sent.

* If the power has been applied with the CLAVI switch being held down, pressing CHORUS switch sends CHORUS ON or OFF message. (MIDI Transmit and Receive mode 3)

● Program Change

<u>Status</u>	<u>Second</u>
CnH	ppH

n = MIDI channel number : 0H - FH (0 - 15) 0 = ch 1 15 = ch 16
pp = Program number : 00H - 7FH (0 - 127)

* When the key witch is related with PROGRAM CHANGE (GROUP A - B, BANK 1 - 8, NUMBER 1 - 8) is pressed while the MIDI switch being held down, a Program Change message will be transmitted.

* If the power has been applied with the CLAVI switch being held down, pressing TONE switch sends PROGRAM CHANGE (0 - 7). (MIDI Transmit and Receive mode 3)

■ Channel Mode Message

● OMNI OFF

<u>Status</u>	<u>Second</u>	<u>Third</u>
BnH	7CH	00H

n = MIDI channel number : 0H - FH (0 - 15) 0 = ch 1 15 = ch 16

● POLY

<u>Status</u>	<u>Second</u>	<u>Third</u>
BnH	7FH	00H

n = MIDI channel number : 0H - FH (0 - 15) 0 = ch 1 15 = ch 16

* When power is first applied, OMNI OFF and POLY ON are sent in the channel 1.

■ System Real-time message

● Active Sensing

<u>Status</u>
FEH

* The message is interleaved when a non-message time is expected to elapse more than 300ms.

2. RECOGNIZED RECEIVE DATA

■ Channel Voice Message

● Note Off

<u>Status</u>	<u>Second</u>	<u>Third</u>
8nH	kkH	vvH
9nH	kkH	00H

n = MIDI channel number : 0H - FH (0 - 15) 0 = ch 1 15 = ch 16
kk = Note number : 00H - 7FH (0 - 127)
vv = velocity : 00H - 7FH (0 - 127)

* The velocity will be ignored.

● Note On

<u>Status</u>	<u>Second</u>	<u>Third</u>
9nH	kkH	vvH

n = MIDI channel number : 0H - FH (0 - 15) 0 = ch 1 15 = ch 16
kk = Note number : 00H - 7FH (0 - 127)
vv = velocity : 01H - 7FH (1 - 127)

* Note numbers outside of the range 15 - 113 are transposed to the nearest octave inside this range.

* The Key Transpose operation from the panel does not affect MIDI IN NOTE numbers.

● Control Change

○ Damper (Hold 1)

<u>Status</u>	<u>Second</u>	<u>Third</u>
BnH	40H	vvH

* Damper is always ready to receive messages.

n = MIDI channel number : 0H - FH (0 - 15) 0 = ch 1 15 = ch 16
vv = Control value : 00H - 7FH (0 - 127) 0 = OFF, 1 - 63 = Half DUMP, 64 - 127 = ON

○ Tremolo

<u>Status</u>	<u>Second</u>	<u>Third</u>
BnH	5CH	vvH

n = MIDI channel number : 0H - FH (0 - 15) 0 = ch 1 15 = ch 16
vv = Control value : 00H - 7FH (0 - 127) 0 = OFF, 64 - 127 = ON

○ Chorus

<u>Status</u>	<u>Second</u>	<u>Third</u>
BnH	5DH	vvH

n = MIDI channel number : 0H - FH (0 - 15) 0 = ch 1 15 = ch 16
vv = Control value : 00H - 7FH (0 - 127) 0 = OFF 64 - 127 = ON

* IF the power has been applied with the VIB switch being held down, CHORUS TREMOLO ON/OFF is ignored. (MIDI transmit and Receive mode 2)

○ Program Change

<u>Status</u>	<u>Second</u>
CnH	ppH

n = MIDI channel number : 0H - FH (0 - 15) 0 = ch 1 15 = ch 16
pp = Program number : 0H - 7H (0 - 7)

* When Program Change is received, CHORUS TREMOLO ON/OFF is set to the memorized status for that Tone.

* If the power has been applied with the VIB switch being held down, PROGRAM CHANGE is ignored. (MIDI transmit and Receive mode 2)

■ Channel Mode Message

● Local Control

<u>Status</u>	<u>Second</u>	<u>Third</u>
BnH	7AH	vvH

n = MIDI channel number : 0H - FH (0 - 15) 0 = ch 1 15 = ch 16
vv = Control value : 00H, 7FH (0, 127) 0 = OFF 127 = ON

● Reset All Controllers

<u>Status</u>	<u>Second</u>	<u>Third</u>
BnH	79H	00H

n = MIDI Channel number : 0H - FH (0 - 15) 0 = ch 1 15 = ch 16

* When this message was received, the values of the controllers listed below will change.

Hold 1 0 (OFF)

● All Note Off

<u>Status</u>	<u>Second</u>	<u>Third</u>
BnH	7BH	00H

n = MIDI channel number : 0H - FH (0 - 15) 0 = ch 1 15 = ch 16

* When All Notes Off is received, all the on-notes of the appropriate channel will be "Off".

If All Notes Off was received, even though there was a note being on (an off-note made to keep emitting a sound by the use of the damper is though to be "off"), all the on-notes received by MIDI are changed to the "Off" condition, and it goes through the same process taken as when "Reset All Controllers" is received.

■ System Real-time Message

● Active Sensing

Status
FEH

* Upon receiving this message, measuring the time at the end of every message is started. If no data was received within 300ms, all the MIDI-on notes will turn off, and goes through the same process taken as when Reset All Controllers was received, then returns to the state which does not measure the time intervals of the messages.

Rhodes

Roland®

10690

UPC

10690



10901

Roland®