

Roland®



DIGITAL INTELLIGENT PIANO



KR-575

Owner's Manual

Before using this unit, carefully read the sections entitled: "IMPORTANT SAFETY INSTRUCTIONS" (Owner's manual p. 2), "USING THE UNIT SAFELY" (Owner's manual p. 3), and "IMPORTANT NOTES" (Owner's manual p. 4). These sections provide important information concerning the proper operation of the unit. Additionally, in order to feel assured that you have gained a good grasp of every feature provided by your new unit, Owner's manual should be read in its entirety. The manual should be saved and kept on hand as a convenient reference.

Copyright © 1998 ROLAND CORPORATION

All rights reserved. No part of this publication may be reproduced in any form without the written permission of ROLAND CORPORATION.

	CAUTION RISK OF ELECTRIC SHOCK DO NOT OPEN	
ATTENTION: RISQUE DE CHOC ELECTRIQUE NE PAS OUVRIR		
CAUTION: TO REDUCE THE RISK OF ELECTRIC SHOCK, DO NOT REMOVE COVER (OR BACK). NO USER-SERVICEABLE PARTS INSIDE. REFER SERVICING TO QUALIFIED SERVICE PERSONNEL.		



The lightning flash with arrowhead symbol, within an equilateral triangle, is intended to alert the user to the presence of uninsulated "dangerous voltage" within the product's enclosure that may be of sufficient magnitude to constitute a risk of electric shock to persons.



The exclamation point within an equilateral triangle is intended to alert the user to the presence of important operating and maintenance (servicing) instructions in the literature accompanying the product.

INSTRUCTIONS PERTAINING TO A RISK OF FIRE, ELECTRIC SHOCK, OR INJURY TO PERSONS.

IMPORTANT SAFETY INSTRUCTIONS

SAVE THESE INSTRUCTIONS

WARNING - When using electric products, basic precautions should always be followed, including the following:

1. Read all the instructions before using the product.
2. Do not use this product near water — for example, near a bathtub, washbowl, kitchen sink, in a wet basement, or near a swimming pool, or the like.
3. This product should be used only with a cart or stand that is recommended by the manufacturer.
4. This product, either alone or in combination with an amplifier and headphones or speakers, may be capable of producing sound levels that could cause permanent hearing loss. Do not operate for a long period of time at a high volume level or at a level that is uncomfortable. If you experience any hearing loss or ringing in the ears, you should consult an audiologist.
5. The product should be located so that its location or position does not interfere with its proper ventilation.
6. The product should be located away from heat sources such as radiators, heat registers, or other products that produce heat.
7. The product should be connected to a power supply only of the type described in the operating instructions or as marked on the product.
8. The power-supply cord of the product should be unplugged from the outlet when left unused for a long period of time.
9. Care should be taken so that objects do not fall and liquids are not spilled into the enclosure through openings.
10. The product should be serviced by qualified service personnel when:
 - A. The power-supply cord or the plug has been damaged; or
 - B. Objects have fallen, or liquid has been spilled into the product; or
 - C. The product has been exposed to rain; or
 - D. The product does not appear to operate normally or exhibits a marked change in performance; or
 - E. The product has been dropped, or the enclosure damaged.
11. Do not attempt to service the product beyond that described in the user-maintenance instructions. All other servicing should be referred to qualified service personnel.

For the USA

This product may be equipped with a polarized line plug (one blade wider than the other) . This is a safety feature. If you are unable to insert the plug into the outlet, contact an electrician to replace your obsolete outlet. Do not defeat the safety purpose of the plug.

For Canada

For Polarized Line Plug

CAUTION: TO PREVENT ELECTRIC SHOCK, MATCH WIDE BLADE OF PLUG TO WIDE SLOT, FULLY INSERT.
ATTENTION: POUR ÉVITER LES CHOCs ÉLECTRIQUES, INTRODUIRE LA LAME LA PLUS LARGE DE LA FICHE DANS LA BORNE CORRESPONDANTE DE LA PRISE ET POUSSER JUSQU' AU FOND.

For the U.K.

IMPORTANT: THE WIRES IN THIS MAINS LEAD ARE COLOURED IN ACCORDANCE WITH THE FOLLOWING CODE.

BLUE: NEUTRAL
 BROWN: LIVE

As the colours of the wires in the mains lead of this apparatus may not correspond with the coloured markings identifying the terminals in your plug, proceed as follows:
 The wire which is coloured BLUE must be connected to the terminal which is marked with the letter N or coloured BLACK.
 The wire which is coloured BROWN must be connected to the terminal which is marked with the letter L or coloured RED.
 Under no circumstances must either of the above wires be connected to the earth terminal of a three pin plug.

USING THE UNIT SAFELY

INSTRUCTIONS FOR THE PREVENTION OF FIRE, ELECTRIC SHOCK, OR INJURY TO PERSONS

About ⚠ WARNING and ⚠ CAUTION Notices

⚠ WARNING	Used for instructions intended to alert the user to the risk of death or severe injury should the unit be used improperly.
⚠ CAUTION	Used for instructions intended to alert the user to the risk of injury or material damage should the unit be used improperly. * Material damage refers to damage or other adverse effects caused with respect to the home and all its furnishings, as well to domestic animals or pets.

About the Symbols

	The ⚠ symbol alerts the user to important instructions or warnings. The specific meaning of the symbol is determined by the design contained within the triangle. In the case of the symbol at left, it is used for general cautions, warnings, or alerts to danger.
	The ⓧ symbol alerts the user to items that must never be carried out (are forbidden). The specific thing that must not be done is indicated by the design contained within the circle. In the case of the symbol at left, it means that the unit must never be disassembled.
	The ● symbol alerts the user to things that must be carried out. The specific thing that must be done is indicated by the design contained within the circle. In the case of the symbol at left, it means that the power-cord plug must be unplugged from the outlet.

ALWAYS OBSERVE THE FOLLOWING

⚠ WARNING

- Before using this unit, make sure to read the instructions below, and the Owner's Manual.
- Do not open or perform any internal modifications on the unit.
- Make sure you always have the unit placed so it is level and sure to remain stable. Never place it on stands that could wobble, or on inclined surfaces.
- Avoid damaging the power cord. Do not bend it excessively, step on it, place heavy objects on it, etc. A damaged cord can easily become a shock or fire hazard. Never use a power cord after it has been damaged.
- In households with small children, an adult should provide supervision until the child is capable of following all the rules essential for the safe operation of the unit.
- Protect the unit from strong impact. (Do not drop it!)
- Do not force the unit's power-supply cord to share an outlet with an unreasonable number of other devices. Be especially careful when using extension cords—the total power used by all devices you have connected to the extension cord's outlet must never exceed the power rating (watts/amperes) for the extension cord. Excessive loads can cause the insulation on the cord to heat up and eventually melt through.
- Before using the unit in a foreign country, consult with your retailer, the nearest Roland Service Center, or an authorized Roland distributor, as listed on the "Information" page.

⚠ CAUTION

- Always grasp only the plug on the power-supply cord when plugging into, or unplugging from, an outlet or this unit.
- Try to prevent cords and cables from becoming entangled. Also, all cords and cables should be placed so they are out of the reach of children.
- Never climb on top of, nor place heavy objects on the unit.
- Never handle the power cord or its plugs with wet hands when plugging into, or unplugging from, an outlet or this unit.
- If you need to move the instrument, take note of the precautions listed below. At least two persons are required to safely lift and move the unit. It should be handled carefully, all the while keeping it level. Make sure to have a firm grip, to protect yourself from injury and the instrument from damage.
 - Check to make sure the screw securing the unit to the stand have not become loose. Fasten them again securely whenever you notice any loosening.
 - Disconnect the power cord.
 - Disconnect all cords coming from external devices.
 - Raise the adjusters on the stand.
 - Close the lid.
 - Fold down the music stand.
- Before cleaning the unit, turn off the power and unplug the power cord from the outlet (p. 4).
- Whenever you suspect the possibility of lightning in your area, pull the plug on the power cord out of the outlet.
- Be careful when opening/closing the lid so you do not get your fingers pinched (p. 16). Adult supervision is recommended whenever small children use the unit.

IMPORTANT NOTES

In addition to the items listed under "IMPORTANT SAFETY INSTRUCTIONS" and "USING THE UNIT SAFELY" on pages 2 and 3, please read and observe the following:

Power Supply

- Do not use this unit on the same power circuit with any device that will generate line noise (such as an electric motor or variable lighting system).
- Before connecting this unit to other devices, turn off the power to all units. This will help prevent malfunctions and/or damage to speakers or other devices.

Placement

- Using the unit near power amplifiers (or other equipment containing large power transformers) may induce hum. To alleviate the problem, change the orientation of this unit; or move it farther away from the source of interference.
- This device may interfere with radio and television reception. Do not use this device in the vicinity of such receivers.
- Observe the following when using the unit's floppy disk drive. For further details, refer to "Before Using Floppy Disks".
 - Do not place the unit near devices that produce a strong magnetic field (e.g., loudspeakers).
 - Install the unit on a solid, level surface.
 - Do not move the unit or subject it to vibration while the drive is operating.
- Do not expose the unit to direct sunlight, place it near devices that radiate heat, leave it inside an enclosed vehicle, or otherwise subject it to temperature extremes. Excessive heat can deform or discolor the unit.
- Do not allow rubber, vinyl, or similar materials to remain on the piano for long periods of time. Such objects can discolor or otherwise harmfully affect the finish.
- Do not put anything that contains water (e.g., flower vases) on the piano. Also, avoid the use of insecticides, perfumes, alcohol, nail polish, spray cans, etc., near the unit. Swiftly wipe away any liquid that spills on the unit using a dry, soft cloth.

Maintenance

- To clean the unit, use a dry, soft cloth; or one that is slightly dampened. Try to wipe the entire surface using an equal amount of strength, moving the cloth along with the grain of the wood. Rubbing too hard in the same area can damage the finish.
- Never use benzine, thinner, alcohol or solvents of any kind, to avoid the possibility of discoloration and/or deformation.

Repairs and Data Additional Precautions

- Unfortunately, it may be impossible to restore the contents of data that was stored on a floppy disk once it has been lost. Roland Corporation assumes no liability concerning such loss of data.
- Use a reasonable amount of care when using the unit's buttons, sliders, or other controls; and when using its jacks and connectors. Rough handling can lead to malfunctions.
- Never strike or apply strong pressure to the display.
- A small amount of noise may be heard from the display during normal operation.
- When connecting / disconnecting all cables, grasp the connector itself—never pull on the cable. This way you will avoid causing shorts, or damage to the cables internal elements.
- A small amount of heat will radiate from the unit during normal operation.
- To avoid disturbing your neighbours, try to keep the unit's volume at reasonable levels. You may prefer to use headphones, so you do not need to be concerned about those around you (especially when it is late at night).
- When you need to transport the unit, package it in the box (including padding) that it came in, if possible. Otherwise, you will need to use equivalent packaging materials.
- Do not pull the music stand too far forward when setting/releasing its latches.

Before Using Floppy Disks

Handling the Floppy Disk Drive

- Install the unit on a solid, level surface in an area free from vibration.
- Avoid using the unit immediately after it has been moved to a location with a level of humidity that is greatly different than its former location. Rapid changes in the environment can cause condensation to form inside the drive, which will adversely affect the operation of the drive and/or damage floppy disks. When the unit has been moved, allow it to become accustomed to the new environment (allow a few hours) before operating it.
- To insert a disk, push it gently but firmly into the drive—it will click into place. To remove a disk, press the EJECT button firmly. Do not use excessive force to remove a disk which is lodged in the drive.
- Never attempt to remove a floppy disk from the drive while the drive is operating (the indicator is brightly lit); damage could result to both the disk and the drive.
- Remove any disk from the drive before powering up or down.
- To prevent damage to the disk drive's heads, always try to hold the floppy disk in a level position (not tilted in any direction) while inserting it into the drive. Push it in firmly, but gently. Never use excessive force.

Handling Floppy Disks

- Floppy disks contain a plastic disk with a thin coating of magnetic storage medium. Microscopic precision is required to enable storage of large amounts of data on such a small surface area. To preserve their integrity, please observe the following when handling floppy disks:
 - Never touch the magnetic medium inside the disk.
 - Do not use or store floppy disks in dirty or dusty areas.
 - Do not subject floppy disks to temperature extremes (e.g., direct sunlight in an enclosed vehicle). Recommended temperature range: 10 to 50° C (50 to 122° F).
 - Do not expose floppy disks to strong magnetic fields, such as those generated by loudspeakers.

- Floppy disks have a "write protect" tab which can protect the disk from accidental erasure. It is recommended that the tab be kept in the Protect position, and moved to the Write position only when you wish to write new data onto the disk.

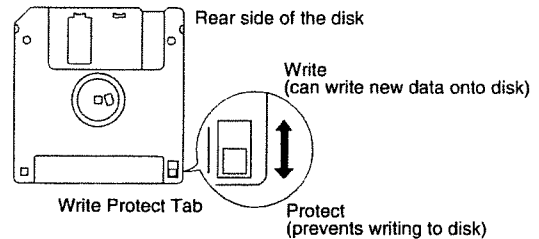

- The identification label should be firmly affixed to the disk. Should the label come loose while the disk is in the drive, it may be difficult to remove the disk.
- Put the disk back into its case for storage.
- Disks containing performance data for this unit should always be locked (have their write protect tab slid to the "Protect" position) before you insert them into the drive on some other unit (except the PR-300, or a product in the HP-G, MT, KR, or Atelier families), or into a computer's drive. Otherwise (if the write protect tab remains in the "Write" position), when you perform any disk operations using the other device's disk drive (such as checking the contents of the disk, or loading data), you risk rendering the disk unreadable by this unit's disk drive.

* GS (GS logo) is a registered trademark of Roland Corporation.

* Apple is a registered trademark of Apple Computer, Inc.

* Macintosh is a registered trademark of Apple Computer, Inc.

* IBM PC is a registered trademark of International Business Machines Corporation.

What You Can Do with the KR-575

We want to take a moment to thank you for your purchase of the Roland KR-575 digital piano. The KR-575's easy-to-operate keyboard and automatic accompaniment makes it truly enjoyable to play.

In order to enjoy reliable performance of your new keyboard for many years to come, please take the time to read through this manual in its entirety.

- **Carry Out a Wide Variety of Actions Just by Touching the Screen**

The large display and built-in Touch Screen let you carry out a wide variety of operations just by touching the screen (page 15).

- **One-button Setup for Performances**

You can make the optimal settings for a piano or organ performance just by pressing a one-touch button (page 24, 25).

- **Add Lively Orchestra and Band Accompaniments to Your Performances Automatically**

Thanks to the Automatic Accompaniment function and a rich array of built-in Music Styles, you can enjoy ensemble performances even when you're playing solo (page 31).

- **Play with a Wide Variety of Instrument Sounds**

You can choose your favorites from among 499 types of instrument sounds for your performances (page 27).

- **Enjoy Authentic Piano Performances**

The KR-575 reproduces high-quality concert-piano sounds and uses a hammer-action keyboard, so you can enjoy realistic piano performance.

- **Simple Operation Makes It Easy to Record Your Own Performances**

Five track buttons can be used like a tape recorder to record what you play (page 35).

- **Make Your Own Authentic Ensemble Songs**

You can use a variety of recording and editing features to compose your own authentic ensemble tunes (page 81, page 100).

- **Make Use of Commercially Available Music Files for Listening or Lessons**

You can use the built-in disk drive to listen to commercial music-file songs and save recorded tunes on floppy disk (page 40).

- **Enjoy the KR-575 with a Microphone**

You can hook up a microphone to use the KR-575 like a karaoke machine (page 52). You can also apply a variety of effects to vocals (page 50).

Conventions Used in This Manual

- Button names are enclosed in square brackets (" []"), as in [Demo] button.
- On-screen text is enclosed in angled brackets (" < >") as in <Clear>.
- The act of lightly contacting the Touch Screen with your finger is called "touching."
- Whether a button light is illuminated, dark, or blinking is illustrated as shown below.

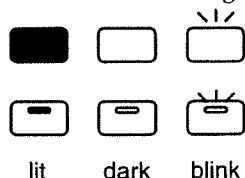

Contents

Using the Unit Safely	3
Important Notes.....	4
What You Can Do with the KR-575.....	6
Conventions Used in This Manual	6

Getting Started 11

Panel Descriptions.....	11
About the Touch Screen	15
About the Screen.....	16

Before You Start Playing 18

Opening and Closing the Cover.....	18
Setting Up the Music Stand.....	18
Pedals	18
Using Headphones.....	18
Switching the Power On and Off	19

Chapter 1—Mastering the Basics 20

Adjusting the Sound Volume and Brilliance.....	20
The Help Function.....	20
An Introduction to the KR-575's Sounds and Tunes—Demo Play	21
Playing the Ear-training Games	22
Let's Try Out the KR-575's Basic Functions	23
Playing the Keyboard Like a Piano—One-touch Piano.....	24
Playing the Keyboard Like an Organ—One-touch Organ	25
Playing Drums from the Keyboard	26
Playing a Wide Variety of Instrument Sounds	27
Using the Metronome	28
Changing the Tempo of the Metronome	28
Changing the Beat of Metronome.....	29
Changing the Metronome Pattern	29
Changing the Volume	30
Changing the Type of Sound.....	30
Changing the Animation	30
Playing with an Automatic Accompaniment—One-touch Arranger.....	31
Let's Try Playing "When the Saints Go Marching In".....	31
The Score for "When the Saints Go Marching In"	32
Changing the Volume Balance for the Accompaniment and keyboard	34
Recording a Performance	35
Recording a Performance with Automatic Accompaniment	35
Recording a performance without using Automatic Accompaniment.....	37
Redoing a Recording	38
Erasing a Recorded Song	39
Erasing the Sound Recorded on Individual Track Buttons	39
Using the Disk Drive.....	40
Inserting and Ejecting a Floppy Disk	40

Contents

Formatting a Floppy Disk.....	40
Saving Your Songs on Floppy Disk.....	42
Listening to Music Files.....	45
Using the KR-575 As a Karaoke Machine.....	48
Connecting a Microphone.....	48
Adjusting the Echo.....	49
Adding Changes to Your Voice.....	50
Adding Harmony.....	51
Enjoying Karaoke Performances.....	52
Chapter 2—Basic Functions	53
Adding an Echo to a Sound.....	53
Adding a Variety of Effects to Sounds.....	53
Combining the Sounds of Two Instruments—Layer Play.....	54
Playing Different Tones with the Left and Right Hands—Split Play.....	56
Playing the Entire Keyboard As a Single Instrument.....	57
Chapter 3—Automatic Accompaniment	58
Choosing a Music Style.....	58
Using a Music Style Disk.....	60
Choosing How the KR-575 Starts and Stops.....	61
Modifying an Accompaniment.....	63
Changing the Accompaniment Pattern.....	63
Changing the Arrangement of the Accompaniment.....	64
Playing a Short Phrase.....	65
Playing Chords with Simple Fingering.....	66
Adding Harmony to the Right-hand Part.....	67
Playing with Automatic Accompaniment Without Splitting the Keyboard - Piano Style Arranger.....	68
Chapter 4—Some Handy Features	69
Adjusting the Tempo.....	69
Determine the Tempo by the Timing of Pressing the Pad Button.....	69
Playback with No Change in Tempo.....	70
Counting Down Before a Performance Starts.....	70
Moving to the Passage You Want to Hear.....	71
Placing Markers.....	72
Listening to the Same Passage Over and Over.....	74
Playing in an Easier Key.....	76
Transposing a Song.....	77
Playing Along with a Song.....	78
Checking Your Performance On Screen.....	79
Chapter 5—Recording Functions	81
The KR-575's Recording Functions.....	81
Using the Ordinary Recording Method.....	81
Recording Sounds in Combination.....	82

Recording the Same Passage Over and Over	83
Re-recording a Specific Passage	84
Recording an Ensemble Tune—16-track Sequencer.....	85
Steps for Recording an Ensemble Tune	86
Changing the Song Settings for Individual Parts.....	88
Creating a Rhythm Part with Ease.....	91
Recording a Song with an Upbeat	92
Composing a Tune That Changes Tempo Partway Through.....	93
Composing a Tune That Changes the Beat Partway Through	95
Changing How Recording Stops.....	96
Composing an Accompaniment Without Playing the Song	97

Chapter 6—Editing Functions 100

Choosing an Editing Function.....	100
Canceling an Edit	101
Correcting Timing Discrepancies.....	102
Copying a Measure	103
Copying a Rhythm Pattern	104
Deleting a Specific Measure.....	105
Inserting a Blank Measure.....	106
Making a Measure Blank.....	107
Transposing Individual Parts	108
Exchanging Parts.....	109
Correcting Notes One by One	110
Modifying the Tone Changes in a Song.....	111
Changing a Song’s Basic Tempo	112

Chapter 7—Other Functions 113

Adjusting the Volume of Each Performance Part.....	113
Creating a Style from a Recorded Song	114
Combining Styles to Create a New Style	116
Storing a User Style	117
Deleting a Song or User Style Saved on Floppy Disk	118
Assigning Functions to Buttons and Pedals.....	118
Shifting the Keyboard Pitch by One of More Octaves	120
Storing Button Settings.....	121
Disabling All Buttons.....	122

Chapter 8—Changing Various Settings 123

Changing the Settings for One-touch Piano.....	123
Enjoying the Ambience of a Wide Variety of Performance Sites.....	123
Changing the Keyboard’s Touch	124
Adjusting the Sensitivity of the Pedals.....	124
Adjusting the Tuning	125
Adjusting the Resonant Sound.....	126
Changing the Settings for One-touch Organ.....	126
Adjusting the Footage	126
Changing the Keyboard’s Split Point.....	127
Using Automatic Accompaniment During an Organ Performance	127
Changing How the Left-hand Keyboard Section Plays.....	127

Contents

Changing the Settings for Automatic Accompaniment.....	128
Keeping the Same Tone and Tempo When the Style Changes	128
Changing How the Automatic Accompaniment Plays	128
Changing the Chord Tone and Bass Tone.....	128
Canceling Chord Intelligence	128
Changing the Keyboard's Split Point	129
Changing How Button Settings Are Called Up	129
Changing the Bend Range.....	130
Changing the Number of Measures Counted and the Count Sound	130
Playing the Count Sound at Each Repetition	131
Placing a Marker in the Middle of a Measure	131
Changing the Standard Pitch—Master Tuning.....	131
Changing the Type of Reverb Effect.....	132
Changing the Type of Chorus Effect	132
Changing the Screen Settings	133
Hiding the On-screen Lyrics	133
Changing the Language for the Help Function.....	133
Adjusting the Contrast of the Screen.....	133
Repositioning the Touch Screen.....	133
Changing the Power-up Screen.....	134
Retaining Settings While the Power Is Switched Off	134
Restoring Settings to Their Default Values.....	135

Chapter 9—Connecting to External Devices 136

Names and Functions of Jacks and Connectors.....	136
Making the Connections.....	137
If You're Using MIDI	138
MIDI Settings	138

Appendices 141

Troubleshooting.....	141
If This Message Appears On Screen	143
Music Style List.....	145
Chord Fingering List.....	147
Tone Name List.....	149
Drum/SFX Set List	153
Rhythm Pattern List	157
Demo Song List.....	158
Effect List	160
Music Files That the KR-575 Can Use	161
Main Specifications	162
Glossary	164
Index	166
MIDI Implementation Chart.....	168

Panel Descriptions

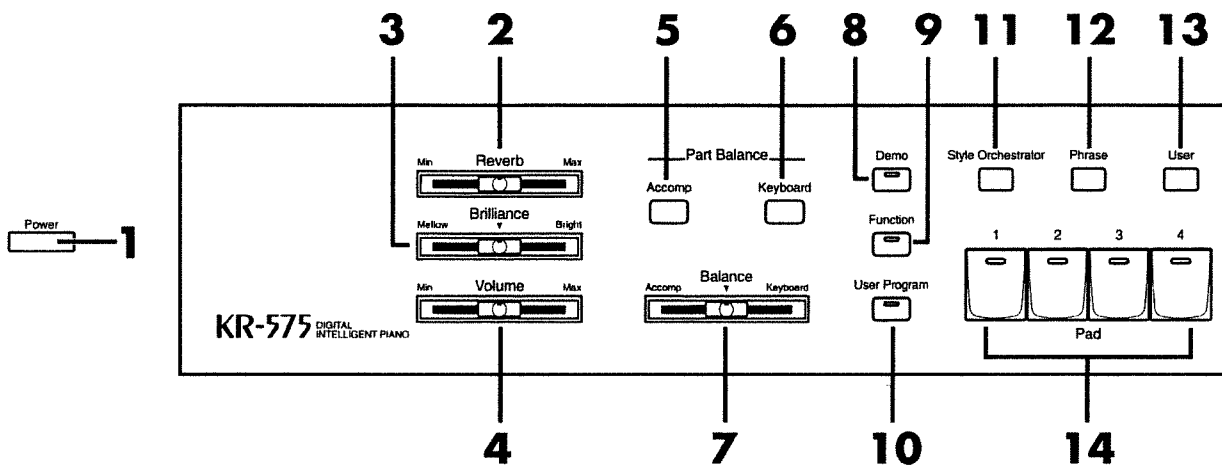

1 [Power] Switch

This is used to switch the power on and off (page 19).

2 [Reverb] Slider

Used to adjust the amount of reverb (page 53).

3 [Brilliance] Slider

This adjusts the sound's brightness (page 20).

4 [Volume] Slider

Adjusts the overall volume (page 20).

5 [Accomp] Button

Adjusts the volume of each Automatic Accompaniment Part that is played (page 113).

6 [Keyboard] Button

Adjusts the volume of percussion or effect sounds played with the keyboard, the volume of the right- or left-hand keyboard section, and the volume during Layer Play (page 113).

7 [Balance] slider

This changes the volume balance for sounds played with the keyboard and for songs and accompaniments (page 34).

8 [Demo] Button

This plays a demo of the KR-575's built-in Tones and Music Styles (page 21).

9 [Function] Button

This selects a variety of play-related functions.

10 [User Program] Button

This stores the selected functions and states of the buttons. It can also call up settings that have been stored (page 121).

11 [Style Orchestrator] Button

This is used to change the arrangement type for automatic accompaniment with the Pad buttons (page 64).

12 [Phrase] Button

This is used to play a short phrase with the Pad buttons (page 65).

13 [User] Button

This is used to assign a variety of functions to the Pad buttons, enabling them to be run (page 118).

14 Pad Buttons

There are four Pad buttons: Pad [1], Pad [2], Pad [3], and Pad [4].

The operation of each is changed using buttons 11, 12, and 13.

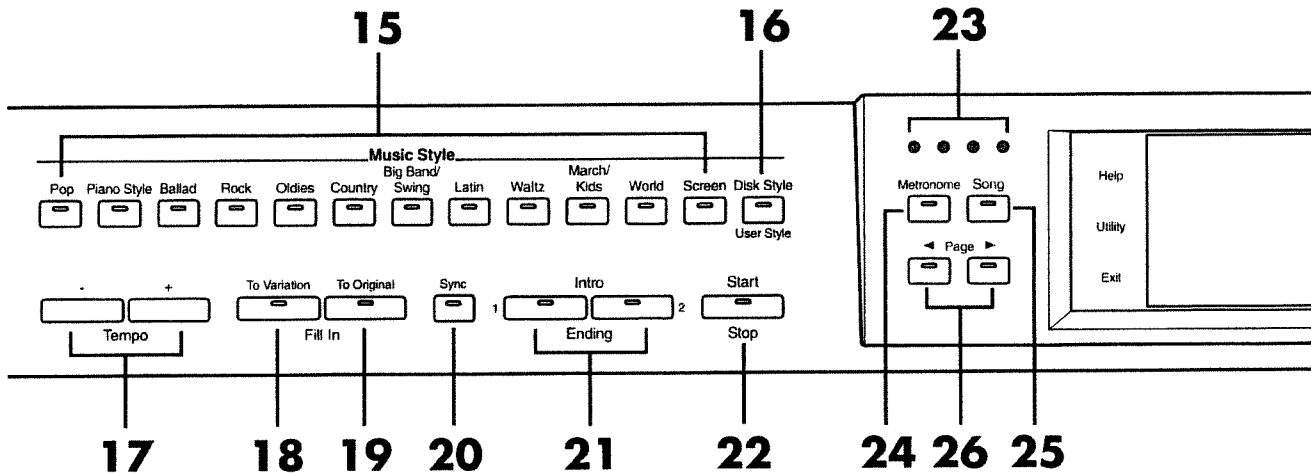

15 Style Buttons

These are called Style buttons.

They're used to select built-in Music Styles (page 58).

[Pop]

[Piano Style]

[Ballad]

[Rock]

[Oldies]

[Country]

[Big Band/Swing]

[Latin]

[Waltz]

[March/Kids]

[World]

[Screen]

16 [Disk/User Style] Button

This selects a Music Style disk (page 60) or a User Style that you've created yourself (page 114 and 116).

17 Tempo [-] and [+] Buttons

These adjust the tempo.

Press the [-] and [+] buttons at the same time to return to the basic tempo.

18 [To Variation] Button

This inserts a fill-in in an automatic accompaniment and changes to the Variation accompaniment pattern (page 63).

19 [To Original] Button

This inserts a fill-in in an automatic accompaniment and changes to the Original accompaniment pattern (page 63).

20 [Sync] Button

When this button's indicator has been lit, Automatic Accompaniment starts at the same time when you play the left-hand section of the keyboard (page 61).

21 Intro/Ending [1] and [2] Buttons

These play an intro or ending during automatic accompaniment (page 61).

22 [Start/Stop] Button

This starts and stops automatic accompaniment (page 61).

23 Beat Indicator

This lights up in correspondence with the beat of the selected song or accompaniment.

24 [Metronome] Button

Activates the built-in metronome (page 28).

25 [Song] Button

This is used to select a song.

26 Page [◀] and [▶] Buttons

These take you to the previous/next screen page. The light comes on when there is another page available in the direction of one of the arrows (page 17).

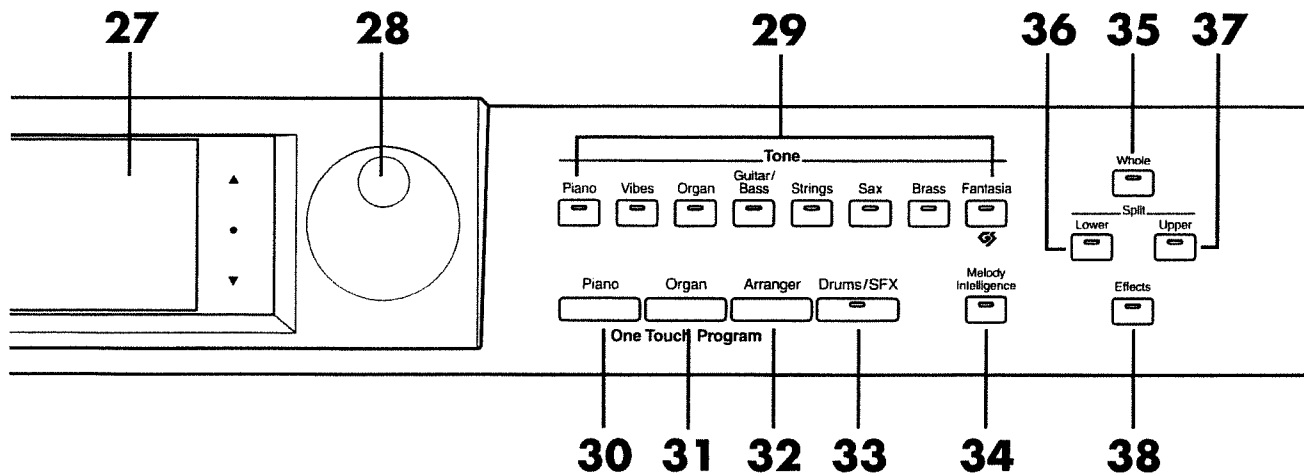
**27 Touch Screen**

This lets you perform a variety of operations just by touching the screen (page 15).

28 Dial

You can use this to change on-screen values or select various items.

29 Tone Buttons

These eight buttons are called Tone buttons. They are used to choose the kinds of sounds (Tone Groups) played by the keyboard (page 27).

[Piano]

[Vibes]

[Organ]

[Guitar/Bass]

[Strings]

[Sax]

[Brass]

[Fantasia/GS]

30 One Touch Program [Piano] Button

This changes the keyboard to a piano sound and makes the optimal settings for a piano performance (page 24).

31 One Touch Program [Organ] Button

This changes the keyboard to an organ sound and makes the optimal settings for an organ performance (page 25).

32 One Touch Program [Arranger] Button

This makes the optimal settings for playing with automatic accompaniment (page 31).

33 [Drums/SFX] Button

This changes the keyboard to play percussion and effect sounds (page 26).

34 [Melody Intelligence] Button

Adds harmony to the sounds played with the keyboard (page 67).

35 [Whole] Button

Used to make the setting so that the entire keyboard plays one type of sound (page 57).

36 Split [Lower] Button

This divides the keyboard into a right-hand section and a left-hand section. It's also used to choose the sounds you play with the lower section (page 56).

37 Split [Upper] Button

This divides the keyboard into a right-hand section and a left-hand section. It's also used to choose the sounds you play with the upper section (page 56).

38 [Effects] Button

Used to apply various effects to the sounds played with the keyboard (page 53).

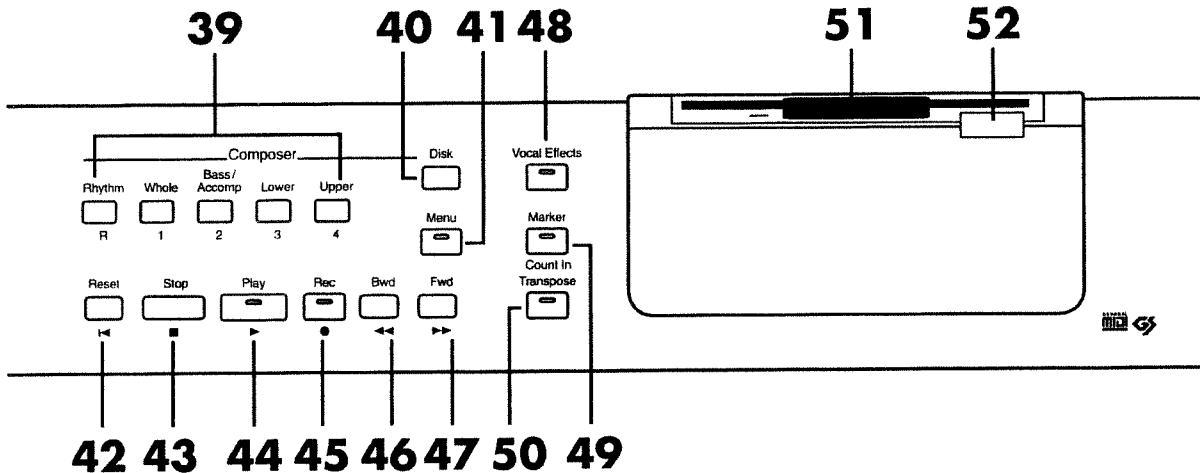

39 Track Buttons

The KR-575 has these five Track buttons.

These are used to play back individual instrument parts of a song or to record your own performances (page 35).

[Rhythm]

[Whole]

[Bass/Accomp]

[Lower]

[Upper]

40 [Disk] Button

This can be used to make settings for the disk drive, such as saving a recorded tune on floppy disk.

41 [Menu] Button

You can use this to choose recording and editing functions.

42 Reset [I◀] Button

This returns the position where playback begins sets the position from which playback will begin to the start of the song (page 71).

43 Stop [■] Button

Pressed to stop playback or recording.

44 Play [▶] Button

This starts playback or recording for a song.

45 Rec [●] Button

Pressed to put the KR-575 in the state in which it is ready and waiting for recording to begin (page 35).

46 Bwd [◀◀] Button

Pressed to rewind the song (page 71).

47 Fwd [▶▶] Button

Pressed to fast-forward through the song (page 71).

48 [Vocal Effects] Button

Applies a variety of effects to vocals from the microphone (page 49)

49 [Marker/Count In] Button

This places a marker in a song to mark the spot where playback starts (page 72).

You can also use it to sound an audible count before playing back a song (page 70).

50 [Transpose] Button

Used to transpose the keyboard or a song (page 76, page 77).

51 Disk Drive

You can insert a floppy disk for playing back or saving songs (page 40).

52 Eject Button

Pressed to eject a floppy disk from the disk drive.

About the Touch Screen

The KR-575 makes use of a Touch Screen. This lets you carry out a wide variety of actions just by touching the screen.

The portion described below is on the touch screen.

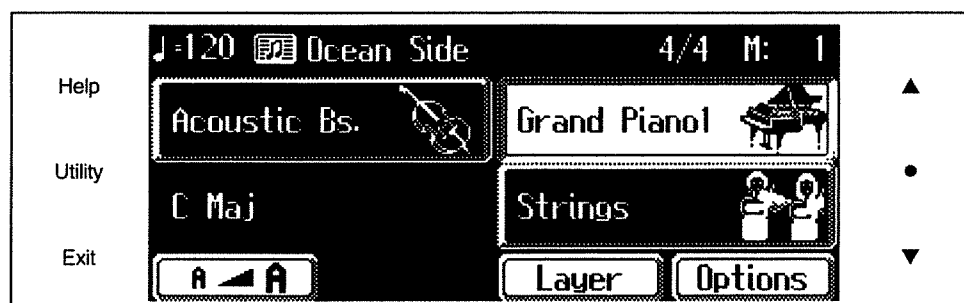

The Touch Screen is operated by touching it lightly with your finger. Pressing hard, or using a hard object can damage the Touch Screen. Be careful not to press too hard, and be sure to use only your fingers to operate the Touch Screen.

The on-screen graphics that appear three dimensional work like buttons. These are called "Icons."

Also, the <Help>, <Utility>, and <Exit> as well as the <▲>, <●>, and <▼> symbols on the left and right areas of the screen are also activated by touching the Touch Screen.

Display	Function
Help	This displays on-screen explanations of different features (page 20).
Utility	This lets you play the ear-training games (page 22) or make use of a wide variety of handy features.
Exit	Returns you to the previous screen or makes the selected Function end.
▲ / ▼	These are used to change the value of a selected on-screen item.
●	If you've changed a value with <▲> or <▼>, this returns it to its initial value.



The positioning of the Touch Screen may become displaced due to changes in the surrounding environment and over time. If this happens, follow the steps in "Repositioning the Touch Screen" (page 133) to correct the pointer position.

About the Screen



When you turn on the power, the Piano screen appears (page 24).

Basic Screen

The following screen is called Basic Screen.

You can usually display this screen by touching <Exit> several times. If touching <Exit> doesn't display this screen, follow either of the procedures described below to display it.

- Press the One Touch Program [Arranger] button thereby making the setting for Automatic Accompaniment.
- Press the One Touch Program [Piano] button or the One Touch Program [Organ] button, then press one of the Tone buttons, then touch <Exit>.

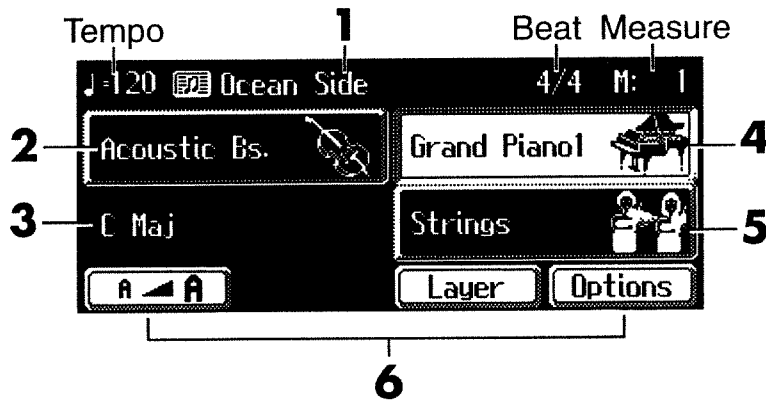

- 1 Such as the name of the song and Music Style appears.
- 2 When the keyboard is set up so that the right and left hands play different sounds (page 56), the Tone name for the left-hand part is displayed. At other times, when you're playing with an automatic accompaniment, this displays the chord fingering.
- 3 When you're playing with an automatic accompaniment, the chord fingering is displayed.
- 4 When set up so that the entire keyboard is played as a single instrument (page 57), the instrument's Tone name is displayed. When the keyboard is split into right- and left-hand sections, which play different sounds (page 56), this shows the Tone name for the right-hand part. When set up to layer the sounds of two instruments (page 54), the name of the Tone played up to then is displayed.
- 5 When set up to layer the sounds of two instruments (page 54), the name of the newly layered Tone is displayed.

6 Here's what the different icons do.

Display	Function
	Tone names and the like are displayed in large text.
	Layer
	Layers (combines) two sounds (page 54).
	Options
	You can change the settings for automatic accompaniment (page 128).

Touching displays a screen like the one shown below.



The name of the Tone, Song, or Music Style appears on the screen.

The tempo, beat, measure number are displayed in large text.

Touching returns you to the Basic screen.



You can adjust the contrast of the screen. Check out "Adjusting the Contrast of the Screen" (page 133).



The explanations in this manual include illustrations that depict what should typically be shown by the display. Note, however, that your unit may incorporate a newer, enhanced version of the system (e.g., includes newer sounds), so what you actually see in the display may not always match what appears in the manual.

■ About the Page buttons

Some screens consist on two or more pages. When such screens are displayed, press the Page [◀] or [▶] button to change the page. The Page buttons' indicators come on when there is another page available in the direction of the arrows.

For example, the Vocal Effect screen (see page 49) consists on two pages.

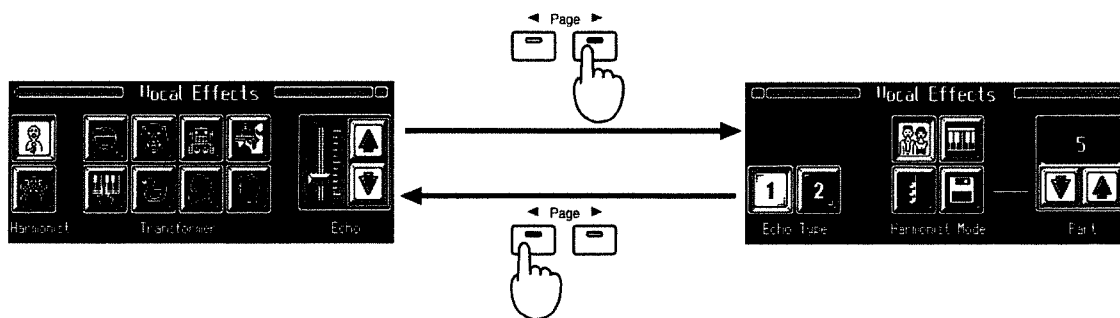

Touch <Exit> to go back to the screen that was displayed before the Vocal Effect screen appears.

Before You Start Playing

Before You Start Playing

Opening and Closing the Cover

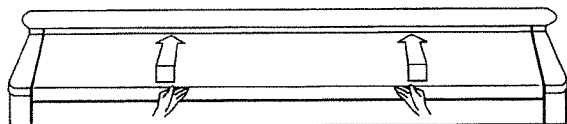

1. When opening the cover, use both hands to gently lift the cover and slide it inward.
2. To close it, slowly pull it to the front as far as it will go, then lower it gently.

NOTE

When opening and closing the cover, be careful not to let your fingers get caught.

Small children should use the KR-575 only under the supervision of an adult.

When moving the KR-575, for safety's sake be sure to close the cover first.

Setting Up the Music Stand

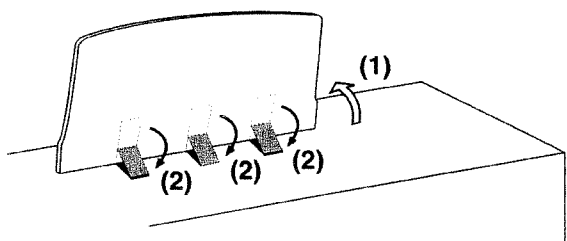

1. Gently stand the music stand upright, then secure it in place as shown in the figure.
2. When folding back the music stand, support it with one hand, fold back the supports, then gently lower the stand.

Pedals

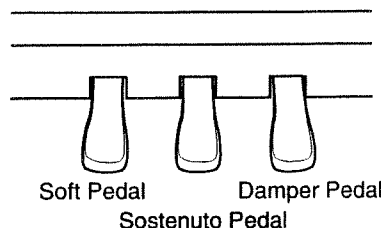

Soft Pedal

This pedal is used to make the sound softer. Playing the keyboard while the soft pedal is depressed makes the sound softer than when played normally with the same force. You can make subtle changes in the softness of the sound by depressing the pedal with greater or lesser force.

Sostenuto Pedal

When this pedal is depressed, reverberations are applied only to the keys being played at that time.

Damper Pedal

This pedal is used to add reverberations to the sound. While the damper pedal is depressed, played notes are held for a long time, even after you release the fingered keys on the keyboard. You can make subtle changes in how long the sound is held by depressing the pedal with greater or lesser force.

MEMO

You can vary the amount of resonance applied when the damper pedal is depressed. Check out "Adjusting Resonant Sounds" (page 126).

You can assign other functions to the soft and sostenuto pedals. See "Assigning Functions to Buttons and Pedals" (page 118).

Using Headphones

The KR-575 has two jacks for plugging in headphones. This means that two people can use headphones at the same time, which can be handy for keyboard lessons or playing duets. This is also great for playing at night or when other people are around.

Phones x 2

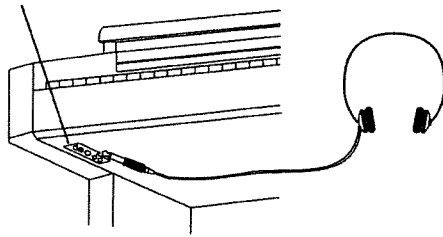

1. Plug the headphones into either of the Phones jacks on the lower-left panel of the KR-575.

The sound from the built-in speakers stops. Now, sound is heard only through the headphones.

2. Use the [Volume] slider on the KR-575 to adjust the volume of the headphones.



Stereo headphones such as the RH-80/120 (Sold Separately) from Roland should be used.

Some Notes on Using Headphones

- To prevent damage to the cord, handle the headphones only by the headset or the plug.
- The headphones may be damaged if the volume is too high when they are plugged in. Lower the volume on the KR-575 before plugging in the headphones.
- To prevent possible auditory damage, loss of hearing, or damage to the headphones, the headphones should not be used at an excessively high volume. Use the headphones at a moderate volume level.

Switching the Power On and Off

Be sure to follow the steps below when turning the power on or off. If this is not done in the correct sequence, you risk causing a malfunction, or even blown speakers.

Turning On the Power

1. Before you switch on the power, turn the volume down by moving the [Volume] slider all the way to the left.

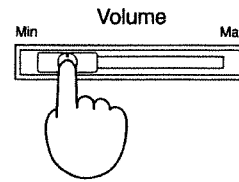

2. Connect the included power cord to the AC inlet on the bottom of the piano.

3. Plug the power cord into an AC outlet.

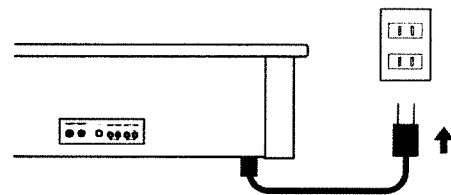

4. Press the [Power] switch.

After a few seconds, the unit becomes operable and playing the keyboard produces sound.

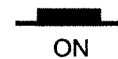

NOTE

- This unit is equipped with a protection circuit. A brief interval (a few seconds) after power up is required before the unit will operate normally.
- Be sure to use only the power cord supplied with the KR-575.

Turning Off the Power

1. Before you switch off the power, turn the volume down by moving the [Volume] slider all the way to the left.
2. Press the [Power] switch. The power is switched off.



Chapter 1 Mastering the Basics

Adjusting the Sound Volume and Brilliance

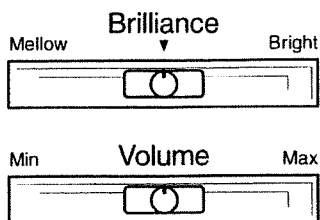

1. Use the [Brilliance] slider to adjust the overall brilliance.
The sound becomes brighter as you move the slider to the right, and more subdued as you move it to the left.
2. Use the [Volume] slider to adjust the overall volume level.
Move the slider to the right to increase the volume, or to the left to lower it.

The Help Function

KR-575 can be displayed the explanation of functions on the screen.

1. Touch <Help> at the left side of the screen.
A screen like the one shown below appears.

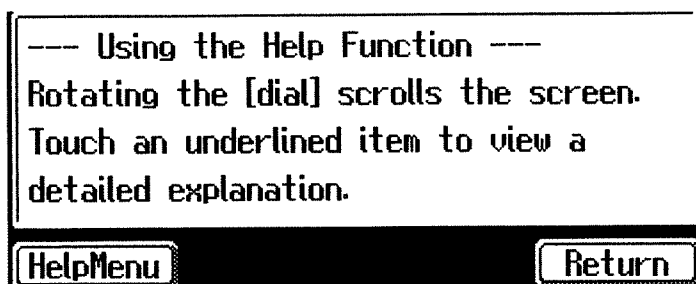

2. Touch an underlined word or phrase to view an explanation in greater detail.



Touch <Help Menu> at the bottom of the screen to display the index.

3. Touch <Return> at the bottom of the screen to go back to the previous passage.
4. Touch <Exit> to end help function.

An Introduction to the KR-575's Sounds and Tunes—Demo Play

Perform the simple steps below to listen to demonstrations of the KR-575's built-in instrument sounds and Music Styles (accompaniment patterns for a variety of musical genres).

1. Press the [Demo] button and confirm that its indicator has lighted.

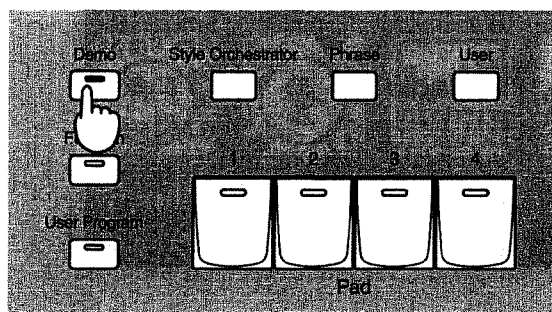

2. Touch the screen to choose an item.
3. Touch <Play> to start the demonstration.
Touch <Next> or <Previous> to change the songs.
4. Press the [Demo] button again to end the demonstration.



Refer to the "Demo Song List" (page 158) for information such as the names of the composers of the demo tunes.



For information on the Music Styles, take a look at the "Music Style List" (page 145).

Playing the Ear-training Games

1. Touch <Utility> at the left side of the screen.
A Utility screen like the one shown below appears.



Touch <Exit> to go back to the previous screen.

2. Touch <Games>.
3. Touch the screen to choose the type of game.
The KR-575 offers the three games described below.

Display	Description
Guess Note	You'll hear a single piano note. Try to play the same note on the keyboard.
Guess Chord	You'll hear a chord. Try to play the same chord on the keyboard.
Chord Practice	The name of a chord is displayed. Try to play the chord on the keyboard.

When you've selected the type of game, touch <Next>.

4. Next, touch the screen to choose the game level.
Each game has three levels.
5. Touch <Start> at the lower portion of the screen.
First, the KR-575 plays a C (if you select <Guess Note>) or a basic chord, then the game starts.
The quicker you guess right, the higher your score is. You can guess as many times as you like until you run out of time.
Each time you play you'll have ten tries. A perfect score is 100 points.
6. When the game finishes, touch <Upgrade>, <Again> or <Exit>.
 - Touch <Upgrade> to try a game in next level.
 - Touch <Again> to retry a game in equal level.
 - Touch <Exit> to quit a game.

Let's Try Out the KR-575's Basic Functions

The KR-575 has a feature that lets you make changes in settings simply by answering a few questions.

1. Touch <Utility> at the left side of the screen.



2. Touch <Easy Play>.
3. Touch the screen and use the dial to answer the questions that appear on the screen.
4. Touch <Next> to display the next question.
5. When you've answered the last of the questions, try fingering the keyboard.

Depending on how you answer the questions, you can enjoy a wide variety of performances.

Playing the Keyboard Like a Piano—One-touch Piano

You can make the optimal settings for a piano performance at the touch of a single button.

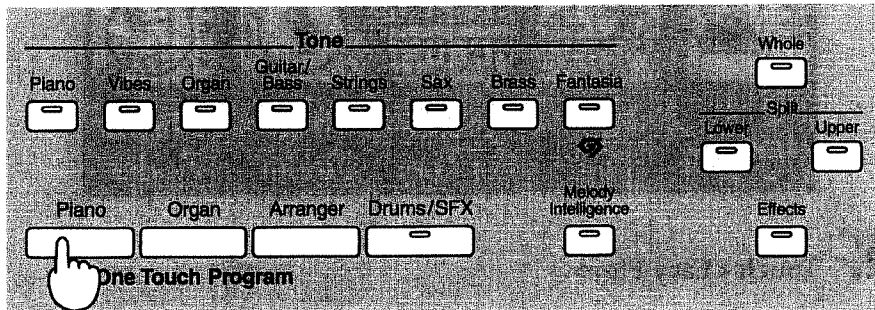

- Settings are made for the following situations.
 - When the keyboard has been split into right- and left-hand sections (page 56), this returns the keyboard to a single section.
 - When the functions of the pedals has been changed (page 118), this returns the pedals to their usual functions(page 18).



1. Press the One Touch Program [Piano] button.
A Piano screen like the one shown below appears.



■ Changing the Piano Sound

1. Touch   .
The opening of the piano's lid changes, and the sound also changes.
You can also change the opening of the piano's lid by pressing the [Effects] button.



You can change settings related to the piano performance by touching <Customize> at the bottom of the screen. For more information, take a look at "Changing the Settings for One-touch Piano" (page 123).

Playing the Keyboard Like an Organ—One-touch Organ

You can make the optimal settings for an organ performance at the touch of a single button.

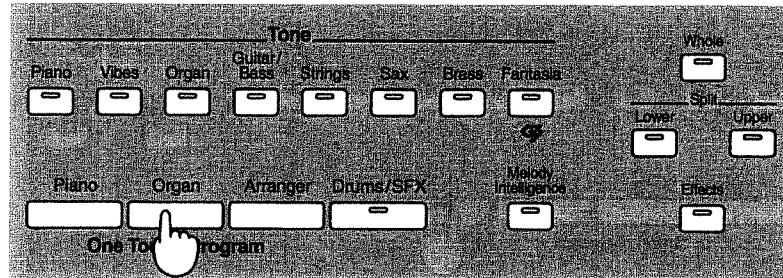

1. Press the One Touch Program [Organ] button.

An Organ screen like the one shown below appears.

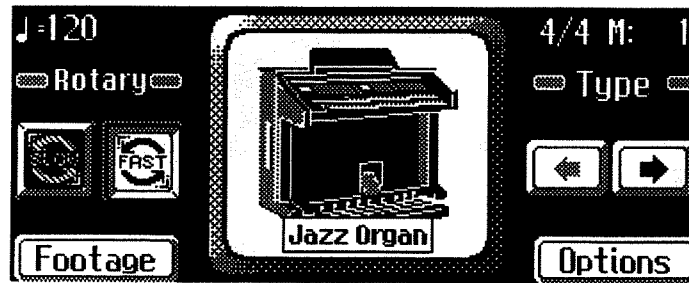

2. Touch <Type> [Left Arrow] [Right Arrow] to choose the organ type.

You can select any of three types of organ.

- Jazz organ
- Church organ
- Theater organ



Choosing “Jazz Organ” makes the keyboard divide into right- and left-hand sections and play different tones on the two sections. This division of the keyboard into a right-hand section and a left-hand section is called a “Split.”

If you want to know more, take a look at “Playing Different Tones with the Left and Right Hands—Split Play” (page 56).

■ Changing the Rotary Effect

The “Jazz Organ” sound has a rotary effect added to it.

Applying a rotary effect to the organ sound gives the same undulations you get with rotating speakers.

You can vary the speed with which the speakers rotate.

1. Touch <Slow> or <Fast>.

Touching <Slow> makes the speed of rotation slower.

Touching <Fast> makes the speed of rotation faster.

You can also change the speed of rotation by pressing the [Effects] button.



You can change the settings for an organ performance by touching <Options> at the bottom of the screen. Also, when you’ve selected Jazz Organ, you can touch <Footage> to create the sound you want. For more information, take a look at “Changing the Settings for One-touch Organ” (page 126).

Playing Drums from the Keyboard

You can use the keyboard to play percussion sounds or effects such as sirens and animal sounds.

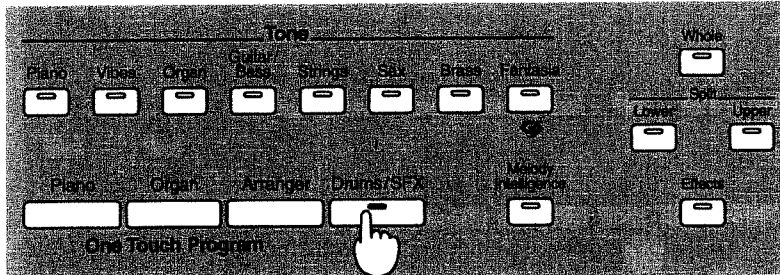

1. Press the [Drums/SFX] button and confirm that its indicator has lighted. When you finger the keyboard now, each key plays a different percussion-instrument sound.

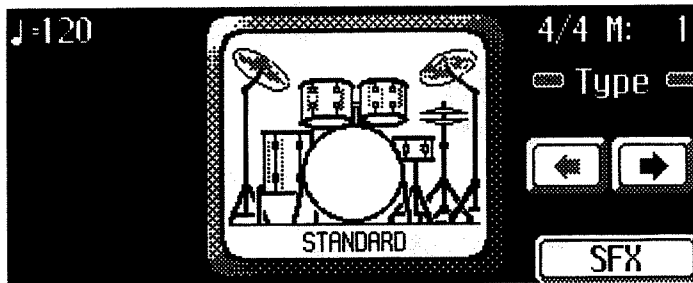

2. Touch <Type> [Left Arrow] [Right Arrow] to change the type of drum set. The drum set appears in the middle of the screen.

Sets of percussion sounds, such as “STANDARD”, are called “Drum Sets”. Each drum set contains a wide variety of percussive instrument sounds and sound effects, and each key plays a different sound.



The combination of sounds assigned to the keyboard varies according to the drum set. Take a look at the “Drum/SFX Set List” (page 153).

Pressing the [Drums/SFX] button again to make the button’s indicator go dark returns the keyboard to the instrument sound in effect before you pressed the [Drums/SFX] button.

■ Playing Effect Sounds

1. Press the [Drums/SFX] button to make the button’s indicator light up.
2. Touch <SFX> at the bottom of the screen.

When you finger the keyboard now, each key plays a different effect sound.

A set of effect sounds is called an “SFX set” (page 156).

Touching <Drums> at the bottom of the screen makes it so that percussion instruments are sounded.

Playing a Wide Variety of Instrument Sounds

The KR-575 comes with a large number of built-in instrument sounds and effects. This lets you enjoy performances with sounds matched to a wide range of musical genres. The various types of built-in sounds are called "Tones." These Tones are divided into eight different Tone Groups.

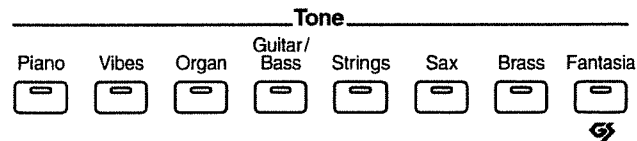

1. Press one of the Tone buttons to choose the Tone Group.

The screen shows four of the Tones included in the chosen Tone Group.

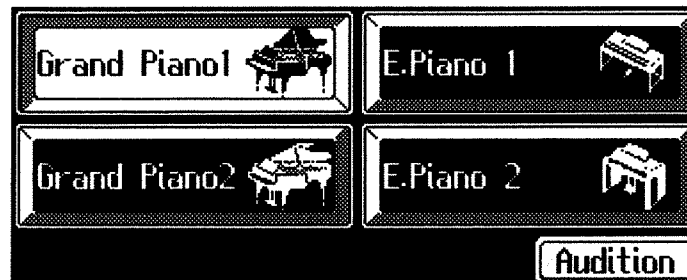

2. Use the Page [◀] and [▶] buttons to switch screens, and touch the screen to choose one of the Tones in the Tone Group.

The Tone you've selected is heard when you finger the keyboard.

Also, this is the Tone that you'll hear the next time you choose this Tone button.

Touch <Exit> to end selecting the Tone.



You can listen to a typical phrase for the Tone by touching <Audition> at the bottom right of the screen.

Changing Tones with the Dial

You can also use the dial to change a Tone. When you use the dial, the pages are switched automatically, without having to use the Page [◀] and [▶] buttons.

1. Press one of the Tone buttons to choose the Tone Group.
2. Turn the dial to choose a Tone.
The indicator for the corresponding Tone button blinks.
3. Finger the keyboard or press the blinking Tone button to confirm your selection.

The Tone button's indicator lights up steadily.
 The Tone you've selected is heard when you finger the keyboard.
 Also, this is the Tone that you'll hear the next time you choose this Tone button.
 Touch <Exit> to end selecting the Tone.



For more about the names of Tones, take a look at the "Tone Name List" (page 149).

Using the Metronome

The KR-575 has a built-in Metronome function.
 You can start or stop the metronome sound with just a single press of the [Metronome] button. During playback of a song, or when performing with automatic accompaniment, the sound of the metronome keeps time with the beat of the tune or accompaniment.

Metronome



1. Press the [Metronome] button to start the metronome's sound.

The [Metronome] button's indicator lights up, and a Metronome screen like the one below appears.

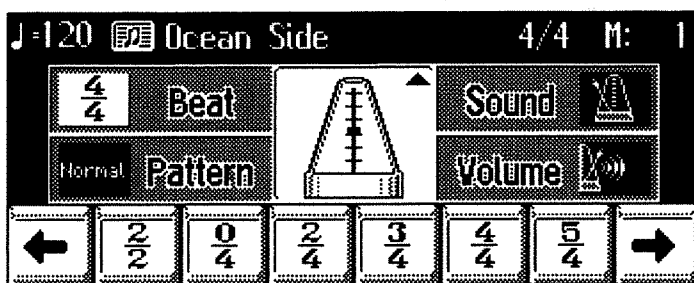

2. Press the [Metronome] button again to stop the metronome's sound.

The [Metronome] button's indicator goes dark.

Touch <Exit> to go back to the previous screen.

Changing the Tempo of the Metronome

1. Use the Tempo [-] and [+] buttons to adjust the tempo.

The setting is at "120" when the KR-575 is powered up.





You can also use the dial to adjust the tempo. Turn it clockwise for a faster tempo or counter-clockwise for a slower tempo.





The tempo changes automatically if you use an automatic accompaniment or play back a song.







■ Changing the Beat of Metronome

1. At the Metronome screen, touch <Beat>. The available choices for the beat appear at the bottom of the screen.
2. Choose the beat from among the selections by touching your choice. You can scroll the display to one side or the other and show other choices for the beat by touching  .

Display	Description
$\frac{2}{2}$	2/2 time
$\frac{0}{4}$	Sounded only on the upbeat
$\frac{2}{4}$	2/4 beat
$\frac{3}{4}$	3/4 beat
$\frac{4}{4}$	4/4 beat
$\frac{5}{4}$	5/4 beat
$\frac{6}{4}$	6/4 beat
$\frac{7}{4}$	7/4 beat
$\frac{3}{8}$	3/8 beat
$\frac{6}{8}$	6/8 beat
$\frac{9}{8}$	9/8 beat
$\frac{12}{8}$	12/8 beat

■ Changing the Metronome Pattern

1. At the Metronome screen, touch <Pattern>. The available choices for the metronome pattern appear at the bottom of the screen.
2. Choose a pattern from among the selections by touching your choice. You can scroll the display to one side or the other and show other choices for the pattern by touching  .

Display	Description
Normal	The metronome sounds in the ordinary way.
	Counting starts at the beginning of the measure, in intervals of dotted half-note upbeats.
	Counting starts at the beginning of the measure, in intervals of half-note upbeats.
	Counting starts at the beginning of the measure, in intervals of dotted quarter-note upbeats.
	Counting starts at the beginning of the measure, in intervals of quarter-note upbeats.
	Counting starts at the beginning of the measure, in intervals of dotted eighth-note upbeats.
	Counting starts at the beginning of the measure, in intervals of eighth-note upbeats.
	Counting starts at the beginning of the measure, in intervals of sixteenth-note upbeats.
+Doubl	The metronome plays with a backbeat added to each beat.
+Tripl	Counting is with triplets for each beat.
+Shuf	The added sounds are shuffled.





With a triplet beat (6/8, 9/8, or 12/8), added notes are sounded as triplets.

■ Changing the Volume

1. At the Metronome screen, touch <Volume>.

The available choices for the volume level appear at the bottom of the screen.

Choosing  sets the volume to the lowest level, and choosing  sets it to the highest level.

Choose  OFF to silence the metronome sound.







2. Select a volume level by touching your choice.

■ Changing the Type of Sound

1. At the Metronome screen, touch <Sound>.

The available choices for the type of sound appear at the bottom of the screen.

2. Select a sound type by touching your choice.

Display	Description
	Ordinary metronome sound
	Electronic metronome sound
いち、に、 ichi, ni,	A voice counting "1, 2, 3" in Japanese
One, two,	A voice counting "1, 2, 3" in English
	Dog and cat sounds
	Woodblock sound
	Triangle and castanet sounds
	Clapping

■ Changing the Animation

A metronome that moves along with the tempo usually is displayed at the center of the Metronome screen. You can change this to an animated bouncing ball (a ball that moves along in time with the tempo) or the other animation by touching the picture.

Playing with an Automatic Accompaniment—One-touch Arranger

With the KR-575, you can make the optimal settings for playing Automatic Accompaniment with just a single touch of the One Touch Program [Arranger] button. You can completely alter the ambience of the performance by changing the Music Style.

For more information, check out “Chapter 3—Automatic Accompaniment” (page 58).

What’s a Music Style?

There are many different varieties of music around the world, and each one has its own unique features.

What gives jazz its “jazziness” and classical music its unmistakable classical feel is the combination of elements such as the instruments used, melody, and phrasing, which interact to create the musical ambience of the genre.

A Music Style makes use of the elements to bring out the distinctive atmosphere and mood of each musical genre.

■ Let’s Try Playing, “When the Saints Go Marching In”

Now let’s try playing a tune called “When the Saints Go Marching In” in time with the automatic accompaniment.

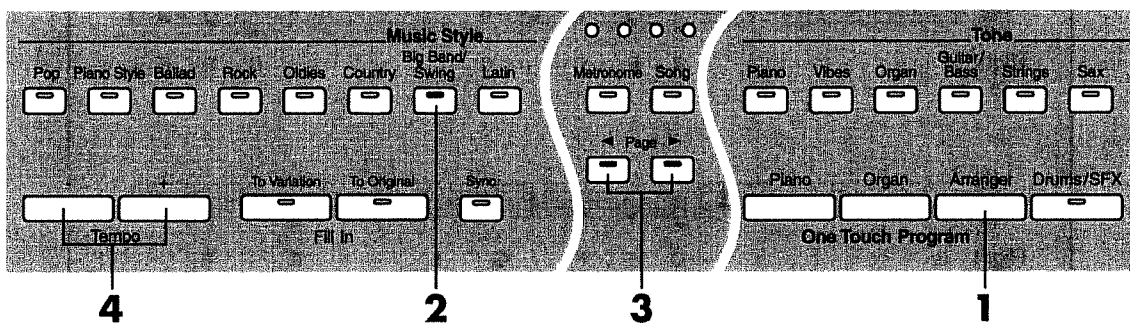

Step 1 - Get ready to play

1. Press the One Touch Program [Arranger] button.
The keyboard is split into left- and right-hand sections at the F#3 key. The F#3 key is part of the left-hand section of the keyboard. Pressing the One Touch Program[Piano] button cancels the automatic accompaniment.
2. Press the [Big Band / Swing] Style button.



- Use the Page [◀] and [▶] buttons to switch pages, then touch the screen to choose <Dixieland>.

The Music Style changes to "Dixieland."

Changing the Music Style also makes the instrument sound played with the right-hand section of the keyboard change to the optimal sound for the selected style.



You can also use the dial to choose the Music Style. When you use the dial, the pages are switched automatically, without having to use the Page [◀] and [▶] buttons.

Touch <Exit> to go back to the Basic screen.

- Use the Tempo [-] and [+] buttons to adjust the tempo of the accompaniment.

Press the Tempo [-] and [+] buttons at the same time to return to the basic tempo.

● The Score for "When the Saints Go Marching In"

When The Saints Go Marching In

American Traditional

The score consists of five systems of music. Each system shows a right-hand part on a treble clef staff and a left-hand part on a bass clef staff. Chords are indicated by letters C, E, F, G, D, and G. The first system starts with a C chord and a triplet of eighth notes. The second system has a G chord. The third system has G and C chords. The fourth system has F, C, and G chords. The fifth system has two endings: the first ending leads to a variation, and the second ending leads to an intro/ending.

Right
Left

Right
Left

Right
Left

Right
Left

Right
Left

1. C
2. C

Right
Left

To Variation

Intro/Ending

Step 2 – Play the performance

5. Play the C key on the keyboard in the figure below.

First a four-bar intro is played, follow the instructions on the score for the right-hand part and the left-hand part to play the tune.

Play the C, G, and F keys on the keyboard with the timing indicated for C, G, and F on the score for the left-hand part, as shown in the figure. There's no need to hold down the key, so you can get ready to finger the next one.

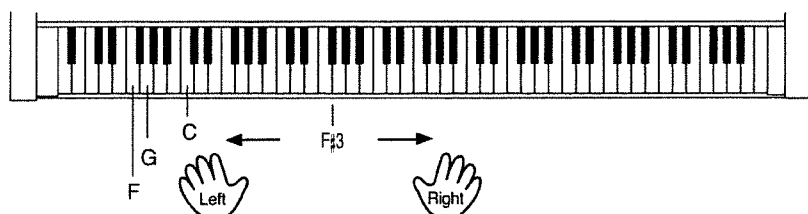

With the KR-575, you can also specify a chord by fingering only one or two keys. This function is called "Chord Intelligence." For more information, take a look at "Playing Chords with Simple Fingering" (page 66).

6. Press the [To Variation] button with the timing for "To Variation" on the score.

The Accompaniment Pattern changes.

Pressing the [To Original] button returns to the original accompaniment pattern.

Once you've familiarized yourself with the performance, try varying the timing for the accompaniment pattern as you like.

7. Press the Intro/Ending [1] button with the timing for "Intro/Ending" on the score.

After the ending plays, the accompaniment stops.

Pressing the Intro/Ending [2] button plays a simple ending.

■ Changing the Volume Balance for the Accompaniment and Keyboard

You can change the volume balance for the tune and accompaniment and the notes played from the keyboard.

1. Use the [Balance] slider to change the volume balance.

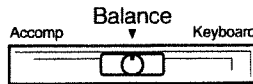

The volume of keyboard is decrease
The song and accompaniment volume is increece

The volume of keyboard is increece
The song and accompaniment volume is decrease



When this slider is all the way to the left, it is hard to hear the sound when you finger the keyboard. Usually, make the slider be at the center position.



You can adjust the volume level for each Part of an automatic accompaniment that is played. For example, you can raise the rhythm volume while lowering the bass volume. Check out "Adjusting the Volume of Each Performance Part" (page 113). For more about performance Parts, take a look at "Choosing a Music Style" (page 58).

Recording a Performance

With the KR-575, you can use the five Track buttons to record a performance easily, or use recording functions like the 16-track Sequencer to create full-fledged ensemble songs.



For an explanation of how to create an ensemble song, take a look at “Recording an Ensemble Tune—16 Track Sequencer” (page 85).

■ Recording a Performance with Automatic Accompaniment

In this section, we’ll record “When the Saints Go Marching In” on page 32. A recorded performance is automatically assigned to a Track button. The five buttons shown below are called Track buttons.

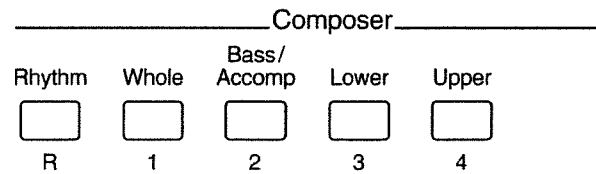

Track button name	Performance recorded
[Rhythm]	The Rhythm Part of an Automatic Accompaniment is recorded here. When a Tone set such as a drum set or an SFX set has been chosen, it is also recorded here.
[Whole]	When the Piano Style Arranger is active (page 68), your performance is recorded here.
[Bass/Accomp]	The bass part and accompaniment parts of an Automatic Accompaniment are recorded here.
[Lower]	When the indicator for the Split [Lower] button is illuminated, your performance on the left-hand section of the keyboard is recorded here.
[Upper]	Your performance on the right-hand section of the keyboard is recorded here.



A Music Style is made up of five Parts. For more information, take a look at “Choosing a Music Style” (page 58).

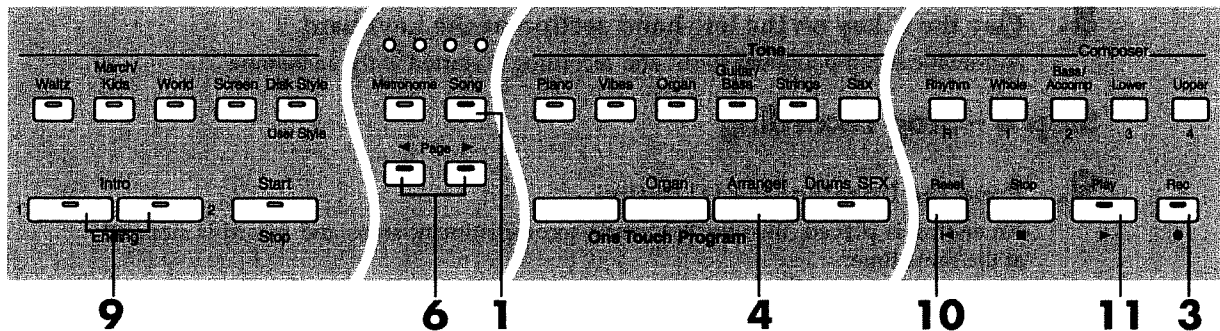

Step 1 – Get ready to record

1. Press the [Song] button.



2. Touch <0:New Song>.

If <0:New Song> doesn't appear on screen, use the Page [◀] and [▶] buttons to switch screens.



You can also use the dial to choose a tune. When you use the dial, the pages are switched automatically, without having to use the Page [◀] and [▶] buttons.

3. Press the Rec [●] button.

The KR-575 enters standby for recording. To stop recording, press the Stop [■] button.

Step 2 – Get ready to play

4. Press the One Touch Program [Arranger] button.
5. Press the [Big Band / Swing] Style button.
6. Use the Page [◀] and [▶] buttons to switch pages, then touch the screen to choose <Dixieland>.

Touch <Exit> to go back to the Basic screen.

7. Use the Tempo [-] and [+] buttons to adjust the tempo of the accompaniment.

Step 3 – Start recording

8. Play the C key on the left-hand section of the keyboard.

Automatic accompaniment starts, and recording is started at the same time.

Step 4 – Stop recording

9. Press the Intro/Ending [1] button.

An ending is played, then the automatic accompaniment stops and record is stopped at the same time.



You can change how recording is stopped when recording a performance with Automatic Accompaniment. Check out "Changing How Recording Stops" (page 96).

Step 5 – Listen to the recorded performance

- 10.** Press the Reset [**↶**] button.
Now you can play back the song from the beginning.
- 11.** Press the Play [**▶**] button.
The recorded performance is played back.



Any performance that has been recorded is deleted when the power to the KR-575 is turned off. If you don't want to lose your recorded performance, save it on a floppy disk. For information on how to save your song, take a look at "Saving Your Songs on Floppy Disk" (page 42). Until a recorded performance is erased, you can't listen to other tunes. Check out "Erasing a Recorded Song" (page 39).

■ Recording a Performance Without Using Automatic Accompaniment

A performance that doesn't use automatic accompaniment is normally recorded on the [Whole] button, but you can also specify a Track button to record it by pressing the Track Buttons. Note that if you are recording with Split (page 56) or Layer Play (page 54) active, the Track button assignments are as follows. Also, percussion sounds and effect sounds are recorded on the [Rhythm] button.

- Recording Layer Play
Recorded to the [Whole] button.
- Recording Split Play
What you play with the left hand is recorded on the [Lower] button, and what you play with the right hand is recorded on the [Upper] button.
- Recording when Layer Play has been changed to Split
What you play with the left hand is recorded on the [Lower] button, and the Layer performance that you play with the right hand is recorded on the [Upper] button.

Step 1 – Get ready to record

- 1.** Press the [Song] button and choose <0:New Song>.
- 2.** Press the Rec [**●**] button.
The KR-575 enters standby for recording. To stop recording, press the Stop [**■**] button.

Step 2 – Start recording

- 3.** Press the Play [**▶**] button.
A two-bar count sound plays, then recording starts.

Step 3 – Stop recording

- 4.** Press the Stop [**■**] button.
Recording stops.

● **If the following message appears**

If you've recorded a tune or changed a song's settings (see page 88), the following message appears on the screen when you try to choose another song.

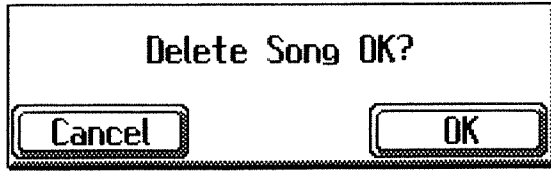

If you don't want to erase the song

1. Touch <Cancel>.

Save the tune on a floppy disk.

For more information, take a look at "Saving Your Songs on Floppy Disk" (page 42).

Erasing a song

1. Touch <OK>.

The recorded performance or song whose settings have been changed is erased.

■ **Redoing a Recording**

Redoing a recording involves specifying a Track button and then recording over again.



When you select a Track button and record over a track that has already been recorded, the newly recorded performance occupies a position extending from the location where you started recording to where you stopped recording. If you want to erase a previous performance entirely before recording over it, take a look at "Erasing the Sound Recorded on Individual Track Buttons" (page 39).

1. Press the Rec [●] button.

The KR-575 enters recording standby. To cancel recording, press the Stop [■] button.

2. Press the Track button for the track you want to record over.

The indicator for the selected Track button blinks. For more information of Track buttons, take a look at page 35.



When any Track buttons aren't blinking, you can't start recording.

3. Press the Bwd [◀◀] button or Fwd [▶▶] button to move the location where you want to start recording.

4. Press the Play [▶] button to start recording.

If you redo a recording with Automatic Accompaniment, specify a chord in the left-hand section of the keyboard, or press the [Start/Stop] button.

5. Press the Stop [■] button to stop recording.

To record the ending over again, press the Intro/Ending [1] or [2] button.

■ Erasing a Recorded Song

You can erase a song that's been recorded.

1. Hold down the [Song] button and press the Rec [●] button.

The following message appears on the screen.

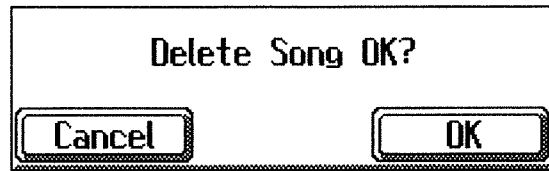

2. Touch <OK> to erase the recorded song.

If you touch <Cancel>, the recorded tune is not erased.

■ Erasing the Sound Recorded on Individual Track Buttons

You can erase the sound recorded to an individual Track button.

1. While holding down the Track button where the sound you want to erase is recorded, press the Rec [●] button.

The Track button's light goes dark, and the recorded sound is erased.



You can't erase the settings for a song's basic tempo or beat.

Using the Disk Drive

Here's where you can know how to use the built-in disk drive to save a recorded tune on floppy disk, or listen to commercially available music files.

■ Inserting and Ejecting a Floppy Disk

NOTE *If you're using the disk drive for the first time, be sure to read the important notes on page 5.*

1. **Hold the floppy disk face up, and push it into the disk drive until it clicks into place.**

The disk drive is on the right-hand side of the unit, above the keyboard.

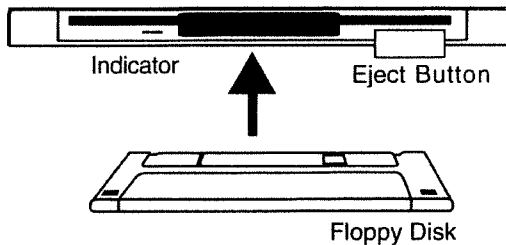

NOTE *The disk-drive indicator comes on brightly while a floppy disk is in use. Don't try to take the floppy disk out of the disk drive while the indicator is illuminated. Doing so may damage the floppy disk, making it unusable.*

2. **Press the Eject button.**

The end of the floppy disk comes out of the slot.
Gently grasp the end of the floppy disk and pull it out.

■ Formatting a Floppy Disk

The floppy disks that you use to save data on need to be formatted first. Formatting a floppy disk erases all information stored on the disk, and puts it in a format that is acceptable for the device in which it will be used. If a floppy disk is in a format that doesn't match the format of this unit, you won't be able to use that floppy disk.

NOTE *Formatting a disk destroys all data previously stored on the disk. If you're formatting a used floppy disk for reuse, be sure to check first to make sure the disk doesn't contain any data you don't want to lose.*

NOTE *If you're using the disk drive for the first time, be sure to read the important notes on page 5.*

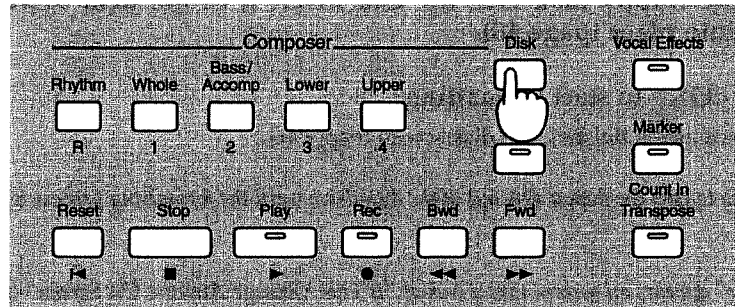

1. Press the [Disk] button.

A Disk screen like the one below appears.

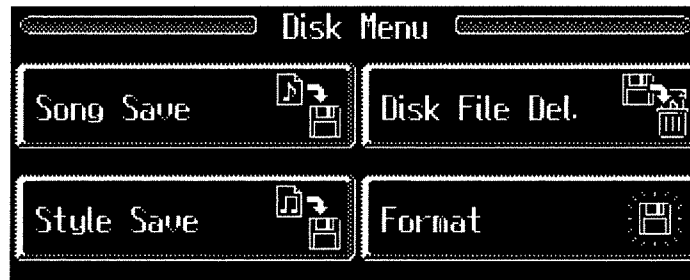

2. Touch <Format> on the screen.

The following screen appears.



3. Make sure the write-protect tab on the floppy disk is positioned at "Write".

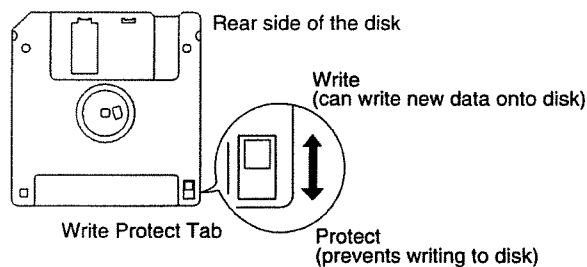

4. Hold the floppy disk face up, and insert it in the disk drive until it clicks into place (page 40).

5. Touch <OK> to start formatting.
When formatting finishes, the disk screen reappears.



Don't try to take the floppy disk out of the disk drive until the formatting process is finished.



If "Error" appears on screen, take a look at "If This Message Appears On Screen" (page 143).

■ Saving Your Songs on Floppy Disk

A recorded performance is discarded when you switch off the power, or choose another tune. It's a good idea to store important songs on floppy disk.



If you're using the disk drive for the first time, be sure to read the important notes on page 5. Some commercially available music files may contain songs that cannot be saved. When using a brand-new floppy disk on the KR-575, first you have to format it using the KR-575. Take a look at "Formatting a Floppy Disk" (page 40).



If not handled with care, a floppy disk can get cracked, or the data on it can get corrupted, making playback impossible. We recommend saving your tunes on two different floppy disks. By putting away for safekeeping an additional copy of a floppy disk on which your tunes are saved, you can feel safer.

Step 1—Insert the floppy disk in the disk drive

- 1.** Make sure the write-protect tab on the floppy disk is positioned at "Write" (page 41).
- 2.** Hold the floppy disk face up, and insert it in the disk drive until it clicks into place (page 40).

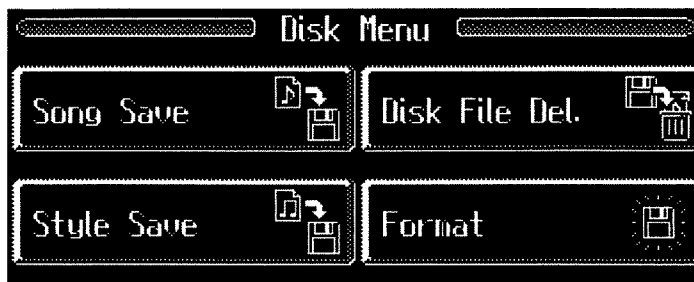

Step 2—Assign a number and name to the song

- 3.** Press the [Disk] button.
The Disk screen appears.



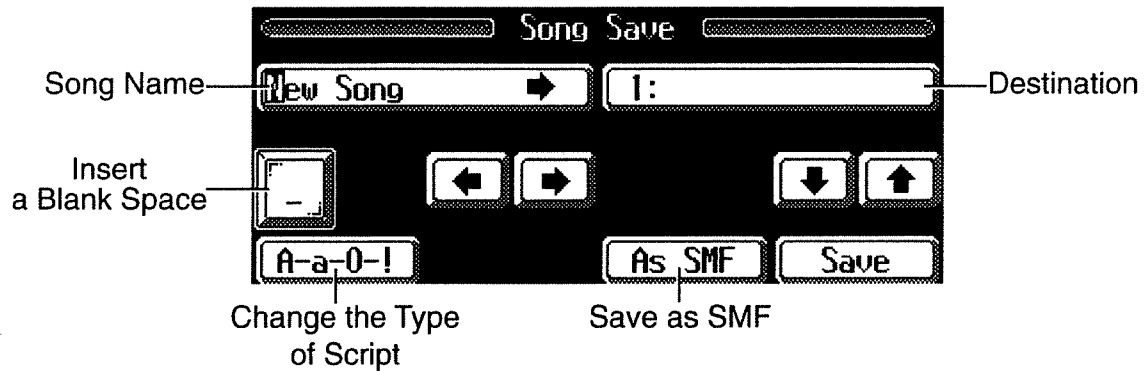

4. Touch <Song Save>.

The following screen appears.

**5.** Touch   to scroll the cursor sideways, and enter the name of the song by using <▲> and <▼> or the dial to choose the letters.

Touch <A-a-0-!> at the bottom of the screen to change the type of script.

Touching <A-a-0-!> cycles the type of characters through "English (upper case)," "English (lower case)," "numerals," "symbols," then back to "English (upper case)." Touching <_> inserts a blank space at the cursor location.

6. After you've entered the name of the tune, touch   to choose a song number.

If you choose a song number where another song is already saved, the previously saved tune is erased, and then the new song is saved. If you don't want to erase a previously saved tune, choose a number where no song name appears in the destination column.

Step 3—Save the song

7. Touch <Save> or <As SMF> to start saving.

There is a difference described below between <Save> and <As SMF> in format for saving.

Display	Description
Save	Saves the song in KR-575 format. You can listen to songs saved in this format on Roland HP-G series and KR series digital pianos, and on the MT series. This format is called "i-format".
As SMF	Saves the song as a SMF (Standard MIDI File). Songs saved in this SMF format can be listened to on many instruments that can play SMF music files (page 161).

Saving may take from several second, to several dozen seconds. When the saving process is finished, the disk screen appears.



You can only save songs in one format on a single floppy disk. A song recorded using commercial a music file can't be saved in "SMF" format.



Depending on the playback instrument, some notes may drop out or sound different.



Don't take the floppy disk out of the disk drive until the saving process is finished.



A tune saved on a floppy disk can be erased at a later time. Take a look at "Deleting a Saved Song or User Style on Floppy Disk" (page 118).

It's a good idea to get into the habit of moving the write-protect tab on the floppy disk to the "Protect" position when you've finished saving your data. Keeping the tab at "Protect" prevents operations that could erase your songs by mistake. Inserting a floppy disk containing saved songs into the disk drive on another device (such as a computer) while the floppy's write-protect tab remains placed at "Write" may make it impossible to play back the songs on the KR-575 afterward (page 5).

■ Listening to Music Files

You can use the built-in disk drive on the KR-575 to listen to the tunes you've saved on floppy disk, or play commercially available music files.



To learn more about music files, refer to "Music Files That the KR-575 Can Use" (page 161).



If you're using the disk drive for the first time, be sure to read the important notes on page 5.

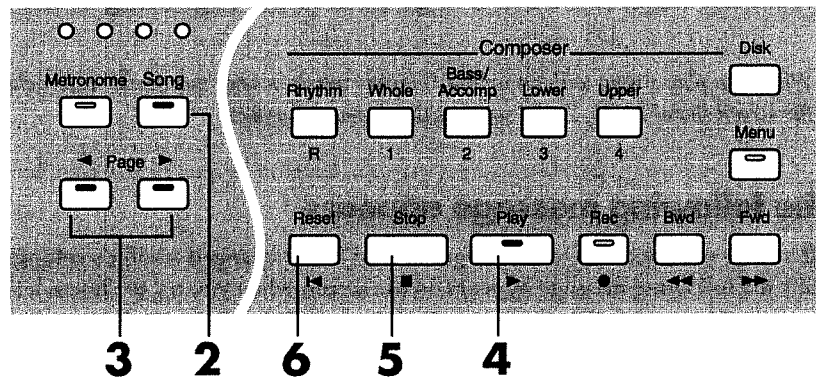

1. Insert the floppy disk into the disk drive (page 40).
2. Press the [Song] button.

The following screen appears.



3. Press the Page [◀] and [▶] buttons to switch screens, and Touch the screen to choose a song.



You can also use the dial to choose a song.

When you use the dial, the pages are switched automatically, without having to use the Page [◀] and [▶] buttons.

You can view some information about the selected song by touching <Song Information>.

4. Press the Play [▶] button or touch <Play> on the screen to play back the song.

The on-screen <Play> changes to <Stop>.

5. Press the Stop [■] button or touch <Stop> on screen to stop playback.

If you let the selected song play to the end, playback stops automatically.
The on-screen <Stop> changes to <Play>.

6. Press the Reset [◀] button to go back to the beginning of the song.



When you play a song with an upbeat (in other words, a song that starts before the first beat), the screen shows PU, 1, 2, and so on as the measure numbers.

● If the following message appears

If you've recorded a tune (see pages 35 and 85) or changed a song's settings (see page 88), the following message appears on the screen when you try to choose a song.

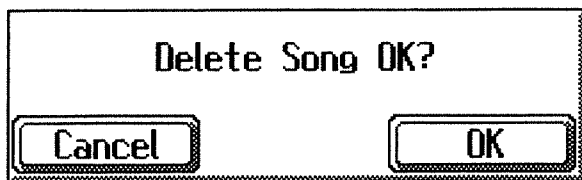

Touch <OK> to erase the recorded song.
If you touch <Cancel>, the recorded tune is not erased.

● Listening to All Songs Continuously

You can continuously repeat playback of all the songs. This function is called "All Song Play."

1. Press the [Song] button.

2. Touch <All Song> on the screen.

All songs are played back in sequence. When playback of the last song finishes, it starts over again from the first song.
The on-screen <Play> changes to <Stop>.

3. Press the Stop [■] button or touch <Stop> on screen to stop playback of the songs.

● Changing the Order of Songs on Floppy Disk

Here's how you can change the order of songs saved on a floppy disk.

- 1.** Have another floppy disk which has been formatted on hand.
- 2.** Insert the floppy disk containing the saved songs into the disk drive.
- 3.** Press the [Song] button to choose the song you want to make song number 1.

Touch <Exit> to display the Basic screen (page 16) after you select a song.

- 4.** Press the Play [▶] button.

The measure number on Basic screen appears in reverse video.



The measure number of the Basic screen appears in reverse video while the KR-575 reads the song data from floppy disk. Don't take the floppy disk out of the drive until the display returns to its original state.

- 5.** When the measure number display returns to its original appearance, press the Stop [■] button.
- 6.** Take the floppy disk out of the disk drive.
- 7.** Insert the blank floppy disk.
- 8.** Save the song in the usual way (page 42).

Repeat these steps to save the tune you want to have song number 2, the tune you want to have song number 3, and so on to the blank floppy disk in the desired song sequence.

Using the KR-575 As a Karaoke Machine

You can connect a microphone into the Mic jack, and enjoy karaoke with KR-575.

■ Connecting a Microphone

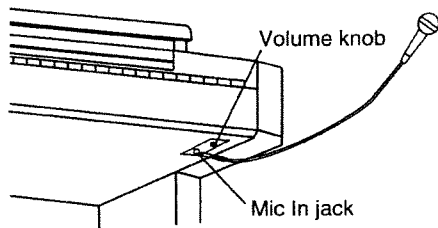

1. Connect a microphone to the Mic In jack on the lower-right area of the instrument.
2. Use the Mic Volume knob in front of the Mic In jack to adjust the volume level for the microphone.



You can use a microphone such as the Roland DR-10/20 (sold separately). When purchasing a microphone, please consult the vendor where you bought the KR-575.

Some Notes on Using a Microphone

- To avoid disturbing others, be careful of the volume level when playing late at night or very early in the morning.
- When connecting a microphone to the KR-575, be sure to lower the volume. If the volume control is too high when the microphone is plugged in, noise may be produced by the speakers.
- Howling could be produced depending on the location of microphones relative to speakers. This can be remedied by:
 - Changing the orientation of the microphone.
 - Relocating microphone at a greater distance from speakers.
 - Lowering volume levels.

■ Adjusting the Echo

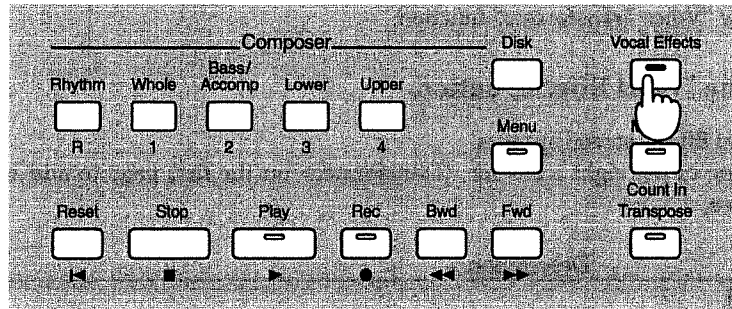

1. Press the [Vocal Effects] button.

The Vocal Effects screen appears.

There are two pages. If necessary, press the Page [◀] and [▶] buttons to switch screens.



2. Touch <Echo> to adjust the amount of echo applied.
3. Touch Echo Type <1> or <2> to change the type of echo.

Display	Description
<1>	Adds clear reverberations.
<2>	Adds reverberations like a karaoke-type echo.









■ Adding Changes to Your Voice

With the KR-575, you can add changes to your voice from the microphone. This is called the “Voice Transformer” function.

1. Press the [Vocal Effects] button.

The Vocal Effects screen appears.

Touch one of the eight icons for <Transformer> on the first page to add changes to your voice.

Display	Description
	Makes your voice sound like a child's.
	Makes your voice sound like a big animal's.
	Makes your voice sound like a robot's.
	Makes your voice sound like an alien's.
	Plays the keyboard notes with a voice scale.
	Makes your voice sound like a duck's.
	Makes a man's voice sound like a woman's.
	Makes a woman's voice sound like a man's.

2. Touch one of the icons on the screen.

3. Sing through the microphone.

Your voice is transformed according to the item you selected.

4. Press the [Vocal Effects] button again to cancel the Voice Transformer function.



When you use the Voice Transformer function, the resonance setting for the piano (see page 126) may sometimes be reset.

■ Adding Harmony





You can sing with a harmony accompaniment, even when you're playing solo. This is called the "Harmonist" function.



1. Press the [Vocal Effects] button to appear the Vocal Effects screen.

2. Touch .

Now you can use the Harmonist function.

3. Touch one of the four icons for <Harmonist> on the second page to choose how to apply the harmony.

Display	Description
	This applies a voice modified by Voice Transformer to your own voice. If you don't use the Voice Transformer function, this lets you sing with a voice one octave higher.
	When you finger the keyboard, harmony is added to the what you play.
	Harmony is added to the chords you play on the keyboard.
	When you play back a song, harmony is added to the tune.

If you chose , then use the <Part>  or  to select the performance part. A matching harmony is added to the performance of the part you chose.

Touch  to cancel the Harmonist function.

NOTE

When you use the Harmonist function, the resonance setting for the piano (see page 126) may sometimes change, and the effects to the notes are canceled.

NOTE

When you've chosen  and used the Voice Transformer feature, you can't use the Harmonist function.

NOTE

When you use the Harmonist function, effects applied to the notes you play on the keyboard (see page 53) may be canceled.

■ Enjoying Karaoke Performances



If you're using the disk drive for the first time, be sure to read the important notes on page 5.



Karaoke music files must be purchased separately. When purchasing music files, please consult the vendor where you bought the KR-575.

Check out "Music Files That the KR-575 Can Use" (page 161).

- 1. Connect the microphone and adjust the volume and echo (page 48 and 49).**

You can also enjoy this with the Voice Transformer function (page 50) and Harmonist function (page 51).

- 2. Insert a floppy disk containing music files into the disk drive (page 40).**

- 3. Press the [Song] button.**

- 4. Touch the screen or use the dial to choose a song.**

- 5. If you need to, use the Tempo [-] and [+] buttons to adjust the tempo.**

- 6. If necessary, change the key of the song (page 77).**

- 7. Press the Play [▶] button to play the song accompaniment.**

Let's sing!

When you play back a Music File with lyrics, the lyrics appear on screen.

- 8. Press the Stop [■] button to stop playback of the song.**



You can hide lyrics, if you like. Take a look at "Hiding the On-screen Lyrics" (page 133).

Chapter 2 Basic Functions

Adding an Echo to a Sound

The KR-575 can apply a reverb effect to the notes you play on the keyboard. Applying reverb adds pleasing reverberations to what you play, almost as if you were playing in a concert hall.

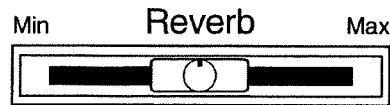

1. Use the [Reverb] slider to adjust the amount of reverb effect applied.

Moving the slider to the right applies a deeper reverb, and moving it to the left applies less reverb.



You can change the type of reverb that's applied. See "Changing the Type of Reverb Effect" (page 132).

Adding a Variety of Effects to Sounds

You can apply a wide range of different effects to the notes you play on the keyboard.

1. Press one of the Tone buttons to choose a Tone to which you want to apply an Effect.

When you press the One Touch Program [Piano] or [Organ] button, you cannot change the type of effects.

2. Press the [Effects] button and confirm that its indicator has lighted. The Effect screen appears and the optimal effect for the keyboard sound is applied.

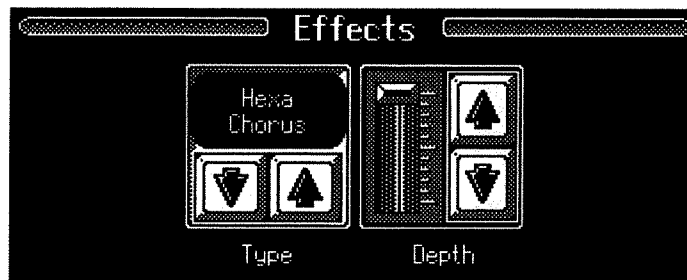



3. Touch the <Type>   to choose the type of effect.

At power-up, the settings are made to apply the optimal effects to each of the tones.



For more information on the different types of effects, take a look at the "Effect List" (page 160).

4. Touch the <Depth>   to adjust the amount of effect applied.

5. Pressing the [Effects] button a second time makes the button's indicator light go out and cancels the effect.



When you've chosen "Rotary" as the effect type, pressing the [Effects] button changes the speed of rotation of the rotary speakers. To cancel the effect, choose another effect, then press the [Effects] button.



The Effects may be canceled when you use the Harmonist function (page 51). Also, when the Layer Play (page 54) or Split Play (page 56) is in effect, you can only apply the effects to the notes displayed at the bottom-right on the screen.

Combining the Sounds of Two Instruments—Layer Play

You can play two different sets of sounds from a single key at the same time. For instance, it's possible to play the Tones for both Piano and Strings in combination. This method of performance is called "Layer Play."

1. Choose one of the two sounds you want to combine (page 27).
2. After choosing the sound, touch <Exit> to display the Basic screen (page 16).
3. Touch <Layer> at the bottom of the screen.

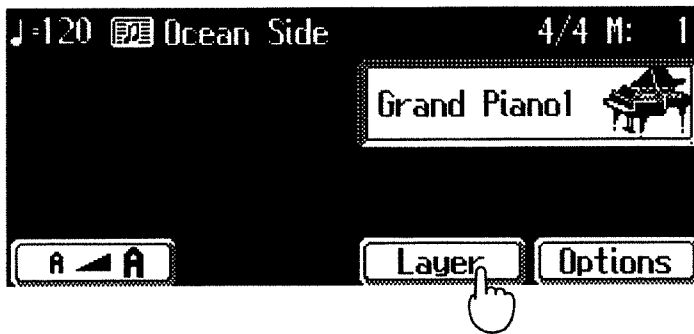

The screen changes as shown below.

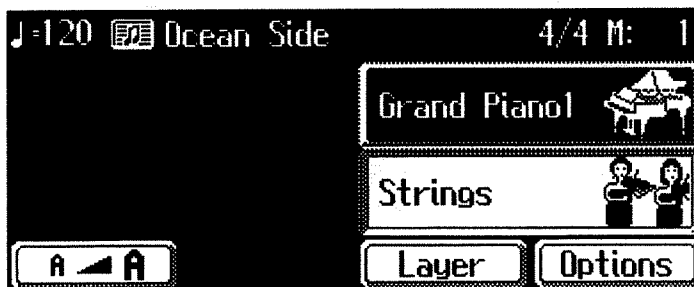

When you finger the keyboard, the sound you chose in step 1 is combined with the sound displayed at the bottom-right area of the screen.

4. Touch <Layer> a second time to cancel Layer Play.

When you finger the keyboard, only the sound displayed at the upper-right area of the screen is played.



You can change the volume level for each of the Tones. Check out "Adjusting the Volume of Each Performance Part" (page 113).

■ Changing the Tones

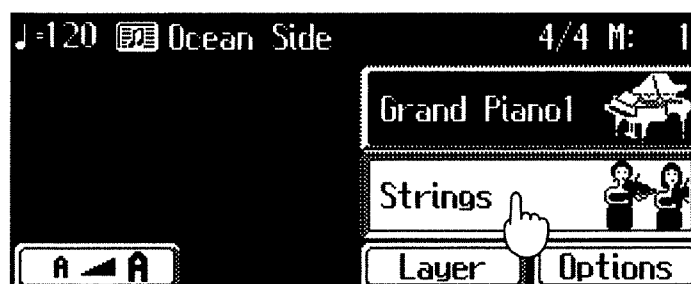

1. On the Touch Screen, touch the name of the Tone you want to change.
2. Press one of the Tone buttons.
The Tone Selection screen appears.
3. Press the Page [◀] and [▶] buttons to switch screens, and touch the screen to choose a Tone.



You can also use the dial to choose a Tone. When you use the dial, the pages are switched automatically, without having to use the Page [◀] and [▶] buttons.

Touch <Exit> to end selecting the Tone.

4. When you finger the keyboard, the selected Tone and the other Tone are played.



When you will change the Tone displayed at the bottom-right area of the screen, <Octave -> and <Octave +> appear at the bottom of the Tone Selection screen. Touching these changes the pitch of the keyboard by octaves. To learn more, check out "Shifting the Keyboard Pitch by One of More Octaves" (page 120).

Playing Different Tones with the Left and Right Hands—Split Play

You can divide the keyboard into right- and left-hand sections with an arbitrary key marking the division, and play different tones on the two sections. Such a division of the keyboard into right- and left-hand sections is called a “Split,” and the key where the division takes place is called the “Split Point.” The split-point key is included in the left-hand section. The split point is set at “F#3” when the power is turned on.



You can change the split point. Take a look at “Changing the Keyboard’s Split Point” (page 129).

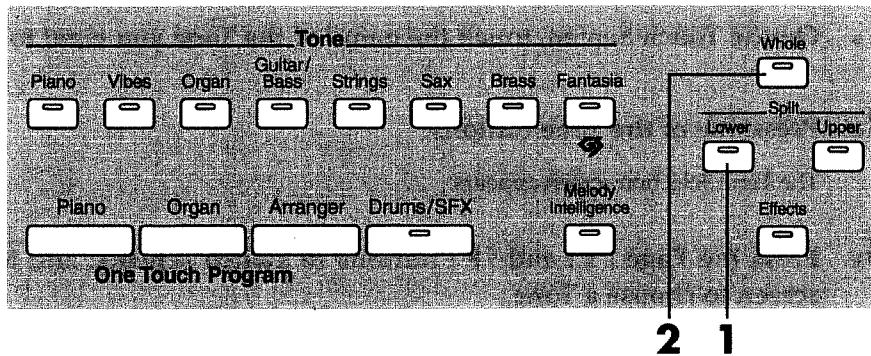

1. Press the Split [Lower] button.

The indicator for the Split [Upper] and Split [Lower] buttons light up, and the keyboard is divided into right-hand and left-hand sections.

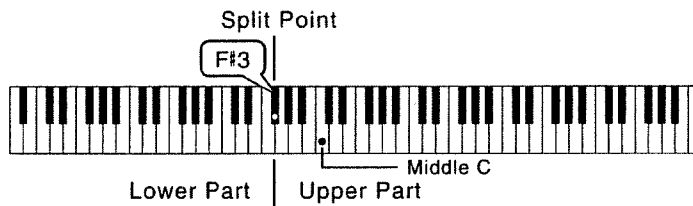

The right-hand section (Upper Part) of the keyboard plays the same sound it did before you divided the keyboard.

The left-hand section (Lower Part) of the keyboard plays a the sound which is displayed on the upper left of the Basic screen (page 16).



If you split the keyboard while using Layer Play (page 54), the two layered sounds go to the upper part of the keyboard.

2. Press the [Whole] button to return the keyboard to an unsplit state.

The Split [Upper] and Split [Lower] buttons go dark.

The entire keyboard now plays with the sound that was assigned to the right-hand section.



You can independently adjust the volume levels of the notes played by the upper and lower sections of the keyboard. Check out “Adjusting the Volume of Each Performance Part” (page 113).



When the keyboard has been divided into upper and lower sections, the damper pedal is applied to only the upper section. If you want to add lingering reverberations to the notes of the lower section, see “Assigning Functions to Buttons and Pedals” (page 118).

■ Changing the Tones



1. On the Touch Screen, touch the name of the Tone you want to change.
You can also choose the Tone that you want to change by pressing the Split [Upper] or Split [Lower] button.
2. Press one of the Tone buttons.
The Tone select screen appears.
3. Use the Page [◀] and [▶] buttons to switch the screens, and select a tone on the screen.



You can also use the dial to choose a Tone. When you use the dial, the pages are switched automatically, without having to use the Page [◀] and [▶] buttons.

Touch <Exit> to end selecting the Tone.

4. Play the keyboard to hear the Tone you selected.



When the Split Play setting is in effect, <Octave -> and <Octave +> appear at the bottom of the Tone Selection screen. These are used to change the pitch of the keyboard by octaves. To learn more, check out “Shifting the Keyboard Pitch by One of More Octaves” (page 120).

■ Playing the Entire Keyboard As a Single Instrument

When the keyboard has been split into right- and left-hand sections, you can rejoin the sections into a single whole. If the Layer Play setting is in effect, the two Tones sounded in the right-hand section is played.

1. Press the [Whole] button.

The entire keyboard now plays with the sound that was assigned to the right-hand section. The keyboard returns to a single, unsplit section even when you press the One Touch Program [Piano] button. When you finger the keyboard, the Grand Piano 1 sound is produced.



Pressing the [Whole] button during automatic accompaniment activates the “Piano Style Arranger”. Take a look at “Playing with Automatic Accompaniment Without Splitting the Keyboard - Piano Style Arranger” (page 68).

Chapter 3 Automatic Accompaniment

With the KR-575, you can make the settings for playing Automatic Accompaniment with just a touch of the One Touch Program [Arranger] button. Using Automatic Accompaniment lets you play accompaniments in a variety of musical genres automatically, making it possible for you to enjoy ensemble performances with orchestral backing, even when you're playing solo.

Choosing a Music Style

The built-in accompaniment patterns in various musical genres are called "Music Styles."

What's a Music Style?

There are many different varieties of music around the world, and each one has its own unique features. What gives jazz its "jazziness" and classical music its unmistakable classical feel is the combination of elements such as the instruments used, melody, and phrasing, which interact to create the musical ambience of the genre. A Music Style makes use of the elements to bring out the distinctive atmosphere and mood of each musical genre.

The Makeup of a Music Style

A Music Style is made up of a set of six performance states called "Divisions." There are "Intro," "Original," "Variation," "Fill In to Original," "Fill In to Variation" and "Ending." In addition, KR-575 has two types of intros and endings. Also, a Music Style is made up of five performance parts: "Rhythm," "Bass," "Accompaniment 1," "Accompaniment 2," and "Accompaniment 3."

What's a "Fill In"

A short improvisational phrase inserted at the bar line (the juncture between one measure and another) is called a "Fill In."



For more information about the types of Music Styles, take a look at the "Music Style List" (page 145).

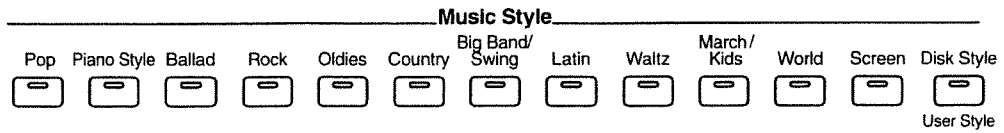

1. Press the One Touch Program [Arranger] button.
2. Press a Style button to choose the group for the Music Style.

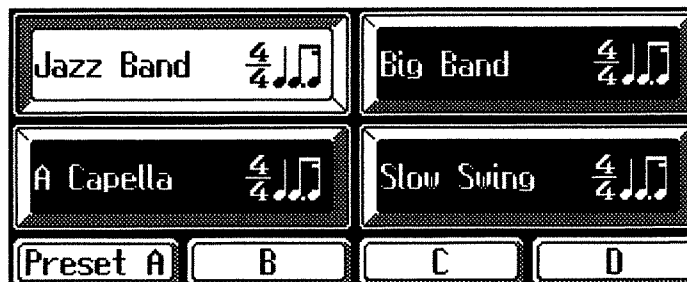

3. Press the Page [◀] and [▶] buttons and the Touch Screen or the dial to choose a Music Style.

When you use the dial, the pages are switched automatically, without having to press the Page [◀] and [▶] buttons.



When you change the Music Style, the tempo and Tone change to match the Music Style you've chosen. If you don't want to change the tempo and Tone, take a look at "Changing the Settings for Automatic Accompaniment" (page 128).

4. To make changes in the Music Style's tempo, the Tone of the right-hand part, and the like, touch <Preset A>, , <C>, or <D> at the bottom of the screen.

By varying the tempo or Tone, you can enjoy performances with a totally different ambience, even when the Music Style is the same.

5. Specify a chord by playing it on the left-hand keyboard section.

The Music Style you chose plays automatically with the specified chord.

6. Press the Intro/Ending [1] or [2] button to play an ending and stop performance of the accompaniment.



There are two types of intros and endings. Pressing the Intro/Ending [2] button plays a simpler accompaniment than the Intro/Ending [1] button. Press the [Start/Stop] button to stop the accompaniment without ending.

■ Searching for a Suitable Music Style for a Song

You can search a large number of styles for the style that best matches the ambience of a particular song.

- 1. Touch <Utility> at the left side of the screen.**
The Utility screen (page 22) appears.
- 2. Touch <Style Finder>.**
- 3. Follow the on-screen message to choose one that suits the song's mood and characteristics.**
- 4. Touch <Exit> to end this function.**

■ Playing Just the Rhythm Pattern

A Music Style can be made to sound only the Rhythm Pattern.

- 1. Press the One Touch Program [Piano] button, then press the [Start/Stop] button.**

Only the Rhythm Pattern of the selected Music Style is played.



Some Music Styles don't contain a Rhythm Pattern, so in some cases you may not hear a Rhythm Pattern played even when you've followed the steps just described.

■ Using a Music Style Disk

You can play Music Styles on the Music Style disk included with the KR-575 or User Styles (page 114 and 116) saved on a floppy disk.

- 1. Insert a floppy disk into the disk drive (page 40).**
- 2. Press the [Disk/User Style] button.**
- 3. Press the Page [◀] and [▶] buttons and use the Touch Screen or the dial to choose a Music Style.**

When you use the dial, the pages are switched automatically, without having to use the Page [◀] and [▶] buttons.

Press the Page [◀] button several times to display the Music Styles stored in KR-575's internal memory.

- 4. Press the One Touch Program [Arranger] button, they specify a chord by playing it on the left-hand section of the keyboard.**

The Music Style you've chosen is sounded.



The Music Style you've selected from the floppy disk remains in memory until you switch off the power. You can play the Music Style you last selected just by pressing the [Disk/User Style] button, even if you've taken the floppy disk out of the disk drive.

Choosing How the KR-575 Starts and Stops

Pressing the One Touch Program [Arranger] button activates Sync Start for the accompaniment (which starts the accompaniment simultaneously when you play something on the left-hand section of the keyboard), and makes the setting for automatically playing an appropriate intro for the accompaniment. You can change how this starting and stopping works in many different ways.

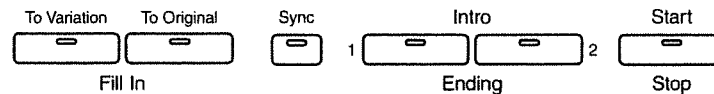

■ Starting Automatic Accompaniment When You Play the Left-hand Section—Sync Start

1. Press the One Touch Program [Arranger] button.

The indicator for the [Sync] button lights up, and the Intro/Ending [1] button's indicator blinks.

2. Specify a chord by playing it on the left-hand keyboard section.

The intro is played and the automatic accompaniment starts.

● Changing the Intro

Before starting automatic accompaniment, you can follow the steps shown below to change or silence the intro.

Starting Without an Intro

Press the Intro/Ending [1] button to make the indicator go dark, then start the automatic accompaniment.

Starting with a Simple Added Intro

Press the Intro/Ending [2] button to make the indicator blink, then start the automatic accompaniment.

■ Starting at the Press of a Button

1. Press the One Touch Program [Arranger] button.

The indicator for the [Sync] button lights up and the Intro/Ending [1] button's indicator blinks.

2. Press the [Sync] button to make the indicator light go dark.

The indicator for the Intro/Ending [1] button also goes dark.

3. Specify a chord by playing it on the left-hand keyboard section.

Fingering a key on the left-hand section of the keyboard while the [Sync] button's indicator is dark causes a chord to be sounded. This note is called the "Chord Tone," and the root of the chord that is played at the same time is called the "Bass Tone."



You can change the sound of the chord tone and bass tone. Take a look at "Changing the Chord Tone and Bass Tone" (page 128).

4. Press the Intro/Ending [1], Intro/Ending [2] button or [Start/Stop] button.

The automatic accompaniment starts.



Pressing the [Start/Stop] button starts the automatic accompaniment without an intro. Pressing the Intro/Ending [2] button plays a simple intro.

■ Stopping Automatic Accompaniment

Stopping with an Added Ending

1. Press the Intro/Ending [1] button or Intro/Ending [2] button.

An ending is played, then the automatic accompaniment stops.



Pressing the Intro/Ending [2] button plays a simple ending.

Stopping at the Press of a Button

1. Press the [Start/Stop] button.

Automatic accompaniment stops as soon as you press the button.

Modifying an Accompaniment

You can perform arrangement of automatic accompaniment or make changes in the accompaniment pattern.

■ Changing the Accompaniment Pattern

There are two accompaniment patterns: the original one, and a variation that's a little more florid. It can be effective to use the quieter original pattern for the first half of the song, and the variation pattern for the second half.

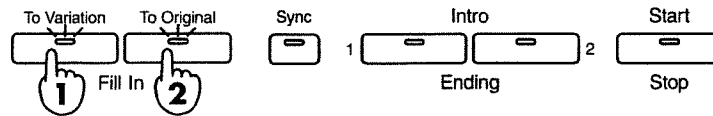

1. Pressing the [To Variation] button to make the button's indicator light up makes the setting for playing the variation accompaniment pattern.
2. Pressing the [To Original] button to make the button light up makes the setting for playing the original accompaniment pattern.

Also, pressing either of these buttons during a performance inserts a fill-in in time with when the button was pressed.

● Adding a Fill-in Without Changing the Accompaniment Pattern

You can play a fill-in without changing the accompaniment pattern by pressing whichever of the [To Original] and [To Variation] buttons whose indicator is lit up while a performance is in progress.



You can use the pedals to change the arrangement or accompaniment pattern or to insert a fill-in. Check out "Assigning Functions to Buttons and Pedals" (page 118).

■ Changing the Arrangement of the Accompaniment

You can change the arrangement of an accompaniment during the performance of automatic accompaniment or while it is stopped. This function is called "Style Orchestrator".

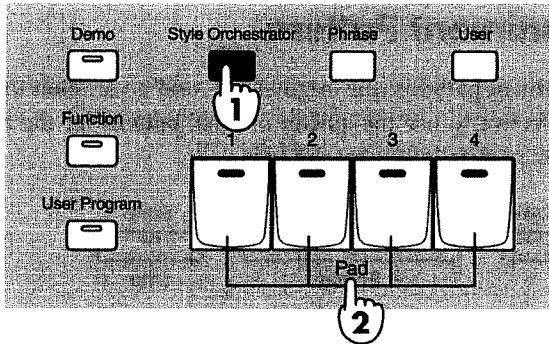

- 1. Press the [Style Orchestrator] button to make the button light up.**

Now, you can use the Pad buttons to change the arrangement.

- 2. Press the Pad buttons to change the arrangement of the accompaniment.**

The Pad [1] button produces the simplest arrangement, and the Pad [4] button produces the most florid.



Some Music Styles don't change the arrangement of the accompaniment when you've followed the steps just described.

■ Playing a Short Phrase

You can play a short phrase of effect sounds or the like.

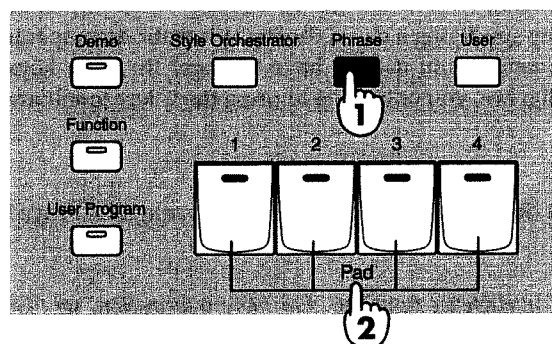



1. Press the [Phrase] button to make the button light up.

Now you can use the Pad buttons to play a short phrase.

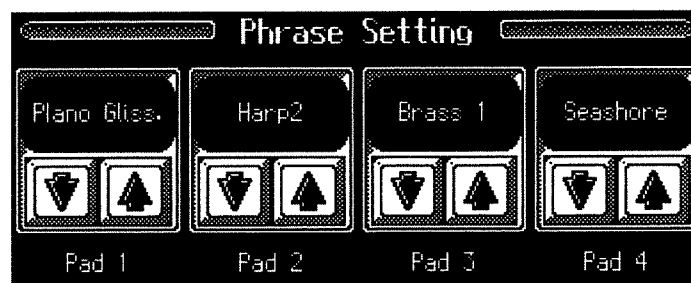
A screen like the one shown below appears.



2. Touch   to choose the type of phrase.
3. Press the Pad button to play the phrase.



Some phrases may keep playing. If this happens, just press the Pad button a second time. Also, some phrases make Automatic Accompaniment stop while they are playing. In such cases, Automatic Accompaniment begins when the phrase ends.



Playing a phrase while playing percussion-instrument sounds on the keyboard (page 26) may make the Drum Set type change.

Playing Chords with Simple Fingering

“Chord Intelligence” is a feature that intelligently decides on accompaniment chords the moment you play a key specifying a chord during automatic accompaniment.

To play a C chord, for example, you usually have to finger the three keys C, E, and G—but with Chord Intelligence, you only have to press the C key to initiate a C chord accompaniment.



For more information about chord fingering, see the “Chord Fingering List” (page 147).



You can cancel the Chord Intelligence function. For more information, see “Changing the Settings for Automatic Accompaniment” (page 128).

■ Displaying the Chord Fingering On Screen

- 1.** Touch <Utility> at the left side of the screen.
The Utility screen (page 22) appears.
- 2.** On the screen, touch <Chord Finder>.
- 3.** Touch the screen to specify the root of the chord you want to check out.
The chord fingering appears on screen.
- 4.** Touch <Exit> to end this function.

Adding Harmony to the Right-hand Part

You can add a harmony to the notes you play with the keyboard.

When the keyboard has been split into a right-hand and left-hand section while an automatic accompaniment is playing, a harmony matched to the chord you designate on the left-hand section of the keyboard is automatically added to the notes you play on the right-hand section.

This function is called “Melody Intelligence.”

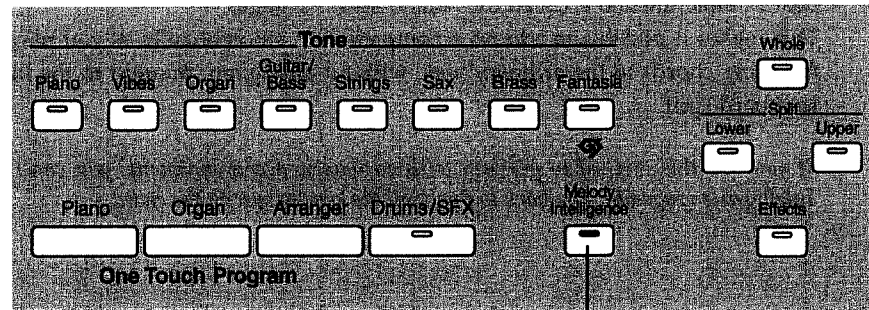

1, 3

1. Press the [Melody Intelligence] button and confirm that its indicator has lighted.

When you play something on the right-hand section of the keyboard, a harmony is added to the notes you finger.

A Melody Intelligence screen like the one following appears.

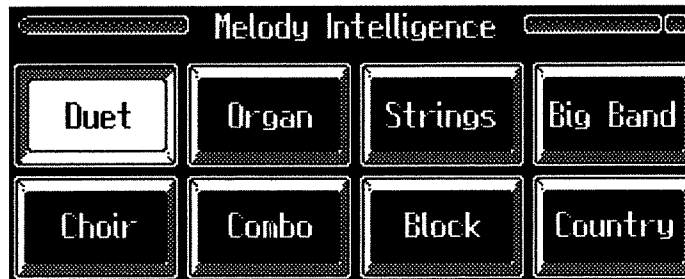

2. Press the Page [◀] and [▶] buttons and use the Touch Screen or the dial to choose a harmony type.

When you play something on the keyboard, a harmony of the type you selected is added to the notes you finger.

Touch <Exit> to go back to the previous screen with the Melody Intelligence function still in effect.

3. Press the [Melody Intelligence] button again to make the indicator light go dark and cancel Melody Intelligence.



The different types of harmonies include some that automatically change the Tone. Also, when you finger several keys at the same time, in some cases only one note is sounded.

Playing with Automatic Accompaniment Without Splitting the Keyboard–Piano Style Arranger

Usually, with an automatic accompaniment performance, the accompaniment is sounded by the chords you specify on the left-hand section of the keyboard, with the melody played on the right-hand section. If you like, however, you can make the KR-575 recognize chords from the entire keyboard, and perform without splitting the keyboard. This function is called the “Piano Style Arranger.”

This makes it possible to add an accompaniment automatically as you play a tune by fingering chords in the ordinary way, without giving any thought to the location of a keyboard split.



If you use this method to perform with automatic accompaniment, you can't use Chord Intelligence (page 66). You have to finger all the keys to specify the chord.

- 1.** Press the One Touch Program [Arranger] button.
- 2.** Press the [Whole] button.
- 3.** Choose a Music Style (page 58).
- 4.** Finger the keyboard.

The accompaniment starts when you finger a chord.

Chapter 4 Some Handy Features

Adjusting the Tempo

You can change a song's tempo. Changing the tempo has no effect on the pitch of the notes. You can even change the tempo during playback.

Use the Tempo [-] and [+] buttons to adjust the tempo.

Each press of the [+] button makes the tempo faster. Holding down the button makes the tempo change (speed up) continuously.

Each press of the [-] button makes the tempo slower. Holding down the button makes the tempo change (slow down) continuously.

Press [-] and [+] at the same time to return to the original tempo.

Use < ▲ > and < ▼ > or the dial to adjust the tempo.

When the tempo is displayed at the upper-left area of the screen, you can use < ▲ > and < ▼ > or the dial to adjust the tempo.

- Turn the dial clockwise or touch < ▲ > to speed up the tempo.
- Turn the dial counterclockwise or touch < ▼ > to make the tempo slower.
- Touch < ● > to go back to the basic tempo.

Determine the Tempo by the Timing of Pressing the Pad Button

You can determine the tempo by the timing with which you press the Pad button. This feature is called "Tap Tempo." In order to use "Tap Tempo", you need to change the function of the Pad buttons. For more information, take a look at "Assigning Functions to Buttons and Pedals" (page 118).

- 1.** Press the [User] button.
- 2.** Assign the "Tap Tempo" to one of the Pad buttons (page 118).
- 3.** Tap the Pad button four times.

The tempo is set according to the timing with which you tap the button.

Playback with No Change in Tempo

If a tune has difficult tempo changes, it can be effective to practice the song first at an unchanging tempo.

Playback of a song at a steady tempo that doesn't change is called "Tempo Muting."

1. Hold down the Stop [■] button and press either the Tempo [-] or [+] button.

Now, songs are played back at an unchanging tempo.

When tempo muting is in effect, the tempo display appears in reverse video.

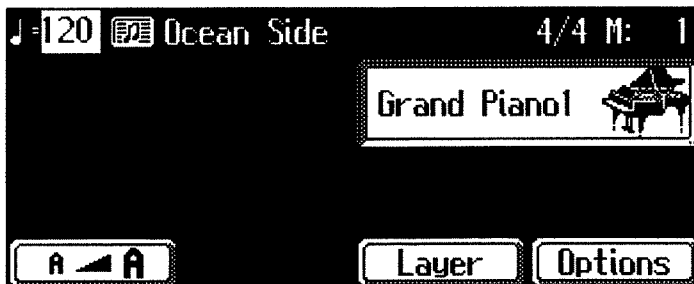

2. Again hold down the Stop [■] button and press either the Tempo [-] or [+] button to cancel tempo muting.

Tempo muting is also canceled if you select another song.

Counting Down Before a Performance Starts

When you're playing along with a song, you can make sure that your playing is in time with the tune by sounding a count before the song starts playing.

This audible count before the playback of a tune is called a "Count-In."

1. Press the [Marker/Count In] button.

A Marker screen like the one shown below appears.

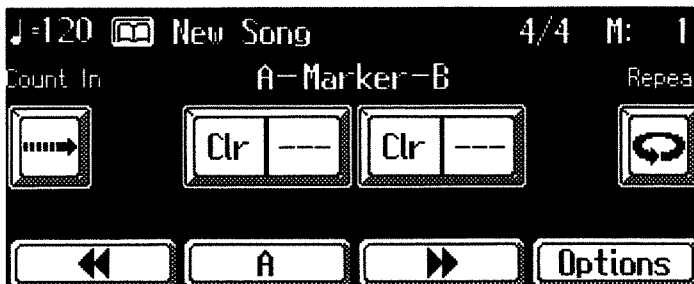

2. Touch the <Count In> icon.
That icon appears in reverse video.
With this setting, two measures are counted down before song playback starts.
3. Touch the <Count In> icon again to get rid of the count-in sound.

Touch <Exit> to go back to the previous screen.



You can change the number of measures counted and the type of sound that you hear. See "Changing the Number of Measures Counted and the Count Sound" (page 130).

Moving to the Passage You Want to Hear

You can move to a certain measure or beat within a song, and play back the tune from that location.

1. Press the Bwd [◀◀] and Fwd [▶▶] buttons to move to the bar you want to hear.

Pressing the button once moves your position by one measure. Hold down the button to move forward or backward continuously.

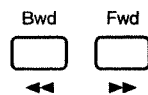

The measure number appears in the top-right area of the Basic screen.

2. Press the Play [▶] button to play back the song from the measure you moved to.

To go back to the beginning of the song

1. Press the Reset [◀] button.



To move to the end of the song

1. Hold down the Stop [■] button and press the Fwd [▶▶] button.

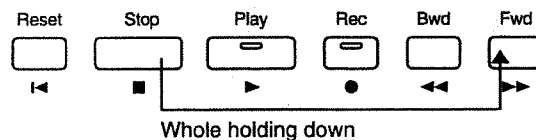

If you've used markers to designate a passage for repeating (page 74), you can only move forward and backward within the range specified by the A and B markers.



When you start playback of Music Data, the measure number on the Basic screen appears in reverse video. While this is in reverse video, the KR-575 is reading data from the floppy disk, so wait a few moments until it finishes.

Placing Markers

Placing markers within a song is a handy way to start playback at the same place as many times as you like.

There are two markers, A and B.

You can add markers or move to a marker even while playback is in progress.

1. Press the [Marker/Count In] button.

The Marker screen appears.

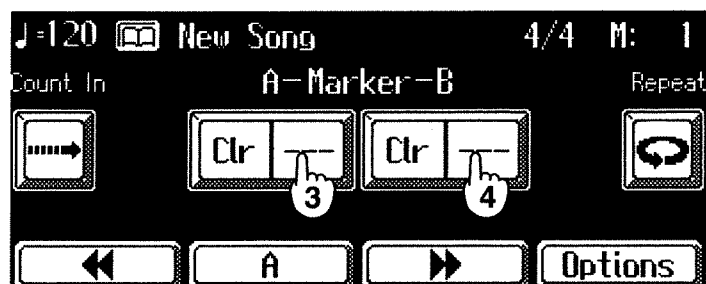

2. Use the Bwd [◀◀] and Fwd [▶▶] buttons to move to where you want to place a marker.

The measure number appears in the top-right area of the screen.

3. Touch <--> for <Marker A>.

Marker A is placed at the beginning of the bar you moved to.

4. In the same way, move a position and touch <--> for <Marker B> to place marker B.

When you've placed a marker, the number of the measure with the marker appears on screen.

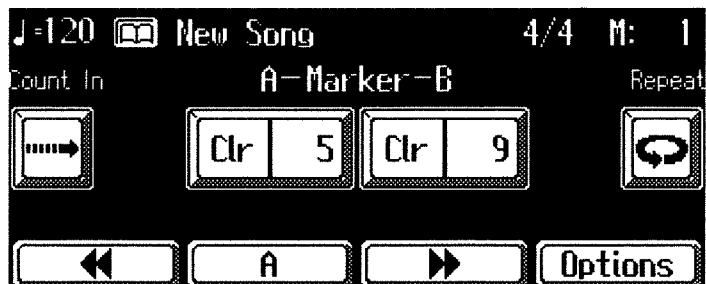

After you've placed the markers, touching the number of the measure with the marker moves the playback position to the corresponding marker.

Touch <Exit> to go back to the previous screen.



You can't place both marker A and marker B at the same location. Also, you can't place marker B at a position earlier than marker A.



The markers are normally placed at bar lines, but you can also place a marker at a position partway through a measure. Take a look at "Placing a Marker in the Middle of a Measure" (page 131).

■ Moving a Marker

1. Touch <A> at the bottom of the screen and select the marker which you want to move.

The display cycles through <A>, , and <A-B>.

Display	Description
A	Moves the position of marker A.
B	Moves the position of marker B.
A-B	Moves marker A and marker B at the same time. (Take a look at "Moving a Repeated Passage" on page 75.)

2. Touch <◀◀> or <▶▶> at the bottom of the screen to move the marker.

Touch <◀◀> to move toward the beginning of the song.

Touch <▶▶> to move toward the end of the song.

Erasing a Marker

1. Touch <Clr> for the marker you want to erase.

The marker disappears and the on-screen display changes to <-->.

Listening to the Same Passage Over and Over

You can play back a particular passage repeatedly. This is convenient when you want to practice the same location over and over.

1. Press the [Marker/Count In] button to display the Marker Screen.
2. Place markers A and B to enclose the passage you want to repeat (page 72).

For instance, suppose you want to play back the passage from the fifth through eighth measures over and over. You should place marker A at the beginning of the fifth bar and marker B at the beginning of the ninth bar.

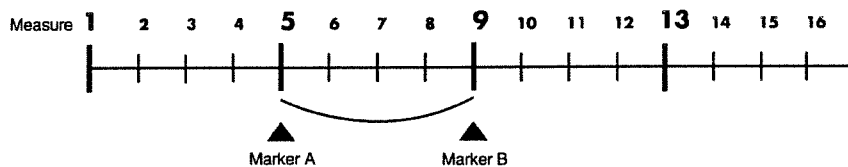

3. Touch the <Repeat> Icon.

The setting is made for repeated playback of the passage from marker A to marker B.

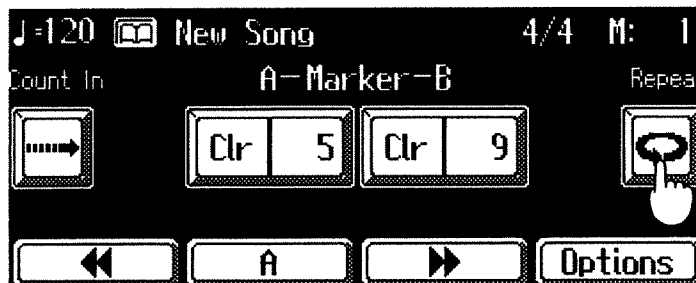

4. Press the Play [▶] button.
 - The passage from marker A to marker B is played repeatedly.
 - If you don't place any markers, playback repeats from the beginning to the end of the song.
 - If you only place marker A, playback repeats from marker A to the end of the song.
 - If you only place marker B, playback repeats from the beginning of the song to marker B.
5. Press the Stop [■] button to stop playback of the song.
6. Touch the <Repeat> Icon again to cancel the setting for repeated playback.

Moving a Repeated Passage

You can shift the entire repeated passage forward or backward.

1. Touch <A> at the lower portion of the Marker screen several times until <A-B> appears.
2. Touch <◀◀> or <▶▶> at the bottom of the screen to move the marker.

As an example, let's suppose that marker A is at the start of the fifth measure and marker B is at the start of the ninth measure

- Touch <▶▶> to shift marker A to the beginning of the ninth measure and marker B to the beginning of the thirteenth measure.

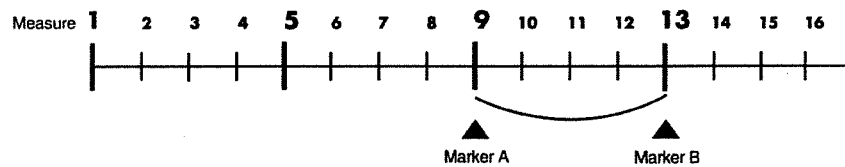

- Touch <◀◀> to shift marker A to the beginning of the first measure and marker B to the beginning of the fifth measure.

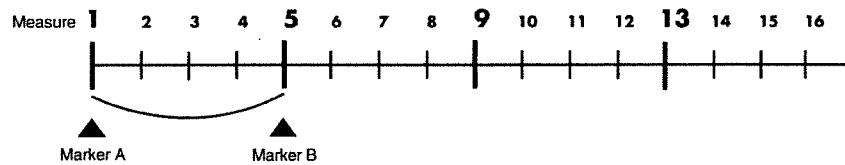

Playing in an Easier Key

You can transpose the key of a performance without having to shift the position of your fingers on the keyboard. This feature is called "Key Transpose."



This lets you take a song in a difficult key with lots of sharps (#) and flats(b) and play it in a key with fingering that's easier for you. For instance, you can play a tune in the key of E major with the keyboard fingering for the key of C major.

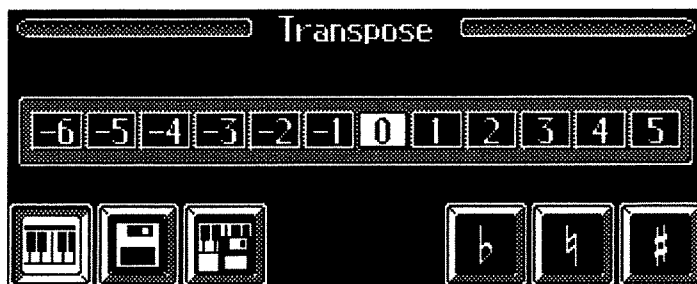

Example: Playing a song in E major with the keyboard fingering for C major

1. Press the [Transpose] button.

A Transpose screen like the one appears.



2. Touch .
3. Choose the value for transposition by touching a numeral on screen or by touching  or .

Each press of  or  transposes the key by a semitone.

You can also use the dial to change the transposition value.

The setting range is from -6 to 0 to +5.

In this example, we'll consider the C note in the key of C major to be the basic note.

From the C note to the note that corresponds to E in the key of E major there are four keys on the keyboard, counting the black ones, so set the value at "+4."

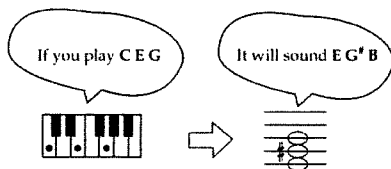

4. Touch  to return the keyboard transposition to the original key.

Touch <Exit> to go back to the previous screen.



The transposition setting returns to its original value when switch off the power or choose another song.



Transposing a Song

You can transpose a song for playback.

1. Press the [Transpose] button.

The Transpose screen appears (page 76).

2. Touch .

3. Choose the value for transposition by touching a numeral on screen or by touching  or .

Each press of  or  transposes the key a semitone.

You can also use the dial to change the transposition value.

You can transpose the song within a range of -24 to +24 semitones.

4. Touch  to return the song transposition to the original key.

● To transpose both the keyboard notes and the song

In step 2 above, touch .

The setting range at this time is from -6 to 0 to +5.



The transposition setting returns to its original value when switch off the power or choose another song.

Playing Along with a Song

With commercially available music files for piano lessons, the part for each hand can be played back independently. This makes it easy to practice the parts for each hand separately. For example, you could try to follow along lightly with your right hand while you listen to that same right-hand part be played; or you could practice the left-hand part while the right-hand part is being played.

For instance, a music file for piano lessons may be assigned to the five Track buttons as shown below.

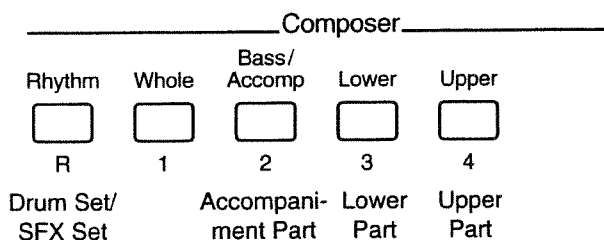

You can even use the songs you create yourself in the same way by recording them on Track buttons.

- 1. Press the [Song] button to choose the song.**
- 2. Press any one of the Track buttons to make the button's indicator light go dark.**

When you play back the song, the sounds for the illuminated Track buttons are played, but no notes are played for the Track button that is dark.

This process of temporarily silencing a Track button by pressing it to make its light go dark is called "Muting." This feature can be used to practice one-handed parts.

- 3. Press the dark Track button again to make the indicator light come back on.**

Now, you can hear the notes for the Track button that just lit up when you pressed it.



If a single Track button includes more than one instrument, and you want to mute out just one of those instruments, take a look at "Changing the Song Settings for Individual Parts" (page 88).



You can change the volume balance for the keyboard and the song. See "Changing the Volume Balance for the Accompaniment and Keyboard" (page 34).



To know more about music files, check out "Music Files That the KR-575 Can Use" (page 161).

■ Checking Your Performance On Screen

You can compare the notes you play yourself with a model song on screen.

1. Touch <Utility> on the left side of the screen.

The Utility screen appears (page 22).

2. Touch <Piano Partner>.

A Keyboard screen or Graph screen like the one shown below is displayed.

The Keyboard Screen

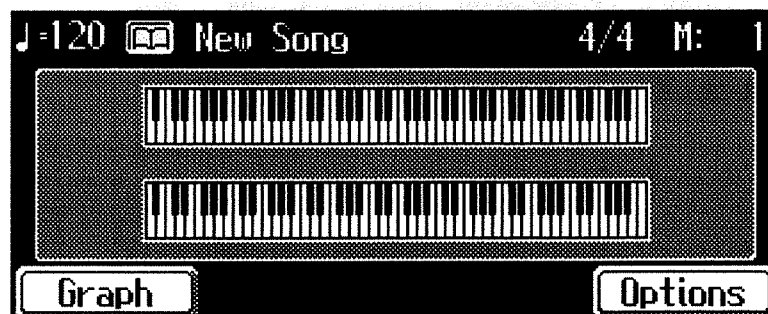

When this screen is visible, you can check the pitch.
The key for the note being played appears in reverse video.

The Graph Screen

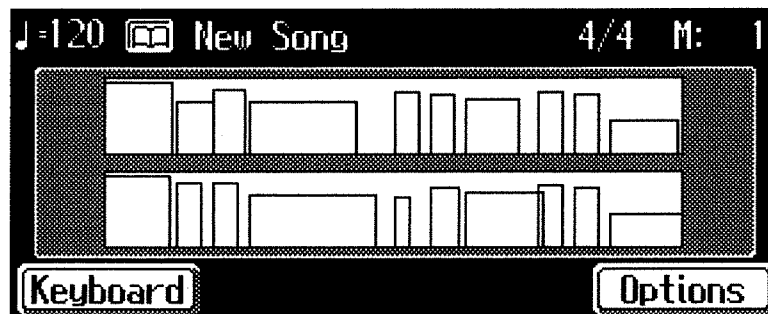

When this screen is visible, you can check a note's velocity and length.
The height shows the note's velocity, and the width shows the note's length.

You can switch between the two screens by touching <Graph> or <Keyboard>.
On each screen, the upper portion shows the performance of the model song and the lower portion shows what's played on the keyboard.

3. Play back the song, and try playing along with it yourself.

Touch <Exit> to go back to the previous screen.

● Changing the Displayed Part

You can display a different Part of the model song.

1. At the Keyboard screen or the Graph screen, touch <Options>.

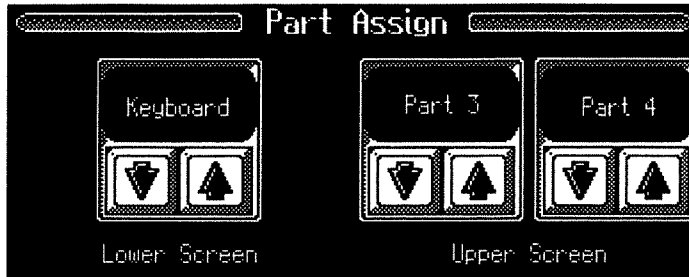

2. Touch   to switch the Part that's displayed.

You can display two parts on the Upper Screen at the same time, so it might be a good idea to choose the right-hand part and the left-hand part. Also, when <Keyboard> is selected in the Lower Screen, the keyboard performance appears, but choosing a recorded Part lets you confirm it again after the performance ends.

Touch <Exit> to go back to the previous screen.



For more information about the Part, take look at "Recording an Ensemble Tune - 16-track Sequencer" (page 85).

Chapter 5 Recording Functions

The KR-575's Recording Functions

The KR-575 has a wide variety of built-in recording functions in addition to the basic recording methods described in the procedures for "Recording a Performance" (page 35). You can use the 16-track sequencer (page 85) in combination with a range of recording methods to compose ensemble songs.

■ A Wide Variety of Recording Methods

Usually, when you record something new, you record over an older recording, erasing it. However, you can choose any of the recording methods described below.

Mix Recording (page 82)

New notes are recorded as a new layer on top of notes recorded earlier.

Loop Recording (page 83)

A specified passage is recorded repeatedly, with new notes being combined with the existing ones.

Punch-in Recording (page 84)

Only a specified passage is re-recorded as you listen to a recorded performance.

Using the Ordinary Recording Method

Recording where you erase previously recorded material as you record something new is called "Replace Recording." This setting is in effect when you turn on the power.

1. Press the [Menu] button and confirm that its indicator has lighted.

A Menu screen like the one shown below appears.



If <Recording Mode> is not displayed, use the Page [◀] and [▶] button to switch screens.

2. Touch <Recording Mode>.

A screen like the one shown below appears.

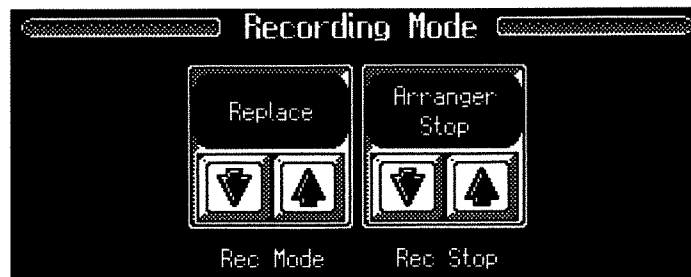

3. Touch the <Rec Mode>  , and choose <Replace>.

The KR-575 enters standby for ordinary recording.

Touch <Exit> twice to go back to the screen that was displayed before you press the [Menu] button.

Recording Sounds in Combination



You can record a performance layered over an previously recorded performance. This method is called "Mix Recording."

1. Press the [Menu] button and confirm that its indicator has lighted.

The Menu screen appears (page 81).

If <Recording Mode> is not displayed, use the Page [◀] and [▶] buttons to switch screens.

2. Touch <Recording Mode>.

3. Touch the <Rec Mode>  , and choose <Mix>.

The recording method changes to "Mix Recording."

Touch <Exit> twice to go back to the screen that was displayed before you press the [Menu] button.



When you're finished with mix recording, go back to the ordinary recording method. Check out "Using the Ordinary Recording Method" (page 81).

Recording the Same Passage Over and Over

You can record a specified passage over and over again as many times as you like, layering the sound with each pass. This method is called “Loop Recording”. This is handy when recording a Rhythm Part.

1. Place A and B markers at the beginning and end of the passage you want to record (page 72).

If you haven’t recorded anything yet, then perform “Blank Recording” for the necessary number of measures before placing the markers.

Blank recording is recording without playing anything.

(1) Hold down the Rec [●] button and press the Play [▶] button.

The indicators for the Rec [●] and Play [▶] buttons light up, and recording starts.

(2) Without actually playing anything, record the necessary number of measures, then press the Stop [■] button.

The indicators for the Rec [●] and Play [▶] buttons go dark, and recording stops.

2. At the Marker screen (page 72), touch the <Repeat> icon.

The recording method changes to loop recording.



When you’re finished with loop recording, touch the <Repeat> icon again to go back to the ordinary recording method.

■ Another Way to Set Loop Recording

You can also use the method described below to make the setting for Loop Recording.

1. Place A and B markers at the beginning and end of the passage you want to record (page 72).



If you haven’t recorded anything yet, then perform “Blank Recording” for the necessary number of measures before placing the markers.

2. Press the [Menu] button and confirm that its indicator has lighted.

The Menu screen appears (page 81).

If <Recording Mode> is not displayed, use the Page [◀] and [▶] buttons to switch screens.

3. Touch <Recording Mode>.

4. Touch the <Rec Mode>  , and choose <Loop>.

The recording method changes to loop recording.

Touch <Exit> twice to go back to the screen that was displayed before you press the [Menu] button.



When you’re finished with loop recording, go back to the ordinary recording method. Take a look at “Using the Ordinary Recording Method” (page 81).

Re-recording a Specific Passage

Re-recording a particular passage as you play back a recorded performance is called “Punch-In Recording.”

There are three punch-in recording methods. These methods are described below.

● Recording a passage specified by markers A and B

Before you start recording, place markers A and B to define the passage you want to record over. Make the setting for punch-in recording, and carry out recording. You can re-record just the passage between markers A and B.



For more information about placing markers, take a look at “Placing Markers” (page 72).

● Starting recording when you depress a pedal

You can play back a recorded performance and depress the pedal at the desired place to start recording. Depressing the pedal a second time cancels recording and returns you to playback.



To use this method, first you need to change how the pedal works. See “Assigning Functions to Buttons and Pedals” (page 118).

● Starting recording when you press a button

You can play back a recorded performance and press the Rec [●] button or a Pad button at the desired place to start recording. Pressing the same button a second time cancels recording and returns you to playback.



To use this method with a Pad button, first you need to assign the function to the Pad button. See “Assigning Functions to Buttons and Pedals” (page 118).

1. Press the [Menu] button and confirm that its indicator has lighted.

The Menu screen appears (page 81).

If <Recording Mode> is not displayed, use the Page [◀] and [▶] buttons to switch screens.

2. Touch <Recording Mode>.

3. Touch the <Rec Mode> , and choose <Auto Punch In/Out> or <Manual Punch In/Out>.

The recording method changes to punch-in recording.

Display	Description
Auto Punch In/Out	The passage specified by markers A and B is recorded.
Manual Punch In/Out	Recording starts at the place where you depress the pedal or press the Rec [●] button or the Pad button.

Touch <Exit> twice to go back to the screen that was displayed before you press the [Menu] button.



When you're finished with punch-in recording, go back to the ordinary recording method. Take a look at “Using the Ordinary Recording Method” (page 81).

Recording an Ensemble Tune – 16-track Sequencer

In this section, we'll take a look at the basic steps for creating ensemble songs using the 16-track sequencer. This procedure is fairly basic. Use the functions of the KR-575 in combination to create and work with your own compositions.

What's the 16-track sequencer?

The 16-track sequencer is a device that lets you simultaneously record or play back 16 individual Parts. For instance, you can create a composition by recording the melody on the first Part, then going back and recording the bass part on the second Part, then recording the next part on the third Part, and on and on until you've finished the song. The Parts of the 16-track sequencer are arranged in five groups on Track buttons (page 35). The 16 Parts of the 16-track sequencer correspond to the five Track buttons as shown below.

Track button	Part
[Rhythm]	D(10), S(11)
[Whole]	1
[Bass/Acomp]	2, 5 to 9, 12 to 16
[Lower]	3
[Upper]	4



Part S (11) of commercially available Roland SMF music files is contained on the [Bass/Acomp] Track button. The correspondences between other Parts and Track buttons are the same.



With the 16-track sequencer, a performance using one type of Tone is recorded on a single track. This means that you can't record while Layer Play (page 54) or Split Play (page 56) is in effect. Also, you can't record the performance with Automatic Accompaniment.

■ Steps for Recording an Ensemble Tune

When you create an ensemble composition, you start by deciding on the basic concept of the song, such as which tones are played with which parts. Then you record each part in sequence, using the tones that you've decided on for the individual parts: the rhythm part, the bass part, the chord part, the melody part, and so on.

● Tips on Composing an Ensemble Tune

- (1) When recording your ensemble song, start by recording the rhythm part to Part D(10). Loop Recording (page 83) can be handy when you record the rhythm part.
- (2) For the rhythm part, you can use a built-in Rhythm Pattern to simplify recording. For more information, take a look at "Creating a Rhythm Part with Ease" (page 91) and "Copying a Rhythm Pattern" (page 104).
- (3) You can use the editing functions to edit and correct the song you've recorded. For more information, check out "Chapter 6 – Editing Functions" (page 100).

Step 1 – Get ready to record

1. Press the [Song] button.

2. Choose <0:New Song>.

Choose the song number "0" for the new tune to be recorded.

If <0:New Song> doesn't appear on screen, use the Page [◀] and [▶] buttons to switch screens. When you use the dial, the pages are switched automatically, so you can choose a song without having to use the Page [◀] and [▶] buttons.

3. Press the [Metronome] button and choose the beat (page 29).

If you don't need the metronome sound, press the [Metronome] button a second time.

4. Press the Tempo [-] and [+] buttons to adjust the tempo.



You can't change a song's beat once it's been recorded. If you want to compose a tune whose beat changes partway through the song, take a look at "Composing a Tune That Changes the Beat Partway Through" (page 95).

Step 2 – Choose the recording method

5. If necessary, choose a recording method.

For more information, take a look at page 81 through page 84.

Step 3 – Choose the recording part

6. Press the [Menu] button.

The Menu screen (page 81) appears.

If <16trk Sequencer> doesn't appear on screen, use the Page [◀] and [▶] buttons to switch screens.

7. Touch <16trk Sequencer> .

A 16-track Sequencer screen like the one shown below appears.

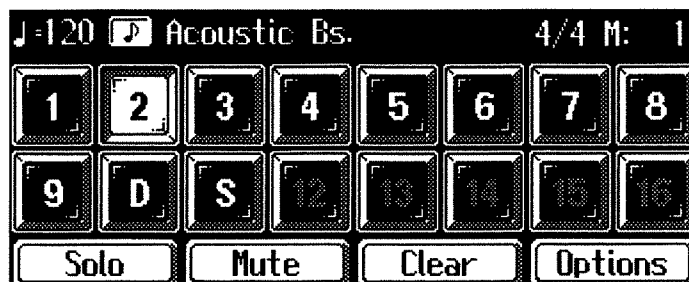

8. Touch the number for the Part you want to record.

The Part you touch appears in reverse video.



You can only record drum sounds or effect sounds on Part D(10) or Part S(11).

Step 4 – Change the Tone

9. Press one of the Tone buttons to choose a Tone (page 27).

To record a drum sound or effect sound, press the [Drums/SFX] button (page 26).

10. After you've chosen a Tone, touch <Exit> to display the 16-track Sequencer screen.

Step 5 – Start recording

11. Press the Reset [◀] button.

This makes it so that recording starts at the beginning of the song.

12. Press the Rec [●] button to make the button's indicator blink.

The KR-575 enters standby for recording.

13. Press the Play [▶] button.

A two-bar count-in sounds, then recording starts.

14. Press the Stop [■] button.

Recording stops.

If your performance is not as expected

- You can erase the selected part by touching <Clear> at the bottom of the screen.
-

Step 6 – Recording a different Part

When you've finished recording, then repeat the operation after "Step 2 – Choose the recording method" to record the other parts. Do this until your song is done.



You only need to follow the procedure described in "Step 1 – Get ready to record" when you're recording the first Part. For the second Part and after, you can skip step 1 and proceed from "Step 2 – Choose the recording method".



The song you've recorded disappears when you switch off the power. Save the tune on a floppy disk. For more information, take a look at "Saving Your Songs on Floppy Disk" (page 42).

■ Changing the Song Settings for Individual Parts

When you've recorded a song with the 16-track sequencer, you can change the volume level, Tone, or other settings for each individual Part, or mute out the sound for a single Part.

1. Press the [Song] button, and touch the screen to choose the song.
2. Press the [Menu] button, and touch <16 track Sequencer>.

Chapter 5

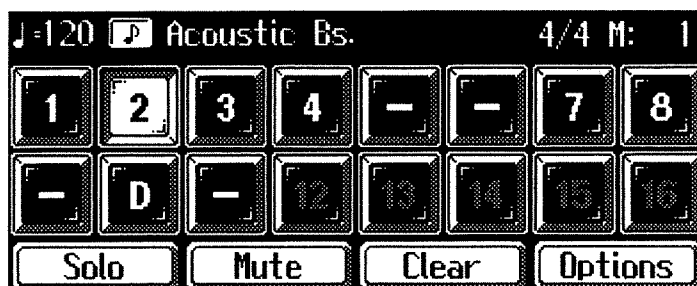

Display	Description
	This Part is played back
	This Part is not played back
	This Part has not been recorded

3. Touch the screen to choose the Part for which you want to make settings.

4. Touch <Solo> or <Mute> at the bottom of the screen to select whether the chosen Part is played.

You can also touch <Clear> to completely erase the Part's performance information. The corresponding functions are shown below.

Display	Function
Solo	Only the selected Part is played back.
Mute	This toggles playback of the selected Part on or off.
Clear	This erases the performance information for the Part.

Touching <Clear> displays the Message for confirm. To erase the recorded sound, touch <OK>. If you don't want to erase the recorded sound, touch <Cancel>.



Once a performance has been erased, it can't be restored.



Making it so that a single Part is not played is called "Minus One". Using Minus One, you can mute out a particular instrument and play the part yourself.

5. You can make detailed settings for the selected Part by touching <Options>.

A screen like the one shown below appears.

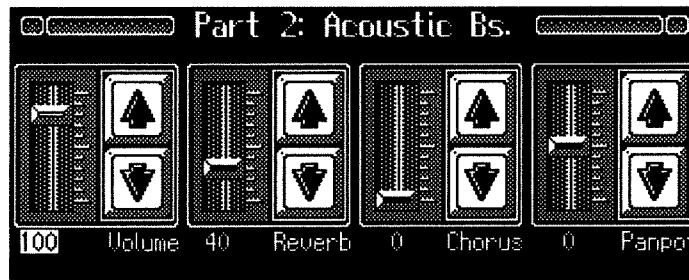

Display	Description
Volume	This changes the volume level.
Reverb	This changes the depth of the reverb effect.
Chorus	This changes the amount of chorus applied.
Panpot	This shifts the direction the sound is heard from to the left or right.





Pressing a [Tone] button to change the Tone while this screen is displayed changes the Tone for the selected Part.

What's Panpot?

Panpot is the control that determines the placement of the sound in the stereo sound field between left and right speakers. By altering the Panpot setting, you can change the perceived location of the sound between the left and right speakers.



6. Touch   for the corresponding item to change the setting.

For <Panpot>, touch  to shift the sound you hear to the right, or touch  to shift it to the left.

7. Press the Play [] button to play back the song with the changed settings.

Check the tune whose settings you've changed.
Press the Stop [] button to stop playback of the song.

8. If necessary, change the settings for other Parts as well.

Press the Page [] and [] buttons to change the Parts

9. Hold down the Rec [] button and press the Reset [] button.

This operation makes it possible to save a song with changed settings for each Part to a floppy disk.

If you don't want to lose the song whose settings for individual Parts you've changed, you should save it on a floppy disk (page42).



The setting that determines whether an individual Part is played or not can't be saved to floppy disk.



Because commercially available Roland SMF music files are also made up of 16 Parts for sounding the notes of individual instruments, you can change the settings for the individual Parts and play them back in the same way.

● If the Following Message Appears

If you try to display another screen after you've changed the song's settings for each Part, a message like the one below may appear.

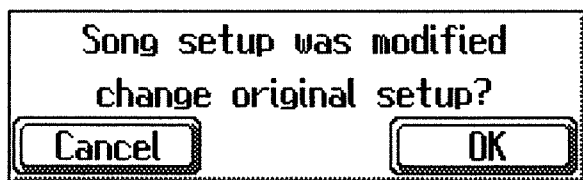

Touch <OK> to change the song's settings.
Touch <Cancel> to discard the changes in settings.

Creating a Rhythm Part with Ease

The KR-575 has a large number of built-in rhythm patterns. You can use these built-in rhythm patterns to create a rhythm part with ease. For more information about the kind of Rhythm Patterns, please refer to “Rhythm Pattern List”(page 157).



A rhythm pattern can only be recorded to Part D(10) (the [Rhythm] button).

- 1. Press the [Menu] button and confirm that its indicator has lighted.**
The Menu screen appears (page 81).
If <Rhythm Pattern> is not displayed, use the Page [◀] and [▶] buttons to switch screens.
- 2. Touch <Rhythm Pattern>.**
A screen like the one shown below appears.

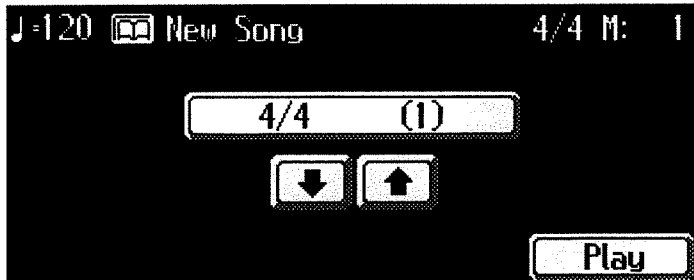
- 3. Touch [↓] [↑] to choose a rhythm pattern.**
Rhythm patterns are shown in the format “name (number of bars).”
- 4. Touch <Play> on screen to hear the rhythm pattern.**
Make sure the rhythm pattern you hear is the one you chose.
To stop the rhythm pattern, touch <Stop> on the screen.
- 5. Press the Rec [●] button and confirm that its indicator has lighted.**
The KR-575 enters recording standby.
Performance of the rhythm pattern stops when the rhythm pattern is playing.
If necessary, choose the Part D(10) or press the [Rhythm] button.
- 6. Press the Play [▶] button or touch <Play> on screen.**
The rhythm pattern begins to play, and at the same time, recording starts.
- 7. Press the Stop [■] button.**
The rhythm pattern stops and recording ends.
Touching <Stop> on the screen stops only the rhythm pattern, and recording continues.
Touch <Exit> to go back to the Menu screen.



You can also paste a rhythm pattern into a song without recording anything. Take a look at “Copying a Rhythm Pattern” (page 104).



For more information about onboard rhythm patterns, please refer to “Rhythm Pattern List”(page 157).

Recording a Song with an Upbeat

With the KR-575, you can record a song with an upbeat (Auftakt). A tune that starts on a beat other than the first beat of the measure is called an "Upbeat" or "Auftakt" song.

1. Press the [Song] button, and choose <0:New Song>.
2. Press the Rec [●] button and confirm that its indicator has lighted.
The KR-575 enters recording standby.
3. Press the Bwd [◀◀] button once.

The measure number at the top-right area of the screen changes to "PU" (pickup).

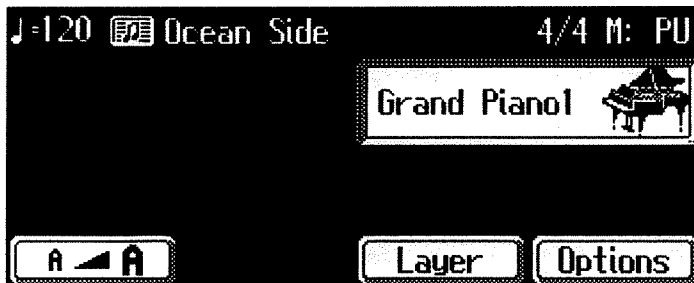

4. Press the Play [▶] button to start recording.

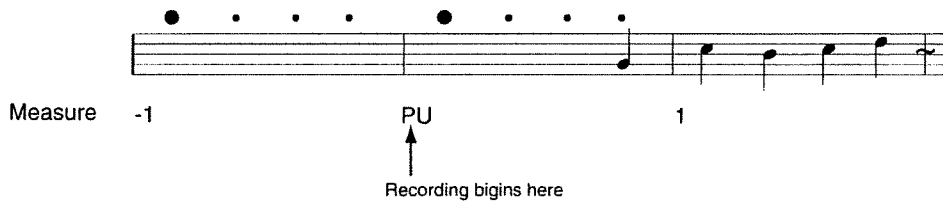

Composing a Tune That Changes Tempo Partway Through

You can add ritardandos and other tempo changes to a recorded composition. Composing a song with a tempo that changes is called "Tempo Recording."



You can't record a performance while you're in the Tempo Recording mode. When you're finished with tempo recording, go back to the ordinary recording method. See "Using the Ordinary Recording Method" (page 81).

■ Adjusting the Tempo While Listening to a Song

1. Press the [Menu] button and confirm that its indicator has lighted.

The Menu screen appears (page 81).

If <Recording Mode> is not displayed use the Page [◀] and [▶] buttons to switch screens.

2. Touch <Recording Mode>.

3. Touch the <Rec Mode>  , and choose <Tempo>.

This makes the setting for tempo recording.

Touch <Exit> twice to go back to the screen that was displayed before you press the [Menu] button.

4. Press the Bwd [◀◀] and Fwd [▶▶] buttons to move to a place a little earlier than the bar where you want to change the tempo.

The measure number appears in the top-right area of the Basic screen.

5. Press the Rec [●] button and confirm that its indicator is blinking.

The KR-575 enters recording standby.

6. Press the Play [▶] button to start recording.

7. When you get to the place where you want to change the tempo, use the Tempo [-] and [+] buttons or the dial to vary the tempo as desired.

8. Press the Stop [■] button to stop recording.

■ Adjusting the Tempo at a Particular Measure

You can move to a particular measure and change the song's tempo from the start of that bar. This is handy when you want to make a sudden change in tempo.

1. Make the setting for Tempo Recording.

The steps are the same as for "Adjusting the Tempo While Listening to a Song."

2. Use the Bwd [◀◀] and Fwd [▶▶] buttons to move to the bar where you want to change the tempo.

The measure number appears in the top-right area of the Basic screen.

3. Press the Rec [●] button and confirm that its indicator is blinking.

The KR-575 enters recording standby.

4. Use the Tempo [-] and [+] buttons or the dial to adjust the tempo.

5. Press the Rec [●] button.

The song's tempo changes starting with the measure where you moved to.

6. Press the Stop [■] button to end recording.



You can also enter the Tempo Recording mode by holding down the Tempo [-] or [+] button and pressing the Rec [●] button. In this case, tempo recording is canceled when recording ends.



If you want to restore the previous tempo, delete the tempo data at the place where the tempo was recorded. For an explanation of how to delete the information of tempo settings, refer to the "Making a Measure Blank" (page 107).

Composing a Tune That Changes the Beat Partway Through

You can create songs whose beat changes during the course of the tune.



You can't change a song's beat once it's been recorded. Before you record your performance, follow the steps below.

1. Press the [Menu] button and confirm that its indicator has lighted.

The Menu screen appears (page 81).

If <Beat Map> is not displayed, use the Page [◀] and [▶] buttons to switch screens.

2. Touch <Beat Map>.

A screen like the one shown below appears.



3. Use the Bwd [◀◀] and Fwd [▶▶] buttons to move to the bar where you want to change the beat.

The measure number appears in the top-right area of the screen.

4. Touch [↓] [↑] to choose the beat, and touch <Execute>.

The beat change starting with the measure where you moved to.

5. Touch <Exit> twice to go back to the screen that was displayed before you press the [Menu] button.

6. Press the Reset [◀] button to return the measure number to "1."

7. Record your performance.

Changing How Recording Stops

You can change how recording is stopped when recording a performance with Automatic Accompaniment.

- 1. Press the [Menu] button and confirm that its indicator has lighted.**

The Menu screen appears (page 81).

If <Recording Mode> is not displayed, use the Page [◀] and [▶] buttons to switch screens.

- 2. Touch <Recording Mode>.**

- 3. Touch the <Rec Stop>   to toggle <Arranger Stop> and <Composer Stop>.**

Display	Description
Arranger Stop	When Automatic Accompaniment stops, recording also stops at the same time.
Composer Stop	Recording doesn't end when Automatic Accompaniment stops. Press the Stop [■] button to stop recording.

Touch <Exit> twice to go back to the screen that was displayed before you press the [Menu] button.

Composing an Accompaniment Without Playing the Song

Before performing a song, you can enter its chord progression, the places where the accompaniment pattern changes, and so on to create an accompaniment for the song. This feature is called "Chord Sequencer."

With chord sequencer, you can create an accompaniment ahead of time and play along with this accompaniment using just your right hand. This makes it easy to enjoy automatic accompaniment.

Step 1 - Get ready to compose the accompaniment

1. Press the [Menu] button to make the button's indicator light up.

The Menu screen appears (page 81).

If <Chord Sequencer> doesn't appear on screen, use the Page [◀] and [▶] buttons to switch screens.

2. Touch <Chord Sequencer>.

A Chord Sequencer screen like the one shown below appears.

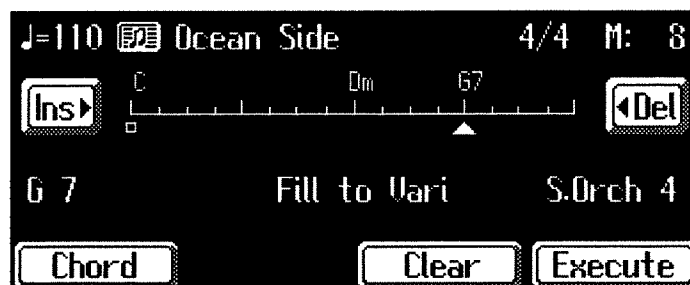

3. Use the Style buttons to choose a Music Style (page 58).

4. After choosing a style, touch <Exit>.

The KR-575 returns to the Chord Sequencer screen.

Step 2 - Compose the accompaniment

5. Use the dial to move the cursor to where you want to make an insertion.

Use the Bwd [◀◀] and Fwd [▶▶] buttons to move the cursor a bar at a time.

6. Enter the chord progression and the changes in the accompaniment pattern and arrangement.

Normally you should enter the information in the same way as for a performance using Automatic Accompaniment (see "Chapter 3 Automatic Accompaniment" page 58).



There are other entry methods, too. Take a look at "Entry Methods" (page 98).

7. Touching <Ins> once inserts a measure after the bar where the cursor is located. Conversely, touching deletes the measure containing the cursor and moves the cursor to the next bar.

Repeat the procedure from 5 to 7 to finish the accompaniment for the tune.

Step 3 – Making corrections

8. If you've made a mistake in an entry, move to the entry and touch <Clr>.

This deletes the entered setting.

Step 4 – Check the accompaniment

9. Press the Play [▶] button to play back the accompaniment.
10. Press the Stop [■] button to stop playback.

Step 5 – Register the accompaniment

11. When you're done making all the settings, check to make sure the settings are correct, then touch <Execute>.

The accompaniment you've composed is registered at "0:New Song."

Press the Play [▶] button and try fingering the melody while the accompaniment you've composed is played back.



The tune you've created disappears when you turn off the power. If you don't want to lose it, you should save it on a floppy disk. Take a look at "Saving Your Songs on Floppy Disk" (page 42).



If you assign the function to a Pad button or a pedal, you can insert a break in the middle of a song. Check out "Assigning Functions to Buttons and Pedals" (page 118).

■ Entry Methods

● Entering a Chord

You can enter a chord by fingering it on the left-hand section of the keyboard (page 66). You can also enter chords using the methods described below.

1. At the Chord Sequencer screen, touch <Chord>.

A screen like the one shown below appears.

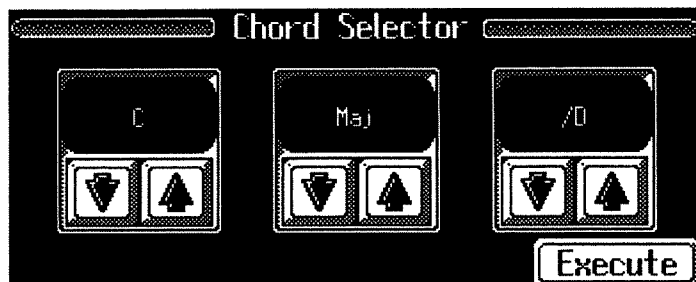

2. Touch the   to specify a chord.

3. Touch <Execute> to enter the chord.



To insert fractional chords such as Fm/C, assign the Leading Bass function to a Pad button or a pedal. Take a look at “Assigning Functions to Buttons and Pedals” (page 118).

● Changing the Accompaniment Pattern

1. Press one of the buttons described below to insert a Division.

Button	Division
[To Variation] button	Fill-in to Variation
[To Original] button	Fill-in to Original
Intro/Ending [1] and [2] buttons	Inserts an intro at the start of the song or and ending at the end of the song.



Pressing the [To Variation] button or the [To Original] button adds a fill-in at the cursor position and a Variation or Original Division at the measure after the fill-in. If you want to enter a Variation or Original Division without inserting a fill-in, you need to assign the function to a Pad button. Check out “Assigning Functions to Buttons and Pedals” (page 118).



You can only insert an intro at the beginning of a tune. When you add an intro, the number of bars corresponding to the length of the intro is inserted automatically.

● Changing the Arrangement of the Accompaniment

1. Press the [Style Orchestrator] button.

2. Press one of the Pad buttons.

The arrangement type appears in the bottom-right area of the screen. The smaller the number, the simpler is the arrangement.

Chapter 6 Editing Functions

Choosing an Editing Function

You can use a wide variety of methods to edit a performance you've recorded with the KR-575.

1. Press the [Menu] button and confirm that its indicator has lighted.

The Menu screen appears (page 81).

If <Song Edit> doesn't appear on the screen, use the Page [◀] and [▶] buttons to switch screens.

2. Touch <Song Edit>.

An Edit screen like the one shown below appears.



Use the Page [◀] and [▶] buttons to switch screens and display other editing functions.

Display	Description
Undo	Cancels an editing operating (page 101).
Copy	Copies a measure or onboard rhythm pattern (page 103, page 104).
Quantize	Evens out fluctuations in the sounds of a recorded performance (page 102).
Delete	Deletes a measure (page 105).
Insert	Adds a blank measure (page 106).
Erase	Makes a measure blank (page 107).
Transpose	Transposes a Part (page 108).
Part Exchange	Exchanges (swaps) the notes in two Parts (page 109).
Note Edit	Used to correct individual notes one at a time (page 110).
PC Edit	Used to correct changes in Tones during the course of a song (page 111).

"PC" is an abbreviation for Program Change, which is a command that means "Change the Tone." In a song that changes Tones partway through, a "PC" is inserted at the place where the Tone changes.

3. Use the Page [◀] and [▶] buttons to switch screens and choose an editing function.

After you make your choice, follow the steps on the page for the selected function to carry out the operation.



Some edits can't be undone, not even by choosing "Undo." We recommend saving your tune on a floppy disk before you edit it. For information on how to save your song, take a look at "Saving Your Songs on Floppy Disk" (page 42).

Canceling an Edit

You can cancel an editing operation that you've just carried out. This is handy when you want to undo an edit and restore it to the way it was before.



There are some edits that can't be restored to their previous state.

1. Follow the steps in "Choosing an Editing Function" (page 100) to choose <Undo>.

Editing functions that can be undone appear on screen.

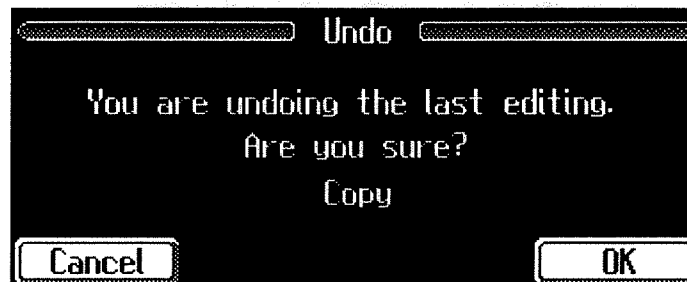

2. Touch <OK> to cancel the editing function shown on screen.

Touching <Cancel> takes you back to the Edit screen without the undo operation.

Correcting Timing Discrepancies

You can correct for timing discrepancies in a recorded performance by having the music be aligned with a timing you specify. This is called “Quantizing.”

As an example, let’s say that the timing of some quarter-notes in a performance is a little off. In this case, you can quantize the performance with quarter-note timing, thus making the timing accurate.

1. Follow the steps in “Choosing an Editing Function” (page 100) to choose <Quantize>.

A screen like the one shown below appears.

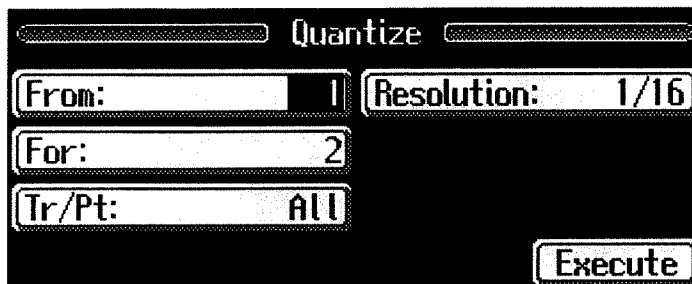

Display	Description
From	The first measure in the passage you want to quantize
For	The number of measures you want to quantize
Tr/Pt	Track button or Part number to quantize
Resolution	Timing of quantizing

- Choosing “All” for <Tr/Pt> quantizes the same passage in all Parts.

2. Touch the screen to choose the item you want to make the setting for.
3. Use the dial or touch <▲> and <▼> to make the setting for the item.

If you want to cancel quantizing, touch <Exit>. The setting is canceled and the KR-575 goes back to the Edit screen.

4. When you’re done making all the settings, touch <Execute>.

Quantizing starts.

When the quantization is finished, the KR-575 returns to the Edit screen.

Copying a Measure

You can copy a portion of a performance to a different bar in the same Part or to a measure in another Part. This is handy when you're composing a tune that repeats a similar phrase.

1. Follow the steps in "Choosing an Editing Function" (page 100) to choose <Copy>.

A screen like the one shown below appears.

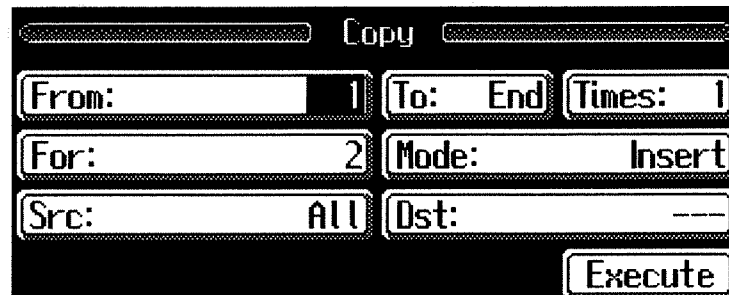

Display	Description
From	The first measure in the passage you want to copy
For	The number of measures to copy
Src	Track button or Part number of the copy source
To	The measure number of the copy destination
Times	The number of times to copy
Dst	Track button or Part number of the copy destination
Mode	Copy type

- Choosing "All" for <Src> copies all Parts. When you do this, <Dst> changes to "---".
- If you choose a Track button for <Src>, you can only copy to the selected Track button. At this time, <Dst> changes to "---".
- Choosing "R.Pattern" for <Src> copies the KR-575's built-in Rhythm Patterns. For more information, take a look at "Copying a Rhythm Pattern" (page 104).
- Choosing "End" for <To> copies to the end of the song.
- There are three types of copying, which are described below.

Display	Description
Replace	When a recorded performance exists at the copy destination, the previous recording is deleted and replaced with the copied passage.
Mix	When a recorded performance exists at the copy destination, the newly copied passage is mixed with the previous recording. When the Tones of the copy source and destination are different, the Tone of the destination is used.
Insert	When a recorded performance exists at the copy destination, the newly copied passage is inserted without deleting the previous recording. This makes the song longer by an amount equal to the number of inserted measures.

2. Touch the screen to choose the item you want to make the setting for.

3. Touch <▲> and <▼> or use the dial to make the setting for the item.

To cancel copying, touch <Exit>.

The setting is canceled and the KR-575 goes back to the Edit screen.

4. When you're done making all the settings, touch <Execute>.

Copying starts.

When copying is done, the KR-575 returns to the Edit screen.

Copying a Rhythm Pattern

The KR-575 has a large number of built-in rhythm patterns. You can copy these rhythm patterns to create a rhythm part. For more information about the kind of Rhythm Patterns, please refer to "Rhythm Pattern List"(page 157).



A rhythm pattern can only be copied to Part D(10) (the [R] button).

1. Follow the steps in "Choosing an Editing Function" (page 100) to choose <Copy>.

If you know more about ordinary copy, please refer to "Copying a Measure" (page 103).

2. Touch <Src>, and use the dial to choose "R.Pattern".

This makes the setting for copying a built-in Rhythm Pattern.

- The <From> column displays the Rhythm Pattern's name and number of bars.
- <Dst> is fixed at "Part D(10)", and can't be changed.
- Switching <Src> to something other than "R.Pattern" makes the setting for ordinary copying.

3. Touch the screen to choose the item you want to make the setting for.

4. Touch <▲> and <▼> or the dial to make the setting for the item.

5. Press the Play [▶] button to hear the rhythm pattern.

Press the Stop [■] button to stop playing the rhythm pattern.

If you want to cancel copying, touch <Exit>.

The setting is canceled and the KR-575 goes back to the Edit screen.

6. When you're done making all the settings, touch <Execute>.

Copying starts.

When the copy is completed, the KR-575 returns to the Edit screen.



You can also record the rhythm pattern. Take a look at "Creating a Rhythm Part with Ease" (page 91).

Deleting a Specific Measure

You can delete a part of a performance measure by measure. When a portion of a performance is deleted, the rest of the performance is shifted up to fill the gap.



Once a measure has been erased, it can't be restored.

1. Follow the steps in “Choosing an Editing Function” (page 100) to choose <Delete>.

A screen like the one shown below appears.

Display	Description
From	The first measure in the passage you want to delete
For	The number of measures to delete
Tr/Pt	Track button or Part number to delete

- Choosing “All” for <Tr/Pt> deletes the same passage in all Parts.

2. Touch the screen to choose the item you want to make the setting for.
3. Touch <▲> and <▼> or use the dial to make the setting for the item.
To cancel deletion of the measure, touch <Exit>.
The setting is canceled and the KR-575 goes back to the Edit screen.
4. When you're done making all the settings, touch <Execute>.

The deletion process starts.

When the deletion is finished, the KR-575 returns to the Edit screen.

Inserting a Blank Measure

You can add a blank measure at a location you specify.

1. Follow the steps in “Choosing an Editing Function” (page 100) to choose <Insert>.

A screen like the one shown below appears.

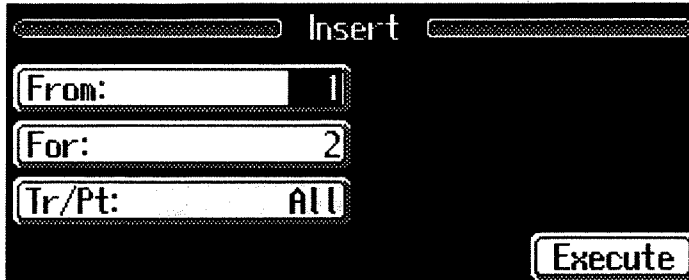

Display	Description
From	The first measure in the passage you want to insert
For	The number of measures to insert
Tr/Pt	Track button or Part number to insert

- Choosing “All” for <Tr/Pt> inserts a blank measure at the same place in all Parts.

2. Touch the screen to choose the item you want to make the setting for.
3. Touch <▲> and <▼> or use the dial to make the setting for the item.

To cancel insertion of a blank measure, touch <Exit>. The setting is canceled and the KR-575 goes back to the Edit screen.

4. When you’re done making all the settings, touch <Execute>.

Insertion of a blank measure starts. When insertion is finished, the KR-575 returns to the Edit screen.

Making a Measure Blank

You can delete data to blank out a passage you specify, without shortening the length of the song.

1. Follow the steps in “Choosing an Editing Function” (page 100) to choose <Erase>.

A screen like the one shown below appears.

The screenshot shows a screen titled "Erase". It contains four input fields: "From:" with the value "1", "Event:" with the value "All", "For:" with the value "2", and "Tr/Pt:" with the value "All". There is an "Execute" button at the bottom right.

Display	Description
From	The first measure in the passage you want to blank out
For	The number of measures to blank out
Tr/Pt	Track button or Part number to blank out
Event	Performance information to erase

- Choosing “All” for <Tr/Pt> blanks out the same place in all Parts.
- The information displayed for <Event> is as shown below.

Display	Description
All	Erases all performance information, such as the notes, tempo, program changes, and volume-level changes.
Tempo	Erases tempo information. By erasing the tempo information for all bars, you can change a song with tempo variations to one with a uniform tempo. In this case, please choose “All” for <Tr/Pt>.
Program change	Erases program change information (page 100).
Note	Erases only notes.
Except Note	Erases performance information for everything but notes.
Expression	Erases Expression (volume change) information.

2. Touch the screen to choose the item you want to make the setting for.

3. Touch <▲> and <▼> or the dial to make the setting for the item.

To cancel the erase operation, touch <Exit>.

The setting is canceled and the KR-575 goes back to the Edit screen.

4. When you’re done making all the settings, touch <Execute>.

The specified passage is blanked out.

When erasing is finished, the KR-575 returns to the Edit screen.

Transposing Individual Parts

You can transpose individual parts.

1. Follow the steps in “Choosing an Editing Function” (page 100) to choose <Transpose>.

A screen like the one shown below appears.

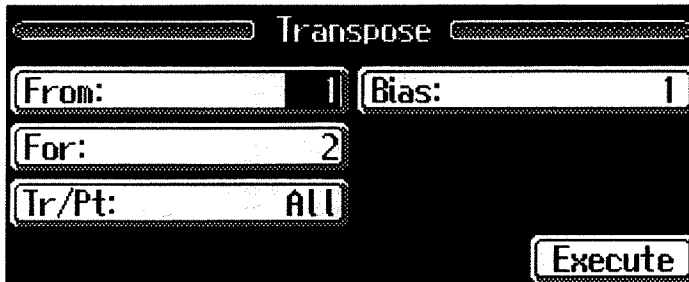

Display	Description
From	The first measure in the passage you want to transpose
For	The number of measures to transpose
Tr/Pt	Track button or Part number to transpose
Value	The amount of transposition

- Choosing “All” for <Tr/Pt> transposes the same passage in all Parts.
- For the range of transposition, you can choose a value from -24 (two octaves lower) to +24 (two octaves higher), in semitone increments.

2. Touch the screen to choose the item you want to make the setting for.

3. Touch <▲> and <▼> or the dial to make the setting for the item.

To cancel transposition, touch <Exit>.

The setting is canceled and the KR-575 goes back to the Edit screen.

4. When you’re done making all the settings, touch <Execute>.

The passage you specified is transposed at the specified value.

When transposition is finished, the KR-575 returns to the Edit screen.

Exchange Parts

You can exchange the notes recorded for a particular part with the notes recorded for another part.

1. Follow the steps in “Choosing an Editing Function” (page 100) to choose <Part Exchange>.

A screen like the one shown below appears.

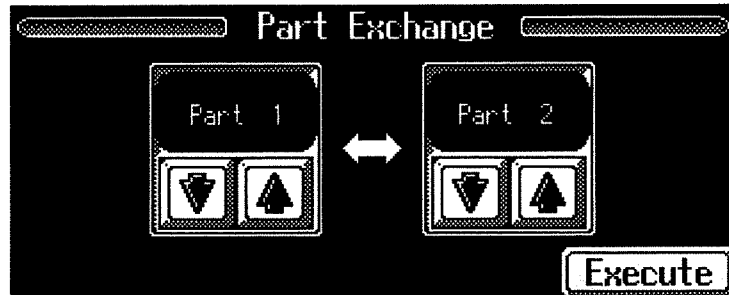

2. Touch each   to choose Parts you want to exchange.

If you want to cancel the Part exchange, touch <Exit>.

The setting is canceled and the KR-575 goes back to the Edit screen.

3. When you're done making all the settings, touch <Execute>.

When the part-exchanging process is finished, the KR-575 returns to the Edit screen.

Correcting Notes One by One

You can make corrections in a recorded performance one note at a time. This process of making changes in individual notes is called “Note Editing.”

- You can make the corrections described below.
 - Deleting misplayed notes
 - Changing the scale of a single note
 - Changing the key velocity of a single note

1. Follow the steps in “Choosing an Editing Function” (page 100) to choose <Note Edit>.

A screen like the one shown below appears.

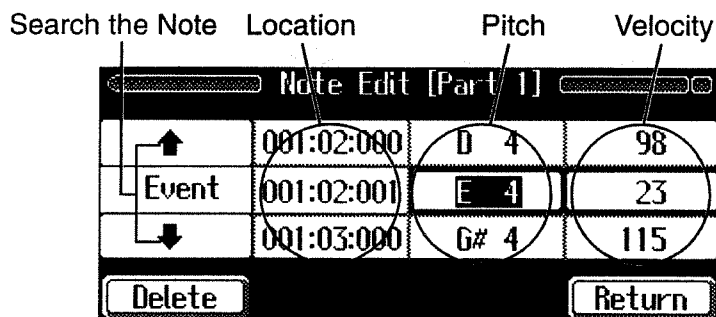

The note-location display uses “Measure:Beat:Tick” as the format. A tick is a unit of time that’s shorter than a beat.

2. Use the Page [◀] and [▶] buttons to choose the Part that contains the note you want to change.

The Part number appears at the top of the screen.

3. Use the Bwd [◀◀] and Fwd [▶▶] buttons or on the screen to find the note you want to correct.

Once you touch <Event>, then you can also search the note by the dial.

4. When you’ve found the note you want to correct, touch <Pitch> or <Velocity> for the note.

5. Use the dial to correct the pitch or velocity. If you want to delete the note, touch <Delete>.

6. When you’re done making all the settings, touch <Return>.

The KR-575 returns to the Edit screen.

Modifying the Tone Changes in a Song

In some songs, the instrument sound changes during the course of the tune (that is, the Tone changes in the middle of a Part). In such songs, an instruction to switch the Tone is inserted at the place where you want the sound to change.

This instruction is called a “Program Change” (PC), and actions such as deleting program changes, or changing the Tone that is selected by them are called “PC Editing.”

1. Follow the steps in “Choosing an Editing Function” (page 100) to choose <PC Edit>.

A screen like the one shown below appears.

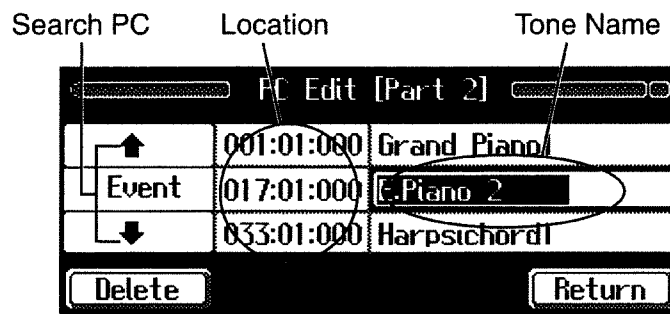

The PC-location display uses “Measure:Beat:Tick” as the format. A tick is a unit of time that’s shorter than a beat.

2. Press the Page [◀] and [▶] buttons to choose the Part that contains the note you want to change.

The Part number appears at the top of the screen.

3. Press the Bwd [◀◀] and Fwd [▶▶] buttons or touch [↓] [↑] on the screen to find the Program Change message you want to correct.

Once you touch <Event>, then you can also search the note by the dial.

4. When you’ve found the Program Change you want to modify, touch <Tone Name> on the screen.

5. If you want to delete the Program Change, touch <Delete>.

6. Press the Tone buttons, and rotate the dial to choose a Tone.

7. When you’re done making all the settings, touch <Return>.

The KR-575 returns to the Edit screen.

Changing a Song's Basic Tempo

You can change the basic tempo of a composition. The basic tempo is that was initially set when the song was recorded.

- 1. Press the Tempo [-] and [+] buttons to choose a tempo.**
- 2. Hold down the Rec [●] button and press the Reset [◀] button.**

The song's basic tempo changes. Save the song on a floppy disk.

The changed setting for the basic tempo is discarded when you turn off the power or choose a different song.



If the song you're working on has tempo changes in it, press the Reset [◀] button to go back to the beginning of the song before you carry out this operation. Changing the tempo without returning to the start of the song causes the proportion by which the tempo is altered at the location of the tempo change to affect the overall tempo of the composition.

Chapter 7 Other Functions

Adjusting the Volume of Each Performance Part

You can adjust the volume level of a Music Style's performance part (page 58).

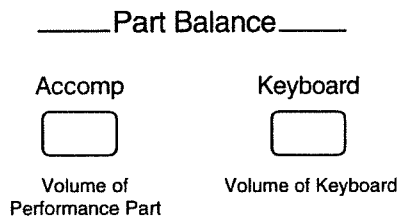

Adjusting the Volume of an Accompaniment

1. Press the [Accomp] button.
A screen like the one shown below appears.

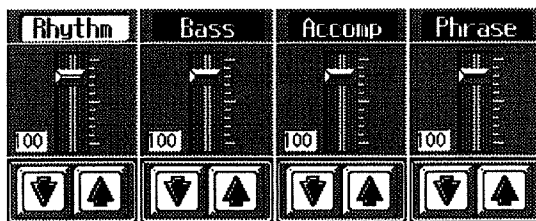

Display	Performance part
Rhythm	Rhythm
Bass	Bass, bass tone
Accomp	Accompaniment 1, Accompaniment 2, and Accompaniment 3
Phrase	A short phrase is played when a Pad button is pressed (page 65).

2. Touch to adjust the volume of the respective Parts.
Touch <Exit> to go back to the previous screen.

Adjusting the Volume of the Keyboard

You can change the volume level not only when you're playing with an automatic accompaniment, but also when you finger the keyboard in the ordinary manner.

1. Press the [Keyboard] button.
A screen like the one shown below appears.

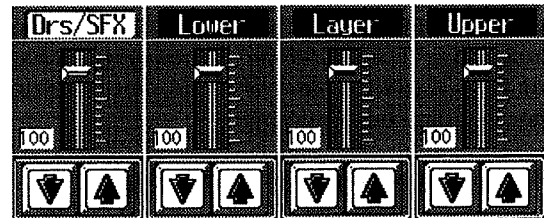

Display	Description
Drs/SFX	Volume of percussion instruments/effects played with the keyboard *1.
Lower	Volume level of the Tone displayed at the upper-left area of the Basic screen *2.
Layer	Volume level of the Tone displayed at the bottom-right area of the Basic screen*3.
Upper	Volume level of the Tone displayed at the upper-right area of the Basic screen

2. Touch to adjust the volume of the respective Parts.
Touch <Exit> to go back to the previous screen.

*1 See "Playing Drums from the Keyboard" (page 26)

*2 See "Playing Different Tones with the Left and Right Hands - Split Play" (page 56)

*3 See "Combining the Sounds of Two Instruments - Layer Play" (page 54)

Creating a Style from a Recorded Song

You can take a song you've composed yourself and extract the portions you need to create your own original Music Style. This function is called the "Style Converter." Also, a Music Style you've created yourself is called a "User Style."

The Style Converter has an "Auto Mode" for creating Music Style simply from a performance with a single chord, and a "Manual Mode" for creating a Music Style from a performance of three chords (major, minor, and diminished seventh).

■ Creating a Style in Auto Mode

1. Use the 16-track sequencer to record the song for making a Music Style (page 85).
 - Use major, minor, or diminished seventh chords to create the tune. We recommend using diminished seventh chords to compose the song.
 - When composing a song for use as a Music Style, it's a good idea to keep the intro, fill-ins and ending in mind when you record.
 - A Music Style is made up of five performance parts. The performance parts correspond to 16-track sequencer parts as shown below.

Rhythm	Part D(10)
Bass	Part 2
Accompaniment 1	Part 7
Accompaniment 2	Part 8
Accompaniment 3	Part 9

→ If you want to extract the performance of a part other than Part 2, 7, 8, 9, or D, check out "Changing an Extracted Part" (page 115).

2. Press the [Menu] button and confirm that its indicator has lighted.

The Menu screen appears (page 81).
If <Style Converter> is not displayed, use the Page [◀] and [▶] buttons to switch screens.
3. Touch <Style Converter>.

If a User Style has already been recorded, a message like the one shown below appears.

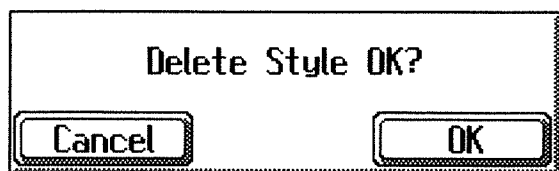

- Touch <Cancel> to display the Menu screen. Please save the User Style on a floppy disk or in the internal memory (page 117).
- Touch <OK> to erase the previous User Style and store the new one.

A screen like the one shown below appears.



Display	Description
Conv. Mode	Changes the Style Converter Mode (Auto/Manual)
Key	The basic key of the recorded performance
Src. Chord	The chord of the recorded performance
Division	Division
From	The first measure in the passage you want to extract
For	The number of measures to extract

Touch <Exit> to go back to the Menu screen.

4. Touch <Conv. Mode>, then use <▲> and <▼> or the dial to switch to "Auto."
This makes the setting for the Auto mode.
5. Touch <Key> and <Src. Chord>, then use <▲> and <▼> or the dial to enter the basic key and chord for the recorded song.
6. Touch <Division> and use <▲> and <▼> or the dial to choose a division.

A Music Style can be broken down into the segments shown below according to the state of play. These are called "Divisions."

Display	Performance division
Intro	Intro
Original	Original accompaniment pattern
Fill to Var	Fill-in to Variation
Variation	Variation accompaniment pattern
Fill to Org	Fill-in to Original
Ending	Ending

* If you select "Fill to Var" (Fill-in to Variation) or "Fill to Org" (Fill-in to Original) as the Division, you can only extract one measure. The number of measures may be limited for other Divisions as well.

7. Touch <From> and <For>, and use <▲> and <▼> or the dial to choose the measures you want to extract.

Touching <Play> at the bottom of the screen, you can listen to performance of the portion which you chose.

8. Repeat steps 6 and 7 to make the settings for all Divisions.

* If no setting is made for a Division, it uses a simple drum pattern.

9. When you're done making all the Division settings, touch <Execute>.

The new User Style is stored to the [Disk/User Style] button.

* If you turn off the power or record a new User Style, any User Style you've previously recorded is lost. If you don't want to lose it, you should save it on a floppy disk. Take a look at "Storing a User Style" (page 117).

* A Music Style contains the data described below. If a song includes data other than this, the results you get might not be what was intended.

- Keyboard performance information
- Amount of reverb
- Amount of chorus

■ Creating a Style in Manual Mode

When you create a Music Style in the Manual mode, you can clearly point up the differences in accompaniment for each individual chord.

1. Use the 16-track sequencer to record the song for making a Music Style .

* When creating a Music Style in the Manual mode, be sure to record your performance with the three chord types of diminished seventh, major, and minor.

It can be convenient to record the sounds shown below for each of the Parts of the 16-track sequencer.

Chords	Rhythm	Bass	Accomp1	Accomp2	Accomp3
Major	D(10)	3	4	5	6
Sevens	-	2	7	8	9
Minor-	-	12	13	14	15

→ The chords all share the same Rhythm Part.

→ If you want to use the performance of other part, check out "Changing an Extracted Part."

2. Press the [Menu] button and choose <Style Converter>.

3. Touch <Conv. Mode>, then use <▲> and <▼> or the dial to switch to "Manual."

This makes the setting for the Manual mode.

4. After that, the steps are the same as for "Creating a Style in Auto Mode."

→ You can listen to a performance of the part selected with <Options> by touching <Play> at the bottom of the screen.

■ Changing an Extracted Part

1. Press the [Menu] button and choose <Style Converter>.

2. Touch <Options> at the bottom of the screen.

A screen like the one shown below appears.



Display	Description
Rhythm	Rhythm part
Bass	Bass part
Accmp. 1	Accompaniment 1 part
Accmp. 2	Accompaniment 2 part
Accmp. 3	Accompaniment 3 part

3. Choose the part you want to change, and press <▲> and <▼> or the dial to determine which 16-track Sequencer part has the performance you want to extract.

* In the Manual Mode, the type of chords appear at the bottom of the screen. Set the Parts for all chords.

4. Touch <Return> to go back to the previous screen.

Combining Styles to Create a New Style

You can create a new User Style by selecting the Rhythm, Bass, Accompaniment 1, Accompaniment 2, and Accompaniment 3 parts from different styles. This function is called the "Style Composer".

* You can only combine the built-in styles.

1. Press the [Menu] button and confirm that its indicator has lighted.

The Menu screen appears (page 81).

If <Style Composer> is not displayed use the Page [◀] and [▶] buttons to switch screens.

2. Touch <Style Composer>.

* If a User Style has already been recorded, a message like the one shown below appears.

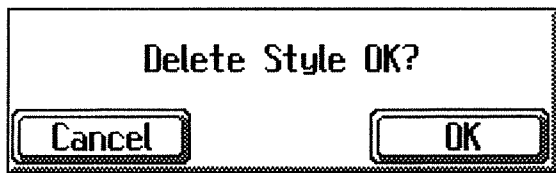

- Touch <Cancel> to display the Menu screen. Please save the User Style on a floppy disk or in the internal memory (page 117).

- Touch <OK> to erase the previous User Style and store the new one.

A screen like the one shown below appears.

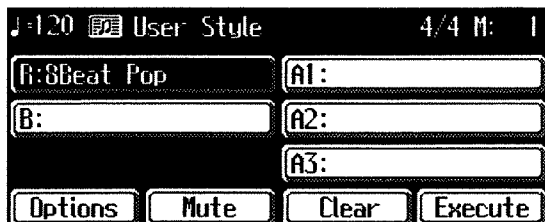

Display	Part
R	Rhythm
B	Bass
A1	Accompaniment 1
A2	Accompaniment 2
A3	Accompaniment 3

Touch <Exit> to go back to the Menu screen.

3. Touch the screen to choose the Part whose style you want to change.

The Part you choose appears in reverse video.

4. Press a Style Group button and touch the screen or use the dial to choose a style.

5. After you've chosen a style, touch <Exit> to display the Style Composer screen.

6. Repeat steps 3, 4, and 5 to determine the style for each Part.

→ You can silence the selected Part by touching <Clear>. You can also mute out the whole Division by touching <Mute>. For more information, take a look at "Muting the Parts for an Entire Division" (page 116).

→ You can adjust the volume level of the Tones for an individual Part by touching <Options>. For more information, take a look at "Changing the Style Settings for Individual Parts" (page 117).

7. When you're done creating the new User Style, touch <Execute>.

A new User Style is stored to the [Disk/User Style] button.

* If you turn off the power or record a new User Style, any User Style you've previously recorded is lost. If you don't want to lose it, you should save it on a floppy disk. Take a look at "Storing a User Style" (page 117).

■ Muting the Parts for an Entire Division

You can mute out a particular Part in each individual Division.

→ For more about Divisions, check out "Choosing a Music Style" (page 58).

1. Touch the screen to choose the Part you want to mute out.

2. Switch to the Division that you want to silence.

3. Touch <Mute>.

The Part you chose is muted out in just the Division you selected.

If you want to hear the muted-out Part, touch <Mute> again.

→ To mute out a Division that changes after a few seconds (intro, ending, or fill-in), touch <Mute> immediately after switching to the Division.

■ Changing the Style Setting for Individual Parts

1. At the Style Composer screen, touch <Options>. A screen like the one shown below appears.

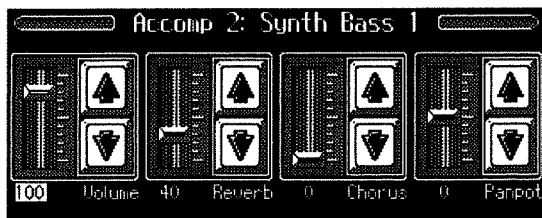

Display	Description
Volume	Adjusts the volume level.
Reverb	Adjusts the amount of reverb.
Chorus	Adjusts the amount of chorus.
Panpot	Adjusts the orientation of the sound.

2. Press the Page [◀] and [▶] buttons to choose the Part that contains the settings you want to change. The Part number appears at the very top of the screen.
3. Touch the corresponding [↓] [↑] to change the settings for each item. Pressing a [Tone] button to change the Tone for the selected Part.
4. When you're done changing the settings, touch <Exit>. The Style Composer screen appears.

Storing a User Style

You can save a User Style you've created yourself on a floppy disk or in the internal memory.

1. To save it on disk, insert a floppy disk in the disk drive (page 40).
2. Press the [Disk/User Style] button.
3. At the bottom of the screen, touch <Memorize> or <Save>. Touching <Memorize> stores a User Style in the internal memory. Touching <Save> stores a User Style on a floppy disk.

When you touch <Memorize>, the screen changes as shown below.

When you try to save on a floppy disk, <Save> is displayed instead of <Execute> at the bottom of the screen.

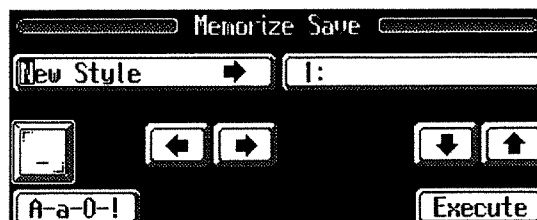

→ Alternatively, instead of carrying out steps 2 and 3, you can also display this screen by pressing the [Disk] button, then touching <Style Save>. The User Style is saved on the floppy disk at that time.

4. Touch [←] [→] to scroll the cursor sideways, and enter the name of the style by using <▲> and <▼> or the dial to choose the letters. Touch <A-a-0-!> at the bottom of the screen to change the type of script. Each touch of <A-a-0-!> cycles the type of characters through "English (upper case)," "English (lower case)," "numerals," "symbols," then back to "English (upper case)." To delete the character under the cursor, touch <_>.
5. After you've enter the style name, use [↓] [↑] to choose the destination for saving it.
 - * If you select a location where a User Style has already been saved, the previously saved User Style is erased and the new one is saved. If you don't want to erase a previously saved tune, choose a number where no song name appears in the destination column.

If you want to cancel saving the User Style, touch <Exit>.
6. Touch <Execute> or <Save> at the bottom right of the screen. The saving process starts.
 - * Attempting to save a User Style containing a lot of performance data in internal memory may cause another User Style to be erased.
 - * Never try to switch off the power while the unit is saving a User Style in its internal memory. Doing so may damage the internal memory, making it impossible to use this instrument.

Deleting a Song or User Style Saved on Floppy Disk

You can erase a song, User Style (page 117), or User Program (page 121) that's been saved on a floppy disk.

1. Insert the floppy disk into the disk drive (page 40).
2. Press the [Disk] button.
The Disk screen (page 41) appears.
3. Touch <Disk File Del>.
A screen like the one shown below appears.



4. Use or the dial to choose the song, user style or user program which you want to delete.
5. Touch <Execute> to display a message like the one shown below.

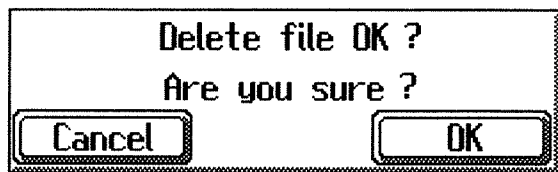

6. Touch <OK>.
The file selected is deleted.
Touching <Cancel> cancels deleting the file.

Assigning Functions to Buttons and Pedals

You can assign a variety of different functions to the Pad buttons, the soft pedal, or the sostenuto pedal. You can then call up the assigned feature simply by pressing the corresponding pedal or button.

Assigning a Function to a Pad Button

1. Press the [User] button and confirm that its indicator has lighted.
A screen like the one shown below appears.

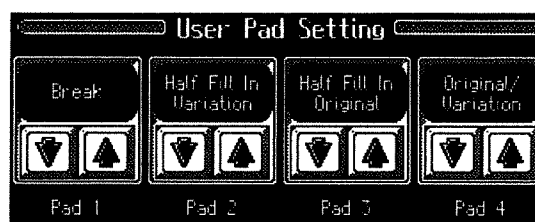

2. Touch to assign the function to the desired Pad button.

Touch <Exit> to go back to the previous screen.

Assignable Functions

Display	Description
Leading Bass	Toggles the Leading Bass function on or off.
Break	During a performance with automatic accompaniment, you can stop the accompaniment for exactly one measure.
Fill In to Variation	This does the same thing as the [To Variation] button (page 63).
Fill In to Original	This does the same thing as the [To Original] button (page 63).
Fill In	A fill-in is inserted, but the accompaniment pattern after that doesn't change.
Half Fill In Variation	This play a fill-in half a measure long, then switches to the Variation accompaniment pattern.
Half Fill In Original	This plays a fill-in half a measure long, then switches to the Original accompaniment pattern.
Original/Variation	This changes the accompaniment pattern without inserting a fill-in.

Orchestrator Up	This changes the automatic accompaniment to a more florid arrangement.
Orchestrator Down	This changes the automatic accompaniment to a simpler arrangement.
Intro 1/Ending 1	This does the same thing as the Intro/Ending [1] button (page 61).
Intro 2/Ending 2	This does the same thing as the Intro/Ending [2] button (page 61).
Arranger Reset	Using this function while Automatic Accompaniment is in use returns the accompaniment to the start of the Division.
Arranger Start/Stop	This does the same thing as the [Start/Stop] button (page 61).
Melody Intelligence	This toggles the Melody Intelligence function on and off (page 67).
Composer Play/Stop	This does the same thing as the Play [▶] button and the Stop [■] button.
Fade In/Out	This starts automatic accompaniment with a fade-in (where the volume gets progressively louder), ends it with a fade-out (where the volume gets progressively softer), then stops.
Rotary Slow/Fast	This switches the speed of the rotary effect (page 25).
Glide	The note's pitch momentarily drops, then gradually returns to its original pitch. This can be effective for simulating the performance of instruments like a Hawaiian guitar.
Punch In/Out	During Punch-in Recording, this starts and stops recording (page 84).
Tap Tempo	This sets the tempo according to the timing with which you tap the button (page 69).

- The function that sounds the lowest note of a fingered chord as the bass tone is called "Leading Bass." When set to "ON," the bass tone changes when an inverted chord is used. This is normal set to "OFF," and the tonic of the fingered chord is sounded as the bass tone.
- You can't use an assigned function here if the [Style Orchestrator] button or the [Phrase] button is lit up (see page 64,65).

* Turning off the power to the KR-575 cancels any assignments of functions to the Pad buttons.

■ Assigning a Function to a Pedal

1. Touch <Options> under the Organ screen (page 25) or the Basic screen (page 16).
2. Use the Page [◀] and [▶] buttons to switch screens and display the screen shown below.

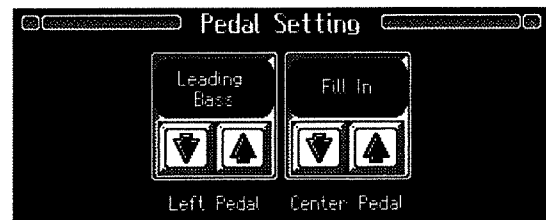

3. Touch [↓] [↑] to assign the function to the desired pedal.

Touch <Exit> to go back to the previous screen.

In addition to the functions you can assign to the Pad buttons, you can also assign the functions described below to the pedals.

● Functions Assignable Only to Pedals

Display	Description
Upper Soft	This makes the soft pedal function in the usual way.
Upper Sostenute	This makes the sostenuto pedal function in the usual way.
Lower Damper	This applies lingering reverberations to notes played with the left-hand section of the keyboard while the damper pedal is depressed.
Bend Up	This raises the pitch of notes you play on the keyboard.
Bend Down	This lowers the pitch of notes you play on the keyboard.

- If you've assigned "Leading Bass" to a pedal, the Leading Bass function is active while you depress the pedal.
- You can vary the maximum range of the pitch change when you've selected "Bend Up" or "Bend Down." Take a look at "Changing the Bend Range" (page 130).

● What's the Bend Range?

The effect of smoothly raising or lowering the pitch of a played note is known as the "Bender Effect," and the pitch's range of change is called the "Bend Range." With the KR-575, you can apply the bender effect by depressing and releasing a pedal.

* *Pressing the One Touch Program [Piano] button returns the pedals to their original functions.*

Shifting the Keyboard Pitch by One of More Octaves

When the keyboard has been set up so that the right-hand and left-hand parts play different sounds (page 56) or so that the sounds for two instruments are played in combination (page 54), you can vary the pitch of the notes you play by an octave at a time. This function is called "Octave Shift."

For instance, you can make the pitch of the keyboard's left-hand part match the pitch of the right-hand part.

* *You can't use this feature when set up so that the entire keyboard is played as a single instrument.*

- 1. Press the Tone button for the Tone you want to play to display the Tone Selection screen.**
- 2. Touch <Octave -> and <Octave +> to adjust the pitch of the sound.**
 - Each touch of <Octave +> raises the pitch one octave.
 - Each touch of <Octave -> lowers the pitch one octave.
 - You can vary the pitch within a range down two octaves or up two. The state of the pitch is displayed at the bottom of the screen.

→ *Take a look at "Playing Different Tones with the Left and Right Hands-Split Play" (page 56) and "Combining the Sounds of Two Instruments-Layer Play" (page 54).*

Storing Button Settings

You can store information such as your presently selected buttons and function settings, then call up these stored settings when you need them again. It can be convenient to store combinations of settings that you often use. Such a set of stored settings is called a "User Program."

1. Press the [User Program] button.

A screen like the one shown below appears.

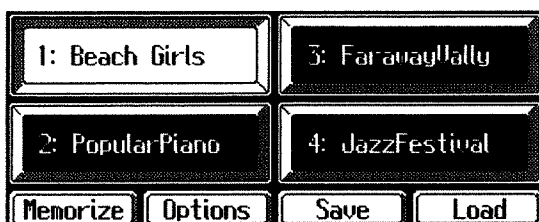

2. Touch <Memorize>.

The screen changes as shown below.

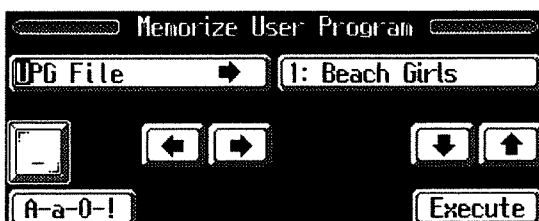

3. Touch to scroll the cursor sideways, and enter the name of the button by using <▲> and <▼> or the dial to choose the letters.

Touch <A-a-0-!> at the bottom of the screen to change the type of script.

Each touch of <A-a-0-!> cycles the type of characters through "English (upper case)," "English (lower case)," "numerals," "symbols," then back to "English (upper case)".

Touching <_> inserts a blank space at the cursor location.

4. After you've entered a name, touch to choose a destination for saving the button settings.

If you want to cancel storing, touch <Exit>.

5. Touch <Execute> to store the button settings in the KR-575.

→ You can restore a User Program to its factory default setting. See "Restoring Settings to Their Default Values" (page 135).

Calling Up Saved User Program

1. Press the [User Program] button.

2. Press the Page [◀] and [▶] buttons and the Touch Screen to select the User Program you want to call up.

* Ordinarily, the setting changes at the same time when you touch the Touch Screen, but you can make it so that the settings for automatic accompaniment don't change when you touch the Touch Screen after not having touched it for some time. If you want to know more, take a look at "Changing How Button Settings Are Called Up" (page 129).

Saving User Programs on Floppy Disk

User Programs stored in memory in the KR-575 can be saved on floppy disk as a single set.

1. Insert a floppy disk in the disk drive (page 40).

2. Press the [User Program] button.

3. Touch <Save> at the bottom of the screen.

A screen like the one shown below appears.

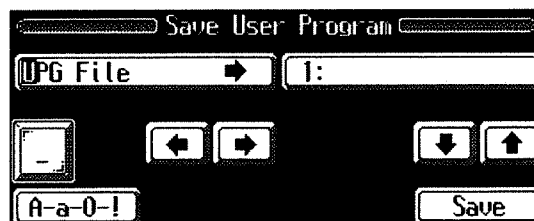

4. Touch to scroll the cursor sideways, and enter the name of the User Program by using <▲> and <▼> or the dial to choose the letters.

Touch <A-a-0-!> at the bottom of the screen to change the type of script.

Each touch of <A-a-0-!> cycles the type of characters through "English (upper case)," "English (lower case)," "numerals," "symbols," then back to "English (upper case)".

Touching <_> inserts a blank space at the cursor location.

5. After you've entered a name, touch to choose a destination for saving the User Program.

* If you save a User Program at a place where another User Program has already been saved, the previously saved User Program is erased and the new one is saved. If you don't want to erase the previously saved User Program, save the new one at a location that has no name.

If you want to cancel storing, touch <Exit>.

Other Functions

6. Touch <Execute> to start saving.

→ You can erase a User Program saved on a floppy disk. Take a look at "Erasing a Saved Song or User Style Saved on Floppy Disk" (page 118).

■ Calling Up User Programs from Floppy Disk

1. Insert a floppy disk in the disk drive (page 40).
2. Press the [User Program] button.
3. Touch <Load> at the bottom of the screen.
A screen like the one shown below appears.

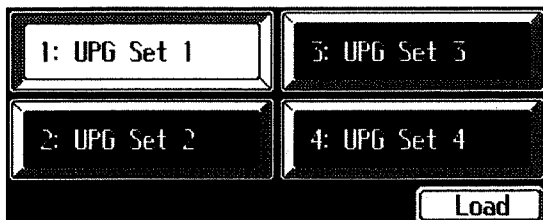

Touch <Exit> to go back the previous screen.

4. Touch the screen to select the User Program set you want to call up.
 5. Touch <Load> at the bottom of the screen.
- * Calling up a User Program from a floppy disk erases all User Programs stored in memory.

Disabling All Buttons

You can disable all of the buttons. This feature is called the "Panel Lock."

This can keep children or others from altering the settings by mistake by accidentally pressing the buttons.

* When the panel is locked, only Grand Piano 1 sounds are played.

1. Lower the volume all the way, then turn off the power.
2. While holding down the [Function] button, switch on the power.
This disables all buttons.
Playing the keyboard now produces a Grand Piano 1 sound.

Switching the power off and back on again cancels the panel lock and returns the KR-575 to its usual state.

→ "Switching the Power On and Off" (page 19)

Chapter 8 Changing Various Settings

Changing the Settings for One-touch Piano

At the Piano screen (page 24), touch <Customize> to display the screen shown below.

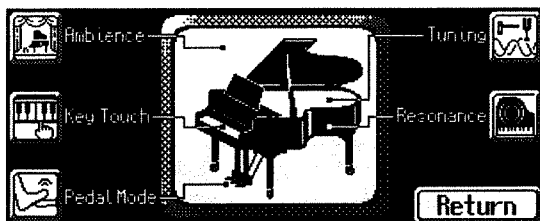

This is called the Piano Customize screen.

Display	Description
	This lets you enjoy the atmosphere of performance in a wide variety of different locations.
	This adjusts the keyboard's touch.
	This adjusts the sensitivity of the pedals.
	This changes the tuning of the piano.
	This adjusts the sympathetic resonance.

●What's sympathetic resonance?

When you depress the damper pedal on an acoustic piano, the sound from the strings that were struck resonates with other strings, adding rich reverberations and broadness to the sound.

This resonance is called "Sympathetic Resonance."

You can make the settings for an item by touching the corresponding icon.

Touch <Return> to go back to the Piano screen.

■ Enjoying the Ambience of a Wide Variety of Performance Sites

You can savor the same atmosphere as performing in a concert hall, a studio, or venues.

1. At the Piano Customize screen, touch . A screen like the one shown below appears.



Display	Description
	On a large open ground
	In a small room
	A large room
	A recording studio
	In a gymnasium
	Concert hall
	A dome ballpark
	In a cavern

2. Touch to choose the type of performance space.
3. Touch <Wide> to add a further sense of expansion to the performance space you've chosen.



Touch <Std> to return it to its original value.

Touch <Return> to go back to the Piano Customize screen.

Changing Various Settings



■ Changing the Keyboard's Touch

You can vary the touch of the keyboard when you finger the keys.

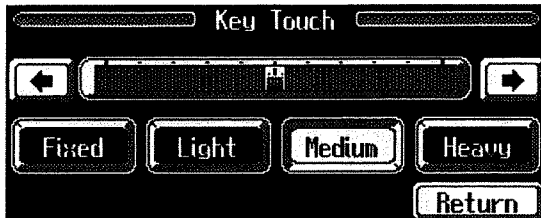
1. At the Piano Customize screen, touch .
A screen like the one shown below appears.



Display	Description
Fixed	Notes are sounded at an unchanging volume level, regardless of how lightly or forcefully you finger the keyboard.
Light	This sets the keyboard to a light touch.
Medium	This sets the keyboard to the standard touch.
Heavy	This sets the keyboard to a heavy touch.

2. Touch <Fixed>, <Light>, <Medium>, or <Heavy> to make the setting for keyboard touch.
 3. To make fine adjustments, touch  .
- The on-screen bar graph shows the keyboard touch.

Touch <Return> to go back to the Piano Customize screen.

■ Adjusting the Sensitivity of the Pedals

This adjusts the sensitivity of the damper pedal and the soft pedal.

Using fewer stages can reduce the amount of data, which is effective at times such as when you record a lengthy song.

1. At the Piano Customize screen, touch .
A screen like the one shown below appears.

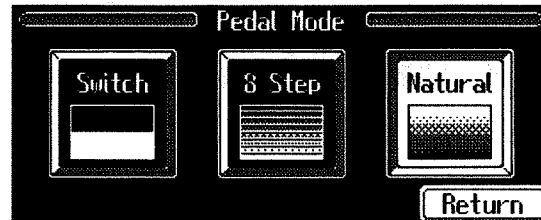

Display	Description
Switch	The KR-575 recognizes two stages of pedal depression (on and off).
8 Step	The KR-575 recognizes eight stages of pedal depression.
Natural	The KR-575 recognizes subtle changes in the amount of pedal depression.

2. Touch <Switch>, <8Step>, or <Natural> to choose the setting you want.
Touch <Return> to go back to the Piano Customize screen.

■ **Adjusting the Tuning**

● **Choosing the Tuning**

You can play classical music such as baroque pieces using their original tuning.

Most modern songs are composed and played with the assumption that equal temperament (the most common tuning in use today) will be used, but when classical music was composed there were a wide variety of other tuning systems (scales) in existence. Playing a composition with its original tuning lets you enjoy the sonorities of the chords that the composer originally intended.

1. At the Piano Customize screen, touch .

One of the screens shown below appears.

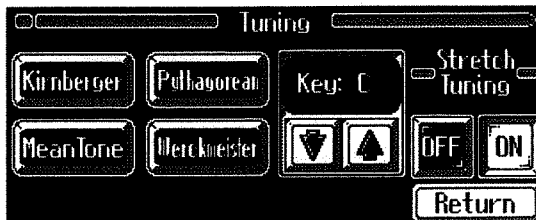
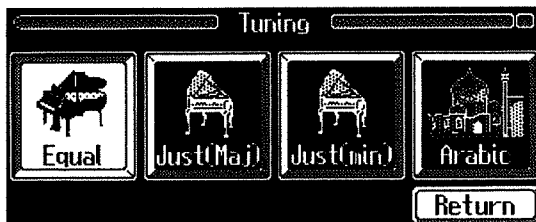

2. Use the Page [◀] and [▶] buttons and the Touch Screen to select the tuning system.

You can choose from among the eight tunings described below.

Tuning system	Characteristics
Equal (equal temperament)	This tuning divides an octave into 12 equal parts. Every interval produces about the same amount of slight impurity. This setting is in effect when you turn on the power.
Pythagorean (Pythagorean scale)	This scale devised by the philosopher Pythagoras eliminates dissonance in fourths and fifths. Dissonance is produced by third-interval chords, but melodies are euphonious.
Just Major (just intonation—major)	This scale eliminates dissonance in fifths and thirds. It is unsuited to playing melodies and cannot be transposed, but produces beautiful chords.

Just Minor (just intonation—minor)

The scales of the major and minor just intonations are different. You can get the same effect with the minor scale as with the major scale.

Mean Tone

This scale makes some compromises in just intonation, enabling transposition to other keys.



Werckmeister

This is a combination of the mean tone and Pythagorean scales. Performances are possible in all keys (first technique, III).

Kirnberger

This scale is a modification of the meantone and just intonations that permits greater freedom in transposition to other keys. Performances are possible in all keys (III).

Arabic Arabic scale

3. Touch   to choose the keynote.

When playing with tuning other than equal temperament, you need to specify the ground note for tuning the song to be performed (that is, the note that corresponds to C for a major key or to A for a minor key).

If you choose an equal temperament, there's no need to select a key note.

● **Changing the Tuning Curve**

A piano is generally tuned to a pitch with a lower bass range and a higher treble range than equal temperament. This special tuning method for pianos is called "Stretch Tuning."

A graph that shows the changes in pitch of actual tuning compared with the changes in equal temperament pitch is called a tuning curve. Changing the tuning curve produces subtle variations in the reverberations of the chords you play.

1. Touch the <ON> or <OFF> of <Stretch Tuning>.

Display	Characteristics
ON	This tuning curve expands the bass and treble ends somewhat. It's suited to performances such as piano solos. This setting is in effect when you turn on the power.
OFF	This is the standard tuning curve. It's suited to Layer Play and ensemble performances with other instruments.



Touch <Return> to go back to the Piano Customize screen.

■ **Adjusting Resonant Sounds**

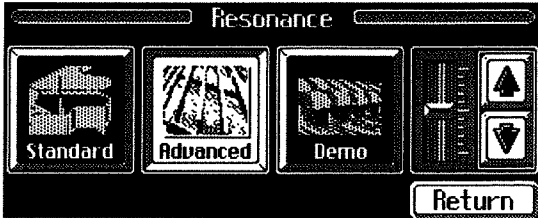
1. At the Piano Customize screen, touch . A screen like the one shown below appears.



Display	Description
Standard	This replicates the resonance inside a piano.
Advanced	This physically reproduces the vibrations imparted to other free strings when a key is played, so it can give you the same feel as the reverberations of an acoustic piano.
Demo	In addition to the effects of Advanced, this also replicates the noise when you depress the pedal.

2. Touch <Standard>, <Advanced>, or <Demo> to choose the type of resonant sound.
3. Touch   on the right side of the screen to adjust the amount of Resonance Sound.

Touch <Return> to go back to the Piano Customize screen.

* If you use the Voice Transformer (page 50) or the Harmonist (page 51), the resonant sound may sometimes be reset to its original value.

→ When you've chosen <Demo>, touching <Return> changes the setting for resonant notes to <Advanced>.

Changing the Settings for One-touch Organ

■ **Adjusting the Footage**

When you've selected Jazz Organ, you can adjust the footage.

● **What's Footage?**

A device for combining different frequencies to create the sound you want is called "Footage."

The on-screen values originally signified the lengths of the pipes on a pipe organ. Reducing the pipe length by half produces a note an octave higher, and doubling the length produces a sound an octave lower. This means that with <8> as the basic value, <16> produces a note one octave lower, and <2> produces a note two octaves higher.

1. At the Organ screen (page 25), touch <Footage> at the bottom left of the screen.

A screen like the one shown below appears.

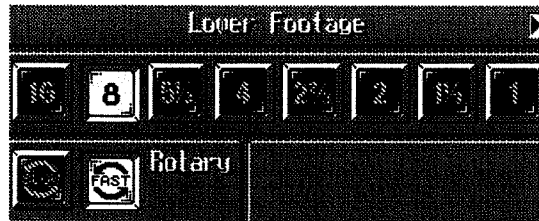

At this screen, you can change the Tone of the left-hand section of the keyboard.

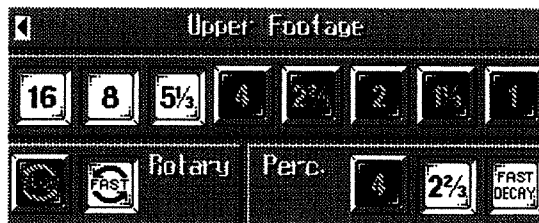

At this screen, you can change the Tone of the right-hand section of the keyboard.



You can use the page[< | >] buttons to switch these two screens.

2. Try experimenting by touching different icons to change the Tone for the left-hand section of the keyboard, and find one you like.

The frequency components of icons that look  are played.

* When all the icons look like  (in other words, when set so that no frequency components are played), no sound is heard when you finger the keyboard.

3. You can also use the icons in the <Perc.> column to add accents to the onset of the note.

You can use Perc.  or Perc.  to change the Tone at the time of its onset.

You can't set both to "On" at the same time.

 makes the accent time shorter.

Touch <Exit> to go back to the Organ screen.



→ For more about Rotary, take a look at "Changing the Rotary Effect" (page 25).

■ Changing the Keyboard's Split Point

When you've selected Jazz Organ, the right- and left-hand sections of the keyboard play different Tones. You can change the location where the keyboard is divided (the split point).

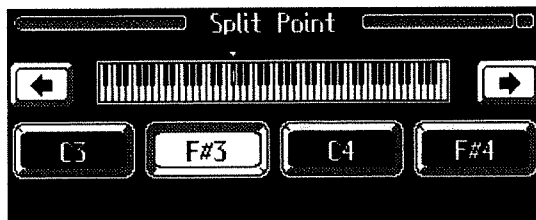
1. At the Organ screen, touch <Options> at the bottom right of the screen.
2. Use the Page [◀] and [▶] buttons to switch screens and display a screen like the one shown below.





3. Touch <C3>, <F#3>, <C4> or <F#4>. The key you chose becomes the split point. The setting is at "F#3" when the KR-575 is powered up.
→ The key you chose for the split point belongs to the left-hand section of the keyboard.
4. To make another key the split point, touch   to move the cursor on screen. You can set the split point within a range of B1 to B6. Touch <Exit> to go back to the Organ screen.

■ Using Automatic Accompaniment During an Organ Performance

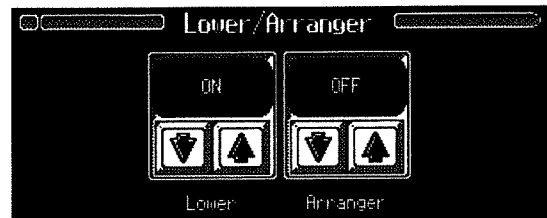

1. At the Organ screen, touch <Options> at the bottom right of the screen.
2. Use the Page [◀] and [▶] buttons to switch screens and display a screen like the one shown below.



3. Touch the <Arranger>   to toggle the setting to "ON" or "OFF."
 - When set to "ON," you can use automatic accompaniment.
 - When set to "OFF," you hear only the rhythm pattern, even if you press the [Start/Stop] button. Touch <Exit> to go back to the Organ screen.
- * If you've selected something other than Jazz Organ, you can't use Chord Intelligence (page 66).

■ Changing How the Left-hand Keyboard Section Plays

You can change how the left-hand section of the keyboard sounds when you've used the automatic accompaniment.

1. At the Organ screen, touch <Options> at the bottom right of the screen.
 2. Use the Page [◀] and [▶] buttons to switch screens and display the same screen as for "Using Automatic Accompaniment During an Organ Performance."
 3. Touch the <Lower>   to toggle the setting to "ON" or "OFF."
 - When set to "ON," you hear the Organ sound.
 - When set to "OFF," you hear no sound.
- * You hear the chord tone and the bass tone, when the automatic accompaniment is not being played. Touch <Exit> to go back to the Organ screen.

Changing the Settings for Automatic Accompaniment

■ Keeping the Same Tone and Tempo When the Style Changes

When you turn on the power and choose another Style, the tempo and tone that you play with the right-hand section of the keyboard are selected automatically to match the Music Style. You can make this setting so that only the tempo changes, or so that only the Tone of the right-hand part changes.

1. At the Basic screen, touch <Options> at the bottom right of the screen.
2. Use the Page [◀] and [▶] buttons to switch screens and display a screen like the one shown below.

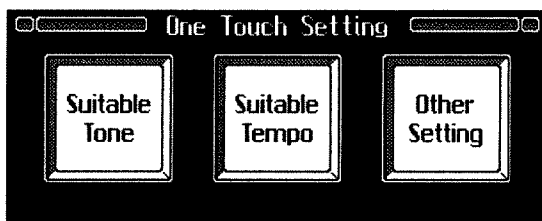

Display	Description
Suitable Tone	The suitable tone for a Music Style will be selected automatically.
Suitable Tempo	The suitable tempo for a Music Style will be selected automatically.
Other setting	The other settings will be suited for a Music Style.

All items are selected when you turn on the power.

3. Touch the icon to change the setting.
Touch <Exit> to go back to the Basic screen.

■ Changing How the Automatic Accompaniment Plays

You can make the setting so that instead of sounding all the parts of a Music Style, only the Music Style's rhythm part, chord tone, and bass tone are played.

1. At the Basic screen, touch <Options> at the bottom right of the screen.
2. Use the Page [◀] and [▶] buttons to switch screens and display a screen like the one shown below.



3. Touch the <Accomp> [↓] [↑] to switch between "Accomp" and "Chord&Bs."

Choosing <Accomp> sounds the Music Style. This is the usual setting.

Choosing <Chord&Bs> sounds the Music Style's rhythm part, chord tone, and bass tone.

Touch <Exit> to go back to the Basic screen.

■ Changing the Chord Tone and Bass Tone

● What Are the Chord Tone and Bass Tone?

When automatic accompaniment is stopped and the [Sync] button light is dark, fingering the left-hand section of the keyboard causes a chord to be sounded. This is called the "Chord Tone," and the root of the chord that is played at the same time is called the "Bass Tone."

1. At the Basic screen, touch <Options> at the bottom right of the screen.
2. Use the Page [◀] and [▶] buttons to switch screens and display the same screen as for "Changing How the Automatic Accompaniment Plays."

3. Touch [↓] [↑] of <Bass Tone> to choose the Bass Tone, and touch [↓] [↑] of <Chord Tone> to choose the Chord Tone

Touch <Exit> to go back to the Basic screen.

■ Canceling Chord Intelligence

1. Use the Page [◀] and [▶] buttons to switch screens and display the same screen as for "Changing How the Automatic Accompaniment Plays."

2. Touch the <Chord Intell.> [↓] [↑] to toggle the setting to "ON" or "OFF."

- When set to "ON," you can use Chord Intelligence.
- When set to "OFF," you can't use Chord Intelligence, so you have to finger the all keys for a chord.

Touch <Exit> to go back to the Basic screen.

Changing the Keyboard's Split Point

You can change the location where the keyboard is divided (the split point).

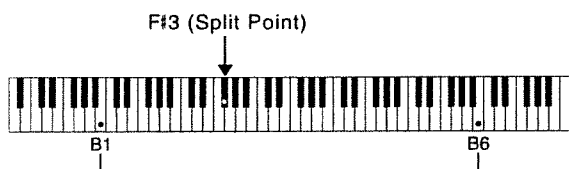

1. At the Basic screen, touch <Options> at the bottom right of the screen.
2. Use the Page [◀] and [▶] buttons to switch screens and display the screen shown below.

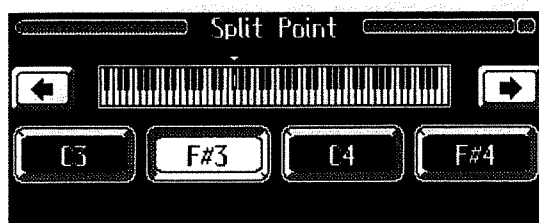

3. Touch either <C3>, <F#3>, <C4>, or <F#4>. The key you chose becomes the split point. The setting is at "F#3" when the KR-575 is powered up.
→ The key you chose for the split point belongs to the left-hand section of the keyboard.
4. To make another key the split point, touch ◀ ▶ to move the cursor on screen. You can set the split point within a range of B1 to B6. Touch <Exit> to go back to the Basic screen.
→ Refer to "Playing Different Tones with the Left and Right Hands" (page 56).

Changing How Button Settings Are Called Up

When calling up the User Program (page 121), you can make it so that the settings related to automatic accompaniment aren't switched unless you touch and hold the Touch Screen for a certain interval.

1. Press the [User Program] button.
2. Touch <Options> at the bottom right of the screen. A screen like the one shown below appear.



3. Touch ◻ ◻ to toggle between <Instant> and <Delayed>.

Display	Description
Instant	The settings related to automatic accompaniment are also switched right away when you touch the Touch Screen.
Delayed	To change the settings related to automatic accompaniment touch and hold the Touch Screen for a short while.

Touch <Exit> to go back to the previous screen.

Changing the Bend Range

The effect of smoothly raising or lowering the pitch of a played note is called the “Bender Effect.”

With the KR-575, you can assign the bender function to a pedal, then apply the bender effect by depressing and releasing the pedal (page 120).

You can also make the setting for how much the pitch of the note changes when you apply the bender. The maximum range of change in pitch is called the “Bend Range.”

1. Press the [Function] button to make the button's indicator light up.
2. Use the Page [◀] and [▶] buttons to switch screens and display the screen shown below.

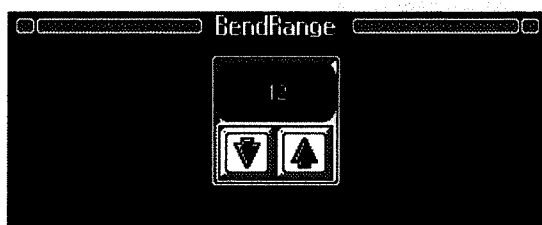

3. Touch the to set the bend range. You can set this to any value within a range of 1 to 12 (in half-tone steps, up to one octave).

Touch <Exit> to go back to the previous screen.

→ Take a look at “Assigning Functions to Buttons and Pedals” (page 118).

Changing the Number of Measures Counted and the Count Sound

When you’ve made the setting for sounding an audible count (page 70), you can change the number of measures that are counted, as well as the type of counting sound.

1. Press the [Marker/Count In] button. The Marker screen appears (page 70).
2. Touch <Options>. A Marker Option screen like the one shown below appears.

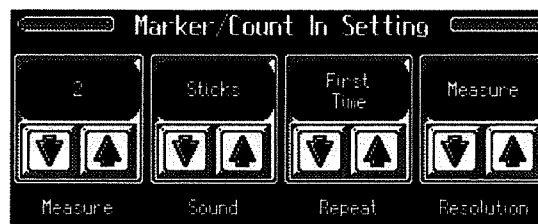

3. Use the <Measure> and <Sound> to choose the number of measures to count and the count sound.

You can set the number of measures to count to either one or two measures.

Types of Count Sounds



Display	Description
Sticks	Sound of tapping with a stick
Click	A bell and a clicking sound
Electronic	Electronic sound
Voice(JP)	A voice counting “1, 2” in Japanese
Voice(ENG)	A voice counting “1, 2” in English
Wood Block	Wood Block
Triangle/Castanet	Triangle and castanet sound
Handclap	Clapping
Animal	Animal Voice

Touch <Exit> to go back to the Marker screen.

→ Take a look at “Counting Down Before a Performance Starts” (page 70).

Playing the Count Sound at Each Repetition

You can choose whether the count is sounded at every repetition when you repeat playback of a song or a particular passage.

1. Press the [Marker/Count In] button.
The Marker screen appears (page 70).
2. Touch <Options>.
The Marker Option screen (page 130) appears.
3. Touch the <Repeat>   to choose either <First Time> or <Every Time>.



Display	Description
First Time	The count is sounded only before the first playback.
Every Time	Playing the Count Sound at Each Repetition

Touch <Exit> to go back to the Marker screen.

→ Take a look at “Counting Down Before a Performance Starts” (page 70).

Placing a Marker in the Middle of a Measure

A marker is normally placed at the start of the selected measure, but you can make the setting so that a marker is placed at a position partway through a measure.

1. Press the [Marker] button.
The Marker Screen (page 72) appears.
2. Touch <Options>.
The Marker Option screen (page 130) appears.
3. Touch the <Resolution>   to change the display from <Measure> to <Beat>.
Touch <Exit> to go back to the Marker screen.
The unit for applying markers changes from “measure” to “beat.”
4. Play back the song, and place the markers during playback.



→ Take a look at “Placing Markers” (page 72).

Changing the Standard Pitch—Master Tuning

The standard pitch generally refers to the pitch of the note that’s played when you finger the middle A key. If you’re performing in an ensemble with other instruments, what you play together won’t sound good if the standard pitches of the instruments aren’t in tune with each other. The process of putting the standard pitches in tune with each other is called “Master Tuning.”

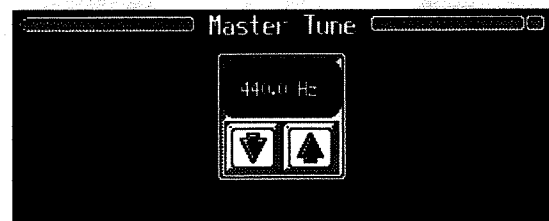
1. Press the [Function] button and confirm that its indicator has lighted.
2. Use the Page [<] and [>] buttons to switch screens and display the screen shown below.



3. Touch   to change the standard pitch.
The setting is at “440.0 Hz” when the KR-575 is powered up.
Press the [Function] button again to make the button’s indicator go dark and go back to the previous screen.

Changing the Type of Reverb Effect

By changing the reverberations of the notes, you can enjoy the atmosphere of performance in a wide variety of different locations.

1. Press the [Function] button and confirm that its indicator has lighted.
2. Use the Page [◀] and [▶] buttons to switch screens and display the screen shown below.

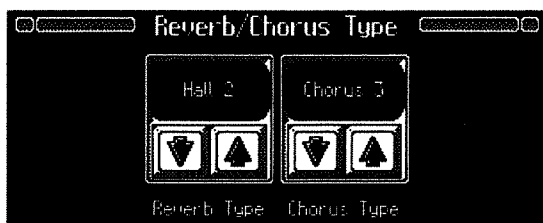

3. Touch the <Reverb Type> [↓] [↑] to change the type of reverb.

Display	Type	Description
Room 1		Simulates the reverb of a conference room
Room 2		Simulates the reverb of a performance lounge
Room 3		Simulates the reverb of a large, open room
Hall 1		Simulates the reverb of a large concert hall
Hall 2		Simulates the reverb of a small concert hall
Plate		Applies a bright, metallic reverb
Delay		Repeats the sound many times, like an echo
Panning Delay		Makes the sound jump back and forth between the left and right speakers

Press the [Function] button again to make the button's indicator go dark and go back to the previous screen.

* Changing the type of Reverb effect may also change the setting for "Enjoying the Ambience of a Wide Variety of Performance Sites" (page 123).

→ Refer to "Adding an Echo to a Sound" (page 53).

Changing the Type of Chorus Effect

You can change the type of chorus that's applied when you press the [Effects] button and apply the Chorus effect (see page 53 and page 160).

1. Press the [Function] button and confirm that its indicator has lighted.
2. Use the Page [◀] and [▶] buttons to switch screens and display the same screen as for "Changing the Type of Reverb Effect."
3. Touch the <Chorus Type> [↓] [↑] to change the type of chorus effect.

Display	Type	Description
Chorus 1		Applies a light chorus effect with slow undulations
Chorus 2		Applies a light chorus effect with quick undulations
Chorus 3		Applies a deep chorus effect with slow undulations
Chorus 4		Applies a deep chorus effect with quick undulations
Flanger		An effect that sounds like a jet plane's ascent/descent
Feedback Chorus		A soft sound with a flanger effect
Short Delay		A short echo effect
Short Delay(Feedback)		A short echo with many repetitions

Press the [Function] button again to make the button's indicator go dark and go back to the previous screen.

Changing the Screen Settings

Some karaoke music files show lyrics on screen. You can hide the on-screen lyrics displayed by such music files. With the KR-575, you can also change the language for the Help function (page 20) and vary the contrast of the screen.

1. Press the [Function] button and confirm that its indicator has lighted.
2. Use the Page [◀] and [▶] buttons to switch screens and display the screen shown below.

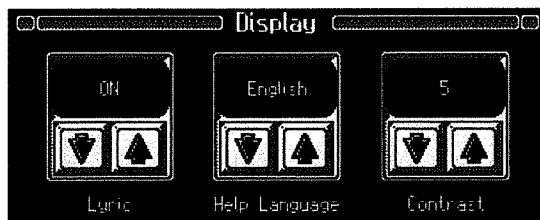

Press the [Function] button again to make the button's indicator go dark and go back to the previous screen.

■ Hiding the On-screen Lyrics

1. Touch the <Lyric> [↓] [↑] to toggle the setting to "ON" or "OFF."
The setting is at "ON" when the KR-575 is powered up.

■ Changing the Language for the Help Function

1. Touch <Help Language> [↓] [↑] to choose the language for the Help Function.
You can select <English>, <Japanese>, <German>, <Spanish>, or <French> as the language.
* If you choose Japanese, the screen messages in other screen besides help function may be displayed in Japanese. In other case, they are displayed in English.

■ Adjusting the Contrast of the Screen

1. Touch the <Contrast> [↓] [↑] to adjust the contrast of the screen.
You can select a contrast level from 1 to 10.

Repositioning the Touch Screen

If you've been using the Touch Screen for some time, the pointer may be shifted, making the KR-575 react incorrectly. You should correct this displacement when necessary by performing calibration (repositioning).

1. Press the [Function] button and confirm that its indicator has lighted.
2. Use the Page [◀] and [▶] buttons to switch screens and display the screen shown below.

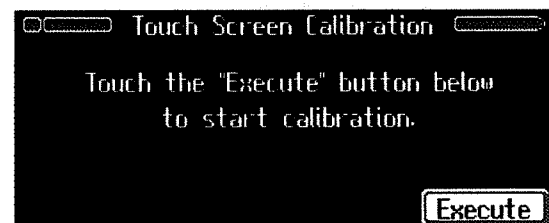

Press the [Function] button again to make the button's indicator go dark and go back to the previous screen.

3. Touch <Execute> on the screen.
4. Touch the points indicated on the touch screen.
* Do this carefully, because touching a location that's different from the one indicated for the pointer may make the displacement even worse. Be sure to touch the pointer accurately.
5. Follow the steps in "Retaining Settings While the Power Is Switched Off", to store the setting of calibration to KR-575.
* If you turn the power off before doing step 5, the setting of calibration will go away.

Changing the Power-up Screen

You can modify this screen to show your favourite phrase when the power is turned on.

1. Press the [Function] button and confirm that its indicator has lighted.
2. Use the Page [◀] and [▶] buttons to switch screens and display the screen shown below.

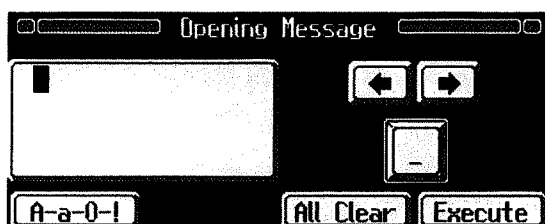

3. Touch ◀ ▶ to scroll the cursor sideways, and enter the text by using <▲> and <▼> or the dial to choose the letters.

Touch <A-a-0-!> at the bottom of the screen to change the type of script.

Touching <_> inserts a blank space at the cursor location.

4. When you're done entering the text, touch <Execute>.

Press the [Function] button again to make the button's indicator go dark and go back to the previous screen.

→ Touching <All Clear> at the bottom of the screen exits this function.

- * Never try to switch off the power while this operation is in progress. Doing so may damage the internal memory, making it impossible to use this instrument.

Retaining Settings While the Power Is Switched Off

Ordinarily, when you turn off the power, settings return to their default values. However, some settings can be stored so that they don't disappear when you turn off the power.

This function is called "Memory Backup."

1. Press the [Function] button and confirm that its indicator has lighted.
2. Use the Page [◀] and [▶] buttons to switch screens and display the screen shown below.



3. Touch <Execute> on the screen.

The confirmation message appears on screen.

4. Touch <OK> to store the settings in memory.

Touch <Cancel> to make the message disappear without storing the settings.

Press the [Function] button to make the button's indicator go dark and go back to the previous screen.

- * Some settings aren't stored even if the Memory Backup is done.

- * Never try to switch off the power while a Memory Backup operation is in progress. Doing so may damage the internal memory, making it impossible to use this instrument.

Restoring Settings to Their Default Values

You can restore the settings stored in memory with “Memory Backup” (page 134) to these original factory-default values. This function is called “Factory Preset.”

* *When you perform a Factory Preset, all settings that have been stored in memory up to then are erased and reset to their factory defaults.*

1. Press the [Function] button and confirm that its indicator has lighted.
2. Use the Page [◀] and [▶] buttons to switch screens and display the screen shown below.

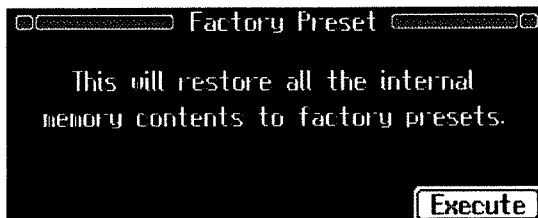

3. Touch <Execute> on the screen.
The confirmation message appears on screen.
 4. Touch <OK> to restore the settings to their factory defaults.
Touch <Cancel> to make the message disappear without restoring the settings.
Press the [Function] button again to make the button's indicator go dark and go back to the previous screen.
- * *Never try to switch off the power while a Factory Preset operation is in progress. Doing so may damage the internal memory, making it impossible to use this instrument.*

Chapter 9 Connecting External Devices

If you want to hook up an external instrument to the KR-575, then this chapter is for you.

Names and Functions of Jacks and Connectors

The jacks and connector ports on the unit's rear and bottom panels have the various functions described below.

■ Rear Panel

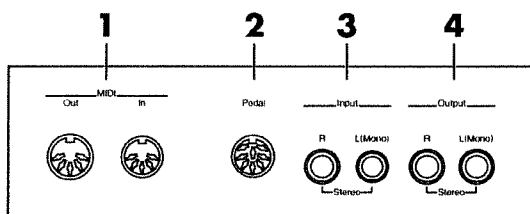

1 MIDI Out/In connectors

You can connect external MIDI instruments to these jacks to exchange performance information (page 138).

* *There's also a MIDI In jack on the bottom panel of the unit. You can't use both MIDI In jacks at the same time.*

2 Pedal jack

The special stand's pedal cord plugs into this jack.

3 Input jacks

You can play output from other sound generators by connecting these sources to the KR-575's input terminals (page 137).

4 Output jacks

You can some awesome sounds if you connect speakers or other audio equipment to these jacks. You can also hook up a portable stereo to record your performances on cassette tape (page 137).

■ Bottom Panel

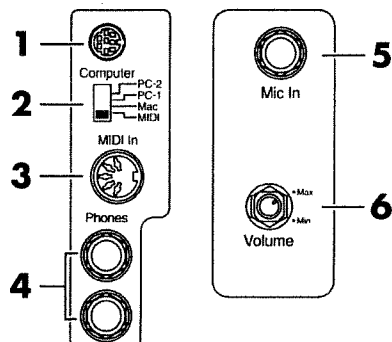

1 Computer jack

You can connect a computer to this jack to exchange performance information (page 137).

* *You can't use the MIDI Out/In connector and the Computer jack at the same time.*

2 Computer switch

Set this switch to Mac, PC-1, or PC-2 according to the type computer that's connected (page 137).

You can also switch between connections to the MIDI Out/In connector and the Computer jack.

3 MIDI In jack

You can connect external MIDI instruments to these jacks to exchange performance information (page 138).

* *There's also a MIDI IN jack on the rear panel of the unit. You can't use both MIDI IN jacks at the same time.*

4 Headphones jacks

→ *Take a look at "Using Headphones" (page 18).*

5 Microphone jack

→ *Take a look at "Connecting a Microphone" (page 48).*

6 Microphone Volume knob

Making the Connections

* If you're planning on connecting the KR-575 to other equipment with cables, be sure to follow the steps shown below to make the connection. By turning on or off devices in the wrong order, you risk causing malfunction and/or damage to speakers and other devices.

1. Turn down the volume all the way on all equipment.
2. Turn off the power to the KR-575 and other connected equipment.
3. Connect the cables.
4. Turn on the connected equipment.
5. Turn on the KR-575.
6. Adjust the volume.

After use, follow the steps below to switch off the power.

1. Turn down the volume all the way on all equipment.
2. Turn off the KR-575.
3. Turn off the connected equipment.

● Connecting Audio Equipment

You can hook up a tape recorder or other audio device and record your performances on the KR-575. Use an audio cable to connect the input jack on the audio set or amp mixer to one of the output jacks on the KR-575. Use an audio cable with a standard plug, such as the PCS-100PW (sold separately). When purchasing an audio cable, please consult the vendor where you bought the KR-575.

● Connecting a Computer

You can connect a computer on which a program such as Roland Visual MT is installed and play sounds from the software sound generator through the KR-575's speakers or save songs recorded on the KR-575 on the computer.

1. Turn on the KR-575 and the computer.
2. Use a computer cable (RSC-15APL, RSC-15AT, or RSC-15N, sold separately) to connect the Computer jack on the KR-575 to a serial port on the computer.

3. Set the Computer switch on the bottom of the unit to match the type of connected computer.

* Take a look at the Connection Examples.

* When the KR-575 is powered up, the setting doesn't change until the power is reset, even if the computer switch is operated.

4. Turn on the computer.

5. Turn on the KR-575.

6. Make the settings for baud rate (transmission speed) for the computer and the software.

* For more information, refer to the documentation for the computer you're using.

7. You should also make the settings for the MIDI send channel (page 138) and Local Control on or off as needed (page 138).

Connection Examples:

○ Connection with an Apple Macintosh computer
Use an RSC-15APL computer cable (sold separately) to connect the Computer jack on the KR-575 to the modem port (or printer port) on the Apple Macintosh. Set the Computer switch to "Mac."

Use "PatchBay" on the Apple Macintosh to set the interface type (the clock speed for the MIDI interface) to "1 MHz."

○ Connection with an IBM PC

Use an RSC-15AT computer cable (sold separately) to connect the Computer jack on the KR-575 to the COM1 or COM2 serial port on the IBM PC. Set the Computer switch to "PC-2."

If You're Using MIDI

● About MIDI

MIDI stands for "Musical Instrument Digital Interface," and is a unified standard for the exchange of performance data and other information between electronic instruments and computers.

The KR-575 is equipped with MIDI connectors and a Computer jack to let it exchange performance information with external devices. These jacks can be used to connect the KR-575 to an external device for even greater versatility.

A separate publication titled "MIDI Implementation" is also available. It provides complete details concerning the way MIDI has been implemented on this unit. If you should require this publication (such as when you intend to carry out byte-level programming), please contact the nearest Roland Service Center or authorized Roland distributor.

● About MIDI Connectors

The KR-575 has two kinds of MIDI connectors (page 136). Connecting these to the MIDI connectors on a MIDI instrument makes it possible for the two instruments to control each other.

For instance, you can output sound from the other instrument or switch Tones on the other instrument.

○ MIDI OUT connector

Performance messages such as information on what keys are played are sent to the MIDI connector on the external device from here.

○ MIDI IN connector

Performance messages from an external MIDI device are received here.

These incoming messages may instruct the receiving MIDI instrument to play sounds or switch Tones.

* The KR-575 has two MIDI IN jacks: one on the rear panel and one on the bottom panel. You can't use both MIDI IN jacks at the same time.

■ Connecting the KR-575 to a MIDI Instrument

1. Turn off the KR-575.

2. Set the Computer switch on the bottom of the KR-575 to "MIDI."

* When the KR-575 is powered up, the setting doesn't change until the power is reset, even if the computer switch is operated.

3. Use a MIDI cable (MSC-15, -25, or -50, sold separately) to connect the MIDI connector on the external instrument to the MIDI connector on the KR-575.

4. You should also set the MIDI send channel and switch Local Control on or off as needed.

Connection Examples:

- Connection with a sound module.

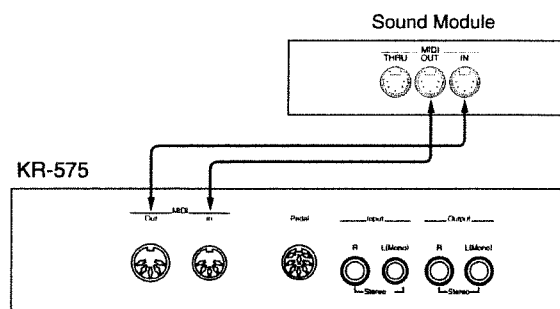

MIDI Settings

With the KR-575, you can make MIDI settings like those described below. Take a look at page 140 for explanations of how to make the various settings.

○ Sending a recorded performance to a MIDI instrument
You can send a performance recorded on the KR-575 to a connected MIDI instrument or computer.

Data is sent when set to "ON." Data is not sent when set to "OFF." The setting is at "OFF" when the KR-575 is powered up.

1. Perform recording on the KR-575.

2. Change the <Composer Out> setting to "ON."

3. Start recording on the connected MIDI instrument.

4. On the KR-575, play back the recorded performance.

○ Choosing a MIDI send channel

MIDI has something called "Channels," which are numbered from 1 to 16. If you hook up two devices with a MIDI cable, you won't be able to play notes or switch tones unless both devices are set to the same MIDI channel.

The KR-575 selects the MIDI channel for sending. The channel setting is at "1" when the KR-575 is powered up.

If the keyboard has been split into right-hand and left-hand sections, information from the left-hand section is not sent.

The KR-575 receives information on all channels from 1 through 16.

○ Switching Local Control on or off

You can connect the KR-575 and a MIDI sequencer, record a keyboard performance on the sequencer, then play back the performance with the sequencer.

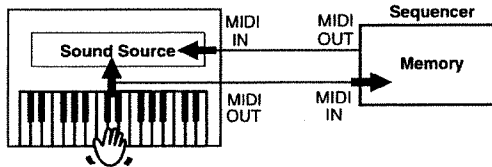

If the sequencer's THRU function is on at this time, the same notes are sounded twice. Performance information from the keyboard reaches the sound generator by two routes, (1) and (2), so the played notes may sound strange, or the number of notes sounded at the same time may decrease. To prevent this, what's known as "Local Control" is set to "off" to isolate route (1).

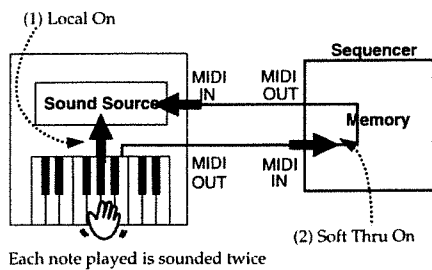

Local Control ON: The keyboard and the internal sound generator are in a linked state.

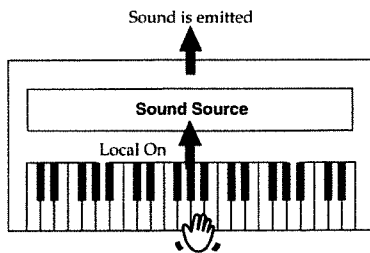

Local Control OFF: The keyboard and the internal sound generator are in an unlinked state. No notes are played when you finger the keyboard.

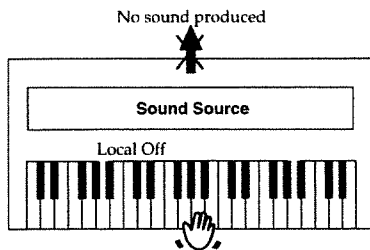

- * The setting is at "Local Control ON" when the KR-575 is powered up.
- * A MIDI sequencer is an instrument that's used to record and play back a performance as MIDI information. Products from Roland include the Roland MT series, which integrates a sequencer and a sound generator in a single unit.

The setting for Local Control is toggled on and off according to the MIDI Local Control messages that are received. When an instrument in the Roland MT series is connected, a Local Control "off" message is when the MT-series instrument is powered up. When you switch on first the KR-575, then the MT-series instrument, the KR-575 automatically turns off Local Control.

○ Sending Program Change messages

You can switch tones on a MIDI instrument connected to the KR-575.

When you choose a Program Change message (Program Number) and send it to the MIDI instrument, the Tone that corresponds to the Program Number on the MIDI instrument is selected.

When set up to send Program Change messages in the usual way, the Tone to send is selected from among 128 Tones. However, some MIDI instruments have more than 128 Tones. With such devices, the Tone is selected through a combination of Program Change messages and Bank Select messages. Bank Select messages consist of two parts: the MSB (Controller Number 0; which takes a value of 0-127), and the LSB (Controller Number 32; with also takes a value of 0-127).

- * Some MIDI instruments can't handle Bank Select messages. Also, there are some that do handle Bank Select messages, but don't recognize the LSB.



→ If you want to know more about how Tones are switched when Program Change messages are received, please consult your nearest Roland Service Station.

■ Making the Settings

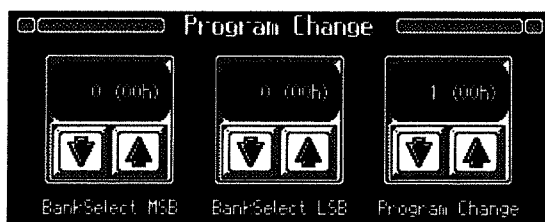
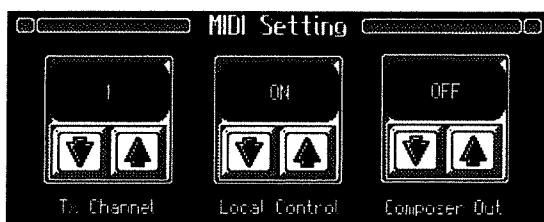
1. Press the [Function] button and confirm that its indicator has lighted.
2. Use the Page [◀] and [▶] buttons to switch screens and display any one of the screens shown below.



Display	Description
Composer Out	Determines whether a recorded performance is sent to the MIDI instrument.
TX. Channel	Chooses the MIDI send channel.
Local Control	Switches Local Control on or off.
Program Change	Sends Program Change messages (Program Numbers).
Bankselect MSB	Sends Bank Select MSB messages.
Bankselect LSB	Sends Bank Select LSB messages.

3. Touch   to make the setting for the corresponding item.

Troubleshooting

If you think there's a problem, read this first.

The power doesn't come on.

- Is the power cord connected and plugged in correctly? (page 19)

The button doesn't work.

- Is the panel locked? (page 122)
Turn the power off, then back on.

No sound is heard.

- Has the [Volume] slider been moved all the way to the left? (page 20)
- Are headphones plugged in? (page 18)
- Has the [Balance] slider been moved all the way to the right or left? (page 34)
- Has the volume been set to "0" using the [Accomp] or [Keyboard] buttons? (page 113)
- Has the footage been adjusted so that all frequency components aren't sounded? (page 126)

No sound is heard (when a MIDI instrument is connected).

- Have all devices been switched on? (page 138)
- Is the Computer switch on the back of the KR-575 set to "MIDI"? (page 136)

No sound is heard when the keyboard is played.

- Has Local Control been set to "off"? (page 139).

Sounds are heard twice (doubled) when the keyboard is played.

- Has the Layer Play mode been enabled? (page 54)
- When the KR-575 is connected to an external sequencer, set it to the Local OFF mode. Alternatively, the sequencer could be set so its Soft Thru feature is OFF (p.139).

Not all played notes are sounded.

- The maximum number of notes that the KR-575 can play simultaneously is 64. Frequent use of the damper pedal during automatic accompaniment or when playing along with a song on floppy disk may result in performance data with too many notes, causing some notes to drop out.

The tuning or pitch of the keyboard or song is off.

- Has the setting for transposition been made? (page 76,77)
- Are the settings for the Temperament) and tuning curve correct? (page 125)
- Is the setting for Master Tuning correct? (page 131)

Effects cannot be applied to Tones.

- It's not possible to apply more than one effect at the same time, so when a performance has been recorded on multiple tracks or when playing along with a song as it's played back, the desired effect may not be applied.

Automatic accompaniment is not heard.

- Has the [Balance] slider been moved all the way to the right? (page 34)
- Have you pressed the One Touch Program [Arranger] button?
If the One Touch Program [Arranger] button has not been pressed, only the rhythm pattern is played (page 60).
- Is the 16-track Sequencer screen displayed (page 87)?

Certain instruments are not heard while playing a song.

- Have song settings been changed for each Part (page 88)?
- Is the light for the Track button extinguished?
If the button light is out, the music on that track is not heard. Press the track button so the light is illuminated (page 78).

A Tone or Music Style cannot be selected.

- Has the [Demo] button been pressed?
Press the button again, then choose the Tone or Music Style (page 21).

There is a slight delay before playback of a song on floppy disk starts.

- There are two types of SMF music data: format 0 and format 1. If the song uses SMF format 1 data, there will be a slight delay until playback starts. Refer to the booklet that came with the music data you're using to determine the format type.

When song playback starts, the on-screen measure number reads "PU" (pickup).

- If the song starts in the middle of a measure, the display shows "PU" (pickup) at the beginning of the song. After that, the measure number is displayed.

The Fwd [▶▶] and Bwd [◀◀] buttons don't work.

- The fast-forward and reverse buttons are ignored while music data is being read in. Wait until processing finishes.

Troubleshooting

Pressing the Reset [◀] button doesn't return to the beginning of the song.

- Some music data may contain settings that stop play at a point partway through the song. When playing such songs, pressing the Reset [◀] button moves the song to the point that has been set. Press the button several times more to return to the beginning of the tune.

The Tone has changed.

- During automatic accompaniment, changing the Music Style automatically changes the Tones and tempo of the upper part of the keyboard to match the new Music Style. If you want to change only the Music Style without also altering the tempo and Tone, check out "Changing the Settings for Automatic Accompaniment" (page 128).
- When a performance made along with a Music Data tune has been recorded, recording the performance to button [1] may make the Tones for buttons [3] and [4] change as well.

Chord Intelligence can't be used.

- Has Chord Intelligence been switched off? (page 128)
- Is the setting for "Piano Style Arranger" active? (page 68)

A note doesn't stop playing

- Have the Chord Tone and Bass Tone been changed (page 128)?
Some Chord Tone and Bass Tone notes may be sounded continuously.
- Have the phrase been changed (page 65)?
Some phrases may be sounded continuously. Press the Pad button a second time.

Recording is not possible.

- Has one of the track buttons for recording been selected (page 38)?
- Has the setting for "Punch-in Recording" (page 84) or "Tempo Recording" (page 93) been made?
To go back to the usual recording method. (page 81)

The recorded performance has disappeared.

- Any performance that has been recorded is deleted when the power to the KR-575 is turned off or a song is selected.
A performance cannot be restored once it's been deleted, so be sure to save it on a floppy disk before you turn off the power (page 42).

Nothing appears on screen.

- The KR-575 uses a liquid-crystal screen, so text may not be displayed when the ambient temperature is below freezing.

Lyrics are not indicated properly in the display.

- With some music files, the lyrics cannot be displayed correctly.
- Lyrics data can not be saved on a floppy disk.
- If you press a button while the lyrics are being shown in the display, the lyrics will disappear. To recall them, press the Play [▶] button.

The Touch Screen doesn't respond correctly.

- The positioning of the Touch Screen may become displaced if some time has passed since it was last used. Take a look at "Repositioning the Touch Screen" (page 133) to correct the positioning.

Depressing a pedal has no effect, or the pedal effect doesn't stop.

- Is the pedal connected correctly?
Make sure the pedal cord extending from the stand is securely connected to the pedal jack on the back of the unit (page 136).
- Has a different function been assigned to the pedal?
See "Assigning Functions to Buttons and pedals" (page 118).
- Normal pedal operation is automatically enabled when the One Touch Program [Piano] button is pressed.

If This Message Appears On Screen

Indication : PU

Meaning : When a song with a pickup (a song that does not start on the first beat) is played back, the measure numbers will be indicated in the display as PU, 1, 2, and so forth.

Indication : Error.00

Meaning : To protect the copyright, this music file cannot be saved as an SMF. Also, the music file can not be saved. If you want to save it, please save on the same floppy disk.

Indication : Error.01

Meaning : You can only read the music file or music style. It can not be saved on a floppy disk or internal memory.

Indication : Error.02

Meaning : The protect tub on the floppy disk is set to the Protect position. Change it to the Write position. Repeat the procedure.

Indication : Error.03

Meaning : This floppy disk cannot store the format or save any data. Insert a different disk and repeat the procedure.

Indication : Error.04

Meaning : The data cannot be saved onto this floppy disk because the format is different. Use the floppy disk in the same format. Also, you can't save User Styles and recorded songs on the same floppy disk.

Indication : Error.05

Meaning : A new song cannot be written on this song. Select a different song number or use a different floppy disk, and repeat the procedure.

Indication : Error.10

Meaning : No floppy disk is connected to the disk drive. Insert the disk correctly, and repeat the procedure.

Indication : Error.11

Meaning : There is not sufficient space left on the floppy disk for the data to be saved. Save the data onto a different floppy disk.

Indication : Error.12

Meaning : The floppy disk inserted into the disk drive can't be read. Be sure you're using Roland SMF Music Files or other music files compatible with Roland digital pianos (page 161). Also, if you want to save your work on floppy disk, you need to format the floppy disk first (page 40).

Indication : Error.13

Meaning : The floppy disk was removed from the disk drive while reading or writing was in progress. Insert the floppy disk and repeat the procedure.

Indication : Error.14

Meaning : This floppy disk is damaged and cannot be used. Insert a different disk and repeat the procedure.

Indication : Error.15

Meaning : This song or music style cannot be read. Be sure you're using Roland SMF Music Files or other music files compatible with Roland digital pianos (page 161). Also, you can only use User Programs that have been saved with the KR-575 (page 121).

Indication : Error.16

Meaning : The KR-575 cannot read the floppy disk quickly enough. Press the Stop [■] button, then press the Reset [◀] button and Play [▶] button to play the song.

Indicated : Error.17

Meaning : The music files cannot be edited on the KR-575. Please use these music files only for playback.

Indication : Error.30

Meaning : The internal memory capacity of the KR-575 is full. Save the song or music style data on a floppy disk to delete the song data or the User style stored on the KR-575 memory.

Indication : Error.40

Meaning : The KR-575 cannot deal with the excessive MIDI data sent from the external MIDI device. Reduce the amount of MIDI data sent to the KR-575.

Indication : Error.41

Meaning : A MIDI cable or computer cable has been disconnected. Connect it properly and securely.

Indication : Error.42

Meaning : An excessive amount of performance data has been sent to KR-575 in one time and therefore could not be recorded. Change the tempo more slowly to record the performance again.

If This Message Appears On Screen

Indication : Error.43

Meaning : The Computer Switch is set to a wrong position or the computer is set wrongly. Switch off the KR-575 then set the Computer Switch to the correct position and set the computer correctly. After that, switch on the KR-575 again.

Indication : Error.51

Meaning : There is something wrong with the system. Repeat the procedure from the beginning.

** If it is not solved after you have tried several times, contact the Roland service center.*

Music Style List

[Pop] group

Music Style

Ocean Side
MorningLight
Rock'n Pop
Rollin'
8Beat Pop
16Beat Pop
Swing Pop
Pop'n Roll
Light Fusion
70's Disco
Power 8Beat
Acoustic Pop

[Piano Style] group

Music Style

Soft Ballad
Pf Concerto
PianoBoogie1
PianoBoogie2
PianoClasic1
PianoClasic2
StridePiano
PianoBallad
ClassicPolka
Club Piano
P.Classic 1
P.Slow Waltz
P.Pop
P.Gospel
P.Country
P.Bossa Nova
P.Ragtime
P.Stride
P.Concerto 1
P.Classic 2
P.Ballad 1
P.Ballad 2
P.Swing Pop
P.Rock'nRoll
P.Concerto 2
P.Concerto 3
P.Swing
P.Shuffle
P.Boogie
P.Slow Swing
P.Slow Rock
P.Latin

[Ballad] group

Music Style

MediumBallad
Torch Song
60's Ballad
Swayin'
Love Romance
Contemporary
16BeatBallad
Chapel
Strings
Crystal

[Rock] group

Music Style

80's Rock
Rock 1
Rock 2
Mersey Beat
AcousticRck1
AcousticRck2
Early Rock
16Beat Rock

[Oldies] group

Music Style

Beach Sound
Rock'n'Roll
60's R&B
50's R&B
Dreamin'
Rock'n'Night
Twist
Cute Pop
50's Pop 1
50's Pop 2
Slow Dance

[Country] group

Music Style

CountryRoads
Western
CtrySerenade
CountryPiano
Easy Country
Twostep
Hoedown
New Country
Bluegrass
CountryBlues
Country Folk
Country Rock
CountryWaltz
Rock'n Cntry
Outlaw

[Big Band/Swing] group

Music Style

Jazz Band
A Capella
Big Band
Slow Swing
Fast BigBand
BigBandSwing
Blues
BigBndBallad
Dixieland
Charleston
Combo

[Latin] group

Music Style

Bossa Nova
Habanera
Mambo
Salsa
Samba
Rhumba
Tango
Beguine
Chacha
Slow Bossa
NewBossaNova

Music Style List

[Waltz] group

Music Style
StringsWaltz
Slow Waltz
Last Dance
DeutschWalzer
Jazz Waltz
Waltzing
Vienna Waltz
Musette
Simple Waltz

[March/Kids] group

Music Style
Fanfare
Kids Dance
March
Kids Pop
Kids Shuffle
Polka
Foxtrot
Kids 4/4
Lullaby 4/4
Music Box
Kids 6/8
SimpleMarch1
SimpleMarch2

[World] group

Music Style
Gospel Piano
Gospel Pop
Ireland
Hawaiian
Gospel
Scotland
Schlager
Japan
Asian Pop
Gt.Arpeggio
Asian Rhumba

[Screen] group

Music Style
Balloon Trip
Raindrops
Little Steps
Cinema
Broadway
WesternMovie
SFX Movie
Black&White
Screen 1
Screen 2
Festival
Summer Days

Music Style Disk

Music Style
Happy Pop 1
Happy Pop 2
Sevilla
Polka 2
S Country
Tango 2
Tango 3
Merengue
Calypso
Torch Song*
Dixieland 1*
CountrySwing*
CntryBallad
CntryWaltz 2*
CountryRock1*
Train Beat
BigBndBalld1*
Big Band 1*
Medium Swing*
Slow Swing
Shuffle
Brush Swing
Fusion
Jungle
House
Techno
Ne JackSwing
Hip-Hop
Dance Pop 1
Dance Pop 2

** A Music Style indicated by "*" has the same name as a built-in Music Style, but its contents are different.*

Chord Fingering List

→ See " Playing with an Automatic Accompaniment – One-touch Arranger " (page 31) and " Playing Chords with Simple Fingering " (page 66) .

● symbol : Indicates the constituent note of chords.

★ symbol : Chord shown with an "★" can be played by pressing just the key marked with the "★".

C	C#	D	E \flat	E	F
CM7	C#M7	DM7	E \flat M7	EM7	FM7
C7	C#7	D7	E \flat 7	E7	F7
Cm	C#m	Dm	E \flat m	Em	Fm
Cm7	C#m7	Dm7	E \flat m7	Em7	Fm7
Cdim	C#dim	Ddim	E \flat dim	Edim	Fdim
Cm7 (b5)	C#m7 (b5)	Dm7 (b5)	E \flat m7 (b5)	Em7 (b5)	Fm7 (b5)
Caug	C#aug	Daug	E \flat aug	Eaug	Faug
Csus4	C#sus4	Dsus4	E \flat sus4	Esus4	Fsus4
C7sus4	C#7sus4	D7sus4	E \flat 7sus4	E7sus4	F7sus4

Chord Fingering List

F#	G	A \flat	A	B \flat	B
F#M7	GM7	A \flat M7	AM7	B \flat M7	BM7
F#7	G7	A \flat 7	A7	B \flat 7	B7
F#m	Gm	A \flat m	Am	B \flat m	Bm
F#m7	Gm7	A \flat m7	Am7	B \flat m7	Bm7
F#dim	Gdim	A \flat dim	Adim	B \flat dim	Bdim
F#m7 (b5)	Gm7 (b5)	A \flat m7 (b5)	Am7 (b5)	B \flat m7 (b5)	Bm7 (b5)
F#aug	Gaug	A \flat aug	Aaug	B \flat aug	Baug
F#sus4	Gsus4	A \flat sus4	Asus4	B \flat sus4	Bsus4
F#7sus4	G7sus4	A \flat 7sus4	A7sus4	B \flat 7sus4	B7sus4

Tone Name List

→ See "Playing a Wide Variety of Instrument Sounds" (page 27).

[Piano] Group

Tone Name
Grand Piano1
Grand Piano2
E.Piano 1
E.Piano 2
Harpsichord1
Harpsichord2
UprightPiano
Rock Piano
Honky-tonk 1
Honky-tonk 2
MIDI Piano1
MIDI Piano2
Piano 1
Piano 2
Piano 3
E.Piano 3
EG+Rhodes 1
EG+Rhodes 2
Hard Rhodes
Soft E.Piano
Detuned EP 1
Detuned EP 2
FM+SA EP
St.FM EP
60's E.Piano
Hard E.Piano
GS E.Piano1
GS E.Piano2
E.Piano 1v
E.Piano 2v
Hard FM EP
Harpsichord
Coupled Hps.
Harpsi.o
Clav.
Analog Clav.

[Vibes] Group

Tone Name
Vibraphone
Celesta
Marimba
Barafon
Xylophone
Glockenspiel
Music Box
Tubular-bell
Carillon
Santur
Steel Drums
Kalimba

[Organ] Group

Tone Name
Jazz Organ 1
Jazz Organ 2
Full Organ 1
Full Organ 2
Lower Organ1
Lower Organ2
Church Organ
Organ Flute
Jazz Organ 3
Jazz Organ 4
Full Organ 3
Full Organ 4
Organ 1
Organ 2
Pop Organ
VS Organ
Rock Organ 1
Rock Organ 2
Rotary Org.S
Rotary Org.F
Metalic Org.
Digi Church
Theater Org.
Trem.Flute
Pipe Org. Bs
Organ Bass
Accordion
Harmonica

[Guitar/Bass] Group

Tone Name
Nylon Guitar
Gut Guitar
Steel Guitar
12str Guitar
Acoustic Bs.
Fingered Bs.
Picked Bs.
Fretless Bs.
Jazz Guitar
JC E.Guitar
Nylon Gt.o
Nylon+Steel
Mandolin
Ukulele
Banjo
Mellow Gt.
Hawaiian Gt.
Muted Gt.
Overdrive Gt
Muted Dis.Gt
DistortionGt
Dazed Guitar
Rock Rhythm
Rock Rhythm2
Feedback Gt.
Feedback Gt2
Power Guitar
Power Gt.2
5th Dist.
Gt.Harmonics
Shamisen
Koto
A.Bass+Cymb
Mute PickBs.
Mr.Smooth
Slap Bass 1
Synth Bass 1
SynthBass101
Reso SH Bass
SH101 Bass

Tone Name List

[Strings] Group

Tone Name
Strings
Slow Strings
Rich Choir
Jazz Voices
Doos Voice
Violin
Slow Violin
Cello
Contrabass
Tremolo Str
PizzicatoStr
Harp
Timpani
Warm Strings
Orchestra
Choir Str.
Choir
Pop Voice
SynVox
Choir Oohs
OrchestraHit
Warm Pad
Syn.Strings1
Syn.Strings2
Harpvox
CC Solo
Syn.Square
JP8 Square
FM Lead 1
FM Lead 2
Mg Lead
P5 Saw Lead
Rhythmic Saw
Waspy Synth
JP8 Pulse
Cheese Saw
Reso Saw
RAVE Vox
Fat & Perky
Fantasia 2
Soft Pad
P5 Poly
Heaven II
JP8 Sqr Pad
Sweep Pad 2
Converge
Vibra Bells
Clear Bells
Soft Crystal
Digi Bells
Nylon Harp
Nylon+Rhodes

Big Panner
Ai-yai-a
Echo Pan 2
Falling Down
Thum Voice
Doot Accent
Dat Accent
Bop Accent

[Sax] Group

Tone Name
Blow Sax
Tenor Sax
Baritone Sax
Soprano Sax
Alto Sax
Oboe
English Horn
Bassoon
Clarinet
Piccolo
Flute
Recorder
Pan Flute
Blow Pipe
Shakuhachi
Ocarina

[Brass] Group

Tone Name
Trumpet
Trombone
Fr.Horn Solo
Brass 1
Trombone 2
Tuba
MutedTrumpet
French Horn
Brass 2
Synth Brass1
Synth Brass2
Soft Brass

[Fantasia] Group

Tone Name
Fantasia
Brightness
Crystal
Piano 1
Piano 1w
Piano 1d
Piano 2
Piano 2w
Piano 3
Piano 3w
Honky-tonk
Honky-tonk 2
GS E.Piano1
Detuned EP 1
E.Piano 1v
60's E.Piano
GS E.Piano2
Detuned EP 2
E.Piano 2v
Harpsichord
Coupled Hps.
Harpsi.w
Harpsi.o
Clav.
Celesta
Glockenspiel
GS Music Box
GS Vibe
Vibe.w
GS Marimba
Marimba
Xylophone
Tubular-bell
Church Bell
Carillon
GS Santur
Organ 1
Detuned Or.1
Pop Organ 1
Full Organ 4
Organ 2
Detuned Or.2
Jazz Organ 1
Rock Organ 2
Church Org.1
Church Org.2
Church Org.3
Reed Organ
Accordion Fr
Accordion It
GS Harmonica
Bandoneon

GS Nylon Gt.	MutedTrumpet	Sitar
Ukulele	French Horn	Sitar 2
Nylon Gt.o	Fr.Horn 2	Banjo
Nylon Guitar	Brass 1	GS Shamisen
Steel-str.Gt	Brass 2	Koto
12-str.Gt	Synth Brass1	Taisho Koto
GS Mandolin	Synth Brass3	Kalimba
Jazz Guitar	AnalogBrass1	Bagpipe
GS Hawaiian	Synth Brass2	Fiddle
Clean Gt.	Synth Brass4	Shanai
Chorus Gt.	AnalogBrass2	Tinkle Bell
Muted Gt.	GS Sop.Sax	Agogo
Funk Gt.	Alto Sax	Steel Drums
Funk Gt.2	Tenor Sax	Woodblock
Overdrive Gt	Baritone Sax	Castanets
GS Dist.Gt	GS Oboe	Taiko
Feedback Gt.	English Horn	Concert BD
Gt.Harmonics	Bassoon	Melo. Tom 1
Gt. Feedback	Clarinet	Melo. Tom 2
GS Ac.Bass	Piccolo	Synth Drum
GS Fing.Bass	GS Flute	808 Tom
GS Picked Bs	Recorder	Elec Perc.
Fretless Bs.	Pan Flute	Reverse Cym.
Slap Bass 1	Bottle Blow	Gt.FretNoise
Slap Bass 2	Shakuhachi	Gt.Cut Noise
Synth Bass 1	Whistle	String Slap
SynthBass101	Ocarina	Breath Noise
Synth Bass 3	Square Wave	Fl.Key Click
Synth Bass 2	Square	Seashore
Synth Bass 4	Sine Wave	Rain
Rubber Bass	Saw Wave	Thunder
GS Violin	Saw	Wind
Slow Violin	Doctor Solo	Stream
Viola	Syn.Calliope	Bubble
GS Cello	Chiffer Lead	Bird
Contrabass	Charang	Dog
Tremolo Str	Solo Vox	Horse-Gallop
PizzicatoStr	5th Saw Wave	Bird 2
GS Harp	Bass & Lead	Telephone 1
Timpani	Warm Pad	Telephone 2
GS Strings	Polysynth	DoorCreaking
Orchestra	Space Voice	Door
GS Sl.Str	Bowed Glass	Scratch
Syn.Strings1	Metal Pad	Windchime
Syn.Strings3	Halo Pad	Helicopter
Syn.Strings2	Sweep Pad	Car-Engine
Choir Aahs	Ice Rain	Car-Stop
Choir	Soundtrack	Car-Pass
Pop Voice	Syn Mallet	Car-Crash
SynVox	Atmosphere	Siren
OrchestraHit	Goblin	Train
GS Trumpet	Echo Drops	Jetplane
GS Trombone	Echo Bell	Starship
Trombone 2	Echo Pan	Burst Noise
Tuba	Star Theme	Applause

Tone Name List

Laughing	Contrabass*	Ice Rain*
Screaming	Tremolo Str*	Soundtrack*
Punch	Pizzicato*	Crystal*
Heart Beat	Harp*	Syn Mallet*
Footsteps	Timpani*	Atmosphere*
Gun Shot	Strings*	Brightness*
Machine Gun	SlowStrings*	Goblin*
Lasergun	Syn.Str 1*	Echo Drops*
Explosion	Syn.Str 2*	Star Theme*
Piano 1*	Choir Aahs*	Sitar*
Piano 2*	Pop Voice*	Banjo*
Piano 3*	SynVox*	Shamisen*
Honky-tonk*	Orche.Hit*	Koto*
E.Piano 1*	Trumpet*	Kalimba*
E.Piano 2*	Trombone*	Bagpipe*
Harpsichord*	Tuba*	Fiddle*
Clav.*	M.Trumpet*	Shanai*
Celesta*	FrenchHorns*	Tinkle Bell*
Glocken*	Brass 1*	Agogo*
Music Box*	SynthBrass1*	Steel Drums*
Vibraphone*	A.Brass 1*	Woodblock*
Marimba*	SynthBrass2*	Taiko*
Xylophone*	Soprano Sax*	Melo.Tom 1*
Tubularbell*	Alto Sax*	Synth Drum*
Santur*	Tenor Sax*	ReverseCym.*
Organ 1*	BaritoneSax*	Fret Noise*
Pop Organ 1*	Oboe*	BreathNoise*
Organ 2*	EnglishHorn*	Seashore*
Rock Organ2*	Bassoon*	Bird*
ChurchOrg.1*	Clarinet*	Telephone 1*
Reed Organ*	Piccolo*	Helicopter*
AccordionFr*	Flute*	Applause*
Harmonica*	Recorder*	Gun Shot*
Bandoneon*	Pan Flute*	
Nylon-strGt*	Bottle Blow*	
Steel-strGt*	Shakuhachi*	
Jazz Guitar*	Whistle*	
Clean Gt.*	Ocarina*	
Muted Gt.*	Square Wave*	
Funk Gt.*	Saw Wave*	
OverdriveGt*	Doctor Solo*	
Dist.Guitar*	SynCalliope*	
Gt.Harmo*	ChifferLead*	
Acoustic Bs*	Charang*	
Fingered Bs*	Solo Vox*	
Picked Bs.*	5th SawWave*	
Fretless Bs*	Bass & Lead*	
Slap Bass 1*	Fantasia*	
Slap Bass 2*	Warm Pad*	
Synth Bass1*	Polysynth*	
Synth Bass2*	Space Voice*	
Rubber Bass*	Bowed Glass*	
Violin*	Metal Pad*	
Viola*	Halo Pad*	
Cello*	Sweep Pad*	

* Tone with a "*" symbol appended to their name may not play back satisfactorily on other GS sound generating devices.

Drum / SFX Set List

→ See “Playing Drums from the Keyboard” (page 26).

Drum Sets

* When Drum Set has been selected, each key plays a different percussion sound.

	1:STANDARD*	3:ROOM*	4:POWER	5:ELECTRONIC
24	Bar Chime	Bar Chime	Bar Chime	Bar Chime
25	Snare Roll	Snare Roll	Snare Roll	Snare Roll
26	Finger Snap	Finger Snap	Finger Snap	Finger Snap
27	High Q	High Q	High Q	High Q
28	Slap	Slap	Slap	Slap
29	Scratch Push [EXC7]	Scratch Push [EXC7]	Scratch Push [EXC7]	Scratch Push [EXC7]
30	Scratch Pull [EXC7]	Scratch Pull [EXC7]	Scratch Pull [EXC7]	Scratch Pull [EXC7]
31	Sticks	Sticks	Sticks	Sticks
32	Square Click	Square Click	Square Click	Square Click
33	Metronome Click	Metronome Click	Metronome Click	Metronome Click
34	Metronome Bell	Metronome Bell	Metronome Bell	Metronome Bell
35	Std Kick 2'	Kick1	Std Kick 2	Std Kick 2
C2 36	Kick 1	Room Kick	MONDO Kick	Elec BD
37	Side Stick	Side Stick	Side Stick	Side Stick
38	Std Snr 1	Room Snr 1	Gated SD	Elec SD
39	Hand Clap	Hand Clap	Hand Clap	Hand Clap
40	Std Snr 2	Std Snr 1	Snare Drum 2	Gated SD
41	Low Tom 2	Room Low Tom 2'	Room Low Tom 2	Elec Low Tom 2
42	Closed Hi-hat 1' [EXC1]	Closed Hi-hat 1' [EXC1]	Closed Hi-hat 1 [EXC1]	Closed Hi-hat 1 [EXC1]
43	Low Tom 1	Room Low Tom 1'	Room Low Tom 1	Elec Low Tom 1
44	Pedal Hi-hat 1' [EXC1]	Pedal Hi-hat 1' [EXC1]	Pedal Hi-hat 1 [EXC1]	Pedal Hi-hat 1 [EXC1]
45	Mid Tom 2	Room Mid Tom 2'	Room Mid Tom 2	Elec Mid Tom 2
46	Open Hi-hat 1' [EXC1]	Open Hi-hat 1' [EXC1]	Open Hi-hat 1 [EXC1]	Open Hi-hat 1 [EXC1]
47	Mid Tom 1	Room Mid Tom 1'	Room Mid Tom 1	Elec Mid Tom 1
C3 48	High Tom 2	Room Hi Tom 2'	Room Hi Tom 2	Elec Hi Tom 2
49	Crash Cymbal 1	Crash Cymbal 1	Crash Cymbal 1	Crash Cymbal 1
50	High Tom 1	Room Hi Tom 1'	Room Hi Tom 1	Elec Hi Tom 1
51	Ride Cymbal 1	Ride Cymbal 1	Ride Cymbal 1	Ride Cymbal 1
52	Chinese Cymbal	Chinese Cymbal	Chinese Cymbal	Reverse Cymbal
53	Ride Bell	Ride Bell	Ride Bell	Ride Bell
54	Tambourine	Tambourine	Tambourine	Tambourine
55	Splash Cymbal	Splash Cymbal	Splash Cymbal	Splash Cymbal
56	Cowbell	Cowbell	Cowbell	Cowbell
57	Crash Cymbal 2	Crash Cymbal 2	Crash Cymbal 2	Crash Cymbal 2
58	Vibra-slap	Vibra-slap	Vibra-slap	Vibra-slap
59	Ride Cymbal 2	Ride Cymbal 2	Ride Cymbal 2	Ride Cymbal 2
C4 60	High Bongo	High Bongo	High Bongo	High Bongo
61	Low Bongo	Low Bongo	Low Bongo	Low Bongo
62	Mute High Conga	Mute High Conga	Mute High Conga	Mute High Conga
63	Open High Conga	Open High Conga	Open High Conga	Open High Conga
64	Low Conga	Low Conga	Low Conga	Low Conga
65	High Timbale	High Timbale	High Timbale	High Timbale
66	Low Timbale	Low Timbale	Low Timbale	Low Timbale
67	High Agogo	High Agogo	High Agogo	High Agogo
68	Low Agogo	Low Agogo	Low Agogo	Low Agogo
69	Cabasa	Cabasa	Cabasa	Cabasa
70	Maracas	Maracas	Maracas	Maracas
71	Short Hi Whistle [EXC2]	Short Hi Whistle [EXC2]	Short Hi Whistle [EXC2]	Short Hi Whistle [EXC2]
C5 72	Long Low Whistle [EXC2]	Long Low Whistle [EXC2]	Long Low Whistle [EXC2]	Long Low Whistle [EXC2]
73	Short Guiro [EXC3]	Short Guiro [EXC3]	Short Guiro [EXC3]	Short Guiro [EXC3]
74	Long Guiro [EXC3]	Long Guiro [EXC3]	Long Guiro [EXC3]	Long Guiro [EXC3]
75	Claves	Claves	Claves	Claves
76	High Wood Block	High Wood Block	High Wood Block	High Wood Block
77	Low Wood Block	Low Wood Block	Low Wood Block	Low Wood Block
78	Mute Cuica [EXC4]	Mute Cuica [EXC4]	Mute Cuica [EXC4]	Mute Cuica [EXC4]
79	Open Cuica [EXC4]	Open Cuica [EXC4]	Open Cuica [EXC4]	Open Cuica [EXC4]
80	Mute Triangle [EXC5]	Mute Triangle [EXC5]	Mute Triangle [EXC5]	Mute Triangle [EXC5]
81	Open Triangle [EXC5]	Open Triangle [EXC5]	Open Triangle [EXC5]	Open Triangle [EXC5]
82	Shaker	Shaker	Shaker	Shaker
83	Jingle Bell	Jingle Bell	Jingle Bell	Jingle Bell
C6 84	Bell Tree	Bell Tree	Bell Tree	Bell Tree
85	Castanets	Castanets	Castanets	Castanets
86	Mute Surdo [EXC6]	Mute Surdo [EXC6]	Mute Surdo [EXC6]	Mute Surdo [EXC6]
87	Open Surdo [EXC6]	Open Surdo [EXC6]	Open Surdo [EXC6]	Open Surdo [EXC6]
88	-----	-----	-----	-----

Drum/SFX Set List

	6:TR-808	7:DANCE	8:JAZZ 11:GS STANDARD	9:BRUSH
24	Bar Chime	Bar Chime	Bar Chime	Bar Chime
25	Snare Roll	Snare Roll	Snare Roll	Snare Roll
26	Finger Snap	Finger Snap	Finger Snap	Finger Snap
27	High Q	High Q	High Q	High Q
28	Slap	Slap	Slap	Slap
29	Scratch Push [EXC7]	Scratch Push [EXC7]	Scratch Push [EXC7]	Scratch Push [EXC7]
30	Scratch Pull [EXC7]	Scratch Pull [EXC7]	Scratch Pull [EXC7]	Scratch Pull [EXC7]
31	Sticks	Dance Snr 1	Sticks	Sticks
32	Square Click	Square Click	Square Click	Square Click
33	Metronome Click	Metronome Click	Metronome Click	Metronome Click
34	Metronome Bell	Metronome Bell	Metronome Bell	Metronome Bell
35	Std Kick 2	Kick 1	Std Kick 2	Kick 2
C2 36	808 Bass Drum 1	808 Bass Drum 2	Std Kick 1	Kick 1
37	808 Rim Shot	808 Rim Shot	Side Stick	Side Stick
38	808 Snare Drum	TR-909 Snr	Snare Drum 1	Brush Tap
39	Hand Clap	Hand Clap	Hand Clap	Brush Slap
40	Snare Drum 2	Dance Snr 2	Snare Drum 2	Brush Swirl
41	808 Low Tom 2	808 Low Tom 2	Low Tom 2	Brush Low Tom 2
42	808 CHH [EXC1]	808 CHH [EXC1]	Closed Hi-hat 1 [EXC1]	Closed Hi-hat 2 [EXC1]
43	808 Low Tom 1	808 Low Tom 1	Low Tom 1	Brush Low Tom 1
44	808 CHH [EXC1]	808 CHH [EXC1]	Pedal Hi-hat 1 [EXC1]	Pedal Hi-hat 2 [EXC1]
45	808 Mid Tom 2	808 Mid Tom 2	Mid Tom 2	Brush Mid Tom 2
46	808 OHH [EXC1]	808 OHH [EXC1]	Open Hi-hat 1 [EXC1]	Open Hi-hat 2 [EXC1]
47	808 Mid Tom 1	808 Mid Tom 1	Mid Tom 1	Brush Mid Tom 1
C3 48	808 Hi Tom 2	808 Hi Tom 2	High Tom 2	Brush Hi Tom 2
49	808 Cymbal	808 Cymbal	Crash Cymbal 1	Crash Cymbal 1
50	808 Hi Tom 1	808 Hi Tom 1	High Tom 1	Brush Hi Tom 1
51	Ride Cymbal 1	Ride Cymbal 1	Ride Cymbal 1	Ride Cymbal 1
52	Chinese Cymbal	Chinese Cymbal	Chinese Cymbal	Chinese Cymbal
53	Ride Bell	Ride Bell	Ride Bell	Ride Bell
54	Tambourine	Tambourine	Tambourine	Tambourine
55	Splash Cymbal	Splash Cymbal	Splash Cymbal	Splash Cymbal
56	808 Cowbell	808 Cowbell	Cowbell	Cowbell
57	Crash Cymbal 2	Crash Cymbal 2	Crash Cymbal 2	Crash Cymbal 2
58	Vibra-slap	Vibra-slap	Vibra-slap	Vibra-slap
59	Ride Cymbal 2	Ride Cymbal 2	Ride Cymbal 2	Ride Cymbal 2
C4 60	High Bongo	High Bongo	High Bongo	High Bongo
61	Low Bongo	Low Bongo	Low Bongo	Low Bongo
62	808 High Conga	808 High Conga	Mute High Conga	Mute High Conga
63	808 Mid Conga	808 Mid Conga	Open High Conga	Open High Conga
64	808 Low Conga	808 Low Conga	Low Conga	Low Conga
65	High Timbale	High Timbale	High Timbale	High Timbale
66	Low Timbale	Low Timbale	Low Timbale	Low Timbale
67	High Agogo	High Agogo	High Agogo	High Agogo
68	Low Agogo	Low Agogo	Low Agogo	Low Agogo
69	Cabasa	Cabasa	Cabasa	Cabasa
70	808 Maracas	808 Maracas	Maracas	Maracas
71	Short Hi Whistle [EXC2]	Short Hi Whistle [EXC2]	Short Hi Whistle [EXC2]	Short Hi Whistle [EXC2]
C5 72	Long Low Whistle [EXC2]	Long Low Whistle [EXC2]	Long Low Whistle [EXC2]	Long Low Whistle [EXC2]
73	Short Guiro [EXC3]	Short Guiro [EXC3]	Short Guiro [EXC3]	Short Guiro [EXC3]
74	Long Guiro [EXC3]	Long Guiro [EXC3]	Long Guiro [EXC3]	Long Guiro [EXC3]
75	808 Claves	808 Claves	Claves	Claves
76	High Wood Block	High Wood Block	High Wood Block	High Wood Block
77	Low Wood Block	Low Wood Block	Low Wood Block	Low Wood Block
78	Mute Cuica [EXC4]	Mute Cuica [EXC4]	Mute Cuica [EXC4]	Mute Cuica [EXC4]
79	Open Cuica [EXC4]	Open Cuica [EXC4]	Open Cuica [EXC4]	Open Cuica [EXC4]
80	Mute Triangle [EXC5]	Mute Triangle [EXC5]	Mute Triangle [EXC5]	Mute Triangle [EXC5]
81	Open Triangle [EXC5]	Open Triangle [EXC5]	Open Triangle [EXC5]	Open Triangle [EXC5]
82	Shaker	Shaker	Shaker	Shaker
83	Jingle Bell	Jingle Bell	Jingle Bell	Jingle Bell
C6 84	Bell Tree	Bell Tree	Bell Tree	Bell Tree
85	Castanets	Castanets	Castanets	Castanets
86	Mute Surdo [EXC6]	Mute Surdo [EXC6]	Mute Surdo [EXC6]	Mute Surdo [EXC6]
87	Open Surdo [EXC6]	Open Surdo [EXC6]	Open Surdo [EXC6]	Open Surdo [EXC6]
88	-----	-----	-----	-----

	10:ORCHESTRA	12:GS ROOM	13:GS BRUSH
24	Bar Chime	Bar Chime	Bar Chime
25	Snare Roll	Snare Roll	Snare Roll
26	Finger Snap	Finger Snap	Finger Snap
27	Close Hi-hat [EXC1]	High Q	High Q
28	Pedal Hi-hat [EXC1]	Slap	Slap
29	Open Hi-hat [EXC1]	Scratch Push [EXC7]	Scratch Push [EXC7]
30	Ride Cymbal	Scratch Pull [EXC7]	Scratch Pull [EXC7]
31	Sticks	Sticks	Sticks
32	Square Click	Square Click	Square Click
33	Metronome Click	Metronome Click	Metronome Click
34	Metronome Bell	Metronome Bell	Metronome Bell
35	Concert BD 2	Std Kick 2	Std Kick 2
C2 36	Concert BD 1	Std Kick 1	Std Kick 1
37	Side Stick	Side Stick	Side Stick
38	Concert SD	Snare Drum 1	Brush Tap
39	Castanets	Hand Clap	Brush Slap
40	Concert SD	Snare Drum 2	Brush Swirl
41	Timpani F	Room Low Tom 2	Low Tom 2
42	Timpani F#	Closed Hi-hat 1 [EXC1]	Closed Hi-hat 1 [EXC1]
43	Timpani G	Room Low Tom 1	Low Tom 1
44	Timpani G#	Pedal Hi-hat 1 [EXC1]	Pedal Hi-hat 1 [EXC1]
45	Timpani A	Room Mid Tom 2	Mid Tom 2
46	Timpani A#	Open Hi-hat 1 [EXC1]	Open Hi-hat 1 [EXC1]
47	Timpani B	Room Mid Tom 1	Mid Tom 1
C3 48	Timpani c	Room Hi Tom 2	High Tom 2
49	Timpani c#	Crash Cymbal 1	Crash Cymbal 1
50	Timpani d	Room Hi Tom 1	High Tom 1
51	Timpani d#	Ride Cymbal 1	Ride Cymbal 1
52	Timpani e	Chinese Cymbal	Chinese Cymbal
53	Timpani f	Ride Bell	Ride Bell
54	Tambourine	Tambourine	Tambourine
55	Splash Cymbal	Splash Cymbal	Splash Cymbal
56	Cowbell	Cowbell	Cowbell
57	Concert Cymbal 2	Crash Cymbal 2	Crash Cymbal 2
58	Vibra-slap	Vibra-slap	Vibra-slap
59	Concert Cymbal 1	Ride Cymbal 2	Ride Cymbal 2
C4 60	High Bongo	High Bongo	High Bongo
61	Low Bongo	Low Bongo	Low Bongo
62	Mute High Conga	Mute High Conga	Mute High Conga
63	Open High Conga	Open High Conga	Open High Conga
64	Low Conga	Low Conga	Low Conga
65	High Timbale	High Timbale	High Timbale
66	Low Timbale	Low Timbale	Low Timbale
67	High Agogo	High Agogo	High Agogo
68	Low Agogo	Low Agogo	Low Agogo
69	Cabasa	Cabasa	Cabasa
70	Maracas	Maracas	Maracas
71	Short Hi Whistle [EXC2]	Short Hi Whistle [EXC2]	Short Hi Whistle [EXC2]
C5 72	Long Low Whistle [EXC2]	Long Low Whistle [EXC2]	Long Low Whistle [EXC2]
73	Short Guiro [EXC3]	Short Guiro [EXC3]	Short Guiro [EXC3]
74	Long Guiro [EXC3]	Long Guiro [EXC3]	Long Guiro [EXC3]
75	Claves	Claves	Claves
76	High Wood Block	High Wood Block	High Wood Block
77	Low Wood Block	Low Wood Block	Low Wood Block
78	Mute Cuica [EXC4]	Mute Cuica [EXC4]	Mute Cuica [EXC4]
79	Open Cuica [EXC4]	Open Cuica [EXC4]	Open Cuica [EXC4]
80	Mute Triangle [EXC5]	Mute Triangle [EXC5]	Mute Triangle [EXC5]
81	Open Triangle [EXC5]	Open Triangle [EXC5]	Open Triangle [EXC5]
82	Shaker	Shaker	Shaker
83	Jingle Bell	Jingle Bell	Jingle Bell
C6 84	Bell Tree	Bell Tree	Bell Tree
85	Castanets	Castanets	Castanets
86	Mute Surdo [EXC6]	Mute Surdo [EXC6]	Mute Surdo [EXC6]
87	Open Surdo [EXC6]	Open Surdo [EXC6]	Open Surdo [EXC6]
88	Applause	----	----

----- : No sound.

[EXC] : will not sound simultaneously with other percussion instruments of the same number.

Drum/SFX Set List

SFX Set

* When SFX Set has been selected, each key plays a different sound effect.

2:SOUND EFFECT	
	39 High Q
40	Slap
	Scratch Push [EXC7]
41	Scratch Pull [EXC7]
	42 Sticks
43	Square Click
	44 Metronome Click
45	Metronome Bell
	46 Guitar sliding Finger
47	Guitar cutting noise (down)
C3	49 Guitar cutting noise (up)
	50 Siring slap of double bass
	51 Fl.Key Click
52	Laughing
	Screaming
53	Punch
	54 Heart Beat
55	Footsteps1
	56 Footsteps2
57	Applause
	58 Door Creaking
59	Door
C4	60 Scratch
	61 Wind Chimes
62	Car-Engine
	63 Car-Stop
64	Car-Pass
	65 Car-Crash
	66 Siren
67	Train
	68 Jetplane
69	Helicopter
	70 Starship
71	Gun Shot
C5	72 Machine Gun
	73 Lasergun
74	Explosion
	75 Dog
76	Horse-Gallop
	77 Birds
	78 Rain
79	Thunder
	80 Wind
81	Seashore
	82 Stream
83	Bubble
C6	84 Cat
	85

[EXC] : will not sound simultaneously with other percussion instruments of the same number.

Rhythm Pattern List

→ See “Creating a Rhythm Part with Ease” (P.91), “Copying a Rhythm Pattern” (P.104)

No.	Rhythm Pattern (Measure)
R-1	4/4 (1)
R-2	3/4 (1)
R-3	6/8 (1)
R-4	8Beat (1)
R-5	16Beat (1)
R-6	Rock (1)
R-7	Ballad (1)
R-8	Disco (1)
R-9	R&B 1 (1)
R10	R&B 2 (1)
R11	Skip Beat (1)
R12	Shuffle (1)
R13	Triplet (1)
R14	March (1)
R15	Waltz (1)
R16	Swing (1)
R17	BossaNova (2)
R18	Samba (1)
R19	Rhumba (2)
R20	Mambo (2)
R21	Tango (2)
R22	Beguine (2)
R23	CountIn 1 (2)
R24	CountIn 2 (2)
R25	C.InSwing (1)
R26	Ending 1 (1)
R27	Ending 2 (1)
R28	Sticks4/4 (1)
R29	Sticks3/4 (1)
R30	Sticks6/8 (1)

Demo Song List

→ See "An Introduction to the KR-575's Sounds and Tunes—Demo Play" (page 21).

<Piano>

● Grand Piano 1 The Keeper's Tale	John Maul (C)1998 Roland Corporation
● Grand Piano 1 "Noel : December" From "The Seasons", Op. 37 (Excerpt)	P. Tchaikovsky (C)1998 Roland Corporation
● Soft E.Piano Polonaise In A-Major And Variation (Excerpt)	John Maul (C)1998 Roland Corporation
● Harpsichord2 Little Prelude In F-Major BWV. 928	J. S. Bach (C)1998 Roland Corporation

<Organ>

● Church Organ Tocatta And Fuga In D-Minor BWV. 565 (Excerpt)	J. S. Bach (C)1996 Roland Corporation
● Jazz Organ1 + Rock Organ2	Music Brains (C)1996 Roland Corporation
● Theater Organ	Jonas Nordwall (C)1996 Rodgers Instrument Corporation
● Acordion Clarinet Polka (Excerpt)	Polish Folksong (C)1998 Roland Corporation

<Others>

● Rich Choir Amazing Grace	American Folksong (C)1998 Roland Corporation
● Flute Meditation From "Thäs" (Excerpt)	J. Massenet (C)1998 Roland Corporation
● Nylon Guitar Greensleeves	English Folksong (C)1998 Roland Corporation
● Harp "Pizzicato" From Opera "Sylvia" (Excerpt)	L. Delibes (C)1998 Roland Corporation
● Jazz Band Little Brown Jog	American Folksong (C)1998 Roland Corporation

● Rock Band		
Distortion Guitar	Music Brains	(C)1998 Roland Corporation
● Symphonic Orchestra		
Scene from "The Swan Lake" Op. 20 (Excerpt)	P. Tcshaikovsky	(C)1998 Roland Corporation
● Latin Band		
Kizmet's Salsa: "The Polovtsian Dance" from Opera "Prince Igor"	A. Borodin, Arranged by John Maul	(C)1998 Roland Corporation
A La Salsa (Excerpt)		
● SFX		
In A Forest	---	(C)1998 Roland Corporation

* All rights reserved. Unauthorized use of this material for purposes other than private, personal enjoyment is a violation of applicable laws.

* No data for the music that is played will be output from MIDI OUT.

Profile

Jonas Nordwall

A native of Portland, Mr. Nordwall received his Bachelor of Music Degree in 1970 from the University of Portland studying with Arthur Hitchcock. Additional study was done with Frederick Geoghegan, the noted English/Canadian organist. As a teenager, Jonas had the privilege to study with Richard Ellsasser, one of the greatest virtuoso organist of this century. Besides serving as Director of Music for the First United Methodist Church in Portland, Oregon and as the Organist for the Oregon Symphony Orchestra. He has been a featured recitalist for national conventions of the American Theatre Organ Society and was Organist of the year for 1987.

John Maul

Music by John Maul Copyright © 1998, Roland UK

John Maul is a musician, composer and arranger having graduated from the Royal Academy of Music in London. John's work encompasses studio recordings and live performances including work with top UK Jazz artists.

His writing credits include commercial music for BBC radio and television, as well as scoring jazz and classical works.

Having been a product specialist for Roland U.K., John is now actively involved in music software composing/programming for both Roland Japan and various music publishers. Quite recently his "Musical Picture Book", a volume of original piano music encompassing all standards of musical ability, which included the piano and orchestral accompaniment data in SMF format, was published and printed.

Music Brains

This is a music creating company established on April 3rd 1992 in Tokyo where it has been mainly working. We make CD's, video BGM, CM, animation music, Karaoke, etc. in our own recording studio. Also, we develop electronic musical instruments, send players, publish manuals, etc. Regarding Roland SMF music data, we have created various titles with the theme of searching reality in music, and have been highly estimated.

Effects List

Display	Description
Chorus	Makes sounds broader and fatter.
Stereo.Chorus	A stereo chorus (stereo chorus).
Hexa Chorus	A multilayer chorus.
Tremolo Chorus	A chorus with a tremolo effect (tremolo chorus).
Space D	A clear chorus.
Rotary	Adds a rotary-speaker effect.
Stereo Delay	Delays the sound with a stereo effect.
Modulation.Delay	Adds a wavering effect to the delayed sound (modulation delay).
Triple Tap Delay	A three-way delay (triple tap delay).
Quadruple Tap Delay	A four-way delay (quadruple tap delay).
Phaser	Adds undulations to the sound.
Stereo Flanger	Adds metallic reverberations (stereo flanger).
Step Flanger	A flanger that varies the pitch in a stepwise fashion.
Enhancer	Adds modulation to the sound.
Overdrive	Applies soft distortion to the sound.
Distortion	Applies hard distortion to the sound.
Auto Wah	Changes the tone in a cyclical manner.
Compressor	Suppresses fluctuations in volume.
Gate Reverb	Cuts off the reverberations before they fade away completely.
2-V Pitch Shifter	Adds two pitch-shifted sounds to the original sound (two-voice pitch shifter).
FB Pitch Shifter	Adds a single pitch-shifted sound to the original sound (feedback pitch shifter).
Enhancer-Chorus	Applies both enhancer and chorus effects.
Enhancer-Flanger	Applies both enhancer and flanger effects.
Enhancer-Delay	Applies both enhancer and delay effects.
Chorus-Delay	Applies both chorus and delay effects.
Flanger-Delay	Applies both flanger and delay effects.
Overdrive-Chorus	Applies both overdrive and chorus effects.
Overdrive-Flanger	Applies both overdrive and flanger effects.
Overdrive-Delay	Applies both overdrive and delay effects.
Distortion-Chorus	Applies both distortion and chorus effects.
Distortion-Flanger	Applies both distortion and flanger effects.
Distortion-Delay	Applies both distortion and delay effects.
Sympathetic Resonance	Applies a resonance effect when the damper pedal is depressed.
Wave Chorus	Produces a chorus with strong undulations.
2 Band Chorus	Applies different chorus effects in the treble and bass bands.
Space Chorus	A chorus with extremely small undulations.
Chorus-Flanger	Applies both chorus and flanger effects.
Rhodes Multi	the optimal effect for an electric piano.
Clean Guitar Multi	Applies an effect that combines compressor, chorus, and delay
Tremolo	Produces cyclical changes in volume.
Auto Pan	Makes the sonic position of the sound move to the left or right.

Music Files That the KR-575 Can Use

What Are Music Files?

Music files contain information describing the details of a musical performance, such as "the C3 key on a keyboard was pressed for this amount of time, using this amount of force." By inserting the floppy disk into the disk drive on the KR-575, the performance information is sent from the floppy disk to the piano, and played faithfully by the piano. This is different than a CD, since the music file does not contain a recording of the sound itself. This makes it possible to erase certain parts, or to change instruments, tempos and keys freely, allowing you to use it in many different ways.

Regarding Copyright

Using existing copyrighted material (commercially available SMF music files, etc.) to create your own composition is permitted only for your private, personal enjoyment. Be aware that any other use may constitute copyright infringement. Roland Corporation assume no responsibility whatever for any copyright infringement that may result from a work that you create.

The KR-575 allows you to use the following music files

Floppy disks saved on a Roland MT Series, or Roland Piano Digital HP-G/KR Series instrument

Roland Digital Piano Compatible music files

Roland's original music file is made specifically for practicing the piano. Some follow an instructional curriculum, allowing for a complete range of lessons, such as "practicing each hand separately" or "listening to only the accompaniment." This format is called "i-format".

SMF Music files (720KB/1.44MB format)

SMFs (Standard MIDI Files) use a standard format for music file that was formulated so that files containing music file could be widely compatible, regardless of the manufacturer of the listening device. An enormous variety of music is available, whether it be for listening, for practicing musical instruments, for Karaoke, etc.

If you wish to purchase SMF music files, please consult the retailer where you purchased your KR-575.

** Before using music files, read p.45, "Listening to Music Files".*

About the KR-575 Sound Generator

The KR-575 come equipped with GM / GS sound generators.

General GM System

The General MIDI system is a set of recommendations which seeks to provide a way to go beyond the limitations of proprietary designs, and standardize the MIDI capabilities of sound generating devices. Sound generating devices and music data that meets the General MIDI standard bears the General MIDI logo. Music data bearing the General MIDI logo can be played back using any General MIDI sound generating unit to produce essentially the same musical performance.

GS format

The GS Format is Roland's set of specifications for standardizing the performance of sound generating devices. In addition to including support for everything defined by the General MIDI System, the highly-compatible GS Format additionally offers an expanded number of sounds, provides for the editing of sounds, and spells out many details for a wide range of extra features, including effects such as reverb and chorus.

Designed with the future in mind, the GS Format can readily include new sounds and support new hardware features when they arrive.

Since it is upwardly compatible with the General MIDI System, Roland's GS Format is capable of reliably playing back GM Scores equally as well as it performs GS Music Data (music data that has been created with the GS Format in mind).

This product supports both the General MIDI system and the GS format, and can be used to play back music data carrying either of these logos.

Main Specifications

<Keyboard>

88 keys (Hammer Action Mechanism)

Touch Sensitivity

Preset: 3 levels, User: 100 levels

Keyboard Mode

Whole
Split (adjustable split point)
Layer
Arranger
Piano Style Arranger
Manual Drum/SFX

<Sound Source>

Comforms to GM/GS

Max. Polyphony

64 Voices

Tones

8 groups 499 variations
(incl. 12 drum sets, 1 SFX set)
Footage Organ Edit

Temperament

8 types, selectable tonic

Stretched Tuning

2 types

Master Tuning

415.3Hz–466.2Hz (0.1Hz Steps)

Transpose

Key Transpose (-6–+5 Half-steps)
Playback Transpose (-24–+24 Half-steps)

Effects

Reverb (8 types, Stepless adjustable)
Chorus (8 types)
Sympathetic Resonance, Rotary and 40 other types
Physical Damper Simulation

<Arranger>

Music Styles

Internal: 12 groups
133 styles x 4 types (Style Orchestrator)
22 Pianist Styles
Music Style Disk: 30 Styles

Programmable Music Styles

Style Converter
Style Composer

Melody Intelligence

24 types

User Programs

Internal: 32
Floppy Disk: Max. 99 sets

Control

Start/Stop
Intro/Ending (2 types for each styles)
Sync. Start
Fill In (Variation/Original)
Melody Intelligence
Break
Leading Bass
Half Fill In (Variation/Original)

<Composer>

Metronome

Beat: 2/2, 0/4, 2/4, 3/4, 4/4, 5/4, 6/4, 7/4, 3/8,
6/8, 9/8, 12/8
Volume: 10 levels
Metronome Pattern: 11 patterns
Sounds: 6 types

Tracks

5/16 tracks

Song

1 song

Note Storage

Approx. 30,000 notes

Tempo

Quarter note = 20–250

Resolution

120 ticks per quarter note

Recording Method

Realtime (Replace, Mix, Auto Punch In, Manual
Punch In, Loop, Tempo)
Step (On Chord Sequence mode)
Beat Map

Edit

Copy, Quantize, Delete, Insert, Erase, Transpose,
Part Exchange, Note Edit, PC Edit



Rhythm Pattern

30 types

Control

Song Select, Reset, Stop, Play, Rec, Bwd, Fwd, All song Play, Track Select, Count In, Playback Balance, Maker Set, Repeat, Tempo Mute

<Disk Drive/Disk Storage>

3.5 inch Micro Floppy Disk Drive

Disk Format

720 K bytes (2DD) /1.44 M bytes (2HD)

Songs

Max. 99 songs

Note Storage

Approx. 120,000 notes (2DD)

Approx. 240,000 notes (2HD)

Playable Software

Standard MIDI Files (Format 0/1)

Roland Original Format (i-format)

Save

Standard MIDI Files (Format 0)

Roland Original Format (i-format)

<Others>

Rated Power Output

40 W x 2

Speakers

20 cm x 2,5 cm x 2

Display

Beat Indicator

Graphic 320 x 128 dot backlit LCD

Language

English/Japanese

Help Language

English/German/French/Spanish/Japanese

Lyric

Yes (Built-in Display, MIDI Out)

Control

Volume, Microphone Volume, Microphone Echo, Brilliance

One Touch Play

One Touch Piano, One Touch Organ, One Touch Arranger

Pedals

Damper (half-pedal recognition)

Soft (half-pedal recognition, Function assignable)

Sostenute (Function assignable)

Vocal Effects

Voice transformer

Harmonist

Other Functions

Games, on-screen help, Audition

Panel Lock

Connectors

Output jacks (L/Mono, R)

Input jacks (L/Mono, R)

Microphone jack (with echo)

Headphone jack x 2 (Stereo)

MIDI In connector x 2

MIDI Out connector

Computer connector

Pedal connector (8 pin DIN type)

Power Supply

AC 117 V / AC 230 V / AC 240 V

Power Consumption

115 W (117 V) / 95 W (230 V) / 95 W (240 V)

Cabinet Finish

Satin mahogany (KR-575)

Polished mahogany (KR-575P)

Dimensions (Including the stand)

1,445 (W) x 528 (D) x 820 (H) mm

56-15 (W) x 20-13/16 (D) x 36-1/4 (H) inches

Weights(Including the stand)

70.0 kg / 154 lbs 5 oz (KR-575)

71.0 kg / 156 lbs 8 oz (KR-575P)

Accessories

Owner's manual

Power Cord

Music Style Disk

* In the interest of product improvement, the specifications and/or appearance of this unit are subject to change without prior notice.

Glossary

Arrange

This is an abbreviation of "Arrangement." It refers to changes that have been made in an original tune, by adding a new accompaniment or by changing the instruments used.

Automatic Accompaniment

The KR-575 automatically plays accompaniment when just a few keys in the lower section of the keyboard are pressed to specify the chord. This is called the "One-touch Arranger" (p.31).

Bouncing Ball

The flashing dot that moves in a semicircular pattern across the screen of the KR-575 is called a "Bouncing Ball" (p.30).

Chord

Two or more notes sounding at the same time (p.26, 61).

Division

The six performance states that make up a Music Style are called "Divisions" (page 58).

Drum Set

A Drum Set is a collection of percussive instrument sounds. With drum sets, a different sound can be heard for each key on the keyboard. The special effects sound set is called the "SFX Set" (p.153).

Edit

Editing is to change the song you have recorded, such as by erasing part of the song, or copying a measure (p.100).

Ending

This is the last part of the accompaniment. When you stop playing the automatic accompaniment, the KR-575 plays an ending appropriate for the style (p. 62).

Ensemble

A combined performance of two or more instruments is called an "Ensemble."

Icon

The on-screen graphics that appear three dimensional work like buttons. These are called "Icons."

Intro

This is the introductory portion of an automatic accompaniment performance. The KR-575 plays an intro ideally suited to each style when it starts playing the automatic accompaniment (p.61).

Key Touch

This is the sensation of heaviness—the "touch"—of the keys when the keyboard is played. The KR-575 100 levels of adjustment (p.124).

Layer Play

Playing with two different tones on a key simultaneously is called "Layer Play" (p.54).

Music Style

Music Styles are performance patterns in various musical genres. A Music Style is played automatically in accord with the specified chord using the KR-575's One-touch Arranger Function (p.58).

Part

On the KR-575, "Part" can have two different meanings. One meaning refers to a performance part (p.58), such as the right-hand part of a piano song. The other refers to the 16 parts in the 16-track sequencer (p.85).

Pickup

A song with a pickup does not start on the first beat (p.92).

Playback

The KR-575 plays back the performance data (p.46).

PU (Pickup)

A song that does not start on the first beat starts with what is called a pickup. When playing a pickup song, the measures will be shown in the display as "PU, 1, 2...".

Save

Saving is storing the recorded performance data onto a floppy disk (p.42).

Sound Generator

The sound generator of the KR-575 supports GM/GS, and can play 499 different sounds (p.149).

Split

The division of the keyboard into upper and lower zones is referred to as "Split," and different tones can be played in the keys on different sides of the key that acts as the boundary between the upper part and lower part (p.56).

Standard Pitch

The pitch of the sound created by playing the middle A on the keyboard is called the "Standard Pitch." Changing the standard pitch of the KR-575 is called "Master Tuning," and tuning to other musical instrument is called "Tuning" (p.131).

Tone

Tones are the musical instruments or effect sounds stored in the internal memory of the KR-575. The display shows "TONE".

Tuning Curves

Graphic representations of the changes in pitch of the equally-tempered tuning versus those of actual tunings are called "Tuning Curves" (p.125).

Index

A

Ambience	123
All Song Play	46
Arrangement	64
Auftakt.....	46, 92
Automatic Accompaniment	31, 58

B

Bass Tone	62, 128
Beat Map	95
Beat Indicator	12
Bend Range.....	120, 130
Blank Recording.....	83
Bouncing Ball.....	30
Break	118
Brilliance.....	20
Bwd(Backward).....	71

C

Chord Finder	66
Chord Intelligence	66
Chord Selector.....	98
Chord Tone.....	62, 128
Chorus Effect.....	89, 132
Computer Switch.....	136
Connectors.....	136
Copy	
Measure	103
Rhythm Pattern	104
Count In	70

D

Delete	
Measure	105
Recording Song	39
Recording Track.....	39
Disk Song	118
User Style	118
User Program.....	118
Demo Play.....	21
Disk Drive	40
Division	58
Drum Set	26, 153

E

Easy Play	23
Edit	100
Effects	53, 160
Eject Button.....	40
Ending	58, 62
Ensemble.....	85
Erase.....	107

F

Factory Preset	135
Fade In/Out.....	119
Fill In.....	58, 63
Floppy Disk	
Format.....	40
Saving Song	42
Listening to the Music Style	45
Saving User Style	117
Saving User Program.....	121
Delete Song or User Program.....	118
Footage	25, 126
Fwd(Forward)	71

G

General MIDI.....	161
Glide	119
GS.....	161

H

Headphone	18
Help Function.....	20

I

i-format.....	44, 161
Icon.....	15
Insert	106
Intro	58,61

K

Karaoke	48
Key Touch.....	124
Key Transpose.....	76

L

Language.....	133
Layer	54
Leading Bass.....	118
Local Control.....	139
Loop Recording.....	83
Lower Part	56
Lyric	52, 133

N

Note Edit	110
-----------------	-----

M

Marker	72
Master Tuning	131
Melody Intelligence.....	67
Memory Backup.....	134
Metronome	28
Mic Echo.....	49
Microphone.....	48
MIDI.....	138
Minus One	89
MIX Recording	82
Music Style.....	31, 58
Music Files	45, 161

Mute.....78, 88,116

O

Octave Shift.....120
 One Touch Program Arranger.....31,58
 One Touch Program Organ.....25
 One Touch Program Piano.....24

P

Panel Lock.....122
 Panpot.....90
 Part
 16 Track Sequencer.....85
 Music Style.....58
 Part Exchange.....109
 PC Edit.....111
 Pedal
 About Pedal.....18
 Changing Function.....118
 Pedal Mode.....124
 Phrase.....65
 Piano Partner.....79
 Piano Style Arranger.....68
 Program Change.....111
 Protect Tab.....41
 PU(Pick up).....46, 92
 Punch In Recording.....84

Q

Quantize.....102

R

Recording
 Truck Button.....35
 16 Truck Sequencer.....85
 Repeat.....74
 Replace Recording.....81
 Resonance.....126
 Reverb Effect.....53, 89, 132
 Rhythm Pattern.....60, 91, 104, 157
 Rotary Effect.....25

S

Save
 Performance Data.....42
 User Style.....117
 User Program.....121
 Sequencer(16 Track Sequencer).....85
 SFX Set.....26, 156
 SMF.....44, 161
 Song Edit.....100
 Song Play.....45
 Sound Generator.....161
 Split.....56
 Split Point.....56, 129
 Standard MIDI Files.....44, 161
 Standard Pitch.....131
 Stretch Tuning.....125

Style Composer.....116
 Style Converter.....114
 Style Finder.....60
 Style Orchestrator.....64
 Sync Start.....61
 Sympathetic Resonance.....123

T

Tempo
 Changing the Tempo.....69
 Tempo Mute.....70
 Tempo Recording.....93
 Temperament.....125
 Tone.....27, 149
 Touch Screen
 About Touch Screen.....15
 Calibration.....133
 Track Button.....35, 78
 Transpose
 Key Transpose.....76
 Playback Transpose.....77
 Individual Part.....108
 Tuning
 Stretch Tuning.....125
 Master Tuning.....131

U

Undo.....101
 Upper Part.....56
 User Style.....114
 User Program.....121

V

Velocity.....110
 Vocal Effects
 Harmonist.....51
 Voice Transformer.....50
 Volume
 Master.....20
 Metronome.....30
 Microphone.....48
 Music Style.....113
 16 Part.....88
 Volume Balance
 Between the song (Accompaniment) and the
 Keyboard.....34

MIDI Implementation Chart

Function...		Transmitted	Recognized	Remarks
Basic Channel	Default Changed	1 1-16	1-16 1-16	
Mode	Default Messages Altered	Mode 3 x *****	Mode 3 Mode 3, 4(M=1)	* 2
Note Number :	True Voice	15-113 *****	0-127 0-127	
Velocity	Note ON Note OFF	O x 8n v=64	O x	
After Touch	Key's Ch's	x x	O *1 O *1	
Pitch Bend		O	O	
Control Change	0, 32	O	O *1	Bank select
	1	O *1	O *1	Modulation
	5	O *1	O *1	Portamento time
	6, 38	O *1	O *1	Data entry
	7	O	O *1	Volume
	10	O *1	O *1	Panpot
	11	O *1	O *1	Expression
	64	O	O *1	Hold 1
	65	O *1	O *1	Portamento
	66	O	O *1	Sostenuto
	67	O	O *1	Soft
	84	O *1	O *1	Portamento control
	91	O	O (Reverb)	Effect1 depth
93	O	O (Chorus)	Effect3 depth	
98, 99	O *1	O *1	NRPN LSB, MSB	
100, 101	O *1	O *1	RPN LSB, MSB	
Prog Change	: True #	O 0-127 *****	O 0-127	Program number 1-128
System Exclusive		O	O	
System Common	: Song Pos : Song Sel : Tune	x x x	x x x	
System Real Time	: Clock : Commands	O x	x x	
Aux Message	: All sound off : Reset all controllers : Local Control : All Notes OFF : Active Sense : Reset	x x x x O x	O (120, 126, 127) O O O (123-125) O x	
Notes	* 1 O x is selectable by SysEx. * 2 Recognized as M=1 even if M≠1.			

Mode 1 : OMNI ON, POLY

Mode 2 : OMNI ON, MONO

O : Yes

Mode 3 : OMNI OFF, POLY

Mode 4 : OMNI OFF, MONO

X : No

MEMO

Information

When you need repair service, call your nearest Roland Service Center or authorized Roland distributor in your country as shown below.

ARGENTINA

Instrumentos Musicales S.A.
Florida 638
(1005) Buenos Aires
ARGENTINA
TEL: (01) 394 4029

BRAZIL

Roland Brasil Ltda.
R. Coronel Octaviano da Silveira
203 05522-010
Sao Paulo BRAZIL
TEL: (011) 843 9377

CANADA

Roland Canada Music Ltd.
(Head Office)
5480 Parkwood Way Richmond
B. C., V6V 2M4 CANADA
TEL: (0604) 270 6626

Roland Canada Music Ltd.
(Toronto Office)
Unit 2, 109 Woodbine Downs
Blvd, Etobicoke, ON
M9W 6Y1 CANADA
TEL: (0416) 213 9707

MEXICO

Casa Veerkamp, s.a. de c.v.
Av. Toluca No. 323 Col. Olivar de
los Padres 01780 Mexico D.F.
MEXICO
TEL: (525) 668 04 80

La Casa Wagner de
Guadalajara s.a. de c.v.
Av. Corona No. 202 S.J.
Guadalajara, Jalisco Mexico
C.P. 44100 MEXICO
TEL: (03) 613 1414

PANAMA

Productos Superiores, S.A.
Apartado 655 - Panama 1
REP. DE PANAMA
TEL: 26 3322

U. S. A.

Roland Corporation U.S.
7200 Dominion Circle
Los Angeles, CA. 90040-3696,
U. S. A.
TEL: (0213) 685 5141

VENEZUELA

Musiland Digital C.A.
Av. Francisco de Miranda,
Centro Parque de Cristal, Nivel
C2 Local 20 Caracas
VENEZUELA
TEL: (02) 285 9218

AUSTRALIA

Roland Corporation
Australia Pty. Ltd.
38 Campbell Avenue
Dee Why West. NSW 2099
AUSTRALIA
TEL: (02) 9982 8266

NEW ZEALAND

Roland Corporation (NZ) Ltd.
97 Mt. Eden Road, Mt. Eden.
Auckland 3, NEW ZEALAND
TEL: (09) 3098 715

CHINA

Beijing Xinghai Musical
Instruments Co., Ltd.
6 Huangmuyang Chao Yang
District, Beijing, CHINA
TEL: (010) 6774 7491

HONG KONG

Tom Lee Music Co., Ltd.
Service Division
22-32 Pun Shan Street, Tsuen
Wan, New Territories,
HONG KONG
TEL: 2415 0911

INDIA

Rivera Traders Pvt. Ltd.
409, Nirman Kendra,
off Dr. Edwin Moses Road,
Mumbai 400011, INDIA
TEL: (022) 498 3079

INDONESIA

PT Galestra Inti
Kompleks Perkantoran
Duta Merlin Blok E No.6-7
Jl. Gajah Mada No.3-5,
Jakarta 10130,
INDONESIA
TEL: (021) 6335416

KOREA

Cosmos Corporation
Service Station
261 2nd Floor Nak-Won Arcade
Jong-Ro ku, Seoul, KOREA
TEL: (02) 742 8844

MALAYSIA

Bentley Music SDN BHD
140 & 142, Jalan Bukit Bintang
55100 Kuala Lumpur, MALAYSIA
TEL: (03) 2443333

PHILIPPINES

G.A. Yupangco & Co. Inc.
339 Gil J. Puyat Avenue
Makati, Metro Manila 1200,
PHILIPPINES
TEL: (02) 899 9801

SINGAPORE

Sing Lee Company
BLOCK 231, Bain Street #03-23
Bras Basah Complex,
SINGAPORE 180231
TEL: 3367886

CRISTOFORI MUSIC PTE LTD

Blk 3014, Bedok Industrial Park E,
#02-2148, SINGAPORE 489980
TEL: 243 9555

TAIWAN

ROLAND TAIWAN
ENTERPRISE CO., LTD.
Room 5, 9th. No. 112 Chung Shan
N.Road Sec.2, Taipei, TAIWAN,
R.O.C.
TEL: (02) 2561 3339

THAILAND

Theera Music Co., Ltd.
330 Veng Nakhorn Kasem, Soi 2,
Bangkok 10100, THAILAND
TEL: (02) 2248821

VIETNAM

Saigon music distributor
160 Nguyen Dinh Chieu St. Dist 3
Ho chi minh City
VIETNAM
TEL: 88-242531

BAHRAIN

Moon Stores
Bab Al Bahrain Road,
P.O.Box 20077
State of BAHRAIN
TEL: 211 005

ISRAEL

Haliit P. Greenspoon &
Sons Ltd.
8 Retzif Fa'aliya Hashnya St.
Tel-Aviv-Yaho ISRAEL
TEL: (03) 682366

JORDAN

AMMAN Trading Agency
Prince Mohammed St. P. O. Box
825 Amman 11118 JORDAN
TEL: (06) 641200

KUWAIT

Easa Husain Al-Yousifi
P.O. Box 126 Safat 13002
KUWAIT
TEL: 5719499

LEBANON

A. Chahine & Fils
P.O. Box 16-5857 Gergi Zeidan St.
Chahine Building, Achrafieh
Beirut, LEBANON
TEL: (01) 335799

OMAN

OHI Electronics & Trading
Co. LLC
P. O. Box 889 Muscat
Sultanate of OMAN
TEL: 959085

QATAR

Badie Studio & Stores
P.O.Box 62,
DOHA QATAR
TEL: 423554

SAUDI ARABIA

Abdul Latif S. Al-Ghamdi
Trading Establishment
Middle East Commercial Center
Al-Khobar Dharan Highway
P.O. Box 3631 Al-Khobar
31952 SAUDI ARABIA
TEL: (03) 898 2332

aDawlah Universal

Electronics APL
P.O.Box 2154 ALKHOBAR 31952,
SAUDI ARABIA
TEL: (03) 898 2081

SYRIA

Technical Light & Sound
Center
Khaled Ibn Al Walid St.
P.O.Box 13520
Damascus - SYRIA
TEL: (011) 2235 384

TURKEY

Barkat Muzik aletleri ithalat
ve ihracat limited ireketi
Sirasevler Cad. Guney Ishani No.
86/6 Taksim, Istanbul TURKEY
TEL: (0212) 2499324

U.A.E

Zak Electronics & Musical
Instruments Co.
Zabeel Road, Al Sherouq Bldg.,
No. 14, Grand Floor DUBAI
U.A.E.
P.O. Box 8050 DUBAI, U.A.E
TEL: (04) 360715

EGYPT

Al Fanny Trading Office
P.O.Box 2904,
El Horneh Heliopolos, Cairo,
EGYPT
TEL: (02) 4171828
(02) 4185531

KENYA

Musik Land Limited
P.O.Box 12183 Moi Avenue
Nairobi Republic of KENYA
TEL: (2) 338 346

REUNION

Maison FO - YAM Marcel
25 Rue Jules Mermet ZL
Chaudron - BP79 97491
Ste Clotilde REUNION
TEL: 28 29 16

SOUTH AFRICA

That Other Music Shop
(PTY) Ltd.
11 Melle Street (Cnr Melle and
Juta Street)
Braamfontein 2001
Republic of SOUTH AFRICA
TEL: (011) 403 4105

Paul Bothner (PTY) Ltd.

17 Werdmuller Centre Claremont
7700
Republic of SOUTH AFRICA
TEL: (021) 64 4030

AUSTRIA

E. Dematte & Co.
Neu-Rum Siemens-Strasse 4
6063 Innsbruck AUSTRIA
TEL: (0512) 26 44 260

BELGIUM/HOLLAND/ LUXEMBOURG

Roland Benelux N. V.
Houtstraat 3 B-2260 Oevel
(Westerlo) BELGIUM
TEL: (014) 575811

BELORUSSIA

TUSHE
UL. Rabkorovskaya 17
220001 MINSK
TEL: (0172) 764-911

CYPRUS

Radex Sound Equipment Ltd.
17 Diagorou St., P.O.Box 2046,
Nicosia CYPRUS
TEL: (02) 453 426

DENMARK

Roland Scandinavia A/S
Langebrogade 6 Post Box 1937
DK-1023 Copenhagen K.
DENMARK
TEL: 32 95 3111

FRANCE

Roland France SA
4, Rue Paul Henri SPAAK
Parc de l'Esplanade F 77 462 St.
Thibault Lagny Cedex FRANCE
TEL: 01 600 73 508

FINLAND

Roland Scandinavia As,
Filial Finland
Lauttasaarentie 54 B
Fin-00201 Helsinki, FINLAND
TEL: (9) 682 4020

GERMANY

Roland Elektronische
Musikinstrumente
Handelsgesellschaft mbH.
Oststrasse 96, 22844 Norderstedt,
GERMANY
TEL: (040) 52 60090

GREECE

V. Dimitriadis & Co. Ltd.
20, Alexandras St. & Bouboulinas
54 St. 106 82 Athens, GREECE
TEL: (01) 8232415

HUNGARY

Intermusica Ltd.
Warehouse Area "DEPO" Pf.83
H-2046 Torokbalint, HUNGARY
TEL: (23) 511011

IRELAND

The Dublin Service Centre
Audio Maintenance Limited
11 Brunswick Place Dublin 2
Republic of IRELAND
TEL: (01) 677322

ITALY

Roland Italy S. p. a.
Viale delle Industrie, 8
20020 Arese Milano, ITALY
TEL: (02) 937 781

NORWAY

Roland Scandinavia Avd.
Kontor Norge
Lilleakerveien 2 Postboks 95
Lilleaker N-0216 Oslo
NORWAY
TEL: 273 0074

POLAND

P. P. H. Brzostowicz Marian
UL. Blokowa 32, 03624 Warszawa
POLAND
TEL: (022) 679 44 19

PORTUGAL

Caius - Tecnologias Audio e
Musica , Lda.
Rue de SANTA Catarina 131
4000 Porto, PORTUGAL
TEL: (02) 38 4456

RUSSIA

Slami Music Company
Sadovaya-Triumfalnaya st., 16
103006 Moscow, RUSSIA
TEL: 095 209 2193

SPAIN

Roland Electronics
de España, S. A.
Calle Bolivia 239 08020 Barcelona,
SPAIN
TEL: (93) 308 1000

SWEDEN

Roland Scandinavia A/S
SWEDISH SALES OFFICE
Danvik Center 28, 2 tr.
S-131 30 Nacka SWEDEN
TEL: (08) 702 0020

SWITZERLAND

Roland (Switzerland) AG
Musitronic AG
Gerberstrasse 5, CH-4410 Liestal,
SWITZERLAND
TEL: (061) 921 1615

UKRAINE

TIC-TAC
Mira Str. 19/108
P.O.Box 180
295400 Munkachevo, UKRAINE
TEL: (03131) 414-40

UNITED KINGDOM

Roland (U.K.) Ltd., Swansea
Office
Atlantic Close, Swansea
Enterprise Park SWANSEA
West Glamorgan SA7 9FJ,
UNITED KINGDOM
TEL: (01792) 700139



This product complies with the requirements of European Directives EMC 89/336/EEC and LVD 73/23/EEC.

For EU Countries

FEDERAL COMMUNICATIONS COMMISSION RADIO FREQUENCY INTERFERENCE STATEMENT

This equipment has been tested and found to comply with the limits for a Class B digital device, pursuant to Part 15 of the FCC Rules. These limits are designed to provide reasonable protection against harmful interference in a residential installation. This equipment generates, uses, and can radiate radio frequency energy and, if not installed and used in accordance with the instructions, may cause harmful interference to radio communications. However, there is no guarantee that interference will not occur in a particular installation. If this equipment does cause harmful interference to radio or television reception, which can be determined by turning the equipment off and on, the user is encouraged to try to correct the interference by one or more of the following measures:

- Reorient or relocate the receiving antenna.
- Increase the separation between the equipment and receiver.
- Connect the equipment into an outlet on a circuit different from that to which the receiver is connected.
- Consult the dealer or an experienced radio/TV technician for help.

Unauthorized changes or modification to this system can void the users authority to operate this equipment.
This equipment requires shielded interface cables in order to meet FCC class B Limit.

For the USA

NOTICE

This Class B digital apparatus meets all requirements of the Canadian Interference-Causing Equipment Regulations.

AVIS

Cet appareil numérique de la classe B respecte toutes les exigences du Règlement sur le matériel brouilleur du Canada.

For Canada

 Roland®

71125645

UPC

71125645



10981