

Roland®



KR-377 DIGITAL INTELLIGENT PIANO

Owner's Manual

Before using this unit, carefully read the sections entitled: "IMPORTANT SAFETY INSTRUCTIONS" (p. 2), "USING THE UNIT SAFELY" (p. 3), and "IMPORTANT NOTES" (p. 5). These sections provide important information concerning the proper operation of the unit. Additionally, in order to feel assured that you have gained a good grasp of every feature provided by your new unit, Owner's Manual should be read in its entirety. The manual should be saved and kept on hand as a convenient reference

Copyright © 2000 ROLAND CORPORATION

All rights reserved. No part of this publication may be reproduced in any form without the written permission of ROLAND CORPORATION.

 <div style="display: inline-block; border: 1px solid black; padding: 2px; text-align: center; font-weight: bold; font-size: 0.8em;"> CAUTION <small>RISK OF ELECTRIC SHOCK DO NOT OPEN</small> </div> 
ATTENTION. RISQUE DE CHOC ELECTRIQUE NE PAS OUVRIIR
<p style="text-align: center; margin: 0;">CAUTION: TO REDUCE THE RISK OF ELECTRIC SHOCK, DO NOT REMOVE COVER (OR BACK). NO USER-SERVICEABLE PARTS INSIDE. REFER SERVICING TO QUALIFIED SERVICE PERSONNEL.</p>



The lightning flash with arrowhead symbol, within an equilateral triangle, is intended to alert the user to the presence of uninsulated "dangerous voltage" within the product's enclosure that may be of sufficient magnitude to constitute a risk of electric shock to persons.



The exclamation point within an equilateral triangle is intended to alert the user to the presence of important operating and maintenance (servicing) instructions in the literature accompanying the product.

INSTRUCTIONS PERTAINING TO A RISK OF FIRE, ELECTRIC SHOCK, OR INJURY TO PERSONS.

IMPORTANT SAFETY INSTRUCTIONS

SAVE THESE INSTRUCTIONS

WARNING - When using electric products, basic precautions should always be followed, including the following:

- | | |
|--|--|
| <ol style="list-style-type: none"> 1. Read these instructions. 2. Keep these instructions. 3. Heed all warnings. 4. Follow all instructions. 5. Do not use this apparatus near water. 6. Clean only with a damp cloth. 7. Do not block any of the ventilation openings. Install in accordance with the manufacturers instructions. 8. Do not install near any heat sources such as radiators, heat registers, stoves, or other apparatus (including amplifiers) that produce heat. 9. Do not defeat the safety purpose of the polarized or grounding-type plug. A polarized plug has two blades with one wider than the other. A grounding type plug has two blades and a third grounding prong. The wide blade or the third prong are provided for your safety. When the provided plug does not fit into your outlet, consult an electrician for replacement of the obsolete outlet. | <ol style="list-style-type: none"> 10. Protect the power cord from being walked on or pinched particularly at plugs, convenience receptacles, and the point where they exit from the apparatus. 11. Only use attachments/accessories specified by the manufacturer. 12. Never use with a cart, stand, tripod, bracket, or table except as specified by the manufacturer, or sold with the apparatus. When a cart is used, use caution when moving the cart/apparatus combination to avoid injury from tip-over. 13. Unplug this apparatus during lightning storms or when unused for long periods of time. 14. Refer all servicing to qualified service personnel. Servicing is required when the apparatus has been damaged in any way, such as power-supply cord or plug is damaged, liquid has been spilled or objects have fallen into the apparatus, the apparatus has been exposed to rain or moisture, does not operate normally, or has been dropped. |
|--|--|



For the U.K.

IMPORTANT: THE WIRES IN THIS MAINS LEAD ARE COLOURED IN ACCORDANCE WITH THE FOLLOWING CODE.

BLUE: NEUTRAL
BROWN: LIVE

As the colours of the wires in the mains lead of this apparatus may not correspond with the coloured markings identifying the terminals in your plug, proceed as follows:
The wire which is coloured BLUE must be connected to the terminal which is marked with the letter N or coloured BLACK.
The wire which is coloured BROWN must be connected to the terminal which is marked with the letter L or coloured RED.
Under no circumstances must either of the above wires be connected to the earth terminal of a three pin plug.

USING THE UNIT SAFELY

INSTRUCTIONS FOR THE PREVENTION OF FIRE, ELECTRIC SHOCK, OR INJURY TO PERSONS

About ⚠ WARNING and ⚠ CAUTION Notices

⚠ WARNING	Used for instructions intended to alert the user to the risk of death or severe injury should the unit be used improperly.
⚠ CAUTION	Used for instructions intended to alert the user to the risk of injury or material damage should the unit be used improperly. * Material damage refers to damage or other adverse effects caused with respect to the home and all its furnishings, as well to domestic animals or pets.

About the Symbols

	The ⚠ symbol alerts the user to important instructions or warnings. The specific meaning of the symbol is determined by the design contained within the triangle. In the case of the symbol at left, it is used for general cautions, warnings, or alerts to danger.
	The ⚡ symbol alerts the user to items that must never be carried out (are forbidden). The specific thing that must not be done is indicated by the design contained within the circle. In the case of the symbol at left, it means that the unit must never be disassembled.
	The ⚡ symbol alerts the user to things that must be carried out. The specific thing that must be done is indicated by the design contained within the circle. In the case of the symbol at left, it means that the power-cord plug must be unplugged from the outlet.

ALWAYS OBSERVE THE FOLLOWING

⚠ WARNING

- Before using this unit, make sure to read the instructions below, and the Owner's Manual.
- Do not open or perform any internal modifications on the unit.
- Do not attempt to repair the unit, or replace parts within it (except when this manual provides specific instructions directing you to do so). Refer all servicing to your retailer, the nearest Roland Service Center, or an authorized Roland distributor, as listed on the "Information" page.
- Never use or store the unit in places that are:
 - Subject to temperature extremes (e.g., direct sunlight in an enclosed vehicle, near a heating duct, on top of heat-generating equipment); or are
 - Damp (e.g., baths, washrooms, on wet floors); or are
 - Humid; or are
 - Exposed to rain; or are
 - Dusty; or are
 - Subject to high levels of vibration.
- Make sure you always have the unit placed so it is level and sure to remain stable. Never place it on stands that could wobble, or on inclined surfaces.
- The unit should be connected to a power supply only of the type described in the operating instructions, or as marked on the unit.

⚠ WARNING

- Do not excessively twist or bend the power cord, nor place heavy objects on it. Doing so can damage the cord, producing severed elements and short circuits. Damaged cords are fire and shock hazards!
- This unit, either alone or in combination with an amplifier and headphones or speakers, may be capable of producing sound levels that could cause permanent hearing loss. Do not operate for a long period of time at a high volume level, or at a level that is uncomfortable. If you experience any hearing loss or ringing in the ears, you should immediately stop using the unit, and consult an audiologist.
- Do not allow any objects (e.g., flammable material, coins, pins); or liquids of any kind (water, soft drinks, etc.) to penetrate the unit.
- In households with small children, an adult should provide supervision until the child is capable of following all the rules essential for the safe operation of the unit.
- Protect the unit from strong impact. (Do not drop it!)
- Do not force the unit's power-supply cord to share an outlet with an unreasonable number of other devices. Be especially careful when using extension cords—the total power used by all devices you have connected to the extension cord's outlet must never exceed the power rating (watts/amperes) for the extension cord. Excessive loads can cause the insulation on the cord to heat up and eventually melt through.
- Before using the unit in a foreign country, consult with your retailer, the nearest Roland Service Center, or an authorized Roland distributor, as listed on the "Information" page.

USING THE UNIT SAFELY

CAUTION

- The unit should be located so that its location or position does not interfere with its proper ventilation.



- Always grasp only the plug on the power-supply cord when plugging into, or unplugging from, an outlet or this unit.



- Try to prevent cords and cables from becoming entangled. Also, all cords and cables should be placed so they are out of the reach of children.



- Never climb on top of, nor place heavy objects on the unit.



- Never handle the power cord or its plugs with wet hands when plugging into, or unplugging from, an outlet or this unit.



- If you need to move the instrument, take note of the precautions listed below. At least two persons are required to safely lift and move the unit. It should be handled carefully, all the while keeping it level. Make sure to have a firm grip, to protect yourself from injury and the instrument from damage.



- Check to make sure the knob bolts securing the unit to the stand have not become loose. Fasten them again securely whenever you notice any loosening.
- Disconnect the power cord.
- Disconnect all cords coming from external devices.
- Raise the adjusters on the stand (p. 14).
- Close the lid.
- Fold down the music stand.

- Before cleaning the unit, turn off the power and unplug the power cord from the outlet (p. 13).



- Whenever you suspect the possibility of lightning in your area, pull the plug on the power cord out of the outlet.



- Be careful when opening/closing the lid so you do not get your fingers pinched (p. 13). Adult supervision is recommended whenever small children use the unit.



IMPORTANT NOTES

In addition to the items listed under “IMPORTANT SAFETY INSTRUCTIONS” and “USING THE UNIT SAFELY” on pages 2, 3 and 4, please read and observe the following:

Power Supply

- Do not use this unit on the same power circuit with any device that will generate line noise (such as an electric motor or variable lighting system).
- Before connecting this unit to other devices, turn off the power to all units. This will help prevent malfunctions and/or damage to speakers or other devices.

Placement

- Using the unit near power amplifiers (or other equipment containing large power transformers) may induce hum. To alleviate the problem, change the orientation of this unit; or move it farther away from the source of interference.
- This device may interfere with radio and television reception. Do not use this device in the vicinity of such receivers.
- Observe the following when using the unit’s floppy disk drive. For further details, refer to “Before Using Floppy Disks”.
 - Do not place the unit near devices that produce a strong magnetic field (e.g., loudspeakers).
 - Install the unit on a solid, level surface.
 - Do not move the unit or subject it to vibration while the drive is operating.
- Do not expose the unit to direct sunlight, place it near devices that radiate heat, leave it inside an enclosed vehicle, or otherwise subject it to temperature extremes. Also, do not allow lighting devices that normally are used while their light source is very close to the unit (such as a piano light), or powerful spotlights to shine upon the same area of the unit for extended periods of time. Excessive heat can deform or discolor the unit.
- To avoid possible breakdown, do not use the unit in a wet area, such as an area exposed to rain or other moisture.
- Do not allow rubber, vinyl, or similar materials to remain on the piano for long periods of time. Such objects can discolor or otherwise harmfully affect the finish.
- Do not put anything that contains water (e.g., flower vases) on the piano. Also, avoid the use of insecticides, perfumes, alcohol, nail polish, spray cans, etc., near the unit. Swiftly wipe away any liquid that spills on the unit using a dry, soft cloth.

Maintenance

- To clean the unit, use a dry, soft cloth; or one that is slightly dampened. Try to wipe the entire surface using an equal amount of strength, moving the cloth along with the grain of the wood. Rubbing too hard in the same area can damage the finish.
- Never use benzene, thinners, alcohol or solvents of any kind, to avoid the possibility of discoloration and/or deformation.

Additional Precautions

- Unfortunately, it may be impossible to restore the contents of data that was stored on a floppy disk once it has been lost. Roland Corporation assumes no liability concerning such loss of data.
- Use a reasonable amount of care when using the unit’s buttons, sliders, or other controls; and when using its jacks and connectors. Rough handling can lead to malfunctions.
- Never strike or apply strong pressure to the display.
- When connecting / disconnecting all cables, grasp the connector itself—never pull on the cable. This way you will avoid causing shorts, or damage to the cable’s internal elements.
- A small amount of heat will radiate from the unit during normal operation.
- To avoid disturbing your neighbors, try to keep the unit’s volume at reasonable levels. You may prefer to use headphones, so you do not need to be concerned about those around you (especially when it is late at night).
- When you need to transport the unit, pack it in shock-absorbent material. Transporting the unit without doing so can cause it to become scratched or damaged, and could lead to malfunction.
- Do not pull the music stand too far forward when setting/releasing its latches.
- Do not allow objects to remain on top of the keyboard. This can be the cause of malfunction, such as keys ceasing to produce sound.
- Use a cable from Roland to make the connection. If using some other make of connection cable, please note the following precautions.
 - Some connection cables contain resistors. Do not use cables that incorporate resistors for connecting to this unit. The use of such cables can cause the sound level to be extremely low, or impossible to hear. For information on cable specifications, contact the manufacturer of the cable.

IMPORTANT NOTES

Before Using Floppy Disks

Handling the Floppy Disk Drive

- Install the unit on a solid, level surface in an area free from vibration. If the unit must be installed at an angle, be sure the installation does not exceed the permissible range.
- Avoid using the unit immediately after it has been moved to a location with a level of humidity that is greatly different than its former location. Rapid changes in the environment can cause condensation to form inside the drive, which will adversely affect the operation of the drive and/or damage floppy disks. When the unit has been moved, allow it to become accustomed to the new environment (allow a few hours) before operating it.
- To insert a disk, push it gently but firmly into the drive—it will click into place. To remove a disk, press the EJECT button firmly. Do not use excessive force to remove a disk which is lodged in the drive.
- The indicator light for the disk drive lights up at full brightness when reading or writing data, and lights up at half brightness at other times. Don't try to eject the disk while reading or writing is in progress (that is, when the indicator light is lit up at full brightness). Attempting to do so may damage the magnetic surface of the disk, rendering it unusable.
- Remove any disk from the drive before powering up or down.
- To prevent damage to the disk drive's heads, always try to hold the floppy disk in a level position (not tilted in any direction) while inserting it into the drive. Push it in firmly, but gently. Never use excessive force.
- To avoid the risk of malfunction and/or damage, insert only floppy disks into the disk drive. Never insert any other type of disk. Avoid getting paper clips, coins, or any other foreign objects inside the drive.

Handling Floppy Disks

- Floppy disks contain a plastic disk with a thin coating of magnetic storage medium. Microscopic precision is required to enable storage of large amounts of data on such a small surface area. To preserve their integrity, please observe the following when handling floppy disks:
 - Never touch the magnetic medium inside the disk.
 - Do not use or store floppy disks in dirty or dusty areas.
 - Do not subject floppy disks to temperature extremes (e.g., direct sunlight in an enclosed vehicle). Recommended temperature range: 10 to 50° C (50 to 122° F).
 - Do not expose floppy disks to strong magnetic fields, such as those generated by loudspeakers.

- Floppy disks have a "write protect" tab which can protect the disk from accidental erasure. It is recommended that the tab be kept in the PROTECT position, and moved to the WRITE position only when you wish to write new data onto the disk.

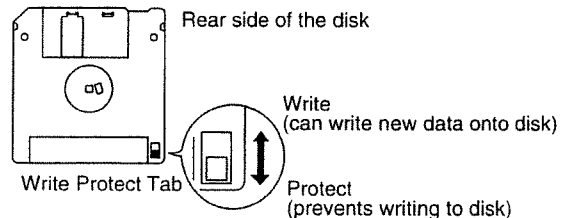

- The identification label should be firmly affixed to the disk. Should the label come loose while the disk is in the drive, it may be difficult to remove the disk.
 - Store all disks in a safe place to avoid damaging them, and to protect them from dust, dirt, and other hazards. By using a dirty or dust-ridden disk, you risk damaging the disk, as well as causing the disk drive to malfunction.
 - Disks containing performance data for this unit should always be locked (have their write protect tab slid to the "Protect" position) before you insert them into the drive on some other unit (except the PR-300, or a product in the HP-G, MT, KR, or Atelier families), or into a computer's drive. Otherwise (if the write protect tab remains in the "Write" position), when you perform any disk operations using the other device's disk drive (such as checking the contents of the disk, or loading data), you risk rendering the disk unreadable by this unit's disk drive.
- * GS () is a registered trademark of Roland Corporation.
- * Apple is a registered trademark of Apple Computer, Inc.
- * Macintosh is a registered trademark of Apple Computer, Inc.
- * IBM PC is a registered trademark of International Business Machines Corporation.
- * COMPOSER is a registered trademark of Roland Corporation.
- * All product names mentioned in this document are trademarks or registered trademarks of their respective owners.

Introduction

Thank you, and congratulations on your choice of the Roland KR-377 Intelligent Piano. While the KR-377 Intelligent Piano certainly allows you to achieve authentic piano performances, it also features easy-to-use Automatic Accompaniment and numerous other useful functions.

In order to enjoy reliable performance of your new keyboard for many years to come, please take the time to read through this manual in its entirety.

Features

Authentic Piano Sound

The KR-377 reproduces the tones of a high-quality grand piano, with stereo sampled sounds that capture the true piano sound so well, you can even hear the hammers hitting the strings. With a maximum polyphony of 64 stereo piano tones, the KR-377 can handle just about any kind of performance, even when extensive pedal work is involved. In addition, the KR-377 features a Progressive Hammer Action, with a heavier touch in the lower keys and lighter touch in the upper keys, for even more realistic piano keyboard feel. All this provides you with more natural, more authentic piano performance.

Score Display

Music files and your recordings are displayed as score in the screen (p. 79).

You can view the score with lyrics, or view a different performance part.

EZ Functions Let You Get Straight to What You Want to Accomplish

The EZ (Easy) function allows even beginners to record/playback (p. 34, p. 39) and use automatic accompaniment (p. 29) easily and interactively. The [Help] button lets you view an on-screen explanation of terms or functions at any time (p. 23).

A Wide Variety of Accompaniment Styles with the Automatic Accompaniment Function

The KR-377 features numerous Music Styles—approximately 162 different Styles are provided—and an Automatic Accompaniment function. You can use these to add the exact accompaniment you have in mind to your own performances (p. 60).

Effects Adding Three-Dimensional Breadth to Your Performances (Advanced 3D)

You can select parts in Performances and add three-dimensional breadth to them.

This provides the pleasant effect of “surrounding” your performance within the sound (p. 33).

Convenient Functions to Support Your Practice Efforts

Numerous functions convenient for practice are provided, including tape recorder-style recording (p. 91), part playback for individual hands (p. 85), and a metronome function (p. 56), making your practice more effective in ways possible only on an electronic piano.

Expandable Ensemble Opportunities Using MIDI (MIDI Ensemble)

You can connect this instrument’s MIDI connector to an electronic percussion instrument or other separate instrument, allowing you to play ensemble performances. By using “MIDI Ensemble,” you can simply connect an instrument to the MIDI connector and start playing using MIDI, without having to be concerned about making a lot of MIDI settings (p. 152).

Making Use of Commercially Available Music Files for Listening or Lessons

You can use the built-in disk drive to listen to commercial Music File songs and save recorded tunes on floppy disk (p. 77, p. 104).

Karaoke Enjoyment

You can connect a microphone and enjoy singing along with songs, just like with a karaoke system (p. 41).

How to Use This Manual

This owner's manual is organized as follows.

Getting Acquainted with the KR-377

For those just starting out with the KR-377, this volume explains how to make use of the instrument's various performance features simply and easily. We highly recommend reading through the manual while you play the instrument, as this will allow you to more fully grasp the kinds of things capable with the KR-377.

Chapters 1 to 9

This section explains the functions available with the KR-377 with easy-to-understand screen shots.

Please refer to the relevant pages for the functions you wish to use.

Refer to the "Contents" when you already know what it is that you want to achieve. If you want to learn how the KR-377's various buttons work, see "Panel Descriptions." Also, be sure to make use of the "Index" at the end of the volume.

Appendices

If the KR-377 does not operate as you expect, read "Troubleshooting" to make sure that your settings are correct. If an error message appears in the display during operation, consult the "Error Messages" section to determine the appropriate action. The appendices also provide other information, including the Tone list, Style list, MIDI implementation chart, etc.

■ Conventions Used in This Manual

- Button or knob names on the panel are enclosed in square brackets "[]", as in [Function] button.
- On screen item is enclosed in angled brackets "< >", as in <Option>. To choose such an item, press the corresponding button (located below or to the side of the item).
- An asterisk (*) or a **NOTE** at the beginning of a paragraph indicates a note or precaution. These should not be ignored.
- (p. **) refers to pages within the manual.

Contents

USING THE UNIT SAFELY	3
IMPORTANT NOTES	5
Introduction	7
Features	7
How to Use This Manual	8
Conventions Used in This Manual	8
Contents	9
Before You Start Playing	13
Connecting the Power Cord	13
Raising the Music Stand	13
Opening and Closing the Lid	13
Turning the Power On and Off	13
Adjusting the Sound Volume	13
About the Pedals	14
Connecting Headphones	15
Connecting a Microphone	15
Basic Operation and How to Read the Display	16
Typographic Conventions Used in this Owner's Manual	16
Basic Screen	16
How to Perform Operations Using the Screen	17
Panel Descriptions	18
Getting Acquainted with the KR-377	21
Watching the Introductory KR-377 Demo (Quick Tour)	21
Playing the Games	22
Using the [Help] Button	23
—Start playing the piano	24
Playing the Keyboard Like a Piano (One-touch Piano)	24
Playing the Keyboard Like an Organ (One-touch Organ)	25
Playing a Wide Variety of Instrument Sounds	26
Handy Features for Selecting Tones (Tone Finder)	27
Sounding the Metronome	28
—Try playing using Automatic Accompaniment	29
Enjoying Automatic Accompaniment with Ease (EZ Arranger)	29
Playing with an Automatic Accompaniment (One-touch Arranger)	30
Effects Adding Three-Dimensional Breadth to Your Performances (Advanced 3D)	33
—Try recording	34
Recording Your Playing With Ease (EZ Recorder)	34
Recording a Performance	35
Listening to the Recorded Performance	37
—Try to use Music Files	38
Using the Disk Drive	38
Listening to Music Files	39
Using the KR-377 as a Karaoke Machine	41
Chapter 1 Playing the Keyboard	42
Playing the Keyboard Like a Piano (One-touch Piano)	42
Playing the Keyboard Like an Organ (One-touch Organ)	43
Playing Drum Sounds	44
Playing Effect Sounds	45
Playing a Wide Variety of Instrument Sounds	46
Combining the Sounds of Two Instruments (Layer Play)	47
Playing Different Tones with the Left and Right Hands (Split Play)	49
Shifting the Keyboard Pitch in Octave Steps (Octave Shift)	51
Adjusting the Sound Brilliance	52
Adding Reverberation to Sounds (The Reverb Effect)	52
Effects Adding Three-Dimensional Breadth to Your Performances (Advanced 3D)	53

Applying an Effect Only to the Layer Tone of the Keyboard	54
Applying Effects to the Sound (Effects)	55
Sounding the Metronome.....	56
Adjusting the Tempo	56
Changing the Beat of Metronome.....	56
Changing the Animation.....	57
Changing How the Metronome Beat (Pattern) Sounds.....	57
Changing the Type of Sound.....	58
Changing the Volume.....	59

Chapter 2 Automatic Accompaniment..... 60

Music Style and Automatic Accompaniment.....	60
About Chords.....	61
Playing Chords with Simple Fingering (Chord Intelligence).....	61
Displaying the Chord Fingering On Screen (Chord Finder)	62
Choosing a Music Style	63
Choosing a Music Style from Data Disk.....	64
Playing Automatic Accompaniment While Playing a Tone in the Left Hand	65
Playing Just the Rhythm Pattern.....	66
Adjusting the Tempo for Automatic Accompaniment	66
Playing a Music Style (Start/Stop).....	67
Starting Automatic Accompaniment When You Play the Left-hand Section (Sync Start)	67
Starting at the Press of a Button	67
Stopping Automatic Accompaniment	68
Adjusting the Timing During the Accompaniment and Starting Over (Reset)	68
Playing the Count Sound at the End of the Intro	69
Modifying an Accompaniment	70
Changing the Accompaniment Pattern Within a Song (Fill-In).....	70
Changing the Arrangement of the Accompaniment	71
Adding Harmony to the Right-hand Part (Melody Intelligence).....	73
Playing the Piano Along with the Automatic Accompaniment (Piano Style Arranger)	74
Changing the Volume Balance for the Accompaniment and Keyboard	75
Adjusting the Volume of Each Performance Part.....	75

Chapter 3 Some Handy Features..... 77

Playing Back Songs for Practice	77
Playing All Songs Continuously	78
Displaying the Score	79
Checking Your Performance on a Graph/Keyboard Screen	80
Adjusting the Tempo	82
Setting the Tempo by Pressing the Button in Time.....	82
Playing back with No Change in Tempo.....	83
Counting Down Before a Performance Starts	84
Preventing the Part to Be Practiced from Sounding.....	85
Practicing with Setting Markers in the Song	86
Setting Markers in the Song/Erasing Markers	86
Playback from a Marker Location.....	87
Moving a Marker.....	87
Playing Back the Same Passage Over and Over	88
Transposing the Key of the Keyboard (Key Transpose).....	89
Changing the Key When Playing Back Songs.....	90

Chapter 4 Recording and Saving the Performance 91

Recording Your Playing with Ease	91
Recording a Performance Using Automatic Accompaniment	94
Redoing a Recording.....	96
Erasing a Recorded Song.....	97

Erasing the Sound Recorded on Individual Track Buttons	97
Changing How Recording Stops.....	98
Recording Songs Starting with Pickups.....	99
Composing an Accompaniment by Entering Chords (Chord Sequencer).....	100
Creating a Rhythm Part with Ease.....	103
Saving Songs to Floppy Disks	104
Formatting Floppy Disks (Format).....	104
Saving Songs on Floppy Disk.....	105
Changing the Tone Set When You Save (Compatibility Function)	107
Deleting Data from Floppy Disks	108
Changing the Order of Songs on Floppy Disk	109
Chapter 5 Advanced Recording Functions	110
Selecting the Recording Method	110
How to Choose the Recording Method	110
Recording While Erasing the Previous Recording (Replace Recording)	110
Overdubbing Without Erasing the Previous Recording (Mix Recording)	110
Repeatedly Recording Over the Same Location (Loop Recording).....	111
Re-Recording Part of Your Performance (Punch-in Recording)	112
Multitrack Recording with 16 Parts (16-Track Sequencer).....	113
The 16-track Sequencer Screen.....	113
Recording with the 16 Track Sequencer	114
Changing the Settings for Each Part.....	115
Composing a Song That Changes the Beat Partway Through.....	116
Changing a Song's Basic Tempo	117
Changing the Tempo Within the Song.....	117
Adjusting the Tempo While Listening to a Song.....	117
Adjusting the Tempo at a Particular Measure	118
Chapter 6 Editing a Song	119
Selecting Editing Functions.....	119
Canceling an Edit.....	119
Copying a Measure	120
Copying a Rhythm Pattern	121
Correcting Timing Discrepancies.....	121
Deleting a Specific Measure.....	122
Inserting a Blank Measure.....	122
Making a Measure Blank.....	123
Transposing Individual Parts	123
Exchanging Parts	124
Correcting Notes One by One	124
Modifying the Tone Changes in a Song	125
Chapter 7 Using Other Functions.....	126
Creating an Original Style (User Style)	126
Combining Styles to Create a New Style (Style Composer)	126
Creating a Style from a Song You Recorded Yourself (Style Converter).....	128
Storing User Styles to the Button	131
Storing the Panel Settings (User Program)	131
Calling Up User Program.....	132
Changing How Button Settings Are Called Up.....	132
Saving User Style Or User Program on Floppy Disk.....	132
Saving User Style Or User Program on Floppy Disk.....	132
Erasing User Style Or User Program Saved on Floppy Disk.....	133
Calling Up Saved User Programs from Floppy Disk.....	133
Disabling Everything Except Piano Play (Panel Lock)	133
Chapter 8 Changing Various Settings.....	134
Changing the Settings for One-touch Piano	134
Adding Ambience from Different Venues to Songs (Ambience).....	134

Changing the Key Touch (Key Touch).....	135
Adjusting the Sensitivity of the Pedals (Pedal Mode).....	135
Adjusting Resonance.....	135
Changing the Tuning.....	136
Fine Adjustment of the Piano Sound (Sound).....	137
Changing the Settings for Automatic Accompaniment.....	137
Changing the Keyboard's Split Point.....	137
Changing How the Automatic Accompaniment Plays.....	138
Changing the Sound for Chord Tone and Bass Tone.....	138
Canceling the Chord Intelligence Function.....	139
Assigning a Function to Pad Buttons or Pedals.....	139
Keeping the Same Tone and Tempo When the Music Style Changes.....	141
Changing the Settings for One-touch Organ.....	141
Changing How the Automatic Accompaniment Plays While Playing the Organ.....	142
Changing How the Left-hand Keyboard Section Plays.....	142
Adjusting the Footage.....	143
Changing the Settings for Score Screen.....	144
Changing the Tone Set To Be Used for Playback.....	144
Changing the Settings for the Marker and the Count Sound.....	145
Changing the Number of Measures Counted and the Count Sound.....	145
Playing the Count Sound at Each Repetition.....	145
Placing a Marker in the Middle of a Measure.....	145
Adjusting the Standard Pitch (Master Tuning).....	146
Changing the Type of Reverb Effect.....	146
Changing the Type of Chorus Effect.....	147
Changing the Bend Range.....	147
Changing the Screen Settings.....	148
Hiding the On-screen Lyrics.....	148
Changing the Language.....	148
Adjusting the Contrast of the Screen.....	148
Displaying the Screen Message When the Power Is Turned On (Opening Message).....	148
Maintaining Settings After the Power Is Turned Off (Memory Backup).....	149
Restoring the Factory Settings (Factory Reset).....	149

Chapter 9 Connecting External Devices..... 150

Names and Functions of Jacks and Connectors.....	150
Connecting MIDI Devices.....	151
Playing in Ensemble with Other MIDI Instruments (MIDI Ensemble).....	152
MIDI Settings.....	152
Connecting to Audio Equipment.....	154
Connecting to a Computer.....	156

Appendices..... 158

Trouble Shooting.....	158
If this Message Appears on Screen.....	160
Tone List.....	162
Drum/SFX Set List.....	166
Music Style List.....	171
Rhythm Pattern List.....	173
Chord List.....	174
Effects List.....	176
Data Disk Song List.....	177
Music Files That the KR-377 Can Use.....	178
The KR-377 allows you to use the following music files.....	178
About the KR-377 Sound Generator.....	178
Glossary.....	179
MIDI Implementation Chart.....	180
Main Specifications.....	181

Before You Start Playing

Connecting the Power Cord

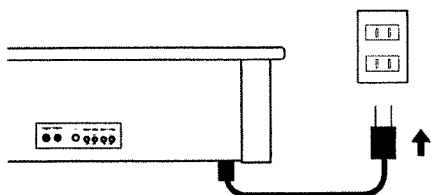

1. Connect the power cord that came with your KR-377 to the AC Inlet socket on the bottom of the unit.
2. Plug the other end of the power cord into a wall outlet.

Raising the Music Stand

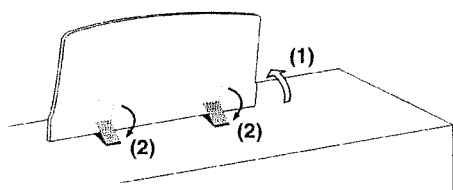

1. Gently raise the music stand, then secure it in place as shown in the figure.
2. To collapse the stand, fold in the metal fittings while supporting the stand with both hands and gently fold down the stand.

NOTE

Do not pull down the music stand.

Opening and Closing the Lid

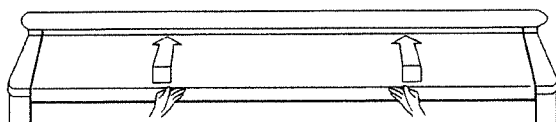

1. When opening the KR-377's lid, grasp the lid with both hands and gently lift it upwards, then slide it towards the back of the piano.
2. When closing the lid, slowly pull it forward, then gently lower it into place.

NOTE

When opening and closing the lid, be careful not to let your fingers get caught. Make sure an adult is on hand to provide assistance when young children are playing the KR-377.

NOTE

If you need to move the piano, make sure the lid is closed first to prevent accidents.

Turning the Power On and Off

Be sure to follow the steps below when turning the power on or off. By turning on devices in the wrong order, you risk causing malfunction and/or damage to speakers and other devices.

■ Turning On the Power

1. Before you switch on the power, rotate the [Volume] knob to "Min" (minimum).



2. Press the [Power] switch.

After a few seconds, the unit becomes operable and playing the keyboard produces sound.

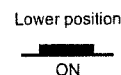

NOTE

This unit is equipped with a protection circuit. A brief interval (a few seconds) after power up is required before the unit will operate normally.

NOTE

Be sure to use the supplied power cord.

■ Turning Off the Power

1. Before you switch off the power, rotate the [Volume] knob to "Min" (minimum) all the way.
2. Press the [Power] switch.
The power is switched off.

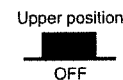

Adjusting the Sound Volume

You can adjust the overall volume level.

1. Rotate the [Volume] knob to the left or right.

The volume increases as the knob is rotated to "Max" and decreases as the dial is rotated to "Min."



Before You Start Playing

About the Pedals

When you press the [Piano] button and play the piano (p. 42), these pedals will function as shown below.

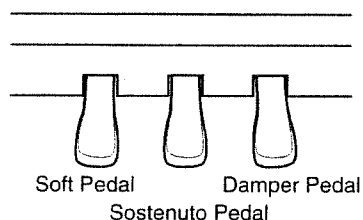

Soft Pedal (the left)

This pedal is used to make the sound softer.

Playing the keyboard while the soft pedal is depressed makes the sound softer than when played normally with the same force. The degree of softness varies subtly with the amount the pedal is pressed.

Sostenuto Pedal (the middle)

When this pedal is depressed, reverberations are applied only to the keys being played at that time.

MEMO

You can assign other functions to the sostenuto pedal and the soft pedal. For more information, see "Assigning a Function to Pad Buttons or Pedals" (p. 139).

Damper Pedal (the right)

Use this pedal when you want the sound to linger.

While the damper pedal is depressed, the sound from the keyboard continues to linger/remain for an extended period, even when you remove your fingers from the keys. The length of time that the sound continues varies subtly with the amount the pedal is pressed.

On acoustic pianos, when the damper pedal is depressed, additional strings are released to resonate with the sound of the keys that have been played, adding richness and breadth to the sound. The damper pedal on the KR-377 recreates this resonance (Sympathetic Resonance).

MEMO

You can change the amount of resonance applied with the damper pedal. Refer to "Adjusting Resonance" (p. 135).

About the Adjuster

After moving the piano, or when the pedal feels unstable, use the following procedure to readjust the adjuster on the underside of the pedals.

- Lower the adjuster, and adjust it until it makes firm contact with the floor surface. Leaving any gap between the adjuster and the floor may result in damage to the pedals when they are depressed. Particularly on floors covered by carpets, or other soft materials, be sure that the adjuster is firmly pressed against the floor surface.

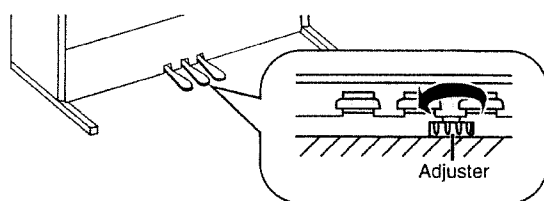

Connecting Headphones

The KR-377 features two headphone jacks. This allows two people to listen through headphones simultaneously, making it very useful for lessons and when performing piano pieces for four hands. Additionally, this allows you to play without having to worry about bothering others around you, even at night.

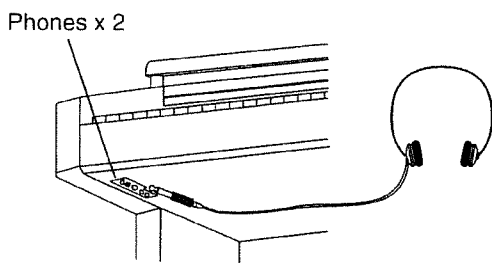

1. Connect the headphones to either of the Phones jacks on the underside of the KR-377, on the left. Sound will no longer be heard from the KR-377's speakers. Sound will be heard only through the headphones.
2. Adjust the headphone volume with the KR-377's main [Volume] knob.

MEMO

Use Stereo headphones.

Some Notes on Using Headphones

- To avoid damaging or severing the headphone cord, be sure to handle the headphones by holding the phones themselves, and grasping the plug and not the cord when pulling the headphone plug.
- The headphones may be damaged if the volume is too high when they are plugged in. Connect the headphones only after turning the volume down completely.
- To prevent possible auditory damage, loss of hearing, or damage to the headphones, the headphones should not be used at an excessively high volume. Listen at appropriate levels.

Connecting a Microphone

You can connect a microphone into the Mic In jack, and enjoy karaoke with the KR-377.

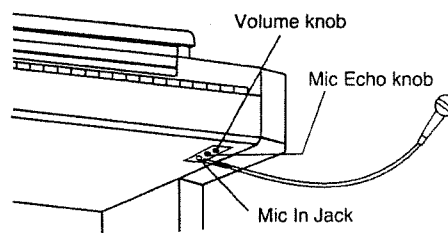

1. Connect a microphone (sold separately) to the Mic In jack on the lower-right area of the instrument.
2. Rotate the [Mic Echo] knob in front of the Mic In jack to adjust the echo level.
3. Rotate the [Mic Volume] knob in front of the [Mic Echo] knob to adjust the volume level for the microphone.

MEMO

Consult your Roland dealer when purchasing a microphone for use with the KR-377.

Some Notes on Using a Microphone

- Be careful of high volume levels when using mikes late at night or early in the morning.
- When connecting a microphone to the KR-377, be sure to lower the volume. If the volume control is too high when the microphone is plugged in, noise may be produced by the speakers.
- Howling could be produced depending on the location of microphones relative to speakers. This can be remedied by:
 - Changing the orientation of the microphone.
 - Relocating microphone at a greater distance from speakers.
 - Lowering volume levels.

Before You Start Playing

Basic Operation and How to Read the Display

A variety of information is shown in the display. In addition, many operations are performed using the display.

■ Typographic Conventions Used in this Owner's Manual

This Owner's Manual uses the following typographic conventions to indicate panel buttons and items appearing on the display.

[] : This indicates a button or knob on the panel.

Example: Press the [Utility] button.

< > : This indicates an item appearing on the display. To choose such an item, press the corresponding button (located below or to the side of the item).

Example: Press <Layer> at the bottom of the display.

[-][+], <◀▶> <▶▶> means that you should press one or the other button.

Example: Tempo [-] [+] buttons, Page <◀▶> <▶▶>, Select <◀▶> <▶▶>

■ Basic Screen

The following screen is called "Basic Screen."

You can usually display this screen by pressing the [Exit] button several times.

If pressing the [Exit] button doesn't display this screen, follow either of the procedures described below to display it.

- Press the One Touch Program [Arranger] button.
The basic screen appears and displays the settings for Automatic Accompaniment.
- Press the One Touch Program [Piano] button or the One Touch Program [Organ] button, and then press any one of the Tone buttons, then press [Exit] button.

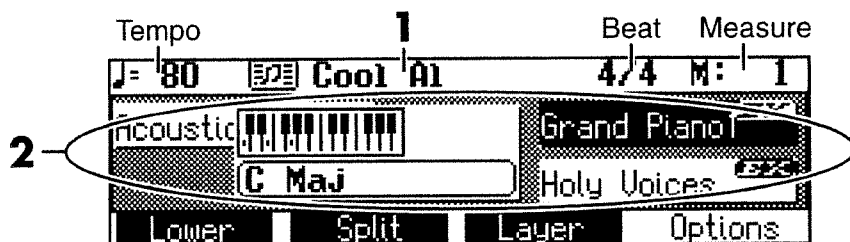

1	Such as the name of the song and Music Style appears.
2	The Tone names are selected appears. Information about the manner in which the chords are played is displayed when Automatic Accompaniment is being used.

■ How to Perform Operations Using the Screen

Changing Screen Pages—Page < ⏪ > < ⏩ >

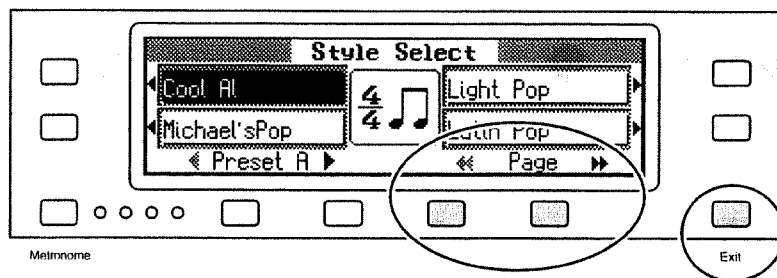

Some screens consist on two or more pages.

By pressing Page < ⏪ > and < ⏩ > at the bottom of the display you will continue to the next page, and pressing Page < ⏪ > and < ⏩ > will return you to the previous page.

Returning to the Previous Screen—The [Exit] Button

Press the [Exit] button when you wish to cancel the settings you are currently making, or to exit the currently displayed screen.

You can usually display the Basic screen or the previous screen by pressing the [Exit] button several times.

- * You can adjust the contrast of the screen. Check out "Adjusting the Contrast of the Screen" (p. 148).
- * The explanations in this manual include illustrations that depict what should typically be shown by the display. Note, however, that your unit may incorporate a newer, enhanced version of the system (e.g., includes newer sounds), so what you actually see in the display may not always match what appears in the manual.

Panel Descriptions

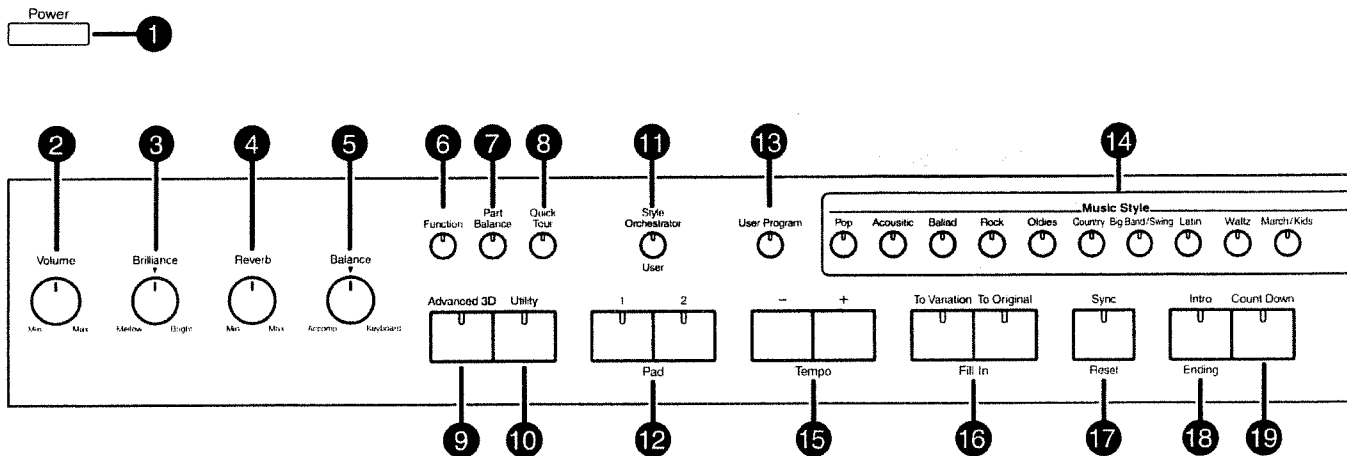

1 [Power] Switch

Pressed to switch the power on and off (p. 13).

2 [Volume] Knob

Adjusts the overall volume level (p. 13).

3 [Brilliance] Knob

Adjusts the tone brightness (p. 52).

4 [Reverb] Knob

Adjusts the amount of reverb (p. 52).

5 [Balance] Knob

Changes the volume balance for sounds played with the keyboard and for songs and accompaniments (p. 75).

6 [Function] Button

Selects a variety of play-related functions (p. 146-p. 149).

7 [Part Balance] Button

Use this button to adjust the relative volumes of each of the parts played in the Automatic Accompaniment, the percussion or effects sounds played with the keyboard, and the tones played with the keys (p. 75).

8 [Quick Tour] Button

Press this to hear a demo song of the build-in Tones and Music Styles and to view the KR-377's main features in the display (p. 21).

9 [Advanced 3D] Button

When performing along with the automatic accompaniment or the internal songs, you can add three-dimensional breadth (p. 33, p. 53).

10 [Utility] Button

Select convenient functions such as a note-guessing game, automatic accompaniment, recording, playback, and sound search.

11 [Style Orchestrator/User] Button

Switch the function of the Pad buttons.

Used to change the arrangement type for automatic accompaniment with the Pad buttons (p. 71), and used to assign a variety of functions to the Pad buttons (p. 139).

12 Pad Buttons

There are two Pad buttons: Pad [1] and Pad [2].

The operation of each is changed using [Style Orchestrator/User] button. (p. 71, p. 139)

13 [User Program] Button

Stores the selected functions and states of the buttons. It can also call up settings that have been stored (p. 131).

14 Music Style Buttons

Selects a internal Music Style (p. 30, p. 63).

15 Tempo [-] [+] Buttons

Adjust the tempo (p. 28, p. 56, p. 66, p. 82).

Press the [-] and [+] buttons at the same time to return to the basic tempo.

16 Fill In

[To Variation] Button

Inserts a fill-in in an automatic accompaniment and changes to the Variation accompaniment pattern (p. 70).

[To Original] Button

Inserts a fill-in in an automatic accompaniment and changes to the Original accompaniment pattern (p. 70).

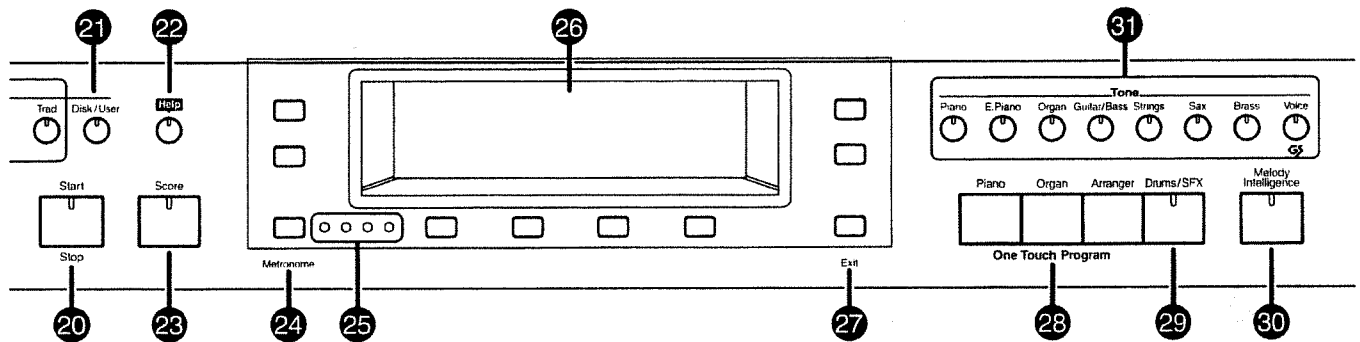

17 [Sync/Reset] Button

This setting simultaneously starts the Automatic Accompaniment when any key in the left side of the keyboard is played (p. 67).

Additionally, by pressing this button while Automatic Accompaniment is being played, you can restart with the accompaniment synchronized (p. 68).

18 Intro/Ending Button

Play an intro or ending during automatic accompaniment (p. 67).

19 [Count Down] Button

Lets you know the end of intro with counts down (p. 69).

20 [Start/Stop] Button

Starts and stops automatic accompaniment (p. 67).

21 [Disk/User] Button

Selects a Style on the floppy disk (p. 64), or to choose a User Style that you've made yourself (p. 126).

22 [Help] Button

Displays on-screen explanations of features (p. 23).

23 [Score] Button

Displays scores of Music files and your recordings (p. 79).

24 [Metronome] Button

Activates the built-in metronome. And you can change the metronome settings (p. 28, p. 56).

25 Beat Indicator

This lights up in correspondence with the beat of the selected song or accompaniment.

26 Display

Displays various information relating to the current operation (p. 16).

27 [Exit] Button

Returns you to the previous screen or makes the selected function end.

28 One Touch Program

[Piano] Button

Changes the keyboard to a piano sound and makes the optimal settings for a piano performance (p. 24, p. 42).

[Organ] Button

Changes the keyboard to an organ sound and makes the optimal settings for an organ performance (p. 25, p. 43).

[Arranger] Button

Makes the optimal settings for playing with automatic accompaniment (p. 30, p. 63).

29 [Drums/SFX] Button

Changes the keyboard to play percussion and effect sounds (p. 44).

30 [Melody Intelligence] Button

Adds harmony to the sounds played with the keyboard (p. 73).

31 Tone Buttons

Selects the kinds of sounds (Tone groups) played by the keyboard (p. 26, p. 46).

Panel Descriptions

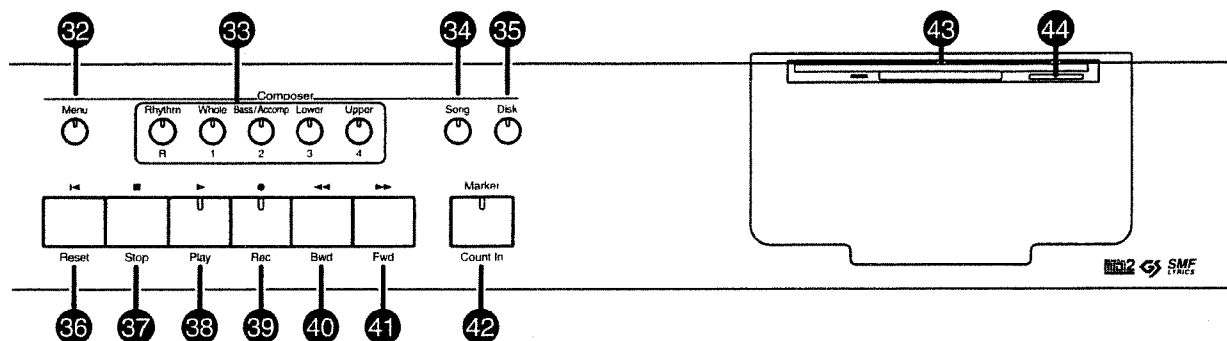

32 [Menu] Button

You can use this to choose recording and editing functions.

33 Track Buttons

Used to play back individual instrument parts of a song or to record your own performances (p. 85, p. 91).

34 [Song] Button

Used to select a song (p. 77).

35 [Disk] Button

This can be used to make settings for the disk, such as saving a recorded song on floppy disk.

36 Reset [◀] Button

Sets the position from which playback will begin to the start of the song.

37 Stop [■] Button

Pressed to stop playback or recording.

38 Play [▶] Button

Starts playback or recording for a song.

39 Rec [●] Button

Puts the keyboard in record standby mode.

40 Bwd [◀◀] Button

Rewinds the song.

41 Fwd [▶▶] Button

Fast-forwards the song.

42 [Marker/Count In] Button

Places a marker in a song to mark the spot where playback starts (p. 86).

You can also use it to sound an audible count before playing back a song (p. 84).

43 Disk Drive

You can insert a floppy disk for playing back or saving songs (p. 38, p. 104).

44 Eject Button

Pressed to eject a floppy disk from the disk drive (p. 38).

Getting Acquainted with the KR-377

Watching the Introductory KR-377 Demo (Quick Tour)

Here you can hear the sound of the KR337's instruments, listen to demo songs that use various Music Styles (accompaniment styles in a variety of musical genres), and view screens that introduce features of the KR-377's sounds and keyboard.

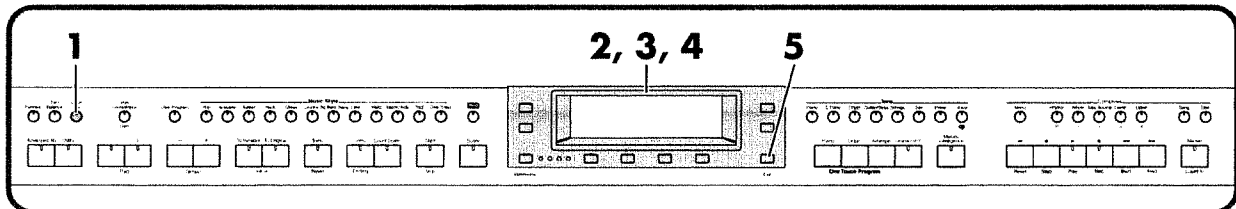

1. Press the [Quick Tour] button.

A Quick Tour screen like the one shown below appears.

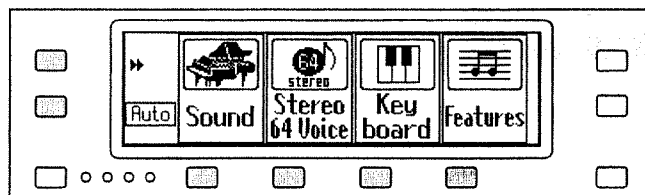

2. Press <◀▶> or <▶▶> at the upper left area of the display to switch screens, then choose a demo.

Indication	Description
Sound	Explanation of the KR-377's piano sounds
Stereo 64 Voice	Explanation of polyphony
Keyboard	Explanation of the KR-377's keyboard (Progressive Hammer Action)
Features	Introduction of the main functions
Tones	Demo performance of the internal sounds
Styles	Demo performance of the internal Music Styles

3. Press the button below the demo that you wish to see.

The demo will begin.

When you press <Auto> located at the left of the display, the "Sound," "Stereo 64 Voice," "Keyboard," and "Features" demos will be repeated automatically.

4. Follow the instructions that appear in the screen.

You can proceed to the next screen by selecting the <▶> button at the right of the display.

5. To end the demo, press the [Exit] button.

Press the [Exit] button several times to return to the previous screen.



For information on Music Styles, take a look at the "Music Style List" (p. 171).



For a complete list of tone names, please refer to the "Tone List" (p. 162).

Getting Acquainted with the KR-377

Playing the Games

The KR-377 also offers games that can help you improve your grasp of notes and chords.

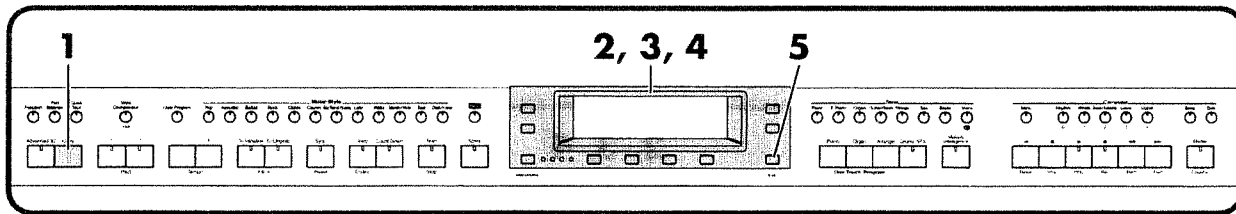

1. Press the [Utility] button.

The Utility screen appears.

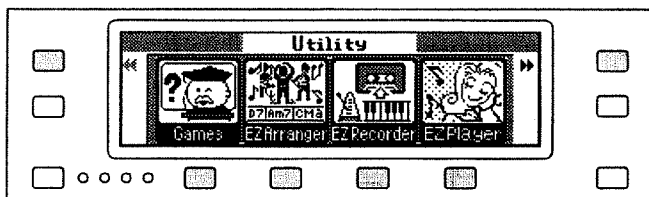

2. Press <Games> at the bottom of the display.

If <Games> doesn't appear on screen, press <◀▶> at the upper left and upper right of the display to switch screens.

3. Press the button at the bottom of the display to select a game.

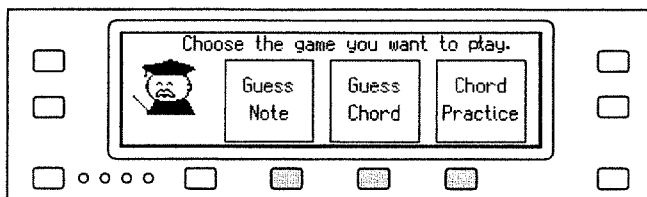

Game	Description
Guess Note	You'll hear a single piano note. Try to play the same note on the keyboard.
Guess Chord	You'll hear a chord. Try to play the same chord on the keyboard.
Chord Practice	The name of a chord is displayed. Try to play the chord on the keyboard.

4. Follow the on-screen instructions to proceed with the game.

5. When you're done the game, press the [Exit] button.

Press the [Exit] button several times to return to the previous screen.

Using the [Help] Button

The KR-377 features a Help function. You can display the explanation of functions on the screen.

When you are not sure how to proceed, use the Help function.

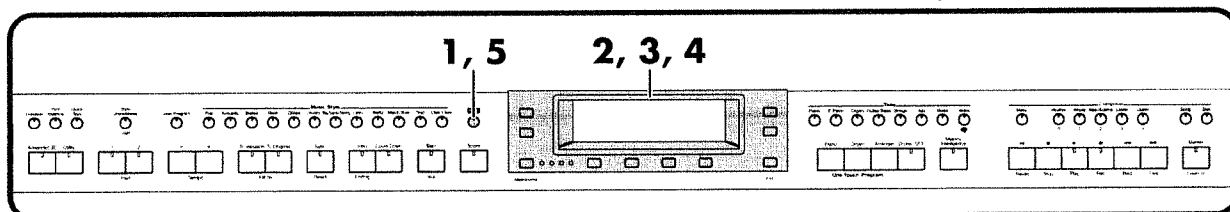

1. Press the [Help] button, getting the indicator to light.

The following screen will appear.

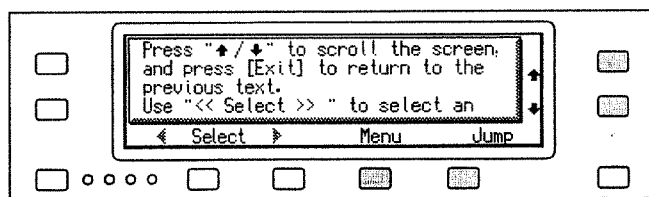

Press <↓> at the right of the display to scroll the explanation downward, or press <↑> to return upward.

2. When you press <Menu> located at the bottom of the display, a list of the explanations will appear.

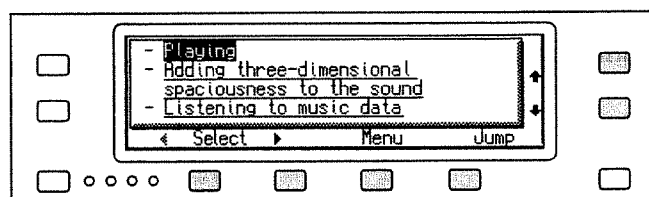

You can view a detailed explanation of the underlined words or phrases.

3. Use Select <←><→> located at the bottom of the display to select the item that you wish to see.

Press <↓> at the right of the display to scroll the explanation downward, or press <↑> to return upward.

4. Press <Jump> located at the bottom of the display.

An explanation for the selected item will appear.

5. To exit the Help function, press the [Help] button, extinguishing its indicator.

You can also return to the previous screen by pressing the [Exit] button several times.

—Start playing the piano

Playing the Keyboard Like a Piano (One-touch Piano)

You can make the optimal settings for a piano performance with the press of a single button.

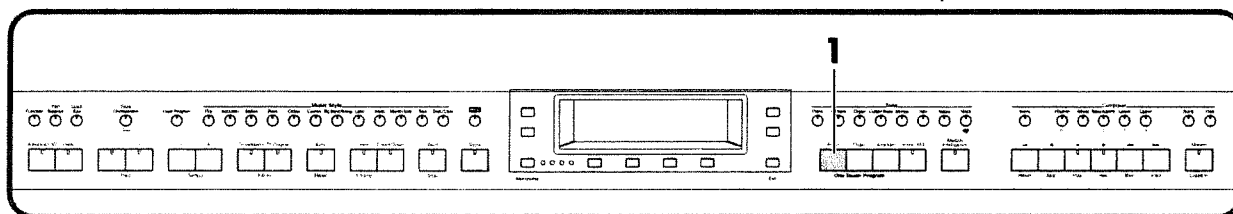

1. Press the One Touch Program [Piano] button.

A Piano screen like the one shown below appears.

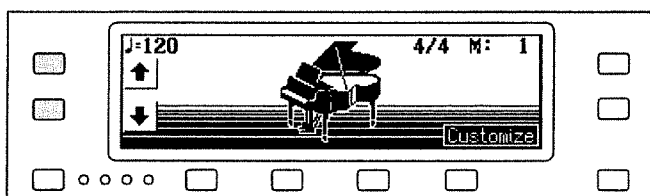

Settings are made for the following situations.

- When the keyboard has been split into upper and lower sections (p. 49), this returns the keyboard to a single section.
- The functioning of the pedals returns the pedals to their usual functions (p. 14).
- The Grand Piano sound is selected.
- The effect is set to "Sympathetic Resonance."

Changing the Piano Sound

1. Press **< ↑ >** **< ↓ >** at the left of the display.

The amount by which the piano's top is opened changes, and the sound also changes.

This simulates the sound reflections that occur when the lid of a grand piano is open.

MEMO

You can change settings related to the piano performance by pressing **<Customize>** at the bottom of the display. For details, refer to "Changing the Settings for One-touch Piano" (p. 134).

NOTE

Since this instrument faithfully reproduces real acoustic piano action and response, sounds in the top one-and-one-half-octave range continue to play, regardless of the damper pedal action, and the tone in this range is audibly different. The Key Transpose setting (p. 89) can also be used to change the range that is unaffected by the damper pedal.

Playing the Keyboard Like an Organ (One-touch Organ)

You can make the optimal settings for an organ performance with the press of a single button.

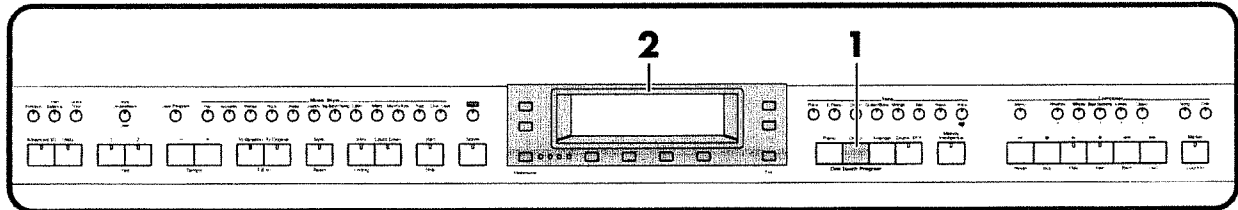

1. Press the One Touch Program [Organ] button.

An Organ screen like the one shown below appears.

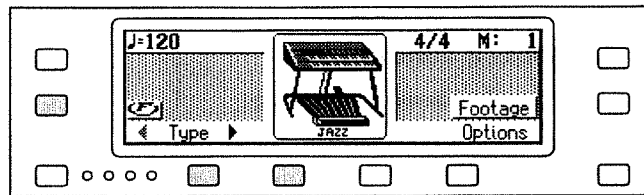

2. Press Type <◀> and <▶> at the bottom of the screen to choose the organ type.

You can select any of four types of organ.

- Jazz Organ
- Church Organ
- Theater Organ
- Classic Organ

■ Changing the Rotary Effect

The "Jazz Organ" sound has a rotary effect added to it.

Applying a rotary effect to the organ sound provides the same undulations you get with rotating speakers. You can vary the speed at which the speakers rotate.

1. Press <F> at the left of the display.

Each time you press the button, <F> and <S> in the display will change.

When <F> is displayed, the speed of rotation is fast. When <S> is displayed, the speed of rotation is slow.

MEMO

Choosing "Jazz Organ" makes the keyboard divide into right- and left-hand sections and play different tones on the two sections. This division of the keyboard into a right-hand section and a left-hand section is called a "Split." If you want to know more, take a look at "Playing Different Tones with the Left and Right Hands (Split Play)" (p. 49)

MEMO

You can change the settings for an organ performance by pressing <Options> at the bottom of the display. Also, when you've selected Jazz Organ, you can press <Footage> at the right of the display to create the sound you want. For more information, take a look at "Changing the Settings for One-touch Organ" (p. 141).

Getting Acquainted with the KR-377

Playing a Wide Variety of Instrument Sounds

The KR-377 comes with a large number of built-in instrument sounds and effects. Enjoy performing with this superb collection of sounds, designed to accommodate almost any imaginable musical genre. The various onboard sounds are called "Tones."

The tones are divided into eight separate groups, each assigned to the Tone buttons.

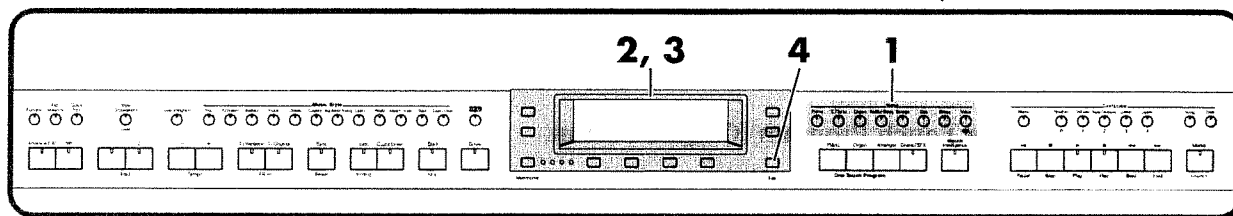

1. Press one of the Tone buttons to choose a Tone Group.

The screen shows four of the Tones included in the chosen Tone Group.

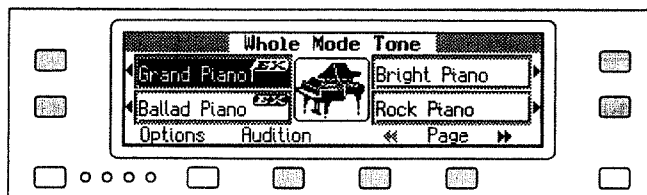

2. You can switch screens by pressing Page <◀◀> <▶▶> at the bottom of the display.

3. Press the button next to the Tone you want to play.

You can listen to a typical phrase for the Tone by pressing <Audition> at the bottom of the display.

The Tone you've selected is heard when you finger the keyboard.

4. Press the [Exit] button to return to the basic screen.

Try choosing and playing a variety of different tones.

About <EX> Tone

These are tones that Roland recommends you use in order to enjoy enhanced expressive capabilities.

Some of the EX Tones change according to the force with which the keys are played (velocity).

Handy Features for Selecting Tones (Tone Finder)

"Tone Finder" lets you use a handy features when selecting tones.

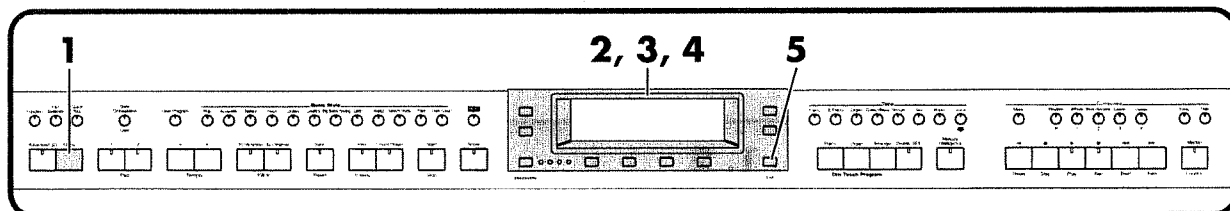

1. Press the [Utility] button.

The Utility screen appears.

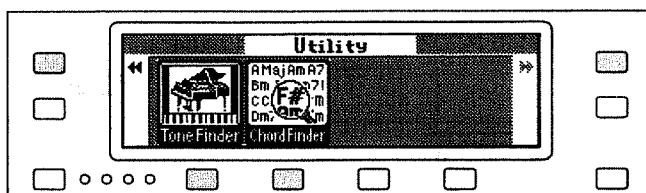

If <Tone Finder> doesn't appear on screen, press <◀▶> <▶▶> at the upper left and upper right of the display to switch screens.

2. Press <Tone Finder> at the bottom of the display.

3. Press the button at the bottom of the display to select a function.

Display	Description
Check It Out!	You can select tones just by selecting icons for the suggested tones, or combination of tones, displayed on the screen.
Find Suitable	After selecting the type of musical instrument and musical genre, you can then find tones that will sound good with your selections.
Index	Allows searching of tones using the first letter of the tone name.

4. Follow the on-screen instructions to select tones.

5. When you're done the function, press the [Exit] button.

Press the [Exit] button several times to return to the previous screen.

Sounding the Metronome

The KR-377 features a built-in metronome. You can turn the metronome sound on and off with the press of a single button.

When turned on during playback of a song, or during a performance with Automatic Accompaniment, the metronome sounds to the tempo and beat of the song in progress.

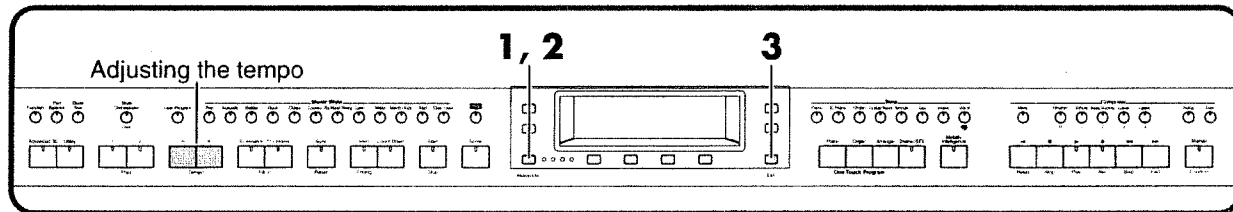

1. Press the [Metronome] button to sound the metronome.

The Metronome screen appears.

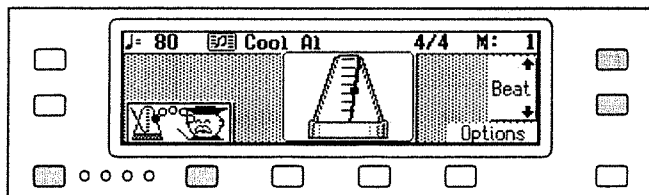

2. Press the [Metronome] button again, and the metronome will stop sounding.

3. Press the [Exit] button to go back to the previous screen.

■ Adjusting the Tempo

You can adjust the tempo of the metronome. The tempo of the metronome changes automatically if you use an Automatic Accompaniment or play back a song.

1. Use the Tempo [-] and [+] buttons to change the tempo.

The tempo of the Metronome can be set within the range of 20 to 250. The setting is at "120" when the piano is powered up.

You can return to the original tempo for a Music Style (p. 60) or a song by pressing [-] and [+] at the same time.

■ Changing the Beat of Metronome

1. From the Metronome screen, press <↑> <↓> at the right of the screen to set the beat.

The beat displayed in the upper portion of the screen will change.

Available beat settings:

2/2, 0/4, 2/4, 3/4, 4/4, 5/4, 6/4, 7/4, 3/8, 6/8, 9/8, 12/8

MEMO

When the Metronome screen is displayed, you can change the volume and the beat. For more information, see "Sounding the Metronome" (p. 56).

MEMO

You can change the animation by pressing the button under . When you turn on the power, "Metronome" is displayed.

MEMO

When $\frac{0}{4}$ is selected, only the upbeat will sound.

—Try playing using Automatic Accompaniment

Enjoying Automatic Accompaniment with Ease (EZ Arranger)

Next, try playing using Automatic Accompaniment.

Automatic Accompaniment is a feature that creates an accompaniment matched to the chords you specify with the left hand, making the performance more impressive and enjoyable.

To use Automatic Accompaniment, you need to press some buttons and make the settings for Automatic Accompaniment, but EZ Arranger lets you use Automatic Accompaniment just by answering some on-screen questions. You can also play chords automatically.

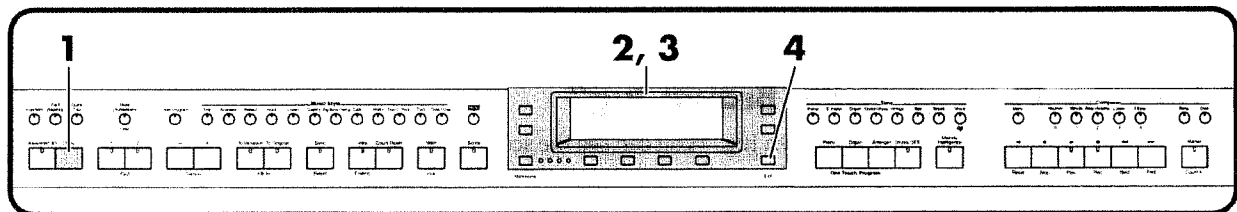

1. Press the [Utility] button.

The Utility screen appears.

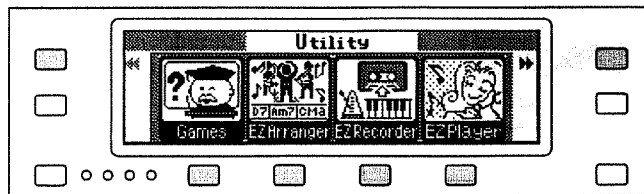

2. Press the <EZ Arranger> button at the bottom of the display.

If <EZ Arranger> doesn't appear on screen, press <◀▶> <▶▶> at the upper left and upper right of the display to switch screens.

3. Follow the on-screen instructions, and answer the questions.

You can proceed to the next screen by selecting the <▶> button at the right of the display. When you've answered all the questions, you can start playing with Automatic Accompaniment right away.

Use the keyboard to try out a variety of methods of play.

You can play chords automatically

When specifying the chords yourself in a performance, specify the chords in the left part of the keyboard, as illustrated below.

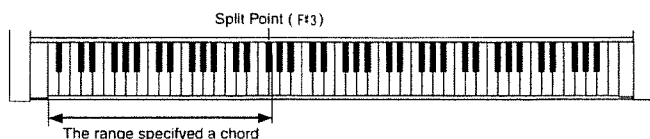

4. Press [Exit] to end the EZ Arranger.

You are returned to the Utility screen.

Playing with an Automatic Accompaniment (One-touch Arranger)

You can make the optimal settings for playing Automatic Accompaniment with just a single press of the One Touch Program [Arranger] button. You can completely alter the ambience of the performance by changing the Music Style.



For more information, check out “Chapter 2 Automatic Accompaniment” (p. 60).

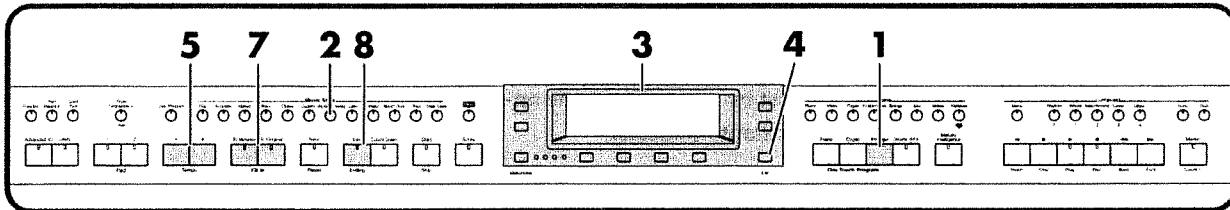

■ Let's Try Playing, “Little Brown Jug”

Now, let's try playing “Little Brown Jug” (you can see the score on page 32) using Automatic Accompaniment.

In this example we'll play the song with the “Swing'in” Music Style.

1. Press the One Touch Program [Arranger] button.

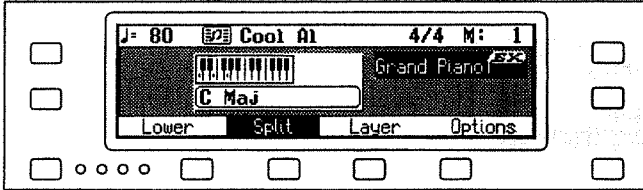

2. Press the [Big Band/Swing] Music Style button.

The following screen appears.

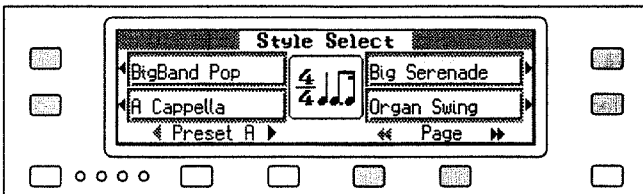

3. Use Page <◀▶> <◀▶> at the bottom of the display to switch screens, then press the button next to <Swing'in>.
4. Press the [Exit] button.
You are returned to the previous screen.
5. Use the Tempo [-] and [+] buttons to adjust the tempo of the accompaniment.
You can return to the original tempo for the selected style by pressing the [-] and [+] buttons at the same time.

6. Finger the "C" key in the following figure to start play.

When you play the keyboard, first an intro of 8 measures is played. Play the right-hand and left-hand parts of the score (p. 32) on the keyboard. There's no need to hold down the key with the left hand, so you can get ready to finger the next one.

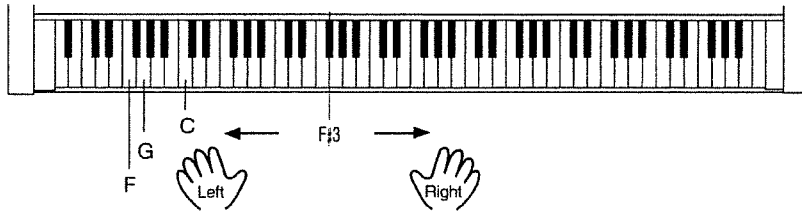

7. Press the Fill In [To Variation] button with the timing on the score.

The accompaniment pattern changes. Pressing the [To Original] button returns you to the original accompaniment pattern. Once you've familiarized yourself with the performance, try varying the timing for the accompaniment pattern as you like.

8. Press the [Intro/Ending] button with the timing on the score.

After the ending plays, the accompaniment stops.

Little Brown Jug

Left

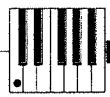

C

Play the C Key on the keyboard.

Intro 8 measures

Right



C F G C

Left



Right



C F G C

Left



Press the Fill In [To Variation] to change the Accompaniment Pattern.



Right



C F G C

Left



Right



C F G C

Left



Press the [Intro/Ending] to sound the Ending.



Effects Adding Three-Dimensional Breadth to Your Performances (Advanced 3D)

When performing along with the Automatic Accompaniment or the internal songs, you can add three-dimensional breadth to the accompaniment sounds.

It also provides the pleasant effect of “wrapping” your performance within the accompaniment.

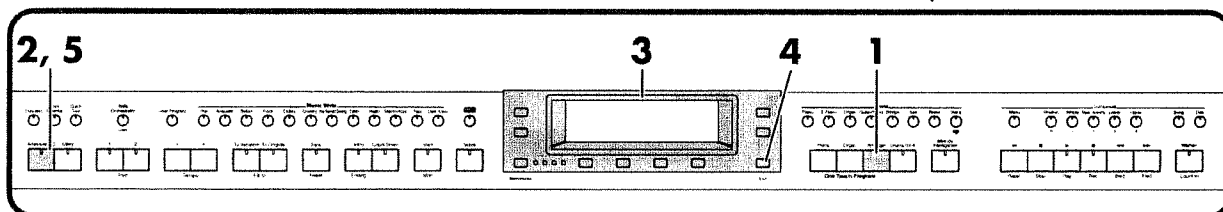

1. Press the One Touch Program [Arranger] button.
2. Press the [Advanced 3D] button.

The Advanced 3D screen appears.

When you play in the left part of the keyboard, the automatic accompaniment starts. Let's try out the Advanced 3D effect.

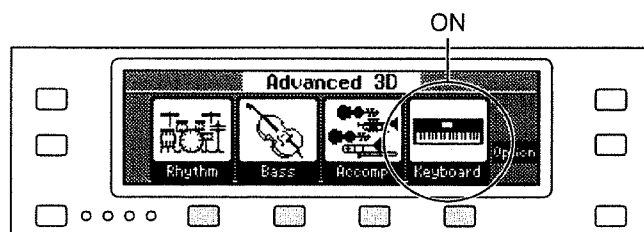

3. Press the button under the icon to turn the effect on or off.

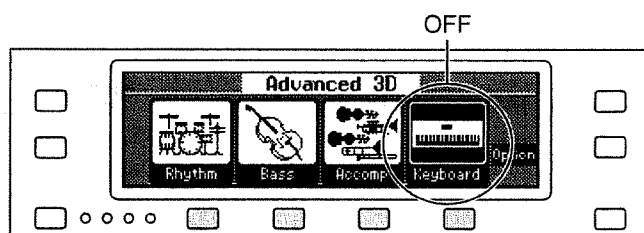

When set to On, three-dimensional breadth is added to the sound of the selected accompaniment part.

4. Press the [Exit] button to go back to the previous screen with the Advanced 3D still in effect.
5. Press the [Advanced 3D] button once more, extinguishing the button's indicator, to eliminate the effect.

The Advanced 3D effect is removed from all parts.

—Try recording

Recording Your Playing With Ease (EZ Recorder)

The KR-377 has an “EZ Recorder” function that makes it easy to record; simply follow the directions in the screen.

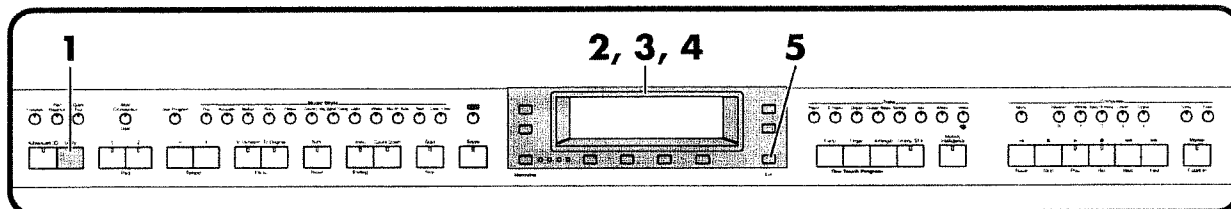

1. Press the [Utility] button.

The Utility screen appears.



2. Press <EZ Recorder> at the bottom of the display.

If <EZ Recorder> doesn't appear on screen, press <◀▶> <▶▶> at the upper left and upper right of the display to switch screens.

3. Follow the on-screen explanations to make the settings for the tone, beat, and tempo.

You can proceed to the next screen by selecting the <▶> button at the right of the display.

4. Follow the on-screen instructions to record the performance.

5. Press [Exit] to end the EZ Arranger.

MEMO

You can save the recorded song on a floppy disk. Have an empty, formatted floppy disk. For more about formatting, take a look at “Formatting Floppy Disks (Format)” (p. 104).

Recording a Performance

In this section, we'll record a performance for "Little Brown Jug" on p. 32.

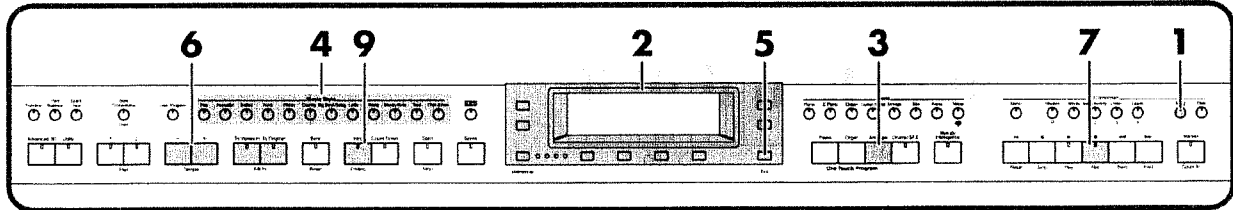

Get Ready to Record

1. Press the [Song] button.

A Song screen like the one below appears.

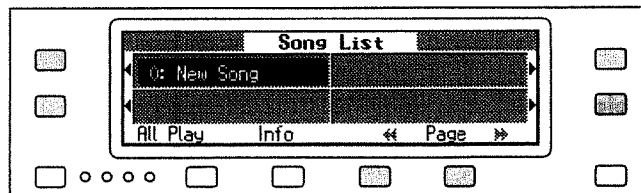

2. Press <0: > at the left of the display, get <0: New Song> to appear in the display.

If <0: > doesn't appear on screen, press Page <◀▶> at the bottom of the display to switch screens.

Get Ready to Play

3. Press the One Touch Program [Arranger] button.
4. Press the Music Style button and the button next to the display to choose the Music Style you want to play.
When playing "Little Brown Jug" (p. 32), press the [Big Band/Swing] button to choose <Swing'in>.
5. Press the [Exit] button to go back to the previous screen.
6. Use the Tempo [-] and [+] buttons to adjust the tempo of the accompaniment.

Start Recording

7. Press the Rec [●] button.

The Play [▶] button's indicator begin blinking, and the unit will be ready for recording.

To stop recording, press the Stop [■] button.

MEMO

If a song is recorded in the internal memory, the message screen appears when you try to choose a song.

Refer to "● When the Following Screen Is Displayed" (p. 36).

Getting Acquainted with the KR-377

8. Play the first chord on the left-hand section of the keyboard.

An intro of Automatic accompaniment starts, and recording is started at the same time.

Now begin playing.

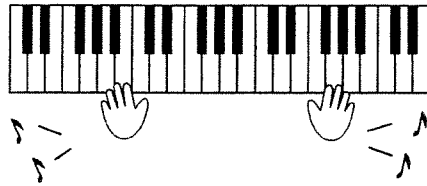

Stop Recording

9. Press the [Intro/Ending] button.

An ending is played, then the Automatic Accompaniment stops, and recording is stopped at the same time.

● When the Following Screen Is Displayed

If a song is recorded in the internal memory, the screen shown below appears when you try to choose a song.



If you don't want to erase the song

Press <Cancel> at the bottom of the display.

Save the song on a floppy disk.

For information on how to save your song, see "Saving Songs to Floppy Disks" (p. 104).

Erasing a song

Press <OK> at the bottom of the display.

The recorded performance or song whose settings have been changed is erased.

Listening to the Recorded Performance

Now listen to the performance you have recorded.

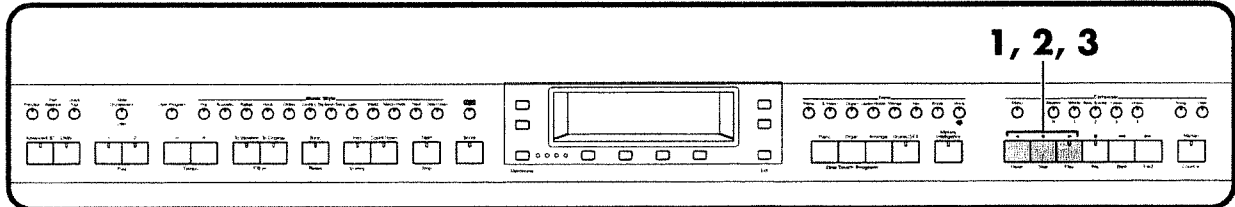

- 1. Press the Reset [◀] button.**
Now you can play back the song from the beginning.
- 2. Press the Play [▶] button.**
The recorded performance is played back.
- 3. Press the Stop [■] button.**
Playback stops.

NOTE

Any performance that has been recorded is deleted when the power to the KR-377 is turned off. If you don't want to lose your recorded performance, save it on a floppy disk. For information on how to save your song, see "Saving Songs to Floppy Disks" (p. 104).

NOTE

If there's a recorded performance in the KR-377's internal memory, you can't play back another song. Check out "Erasing a Recorded Song" (p. 97).

—Try to use Music Files

Using the Disk Drive

Here's where you can know how to use the disk drive to listen to commercially available music files.

You can also listen to KR-377 performance data saved on a floppy disk in the same way.

■ Inserting and Ejecting a Floppy Disk

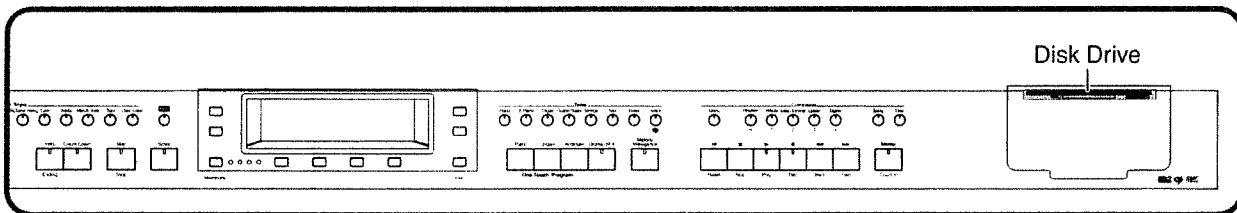

- 1. Hold the floppy disk face up, and push it into the disk drive until it clicks into place.**

The disk drive is on the right side of the unit, above the keyboard.

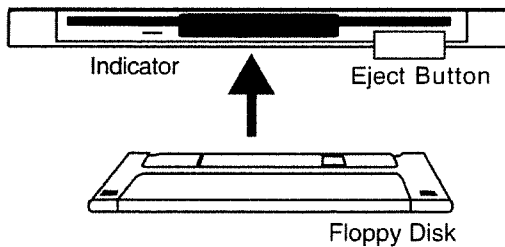

- 2. To remove a disk, press the Eject button.**

The end of the floppy disk comes out of the slot. Gently grasp the end of the floppy disk and pull it out.

NOTE

If you're using the disk drive for the first time, be sure to read the important notes on p. 6.

NOTE

Don't try to eject the disk while reading or writing is in progress. Attempting to do so may damage the magnetic surface of the disk, rendering it unusable. (The indicator light for the disk drive lights up at full brightness when reading or writing data. Ordinarily, the indicator will be less brightly lighted, or be extinguished.)

Listening to Music Files

Here's where you can know how to use the disk drive to listen to commercially available Music Files or a song on the Data Disk (p. 177) included with the KR-377.

■ Playing the Song with Ease (EZ Player)

By using "EZ Player," you can play back song data such as music data as easily as operating a CD player.



To learn more about Music Files, refer to "Music Files That the KR-377 Can Use" (p. 178).

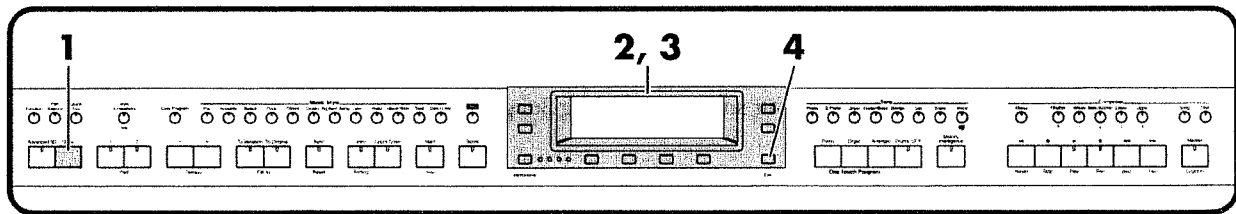

1. Press the [Utility] button.

The Utility screen appears.

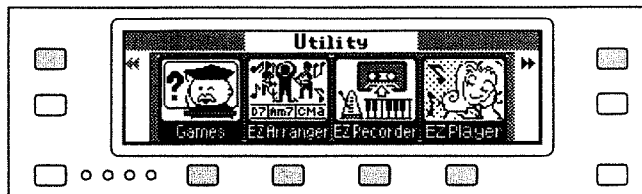

2. Press <EZ Player> at the bottom of the display.

If <EZ Player> doesn't appear on screen, press <◀▶> at the upper left and upper right of the display to switch screens.

3. Press the button at the bottom of the display to listen to the songs.

Button	Description
◀◀	Selects the previous song. If you press this button while a song is playing, you will play back the previous song.
■	Stops playback.
▶▶	Starts playback.
▶▶	Selects the next song. If you press this button while a song is playing, you will play back the next song.

4. Press the [Exit] button to end the EZ Player.

Press the [Exit] button several times to return to the previous screen.



If you're using the disk drive for the first time, be sure to read the important notes on p. 6.



If a song is recorded in the internal memory, the message screen appears when you try to choose a song.

Refer to "● When the Following Screen Is Displayed" (p. 40).



You can view some information about the selected song by pressing <Info> at the bottom of the Song screen.

For more about the Song screen, refer to "Playing Back Songs for Practice" (p. 77).

Getting Acquainted with the KR-377

● When the Following Screen Is Displayed

If a song is recorded in the internal memory, the screen shown below appears when you try to choose a song.



If you don't want to erase the song

Press <Cancel> at the bottom of the display.

Save the song on a floppy disk.

For information on how to save your song, see "Saving Songs to Floppy Disks" (p. 104).

Erasing a song

Press <OK> at the bottom of the display.

The recorded performance or song whose settings have been changed is erased.

Using the KR-377 as a Karaoke Machine

You can connect a microphone into the Mic jack, and enjoy karaoke with the KR-377.

■ Connecting a Microphone

You can hook up a microphone to the KR-377.

The Mic jack is located at the right of the bottom panel of the KR-377.

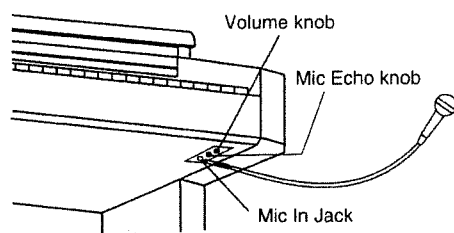

Adjust the volume level for the microphone with the Microphone [Volume] knob, next to the Mic jack.

Use the Microphone [Echo] knob to adjust the echo level for the microphone.

■ Enjoying Karaoke Performances

1. Connect the microphone and adjust the volume and echo.
2. Insert the floppy disk that contains music files into the disk drive.
Refer to "Inserting and Ejecting a Floppy Disk" (p. 38).
3. Press the [Song] button.
4. Press the button next to the display to select a song.
5. If you need to, use the Tempo [-] and [+] buttons to adjust the tempo.
6. If necessary, change the key of the song (p. 90).
7. Press the Play [▶] button to play the song accompaniment.
Now, start singing!
When you play back a Music File with lyrics, the lyrics appear on screen.
8. Press the Stop [■] button to stop playback of the song.

MEMO

Karaoke music files must be purchased separately. Check out "Music Files That the KR-377 Can Use" (p. 178).

NOTE

If you're using a microphone for the first time, be sure to read "Connecting a Microphone" (p. 15).

MEMO

Consult your Roland dealer when purchasing a microphone for use with the KR-377.

MEMO

You can hide lyrics, if you like. Take a look at "Hiding the On-screen Lyrics" (p. 148).

Chapter 1 Playing the Keyboard

Playing the Keyboard Like a Piano (One-touch Piano)

You can make the optimal settings for a piano performance with the press of a single button.

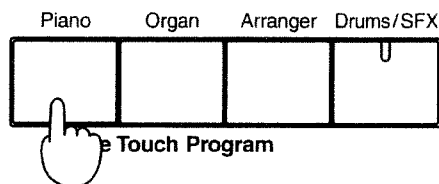

1. Press the One Touch Program [Piano] button.

A Piano screen like the one shown below appears.



Settings are made for the following situations.

- When the keyboard has been split into upper and lower sections (p. 49), this returns the keyboard to a single section.
- The functioning of the pedals returns the pedals to their usual functions (p. 14).
- The Grand Piano sound is selected.
- The effect is set to "Sympathetic Resonance."

Changing the Piano Sound

1. Press < ↑ > < ↓ > at the left of the display.

The amount by which the piano's top is opened changes, and the sound also changes.

This simulates the sound reflections that occur when the lid of a grand piano is open.

MEMO

You can change settings related to the piano performance by pressing <Customize> at the bottom of the display. For details, refer to "Adjusting Resonance" (p. 135).

MEMO

Since this instrument faithfully reproduces real acoustic piano action and response, sounds in the top one-and-one-half-octave range continue to play, regardless of the damper pedal action, and the tone in this range is audibly different. The Key Transpose setting (p. 89) can also be used to change the range that is unaffected by the damper pedal.

Playing the Keyboard Like an Organ (One-touch Organ)

You can make the optimal settings for an organ performance with the press of a single button.

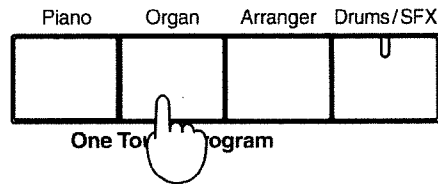

1. Press the One Touch Program [Organ] button.

An Organ screen like the one shown below appears.



2. Press Type <Left> <Right> to choose the organ type.

You can select any of four types of organ.

- Jazz Organ
- Church Organ
- Theater Organ
- Classic Organ

Changing the Rotary Effect

The "Jazz Organ" sound has a rotary effect added to it.

Applying a rotary effect to the organ sound gives the same undulations you get with rotating speakers. You can vary the speed with which the speakers rotate.

1. Press <Fast> at the left of the display.

Each time you press the button, <Fast> and <Slow> in the display will change.

When <Fast> is displayed, the speed of rotation is fast. When <Slow> is displayed, the speed of rotation is slow.

MEMO

Choosing "Jazz Organ" makes the keyboard divide into right- and left-hand sections and play different tones on the two sections. This division of the keyboard into a right-hand section and a left-hand section is called a "Split." If you want to know more, take a look at "Playing Different Tones with the Left and Right Hands (Split Play)" (p. 49).

MEMO

You can change the settings for an organ performance by pressing <Options> at the bottom of the display. Also, when you've selected Jazz Organ, you can press <Footage> to create the sound you want. For more information, take a look at "Changing the Settings for One-touch Organ" (p. 141).

Playing Drum Sounds

You can use the keyboard to play percussion sounds or effects such as sirens and animal sounds.

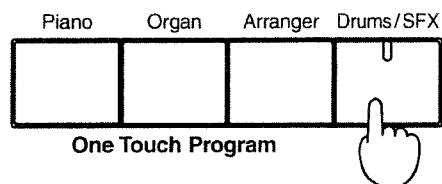

1. Press the [Drums/SFX] button.

The button's indicator lights up, and the Drum screen appears.

When you finger the keyboard now, each key plays a different percussion-instrument sound.

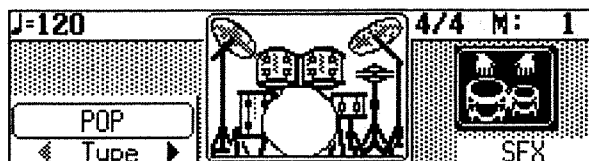

2. Press Type <◀> <▶> at the bottom of the display to change the type of drum set.

The drum set appears in the middle of the screen.

Sets of percussion sounds, such as "STANDARD," are called "Drum Sets."

Each drum set contains a wide variety of percussive instrument sounds and sound effects, and each key plays a different sound.

3. Press the [Drum/SFX] button once again to return to the previous sound.

The button's indicator is extinguished, and you are returned to the previous screen.

The sound played with the keyboard reverts to the instrument sound used before the [Drums/SFX] button was pressed.



The combination of sounds assigned to the keyboard varies according to the drum set. Take a look at the "Drum/SFX Set List" (p. 166).

■ Playing Effect Sounds

1. Press the [Drums/SFX] button.

The button's indicator lights up, and the Drum screen appears.

2. Press <SFX> at the bottom of the display.

The following screen is called up.

When you finger the keyboard now, each key plays a different effect sound.

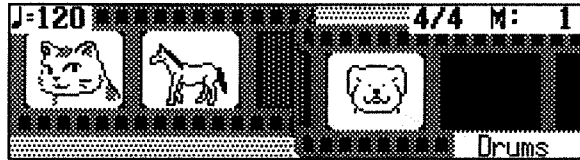

A set of effect sounds is called an "SFX set."

Pressing <Drums> at the bottom of the screen displays the Drum screen and makes it so that percussion instruments are sounded.

3. Press the [Drum/SFX] button once again to return to the previous sound.

The button's indicator is extinguished, and you are returned to the previous screen.

The sound played with the keyboard reverts to the instrument sound used before the [Drums/SFX] button was pressed.



For details of the sounds included in the SFX set, refer to "Drum/SFX Set List" (p. 166).

Playing a Wide Variety of Instrument Sounds

The KR-377 comes with a large number of built-in instrument sounds and effects. This lets you enjoy performances with sounds matched to a wide range of musical genres. The various types of built-in sounds are called "Tones." The tones are divided into eight separate groups, each assigned to one of the eight Tone buttons.

The buttons shown below are called the Tone buttons.

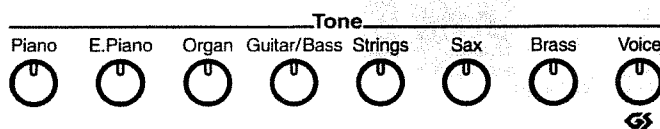

1. Press one of the Tone buttons to choose a Tone Group.

The pressed Tone button's indicator will light.

The screen shows four of the Tones included in the chosen Tone Group.

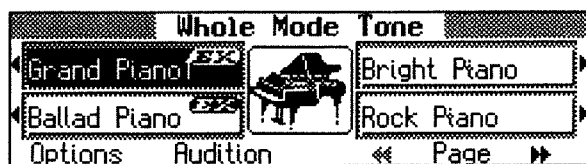

This screen is called the "Tone Selection" screen.

2. Press the button next to the display to select a Tone.

When you use Page <◀▶> at the bottom of the display to switch screens, other Tones will be displayed.

The Tone you've selected is heard when you finger the keyboard. Also, this is the Tone that you'll hear the next time you choose this Tone button.

You can audition tones by listening to a typical phrase for the Tone by pressing <Audition> at the bottom of the display.

3. Press the [Exit] button.

You are returned to the previous screen.

About <EX> Tone

These are tones that Roland recommends you use in order to enjoy enhanced expressive capabilities.

Some of the EX Tones change according to the force with which the keys are played (velocity).



By pressing <Options> located at the bottom of the display in the Tone Selection screen, you can apply effects to the sound and make other settings. For details, refer to "Applying Effects to the Sound (Effects)" (p. 55).



For more about the names of Tones, take a look at the "Tone List" (p. 162).

Combining the Sounds of Two Instruments (Layer Play)

You can play two different sounds from a single key at the same time. This method of performance is called "Layer Play." For instance, it's possible to play the Tones for both Piano and Strings in combination.

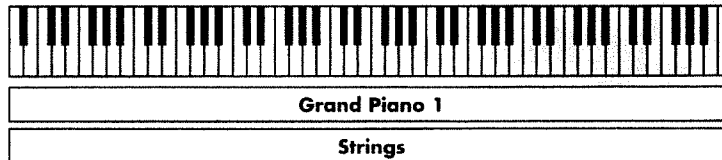

1. From the basic screen, press <Layer> at the bottom of the display.

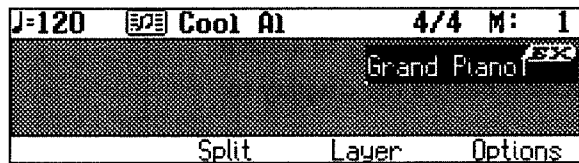

The screen changes as shown below.

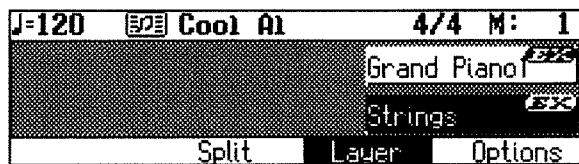

The Tone name appears at the lower-right area of the screen. This Tone is called "Layer Tone."

When you finger the keyboard, the sound you chose in step 1 is combined with the layer tone.

2. To cancel Layer Play, press <Layer> once again.

When you finger the keyboard, only the sound displayed at the upper-right area of the screen is played.



Basic Screen (p. 16)



You can adjust the volume level for each of the Tones. For instructions, see "Adjusting the Volume of Each Performance Part" (p. 75).

Chapter 1 Playing the Keyboard

To Change Tones

1. Press the button located beside the name of the Tone you wish to change.

The selected Tone will be highlighted.

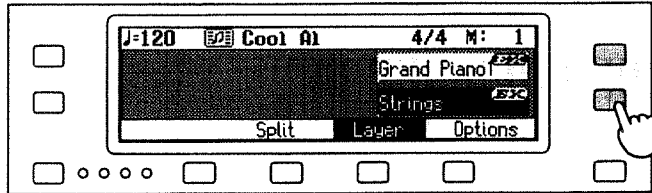

2. Press a Tone button.
The Tone Selection screen appears.
3. Use Page < << >> > at the bottom of the display to switch screens, and use the buttons located beside the display to select Tones.

4. Press the [Exit] button.

The previous screen appears.

When you finger the keyboard, the selected Tone and the other Tone are played.

MEMO

If Layer Play is turned on, you can press <Options> located at the bottom of the Tone Selection screen to change the pitch of the keyboard sound in octave units. To learn more, see "Shifting the Keyboard Pitch in Octave Steps (Octave Shift)" (p. 51).

Playing Different Tones with the Left and Right Hands (Split Play)

The Split feature allows you to split the keyboard into two zones, then play a different sound in each zone.

Such a division of the keyboard into right- and left-hand sections is called a "Split," and the key where the division takes place is called the "Split Point." The split-point key is included in the left-hand section. Each time power to the keyboard is turned on, the split point is reset to "F#3."

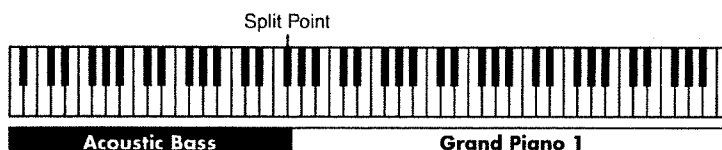

• Switching to Split Play directly from Layer Play

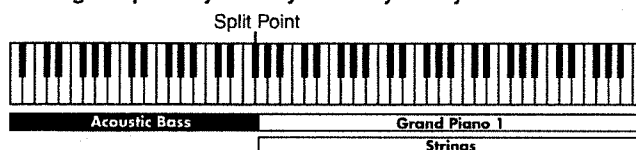

1. From the basic screen, press <Split> at the bottom of the display.

The tone in the right-hand part is the tone displayed on the upper right part of the screen, and the tone in the lower part is the tone displayed on the upper left part of the screen.

The tone in the upper part of the keyboard is called the "Upper Tone," and the tone in the lower part is called the "Lower Tone."

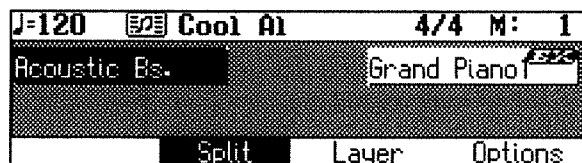

2. To cancel the split function, press <Split> once again.

The tone in the upper part then is effective for the entire keyboard.



You can change the split point. Please refer to "Changing the Keyboard's Split Point" (p. 137).



When you switch to Split Play directly from Layer Play, the two tones played in Layer Play become the tone of the right-hand of the keyboard in Split mode.



Basic Screen (p. 16)



When the keyboard has been divided into upper and lower sections, the damper pedal is applied to only the upper section. If you want to add lingering reverberations to the notes of the lower section, see "Assigning a Function to Pad Buttons or Pedals" (p. 139).



You can adjust the volume level for each of the Tones. For instructions, see "Adjusting the Volume of Each Performance Part" (p. 75).

Chapter 1 Playing the Keyboard

Changing the Tones

1. Press the button next to the name of the Tone you want to change.

The selected Tone will be highlighted.

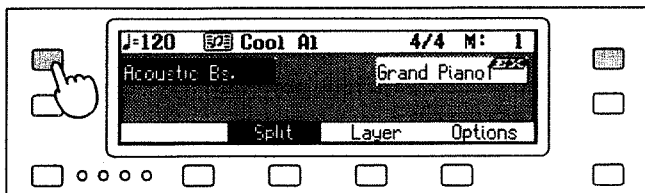

2. Press one of the Tone buttons.
The Tone Selection screen appears.
3. Use Page <◀> <▶> at the bottom of the display to switch screens, then use the button next to the display to choose the Tone.
4. Press the [Exit] button.
The previous screen appears.
Play the keyboard to hear the Tone you selected.

MEMO

Pressing <Split> to cancel the Split Play during Automatic Accompaniment activates the "Piano Style Arranger." Take a look at "Playing the Piano Along with the Automatic Accompaniment (Piano Style Arranger)" (p. 74).

MEMO

If Split Play is turned on, you can press <Options> located at the bottom of the Tone Selection screen to change the pitch of the keyboard sound in octave units. To learn more, see "Shifting the Keyboard Pitch in Octave Steps (Octave Shift)" (p. 51).

Shifting the Keyboard Pitch in Octave Steps (Octave Shift)

When the keyboard has been set up so that the right-hand and left-hand parts play different sounds (Split Play → p. 49), or so that the sounds for two instruments are played in combination (Layer Play → p. 47), you can shift the pitch of the notes you play by an octave at a time. This function is called “Octave Shift.”

For instance, you can make the pitch of the keyboard’s left-hand part match the pitch of the right-hand part during Split Play. Or, you could change the pitch of each tone, and play both tones together during Layer Play.

1. Make sure the basic screen is displayed.

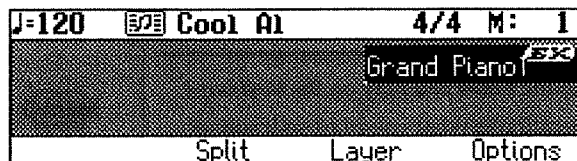

2. Press <Layer> or <Split> at the bottom of the display to select Layer play or Split play.
3. Press the button next to the Tone on which to use Octave Shift.
The selected Tone will be highlighted.
4. Press the Tone button for the Tone you want to play.
The Tone Selection screen appears.
5. Press <Options> at the bottom of the display.

A screen like the one shown below appears.

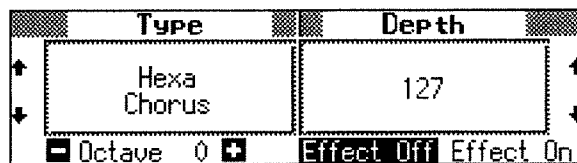

6. Use Octave ** <[-]> <[+]> to adjust the pitch of the sound.

“Octave **” displays the pitch of the currently selected note.

Each time you press Octave <[+]>, the pitch will be raised one octave.

Each time you press Octave <[-]>, the pitch will be lowered one octave.

The pitch can be lowered by up to two octaves, or raised as much as two octaves (-2 to +2).

NOTE

You can't use this feature when set up so that the entire keyboard is played as a single instrument.

MEMO

Basic Screen (p. 16)

Adjusting the Sound Brilliance

1. Use the [Brilliance] knob to adjust the overall brilliance.

Rotating the knob clockwise makes the tone brighter; rotating it counterclockwise makes the sound more mellow.

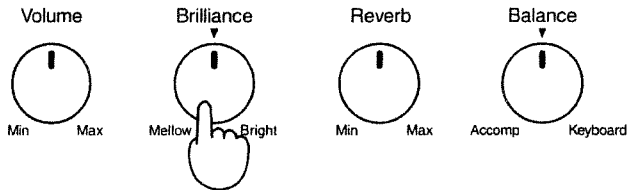

Adding Reverberation to Sounds (The Reverb Effect)

The KR-377 can apply a reverb effect to the notes you play on the keyboard. Applying reverb adds pleasing reverberation to what you play, so it sounds almost as if you were playing in a concert hall.

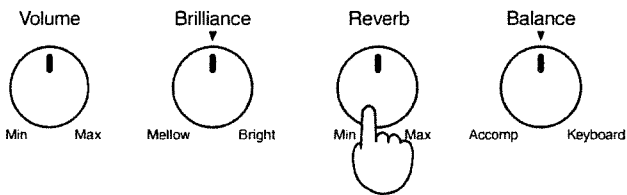

1. Adjust the [Reverb] knob to select the amount of reverb effect to be applied.

Rotating the knob clockwise applies a deeper reverb, and rotating it counterclockwise applies less reverb.

MEMO

You can change the type of reverb that's applied. Please refer to "Changing the Type of Reverb Effect" (p. 146).

NOTE

If you press the One Touch Program [Piano] button for the purposes of a piano performance, settings for the reverb effect that were made using the [Reverb] knob could get altered.

Effects Adding Three-Dimensional Breadth to Your Performances (Advanced 3D)

When performing along with the Automatic Accompaniment or the internal songs, you can add three-dimensional breadth to the accompaniment sounds. It provides the pleasant effect of “surrounding” your performance within the accompaniment.

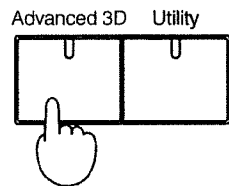

1. Press the [Advanced 3D] button.
The button's indicator lights up, and the Advanced 3D screen appears.
2. Press the button under the corresponding performance part to turn Parts on/off.

Three-dimensional breadth is added to the performance Part which is turned on.

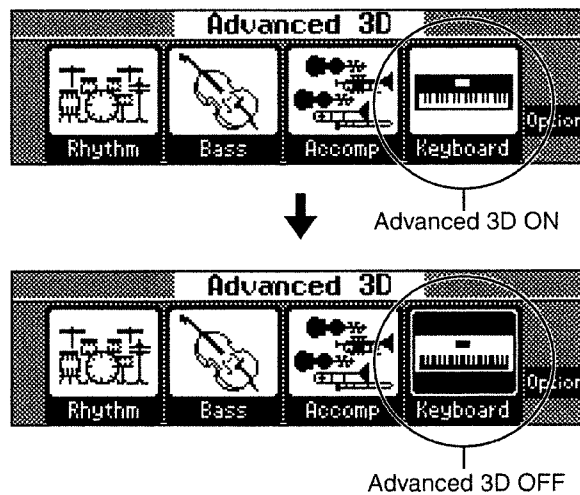

When you press the [Exit] button you will return to the previous screen. However if the [Advanced 3D] button's indicator is lit, the effect will apply to the selected Part.

3. To eliminate the effect, press the [Advanced 3D] button once more, extinguishing the button's indicator.
The Advanced 3D effect is removed from all parts.

Chapter 1 Playing the Keyboard

■ Applying an Effect Only to the Layer Tone of the Keyboard

When the Advanced 3D effect is being applied to "Keyboard," you can apply the effect only to the Layer tone (p. 47).

The setting is at "ALL" when the piano is powered up.

1. From the Advanced 3D screen, press <Option>.

The following screen appears.

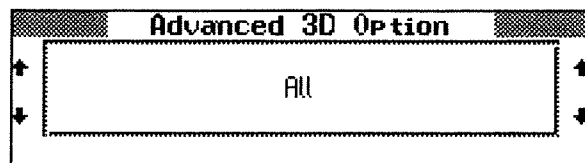

Display	Description
All	The effect is applied to all the notes you play on the keyboard.
Layer	The effect is applied to the Layer tones. When Layer Play is not being used, the effect is not applied to what is played on the keyboard, even if "Keyboard" is set to On.

2. Use <↑> <↓> next to the display to choose the setting.

Press the [Exit] button to go back to the Advanced 3D screen.

Applying Effects to the Sound (Effects)

You can apply a wide range of different effects to the notes you play on the keyboard.

1. Press one of the Tone buttons to choose a Tone to which you want to apply an effect.

The Tone Selection screen appears.

2. From the Tone Selection screen, press <Options> at the bottom of the display.

A screen like the one shown below appears.

This screen is called the “Effects screen.”

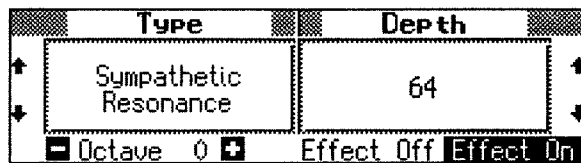

3. Press <Effect On> at the bottom of the display.
The optimal effect is applied for the currently selected Tone.
4. Use <↑> <↓> at the left of the display to choose “Type” (the type of effect).
5. Use <↑> <↓> at the right of the display to adjust “Depth” (the amount of effect applied).
6. To cancel the effect, press <Effect Off> at the bottom of the display.

Press the [Exit] button to return to the Tone Selection screen.

About the Effects

When the effects is set to ON, the optimal effect is applied for the currently selected sound. Also you can apply effects for each tone. Although turning off the power returns the effects to their initial settings, carrying out Memory Backup (p. 149) allows you to save and store the effect settings even after the power is turned off.

NOTE

When you press the One Touch Program [Piano] or [Organ] button, you cannot change the type of effects.

NOTE

If you apply a different effect to the Layer sound (p. 47) or the Lower sound (p. 49) than the effect applied to the Upper sound (the sound shown in the upper right of the main screen), the effect may not be applied in some cases. Select the same effect as for the Upper sound.

MEMO

For more information on the different types of effects, take a look at the “Effects List” (p. 176).

Sounding the Metronome

The KR-377 features a built-in metronome.

You can start or stop the metronome sound with just a single press of the [Metronome] button. During playback of a song, or when performing with Automatic Accompaniment, the metronome sounds to the tempo and beat of the song or accompaniment.

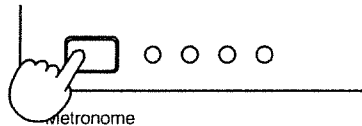

1. Press the [Metronome] button to sound the metronome.

The button's indicator lights up, and a Metronome screen like the one below appears.

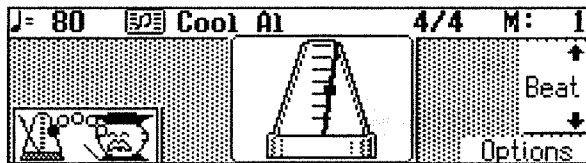

2. To stop the metronome's sound, press the [Metronome] button again.

The [Metronome] button's indicator goes dark. Press the [Exit] button to go back to the previous screen.

■ Adjusting the Tempo

You can adjust the tempo of the metronome. The tempo and beat of the metronome change automatically if you use an Automatic Accompaniment or play back a song.

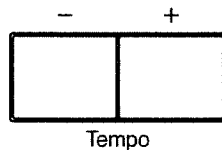

1. Use the Tempo [-] and [+] buttons to adjust the tempo.

The tempo of the Metronome can be set within the range of 20 to 250. The setting is at "120" when the piano is powered up. You can return to the original tempo for a Music Style (p. 60) or a song by pressing [-] and [+] at the same time.

■ Changing the Beat of Metronome

1. From the Metronome screen, press <↑> <↓> at the right of the screen to set the beat.

The beat displayed in the upper portion of the screen will change. Available beat settings:
2/2, 0/4, 2/4, 3/4, 4/4, 5/4, 6/4, 7/4, 3/8, 6/8, 9/8, 12/8



When $\frac{0}{4}$ is selected, only the upbeat will sound.

■ Changing the Animation

You can change what is normally displayed in the center of the metronome screen.

When you turn on the power, “Metronome” is displayed.

1. From the Metronome screen, press the button under









The animation type will change.

■ Changing How the Metronome Beat (Pattern) Sounds

The metronome usually sounds one beat per quarter note, but you can change the beat pattern to sound, for example, one beat for every dotted quarter note.

1. From the Metronome screen, press <Options> at the bottom of the display.
2. Use Select <◀> and <▶> at the bottom of the screen to choose <Pattern>.
The selected item will be highlighted.
3. Use <↑> <↓> next to the display to choose the pattern.

Display	Description
Normal	The metronome sounds in the ordinary way.
	Counting starts at the beginning of the measure, in intervals of dotted half-note upbeats.
	Counting starts at the beginning of the measure, in intervals of half-note upbeats.
	Counting starts at the beginning of the measure, in intervals of dotted quarter-note upbeats.
	Counting starts at the beginning of the measure, in intervals of quarter-note upbeats.
	Counting starts at the beginning of the measure, in intervals of dotted eighth-note upbeats.
	Counting starts at the beginning of the measure, in intervals of eighth-note upbeats.
	Counting starts at the beginning of the measure, in intervals of sixteenth-note upbeats.
+Doubl	Plays with backbeats as the added sound.
+Tripl	Plays with triplets as the added sound.
+Shufl	Adds a shuffle.

Press the [Exit] button to go back to the Metronome screen.



With a triplet beat (6/8, 9/8, or 12/8), added notes are sounded as triplets.

Chapter 1 Playing the Keyboard

■ Changing the Type of Sound

You can change the type of sound of the metronome.

* The setting is at "ordinary metronome sound" when the KR-377 is powered up.







1. From the Metronome screen, press <Options> at the bottom of the display.



2. Use Select <◀> and <▶> at the bottom of the screen to choose <Sound>.

The selected item will be highlighted.

3. Use <↑> <↓> next to the display to choose the tone.

Display	Description
	Ordinary metronome sound
	Electronic metronome sound
いち、に、 ichi, ni,	A voice counting "1, 2, 3" in Japanese.
One, two,	A voice counting "1, 2, 3" in English
	Dog and cat cries
	Woodblock sound
	Triangle and castanet sounds
	Clapping

Press the [Exit] button to go back to the Metronome screen

■ Changing the Volume

You can adjust the volume of the metronome to any of ten possible levels.

When the piano is switched on, " (5)" will be automatically selected.

- 1.** From the Metronome screen, press <Options> at the bottom of the display.
- 2.** Use Select <◀> and <▶> at the bottom of the screen to choose <Volume>.

The selected item will be highlighted.
- 3.** Use <↑><↓> next to the display to adjust the volume.

Choosing  sets the volume to the lowest level, and choosing

 sets it to the highest level.

Choose  to silence the metronome sound.

Press the [Exit] button to go back to the Metronome screen.

Chapter 2 Automatic Accompaniment

Music Style and Automatic Accompaniment

What's a Music Style?

A Music Style is an accompaniment pattern that has been designed to fit in with a particular musical style.

There are many different varieties of music around the world, and each one has its own unique features. What gives jazz its "jazziness" and classical music its unmistakable classical feel is the unique combination of elements, such as the instruments used, melody, and phrasing, which interact to create the musical character of the genre. A Music Style makes use of such elements to bring out the distinctive atmosphere and mood of each musical genre.

The Makeup of a Music Style

A Music Style is made up of five performance parts: "Rhythm," "Bass," "Accompaniment 1," "Accompaniment 2," and "Accompaniment 3."

Also, a Music Style is made up of a set of six performance states called "Divisions."

Division	Performance division
Intro	The intro is played at the start of a song.
Ending	This is played at the end of a song.
Original	This is a basic accompaniment pattern.
Variation	This is a developmental accompaniment pattern. It is a variation on an Original.
Fill In To Variation	This is a one-measure phrase inserted at a juncture where the mood changes. Use this when you wish to create more energy (shift to a variation) within the song.
Fill In To Original	This is a one-measure phrase inserted at a juncture where the mood changes. Use this when you wish to create more sedate (shift to a original) within the song.

What is Automatic Accompaniment?

With the KR-377, just by pressing the One Touch Program [Arranger] button, you can select Automatic Accompaniment. Automatic Accompaniment is a function that provides you with accompaniment in a variety of musical genres, played automatically, just by specifying chords in the left hand. Automatic Accompaniment lets you enjoy ensemble play with orchestral backing, even when performing alone!



For information on how to play Automatic Accompaniment, see "Choosing a Music Style" (p. 63).

About Chords

A chord is what is produced when multiple notes are played simultaneously. Chords are indicated by the pitch of the fundamental note of the chord (the root) and the chord type, which is determined by the other notes that comprise the chord.

For example, the chord C Maj is expressed with the root note "C" and the chord type "Maj" (Major). C Maj is composed of the three notes "C," "E," and "G."

"C Maj" appears as the chord name at the left of the basic screen.

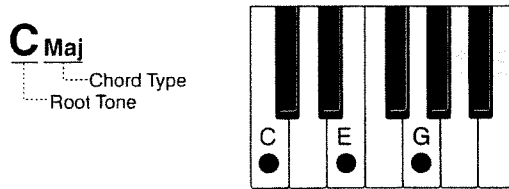

The root notes of chords are all indicated by a letter of the alphabet, # (sharp) and b (flat), which correspond as follows.

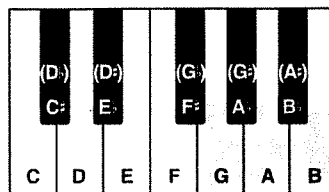

■ Playing Chords with Simple Fingering (Chord Intelligence)

"Chord Intelligence" is a feature that intelligently decides on accompaniment chords the moment you play some keys specifying a chord during Automatic Accompaniment.

To play a "C Maj" chord, for example, you usually have to finger the three keys C, E, and G; but with Chord Intelligence, you only have to press the C key to initiate a "C Maj" chord accompaniment.

- How to play the chord in the Chord Intelligence mode

Major

Ex: C Maj



Play the chord root.

Minor

Ex: C min



Play the root and the third key above it.

Seventh

Ex: C 7



Play the root and the second key above it.

Minor Seventh

Ex: C min 7



Play the root, the third key above it, and the second key below it.

Major Seventh

Ex: C Maj 7



Play the root and the first key below it.

Diminished

Ex: C dim



Play the root and the sixth key above it.



For more information about chord fingering, refer to the "Chord List" (p. 174).



Basic Screen (p. 16)



You can cancel the Chord Intelligence function. For more information, see "Canceling the Chord Intelligence Function" (p. 139).

■ Displaying the Chord Fingering On Screen (Chord Finder)

Whenever you are not sure how a certain chord is fingered, you can have the notes comprising the chord be shown in the screen.

1. Press the [Utility] button.

The Utility screen appears.

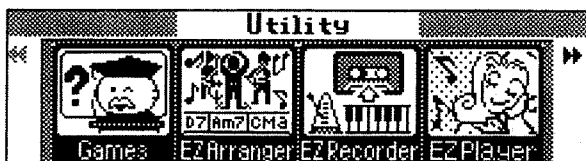

2. Press <Chord Finder> at the bottom of the display.

If <Chord Finder> doesn't appear on screen, press <◀▶> <▶▶> at the upper left and upper right of the display to switch screens.

3. Use <◀▶> <▶▶> at the bottom of the display to specify the root of the chord you want to learn about.

The chord fingering appears on screen.



Press the [Exit] button to return to the Utility screen.

Choosing a Music Style

You can choose a wide variety of Music Styles by pressing the Music Style button. The following buttons are called Music Style buttons.

A Music Style can be broken down into 11 groups.



When you press the One Touch Program [Arranger] button to change the Music Style, the played notes and tempo of the right-hand part of the keyboard change to the optimal Music Style, and the settings that let you play with Automatic Accompaniment are made right away.

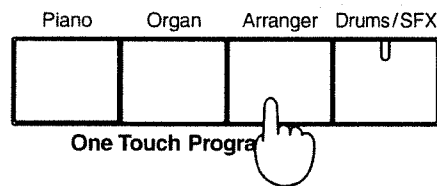

1. Press the One Touch Program [Arranger] button.

The basic screen like the one shown below appears.

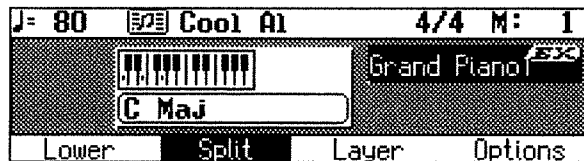

2. Press the Music Style button to choose the group for the Music Style.

The following screen is called the "Style Selection" screen.



3. Use Page <<> <>> at the bottom of the display to switch screens, then press the button next to the Style name to choose the Music Style.
4. Use <<> and <>> at the bottom of the screen to choose any one of Presets A–D.

When you change Preset type, the Music Style's tempo, the tone of the right-hand part, the settings of the Style Orchestrator (p. 71), and the like change. By varying the tempo or Tone, you can enjoy performances with a totally different ambience, even when the Music Style is the same.

Press the [Exit] button to return to the basic screen.



For more information about the types of Music Styles, take a look at the "Music Style List" (p. 171).



When you change the Music Style, the tempo and Tone change to match the Music Style you've chosen. If you don't want to change the tempo and Tone, take a look at "Keeping the Same Tone and Tempo When the Music Style Changes" (p. 141).

Chapter 2 Automatic Accompaniment

- Specify a chord by playing it on the left-hand keyboard section.

The Music Style you chose plays automatically with the specified chord.

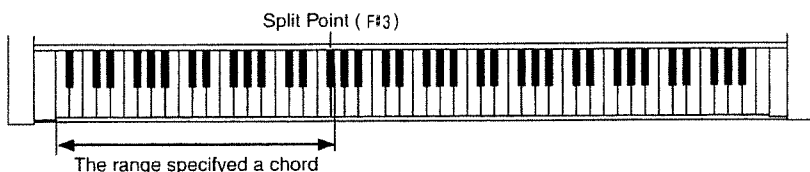

- Press the [Intro/Ending] button to play an ending and stop the accompaniment.

■ Choosing a Music Style from Data Disk

You can play with Music Styles on the Data Disk included with the KR-377, as well as User Styles saved on floppy disk (p. 132).

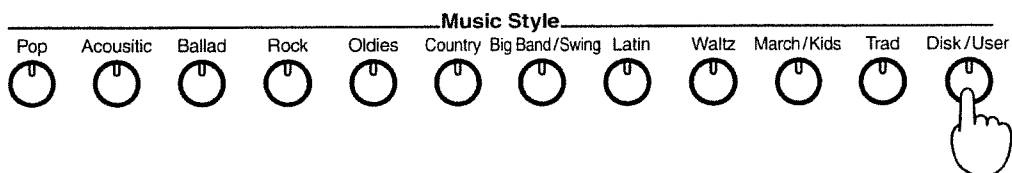

- Insert the floppy disk into the disk drive.

For information on how to use the disk drive, see p. 38.

- Press the [Disk/User] button.

A screen like the one shown below appears.

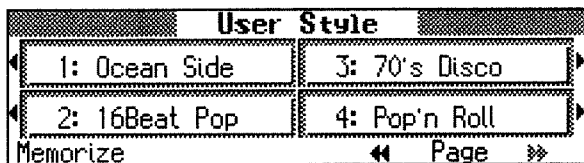

- Use Page < << >> > at the bottom of the display to switch screens, and select a Style.

When you press Page < << >> several times, the Styles registered in the [Disk/User] button will be displayed.

Styles with numbers beginning with "L" are styles that are stored in internal memory. Disk styles will be displayed following these.

- Press the One Touch Program [Arranger] button, then specify a chord by playing it in the lower section of the keyboard.

The Style you've chosen is sounded.

The Music Style you've selected from the floppy disk remains in internal memory until you switch off the power. You can play the Music Style you last selected just by pressing the [Disk/User] button, even if you've taken the floppy disk out of the disk drive.



Press the [Start/Stop] button to stop the accompaniment without ending (p. 67).



Multiple User Styles can be registered in the [Disk/User] button of the KR-377. Refer to "Storing User Styles to the Button" (p. 131)

Playing Automatic Accompaniment While Playing a Tone in the Left Hand

Normally when you play using Automatic Accompaniment, sound will not be heard when you play the left-hand area of the keyboard. However by selecting <Lower>, you can sound the tone played in the left hand (the Lower Tone) at the same time as the automatic accompaniment.

1. Press the One Touch Program [Arranger] button.

The basic screen will appear.



2. Press the <Lower> button at the bottom of the display.

The following screen will appear.

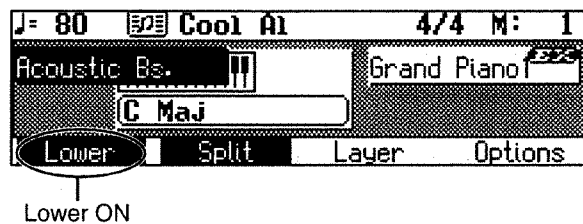

3. Specify a chord in the left-hand keyboard area.

The Automatic Accompaniment intro will play.

When you play a chord in the left-hand keyboard area, the notes you play will be heard, and the accompaniment chord will change.

4. If you no longer wish to hear the sound of the left-hand keyboard area, press <Lower> once again.

MEMO

To change the Lower Tone, refer to "Changing the Tones" (p. 50).

Playing Just the Rhythm Pattern

A Music Style can be made to sound only the Rhythm Pattern.

1. Use a Music Style button to choose a Music Style.
2. Press the One Touch Program [Piano] button, then press the [Start/Stop] button.
Only the Rhythm Pattern of the selected Music Style is played.

Adjusting the Tempo for Automatic Accompaniment

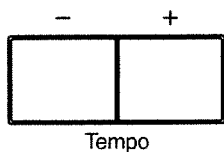

1. Press the One Touch Program [Arranger] button.
This makes the setting for Automatic Accompaniment.
2. Use the Tempo [-] and [+] buttons to adjust the tempo.
The tempo appears at the top-left area of the screen.
Pressing the [+] button makes the tempo faster, and pressing [-] makes the tempo slower.
You can return to the original tempo for the style by pressing [-] and [+] at the same time.

NOTE

There are other patterns in the Music Styles that are not included in the Rhythm Patterns. In certain cases, such as when such Music Styles are selected, the Rhythm Pattern may not play.

MEMO

You can change the tempo of Automatic Accompaniment even while the Automatic Accompaniment is playing.

Playing a Music Style (Start/Stop)

Pressing the One Touch Program [Arranger] button activates Sync Start for the accompaniment (which starts the accompaniment simultaneously when you play something in the lower section of the keyboard), and makes the setting for automatically playing an appropriate intro for the accompaniment. You can change how this starting and stopping works in many different ways.

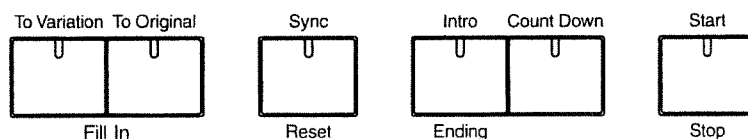

■ Starting Automatic Accompaniment When You Play the Left-hand Section (Sync Start)

1. Press the [Sync/Reset] button, getting it to light up.
The [Intro/Ending] button's indicator starts blinking.
2. Specify the chord on the lower-part of keyboard.
The intro is played and the Automatic Accompaniment starts.

Making the Intro Short and Simple

1. Press the [Sync/Reset] button, getting it to light up.
The [Intro/Ending] button's indicator starts blinking.
2. Press the Fill In [To Original] button, getting its indicator to blink.
3. Specify the chord on the lower-part of keyboard.
A short intro is played and the accompaniment starts.

Starting Without an Intro

Before starting Automatic Accompaniment, you can follow the steps shown below to silence the intro.

1. Press the [Intro/Ending] button, extinguishing the indicator.
2. Specify the chord on the lower-part of keyboard.
The Automatic Accompaniment starts without playing an intro.

■ Starting at the Press of a Button

1. Press the [Sync/Reset] button, extinguishing the indicator.
The indicator for the [Intro/Ending] button also goes dark.
2. Specify the first chord on the lower-part of keyboard.



Pressing the Fill In [To Original] or [To Variation] button makes the accompaniment pattern change as well. For more information, take a look at "Changing the Accompaniment Pattern Within a Song (Fill-In)" (p. 70).

Chapter 2 Automatic Accompaniment

3. Press the [Intro/Ending] button or the [Start/Stop] button.

The Automatic Accompaniment starts.

Pressing the [Start/Stop] button starts the Automatic Accompaniment without an intro.

The Chord Tone and Bass Tone

Fingering a key on the left-hand section of the keyboard while the [Sync/Reset] button's indicator is dark causes a chord to be sounded. This note is called the "Chord Tone," and the root of the chord that is played at the same time is called the "Bass Tone."



You can change the sound of the chord tone and bass tone. Take a look at "Changing the Sound for Chord Tone and Bass Tone" (p. 138).

■ Stopping Automatic Accompaniment

Stopping with an Added Ending

1. Press the [Intro/Ending] button.

An ending is played, then the Automatic Accompaniment stops.

Making the Ending Short and Simple

1. Press the Fill In [To Original] button, getting its indicator to blink.

2. While the Fill In [To Original] button is blinking, press the [Start/Stop] button.

A short ending is played and the accompaniment stops.

Stopping at the Press of a Button

1. Press the [Start/Stop] button.

Automatic accompaniment stops as soon as you press the button.

■ Adjusting the Timing During the Accompaniment and Starting Over (Reset)

If the timing of the accompaniment is off during a performance, pressing this button lets you start playing over from the beginning of the division (p. 60).

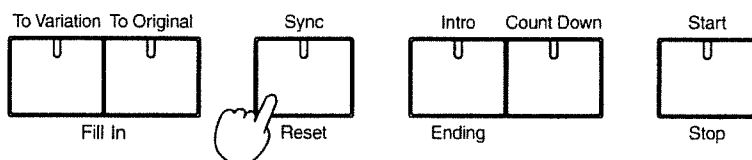

1. Press the [Sync/Reset] button.

The count sound begins immediately, then the accompaniment starts.



Pressing the Fill In [To Original] or [To Variation] button makes the accompaniment pattern change as well. For more information, take a look at "Changing the Accompaniment Pattern Within a Song (Fill-In)" (p. 70).

Playing the Count Sound at the End of the Intro

If an intro is played before your performance, you can have a count-in sound played to the end of the intro, allowing you to understand easily where you are to start playing.

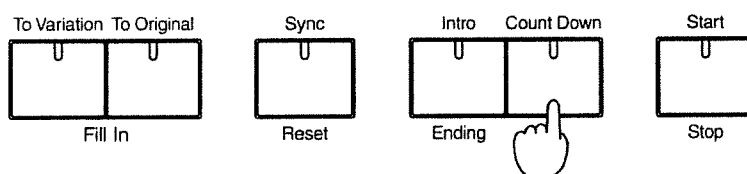

- 1.** Press the [Count Down] button, getting it to light up.
- 2.** Press the [Intro/Ending] button.

The intro will begin, and after the intro a one-measure count will sound. If the [Sync/Reset] button's indicator is lit, specifying a chord in the left-hand area will cause the intro to start, and a count to sound in the same way.

Ex: 4/4

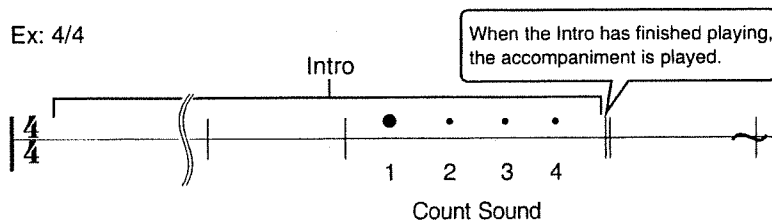

- 3.** To stop the countdown, press the [Count Down] button, extinguishing its indicator.

Modifying an Accompaniment

You can change the arrangement of Automatic Accompaniment and the accompaniment pattern.

■ Changing the Accompaniment Pattern Within a Song (Fill-In)

There are two accompaniment patterns: the original one, and a variation. In addition, a fill-in (a short phrase) is added at the points where the accompaniment patterns change, which adds more variation to the song. It can be effective to use the quieter original pattern for the first half of the song, and the variation pattern for the second half.

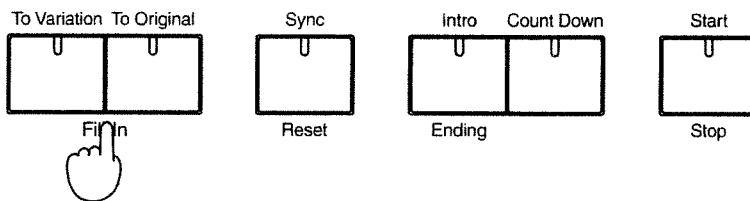

1. Pressing the Fill In [To Variation] button (its indicator should light) makes the setting for playing the variation accompaniment pattern.
2. Pressing the Fill In [To Original] button (its indicator should light) makes the setting for playing the original accompaniment pattern.

Pressing these buttons during a performance inserts a one-bar fill-in in time with when the buttons were pressed, and the accompaniment pattern changes.

What's a Fill-In?

A short improvisational phrase inserted at the bar line is called a "Fill-In." The KR-377 plays the optimal phrase for the selected Music Style.

Adding a Fill-in Without Changing the Accompaniment Pattern

You can play only a fill-in without changing the accompaniment pattern by pressing whichever of the Fill In [To Original] and [To Variation] buttons whose indicator is lit up while a performance is in progress.



You can change the accompaniment pattern without inserting a fill-in. In that case, assign the function to the pedal and use it. See "Assigning a Function to Pad Buttons or Pedals" (p. 139).



You can use the pedals to change the arrangement or accompaniment pattern or to insert a fill-in. See "Assigning a Function to Pad Buttons or Pedals" (p. 139).

■ Changing the Arrangement of the Accompaniment

You can change the arrangement of an accompaniment during the performance of Automatic Accompaniment or while it is stopped. This function is called “Style Orchestrator.”

There are four arrangement types of the accompaniment for each Music

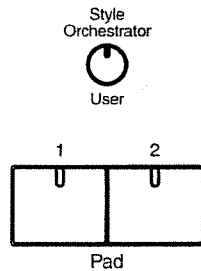

1. Press the [Style Orchestrator/User] button, getting the indicator light up.

The Pad [1] and Pad [2] buttons can be used to change the arrangement.

A screen like the one shown below appears.

The value of the currently selected Style Orchestrator will appear.

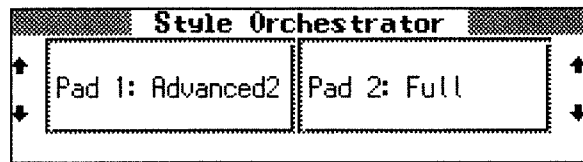

Display	Description
Basic	The simplest arrangement
Advanced 1	A more elaborate arrangement
Advanced 2	
Full	The most elaborate arrangement

2. Press the [Exit] button.
You are returned to the previous screen.
3. Press the Pad [1] or Pad [2] button to change the arrangement of the accompaniment.

MEMO

If the [Style Orchestrator/ User] button's indicator goes out, you cannot change the Style Orchestrator with the Pad buttons. Refer to “Assigning a Function to Pad Buttons or Pedals” (p. 139).

MEMO

Some Music Styles don't change the arrangement of the accompaniment when you've followed the steps just described.

Chapter 2 Automatic Accompaniment

Changing the Assignments for Style Orchestrator

You can change the value for the Style Orchestrator assigned to the Pad [1] or [2].

1. Press the [Style Orchestrator/User] button, getting the indicator light up.

A screen like the one shown below appears.

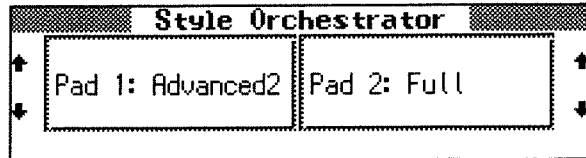

2. Use <↑> <↓> next to the display to choose the value assigned to the pad.

Use the buttons located at the left of the display to change the value assigned to Pad[1].

Use the buttons located at the right of the display to change the value assigned to Pad[2].

Display	Description
Basic	The simplest arrangement
Advanced 1	A more elaborate arrangement
Advanced 2	
Full	The most elaborate arrangement

3. Press the [Exit] button.

Press the Pad [1] or Pad [2] button to change the arrangement of the accompaniment.

Adding Harmony to the Right-hand Part (Melody Intelligence)

You can add a harmony to the notes you play with the keyboard.

While an Automatic Accompaniment is playing, a harmony matched to the chord you designate in the lower section of the keyboard is automatically added to the notes you play with the right hand. This function is called "Melody Intelligence."

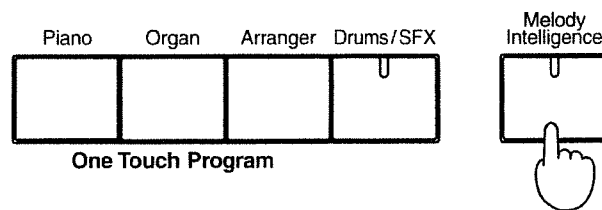

1. Press the [Melody Intelligence] button, getting it to light up.

When you play something on the right-hand section of the keyboard, a harmony is added to the notes you finger.

A Melody Intelligence screen like the one following appears.

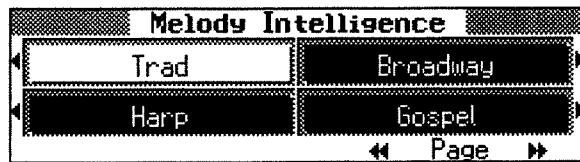

2. Use Page < <> > > at the bottom of the display to switch screens, then choose the harmony type.

When you play something on the keyboard, a harmony of the type you selected is added to the notes you finger.

Press the [Exit] button to go back to the previous screen with the Melody Intelligence function still in effect.

3. To cancel the Melody Intelligence function, press the [Melody Intelligence] button to extinguish the indicator.

MEMO

The different types of harmonies include some that automatically change the Tone. Also, when you finger several keys at the same time, in some cases harmony may be added to one note.

Playing the Piano Along with the Automatic Accompaniment (Piano Style Arranger)

Usually, with an Automatic Accompaniment performance, the accompaniment is sounded by the chords you specify on the left-hand section of the keyboard, with the melody played on the right-hand section. If you like, however, you can make the KR-377 recognize chords from the entire keyboard, and perform without splitting the keyboard. This function is called the "Piano Style Arranger."

This makes it possible to add an Automatic Accompaniment as you play the keyboard, without giving any thought to the location of a keyboard split.

1. Press the One Touch Program [Arranger] button.

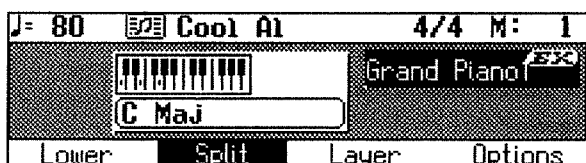

2. Press <Split> at the bottom of the display to cancel the split function.

The following screen is called up.

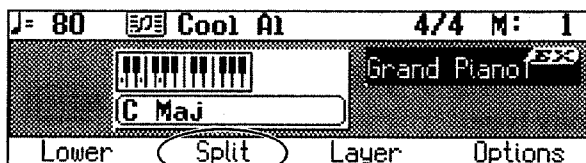

Split OFF

3. Press a Music Style button to choose a Music Style.

Press the [Exit] button to return to the basic screen.

4. Play the keyboard.

The accompaniment starts when you finger a chord.

Changing the Volume Balance for the Accompaniment and Keyboard

You can change the volume balance for the song and accompaniment and the notes played from the keyboard.

1. Use the [Balance] knob to change the volume balance.

Turning the knob toward “Accomp” lowers the volume of the keyboard. Turning the knob toward “Keyboard” lowers the volume of the song and accompaniment.

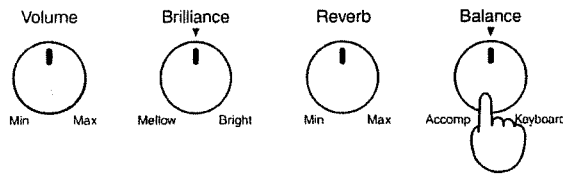

Adjusting the Volume of Each Performance Part

You can adjust the volume balance of each part of the Music Style and of each tone when playing more than one tone with the keyboard.

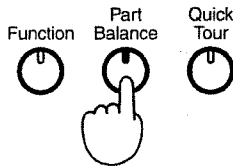

1. Press the [Part Balance] button.

A screen like the one shown below appears.

Press < <<> or <>> > at the upper-left area of the display to switch the two screens.

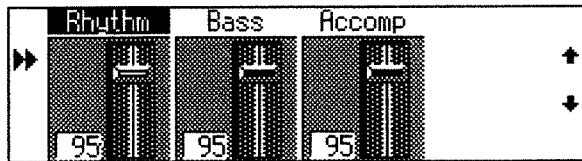

This shows the volume balance of each part of the Music Style.

Display	Performance part
Rhythm	Rhythm
Bass	Bass, Bass tone (p. 68)
Accomp	Accompaniment 1, Accompaniment 2, and Accompaniment 3



When the knob is all the way to “Accomp,” no sound is heard when you play the keyboard. You can usually leave the knob at the center position.



For more about performance Parts, take a look at “The Makeup of a Music Style” (p. 60).

Chapter 2 Automatic Accompaniment

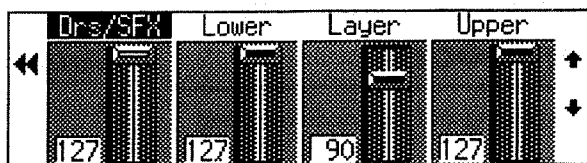

This shows the volume balance of each keyboard tone during Layer play (p. 47) or Split play (p. 49), or when playing percussion or effect sounds with the keyboard (p. 44).

Display	Part
Drs/SFX	Percussion instruments/effects played with the keyboard
Lower	Lower Tone (The Tone displayed at the upper-left area of the basic screen)
Layer	Layer Tone (The Tone displayed at the bottom-right area of the basic screen)
Upper	Upper Tone (The Tone displayed at the upper-right area of the basic screen)



Basic Screen (p. 16)

- 2.** Press the buttons located below each volume in the screen to select the Part whose volume you wish to adjust.
- 3.** Use < ↑ > < ↓ > at the right of the display to adjust the volume.

The volume of the selected Part is changed.

Press the [Exit] button to go back to the previous screen.

Chapter 3 Some Handy Features

Playing Back Songs for Practice

Here's how to practice along with commercially available Music Files or songs that were saved on a floppy disk.

You can use rewind or fast-forward to move to the desired measure, and play back from that point.

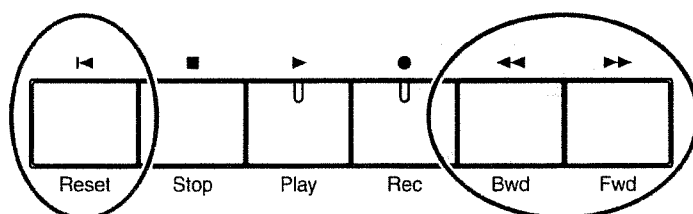

1. Insert the floppy disk into the disk drive.
2. Press the [Song] button.
The Song screen appears.
3. Press the button next to the display to select a song.
If the disk contains four or more songs, use Page < ◀ ▶ > at the bottom of the display to change the songs that are displayed.
Press the [Exit] button to extinguish the [Song] button's indicator and go back to the previous screen.
4. Press the Play [▶] button.
The song will begin playing back.
5. Press the Bwd [◀◀] and Fwd [▶▶] buttons to move to a bar where you want to listen.
Pressing the button once moves your position by one measure. Hold down the button to move forward or backward consecutively.
The measure number appears in the top-right area of the basic screen.
6. To stop playback of the song, press the Stop [■] button.

To go back to the beginning of the song

1. Press the Reset [◀] button.

To move to the end of the song

1. Press the Fwd [▶▶] button while holding down the Stop [■] button.

MEMO

To learn more about Music Files, refer to "Music Files That the KR-377 Can Use" (p. 178).

NOTE

If you're using the disk drive for the first time, be sure to read the important notes on p. 6.

MEMO

You can view some information about the selected song by pressing <Info> at the bottom of the display.

MEMO

When you play a song with an upbeat (in other words, a song that starts before the first beat), the basic screen shows "PU," "1," "2," and so on as the measure numbers.

NOTE

When you start playback of Music Files, the measure number on the basic screen appears in reverse video. While this is in reverse video, the KR-377 is reading data from the floppy disk, so wait a few moments until it finishes.

NOTE

If you've used markers to designate a passage for repeating (p. 88), you can only move forward and backward within the range specified by the A and B markers.

■ Playing All Songs Continuously

You can continuously repeat playback of all the songs. This function is called "All Song Play."

1. From the Song screen, press <All Play> at the bottom of the display.

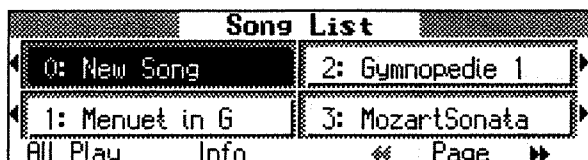

All songs are played back in sequence. When the last song has finished playing, playback then repeats after returning to the first song.

2. Press <All Play> at the bottom of the display once again.

Playback stops.

You can stop playback by pressing the Stop [■] button.

When the Following Screen Is Displayed

If a song is recorded in the KR-377's internal memory, the screen shown below appears when you try to choose a song.

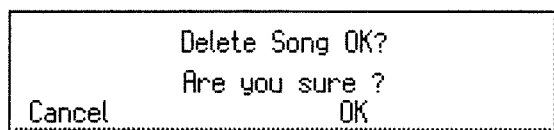

If you don't want to erase the song

Press <Cancel> at the bottom of the display.

Save the song on a floppy disk.

For information on how to save your song, see "Saving Songs to Floppy Disks" (p. 104).

Erasing a song

Press <OK> at the bottom of the display.

The recorded performance or song whose settings have been changed is erased.

Displaying the Score

You can have the musical score of a recorded performance or a song from floppy disk be displayed.

When you play back a Music File with lyrics, the lyrics appear on screen.

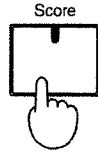

1. Press the [Song] button.
The Song screen appears.
2. Press the button next to the display to select a song.
For an explanation of how to select the song, refer to (p. 77).
3. Press the [Score] button.
The Score screen appears.



Display	Description
Mute	Mutes the sound of the part whose score is displayed. While muting, the mark changes to .
Left	Displays the score of the left-hand part (Part 3).
Right	Displays the score of the right-hand part (Part 4).
User	Displays the score of the part you yourself recorded (Part 1).
Options	You can change the part that is displayed, or modify how the score is displayed (p. 144).
Lyric	Displays lyrics in the score.

4. Press the Play [▶] button.
The song will begin playing, and the score will advance along with the song.

Some notes on a Score Screen

- When you start playback of music files, the marks appears. While this appears on the score, the KR-377 is reading data from the floppy disk and making the score. Please wait until reading of the data is complete.
- In the Score screen, some lyrics or notes could extend beyond the edges of the screen, and not be displayed.
- The scores that are presented by the display are produced based on the music files. Viewing ease is given priority over precise expression when dealing with complex, high-level music. Because of this, you may find that the score shown in the display does not match what is provided on commercially available sheet music. The score display feature is particularly unsuitable for the display of difficult, complex musical works that demand accurate notation. In addition, the display cannot show notes that are briefer than a sixteenth note.

MEMO

If you select a part that does not contain performance data, notes will not be displayed in the score. Use <Options> to change the part that is displayed. For details refer to "Changing the Settings for Score Screen" (p. 144). For more information about Parts, refer to "Multitrack Recording with 16 Parts (16-Track Sequencer)" (p. 113).



MEMO

If you use the buttons located below the display to change the displayed part while the song is playing, the song may be played back from the beginning.

MEMO

If you are playing data that contains lyrics data and the lyrics are not displayed even though you press <Lyric>, the lyrics display setting is turned "OFF." Turn "ON" the setting in "Hiding the On-screen Lyrics" (p. 148).

■ Checking Your Performance on a Graph/Keyboard Screen

1. From the Score screen, press <  > (Keyboard) or <  > (Graph) at the left of the display.

A Keyboard screen or Graph screen like the one shown below is displayed.

Keyboard Screen

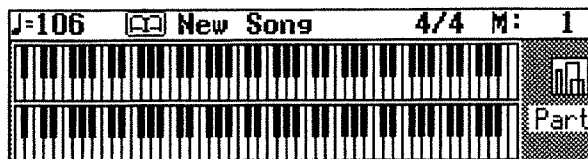

When this screen is visible, you can check the pitch.

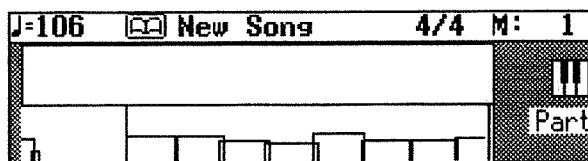

The key for the note being played is indicated.

Graph Screen



When this screen is visible, you can check a note's velocity and length.

The height of the bar graph shows the note's velocity, and the width shows the note's length.

Press <  > or <  > at the upper-right area of the screen to switch the two screens.

With either screen, the upper portion shows the playback of the song, and the lower portion shows what's played on the keyboard.

2. Press the Play [▶] button to play back the song, then play the piano along with the song.

Now let's check your performance on the screen.

Press the [Exit] button to go back to the previous screen.

MEMO

If the upper screen doesn't change when you play back a song, the part settings displayed in the upper screen do not match. Take a look at "Specifying the Part to Display" (p. 81) and make the settings for the part to display.

Specifying the Part to Display

You can display a different Part of the model song.

1. From the Keyboard screen or the Graph screen, press <Part> at the right bottom of the display.

The following screen appears.

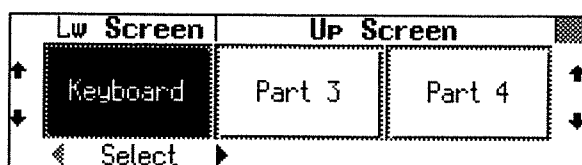

2. Use Select <◀> and <▶> at the bottom of the screen to choose the item you wish to set.

Setting	Value
Lower Screen (Lw Screen)	Keyboard, Parts 1-16
Upper Screen (Up Screen)	Parts 1-16, OFF

3. Press <↑> <↓> next to the display to switch the part shown in the display.

You can display two parts on the Upper Screen at the same time, so it might be a good idea to choose the right-hand part and the left-hand part.

You can display just the part for one hand by choosing "OFF" for one or the other.

When <Keyboard> is selected in the Lower Screen, the keyboard performance appears.

After recording your performance, if you want to compare it with the model performance again, all you have to do is to choose the part where you recorded your performance.

4. When you're done making all the settings, press the [Exit] button.

You are returned to the Keyboard screen or Graph screen.

MEMO

For more information about Parts, refer to "Multitrack Recording with 16 Parts (16-Track Sequencer)" (p. 113).

Adjusting the Tempo

You can change the tempo of a Music Style and a song. Changing the tempo has no effect on the pitch of the notes. And you can change the tempo even when the song is in progress.

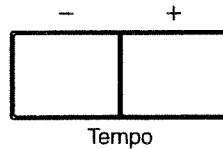

1. Use the Tempo [-] and [+] buttons to adjust the tempo.

- Pressing the [+] button once increases the tempo by one unit. Holding down the button makes the tempo change (speed up) continuously.
- Pressing the [-] button once decreases the tempo by one unit. Holding down the button makes the tempo change (slow down) continuously.
- Press [+] and [-] at the same time to return to the original tempo.

■ Setting the Tempo by Pressing the Button in Time

You can determine the tempo by the timing with which you press the Pad button. This feature is called "Tap Tempo." By using the Tap Tempo function, you can quickly set the tempo you are thinking of, without specifying the tempo in numerical terms.

In order to use "Tap Tempo," you need to assign the function to the Pad buttons.

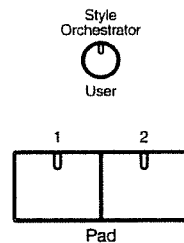

1. Press the [Style Orchestrator/User] button, extinguishing its indicator.

A screen like the one shown below appears.

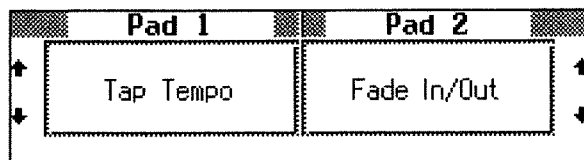

2. To assign "Tap Tempo" to Pad [1], press <↑> <↓> located at the left of the display. To assign it to Pad [2], press <↑> <↓> located at the right of the display.

3. Press the [Exit] button.
You are returned to the previous screen.
4. Tap, several times in succession, the pad button to which you assigned "Tap Tempo."
The tempo is set to the timing you used when tapping the button.

Playing back with No Change in Tempo

If a song has difficult tempo changes, it can be effective to practice the song first at an unchanging tempo. Playback of a song at a steady tempo that doesn't change is called "Tempo Muting."

1. Hold down the Stop [■] button and press either the Tempo [-] or [+] button.

Now, songs are played back at an unchanging tempo.

When tempo muting is in effect, the tempo display will be highlighted.

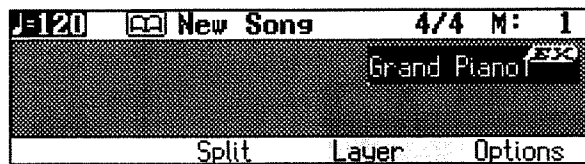

2. Again hold down the Stop [■] button and press either the Tempo [-] or [+] button.

Tempo muting is canceled.

Tempo muting is also canceled if you select another song.

Counting Down Before a Performance Starts

When you're playing along with a song, you can make sure that your playing is in time with the song by sounding a count before the song starts playing.

This audible count before the playback of a song is called a "Count-In."

1. Press the [Marker/Count In] button.

A Marker screen like the one shown below appears.

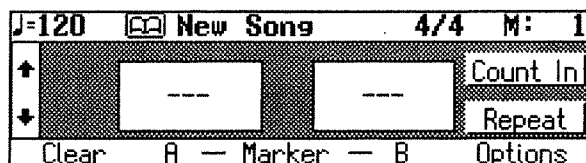

2. Press <Count In> at the right of the display.

The <Count In> display will be highlighted, and a two-measure count will be heard before the song plays back.

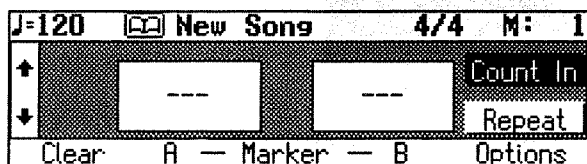

3. To stop the count-in sound, press <Count In> at the right of the display again.

Press the [Exit] button to return to the previous screen.

MEMO

You can change the number of measures counted and the type of sound that you hear. See "Changing the Settings for the Marker and the Count Sound" (p. 145).

Preventing the Part to Be Practiced from Sounding

With commercially available Music Files for piano lessons, the part for each hand can be played back independently. This makes it easy to practice the parts for each hand separately. For example, you could try to follow along lightly with your right hand while you listen to that same right-hand part be played; or you could practice the left-hand part while the right-hand part is being played.

For instance, a Music File for piano lessons may be assigned to the five Track buttons as shown below.

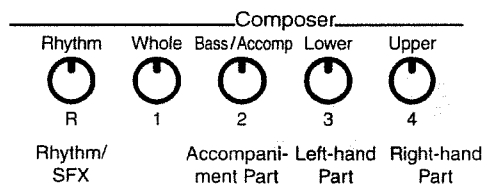

By using these Track buttons, you can temporarily silence a specific Part. Preventing specified Parts' sound from being played is called "muting." By recording your own performances to the Track buttons in this fashion, you can mute the Parts the same way.

- 1. Press any one of the Track buttons to make the button's indicator light go dark.**
The sound of the Track button you chose is muted out.
- 2. Press the Play [▶] button.**
The song is played back.
The sounds for the illuminated Track buttons are played, but no notes are played for the Track button that is dark.
- 3. Press the dark Track button again to make the indicator light come back on.**
Now, you can hear the notes for the Track button that just lit up when you pressed it.



To learn more about Music Files, refer to "Music Files That the KR-377 Can Use" (p. 178).



If a single Track button includes more than one instrument, and you want to mute out just one of those instruments, take a look at "Changing the Settings for Each Part" (p. 115).



You can change the volume balance for the keyboard and the song. Check out "Changing the Volume Balance for the Accompaniment and Keyboard" (p. 75).

Practicing with Setting Markers in the Song

By setting markers at points in a song that you want to practice repeatedly, you can then easily move and repeatedly play back the selected measures.

■ Setting Markers in the Song/Erasing Markers

You can place two separate markers (Marker A and Marker B) in one song. The marker is placed at the beginning of the bar. Placing markers is a handy way to start playback at the same place as many times as you like.

Wait until this measure indication is no longer highlighted before setting any markers.

1. Press the [Marker/Count In] button.

The Marker screen appears.

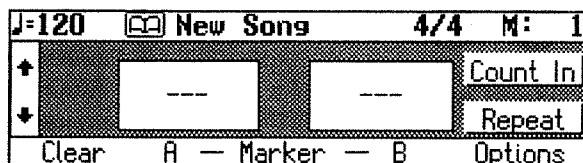

2. Use the Bwd [◀◀] and Fwd [▶▶] buttons to move to where you want to place the marker.

The measure number appears in the top-right area of the screen.

3. Press Marker <A> at the bottom of the display.

Marker A is placed at the beginning of the bar you moved to. “—” in the screen will change to the number of the measure where you placed the marker.

4. In the same way, move a position and press Marker at the bottom of the display. The marker B will be placed.

When you’ve placed a marker, the number of the measure with the marker appears on screen.

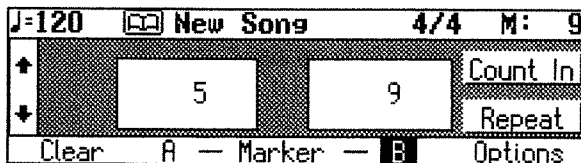

Press the [Exit] button to return to the previous screen.

Erasing a Marker

1. At the Marker screen, while holding down the <Clear> at the bottom of the screen, press the button below the marker you wish to erase.

The marker disappears and the on-screen display changes to <—>.

NOTE

The indication of the measure number, which appears in the upper right of the screen, is highlighted while a song is being loaded.

MEMO

You can also add markers in the same way or move to a marker even while playback is in progress.

NOTE

You cannot place both marker A and marker B at the same location. Also, you cannot place marker B at a position earlier than marker A.

MEMO

A marker is normally placed at the beginning of the measure, but you can also place a marker at a position part way through a measure. Take a look at “Placing a Marker in the Middle of a Measure” (p. 145).

■ Playback from a Marker Location

- At the Marker screen, press the button under the Marker (A or B) you want to move.
The position from which playback will start is moved to the location where marker A or marker B is set.

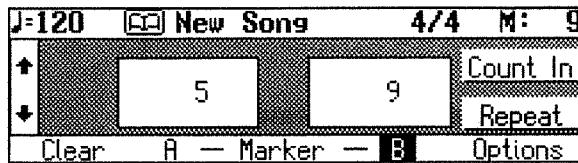

- Press Play [▶] to play back the song from the Marker location.
Press the [Exit] button to return to the previous screen.

■ Moving a Marker

You can move a marker that has been placed in a song.
You can move the entire segment between Marker A and Marker B forward or back, without changing the passage itself.

- At the Marker screen, press the button below the marker (A or B) you wish to move, and press <↑> or <↓> at the left of the display.
The measure number of the marker will change.

Simultaneously Moving Markers A and B

- At the Marker screen, press both buttons below markers <A> and , and then press <↑> or <↓> at the left of the display.

The passage between markers A and B will be preserved as the markers are moved.

As an example, let's suppose that marker A is at the start of the fifth measure and marker B is at the start of the ninth measure.

- Press <↑> to shift marker A to the beginning of the ninth measure and marker B to the beginning of the thirteenth measure.

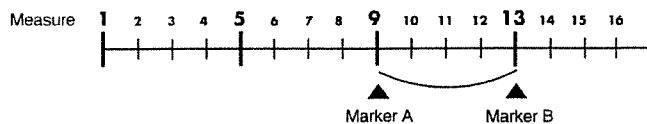

- Press <↓> to shift marker A to the beginning of the first measure and marker B to the beginning of the fifth measure.

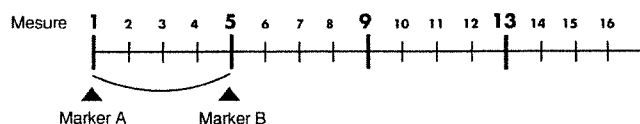

Playing Back the Same Passage Over and Over

You can play back a particular passage repeatedly. This is convenient when you want to practice the same passage a number of times.

1. Press the [Marker/Count In] button.

The Marker screen appears.

2. Place markers A and B to enclose the passage you want to repeat.

For more info about placing markers, refer to p. 86.

For instance, suppose you want to play back the passage from the fifth through eighth measures over and over. You should place marker A in the fifth bar and marker B in the ninth bar.

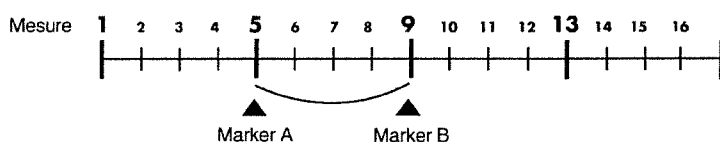

3. Press <Repeat> at the right of the display.

The <Repeat> display will be highlighted, and the region from marker A to marker B will be played back repeatedly.

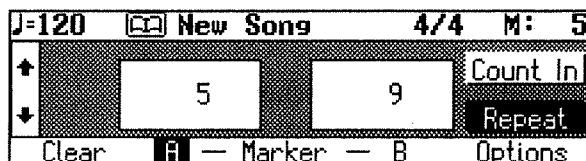

4. Press the Play [▶] button.

The passage from marker A to marker B is played repeatedly.

- If you don't place any markers, playback repeats from the beginning to the end of the song.
- If you only place marker A, playback repeats from marker A to the end of the song.
- If you only place marker B, playback repeats from the beginning of the song to marker B.

5. To stop playback of the song, press the Stop [■] button.

To cancel the setting for repeated playback, press <Repeat> in the Marker screen.

Press the [Exit] button to return to the previous screen.

Transposing the Key of the Keyboard (Key Transpose)

You can transpose the key of a performance without having to shift the position of your fingers on the keyboard. This feature is called “Key Transpose.”

This lets you take a song in a difficult key, with lots of sharps \sharp and flats \flat , and play it in a key with fingering that’s easier for you. For instance, you can play a tune in the key of E major with the keyboard fingering for the key of C major.

In situations such as when providing accompaniment to a song, using the Key Transpose function to match the singer’s vocal register lets you easily transpose the sounds without changing the score.

1. **Display the basic screen, then press <Options> at the bottom of the display.**

The Arranger Menu screen appears.

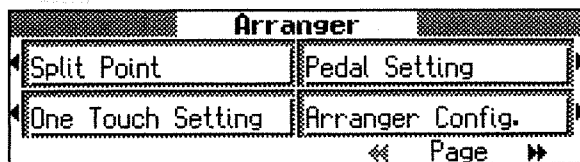

If <Transpose> doesn’t appear on screen, press Page <◀◀> <▶▶> at the bottom of the display to switch screens.

2. **Press <Transpose> next to the display.**

A Transpose screen like the one below appears.

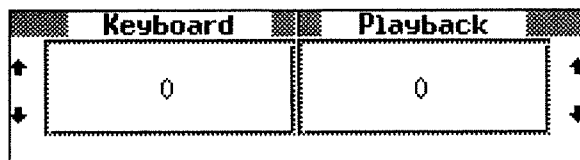

To transpose the pitch of the keyboard, set the <Keyboard> value.

3. **Use the <↑> <↓> located at the left of the display to select the transposition value.**

The available range is -6 to 0 to 5.

As the value changes “1” unit, the pitch of the keyboard will change one semitone.

4. **When this is set to 0, the keyboard transposition will be returned to the original key.**

Press the [Exit] button to return to the Arranger Menu screen.



Basic screen (p. 16)



You can make the “Transpose” settings in <Customize> (p. 134) in the Piano screen and <Options> (p. 141) in the Organ screen.



The transposition setting returns to its original value when you switch off the power, or choose another song.

Chapter 3 Some Handy Features

Example: Playing a song in E major with the keyboard fingering for C major
In this example, we'll consider the C note in the key of C major to be the basic note. Counting from the tonic to the major third of C (E), there are four keys, including the black keys, so set the value to "4."

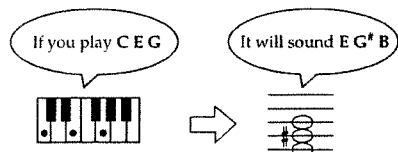

Changing the Key When Playing Back Songs

You can transpose a song for playback.

1. Display the basic screen, then press <Options> at the bottom of the display.

If <Transpose> doesn't appear on screen, press Page <◀◀><▶▶> at the bottom of the display to switch screens.

2. Press <Transpose> next to the display.

A Transpose screen like the one below appears.

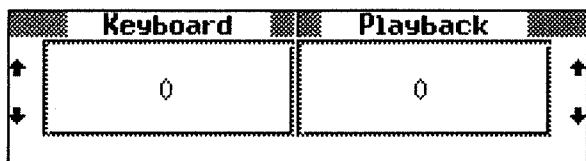

To transpose the pitch of sounds for playback, set the <Playback> value.

3. Use <↑> <↓> at the right of the display to choose the value by which to transpose.

The setting range is from -24 to 0 to +24.

As the value changes "1" unit, the pitch of the sound to be played back will change one semitone.

4. When this is set to 0, the song transposition will be returned to the original key.

Press the [Exit] button to return to the Arranger Menu screen.



Basic screen (p. 16)



You can make the "Transpose" settings in <Customize> (p. 134) in the Piano screen and <Options> (p. 141) in the Organ screen.



The transposition setting returns to its original value when you switch off the power, or choose another song.

Chapter 4 Recording and Saving the Performance

With the KR-377, you can use the five Track buttons to record a performance easily, or use recording functions like the 16-track Sequencer to create full-fledged ensemble songs.

Recording Your Playing with Ease

This records only what you play on the keyboard, without using Automatic Accompaniment.

The five buttons shown below are called Track buttons.

The recorded performance will be automatically assigned to the five Track buttons according to the recorded part.

You can record or play back independently by specifying the desired Track button; for example, when you wish to re-record a track.

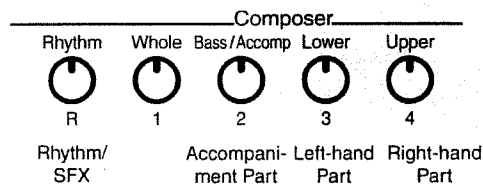

A performance that does not use automatic accompaniment will be assigned to the Track buttons as follows.

Track button name	Performance recorded
[R/Rhythm]	A percussion sound and SFX is recorded.
[1/Whole]	Performances without Automatic Accompaniment are normally recorded here. Layer Play (p. 47) performance is also recorded here.
[2/Bass/Accomp]	If automatic accompaniment is not used, this will not be recorded. It can be recorded if you specify the track button for recording (p. 96).
[3/Lower]	When you're using Split Play (p. 49), the Lower part is recorded.
[4/Upper]	When you're using Split Play (p. 49), the Upper part is recorded. When Layer Play has been changed to Split Play, Layer Tone (p. 47) is also recorded here.

A performance is normally recorded on the [1/Whole] button, but you can also specify a Track button to record it by pressing the track buttons.



For an explanation of how to create an ensemble song, refer to "Multitrack Recording with 16 Parts (16-Track Sequencer)" (p. 113).

Chapter 4 Recording and Saving the Performance

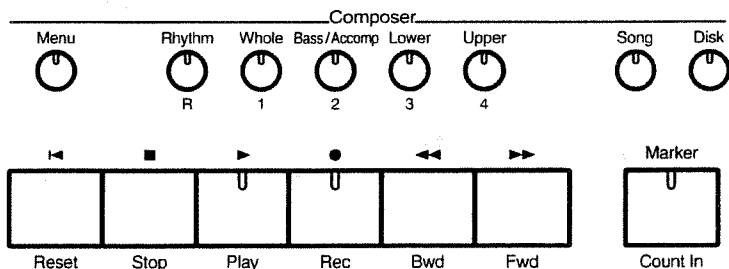

Step 1 Get ready to record

1. Press the [Song] button.

The Song screen appears.

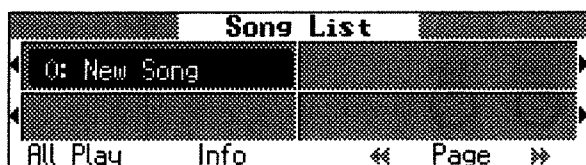

2. Press <0: > next to the display, get <0: New Song> to appear in the display.

If <0: > doesn't appear on screen, press Page <◀◀ >>▶▶> at the bottom of the display to switch screens.

3. Press the One Touch Play [Piano] button.

4. Decide on the tone, tempo, and beat of the performance.

Use the Tone buttons and the buttons next to the display to choose the tone. If necessary, press the [Metronome] button to play the metronome.

5. Press the Rec [●] button.

The Play [▶] button's indicator begin blinking, and the unit will be ready for recording.

To stop recording, press the Stop [■] button.

Step 2 Recording Your Performance

6. Press the Play [▶] button to start recording.

A two-bar count sound plays, then recording starts.

Recording will begin when you start playing the keyboard, even if you do not press the Play button. In this case, the count will not be heard.

When recording begins, the Play [▶] button's indicator changes to a constant light.

7. Press the Stop [■] button to stop recording.



For an explanation of how to select the tempo and the beat, refer to p. 52.

Listening to the Recorded Performance

- 1. Press the Reset [◀] button.**
Now you can play back the song from the beginning.
- 2. Press the Play [▶] button.**
The recorded performance is played back.
- 3. To stop playback, press the Stop [■] button.**

● If the following message appears

If you've recorded a tune in the internal memory, the following message appears on the screen when you try to choose another song.

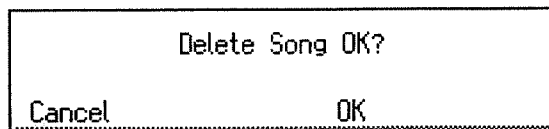

If you don't want to erase the song

Press <Cancel> at the bottom of the display.

Save the song on a floppy disk.

For information on how to save your song, see "Saving Songs to Floppy Disks" (p. 104).

Erasing a song

Press <OK> at the bottom of the display.

The recorded performance or song whose settings have been changed is erased.

NOTE

Any performance that has been recorded is deleted when the power to the KR-377 is turned off. If you don't want to lose your recorded performance, save it on a floppy disk. For information on how to save your song, see "Saving Songs to Floppy Disks" (p. 104).

NOTE

Until a recorded performance is erased, you can't listen to other tunes. Check out "Erasing a Recorded Song" (p. 97).

Recording a Performance Using Automatic Accompaniment

You can record the performance with Automatic Accompaniment. A recorded performance is assigned to the Track buttons as follows.

Track button name	Performance recorded
[R/Rhythm]	The rhythm part of an Automatic Accompaniment is recorded here. When a Tone set such as a drum set or an SFX set has been chosen, it is also recorded here.
[1/Whole]	When the Piano Style Arranger is active (p. 74), your performance is recorded here.
[2/Bass/Accomp]	The bass part of an Automatic Accompaniment and the accompaniment part are recorded here.
[3/Lower]	With Automatic Accompaniment set to play along with the sounds you play in the left part of the keyboard (p. 65), your own performance with the left hand is recorded.
[4/Upper]	Your performance on the right-hand section of the keyboard is recorded. Layer Tone (p. 47) is also recorded here.

MEMO

A Music Style is made up of five Parts. For more information, see "Choosing a Music Style" (p. 63).

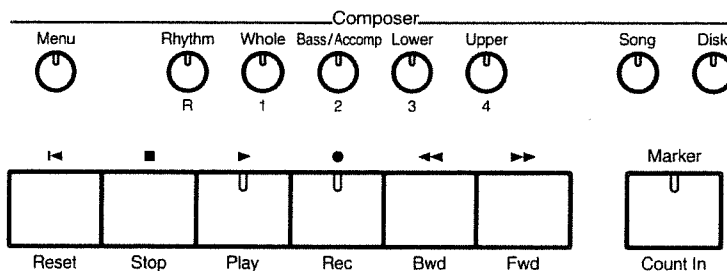

Step 1 Get ready to record

1. Press the [Song] button.

The Song screen appears.



2. Press <0: > next to the display, get <0: New Song> to appear in the display.

If <0: > doesn't appear on screen, press Page <<>> at the bottom of the display to switch screens.

Step 2 Get ready to play

- 3.** Press the One Touch Program [Arranger] button.
- 4.** Press the Music Style button and the button next to the display to choose the Music Style.
- 5.** Press [Exit] button.
The Basic screen appears.
- 6.** Use the Tempo [-] and [+] buttons to adjust the tempo of the accompaniment.
You can return to the original tempo of the selected style by pressing the Tempo [-] and [+] buttons at the same time.
- 7.** Press the Rec [●] button.
The piano enters recording standby.
To stop recording, press the Stop [■] button.

Step 3 Start recording

- 8.** Play a chord on the lower keyboard section.
Automatic Accompaniment starts, and recording is started at the same time.

Step 4 Stop recording

- 9.** Press the [Intro/Ending] button.
An ending is played, then the Automatic Accompaniment stops, and recording is stopped at the same time.

Listening to the Recorded Performance

- 1.** Press the Reset [◀] button.
Now you can play back the song from the beginning.
- 2.** Press the Play [▶] button.
The recorded performance is played back.
- 3.** To stop playback, press the Stop [■] button.



You can change how recording is stopped when recording a performance with Automatic Accompaniment. To learn how, see "Changing How Recording Stops" (p. 98).

Redoing a Recording

Redoing a recording involves specifying a Track button you want to record over and then recording over again.

When you select a Track button and record over a track that has already been recorded, the newly recorded performance occupies a position extending from the location where you started recording to where you stopped recording.

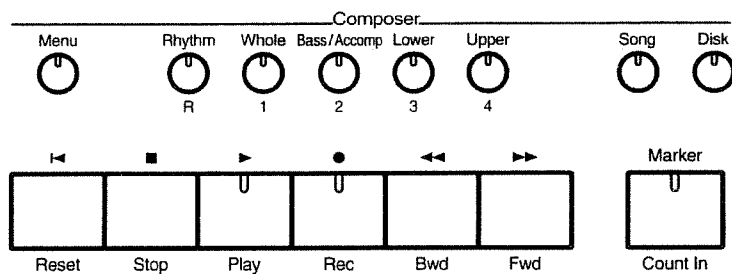

- 1. Use the Reset [◀], Bwd [◀◀] and Fwd [▶▶] buttons to move to the measure where you want redoing a recording.**
- 2. Press the Rec [•] button.**
To stop recording, press the Stop [■] button.
- 3. Press the Track button for the track you want to record over.**
The indicator for the selected Track button starts blinking.
The Play [▶] button's indicator begin blinking, and the unit will be ready for recording.
- 4. Begin recording.**
If you are re-recording a piece with Automatic Accompaniment, specify a chord in the left-hand section of the keyboard, or press the [Start/Stop] button. If you don't use Automatic Accompaniment, press the [Sync/Reset] button to extinguish the indicator, and then press the Play [▶] button.
- 5. Press the Stop [■] button to stop recording.**
To record the ending over again, press the [Intro/Ending] button.

MEMO

If you want to erase a previous performance entirely before recording over it, take a look at "Erasing the Sound Recorded on Individual Track Buttons" (p. 97).

MEMO

The song's basic tempo is determined when the song is first recorded. Even when each track is recorded over with the tempo changed, the song is played back at the tempo selected when the song was first recorded. To change the tempo of a song that has already been recorded, see "Changing a Song's Basic Tempo" (p. 117).

Erasing a Recorded Song

You can erase a song that's been recorded.

1. While holding down the [Song] button, press the Rec [●] button.

The following screen appears.

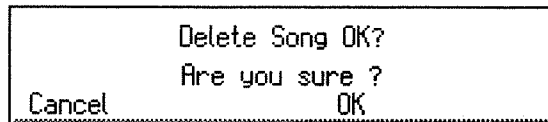

2. Press <OK> at the bottom of the display to erase the recorded song.

If you press <Cancel> at the bottom of the display, the recorded song is not erased.

■ Erasing the Sound Recorded on Individual Track Buttons

You can erase the sound recorded to an individual Track button.

1. While holding down the Track button where the sound you want to erase is recorded, press the Rec [●] button.

The selected Track button's light goes dark, and the recorded sound is erased.

NOTE

You can't erase the settings for the recorded song's basic tempo or beat.

Changing How Recording Stops

You can change how recording is stopped when recording a performance with Automatic Accompaniment.

1. Press the [Menu] button and confirm that its indicator has lighted.

The Composer Menu screen appears.

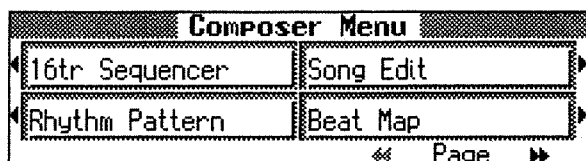

If <Rec Mode> doesn't appear on screen, press Page <◀▶> at the bottom of the display to switch screens.

2. Press <Rec Mode> next to the display.

The following screen appears.

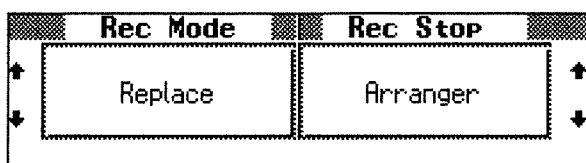

3. Use <↑> <↓> at the right of the display to select <Rec Stop> "Arranger" or "Composer."

Indication	Description
Arranger	When Automatic Accompaniment stops, recording also stops at the same time.
Composer	Recording doesn't end when Automatic Accompaniment stops. Press the Stop [■] button to stop recording.

Press the [Exit] button to return to the Composer Menu screen.

Recording Songs Starting with Pickups

You can record songs that start with pickups. Songs that begin on a beat other than the downbeat are called “songs with pickups.”

1. Press the [Song] button, getting the indicator to light.

The Song screen appears.

2. Select <0: > to display <0: New Song>.

If <0: > doesn't appear on screen, press Page <◀> <▶> at the bottom of the display to switch screens.

3. Press [Exit] button several times.

The Basic screen appears.

4. Press the Rec [●] button, getting the button's indicator to light.

The piano enters recording standby.

5. Press the Bwd [◀◀] button once.

The measure number at the top-right area of the basic screen changes to “PU” (pickup).



6. Press the Play [▶] button to start recording.

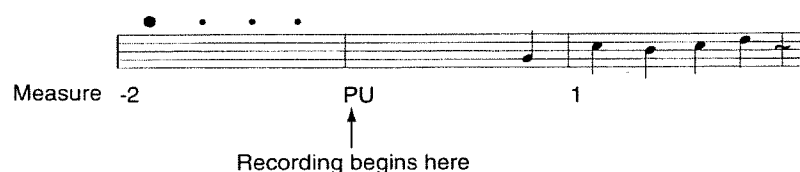

7. To stop recording, press the Stop [■] button.

Composing an Accompaniment by Entering Chords (Chord Sequencer)

You can enter its chord progression, the places where the accompaniment pattern changes, and so on to create an accompaniment for the song. This feature is called “Chord Sequencer.”

Thanks to the chord sequencer, you can create an accompaniment ahead of time and play along with this accompaniment using just your right hand. This makes it convenient to enjoy Automatic Accompaniment.

1. Press the [Menu] button and confirm that its indicator has lighted.

The Composer Menu screen appears.

2. Press <Chord Sequencer> next to the display.

If <Chord Sequencer> doesn't appear on screen, press Page <◀▶> <▶▶> at the bottom of the display to switch screens.

The screen like the one shown below is called “Chord Sequencer screen.”

This is the “cursor.”
The cursor shows where the chord change or other information is input.

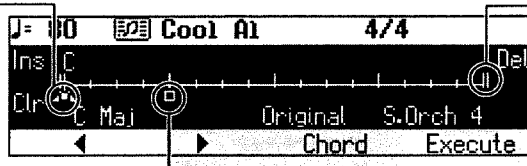

This is the end of the song. When continuing to add input, insert measures by touching <Ins>.

This indicates the position where the accompaniment pattern (Division) or the Style Orchestrator changes.

Indication	Description
<Ins>	One measure is inserted before the measure indicated by the cursor.
	This deletes the measure indicated by the cursor.
<Clr>	This clears the settings in the measure where the cursor is positioned.
<Chord>	You can input the chord without playing the keyboard. For details, refer to “Inputting Chords Without Playing the Keyboard” (p. 102).
<Execute>	This records the accompaniment you have composed. Press this button when you have finished creating all your input.

3. Use the Music Style button and the button next to the display to choose the Music Style.

4. Press the [Exit] button.

You are returned to the Chord Sequencer screen.

5. Enter the chord progression and the accompaniment pattern.

Inputting Chords with the Chord Sequencer

Change the accompaniment arrangements

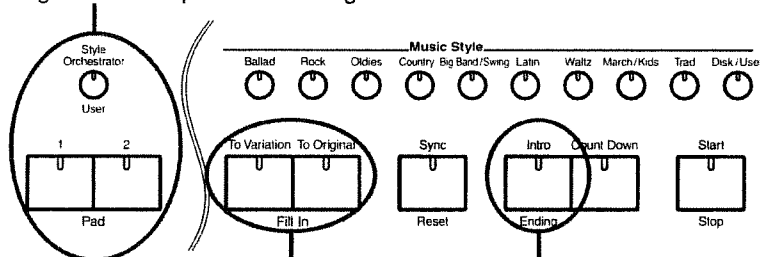

Select the accompaniment pattern (Division)

1. Press the Bwd [◀] and Fwd [▶] buttons to move the cursor to the position for the data to be inserted.

Press < ◀ > < ▶ > at the bottom of the display to move the cursor half a bar.

2. Enter the chord progression and the changes in the accompaniment pattern and arrangement.

Just as when performing with Automatic Accompaniment, press the keys to specify a chord, and press a button to select the accompaniment pattern (p. 70). You can change the accompaniment arrangement with the [Style Orchestrator/User] button (p. 71).

3. Pressing <Ins> at the left of the display once inserts a measure before the bar where the cursor is located.

Conversely, pressing at the right of the display deletes the measure containing the cursor and moves the cursor to the next bar.

4. To clear data you have input, move the cursor to the position for the data to be removed, then press <Clear> at the left of the display.

This deletes the entered setting.

Check the Accompaniment You Inserted

Here's how to play back the accompaniment as far as you input it.

1. Press the Reset [◀] button to go back the beginning of the accompaniment.
2. Press the Play [▶] button to play back the accompaniment.
3. Press the Stop [■] button to stop playback.

6. When you have finished inputting all the data, press <Execute> at the bottom of the display.

The accompaniment you've composed is registered at "0:New Song."

Press the Play [▶] button and try fingering the melody while the accompaniment you've composed is played back.

MEMO

Pressing the [To Variation] button or the [To Original] button adds a fill-in at the cursor position and a Variation or Original Division at the measure after the fill-in. If you want to enter a Variation or Original Division without inserting a fill-in, you need to assign the function to the pedal. See "Assigning a Function to Pad Buttons or Pedals" (p. 139).

MEMO

To insert fractional chords such as Fm/C, assign the "Leading Bass function" to a pedal. See "Assigning a Function to Pad Buttons or Pedals" (p. 139).

MEMO

You can only insert an intro at the beginning of a song. When you add an intro, the number of bars corresponding to the length of the intro is inserted automatically.

MEMO

If you assign the function to a pedal, you can insert a break in the middle of a song. See "Assigning a Function to Pad Buttons or Pedals" (p. 139).

MEMO

Songs you've created are discarded as soon as you turn off the power. If you don't want to lose it, you should save it on a floppy disk. Take a look at "Saving Songs to Floppy Disks" (p. 104).

Chapter 4 Recording and Saving the Performance

Inputting Chords Without Playing the Keyboard

You can use <Chord> in the Chord Sequencer screen to specify chords on the screen.

1. At the Chord Sequencer screen, press <Chord> at the bottom of the display.

A screen like the one shown below appears.

Root	Type	Bass
C	Maj	

◀ Select ▶ Execute

2. Use Select <◀> and <▶> at the bottom of the screen to choose the item you wish to set.
3. Press <↑> <↓> next to the display to make the setting for the item.
4. Repeat steps 2 and 3 to specify the chord.
5. Press <Execute> at the bottom of the display to input the chord.

You are returned to the Chord Sequencer screen.

Erasing all the accompaniment you created

1. In the Chord Sequencer screen, hold down <Clr> and press <Execute>.

All the data you input will be erased.

Creating a Rhythm Part with Ease

The KR-377 has a large number of onboard rhythm patterns. You can use these onboard rhythm patterns to create a rhythm part with ease.

1. Press the [Menu] button, getting its indicator to light.

The Composer Menu screen appears.

2. Press <Rhythm Pattern> next to the display.

If <Rhythm Pattern> doesn't appear on screen, press Page <◀▶> <▶▶> at the bottom of the display to switch screens.

A screen like the one shown below appears.



Press the [Exit] button to return to the Composer Menu screen.

3. Press the button next to the display to choose the rhythm pattern.

Rhythm patterns are shown in the format "name (number of bars)."

You can switch the displayed rhythm pattern by pressing Page <◀▶> <▶▶> at the bottom of the display.

4. Press <Play> at the bottom of the display to hear the rhythm pattern.

Make sure the rhythm pattern you hear is the one you chose.

Press <Stop> to stop playing the rhythm pattern.

5. Press the Rec [●] button, getting the button's indicator to light.

The piano enters recording standby.

When the rhythm pattern is playing, performance of the rhythm pattern stops and the KR-377 is ready for recording.

6. Press the Play [▶] button.

The rhythm pattern begins to play, and at the same time, recording starts. Record rhythm patterns for the necessary number of measures.

7. Press the Stop [■] button.

The rhythm pattern stops, and recording ends.

MEMO

For more information about onboard rhythm patterns, please refer to "Rhythm Pattern List" (p. 173).

MEMO

The rhythm pattern is recorded to the [R/Rhythm] Track button or Part D (10) of the 16-track sequencer (p. 113).

MEMO

If the [R/Rhythm] button's indicator isn't blinking, press the [R/Rhythm] button so it starts blinking.

MEMO

You can also paste a rhythm pattern into a song without recording anything. Take a look at "Copying a Rhythm Pattern" (p. 121).

Saving Songs to Floppy Disks

The performance data recorded in the KR-377 will be lost when you switch to another song or when the power is turned off.

Be sure to save unfinished performance data, as well as other important performance data onto a floppy disk.

■ Formatting Floppy Disks (Format)

New floppy disks or disks that have been used on another device cannot be used with the KR-377 just as they are. The operation that readies floppy disks for use with the KR-377 is called "Format."

If a floppy disk is in a format that doesn't match the format of this unit, you won't be able to use that floppy disk.

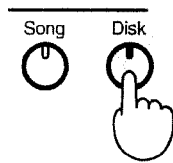

1. Make sure the write-protect tab on the floppy disk is positioned at "WRITE" (write enabled).

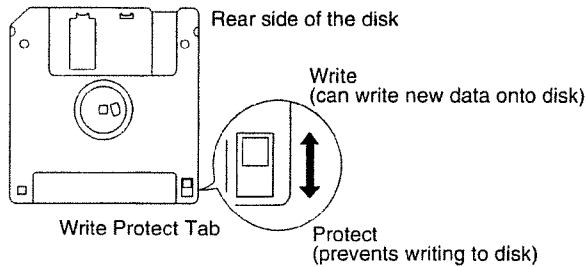

2. With the label of the floppy disk facing upward, insert it into the disk drive until it clicks into position.
3. Press the [Disk] button.

The Disk Menu screen appears.

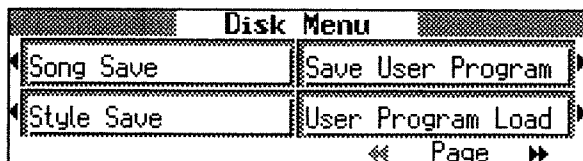

If <Format> doesn't appear on screen, press Page <◀▶> at the bottom of the display to switch screens.

NOTE

If you're using the disk drive for the first time, be sure to read the important notes on p. 6.

NOTE

Formatting a disk destroys all data previously stored on the disk. If you're formatting a used floppy disk for reuse, be sure to check first to make sure the disk doesn't contain any data you don't want to lose.

4. Press <Format> next to the display.

The following screen appears.

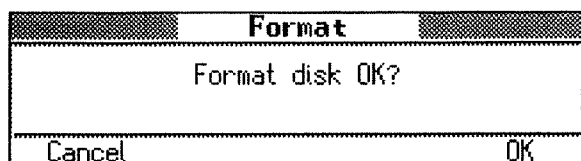

Press <Cancel> at the bottom of the display to go back to the Disk Menu screen.

5. Press <OK> at the bottom of the display to start formatting.

When formatting finishes, the Disk Menu screen reappears.

Press the [Exit] button several times to go back to the previous screen.

■ Saving Songs on Floppy Disk

A recorded performance is discarded when you switch off the power, or choose another song. The process of storing data such as recorded performances on floppy disk is called "saving." It's a good idea to store important songs on floppy disk.

When using a brand-new floppy disk on the unit, first you have to format it using the KR-377. Take a look at "Formatting Floppy Disks (Format)" (p. 104).

Step 1 Insert the floppy disk in the disk drive**1.** Make sure the write-protect tab on the floppy disk is positioned at "WRITE" (write enabled).

For details, refer to p. 104.

2. With the label of the floppy disk facing upward, insert it into the disk drive until it clicks into position.**Step 2 Assign a number and name to the song****3.** Press the [Disk] button.

The Disk Menu screen appears.

If <Song Save> doesn't appear on screen, press Page <◀▶> <▶▶> at the bottom of the display to switch screens.

4. Press <Song Save> next to the display.**NOTE**

Don't try to take the floppy disk out of the disk drive until the formatting process is finished.

MEMO

If "Error" appears on screen, take a look at "If this Message Appears on Screen" (p. 160).

MEMO

If not handled with care, a floppy disk can get cracked, or the data on it can get corrupted, making playback impossible. We recommend saving your songs on two different floppy disks. By putting away for safekeeping an additional copy of a floppy disk on which your songs are saved, you can feel safer.

NOTE

Inserting a floppy disk containing one or more saved data into another device (such as a computer) with the floppy disk's protect tab left in the "write" position may, depending on the device, render the songs on that floppy disk permanently unplayable (refer to the cautions on p. 6).

NOTE

Some commercially available music files cannot be saved because they are copyrighted.

Chapter 4 Recording and Saving the Performance

A screen like the one shown below appears.

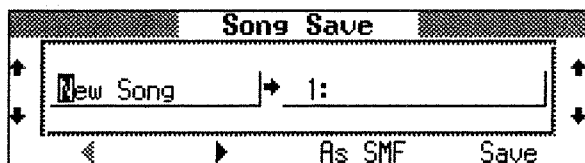

Press the [Exit] button to go back to the Disk Menu screen.

5. Press <◀> <▶> to scroll the cursor sideways, and enter the name of the song by using <↑> <↓> at the left of the display to choose the letters.
6. After you've entered the name of the song, press <↑> <↓> at the right of the display to choose a song number.

When you select a song number that is already being used for another song, the name of the song appears in the save destination column. If you then proceed to save the new material to that song, the song previously saved in that destination is erased, and the new song is saved in its place. If you don't want to erase a previously saved song, choose a number where no song name appears in the destination column.

Step 3 Save the song

7. Press <Save> or <As SMF> at the bottom of the display to start saving.

The resulting file format will be different depending on whether <Save> or <As SMF> is chosen, as described below.

Indication	Description
Save	Saves the song in KR-377 format. You can listen to songs saved in this format on the Roland HP-G series and KR series keyboards as well as on Roland MT series devices. This format is called "i-format".
As SMF	Saves the song as a SMF (Standard MIDI File). Songs saved in this SMF format can be listened to on many instruments that can play SMF music files (p. 178).

Saving may take from several seconds, to several dozen seconds.

When the saving process is finished, the Disk Menu screen appears.

Press the [Exit] button to go back to the previous screen.

NOTE

If you save with the Compatibility function turned "GS," the performance may differ slightly from the original recording when played back on the KR-377. For more about the Compatibility function, please refer to "Changing the Tone Set When You Save (Compatibility Function)" (p. 107).

NOTE

Depending on the playback instrument, some notes may drop out or sound different.

NOTE

You can only save songs in one format on a single floppy disk. And a song recorded using commercial music files can't be saved in "Save As SMF" format for reasons of copyright protection.

NOTE

Don't take the floppy disk out of the disk drive until the saving process is finished.

MEMO

It's a good idea to get into the habit of moving the write-protect tab on the floppy disk to the "Protect" position when you've finished saving your data. Keeping the tab at "Protect" prevents operations that could erase your songs by mistake.

■ Changing the Tone Set When You Save (Compatibility Function)

For maximum richness and realism, some of the Tones are unique to the KR-377. Data that is recorded using these tones may not play back correctly on other devices. If you wish to save the data in a form that can be played back on other GS instruments, turn Compatibility "GS" when you save the data.

- 1.** Press the [Disk] button.
- 2.** Press <Compatibility> located at the side of the display.

If <Compatibility> is not displayed, press Page <◀▶> <▶▶> located below the display to switch screens.

The following screen will appear.

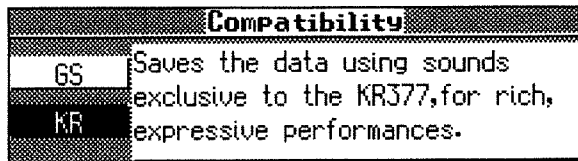

Compatible	Explanation
GS	Data is saved in a form that can also be played on GS instruments other than the KR-377.
KR	Data is saved in a form that will reproduce the performance using expressive tones found only on the KR-377.

- 3.** Use the button at the left of the display to choose <GS> or <KR>.

Press the [Exit] button to return to the Disk Menu screen.

NOTE

If the Compatibility function is "GS" when you save the data, the performance may differ slightly from the original recording when played back on the KR-377.

Deleting Data from Floppy Disks

You can erase songs, User Styles, or User Programs saved on the floppy disk (p. 132).

1. Make sure the write-protect tab on the floppy disk is positioned at "WRITE" (write enabled).

Refer to p. 104.

2. Insert the floppy disk into the disk drive.

3. Press the [Disk] button.

The Disk Menu screen appears.

If <Delete Disk File> doesn't appear on screen, press Page <◀▶> at the bottom of the display to switch screens.

4. Select <Delete Disk File>.

A screen like the one shown below appears.



Press the [Exit] button to go back to the Disk Menu screen.

5. Press any one of the <Song>, <Style> or <User Program> buttons to select the type of data to be deleted.
6. Use <↑> <↓> at the left of the display to choose the data to be deleted.
7. Press <Execute> at the bottom of the display to display a message like the one shown below.

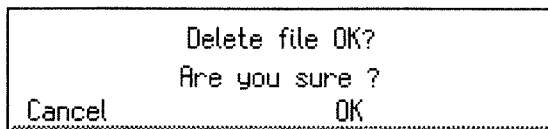

8. Press <OK>.

The file selected is deleted.

Pressing <Cancel> cancels deleting the file.

Changing the Order of Songs on Floppy Disk

Here's how you can change the order of songs saved on a floppy disk.

- 1.** Have ready an empty, formatted floppy disk.
- 2.** Insert the floppy disk containing the saved songs into the disk drive.
- 3.** Press the [Song] button.
- 4.** Press the button next to the display to choose the song you want to make song number 1.
- 5.** When you select the song, press the [Exit] button some times to display the Basic screen (p. 16).
Display the screen where the measure number appears in the top-right area of the screen.
- 6.** Press the Play [▶] button.
The measure number on the screen appears highlighted.
- 7.** When the measure number display returns to its original appearance, press the Stop [■] button.
- 8.** Take the floppy disk out of the disk drive.
- 9.** Insert a blank floppy disk.
- 10.** Save the song in the usual way (p. 104).

Repeat these steps to save the song you want to have song number 2, the song you want to have song number 3, and so on to the blank floppy disk in the desired song sequence.

MEMO

For more about formatting, take a look at "Formatting Floppy Disks (Format)" (p. 104).

NOTE

The measure number of the screen appears highlighted while the KR-377 reads the song data from floppy disk. Don't take the floppy disk out of the drive until the display returns to its original state.

Chapter 5 Advanced Recording Functions

In addition to the functions introduced in “Chapter 4 Recording and Saving Performances,” the KR-377 features a variety of other recording functions that allow you to record more advanced performance data with even greater efficiency.

Selecting the Recording Method

You can use any of the four methods below to record with the KR-377.

Although you will normally be using “Replace Recording,” whereby previously recorded material is erased when new sounds are recorded, you’ll find that you can record songs easily by using this method in combination with other recording methods.

- **Replace Recording**

This is the normal method for recording. New material is recorded as previously recorded material is erased.

- **Mix Recording (p. 110)**

New notes are recorded on top of notes previously recorded.

This convenient feature makes it easy for you to record the melodies you play over prerecorded accompaniment.

- **Loop Recording (p. 111)**

Specified measures are recorded repeatedly, with new notes being combined with existing ones.

A convenient feature for creating rhythm parts, Loop Recording allows you to record over and over within a selected segment, with a different percussion sound added with each pass.

- **Punch-in Recording (p. 112)**

You can re-record only a specified passage as you listen to a recorded performance.

* *Immediately after the power is turned on, Replace Recording is selected.*

■ How to Choose the Recording Method

1. Press the [Menu] button.

The Composer Menu screen appears.

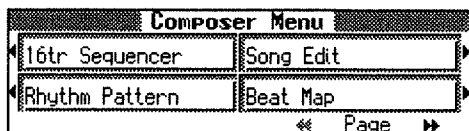

If <Rec Mode> doesn’t appear on screen, press Page <◀▶> at the bottom of the display to switch screens.

2. Press <Rec Mode> next to the display.

A Recording Mode screen like the one shown below appears.

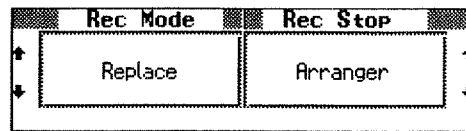

3. Press <↑> <↓> at the left of the display to choose the recording type of <Rec Mode>.

Display	Recording Method
Replace	Replace Recording
Mix	Mix Recording
Loop	Loop Recording
Auto Punch In/Out	Punch In Recording at the passage between the markers.
Manual Punch In/Out	Punch In Recording starts at the place where you depress the pedal or press the button.
Tempo	You can add tempo changes to a recorded composition. See p. 117.

■ Recording While Erasing the Previous Recording (Replace Recording)

Recording whereby you erase previously recorded material as you record something new is called “Replace Recording.” This setting is in effect when you turn on the power.

1. From the Recording Mode screen, choose “Replace.”

Press the [Exit] button to go back to the previous screen. The piano enters Replace Recording mode.

Follow the recording method in Chapter 4 (p. 91) or the procedures described in “Multitrack Recording with 16 Parts (16-Track Sequencer)” (p. 113) to record the performance.

■ Overdubbing Without Erasing the Previous Recording (Mix Recording)

You can record a performance layered over a previously recorded performance. This method is called “Mix Recording.”

1. From the Recording Mode screen, choose “Mix.”

Press the [Exit] button to go back to the previous screen. The recording method changes to mixing recording. Record the performance, following the procedures described in “Redoing a Recording” (p. 96) or “Multitrack Recording with 16 Parts (16-Track Sequencer)” (p. 113).

* *After you have finished with mix recording, return to the usual replace recording mode.*

■ Repeatedly Recording Over the Same Location (Loop Recording)

You can record a specified passage over and over again as many times as you like, layering the sound with each pass. This method is called "Loop Recording." This is handy when recording a Rhythm Part.

For example, use this method to make a Loop Recording of a four-measure segment.

First record the bass drum, the snare drum next, then the hi-hat after that, and so on, repeatedly layering a different instrument onto the same four measures. After you have finished recording the four-measure rhythm pattern, you can then just use the procedure in "Copying a Measure" (p. 120) to create as many copies of the four measures as you need, making completion of the Rhythm Part very simple.

1. Place A and B markers at the beginning and end of the passage you want to record.

Take a look at "Setting Markers in the Song/Erasing Markers" (p. 86).

If you haven't recorded anything yet, then perform "Blank Recording" for the necessary number of measures before placing the markers.

What is Blank Recording?

Blank Recording is the recording of blank measures, that is, measures with no performance recorded to them.

1. **Set the basic tempo and beat of the song.**
2. **Hold down the Rec [●] button, then press the Play [►] button.**
The indicators for the Rec [●] and Play [►] buttons light up, and recording starts.
3. **Without actually playing anything, record the necessary number of measures, then press the Stop [■] button.**

The indicators for the Rec [●] and Play [►] buttons go dark, and recording stops.

2. From the Recording Mode screen (p. 110), choose "Loop."

Press the [Exit] button to go back to the previous screen. The recording method changes to loop recording.

3. Press the Rec [●] button.

The piano enters recording standby.

4. Press the Play [►] button to start recording.

Recording starts from the measure in which Marker A was placed.

When the song advances to Marker B, it then returns to Marker A, where recording continues.

Each time the recording is looped, the sounds being played are layered over the sounds recorded on previous passes.

5. Press the Stop [■] button to stop recording.

- * When you're finished with Loop Recording, return to the ordinary Replace Recording mode at the Recording Mode screen (p. 110).

Loop Recording Shortcut

You can also use the method described below to make the setting for Loop Recording.

1. Place A and B markers at the beginning and end of the passage you want to record.

Take a look at "Setting Markers in the Song/Erasing Markers" (p. 86).

If you haven't recorded anything yet, then perform "Blank Recording" for the necessary number of measures before placing the markers.

2. From the Marker screen (p. 86), press <Repeat> at the right of the display.

This sets the loop recording mode.

Start a recording.

- * When Loop Recording is finished, remember to press the button at the right of <Repeat> in the "Marker screen" once more to return to the usual Replace Recording mode.

Chapter 5 Advanced Recording Functions

■ Re-Recording Part of Your Performance (Punch-in Recording)

You can re-record only a specified passage as you listen to a recorded performance.

This recording method is called “Punch-in Recording.”

This function lets you record over only a specified point in a part, as you listen to a prerecorded performance in another section. This is a very convenient feature to have in situations such as when you want to record over only one part of the melody.

Punch-In Recording offers the following two methods.

- **Recording the passage specified by markers A and B (Auto Punch In/Out)**

Before you start recording, place markers A and B to define the passage you want to record over. Make the setting for punch-in recording, and carry out recording. You can re-record just the passage between markers A and B.

- **Beginning recording at the point where either the button or the pedal is pressed (Manual Punch In/Out)**

You can play back a recorded performance and depress the pedal at the desired place to start recording.

Depressing the pedal a second time cancels recording and returns you to playback.

If using the buttons, press the Pad button or the Rec [●] button when you reach the designated point in the song to begin recording.

Pressing the Pad button or the Rec [●] button a second time cancels recording and returns you to playback.

- * *To use this method, first you need to change how the pad button or pedal works. See “Assigning a Function to Pad Buttons or Pedals” (p. 139).*

Recording a Passage specified by markers

1. **Before you start recording, place markers A and B to define the passage you want to record over.**

Following the procedures described in “Setting Markers in a Song,” use Markers A and B to specify the passage.

2. **From the Recording Mode screen (p. 110), choose “Auto Punch In/Out.”**

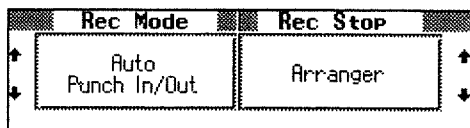

This changes the recording mode to “Punch-In Recording.”

Press the [Exit] button to go back to the previous screen.

3. **Begin recording.**

Start recording as described in “Redoing a Recording” (p. 96).

Up until the specified passage, the performance as already recorded is played back.

When you reach the specified passage, sounds are erased as recording starts; begin playing now.

When the end of the specified passage is passed, recording stops, and the KR-377 returns to playback of the performance already recorded.

4. **Press the Stop [■] button to stop playback.**

Starting Recording from the Measure Specified by Buttons and Pedals

- * *First you need to assign the “Punch In/Out” function to pad buttons or pedals. See “Assigning a Function to Pad Buttons or Pedals” (p. 139).*

1. **From the Recording Mode screen (p. 110), choose “Manual Punch In/Out.”**

This changes the recording mode to “Punch-In Recording.”

Press the [Exit] button to go back to the previous screen.

2. **Begin recording.**

Start recording as described in “Redoing a Recording” (p. 96).

The performance that you recorded will be played back. Press the Rec [●] button or the Pad button to which the function has been assigned, or depress the pedal and recording will start. Start playing the music you are recording.

Pressing the Rec [●] button or the Pad button or the pedal once more stops the recording, and previously recorded material is played back.

3. **Press the Stop [■] button to stop playback.**

Press the [Exit] button to go back to the previous screen.

- * *When you’re finished with Punch In Recording, return to the ordinary Replace Recording mode at the Recording Mode screen (p. 110).*
- * *When you press the One Touch Program [Piano] button, the functioning of the pedals returns the pedals to their usual functions (p. 14). If you record the piano performance using the One Touch Program [Piano] button, use the button for the punch in recording.*

Multitrack Recording with 16 Parts (16-Track Sequencer)

Multitrack recording is a method of recording whereby you listen to previously recorded material while continuing to add performances of other parts.

The KR-377 is capable of multitrack recording of up to sixteen parts. Since each part's performance is recorded using one tone, you can layer performances, using up to sixteen tones for the data in one song.

The function used to layer these sixteen parts one at a time is called the "16 Track Sequencer."

16 Track Sequencer and Track Buttons

In addition to the "16 Track Sequencer" function, the "Track Buttons" are another of the unit's recording functions.

These "Track buttons" comprise five buttons used for organizing the 16 Track Sequencer's sixteen parts. This allows you to use the 16 Track Sequencer to add even more sounds to performances recorded with the Track buttons, and make even more detailed edits of the songs.

Additionally, you can easily play back the original song data with the 16 Track Sequencer, mute parts just by pressing the Track buttons, and more.

The track buttons correspond to 16-track sequencer parts as shown below.

Track button	Part
[R/Rhythm]	D(10), S(11)
[1/Whole]	1
[2/Bass/Accomp]	2, 5 to 9, 12 to 16
[3/Lower]	3
[4/Upper]	4

Since the 16 Track Sequencer records one tone to one part, you cannot use Layer Play (p. 47), Split Play (p. 49), or other such functions to record two or more tones simultaneously. Also, you can't record the performance with Automatic Accompaniment.

When you want to record with Automatic Accompaniment, then you should use the Track buttons for recording. (Refer to "Recording a Performance Using Automatic Accompaniment" (p. 94).

Commercially Available Music Files

Commercially available song data recorded in Roland's SMF format is also composed of sixteen parts.

By loading the song data from the floppy disk and using the 16 Track Sequencer, you can then also edit the song data.

* Although Part 11 on commercial Roland SMF music data is included in the [2/Bass/Accomp] Track button, the correspondence between all other parts and the Track buttons remains unchanged.

* With some commercially available music files, you cannot edit the data.

The 16-track Sequencer Screen

When recording with 16-track Sequencer, display the 16-track Sequencer screen.

1. Press the [Menu] button.

If <16Tr Sequencer> doesn't appear on screen, press Page <◀▶> at the bottom of the display to switch screens.

2. Press <16Tr Sequencer>.

A screen like the one shown below appears. This is called the "16-track Sequencer screen."

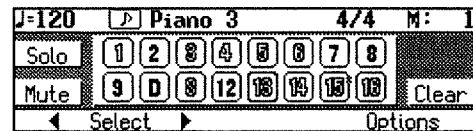

Indication	Description
<1>-<16>	Use Select <◀▶> located below the display to choose the part that you wish to record or whose settings you wish to change. The selected Part will be enclosed by a heavy square.
8	The selected Part
7	The Part to be played back
-	The Part not to be played back (Muted Part)
1	Parts that do not have performance data recorded to them.
<Solo>	Only the selected Part is played back.
<Clear>	Erases the performance data for the Part.
<Mute>	This allows you to prevent the sound for the selected part from playing.
<Options>	Displays the Part Settings screen, in which you can make detailed settings for each part. For details, refer to p. 115.

Chapter 5 Advanced Recording Functions

■ Recording with the 16 Track Sequencer

Step 1 Get ready to record

1. Press the [Song] button.
2. Select the song number to which you want to record.
To record a new song, select <0> to display <0: New Song>.
If <0> doesn't appear on screen, press Page <◀◀> <▶▶> at the bottom of the display to switch screens.
If you have recorded a song or changed a song's settings, the message "Delete Song OK?" appears on the screen when you press <0: New Song>. For more information, take a look at "● If the following message appears" (p. 93).
3. Press the [Metronome] button to choose the beat (p. 57).
If you don't need the metronome sound, press the [Metronome] button a second time.
4. Press the Tempo [-] and [+] buttons to set the basic tempo of the song.
** This procedure cannot be used to change the tempo when prerecorded song data is used.
To change the basic tempo of a song, please refer to "Changing a Song's Basic Tempo" (p. 117).
You cannot make changes to the beat of a song after it has been recorded.*
** You can't change a song's beat once it's been recorded. If you want to compose a song whose beat changes partway through the song, take a look at "Composing a Song That Changes the Beat Partway Through" (p. 116).*

Step 2 Start recording

If necessary, choose a recording method.

For more information, take a look at p. 110 through p. 112.

If you record for the first time, there's no need to select the recording method.

1. Display the 16-track Sequencer screen.
Follow the procedure described in "16 Track Sequencer Screen" above.
2. Press Select <◀> and <▶> at the bottom of the display to choose the number of the Part to which you wish to record.
The selected Part will be enclosed by a heavy square.
You can only record drum sounds or effect sounds on Part D (10) or Part S (11).

3. Use the Tone buttons to choose a Tone to play.
To record a drum sound or effect sound, press the [Drums/SFX] button (p. 44).
After you've chosen a Tone, press the [Exit] button to display the 16-track Sequencer screen.
4. Press the Reset [◀] button.
This makes it so that recording starts at the beginning of the song.
When you want to start recording from a point in the song other than the beginning, use the Bwd [◀◀] or Fwd [▶▶] button to select the measure from which to start.
5. Press the Rec [●] button, getting the button's indicator to light.
The piano enters recording standby.
6. Press the Play [▶] button.
A two-bar count-in sounds, then recording starts.
Start a recording.
7. Press the Stop [■] button.
Recording stops.
When the recording of one part is finished, select another part and continue by recording that part.
Record the parts you need, layering each additional part, to complete the song.
** You only need to follow the procedure described in "Step 1 Get ready to record" when you're recording the first Part. For the second Part and after, you can skip step 1 and proceed from "Step 2 Start recording."*
** The song you've recorded disappears when you switch off the power. Save the song on a floppy disk. For more information, see "Saving Songs to Floppy Disks" (p. 104).*

Changing the Settings for Each Part

When you've recorded a song with the 16-track sequencer, you can change the volume level, Tone, or set to mute out the sound for a single Part.

* Because commercially available Roland SMF Music Data is also made up of 16 Parts for sounding the notes of individual instruments, you can change the settings for the individual Parts and play them back in the same way.

1. Press the [Song] button, then choose the song with the button next to the display.

2. Press the [Menu] button.

If <16Tr Sequencer> doesn't appear on screen, press Page <◀▶> at the bottom of the display to switch screens.

3. Press <16Tr Sequencer>.

A 16-track Sequencer screen like the one shown below appears.

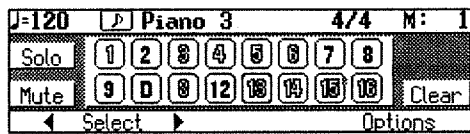

4. Press Select <◀▶> and <▶▶> at the bottom of the display to choose the Part you want to set.

5. Change the settings for the selected Part.

Display	Function
Solo	Only the selected Part is played back.
Mute	Toggles playback of the selected Part on or off.
Clear	Erases the performance information for the Part. Pressing <Clear> displays the Message for confirm. To erase the recorded sound, Press <OK>. If you don't want to erase the recorded sound, press <Cancel>. Once a performance has been erased, it can't be restored.

* Making it so that a single Part is not played is called "Minus One." Using Minus One, you can mute out a particular instrument and play the part yourself.

6. You can make detailed settings for the selected Part by pressing <Options> at the bottom of the display.

A screen like the one shown below appears.

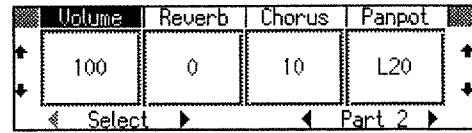

You can change the Tone for the selected Part by pressing a [Tone] button to change the Tone while this screen is displayed.

7. Press Select <◀▶> and <▶▶> at the bottom of the display to choose the item you wish to set.

Indication	Description
Volume	Changes the volume level.
Reverb	Changes the depth of the reverb effect.
Chorus	Changes the amount of chorus applied.
Panpot	Shifts the direction from which the sound is heard between left and right. When you press <▲> located beside the display, the sound will move toward the right. When you press <▼>, the sound will move toward the left.

What's Panpot?

Panpot is the control that determines the placement of the sound in the stereo sound field between left and right speakers. By altering the Panpot setting, you can change the perceived location of the sound between the left and right speakers.

8. Use <▲> <▼> next to the display to change the value.

9. Press the Play [▶] button to play back the song with the changed settings.

Monitor the effect by actually listening to the song. Press the Stop [■] button to stop playback.

10. Press Part <◀▶> <▶▶> at the bottom of the display to change the settings for other Parts as well.

11. While holding down the Rec [●] button, press the Reset [◀] button.

This operation set the changes in the settings.

The song with the changed settings can then be saved to a floppy disk.

If you don't want to lose the song whose settings for individual Parts you've changed, you should save it on a floppy disk (p. 104).

* The setting that determines whether an individual Part is played or not can't be saved to floppy disk.

Chapter 5 Advanced Recording Functions

● If the following message appears

If you try to display another screen after you've changed the song's settings for each Part, a message like the one below may appear.

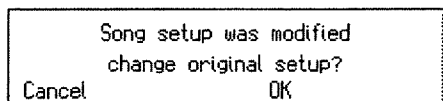

Press <OK> to change the song's settings.

Press <Cancel> to discard the changes in settings.

Composing a Song That Changes the Beat Partway Through

You can create songs that have beat changes during the course of the song.

* You can't change a song's beat once it's been recorded. Before recording the performance, determine the beat to be used.

1. Press the [Menu] button.

If <Beat Map> doesn't appear on screen, press Page <◀▶> at the bottom of the display to switch screens.

2. Press <Beat Map>.

A screen like the one shown below appears.

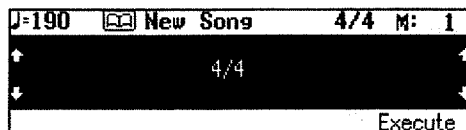

Press the [Exit] button to go back to the previous screen.

3. Use the Fwd [▶▶] button to move to the bar where you want to change the beat.

The measure number appears in the top-right area of the screen.

4. Press <↑> <↓> next to the display to choose the beat.

The beat displayed on the screen will change.

5. Press <Execute> at the bottom of the display.

The beat change starting with the measure where you moved to.

6. Press the [Exit] button twice.

The screen displayed before you pressed the [Menu] button appears.

7. Press the Reset [◀] button to return the measure number to "1."

8. Start a recording.

Follow the recording method in Chapter 4 (p. 91) or the procedures described in "Multitrack Recording with 16 Parts (16-Track Sequencer)" (p. 113) to record the performance.

Changing a Song's Basic Tempo

You can change the basic tempo of a composition. The basic tempo is that was initially set when the song was recorded.

1. Press the Tempo [-] and [+] buttons to choose a tempo.
2. While holding down the Rec [●] button, press the Reset [◀] button.

The song's basic tempo changes. Save the song on a floppy disk.

The changed setting for the basic tempo is discarded when you turn off the power or choose a different song.

- * If the song you're working on has tempo changes in it, press the Reset [◀] button to go back to the beginning of the song before you carry out this operation. Changing the tempo without returning to the start of the song causes the proportion by which the tempo is altered at the location of the tempo change to affect the overall tempo of the composition.

Changing the Tempo Within the Song

You can add tempo changes to a recorded composition.

The KR-377 stores song tempo information and performance data separately. Therefore, when making changes to the tempo in a song, you must record the changes in the tempo information independently of the performance data.

This recording of the tempo is called "Tempo Recording."

- * During tempo recording, the tempo display in the upper left of the screen will be highlighted.

■ Adjusting the Tempo While Listening to a Song

You can add ritardando and other such gradual tempo changes.

1. Press the [Menu] button.

If <Rec Mode> doesn't appear on screen, press Page <◀▶> at the bottom of the display to switch screens.

2. Press <Rec Mode> next to the display.

The Recording Mode screen appears.

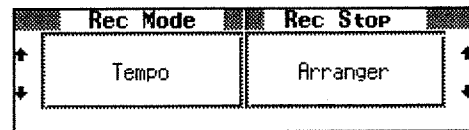

3. Use <↑> <↓> at the left of the display to choose "Tempo."

This makes the setting for tempo recording.

Press the [Exit] button several times to go back to the screen that shows the measure number in the top-right area of the screen.

4. Press the Bwd [◀◀] and Fwd [▶▶] buttons to move to a place a little earlier than the bar where you want to change the tempo.

5. Press the Rec [●] button and confirm that its indicator blinking.

The piano enters recording standby.

6. Press the Play [▶] button to start recording.

7. When you get to the place where you want to change the tempo, use the Tempo [-] and [+] buttons to vary the tempo as desired.

8. Press the Stop [■] button to stop recording.

The song's tempo changes.

- * You cannot record performances while in Tempo Recording mode. When you're finished tempo recording, go back to the ordinary Replace Recording. Take a look at "How to Choose the Recording Method" (p. 110).

Chapter 5 Advanced Recording Functions

■ Adjusting the Tempo at a Particular Measure

You can have the tempo change at the beginning of a measure where you moved to. This is handy when you want to make a sudden change in tempo.

1. Make the setting for Tempo Recording at the Recording Mode screen.

The steps are the same as the steps 1 to 3 in “Adjusting the Tempo While Listening to a Song” (p. 117).

When you’re done making the setting, press the [Exit] button several times to go back to the screen that shows the measure number in the top-right area of the screen.

2. Use the Bwd [◀] and Fwd [▶] buttons to move to the bar where you want to change the tempo.

The measure number appears in the top-right area of the basic screen.

3. Press the Rec [●] button and confirm that its indicator blinking.

The piano enters recording standby.

4. Use the Tempo [-] and [+] buttons to change the tempo.

5. Press the Rec [●] button.

The song’s tempo changes starting with the measure where you moved to.

6. Press the Stop [■] button to end recording.

* You cannot record performances while in Tempo Recording mode. When you’re finished tempo recording, go back to the ordinary Replace Recording. Take a look at “How to Choose the Recording Method” (p. 110).

* If you want to restore the previous tempo, delete the tempo data at the place where the tempo was recorded. For an explanation of how to delete the information of tempo settings, refer to the “Making a Measure Blank” (p. 123).

Tempo Recording Shortcut

You can also enter the Tempo Recording mode by holding down the Rec [●] button and pressing the Tempo [-] or [+] button.

Record tempo information.

In this case, tempo recording is canceled when recording ends.

Chapter 6 Editing a Song

Selecting Editing Functions

There is a variety of ways you can edit performances recorded using the KR-377 Track button or 16-track sequencer.

1. Press the Composer [Menu] button.

The Composer Menu screen appears.

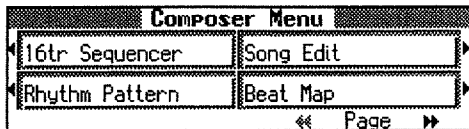

If <Song Edit> doesn't appear on screen, press Page < << > >> > at the bottom of the display to switch screens.

2. Press <Song Edit>.

An Edit screen like the one shown below appears.

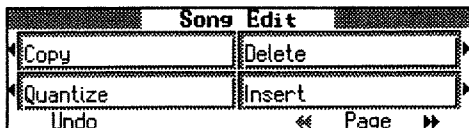

Indication	Description
Undo	Cancels an editing operating.
Copy	Copies a measure or onboard rhythm pattern (p. 120, p. 121).
Quantize	Corrects discrepancies in the timing of notes in a recorded performance (p. 121).
Delete	Deletes a measure (p. 122).
Insert	Adds a blank measure (p. 122).
Transpose	Transposes a Part (p. 123).
Erase	Makes a measure blank (p. 123).
Part Exchange	Exchanges the notes in two Parts (p. 124).
Note Edit	Used to correct individual notes one at a time (p. 124).
PC* Edit	Used to correct changes in Tones during the course of a song (p. 125).

* What's "PC"?

"PC" is an abbreviation for Program Change, which is a command that means "Change the Tone." In a song that changes Tones partway through, a "PC" is inserted at the place where the Tone changes.

Press the [Exit] button to return to the Composer Menu screen.

3. Press the button to choose the edit function.

After you make your choice, follow the steps on the page for the selected function to carry out the operation.

- * *Some edits can't be undone, not even by choosing "Undo." We recommend saving your song on a floppy disk before you edit it. For information on how to save your song, see "Saving Songs to Floppy Disks" (p. 104).*

Canceling an Edit

You can cancel an editing operation that you've just carried out. This is handy when you want to undo an edit and restore it to the way it was before.

- * *There are some edits that can't be restored to their previous state.*

1. Follow the steps in "Choosing an Editing

Function" to choose <Undo> at the bottom of the display.

Editing functions that can be undone appear on screen.

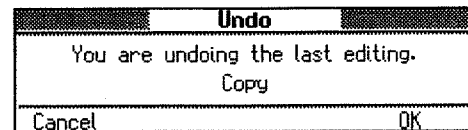

Pressing <Cancel> takes you back to the Edit screen without the undo operation.

2. Press <OK> to cancel the editing function shown on screen.

You are returned to the Edit screen.

Chapter 6 Editing a Song

Copying a Measure

You can copy a portion of a performance to a different bar in the same Part or to a measure in another Part. This is handy when you're composing a song that repeats a similar phrase.

Ex. To copy measure 5-7 to measure 8.

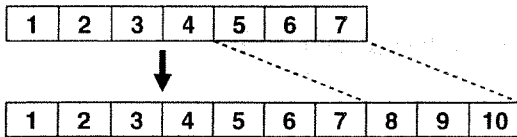

1. Follow the steps in "Choosing an Editing Function" (p. 119) to choose <Copy>.

A screen like the one shown below appears.

Copy			
From:	5	To:	End
For:	3	Mode:	Replace
Src:	All	Dst:	---
Select		Execute	

Display	Description
From	The first measure in the passage you want to copy
For	The number of measures to copy
Src	Track button or Part number of the copy source Choosing "All" copies all Parts. When you do this, <Dst> changes to "—." Choosing "R.Pattern" copies the KR-377's built-in Rhythm Patterns. For more information, take a look at "Copying a Rhythm Pattern" (p. 121). If you choose a Track button, you can only copy to the selected Track button.
To	The measure number of the copy destination Choosing "End" copies to the end of the song.
Times	The number of times to copy
Mode	Copy type There are three types of copying, which are described below. Replace When a recorded performance exists at the copy destination, the previous recording is deleted and replaced with the copied passage.

Mix

When a recorded performance exists at the copy destination, the newly copied passage is mixed with the previous recording. When the Tones of the copy source and destination are different, the Tone of the destination is used.

Insert

When a recorded performance exists at the copy destination, the newly copied passage is inserted without deleting the previous recording. This makes the song longer by an amount equal to the number of inserted measures.

Dst Part number of the copy destination

2. Use Select <◀> and <▶> at the bottom of the screen to choose the item you wish to set.
3. Use <↑> <↓> next to the display to make the setting for the item.
To stop copying, press the [Exit] button.
The copy is canceled, then you are returned to the Edit screen.
4. When you're done making all the settings, press <Execute>.
Copying starts.
When copying is finished, you are returned to the Edit screen.

Copying a Rhythm Pattern

The KR-377 has a large number of onboard rhythm patterns. You can copy these rhythm patterns to create a rhythm part. For more information about the kind of Rhythm Patterns, please refer to "Rhythm Pattern List" (p. 173).

1. Follow the steps in "Choosing an Editing Function" (p. 119) to choose <Copy>.

For more about ordinary copying, please refer to "Copying a Measure" (p. 120).

2. Use Select <◀> and <▶> at the bottom of the screen to choose <Src>.

3. Use <↑> <↓> next to the display to choose "R.Pattern."

A screen like the one shown below appears, and the settings for copying the built-in Rhythm Pattern are made.

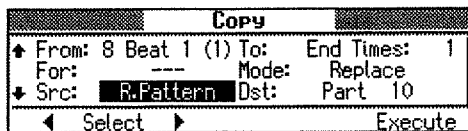

- The <From> column displays the Rhythm Pattern's name and number of bars.
- <Dst> is fixed at "Part 10 (D)," and can't be changed.
- Switching <Src> to something other than "R.Pattern" makes the setting for ordinary copying.

4. Use Select <◀> and <▶> at the bottom of the screen to choose the item you wish to set.

5. Use <↑> <↓> next to the display to make the setting for the item.

You can hear the rhythm pattern by pressing the Play [▶] button. Press the Stop [■] button to stop playing the rhythm pattern.

Pressing the [Exit] button returns you to the Edit screen, without the copy being executed.

6. When you're done making all the settings, press <Execute>.

Copying starts.

When copying is finished, you are returned to the Edit screen.

* You can also record the rhythm pattern. Take a look at "Creating a Rhythm Part with Ease" (p. 103).

Correcting Timing Discrepancies

You can correct for timing discrepancies in a recorded performance by having the music be aligned with a timing you specify. This is called "Quantizing."

As an example, let's say that the timing of some quarter-notes in a performance is a little off. In this case, you can quantize the performance with quarter-note timing, thus making the timing accurate.

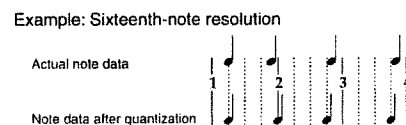
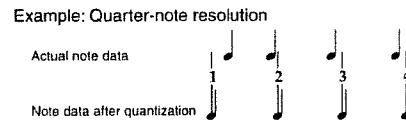

1. Follow the steps in "Choosing an Editing Function" (p. 119) to choose <Quantize>.

A screen like the one shown below appears.

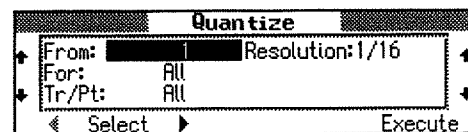

Display	Description
From	The first measure in the passage you want to quantize
For	The number of measures you want to quantize
Tr/Pt	Track button or Part number to quantize Choosing "All" quantizes the same passage in all Parts.
Resolution	Timing of quantizing Select one of the following values. 1/2 (half note), 1/4 (quarter note), 1/6 (quarter-note triplet), 1/8 (eighth note), 1/12 (eighth-note triplet), 1/16 (sixteenth note), 1/24 (sixteenth-note triplet), 1/32 (thirty-second note)

2. Use Select <◀> and <▶> at the bottom of the screen to choose the item you wish to set.

3. Use <↑> <↓> next to the display to make the setting for the item.

If you want to cancel quantizing, press the [Exit] button. The Quantize operation will be canceled, and the Edit screen will reappear.

4. When you're done making all the settings, press <Execute>.

Quantizing starts.

When the quantization is finished, you are returned to the Edit screen.

Chapter 6 Editing a Song

Deleting a Specific Measure

You can delete a part of a performance measure by measure. When you erase a measure, the measures that follow it are shifted to the left. Deleting measures in a specified passage is called "deleting."

Ex. To delete measures (bars) 5-8

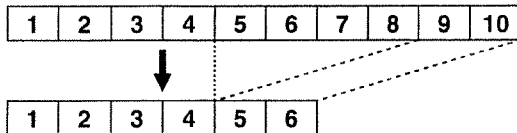

1. Follow the steps in "Choosing an Editing Function" (p. 119) to choose <Delete>.

A screen like the one shown below appears.

Delete	
From:	5
For:	4
Tr/Pt:	All
◀ Select ▶ Execute	

Display	Description
From	The first measure in the passage you want to delete
For	The number of measures to delete
Tr/Pt	Track button or Part number to delete Choosing "All" deletes the same location in all Parts.

2. Use Select <◀> and <▶> at the bottom of the screen to choose the item you wish to set.

3. Use <↑> <↓> next to the display to make the setting for the item.

If you want to cancel deleting the measure, press the [Exit] button.

The deletion is canceled and the KR-377 goes back to the Edit screen.

4. When you're done making all the settings, press <Execute>.

The deletion process starts.

When the deletion is finished, you are returned to the Edit screen.

Inserting a Blank Measure

You can add a blank measure at a location you specify. This addition of a blank measure is called "Insertion."

Ex. To insert measures (bars) 5-7

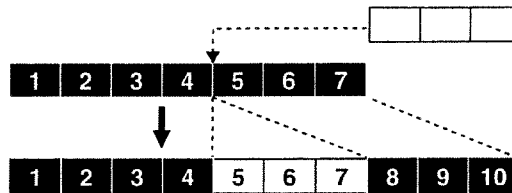

1. Follow the steps in "Choosing an Editing Function" (p. 119) to choose <Insert>.

A screen like the one shown below appears.

Insert	
From:	5
For:	3
Tr/Pt:	All
◀ Select ▶ Execute	

Display	Description
From	The first measure in the passage you want to insert
For	The number of measures to insert
Tr/Pt	Track button or Part number to insert Choosing "All" inserts the blank measures at the same location in all Parts.

2. Use Select <◀> and <▶> at the bottom of the screen to choose the item you wish to set.

3. Use <↑> <↓> next to the display to make the setting for the item.

If you want to cancel inserting measures, press the [Exit] button.

The insertion is canceled and the KR-377 goes back to the Edit screen.

4. When you're done making all the settings, press <Execute>.

Insertion of a blank measure starts.

When insertion is finished, you are returned to the Edit screen.

Making a Measure Blank

You can erase the performance data in the specified block of measures, making these blank measures. This process of making certain measures blank is called "Erasing."

Ex. To erase measures (bars) 5-8

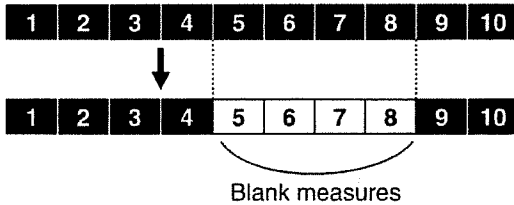

1. Follow the steps in "Choosing an Editing Function" (p. 119) to choose <Erase>.

A screen like the one shown below appears.

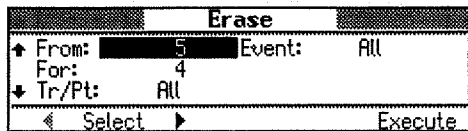

Display	Description
From	The first measure in the passage you want to blank out
For	The number of measures to blank out
Tr/Pt	Track button or Part number to blank out Choosing "All" blanks out the same location in all Parts.
Event	Performance information to erase Select from the following settings. All Erases all performance messages, such as the notes, tempo, tone changes, and volume-level changes. Tempo Erases tempo information. By erasing the tempo information for all bars, the song will change with a uniform tempo. In this case, please choose "All" for <Tr/Pt>. Program Change Erases Program Change messages (p. 119). Note Erases only notes. Except Note Erases performance information for everything but notes. Expression Erases Expression (volume change) information.

2. Use Select <◀> and <▶> at the bottom of the screen to choose the item you wish to set.

3. Use <↑> <↓> next to the display to make the setting for the item.

If you want to cancel erasing the performance data, press the [Exit] button.

This returns you to the Edit screen without erasing the performance data.

4. When you're done making all the settings, press <Execute>.

The specified passage is blanked out.

When the erasure is finished, you are returned to the Edit screen.

Transposing Individual Parts

You can transpose specified parts and tracks individually.

1. Follow the steps in "Choosing an Editing Function" (p. 119) to choose <Transpose>.

A screen like the one shown below appears.

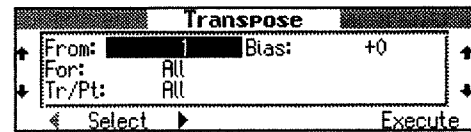

Display	Description
From	The first measure in the passage you want to transpose
For	The number of measures to transpose
Tr/Pt	Track button or Part number to transpose Choosing "All" transposes the same location in all Parts.
Bias	The amount of transposition You can choose a value from -24 (two octaves lower) to +24 (two octaves higher), in semitone increments.

2. Use Select <◀> and <▶> at the bottom of the screen to choose the item you wish to set.

3. Use <↑> <↓> next to the display to make the setting for the item.

If you want to cancel transposing, press the [Exit] button. The transposition is canceled, you are returned to the Edit screen.

4. When you're done making all the settings, press <Execute>.

The passage you specified is transposed at the specified value.

When transposition is finished, you are returned to the Edit screen.

Exchanging Parts

You can exchange the notes recorded for a particular part with the notes recorded for another part.

This process of swapping parts is called "Part Exchange." For instance, swapping the part you want to practice with any one of Parts 1, 3, and 4 lets you mute out (silence) the part with the Track buttons while playing back the song, which can be handy.

For more about assigning parts to Track buttons, take a look at "16 Track Sequencer and Track Buttons" (p. 113).

1. Follow the steps in "Choosing an Editing Function" (p. 119) to choose <Part Exchange>.

A screen like the one shown below appears.

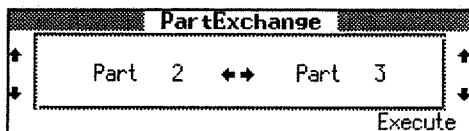

2. Use <↑> <↓> next to the display to choose Parts you want to exchange.

If you want to cancel the Part exchange, press the [Exit] button.

The exchange is canceled and the KR-377 goes back to the Edit screen.

3. When you're done making all the settings, press <Execute>.

When the part-exchanging process is finished, you are returned to the Edit screen.

Correcting Notes One by One

You can make corrections in a recorded performance one note at a time. This process of making changes in individual notes is called "Note Editing."

You can make the corrections described below by using Note Editing.

- Delete mistaken notes
- Changing the scale of a single note
- Changing the key velocity of a single note

1. Follow the steps in "Choosing an Editing Function" (p. 119) to choose <Note Edit>.

A screen like the one shown below appears.

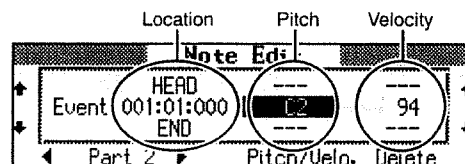

The note-location display uses "Measure:Beat:Tick" as the format. A tick is a unit of time that's shorter than a beat.

2. Use Part <◀> and <▶> at the bottom of the screen to choose the Part you wish to correct. "Part **" displays the number of the currently selected Part.
3. Use <↑> <↓> at the left of the display to find the note you want to change.
By using the Bwd [◀◀] and Fwd [▶▶] buttons you can search for notes in units of a measure.
4. When you've found the note you want to modify, press <Pitch/Velo> at the bottom of the display to choose the item.
The cursor then moves.
5. Use <↑> <↓> at the right of the display to modify "Pitch" and "Velocity."
If you want to delete the note, press <Delete> at the bottom of the display.
6. When you're done making all the settings, press the [Exit] button.

You are returned to the Edit screen.

Modifying the Tone Changes in a Song

In some songs, the Tone changes during the course of the song (that is, the Tone changes in the middle of a Part). In such songs, an instruction to switch the Tone is inserted at the place where you want the sound to change. This instruction is called a "Program Change" (PC), and actions such as deleting program changes, or changing the Tone that is selected by them are called "PC Editing."

1. Follow the steps in "Choosing an Editing Function" (p. 119) to choose <PC Edit>.

A screen like the one shown below appears.

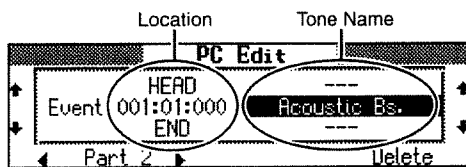

The PC-location display uses "Measure:Beat:Tick" as the format. A tick is a unit of time that's shorter than a beat.

2. Use Part <◀> and <▶> at the bottom of the screen to choose the Part that contains the note you want to change.
"Part ***" displays the number of the currently selected Part.
3. Use <↑> <↓> at the left of the display to find the Program Change you want to modify.
By using the Bwd [◀◀] and Fwd [▶▶] buttons you can search for program change in units of a measure.
4. Press the [Tone] button to choose the Tone group, and use the button next to the display to choose one of the tones.
5. Press the [Exit] button to go back to the previous screen.
If you want to delete the Program Change, press <Delete> at the bottom of the display.
6. When you're done making all the settings, press the [Exit] button.
You are returned to the Edit screen.

Chapter 7 Using Other Functions

Creating an Original Style (User Style)

The KR-377 has built-in Music Styles in a variety of genres, but you can also create your own original styles.

The original style is called a "User Style."

You can use either of the two methods described below to create a User Style.

- **Style Composer**

This method combines the KR-377's onboard Music Styles to create a new style. You can create a new style just by selecting from among the Rhythm, Bass, Accompaniment 1, Accompaniment 2, and Accompaniment 3 parts from different styles.

- **Style Converter (p. 128)**

This method extracts the portions you need from songs composed with the 16-track sequencer to create a new style. When you're composing a song, there's no need to specify all the chords. You can specify just some of the chords, and working on that, the KR-377 automatically extrapolates the other chords, and arranges the style.

The Style Converter has an "Auto Mode" for creating Music Styles simply from a song with a single chord, and a "Manual Mode" for creating a Style from a song of three chords (major, minor, and diminished seventh).

Combining Styles to Create a New Style (Style Composer)

You can create a new User Style by selecting the Rhythm, Bass, Accompaniment 1, Accompaniment 2, and Accompaniment 3 parts from different styles. This function is called the "Style Composer."

* You can only combine the KR-377's built-in styles.

1. Press the [Menu] button.

The Composer Menu screen appears.

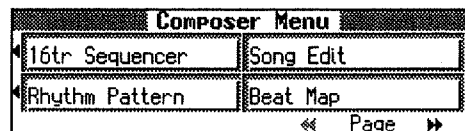

If <Create Style> doesn't appear on screen, press Page < << > >> > at the bottom of the display to switch screens.

2. Select <Create Style>.

A screen like the one shown below appears.

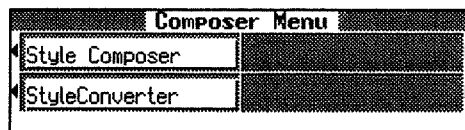

3. Select <Style Composer>.

* If a User Style has already been recorded, a message like the one shown below appears.

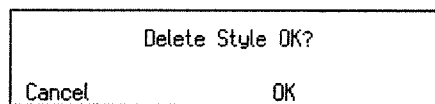

- Press <Cancel> to return to the Composer Menu screen. Please save the User Style on a floppy disk (p. 132) or in the internal memory (p. 131).
- Press <OK> to erase the previous User Style.

A Style Composer Screen like the one shown below appears.

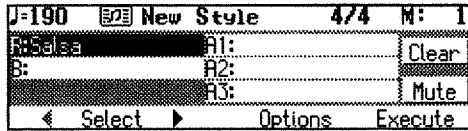

Display	Part
R	Rhythm
B	Bass
A1	Accompaniment 1
A2	Accompaniment 2
A3	Accompaniment 3

4. Press Select <◀> and <▶> at the left bottom of the display to choose the Part whose style you want to change.
5. Use the Style buttons to choose the Style.
6. When you select the Style, press the [Exit] button. You are returned to the Style Composer screen. If you press <Clear> at the right of the display, the changes of the Style will be canceled.
7. Repeat steps 4, 5, and 6 to determine the style for each Part.
8. When you have finished setting the Styles for all Parts, press <Execute>. You create a new Style. The new User Style is stored to the [Disk/User] button with the name of "New Style." Try playing with the created Style to play.

* If you turn off the power or record a new User Style, any User Style you've previously created is lost. If you don't want to delete the Style, store the Style to the [Disk/User] button or save it on a floppy disk. For details, refer to "Storing User Styles to the Button" (p. 131) or "Saving User Style Or User Program on Floppy Disk" (p. 132).

Muting Parts for a Particular Division

You can mute the sound of particular Parts in specific Divisions.

For instance, you can sound all parts when in Variation (the Variation accompaniment pattern), or mute out Accompaniment 2 and Accompaniment 3 when in Original (the Original accompaniment pattern).

This has the effect of making the accompaniment more lively when you change the accompaniment pattern from Original to Variation.

→ For more about Division, see "The Makeup of a Style" (p. 128).

1. From the Style Composer screen, choose the Part you want to mute out.
2. Press the button to switch to the Division that you want to silence. For example, to mute the Variation accompaniment pattern, press the Fill In [To Variation] button.
3. Press <Mute> at the right of the display.

The Part you chose is muted out in just the Division you selected.

If you want to hear the muted-out Part, press <Mute> again.

To mute out a Division that changes after a few seconds (intro, ending, or fill-in), press <Mute> immediately after switching to the Division.

Chapter 7 Using Other Functions

Changing the Style Setting for Individual Parts

1. From the Style Composer screen, press <Options> at the bottom of the display.

A screen like the one shown below appears.

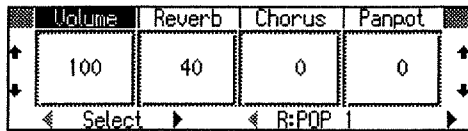

2. Press <◀><▶> at the right bottom of the display to choose the Part that contains the settings you want to change.

3. Use Select <◀> and <▶> at the bottom of the screen to choose the item you wish to set.

Indication	Description
Volume	Adjusts the volume level.
Reverb	Adjusts the depth of the reverb effect.
Chorus	Adjusts the amount of chorus.
Panpot	Shifts the direction the sound is heard from to the left or right. When you press <▲>, the sound will move toward the right. When you press <▼>, the sound will move toward the left.

4. Use <▲><▼> at the left of the display to change the setting for each item.

You can change the Tone for the selected Part by pressing the [Tone] button to change the Tone.

5. When you're done making all the settings, press the [Exit] button.

You are returned to the Style Composer screen.

Creating a Style from a Song You Recorded Yourself (Style Converter)

You can take a song you've composed yourself and extract the portions you need to create your own original Style.

Note that when you're composing a song, there's no need to specify all the chords. You can specify just some of the chords, and working on that, the KR-377 automatically extrapolates the other chords, and arranges the style.

The Style Converter has an "Auto Mode" for creating Music Styles simply from a song with a single chord, and a "Manual Mode" for creating a Style from a song of three chords (major, minor, and diminished seventh).

When you're creating a User Style, think about the structure of the style.

The Makeup of a Style

A Music Style is made up of five performance parts:

"Rhythm," "Bass," "Accompaniment 1," "Accompaniment 2," and "Accompaniment 3."

Also, a song progresses in a sequence, such as intro, melody A, melody B, bridge, and ending.

With the KR-377, such changes in songs are allocated to the following six performance states. The six performance states are called "Divisions" for Style.

Division	Performance division
Intro	The intro is played at the start of a song.
Ending	This is played at the end of a song.
Original	This is a basic accompaniment pattern.
Variation	This is a developmental accompaniment pattern. It is a variation on an Original.
Fill In To Variation	This is a one-measure phrase inserted at a juncture where the mood changes. Use this when you wish to create more energy (shift to a variation) within the song.
Fill In To Original	This is a one-measure phrase inserted at a juncture where the mood changes. Use this when you wish to create more sedate (shift to a original) within the song.

You can make a song more lively or more restrained by increasing or reducing played parts by Divisions. You can also modify a song by changing the played parts by Divisions.

Creating a Style in Auto Mode

Tips on creating a song

- Use one of the major, minor, or diminished seventh chords to create the song. We recommend using diminished seventh chords to compose the song.
- It can be convenient to record the sounds shown below for the Parts of the 16-track sequencer.

Rhythm	Bass	Accomp 1	Accomp 2	Accomp 3
D (10)	2	7	8	9

→ If you want to extract the performance of a part other than Part 2, 7, 8, 9, or D, check out "Changing an Extracted Part" (p. 130).

- 1. Use the 16-track sequencer to record the song.**
Refer to "Multitrack Recording with 16 Parts (16-Track Sequencer)" (p. 113) and the like and record the song.
- 2. Press the [Menu] button.**
The Composer Menu screen appears.
If <Create Style> doesn't appear on screen, press Page <◀▶> at the bottom of the display to switch screens.
- 3. Press <Create Style>.**
- 4. Select <Style Converter>.**

* If a User Style has already been recorded, a message like the one shown below appears.

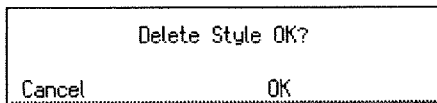

- Press <Cancel> to return to the Composer Menu screen. Please save the User Style on a floppy disk (p. 132) or in the internal memory (p. 131).
- Press <OK> to erase the previous User Style.

A Style Converter screen like the one shown below appears.

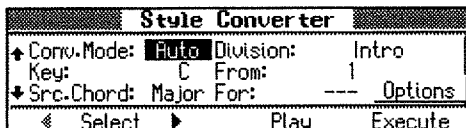

Display	Description
Conv. Mode	Changes the Style Converter Mode (Auto/Manual)
Key	The basic key of the recorded performance

Src. Chord	The chord of the recorded performance (Major/minor/7th)
Division	Division
From	The first measure in the passage you want to extract
For	The number of measures to extract

- 5. Use Select <◀> and <▶> at the bottom of the display to choose <Conv.Mode>, then use <▲> <▼> at the left of the display to choose "Auto."**
This makes the setting for the Auto mode.
- 6. Enter the basic key and chord for the recorded song to the items <Key> and <Src.Chord>.**
Use Select <◀> and <▶> at the bottom of the display to choose the item, then use <▲> <▼> at the left of the display to choose the value.
- 7. Make the settings for the value of <Division>.**

Display	Performance division
Intro	Intro
Original	Original accompaniment pattern
Fill To Var	Fill-in to Variation
Variation	Variation accompaniment pattern
Fill To Org	Fill-in to Original
Ending	Ending

* If you select "Fill to Var" (Fill-in to Variation) or "Fill to Org" (Fill-in to Original) as the Division, you can only extract one measure. The number of measures may be limited for other Divisions as well.

- 8. With the items <From> and <For>, choose the measures you want to extract.**
Pressing <Play> at the bottom of the screen, you can listen to performance of the portion which you chose.
- 9. Repeat steps 6, 7 and 8 to make the settings for all Divisions.**
* If no setting is made for a Division, it uses a simple drum pattern.

10. When you're done making all the Division settings, press <Execute>.

The new User Style is stored to the [Disk/User] button with the name of "New Style."

* If you turn off the power or record a new User Style, any User Style you've previously created is lost. If you don't want to delete the Style, store the Style to the [Disk/User] button or save it on a floppy disk. For details, "Storing User Styles to the Button" (p. 131) or "Saving User Style Or User Program on Floppy Disk" (p. 132).

Chapter 7 Using Other Functions

* The data described below is saved in a Style. If a song includes data other than this, the results you get might not be what was intended.

- Keyboard performance information
- Depth of Reverb
- Amount of Chorus

Creating a Style in Manual Mode

When you create a User Style in the Manual mode, you can clearly point up the differences in accompaniment for each individual chord.

Tips on creating a song

- Record your performance with the three chord types of diminished seventh, major, and minor.
- It can be convenient to record the sounds shown below for the Parts of the 16-track sequencer.

Chords	Rhythm	Bass	Accomp 1	Accomp 2	Accomp 3
Major	D (10)	3	4	5	6
Seventh	-	2	7	8	9
Minor	-	12	13	14	15

→ The chords all share the same Rhythm Part.

→ If you want to use the performance of other part, check out "Specifying an Extracted Part."

1. Use the 16-track sequencer to record the song.

Refer to "Multitrack Recording with 16 Parts (16-Track Sequencer)" (p. 113) and the like and record the song.

2. Press the [Menu] button to choose <Create Style>.

3. Select <Style Converter>.

A Style Converter screen appears.

4. Use Select <◀> and <▶> at the bottom of the display to choose <Conv.Mode>, then use <↑> <↓> at the left of the display to choose "Manual."

This makes the setting for the Manual mode.

→ You can listen to a performance of the part selected with <Options> by pressing <Play> at the bottom of the screen.

Changing an Extracted Part

You can specify which part of the song created with 16-track sequencer to extract the performance from.

1. At the Style Converter screen, press <Options> at the right of the display.

A screen like the one shown below appears.

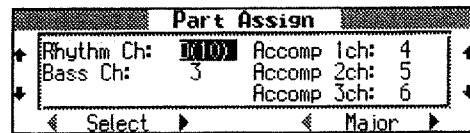

Display	Performance part
Rhythm Ch	Rhythm
Bass Ch	Bass
Accomp 1ch	Accompaniment 1
Accomp 2ch	Accompaniment 2
Accomp 3ch	Accompaniment 3

→ If you create a Style in Manual mode, use <◀> <▶> at the right bottom of this screen to choose the chord type. Make the Part settings for each chord.

2. Use Select <◀> and <▶> at the left bottom of the display to choose the performance Part whose settings you want to change.

3. Use <↑> <↓> next to the display to specify which 16-track Sequencer part has the performance you want to extract.

4. Press the [Exit] button to return to the Style Converter screen.

Storing User Styles to the Button

You can store User Styles you've created at the [Disk/User] button.

The Styles stored at the [Disk/User] button will not be lost even if the power is turned off. You can choose the stored User Style by pressing the [Disk/User] button. You can store up to three User Styles at the [Disk/User] button.

The process of storing data to the [Disk/User] button is called "memorizing."

1. Press the [Disk/User] button.

A screen like the one shown below appears.

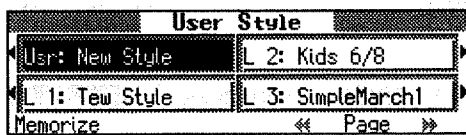

2. Press <Memorize> button at the bottom of the display.

The screen changes as shown below.

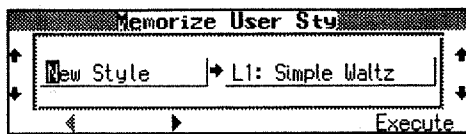

3. Use <◀><▶> to scroll the cursor sideways, and enter the name of the song by using <↑><↓> at the left of the display to choose the letters.

4. After you've entered the name of the Style, press <↑><↓> to choose the save destination.

If you press the [Exit] button, the User Style will be not saved, and you are returned to the previous screen.

5. Press <Execute> at the bottom of the display.

The saving process starts.

- * If you select a location where a User Style has already been saved, the previously saved User Style is erased and the new one is saved.
- * Attempting to save a User Style containing a lot of performance data to the [Disk/User] button may cause another User Style to be erased.
- * Never try to switch off the power while this operation is in progress. Doing so may damage the internal memory, making it impossible to use this instrument.
- * You can restore the settings stored at the [Disk/User] button to their original factory-default values. To learn how, see "Restoring the Factory Settings (Factory Reset)" (p. 149).

Storing the Panel Settings (User Program)

You can store the presently selected buttons, feature settings, and the like to the [User Program] button (internal memory). You can then call up the stored settings by pressing the [User Program] button. This is handy for storing often-used combinations of styles, tone, and other settings. Such a set of stored settings is called a "User Program."

You can save up to 32 User Programs on the [User Program] button.

1. Press the [User Program] button.

A screen like the one shown below appears.

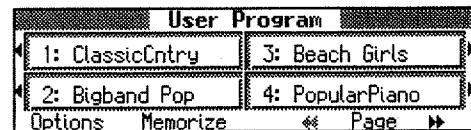

2. Press <Memorize> button at the bottom of the display.

The screen changes as shown below.

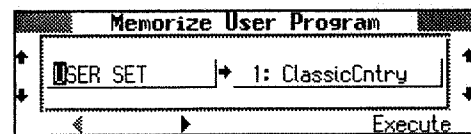

3. Use <◀><▶> to scroll the cursor, and enter the name of the song by using <↑><↓> at the left of the display to choose the letters.

4. After you've entered the name, press <↑><↓> to choose the save destination.

If you press the [Exit] button, the User Program will be not saved, and you are returned to the previous screen.

5. Press <Execute> at the bottom of the display.

The present panel settings (User Program) are stored on the KR-377's [User Program] button.

- * Never try to switch off the power while this operation is in progress. Doing so may damage the internal memory, making it impossible to use this instrument.
- You can return the settings stored on the [User Program] button to the product's factory defaults. Check out "Restoring the Factory Settings (Factory Reset)" (p. 149).

Calling Up User Program

1. Press the [User Program] button.
2. Use Page <◀▶> <▶▶> at the bottom of the display to switch screens, then choose the User Program name you wish to call up.
Choosing the User Program name changes the panel settings to the stored values.

Changing How Button Settings Are Called Up

If you wish, for times when you call up a User Program, you can set it so settings related to Automatic Accompaniment aren't changed unless you continue pressing the button for a certain period of time.

1. Press the [User Program] button.
2. Press <Options> at the bottom of the display.
A screen like the one shown below appears.

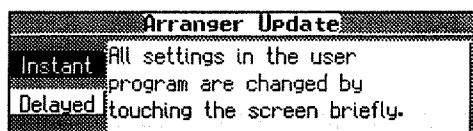

Indication	Description
Instant	The settings related to Automatic Accompaniment are also switched right away when you press the button.
Delayed	To change the settings related to Automatic Accompaniment, continue pressing the button for a short while.

3. Use the button at the left of the display to choose <Instant> or <Delayed>.
Press the [Exit] button to go back to the previous screen.

Saving User Style Or User Program on Floppy Disk

Storing a User Style

You can save a User Style you've created yourself on a floppy disk.

When using the User Style saved on the floppy disk, refer to "Choosing a Music Style from Data Disk" (p. 64).

Saving a User Program

You can save all User Programs now stored on the [User Program] button (internal memory) on floppy disk as a single set.

When using the User Program set saved on the floppy disk, refer to "Calling Up User Program" (p. 132).

Saving User Style Or User Program on Floppy Disk

1. Insert the floppy disk into the disk drive.
Refer to "Inserting and Ejecting a Floppy Disk" (p. 38).
2. Press the [Disk] button.
The Disk Menu screen appears.

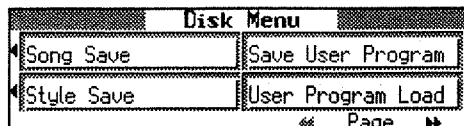

3. Choose <Style Save> or <User Program Save>.
A screen like the one shown below appears.

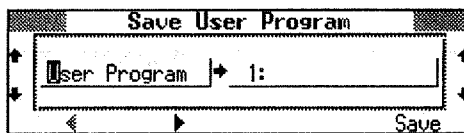
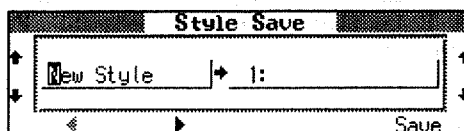

4. Use <◀▶> <▶▶> to move the cursor, and enter the name of the song by using <↑> <↓> at the left of the display to choose the letters.
5. After you've entered the name, press <↑> <↓> to choose the save destination.
Pressing the [Exit] button returns you to the previous screen, without saving executed.
6. Press <Save> at the bottom of the display to start saving the song.

* If you select a location where data has already been saved, the previously saved User Style or User Program is erased and the new one is saved.

→ You can erase the Style or User Program saved on a floppy disk. Take a look at "Erasing User Style Or User Program Saved on Floppy Disk" (p. 133).

Erasing User Style Or User Program Saved on Floppy Disk

You can erase User Style or User Program set saved on the floppy disk.

1. Insert the floppy disk into the disk drive.
Refer to "Inserting and Ejecting a Floppy Disk" (p. 38)

2. Press the [Disk] button.
The Disk Menu screen appears.

3. Select <Disk File Del.>.
A screen like the one shown below appears.

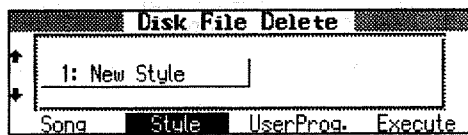

4. Use the button at the bottom of the display to choose <Style> or <UserProg.>.
5. Use <↑> <↓> at the left of the display to choose the file to be deleted.
6. Press <Execute> at the bottom of the display.
The confirmation screen appears.

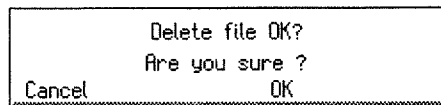

Press the [Exit] button to go back to the previous screen.

7. Press <OK> at the bottom of the display.
The selected file is erased.
Choose <Cancel> to return to the previous screen, without erasing the file.

Calling Up Saved User Programs from Floppy Disk

You can call up an entire set of User Programs saved on floppy disk to the [User Program] button.

* Please note that calling up User Programs from floppy disk erases all User Programs stored at the [User Program] button.

1. Insert the floppy disk into the disk drive.
Refer to "Inserting and Ejecting a Floppy Disk" (p. 38).
2. Press the [Disk] button.
The Disk Menu screen appears.

3. Select <User Program Load>.
A screen like the one shown below appears.

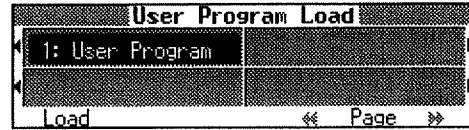

Press the [Exit] button to go back to the previous screen.

4. Use Page <←> <→> at the bottom of the display to switch screens, then choose the User Program set you wish to call up.
5. Press <Load> at the bottom of the display.
The User Program saved on a floppy disk will be loaded to the [User Program] button.

Disabling Everything Except Piano Play (Panel Lock)

Making the setting for the panel lock enables a state where only piano play is possible, and all buttons are disabled. Even if the buttons are pressed mistakenly, such as might be the case with children, no unwanted settings or changes will result.

* When the panel is locked, only Grand Piano sounds are played.

1. Turn down the volume all the way.
2. Press the [Power] switch to turn off the power.
3. While holding down the [Function] button, press the [Power] switch to turn the power on.
Then, continue to hold down these two buttons for a few seconds.
4. Adjust the volume.
All buttons except for piano play are disabled. When you play the keyboard, "Grand Piano" tone is played.
By turning the power off and then on once again, the keyboard returns to its normal status with Panel Lock cancelled.

Chapter 8 Changing Various Settings

Changing the Settings for One-touch Piano

You can make a variety of settings related to the piano-play settings made when you press the One Touch Program [Piano] button.

These settings remains in effect until you turn off the power. From the Piano screen (p. 42), press <Customize> to display the screen shown below.

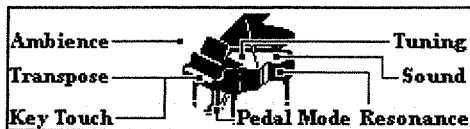

This is called the Piano Customize screen.

You can make the settings for an item by choosing the corresponding item.

Press the [Exit] button to return to the Piano Customize screen.

Indication	Description
Ambience	This lets you enjoy the atmosphere of performance in a wide variety of different locations.
Transpose	Changes the pitch of the keyboard (p. 89).
Key Touch	Changes the touch of the keyboard.
Pedal Mode	Adjusts the sensitivity of the pedals.
Resonance	Adjusts the sympathetic resonance.
Tuning	Changes the tuning of the piano.
Sound	This lets you make more detailed adjustments to the piano's tone.

What's Sympathetic Resonance?

On acoustic pianos, when the damper pedal is depressed, additional strings are released to resonate with the sound of the keys that have been played, adding richness and breadth to the sound. This resonance is called "Sympathetic Resonance."

■ Adding Ambience from Different Venues to Songs (Ambience)

You can savor the same atmosphere as experienced when performing in a concert hall, studio and other venues.

1. From the Piano Customize screen, choose <Ambience>.

A screen like the one shown below appears.



2. Use Type <◀> and <▶> at the bottom of the screen to choose the performance space.

Indication	Description
Ground	On a large open ground
Room	In a small room
Lounge	A large room
Studio	A recording studio
Gymnasium	In a gymnasium
Hall	Concert hall
Dome	A domed ballpark
Cave	In a cavern

3. Use <Std> or <Wide> at the right of the display to select the size of the performance space.

Indication	Description
Std	This is the normal condition.
Wide	Provides an effect simulating the sound as it would be perceived in a larger, wider space.

Press the [Exit] button to return to the Piano Customize screen.

■ Changing the Key Touch (Key Touch)

The setting below allows you to adjust the response you get from the keyboard when you finger the keys.

1. From the Piano Customize screen, choose <Key Touch>.

A screen like the one shown below appears.



2. Make the desired selection at the bottom of the display to set the key touch.

Indication	Description
Fixed	Notes are sounded at an unchanging volume level, regardless of how lightly or forcefully you finger the keyboard.
Light	This sets the keyboard to a light touch. You can achieve fortissimo (ff) play with a less forceful touch than usual, so the keyboard feels lighter. This setting makes it easy to play, even for children.
Medium	This sets the keyboard to the standard touch. You can play with the most natural touch. This is the closest to the touch of an acoustic piano.
Heavy	This sets the keyboard to a heavy touch. You have to finger the keyboard more forcefully than usual in order to play fortissimo (ff), so the keyboard touch feels heavier. Dynamic fingering adds even more feeling to what you play.

3. To make fine adjustments, use <◀> and <▶> at the upper left and upper right of the screen to adjust the on-screen slider.

The on-screen slider shows the keyboard touch. Move the slider toward the right to make the touch heavier, or toward the left to make it lighter. Press the [Exit] button to return to the Piano Customize screen.

■ Adjusting the Sensitivity of the Pedals (Pedal Mode)

This adjusts the sensitivity of the damper pedal and the soft pedal (p. 14).

Using fewer stages can reduce the amount of data, which is effective at times such as when you record a lengthy song.

1. From the Piano Customize screen, choose <Pedal Mode>.

A screen like the one shown below appears.

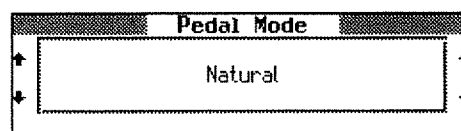

2. Press <↑> <↓> next to the display to make the setting.

Indication	Description
Natural	The KR-377 recognizes subtle changes in the amount of pedal depression.
8 Steps	The KR-377 recognizes eight stages of pedal depression.
Switch	The KR-377 recognizes two stages of pedal depression (on and off).

Press the [Exit] button to return to the Piano Customize screen.

■ Adjusting Resonance

You can adjust this resonance (Sympathetic Resonance) when the damper pedal is depressed.

On acoustic pianos, when the damper pedal is depressed, additional strings are released to resonate with the sound of the keys that have been played, adding richness and breadth to the sound. This resonance is called "Sympathetic Resonance."

1. From the Piano Customize screen, choose <Resonance>.

A screen like the one shown below appears.

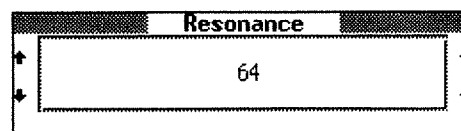

2. Use <↑> <↓> next to the display to adjust the amount of Resonance applied.

As the value increases, the effect becomes deeper. Press the [Exit] button to return to the Piano Customize screen.

Chapter 8 Changing Various Settings

■ Changing the Tuning

Choosing the Tuning

You can play classical music such as baroque pieces using their original tuning.

Most modern songs are composed and played with the assumption that equal temperament (the most common tuning in use today) will be used, but when classical music was composed, there were a wide variety of other tuning systems in existence. Playing a composition with its original tuning lets you enjoy the sonorities of the chords that the composer originally intended.

1. From the Piano Customize screen, choose

<Tuning>.

A screen like the one shown below appears.

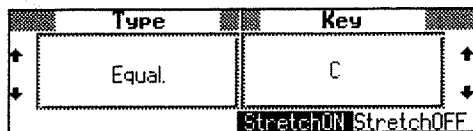

2. Use <↑> <↓> at the left of the display to choose "Type" (the type of tuning).

You can choose from among the eight tunings described below.

Tuning system	Characteristics
Equal	This tuning divides the octave equally into 12 intervals. Every interval produces about the same amount of slight dissonance. This setting is in effect when you turn on the power.
Just Major	This scale eliminates dissonance in fifths and thirds. It is unsuited to playing melodies and cannot be transposed, but produces beautiful chords.
Just Minor	The scales of the major and minor just intonations are different. You can get the same effect with the minor scale as with the major scale.
Arabic	Arabic scale
Kirnberger	This scale is a modification of the meantone and just intonations that permits greater freedom in transposition to other keys. Performances are possible in all keys (III).
Mean Tone	This scale makes some compromises in just intonation, enabling transposition to other keys.

Pythagorean This scale devised by the philosopher Pythagoras eliminates dissonance in fourths and fifths. Dissonance is produced by third-interval chords, but melodies are euphonious.

Werckmeister This is a combination of the mean tone and Pythagorean scales. Performances are possible in all keys (first technique, III).

3. Press <↑> <↓> at the right of the display to choose the keynote (Key).

When playing with tuning other than equal temperament, you need to specify the keynote for tuning the song to be performed (that is, the note that corresponds to C for a major key or to A for a minor key).

If you choose an equal temperament, there's no need to select a keynote.

Changing the Tuning Curve

A piano is generally tuned to a pitch with a lower bass range and a higher treble range than equal temperament. This special tuning method for pianos is called "Stretch Tuning." A graph that shows the changes in pitch of actual tuning compared with the changes in equal temperament pitch is called a tuning curve. Changing the tuning curve produces subtle variations in the reverberations of the chords you play.

1. Press either <Stretch ON> or <Stretch OFF> to choose the tuning curve.

Display	Characteristics
Stretch ON	This tuning curve expands the bass and treble ends somewhat (Stretch Tuning). It is suitable for performances such as piano solos. This setting is in effect when you turn on the power.
Stretch OFF	This is the standard tuning curve. It is suitable when playing layered tones, or for playing in ensemble with other instruments.

Press the [Exit] button to return to the Piano Customize screen.

■ Fine Adjustment of the Piano Sound (Sound)

You can make more precise adjustments of the piano's tone.

1. From the Piano Customize screen, choose <Sound>.

A screen like the one shown below appears.



2. Use Select <◀> and <▶> at the bottom of the screen to choose the item you wish to set.

Indication	Description
Dynamic range	Adjusts the extent of tonal change in response to your playing strength. If you select " Wide ," the maximum tonal change will occur. If you select " Narrow ," less tonal change will occur.
Brightness	Adjusts the brightness of the piano sound. If you select " Bright " the sound will be brighter, and if you select " Dark " the sound will be more muted.
Release	Adjusts the length of the decay that occurs after you release your fingers from the keys. Select " Long " for a longer decay, or " Short " for a shorter decay.

3. Use <↑> <↓> next to the display to choose the setting.
Press the [Exit] button to return to the Piano Customize screen.

Changing the Settings for Automatic Accompaniment

You can change a variety of settings for Automatic Accompaniment.

Pressing <Options> at the bottom of the Basic screen (p. 16) displays the menu screen for the setting item.

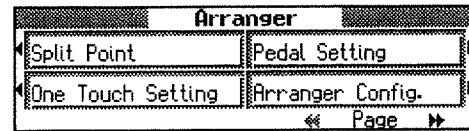

This is called the "Arranger Option" screen.

■ Changing the Keyboard's Split Point

You can change the location where the keyboard is divided (the split point).

The setting is at "F#3" when the piano is powered up.

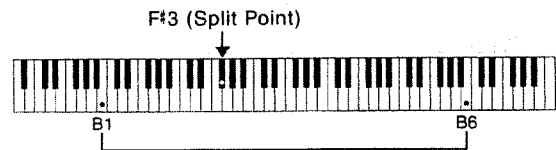

1. Press the One Touch Program [Arranger] button to display the basic screen.
2. Press <Options> at the bottom of the display.
3. The Arranger Option screen appears.
If <Split Point> doesn't appear on screen, press Page <◀> <▶> at the bottom of the display to switch screens.
4. Press <Split Point> next to the display.



5. Choose <C3>, <F#3>, <C4>, or <F#4>.
The key you chose becomes the split point.
The key you chose for the split point belongs to the left-hand section of the keyboard.
6. To make another key the split point, use <◀> and <▶> to select the key on screen.
You can set the split point within a range of B1 to B6.
Press the [Exit] button to return to the Arranger Option screen.

→ See "Playing Different Tones with the Left and Right Hands (Split Play)" (p. 49).

Chapter 8 Changing Various Settings

■ Changing How the Automatic Accompaniment Plays

You can set it the setting so that instead of sounding all the parts of a Music Style, only the Music Style's rhythm part, chord tone, and bass tone are played.

► For more on chord tones and bass tones, see "What Are the Chord Tone and Bass Tone."

1. Press the One Touch Program [Arranger] button to display the basic screen.
2. Press <Options> at the bottom of the display.
The Arranger Option screen appears.
If <Arranger Config.> doesn't appear on screen, press Page <◀▶> <▶▶> at the bottom of the display to switch screens.
3. Press <Arranger Config.> next to the display.

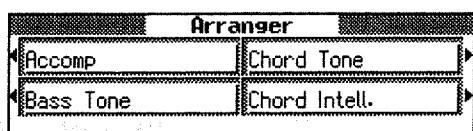

4. Choose <Accomp>.

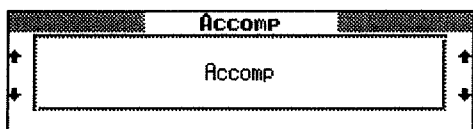

Indication	Description
Accomp	Sounds all Parts of the Music Style. This is the usual setting.
Chord+Bs	The Music Style's rhythm part, chord tone, and bass tone are sounded.

Press the [Exit] button twice to return to the Arranger Option screen.

■ Changing the Sound for Chord Tone and Bass Tone

You can change the sound of the chord tone and bass tone.

What Are the Chord Tone and Bass Tone?

When Automatic Accompaniment is stopped and the [Sync/Reset] button's indicator is dark, fingering the left-hand section of the keyboard causes a chord to be sounded. This is called the "Chord Tone," and the root of the chord that is played at the same time is called the "Bass Tone."

1. Press the One Touch Program [Arranger] button to display the basic screen.
2. Press <Options> at the bottom of the display.
The Arranger Option screen appears.
If <Arranger Config.> doesn't appear on screen, press Page <◀▶> <▶▶> at the bottom of the display to switch screens.
3. Press <Arranger Config.> next to the display.

4. To change the Bass Tone, choose <Bass Tone>. To change the Chord Tone, choose <Chord Tone>.

A screen like the one shown below appears.

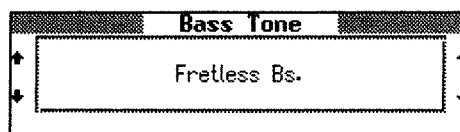

When "OFF" is selected, the bass tone or chord tone sound is muted.

Tone	Available tones
Bass Tone	OFF, Acoustic Bs., A.Bass + Cymbal, Fingered Bs., Picked Bs., Fretless Bs., Slap Bass, Organ Bass, SynthBass101, Thum Voice
Code Tone	OFF, E.Piano 1, E.Piano 2, Soft E.Piano, Hard E.Piano, Slow Strings, Strings, Choir, Doos Voice

Press the [Exit] button twice to return to the Arranger Option screen.

■ Canceling the Chord Intelligence Function

The “Chord Intelligence function” (p. 61) is the function in Automatic Accompaniment that instantly recognizes the accompaniment chord that is to be played, merely when you press some keys specifying the chord. Although the Chord Intelligence function is normally turned on when you press the One Touch Program [Arranger] button and have Automatic Accompaniment play, you can turn off the Chord Intelligence function.

1. Press the One Touch Program [Arranger] button to display the basic screen.
2. Press <Options> at the bottom of the display. The Arranger Option screen appears. If <Arranger Config.> doesn't appear on screen, press Page <◀▶> <▶▶> at the bottom of the display to switch screens.
3. Press <Arranger Config.> next to the display.
4. Select <Chord Intell.>.

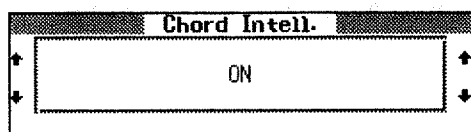

5. Use <↑> <↓> next to the display to select “ON” or “OFF.”

Indication	Description
ON	The Chord Intelligence function can be used.
OFF	The Chord Intelligence function cannot be used. You have to finger all the keys to specify the chord.

Press the [Exit] button twice to return to the Arranger Option screen.

■ Assigning a Function to Pad Buttons or Pedals

You can assign a variety of different functions to the soft pedal and the sostenuto pedal or the Pad Buttons. You can then call up the assigned feature simply by pressing the corresponding pedal.

* When you press the One Touch Program [Piano] button, the functioning of the pedals returns the pedals to their usual functions (p. 14).

Assigning a Function to a Pad Button

1. Press the [Style Orchestrator/User] button, extinguishing the button's indicator.

A screen like the one shown below appears.

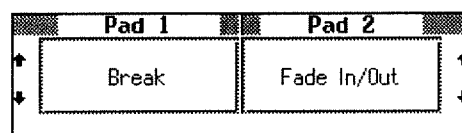

2. Use <↑> <↓> next to the display to choose the function assigned to the pad.

The buttons at the left of the display will change the function of Pad [1]. The buttons at the right of the display will change the function of Pad [2].

For details on the functions that can be assigned, refer to “Functions that can be assigned,” below.

3. Press the [Exit] button.

You are returned to the previous screen. Now, you can press the Pad [1] or [2] button to use the assigned function.

* When the [Style Orchestrator/User] button's indicator is lit, the Pad buttons are used to make changes for the style orchestrator (p. 71).

To use the assigned functions, get the indicator for the [Style Orchestrator/User] button to light.

* Any function assignments that you've made for the Pad buttons will be discarded as soon as you switch off the power.

Assigning Functions to Pedals

1. Press the One Touch Program [Arranger] button to display the basic screen.

2. Press <Options> at the bottom of the display.

The Arranger Option screen appears.

If <Pedal Setting> doesn't appear on screen, press Page <◀▶> <▶▶> at the bottom of the display to switch screens.

3. Press <Pedal Setting> to display a screen like the one shown below.

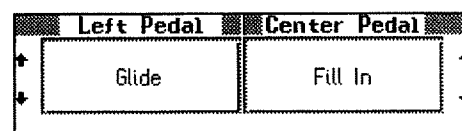

4. Press <↑> <↓> next to the display to assign the function to each pedal.

Press the [Exit] button to return to the Arranger Option screen.

Chapter 8 Changing Various Settings

○ The Functions You Can Assign to the Pad Buttons

Indication	Description
Leading Bass	Toggles the Leading Bass function on or off.
Break	During a performance with Automatic Accompaniment, you can stop the accompaniment for exactly one measure.
Fill In to Variation	This does the same thing as the [To Variation] button (p. 70).
Fill In to Original	This does the same thing as the [To Original] button (p. 70).
Fill In	A fill-in is inserted, but the accompaniment pattern after that doesn't change.
Half Fill In Variation	This play a fill-in half a measure long, then switches to the Variation accompaniment pattern.
Half Fill In Original	This plays a fill-in half a measure long, then switches to the Original accompaniment pattern.
Original/Variation	This changes the accompaniment pattern without inserting a fill-in.
Arranger Reset	Using this function while Automatic Accompaniment is in use returns the accompaniment to the start of the Division.
Intro/Ending	This does the same thing as the [Intro/Ending] button (p. 67).
Arranger Start/Stop	This does the same thing as the [Start/Stop] button (p. 67).
Orchestrator Up	This changes the Automatic Accompaniment to a more florid arrangement.
Orchestrator Down	This changes the Automatic Accompaniment to a simpler arrangement.
Melody Intelligence	This toggles the Melody Intelligence function on and off (p. 61).
Fade In/Out	This starts Automatic Accompaniment with a fade-in (where the volume gets progressively louder), ends it with a fade-out (where the volume gets progressively softer), then stops.
Rotary Slow/Fast	This switches the speed of the rotary effect (p. 43).

Glide	The sound's pitch is temporarily lowered while the Glide pedal is pressed; when the pedal is released, the pitch gradually returns to normal. This can be effective for simulating the performance of instruments like a Hawaiian guitar.
Composer Play/Stop	This does the same thing as the Play [▶] button and the Stop [■] button.
Punch In/Out	During Punch-in Recording, this starts and stops recording (p. 112).
Tap Tempo	This sets the tempo according to the timing with which you tap the button (p. 82).

What is the leading bass function?

The function that sounds the lowest note of a fingered chord as the bass tone is called "Leading Bass." When set to "ON," the bass tone changes when an inverted chord is used. Usually the tonic of the fingered chord is sounded as the bass tone.

→ If you've assigned "Leading Bass" to a pedal, the Leading Bass function is active while you depress the pedal.

○ Functions Assignable Only to Pedals

Indication	Description
Upper Soft	The pedal in the left functions the Soft pedal (p. 14).
Upper Sostenuto	The pedal in the middle functions the Sostenuto pedal (p. 14).
Lower Damper	This applies lingering reverberations to notes played with the left-hand section of the keyboard while the damper pedal is depressed.
Bend Up	This raises the pitch of notes you play on the keyboard.
Bend Down	This lowers the pitch of notes you play on the keyboard.

→ When the "Bend Up" or "Bend Down" function is used with Split (p. 49) selected, the pitch of the sounds played in the right hand are then altered. Additionally, the maximum degree of change in the pitch when the Bender effect is used is called the "bend range." Take a look at "Changing the Bend Range" (p. 147).

What's the Bend Range?

The effect of smoothly raising or lowering the pitch of a played note is known as the "Bender Effect," and the pitch's range of change is called the "Bend Range." With the KR-377, you can apply the bender effect by depressing and releasing a pedal.

* Pressing the One Touch Program [Piano] button returns the pedals to their original functions (p. 14).

■ Keeping the Same Tone and Tempo When the Music Style Changes

Normally, when you select a music Style, the default setting has the tone in the right hand and the tempo selected automatically. This setting prevents the tempo and tone from changing, even when the music Style is changed. All items are set to ON when you turn on the power.

1. Press the One Touch Program [Arranger] button to display the basic screen.
2. From the basic screen, press <Options> at the bottom right of the screen.
The Arranger Option screen appears.
If <One Touch Setting> doesn't appear on screen, press Page <◀▶> at the bottom of the display to switch screens.
3. Choose <One Touch Setting> next to the display.
A screen like the one shown below appears.

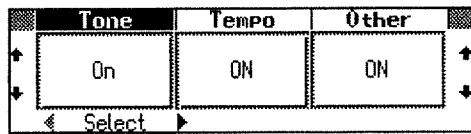

4. Press Select <◀▶> and <▶▶> at the bottom of the display to choose the item you wish to set.
5. Use <▲> <▼> next to the display to select On or Off.

Indication	Description
Tone	The suitable tone for a Music Style will be selected automatically.
Tempo	The suitable tempo for a Music Style will be selected automatically.
Other	Other settings (Style Orchestrator settings, etc.) are changed automatically.

The parameters that are turned Off do not change, even when the Music Style is changed.

Changing the Settings for One-touch Organ

You can change a variety of settings for organ performance. Pressing <Options> at the bottom of the Organ screen (p. 43) displays the menu screen for the setting item.

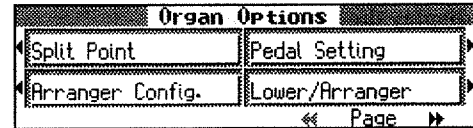

This is called the Organ Option screen.

Indication	Description
Split Point	When you've selected Jazz Organ, the right- and left-hand sections of the keyboard play different Tones. You can change the location where the keyboard is divided (the split point). Please refer to p. 49.
Arranger Config.	You can modify the settings of the arranger (p. 138–p. 139).
Pedal Setting	You can change the function assigned to the pedal (p. 139).
Lower/Arranger	You can change the ways in which the automatic accompaniment and the left-hand section of the keyboard sounds. See "Changing How the Automatic Accompaniment Plays While Playing the Organ" and "Changing How the Left-hand Keyboard Section Plays" on the next page.
Transpose	You can transpose the keyboard or the song that you play back (p. 89–p. 90).

Chapter 8 Changing Various Settings

■ Changing How the Automatic Accompaniment Plays While Playing the Organ

You can play only the Rhythm Pattern of the Automatic Accompaniment.

1. Press the One Touch Program [Arranger] button to display the Organ screen.

2. From the Organ screen, press <Options> at the bottom of the display.

The Organ Option screen appears.

If <Lower/Arranger> doesn't appear on screen, press Page <◀▶> <▶▶> at the bottom of the display to switch screens.

3. Press <Lower/Arranger> to display the following screen.

A screen like the one shown below appears.

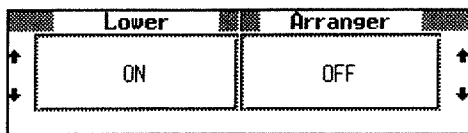

4. Use <Arranger> ↑ ↓ at the right of the display to select "ON" or "OFF."

Indication	Description
ON	All Automatic Accompaniment in the Music Style is used.
OFF	Only the Rhythm Patterns are selected.

Press the [Exit] button twice to return to the Organ screen.

■ Changing How the Left-hand Keyboard Section Plays

You can change how the left-hand section of the keyboard sounds when you've used the Automatic Accompaniment.

1. From the Organ screen, press <Options> at the bottom of the display.

The Organ Option screen appears.

If <Lower/Arranger> doesn't appear on screen, press Page <◀▶> <▶▶> at the bottom of the display to switch screens.

2. Press <Lower/Arranger> to display the following screen.

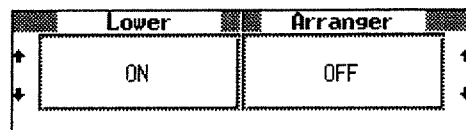

3. Use <Lower> ↑ ↓ at the right of the display to select "ON" or "OFF."

Indication	Description
ON	Accompaniment and all sounds played in the Lower section of the keyboard are sounded.
OFF	Accompaniment sounds. The notes played in the Lower section of the keyboard are not sounded.

Press the [Exit] button twice to return to the Organ screen.

→ For more on chord tones and bass tones, see "What Are the Chord Tone and Bass Tone?" (p. 138).

■ Adjusting the Footage

If you have selected “Jazz Organ,” you can adjust the “footage” to create different timbres by combining various elements of sound.

What’s Footage?

A device for combining different frequencies to create the sound you want is called “Footage.” The numbers that are displayed originally referred to the lengths of the pipes on a pipe organ. Reducing the pipe length by half produces a note an octave higher, and doubling the length produces a sound an octave lower. This means that with <8> as the base value, <16> produces a note one octave lower, and <2> produces a note two octaves higher.

1. Press the One Touch Program [Arranger] button to display the Organ screen.
2. Choose “Jazz Organ” as the organ type.
3. From the Organ screen, press <Footage> at the right of the screen.

A screen like the one shown below appears.

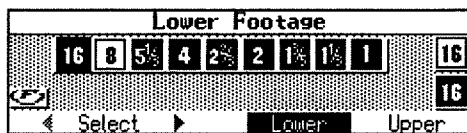

In this screen, you can change the Tone of the left-hand section of the keyboard.

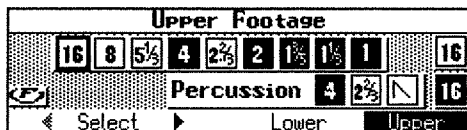



In this screen, you can change the Tone of the right-hand section of the keyboard.

You can use <Upper> and <Lower> at the bottom of the display to switch between these two screens.



4. Use Select < ◀ > and < ▶ > at the bottom of the display to select the icon to be switched on/off. Larger numbers indicate lower-frequency portions; smaller numbers indicate higher-frequency portions.

5. Use the buttons at the right of the display to switch the selected icon on/off.



An icon with a white background, such as  is sounded; an icon with a black background, such as  is not sounded.

* If all icons are off (black background), there will be no sound when you play the keyboard.

6. You can also use the icons in the “Percussion” column to add accents to the onset of the note.

You can use Perc.  or  to change the Tone at the time of its onset. You can’t set both to “On” at the same time.

Switching  on makes the accent time shorter. Press the [Exit] button to go back to the Organ screen.

→ For more about  (or ), take a look at “Changing the Rotary Effect” (p. 43).

Changing the Settings for Score Screen

You can set which parts are displayed, and how the scores are to be displayed.

1. Press the [Score] button.
A Score screen appears.
2. Press <Options> at the right of the display.
The following screens appears.
This screen consists of two pages. Use Page <◀▶> and <⏪⏩> to change pages.

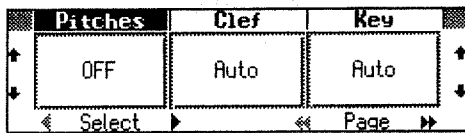

Display	Value	Description
Pitches	Off	No pitches displayed
	C,D,E	Letter names (fixed do) are displayed in the detailed score.
	Do,Re,Mi	Solmization syllables (movable do) are displayed in the detailed score.
Clef	Auto	Changes the clef automatically
	G Clef	Display the G-clef staff
	F Clef	Display the F-clef staff
Key	Auto	Display automatically
	b x 5-0-# x 6	Display the score in the selected key



Display	Value	Description
Left Hand	1-16	Select the part to be displayed as the left-hand part. The power-up default is "3."
Right Hand	1-16	Select the part to be displayed as the right-hand part. The power-up default is "4."
User	1-16	Select the part used for recording your performance. The power-up default is "1."

3. Press Select <◀> and <▶> at the bottom of the display to choose an item.
4. Use <⬆> and <⬇> next to the display to choose the setting.
→ Refer to "Displaying the Score" (p. 79).

Changing the Tone Set To Be Used for Playback

With the normal setting, the tones that are compatible with other GS instruments will normally be used to play back song data. By changing this setting, you can have the song be played back using specific tones, for certain portions of the data.

1. Press the [Menu] button.
The Composer Menu screen appears.
2. Press <Play Mode> next to the display.
If <Play Mode> doesn't appear on screen, press Page <◀▶> at the bottom of the display to switch screens.
A screen like the one shown below appears.

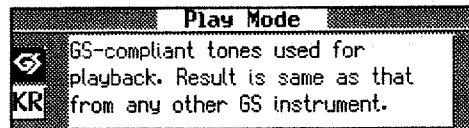

3. Press the button at the left of the display to select the setting.

Icon	Description
GS	Playback uses GS-compatible tones. Result is same as that from any other GS instrument.
KR	Playback will use KR tones for some tones. This will make the performance more expressive. However when the data is played back on non-KR models, the nuances of the performance may be different.

Press the [Exit] button to return to the Composer Menu screen.

Changing the Settings for the Marker and the Count Sound

1. Press the [Marker/Count In] button.
The Marker screen appears.
2. Press <Options> at the bottom of the display.
A Marker Option screen like the one shown below appears.
The Marker Option screen is made up of two pages.

Count In Settings

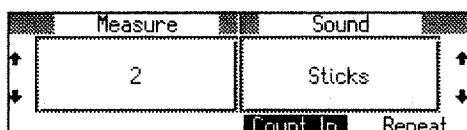

Repeat/Marker Settings

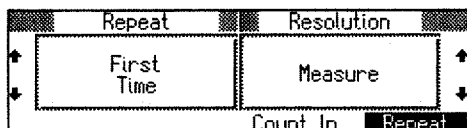

Changing the Number of Measures Counted and the Count Sound

When you've made the setting for sounding an audible count (p. 84), you can change the number of measures that are counted, as well as the type of counting sound.

1. Display the Marker Option screen.
2. Press <CountIn> at the bottom of the display.
3. Use <↑> <↓> at the left of the display to choose the number of measures to count.

Indication	Description
1	The one-bar count will sound.
2	The two-bar count will sound.

4. Use <↑> <↓> at the right of the display to choose the count sound.

Indication	Description
Sticks	Sound of tapping with a stick
Click	A bell and a clicking sound
Electronic	Electronic sound
Voice(JP)	A voice counting "1, 2" in Japanese
Voice(ENG)	A voice counting "1, 2" in English
Wood Block	Wood Block
Triangle/Castanet	Triangle and castanet sound

Handclap	Clapping
Animal	Animal Voice

Press the [Exit] button to go back to the Marker screen.

- Take a look at "Counting Down Before a Performance Starts" (p. 84).

Playing the Count Sound at Each Repetition

You can choose whether the count is sounded at every repetition when you repeat playback of a song or a particular passage.

1. Display the Marker Option screen.
2. Press <Repeat> at the bottom of the display.
3. Use <↑> <↓> at the left of the display to select the way to be played.

Indication	Description
First Times	The count is sounded only before the first playback.
Every Times	The count is sounded each time the song is played.

Press the [Exit] button to go back to the Marker screen.

- Take a look at "Counting Down Before a Performance Starts" (p. 84).

Placing a Marker in the Middle of a Measure

A marker is normally placed at the start of the selected measure, but you can also set it so a marker is placed at a position partway through a measure.

1. Display the Marker Option screen.
2. Press <Repeat> at the bottom of the display.
3. Press <↑> <↓> at the right of the display to choose the Marker setting.

Display	Description
Measure	This lets you place a marker at the beginning of the measure.
Beat	This lets you place a marker at the beginning of the beat.

Press the [Exit] button to go back to the Marker screen.

- When "Beat" is selected for this setting, place the markers while the song is played back. For information about placing markers, take a look at "Setting Markers in the Song/Erasing Markers" (p. 86).

Adjusting the Standard Pitch (Master Tuning)

The standard pitch generally refers to the pitch of the note that's played when you finger the middle A key. For a cleaner ensemble sound while performing with one or more other instruments, ensure that each instrument's basic pitch is in tune with that of the other instruments. This tuning of all the instruments to a standard pitch is called "master tuning."

1. Press the [Function] button, getting its indicator to light.

The Function Menu screen appears.

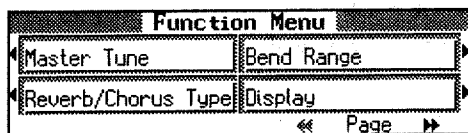

If <Master Tune> doesn't appear on screen, press Page <◀▶> at the bottom of the display to switch screens.

2. Press <Master Tune> next to the display.

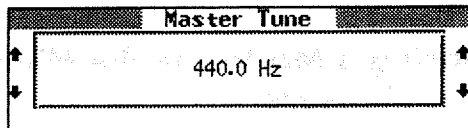

3. Use <↑> <↓> next to the display to choose the standard pitch.

The standard pitch can be set to any value from 415.3–466.2 Hz.

The setting is at "440.0 Hz" when the piano is powered up.

Press the [Exit] button to go back to the Function screen.

Changing the Type of Reverb Effect

By changing the reverberations of the notes, you can enjoy the atmosphere of performance in a wide variety of different locations.

1. Press the [Function] button, getting the indicator to light.

The Function Menu screen appears.

If <Reverb/Chorus Type> doesn't appear on screen, press Page <◀▶> at the bottom of the display to switch screens.

2. Press <Reverb/Chorus Type> next to the display.

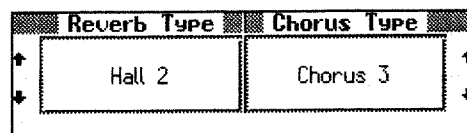

3. Use <↑> and <↓> at the left of the display to change the Reverb effect type.

Display	Description
Room 1	Simulates the reverb of a conference room
Room 2	Simulates the reverb of a performance lounge
Room 3	Simulates the reverb of a large, open room
Hall 1	Simulates the reverb of a large concert hall
Hall 2	Simulates the reverb of a small concert hall
Plate	Applies a bright, metallic reverb
Delay	Repeats the sound many times, like an echo
Panning Delay	Makes the sound jump back and forth between the left and right speakers

Press the [Exit] button several times to go back to the previous screen.

* Changing the type of Reverb effect may also change the setting for "Adding Ambience from Different Venues to Songs (Ambience)" (p. 134).

→ Check out "Adding Reverberation to Sounds (The Reverb Effect)" (p. 52).

Changing the Type of Chorus Effect

* When the chorus effect is applied (p. 55, p. 176), you can change the chorus effect type.

1. Press the [Function] button, getting its indicator to light.

The Function Menu screen appears.

If <Reverb/Chorus Type> doesn't appear on screen, press Page <◀▶> <▶▶> at the bottom of the display to switch screens.

2. Press <Reverb/Chorus Type> next to the display.

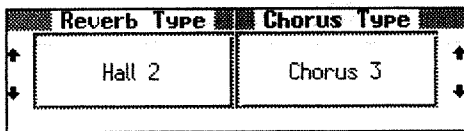

3. Use <↑> and <↓> at the right of the display to change the Chorus effect type.

Display	Description
Chorus 1	Applies a light chorus effect with slow undulations
Chorus 2	Applies a light chorus effect with quick undulations
Chorus 3	Applies a deep chorus effect with slow undulations
Chorus 4	Applies a deep chorus effect with quick undulations
Feedback	A soft sound with a flanger effect
Flanger	An effect that sounds like a jet plane's ascent/descent
Short Delay	A short echo effect
Short Delay (FeedBack)	A short echo with many repetitions

Press the [Exit] button several times to go back to the previous screen.

Changing the Bend Range

The effect of smoothly raising or lowering the pitch of a played note is called the "Bender Effect."

With the KR-377, you can assign the bender function to a pedal, then apply the bender effect by depressing and releasing the pedal (p. 139).

You can also make a setting that determines how much the pitch of the note changes when you apply the bender. The maximum range of change in pitch is called the "bend range."

1. Press the [Function] button, getting its indicator to light.

The Function Menu screen appears.

If <Bend Range> doesn't appear on screen, press Page <◀▶> <▶▶> at the bottom of the display to switch screens.

2. Press <Bend Range> next to the display.

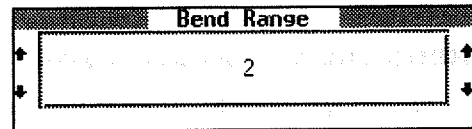

3. Use <↑> <↓> next to the display to choose the bend range.

You can set this to any value within a range of 1 to 12 (in half-tone steps, up to one octave).

Press the [Exit] button several times to go back to the previous screen.

→ Take a look at "Assigning a Function to Pad Buttons or Pedals" (p. 139).

Changing the Screen Settings

Some Karaoke Music Files contain lyrics data. You can hide the on-screen lyrics displayed by such Music Files. With the KR-377, you can also change the language and vary the contrast of the screen.

1. Press the [Function] button, getting its indicator to light.
The Function Menu screen appears.
If <Display> doesn't appear on screen, press Page <◀▶> at the bottom of the display to switch screens.
2. Press <Display> next to the display.



Press the [Exit] button several times to go back to the previous screen.

Hiding the On-screen Lyrics

1. Press Select <◀▶> and <▶> at the bottom of the display to choose "Lyric."
2. Use <▲> <▼> next to the display to choose the setting.

Indication	Description
ON	Lyrics are displayed (when performance data containing lyrics is played back).
OFF	Lyrics are not displayed.

Changing the Language

1. Press Select <◀▶> and <▶> at the bottom of the display to choose "Language."
2. Use <▲> <▼> next to the display to choose the language.

Indication: **English, Japanese, German, French, Spanish**

* German, Spanish, and French are displayed only when some functions are used. In other situations, English is used.

Adjusting the Contrast of the Screen

1. Press Select <◀▶> and <▶> at the bottom of the display to choose "Contrast."
2. Use <▲> <▼> next to the display to adjust the contrast of the screen.
You can adjust the contrast level along a ten-stage range. The higher the value set, the brighter it is displayed.

Displaying the Screen Message When the Power Is Turned On (Opening Message)

You can select the words and messages you want to have displayed on the KR-377's screen when the power is turned on.

1. Press the [Function] button, getting its indicator to light.
The Function Menu screen appears.
If <Opening Message> doesn't appear on screen, press Page <◀▶> <▶> at the bottom of the display to switch screens.
2. Press <Opening Message> next to the display.



3. Use <◀▶> and <▶> to move the cursor, and enter the name of the song by using <▲> <▼> to choose the letters.
Press <A-a-0-!> at the bottom of the display to change the type of script.
4. When you're done entering the text, press <Execute>.
Press the [Exit] button several times to go back to the previous screen.
→ Press <All Clear> at the bottom of the display to clear all of your message. Then pressing <Execute> will disappear your opening message.
* Never switch off the power while this operation is in progress! Doing so may damage the internal memory, making it impossible to use this instrument.

Maintaining Settings After the Power Is Turned Off (Memory Backup)

Ordinarily, when you turn off the power, settings return to their default values. However, some settings can be stored, so they won't be discarded when you turn off the power. This function is called "Memory Backup."

1. Press the [Function] button, getting the indicator to light.

The Function Menu screen appears.

If <Memory Backup> doesn't appear on screen, press Page <◀▶> and <▶▶> at the bottom of the display to switch screens.

2. Press <Memory Backup> next to the display.

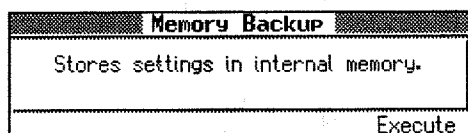

3. Press <Execute> at the bottom of the display.

The confirmation message appears on screen.

4. Press <OK> to store the settings in memory.

When the setting has been stored in memory, the Function Menu screen will reappear.

* *Never switch off the power while a Memory Backup operation is in progress. Doing so can damage the internal memory, making it impossible to use this instrument.*

Restoring the Factory Settings (Factory Reset)

You can restore the settings stored in memory with "Memory Backup" to these original factory-default values. This function is called "Factory Reset."

* *When you perform a Factory Preset, all settings that have been stored in memory up to then are erased and reset to their factory defaults.*

1. Press the [Function] button, getting its indicator to light.

The Function Menu screen appears.

If <Factory Reset> doesn't appear on screen, press Page <◀▶> and <▶▶> at the bottom of the display to switch screens.

2. Press <Factory Reset> next to the display.

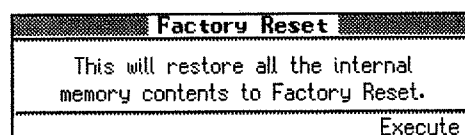

3. Press <Execute> at the bottom of the display.

The confirmation message appears on screen.

4. Press <OK> to restore the settings to their factory defaults.

When the setting is changed, the Function Menu screen returns.

Press <Cancel> to make the message disappear without changing the settings.

* *Never switch off the power while this operation is in progress! Doing so may damage the internal memory, making it impossible to use this instrument.*

Chapter 9 Connecting External Devices

By connecting the KR-377 to external devices such as audio equipment and MIDI instruments, you can enjoy in the following ways.

Connecting MIDI Devices (p. 151)

You can connect a MIDI sequencer and record performance data from the KR-377 or play performance data from the KR-377 on the sequencer. Also, when you connect a MIDI sound module, you can perform on the KR-377 and hear the sounds played through the MIDI sound module.

Connecting Audio Equipment (p. 154)

The KR-377 has high-quality built-in stereo speakers, but you can also hook up a stereo system, and enjoy performances that are even more impressive.

You can also connect it to a tape recorder or other recording equipment and record your performances.

Connecting a Computer (p. 156)

With the KR-377 connected to a computer, you can use sequencer software (such as Roland's Visual-MT or other software) to record and save KR-377 performances. Performances recorded to such software can also be played back on the KR-377. Furthermore, you can also enjoy the Minus One Play function to play along with commercially available music data in a variety of musical genres. With Roland's Visual-MT, you can also display a score of the recorded performance.

Names and Functions of Jacks and Connectors

The functions of the jacks on the rear panel and underside are described below.

Rear Panel

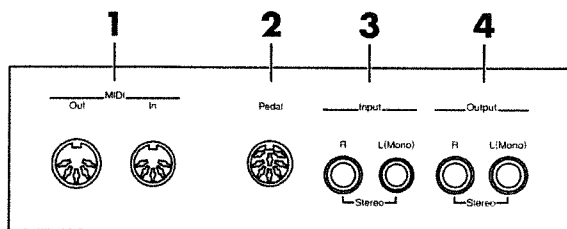

1 MIDI Out/In Connectors

You can connect external MIDI devices to the KR-377 and exchange performance data between them (p. 151).

* There's also a MIDI In connector on the bottom panel of the unit. You can't use both MIDI In connectors at the same time.

2 Pedal Jack

This is for connecting the separate stand pedal cord.

3 Input Jacks

Using this jack, you can connect other sound generating devices or audio equipment and play sounds from other devices through the KR-377's speaker (p. 154).

4 Output Jacks

Allow you to output the piano's sound to sound reinforcement equipment to obtain a more powerful sound. Additionally, by connecting the keyboard to a tape recorder, you can record your performances on cassette tapes (p. 154).

Underside

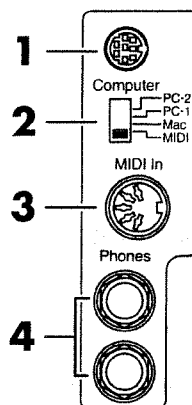

1 Computer Connector

You can connect a computer to the KR-377 and exchange performance data between the two (p. 156).

2 Computer Switch

Set this switch to Mac, PC-1, or PC-2 according to the type computer that's connected. Additionally, this switches between MIDI In connector and the Computer connector (p. 156).

* The MIDI Out/In connector and the computer connector cannot be used at the same time.

3 MIDI IN Connector

* There's also a MIDI In connector on the rear panel of the unit. You can't use both MIDI In connectors at the same time.

4 Phones Jacks

For more information about the Phones jack, please refer to "Connecting Headphones" (p. 15).

Connecting MIDI Devices

By connecting an external MIDI device and exchanging performance data, you can control the performances on one device from the other. For instance, you can output sound from the other instrument or switch Tones on the other instrument.

About MIDI

MIDI stands for Musical Instrument Digital Interface, an international standard which allows performance information to be communicated among electronic musical instruments and computers.

The KR-377 is equipped with MIDI connectors and a Computer connector to let it exchange performance data with external devices. These connectors can be used to connect the KR-377 to an external device for even greater versatility.

* A separate publication titled "MIDI Implementation" is also available. It provides complete details concerning the way MIDI has been implemented on this unit. If you should require this publication (such as when you intend to carry out byte-level programming), please contact the nearest Roland Service Center or authorized Roland distributor.

Connectors

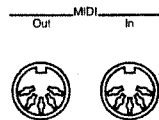

MIDI Out Connector

Connect this to the MIDI In connector on an external MIDI device using a MIDI cable (sold separately).

Performance data when you finger the keyboard or depress a pedal is sent from this connector to the external MIDI connector.

MIDI In Connector

Connect this to the MIDI Out connector on an external MIDI device using a MIDI cable (sold separately).

This receives MIDI messages that are sent from external MIDI devices. The KR-377 that receives MIDI messages can output sounds, exchange tones, and perform other operations.

* The KR-377 has two MIDI In Connectors on the rear and the bottom panels of the unit. You can't use both MIDI In Connectors at the same time.

Making the Connections

* To prevent malfunction and/or damage to speakers or other devices, always turn down the volume, and turn off the power on all devices before making any connections.

1. Turn the volume all the way down on the KR-377 and on the device you're about to connect.
2. Turn off the power to the KR-377 and other connected equipment.
3. Set the Computer switch at the bottom of the unit to "MIDI."
4. Use a MIDI cable (sold separately) to connect the MIDI connectors to each other. Please refer to the connection examples below.
5. Switch on the power to the KR-377 and the connected device.
6. Adjust the volume level on the KR-377 and the connected device.
7. You should also set the MIDI settings as needed. For details on the MIDI-related settings, refer to p. 152.

Connection examples:

Setup with a MIDI Sequencer

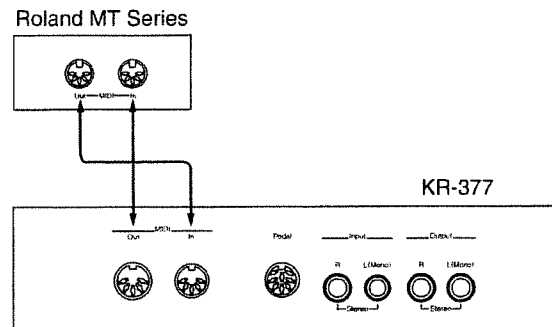

* When the KR-377 is connected to a MIDI sequencer, set it to Local OFF. Refer to "Disconnecting the Internal Sound Generator and Keyboard (Local Control)" (p. 153).

Connecting to a MIDI Sound Module

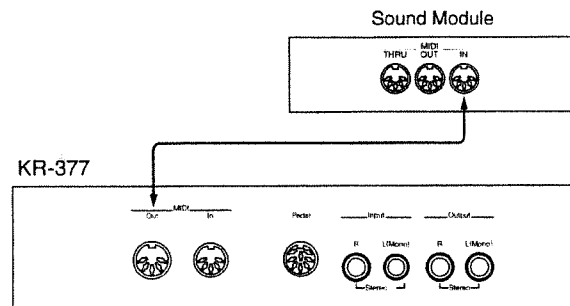

Playing in Ensemble with Other MIDI Instruments (MIDI Ensemble)

You can connect this instrument's MIDI connector to an electronic percussion instrument or other such outboard instrument, allowing you to play ensemble performances. You can easily make the MIDI settings for the MIDI instrument connected to the MIDI In connector. The sounds of the connected MIDI instrument are output from the KR-377's speaker.

1. Press the [Function] button.

The Function Menu screen appears.

If <MIDI Ensemble> doesn't appear on screen, press Page <◀◀> <▶▶> at the bottom of the display to switch screens.

2. Press <MIDI Ensemble> next to the display.

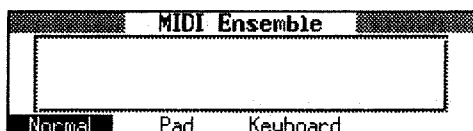

3. Use the button at the bottom of the display to choose <Normal> or <Keyboard>.

Indication	Description
Normal	This is the usual setting. When changing MIDI-related settings, see "MIDI Settings."
Pad	Choose this when a percussion pad (such as the Roland SPD-20 Total Percussion Pad) is connected to the MIDI In connector on the KR-377. You don't need to make any MIDI settings on the KR-377. Make the settings for the pad sounds or others on the pad. (For more information, refer to the pad's manual.)
Keyboard	Choose this when a keyboard (such as the Roland PC-180 or AX-1 MIDI Keyboard Controller) is connected to the MIDI In connector on the KR-377. You can choose the tones played with the connected keyboard on the KR-377.

4. If you selected <Keyboard> in step 3, use <↓> and <↑> next to the display to choose the Tone.

You can play the connected keyboard with the selected Tone.

Press the [Exit] button several times to go back to the previous screen.

MIDI Settings

With the KR-377, you can make MIDI settings like those described below.

<MIDI Settings>

Indication	Description
TX. Channel	Chooses the MIDI send channel. (p. 153)
Local Control	Switches Local Control on or off. (p. 153)
Composer Out	Determines whether a recorded performance is sent to the MIDI instrument. (p. 153)

<Program Change>

Indication	Description
Program Change	Sends Program Change messages (Program Numbers). (p. 153)
Bankselect MSB	Sends Bank Select MSB messages. (p. 153)
Bankselect LSB	Sends Bank Select LSB messages. (p. 153)

Making the Settings

1. Press the [Function] button.

The Function Menu screen appears.

2. Choose <MIDI Setting> or <Program Change>.

A screen like the one shown below appears.

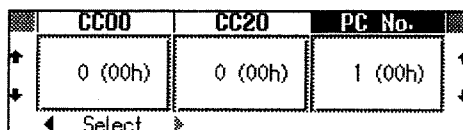
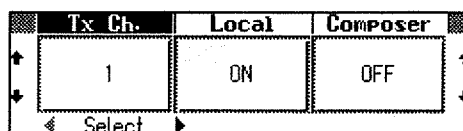

3. Use Select <◀> and <▶> at the bottom of the screen to choose the item you wish to set.

4. Use <↑> <↓> next to the display to make the setting.

Press the [Exit] button several times to go back to the previous screen.

Selecting the Transmit Channel (Tx. Channel)

MIDI features sixteen MIDI channels, numbered 1–16. Simply connecting a cable is not enough for communication to take place. The connected devices must be set to use the same MIDI channels. Otherwise, no sound will be produced, and no sounds can be selected.

Select the transmit channel (1–16) of the KR-377.

When the piano is turned on, Channel "1" is selected.

If the keyboard has been split into right-hand and left-hand sections, messages from the left-hand section are not sent.

The KR-377 receives messages on all channels from 1 through 16.

Disconnecting the Internal Sound Generator and Keyboard (Local Control)

When connecting a MIDI sequencer, set Local Control to "off."

The setting is at "Local Control ON" when the KR-377 is powered up.

As illustrated, information describing what has been played on the keyboard is passed to the sound module over two different routes, (1) and (2). As a result, you hear overlapping or intermittent sounds. To prevent this from happening, route (1) must be severed, by setting the unit to what is known as "Local Off."

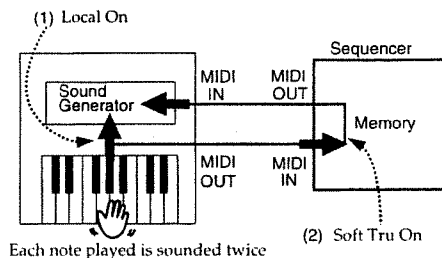

Local Control ON: The keyboard and the internal sound generator are in a linked state.

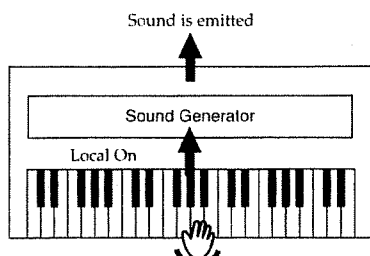

Local Control OFF: The keyboard and the internal sound generator are in an unlinked state. No sound will be produced by the keyboard when it is played.

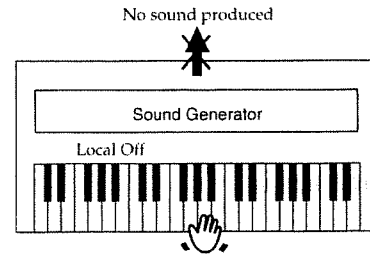

→ When connecting a unit in the Roland MT series, you don't need to switch off Local Control. The KR-377 transmit Local Off messages when their power is switched on. If you first switch on the KR-377, then the MT-series device, Local Control is automatically switched off on the KR-377.

Sending Recorded Performance Data to a MIDI Device (Composer Out)

When Composer Out is active, you can send performance data recorded with the KR-377 to a connected MIDI device or computer.

When you turn on the power, this is set to "OFF" (data is not sent).

Sending Tone Change Messages (Program Change/Bank Select MSB/Bank Select LSB)

A Program Change is a message that means "change to the tone of the specified number." The device that receives this changes to the tone of the corresponding number.

When you choose a Program Change message (Program Number), the Program Number will be transmitted to the MIDI device connected to the KR-377. The MIDI device that receives the Program Number changes the tone to the corresponding Program Number.

Normally, the Tone is selected from the 128 Tones available. Some MIDI devices, however, have more than 128 Tones. With such devices, the Tone is selected through a combination of Program Change messages and Bank Select messages. There are two parts of a Bank Select message: the MSB (Controller 0, with a value of 0–127) and the LSB (Controller 32, with a value of 0–127).

* Some MIDI instruments can't handle Bank Select messages. Also, there are some that do handle Bank Select messages, but don't recognize the LSB.

→ If you want to know more about how sounds are changed upon reception of Program Change messages, please see "MIDI Implementation" (sold separately). If you should require the "MIDI Implementation," please contact the nearest Roland Service Center or authorized Roland distributor.

Chapter 9 Connecting External Devices

Connecting to Audio Equipment

When you connect the KR-377 to audio equipment, you can play the sounds from the KR-377 through the speakers on the audio equipment or record your performances on a tape recorder or other recording device.

When connecting, please use an audio cable with a standard phone plug (sold separately).

Connectors

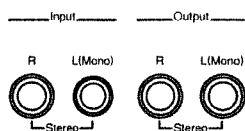

Output Jacks

You can connect audio equipment using audio cables (sold separately) and play the sounds from the KR-377 through the speakers on the connected equipment or record your performances on a tape recorder or other recording device. If the input of the connected device is monaural, you must use the L (Mono) jack.

Input Jacks

You can connect another sound source, such as audio equipment or an electronic instrument using audio cables (sold separately) and play the sounds from the connected device through the speakers on the KR-377.

If the output of the connected device is monaural, you must use the L (Mono) jack.

Making the Connections

* To prevent malfunction and/or damage to speakers or other devices, always turn down the volume, and turn off the power on all devices before making any connections.

Playing Sounds from the KR-377 Through the Speakers on Audio Equipment or Recording Your Performances on a Recording Device

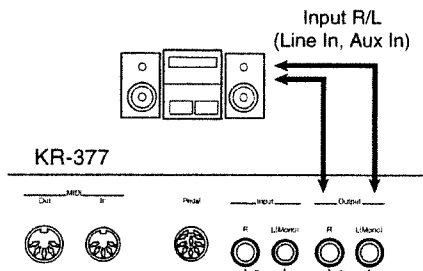

1. Turn the volume all the way down on the KR-377 and on the device you're about to connect.

2. Turn off the power to the KR-377 and other connected equipment.
3. Use audio cables (sold separately) to make the connection.
4. Turn on the power of the KR-377.
5. Switch on the connected device.
6. Adjust the volume level on the KR-377 and the connected device.

When Recording KR-377 Performances on a Recording Device

7. Start recording with the connected device.
8. Play the keyboard.
9. When the performance ends, stop recording on the connected equipment.

Playing Audio Equipment Sounds Through the Speakers on the KR-377

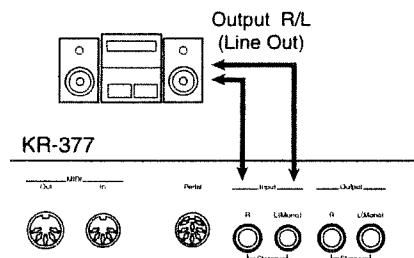

1. Turn the volume all the way down on the KR-377 and on the device you're about to connect.
2. Turn off the power to the KR-377 and other connected equipment.
3. Use audio cables (sold separately) to make the connection.
4. Turn on the connected equipment.
5. Turn on the KR-377.
6. Adjust the volume level on the KR-377 and the connected device.

After use, follow the steps below to switch off the power.

1. Turn the volume all the way down on the KR-377 and on the device you're about to connect.
2. Turn off the KR-377.
3. Turn off the connected equipment.

■ Optimizing the sound for connected external speakers (Sound Mode)

The sound of the KR-377 can be optimized for playback from a connected set of external speakers, although this function is normally set to "Internal."

1. Press the [Function] button, getting the indicator to light.

The Function Menu screen appears.

If <Sound Mode> doesn't appear on screen, press Page <◀▶> and <▶▶> at the bottom of the display to switch screens.

2. Press <Sound Mode> next to the display.

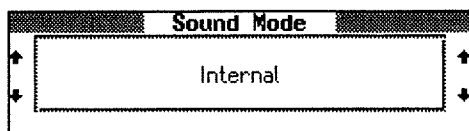

3. Use <↑> <↓> next to the display to choose <Output> or <Internal>.

Indication	Description
Internal	The sound will be optimized for playback from the built-in speakers of the KR-377.
Output	The sound will be optimized for playback from external speakers connected to the Output jacks.

Press the [Exit] button several times to go back to the previous screen.

Connecting to a Computer

You can connect a computer on which a sequencing program such as Roland Visual MT is installed and play sounds from the software sound generator through the KR-377's speakers or save songs recorded on the KR-377 on the computer.

■ Connectors

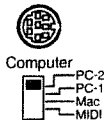

Computer Connector

You can connect a computer to this connector to exchange performance information.

Use a computer cable (sold separately) to make the connection.

The type of cable required will depend on your computer.

Computer Switch

The setting for this switch is made depending on the computer connected— Mac/PC-1/PC-2.

When this switch is set to MIDI, this connector cannot be used.

■ Making the Connections

* To prevent malfunction and/or damage to speakers or other devices, always turn down the volume, and turn off the power on all devices before making any connections.

1. Turn off the power to the KR-377 and the computer.
2. Using a compatible computer cable (sold separately), connect the Computer connector on the bottom of the piano with the computer's serial port.
3. Set the computer switch on the bottom of the keyboard to match the type of computer connected.

Please refer to the connection examples below.

4. Turn on the power to the computer.
5. Turn on the KR-377.

6. Set the computer's and software's baud rates to match each other. For more information on this procedure, please refer to the owner's manual for your computer.

7. You should also make the settings for the MIDI send channel (p. 153) and Local Control on or off (p. 153) as needed.

* Change the setting of the Computer switch only after the power to the unit is off.

Connection Examples:

- Connection with an Apple Macintosh computer

Use a computer cable (sold separately) to connect the Computer connector on the KR-377 to the modem port (or printer port) on the Apple Macintosh. Set the Computer switch to "Mac."

When using the Macintosh "Patch Bay" utility, specify 1 MHz as the Interface Type (MIDI Interface Clock).

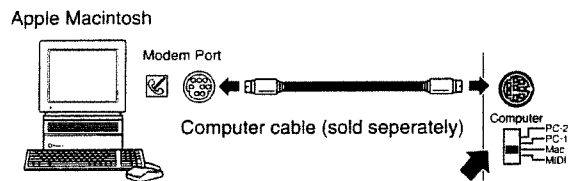

- Connection with an IBM PC

Use a computer cable (sold separately) to connect the Computer connector on the KR-377 to the COM1 or COM2 serial port on the IBM PC. Set the Computer switch to "PC-2."

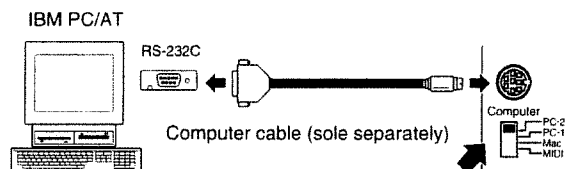

MEMO

Trouble Shooting

If you think there's a problem, read this first.

The power doesn't come on.

- Is the power cord connected and plugged in correctly? (p. 13)

The button doesn't work.

- Is the panel locked? (p. 133)
Turn the power off, then back on.

No sound is heard.

- Has the [Volume] knob been moved all the way to the left? (p. 13)
- Are headphones plugged in? (p. 15)
- Has the [Balance] knob been moved all the way to the right or left? (p. 75)
- Has the volume been set to "0" using the [Part Balance] buttons? (p. 75)
- Has the footage been adjusted so that all frequency components aren't sounded? (p. 143)

No sound is heard (when a MIDI instrument is connected).

- Have all devices been switched on? (p. 151)
- Is the Computer switch on the bottom of the KR-377 set to "MIDI"? (p. 151)

No sound is heard when the keyboard is played.

- Has Local Control been set to "off"? (p. 153).

Sounds are heard twice (doubled) when the keyboard is played.

- Has the Layer Play mode been enabled? (p. 47)
- When the KR-377 is connected to an external sequencer, set it to the Local OFF mode. Alternatively, the sequencer could be set so its Soft Thru feature is OFF (p. 153).

Not all played notes are sounded.

- The maximum number of notes that the KR-377 can play simultaneously is 64 (stereo). Frequent use of the damper pedal during automatic accompaniment or when playing along with a song on floppy disk may result in performance data with too many notes, causing some notes to drop out.

The tuning or pitch of the keyboard or song is off.

- Has the setting for transposition been made? (p. 89, 90)
- Are the settings for the Temperament and tuning curve correct? (p. 136)
- Is the setting for Master Tune correct? (p. 146)

Effects cannot be applied to Tones.

- It's not possible to apply more than one effect at the same time, so when a performance has been recorded on multiple tracks or when playing along with a song as it's played back, the desired effect may not be applied.

Automatic accompaniment is not heard.

- Has the [Balance] knob been moved all the way to the "Keyboard"? (p. 75)
- Have you pressed the One Touch Program [Arranger] button?
If the One Touch Program [Arranger] button has not been pressed, only the rhythm pattern is played (p. 66).
- Is the 16-track Sequencer screen displayed (p. 113)?

Certain instruments are not heard while playing a song.

- Have song settings been changed for each Part (p. 115)?
- Is the light for the Track button extinguished?
If the button light is out, the music on that track is not heard. Press the track button so the light is illuminated.

A Tone or Music Style cannot be selected.

- Press the [Exit] button several times to display the Basic screen (p. 16), then choose the Tone or Music Style.

There is a slight delay before playback of a song on floppy disk starts.

- There are two types of SMF Music Files: format 0 and format 1. If the song uses SMF format 1 data, there will be a slight delay until playback starts. Refer to the booklet that came with the Music Files you're using to determine the format type.

When song playback starts, the on-screen measure number reads "PU" (pickup).

- If the song starts in the middle of a measure, the display shows "PU" (pickup) at the beginning of the song. After that, the measure number is displayed.

The Fwd [▶▶] and Bwd [◀◀] buttons don't work.

- The fast-forward and reverse buttons are ignored while Music Files is being read in. Wait until processing finishes.

Pressing the Reset [◀] button doesn't return to the beginning of the song.

- Some Music Files may contain settings that stop play at a point partway through the song. When playing such songs, pressing the Reset [◀] button moves the song to the point that has been set. Press the button several times more to return to the beginning of the tune.

The Tone has changed.

- During automatic accompaniment, changing the Music Style automatically changes the Tones and tempo of the upper part of the keyboard to match the new Music Style. If you want to change only the Music Style without also altering the tempo and Tone, check out "Keeping the Same Tone and Tempo When the Music Style Changes" (p. 141).
- When a performance made along with a Music Files tune has been recorded, recording the performance to button [1] may make the Tones for buttons [3] and [4] change as well.

Chord Intelligence can't be used.

- Has Chord Intelligence been switched off? (p. 139)
- Is the setting for "Piano Style Arranger" active? (p. 74)

A note doesn't stop playing

- Have the Chord Tone and Bass Tone been changed (p. 138)?
Some Chord Tone and Bass Tone notes may be sounded continuously.

Recording is not possible.

- Has one of the track buttons for recording been selected (p. 96)?
- Has the setting for "Punch-in Recording" (p. 112) or "Tempo Recording" (p. 117) been made?
Select the "Replace Recording" (p. 110).

The recorded performance has disappeared.

- Any performance that has been recorded is deleted when the power to the KR-377 is turned off or a song is selected. A performance cannot be restored once it's been deleted, so be sure to save it on a floppy disk before you turn off the power (p. 104).

Nothing appears on screen.

- The KR-377 uses a liquid-crystal screen, so text may not be displayed when the ambient temperature is below freezing.

Lyrics are not indicated properly in the display.

- With some music files, the lyrics cannot be displayed correctly.
- Lyrics data can not be saved on a floppy disk.
- If you press a button while the lyrics are being shown in the display, the lyrics will disappear. To recall them, press the Play [▶] button.

Score is not indicated properly in the display.

- In the Score screen, some lyrics or notes could extend beyond the edges of the screen, and not be displayed.
- The score display feature is particularly unsuitable for the display of difficult, complex musical works that demand accurate notation.
Refer to "Some notes on a Score Screen" (p. 79).
- If you select a part that does not contain performance data, notes will not be displayed in the score.
Change the part that is displayed (p. 144).

Depressing a pedal has no effect, or the pedal effect doesn't stop.

- Is the pedal connected correctly?
Make sure the pedal cord extending from the stand is securely connected to the pedal jack on the rear of the unit (p. 150).
- Has a different function been assigned to the pedal? See "Assigning a Function to Pad Buttons or Pedals" (p. 139).

- Normal pedal operation is automatically enabled when the One Touch Program [Piano] button is pressed.

A High-pitched whine is produced

● When listening through headphones:

Some of the more flamboyant and effervescent piano tones feature an ample high-end component, which may make the sound appear to have metallic reverberation added. Since this reverberation becomes particularly audible when supplemented by heavy reverb, you may be able to diminish the problem by reducing the amount of reverb applied to the sound.

When listening through speakers:

Here, a different cause (such as resonance produced by the KR-377) would be suspect. Consult your Roland dealer or nearest Roland Service Center.

The bass range sounds odd, or there is a vibrating resonance

● When listening through speakers:

Playing at loud volumes may cause instruments near the KR-377 to resonate. Resonance can also occur with fluorescent light tubes, glass doors, and other objects. In particular, this problem occurs more easily when the bass component is increased, and when the sound is played at higher volumes. Use the following measures to suppress such resonance.

- Place speakers so they are 10–15 cm from walls and other surfaces.
- Reduce the volume.
- Move the speakers away from any resonating objects.

When listening through headphones:

Here, a different cause (such as resonance produced by the KR-377) would be suspect. Consult your Roland dealer or nearest Roland Service Center.

Reverberation still audible even with Reverb turned off

- Since the KR-377's piano sounds faithfully reproduce the sense of spaciousness and reverberation of an actual acoustic piano's sound, a certain amount of reverberation is still perceptible, even with the reverb effect deactivated.

The volume level of the instrument connected to KR-377 is too low.

- Could you be using a connection cable that contains a resistor?
Use a connection cable that does not contain a resistor.

If this Message Appears on Screen

Indication: PU

Meaning: When a song with a pickup (a song that does not start on the first beat) is played back, the measure numbers will be indicated in the display as PU, 1, 2, and so forth.

Indication:Error.00

Meaning: To protect the copyright, this music file cannot be saved as an SMF. Also, the music file can not be saved. If you want to save it, please save on the same floppy disk.

Indication:Error.01

Meaning: You can only read the music file or Music Style. It can not be saved on a floppy disk or internal memory.

Indication:Error.02

Meaning: The protect tab on the floppy disk is set to the Protect position. Change it to the Write position. Repeat the procedure.

Indication:Error.03

Meaning: This floppy disk cannot store the format or save any data. Insert a different disk and repeat the procedure.

Indication:Error.04

Meaning: The data cannot be saved onto this floppy disk because the format is different. Use the floppy disk in the same format.

Indication:Error.05

Meaning: A new song cannot be written on this song. Select a different song number or use a different floppy disk, and repeat the procedure.

Indication:Error.10

Meaning: No floppy disk is connected to the disk drive. Insert the disk correctly, and repeat the procedure.

Indication:Error.11

Meaning: There is not sufficient space left on the floppy disk for the data to be saved. Save the data onto a different floppy disk.

Indication:Error.12

Meaning: The floppy disk inserted into the disk drive can't be read. Be sure you're using Roland SMF Music Files or other music files compatible with Roland digital pianos (p. 178). Also, if you want to save your work on floppy disk, you need to format the floppy disk first (p. 104).

Indication:Error.13

Meaning: The floppy disk was removed from the disk drive while reading or writing was in progress. Insert the floppy disk and repeat the procedure.

Indication:Error.14

Meaning: This floppy disk is damaged and cannot be used. Insert a different disk and repeat the procedure.

Indication:Error.15

Meaning: This song or Music Style cannot be read. Also, you can only use User Programs that have been saved with the KR-377 (p. 132).

Indication:Error.16

Meaning: The KR-377 cannot read the floppy disk quickly enough. Press the Stop [■] button, then press the Reset [◀] button and Play [▶] button to play the song.

Indicated:Error.17

Meaning: The music files cannot be edited on the KR-377. Please use these music files only for playback.

Indication:Error.30

Meaning: The internal memory capacity of the KR-377 is full. Save the song or Music Style data on a floppy disk (p. 104) to delete the song data or the User style stored on the KR-377 memory.

Indication:Error.40

Meaning: The KR-377 cannot deal with the excessive MIDI data sent from the external MIDI device. Reduce the amount of MIDI data sent to the KR-377.

Indication:Error.41

Meaning: A MIDI cable or computer cable has been disconnected. Connect it properly and securely.

Indication:Error.42

Meaning: An excessive amount of performance data has been sent to KR-377 in one time and therefore could not be recorded. Change the tempo more slowly to record the performance again.

Indication: Error.43

Meaning: The Computer Switch is set to a wrong position or the computer is set wrongly. Switch off the KR-377 then set the Computer Switch to the correct position and set the computer correctly (p. 156). After that, switch on the KR-377 again.

Indication:Error.51

Meaning: There is something wrong with the system. Repeat the procedure from the beginning. If it is not solved after you have tried several times, contact the Roland service center.

Tone List

[Piano] Group

Grand Piano1
Ballad Piano
Bright Piano
Rock Piano
Piano Choir
PianoStrings
Harpsi.Singl
Harpsi.Doubl
Air Grand
Bell Piano
Harpsichord
Synth Harpsi
Honky-tonk
Honky-tonk 2
Harpsi.o
Coupled Hps.
Grand Piano2
Piano Oohs
MIDI Piano1
MIDI Piano2
UprightPiano
Piano 1
Piano 2
Piano 3

[E.Piano] Group

E.Piano 1
E.Piano 2
Dyno Rhodes
Stage Rhodes
Suitcase
Wurly
Vibraphone
Celesta
FM+SA EP
St.FM EP
Marimba
Soft Marimba
E.Piano 3
Hard FM EP
Glockenspiel
Xylophone
EG+Rhodes 1
EG+Rhodes 2
Vibra Bells
Music Box
Detuned EP 1
Detuned EP 2
Pop Vibe.
Pop Celesta
Hard Rhodes
Hard E.Piano
Clav.
Hard Clav.
Soft Clav.
Analog Clav.
SynRingClav.
Phase Clav.
Soft E.Piano
60's E.Piano
Balafon
Tubular-bell
Carillon
Santur
Steel Drums
Kalimba

[Organ] Group

Jazz Organ1
Full Organ 1
Nason flt 8'
Diapason 8'
Jazz Organ2
Full Organ 2
Lower Organ1
Lower Organ2
Rock Organ1
Rock Organ2
L-Organ
Pop Organ
Jazz Organ3
Jazz Organ4
Full Organ 3
Full Organ 4
Accordion
Hard Accord
Church Organ
Theater Org.
Organ Flute
Trem.Flute
Harmonica
Metalic Org.
Rotary Org.S
Rotary Org.F
CheeseOrgan
VS Organ
Organ 1
Organ 2
Pipe Org. Bs
Organ Bass
Digi Church

[Guitar/Bass] Group

Nylon Guitar
 Steel Guitar
 Jazz Guitar
 JC E.Guitar
 Nylon+Steel
 Nylon Gt.o
 Mandolin
 Gut Guitar
 Rock Rhythm
 Rock Rhythm2
 Power Guitar
 Power Gt.2
 DistortionGt
 Overdrive Gt
 Feedback Gt2
 Gt.Harmonics
 12str Guitar
 Steel Vox
 Acoustic Bs.
 A.Bass+Cymb1
 Muted Dis.Gt
 Muted Gt.
 Fingered Bs.
 Picked Bs.
 Mellow Gt.
 5th Dist.
 Fretless Bs.
 Slap Bass
 Mute PickBs.
 Mr.Smooth
 Jungle Bass
 Modular Bass
 WireStr Bass
 SynthBass101
 Synth Bass 1
 SH101 Bass
 ResoSH Bass
 Acid Guitar
 Dazed Guitar
 Hawaiian Gt.
 Ukulele
 Banjo
 Koto
 Shamisen

[Strings] Group

Strings
 Slow Strings
 Violin
 Harp
 Tremolo Str
 Suspense Str
 Velo Strings
 EX Orchestra
 SlowStrings2
 Legato Str
 PizzicatoStr
 Mellow Pizz.
 Oct Strings
 Choir Str
 Harp Strings
 Bell Strings
 Strings 2
 Warm Strings
 Cello
 Timpani
 Orchestra
 OrchestraHit
 Syn.Strings1
 Syn.Strings2
 Syn.Slow Str
 Warm JP Str
 Slow Violin
 Contrabass
 OB Strings
 Euro Hit
 6th Hit
 Bass Hit

[Sax] Group

Blow Sax
 AltoSax + Tp
 Flute
 Oboe
 Soprano Sax
 Grow Sax
 English Horn
 Bs Clarinet
 AltoSax Soft
 Tenor Sax f
 Pan Flute
 Piccolo
 Baritone Sax
 GS Bari Sax
 Clarinet
 GS Pan Flute
 Alto Sax
 Tenor Sax
 Bottle Blow
 Bassoon
 Recorder
 Blow Pipe
 Ocarina
 Shakuhachi

[Brass] Group

Power Brass
 Bright Brass
 Flugel Horn
 SuperF.Horns
 St. Brass ff
 Brass ff
 Trumpet
 Trombone
 BrassSection
 OrchestraBrs
 TromboneSoft
 Fr.Horn Solo
 Soft Brass
 DeepSynBrass
 Oct SynBrass
 Tuba
 Brass 1
 Brass 2
 Trombone 2
 MutedTrumpet
 Synth Brass1
 Synth Brass2
 French Horn

Tone List

[Voice/GS] Group

Jazz Scat	JP8 Sqr Pad	Rock Organ2	Pop Voice
Humming	Sweep Pad 2	Reed Organ	SynVox
Rich Choir	Converge	Accordion Fr	OrchestraHit
Dreamy Choir	Big Panner	Accordion It	GS Trumpet
Doos Voice	Ai-yai-a	GS Harmonica	GS Trombone
Doot Accent	Echo Pan 2	Bandoneon	Trombone 2
Holy Voices	Falling Down	GS Nylon Gt.	GS Tuba
HollowReleas	Poly King	Nylon Guitar	MutedTrumpet
Dat Accent	Octave Stack	Nylon Gt.o	French Horn
Bop Accent	Warm Pad	Ukulele	Fr.Horn 2
New Age Pad	Piano 1	Steel-str.Gt	Brass 1
Sugar Key	Piano 1w	12-str.Gt	Brass 2
Thum Voice	Piano 1d	GS Mandolin	Synth Brass1
Pop Voice	Piano 2	Jazz Guitar	Synth Brass2
Warm SquPad	Piano 2w	GS Hawaiian	Synth Brass3
Natural Lead	Piano 3	Clean Gt.	Synth Brass4
Choir Oohs	Piano 3w	Chorus Gt.	AnalogBrass1
Choir	GS Honkytonk	Muted Gt.	AnalogBrass2
LM Square	Honky-tonk 2	Funk Gt.	GS Sop.Sax
2600 SubOsc	GS E.Piano1	Funk Gt.2	Alto Sax
SynVox	GS E.Piano2	Overdrive Gt	Tenor Sax
SquareWave2	60's E.Piano	GS Dist.Gt	GS Bari Sax
Org Bells	E.Piano 1v	Feedback Gt.	GS Oboe
Fantasia	E.Piano 2v	Gt.Harmonics	GS Eng.Horn
Crystal	Detuned EP 1	Gt. Feedback	Bassoon
Harpvox	Detuned EP 2	GS Ac.Bass	Clarinet
Brightness	GS Harpsi.	GS Fing.Bass	Piccolo
Clear Bells	Coupled Hps.	GS Picked Bs	GS Flute
Soft Crystal	Harpsi.w	Fretless Bs.	Recorder
Digi Bells	Harpsi.o	Slap Bass	GS Pan Flute
Dual Sqr&Saw	Soft Clav.	Slap Bass 2	Bottle Blow
P5 Saw Lead	Celesta	SynthBass101	Shakuhachi
Rhythmic Saw	GS Glocken	Synth Bass 1	Whistle
Waspy Synth	GS Music Box	Synth Bass 2	Ocarina
Syn.Square	GS Vibe	Synth Bass 3	Square Wave
JP8 Square	Vibe.w	Synth Bass 4	Square
FM Lead 1	GS Marimba	Rubber Bass	Sine Wave
FM Lead 2	Marimba	GS Violin	Saw Wave
CC Solo	Xylophone	Slow Violin	Saw
Mg Lead	Tubular-bell	Viola	Doctor Solo
JP8 Pulse	Church Bell	GS Cello	Syn.Calliope
Cheese Saw	Carillon	Contrabass	Chiffer Lead
Nylon Harp	GS Santur	GS Trem.Str	Charang
Nylon+Rhodes	Organ 1	PizzicatoStr	Solo Vox
Fantasia 2	Organ 2	GS Harp	5th Saw Wave
Soft Pad	Pop Organ 1	Timpani	Bass & Lead
P5 Poly	Detuned Or.1	GS Strings	Fantasia
Reso Saw	Detuned Or.2	Orchestra	Warm Pad
RAVE Vox	Church Org.1	GS Sl.Str	Polysynth
Fat & Perky	Church Org.2	Syn.Strings1	Space Voice
Heaven II	Church Org.3	Syn.Strings2	Bowed Glass
	Full Organ 4	Syn.Strings3	Metal Pad
	Jazz Organ1	Choir Aahs	Halo Pad
		Choir	Sweep Pad

Ice Rain	Windchime	Gt.Harmo*	SynCalliope*
Soundtrack	Helicopter	Acoustic Bs*	ChifferLead*
Crystal	Car-Engine	Fingered Bs*	Charang*
Syn Mallet	Car-Stop	Picked Bs.*	Solo Vox*
Atmosphere	Car-Pass	Fretless Bs*	5th SawWave*
Brightness	Car-Crash	Slap Bass 1*	Bass & Lead*
Goblin	Siren	Slap Bass 2*	Fantasia*
Echo Drops	Train	Synth Bass1*	Warm Pad*
Echo Bell	Jetplane	Synth Bass2*	Polysynth*
Echo Pan	Starship	Rubber Bass*	Space Voice*
Star Theme	Burst Noise	Violin*	Bowed Glass*
Sitar	Applause	Viola*	Metal Pad*
Sitar 2	Laughing	Cello*	Halo Pad*
Banjo	Screaming	Contrabass*	Sweep Pad*
GS Shamisen	Punch	Tremolo Str*	Ice Rain*
Koto	Heart Beat	Pizzicato*	Soundtrack*
Taisho Koto	Footsteps	Harp*	Crystal*
Kalimba	Gun Shot	Timpani*	Syn Mallet*
Bagpipe	Machine Gun	Strings*	Atmosphere*
Fiddle	Lasergun	SlowStrings*	Brightness*
Shanai	Explosion	Syn.Str 1*	Goblin*
Tinkle Bell	Piano 1*	Syn.Str 2*	Echo Drops*
Agogo	Piano 2*	Choir Aahs*	Star Theme*
Steel Drums	Piano 3*	Pop Voice*	Sitar*
Woodblock	Honky-tonk*	SynVox*	Banjo*
Castanets	E.Piano 1*	Orche.Hit*	Shamisen*
Taiko	E.Piano 2*	Trumpet*	Koto*
Concert BD	Harpsichord*	Trombone*	Kalimba*
Melo. Tom 1	Clav.*	Tuba*	Bagpipe*
Melo. Tom 2	Celesta*	M.Trumpet*	Fiddle*
Synth Drum	Glocken*	FrenchHorns*	Shanai*
808 Tom	Music Box*	Brass 1*	Tinkle Bell*
Elec Perc.	Vibraphone*	SynthBrass1*	Agogo*
Reverse Cym.	Marimba*	SynthBrass2*	Steel Drums*
Gt.FretNoise	Xylophone*	A.Brass 1*	Woodblock*
Gt.Cut Noise	Tubularbell*	Soprano Sax*	Taiko*
String Slap	Santur*	Alto Sax*	Melo.Tom 1*
Breath Noise	Organ 1*	Tenor Sax*	Synth Drum*
Fl.Key Click	Organ 2*	BaritoneSax*	ReverseCym.*
Seashore	Pop Organ 1*	Oboe*	Fret Noise*
Rain	Rock Organ2*	EnglishHorn*	BreathNoise*
Thunder	ChurchOrg.1*	Bassoon*	Seashore*
Wind	Reed Organ*	Clarinet*	Bird*
Stream	AccordionFr*	Piccolo*	Telephone 1*
Bubble	Harmonica*	Flute*	Helicopter*
Bird	Bandoneon*	Recorder*	Applause*
Dog	Nylon-strGt*	Pan Flute*	Gun Shot*
Horse-Gallop	Steel-strGt*	Bottle Blow*	
Bird 2	Jazz Guitar*	Shakuhachi*	
Telephone 1	Clean Gt.*	Whistle*	
Telephone 2	Muted Gt.*	Ocarina*	
DoorCreaking	Funk Gt.*	Square Wave*	
Door	OverdriveGt*	Saw Wave*	
Scratch	Dist.Guitar*	Doctor Solo*	

* Tone with a "*" symbol appended to their name may not play back satisfactorily on other GS sound generating devices.

Drum/SFX Set List

	POP	ROCK	JAZZ BRUSH	VOX DRUM
21	R&B Snare	R&B Snare	R&B Snare	R&B Snare
22	Rock Snare	Pop Snare m	Pop Snare m	Rock Snare
23	Rock Snare	Pop Snare m	Pop Snare m	Rock Snare
24	Pop Snare m	Pop Snare m	Pop Snare m	Pop Snare m
25	Pop Snare Ghost	Pop Snare Ghost	Pop Snare Ghost	Pop Snare Ghost
26	Pop Snare m	Pop Snare m	Pop Snare m	Pop Snare m
27	Finger Snap	Finger Snap	Finger Snap	Finger Snap
28	707 Claps	707 Claps	707 Claps	707 Claps
29	Hand Clap [EXC7]	Hand Clap [EXC7]	Hand Clap [EXC7]	Hand Clap [EXC7]
30	Hand Clap2 [EXC7]	Hand Clap2 [EXC7]	Hand Clap2 [EXC7]	Hand Clap2 [EXC7]
31	Hand Clap	Hand Clap	Hand Clap	Hand Clap
32	Pop Pedal HH [EXC1]	Pop Pedal HH [EXC1]	Pop Pedal HH [EXC1]	Pop Pedal HH
33	Gospel Hand Clap	Gospel Hand Clap	Gospel Hand Clap	Gospel Hand Clap
34	Snare Roll	Snare Roll	Snare Roll	Vox Dut
35	Pop Kick	Rock Kick	Pop Kick	Vox Dom
C2 36	Pop Kick	Rock Kick	Pop Kick	Vox Tuush
37	Pop Side Stick	Rock Side Stick	Jazz Snare Swing	Vox Hehho
38	Pop Sanre s	Rock Sanre s	Jazz Sanre	Vox Doyear
39	Pop Snare Ghost	Rock Snare Ghost	Pop Snare Swing	Vox Thu!
40	Pop Snare s	Rock Snare s	Jazz Sanre	Vox That
41	Pop Low Tom f	Rock Low Tom f	Jazz Low Tom f	Vox Aahhh
42	Pop CHH 1 [EXC1]	Rock CHH 1 [EXC1]	Pop CHH 1 [EXC1]	Vox Tu
43	Pop Low Tom	Rock Low Tom	Jazz Low Tom	Vox Dooh
44	Pop CHH 2 [EXC1]	Rock CHH 2 [EXC1]	Pop CHH 2 [EXC1]	Vox Ptu
45	Pop Mid Tom f	Rock Mid Tom f	Pop Mid Tom f	Vox Down
46	Pop OHH [EXC1]	Rock OHH [EXC1]	Pop OHH [EXC1]	Vox Pa
47	Pop Mid Tom	Rock Mid Tom	Jazz Mid Tom	Vox Bom
C3 48	Pop High Tom f	Rock High Tom f	Jazz High Tom f	Vox Toear
49	Pop Crash Cymbal 1	Rock Crash Cymbal	Jazz Crash Cymbal 1	Vox Aahhu
50	Pop High Tom	Rock High Tom	Jazz High Tom	Vox Toya
51	Pop Ride Cymbal 1	Rock Ride Cymbal 1	Jazz Ride Cymbal 1	Vox Thu
52	Pop Chinees Cymbal	Pop Chinees Cymbal	Jazz Chinees Cymbal	Vox Cheey
53	Pop Ride Bell	Pop Ride Bell	Jazz Ride Cymbal 2	Vox Cymm
54	Tambourine 2	Tambourine 2	Tambourine 2	Vox Trub
55	Splash Cymbal	Splash Cymbal	Splash Cymbal	Vox Pruru
56	Cha Cha Cowbell	Cha Cha Cowbell	Cha Cha Cowbell	Vox Tut
57	Pop Crash Cymbal 2	Chinees Cymbal	Jazz Crash Cymbal 2	Vox Tyun
58	Vibra-slap 2	Vibra-slap 2	Vibra-slap 2	Vox Tdum
59	Pop Ride Cymbal 2	Pop Ride Cymbal 3	Pop Ride Cymbal 2	Vox Afahhhh
C4 60	High Bongo 2	High Bongo 2	High Bongo 2	High Bongo 2
61	Low Bongo 2	Low Bongo 2	Low Bongo 2	Low Bongo 2
62	Mute Conga	Mute Conga	Mute Conga	Mute Conga
63	High Conga 2	High Conga 2	High Conga 2	High Conga 2
64	Low Conga 2	Low Conga 2	Low Conga 2	Low Conga 2
65	High Timbale 2	High Timbale 2	High Timbale 2	High Timbale 2
66	Low Timbale 2	Low Timbale 2	Low Timbale 2	Low Timbale 2
67	High Agogo	High Agogo	High Agogo	High Agogo
68	Low Agogo	Low Agogo	Low Agogo	Low Agogo
69	Shaker 3	Shaker 3	Shaker 3	Shaker 3
70	Shaker 4	Shaker 4	Shaker 4	Shaker 4
71	Short Hi Whistle [EXC2]	Short Hi Whistle [EXC2]	Short Hi Whistle [EXC2]	Short Hi Whistle [EXC2]
C5 72	Long Low Whistle [EXC2]	Long Low Whistle [EXC2]	Long Low Whistle [EXC2]	Long Low Whistle [EXC2]
73	Short Guiro [EXC3]	Short Guiro [EXC3]	Short Guiro [EXC3]	Short Guiro [EXC3]
74	Long Guiro [EXC3]	Long Guiro [EXC3]	Long Guiro [EXC3]	Long Guiro [EXC3]
75	Claves	Claves	Claves	Claves
76	High Wood Block	High Wood Block	High Wood Block	High Wood Block
77	Low Wood Block	Low Wood Block	Low Wood Block	Low Wood Block
78	Mute Cuica [EXC4]	Mute Cuica [EXC4]	Mute Cuica [EXC4]	Mute Cuica [EXC4]
79	Open Cuica [EXC4]	Open Cuica [EXC4]	Open Cuica [EXC4]	Open Cuica [EXC4]
80	Mute Triangle [EXC5]	Mute Triangle [EXC5]	Mute Triangle [EXC5]	Mute Triangle [EXC5]
81	Open Triangle [EXC5]	Open Triangle [EXC5]	Open Triangle [EXC5]	Open Triangle [EXC5]
82	Shaker	Shaker	Shaker	Shaker
83	Jingle Bell	Jingle Bell	Jingle Bell	Jingle Bell
C6 84	Bell Tree	Bell Tree	Bell Tree	Bell Tree
85	Castanets	Castanets	Castanets	Castanets
86	Mute Surdo [EXC6]	Mute Surdo [EXC6]	Mute Surdo [EXC6]	Mute Surdo [EXC6]
87	Open Surdo [EXC6]	Open Surdo [EXC6]	Open Surdo [EXC6]	Open Surdo [EXC6]
88	Cana	Cana	Cana	Cana

* -----: No sound.

* [EXC]: will not sound simultaneously with other percussion instruments of the same number.

Drum/SFX Set List

	POP	ROCK	JAZZ BRUSH	VOX DRUM
89	Falamento Hi-Timbale	Falamento Hi-Timbale	Falamento Hi-Timbale	Falamento Hi-Timbale
90	Falamento Lo-Timbale	Falamento Lo-Timbale	Falamento Lo-Timbale	Falamento Lo-Timbale
91	Falamento Tmbl Flam	Falamento Tmbl Flam	Falamento Tmbl Flam	Falamento Tmbl Flam
92	Shekere 1	Shekere 1	Shekere 1	Shekere 1
93	Shekere 2	Shekere 2	Shekere 2	Shekere 2
94	Low Bongo Mute	Low Bongo Mute	Low Bongo Mute	Low Bongo Mute
95	High Bongo Mute	High Bongo Mute	High Bongo Mute	High Bongo Mute
C7 96	-----	-----	-----	-----
97	-----	-----	-----	-----
98	-----	-----	-----	-----
99	-----	-----	-----	-----
100	Falamento HC	Falamento HC	Falamento HC	Falamento HC
101	Falamento HC	Falamento HC	Falamento HC	Falamento HC
102	Bongo Cowbell	Bongo Cowbell	Bongo Cowbell	Bongo Cowbell
103	-----	-----	-----	-----
104	Bongo Cowbell	Bongo Cowbell	Bongo Cowbell	Bongo Cowbell
105	-----	-----	-----	-----

Drum/SFX Set List

	STANDARD	ROOM	POWER	ELECTRONIC
21	----	----	----	----
22	----	----	----	----
23	----	----	----	----
24	Bar Chime	Bar Chime	Bar Chime	Bar Chime
25	Snare Roll	Snare Roll	Snare Roll	Snare Roll
26	Finger Snap	Finger Snap	Finger Snap	Finger Snap
27	High Q	High Q	High Q	High Q
28	Slap	Slap	Slap	Slap
29	Scratch Push [EXC7]	Scratch Push [EXC7]	Scratch Push [EXC7]	Scratch Push [EXC7]
30	Scratch Pull [EXC7]	Scratch Pull [EXC7]	Scratch Pull [EXC7]	Scratch Pull [EXC7]
31	Sticks	Sticks	Sticks	Sticks
32	Square Click	Square Click	Square Click	Square Click
33	Metronome Click	Metronome Click	Metronome Click	Metronome Click
34	Metronome Bell	Metronome Bell	Metronome Bell	Metronome Bell
35	Std Kick 2'	Kick1	Std Kick 2'	Std Kick 2'
C2 36	Kick 1	Room Kick	MONDO Kick	Elec BD
37	Side Stick	Side Stick	Side Stick	Side Stick
38	Std Snr 1	Room Snr 1	Gated SD	Elec SD
39	Hand Clap	Hand Clap	Hand Clap	Hand Clap
40	Std Snr 2	Std Snr 1	Snare Drum 2	Gated SD
41	Low Tom 2	Room Low Tom 2'	Room Low Tom 2	Elec Low Tom 2
42	Closed Hi-hat 1' [EXC1]	Closed Hi-hat 1' [EXC1]	Closed Hi-hat 1 [EXC1]	Closed Hi-hat 1 [EXC1]
43	Low Tom 1	Room Low Tom 1'	Room Low Tom 1	Elec Low Tom 1
44	Pedal Hi-hat 1' [EXC1]	Pedal Hi-hat 1' [EXC1]	Pedal Hi-hat 1 [EXC1]	Pedal Hi-hat 1 [EXC1]
45	Mid Tom 2	Room Mid Tom 2'	Room Mid Tom 2	Elec Mid Tom 2
46	Open Hi-hat 1' [EXC1]	Open Hi-hat 1' [EXC1]	Open Hi-hat 1 [EXC1]	Open Hi-hat 1 [EXC1]
47	Mid Tom 1	Room Mid Tom 1'	Room Mid Tom 1	Elec Mid Tom 1
C3 48	High Tom 2	Room Hi Tom 2'	Room Hi Tom 2	Elec Hi Tom 2
49	Crash Cymbal 1	Crash Cymbal 1	Crash Cymbal 1	Crash Cymbal 1
50	High Tom 1	Room Hi Tom 1'	Room Hi Tom 1	Elec Hi Tom 1
51	Ride Cymbal 1	Ride Cymbal 1	Ride Cymbal 1	Ride Cymbal 1
52	Chinese Cymbal	Chinese Cymbal	Chinese Cymbal	Reverse Cymbal
53	Ride Bell	Ride Bell	Ride Bell	Ride Bell
54	Tambourine	Tambourine	Tambourine	Tambourine
55	Splash Cymbal	Splash Cymbal	Splash Cymbal	Splash Cymbal
56	Cowbell	Cowbell	Cowbell	Cowbell
57	Crash Cymbal 2	Crash Cymbal 2	Crash Cymbal 2	Crash Cymbal 2
58	Vibra-slap	Vibra-slap	Vibra-slap	Vibra-slap
59	Ride Cymbal 2	Ride Cymbal 2	Ride Cymbal 2	Ride Cymbal 2
C4 60	High Bongo	High Bongo	High Bongo	High Bongo
61	Low Bongo	Low Bongo	Low Bongo	Low Bongo
62	Mute High Conga	Mute High Conga	Mute High Conga	Mute High Conga
63	Open High Conga	Open High Conga	Open High Conga	Open High Conga
64	Low Conga	Low Conga	Low Conga	Low Conga
65	High Timbale	High Timbale	High Timbale	High Timbale
66	Low Timbale	Low Timbale	Low Timbale	Low Timbale
67	High Agogo	High Agogo	High Agogo	High Agogo
68	Low Agogo	Low Agogo	Low Agogo	Low Agogo
69	Cabasa	Cabasa	Cabasa	Cabasa
70	Maracas	Maracas	Maracas	Maracas
71	Short Hi Whistle [EXC2]	Short Hi Whistle [EXC2]	Short Hi Whistle [EXC2]	Short Hi Whistle [EXC2]
C5 72	Long Low Whistle [EXC2]	Long Low Whistle [EXC2]	Long Low Whistle [EXC2]	Long Low Whistle [EXC2]
73	Short Guiro [EXC3]	Short Guiro [EXC3]	Short Guiro [EXC3]	Short Guiro [EXC3]
74	Long Guiro [EXC3]	Long Guiro [EXC3]	Long Guiro [EXC3]	Long Guiro [EXC3]
75	Claves	Claves	Claves	Claves
76	High Wood Block	High Wood Block	High Wood Block	High Wood Block
77	Low Wood Block	Low Wood Block	Low Wood Block	Low Wood Block
78	Mute Cuica [EXC4]	Mute Cuica [EXC4]	Mute Cuica [EXC4]	Mute Cuica [EXC4]
79	Open Cuica [EXC4]	Open Cuica [EXC4]	Open Cuica [EXC4]	Open Cuica [EXC4]
80	Mute Triangle [EXC5]	Mute Triangle [EXC5]	Mute Triangle [EXC5]	Mute Triangle [EXC5]
81	Open Triangle [EXC5]	Open Triangle [EXC5]	Open Triangle [EXC5]	Open Triangle [EXC5]
82	Shaker	Shaker	Shaker	Shaker
83	Jingle Bell	Jingle Bell	Jingle Bell	Jingle Bell
C6 84	Bell Tree	Bell Tree	Bell Tree	Bell Tree
85	Castanets	Castanets	Castanets	Castanets
86	Mute Surdo [EXC6]	Mute Surdo [EXC6]	Mute Surdo [EXC6]	Mute Surdo [EXC6]
87	Open Surdo [EXC6]	Open Surdo [EXC6]	Open Surdo [EXC6]	Open Surdo [EXC6]
88	----	----	----	----

* ----: No sound.

* [EXC]: will not sound simultaneously with other percussion instruments of the same number.

Drum/SFX Set List

	TR-808	DANCE	JAZZ GS STANDARD	BRUSH
21	----	----	----	----
22	----	----	----	----
23	----	----	----	----
24	Bar Chime	Bar Chime	Bar Chime	Bar Chime
25	Snare Roll	Snare Roll	Snare Roll	Snare Roll
26	Finger Snap	Finger Snap	Finger Snap	Finger Snap
27	High Q	High Q	High Q	High Q
28	Slap	Slap	Slap	Slap
29	Scratch Push [EXC7]	Scratch Push [EXC7]	Scratch Push [EXC7]	Scratch Push [EXC7]
30	Scratch Pull [EXC7]	Scratch Pull [EXC7]	Scratch Pull [EXC7]	Scratch Pull [EXC7]
31	Sticks	Dance Snr 1	Sticks	Sticks
32	Square Click	Square Click	Square Click	Square Click
33	Metronome Click	Metronome Click	Metronome Click	Metronome Click
34	Metronome Bell	Metronome Bell	Metronome Bell	Metronome Bell
35	Std Kick 2	Kick 1	Std Kick 2	Kick 2
C2 36	808 Bass Drum 1	808 Bass Drum 2	Std Kick 1	Kick 1
37	808 Rim Shot	808 Rim Shot	Side Stick	Side Stick
38	808 Snare Drum	TR-909 Snr	Snare Drum 1	Brush Tap
39	Hand Clap	Hand Clap	Hand Clap	Brush Slap
40	Snare Drum 2	Dance Snr 2	Snare Drum 2	Brush Swirl
41	808 Low Tom 2	808 Low Tom 2	Low Tom 2	Brush Low Tom 2
42	808 CHH [EXC1]	808 CHH [EXC1]	Closed Hi-hat 1 [EXC1]	Closed Hi-hat 2 [EXC1]
43	808 Low Tom 1	808 Low Tom 1	Low Tom 1	Brush Low Tom 1
44	808 CHH [EXC1]	808 CHH [EXC1]	Pedal Hi-hat 1 [EXC1]	Pedal Hi-hat 2 [EXC1]
45	808 Mid Tom 2	808 Mid Tom 2	Mid Tom 2	Brush Mid Tom 2
46	808 OHH [EXC1]	808 OHH [EXC1]	Open Hi-hat 1 [EXC1]	Open Hi-hat 2 [EXC1]
47	808 Mid Tom 1	808 Mid Tom 1	Mid Tom 1	Brush Mid Tom 1
C3 48	808 Hi Tom 2	808 Hi Tom 2	High Tom 2	Brush Hi Tom 2
49	808 Cymbal	808 Cymbal	Crash Cymbal 1	Crash Cymbal 1
50	808 Hi Tom 1	808 Hi Tom 1	High Tom 1	Brush Hi Tom 1
51	Ride Cymbal 1	Ride Cymbal 1	Ride Cymbal 1	Ride Cymbal 1
52	Chinese Cymbal	Chinese Cymbal	Chinese Cymbal	Chinese Cymbal
53	Ride Bell	Ride Bell	Ride Bell	Ride Bell
54	Tambourine	Tambourine	Tambourine	Tambourine
55	Splash Cymbal	Splash Cymbal	Splash Cymbal	Splash Cymbal
56	808 Cowbell	808 Cowbell	Cowbell	Cowbell
57	Crash Cymbal 2	Crash Cymbal 2	Crash Cymbal 2	Crash Cymbal 2
58	Vibra-slap	Vibra-slap	Vibra-slap	Vibra-slap
59	Ride Cymbal 2	Ride Cymbal 2	Ride Cymbal 2	Ride Cymbal 2
C4 60	High Bongo	High Bongo	High Bongo	High Bongo
61	Low Bongo	Low Bongo	Low Bongo	Low Bongo
62	808 High Conga	808 High Conga	Mute High Conga	Mute High Conga
63	808 Mid Conga	808 Mid Conga	Open High Conga	Open High Conga
64	808 Low Conga	808 Low Conga	Low Conga	Low Conga
65	High Timbale	High Timbale	High Timbale	High Timbale
66	Low Timbale	Low Timbale	Low Timbale	Low Timbale
67	High Agogo	High Agogo	High Agogo	High Agogo
68	Low Agogo	Low Agogo	Low Agogo	Low Agogo
69	Cabasa	Cabasa	Cabasa	Cabasa
70	808 Maracas	808 Maracas	Maracas	Maracas
71	Short Hi Whistle [EXC2]	Short Hi Whistle [EXC2]	Short Hi Whistle [EXC2]	Short Hi Whistle [EXC2]
C5 72	Long Low Whistle [EXC2]	Long Low Whistle [EXC2]	Long Low Whistle [EXC2]	Long Low Whistle [EXC2]
73	Short Guiro [EXC3]	Short Guiro [EXC3]	Short Guiro [EXC3]	Short Guiro [EXC3]
74	Long Guiro [EXC3]	Long Guiro [EXC3]	Long Guiro [EXC3]	Long Guiro [EXC3]
75	808 Claves	808 Claves	Claves	Claves
76	High Wood Block	High Wood Block	High Wood Block	High Wood Block
77	Low Wood Block	Low Wood Block	Low Wood Block	Low Wood Block
78	Mute Cuica [EXC4]	Mute Cuica [EXC4]	Mute Cuica [EXC4]	Mute Cuica [EXC4]
79	Open Cuica [EXC4]	Open Cuica [EXC4]	Open Cuica [EXC4]	Open Cuica [EXC4]
80	Mute Triangle [EXC5]	Mute Triangle [EXC5]	Mute Triangle [EXC5]	Mute Triangle [EXC5]
81	Open Triangle [EXC5]	Open Triangle [EXC5]	Open Triangle [EXC5]	Open Triangle [EXC5]
82	Shaker	Shaker	Shaker	Shaker
83	Jingle Bell	Jingle Bell	Jingle Bell	Jingle Bell
C6 84	Bell Tree	Bell Tree	Bell Tree	Bell Tree
85	Castanets	Castanets	Castanets	Castanets
86	Mute Surdo [EXC6]	Mute Surdo [EXC6]	Mute Surdo [EXC6]	Mute Surdo [EXC6]
87	Open Surdo [EXC6]	Open Surdo [EXC6]	Open Surdo [EXC6]	Open Surdo [EXC6]
88	----	----	----	----

Drum/SFX Set List

SFX

	ORCHESTRA	GS ROOM	GS BRUSH	SOUND EFFECTS
21	----	----	----	----
22	----	----	----	----
23	----	----	----	----
24	Bar Chime	Bar Chime	Bar Chime	----
25	Snare Roll	Snare Roll	Snare Roll	----
26	Finger Snap	Finger Snap	Finger Snap	----
27	Close Hi-hat [EXC1]	High Q	High Q	----
28	Pedal Hi-hat [EXC1]	Slap	Slap	----
29	Open Hi-hat [EXC1]	Scratch Push [EXC7]	Scratch Push [EXC7]	----
30	Ride Cymbal	Scratch Pull [EXC7]	Scratch Pull [EXC7]	----
31	Sticks	Sticks	Sticks	----
32	Square Click	Square Click	Square Click	----
33	Metronome Click	Metronome Click	Metronome Click	----
34	Metronome Bell	Metronome Bell	Metronome Bell	----
35	Concert BD 2	Std Kick 2	Std Kick 2	----
C2 36	Concert BD 1	Std Kick 1	Std Kick 1	----
37	Side Stick	Side Stick	Side Stick	----
38	Concert SD	Snare Drum 1	Brush Tap	----
39	Castanets	Hand Clap	Brush Slap	High Q
40	Concert SD	Snare Drum 2	Brush Swirl	Slap
41	Timpani F	Room Low Tom 2	Low Tom 2	Scratch Push [EXC7]
42	Timpani F#	Closed Hi-hat 1 [EXC1]	Closed Hi-hat 1 [EXC1]	Scratch Pull [EXC7]
43	Timpani G	Room Low Tom 1	Low Tom 1	Sticks
44	Timpani G#	Pedal Hi-hat 1 [EXC1]	Pedal Hi-hat 1 [EXC1]	Square Click
45	Timpani A	Room Mid Tom 2	Mid Tom 2	Metronome Click
46	Timpani A#	Open Hi-hat 1 [EXC1]	Open Hi-hat 1 [EXC1]	Metronome Bell
47	Timpani B	Room Mid Tom 1	Mid Tom 1	Guitar sliding Finger
C3 48	Timpani c	Room Hi Tom 2	High Tom 2	Guitar cutting noise (up)
49	Timpani c#	Crash Cymbal 1	Crash Cymbal 1	Guitar cutting noise (down)
50	Timpani d	Room Hi Tom 1	High Tom 1	String slap of double bass
51	Timpani d#	Ride Cymbal 1	Ride Cymbal 1	Fl.Key Click
52	Timpani e	Chinese Cymbal	Chinese Cymbal	Laughing
53	Timpani f	Ride Bell	Ride Bell	Screaming
54	Tambourine	Tambourine	Tambourine	Punch
55	Splash Cymbal	Splash Cymbal	Splash Cymbal	Heart Beat
56	Cowbell	Cowbell	Cowbell	Footsteps1
57	Concert Cymbal 2	Crash Cymbal 2	Crash Cymbal 2	Footsteps2
58	Vibra-slap	Vibra-slap	Vibra-slap	Applause
59	Concert Cymbal 1	Ride Cymbal 2	Ride Cymbal 2	Door Creaking
C4 60	High Bongo	High Bongo	High Bongo	Door
61	Low Bongo	Low Bongo	Low Bongo	Scratch
62	Mute High Conga	Mute High Conga	Mute High Conga	Wind Chimes
63	Open High Conga	Open High Conga	Open High Conga	Car-Engine
64	Low Conga	Low Conga	Low Conga	Car-Stop
65	High Timbale	High Timbale	High Timbale	Car-Pass
66	Low Timbale	Low Timbale	Low Timbale	Car-Crash
67	High Agogo	High Agogo	High Agogo	Siren
68	Low Agogo	Low Agogo	Low Agogo	Train
69	Cabasa	Cabasa	Cabasa	Jetplane
70	Maracas	Maracas	Maracas	Helicopter
71	Short Hi Whistle [EXC2]	Short Hi Whistle [EXC2]	Short Hi Whistle [EXC2]	Starship
C5 72	Long Low Whistle [EXC2]	Long Low Whistle [EXC2]	Long Low Whistle [EXC2]	Gun Shot
73	Short Guiro [EXC3]	Short Guiro [EXC3]	Short Guiro [EXC3]	Machine Gun
74	Long Guiro [EXC3]	Long Guiro [EXC3]	Long Guiro [EXC3]	Lasergun
75	Claves	Claves	Claves	Explosion
76	High Wood Block	High Wood Block	High Wood Block	Dog
77	Low Wood Block	Low Wood Block	Low Wood Block	Horse-Gallop
78	Mute Cuica [EXC4]	Mute Cuica [EXC4]	Mute Cuica [EXC4]	Birds
79	Open Cuica [EXC4]	Open Cuica [EXC4]	Open Cuica [EXC4]	Rain
80	Mute Triangle [EXC5]	Mute Triangle [EXC5]	Mute Triangle [EXC5]	Thunder
81	Open Triangle [EXC5]	Open Triangle [EXC5]	Open Triangle [EXC5]	Wind
82	Shaker	Shaker	Shaker	Seashore
83	Jingle Bell	Jingle Bell	Jingle Bell	Stream
C6 84	Bell Tree	Bell Tree	Bell Tree	Bubble
85	Castanets	Castanets	Castanets	Cat
86	Mute Surdo [EXC6]	Mute Surdo [EXC6]	Mute Surdo [EXC6]	----
87	Open Surdo [EXC6]	Open Surdo [EXC6]	Open Surdo [EXC6]	----
88	Applause	----	----	----

* ----: No sound.

* [EXC]: will not sound simultaneously with other percussion instruments of the same number.

Music Style List

Pop

Cool Al
Michael'sPop
Light Pop
Latin Pop

Power Pop
16Beat Pop 1
West Coast
MorningLight

Rollin'
8Beat Pop 1
Swing Pop
Rock'n Pop

Euro Dance
Light Fusion
Mersey Beat
Acoustic Pop

Acoustic

Piano Pop
Guitar Waltz
Piano Latin
PianoRagtime

Piano Night
Piano Waltz
Piano Jazz
PianoShuffle

Pf Concerto
PianoBoogie
PianoClasic1
StridePiano

Gtr.FastPop2
P.Slow Waltz
Strings
Piano Gospel

P.Country
P.Bossa Nova
P.Pop 2
P.Ragtime

P.Stride
P.Concerto 1
P.Ballad 1
P.Swing Pop

P.Rock'nRoll
P.Concerto 2
P.Swing
P.Slow Swing

P.Latin

Ballad

Pop Ballad
Swing Ballad
70's 8beat
12/8 Ballad

6/8 Ballad
Soulful Sax
MediumBallad
Love Romance

Gt.Arpeggio
70's Ballad
Chapel
PianoBallad

Rock

70's 1
Easy Rock
80's Rock
16Beat Rock

Rock 1
Rock 2
AcousticRck1
Early Rock

Oldies

JB Soul
The Blues
Rock n Roll
50's R&B

Beach Sound
Cute Pop
Dreamin'
50's Pop 1

Slow Dance
Rock'n Cntry
P.50's Rock
P.Boogie

60's R&B
Enka 1
Enka 2

Country

Lets Twist
Cntry Pickin
HonkyTonkin'
Country Song

Cntry Rockin
Tejano
Walk'n
Bluegrass

Western
CountryWaltz
Country Rock
Twostep

Country Tune

Big Band/Swing

BigBand Pop
A Cappella
Big Serenade
Organ Swing

Fast BigBand
BigBandBlues
Scat Swing
Slow Swing

Swing'in

Latin

Bossa Nova 1
Bossa Nova 2
Latin
Mambo

Salsa
Samba
Rhumba
Beguine

Chacha
Tango
Slow Bossa

Music Style List

Waltz

ViennaWaltz2
Fast Waltz
Screen 1
Raindrops

Balloon Trip
StringsWaltz
Slow Waltz
Last Dance

Screen 2
Cinema
Festival
Waltzing

Vienna Waltz
Musette
SFX Movie
WesternMovie

Little Steps
DeutschWalzr
Summer Days
Black&White

Simple Waltz

March/Kids

March
Parade
Kids
Circus

Fanfare
Kids Pop
Kids 4/4
Kids Dance

SimpleMarch1
SimpleMarch2
Lullaby 4/4
Music Box

Kids 6/8

Trad

Gospel Shout
Gospel Piano
Foxtrot
Foxtrot 2

Gospel Pop
Anthem
Dixieland
Charleston

Gospel
Schlager
Polka
Ireland

Scotland
Hawaiian
Japan

Data Disk Style

01 Ocean Side
02 16Beat Pop
03 70's Disco
04 Pop'n Roll
05 16BeatBallad
06 60's Ballad
07 Swayin'
08 Contemporary *
09 Club Piano
10 G.Pop
11 Twist
12 Shuffle
13 PianoBoogie2
14 CountryRoads
15 CtrySerenade
16 CountryPiano
17 Easy Country
18 Hoedown
19 Cajun
20 CountryBlues
21 BigBandSwing
22 BigBndBallad
23 Slow Swing *
24 Blues
25 Combo
26 Mambo *
27 Merengue *
28 Calypso
29 NewBossaNova
30 Broadway
31 Jazz Waltz *
32 March *
33 Habanera
34 Sevilla

* A Music Style indicated by "*" has the same name as a built-in Music Style, but its contents are different.

Rhythm Pattern List

Prhythm Pattern	(Measure)
8 Beat 1	(1)
8 Beat 2	(1)
8 Beat 3	(2)
8 Beat 4	(1)
16Beat 1	(1)
16Beat 2	(2)
Rock 1	(2)
Rock 2	(2)
House 1	(2)
House 2	(1)
Shuffle1	(1)
Shuffle2	(1)
Brush	(2)
Swing 1	(1)
Swing 2	(4)
Waltz	(2)
March 1	(1)
March 2	(2)
BossaNova	(2)
Samba 1	(1)
Samba 2	(1)
Rhumba	(2)
Mambo	(2)
Tango	(2)
Beguine	(1)
Simple4/4	(1)
Simple3/4	(1)
Simple6/8	(2)
CountIn 1	(1)
CountIn 2	(1)
C.InSwing	(1)
Fill In1	(1)
Fill In2	(1)
Fill In3	(1)
Ending 1	(1)
Ending 2	(1)
Ending 3	(1)
Stick 4/4	(1)
Stick 3/4	(1)
Stick 6/8	(1)

Chord List

● symbol : Indicates the constituent note of chords.

★ symbol : Chord shown with an "★" can be played by pressing just the key marked with the "★" (p. 61).

C	C#	D	E \flat	E	F
C \flat 7	C#7	D7	E \flat 7	E7	F7
C7	C#7	D7	E \flat 7	E7	F7
Cm	C#m	Dm	E \flat m	Em	Fm
Cm7	C#m7	Dm7	E \flat m7	Em7	Fm7
Cdim	C#dim	Ddim	E \flat dim	Edim	Fdim
Cm7 (\flat 5)	C#m7 (\flat 5)	Dm7 (\flat 5)	E \flat m7 (\flat 5)	Em7 (\flat 5)	Fm7 (\flat 5)
Caug	C#aug	Daug	E \flat aug	Eaug	Faug
Csus4	C#sus4	Dsus4	E \flat sus4	Esus4	Fsus4
C7sus4	C#7sus4	D7sus4	E \flat 7sus4	E7sus4	F7sus4
C6	C#6	D6	E \flat 6	E6	F6
Cm6	C#m6	Dm6	E \flat m6	Em6	Fm6

F#	G	A \flat	A	B \flat	B
F#M7	GM7	A \flat M7	AM7	B \flat M7	BM7
F#7	G7	A \flat 7	A7	B \flat 7	B7
F#m	Gm	A \flat m	Am	B \flat m	Bm
F#m7	Gm7	A \flat m7	Am7	B \flat m7	Bm7
F#dim	Gdim	A \flat dim	Adim	B \flat dim	Bdim
F#m7 (\flat 5)	Gm7 (\flat 5)	A \flat m7 (\flat 5)	Am7 (\flat 5)	B \flat m7 (\flat 5)	Bm7 (\flat 5)
F#aug	Gaug	A \flat aug	Aaug	B \flat aug	Baug
F#sus4	Gsus4	A \flat sus4	Asus4	B \flat sus4	Bsus4
F#7sus4	G7sus4	A \flat 7sus4	A7sus4	B \flat 7sus4	B7sus4
F#6	G6	A \flat 6	A6	B \flat 6	B6
F#m6	Gm6	A \flat m6	Am6	B \flat m6	Bm6

Effects List

Display	Description
Chorus	Makes sounds broader and fatter.
Stereo Chorus	A stereo chorus.
Hexa Chorus	A multilayer chorus.
Tremolo Chorus	A chorus with a tremolo effect.
Space D	A clear chorus.
Rotary	Adds a rotary-speaker effect.
Stereo Delay	Delays the sound with a stereo effect.
Modulation Delay	Adds a wavering effect to the delayed sound.
Triple Tap Delay	A three-way delay.
Quadruple Tap Delay	A four-way delay.
Phaser	Adds undulations to the sound.
Stereo Flanger	Adds metallic reverberations.
Step Flanger	A flanger that varies the pitch in a stepwise fashion.
Enhancer	Adds modulation to the sound.
Overdrive	Applies soft distortion to the sound.
Distortion	Applies hard distortion to the sound.
Auto Wah	Changes the tone in a cyclical manner.
Compressor	Suppresses fluctuations in volume.
Gate Reverb	Cuts off the reverberations before they fade away completely.
2V Pitch Shifter	Adds two pitch-shifted sounds to the original sound (two-voice pitch shifter).
FB Pitch Shifter	Adds a single pitch-shifted sound to the original sound (feedback pitch shifter).
Enhancer->Chorus	Applies both enhancer and chorus effects.
Enhancer->Flanger	Applies both enhancer and flanger effects.
Enhancer->Delay	Applies both enhancer and delay effects.
Chorus->Delay	Applies both chorus and delay effects.
Flanger->Delay	Applies both flanger and delay effects.
Overdrive->Chorus	Applies both overdrive and chorus effects.
Overdrive->Flanger	Applies both overdrive and flanger effects.
Overdrive->Delay	Applies both overdrive and delay effects.
Distortion->Chorus	Applies both distortion and chorus effects.
Distortion->Flanger	Applies both distortion and flanger effects.
Distortion->Delay	Applies both distortion and delay effects.
Sympathetic Resonance	Applies a resonance effect when the damper pedal is depressed.

Data Disk Song List

No.	Title	Composer	Copyright
1	Menuet in G Major, BWV. Anh. 114 from "Notebook Of Anna Magdalena Bach"	J. S. Bach	© 1992 Roland Corporation
2	Gymnopedie No. 1	E. Satie	© 1997 Roland Corporation
3	Piano Sonata No. 15 in C Major, 1st Movement	W. A. Mozart	© 1996 Roland Corporation
4	"Fröhlicher Landmann" from "Album Für Die Jugend" Op. 68	R. Schumann	© 1996 Roland Corporation
5	Londonderry Air	Irish Folksong	© 1993 Roland Corporation
6	A Maiden's Prayer	T. Badarzewska	© 1996 Roland Corporation
7	Ave Maria	C. Gounod	© 1993 Roland Corporation
8	The Entertainer	S. Joplin	© 1994 Roland Corporation
9	Air from Ouverture No.3 BWV.1068	J. S. Bach	© 1996 Roland Corporation
10	Etude No. 74 from "Beyer Piano Textbook"	F. Beyer	© 1996 Roland Corporation
11	Etude No. 78 from "Beyer Piano Textbook"	F. Beyer	© 1996 Roland Corporation
12	Etude No. 90 from "Beyer Piano Textbook"	F. Beyer	© 1996 Roland Corporation
13	No. 2 "Arabesque" from 25 Easy Studies Op. 100	F. Burgmüller	© 1999 Roland Corporation
14	No. 5 "Innocence" from 25 Easy Studies Op. 100	F. Burgmüller	© 1999 Roland Corporation
15	No. 6 "Progrès" from 25 Easy Studies Op. 100	F. Burgmüller	© 1999 Roland Corporation
16	No. 11 "La Bergeronnette" from 25 Easy Studies Op. 100	F. Burgmüller	© 1999 Roland Corporation
17	No. 17 "La Babillarde" from 25 Easy Studies Op. 100	F. Burgmüller	© 1999 Roland Corporation

* Use of the song data and music style data supplied with this product for any purpose other than private, personal enjoyment without the permission of the copyright holder is prohibited by law. Additionally, this data must not be copied, nor used in a secondary copyrighted work without the permission of the copyright holder.

Music Files That the KR-377 Can Use

What Are Music Files?

Music Files contain information describing the details of a musical performance, such as “the C3 key on a keyboard was pressed for this amount of time, using this amount of force.” By inserting the floppy disk into the disk drive on the KR-377, the performance information is sent from the floppy disk to the piano, and played faithfully by the piano. This is different than a CD, since the music file does not contain a recording of the sound itself. This makes it possible to erase certain parts, or to change instruments, tempos and keys freely, allowing you to use it in many different ways.

Regarding Copyright

Use of the song data supplied with the Data Disk attached to this product for any purpose other than private, personal enjoyment without the permission of the copyright holder is prohibited by law. Additionally, this data must not be copied, nor used in a secondary copyrighted work without the permission of the copyright holder.

■ The KR-377 allows you to use the following music files

Floppy disks saved on a Roland MT Series, or Roland Piano Digital HP-G/KR Series instrument

● Roland Digital Piano Compatible Music Files

Roland’s original music file is made specifically for practicing the piano. Some follow an instructional curriculum, allowing for a complete range of lessons, such as “practicing each hand separately” or “listening to only the accompaniment.”

● SMF Music Files (720KB/1.44MB format)

SMFs (Standard MIDI Files) use a standard format for music file that was formulated so that files containing music file could be widely compatible, regardless of the manufacturer of the listening device. An enormous variety of music is available, whether it be for listening, for practicing musical instruments, for Karaoke, etc.

If you wish to purchase SMF Music Files, please consult the retailer where you purchased your KR-377.

SMF with Lyrics

“SMF with Lyrics” refers to SMF (Standard MIDI File) that contains the lyrics. When Music Files carrying the “SMF with Lyrics” logo are played back on a compatible device (one bearing the same logo), the lyrics will appear in its display.

■ About the KR-377 Sound Generator

The KR-377 come equipped with GM 2/GS sound generators.

General MIDI

The General MIDI is a set of recommendations which seeks to provide a way to go beyond the limitations of proprietary designs, and standardize the MIDI capabilities of sound generating devices. Sound generating devices and music files that meets the General MIDI standard bears the General MIDI logo. Music files bearing the General MIDI logo can be played back using any General MIDI sound generating unit to produce essentially the same musical performance.

General MIDI 2

The upwardly compatible General MIDI 2 recommendations pick up where the original General MIDI left off, offering enhanced expressive capabilities, and even greater compatibility.

Issues that were not covered by the original General MIDI recommendations, such as how sounds are to be edited, and how effects should be handled, have now been precisely defined. Moreover, the available sounds have been expanded.

General MIDI 2 compliant sound generators are capable of reliably playing back music files that carry either the General MIDI or General MIDI 2 logo.

In some cases, the conventional form of General MIDI, which does not include the new enhancements, is referred to as “General MIDI 1” as a way of distinguishing it from General MIDI 2.

GS Format

The GS Format is Roland’s set of specifications for standardizing the performance of sound generating devices. In addition to including support for everything defined by the General MIDI, the highly compatible GS Format additionally offers an expanded number of sounds, provides for the editing of sounds, and spells out many details for a wide range of extra features, including effects such as reverb and chorus.

Designed with the future in mind, the GS Format can readily include new sounds and support new hardware features when they arrive.

Since it is upwardly compatible with the General MIDI, Roland’s GS Format is capable of reliably playing back GM Scores equally as well as it performs GS music files (music files that have been created with the GS Format in mind). This product supports both the General MIDI 2 and the GS Format, and can be used to play back music data carrying either of these logos.

Glossary

Arrange

This is an abbreviation of "Arrangement." It refers to changes that have been made in an original tune, by adding a new accompaniment or by changing the instruments used.

Automatic Accompaniment

The KR-377 automatically plays accompaniment when just a few keys in the lower section of the keyboard are pressed to specify the chord. This is called the "One Touch Arranger" (p. 30).

Bouncing Ball

The flashing dot that moves in a semicircular pattern across the screen of the KR-377 is called a "Bouncing Ball" (p. 57).

Chord

Two or more notes sounding at the same time (p. 61).

Division

The six performance states that make up a Music Style are called "Divisions" (p. 60).

Drum Set

A Drum Set is a collection of percussive instrument sounds. With drum sets, a different sound can be heard for each key on the keyboard. The special effects sound set is called the "SFX Set" (p. 44).

Edit

Editing is to change the song you have recorded, such as by erasing part of the song, or copying a measure (p. 119).

Ending

This is the last part of the accompaniment. When you stop playing the automatic accompaniment, the KR-377 plays an ending appropriate for the style (p. 67).

Ensemble

A combined performance of two or more instruments is called an "Ensemble."

Icon

The on-screen graphics that appear three dimensional work like buttons. These are called "Icons."

Intro

This is the introductory portion of an automatic accompaniment performance. The KR-377 plays an intro ideally suited to each style when it starts playing the automatic accompaniment (p. 67).

Key Touch

This is the sensation of heaviness—the "touch"—of the keys when the keyboard is played (p. 135).

Layer Play

Playing with two different tones on a key simultaneously is called "Layer Play" (p. 47).

Music Style

Music Styles are performance patterns in various musical genres. A Music Style is played automatically in accord with the specified chord using the KR-377's One-touch Arranger Function (p. 63).

Part

On the KR-377, "Part" can have two different meanings. One meaning refers to a performance part (p. 60), such as the right-hand part of a piano song. The other refers to the 16 parts in the 16-track sequencer (p. 113).

Pickup

A song with a pickup does not start on the first beat (p. 99).

PU (Pickup)

A song that does not start on the first beat starts with what is called a pickup. When playing a pickup song, the measures will be shown in the display as "PU, 1, 2..."

Save

Saving is storing the recorded performance data onto a floppy disk (p. 104).

Sound Generator

The sound generator of the KR-377 supports GM2/GS, and can play 589 different sounds (p. 178).

Split Play

The division of the keyboard into upper and lower zones is referred to as "Split," and different tones can be played in the keys on different sides of the key that acts as the boundary between the upper part and lower part (p. 49).

Standard Pitch

The pitch of the sound created by playing the middle A on the keyboard is called the "Standard Pitch." Changing the standard pitch of the KR-377 is called "Master Tune," and tuning to other musical instrument is called "Tuning" (p. 146).

Tone

Tones are the musical instruments or effect sounds stored in the internal memory of the KR-377. The display shows "TONE."

Tuning Curves

Graphic representations of the changes in pitch of the equally-tempered tuning versus those of actual tunings are called "Tuning Curves" (p. 136).

Main Specifications

<Keyboard>

Keyboard

88 keys Progressive Hammer Action mechanism

Touch Sensitivity

100 Levels

Keyboard Mode

Whole

Split (adjustable Split Point)

Layer

Arranger

Piano Style Arranger

Manual Drum/SFX

<Sound Source>

Conforms to GM2/GS

Max. Polyphony

Stereo 64 voices

Tones

8 groups 589 variations (including 16 drum sets, 1 SFX set)

Temperament

8 types, selectable tonic

Stretched Tuning

2 types

Master Tunings

415.3 Hz to 466.2 Hz (0.1 Hz steps)

Transpose

Key Transpose (-6 to +5 half-steps)

Playback Transpose (-24 to +24 half-steps)

Effects

Reverb (8 types, stepless level adjustable)

Chorus (8 types, 127 levels)

Sympathetic Resonance, Rotary and 32 other types

Advanced 3D

<Arranger>

Music Style

Internal: 11 groups 162 styles x 4 types (Style Orchestrator)

Data Disk: 34 styles

Programmable Music Styles

Style Converter

Style Composer

Melody Intelligence

24 types

User Programs

Internal: 32

Disk: Max. 99 sets

Control

Start/Stop, Intro/Ending, Sync. Start,

Fill-In (Variation/Original), Arranger Reset, Count Down,

Melody Intelligence, Break, Leading Bass,

Half Fill-In (Variation/Original)

<Composer>

Metronome

Beat: 2/2, 0/4, 2/4, 3/4, 4/4, 5/4, 6/4, 7/4, 3/8, 6/8, 9/8, 12/8

Volume: 10 levels

Pattern: 11 patterns

Sounds: 8 types

Track

5/16 tracks

Song

1 song

Note Storage

Approx. 30,000 notes

Tempo

Quarter note = 20 to 250

Resolution

120 ticks per quarter note

Recording Method

Realtime (Replace, Mix, Auto Punch In,

Manual Punch In, Loop, Tempo)

Step (on Chord Sequence Mode)

Beat Map

Edit

Copy, Quantize, Delete, Insert, Erase, Transpose,

Part Exchange, Note Edit, PC Edit

Rhythm Pattern

40 types

Control

Song Select, Reset, Stop, Play, Rec, Bwd, Fwd,

All Song Play, Track Select, Count In, Playback Balance,

Marker Set, Repeat, Tempo Mute

Main Specifications

<Disk Drive/Disk Storage>

Disk Drive / Disk Storage

3.5 inch micro floppy disk

Disk Format

720 K bytes (2DD)

1.44 M bytes (2HD)

Songs

Max. 99 songs

Note Storage

Approx. 120,000 notes (2DD)

Approx. 240,000 notes (2HD)

Playable Software

Standard MIDI Files (format 0/1)

Roland Original Format (i-format)

Save

Standard MIDI Files (format 0)

Roland Original Format (i-format)

<Others>

Rated Power Output

30 W x 2

Speakers

20 cm x 2

Display

Beat Indicator

240 x 64 dots Graphic LCD with backlighting

Language: English/German/French/Spanish/Japanese

Score

G Clef staff, F Clef staff

With pitches, with lyrics

Lyrics

Yes (Built-in Display, MIDI Out)

Control

Volume, Brilliance, Reverb, Balance, Microphone Volume,

Microphone Echo

One Touch Play

One Touch Piano, One Touch Organ, One Touch Arranger

Pedals

Damper (half-pedal recognition)

Soft (half-pedal recognition, Function assignable)

Sostenuto (Function assignable)

Other Functions

EZ Arranger, EZ Player, EZ Recorder, Tone Finder, Games, On-screen Help, Audition, Panel Lock

Connectors

Output jacks (L/Mono, R)

Input jacks (L/Mono, R)

Microphone jack

Headphone jack (stereo) x 2

MIDI In connector x 2

MIDI Out connector

Computer connector

Pedal Connector (8 pin DIN type)

Power supply

AC 117 V / 230 V / 240 V

Power Consumption

69 W

Cabinet Finish

Satin Mahogany

Dimensions (including Piano Stand)

1,449 (W) x 528 (D) x 911 (H) mm

57-1/16 (W) x 20-13/16 (D) x 35-7/8 (H) inches

Weights (including Piano Stand)

63.3 kg / 139 lbs 9 oz

Accessories

Owner's manual

Power Cord

Data Disk

* In the interest of product improvement, the specifications and/or appearance of this unit are subject to change without prior notice.

Index

Numerics

- 16 Track Sequencer 114
- 5 Track Buttons 85, 91, 94

A

- Advanced 3D 33, 53–54
- All Song Play 78
- Ambience 134
- Arrangement 71
- Audio Equipment 154
 - Sound Mode 155
- Automatic Accompaniment 29, 60, 137

B

- Bankselect 152
- Basic Screen 16
- Basic Tempo 117
- Bass Tone 68, 138
- Beat 56
- Beat Map 116
- Bend 140
- Bend Range 140, 147
- Break 140
- Brilliance 52

C

- Check It Out! 27
- Chord 61, 174, 177
- Chord Finder 62
- Chord Intelligence 61, 139
- Chord Sequencer 100
- Chord Tone 68, 138
- Chord Type 61
- Chorus Effect 147
- Computer 156
- Copy
 - Measure 120
 - Rhythm Pattern 121
- Count Down 69
- Count Sound 69
- Count-In 84, 145

D

- Damper Pedal 14
- Data Disk 64, 172
- Delete
 - Measure 122
 - User Program 133
 - User Style 133
 - Song 97
- Demo 21
- Disk Drive 38
- Display Setting 148
- Division 60
- Drum Sets 44, 166
- Drum Sounds 44

E

- Echo 15
- Edit 119
- Effect Sound 45, 170
- Effects 55, 176

- Ending 60, 68
- Erase 123
- EX Tone 26, 46
- EZ Arranger 29
- EZ Player 39
- EZ Recorder 34

F

- Factory Reset 149
- Fade In/Out 140
- Fill In To Original 60
- Fill In To Variation 60
- Fill-In 70
- Find Suitable 27
- Floppy Disk 38
 - Format 104
 - Write-Protect Tab 104
- Footage 143
- Format 104

G

- Game 22
- General MIDI 178
- Glide 140
- Graph Screen 80
- GS 178

H

- Headphone 15
- Help 23

I

- i-format 106
- Index 27
- Inputting Chord 102
- Insert 122
- Intro 60, 67

K

- Karaoke 41
- Key Touch 135
- Key Transpose 89
- Keyboard Screen 80

L

- Language 148
- Layer Play 47
- Leading Bass 140
- Local Control 152
- Lower 65
- Lyric 148

M

- Marker 86, 145
 - Erasing 86
 - Moving 87
 - Setting 86
- Master Tuning 146
- Melody Intelligence 73
- Memory Backup 149

Index

Metronome28, 56
 Animation57
 Beat56
 Pattern57
 Sound58
 Tempo56
 Volume59
Microphone15
MIDI151
MIDI Ensemble152
Music File38, 178
Music Style60, 63, 171
Mute85

N

Note Edit124

O

Octave Shift51
One-touch Arranger30
One-touch Organ25, 43, 141
One-touch Piano24, 42, 134
Opening Message148
Original60

P

Panel Lock133
Panpot115
Part Exchange124
PC119
PC Edit125
Pedal14, 139
Pedal Mode135
Performance Part60
Piano Style Arranger74
Pickup99
Play Mode144
Playing Back Songs77
Power13
Preset63
Program Change125, 152
PU (Pickup)99

Q

Quantize121
Quick Tour21

R

Rec Stop98
Recording34, 91, 94
 16 Track Sequencer114
 Erasing a Recorded Song97
 Redoing a Recording96
 Tempo117
Repeat88
Reset68
Resonance135
Reverb Effect52, 146
Rhythm Pattern66, 103, 173
Root Note61
Rotary Effect25, 43

S

Save
 Compatibility107
 Save As SMF106
 User Program132
 User Style131–132
 Song104
Score79, 144
Screen Setting148
SFX45, 170
SMF Music files178
Soft Pedal14
Song
 Playback77
 Record34, 91, 94, 114
 Save104
 Delete97
Song Edit119
Sostenuto Pedal14
Sound137
Sound Generator178
Sound Mode155
Split Play49
Split Point137
Stretch Tuning136
Style Composer126
Style Converter128
Style Orchestrator71
Sync Start67

T

Tap Tempo82
Tempo
 Automatic Accompaniment66
 Metronome56
 Song82
Tempo Muting83
Tempo Recording117
Tone26, 46
Tone Finder27
Track button85, 91, 94, 96
Transpose
 Individual Part123
 Keyboard89
 Song90
Tuning136
Tuning Curve136
TX. Channel152

U

Undo119
User Program131–132
User Style64, 126

V

Variation60
Velocity124
Volume
 Master13
 Metronome59
 Microphone15

MEMO

Information

When you need repair service, call your nearest Roland Service Center or authorized Roland distributor in your country as shown below.

AFRICA

EGYPT

Al Fanny Trading Office
P.O. Box 2904,
El Horrieh Heliopolis, Cairo,
EGYPT
TEL: (02) 4185531

REUNION

Maison FO - YAM Marcel
25 Rue Jules MermanZL
Chaudron - BP79 97491
Ste Clotilde REUNION
TEL: 28 29 16

SOUTH AFRICA

**That Other Music Shop
(PTY) Ltd.**
11 Melle Street (Cnr Melle and
Juta Street)
Braamfontein 2001
Republic of SOUTH AFRICA
TEL: (011) 403 4105

Paul Bothner (PTY) Ltd.
17 Werdmuller Centre Claremont
7700
Republic of SOUTH AFRICA

P.O. Box 23032
Claremont, Cape Town
SOUTH AFRICA, 7735
TEL: (021) 64 4030

ASIA

CHINA

**Beijing Xinghai Musical
Instruments Co., Ltd.**
6 Huangmchang, Chao Yang
District, Beijing, CHINA
TEL: (010) 6774 7491

HONG KONG

**Tom Lee Music Co., Ltd.
Service Division**
22-32 Pun Shan Street, Tsuen
Wan, New Territories,
HONG KONG
TEL: 2415 0911

INDIA

Rivera Digitec (India) Pvt. Ltd.
409, Nirman Kendra Mahalaxmi
Flats Compound Off. Dr. Edwin
Moses Road, Mumbai-400011,
INDIA
TEL: (022) 498 3079

INDONESIA

PT Citra Inti Rama
Jl. Cideng Timur No. 15-150
Jakarta Pusat
INDONESIA
TEL: (021) 6324170

KOREA

**Cosmos Corporation
Service Station**
261 2nd Floor Nak-Won Arcade
Jong-Ro ku, Seoul, KOREA
TEL: (02) 742 8844

MALAYSIA

Bentley Music SDN BHD
140 & 142, Jalan Bukit Bintang
55100 Kuala Lumpur, MALAYSIA
TEL: (03) 2443333

PHILIPPINES

G.A. Yupangco & Co. Inc.
339 Gil J. Puyat Avenue
Makati, Metro Manila 1200,
PHILIPPINES
TEL: (02) 899 9801

SINGAPORE

Swee Lee Company
150 Sims Drive,
SINGAPORE 387381
TEL: 748-1669

CRISTOFORI MUSIC PTE LTD

Bk 3014, Bedok Industrial Park E,
#02-2148, SINGAPORE 489980
TEL: 243 9555

TAIWAN

**ROLAND TAIWAN
ENTERPRISE CO., LTD.**
Room 5, 9th. No. 112 Chung Shan
N.Road Sec.2, Taipei, TAIWAN,
R.O.C.
TEL: (02) 2561 3339

THAILAND

Theera Music Co., Ltd.
330 Verng NakornKasem, Soi 2,
Bangkok 10100, THAILAND
TEL: (02) 2248821

VIETNAM

Saigon Music
138 Tran Quang Khai St.,
District 1
Ho Chi Minh City
VIETNAM
TEL: (08) 844-4068

AUSTRALIA/ NEW ZEALAND

AUSTRALIA

**Roland Corporation
Australia Pty., Ltd.**
38 Campbell Avenue
Dee Why West, NSW 2099
AUSTRALIA
TEL: (02) 9982 8266

NEW ZEALAND

Roland Corporation (NZ) Ltd.
97 Mt. Eden Road, Mt. Eden,
Auckland 3, NEW ZEALAND
TEL: (09) 3098 715

CENTRAL/LATIN AMERICA

ARGENTINA

Instrumentos Musicales S.A.
Florida 656 2nd Floor
Office Number 206A
Buenos Aires
ARGENTINA, CP1005
TEL: (54-11) 4- 393-6057

BRAZIL

Roland Brasil Ltda.
R. Coronel Octaviano da Silveira
203 05522-010
Sao Paulo BRAZIL
TEL: (011) 3743 9377

CHILE

Comercial Fancy S.A.
Avenida Rancagua #0330
Providencia Santiago, CHILE
TEL: 56-2-373-9100

EL SALVADOR

OMNI MUSIC
75 Avenida Notre y Alameda
Juan Pablo 2 No. 4010
San Salvador, EL SALVADOR
TEL: (503) 262-0788

MEXICO

Casa Veerkamp, s.a. de c.v.
Av. Toluca No. 323 Col. Olivar de
los Padres 01780 Mexico D.F.
MEXICO
TEL: (525) 668 04 80

La Casa Wagner de

Guadalajara s.a. de c.v.
Av. Corona No. 202 S.J.
Guadalajara, Jalisco Mexico
C.P.4100 MEXICO
TEL: (3) 613 1414

PANAMA

Productos Superiores, S.A.
Apartado 655 - Panama 1
REP. DE PANAMA
TEL: (507) 270-2200

URUGUAY

Todo Musica
Cuareim 1488, Montevideo,
URUGUAY
TEL: 5982-924-2335

VENEZUELA

Musicaland Digital C.A.
Av. Francisco de Miranda,
Centro Parque de Cristal, Nivel
C2 Local 20 Caracas
VENEZUELA
TEL: (02) 285 9218

EUROPE

AUSTRIA

Roland Austria GES.M.B.H.
Siemensstrasse 4, P.O. Box 74,
A-6063 RUM, AUSTRIA
TEL: (0512) 26 44 260

BELGIUM/HOLLAND/ LUXEMBOURG

Roland Benelux N. V.
Houtstraat 3 B-2260 Orvel
(Westerlo) BELGIUM
TEL: (014) 575811

DENMARK

Roland Scandinavia A/S
Nordhavnsvej 7, Postbox 880
DK-2100 Copenhagen
DENMARK
TEL: (039)16 6200

FRANCE

Roland France SA
4, Rue Paul Henri SPAAK
Parc de l'Esplanade F 77 462 St.
Thibault Lagny Cedex FRANCE
TEL: 01 600 73 500

FINLAND

**Roland Scandinavia As,
Filial Finland**
Lauttasarentie 54 B
Fin-00201 Helsinki, FINLAND
TEL: (9) 682 4020

GERMANY

**Roland Elektronische
Musikinstrumente
Handelsgesellschaft mbH.**
Oststrasse 96, 22844 Norderstedt,
GERMANY
TEL: (040) 52 60090

GREECE

**STOLLAS S.A.
Music Sound Light**
155, New National Road
26422 Patras, GREECE
TEL: 061-435400

HUNGARY

Intermusica Ltd.
Warehouse Area 'DEPO' Pl.83
H-2046 Torokbalint, HUNGARY
TEL: (23) 511011

IRELAND

Roland Ireland
Audio House, Belmont Court,
Donnybrook, Dublin 4,
Republic of IRELAND
TEL: (01) 2603501

ITALY

Roland Italy S. p. A.
Viale delle Industrie, 8
20020 Aresè Milano, ITALY
TEL: (02) 937-78300

NORWAY

**Roland Scandinavia Avd.
Kontor Norge**
Lilleakerveien 2 Postboks 95
Lilleaker N-0216 Oslo
NORWAY
TEL: 273 0074

POLAND

P. P. H. Brzostowicz
UL. Gibraltarska 4,
PL-03664 Warszawa POLAND
TEL: (022) 679 44 19

PORTUGAL

**Tecnologias Musica e Audio,
Roland Portugal, S.A.**
RUA SANTA CATARINA
131 - 4000 Porto-PORTUGAL
TEL: (02) 208 44 56

ROMANIA

FBS LINES
Plata Libertatii 1,
RO-4200 Cheorgheni
TEL: (066) 164-609

RUSSIA

Slami Music Company
Sadovaya-Triumfalnaja st., 16
103006 Moscow, RUSSIA
TEL: 095 209 2193

SPAIN

**Roland Electronics
de España, S. A.**
Calle Bofivia 239(08020) Barcelona,
SPAIN
TEL: (93) 308 1000

SWEDEN

**Roland Scandinavia A/S
SWEDISH SALES OFFICE**
Danvik Center 28, 2 tr.
S-131 30 Nacka SWEDEN
TEL: (08) 702 0020

SWITZERLAND

**Roland (Switzerland) AG
Musitronic AG**
Gerberstrasse 5, CH-4110 Liestal,
SWITZERLAND
TEL: (061) 921 1615

UKRAINE

TIC-TAC
Mira Str. 19/108
P.O. Box 180
295400 Munkachevo, UKRAINE
TEL: (03131) 414-40

UNITED KINGDOM

Roland (U.K.) Ltd.
Atlantic Close, Swansea
Enterprise Park SWANSEA
SA7 9FJ,
UNITED KINGDOM
TEL: (01792) 700139

MIDDLE EAST

BAHRAIN

Moon Stores
Bab Al Bahrain Road,
P.O. Box 20077
State of BAHRAIN
TEL: 211 005

CYPRUS

Radex Sound Equipment Ltd.
17 Diagonou St., P.O. Box 2046,
Nicosia CYPRUS
TEL: (02) 453 426

ISRAEL

**Halilit P. Greenspoon &
Sons Ltd.**
8 Retzif Fa'aliya Hashnya St
Tel-Aviv-Yahv ISRAEL
TEL: (03) 6823666

JORDAN

AMMAN Trading Agency
Prince Mohammed St. P.O. Box
825 Amman 11118 JORDAN
TEL: (06) 4641200

KUWAIT

Easa Husain Al-Yousifi
P.O. Box 126 Safat 13002
KUWAIT
TEL: 5719499

LEBANON

A. Chahine & Fils
P.O. Box 16-5857 Gergi Zeidan St.
Chahine Building, Achrafieh
Beirut, LEBANON
TEL: (01) 335799

OMAN

**OHI Electronics & Trading
Co. LLC**
P.O. Box 889 Muscat
Sultanate of OMAN
TEL: 959085

QATAR

Badie Studio & Stores
P.O. Box 62,
DOHA QATAR
TEL: 423554

SAUDI ARABIA

**aDawlah Universal
Electronics APL**
P.O. Box 2154 ALKHOBAR 31952,
SAUDI ARABIA
TEL: (03) 898 2081

SYRIA

**Technical Light & Sound
Center**
Khaled Ibn Al Walid St.
P.O. Box 13520
Damascus - SYRIA
TEL: (011) 2235 384

TURKEY

**Barkat Muzik aletleri ithalat
ve ihracat limited ireketi**
Siraselviler Cad. Billurcu Sok.
Mucaddele Cikmeze No. 11-13
Taksim, Istanbul, TURKEY
TEL: (0212) 2499324

U.A.E.

**Zak Electronics & Musical
Instruments Co.**
Zabeel Road, Al Sherooq Bldg.,
No. 14, Grand Floor DUBAI
U.A.E.
P.O. Box 8050 DUBAI, U.A.E.
TEL: (04) 360715

NORTH AMERICA

CANADA

**Roland Canada Music Ltd.
(Head Office)**
5480 Parkwood Way Richmond
B. C., V6V 2M4 CANADA
TEL: (0604) 270 6626

Roland Canada Music Ltd.

(Toronto Office)
Unit 2, 109 Woodbine Downs
Blvd, Etobicoke, ON
M9W 6Y1 CANADA
TEL: (0416) 213 9707

U. S. A.

Roland Corporation U.S.
5100 S. Eastern Avenue
Los Angeles, CA 90040-2938,
U. S. A.
TEL: (323) 890 3700



For EU Countries

This product complies with the requirements of European Directives EMC 89/336/EEC and LVD 73/23/EEC.

For the USA

FEDERAL COMMUNICATIONS COMMISSION RADIO FREQUENCY INTERFERENCE STATEMENT

This equipment has been tested and found to comply with the limits for a Class B digital device, pursuant to Part 15 of the FCC Rules. These limits are designed to provide reasonable protection against harmful interference in a residential installation. This equipment generates, uses, and can radiate radio frequency energy and, if not installed and used in accordance with the instructions, may cause harmful interference to radio communications. However, there is no guarantee that interference will not occur in a particular installation. If this equipment does cause harmful interference to radio or television reception, which can be determined by turning the equipment off and on, the user is encouraged to try to correct the interference by one or more of the following measures:

- Reorient or relocate the receiving antenna.
- Increase the separation between the equipment and receiver.
- Connect the equipment into an outlet on a circuit different from that to which the receiver is connected.
- Consult the dealer or an experienced radio/TV technician for help.

Unauthorized changes or modification to this system can void the users authority to operate this equipment.
This equipment requires shielded interface cables in order to meet FCC class B Limit.

For Canada

NOTICE

This Class B digital apparatus meets all requirements of the Canadian Interference-Causing Equipment Regulations.

AVIS

Cet appareil numérique de la classe B respecte toutes les exigences du Règlement sur le matériel brouilleur du Canada.

 Roland®

71675745

UPC

71675745



:8981