



Roland

KR-777/177

DIGITAL INTELLIGENT PIANO

Owner's Manual

	CAUTION RISK OF ELECTRIC SHOCK DO NOT OPEN	
ATTENTION: RISQUE DE CHOC ELECTRIQUE NE PAS OUVRIR		
CAUTION: TO REDUCE THE RISK OF ELECTRIC SHOCK, DO NOT REMOVE COVER (OR BACK). NO USER-SERVICEABLE PARTS INSIDE. REFER SERVICING TO QUALIFIED SERVICE PERSONNEL.		



The lightning flash with arrowhead symbol, within an equilateral triangle, is intended to alert the user to the presence of uninsulated "dangerous voltage" within the product's enclosure that may be of sufficient magnitude to constitute a risk of electric shock to persons.



The exclamation point within an equilateral triangle is intended to alert the user to the presence of important operating and maintenance (servicing) instructions in the literature accompanying the product.

INSTRUCTIONS PERTAINING TO A RISK OF FIRE, ELECTRIC SHOCK, OR INJURY TO PERSONS.

IMPORTANT SAFETY INSTRUCTIONS

SAVE THESE INSTRUCTIONS

WARNING - When using electric products, basic precautions should always be followed, including the following:

1. Read all the instructions before using the product.
2. Do not use this product near water — for example, near a bathtub, washbowl, kitchen sink, in a wet basement, or near a swimming pool, or the like.
3. This product should be used only with a cart or stand that is recommended by the manufacturer.
4. This product, either alone or in combination with an amplifier and headphones or speakers, may be capable of producing sound levels that could cause permanent hearing loss. Do not operate for a long period of time at a high volume level or at a level that is uncomfortable. If you experience any hearing loss or ringing in the ears, you should consult an audiologist.
5. The product should be located so that its location or position does not interfere with its proper ventilation.
6. The product should be located away from heat sources such as radiators, heat registers, or other products that produce heat.
7. The product should be connected to a power supply only of the type described in the operating instructions or as marked on the product.
8. The power-supply cord of the product should be unplugged from the outlet when left unused for a long period of time.
9. Care should be taken so that objects do not fall and liquids are not spilled into the enclosure through openings.
10. The product should be serviced by qualified service personnel when:
 - A. The power-supply cord or the plug has been damaged; or
 - B. Objects have fallen, or liquid has been spilled onto the product; or
 - C. The product has been exposed to rain; or
 - D. The product does not appear to operate normally or exhibits a marked change in performance; or
 - E. The product has been dropped, or the enclosure damaged.
11. Do not attempt to service the product beyond that described in the user-maintenance instructions. All other servicing should be referred to qualified service personnel.

For the USA

This product may be equipped with a polarized plug (one blade wider than the other). This is a safety feature. If you are unable to insert the plug into the outlet, contact an electrician to replace your obsolete outlet. Do not defeat the safety purpose of the plug.

For Canada

For Polarized Line plug

CAUTION: TO PREVENT ELECTRICK SHOCK, MATCH WIDE BLADE OF PLUG TO WIDE SLOT, FULLY INSERT.

ATTENTION: POUR ÉVITER LES CHOCS ÉLECTRIQUES, INTRODUIRE LA LAME LA PLUS LARGE DE LA FICHE DANS LA BORNE CORRESPONDANTE DE LA PRISE ET POUSSER JUSQU'AU FOND.

For the UK

IMPORTANT:THE WIRES IN THIS MAINS LEAD ARE COLOURED IN ACCORDANCE WITH THE FOLLOWING CODE.

BLUE: NEUTRAL
 BROWN: LIVE

As the colours of the wires in the mains lead of this apparatus may not correspond with the coloured markings identifying the terminals in your plug, proceed as follows:
 The wire which is coloured BLUE must be connected to the terminal which is marked with the letter N or coloured BLACK.
 The wire which is coloured BROWN must be connected to the terminal which is marked with the letter L or coloured RED.

Assembling the KR-777

! Please consult your Roland dealer to assemble the piano. Roland cannot warrant the safety of the assemble operation, if this operation is carried out by the customer.

! As the piano and stand are very heavy, always use at least three people when moving the KR-777, and be sure to handle it carefully. The piano must be carefully placed on a stable and level surface.

Check the Parts

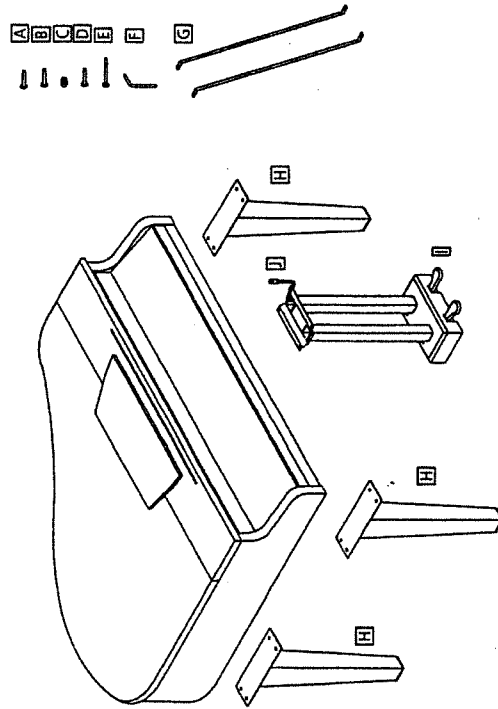

Before you begin assembling the stand, check whether the following parts were supplied.

[A]	Black M6 x 20 screws	4
[B]	Black M6 x 30 screws	12
[C]	Black washers	12
[D]	Golden M6 x 25 screws	2
[E]	Golden M6 x 40 screws	2
[F]	Hexagonal wrench	1
[G]	Lyre support sticks	2
[H]	Legs	3
[I]	Lyre assembly	1

Assembly

Attach the stands (legs) to the piano

1. Position the legs [H] in place beneath the piano.
2. Use the hexagonal wrench [F] to fasten the first leg to the piano (at four points) with the screws [D] and washers [C].
3. Fasten the remaining two legs [H] to the piano in the same fashion.

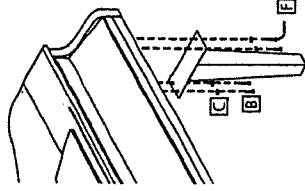

Attach the lyre assembly

4. Position the lyre assembly underneath the front part (below the keyboard, see also the illustration to the left) of the KR-777.
5. Connect the protruding pedal cable jack [G] to the PEDAL socket on the KR-777's bottom panel.
6. Using the screws [A], fasten the lyre assembly to the piano (at four points). Tighten the screws firmly with the hexagonal wrench.
7. Using the screws [E], fasten the lyre support sticks to the lyre box [I] (at one point each).
8. Using the screws [D], fasten the lyre support sticks [G] to the piano (at one point each).
9. Turn out the adjuster screw underneath the pedal unit (on the lyre assembly) until it firmly touches the ground, and until the pedal no longer gives way when you press a pedal.

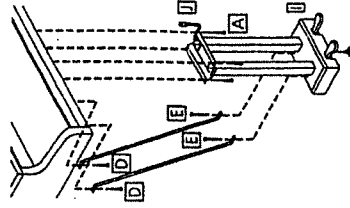

Connecting the Power Cord

1. Connect the supplied power cord to the AC inlet socket.
2. Plug the power cord into a wall outlet.

Please keep this leaflet together with the Owner's Manual so that you can quickly refer to it again when necessary. Also be sure to keep the hexagonal wrench in a safe place.

Montage du KR-777



Confiez le montage du piano exclusivement à un revendeur Roland. Roland ne peut pas garantir la sécurité du montage si ce dernier est effectué par l'utilisateur.



Vu le poids très important du piano et du stand, veuillez toujours à disposer d'au moins trois personnes pour déplacer le KR-777 et effectuez tout déplacement avec une prudence extrême. Déposez le piano précautionneusement sur un sol stable et de niveau.

Vérification des éléments

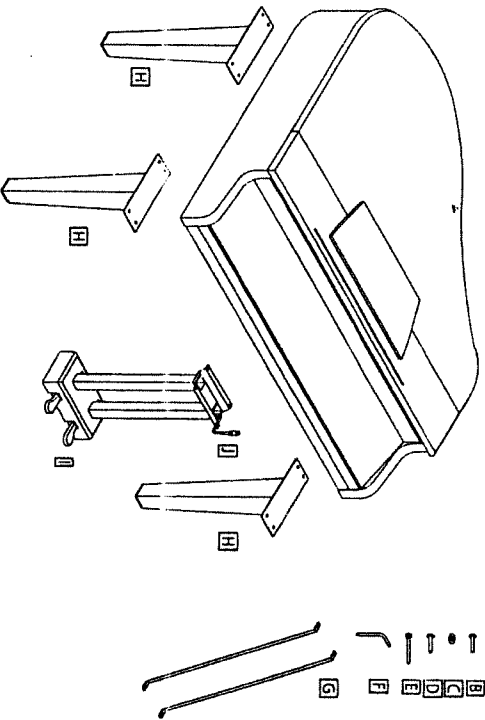

[A]	Vis noire M6 x 20	4
[B]	Vis noire M6 x 30	12
[C]	Rondelle noire	12
[D]	Vis dorée M6 x 25	2
[E]	Vis dorée M6 x 40	2
[F]	Clé hexagonale	1
[G]	Tige de support de la lyre	2
[H]	Pied	3
[I]	Lyre	1

Avant d'entamer le montage du stand, vérifiez si vous disposez bien des pièces ci-dessous.

Montage

Montage des pieds sur le piano

1. Mettez les pieds [H] en place sous le piano.
2. Fixez le premier pied au piano en montant les vis [B] et rondelles [C] à l'aide de la clé hexagonale [F] (en quatre points).
3. Fixez les deux pieds restants [H] au piano de la même manière.

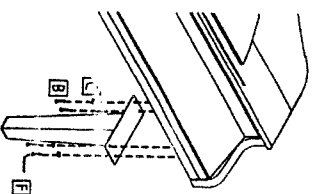

Montage de la lyre

4. Placez la lyre sous le côté avant (en dessous du clavier; voyez aussi l'illustration à gauche) du KR-777.
5. Connectez le câble de pédale [I] ressortant de la lyre à la prise PEDAL du panneau inférieur du KR-777.
6. Fixez la lyre sur le piano (en quatre points) avec les vis [A]. Serrez fermement les vis à l'aide de la clé hexagonale.
7. Fixez les tiges de support de la lyre au boîtier de lyre [D] (chacune en un point) avec les vis [E].
8. Fixez ensuite les tiges de support de la lyre [G] au piano (chacune en un point) avec les vis [D].
9. Desserrez la vis de réglage sous le pédalier (de la lyre) jusqu'à ce qu'il soit parfaitement stable et ne glisse plus quand vous enfoncez une pédale.

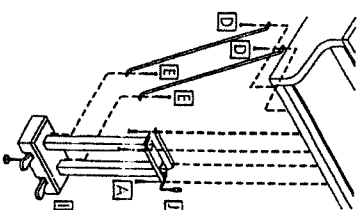

Branchement au secteur

1. Branchez le cordon secteur fourni à la prise A.C.
2. Branchez l'autre bout du cordon à une prise de courant.

Conservez précieusement cette notice avec le Manuel d'utilisation car elle pourra vous être utile lors de références ultérieures. Veuillez en outre à ranger la clé hexagonale en lieu sûr.

Zusammenbau des KR-777

- ⚠ Bitte! Sie Ihren Roland-Händler, Ihnen beim Zusammenbau zumindest zu helfen. Roland haftet sich für Sachschäden oder Verletzungen, die beim Zusammenbau auftreten können.
- ⚠ Sowohl das Piano als auch die Ständerbeine sind ausgesprochen schwer. Deswegen sollten mindestens drei Personen für den Zusammenbau des KR-777 zur Verfügung stehen. Gehen Sie mit äußerster Vorsicht vor. Stellen Sie das Piano auf eine stabile und ebene Oberfläche.

Kontrolle des Lieferumfangs

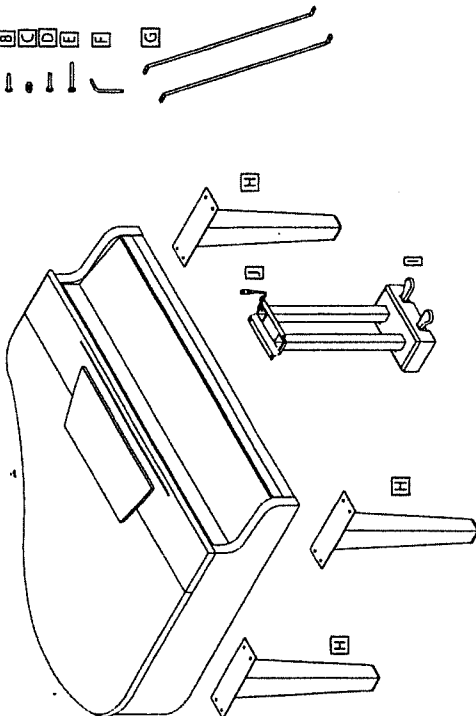

Kontrollieren Sie vor dem Zusammenbau, ob folgende Gegegenstände vorhanden sind:

[A]	Schwarze M6 x 20-Schrauben	4
[B]	Schwarze M6 x 30-Schrauben	12
[C]	Schwarze Ringe	12
[D]	Goldene M6 x 25-Schrauben	2
[E]	Goldene M6 x 40-Schrauben	2
[F]	Sechskantschraubenschlüssel	1
[G]	Stützen der Pedaleinheit	2
[H]	Beine	3
[I]	Pedaleinheit	1

Montage Befestigen Sie die Beine am Piano

1. Ordnen Sie die Beine [H] unter dem Klavier an.
2. Schrauben Sie das erste Bein mit dem Sechskantschraubenschlüssel fest (vier Stellen). Verwenden Sie hierfür die Schrauben [B] und Ringe [C].
3. Befestigen Sie nun auch die anderen beiden Beine [H] am Piano.

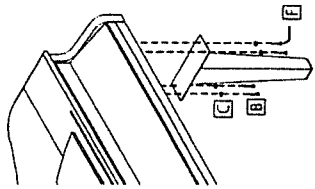

Anbringen der Pedaleinheit

4. Ordnen Sie die Pedaleinheit unter der Frontseite (unter der Tastatur, siehe auch die Abbildung links) des KR-777 an.
5. Verbinden Sie den Stecker des herausragenden Kabels [D] mit dem PEDAL-Anschluss an der Unterseite des KR-777.
6. Befestigen Sie die Pedaleinheit mit den Schrauben [A] am Piano (vier Befestigungspunkte). Drehen Sie die Schrauben mit dem Sechskantschraubenschlüssel fest.
7. Befestigen Sie die Stützen der Pedaleinheit mit den Schrauben [E] an der Pedaleinheit [I] (je ein Befestigungspunkt).
8. Verwenden Sie die Schrauben [D], um die Stützen [G] am Klavier zu befestigen (je ein Befestigungspunkt).
9. Drehen Sie die Einstellschraube unter der Pedaleinheit so weit heraus, bis sie den Boden berührt und bis sich die Einheit bei Betätigung eines Pedals nur noch minimal bewegt.

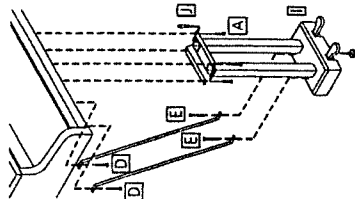

Anschließen des Netzkabels

1. Verbinden Sie das beiliegende Netzkabel mit dem AC IN-Anschluss des KR-777.
2. Schließen Sie das andere Ende an eine geeignete Steckdose an.

Bitte bewahren Sie dieses Blatt gemeinsam mit der Bedienungsanleitung auf, weil Sie es später vielleicht noch einmal brauchen. Auch den Sechskantschraubenschlüssel sollten Sie aufbewahren.

Roland



KR-777/177

DIGITAL INTELLIGENT PIANO

Owner's Manual

We'd like to take a moment to thank you for purchasing the Roland KR-777/177 Digital Intelligent Piano.

In order to enjoy reliable performance for many years to come, please take the time to read this manual in its entirety.

Main features

❑ Three instruments in one

The KR-777/177 can be used as piano, organ, or "keyboard" (i.e. a synthesizer with automatic accompaniment) – all at the touch of a button.

❑ 270 Tones (sounds) and 111 Styles built-in

Support for a wide range of musical genres. Additional "Acoustic" Styles are provided on the included Style disk.

❑ Piano Tones that rely on stereo sampling

The technology used ensures that your KR-777/177 provides some of the finest concert grand piano sounds available on electronic musical instruments.

❑ 64-voice polyphony

Up to 64 voices can be played simultaneously. (In most instances your KR-777/177 is 64-voice polyphonic.)

❑ Simple yet versatile Composer

Simple recording.
Playback of commercial music data.
A comprehensive Composer menu:

- 16-track Sequencer
- Chord Sequencer
- Song Edit
- Style Composer
- Style Converter

❑ GM (General MIDI) and GS compatible

• General MIDI System

The General MIDI System is a set of recommendations which seeks to standardize the MIDI support features of sound generating devices. Sound generating devices and musical data (disks) carrying the General MIDI logo conform to the General MIDI specifications. This means that whenever you play back music data marked with the General MIDI logo, the musical response will be identical when played on any device which also carries the General MIDI logo.

• GS Format

Roland developed the GS Format to standardize the response of sound generators when MIDI is used for the production of music. By using a GS Format sound generating device, you can be assured that you will always obtain a faithful, high-quality rendition of any commercially available music data that carries the GS Format logo.

The KR-777/177's tone generator fully supports both the General MIDI system and the GS Format—so you can use music data that is designed for either standard.

❑ Reads and writes SMF Music Data

The KR-777/177 is capable of playing Standard MIDI Files, such as "SMF Music Data" (720 KB/1.44 MB format 3.5 inch floppy disks).

Copyright © 2001 ROLAND EUROPE spa.



All rights reserved. No part of this publication may be reproduced in any form without the written permission of ROLAND EUROPE spa.



Contents

1. Important notes	5	10. Function Menu	40
2. Panel descriptions	6	10.1 Piano screen functions	40
3. Before using the KR-777/177	9	10.2 Organ screen functions	42
3.1 Setting up the music rest	9	10.3 Basic screen functions	42
3.2 Connecting the power cable	9	11. User Programs, Pad buttons, pedals	43
3.3 Turning the instrument on and off	9	11.1 User Program: registering panel settings	43
3.4 Using headphones	9	11.2 Pad buttons: additional or frequently used functions	44
3.5 Connecting external amplifiers and other devices	9	11.3 Pedal functions	45
3.6 Opening and closing the top (KR-777)	10	12. Utility Menu	46
3.7 About the adjuster	10	12.1 Operating procedure	46
4. Basic operation and display	11	12.2 Utility functions	46
5. Overview of the KR-777/177	12	Master Tune	46
5.1 Introduction of the main functions — [DEMO]	12	Key Touch/Key Transpose	46
5.2 Performance functions	13	Metronome Volume and Beat	47
5.3 Playing back songs on disk	16	Selecting a different Reverb and/or Chorus effect	47
5.4 Pitch Bend and Transpose	17	Expansion Tone	47
6. Tones and related functions	18	Lyric: switching off the display of lyrics	47
6.1 Selecting Tones	18	Pitch Bend Range	47
Drum sounds and sound effects — [DRUMS/SEFX]	18	Program Change (and Bank Select)	48
Adding effects to Tones	19	MIDI: TX MIDI Ch./Local Control	48
Octave Shift: changing the pitch by octaves	19	User Program Arranger Update	49
6.2 Keyboard modes	20	Memory Backup	49
7. Playing with accompaniment (Arranger) ..	22	Factory Preset (initialization)	49
7.1 What is an Arranger?	22	Link to 16TRK Sequencer	49
7.2 Selecting Music Styles	23	13. Connecting MIDI instruments	50
7.3 Starting and stopping Styles	24	14. Appendix	51
7.4 Style tempo	25	14.1 DSP effects	51
7.5 Accompaniment and melody volume balance	25	14.2 Specifications	51
7.6 Switching Style arrangements (divisions)	26	Tones, Drum Sets, Music Styles	156
7.7 Easy fingering – Chord Intelligence	27		
7.8 Melody Intelligence	28		
8. Recording and Playback	29		
8.1 Recording	29		
8.2 Playing back a Composer song	31		
8.3 Track Mute: Muting specific tracks	31		
8.4 Playing back songs without tempo changes	31		
8.5 Erasing the Composer song	31		
8.6 Saving a song to disk	32		
9. Composer Menu	32		
9.1 16-track Sequencer	32		
9.2 Chord Sequencer	33		
9.3 Recording Mode	34		
9.4 Formatting disks	34		
9.5 Style Composer	35		
9.6 Style Converter	36		
9.7 Saving User Styles	37		
9.8 Song Edit	37		







USING THE UNIT SAFELY

INSTRUCTIONS FOR THE PREVENTION OF FIRE, ELECTRIC SHOCK, OR INJURY TO PERSONS

About  WARNING and  CAUTION Notices

 WARNING	Used for instructions intended to alert the user to the risk of death or severe injury should the unit be used improperly.
 CAUTION	Used for instructions intended to alert the user to the risk of injury or material damage should the unit be used improperly. * Material damage refers to damage or other adverse effects caused with respect to the home and all its furnishings, as well to domestic animals or pets.

About the Symbols

	The  symbol alerts the user to important instructions or warnings. The specific meaning of the symbol is determined by the design contained within the triangle. In the case of the symbol at left, it is used for general cautions, warnings, or alerts to danger.
	The  symbol alerts the user to items that must never be carried out (are forbidden). The specific thing that must not be done is indicated by the design contained within the circle. In the case of the symbol at left, it means that the unit must never be disassembled.
	The  symbol alerts the user to things that must be carried out. The specific thing that must be done is indicated by the design contained within the circle. In the case of the symbol at left, it means that the power-cord plug must be unplugged from the outlet.



ALWAYS OBSERVE THE FOLLOWING

WARNING

- Before using this unit, make sure to read the instructions below, and the Owner's Manual. 

- Do not open or perform any internal modifications on the unit. 

- Do not attempt to repair the unit, or replace parts within it (except when this manual provides specific instructions directing you to do so). Refer all servicing to your retailer, the nearest Roland Service Center, or an authorized Roland distributor, as listed on the "Information" page. 

- Never use or store the unit in places that are:
 - Subject to temperature extremes (e.g., direct sunlight in an enclosed vehicle, near a heating duct, on top of heat-generating equipment); or are 
 - Damp (e.g., baths, washrooms, on wet floors); or are 
 - Humid; or are
 - Exposed to rain; or are
 - Dusty; or are
 - Subject to high levels of vibration.

- Make sure you always have the unit placed so it is level and sure to remain stable. Never place it on stands that could wobble, or on inclined surfaces. 

- The unit should be connected to a power supply only of the type described in the operating instructions, or as marked on the unit. 

- Do not excessively twist or bend the power cord, nor place heavy objects on it. Doing so can damage the cord, producing severed elements and short circuits. Damaged cords are fire and shock hazards! 

WARNING

- This unit, either alone or in combination with an amplifier and headphones or speakers, may be capable of producing sound levels that could cause permanent hearing loss. Do not operate for a long period of time at a high volume level, or at a level that is uncomfortable. If you experience any hearing loss or ringing in the ears, you should immediately stop using the unit, and consult an audiologist. 

- Do not allow any objects (e.g., flammable material, coins, pins); or liquids of any kind (water, soft drinks, etc.) to penetrate the unit. 

- In households with small children, an adult should provide supervision until the child is capable of following all the rules essential for the safe operation of the unit. 

- Protect the unit from strong impact. (Do not drop it!) 

- **For the KR-777:** When the top is open, do not put your head or any other part of your body under it. The lid could be dislodged and then fall on you. 

- **For the KR-777:** When the top is open, do not touch the topboard propstick unless you are in the process of lowering the lid to close the instrument. If you inadvertently touch the propstick, it could be loosened and the lid could fall on part of your body. 

- Do not force the unit's power-supply cord to share an outlet with an unreasonable number of other devices. Be especially careful when using extension cords—the total power used by all devices you have connected to the extension cord's outlet must never exceed the power rating (watts/ampere) for the extension cord. Excessive loads can cause the insulation on the cord to heat up and eventually melt through. 

- Before using the unit in a foreign country, consult with your retailer, the nearest Roland Service Center, or an authorized Roland distributor, as listed on the "Information" page. 

CAUTION

- The unit should be located so that its location or position does not interfere with its proper ventilation. 

- Always grasp the plug on the power-supply cord when plugging into, or unplugging from, an outlet or this unit. 

- Try to prevent cords and cables from becoming entangled. Also, all cords and cables should be placed so they are out of the reach of children. 

- Never climb on top of, nor place heavy objects on the unit. 

- Never handle the power cord or its plugs with wet hands when plugging into, or unplugging from, an outlet or this unit. 

- Before moving the instrument take note of the precautions listed below. At least two persons are required to safely lift and move the unit. It should be handled carefully, all the while keeping it level. Make sure to have a firm grip, to protect yourself from injury and the instrument from damage. 
 - Check to make sure the knob bolts securing the unit to the stand have not become loose. Fasten them again securely whenever you notice any loosening.
 - Disconnect the power cord.
 - Disconnect all cords coming from external devices.
 - Raise the adjusters on the stand.
 - Close the lid.
 - Remove the music stand.

- Before cleaning the unit, turn off the power and unplug the power cord from the outlet. 

- Whenever you suspect the possibility of lightning in your area, pull the plug on the power cord out of the outlet. 

- Be careful when opening/closing the lid so you do not get your fingers pinched. Adult supervision is recommended whenever small children use the unit. 

- Should you remove the screws fastening the stand, make sure to put them in a safe place out of children's reach, so there is no chance of them being swallowed accidentally. 

1. Important notes

In addition to the items listed under “IMPORTANT SAFETY INSTRUCTIONS” and “USING THE UNIT SAFELY”, please read and observe the following:

❑ Power supply

- Before connecting the KR-777/177 to other devices, turn off the power to all units. This will help prevent malfunctions and/or damage.
- Do not use the KR-777/177 on the same power circuit with any device that will generate line noise; an electric motor or variable lighting system for example.

❑ Placement

- This instrument may interfere with radio and television reception. Do not use this instrument in the vicinity of such receivers.
- Do not place the instrument near devices that produce a strong magnetic field (e.g., loudspeakers).
- Install the instrument on a solid, level surface.
- Do not move the instrument or subject it to vibration while the disk drive is operating.
- Do not expose the KR-777/177 to direct sunlight, place it near devices that radiate heat, leave it inside an enclosed vehicle, or otherwise subject it to temperature extremes. Excessive heat can deform or discolor the unit.

❑ Maintenance

- For everyday cleaning wipe the instrument with a soft, dry cloth or one that has been slightly dampened with water. To remove stubborn dirt, use a mild, non-abrasive detergent. Afterwards, be sure to wipe the instrument thoroughly with a soft, dry cloth.
- Never use benzene, thinners, alcohol or solvents of any kind, to avoid the possibility of discoloration and/or deformation.

❑ Repairs and data backup

- Please be aware that data contained in the KR-777/177's memory may be lost when the instrument is sent for repairs. Important data should always be backed up on a floppy disk, or written down on paper (if possible). During repairs, due care is taken to avoid the loss of data. However, in certain cases (such as when circuitry related to memory itself is out of order), we regret that it may not be possible to restore the data, and Roland assumes no liability concerning such loss of data.

❑ Additional precautions

- Please be aware that the contents of memory can be irretrievably lost as a result of a malfunction, or the improper operation of the instrument. To protect yourself against the risk of losing important data, we recommend that you periodically save a backup copy of important data to a high-quality floppy disk. Bear in mind, however, that it may be impossible to restore the contents of data that was stored on a floppy disk. Roland Corporation assumes no liability concerning such loss of data.
- Use a reasonable amount of care when operating the instrument's buttons, sliders other controls. Rough handling can lead to malfunctions.
- Never strike or apply strong pressure to the display.

- When connecting/disconnecting all cables, grasp the connector itself—never pull on the cable. This way you will avoid causing shorts, or damage to the cable wires.
- A small amount of heat will radiate from the instrument during normal operation.
- To avoid disturbing your neighbors, try to keep the instrument's volume at a reasonable level. At times, it may be preferable to use headphones.
- When you need to transport the KR-777/177, package it in the box (including padding) that it came in or use a hard or soft case.

Before using floppy disks

❑ Floppy disk drive

- Avoid using the KR-777/177 immediately after it has been moved to a location with a significantly higher or lower level of humidity. Rapid changes in the environment can cause condensation to form inside the drive, which will adversely affect the operation of the drive and/or damage floppy disks. When the instrument has been moved, switch it on and wait at least one hour before using the disk drive.
- To insert a disk, push it gently but firmly into the drive—it will click into place. To remove a disk, press the EJECT button.
- Never attempt to remove a floppy disk from the drive while the drive is operating (the indicator is brightly lit); damage could result to both the disk and the drive.
- Remove any disk from the drive before powering up or down.
- To prevent damage to the disk drive's heads, always try to hold the floppy disk in a level position (not tilted in any direction) while inserting it into the drive.

❑ Handling floppy disks

- Floppy disks contain a plastic disk with a thin magnetic coating. Microscopic precision is required to enable storage of large amounts of data on such a small surface area. To preserve their integrity, please observe the following when handling floppy disks:
- Never touch the magnetic medium inside the disk.
- Do not use or store floppy disks in dirty or dusty areas.
- Do not subject floppy disks to temperature extremes (e.g., direct sunlight in an enclosed vehicle). Recommended temperature range: 10 to 50° C (50 to 122° F).
- Do not expose floppy disks to strong magnetic fields, such as those generated by loudspeakers.

- Floppy disks have a "WRITE PROTECT" tab which can protect the disk from accidental erasure. It is recommended that the tab be kept in the PROTECT position, and moved to the WRITE position only when you wish to write new data onto the disk.

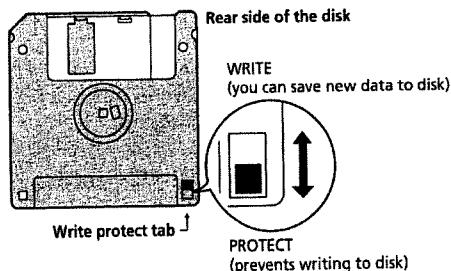

- Disks containing important performance data for this unit should always be locked (have their write protect tab slid to the "Protect" position) before you insert them into the drive of another instrument (except the PR-300, or a product of the HP-G, MT, KR, or Atelier families), or into a computer's drive. Otherwise, when performing any disk operations (such as checking the contents of the disk, or loading data), you risk rendering the disk unreadable by the KR-777/177's disk drive.
- The identification label should be firmly affixed to the disk. If the label comes loose while the disk is in the drive, it may be difficult to remove the disk.
- Put the disk back into its case for storage.

2. Panel descriptions

2.1 Front panel

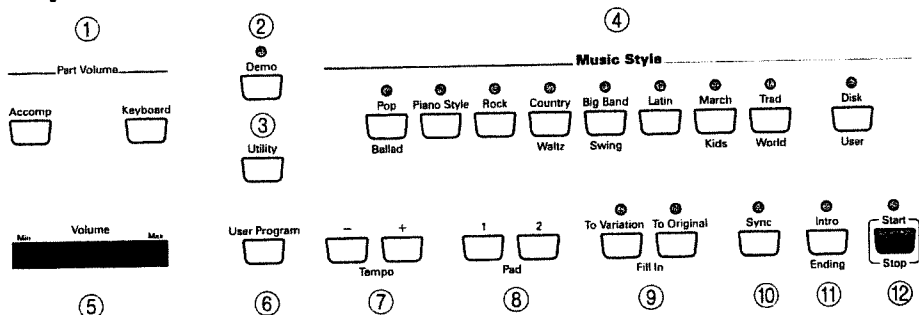

① Part Volume ACCOMP and KEYBOARD buttons

Use the [ACCOMP] button to set the volume of each individual accompaniment part. The [KEYBOARD] button provides access to a display page where you can set the volume of the part(s) played via the keyboard.

② DEMO button

This button provides access to an on-screen Help function with explanations of the KR-777/177's functions, games allowing you to identify sounds and chords, etc. It also allows you to listen to the internal demo songs.

③ UTILITY button

Press this button to access the KR-777/177's Utility functions (see "Utility Menu" on page 46).

④ MUSIC STYLE buttons

Use these buttons to select Music Style groups. Refer to "Internal Music Styles & Disk Styles" at the end of this manual.

⑤ VOLUME slider

Adjusts the instrument's overall volume.

⑥ USER PROGRAM button

Press this button if you wish to write the panel settings to a User Program or recall the panel settings for a given song.

⑦ TEMPO buttons

Use these buttons to adjust the tempo of the selected Music Style or of the song you are playing back.

⑧ PAD buttons

Various functions can be assigned to these buttons (see "Pad buttons: additional or frequently used functions" on page 44).

⑨ FILL IN buttons

These buttons have two functions: you can use them to select the accompaniment pattern for a Music Style or to switch from the accompaniment pattern to a Fill-In during a performance.

⑩ SYNC button

Allows you to start a Music Style by playing on the keyboard.

11 INTRO/ENDING button

Press this button when you want to start a Style performance with an introduction, or to stop Music Style playback with a musical ending.

12 START/STOP button

Used to start or stop a Style performance.

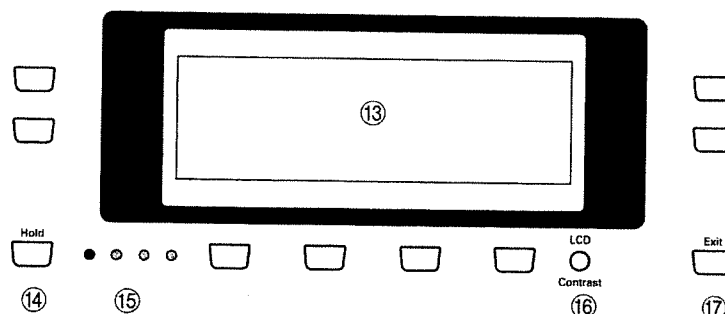

13 Display and related buttons

The display shows all the information you need in a given situation. The soft keys next to the display (whose function varies according to the selected display page) allow you to select one of the available menu options.

14 HOLD button

In most cases, the selected display page will disappear after a few seconds. Press this button to "lock" the currently selected display page. Press it again to release the Hold function, or [EXIT] to leave it right away.

15 Tempo indicators

These indicators flash in the rhythm of the selected Music Style, sequence, or Song to indicate the tempo and time signature. Depending on the time signature, not all indicators may be used, or the last indicator may flash several times (e.g. for 6/8).

16 LCD Contrast knob

Use this knob to change the contrast whenever the display is difficult to read.

17 EXIT button

Press this button to return to the previous display page or the Master page.

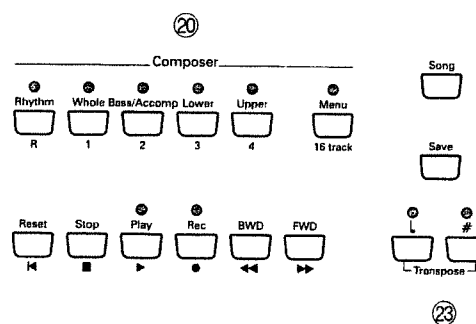
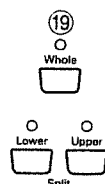
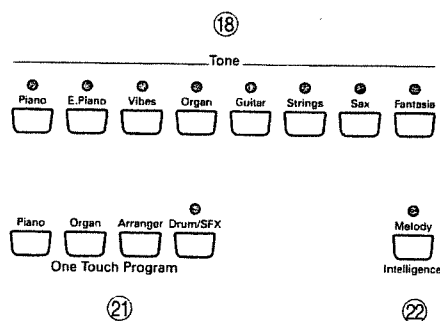

18 TONE buttons

Used to select a Tone Group (see "Selecting Tones" on page 18).

19 Keyboard Mode buttons (Whole, Lower, Upper)

Use these buttons to select whether you want to play one sound (Tone) on the entire keyboard ("Whole"), or one sound for the left hand and another one for the right hand.

20 COMPOSER section

Use these buttons to control the on-board sequencer (called *Composer*).

21 ONE TOUCH PROGRAM buttons

These buttons allow you to instantly recall the appropriate settings for the music you want to play.

22 MELODY INTELLIGENCE button

Press this button to add a harmony to the melody you play.

23 TRANSPOSE [b]/[#] buttons

Change the key of the music being played.

24 POWER switch (left side)

Press this button to switch the KR-777/177 on and off.

25 Disk drive (right side)

Used for playing back material recorded on floppy disks, or saving and loading songs or settings to/from disk.

Ⓜ PHONES jacks (left, below the keyboard)

This is where you can connect two pairs of headphones (preferably Roland RH-25 or RH-50). Connecting a pair of headphones to one of the PHONES jacks turns off the built-in speakers.

2.2 Connections

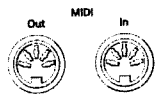

①



②

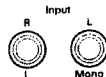

③

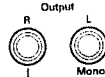

④

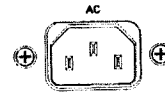

⑤

① MIDI connectors (IN/OUT)

Use these connectors to exchange MIDI data with external MIDI devices.

② PEDAL jack

This is where you can connect the pedal cable of the stand.

③ INPUT R/L (MONO) jacks

This is where you can connect the audio outputs of another MIDI instrument, a CD or cassette player, etc. The signals of that audio source will be amplified and mixed with the KR-777/177's own audio signals.

④ OUTPUT R/L (MONO) jacks

To connect the KR-777/177 to an external amplifier or mixing console, or to record your music with a tape recorder, connect these jacks to the external device (see "Sending audio to external equipment" on page 9).

⑤ AC IN

The supplied power cord connects here.

3. Before using the KR-777/177

3.1 Setting up the music rest

The music rest sets up easily with two sections folding to the inside. To put the stand away, hold it firmly with your hands, undo the fittings, and slowly collapse the rest.

3.2 Connecting the power cable

1. Set the [POWER] switch on the front panel (left side) to the OFF position.
2. After plugging the power cable included with your instrument into the AC IN jack, plug the other end into a wall socket.

Note: If you are not going to use the instrument for some time, unplug the power cord from the socket.

3.3 Turning the instrument on and off

1. Before turning the instrument on, lower the volume with the [VOLUME] slider on the front panel.

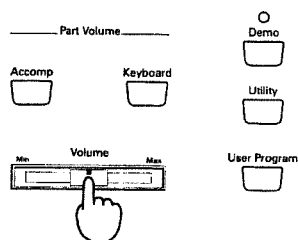

2. Press the [POWER] switch to the left of the keyboard.

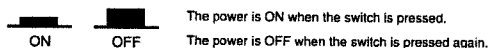

A few seconds after turning the power on you will be able to hear the notes you play on the keyboard.

Note: In order to protect its circuits, the instrument requires a few moments after powering up before it is ready for operation.

3.4 Using headphones

You can connect one or two pairs of stereo headphones (preferably Roland RH-25, RH-50) that carry the same signal as the one sent to the OUTPUT R, L/MONO jacks. Connecting a pair of headphones to one of the PHONES jacks turns off the built-in speakers. There are two jacks, so that two pairs of headphones can be connected.



LEFT SIDE (below the keyboard) Two pairs of headphones can be connected.

The volume of the headphones can be adjusted using the main [VOLUME] slider.

Note: Please use stereo headphones, preferably the Roland RH-50, RH-25.

Note: Listening at excessive volume levels for extended periods may result in impaired hearing – please take appropriate caution.

3.5 Connecting external amplifiers and other devices

If the KR-777/177's amplification system doesn't deliver enough power for your application, you can take advantage of its OUTPUT jacks.

Sending audio to external equipment

Before connecting the KR-777/177 to another piece of equipment, turn off the power to both devices.

If you wish to amplify the KR-777/177 through an external system, or record your music using a tape recorder, connect the KR-777/177's OUTPUT jacks to the AUX IN, LINE IN, or CH IN jacks of the external (keyboard) amplifier, mixer, or tape deck.

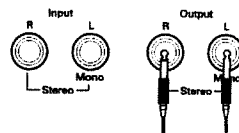

To the AUX IN/LINE IN jacks of the external amplifier/mixer, etc.

Note: If you are connecting the KR-777/177 to a device with a monaural input, be sure to use the L/MONO jack.

Note: For cassette decks or HiFi amplifiers, you need audio leads with mono jacks at one end and (usually) RCA/cinch jacks at the other.

After connecting the KR-777/177 to the amplifier, etc., be sure to switch on the KR-777/177 and the external device(s) in the following sequence:

1. First turn on the power to the KR-777/177.
2. Then turn on the power to the mixing console, amp, etc. (in that order).

Receiving audio signals from external sources

You can connect the audio outputs of an external MIDI instrument, CD or cassette player, etc., to the INPUT jacks. That has the advantage that such signals can be amplified by the KR-777/177 and are therefore also present in the headphones (if connected).

To connect an external signal source, follow the instructions above but be sure to connect the LINE OUT, etc., jacks of the external source to the KR-777/177's INPUT jacks.

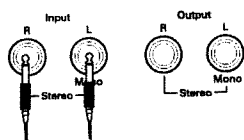

From the LINE OUT, etc., jacks of the external instrument, CD player, etc.

3.6 Opening and closing the top (KR-777)

The KR-777's lid can be raised and closed like on an acoustic grand piano. Though this is mainly intended to help you obtain a better spread of the sound, it also changes the KR-777's tone color.

1. Lift the right front (the upper-note side) of the top board with both hands, fold it up.
2. While holding up the top with one hand, lift up the top stick and insert its end into the top slip.

Here's what your KR-777 should look like once the lid is in place:

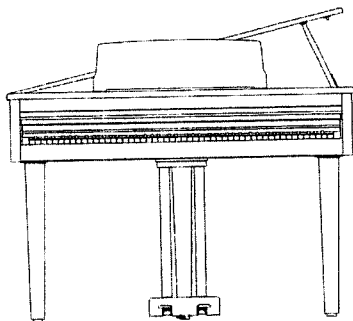

⚠ WARNING: Children must not be permitted to open or close the top on their own – adult supervision is required.

⚠ CAUTION: Always be sure to put the music stand in the upright position before opening and raising the piano top. Be sure to leave the music stand in the upright position before closing the piano top.

⚠ CAUTION: Do not move the KR-777 with the top in the open position. The top stick may disengage from the socket, causing the top to fall.

⚠ WARNING: When opening the top, be careful not to open it too far. Opening the top at an angle in excess of 45° may damage the unit, or cause the top to drop. Also, before opening the top, make sure no one is in the path of the top as it is opened.

⚠ CAUTION: When moving the piano, for safety's sake, be sure to close the lid first.

3.7 About the adjuster

After you have moved the KR-777/177, or when you feel it is unstable, lower the adjuster at the bottom of the pedal board as follows:

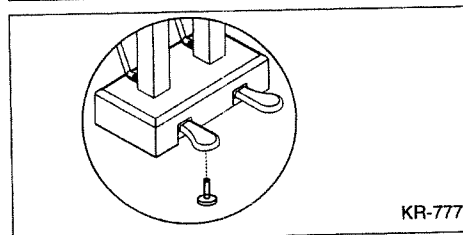
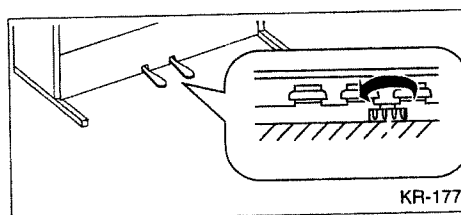

Lower the adjuster so that it is firmly in contact with the floor. If there is a gap between the adjuster and the floor, the unit may malfunction when the pedal is pressed. In particular when the instrument is placed on a carpeted floor, you must lower the adjuster so that it presses strongly against the floor.

3.8 About the lid (KR-777)

When opening the KR-777's lid, grasp it with both hands and gently lift it upwards, then slide it towards the back of the KR-777.

When closing the lid, slowly pull it forward, then gently lower it into place.

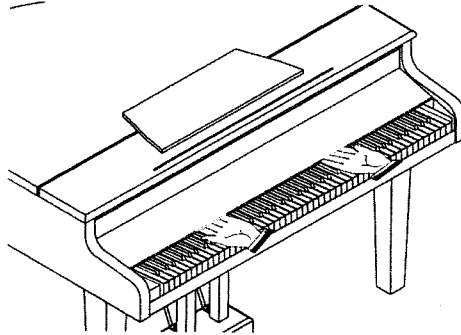

4. Basic operation and display

The KR-777/177 features a large-sized screen that keeps you informed about the status of your instrument and allows you to access functions for which there is (usually) no button or slider.

Typographic conventions used in this owner's manual

This Owner's Manual uses the following typographic conventions to indicate panel buttons and items appearing on the display.

[]— This indicates a button or slider on the panel.
Example: the TONE [PIANO] button.

< >— This indicates an item appearing on the display.
To choose such an item, press the corresponding soft button (located below or next to the item).
Example: the <Layer> button (see below).

The Basic/Home screen

Here is the display page (called *Basic screen*) that will be displayed every time you press the One Touch Program [ARRANGER] button.

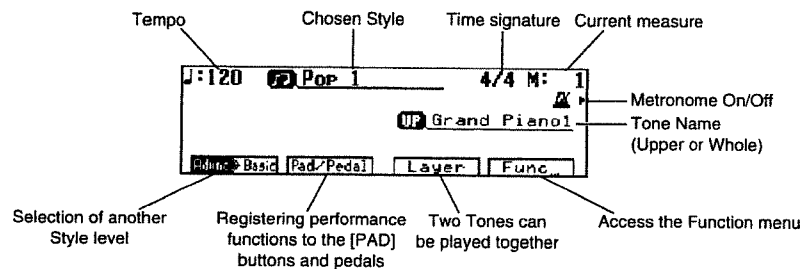

Note: If you can hardly read what is being displayed, use the CONTRAST knob to change the display contrast.

Navigating through the display pages

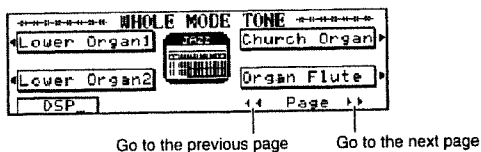

Changing screen pages— <◀◀PAGE> and <PAGE▶▶>

Some screens may comprise multiple display pages. By pressing <PAGE▶▶> you will go to the next page. Press <◀◀PAGE> to return to the previous display page.

Retaining a screen— the [HOLD] button

Some screens are only displayed for a few seconds, after which you will be returned to the previous screen, or to the Basic screen. If you do not want the screen to change, you can “lock” the current screen on the display by pressing the [HOLD] button.

Returning to the previous screen, or to the Basic screen— [EXIT] button

By pressing the [EXIT] button, you will be returned to the previous screen, or to the Basic screen.

5. Overview of the KR-777/177

5.1 Introduction of the main functions — [DEMO]

Let's take a look at the most striking features of your KR-777/177. Just follow the instructions or items that appear on the display.

1. Press the [DEMO] button.

A “Demo” screen appears on the display. The Demo screen is made up of three pages.

2. Press <▲> and <▼> to the right of the display to select another page.

The screen changes, allowing you to view the introduction to other functions.

3. Press a button below the display to choose an item. A screen showing the functions and controls of the selected item appears.

4. Press the [DEMO] button to leave the Demo screen.

Tone and Style demo — <Sound>/<Style>

To give you a better idea of the KR-777/177's Tones (sounds) and Music Styles (accompaniments) and their quality, the KR-777/177 comes with a Sound and Style Demo function. Here is how to use them.

1. On the Demo screen, press <Sound> for a demonstration of the Tones, or <Style> for an explanation and demonstration of the Music Styles.

2. Press <Demo> at the bottom right of the display.

3. Use the buttons to the left and right of the display to choose the instrument you want to hear, or press <Next> to audition the next Music Style.

A demo song using the selected Tone or Music Style is played. The number of demo songs varies according to the Tone you select. When the first song ends, the next one starts to play.

4. You can start playback of the second demo by pressing the same button (or <Next>) again.

The performance stops automatically when all songs have been played.

5. Press <Exit> or <To Menu> to stop playback.

Note: All rights reserved. Unauthorized use of the demo songs for purposes other than private enjoyment is a violation of applicable laws.

Note: The performance data of the demo songs are not transmitted to the MIDI OUT connector.

Choosing the display language

The Basic menu and part of the Demo menu can be displayed in other languages.

1. On the Demo screen, press <Language>.

2. Use the buttons to the left and right of the display to choose the language.

Note: This setting reverts to the original language when the power is switched off. If you prefer the KR-777/177 to select another language, see “Memory Backup” on page 49.

Using <Game>

The <Game> option lets you play a note- or chord-guessing game.

1. On the Demo screen, press <Game>.
2. Use the buttons at the bottom of the display to select a game.

From left to right, the games displayed are “Guess the Note”, “Guess the Chord”, and “Chord Practice.”

Guess the Note— Listen to the sound that’s played, and guess what note it is.

Guess the Chord— Listen to the chord that’s played, and guess what notes are used to make it up.

Chord Practice— Look at the chord and try to play it.

Here’s how the game progresses:

3. Use the buttons below the display to choose either “Beginner” or “Advanced”.

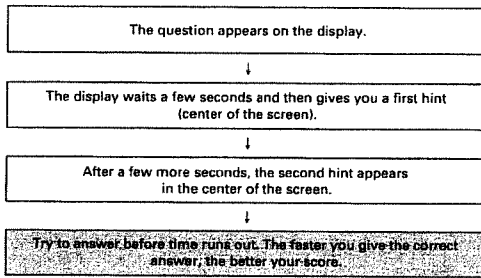

5.2 Performance functions

One Touch Program: Selecting the “instrument type”

By pressing the One Touch Program [PIANO], [ORGAN], or [ARRANGER] buttons, you will access suitable settings (registrations) for the kind of music you wish to play. To play a piano piece, for instance, press the [PIANO] button. Press [ORGAN] to transform your KR-777/177 into an organ. To play a song using the automatic accompaniment, press [ARRANGER].

Piano music — One Touch Program [PIANO]

The settings assigned to this button are loaded every time you turn the power on.

1. Press the One Touch Program [PIANO] button.

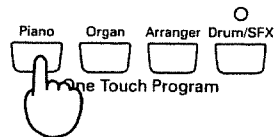

A picture of a piano will be displayed to signal that you can play a piano sound on the entire keyboard. The Tone that is selected is called “Grand Piano 1”.

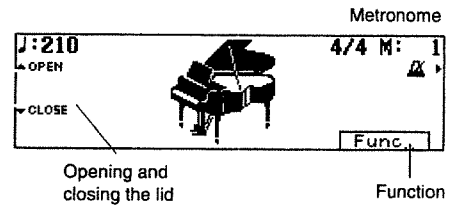

■ Adjusting the piano tone

With the KR-777/177, you can simulate changes in tone of a grand piano that come about when the piano’s lid is opened or closed.

2. Press the One Touch Program [PIANO] button, and the Piano screen will appear.

Pressing <▲Open> and <▼Close> adjusts the amount of the “opening” of the piano lid.

Each time you press the <▲Open> button, the lid of the piano shown on the screen will open more, creating a brighter tone.

Each time you press the <▼Close> button, the lid of the piano shown on the screen will close more, creating a mellower tone.

■ Using the metronome

The KR-777/177 features a metronome function. Use the metronome whenever you want to practice at a given tempo. By pressing the button to the right of the metronome icon, you can turn the metronome on and off.

When desired, adjust the tempo with the TEMPO [+] and [-] buttons. Pressing the [+] and [-] buttons simultaneously will return the keyboard to the default (preset) tempo.

Note: You can change the metronome’s volume and time signature. Please refer to “Metronome volume and beat” on page 40.

Note: The metronome always uses the same time signature (beat) and tempo as the currently selected Style.

■ Using the pedals

The KR-777/177 features a PEDAL jack where you should connect the pedals that are built into the stand. Each time you switch on the KR-777/177, or whenever you press the One Touch Program [PIANO] button, the functions of these pedals are as follows:

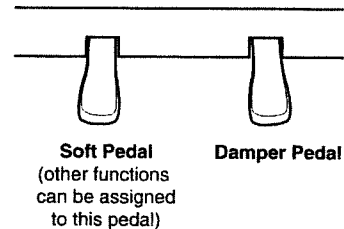

Soft (left)— Pressing the Soft pedal yields a softer tone.

Damper (right)— Press the Damper pedal to sustain all notes being played.

Note: The function of the left (Soft) pedal differs in Arranger and Split modes. See also "Pedal functions" on page 45.

■ **The Function menu** — <Func...>

This feature is used to make various useful settings for piano performances. For more detailed information, please refer to "Function Menu" on page 40.

Please note that your KR-777/177 comes with a variety of Tones (not just piano sounds). See "Selecting Tones" on page 18 for how to select them.

Organ music — One Touch Program [ORGAN]

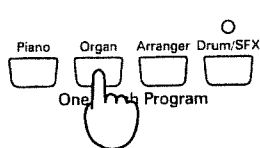

Press the One Touch Program [ORGAN] button.

A picture of an organ will appear on the screen, with the keyboard being split at F#3 into Lower (left hand) and Upper (right hand) parts.

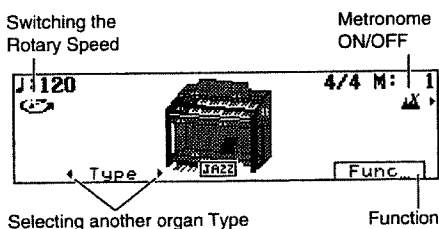

The Tones currently assigned to the left (Lower) and right (Upper) halves of the keyboard are called "Lower Organ 1" and "Jazz Organ 1". These Tones make up the Jazz Organ type. See below for how to choose another organ Type.

■ **Adjusting the Rotary Effect**

The Jazz Organ has a rotary effect added to it. This simulates the effect obtained with those famous rotary speakers that are indispensable for a true organ sound. To change the rotation speed, press of the soft button assigned to this function. Each press toggles the rotation speed between S (Slow) and F (Fast).

■ **Selecting an organ Type**

Use <◀Type> and <Type▶> to make your selection. The selected organ Type is memorized until power is turned off. In other words, if you select another One Touch Program mode and then press [ORGAN] again, the KR-777/177 will use the last organ Type you selected.

Note: When the power is switched off, the KR-777/177 reverts to "Jazz Organ".

■ **The Function menu** —<Func...>

This feature is used to make settings for the various functions related to organ performances. For more detailed information, please refer to "Function Menu" on page 40.

Accompaniment — One Touch Program [ARRANGER]

The KR-777/177 comes with an "Arranger" function that provides an automatic, yet interactive, accompaniment you can use as backing for your melodies and solos. 111 accompaniments (called Music Styles) covering all popular musical genres are built-in. Other Styles can be loaded from the supplied floppy disk, while you can also create your own Styles.

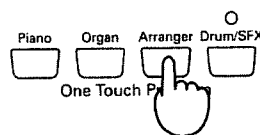

The Arranger is interactive: it always adapts the key of the accompaniments to the chords you play (see "What is an Arranger?" on page 22).

■ **Simple explanation of how to use the Arranger**

Here's what you need to do to be able to use the KR-777/177's Arranger:

1. Press the One Touch Program [ARRANGER] button.

The keyboard is now split at F#3 into a Lower (left half of the keyboard) and an Upper section (right half).

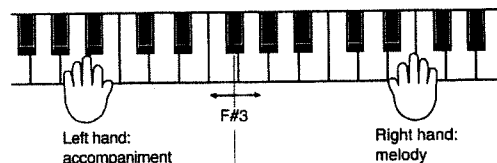

2. Select a Music Style (see "Selecting Music Styles" on page 23).

3. Play a chord in the Lower section to start the accompaniment.

Style playback starts with an introduction. Wait until the Intro is finished before you start playing the melody in the Upper section. If the accompaniment is too fast, you can slow it down with the TEMPO [-] button.

The KR-777/177 has a number of features that will facilitate playing with the Arranger:

- For major chords, you only need to press the key of the root note (see "Easy fingering – Chord Intelligence" on page 27).
- You can release the keys in the Lower section after playing the desired chord. The Arranger will go on playing in that key until you play another chord.

4. At the end of your song, press the [INTRO/ENDING] button.
 How about trying using the Arranger in a real-life situation? We've prepared a little piece you probably know. Here's what to do to play it:

Example: "When The Saints Go Marching In"

1. Press the One Touch Program [ARRANGER] button.
 The Basic screen will be displayed. The names of the chords you play in the Lower section appear on the display:

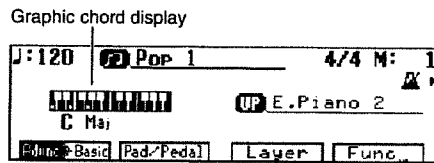

2. Press the Music Style [BIG BAND] button.
 3. From the list of Music Styles shown on the display, select <Jazz Band>.



(The Style "Jazz Band" has now been selected.) After a few seconds, the display returns to the Basic screen.

4. Start the accompaniment by pressing the C key (see the score for the chords to play).
 As explained above, this is the easy way of playing chords: by pressing the C, you actually play a C major chord.

The Arranger will start with an eight-measure Intro. Wait until the Intro is finished before playing the melody.

Here are the "chords" you need for "The Saints":

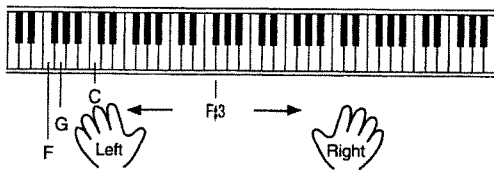

Remember that you can slow down the tempo by pressing the TEMPO [-] button. If you think the accompaniment is too slow, press TEMPO [+] instead.

Pressing the [+] and [-] buttons simultaneously will return the Arranger to the default tempo of the Jazz Band Style.

5. At the end of the song, press the [INTRO/ENDING] button.

If you want to play the song again, press the [SYNC] button and play the first chord (C).

Note: There are various ways to start and stop a Style (see "Starting and stopping Styles" on page 24).

Once you feel you master the basic version of "The Saints", try adding some variation here and there. Where "To Variation" is indicated in the music, press the Fill In [TO VARIATION] button. Of course, there is a lot more you can do with the KR-777/177's Arranger.

When The Saints Go Marching In

The image shows a musical score for "When The Saints Go Marching In" in American Traditional style. It includes a melody line and a bass line with chord diagrams. The score is divided into sections: an eight-measure intro, a main section, and a variation section. Performance instructions include "To Variation" and "Intro/Ending" buttons.

5.3 Playing back songs on disk

The KR-777/177 is fitted with a floppy disk drive. Among other things, it allows you to listen to commercially available music data (Standard MIDI Files) or to play back songs you created and saved onto disk. Here is how to listen to such music data:

Note: Before using disks, please carefully read "Before using floppy disks" on page 5.

1. Insert the music data disk into the floppy disk drive.
2. Press the [SONG] button.

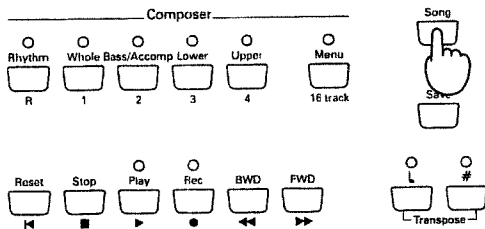

The "Song Select" function will be displayed.

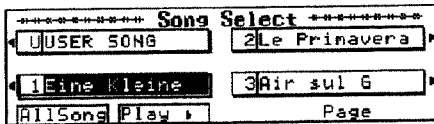

Every song you play back from disk is automatically copied to the KR-777/177's internal Composer memory. (The advantage of that is that you can remove the music data disk after listening to the song once.) If the KR-777/177's memory already contains a song, the following message appears:

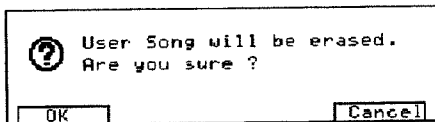

If you don't want to lose the song in the KR-777/177's internal memory, press <CANCEL> and see "Saving a song to disk" on page 32. Otherwise, press <OK>.

Selecting and playing back Songs

3. Use the buttons next to the display to select the song you want to listen to.

If not all songs of the disk fit on one page, use <<<PAGE> and <PAGE>>> to jump to the desired Song Select page.

4. Press <Play> or the [PLAY] button.

The performance will begin. After several seconds, the display returns to previous screen.

Note: For songs that do not begin on the downbeat of the first measure, "PU" (Pickup) will be displayed when the song begins. After that, measure numbers will be displayed.

5. Playback stops automatically at the end of the song.

You can stop playback any time by pressing <STOP> or the [STOP] button.

If you press the [RESET] button, playback stops and the song is rewound to the beginning of the first measure.

Listening to all songs one after another

6. Press <All Song>.

The entire group of songs will begin playing in order. The set will repeat if you do not stop the performance.

7. To stop playback, press <STOP> or the [STOP] button.

If you press the [RESET] button, playback stops and the song is rewound to the beginning of the first measure.

Rewinding and fast forwarding

By pressing the [FWD] and [BWD] buttons, you can advance to later measures or return to previous ones. Doing so allows you to start playback from the desired measure.

Each press of one of the buttons moves you ahead or back one measure at a time, and when you hold the button down, the movement is continuous.

Note: Depending on the size of the song data, rewinding and fast forwarding may take some time.

Note: It is also possible to mute one of the song parts and play it yourself. See "Track Mute: Muting specific tracks" on page 31.

Note: The KR-777/177 provides a function for practising difficult passages. Such passages can be marked and repeated over and over. See "Marker function: repeatedly playing back the same section" on page 41.

5.4 Pitch Bend and Transpose

The KR-777/177's left pedal (Soft) can be used to bend the notes you play. To do so, you must assign it the Pitch Bend function (see "Pedal functions" on page 45 for details) and specify whether you want to bend the notes upward ("Bend Up") or downward ("Bend Down"). Furthermore, you must set the "Pitch Bend Range" (see page 47), i.e. the interval (or number of semitones) by which the notes will be shifted when you press the Soft pedal.

If you are playing a C and want to shift it to D by pressing the pedal, set Pitch Bend Range to "2" (two semitones, i.e. one whole tone) and select "Bend Up" as *Pedal Assign* function. To bend to the G *below* the C you are playing, set the Range value to "5" and *Pedal Assign* to "Bend Down" (select "7" and "Bend Up" to shift to the G *above* the C).

If you find the key of a song difficult to sing in, select a different one with the TRANSCOPE [b]/[#] buttons.

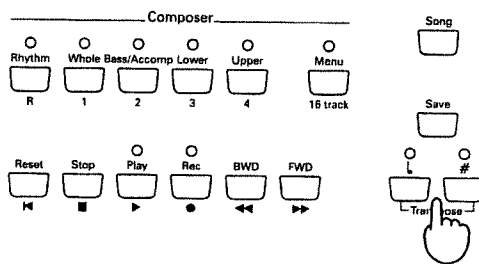

Each time you press the [b] button, the key will be lowered a semitone; each time you press the [#] button, the key will be raised a semitone. Pressing the [b]/[#] buttons simultaneously will return the song to the original key.

Note: The transposition interval can also be set via the display. See "Key Touch/Key Transpose" on page 46.

6. Tones and related functions

6.1 Selecting Tones

The KR-777/177 comes with a host of instrument sounds (called Tones). These Tones are divided into eight categories, called Groups.

Selecting "normal" Tones

1. Press the TONE button of the Group that contains the Tone you need.

The button's indicator will go on, and a Tone select screen (e.g. Whole Mode Tone) will be displayed.

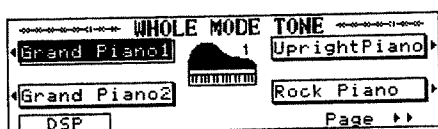

Each Tone Group contains a varying number of Tones.

2. Select a Tone by pressing the buttons to the side of the display screen.

The name of the Tone selected will be highlighted on the display. Play a few notes on the keyboard to confirm that the Tone is what you had in mind.

The Tone Select screen is composed of multiple pages. Use <<<PAGE> and <PAGE>>> to turn to another page.

Note: If you want to try out several Tones from a Tone Group, pressing the [HOLD] button will lock the Tone Select screen and keep it from vanishing after a few seconds of inaction.

Note: See "Normal Tones" at the end of this manual for the number and kinds of Tones each Group contains.

You may wonder why we use "Normal Tones" rather than just "Tones". That is because the above procedure does not provide access to all Tones the KR-777/177 contains. See "Selecting Expansion Tones" for more details about how to access all Tones.

Note: See also "Selecting Tones for the Upper and Lower parts" on page 21 for how to assign Tones in Split mode.

Selecting Expansion Tones

Expansion Tones can only be assigned to the Upper part (Whole Keyboard, Split, and Arranger modes).

Caution—Expansion Tones are only temporarily selected and cannot be written to a User Program (see page 43). Whenever you select another mode (for example, if you change from Whole mode to Split mode), the Upper part returns to last "normal" Tone you selected.

1. Press [UTILITY] and use <<<PAGE> or <PAGE>>> to select the following display page.

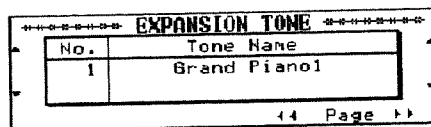

2. Use the buttons to the left and right of the display to select a Tone.

See "Expansion Tones" at the end of this manual for a list of the available Tones.

Note: You can use Expansion Tones for recording the melody with the KR-777/177's Composer (see page 32).

Drum sounds and sound effects — [DRUMS/SFX]

Instead of playing melodies, you can also "drum" on the KR-777/177's keyboard, or play sound effects, such as trains noises, helicopter sounds, etc.

Press the [DRUMS/SFX] button (indicator lights).

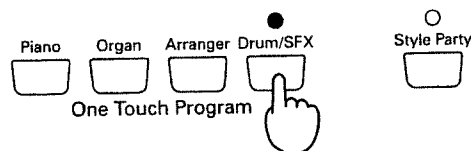

The display switches to the "Drum Screen". Every key is now assigned to a different drum or percussion sound. Play a few notes and listen – and watch the display.

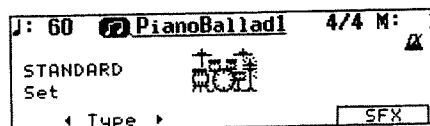

Note: See "Drum Sets" at the end of this manual for details about the assignments of drum sounds and sound effects to the keyboard.

Press the [DRUMS/SFX] button once more (or the [EXIT] button), to return to the previous screen.

toggling between drum sounds and sound effects

1. If necessary, press [DRUMS/SFX] again (indicator must light).

2. Press <SFX>.

The display will switch to the "SFX Screen". Play a few notes on the keyboard. This time, you will hear sound effects rather than drum sounds. Again, the display will show you pictures of the sounds being played.

3. Press <Drums>.

The display jumps to the Drum Screen. With each press of the button you will toggle between drums sounds and effects.

Selecting Drum Set Types

Press <◀Type> or <Type▶>.

Each time you press one of these buttons, the drum set type will change, and the names of the drum sounds appearing on the display will change.

Note: There is one SFX set.

Adding effects to Tones**Reverberation (REV)**

Reverb is a digital effect that gives the impression that you are playing in a concert hall.

1. Press the [UTILITY] button.

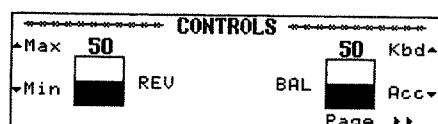

2. Use the <▲> and <▼> buttons to the left of the display to modify the Reverb balance.

Setting the value to “100” gives you maximum Reverb, while selecting “0” removes all Reverb from the sound. The REV parameter actually increases or decreases the Reverb Depth for the sound that is assigned to the keyboard, i.e. the part volume for the signal that is fed to the Reverb effect. Setting a high Reverb value means that you effectively increase the effect volume for the keyboard part. It works much the same way as a cathedral: the louder you sing, the more Reverb you hear. In the case of the cathedral, singing louder means that you increase the effect send level, i.e. the level of the signal (your voice) that will be processed by the acoustic environment. The overall volume of the effect (cathedral) itself, however, does not change.

That, in turn, is a good thing because other parts (the Arranger and Composer parts) are also processed by the same Reverb effect. If REV were assigned to the volume of the effect itself, selecting the Min value would also strip the accompaniment of Reverb.

Note: The KR-777/177 contains several Reverb programs (called Types), so that you can always use the Reverb type that best suits your needs. See “Reverb Types” on page 47.

Note: You cannot adjust the Reverb Depth of the Arranger parts or the sounds played back by the Composer function.

Adding other effects — DSP effect

DSP is short for *Digital Signal Processor*. Of course, the Reverb effect is also digital, but we preferred not to use “multi-effect” here because that term may be misleading. What it boils down to, however, is that the DSP effect contains a variety of effects programs, one of

which you can select for the song you are about to play. See “DSP effects” on page 51 for a list of all DSP effects the KR-777/177 contains.

1. Select <DSP...> on the Tone Select screen.

The display now jumps to a screen similar to the following:

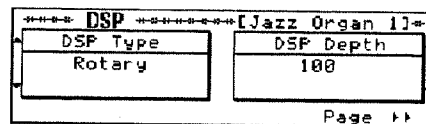

2. Use the buttons to the left of the display to select the Type (kind of effect), and set its Depth with the buttons to the right of the display.

Select “OFF” from the Type screen if you don’t need a DSP effect.

Note: Only one DSP effect can be used at a time.

Note: When you select Upper, Lower, or Whole and choose the Rotary Effect, you can switch the rotation speed with the button at the upper left of the display.

Chorus effect

Your KR-777/177 also contains a Chorus effect. Chorus is an effect that creates a more spacious, “fatter” sound.

1. After pressing <DSP...> on the Tone Select screen, press <PAGE▶▶>.

The display now jumps to a page similar to the following:

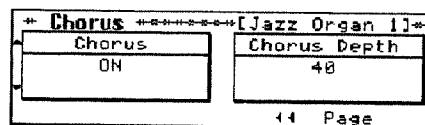

2. Turn the Chorus on and off with the buttons to the left of the display, and select the Chorus Depth with the buttons to the right of the display.

After several seconds, the display returns to the previous screen.

Note: The KR-777/177 contains several Chorus programs (called Types), so that you can always use the Chorus type that best suits your needs. See “Chorus Types” on page 47.

Octave Shift: changing the pitch by octaves

Octave Shift is a function that changes the pitch of a sound in octave steps. Octave Shift can be set independently for the Lower and Upper parts.

To give you an idea of the flexibility of this system, here is an example: suppose you assign the same Tone (E.Piano 1) to both the Upper and Lower keyboard section. Though you are using the same sound, it is assigned to two parts you can shift individually. Thus, by setting Octave Shift to “+1” for the Lower part, while leaving it at “0” for the Upper part, you create an

overlap of the octaves immediately to the left (Lower) and right (Upper) of the split point. You could use this feature for playing intricate parts.

1. Start by selecting the Tone you need on the Tone Select screen (see page 18).

2. Select the octave (shift amount) by pressing <Octave>.

You can raise or lower the pitch by a maximum of two octaves. After a few seconds, the display will revert to the Basic screen.

Note: When you switch off the KR-777/177, the Octave Shift settings return to their preset values. If you'd like the KR-777/177 to memorize your settings, see "Memory Backup" on page 49.

Note: When using Octave Shift, you may sometimes notice that notes to the far right of the keyboard sound in the "wrong" octave. That is because all Tones have an upper limit beyond which they cannot be transposed.

Note: You cannot use Octave Shift in Whole mode (see below).

6.2 Keyboard modes

Whole: one Tone for the entire keyboard

In Whole mode, one Tone is assigned to the entire keyboard, thus allowing you to play piano or other parts involving both your left and right hand. That explains why Whole is automatically selected when you press the One Touch Program [PIANO] button.

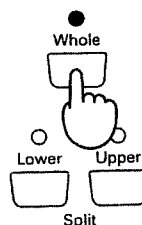

Press the [WHOLE] button.

The button's indicator will go on, and the Tone selected for the Upper part will be assigned to the entire keyboard.

Note: If you press the [WHOLE] button while using the Arranger, the KR-777/177 will switch to Piano Style Arranger mode (see page 23).

Split: different Tones in the left and right hand

It is also possible to split the keyboard, so that you can play two different sounds with your left and right hand, e.g. a bass and a piano sound. The key (or note) where the keyboard is divided is called the *split point*. You are free to choose another split point, but do remember that the KR-777/177 automatically selects F#3 whenever you switch it off. Just for your information: the key that acts as split point is the highest note of the Lower part.

As organ playing usually involves two different sounds, the keyboard is automatically split whenever you press the One Touch Program [ORGAN] button and select "Jazz Organ".

Here is how to split the keyboard:

Press the SPLIT [LOWER] or [UPPER] button.

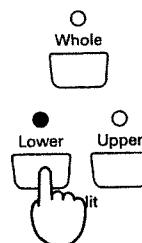

The indicators of both the [LOWER] and [UPPER] buttons light to signal that the keyboard has been split at F#3:

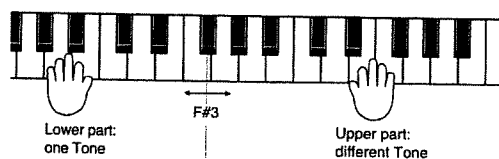

Play a few notes to confirm that different Tones are assigned to the Lower and Upper parts. In Split mode, the names of both Tones being used are displayed.

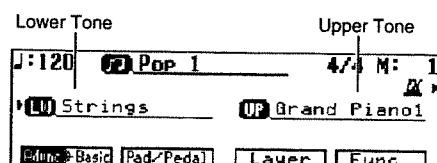

The Tone assigned to the Upper Part will be used when you switch to Whole mode (see above). When you power on the KR-777/177, the Tone assigned to the Lower part will be “Strings.”

Selecting Tones for the Upper and Lower parts

1. Press the button of the part ([LOWER] or [UPPER]) you wish to assign another Tone to. The arrow (▶) will jump to the selected Part.

2. Press a TONE button.
The Tone Select screen will be displayed.

3. Select a Tone.
After several seconds, the display reverts to the Basic screen.

Note: There is no need to select a part by pressing its button when an arrow (▶) appears next to its name.

Note: You can change the location where the keyboard is split. Refer to “Lower Tone on/off and split point” on page 42.

Note: Sometimes, the pitch changes when the keyboard is split. That is because the KR-777/177 automatically selects a suitable Octave Shift value to avoid notes sounding way too low or too high.

Layer: two Tones

The word *Layer* is used to describe a situation where every note you play triggers two Tones. The most popular Tone combination for layers is piano and strings but you are free to use whichever Tone combination you like.

Note: Layers are only available for the Upper part.

Here’s an example of how to layer two Tones (let’s use piano and strings here).

1. Press the TONE [PIANO] button and select the desired piano Tone.

2. Press <Layer> on the Basic screen.

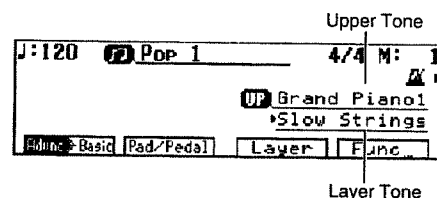

3. Press the TONE [STRINGS] button.

The indicator of the TONE button you have just pressed will light. Play a few notes on the keyboard to confirm that the KR-777/177 is producing a piano and a strings sound. Let’s agree to call the two Tones being used “Upper Tone” and “Layer Tone”.

You can now select another Tone of the Strings group, if you like. If, after choosing a Layer Tone, you decide to use another Upper Tone, press <Layer> again (to leave Layer mode) and select the desired Tone (see above).

Note: Another way to select the Layer mode is to press two TONE buttons simultaneously.

7. Playing with accompaniment (Arranger)

7.1 What is an Arranger?

Think of the Arranger's Music Styles as your backing band. The following illustration shows that this suggestion is not as preposterous as it may sound because your KR-777/177 is capable of playing several "variations" (called divisions) of a given accompaniment. All you have to do is make up your mind about the kind of music you want to play: is it going to be salsa, rumba, pop-rock, or big band?

You are the band leader, which means that you have to tell the members of your band what to play. In other words, you must explain how many bars there are to each song part and how the melody and/or solo should be accompanied.

There are two main levels: Basic and Advanced, each consisting of two divisions called Original and Variation.

As its name implies, Basic is the "normal" accompaniment level, with only the basic ingredients of a professional sounding accompaniment. The Advanced level, on the other hand, may contain another version of the selected Music Style or just a more elaborate one. On either level (Basic and Advanced) you can choose between the Original accompaniment or an alternative (called Variation). The latter usually adds one or two parts to the current accompaniment.

As the leader of your band, you have to tell the musicians what to play and when to play it. If you want the accompaniment to become more complex as the song evolves, here is a useful sequence:

Typical song structure

1st Verse	2nd Verse	1st Chorus	3rd Verse	2nd Chorus
Basic Original	Basic/ Variation	Advanced/ Original	Basic/ Variation	Advanced/ Variation

Other elements help you refine the accompaniment. Instead of abruptly changing to Advanced/Original, you may want to play a short transition to announce a new part of the song. That is what Fill In [TO VARIATION] and [TO ORIGINAL] are for.

See "Switching Style arrangements (divisions)" on page 26 for other Music Style divisions and functions you can use to create a professional sounding accompaniment.

Each accompaniment (or Music Style) can consist of up to five parts:

Rhythm— This part takes care of the drums and percussion.

Bass— This part plays the bass line of the selected Music Style.

Accomp. 1–3— These are the melodic accompaniment parts. Depending on the Music Style you selected, only a few of them actually play something, which can be anything from a piano line, a guitar line, an organ line, etc., to a synth pad line.

The bass and accompaniment parts rely on the chord or note information you play in the *chord recognition* area, i.e. the keyboard zone you have assigned to the Arranger (originally the left half of the keyboard).

Also note that you can use the drum patterns of a Music Style in other One Touch Program modes (Piano and Organ). These patterns can be started in the same way as entire Music Styles (with bass and melodic accompaniments). See "Starting and stopping Styles" on page 24.

Settings

Press the One Touch Program [ARRANGER] button.

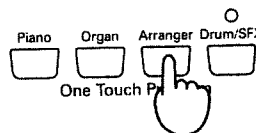

The KR-777/177 now automatically makes the following settings:

- The Sync Start function is turned on. This means that the Arranger will start as soon as you play one or several notes with your left hand.
- The Intro function is activated so that Style playback will start with a musical introduction.
- The keyboard is split at F#3. Use your left hand to "transpose" the accompaniment pattern(s), and play the melody with your right hand.
- It selects a suitable (preset) tempo as well as an Upper Tone for the selected Music Style.

■ Additional notes

- Feel free to change the split point "Lower Tone on/off and split point" on page 42.
- As in Split mode, the KR-777/177 automatically selects the most appropriate pitch for the Tone assigned to the Upper part. If you want to shift the pitch of the Upper Tone in octave steps, see "Octave Shift: changing the pitch by octaves" on page 19.
- See "Auto: changing the Arranger defaults" on page 42 if you don't want the KR-777/177 to change the tempo and select another Upper Tone every time you choose a Music Style.

Piano Style Arranger — chord recognition on the entire keyboard

If you press the [WHOLE] button after pressing the One Touch Program [ARRANGER] button, the entire keyboard will be scanned for chord information for the Arranger. This is probably the mode you will select if you are a pianist. Let's agree to call this mode *Piano Style Arranger* mode.

The Piano Style Arranger mode works as follows: the Arranger decodes every chord you play – no matter where you play it. Causing the Arranger to play another chord requires that you play at least a triad (i.e. the three notes that make up a chord). You are free to play more than three chord notes but remember that two notes won't cause the Arranger change chords.

Note: In Piano Style Arranger mode, you cannot use the Chord Intelligence function (see page 27). You will have to play full chords using normal fingering.

7.2 Selecting Music Styles

The KR-777/177 contains 111 Music Styles. These Styles are divided into eight Groups – one for each genre (see the MUSIC STYLE buttons and list on the front panel).

1. Press a MUSIC STYLE button.

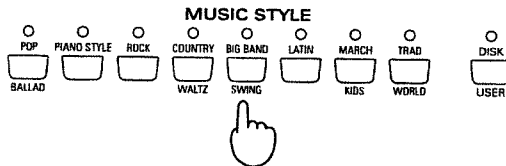

The button's indicator will light, and a "Music Style" screen, like the one shown below, will be displayed.



Once a Music Style Group has been selected, you can choose a Style from that Group.

2. Select a Music Style by pressing the buttons to the side of the display.

The name of the Music Style you select will be highlighted on the display. The Music Style screen is spread over multiple pages. Use <<PAGE> and <PAGE>>> to jump to another page if the Music Style you need doesn't appear on the display.

As always, the display returns to the previous page after a few seconds of inaction. If you want to take your time and try out several Music Styles of the selected Group, press the [HOLD] button.

Note: The number of Styles in each group varies.

3. Play a note or chord to the left of the split point. The Arranger starts playing the introduction of the Music Style you selected. Press the [START/STOP] button.

Note: Whenever the Arranger is not playing, the left half of the keyboard is reassigned to the Chord and Bass parts. That allows you to play your own chord backing and bass notes. You could use this for transitions, etc. See "Chord Tone Setting" on page 43 for how to assign a Tone to those parts.

Using Style disks (User Styles)

The KR-777/177 comes with a Style Disk that contains additional Music Styles and 16 Acoustic styles. These Styles need to be loaded into the KR-777/177's internal memory and will be erased when you switch off your instrument.

Note: See "Internal Music Styles & Disk Styles" at the end of this manual for a list of the Music Styles on the supplied Style disk.

Note: Loading Music Styles from disk means that the Style in the KR-777/177's User Style memory will be erased.

Always save your own Styles to disk before loading another one. See "Saving User Styles" on page 37.

1. Insert the Style Disk into the disk drive.

2. Press the [DISK/USER] button.

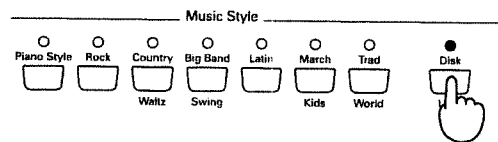

A list of the Styles on disk will be displayed.

3. Use the buttons next to the display to select the Style you want to load.

The name of the selected Style will be highlighted.

The indicator of the [DISK/USER] button remains lit to signal that the KR-777/177 now contains a User Style. To select it, press [DISK/USER].

Note: When you switch off your KR-777/177, the Style you loaded from disk is erased. You will have to load it again next time you wish to use it.

Note: If you insert the Style disk into the drive before switching on the KR-777/177, it will automatically load the "Easy Listen" Style.

Note: Unlike internal Music Styles, Styles loaded from disk contain no default Upper Tone setting.

7.3 Starting and stopping Styles

Starting a Music Style

You may remember that by pressing One Touch Program [ARRANGER] you also select a number of settings, one of which is called Sync Start. Let's look at that function first.

Starting automatically (Sync Start)

■ Starting with a musical introduction

You can start Style playback in much the same way as a band or orchestra – with a nice introduction (called *Intro*). The length of the introduction depends on the Style you selected. Some Intros are two measures long, others eight, and so on.

1. Press the [SYNC] button.

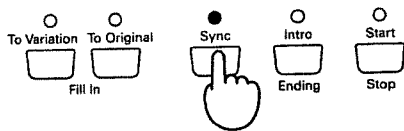

The [SYNC] button's indicator will light, and the TEMPO and [INTRO/ENDING] indicators will begin flashing.

Now all you have to do is to play a note or a chord in the chord recognition area (either the left half of the keyboard, or anywhere in Piano Style Arranger mode) to start the Arranger.

2. Play a note or chord in the chord recognition area. The Arranger now plays the Intro pattern. The INTRO/ENDING indicator will light, and go off at the end of the Intro.

To cancel Sync Start, just press the [SYNC] button once more.

■ Shorter/simpler Intro

- Press the [SYNC] button (indicator lights).
- Press the Fill In [TO ORIGINAL] button (indicator flashes).
- Play in the chord recognition area of the keyboard. Style playback will begin with a short Intro.

■ Starting without an Intro

1. Press the [SYNC] button.

The [SYNC] button's indicator will light, and the TEMPO and [INTRO/ENDING] indicators will begin flashing.

2. Press the flashing [INTRO/ENDING] button (indicator goes off).
3. Play a note or chord in the chord recognition area.

Starting manually

If you prefer to be in complete control of the Arranger and therefore do not want it to start as soon as you play one or several notes, there are two options.

■ Starting with an Intro

1. If necessary, press the [SYNC] button to switch off the Sync Start function.

Remember that you can now play your own chords and bass notes using the Chord and Bass parts that are automatically assigned to the Lower section of the keyboard.

2. Press the [INTRO/ENDING] button to start Style playback with the corresponding Intro.

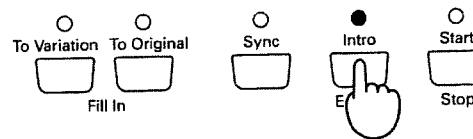

During the Intro, the [INTRO/ENDING] button's indicator will be lit. When the Intro is over, the indicator will go off.

■ Starting without an Intro

1. If necessary, press the [SYNC] button to switch off the Sync Start function.
2. Press the [START/STOP] button. The Style will begin playing.

Stopping a Music Style

There are two ways to stop Style playback:

Stopping a Style with an Ending

An Ending is usually referred to as a *Coda*. This is a musical way of ending a song, some of the most impressive examples can be found in classical music. But also in pop music, a song usually doesn't just stop. If that is what you are after, here is what to do:

Press the [INTRO/ENDING] button while the Music Style is running.

During the ending, the [INTRO/ENDING] button's indicator will be lit. When the Ending is over, the indicator will go off.

Again, the length of the Ending depends on the Music Style you select.

■ If you want to shorten/simplify the Ending:

- Press the Fill In [TO ORIGINAL] button (indicator starts flashing).
- While the [TO ORIGINAL] button's indicator is flashing, press the [START/STOP] button.

Stopping a Music Style immediately

Press the [START/STOP] button.

Alternatives for starting and ending Music Style playback

Using a PAD button or a footswitch, you can fade in (whereby the volume gradually increases) to the start of a Style, or fade out (whereby the volume gradually decreases) to the end of a Style. Please refer to “Pad buttons: additional or frequently used functions” on page 44 and “Pedal functions” on page 45.

7.4 Style tempo

Every Style also contains a preset tempo value. If you think the Style is too slow or too fast, here is how to change it:

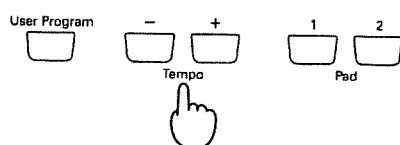

Press TEMPO [+] to increase the tempo and TEMPO [-] to decrease it.

The tempo value appears in the upper left part of the display. Additionally, you can confirm the tempo and time signature by looking at the TEMPO indicators.

7.5 Accompaniment and melody volume balance

Global balance

You can adjust the balance of volume of the accompaniment (Music Style) and the Upper Tone you use to play the melody.

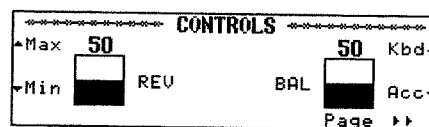

Press [UTILITY] and use the <▲> and <▼> to the right of the display to adjust the volume balance.

Adjusting the volume of each part — Part Volume

The BAL function adjusts the balance of the overall accompaniment volume and that of the melody (Upper). With the Part Volume buttons, you can adjust the volume of individual parts, or prevent a part from even sounding.

There are two Part Volume buttons: [ACCOMP] and [KEYBOARD]. Press [ACCOMP] if you want to change the volume of an accompaniment part, and the [KEYBOARD] button to adjust the volume of a part that can be assigned to the keyboard.

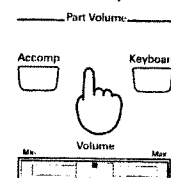

Volume of the Rhythm, Bass, Accomp, and Chord/Bass Tones

These Tones are assigned or related to the Arranger (the automatic accompaniment).

1. Press the Part Volume [ACCOMP] button.

For each part, a bar graph and numerical value are displayed on screen. The correspondence between the parts and what is shown on the screen is as follows:

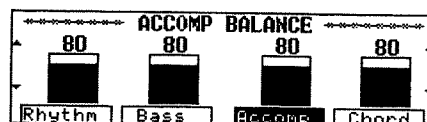

<Rhythm>— Drums

<Bass>— Accompaniment Bass and Bass Tones

<Accomp>— Accompaniment parts (1-3)

<Chord>— Chord Tone (see “Chord Tone Setting” on page 43 for details about the Chord and Bass Tones).

2. Select the part whose volume you wish to adjust using the buttons below the display.
3. Adjust its volume with the <▲> and <▼> buttons. Press the <▲> button to increase the volume, and the <▼> button to decrease it.

Volume of the Drums, SFX, Lower, Upper, or Layer Tone

These are the parts you can play yourself, which is why you need to press the other Part Volume button.

1. Press the Part Volume [KEYBOARD] button. For each part, a bar graph and numerical value are displayed on the screen.

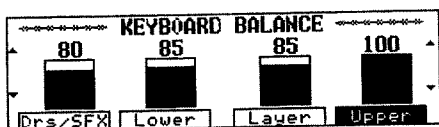

The correspondence between the parts and what is shown on the screen is as follows:

- <Drs/SFX>— Drums and SFX (sound effects)
 - <Lower>— Lower
 - <Layer>— Layer
 - <Upper>— Upper
2. Use the buttons below the display to select the part whose volume you wish to adjust.
 3. Use the <▲> and <▼> buttons to adjust the volume.

7.6 Switching Style arrangements (divisions)

For each Style, you can select the particulars of the orchestration (arrangement) and accompaniment pattern type. You can do this before starting a Style, or during playback of the Style.

Note: There are other Arranger functions you can use by assigning them to a PAD button. See "Pad buttons: additional or frequently used functions" on page 44.

Basic/Advanced: Level

At power on, the "Advanced" level is selected.

Advanced— more complex arrangement with more accompanying instruments.

Basic— simple arrangement with fewer accompanying instruments.

Here is how to select the desired level:

Press <Advnc><Basic> or <Advnc><Basic> on the Basic screen.

The correspondence between the levels and what is shown on the display is as follows:

<Advnc><Basic>	Appears when Basic Arrangement is selected. Press <Advnc><Basic> to switch to the Advanced level.
<Advnc>>Basic>	Appears when Advanced Arrangement is selected. Press <Advnc>>Basic> to switch to Basic level.

Original/Variation: Accompaniment pattern

There are two kinds of accompaniment patterns: Original and Variation. The accompaniment pattern type is set to "Original" when power to the instrument is turned on. See "What is an Arranger?" for details.

Press <To Variation> or <To Original> on the Basic screen.

Fill-Ins (transitions between Original and Variation)

Fill In To Original and To Variation are two fills (or transitions) you can use at the end of a musical phrase (verse, chorus, bridge). The two buttons do two things at a time:

	In Original mode	In Variation mode
TO ORIGINAL	Plays the Original Fill.	Plays the Original Fill and selects the Original pattern.
TO VARIATION	Plays the Variation Fill and selects the Variation pattern.	Plays the Variation Fill.

Press these buttons now. Start with [TO VARIATION], next press [TO ORIGINAL].

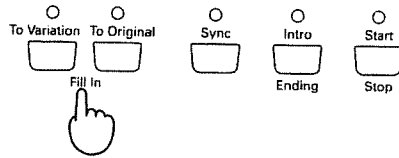

Think of a Fill as the moment in a song when the drummer is allowed to play a roll and the bassist and keyboard players vary their accompaniment by adding a few notes here and there.

Fill-Ins last one bar, but you can produce shorter fills by proceeding as follows: press [TO VARIATION] or [TO ORIGINAL] on the first through the penultimate beat of a bar (i.e. the 1st, 2nd or 3rd beat of a 4/4 bar, or the 1st or 2nd beat of a 3/4 bar) to start the fill right away. It will then last until the end of the current bar. If you press the [TO VARIATION] or [TO ORIGINAL] button on the last beat of the current bar, the fill will start on the following downbeat and last an entire bar.

Note: Every time you stop a Music Style in One Touch Program ARRANGER mode, the KR-777/177 will select the Original pattern again.

7.7 Easy fingering – Chord Intelligence

As stated before, the Arranger relies on the chords you play for choosing the key of the accompaniment. Playing chords isn't always easy, especially when you need to concentrate on your melody. That is why the KR-777/177 features a function called Chord Intelligence.

It is intelligent in that it allows you to play major chords by pressing just one key (the root note), while minor chords can be played with two keys, and complex chords with only three keys. Unlike other brands, Roland uses a musical system for simplifying chord fingering, so that once you understand the “intelligent” versions, you will have little trouble supplying the “missing” notes and playing full chords.

Note: Chord Intelligence is normally set to “On,” but you can turn it off. See “Auto: changing the Arranger defaults” on page 42.

Here is how to play chords in Chord Intelligent and normal (without Chord Intelligence) modes. All examples are based on a “C” chord. For other chords, either count the distance of the indicated keys from the root note, or refer to “Chord Intelligence” at the end of this manual.

Major chords:



Chord Intelligence



Normal

Minor chords (m):



Chord Intelligence



Normal

Seventh chords (7):



Chord Intelligence



Normal

Major Seventh chords (M7):



Chord Intelligence

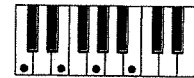

Normal

Minor seventh chords (m7):



Chord Intelligence



Normal

Diminished (dim) chords:



Chord Intelligence



Normal

Minor Major Seventh (mM7):



Chord Intelligence



Normal

Note: Even in Chord Intelligence mode, you can play chords the usual way. Sometimes, however, you may get a result that doesn't quite live up to your expectations. Furthermore, the name of the chord that appears on the display may not be the one you thought you were playing.

7.8 Melody Intelligence

The Arranger of your KR-777/177 can not only play chords but also a counter-melody based on the chords you play in the chord recognition area. This counter-melody will be added to the Upper part.

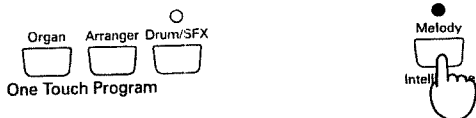

1. Press the [MELODY INTELLIGENCE] button to switch Melody Intelligence on (indicator lights) and off.

When you press the button and the indicator lights, harmony voices will be added to your melody. A screen like the one shown below will be displayed.

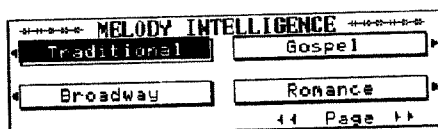

2. Use the buttons next to the display to select a Melody Intelligence type.

There are five pages you can select with <<<PAGE> and <PAGE>>>. Select the type you need for the song you want to play:

Duet	Broadway
Organ	Gospel
Combo	Romance
Strings	Latin
Choir	Country Guitar
Block	Country Ballad
BigBand	Waltz Organ
Country	Octave Type 1
Traditional	Octave Type 2

After several seconds, the previous screen will return to the display.

Note: When "Full Auto" or "Tempo Lock" has been selected (see "Auto: changing the Arranger defaults"), the type of Melody Intelligence that is set may vary according to the Style.

Note: Please note that not all harmony voices will be played at all times, which is usually due to the fact that you play extremely high or low notes.

8. Recording and Playback

8.1 Recording

Normal recording

The KR-777/177 also features a “Composer” that functions like a tape recorder but is, of course, digital. You can record your own songs, as well as play songs using commercially available music data. Please be aware that the Composer records instructions (called *MIDI messages*) rather than sounds. That explains why you cannot record your singing or any other part picked up using the microphone.

You can store one song at a time. During recording, the data is automatically separated and recorded onto five separate tracks.

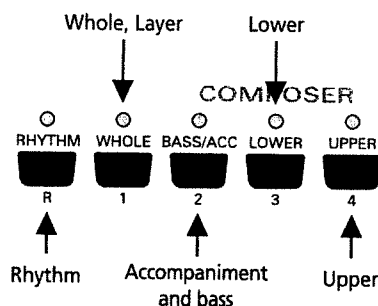

What is a track?

On devices like tape recorders, sounds that are played back via the left speaker and those that are played back via the right speaker are recorded onto separate places on tape. These “places” are called “tracks”. As you see, your KR-777/177 provides five tracks in Normal mode, i.e. five places where MIDI messages can be recorded. The advantage of working with tracks is that you can re-record or change (edit) just one part (on one track) while listening to the other tracks.

Let's record something

1. Press the [REC] button.

The Composer goes into standby mode. The [REC] indicator lights, while the [PLAY] indicator flashes.

The tracks onto which the performance is recorded are selected automatically, and the track button's indicator will flash.

In Whole Keyboard mode, you can record onto any track except the Rhythm track. In that case, the track whose button was last pressed will be the recording track.

Note: If a disk has been inserted into the disk drive, or after playing back a song on disk, you need to press the [SONG] button to bring up the Song Select screen. Select <U: User Song> and press the [REC] button.

2. Begin recording.

- When you are ready to record the melody of a song with Arranger backing, start Style playback (see “Starting a Music Style”), and recording begins.
- To record a piano or organ piece without accompaniment, press the [PLAY] button.
Note: Remember that you can use the Rhythm section when playing a piano or organ piece. If that is what you want to do, see the preceding bullet.

Two measures of count-in will sound, after which recording will begin. The [PLAY] indicator now lights.

3. When the song is finished, press the [STOP] or [RESET] button.

The indicator on the button for the track on which the performance was recorded will light.

Note: Recording will also stop if you stop the Style (see above) by pressing either the [INTRO/ENDING] or the [START/STOP] button.

Note: It is also possible to keep the Composer from deactivating the Record Standby mode whenever you stop recording. See “Recording Mode” on page 34.

Note: If the internal memory of your KR-777/177 already contains a song, you will be unable to select songs from a disk. If that is what you want to do, first save your song to another disk (see page 32), then erase the song in the KR-777/177's internal memory (see “Erasing the Composer song” on page 31). Alternatively, press <OK> in response to the message “User Song will be erased. Are you sure?”

Note: Remember that there is only one DSP effect. That is why it is impossible to use different DSP types for different tracks.

Cautions to take after recording

If, after recording, the power is turned off, the recorded performance will be erased. If you want to save performances you've recorded, please refer to “Saving a song to disk”.

Recording Minus-One performances

Minus-One refers to a technique whereby a Standard MIDI File is used as backing, while you can mute the part you wish to play (usually the melody). Thanks to a clever system, you can mute any part of a Standard MIDI File and play (and record) it yourself. If you just want to have fun with a Standard MIDI File without recording your performance, see “Track Mute: Muting specific tracks” on page 31.

1. Insert a music data disk into the disk drive.

2. Press the [SONG] button.

The Song Select screen will be displayed.

3. Select a song with the soft buttons surrounding the display. If necessary, use <<◀◀PAGE>> and <PAGE▶▶> to jump to another Song Select page.

4. Press the [REC] button (indicator lights).

Now you need to select the track you wish to record your part to.

5. See below for which button to press.

As you know, the available parts are closely linked to the Keyboard modes. That is why you need to perform several actions to ensure that the right sound will be used for recording.

[Whole]— Press One Touch Program [PIANO].

[Lower], [Upper]— Press the [LOWER] button and select the Split mode.

[Rhythm]— Press the [Drums/SFX] button and select <Drum Set> or <SFX>.

Note: You cannot record onto the [BASS/ACCOMP] track.

Note: If you select a part other than the ones shown above, nothing will be recorded on the corresponding track. Please be aware that Minus-One recording will erase all data on the selected track.

6. Press the button of the track you want to record to (indicator flashes).

7. Press the [PLAY] button.

Two measures of count-in will sound, after which recording will begin.

8. Press the [STOP] or [RESET] button to stop recording.

The indicator of the track button you pressed now lights to signal that the track contains data.

Note: See also “Saving a song to disk” on page 32. Be aware, however, that due to copyright protection of the Standard MIDI File you used, it may not be possible to save a Minus-One song to disk.

Note: If you record in Whole mode, the Tone of the Lower and Upper parts you are playing may change. That is because a Standard MIDI File also contains so-called program change messages that tell your KR-777/177 which Tones to use.

Correcting minor mistakes

Let us now look at the advantages of working with tracks. If you don't like a particular line (the melody, say), you can correct it without re-recording the entire song. Here is how to:

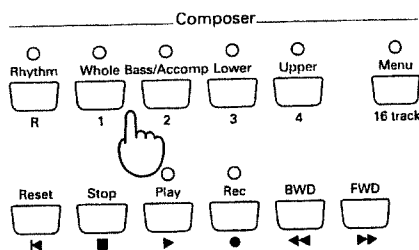

1. Press the [REC] button (indicator lights).

2. Press the button of the track you want to fix.

The track button's indicator and the [PLAY] indicator will flash.

3. Press the [PLAY] button.

Two measures of count-in will sound, after which recording will begin.

4. Play the correct (or desired) version of the part.

5. Press the [STOP] or [RESET] button when you're done.

Notes about correcting mistakes

- If the re-recorded bit is shorter than the original track, all notes that lie beyond the point where you stopped recording will remain. To erase the entire track, see “Erase: removing data from a track or song” on page 38 and go back to step (1).
- There is no need to start at the beginning of the song. Use the [BWD] and [FWD] buttons to call up the measure where you want to start recording, and press the [REC] button. Press the [PLAY] button, and recording will begin after two measures of count-in.
- It is also possible to *add* (overdub) additional notes to a track without erasing what you have previously recorded. See “Recording Mode” on page 34 for details.

8.2 Playing back a Composer song

1. Press the [RESET] button to “rewind” to the beginning of the song.

By pressing [RESET], you will actually jump back to the first measure of the song, which is similar to using the SKIP function of a CD player.

2. Press the [PLAY] button.

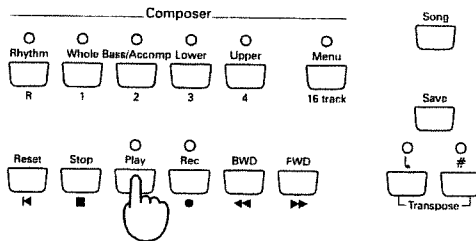

The recorded performance will begin to play. If there is a particular passage you want to listen to, select its measure by pressing [FWD] and then press [PLAY]. Likewise, you could rewind to a previous measure by pressing [BWD] and start playback.

3. The song stops automatically when the song is finished.

To stop while the performance is running, press the [STOP] or the [RESET] button.

Starting with a metronome count-in

By pressing the [PLAY] button while holding down the [STOP] button, you can have the song play back after two metronome count-in measures.

8.3 Track Mute: Muting specific tracks

It is also possible to temporarily switch off (mute) certain tracks. You could take advantage of this function when adding intricate (usually syncopated) parts to a complex accompaniment. Muting all distracting parts indeed helps you concentrate on the work at hand.

You can also use the Track Mute function to switch off the part of a pre-recorded song you yourself would like to play (usually the melody). Playing to a Standard MIDI File or Composer song backing is called “Minus-One Play.” You can also record your Minus-One performance. Please refer to “Recording Minus-One performances” on page 30.

Press the button of the track you wish to mute (indicator goes off).

The track in question will no longer be played back. You can mute several tracks, if you like.

Press the track button once more to switch the track(s) on again.

8.4 Playing back songs without tempo changes

Some songs on music data disks contain tempo changes. When you use these kinds of songs for Minus-One play or recording, you may find it difficult to follow these tempo changes. Here is how to ignore these tempo changes.

While holding down the Composer [STOP] button, press either the Tempo [+] or [-] button.

The tempo value will be highlighted on the display.

Note: If at this point you play back another song, or carry out the above step once again, the Composer will revert to the normal tempo mode and play back the song with tempo changes.

8.5 Erasing the Composer song

Here is how to erase the entire song in the KR-777/177's internal memory. Before even thinking of doing so, you should save songs you wish to keep to disk (see below).

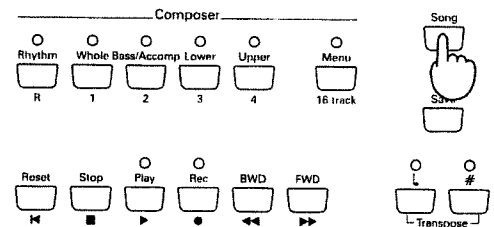

1. Press the [SONG] button.

A message will be displayed, asking you to confirm whether you want to erase the song if you have not yet saved the song to disk.

2. If you want to erase the data, press <OK>.

To cancel the operation without erasing the song, press <Cancel>.

After the song has been erased, the Song Select screen will be displayed.

3. Press <U: User Song> at the upper left of the display.

8.6 Saving a song to disk

The song in the Composer's memory is erased when the power is turned off. If you don't want to lose it, please use the method shown below.

The number of songs that can be saved onto a disk depends on the amount of performance data they contain, but the maximum number of songs you can save is 99.

Note: New disks or disks which have been used on other equipment cannot be used just as they are. Please refer to "Formatting disks" on page 34.

1. Insert a disk you want to save your song to into the disk drive. Make sure the write protect tab is set to "Write".

You can save onto the following disks:

- New disks formatted on the KR-777177.
- Disks already containing KR-777177, KR-75, E-300, or E-500 songs.

2. Press the Composer [SAVE] button.

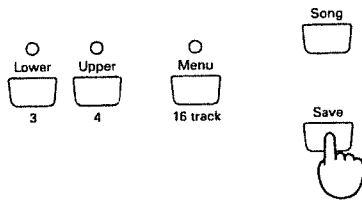

The display now jumps to the Song Save screen.

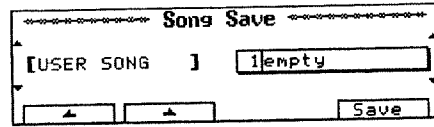

3. Use the <▲> and <▼> buttons to the right of the display to select a song number.

You can choose any number between "1" and "99". Do note, however, that selecting a song number that already contains data means that the song in question will be overwritten by your new song.

4. Enter a name for your song with <◀> and <▶> below the display, and <▲> and <▼> to the left of the screen.

The characters you can use to do this are listed below:

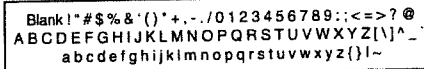

5. Press <Save>.

Press [EXIT] instead if you do not want to save your song after all.

9. Composer Menu

Functions of the Composer Menu

1. Press the Composer [MENU] button.

The display now jumps to the Composer Menu.

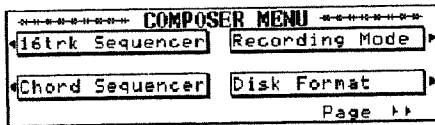

Choose one of the seven functions "on the menu".

2. Use the buttons next to the display to select the function.

The Composer Menu has two pages. Use the <◀◀PAGE> and <PAGE▶▶> buttons to bring up the other page.

To leave the menu, press the [EXIT] button. The display then returns to the previous screen.

9.1 16-track Sequencer

This sequencer allows you to record up to 16 different parts onto separate tracks using different Tones. Needless to say that you should take advantage of the sequencer to record your own songs with original arrangements.

Note: See "Link to 16TRK Sequencer" on page 49 for a parameter you may want to set first.

1. On the Composer Menu, press <16trk Sequencer>. The display now jumps to a 16-Track Sequencer screen that looks similar to the following.

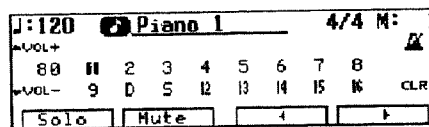

The [WHOLE] button also lights to signal that the KR-777/177 will now function in Whole mode. The 16-track Sequencer indeed only uses one Tone for each track, so you cannot record in Split or Layer modes.

2. Use <◀> and <▶> to the lower right of the display to select the track you wish to record.

The currently selected track appears in reverse video on the display.

Note: Drum or SFX parts can only be recorded on the “D” or “S” tracks.

3. Get ready to play.

Choose the Tone and make the necessary settings for the performance.

Note: You can only assign Drum Sets to the “D” track, while the “S” track only triggers sound effects.

Use <VOL+> and <VOL-> to the left of the display to set the volume level of each track.

Note: To record the volume settings, press the [RESET] button while holding the [REC] button.

4. Press the [REC] button and then the [PLAY] button.

Two bars are counted down, and after that recording starts.

5. Press the [STOP] button to stop recording.

A “□” appears next to the track that was recorded.

6. Repeat steps 2, 3, 4, and 5 to record other parts.

You can delete the data of a selected track by pressing <CLR>.

If you want to start recording halfway into the song, use the Composer [FWD] and [BWD] buttons to move to the desired measure.

Muting or playing selected tracks

<Mute>	Choosing a track and pressing <Mute> switches off playback of that track. A dotted “□” appears next to the muted track. Each press of <Mute> toggles between Mute on and off.
<Solo>	Choose a track and press <Solo> if you want to listen to a track without hearing the others. Each press of <Solo> toggles between Solo on and off.

Note: There is only one DSP effect, so that you can only use one DSP Type for all 16 tracks. You should therefore use a DSP Type that can either be used for several tracks or restrict the use of the DSP effect to only one track.

Tracks vs. MIDI channels

The relationship between tracks and MIDI channels is as follows:

Track	1	2	3	4	5	6	7	8	9	D	S	12	13	14	15	16
MIDI channel	1	2	3	4	5	6	7	8	9	10	11	12	13	14	15	16

Note: When using 16-track Sequencer, the Composer’s five Track buttons do not function.

Note: Set the beat of the metronome before recording with the 16-track Sequencer. The Composer will use the metronome settings (time signature and tempo) in effect at the time you start recording the first track.

9.2 Chord Sequencer

The Chord Sequencer allows you to “pre-program” the chord progression and Style divisions to be used by the Arranger. Doing so will allow you to concentrate on the melody because the Chord Sequencer will take care of feeding the Arranger with the correct chord information and selecting the desired Style division.

1. Press <Chord Sequencer> on the Composer Menu page.

A Chord Sequencer screen like the one below appears on the display.

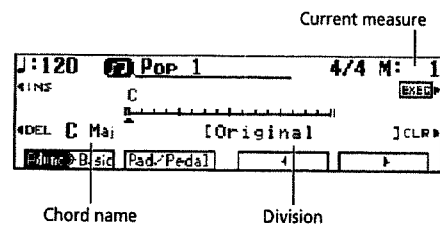

(For more information on divisions, see “Muting parts of a division” on page 36.)

2. Use the MUSIC STYLE buttons to choose a Style group.

After several seconds, the display returns to the Chord Sequencer screen.

3. Use <INS> to insert the desired number of blank measures for the song you wish to input.

4. Use the <◀> and <▶> at the bottom right of the display or the [BWD] and [FWD] buttons to move the cursor (▲) to the position where the chord and division are to be input.

5. To enter a chord, play it in the lower half of the keyboard.

The chord display serves as a guide for entering chords. If you have doubts about the correct way of playing a given chord, just look at what the display says.

■ Here are the other things you can program:

- Entering an Intro or Ending: press the [INTRO/ENDING] button.
- Changing the Style Level: press <Advnc▶Basic> (or <Advnc◀Basic>).
- Entering a Fill-In: press the desired Fill In button. (By assigning other functions to the PAD buttons or the left pedal, you can also use functions such as “Break.”)

You can also insert and delete measures by pressing <INS>, , and <CLR> next to the display.

<INS>— Inserts a single blank measure at the position of the cursor.

— Deletes a single measure after the position of the cursor, and shifts all subsequent bars to the left.

<CLR>— Deletes the information (chords and divisions) at the position of the cursor.

Note: Activate the Leading Bass function if you wish to play complex chords, such as "Fm/C". See "Pad buttons: additional or frequently used functions" on page 44.

6. Press the Composer [PLAY] button to check your Chord Sequence.

The accompaniment you've created is played, starting from the position of the cursor.

Press the Composer [STOP] button to stop playback.

7. When you've finished inputting the accompaniment, press <EXEC> at the right-hand side of the display.

After several seconds, the display returns to the Composer Menu screen.

8. Press the Composer [PLAY] button.

The accompaniment you've created is played, so try playing the melody along with the accompaniment as backing.

Note: Once <EXEC> has been pressed, what you've input cannot be corrected. Always check whether everything has been entered correctly before you press <EXEC>.

Note: An Intro can only be input at the start of a song. Entering an Intro causes the number of measures corresponding to the Intro's length to be inserted automatically.

because it allows you to start with the bass drum and snare drum and to add the HiHat and cymbals the second time around.

Note: If you choose Mix to add notes to a melodic part, be sure to switch on the Link function (see page 49). Otherwise, the track may suddenly use a different Tone.

Punch In/Out— This mode allows you to use a footswitch (or a PAD button) to start and stop recording while listening to your song. Select this mode to correct minor mistakes (such as flat notes here and there, or shaky timing of a phrase). Press the pedal (or PAD button) again to cancel recording and returns to the playback state.

Punch-in recording can only be performed when "Punch In/Out" has been set as the footswitch (or the PAD button) function. To perform recording, be sure to set the pedal function before you start. See "Pedal functions" on page 45 and "Pad buttons: additional or frequently used functions" on page 44.

Note: Punch-in recording erases the previously recorded performance (same as Replace mode).

Stopping a recording (Rec Stop)

Arranger Stop— Recording ends as soon as you stop the Arranger.

Composer Stop— Pressing the Composer [STOP] button ends recording. In this case, you can stop the Arranger and go on recording until you press the [STOP] button.

9.3 Recording Mode

You can select the recording method and the way that recording is stopped.

1. On the Composer Menu, press <Recording Mode>. A screen like the one below appears on the display.

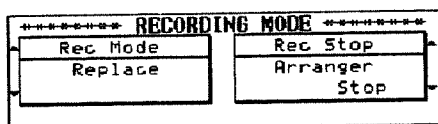

2. Use the buttons on the left side of the display to select the recording method (Rec Mode), and the buttons on the right side of the display to select how recording ends (Rec Stop).

Recording method (Rec Mode)

Replace— This is the usual recording mode. When recording to a track that already contains data, you overwrite the previous version up to the point where you stop recording. (This is also the case when you start recording without playing anything: the Composer will then record the equivalent number of rests.)

Mix— Allows you to add new notes to an existing recording without overwriting the previous version. This mode is ideal for programming the drums

9.4 Formatting disks

In order to use new disks or disks which have been used on other equipment, it will be necessary to "format" such disks.

Note: When a disk is formatted, all the data stored on it is completely erased. As a rule, you should always check the contents of a used disk (either on the KR-777/177 or on a PC) before formatting it.

1. Set the Write Protect tab on the disk to the "Write" position and insert the disk into the disk drive.

2. Press <Disk Format> on the Composer Menu screen.

A screen like the one shown below will be displayed.

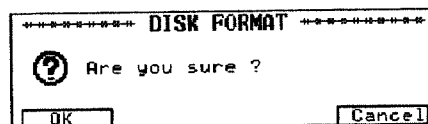

3. If you really want to format the disk, press <OK>. When the formatting operation begins, a countdown will begin on the screen.

To cancel the operation, press <Cancel> shown on the screen, or the [EXIT] button.

Note: Never remove a disk that is being formatted. Doing so may damage both the disk and the floppy drive.

9.5 Style Composer

The KR-777/177 has a function called “Style Composer” that lets you compile new Music Styles from existing Style parts. Thus, you could take the bass part from the “Slow Waltz 1” Style, add the drums of the “Waltz” Style and use the melodic accompaniment of the “Vienna Waltz” Style. Music Styles you create with the Style Composer (or the Style Converter, see “Style Converter” on page 36) are called “User Styles”.

Every Music Style of the KR-777/177 is made up of five parts that are assigned to Arranger tracks (see below).

Note: The User Style is deleted when the power is turned off. Do not forget to save it to disk (see “Saving User Styles” on page 37).

1. On the Composer Menu screen, press <Style Composer>.

The rhythm part of the currently selected Music Style is played back, and a screen like the one below appears on the display.

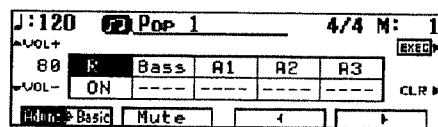

The part names are displayed at the center of the screen. The part that appears in reverse video is currently selected.

The Track buttons correspond to the parts as follows.

Arranger track	Display	Track button
Rhythm	R	[Rhythm]
Bass	Bass	[Bass/Accomp]
Accompaniment 1	A1	[Lower]
Accompaniment 2	A2	[Upper]
Accompaniment 3	A3	[Whole]

The tempo of a “composed” Style is determined by the tempo of the “R” track. You can change it, however, with the TEMPO [+]/[-] buttons.

Note: You cannot use Arranger parts of a User Style because the KR-777/177 has only one User Style memory – the one you are copying Style parts to.

2. Use the MUSIC STYLE buttons and the buttons next to the display to select the Style that contains the desired rhythm part.

Every time you select another Music Style, the rhythm that is played back changes. After several seconds, the display returns to the Style Composer screen.

3. After choosing the rhythm, use <◀> and <▶> at the lower right of the display to select another part.

You can also choose a Part by pressing the Track buttons (see above). The selected part will be played along with the “R” and any other part you have already copied.

4. Repeat steps 2 and 3 to make the settings for the remaining parts.

You can use <VOL+> and <VOL-> to the left of the display to set the volume level for each track.

5. Press the <EXEC> button or the Composer [REC] button to confirm your settings.

The User Style is temporarily saved in the memory assigned to the [DISK/USER] button (indicator lights) and can be selected by pressing this button (see also “Using Style disks (User Styles)” on page 23).

You can also use the Composer [REC] button to end your programming session. To stop the operation, press the [Exit] button.

Note: Press <Advnc▶Basic> (or <Advnc◀Basic>) at the lower left of the display to change the Style Level.

Note: Please note that Rhythm parts can only be assigned to “R”, while bass parts can only be assigned to “Bass”. The “A” parts, on the other hand can be freely assigned to memories A1~A3.

As stated earlier, not all Music Styles use all available Arranger tracks (R, Bass, and A1~A3). If a given track is empty, select another one. Likewise, you don’t have to copy Style parts to all available Arranger tracks.

Editing your User Style

See the above chart for the correspondences between Track buttons and Arranger parts.

1. On the Composer Menu screen, press <Style Composer>.

The User Style is played back and the indicators of all Arranger tracks that contain data light.

2. Use <◀> and <▶> at the bottom of the display to select the part on screen that you wish to change.

You can also select it by pressing the corresponding Track button (indicator must light).

3. Use the MUSIC STYLE buttons and the buttons next to the display to select the desired Style.

Every time the Style is changed, the parts that are played back change.

4. Use <◀> and <▶> at the bottom of the display to select another part.

5. If necessary, repeat steps 2, 3, and 4 until you’re happy with your User Style.

Press the <CLR> button to temporarily mute the selected Arranger part.

6. Press the <EXEC> button or the Composer [REC] button to confirm your settings.

Muting parts of a division

See "What is an Arranger?" on page 22 for more information about Divisions. Here is a brief summary of the available divisions: Intro, Original, Variation, Fill In To Variation/To Original, Ending.

The KR-777177 allows you to silence (mute) selected parts of a Style division.

You could, for example, mute the Accompaniment 1 part of a Variation pattern. Here's how to:

1. On the Composer Menu screen, press <Style Composer>.

The User Style is played back and the Track buttons of all active Arranger tracks light up.

2. Press the Fill In [TO VARIATION] button to select it.

Some divisions are not played back continuously (Intro, Ending or Fill-in), so carry out the next step while the Arranger plays it back.

3. Use <◀> and <▶> at the bottom of the display to choose "A1", then press <Mute>.

(You can also select another part and then press <Mute>.)

Accompaniment 1 is muted, and the Track [UPPER] indicator goes out. To switch the A1 part back on again, press <Mute> once more.

Another way of muting an Arranger part is to hold down Composer [FWD] button and press the Track button assigned to the part you wish to mute. In this case, each press of the Track button toggles between playback (indicator lights) and muting (indicator off) of the Part.

4. Press the <EXEC> button or the Composer [REC] button to confirm your settings.

9.6 Style Converter

You can also program User Styles by using short phrases of a song recorded with the 16-track Sequencer (see page 32).

1. Use the 16-track Sequencer to record a performance of "Major", "Minor", or "Seventh" type. Because only certain tracks can be converted to Style data, you should record the performance on the following tracks.

Track	Arranger Part
2	Bass
7	Accomp1
8	Accomp2
9	Accomp3
D	Rhythm

If you want to create a "professional" Style, don't forget to program the Intro, Fill-ins, and Ending as you record.

Note: You want to brush up your song data before converting them into a User Style. See "Song Edit" below for details.

2. On the Composer Menu screen, press <Style Converter>.

A screen like the one below appears on the display.

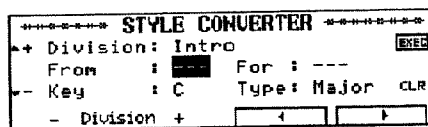

3. For each division, select the bars to be used, the key, the chord type, and other settings.

Use <◀> and <▶> at the bottom of the display to select the items to be set, and use the buttons on the left to change the settings.

Press <CLR> to disable a setting.

Division:	Accompaniment pattern.
From:	Starting measure of the excerpt.
For:	Number of bars from the starting measure.
Key:	Key of the excerpt.
Chord:	Chord type of the excerpt (select Major, Minor, or Seventh.)

4. Press the Composer [PLAY] button to listen to the isolated passage.

5. After you've checked all the divisions that you want to make settings for, press <EXEC>.

The Style is saved to the [DISK/USER] button.

Note: For information on divisions, see page 22.

Note: Only certain tracks can be handled as Style data. If the performance has been recorded with the Composer, or if the song data is not on the specified tracks, use Track Exchange on the Edit screen to change the tracks. See page 39.

Note: If “Fill to Variation” or “Fill to Original” has been chosen for “Division”, only one measure can be cut out.

Note: Preset selections are used for divisions which are not selected.

Note: Be careful to remove all data types except the following from your song before converting it to a User Style: Performance information from the keyboard (notes and pedal information), Reverb Depth, Chorus Depth.

Note: Once <EXEC> has been pressed, the previous settings cannot be recovered.

9.7 Saving User Styles

You can save User Styles onto floppy disks. You can call up Styles that have been saved to disk in the same way you do with Style disks.

1. Insert a formatted disk into the disk drive.
2. Press the [DISK/USER] button.

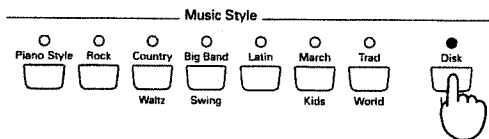

The Song Select Screen will be displayed.

3. Press <Save>.
4. Select a number with the <▲> and <▼> buttons to the left of the screen.

You can choose any number between “1” and “99”. Do note, however, that selecting a User Style number that already contains data means that the Style in question will be overwritten by your new User Style.

5. Enter a name for the User Style with <◀> and <▶> below the display and the <▲> and <▼> buttons to the left of the screen.

Please refer to page 32 for the list of the available characters.

6. Press <Save>.

Note: If you want to cancel the operation, press the [EXIT] button.

9.8 Song Edit

The KR-777/177 has eight functions that you can use to edit the songs you have recorded.

Note: After carrying out one of the following functions, it may be impossible to restore the previous settings. Also, songs recorded with Arranger backing may sometimes yield surprising (and highly irritating) results. We recommend that you save your song to disk before editing it.

Steps for editing

1. On the Composer Menu screen, press <Song Edit>. An Edit Menu screen like the one below appears on the display.

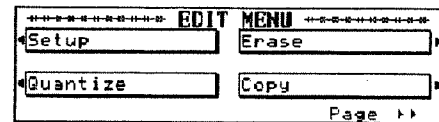

2. Use the buttons next to the display to choose the editing function.

The Edit screen has two pages. Use <<<PAGE> and <PAGE>>> to bring up the other page.

1. Changing the Tempo and Volume of a song – Setup.
2. Aligning imperfect Notes – Quantize
3. Erasing notes or tracks – Erase
4. Duplicating phrases – Copy
5. Deleting measures – Delete
6. Inserting blank measures – Insert
7. Changing the key – Transpose
8. Swapping and copying tracks – Track Exchange/Track Copy

Note: To cancel an operation, press the [EXIT] button.

You can also edit a song on a floppy disk: Insert the disk in the disk drive and play back the performance one time. Then edit it.

Setup: tempo and volume

Changes in tempo and volume that are made with the TEMPO and Part Volume buttons are only temporary. If you like your new settings better than the original ones, here is how to correct your song:

Before selecting the Song Edit screen, set the tempo by pressing the TEMPO buttons, and set the volume of the tracks you want to change in the 16-track Sequencer screen.

1. Press <Setup> on the Edit screen.

A screen like the one shown below will appear.

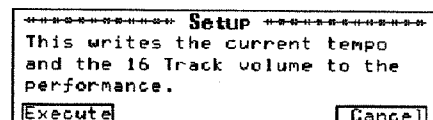

2. Press <Execute>.

The new tempo and volume values are stored.

Note: You can also change the setting by holding down [REC] and pressing the [RESET] button.

Quantize: timing corrections

Quantize is a function that corrects minor timing problems. It shifts the notes whose timing is not exactly right to the nearest "correct" unit.

Be careful, though, because the timing of the quantized notes may be mathematically correct, while the result is not what you expected. Always select a resolution value that is fine enough to accept all note values you play. If the shortest notes of your accompaniment are 1/16th note triplets, set the Resolution value to 1/16t.

1. Press <Quantize>.

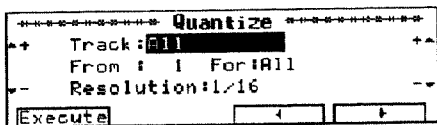

2. Use <◀> and <▶> below the display to select a parameter, and set the value with <+> and <->.

Track— Track number (you can also select "All" tracks)

From— The starting measure

For— The number of bars from the starting measure (you can also select "All" measures).

Resolution— Note value to be used for correcting the timing. (Select the length of the shortest note of the data to be quantized.)

3. Press the <EXEC> button to confirm your settings and edit the data.

Erase: removing data from a track or song

Erase is a function that erases a portion of the selected song, without removing the measures themselves.

That will leave you with the equivalent number of blank measures. You could then record new data in those measures using the Punch In/Out recording method (see page 34).

Note: The notes you erase cannot be restored.

1. Press <Erase>.

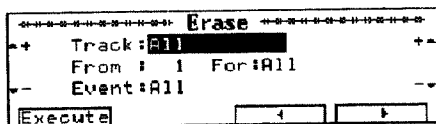

2. Use <◀> and <▶> below the display to select a parameter, and set the value with <+> and <->.

"Track", "From", "For": see step (2) under "Quantize: timing corrections".

Event refers to the types of data that will be erased:

- *All*: all data
- *Note*: the notes you played on the keyboard.
- *Except Note*: all data except the notes (e.g. footswitch, Pitch Bend, and Modulation data).
- *Tempo*: all tempo settings (changes) except the preset tempo. "Tempo" erases all tempo data, regardless of what Track numbers have been selected.

3. Press the <EXEC> button to confirm your settings and edit the data.

Copy(ing) measures

This copies a portion of a track to another bar of the same track. Use this function if you'd rather not play the chorus or verse of a song more than once.

Note: All data present at the copy destination is overwritten by what is copied.

1. Press <Copy>.

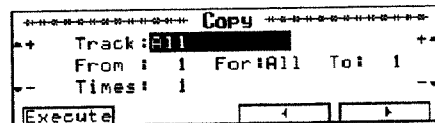

2. Use <◀> and <▶> below the display to select a parameter, and set the value with <+> and <->.

"Track", "From", "For": see step (2) under "Quantize: timing corrections".

To— The copy destination measure ("End" refers to the end of the song).

Times— The number of times the selected measures are to be copied.

3. Press the <EXEC> button to confirm your settings and edit the data.

Delete: removing measures

Though similar to *Erase*, the Delete function also removes the selected measures. You cannot select the data type to be deleted because Delete removes everything.

Delete means "remove all measures within the specified range" (for example bars 1 and 2 of a track, so that bar 3 becomes bar 1).

Note: Once a measure has been deleted, it cannot be restored.

1. Press <Delete>.

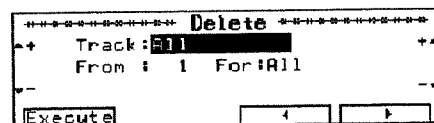

2. Use <◀> and <▶> below the display to select a parameter, and set the value with <+> and <->.

"Track", "From", "For": see step (2) under "Quantize: timing corrections".

3. Press the <EXEC> button to confirm your settings and edit the data.

Insert: adding blank measures

Insert allows you to make a track longer by adding rests at the specified position. This will make room for new data and shift data that lie behind the From position further to the right. New data can be added using the Punch In/Out method (see page 34) or by copying excerpts.

Note: The Insert function does not provide a To pointer. Instead, you have to specify the length of the insert using the For value. "For 2" thus means "insert 2 bars".

1. Press <Insert>.

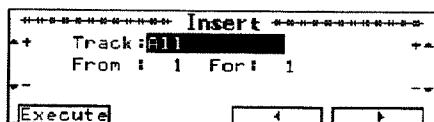

2. Use <◀> and <▶> below the display to select a parameter, and set the value with <+> and <->. "Track", "From": see step (2) under "Quantize: correcting the timing".
For— The number of bars to insert.
3. Press the <EXEC> button to confirm your settings and edit the data.

Transpose: changing the key

Transpose allows you to change the key of what has already been recorded. It can be invaluable for tricky phrases that you want to play only once.

1. Press <Transpose>.

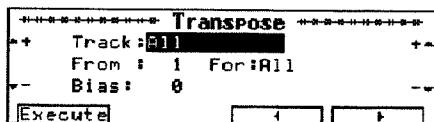

2. Use <◀> and <▶> below the display to select a parameter, and set the value with <+> and <->. "Track", "From", "For": see step (2) under "Quantize: timing corrections".
Bias— Amount of transposition. A value within the range of -24~+24 semitones (-2~+2 octaves) can be specified.
3. Press the <EXEC> button to confirm your settings and edit the data.

Track Exchange/Track Copy: swapping and copying tracks

Here, you can choose to exchange the data of one track against that of another track or to copy data from one track to another (so that they both play the same from start to finish).

1. Press <Trk Exchng/Copy>.

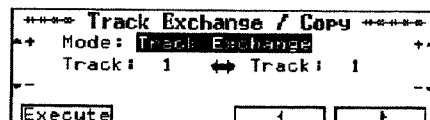

2. Use <◀> and <▶> below the display to select a parameter, and set the value with <+> and <->. Mode— Track Exchange: Swaps tracks
Track Copy: Copies a track

3. Press the <EXEC> button to confirm your settings and edit the data.

Note: When copying a track, data existing at the copy destination is overwritten by what is copied.

10. Function Menu

The Basic, Piano, and Organ screens provide access to several convenient functions you could take advantage of for optimizing your KR-777/177's response.

Operating procedure for the Function Menu

1. Press <Func.>.

The Function menu will appear on the screen.

2. Select a function with the buttons below the display.

3. Set the function with the buttons to the side of the display.

Simultaneously press <▲> and <▼> to revert to the default setting. The display automatically returns to the previous page after several seconds of inaction. If you can't wait to do something else, press the [EXIT] button.

If you want to cancel the operation, press the [EXIT] button before changing the settings.

The velocity of the last note you played is displayed on the left-hand side of the screen. You can refer to this when setting the touch as you play the keyboard.

2. Move the arrow (▼) with the buttons to the right of the screen.

Each time you move the arrow, the touch level changes. The velocity sensitivity and the arrow correspond in the following way:

Light	Little strength is required to play fortissimo.
Heavy	Select this setting for maximum expressiveness: even small variations of the force with which you strike a key produce audible changes. The trade-off is, however, that you have to strike the keys forcefully to achieve the maximum volume.
(Center)	Normal setting. Velocity sensitivity closest to that of an acoustic piano.

Note: You can also change the velocity sensitivity using the Utility Menu (see page 46).

10.1 Piano screen functions

Metronome volume and beat

1. Press <Metronome>.

"Volume" (1-10) and "Beat" will be displayed.

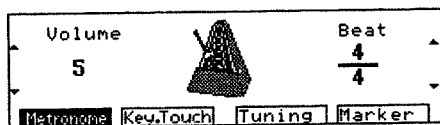

2. Adjust the volume and beat (time signature) with the buttons next to the display.

Note: The volume is set to "5" when the power is turned on. The available Beat settings are: 0/4, 2/4, 3/4-7/4, 3/8, 6/8, 9/8, 12/8. The metronome always uses the time signature of the last Music Style you selected, so that you could set the Beat by selecting a Style with the appropriate time signature.

Note: You cannot change the Beat in the Arranger mode or when you are using the Composer function.

Key Touch (velocity sensitivity)

You can adjust the way in which the KR-777/177 translates the velocity data.

1. Press <Key Touch>.

The touch level will appear in the right half of the screen. Refer to this scale when making settings as you play on the keyboard.

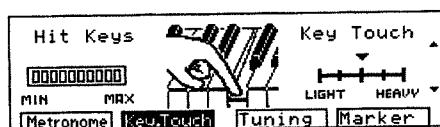

Tuning

You can select the tuning of the keyboard.

1. Press <Tuning>.

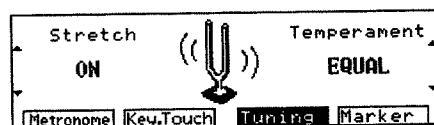

■ Stretch Tuning

"Stretch Tuning" is a method of tuning unique to pianos. Compared with equal tuning, low notes are tuned slightly lower, while high notes are tuned slightly higher. At power on, this parameter is set to On.

2. Set the Stretch Tuning ON/OFF with the buttons to the left of the display.

ON— Like an acoustic piano, the low range is a little flat, and the upper range a little sharp.

OFF— The tuning of all notes is scientifically correct.

■ Temperament

"Temperament" refers to alternative ways of tuning an instrument. Some of the options provided here allow you to play Baroque and Classical pieces with the tuning of those periods.

3. Set the tuning method with the buttons to the right of the display.

You can choose from the following seven types of tuning.

EQUAL— The most common kind of tuning today. In this tuning, an octave is divided into twelve equal steps.

PYTHAGOREAN— Uses the Pythagorean scale. Devised by Pythagoras, the fourth and fifth are kept from becoming ambiguous in this tuning.

JUST (MAJOR)— In this tuning, the third and fifth are kept from becoming too ambiguous. Choose this setting for pieces in a major key.

JUST (MINOR)— With this tuning you can achieve the same effect as for Just Major, this time for pieces in a minor key.

MEAN TONE— A partial compromise of the Just (Major) tuning, to make transposition possible.

WERCKMEISTER— A combination of Mean Tone and Pythagorean tunings.

KIRNBERGER— An improvement of the Mean Tone and Just (Major) tunings, it is a tuning which allows greater freedom of transposition.

When performing with these alternative tunings, you need to specify the fundamental tone (the root for a major key, the sixth for minor) to match the key of the song you are performing.

When you are accompanying another instrument, please tune to the fundamental tones of that instrument.

4. Set the Key note by pressing the key while holding down <Tuning>.

You need to do this for all temperaments except Equal. *Note: The temperament you select here applies to all KR-777/177 parts (the keyboard parts, the Arranger parts, and the Composer tracks/parts).*

Marker function: repeatedly playing back the same section

The KR-777/177 also provides a Marker and loop function for you to practice difficult solos or to repeat a given song part.

Markers are placed at the beginning of measures.

1. Press <Marker>.

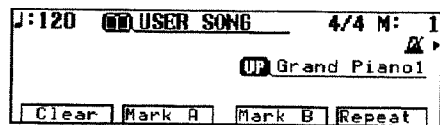

You can place markers at two locations in a song. When you put a marker in a song, playback will start from the beginning of the measure where the A marker is put.

By way of example, let's place a Marker at the beginning of measure 5.

2. Go to the target measure by pressing the [FWD] and [BWD] buttons.

The measure number appears in the upper right of the screen. Select measure 5.

3. Press <Mark A>.

<Mark A> changes to "A:5."

4. Press the [PLAY] button.

Playback of the performance will begin at the beginning of measure 5.

5. Press <A:5>.

The KR-777/177 will return to the beginning of the fifth measure, and begin playing back again.

You can press the <Mark A> button before, during, or after playback.

The KR-777/177 memorizes the next downbeat. In other words, if you press <Mark A> on the fourth beat of measure 4, for example, the beginning of measure 5 will be marked. A more precise approach would be to stop playback, fast forward or rewind to the desired measure and then press <Mark A>.

■ Repeated playback (Repeat)

Example: Repeating playback of measures 5- 8

6. See steps (2) and (3) above.

7. Go to the measure where you want the loop to end by pressing the [FWD] and [BWD] buttons.

The measure number appears in the upper right of the screen. Select measure 9.

8. Press <Mark B>.

Here is what you have just programmed:

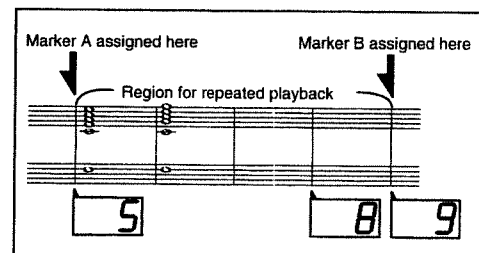

9. Press <Repeat>.

The song will return to measure five, where Mark A is located.

10. Press the [PLAY] button.

Measures 5~8 will play back repeatedly.

Note: If you forgot to program <Mark B>, the song will repeat between <Mark A> and the end of the song.

Note: Likewise, if a song only has a <Mark B>, pressing <Repeat> will start a loop between the beginning of the song and <Mark B>.

■ Erasing Marks

Hold down <Clear> and press either <A: (the measure number)> or <B: (the measure number)> to erase a marker.

10.2 Organ screen functions

For information on using markers, see above.

Using the Arranger

You may remember that we told you that, by pressing the [START/STOP] or [INTRO/ENDING] button, you can start playback of the drum pattern of the selected Music or User Style. The Organ screen does, however, provide an Arranger function that allows you to use entire Music Styles (with bass and accompaniment lines). The split point can be set anywhere between the B1 and the B6.

1. Press <Arranger>.

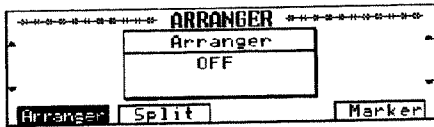

2. Using the button to the side of the display, you can turn the Arranger function on and off.

At power on, this function will be set to Off.

Lower Tone on/off and split point

You can switch the Lower Tone on and off and set the split point anywhere between the B1 and the B6.

1. Press <Split>.

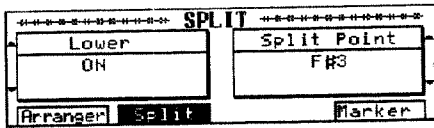

■ Turning the Lower Tone on and off

Use the buttons to the left of the display to switch the Lower Tone on or off.

■ Changing the Split point

Use the buttons to the right of the display to select the Split point.

Each time you press the button, the Split point will shift one key.

Note: You can also set the split point by pressing the key where you want the keyboard to be split while holding down <Split>.

10.3 Basic screen functions

Note: See above for how to set the split point.

Note: See page 41 for information on using markers.

Auto: changing the Arranger defaults

You may remember that selecting a Music Style means that the KR-777/177 automatically loads its preset tempo, selects an Upper Tone that matches the mood of the Styles, and activates the Chord Intelligence function. Here is how to keep the KR-777/177 from loading some or all of these settings:

1. Press <Auto>.

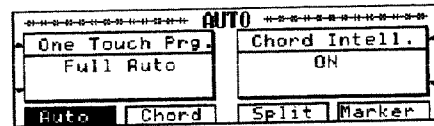

2. Select what you are going to change with the buttons to the left of the display.

■ One Touch Prg

Full Aut— By selecting a Music Style, you also recall its preset tempo, a suitable Upper Tone and a few other settings (see “Settings” on page 22).

Tone Lock— The KR-777/177 no longer selects an Upper Tone when you choose another Music Style.

Tempo Lock— The KR-777/177 no longer sets the preset tempo of the selected Music Style.

Tone, Tempo Lock— Selecting another Music Style no longer loads the preset tempo and Upper Tone.

OFF— In this mode, the KR-777/177 loads none of the settings related to the Music Style you select (see “Settings” on page 22).

Note: Full Auto is switched on by default.

■ Chord Intelligence ON/OFF

3. Switch the Chord Intelligence function on/off with the buttons to the right of the display.

Chord Intelligence is set to be switched on by default.

For more detailed information about Chord Intelligence, please refer to “Easy fingering – Chord Intelligence” on page 27.

Chord Tone Setting

After stopping Style playback (or before starting the Arranger), you can play chords with your left hand that will be sounded the way you play them (without the automatic accompaniment). The Tone being used for sounding the chords is appropriately called “Chord Tone.” Along with the Chord Tone, the KR-777/177 will also play a bass note with (you guessed it) the “Bass Tone”.

Ordinarily these Tones are preset, but they can be changed through the following procedure.

1. Press <Chord>.

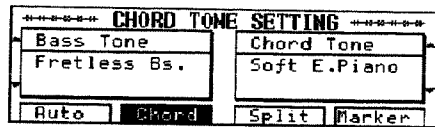

2. Select the Bass Tone using the buttons to the left of the display, and the Chord Tone with the buttons to the right of the display.

If you don't want the Bass Tone or Chord Tone to sound, select “OFF.”

Note: Some Tones allow you to sustain the notes you play until you play other notes (Hold function), thus freeing up your left hand for other tasks between the changes.

Note: When the power is turned on, <Chord Tone> is set to “Soft E.Piano” and <Bass Tone> is set to “Fretless Bs.”

Note: See also “Volume of the Rhythm, Bass, Accomp, and Chord/Bass Tones” on page 25.

11. User Programs, Pad buttons, pedals

11.1 User Program: registering panel settings

The KR-777/177 is equipped with 32 User Program memories that allow you to store almost all settings (or registrations) you make on the front panel. So far, we have only discussed the easy part of changing the preset settings. Later on, you will discover that you can also carry out a lot of in-depth work. Those settings can also be saved to a User Program.

1. Make the settings that you want to register.
2. Press the [USER PROGRAM] button.

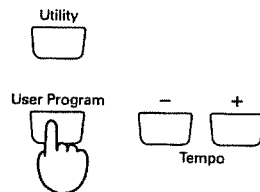

The display responds with:

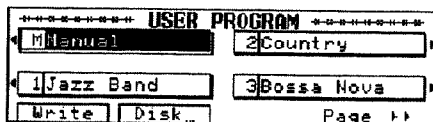

3. While holding down <Write>, use the buttons to the side of the display to choose a User Program number.

After a few seconds, the display returns to the previous page.

Note: You cannot store settings to the <Manual> memory.

Note: The KR-777/177 comes with a number of User Programs you could use as starting points for your own settings.

Feel free to overwrite them when you run out of internal User Programs. Otherwise save your User Programs to disk.

Note: You can also name your User Programs (see below).

Loading a User Program

1. Press the [USER PROGRAM] button
The User Program screen (see above) is displayed.
2. Use the buttons to the side of the display to select a User Program memory.

Note: Choosing <Manual> changes the panel settings to the ones in effect before the User Program was called up.

Note: You can also decide when the settings relating to the Arranger are loaded. See “User Program Arranger Update” on page 49.

Naming (or renaming) a User Program

Here is how to name or rename a User Program:

1. On the User Program screen, hold down the [USER PROGRAM] button and select a User Program memory.

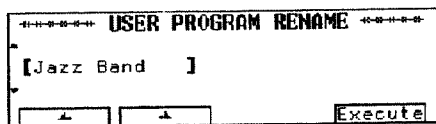

2. Use <◀> and <▶> below the display and <▲> and <▼> to the left of the display to enter the name. See page 32 for a list of available characters.
3. Press <Execute>.

Saving User Programs to disk

You can store up to 32 User Programs, including Manual settings, on the KR-777/177. These 32 User Programs make up one set, and up to 99 sets can be saved on a disk.

User Programs can only be saved on a disk that has been formatted by the KR-777/177. If you're using a new disk, first format it (see page 34), then carry out the following steps.

1. Set the Write Protect tab on the disk to the "Write" position and insert the disk into the disk drive.
2. Press the [USER PROGRAM] button. The User Program screen is displayed.
3. Press <Disk...>.

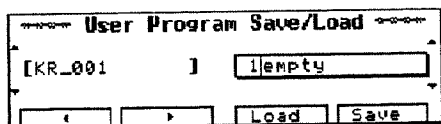

4. Use <▲> and <▼> to the right of the display to select a number. You can choose any number between "1" and "99". Do note, however, that selecting a User Program number that already contains data means that the User Program Set (i.e. 32 precious User Programs) in question will be overwritten by your new set.
5. Use <◀> and <▶> below the display and <▲> and <▼> to the left of the display to enter a name. See page 32 for a list of available characters.
6. Press <Save> at the bottom right of the display. *Note: To cancel without saving the User Program Set, press the [EXIT] button.*

Loading a User Program set from disk

1. Insert the floppy disk that contains the desired User Program into the disk drive.
2. Press the [USER PROGRAM] button. The User Program screen is displayed.
3. Press <Disk...>.

4. Use <▲> and <▼> to the right of the display to choose the User Program.

5. Press <Load> at the bottom right of the display. *Note: Please bear in mind that loading a User Program set means that all 32 internal User Program memories will be overwritten. You may want to save them to disk first (see above).*

Note: To stop the operation, press the [EXIT] button.

11.2 Pad buttons: additional or frequently used functions

You can assign a wide variety of performance-related functions to the two PAD buttons on the panel. After a function has been assigned, it can be called up by pressing the corresponding PAD button.

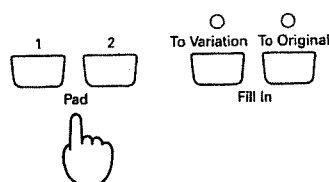

1. On the Basic screen, press <Pad/Pedal>.

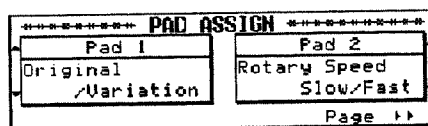

2. Use <▲> and <▼> next to the display to assign a function to "Pad 1" and "Pad 2." Press [EXIT] if you've changed your mind about assigning one of the following functions to a PAD button.

Here are the functions you can assign to the PAD buttons:

Leading Bass— This switches the Leading Bass function on or off. During normal Style Play, the root of the chord played is used as the bass note, but when the Leading Bass function is used, the lowest note of the chord actually played is used as the bass note. This means that the bass note changes when an inverted chord is used.

Note: If you assign this function to a footswitch, the Leading Bass function is "On" whenever the footswitch is depressed.

Break— Break is a great function for Rock'n'Roll songs and ballads. Use it to halt the Arrangement either for the remainder of the current bar or for an entire bar (when pressed on the last beat of a bar). Usually, the melody or solo continues during such a silent (tacet) bar. Break allows you to achieve the breaks in "Great Balls Of Fire", for example.

Fill In To Variation.— This has the same function as the Fill In [TO VARIATION] button.

Fill In To Original.— This has the same effect as the Fill In [TO ORIGINAL] button.

Fill In— This inserts a Fill-in, but the accompaniment pattern thereafter does not change.

Original/Variation— This changes to Original or Variation without inserting a Fill-in.

Basic/Advanced— This has the same effect as pressing <Advnc◀Basic> or <Advnc▶Basic>.

Simple Intro/Ending— This function allows you to select the simple version of an Intro or Ending at the press of a button.

Melody Intelligence— This has the same effect as the [MELODY INTELLIGENCE] button.

Arranger Intro/Ending— This has the same effect as the [INTRO/ENDING] button.

Arranger Start/Stop— This has the same effect as the [START/STOP] button.

Fade In/Out— This function allows you to fade in (whereby the volume gradually increases) when the Arranger is started, or to fade out (whereby the volume gradually decreases) at the end of your song.

Chorus ON/OFF— This switches the Chorus effect for the Whole or Upper Tones on or off.

Rotary Speed Fast/Slow— This changes the speed of the Rotary effect.

DSP ON/OFF— This switches the DSP effect on or off.

Glide— When the button assigned to this function is pressed, the pitch drops momentarily, then gradually rises to its original level. This is effective when used to play a Hawaiian guitar, and the like.

Composer Play/Stop— This has the same effect as the Composer [PLAY] and [STOP] buttons.

Metronome ON/OFF— This switches the metronome on or off.

Punch In/Out— When you select this function, you can activate and deactivate the recording process during playback. See page 34 for details.

11.3 Pedal functions

You can also assign other functions to left pedal (Soft).

1. On the Basic screen, press <Pad/Pdl>.
2. Press <Page>.
3. Use <▲> and <▼> to the side of the display to select the functions of the SOFT footswitch.

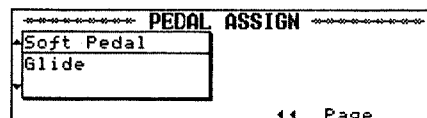

In addition to the following functions, all functions listed under “Pad buttons: additional or frequently used functions” can be assigned to either footswitch.

Soft for Upper— The footswitch acts as Soft pedal (affecting the Upper Part or the Whole Part).

Sostenuto for Upper— The pedal acts as Sostenuto pedal (affecting the Upper Part or the Whole Part).

Damper for Lower— The footswitch acts as separate Damper pedal for the Lower part.

Bend Up— Select this function if you want to use the left pedal to shift the pitch of the notes you are playing upward. The interval (range) can be set using the Pitch Bend Range parameter (see page 47). To shift a “C” to the “G” note above the C, set Pitch Bend Range to “7” and select “Bend Up”. “Bend Up” is probably what you will use most of the time.

Bend Down— Select this function if you want to use the left pedal to shift the pitch of the notes you are playing downward. The interval (range) can be set using the Pitch Bend Range parameter. To shift a “C” to the “G” note below the C, set Pitch Bend Range to “5” and select “Bend Down”.

After a few seconds, the display returns to the previous screen.

Note: When you press the One Touch Program [PIANO] button, the pedals once again assume their “official” functions (Soft and Sustain).

12. Utility Menu

12.1 Operating procedure

1. Press the [UTILITY] button.

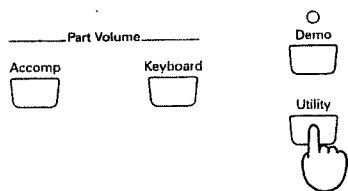

The Utility Menu screen appears. You can now select the function you wish to set.

2. Use <◀◀PAGE> and <PAGE▶▶> to jump to another Utility page.

The Utility Menu is made up of 14 pages.

3. Use the buttons to the side and below the display to make the settings for each of the functions.

To return to the settings in effect when the power was first turned on, simultaneously press <▲> and <▼>.

The display automatically returns to the original screen after a few seconds. You can also return to the original screen by pressing the [EXIT] button.

Note: If you want to cancel the operation, press the [EXIT] button before changing any settings.

12.2 Utility functions

Master Tune

Master Tune allows you to tune your KR-777/177 to acoustic instruments that cannot be tuned. Like all electronic musical instruments, your KR-777/177 is set to A4= 440Hz, which may be flat for certain acoustic instruments. Please note that the KR-777/177 will revert to A4= 440Hz whenever you switch it on.

1. On the Utility Menu screen, press <◀◀PAGE> or <PAGE▶▶> to select the following display page:

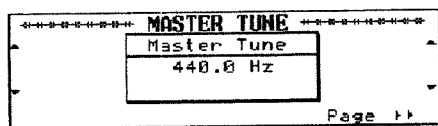

2. Use the buttons to the left and right of the display to set the standard pitch (415.3~466.2Hz).

Note: This setting affects all sounds, including songs played back from a disk.

Key Touch/Key Transpose

1. On the Utility Menu screen, press <◀◀PAGE> or <PAGE▶▶> to select the following display page.

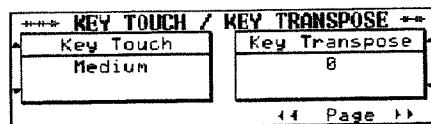

■ Key Touch (velocity sensitivity)

Except for the fact that there are five options here, this function does the same as “Key Touch (velocity sensitivity)” on page 40.

2. Use the buttons on the left of the display to set the Key Touch.

For “Light”, “Medium”, and “Heavy”, see page 40.

Super Light— Playing fortissimo doesn’t require much strength.

Super Heavy— This setting is probably only useful for practising purposes.

■ Transpose

If you are used to playing a song in a particular key, the Transpose function will allow you to keep playing in that key while sounding in another one. Doing so will allow you to accommodate the singer or musician you play with or to play to a Standard MIDI File backing that (for some inexplicable reason) was recorded in another key than the one you normally choose.

This function has the same effect as using the TRANSPOSE buttons, only here you see the value you set.

3. Use the buttons to the right of the display to select the amount of transposition.

Your setting (–12~0~12) appears on the display. The key changes in semitone steps.

Example: When you select “2”.

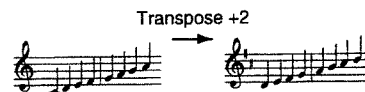

This is what you play,... ...this is what you hear.

Note: Key Transpose affects the entire keyboard and thus also the chords sent to the Arranger.

Note: You can also set the desired transposition interval with the TRANSPOSE [+] and [–] buttons. Press these buttons simultaneously to return to normal pitch (no transposition).

Metronome Volume and Beat

1. On the Utility Menu screen, press <<◀PAGE> or <PAGE>>> to select the following display page:

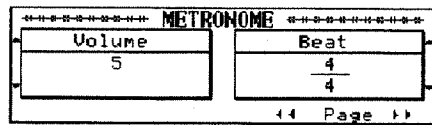

2. Use the buttons to the left and right of the display to set the desired values.

For Volume, a higher value produces a louder sound.

Note: Whenever you press a MUSIC STYLE button, the Beat value (time signature) is automatically set to match the time signature of the Music Style.

Note: Beat cannot be changed during Style playback or when using the Composer.

Selecting a different Reverb and/or Chorus effect

As stated earlier, the KR-777/177 provides several types of Reverb and Chorus effects. Choose the one that matches the mood of the song you wish to play.

1. On the Utility Menu screen, press <<◀PAGE> or <PAGE>>> to select the following display page:

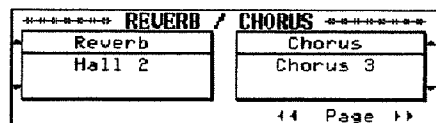

2. Use the buttons to the left of the display to choose the Reverb type, and the buttons to the right to choose the Chorus type.

■ Reverb Types

Room 1— Reverberation of a conference room

Room 2— Reverberation of a small live-stage house

Room 3— Reverberation with a feeling of spaciousness

Hall 1— Reverberation of a large concert hall

Hall 2— Reverberation of a small concert hall

Plate— Bright, metallic reverberations

Delay— A sound that is repeated like an echo

Panning Delay— A delay sound that moves back and forth between the left and right speakers

■ Chorus Types

Chorus 1— A light chorus with slow undulations

Chorus 2— A light chorus with rapid undulations

Chorus 3— A strong chorus with slow undulations

Chorus 4— A deep chorus with rapid undulations

Feedback Cho.— A soft sound with an effect like a flanger

Flanger— An effect that reminds you of a jet taking off and landing (ideal for guitar sounds).

Short Delay— A delay with a short delay time

Short Dly (FB)— A short delay with many repetitions

Note: The type you select here is applied to all Tones (including the Arranger and the Composer).

Expansion Tone

See “Selecting Expansion Tones” on page 18.

Lyric: switching off the display of lyrics

When using the KR-777/177 to play music data containing Lyrics, the lyrics are shown on the display. You can switch off this display of the lyrics.

1. On the Utility Menu screen, press <<◀PAGE> or <PAGE>>> to select the following display page:

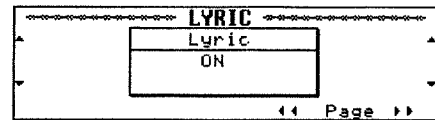

2. Use the buttons to the left and right of the display to select On or Off.

Now press any button on the front panel to hide the lyrics that are already being displayed. Press [PLAY] if you want to pursue your Karaoke performance.

Pitch Bend Range

This sets the maximum amount of change (range) that control how much the pitch changes when you press the Soft pedal. This only works when you assign the “Bend Up” or “Bend Down” function to the left pedal (see page 45).

1. On the Utility Menu screen, press <<◀PAGE> or <PAGE>>> to select the following display page:

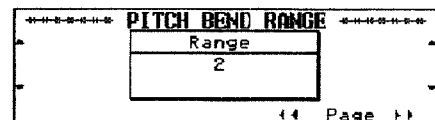

2. Use the buttons to the left and right of the display to set the value.

The value can be set to any number from 0 to 12 (in semitone steps, for a maximum of one octave).

Program Change (and Bank Select)

“Program changes” are MIDI messages that tell the receiving instrument to select another sound (or Tone) and also contain information about which Tone to select. There may be situations where you would like to double the Upper part melody with a sound of an external instrument that is not automatically selected.

Enter the Program Change function. It allows you to transmit sound select messages without choosing Tones on the KR-777/177 itself.

(*) Let's agree to use the term *sound select message* to describe MIDI message clusters consisting of one or two bank select messages and a program change message.

1. On the Utility Menu screen, press <◀◀PAGE> or <PAGE▶▶> to select the following display page:

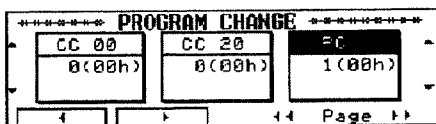

2. Use the <◀> and <▶> buttons at the lower left of the display to select the message type.

3. Use <▲> and <▼> to the left and right of the display to set the value.

Display	MIDI message	Value
CC 00	Bank Select MSB	0~127
CC 20	Bank Select LSB	0~127
PC	Program Change	1~128

Please note that each press of a <▲> or <▼> button will cause the KR-777/177 to transmit the value you set. Always set the numbers in the same order as they appear on the display: start with CC00, then set CC20, and finally set a PC value.

Note: Most instruments do not understand CC20 messages, so feel free to skip that one.

Note: Sound select messages transmitted on the Program Change page are not executed by the KR-777/177.

MIDI: TX MIDI Ch./Local Control

1. On the Utility Menu screen, press <◀◀PAGE> or <PAGE▶▶> to select the following display page:

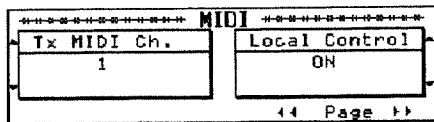

TX MIDI Channel

TX MIDI Ch refers to the MIDI channel used for transmitting messages from the KR-777/177 to external instruments (TX is short for transmit). If the external instrument is set to receive on (RX) MIDI channel 3, select “3” here. Otherwise, the external instrument will neither play nor select sounds, etc.

2. Use the buttons to the left of the display to choose the MIDI transmit channel.

That channel number (1~16) appears on the display. *Note: MIDI messages sent from the external MIDI instrument to the KR-777/177 are received on all channels. However, all keyboard information (of the Upper, Layer, Lower, Chord, and Bass Tones) will be transmitted on one channel. Note: Composer and Music Style data are not transmitted.*

Local Control

Local Control is a switch between the keyboard of your KR-777/177 and its tone generator. This switch is usually set to On so that you hear the notes you play. When working with an external sequencer, you may have to select Off, though, to avoid that every note is sounded twice (once by yourself and again by the sequencer).

Local Control has no effect on what is being transmitted to the MIDI OUT connector.

After setting Local Control to Off, do not forget to set the sequencer's Soft Thru parameter to On. That way, the messages can be transmitted from the sequencer's MIDI OUT connector to the KR-777/177's MIDI IN connector (use a MIDI cable to establish this connection).

3. Use the buttons on the right of the display to switch Local Control on or off.

User Program Arranger Update

You can also set when the Arranger's settings will change after you have selected another User Program (see page 43).

1. On the Utility Menu screen, press <◀◀PAGE> or <PAGE▶▶> to select the following display page:

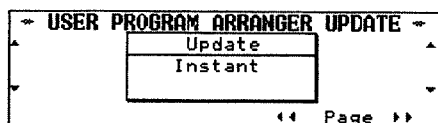

2. Use the buttons to the left and right of the display to select an option.

Instant— Arranger-related settings are called up as soon as the User Program is selected.

Delayed— Arranger-related settings are only recalled if you hold down the soft button assigned to the desired User Program.

Note: All other programmable settings will be selected immediately.

Memory Backup

Some settings return to their initial values when the power is switched off. The Memory Backup function makes it possible to save such settings so that they don't revert to their initial values.

The following settings can be saved:

- Basic screen and Demo screen language
- Stretch Tuning, Temperament
- Octave Shift
- Types and depth of DSP effects for each Tone
- Chorus effect on/off status for each Tone

1. On the Utility Menu screen, press <◀◀PAGE> or <PAGE▶▶> to select the following display page:

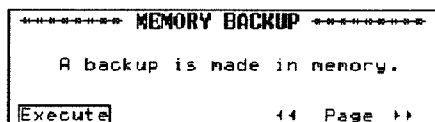

2. Press <Execute>.
3. Press <OK>.

Note: To stop the operation, press <Cancel>.

Note: Do not turn the instrument off until the display shows "Backup complete".

Factory Preset (Initialization)

This returns all settings stored in the KR-777/177 to their initial values when shipped from the factory.
Note: The User Programs also return to their initial settings, so be sure to save them to disk first.

1. On the Utility Menu screen, press <◀◀PAGE> or <PAGE▶▶> to select the following display page:

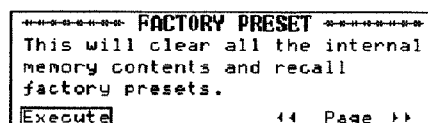

2. Press <Execute>.
3. Press <OK>.

All settings are returned to their initial values.

Note: To cancel the operation without initializing the KR-777/177, press <Cancel>.

Note: Do not turn the instrument off until the display shows "Reset complete".

Link to 16TRK Sequencer

Link is a function you may need when working with the 16-track Sequencer. It allows you to establish a connection between the selected Composer track (in 16-track Sequencer mode) and the keyboard, so that the keyboard triggers the same Tone as the one assigned to the track.

Normally, such as when taking advantage of the Minus-One facility, it is wiser to set Link to off. Doing so means that you can select whichever Tone you like for the part you play. If Link is set to On, the keyboard uses the Tone assigned to the track you select, thereby overruling your own selection.

1. On the Utility Menu screen, press <◀◀PAGE> or <PAGE▶▶> to select the following display page:

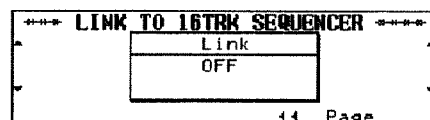

2. Use the buttons to the left and right of the display to switch Link on or off.

13. Connecting MIDI instruments

MIDI is a language that translates every action relating to music into binary digits that can be transferred via a MIDI cable. It is a universal standard, which means that musical data can be sent to and received by instruments of different types and manufacturers. Furthermore, MIDI allows you to connect your KR-777/177 to a computer or hardware sequencer.

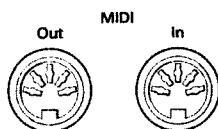

MIDI messages are transmitted and received using three connectors and special MIDI cables:

- MIDI IN: This connector receives messages from other MIDI devices.
- MIDI OUT: This connector transmits MIDI messages generated on your KR-777/177
- MIDI THRU: This connector “echoes back” all MIDI messages received via MIDI IN. The KR-777/177 does not provide a MIDI THRU connector.

Here is how to connect the KR-777/177 to an external sound module, sequencer, etc. When working with an external sequencer, be sure to establish both connections and to set Local Control (see page 48) to Off.

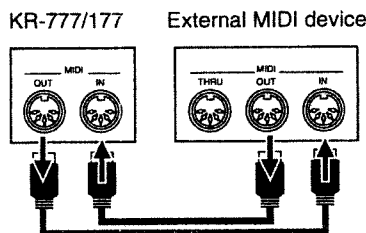

Note: You don't always need two MIDI cables. Just look at the arrows in the above illustration for deciding which ports you need to connect the cables to.

■ Caution

The KR-777/177 only transmits “realtime” MIDI data. Thus, only the notes you play on the keyboard as well as the Pitch Bend, Modulation, and pedal data are transmitted (but not the Arranger or Composer data). If you want to use the data of a Music Style (notes and sound select messages) on your computer, you can record them (see page 29), save them to disk, and then import them into your sequencer (software) as Standard MIDI File.

The KR-777/177 does not receive SysEx messages when the Composer is being used.

14. Appendix

14.1 DSP effects

1. Overdrive: Distorts the sound a little
2. Distortion: Distorts the sound a lot
3. Phaser: Gives a swelling sound
4. Enhancer: Makes the sound brighter and seemingly louder
5. Auto Wah: Changes the timbre in cycles
6. Compressor: Limits the dynamic range by reducing higher volumes
7. Gate Reverb: A reverb that ends abruptly
8. Rotary: Modulation effect of a rotating speaker
9. Hexa Chorus: Lends thickness and breadth to the sound
10. Tremolo Chorus: Thick tremolo effect
11. Stereo Chorus: A stereo chorus
12. Stereo Flanger: Adds metallic reverberations to the sound
13. Step Flanger: A flanger with stepwise changes in pitch
14. Stereo Delay: Adds a delay to the stereo sound
15. Modulation Delay: A delay that adds undulations to the delayed sound
16. Triple Tap Delay: A three-way delay
17. Quadruple Tap Delay: A four-way delay
18. 2-Voice Pitch Shifter: Adds two pitch-shifted notes to the original sound
19. Feedback Pitch Shifter: Adds a single pitch-shifted note the original sound
20. Overdrive → Chorus: Overdrive that is processed by a chorus
21. Overdrive → Flanger: Overdrive that is processed by a flanger
22. Overdrive → Delay: Overdrive that is processed by a delay
23. Distortion → Chorus: Distortion that is processed by a chorus
24. Distortion → Flanger: Distortion that is processed by a flanger
25. Distortion → Delay: Distortion that is processed by a delay
26. Enhancer → Chorus: Enhancer that is processed by a chorus
27. Enhancer → Flanger: Enhancer that is processed by flanger
28. Enhancer → Delay: Enhancer that is processed by a delay
29. Chorus → Delay: Chorus that is processed by a delay
30. Flanger → Delay: Flanger that is processed by a delay
31. Chorus → Flanger: Chorus that is processed by a flanger.
32. Sympathetic Resonance: A resonance effect that is produced every time you press the Damper pedal.

14.2 Specifications

Keyboard

88 weighted keys (TP-23)

Keyboard modes

Whole, Split, Layer, Split Arranger, Piano Style Arranger, Manual Drum/SFX

Velocity sensitivity

Super Light, Light, Medium, Heavy, Super Heavy

Maximum polyphony

64 voices

Tones

8 Groups, 124 Variations
(Tone Expansion Mode: 270 variations)

Music Styles

Internal: 111 Styles, Disk: 32 Styles
Expandable using (MSA) Music Style disks.

Manual Drum/SFX Sets

Drum Set: 8/SFX Set: 1

Programmable Music Styles

Yes

Effects

Reverb (8 types), Chorus (8 types), DSP (32 types)

Melody Intelligence

18 types

User Programs

Internal: 32 memories, Disk: Max. 99 sets

Composer

Tracks: 16 (Easy Mode: 5 tracks), Song: 1
Note Storage: ±30,000 notes, Tempo: ♩ = 20~250
Resolution: 120 ticks per quarter note
Recording methods: Realtime, Step (in Chord Sequencer Mode)
Playback: Standard MIDI File (Format 0/1), KR Songs
Save: Standard MIDI File (Format 0)
Edit: Setup, Copy, Quantize, Erase, Delete, Insert, Transpose,
Track exchange, Track Copy

Disk drive/data storage

3.5 inch micro floppy disk drive

Disk Format: 720K bytes (2DD), 1.44M bytes (2HD)

Songs: Max. 99

Note Storage: ± 120,000 notes (2DD), ± 240,000 notes (2HD)

Lyrics

Yes

Languages

4 languages (English, German, French, Japanese)

Display

AGD (Animated Graphic Display) 240 x 64 dots, graphic LCD

Rated Output Power

20W x 2

Power Supply

117/230/230VE/240VA, power cable (supplied)

Speakers

KR-177: 16cm x2

KR-777: 16cm x2 (woofer), 5.5cm x2 (tweeter)

Dimensions

KR-177: 1387 (W) x 477 (D) x 829 (H) mm.

KR-777: 1400 (W) x 940 (D) x 945 (H) mm

Options

MSA Music Style Disks, SMF Music Data

Headphones (RH25/50)

LVC-1 Lyrics to Video Converter

Weight

KR-177: 46kg

KR-777: 102kg

Accessories

Owner's Manual, Music Style/Acoustic Style Disk

Stand

AC power cable

Note: In the interest of product improvement, the specifications and/or appearance of this instrument are subject to change without prior notice.

Notes

Tones, Drum Sets, Music Styles

Normal Tones

Piano

Grand Piano 1
Grand Piano 2
Upright Piano
Rock Piano
Honky-tonk 1
Honky-tonk 2
MIDI Piano 1
MIDI Piano 2

E.Piano

E.Piano 1
Soft E.Piano
E.Piano 2
Hard E.Piano
60's E.Piano
Clav.
Harpsichord 1
Harpsichord 2

Vibes

Vibraphone
Celesta
Marimba
Xylophone
Glockenspiel
Music Box
Tubular-bell
Santur
Steel Drums
Kalimba
Barafon
Vibra Bells

Organ

Jazz Organ 1
Jazz Organ 2
Full Organ 1
Full Organ 2
Lower Organ 1
Lower Organ 2
Church Organ
Organ Flute
Theater Org.
Trem.Flute
Rock Organ 1
Rock Organ 2
Jazz Organ 3
Jazz Organ 4
Full Organ 3

Full Organ 4
Pop Organ
VS Orgn
Accordion
Harmonica

Guitar

Nylon Guitar
Gut Guitar
Steel Guitar
12str Guitar
Mandolin
Banjo
Hawaiian Gt.
Muted Gt.
JC E.Guitar
Jazz Guitar
Overdrive Gt.
Distortion Gt.
Power Guitar
Rock Rhythm
Shamisen
Koto

Strings

Slow Strings
Strings
Violin
Cello
Choir
Choir Oohs
Pop Voice
Syn Vox
Harp
Orchestra
Syn.Strings 1
Warm Pad

Sax

Blow Sax
Soprano Sax
Alto Sax
Oboe
Bassoon
Clarinet
Flute
Blow Pipe
Trumpet
Muted Trumpet
Trombone

Fr.Horn Solo
Brass1
French Horn
Synth Brass 1
Synth Brass 2

Fantasia

Fantasia
Brightness
Harvox
Polysynth
CC Solo
Square Wave
Saw Wave
Saw
Doctor Solo
Syn.Calliope
Charang
Bass & Lead
Pan Flute
Shakuhachi
Whistle
Ocarina
Metal Pad
Sweep Pad
Soundtrack
Atmosphere
Crystal
Sitar
Orchestra Hit
Pizzicato Str.
Acoustic Bs.
A.Bass+Cymbal
Fingered Bs.
Picked Bass
Fretless Bs.
Slap Bass 1
Organ Bass
Synth Bass 101

Expansion Tones

No.	Tone Name	CC 0	CC 32	PC#	No.	Tone Name	CC 0	CC 32	PC#	No.	Tone Name	CC 0	CC 32	PC#
* 001	Grand Piano1	08	64	001	* 049	Jazz Organ 4	00	65	018	097	Clean Gt.	00	00	028
* 002	Grand Piano2	08	64	002	* 050	Full Organ 1	00	65	017	098	Chorus Gt.	08	00	028
* 003	UprightPiano	16	64	001	* 051	Full Organ 2	08	65	017	* 099	Muted Gt.	00	00	029
* 004	MIDI Piano1	00	65	001	* 052	Full Organ 3	16	65	017	100	Muted Dis.Gt	00	64	029
* 005	MIDI Piano2	00	65	002	* 053	Full Organ 4	32	65	017	101	Funk Gt.	08	00	029
006	Piano 1	00	00	001	* 054	Lower Organ1	00	66	017	102	Funk Gt.2	16	00	029
007	Piano 2	00	00	002	* 055	Lower Organ2	08	66	017	* 103	Overdrive Gt	00	00	030
008	Piano 3	00	00	003	056	Organ 1	00	00	017	* 104	DistortionGt	00	64	031
009	EG+Rhodes 1	00	65	003	057	Organ 2	00	00	018	105	GS Dist.Gt.	00	00	031
010	EG+Rhodes 2	00	66	003	* 058	Pop Organ	18	00	017	106	Dazed Guitar	00	65	031
* 011	Rock Piano	08	64	003	* 059	VS Organ	32	64	017	* 107	Rock Rhythm	08	66	031
* 012	Honky-tonk 1	08	64	004	060	Metalic Org.	32	66	017	108	Rock Rhythm2	00	66	031
* 013	Honky-tonk 2	08	00	004	061	Detuned Or.1	08	00	017	109	Feedback Gt.	08	00	031
* 014	E.Piano 1	16	64	005	062	Detuned Or.2	08	00	018	110	Feedback Gt2	09	02	031
* 015	E.Piano 2	16	64	006	* 063	Rock Organ 1	00	64	019	* 111	Power Guitar	08	65	031
016	E.Piano 3	00	65	006	* 064	Rock Organ 2	00	00	019	112	Power Gt.2	08	64	031
017	Hard Rhodes	00	65	005	065	Rotary Org.S	00	65	019	113	5th Dist.	18	02	031
018	Detuned EP 1	08	00	005	066	Rotary Org.F	00	66	019	114	Gt.Harmonics	00	00	032
019	Detuned EP 2	08	00	006	* 067	Organ Flute	00	64	020	* 115	Acoustic Bs.	00	64	033
* 020	Soft E.Piano	08	64	005	* 068	Church Organ	08	65	020	* 116	A.Bass+Cymb1	00	65	033
021	FM+SA EP	16	02	005	069	Digi Church	00	64	021	117	GS Ac.Bass	00	00	033
* 022	60's E.Piano	24	00	005	* 070	Theater Org.	16	64	020	* 118	Fingered Bs.	00	64	034
* 023	Hard E.Piano	00	64	006	* 071	Trem.Flute	08	64	020	119	GS Fing.Bass	00	00	034
024	St.FM EP	08	64	006	072	Pipe Org. Bs	32	65	018	* 120	Picked Bass	00	64	035
025	Hard FM EP	08	66	006	* 073	Organ Bass	40	02	017	121	GS Picked Bs	00	00	035
026	E.Piano 1	00	00	005	* 074	Accordion	00	64	022	122	Mute PickBs.	00	65	035
027	E.Piano 1v	16	00	005	075	Accordion Fr	00	00	022	* 123	Fretless Bs.	00	00	036
028	GS E.Piano2	00	00	006	076	Accordion It	08	00	022	124	Mr.Smooth	05	02	036
029	E.Piano 2v	16	00	006	* 077	Harmonica	00	64	023	* 125	Slap Bass 1	00	00	037
* 030	Harpsichord1	00	64	007	078	GS Harmonica	00	00	023	126	Slap Bass 2	00	00	038
* 031	Harpsichord2	08	64	007	079	Bandoneon	00	00	024	127	Synth Bass 1	00	00	039
032	Harpsichord	00	00	007	* 080	Nylon Guitar	00	64	025	128	Synth Bass 2	00	00	040
033	Coupled Hps.	08	00	007	* 081	Gut Guitar	00	65	025	129	Synth Bass 3	08	00	039
034	Harpsi.o	24	00	007	082	GS Nylon Gt.	00	00	025	130	Synth Bass 4	08	00	040
* 035	Clav.	00	00	008	083	Ukulele	08	00	025	* 131	SynthBass101	01	00	039
036	Analog Clav.	00	64	008	084	Nylon Gt.o	16	00	025	132	Reso SH Bass	16	02	039
* 037	Celesta	00	00	009	* 085	Steel Guitar	00	64	026	133	SH101 Bass	16	64	040
* 038	Glockenspiel	00	00	010	086	Steel-str.Gt	00	00	026	* 134	Violin	00	64	041
* 039	Music Box	00	00	011	* 087	12str Guitar	08	64	026	135	GS Violin	00	00	041
* 040	Vibraphone	00	64	012	088	12-str.Gt	08	00	026	136	Slow Violin	08	00	041
* 041	Marimba	08	00	013	089	Nylon+Steel	08	65	026	137	Viola	00	00	042
* 042	Barafon	08	64	013	* 090	Mandolin	16	64	026	* 138	Cello	00	64	043
* 043	Xylophone	00	00	014	091	GS Mandolin	16	00	026	139	GS Cello	00	00	043
* 044	Tubular-bell	00	00	015	* 092	Jazz Guitar	00	00	027	140	Contrabass	00	00	044
* 045	Santur	00	64	016	093	Mellow Gt.	01	02	027	141	Tremolo Str	00	00	045
* 046	Jazz Organ 1	32	00	018	* 094	Hawaiian Gt.	08	64	027	* 142	PizzicatoStr	00	00	046
* 047	Jazz Organ 2	32	64	018	095	GS Hawaiian	08	00	027	* 143	Harp	00	64	047
* 048	Jazz Organ 3	08	64	018	* 096	JC E.Guitar	00	64	028	144	GS Harp	00	00	047

No.	Tone Name	CC 0	CC 32	PC#	No.	Tone Name	CC 0	CC 32	PC#	No.	Tone Name	CC 0	CC 32	PC#
145	Timpani	00	00	048	193	Bottle Blow	00	00	077	241	Clear Bells	00	65	099
* 146	Strings	00	64	049	* 194	Shakuhachi	00	00	078	242	Soft Crystal	02	02	099
147	GS Strings	00	00	049	* 195	Whistle	00	00	079	243	Digi Bells	09	02	099
* 148	Slow Strings	00	64	050	* 196	Ocarina	00	00	080	244	Syn Mallet	01	00	099
149	GS Sl.Str	00	00	050	* 197	Square Wave	00	00	081	* 245	Atmosphere	00	00	100
150	Warm Strings	09	02	050	198	Syn.Square	00	64	081	* 246	Harpvox	00	64	100
* 151	Orchestra	08	00	049	* 199	CC Solo	00	65	081	247	Nylon Harp	00	65	100
152	Choir Str.	11	02	049	200	Square	01	00	081	248	Nylon+Rhodes	00	66	100
* 153	Syn.Strings1	00	00	051	201	FM Lead 1	01	64	081	* 249	Brightness	00	00	101
154	Syn.Strings2	00	00	052	202	FM Lead 2	00	64	088	250	Goblin	00	00	102
155	Syn.Strings3	08	00	051	203	JP8 Square	08	64	081	251	Echo Drops	00	00	103
* 156	Choir	32	00	053	* 204	Saw Wave	00	00	082	252	Echo Bell	01	00	103
* 157	Pop Voice	00	00	054	* 205	Saw	01	00	082	253	Big Panner	00	64	103
* 158	SynVox	00	00	055	206	Mg Lead	00	64	082	254	Ai-yai-a	01	64	103
* 159	Choir Oohs	00	64	055	207	P5 Saw Lead	01	64	082	255	Echo Bell	01	65	103
* 160	OrchestraHit	00	00	056	* 208	Doctor Solo	08	00	082	256	Echo Pan	02	00	103
* 161	Trumpet	00	64	057	209	Rhythmic Saw	08	64	082	257	Echo Pan 2	02	64	103
162	GS Trumpet	00	00	057	210	Waspy Synth	16	02	082	258	Big Panner	04	02	103
* 163	Trombone	00	64	058	* 211	Syn.Calliope	00	00	083	259	Star Theme	00	00	104
164	Trombone 2	01	00	058	212	JP8 Pulse	00	64	083	* 260	Sitar 2	01	00	105
165	Tuba	00	00	059	213	Chiffer Lead	00	00	084	* 261	Banjo	00	00	106
* 166	MutedTrumpet	00	00	060	214	Cheese Saw	00	64	084	* 262	Shamisen	00	64	107
* 167	French Horn	00	00	061	* 215	Charang	00	00	085	* 263	Koto	00	00	108
* 168	Fr.Horn Solo	00	64	061	216	Reso Saw	00	64	085	* 264	Kalimba	00	00	109
* 169	Brass 1	00	00	062	217	Solo Vox	00	00	086	265	Bagpipe	00	00	110
170	Brass 2	08	00	062	218	RAVE Vox	00	64	086	266	Fiddle	00	00	111
* 171	Synth Brass1	00	00	063	219	5th Saw Wave	00	00	087	267	Shanai	00	00	112
* 172	Synth Brass2	00	00	064	* 220	Bass & Lead	00	00	088	268	Tinkle Bell	00	00	113
173	Synth Brass3	08	00	063	221	Fat & Perky	02	02	088	* 269	Steel Drums	00	00	115
174	Synth Brass4	08	00	064	* 222	Fantasia	00	00	089	270	Falling Down	07	64	126
175	Soft Brass	01	02	064	223	Fantasia 2	00	64	089					
* 176	Soprano Sax	00	64	065	* 224	Warm Pad	00	00	090					
177	GS Sop.Sax	00	00	065	225	Soft Pad	00	64	090					
* 178	Alto Sax	00	00	066	* 226	Polysynth	00	00	091					
* 179	Blow Sax	00	64	067	227	P5 Poly	00	64	091					
180	Tenor Sax	00	00	067	228	Space Voice	00	00	092					
181	Baritone Sax	00	00	068	229	Heaven II	00	64	092					
* 182	Oboe	00	64	069	230	Bowed Glass	00	00	093					
183	GS Oboe	00	00	069	* 231	Metal Pad	00	00	094					
184	English Horn	00	00	070	232	Halo Pad	00	00	095					
* 185	Bassoon	00	00	071	233	JP8 Sqr Pad	00	64	095					
* 186	Clarinet	00	00	072	* 234	Sweep Pad	00	00	096					
187	Piccolo	00	00	073	235	Sweep Pad 2	00	64	096					
188	GS Flute	00	00	074	236	Converge	00	66	096					
* 189	Flute	00	64	074	237	Ice Rain	00	00	097					
190	Recorder	00	00	075	* 238	Soundtrack	00	00	098					
* 191	Pan Flute	00	00	076	* 239	Crystal	00	00	099					
* 192	Blow Pipe	00	64	076	* 240	Vibra Bells	00	64	099					

Internal & Disk Music Styles

POP/BALLAD

Pop 1	♩ = 120, 4/4
Pop 2	♩ = 130, 4/4
Pop 3	♩ = 120, 4/4
Pop 4	♩ = 115, 4/4
Rollin'	♩ = 108, 4/4
Swing Pop	♩ = 85, 4/4
16 Beat Pop	♩ = 120, 4/4
50's	♩ = 131, 4/4
70's	♩ = 121, 4/4
Slow Dance	♩ = 82, 4/4
Ballad 1	♩ = 60, 4/4
Ballad 2	♩ = 95, 4/4
16Bt Ballad1	♩ = 78, 4/4
16Bt Ballad2	♩ = 95, 4/4
Love Songs	♩ = 50, 4/4
60's Ballad	♩ = 85, 4/4
Torch Song	♩ = 72, 4/4

PIANO STYLE

PianoBallad1	♩ = 60, 4/4
PianoBallad2	♩ = 60, 4/4
PianoBallad3	♩ = 55, 4/4
PianoBallad4	♩ = 135, 4/4
Piano Boogie	♩ = 165, 4/4
Stride Piano	♩ = 130, 4/4
Club Piano	♩ = 106, 4/4
Classic 1	♩ = 107, 4/4
Classic 2	♩ = 115, 3/4

ROCK

Rock 1	♩ = 140, 4/4
Rock 2	♩ = 113, 4/4
UK Rock	♩ = 130, 4/4
Rock 3	♩ = 114, 4/4
Rock 4	♩ = 155, 4/4
Rock'n Roll1	♩ = 160, 4/4
Rock'n Roll2	♩ = 190, 4/4
R&B	♩ = 114, 4/4

COUNTRY/WALTZ

Cntry Swing	♩ = 127, 4/4
TwoStep	♩ = 122, 4/4
Cntry Ballad	♩ = 82, 4/4
Hoedown	♩ = 117, 4/4
Bluegrass	♩ = 152, 4/4
New Country	♩ = 114, 4/4
Train Beat	♩ = 140, 4/4
Cntry Waltz1	♩ = 120, 3/4
Cntry Waltz2	♩ = 86, 3/4
Western	♩ = 90, 4/4
Country Folk	♩ = 72, 4/4
Easy Country	♩ = 74, 4/4
Slow Waltz 1	♩ = 88, 3/4
Waltzing	♩ = 176, 3/4
Vienna Waltz	♩ = 180, 3/4
Musette	♩ = 192, 3/4
Slow Waltz 2	♩ = 84, 3/4
Pop Waltz	♩ = 120, 3/4
Jazz Waltz	♩ = 120, 3/4

BIG BAND/SWING

Jazz Band	♩ = 124, 4/4
BigBnd Swing	♩ = 109, 4/4
BigBnd Bld 1	♩ = 74, 4/4
Boogie	♩ = 164, 4/4
BigBnd Bld 2	♩ = 85, 4/4
Big Band	♩ = 130, 4/4
Vocal Swing	♩ = 112, 4/4
Medium Swing	♩ = 109, 4/4
Shuffle	♩ = 181, 4/4
Slow Swing	♩ = 60, 4/4
Brush Swing	♩ = 176, 4/4
Combo	♩ = 140, 4/4

LATIN

Bossa Nova 1	♩ = 120, 4/4
Fast Bossa	♩ = 120, 4/4
Rhumba	♩ = 109, 4/4
Bossa Nova 2	♩ = 120, 4/4
Beguine	♩ = 124, 4/4
Mambo	♩ = 120, 4/4
Cha Cha	♩ = 125, 4/4
Salsa	♩ = 95, 4/4
Merengue	♩ = 122, 4/4
Tango 1	♩ = 125, 4/4
Tango 2	♩ = 120, 4/4
Bossa Nova 3	♩ = 140, 4/4
Samba	♩ = 110, 4/4
New Bossa	♩ = 92, 4/4
Rio	♩ = 130, 4/4

MARCH/KIDS

March 6/8	♩ = 120, 4/4
March 4/4	♩ = 120, 4/4
March 2/4	♩ = 115, 2/4
German Polka	♩ = 127, 4/4
German Waltz	♩ = 180, 3/4
Polka	♩ = 130, 4/4
Fanfare	♩ = 108, 4/4
Kids 1	♩ = 180, 4/4
Kids 2	♩ = 120, 4/4
Kids 3	♩ = 140, 4/4
Kids Waltz	♩ = 110, 3/4

TRAD/WORLD

Broadway	♩ = 125, 4/4
Foxtrot	♩ = 184, 4/4
Hawaiian	♩ = 110, 4/4
Gospel	♩ = 88, 3/4
Dixieland	♩ = 180, 4/4
Slow Foxtrot	♩ = 98, 4/4
Charleston	♩ = 210, 4/4
Twist	♩ = 150, 4/4
70's Disco	♩ = 112, 4/4
Screen 1	♩ = 80, 4/4
Screen 2	♩ = 104, 4/4
Chapel	♩ = 70, 4/4
Techno	♩ = 126, 4/4
House	♩ = 130, 4/4
Triplet Enka	♩ = 80, 4/4
Fusion	♩ = 116, 4/4
Enka	♩ = 77, 4/4
8 Beat Enka	♩ = 85, 4/4
16 Beat Enka	♩ = 90, 4/4
Kayou	♩ = 100, 4/4

MUSIC STYLE DISK

01) 50's Ballad1	29) G FstPop (A)
02) ClassicCntry	30) G Pop (A)
03) 16BtShuffle	31) G Slow (A)
04) 30's Jazz	32) G SlRock (A)
05) 50's Ballad2	33) Light Fusion
06) 50's Pop	34) Revival
07) Anthem	35) Nickel Odeon
08) Big Band2	36) Festival
09) PianoBallad5	37) P Ballad (A)
10) Blues2	38) P Fusion (A)
11) Cinema	39) P Jazz (A)
12) Cntry Blues	40) P Night (A)
13) Rock5	41) P Pop (A)
14) Easy Listen1	42) P RagTim (A)
15) Easy Listen2	43) P Rock'N (A)
16) Easy Listen3	44) P Shuffl (A)
17) Easy Listen4	45) P Slow (A)
18) Easy Listen5	46) P Waltz (A)
19) Easy Listen6	47) Rock'N'Shffl
20) Five	48) Schlager
21) Funk1	49) SCountry
22) Funk2	50) Showtime1
23) Gt Arpeggio	51) Showtime2
24) Gospel2	52) Standard
25) Gospel3	53) Blues1
26) Rock Ballad	54) Swing Waltz
27) G Ballad (A)	55) Vlk Music
28) G Bossa (A)	56) Waltz

Drum Sets

PC#	1	9	17	25	26
CC32	64	64	0	0	0
Type	STANDARD	ROOM	POWER	ELECTRONIC	TR-808
25	Bar Chime	-----			
26	Finger Snap	-----			
27	High Q				
28	Slap				
29	Scratch Push [EXC7]				
30	Scratch Pull [EXC7]				
31	Sticks				
32	Square Click				
33	Metronome Click				
34	Metronome Bell				
35	Std Kick 2	Std Kick 1	Kick 2	Kick 2	Kick 2
C2 36	Std Kick 1	Room Kick	MONDO Kick	Elec BD	808 Bass Drum 1
37	Side Stick				808 Rim Shot
38	Std Snr 1	Room Snr 1	Gated SD	Elec SD	808 Snare Drum
39	Hand Clap				
40	Std Snr 2	Std Snr 1	Snare 2	Gated SD	Snare 2
41	Low Tom 2	Room Low Tom 2		Elec Low Tom 2	808 Low Tom 2
42	Closed Hi-hat 1 [EXC1]		Closed Hi-hat 2 [EXC1]	Closed Hi-hat 2 [EXC1]	808 CHH [EXC1]
43	Low Tom 1	Room Low Tom 1		Elec Low Tom 1	808 Low Tom 1
44	Pedal Hi-hat 1 [EXC1]		Pedal Hi-hat 2 [EXC1]	Pedal Hi-hat 2 [EXC1]	808 CHH [EXC1]
45	Mid Tom 2	Room Mid Tom 2		Elec Mid Tom 2	808 Mid Tom 2
46	Open Hi-hat 1 [EXC1]		Open Hi-hat 2 [EXC1]	Open Hi-hat 2 [EXC1]	808 OHH [EXC1]
47	Mid Tom 1	Room Mid Tom 1	Room Mid Tom 1	Elec Mid Tom 1	808 Mid Tom 1
C3 48	High Tom 2	Room Hi Tom 2	Room Hi Tom 2	Elec Hi Tom 2	808 Hi Tom 2
49	Crash Cymbal1				808 Cymbal
50	High Tom 1	Room Hi Tom 1	Room Hi Tom 1	Elec Hi Tom 1	808 Hi Tom 1
51	Ride Cymbal 1				
52	Chinese Cymbal			Reverse Cymbal	
53	Ride Bell				
54	Tambourine				
55	Splash Cymbal				
56	Cowbell				808 Cowbell
57	Crash Cymbal 2				
58	Vibra-slap				
59	Ride Cymbal 2				
C4 60	High Bongo				
61	Low Bongo				
62	Mute High Conga				808 High Conga
63	Open High Conga				808 Mid Conga
64	Low Conga				808 Low Conga
65	High Timbale				
66	Low Timbale				
67	High Agogo				
68	Low Agogo				
69	Cabasa				
70	Maracas				808 Maracas
71	Short Hi Whistle [EXC2]				
C5 72	Long Low Whistle [EXC2]				
73	Short Guiro [EXC3]				
74	Long Guiro [EXC3]				
75	Claves				808 Claves
76	High Wood Block				
77	Low Wood Block				
78	Mute Cuica [EXC4]				
79	Open Cuica [EXC4]				
80	Mute Triangle [EXC5]				
81	Open Triangle [EXC5]				
82	Shaker				
83	Jingle Bell				
C6 84	Bell Tree				
85	Castanets				
86	Mute Surdo [EXC6]				
87	Open Surdo [EXC6]				
88	-----	-----	-----	-----	-----

PC#	26	41	49
CC32	64	64	0
Type	DANCE	BRUSH	ORCHESTRA
25			
26			
27			
28			
29			
30			
31	Dance Snr 1		
32			
33			
34			
35	Std Kick 1	Kick 2	Concert BD 2
C2 36	808 Bass Drum 2	Kick 1	Concert BD 1
37	808 Rlm Shot		
38	TR-909 Snr		
39		Brush Tap	Concert SD
40	Dance Snr 2	Brush Slap	Castanets
		Brush Swirl	Concert SD
41	808 Low Tom 2	Brush Low Tom 2	Timpani F
42	808 CHH [EXC1]	Closed Hi-hat 2 [EXC1]	Timpani F#
43	808 Low Tom 1	Brush Low Tom 1	Timpani G
44	808 CHH [EXC1]	Pedal Hi-hat 2 [EXC1]	Timpani G#
45	808 Mid Tom 2	Brush Mid Tom 2	Timpani A
46	808 OHH [EXC1]	Open Hi-hat 2 [EXC1]	Timpani A#
47	808 Mid Tom 1	Brush Mid Tom 1	Timpani B
C3 48	808 Hi Tom 2	Brush Hi Tom 2	Timpani c
49	808 Cymbal		Timpani c#
50	808 Hi Tom 1	Brush Hi Tom 1	Timpani d
51			Timpani d#
52			Timpani e
53			Timpani f
54			
55	808 Cowbell		
56			Concert Cymbal 2
57			
58			Concert Cymbal 1
59			
C4 60			
61	808 High Conga		
62	808 Mid Conga		
63	808 Low Conga		
64			
65			
66			
67			
68			
69	808 Maracas		
70			
71			
C5 72			
73	808 Claves		
74			
75			
76			
77			
78			
79			
80			
81			
82			
83			
C6 84			
85			
86			
87			
88	-----	-----	Applause











































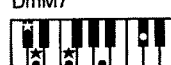





● SFX Set

PC#	57
CC32	0
Type	SFX
39	High Q
40	Slap
	Scratch Push [EXC7]
41	Scratch Pull [EXC7]
42	
43	Sticks
44	Square Click
45	Metronome Click
46	Metronome Bell
47	Guitar sliding Finger
C3 48	Guitar cutting noise (down)
49	Guitar cutting noise (up)
50	String slap of double bass
51	Fl.Key Click
52	Laughing
53	Screaming
54	Punch
55	Heart Beat
56	Footsteps1
57	Footsteps2
58	Applause
59	Door Creaking
C4 60	Door
	Scratch
61	Wind Chimes
62	Car-Engine
63	Car-Stop
64	Car-Pass
65	Car-Crash
66	Siren
67	Train
68	Jetplane
69	Helicopter
70	Starship
71	Gun Shot
C5 72	Machine Gun
73	Lasergun
74	Explosion
75	Dog
76	Horse-Gallop
77	Birds
78	Rain
79	Thunder
80	Wind
81	Seashore
82	Stream
83	Bubble
C6 84	Cat
85	

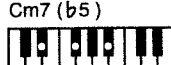
PC# : Program Change Number
 CC32 : Value of Control Change 32
 * Value of Control Change is set 0.

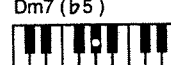
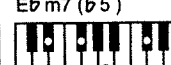
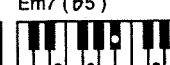
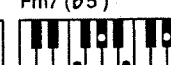
Blank : same percussion instruments
 as the Standard Set
 ---- : No sound
 [EXC] : will not sound simultaneously
 with other percussion instruments
 of the same EXC number

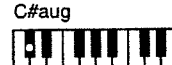
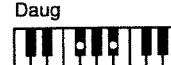
Chord Intelligence

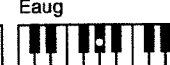
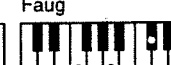
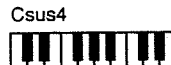
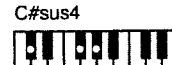
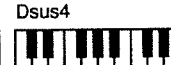
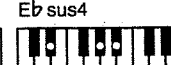
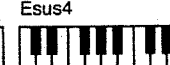
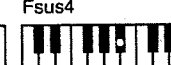
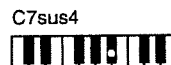
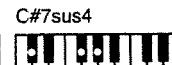
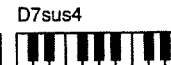
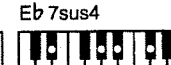
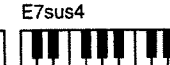
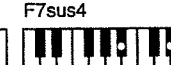
C	C#	D	E \flat	E	F
					
CM7	C#M7	DM7	E \flat M7	EM7	F M7
					
C7	C#7	D7	E \flat 7	E7	F7
					
Cm	C#m	Dm	E \flat m	Em	Fm
					
Cm7	C#m7	Dm7	E \flat m7	Em7	Fm7
					
CmM7	C#mM7	DmM7	E \flat mM7	EmM7	FmM7
					
Cdim	C#dim	Ddim	E \flat dim	Edim	Fdim
					
Cm7 (b5)	C#m7 (b5)	Dm7 (b5)	E \flat m7 (b5)	Em7 (b5)	Fm7 (b5)
					
Caug	C#aug	Daug	E \flat aug	Eaug	Faug
					
Csus4	C#sus4	Dsus4	E \flat sus4	Esus4	Fsus4
					
C7sus4	C#7sus4	D7sus4	E \flat 7sus4	E7sus4	F7sus4
					

F#	G	A \flat	A	B \flat	B
F#M7	GM7	A \flat M7	AM7	B \flat M7	BM7
F#7	G7	A \flat 7	A7	B \flat 7	B7
F#m	Gm	A \flat m	Am	B \flat m	Bm
F#m7	Gm7	A \flat m7	Am7	B \flat m7	Bm7
F#mM7	GmM7	A \flat mM7	AmM7	B \flat mM7	BmM7
F#dim	Gdim	A \flat dim	Adim	B \flat dim	Bdim
F#m7 (\flat 5)	Gm7 (\flat 5)	A \flat m7 (\flat 5)	Am7 (\flat 5)	B \flat m7 (\flat 5)	Bm7 (\flat 5)
F#aug	Gaug	A \flat aug	Aaug	B \flat aug	Baug
F#sus4	Gsus4	A \flat sus4	Asus4	B \flat sus4	Bsus4
F#7sus4	G7sus4	A \flat 7sus4	A7sus4	B \flat 7sus4	B7sus4

REFERENCE

Notes

Notes

Notes

REFERENCE

Distributors

AFRICA

EGYPT
Al Fanny Trading Office
 P.O. Box 2904,
 El Horrich Heliopolis, Cairo,
 EGYPT
 TEL: (02) 4185531

REUNION
Maison FO - YAM Marcel
 25 Rue Jules MormanZL
 Chaudron - BP79 97491
 Ste-Clotilde-REUNION
 TEL: 28 29 16

SOUTH AFRICA
That Other Music Shop
 (PTY) Ltd.
 11 Melle Street (Cnr Melle and
 Juta Street)
 Braamfontein 2001
 Republic of SOUTH AFRICA
 TEL: (011) 403-4105

Paul Bothner (PTY) Ltd.
 17 Werdmuller Centre Claremont
 7700
 Republic of SOUTH AFRICA

P.O. Box 23032
 Claremont, Cape Town
 SOUTH AFRICA, 7735
 TEL: (021) 64-4030

ASIA

CHINA
Beijing Xinghai Musical
Instruments Co., Ltd.
 6 Huangmchang Chao Yang
 District, Beijing, CHINA
 TEL: (010) 6774 7491

HONG KONG
Tom Lee Music Co., Ltd.
Service Division
 22-32 Pun Shan Street, Tsuen
 Wan, New Territories,
 HONG KONG
 TEL: 2415 0911

INDIA
Rivera Digitec (India) Pvt. Ltd.
 409, Nirman Kendra Mahatma
 Flats Compound Off. Dr. Edwin
 Moses Road, Mumbai-400011
 INDIA
 TEL: (022) 498 3079

INDONESIA
PT Citra Inti Rama
 Jl. Cideng Timur No. 151-150
 Jakarta Pusat
 INDONESIA
 TEL: (021) 6324170

KOREA
Cosmos Corporation
Service Station
 261 2nd Floor Nak-Won Arcade
 Jung-Ro ku, Seoul, KOREA
 TEL: (02) 742 8844

MALAYSIA
Bentley Music SDN BHD
 140 & 142, Jalan Bukit Bintang,
 55100 Kuala Lumpur, MALAYSIA
 TEL: (03) 2443333

PHILIPPINES
G.A. Yupangco & Co. Inc.
 339 Gil J, Fuyat Avenue
 Makati, Metro Manila 1200,
 PHILIPPINES
 TEL: (02) 899 9801

SINGAPORE
Swee Lee Company
 150 Sims Drive,
 SINGAPORE 387381
 TEL: 748-1669

CRISTOFORI MUSIC PTE
LTD
 Blk. 3014, Bedok Industrial Park E,
 #02-2148, SINGAPORE 489980
 TEL: 243 9555

TAIWAN
ROLAND TAIWAN
ENTERPRISE CO., LTD.
 Room 5, 9F, No. 112 Chung Shan
 N.Road Sec.2, Taipei, TAIWAN,
 R.O.C.
 TEL: (02) 2561 3339

THAILAND
Theera Music Co., Ltd.
 330 Verg NakornKasem, Soi 2,
 Bangkok 10100, THAILAND
 TEL: (02) 2348821

VIETNAM
Saigon Music
 138 Tran Quang Khai St.,
 District 1
 Ho Chi Minh City
 VIETNAM
 TEL: (08) 844-4068

**AUSTRALIA/
 NEW ZEALAND**

AUSTRALIA
Roland Corporation
Australia Pty., Ltd.
 38 Campbell Avenue
 Dee Why West, NSW 2099
 AUSTRALIA
 TEL: (02) 9982 8266

NEW ZEALAND
Roland Corporation (NZ) Ltd.
 97 Mt. Eden Road, Mt. Eden,
 Auckland 3, NEW ZEALAND
 TEL: (09) 3098 715

**CENTRAL/LATIN
 AMERICA**

ARGENTINA
Instrumentos Musicales S.A.
 Florida 656 2nd Floor
 Office Number 206A
 Buenos Aires
 ARGENTINA, CP1005
 TEL: (54-11) 4-393-6057

BRAZIL
Roland Brasil Ltda.
 R. Coronel Octaviano da Silveira
 203 05522-010
 Sao Paulo BRAZIL
 TEL: (011) 3743 9377

CHILE
Comercial Fancy S.A.
 Avenida Rancagua #0330
 Providencia Santiago, CHILE
 TEL: 56-2-373-9100

EL SALVADOR
OMNI MUSIC
 75 Avenida Notre y Alameda
 Juan Pablo 2 No. 4010
 San Salvador, EL SALVADOR
 TEL: (503) 262-0788

MEXICO
Casa Veerkamp, s.a. de c.v.
 Av. Toluca No. 323 Col. Olivares
 los Padres 01780 Mexico D.F.
 MEXICO
 TEL: (525) 668 04 80

La Casa Wagner de
Guadalajara s.a. de c.v.
 Av. Corona No. 202 S.J.
 Guadalajara, Jalisco Mexico
 C.P. 44100 MEXICO
 TEL: (3) 613 1414

PANAMA
Productos Superiores, S.A.
 Apartado 955 - Panama 1
 REP. DE PANAMA
 TEL: (507) 270-2200

URUGUAY
Todo Musica
 Cuareim 1488, Montevideo,
 URUGUAY
 TEL: 5982-924-2335

VENEZUELA
Musiland Digital C.A.
 Av. Francisco de Miranda,
 Centro Parque de Cristal, Nivel
 C2 Local 20 Caracas
 VENEZUELA
 TEL: (02) 285 9218

EUROPE

AUSTRIA
Roland Austria GES.M.B.H.
 Siemensstrasse 4, P.O. Box 74,
 A-8463 RUM, AUSTRIA
 TEL: (0512) 26-44 260

**BELGIUM/HOLLAND/
 LUXEMBOURG**
Roland Benelux N. V.
 Houstraat 3 B-2260 Oevel
 (Westerlo) BELGIUM
 TEL: (014) 575811

DENMARK
Roland Scandinavia A/S
 Nordhavnsvej 7, Postbox 880
 DK-2100 Copenhagen
 DENMARK
 TEL: (039) 16 6200

FRANCE
Roland France SA
 4, Rue Paul Henri SPAAK
 Parc de l'Esplanade F 77 462 St.
 Thibault Lagay Cedex FRANCE
 TEL: 01 600 73 500

FINLAND
Roland Scandinavia As,
 Filiaal Finland
 Lauttasarentie 54 B
 Fin-00201 Helsinki, FINLAND
 TEL: (9) 862 4020

GERMANY
Roland Elektronische
Musikinstrumente
Handelsgesellschaft mbH.
 Oststrasse 96, 22844 Nordstedt,
 GERMANY
 TEL: (040) 52 60090

GREECE
STOLLAS S.A.
Music Sound Light
 155, New National Road
 26422 Patras, GREECE
 TEL: 061-435400

HUNGARY
Intermusica Ltd.
 Warehouse Area 'DEPO' Pf.83
 H-2046 Torokbalint, HUNGARY
 TEL: (23) 511011

IRELAND
Roland Ireland
 Audio House, Belmont Court,
 Donnybrook, Dublin 4,
 Republic of IRELAND
 TEL: (01) 2603501

ITALY
Roland Italy S. p. A.
 Viale delle Industrie, 8
 20020 Aresè Milano, ITALY
 TEL: (02) 937-78300

NORWAY
Roland Scandinavia Avd.
Kontor Norge
 Lillekerveien 2 Postboks 95
 Lilleaker N-0216 Oslo
 NORWAY
 TEL: 273 0074

POLAND
P. P. H. Brzostowicz
 UL. Gibraltarska 4,
 PL-03664 Warszawa POLAND
 TEL: (022) 679 44 19

PORTUGAL
Tecnologias Musica e Audio,
Roland Portugal, S.A.
 RUA SANTA CATARINA
 131 - 4000 Porto -PORTUGAL
 TEL: (02) 208 44 56

ROMANIA
FBS LINES
 Plata Libertatii 1,
 RO-4200 Chisoghieni
 TEL: (066) 164-609

RUSSIA
Slami Music Company
 Sadojava-Triumfalnaja st., 6
 103006 Moscow, RUSSIA
 TEL: 095 209 2193

SPAIN
Roland Electronics
de España, S. A.
 Calle Bolivia 239 (08020 Barcelona,
 SPAIN
 TEL: (93) 308 1000

SWEDEN
Roland Scandinavia A/S
SWEDISH SALES OFFICE
 Danvik Center 28, 2 tr.
 S-131 30 Nacka SWEDEN
 TEL: (08) 702 (0)20

SWITZERLAND
Roland (Switzerland) AG
Musitronic AG
 Gerberstrasse 5, CH-4410 Liestal,
 SWITZERLAND
 TEL: (061) 921 615

UKRAINE
TIC-TAC
 Mira Str. 19/108
 P.O. Box 180
 295400 Munkachevo, UKRAINE
 TEL: (03131) 414-40

UNITED KINGDOM
Roland (U.K.) Ltd.
 Atlantic Close, Swansea
 Enterprise Park SWANSEA
 SA7 9EJ,
 UNITED KINGDOM
 TEL: (01792) 700139

MIDDLE EAST

BAHRAIN
Moon Stores
 Bab Al Bahrain Road,
 P.O. Box 20077
 State of BAHRAIN
 TEL: 211 005

CYPRUS
Radex Sound Equipment Ltd.
 17 Diagonou St., P.O. Box 2046,
 Nicosia CYPRUS
 TEL: (02) 453 426

ISRAEL
Halilit P. Greenspoon &
Sons Ltd.
 8 Reizif Fa'aliya Hashnya St.
 Tel-Aviv-Yahio ISRAEL
 TEL: (03) 6823666

JORDAN
AMMAN Trading Agency
 Prince Mohammed St. P.O. Box
 825 Amman 11118 JORDAN
 TEL: (06) 4641200

KUWAIT
Easa Husain Al-Yousifi
 P.O. Box 126 Sufat 13002
 KUWAIT
 TEL: 5719499

LEBANON
A. Chahine & Fils
 P.O. Box 16-5857 Gergi Zeidan St.
 Chahine Building, Achrafieh
 Beirut, LEBANON
 TEL: (01) 335799

OMAN
OHI Electronics & Trading
Co. LLC
 P.O. Box 889 Muscat
 Sultanate of OMAN
 TEL: 959085

QATAR
Badie Studio & Stores
 P.O. Box 62,
 DOHA QATAR
 TEL: 423554

SAUDI ARABIA
aDawlah Universal
Electronics APL
 P.O. Box 2154 ALKHOBAR 31952,
 SAUDI ARABIA
 TEL: (03) 898 2081

SYRIA
Technical Light & Sound
Center
 Khaled Ibn Al Walid St.
 P.O. Box 13520
 Damascus - SYRIA
 TEL: (011) 2235 384

TURKEY
Barkat Muzik aletleri ithalat
ve ihracat limited ireketi
 Straselviler Cad. Billurcu Sok.
 Mucadelle Cikmeze No. 11-13
 Taksim. Istanbul. TURKEY
 TEL: (0212) 2499324

U.A.E.
Zak Electronics & Musical
Instruments Co.
 Zabeel Road, Al Shercoq Bldg.,
 No. 14, Grand Floor DUBAI
 U.A.E.
 P.O. Box 8050 DUBAI, U.A.E.
 TEL: (04) 360715

NORTH AMERICA

CANADA
Roland Canada Music Ltd.
(Head Office)
 5480 Parkwood Way Richmond
 B. C., V6V 2M4 CANADA
 TEL: (0604) 270 6626

Roland Canada Music Ltd.
(Toronto Office)
 Unit 2, 109 Woodbine Downs
 Blvd, Etobicoke, ON
 M9W 6Y1 CANADA
 TEL: (0416) 213 9707

U. S. A.
Roland Corporation U.S.
 5100 S. Eastern Avenue
 Los Angeles, CA 90040-2938,
 U. S. A.
 TEL: (323) 890 3700



For EU Countries

This product complies with the requirements of European Directives EMC 89/336/EEC and LVD 73/23/EEC.

For the USA

FEDERAL COMMUNICATIONS COMMISSION RADIO FREQUENCY INTERFERENCE STATEMENT

This equipment has been tested and found to comply with the limits for a Class B digital device, pursuant to Part 15 of the FCC Rules. These limits are designed to provide reasonable protection against harmful interference in a residential installation. This equipment generates, uses, and can radiate radio frequency energy and, if not installed and used in accordance with the instructions, may cause harmful interference to radio communications. However, there is no guarantee that interference will not occur in a particular installation. If this equipment does cause harmful interference to radio or television reception, which can be determined by turning the equipment off and on, the user is encouraged to try to correct the interference by one or more of the following measures:

- Reorient or relocate the receiving antenna.
- Increase the separation between the equipment and receiver.
- Connect the equipment into an outlet on a circuit different from that to which the receiver is connected.
- Consult the dealer or an experienced radio/TV technician for help.

This device complies with Part 15 of the FCC Rules. Operation is subject to the following two conditions:

- (1) This device may not cause harmful interference, and
- (2) This device must accept any interference received, including interference that may cause undesired operation.

Unauthorized changes or modification to this system can void the users authority to operate this equipment.
This equipment requires shielded interface cables in order to meet FCC class B Limit.

For Canada

NOTICE

This Class B digital apparatus meets all requirements of the Canadian Interference-Causing Equipment Regulations.

AVIS

Cet appareil numérique de la classe B respecte toutes les exigences du Règlement sur le matériel brouilleur du Canada.

Roland®

K6018462

UPC

K6018462

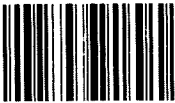

10981

KR-777/177

RES 312-01

Printed in Italy by Anballi Grafiche srl - Ancona

10-01 - KR-777/177 - O.M./E-D-F

Roland®

602153461