

# Roland

## KR-11 DIGITAL INTELLIGENT PIANO





### Owner's Manual

Thank you for purchasing the Roland KR-11 Digital Intelligent Piano!

So that you may enjoy reliable performance for years to come, please take time to read this manual from beginning to end.

### Main features

- ❑ **Three instruments in one**  
The KR-11 can be used as piano, organ or “keyboard” (i.e. a synthesizer with automatic accompaniment) – all at the touch of a button.
- ❑ **270 Tones (sounds) and 136 Styles built-in**  
Support for a wide range of musical genres. You'll find additional Styles on the enclosed Style disk.
- ❑ **Piano Tones that rely on stereo sampling**  
The Roland technology used ensures that your KR-11 offers some of the finest concert grand piano sounds available on electronic musical instruments.
- ❑ **64-voice polyphony**  
Up to 64 voices can be played simultaneously. (In most instances your KR-11 is 64-voice polyphonic.)
- ❑ **Simple yet versatile Composer**  
Recording and playback of commercial music data is easy with the KR-11.  
The comprehensive Composer menu includes:
  - 16-track Sequencer
  - Chord Sequencer
  - Song Edit
  - Style Composer
  - Style Converter
- ❑ **GM (General MIDI) and GS compatible**
  - **General MIDI System**   
The General MIDI System is a set of recommendations which seeks to standardize the MIDI support features of sound generating devices. Sound generating devices and musical data (disks) carrying the General MIDI logo conform to General MIDI specifications. This means that whenever you play back music data marked with the General MIDI logo, the musical response will be identical when played on any device also carrying the General MIDI logo.
  - **GS Format**   
Roland developed the GS Format to standardize the response of sound generators when MIDI is used for the production of music. By using a GS Format sound generating device, you can be assured that you will always hear a faithful, high-quality rendition of any commercially available music data that carries the GS Format logo.  
The KR-11's tone generator fully supports both the General MIDI system and GS Format so you can use music data that is designed for either standard.
- ❑ **Reads and writes SMF Music Data**  
The KR-11 is capable of playing Standard MIDI Files such as “SMF Music Data” (720 KB/1.44 MB format 3.5 inch floppy disks).



# Contents

<b>1. Important notes</b> .....	<b>5</b>	<b>9. Composer Menu</b> .....	<b>34</b>
<b>2. Panel descriptions</b> .....	<b>7</b>	9.1 16-track Sequencer .....	34
<b>3. Before using the KR-11</b> .....	<b>9</b>	9.2 Chord Sequencer .....	35
3.1 Connections .....	9	9.3 Recording Mode .....	36
3.2 Setting up the music stand .....	9	9.4 Formatting disks .....	36
3.3 Opening and closing the keyboard lid .....	9	9.5 Style Composer .....	37
3.4 Opening and closing the lid .....	10	9.6 Style Converter .....	38
3.5 Connecting Headphones .....	10	9.7 Saving User Styles .....	39
3.6 Turning the power on/off .....	11	9.8 Song Edit .....	39
3.7 Adjusting the sound's volume and brilliance .....	11	<b>10. Function Menu</b> .....	<b>42</b>
3.8 About the pedals .....	11	10.1 Piano screen functions .....	42
3.9 Connecting external amplifiers and other devices .....	12	10.2 Organ screen functions .....	44
<b>4. Basic operation and display</b> .....	<b>13</b>	10.3 Basic screen functions .....	44
<b>5. Overview of the KR-11</b> .....	<b>14</b>	<b>11. Music Assistant, Pad buttons, pedals</b> .....	<b>45</b>
5.1 Introduction of the main functions — [DEMO] .....	14	11.1 Music Assistant: registering panel settings .....	45
5.2 Performance functions .....	15	11.2 Performance Pad buttons: additional or frequently used functions .....	46
5.3 Playing back songs on disk .....	18	11.3 Pedal functions .....	47
5.4 Pitch Bend and Transpose .....	19	<b>12. Utility Menu</b> .....	<b>48</b>
<b>6. Tones and related functions</b> .....	<b>20</b>	12.1 Operating procedure .....	48
6.1 Selecting Tones .....	20	12.2 Utility functions .....	48
Drum sounds and sound effects — [DRUMS/SFX] .....	20	Master Tune .....	48
Adding effects to Tones .....	21	Key Touch/Key Transpose .....	48
Octave Shift: changing the pitch by octaves .....	21	Metronome Volume and Beat .....	49
6.2 Keyboard modes .....	22	Selecting a different Reverb and/or Chorus effect .....	49
<b>7. Playing with accompaniment (Arranger)</b> ..	<b>24</b>	Expansion Tone .....	49
7.1 What is an Arranger? .....	24	Lyric: switching off the display of lyrics .....	49
7.2 Selecting Music Styles .....	25	Pitch Bend Range .....	49
7.3 Starting and Stopping Styles .....	26	Program Change (and Bank Select) .....	50
7.4 Style tempo .....	27	MIDI: TX MIDI Ch./Local Control .....	50
7.5 Accompaniment and melody volume balance .....	27	Music Assistant Arranger Update .....	51
7.6 Switching Style arrangements (divisions) .....	28	Memory Backup .....	51
7.7 Easy fingering – Chord Intelligence .....	29	Factory Preset (initialization) .....	51
7.8 Melody Intelligence .....	30	Link to 16TRK Sequencer .....	51
<b>8. Recording and Playback</b> .....	<b>31</b>	<b>13. Connecting MIDI instruments</b> .....	<b>52</b>
8.1 Recording .....	31	<b>14. Appendix</b> .....	<b>53</b>
8.2 Playing back a Composer song .....	33	14.1 DSP effects .....	53
8.3 Track Mute: Muting specific tracks .....	33	14.2 Specifications .....	53
8.4 Playing back songs without tempo changes .....	33	<b>Tones, Drum Sets, Music Styles</b> .....	<b>54</b>
8.5 Erasing the Composer song .....	33		
8.6 Saving a song to disk .....	34		







# USING THE UNIT SAFELY

## INSTRUCTIONS FOR THE PREVENTION OF FIRE, ELECTRIC SHOCK, OR INJURY TO PERSONS

About  **WARNING** and  **CAUTION** Notices

 <b>WARNING</b>	Used for instructions intended to alert the user to the risk of death or severe injury should the unit be used improperly.
 <b>CAUTION</b>	Used for instructions intended to alert the user to the risk of injury or material damage should the unit be used improperly.  * Material damage refers to damage or other adverse effects caused with respect to the home and all its furnishings, as well to domestic animals or pets.

About the Symbols

	The  symbol alerts the user to important instructions or warnings. The specific meaning of the symbol is determined by the design contained within the triangle. In the case of the symbol at left, it is used for general cautions, warnings, or alerts to danger.
	The  symbol alerts the user to items that must never be carried out (are forbidden). The specific thing that must not be done is indicated by the design contained within the circle. In the case of the symbol at left, it means that the unit must never be disassembled.
	The  symbol alerts the user to things that must be carried out. The specific thing that must be done is indicated by the design contained within the circle. In the case of the symbol at left, it means that the power-cord plug must be unplugged from the outlet.

### ----- ALWAYS OBSERVE THE FOLLOWING -----

#### **WARNING**

- Before using this unit, make sure to read the instructions below, and the Owner's Manual. 



---

- Do not open or perform any internal modifications on the unit. 

---

- Do not attempt to repair the unit, or replace parts within it (except when this manual provides specific instructions directing you to do so). Refer all servicing to your retailer, the nearest Roland Service Center, or an authorized Roland distributor, as listed on the "Information" page. 

---

- Never use or store the unit in places that are:
  - Subject to temperature extremes (e.g., direct sunlight in an enclosed vehicle, near a heating duct, on top of heat-generating equipment); or are 
  - Damp (e.g., baths, washrooms, on wet floors); or are 
  - Humid; or are
  - Exposed to rain; or are
  - Dusty; or are
  - Subject to high levels of vibration.

---

- Make sure you always have the unit placed so it is level and sure to remain stable. Never place it on stands that could wobble, or on inclined surfaces. 

- The instrument should be connected to a power supply only of the type described in the operating instructions, or as marked on the unit. 



#### **WARNING**

- Do not excessively twist or bend the power cord, nor place heavy objects on it. Doing so can damage the cord, producing severed elements and short circuits. Damaged cords are fire and shock hazards! 

---

- This unit, either alone or in combination with an amplifier and headphones or speakers, may be capable of producing sound levels that could cause permanent hearing loss. Do not operate for a long period of time at a high volume level, or at a level that is uncomfortable. If you experience any hearing loss or ringing in the ears, you should immediately stop using the unit, and consult an audiologist. 

---

- Do not allow any objects (e.g., flammable material, coins, pins); or liquids of any kind (water, soft drinks, etc.) to penetrate the unit.   



---

- In households with small children, an adult should provide supervision until the child is capable of following all the rules essential for the safe operation of the unit. 

---

- Protect the unit from strong impact. (Do not drop it!) 

- When the top is open, do not put your head or any other part of your body under it. The lid could be dislodged and then fall on you. 

- When the top is open, do not touch the topboard propstick unless you are in the process of lowering the lid to close the instrument. If you inadvertently touch the propstick, it could be loosened and the lid could fall on part of your body. 

- When opening the lid, be careful not to open it too far. Opening the lid to greater than the provided the supporting legs permit may damage the unit, or cause the lid to drop. Also, before opening the lid, make sure that no one is in the path of the lid as it is opened. 

- Do not force the unit's power-supply cord to share an outlet with an unreasonable number of other devices. Be especially careful when using extension cords—the total power used by all devices you have connected to the extension cord's outlet must never exceed the power rating (watts/amperes) for the extension cord. Excessive loads can cause the insulation on the cord to heat up and eventually melt through. 

**⚠ WARNING**

- Before using the unit in a foreign country, consult with your retailer, the nearest Roland Service Center, or an authorized Roland distributor, as listed on the "Information" page. 

**⚠ CAUTION**

- The unit should be located so that its location or position does not interfere with its proper ventilation. 

- Always grasp only the plug on the power-supply cord when plugging into, or unplugging from, an outlet or this unit. 

- Try to prevent cords and cables from becoming entangled. Also, all cords and cables should be placed so they are out of the reach of children. 

- Never climb on top of, nor place heavy objects on the unit. 

- Never handle the power cord or its plugs with wet hands when plugging into, or unplugging from, an outlet or this unit. 

- If you need to move the instrument, take note of the precautions listed below. At least two persons are required to safely lift and move the unit. It should be handled carefully, all the while keeping it level. Make sure to have a firm grip, to protect yourself from injury and the instrument from damage. 
  - Check to make sure the knob bolts securing the unit to the stand have not become loose. Fasten them again securely whenever you notice any loosening.
  - Disconnect the power cord.
  - Disconnect all cords coming from external devices.
  - Raise the adjusters on the stand.
  - Close the lid.
  - Close the keyboard lid
  - Fold down the music stand.

- Before cleaning the unit, turn off the power and unplug the power cord from the outlet (p. 9). 

- Whenever you suspect the possibility of lightning in your area, pull the plug on the power cord out of the outlet. 

- Be careful when opening/closing the lid so you do not get your fingers pinched (see page 9). Adult supervision is recommended whenever small children use the unit. 

- Should you remove the screws fastening the stand, make sure to put them in a safe place out of children's reach, so there is no chance of them being swallowed accidentally. 

# 1. Important notes

In addition to the items listed under “IMPORTANT SAFETY INSTRUCTIONS” and “USING THE UNIT SAFELY”, please read and observe the following:

## Power Supply

- Do not use this unit on the same power circuit with any device that will generate line noise (such as an electric motor or variable lighting system).
- Before connecting the KR-11 to other devices, turn off the power to all units. This will help prevent malfunctions and/or damage to speakers or other devices.

## Placement

- Using the unit near power amplifiers (or other equipment containing large power transformers) may induce hum. To alleviate the problem, change the orientation of this unit; or move it farther away from the source of interference.
- This device may interfere with radio and television reception. Do not use this device in the vicinity of such receivers.
- Noise may be produced if wireless communications devices, such as cell phones, are operated in the vicinity of this unit. Such noise could occur when receiving or initiating a call, or while conversing. Should you experience such problems, you should relocate such wireless devices so they are at a greater distance from this unit, or switch them off.
- Do not expose the unit to direct sunlight, place it near devices that radiate heat, leave it inside an enclosed vehicle, or otherwise subject it to temperature extremes. Also, do not allow lighting devices that normally are used while their light source is very close to the unit (such as a piano light), or powerful spotlights to shine upon the same area of the unit for extended periods of time. Excessive heat can deform or discolor the unit.
- To avoid possible breakdown, do not use the KR-11 in a wet area, such as an area exposed to rain or other moisture.
- Do not allow rubber, vinyl, or similar materials to remain on the KR-11 for long periods of time. Such objects can discolor or otherwise harmfully affect the finish.
- Do not put anything that contains water (e.g., flower vases) on the piano. Also, avoid the use of insecticides, perfumes, alcohol, nail polish, spray cans, etc., near the unit. Swiftly wipe away any liquid that spills on the unit using a dry, soft cloth.
- Do not allow objects to remain on the keyboard. This can be the cause of malfunction, such as keys ceasing to produce sound.
- Do not paste stickers, decals, or the like to this instrument. Peeling such matter off the instrument may damage the exterior finish.

## Maintenance

- To clean the unit, use a dry, soft cloth; or one that is slightly dampened. Try to wipe the entire surface using an equal amount of strength, moving the cloth along with the grain of the wood. Rubbing too hard in the same area can damage the finish.
- Never use benzine, thinners, alcohol or solvents of any kind, to avoid the possibility of discoloration and/or deformation.
- The pedals of this instrument are made of brass. Brass eventually darkens as the result of the natural oxidization process. If the brass becomes tarnished, polish it using commercially available metal polisher.

## Additional precautions

- Use a reasonable amount of care when using the KR-11's buttons, sliders, or other controls; and when using its jacks and connectors. Rough handling can lead to malfunctions.
- When connecting/disconnecting cables, grasp the connector itself—never pull on the cable. This way you will avoid causing shorts, or damage to the cable's internal elements.
- A small amount of heat will radiate from the unit during normal operation.
- To avoid disturbing your neighbors, try to keep the unit's volume at reasonable levels. You may prefer to use headphones.
- When you need to transport the unit, pack it in shock-absorbent material. Transporting the unit without doing so can cause it to become scratched or damaged, and could lead to malfunction.
- Use a cable from Roland to make the connection. If using some other make of connection cable, please note the following precautions.
  - Some connection cables contain resistors. Do not use cables that incorporate resistors for connecting to this unit. The use of such cables can cause the sound level to be extremely low, or impossible to hear. For information on cable specifications, contact the manufacturer of the cable.

## Before using floppy disks

### □ Floppy disk drive

- Avoid using the KR-11 immediately after it has been moved to a location with a significantly higher or lower level of humidity. Rapid changes in the environment can cause condensation to form inside the drive, which will adversely affect the operation of the drive and/or damage floppy disks. When the instrument has been moved, switch it on and wait at least one hour before using the disk drive.
- To insert a disk, push it gently but firmly into the drive—it will click into place. To remove a disk, press the EJECT button.
- Never attempt to remove a floppy disk from the drive while the drive is operating (the indicator is brightly lit); damage could result to both the disk and the drive.

- Remove any disk from the drive before powering up or down.
- To prevent damage to the disk drive's heads, always try to hold the floppy disk in a level position (not tilted in any direction) while inserting it into the drive.

❑ **Handling floppy disks**

- Floppy disks contain a plastic disk with a thin magnetic coating. Microscopic precision is required to enable storage of large amounts of data on such a small surface area. To preserve their integrity, please observe the following when handling floppy disks:
- Never touch the magnetic medium inside the disk.
- Do not use or store floppy disks in dirty or dusty areas.
- Do not subject floppy disks to temperature extremes (e.g., direct sunlight in an enclosed vehicle). Recommended temperature range: 10 to 50° C (50 to 122° F).
- Do not expose floppy disks to strong magnetic fields, such as those generated by loudspeakers.
- Floppy disks have a “WRITE PROTECT” tab which can protect the disk from accidental erasure. It is recommended that the tab be kept in the PROTECT position, and moved to the WRITE position only when you wish to write new data onto the disk.

- Disks containing important performance data for this unit should always be locked (have their write protect tab slid to the “Protect” position) before you insert them into the drive of another instrument (except the PR-300, or a product of the HP-G, MT, KR, or Atelier families), or into a computer's drive. Otherwise, when performing any disk operations (such as checking the contents of the disk, or loading data), you risk rendering the disk unreadable by the KR-11's disk drive.
- The identification label should be firmly affixed to the disk. If the label comes loose while the disk is in the drive, it may be difficult to remove the disk.
- Put the disk back into its case for storage.

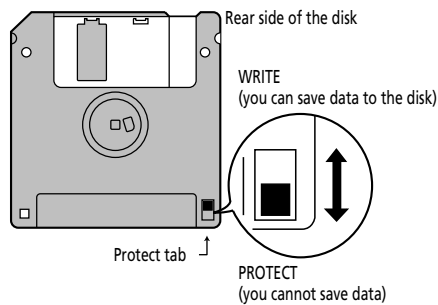

## 2. Panel descriptions

### 2.1 Front panel

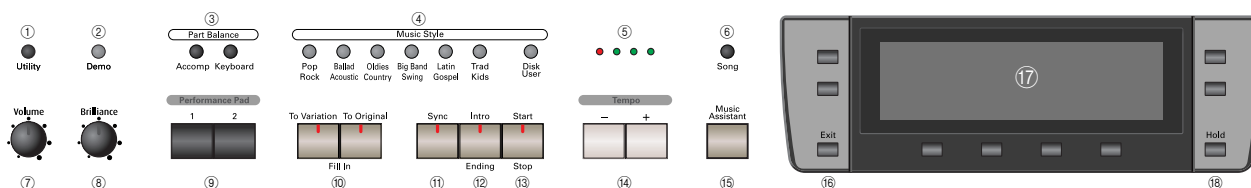

#### ① UTILITY button

Press this button to access the KR-11's Utility functions (see "Utility Menu" on page 48).

#### ② DEMO button

This button provides access to an on-screen Help function with explanations of the KR-11's functions, games allowing you to identify sounds and chords, etc. It also allows you to listen to the internal demo songs.

#### ③ Part Balance ACCOMP and KEYBOARD buttons

Use the [ACCOMP] button to set the volume of each individual accompaniment part. The [KEYBOARD] button provides access to a display page where you can set the volume of the part(s) played with the keyboard.

#### ④ MUSIC STYLE buttons

Use these buttons to select Music Style groups. Refer to "Internal Music Styles" at the end of this manual.

#### ⑤ Tempo indicators

These indicators flash in the rhythm of the selected Music Style, sequence, or Song to indicate the tempo and time signature. Depending on the time signature, not all indicators may be used, or the last indicator may flash several times (e.g. for 6/8).

#### ⑥ SONG button

Press this button to load songs you recorded using the KR-11's Song Composer and saved to floppy disk.

#### ⑦ VOLUME knob

Adjusts the instrument's overall volume.

#### ⑧ BRILLIANCE knob

Allows you to make the overall sound brighter or darker.

#### ⑨ PERFORMANCE PAD buttons

Various functions can be assigned to these buttons (see "Performance Pad buttons: additional or frequently used functions" on page 46).

#### ⑩ TO VARIATION & TO ORIGINAL buttons

These buttons have two functions: you can use them to select the accompaniment pattern for a Music Style or to switch from the accompaniment pattern to a Fill-In during a performance.

#### ⑪ SYNC button

Allows you to start a Music Style by playing on the keyboard.

#### ⑫ START/STOP button

Used to start or stop a Style performance.

#### ⑬ INTRO/ENDING button

Press this button when you want to start a Style performance with an introduction, or to stop Music Style playback with a musical ending.

#### ⑭ TEMPO buttons

Use these buttons to adjust the tempo of the selected Music Style or the song you are playing back.

#### ⑮ MUSIC ASSISTANT button

Press this button if you wish to store the panel settings or recall the settings for a given song.

#### ⑯ EXIT button

Press this button to return to the previous display page or the Master page.

#### ⑰ Display and related buttons

The display shows all the information you need in a given situation. The soft keys next to the display (whose function varies according to the selected display page) allow you to select one of the available menu options.

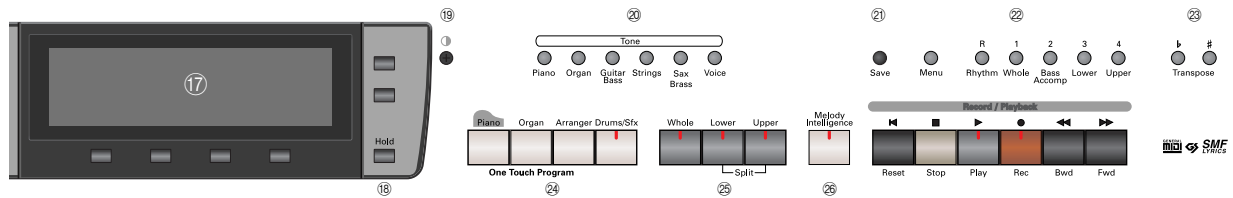

**18 HOLD button**

In most cases, the selected display page will disappear after a few seconds. Press this button to “lock” the currently selected display page. Press it again to release the Hold function, or [EXIT] to leave it right away.

**19 LCD contrast knob**

Use this knob to change the contrast whenever the display is difficult to read.

**20 TONE buttons**

Used to select a Tone Group (see “Selecting Tones” on page 20).

**21 SAVE button**

Press this button to save the Song in the KR-11’s internal memory to disk.

**22 COMPOSER section**

Use these buttons to control the on-board sequencer (called *Composer*).

**23 TRANSPOSE [b]/[#] buttons**

Change the key of the music being played.

**24 ONE TOUCH PROGRAM buttons**

These buttons allow you to instantly recall the appropriate settings for the music you want to play.

**25 Whole, Lower, Upper buttons**

Use these buttons to select whether you want to play one sound (Tone) on the entire keyboard (“Whole”), or one sound for the left hand and another one for the right hand.

**26 MELODY INTELLIGENCE button**

Press this button to add a harmony to the melody you are playing.

**27 POWER switch (left side)**

Press this button to switch the KR-11 on and off.

**28 Disk drive (right side)**

Used for playing back material recorded on floppy disks, or saving and loading songs or settings to/from disk.

**29 PHONES jacks (left, below the keyboard)**

This is where you can connect two pairs of headphones (preferably Roland RH-25 or RH-50 model). Connecting a pair of headphones to one of the PHONES jacks turns off the built-in speakers.

## 2.2 Connections

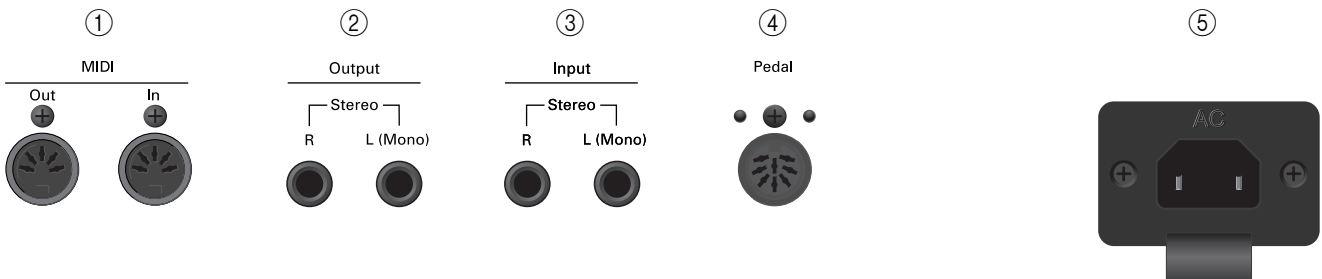

**1 MIDI sockets (Out, In)**

Use these connectors to exchange MIDI data with external MIDI devices.

**2 OUTPUT R/L (MONO) sockets**

To connect the KR-11 to an external amplifier or mixing console, or to record your music with a tape recorder, connect these jacks to the external device (see “Sending audio to external equipment” on page 12).

**3 INPUT R/L (MONO) sockets**

This is where you can connect the audio outputs of another MIDI instrument, a CD or cassette player, etc. The signals of that audio source will be amplified and mixed with the KR-11’s own audio signals.

**4 PEDAL socket**

This is where you can connect the pedal cable of the stand.

**5 AC IN**

The KR-11’s power cord connects here.



# 3. Before using the KR-11

## 3.1 Connections

### Connecting the Pedal Cable

Insert the pedal cable into the Pedal connector on the panel of the KR-11.

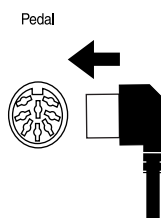

### Connecting the power cord

To prevent malfunction and/or damage to speakers or other devices, always turn down the volume, and turn off the power on all devices before making any connections.

1. Connect the supplied power cable to the AC Inlet on the KR-11's panel.
2. Connect the power cable to an AC outlet.

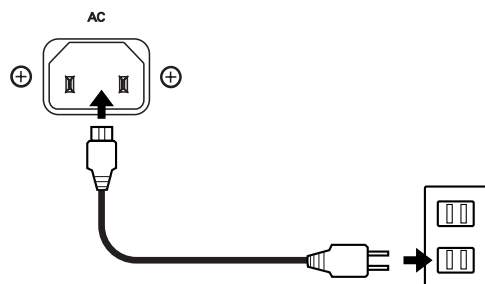

Be sure to use the supplied power cord.

## 3.2 Setting up the music stand

Set up the music stand as shown in the figure below.

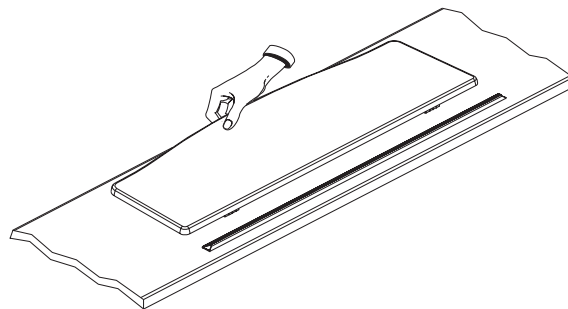

Fold the three supporting feet at the back of the stand and check whether the stand is held in place.

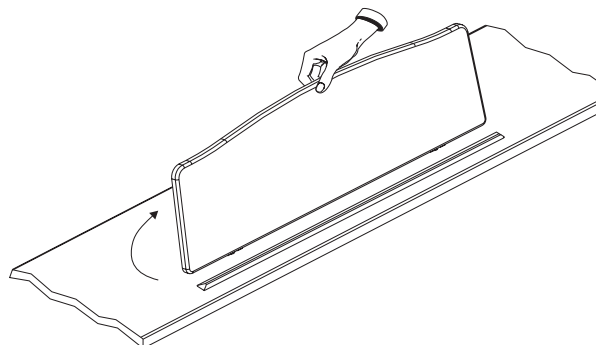

Before moving the KR-11, be sure to lower the music stand as a safety precaution.

## 3.3 Opening and closing the keyboard lid

1. When opening the KR-11's lid, grasp it with both hands and gently lift it upwards, then slide it towards the back of the piano.
2. When closing the lid, slowly pull it forward, then gently lower it into place.

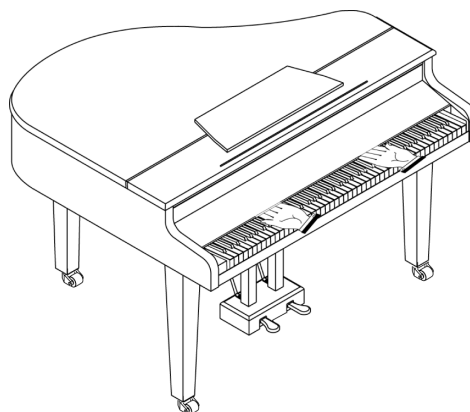

Never insert your hands between the lid and the keyboard.

Take care not to allow fingers to be caught or pinched when opening and closing the lid. Make sure an adult is on hand to provide assistance when young children are playing the KR-11.

For safety, transport the KR-11 only with the lid in the closed position.

### 3.4 Opening and closing the lid

The KR-11's lid can be raised and closed like on an acoustic grand piano. Though this is mainly intended to help you obtain a better spread of the sound, it also changes the KR-11's tone color.

1. Carefully raise the lid with one hand, taking care to get a secure grip.
2. Fold out the supporting leg.
3. Lower the lid until you are sure it is supported by the leg.

Here's what your KR-11 should look like once the lid is in place:

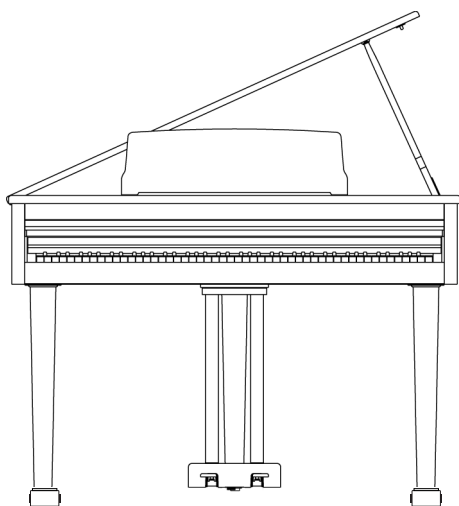

*Note: If you are not sure how to raise the lid, ask your Roland dealer to show you how it's done.*

#### **CAUTION**

*When opening the lid, be careful not to open it too far. Opening the lid to greater than the provided the supporting legs permit may damage the unit, or cause the lid to drop. Also, before opening the lid, make sure that no one is in the path of the lid as it is opened.*

### 3.5 Connecting Headphones

The KR-11 has two jacks for plugging in headphones. This allows two people to listen through headphones simultaneously, making it very useful for lessons and when performing piano pieces for four hands. Additionally, this allows you to play without having to worry about bothering others around you, even at night.

Plug the headphones into a Phones jack located at the bottom left of the piano.

Connecting headphones will automatically mute the sound from the internal speakers.

The headphone volume is adjusted by the [Volume] knob (p. 11) of the KR-11.

Phones socket x2

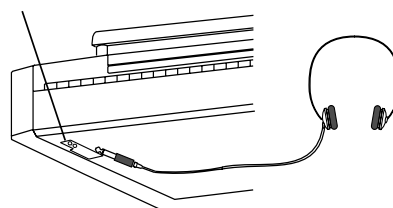

*Note: Be sure to use stereo headphones (such as the Roland RH-25 or RH-50).*

#### Notes on using headphones

- To prevent damage to the cord, handle the headphones only by the headset or the plug.
- Connecting the headphones when the volume of connected equipment is turned up may result in damage to the headphones. Lower the volume on the KR-11 before plugging in the headphones.
- Listening at excessively high volume levels will not only damage the headphones, but may also cause hearing loss. Use the headphones at a moderate volume level.

### 3.6 Turning the power on/off

Turn on power to your various devices in the order specified. By turning on devices in the wrong order, you risk causing malfunction and/or damage to speakers and other devices.

To turn the power on, turn the [Volume] knob all the way down, and then press the [Power] button.

The power will turn on, and the Power indicator at the left front of the KR-11 will light.

After a few seconds, you will be able to play the keyboard to produce sound.

Use the [Volume] knob to adjust the volume.

The KR-11 is equipped with a protection circuit. A brief interval (a few seconds) after power up is required before the unit will operate normally.

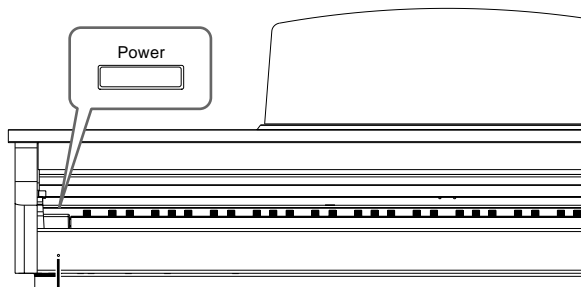

Power Indicator

To turn the power off, turn the [Volume] knob all the way to the left, and press the [Power] switch.

The Power indicator at the left front of the KR-11 will go dark, and the power will be turned off.

### 3.7 Adjusting the sound's volume and brilliance

1. Turn the [Volume] knob to adjust the overall volume.

2. Turn the [Brilliance] knob to adjust the brightness of the sound.

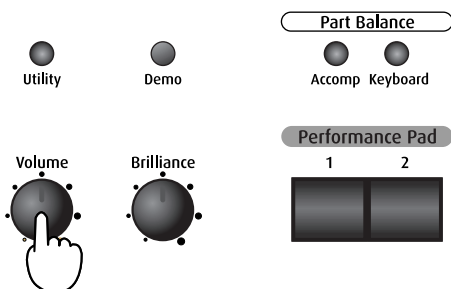

### 3.8 About the pedals

The KR-11 comes with two pedals that are built into the supplied stand:

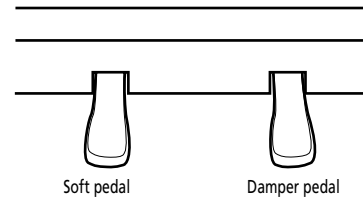

**Soft pedal**— This pedal softens the sound. Playing with the soft pedal depressed produces a sound that is not as strong as when played with the equivalent strength. This is the same function as the left-most pedal on an acoustic piano.

*Note: You can change the left pedal's function (see page 47).*

**Damper pedal**— Use this pedal when you want the sound to linger on. While the damper pedal is depressed, the sound from the keyboard continues to linger for an extended period, even when you remove your fingers from the keys.

This is the same function as the right-most pedal on an acoustic piano.

#### About the adjuster

When you move the KR-11 or if you feel that the pedals are unstable, set the adjuster located below the pedals as follows.

Rotate the adjuster to lower it so that it is in firm contact with the floor. If there is a gap between the pedals and the floor, the pedals may be damaged. In particular when placing the instrument on a carpet, adjust this so that the pedals firmly contact the floor.

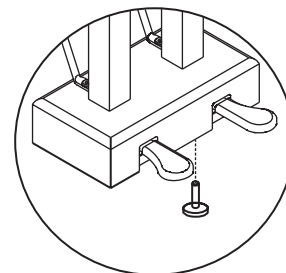

### 3.9 Connecting external amplifiers and other devices

If the KR-11's amplification system doesn't deliver enough power for your application, you can take advantage of its OUTPUT jacks.

#### Sending audio to external equipment

Before connecting the KR-11 to another piece of equipment, turn off the power to both devices.

If you wish to amplify the KR-11 through an external system, or record your music using a tape recorder, connect the KR-11's OUTPUT jacks to the AUX IN, LINE IN or CH IN jacks of the external (keyboard) amplifier, mixer or tape deck.

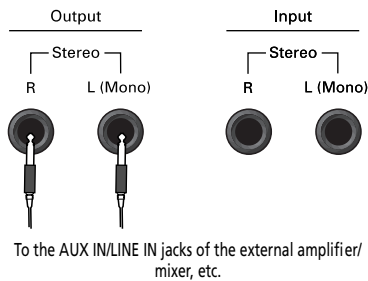

*Note: If you are connecting the KR-11 to a device with a monaural input, be sure to use the L/MONO jack.*

*Note: For cassette decks or HiFi amplifiers, you need audio leads with mono jacks at one end and (usually) RCA/cinch jacks at the other.*

After connecting the KR-11 to the amplifier, etc., be sure to switch on the KR-11 and the external device(s) in the following sequence:

1. First turn on the power to the KR-11.
2. Then turn on the power to the mixing console, amp, etc. (in that order).

#### Receiving audio signals from external sources

You can connect the audio outputs of an external MIDI instrument, CD or cassette player, etc., to the INPUT jacks. That has the advantage that such signals can be amplified by the KR-11 and are therefore also present in the headphones (if connected).

To connect an external signal source, follow the instructions above but be sure to connect the LINE OUT, etc., jacks of the external source to the KR-11's INPUT jacks.

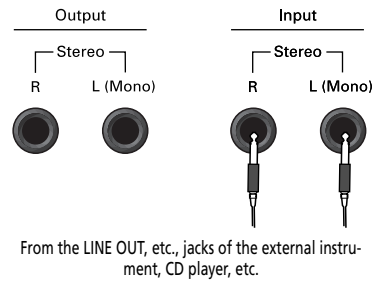

# 4. Basic operation and display

The KR-11 features a large-sized screen that keeps you informed about the status of your instrument and allows you to access functions for which there are (usually) no buttons or sliders.

## Symbols used in this owner's manual

This Owner's Manual uses the following symbols to indicate panel buttons and items appearing on the display.

[ ]— This indicates a button or slider on the panel.

Example: the TONE [PIANO] button.

< >— This indicates an item appearing on the display.

To choose such an item, press the corresponding soft button (located below or next to the item).

Example: the <Layer> button (see below).

## The Basic/Home screen

This is the display page (called *Basic screen*) that will be displayed every time you press the One Touch Program [ARRANGER] button.

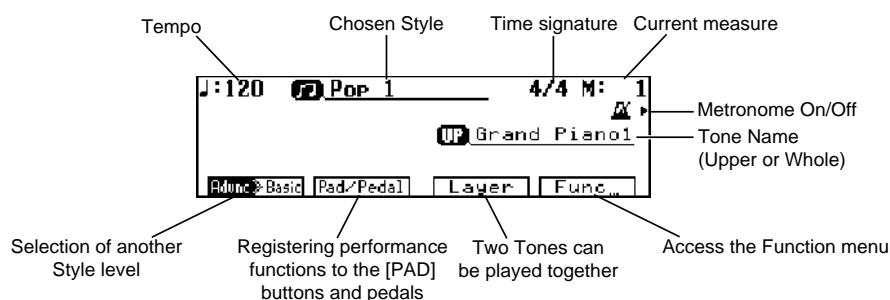

Note: If the display is difficult to read, use the CONTRAST knob to change the display contrast.

## Navigating through the display pages

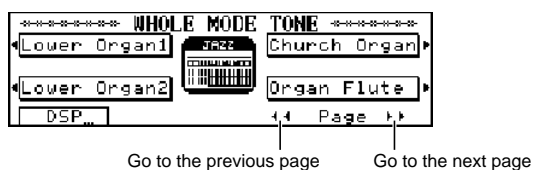

Changing screen pages— <<<PAGE> and <PAGE>>>

Some screens may comprise multiple display pages. By pressing <PAGE>>> you will go to the next page.

Press <<<PAGE> to return to the previous display page.

Retaining a screen— the [HOLD] button

Some screens are only displayed for a few seconds, after which you return to the previous screen, or the Basic screen. If you do not want the screen to change, you can “lock” the current screen on the display by pressing the [HOLD] button.

Returning to the previous screen or the Basic screen— [EXIT] button

By pressing the [EXIT] button, you return to the previous screen or the Basic screen.

# 5. Overview of the KR-11

## 5.1 Introduction of the main functions — [DEMO]

Let's take a look at the most striking features of your KR-11. Just follow the instructions or items that appear on the display.

**1. Press the [DEMO] button.**

A "Demo" screen appears on the display. The Demo screen is made up of three pages.

**2. Press <▲> and <▼> to the right of the display to select another page.**

The screen changes, allowing you to view the introduction to other functions.

**3. Press a button below the display to choose an item.**

A screen showing the functions and controls of the selected item appears.

**4. Press the [DEMO] button to leave the Demo screen.**

### Tone and Style demo — <Sound>/<Style>

To give you a better idea of the KR-11's Tones (sounds) and Music Styles (accompaniments), the KR-11 comes with a Sound and Style Demo function. Here is how to use them.

**1. On the Demo screen, press <Sound> for a demonstration of the Tones, or <Style> for an explanation and demonstration of the Music Styles.**

**2. Press <Demo> at the bottom right of the display.**

**3. Use the buttons to the left and right of the display to choose the instrument you want to hear, or press <Next> to audition the next Music Style.**

A demo song using the selected Tone or Music Style is played. The number of demo songs varies according to the Tone you select. When the first song ends, the next one starts to play.

**4. You can start playback of the second demo by pressing the same button (or <Next>) again.**

The performance stops automatically when all songs have been played.

**5. Press <Exit> or <To Menu> to stop playback.**

*Note: All rights reserved. Unauthorized use of the demo songs for purposes other than private enjoyment is a violation of applicable laws.*

*Note: The performance data of the demo songs are not transmitted to the MIDI OUT connector.*

### Choosing the display language

The Basic menu and part of the Demo menu can be displayed in other languages.

**1. On the Demo screen, press <Language>.**

**2. Use the buttons to the left and right of the display to choose the language.**

*Note: This setting reverts to the original language when the power is switched off. If you prefer the KR-11 to select another language, see "Memory Backup" on page 51.*

### Using <Game>

The <Game> option lets you play a note- or chord-guessing game.

**1. On the Demo screen, press <Game>.**

**2. Use the buttons at the bottom of the display to select a game.**

From left to right, the games displayed are "Guess the Note", "Guess the Chord" and "Chord Practice."

**Guess the Note**— Listen to the sound that's played, and guess what note it is.

**Guess the Chord**— Listen to the chord that's played, and guess what notes are used to make it up.

**Chord Practice**— Look at the chord and try to play it.

Here's how the game progresses:

**3. Use the buttons below the display to choose either "Beginner" or "Advanced".**

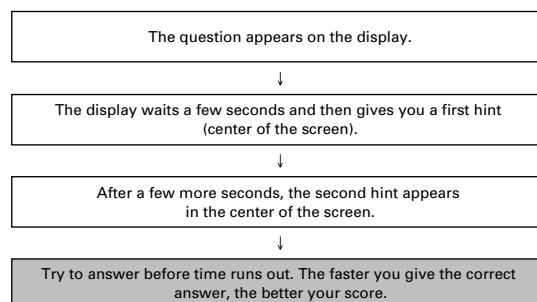

## 5.2 Performance functions

### Brilliance knob

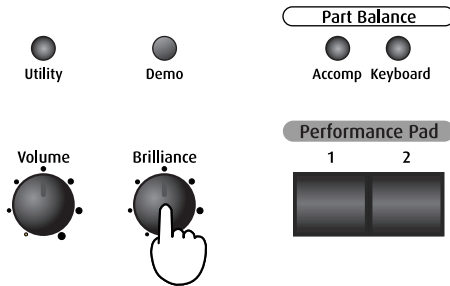

Use the [Brilliance] knob to make the overall sound brighter or darker.

### One Touch Program: Selecting the “instrument type”

By pressing the One Touch Program [PIANO], [ORGAN], or [ARRANGER] buttons, you will access suitable settings (registrations) for the kind of music you wish to play. To play a piano piece, for instance, press the [PIANO] button. Press [ORGAN] to transform your KR-11 into an organ. To play a song using the automatic accompaniment, press [ARRANGER].

#### Piano music — One Touch Program [PIANO]

The settings assigned to this button are loaded every time you turn the power on.

1. Press the One Touch Program [PIANO] button.

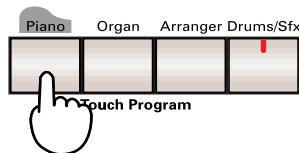

A picture of a piano will be displayed to signal that you can play a piano sound on the entire keyboard. The Tone that is selected is called “Grand Piano 1”.

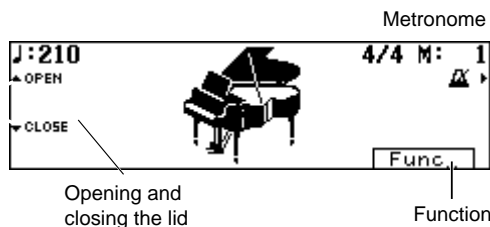

#### ■ Adjusting the piano tone

With the KR-11, you can simulate changes in the tone of a grand piano that come about when the piano’s lid is opened or closed.

2. Press the One Touch Program [PIANO] button, and the Piano screen will appear.

Pressing <▲Open> and <▼Close> adjusts the “opening” of the piano lid.

Each time you press the <▲Open> button, the lid of the piano shown on the screen opens more, creating a brighter tone.

Each time you press the <▼Close> button, the lid of the piano shown on the screen closes more, creating a mellower tone.

#### ■ Using the metronome

The KR-11 features a metronome function. Use the metronome whenever you want to practice at a given tempo. By pressing the button to the right of the metronome icon, you can turn the metronome on and off. You can adjust the tempo with the TEMPO [+] and [-] buttons. Pressing the [+] and [-] buttons simultaneously will return the keyboard to the default (pre-set) tempo.

*Note: You can change the metronome’s volume and time signature. Please refer to “Metronome volume and beat” on page 42.*

*Note: The metronome always uses the same time signature (beat) and tempo as the currently selected Style.*

#### ■ Using the pedals

The KR-11 features a PEDAL jack where you connect the pedals that are built into the stand. Each time you switch on the KR-11 or press the One Touch Program [PIANO] button, the functions of these pedals are as follows:

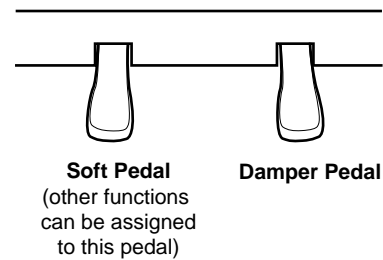

**Soft (left)**— Pressing the Soft pedal yields a softer tone.

**Damper (right)**— Press the Damper pedal to sustain all notes being played.

*Note: The function of the left (Soft) pedal differs in Arranger and Split modes. See also “Pedal functions” on page 47.*

#### ■ The Function menu — <Func...>

This feature is used to make various useful settings for piano performances. For more detailed information, please refer to “Function Menu” on page 42.

Please note that your KR-11 comes with a variety of Tones (not just piano sounds). See “Selecting Tones” on page 20 for how to select them.

### Organ music — One Touch Program [ORGAN]

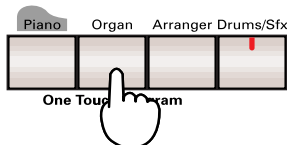

Press the One Touch Program [ORGAN] button. A picture of an organ will appear on the screen, with the keyboard split at F#3 into Lower (left hand) and Upper (right hand) parts.

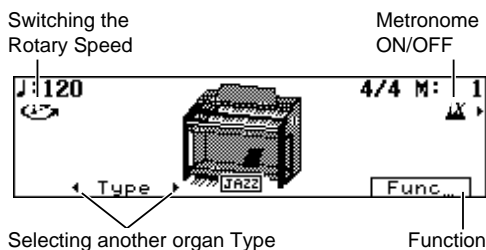

The Tones currently assigned to the left (Lower) and right (Upper) halves of the keyboard are called “Lower Organ 1” and “Jazz Organ 1”. These Tones make up the Jazz Organ type. See below for how to choose another organ Type.

#### ■ Adjusting the Rotary Effect

The Jazz Organ has an added rotary effect. This simulates those famous rotary speakers that are indispensable for a true organ sound.

To change the rotation speed, press the soft button assigned to this function. Each press toggles the rotation speed between S (Slow) and F (Fast).

#### ■ Selecting an organ Type

Use <◀Type> and <Type▶> to make your selection. The selected organ Type remains in effect until the power is turned off. In other words, if you select another One Touch Program mode and then press [ORGAN] again, the KR-11 will use the last organ Type you selected.

*Note: When the power is switched off, the KR-11 reverts to “Jazz Organ”.*

#### ■ The Function menu —<Func...>

This feature is used to make settings for the various functions related to organ performances. For more information, please refer to “Function Menu” on page 42.

### Accompaniment — One Touch Program [ARRANGER]

The KR-11 comes with an “Arranger” function that provides an automatic, yet interactive, accompaniment you can use to accompany your melodies and solos. 136 accompaniments (called Music Styles) covering all popular musical genres are built-in. Other Styles can be loaded from the supplied floppy disk, while you can also create your own Styles.

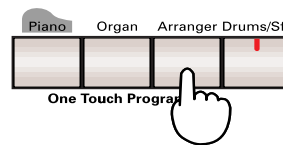

The Arranger is interactive and always adapts the key of the accompaniments to the chords you play (see “What is an Arranger?” on page 24).

#### ■ How to use the Arranger

Here’s all you need to do to be able to use the KR-11’s Arranger:

**1. Press the One Touch Program [ARRANGER] button.**

The keyboard is now split at F#3 into a Lower (left half of the keyboard) and an Upper section (right half).

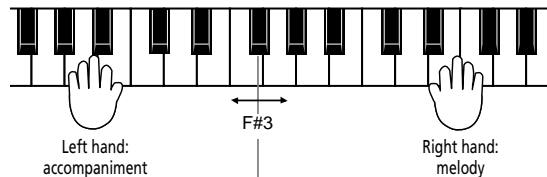

**2. Select a Music Style** (see “Selecting Music Styles” on page 25).

**3. Play a chord in the Lower section to start the accompaniment.**

Style playback starts with an introduction. Wait until the Intro is finished before you start playing the melody in the Upper section. If the accompaniment is too fast, you can slow it down with the TEMPO [-] button.

The KR-11 has a number of features that make playing with the Arranger even easier:

- For major chords, just press the key of the root note (see “Easy fingering – Chord Intelligence” on page 29).
- You can release the keys in the Lower section after playing the desired chord. The Arranger will go on playing in that key until you play another chord.

**4. At the end of your song, press the [INTRO/ENDING] button.**

How about trying using the Arranger in a real-life situation? Here’s what to do to play this piece that you probably know already:



**Example: “When The Saints Go Marching In”**

1. Press the One Touch Program [ARRANGER] button.

The Basic screen is displayed. The names of the chords you play in the Lower section appear on the display:

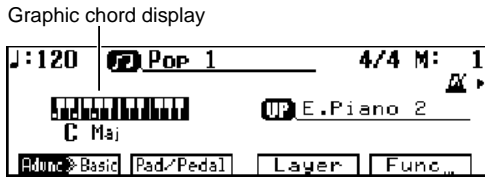

2. Press the Music Style [Big Band/Swing] button.

3. From the list of Music Styles shown on the display, select <Jazz Band>.



(The Style “Jazz Band” has now been selected.) After a few seconds, the display returns to the Basic screen.

4. Start the accompaniment by pressing the C key (see the score for the chords to play).

As explained above, this is the easy way to play chords. By pressing the C, you actually play a C major chord.

The Arranger will start with an eight-measure Intro. Wait until the Intro is finished before playing the melody.

Once you feel you master the basic version of “The Saints”, try adding some variation here and there. When “To Variation” is indicated in the music, press the [TO VARIATION] button. Of course, there is a lot more you can do with the KR-11’s Arranger.

**When The Saints Go Marching In**

American Traditional

The score shows the melody and accompaniment with chords: C, C E F, G, C E F, G, E E D, C, C E G, G F, E F, G E, C D, C, C E F, C. It includes an 8-measure intro and two endings.

Here are the “chords” you need for “The Saints”:

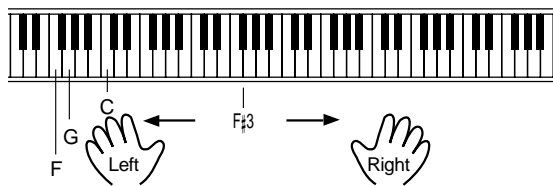

You can slow down the tempo by pressing the TEMPO [-] button. If you think the accompaniment is too slow, press TEMPO [+] instead.

Pressing the [+] and [-] buttons simultaneously will return the Arranger to the default tempo of the Jazz Band Style.

5. At the end of the song, press the [INTRO/ENDING] button.

If you want to play the song again, press the [SYNC] button and play the first chord (C).

Note: There are various ways to start and stop a Style (see “Starting and Stopping Styles” on page 26).

## 5.3 Playing back songs on disk

The KR-11 is fitted with a floppy disk drive. It allows you to listen to commercially available music data (Standard MIDI Files) or play back songs you create and save to disk. Here is how to listen to such music data:

*Note: Before using disks, please carefully read “Before using floppy disks” on page 5.*

1. Insert the music data disk into the floppy disk drive.
2. Press the [SONG] button.

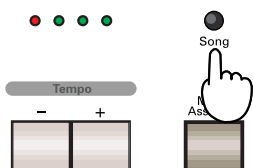

The “Song Select” function will be displayed.



Every song you play back from disk is automatically copied to the KR-11’s internal Composer memory. (You can remove the music data disk after listening to the song only once.) If the KR-11’s memory already contains a song, the following message appears:

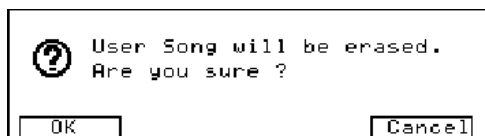

If you don’t want to lose the song in the KR-11’s internal memory, press <CANCEL> and see “Saving a song to disk” on page 34. Otherwise, press <OK>.

### Selecting and playing back Songs

3. Use the buttons next to the display to select the song you want to listen to.

If all songs of the disk won’t fit on one page, use <<PAGE> and <PAGE>> to jump to the desired Song Select page.

4. Press <Play> or the [PLAY] button.

The performance will begin. After several seconds, the display returns to the previous screen.

*Note: For songs that do not begin on the downbeat of the first measure, “PU” (Pickup) will be displayed when the song begins. After that, measure numbers will be displayed.*

5. Playback stops automatically at the end of the song. You can stop playback at any time by pressing <STOP> or the [STOP] button.

If you press the [RESET] button, playback stops and the song is rewound to the beginning of the first measure.

### Listening to all songs

6. Press <All Song>.

The entire group of songs will begin playing in order. The set will repeat if you do not stop the performance.

7. To stop playback, press <STOP> or the [STOP] button.

If you press the [RESET] button, playback stops and the song is rewound to the beginning of the first measure.

### Rewinding and fast forwarding

By pressing the [FWD] and [BWD] buttons, you can advance to later measures or return to previous ones. Doing so allows you to start playback from the desired measure.

Each press of one of the buttons moves you either ahead or back one measure at a time, and when you hold the button down, the movement is continuous.

*Note: Depending on the size of the song data, rewinding and fast forwarding may take some time.*

*Note: It is also possible to mute one of the song parts and play it yourself. See “Track Mute: Muting specific tracks” on page 33.*

*Note: The KR-11 provides a function for practicing difficult passages. Such passages can be marked and played back repeatedly. See “Marker function: repeatedly playing back the same section” on page 43.*

## 5.4 Pitch Bend and Transpose

The KR-11's left pedal (also known as “Soft” pedal) can be used to bend the notes you play. To do so, you must assign it the Pitch Bend function (see “Pedal functions” on page 47 for details) and specify whether you want to bend the notes upward (“Bend Up”) or downward (“Bend Down”). You must set the “Pitch Bend Range” (see page 49), which is the interval (or number of semitones) by which the notes will be shifted when you press the Soft pedal.

If you are playing a C and want to shift it to D by pressing the pedal, set Pitch Bend Range to “2” (two semitones or one whole tone) and select “Bend Up” as *Pedal Assign* function. To bend to the G *below* the C you are playing, set the Range value to “5” and *Pedal Assign* to “Bend Down” (select “7” and “Bend Up” to shift to the G *above* the C).

If it is difficult to play a song in a particular key, select a different one with the TRANSPOSE [b]/[#] buttons.

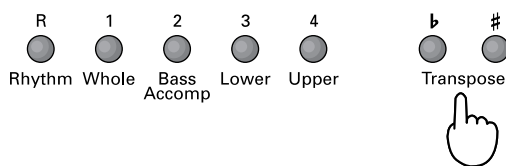

Each time you press the [b] button, the key will be lowered a semitone; each time you press the [#] button, the key will be raised a semitone. Pressing the [b]/[#] buttons simultaneously will return the song to the original key.

*Note: The transposition interval can also be set via the display. See “Key Touch/Key Transpose” on page 48.*

# 6. Tones and related functions

## 6.1 Selecting Tones

The KR-11 comes with a host of instrument sounds (called Tones). These Tones are divided into eight categories, called Groups.

### Selecting “normal” Tones

1. Press the TONE button of the Group that contains the Tone you need.

The button’s indicator light will go on, and a Tone select screen (e.g. Whole Mode Tone) will be displayed.



Each Tone Group contains several Tones.

2. Select a Tone by pressing the buttons to the side of the display screen.

The name of the Tone selected will be highlighted on the display. Play a few notes on the keyboard to confirm that the Tone is what you had in mind.

The Tone Select screen is composed of multiple pages. Use <◀◀PAGE> and <PAGE▶▶> to turn to another page.

*Note: If you want to try out several Tones from a Tone Group, pressing the [HOLD] button will lock the Tone Select screen and keep it from disappearing after a few seconds.*

*Note: See “Normal Tones” at the end of this manual for the number and kinds of Tones each Group contains.*

You may wonder why we use the term “Normal Tones” rather than just “Tones”. That is because the instructions above do not give you access to all Tones the KR-11 contains. See “Selecting Expansion Tones” for more details about how to access all Tones.

*Note: See also “Selecting Tones for the Upper and Lower parts” on page 22 for how to assign Tones in Split mode.*

### Selecting Expansion Tones

Expansion Tones can only be assigned to the Upper part of the keyboard (Whole Keyboard, Split, and Arranger modes).

**Caution**— Expansion Tones are only temporarily selected and cannot be written to a Music Assistant memory (see page 45). Whenever you select another mode (for example, if you change from Whole mode to Split mode), the Upper part returns to last “normal” Tone you selected.

1. Press [UTILITY] and use <◀◀PAGE> or <PAGE▶▶> to select the following display page.

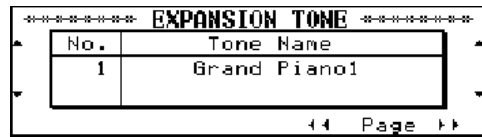

2. Use the buttons to the left and right of the display to select a Tone.

See “Expansion Tones” at the end of this manual for a list of the available Tones.

*Note: You can use Expansion Tones for recording the melody with the KR-11’s Composer (see page 34).*

## Drum sounds and sound effects — [DRUMS/SFX]

Instead of playing melodies, you can also “drum” on the KR-11’s keyboard, or play sound effects like train noises, helicopter sounds, etc.

Press the [DRUMS/SFX] button (indicator lights).

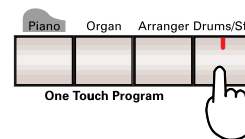

The display switches to the “Drum Screen”. Every key is now assigned to a different drum or percussion sound. Play a few notes and listen – and watch the display.

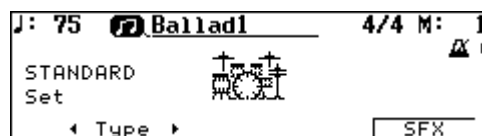

*Note: See “Drum Sets” at the end of this manual for details about the assignments of drum sounds and sound effects to the keyboard.*

Press the [DRUMS/SFX] button once more (or the [EXIT] button), to return to the previous screen.

### Toggling between drum sounds and sound effects

1. If necessary, press [DRUMS/SFX] again (indicator must light).

2. Press <SFX>.

The display will switch to the “SFX Screen”. Play a few notes on the keyboard. This time, you will hear sound effects rather than drum sounds. Again, the display will show you pictures of the sounds being played.

3. Press <Drums>.

The display jumps to the Drum Screen. With each press of the button you will toggle between drums sounds and effects.

### Selecting Drum Set Types

Press <◀Type> or <Type▶>.

Each time you press one of these buttons, the drum set type will change, and the names of the drum sounds appearing on the display will change.

*Note: There is one SFX set.*

### Adding effects to Tones

#### Reverberation (REV)

Reverb is a digital effect that gives the impression that you are playing in a concert hall.

1. Press the [UTILITY] button.

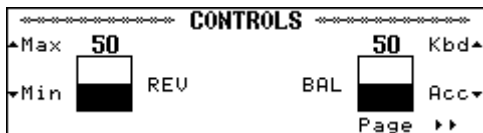

2. Use the <▲> and <▼> buttons to the left of the display to modify the Reverb balance.

Setting the value to "100" gives you maximum Reverb, while selecting "0" removes all Reverb from the sound. The REV parameter actually increases or decreases the Reverb Depth for the sound currently assigned to the keyboard. It works much the same way as a cathedral: the louder you sing, the more Reverb you hear. In the case of the cathedral, singing louder means that you increase the effect send level, i.e. the level of the signal (your voice) that will be processed by the acoustic environment. The overall volume of the effect (cathedral) itself, however, does not change.

The other parts (the Arranger and Composer parts) are also processed by the same Reverb effect. If REV were assigned to the volume of the effect itself, selecting the Min value would also strip the accompaniment of Reverb.

*Note: The KR-11 contains several Reverb programs (called Types), so that you can always use the Reverb type that best suits your needs. See "Reverb Types" on page 49.*

*Note: You cannot adjust the Reverb Depth of the Arranger parts or the sounds played back by the Composer function.*

#### Adding other effects — DSP effect

DSP is short for *Digital Signal Processor*. The DSP effect contains a variety of effects programs, one of which you can select for the song you are about to play. See "DSP effects" on page 53 for a list of all DSP effects the KR-11 contains.

1. Select <DSP...> on the Tone Select screen.

The display now jumps to a screen similar to the following:

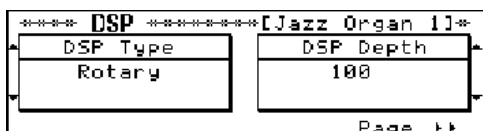

2. Use the buttons to the left of the display to select the Type (kind of effect), and set its Depth with the buttons to the right of the display.

Select "OFF" from the Type screen if you don't need a DSP effect.

*Note: Only one DSP effect can be used at a time.*

*Note: When you select Upper, Lower, or Whole and choose the Rotary Effect, you can switch the rotation speed with the button at the upper left of the display.*

#### Chorus effect

Your KR-11 also contains a Chorus effect. Chorus is an effect that creates a more spacious, "fatter" sound.

1. After pressing <DSP...> on the Tone Select screen, press <PAGE▶▶>.

The display now jumps to a page similar to the following:

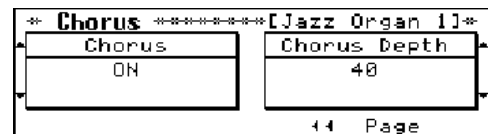

2. Turn the Chorus on and off with the buttons to the left of the display, and select the Chorus Depth with the buttons to the right of the display.

After several seconds, the display returns to the previous screen.

*Note: The KR-11 contains several Chorus programs (called Types), so that you can always use the Chorus type that best suits your needs. See "Chorus Types" on page 49.*

### Octave Shift: changing the pitch by octaves

Octave Shift is a function that changes the pitch of a sound in octave steps. Octave Shift can be set independently for the Lower and Upper parts.

To give you an idea of the flexibility of this system, here is an example: suppose you assign the same Tone (E.Piano 1) to both the Upper and Lower keyboard section. Though you are using the same sound, it is assigned to two parts you can shift individually. Thus, by setting Octave Shift to "+1" for the Lower part, while leaving it at "0" for the Upper part, you create an overlap of the octaves immediately to the left (Lower) and right (Upper) of the split point. You could use this feature for playing intricate parts.

1. Start by selecting the Tone you need on the Tone Select screen (see page 20).

2. Select the octave (shift amount) by pressing <Octave>.

You can raise or lower the pitch by a maximum of two octaves. After a few seconds, the display will revert to the Basic screen.

*Note: When you switch off the KR-11, the Octave Shift settings return to their preset values. If you'd like the KR-11 to memorize your settings, see "Memory Backup" on page 51.*

Note: When using Octave Shift, you may sometimes notice that notes to the far right of the keyboard sound in the “wrong” octave. That is because all Tones have an upper limit beyond which they cannot be transposed.

Note: You cannot use Octave Shift in Whole mode (see below).

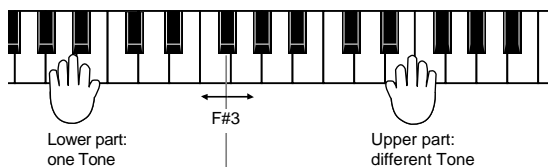

Play a few notes to confirm that different Tones are assigned to the Lower and Upper parts. In Split mode, the names of both Tones being used are displayed.

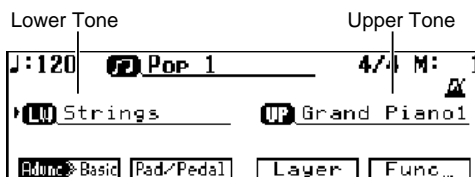

The Tone assigned to the Upper Part will be used when you switch to Whole mode (see above). When you power on the KR-11, the Tone assigned to the Lower part will be “Strings.”

## 6.2 Keyboard modes

### Whole: one Tone for the entire keyboard

In Whole mode, one Tone is assigned to the entire keyboard, thus allowing you to play piano or other parts involving both your left and right hand. That explains why Whole is automatically selected when you press the One Touch Program [PIANO] button.

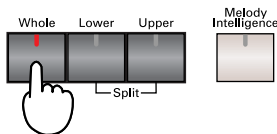

Press the [WHOLE] button.

The button's indicator light will go on, and the Tone selected for the Upper part will be assigned to the entire keyboard.

Note: If you press the [WHOLE] button while using the Arranger, the KR-11 will switch to Piano Style Arranger mode (see page 24).

### Split: different Tones in the left and right hand

It is also possible to split the keyboard, so that you can play two different sounds with your left and right hand, e.g. a bass and a piano sound. The key (or note) where the keyboard is divided is called the *split point*. You are free to choose another split point, but do remember that the KR-11 automatically selects F#3 whenever you switch it off. For your information: the key that acts as the split point is the highest note of the Lower part.

Organ playing usually involves two different sounds, so the keyboard is automatically split whenever you press the One Touch Program [ORGAN] button and select “Jazz Organ”.

Here is how to split the keyboard:

Press the SPLIT [LOWER] or [UPPER] button.

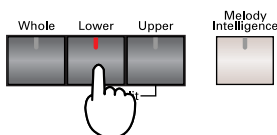

The indicators of both the [LOWER] and [UPPER] buttons light to signal that the keyboard has been split at F#3:

### Selecting Tones for the Upper and Lower parts

1. Press the button of the part ([LOWER] or [UPPER]) you wish to assign another Tone to. The arrow (▶) will jump to the selected Part.

2. Press a TONE button.

The Tone Select screen will be displayed.

3. Select a Tone.

After several seconds, the display reverts to the Basic screen.

Note: There is no need to select a part by pressing its button when an arrow (▶) appears next to its name.

Note: You can change the location where the keyboard is split. Refer to “Lower Tone on/off and split point” on page 44.

Note: Sometimes, the pitch changes when the keyboard is split. That is because the KR-11 automatically selects a suitable Octave Shift value to avoid notes sounding too low or too high.

## Layer: using two Tones simultaneously

The word *Layer* is used to describe a situation where every note you play triggers two Tones. The most popular Tone combination for layers is piano and strings, but you are free to use any Tone combination you like.

*Note: Layers are only available for the Upper part.*

Here's an example of how to layer two Tones (let's use piano and strings here).

1. Press the TONE [PIANO] button and select the desired piano Tone.
2. Press <Layer> on the Basic screen.

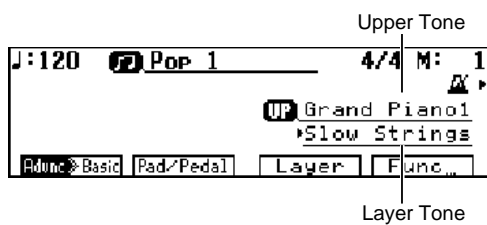

3. Press the TONE [STRINGS] button.

The indicator of the TONE button you press lights up. Play a few notes on the keyboard to confirm that the KR-11 is producing both a piano and a strings sound. Let's call the two Tones "Upper Tone" and "Layer Tone".

You can now select another Tone from the Strings group. If, after choosing a Layer Tone, you decide to use another Upper Tone, press <Layer> again (to leave Layer mode) and select the desired Tone (see above).

*Note: Another way to select the Layer mode is to press two TONE buttons simultaneously.*

# 7. Playing with accompaniment (Arranger)

## 7.1 What is an Arranger?

Think of the Arranger's Music Styles as your backup band. Your KR-11 is capable of playing several "variations" (called divisions) of a given accompaniment. All you have to do is decide what kind of music you want to play: salsa, rumba, pop-rock or big band?

You are the band leader, which means that you have to tell the members of your band what to play, including how many bars there are to each song part and how the melody and/or solo should be accompanied.

There are two main levels: Basic and Advanced, each consisting of two divisions called Original and Variation.

As the name implies, Basic is the "normal" accompaniment level, with the basic ingredients of a professional sounding accompaniment. The Advanced level may contain another version of the selected Music Style or a more elaborate one. On either level (Basic and Advanced) you can choose between the Original accompaniment or an alternative (called Variation). The latter usually adds one or two parts to the current accompaniment.

If you want the accompaniment to become more complex as the song evolves, here is a useful sequence:

Typical song structure

1st Verse	2nd Verse	1st Chorus	3rd Verse	2nd Chorus
Basic Original	Basic Variation	Advanced Original	Basic Variation	Advanced Variation

Other elements help you refine the accompaniment. Instead of abruptly changing to Advanced/Original, you may want to play a short transition to announce a new part of the song. That is what Fill In [TO VARIATION] and [TO ORIGINAL] are for.

See "Switching Style arrangements (divisions)" on page 28 for other Music Style divisions and functions you can use to create a professional sounding accompaniment.

Each accompaniment (or Music Style) consists of up to five parts:

**Rhythm**— This part takes care of the drums and percussion.

**Bass**— This part plays the bass line of the selected Music Style.

**Accomp. 1~3**— These are the melodic accompaniment parts. Certain Music Styles use this feature, playing anything from a piano line to a guitar line, an organ line to a synth pad line.

The bass and accompaniment parts rely on the chord or note information you play in the *chord recognition* area, i.e. the keyboard zone you have assigned to the Arranger (originally the left half of the keyboard).

Also note that you can use the drum patterns of a Music Style in other One Touch Program modes (Piano and Organ). These patterns can be started in the same way as entire Music Styles (with bass and melodic accompaniments). See "Starting and Stopping Styles" on page 26.

## Settings

Press the One Touch Program [ARRANGER] button.

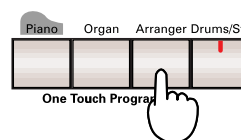

The KR-11 now automatically makes the following settings:

- The Sync Start function is turned on. This means that the Arranger will start as soon as you begin playing with your left hand.
- The Intro function is activated so that Style playback will start with a musical introduction.
- The keyboard is split at F#3. Use your left hand to "transpose" the accompaniment pattern(s), and play the melody with your right hand.
- It selects a suitable (preset) tempo as well as an Upper Tone for the selected Music Style.

### ■ Additional notes

- To change the split point, see "Lower Tone on/off and split point" on page 44.
- As in Split mode, the KR-11 automatically selects the most appropriate pitch for the Tone assigned to the Upper part. If you want to shift the pitch of the Upper Tone in octave steps, see "Octave Shift: changing the pitch by octaves" on page 21.
- See "Auto: changing the Arranger defaults" on page 44 if you don't want the KR-11 to change the tempo and select another Upper Tone every time you choose a Music Style.

### Piano Style Arranger — chord recognition on the entire keyboard

If you press the [WHOLE] button after pressing the One Touch Program [ARRANGER] button, the entire keyboard will be scanned for chord information for the Arranger. Let's call this mode *Piano Style Arranger* mode.

The Arranger decodes every chord you play – no matter where you play it. Causing the Arranger to play another chord requires that you play at least a triad



(i.e. the three notes that make up a chord). You can play more than three chord notes, but remember that two notes won't cause the Arranger to change chords. *Note: In Piano Style Arranger mode, you cannot use the Chord Intelligence function (see page 29). There, you need to play full chords using normal fingering.*

## 7.2 Selecting Music Styles

The KR-11 contains 136 Music Styles. These Styles are divided into six Groups (see the MUSIC STYLE buttons and list on the front panel).

### 1. Press a MUSIC STYLE button.

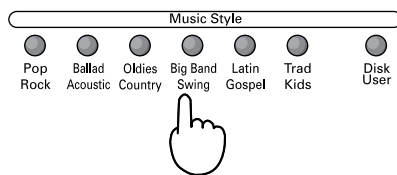

The button's indicator lights up, and a "Music Style" screen, like the one shown below, will be displayed.



Once a Music Style Group has been selected, you can choose a Style from that Group.

There are two sets of settings that prepare everything for you ("A" and "B"): a suitable sound for your right hand, matching effect settings, etc. Before selecting a Music Style, you should decide whether to work with set <A> or <B>:

### 2. Press the button below the display that corresponds to the presets you wish to use.

You need to do so before selecting a Music Style (see the next step).

### 3. Select a Music Style by pressing the buttons to the side of the display.

The name of the Music Style you select will be highlighted on the display. The Music Style screen is spread over multiple pages. Use <◀◀PAGE> and <PAGE▶▶> to jump to another page if the Music Style you need doesn't appear on the display.

As always, the display returns to the previous page after a few seconds of inaction. If you want to take your time and try out several Music Styles of the selected Group, press the [HOLD] button.

*Note: The number of Styles in each group varies.*

### 4. Play a note or chord to the left of the split point.

The Arranger starts playing the introduction of the Music Style you selected. Press the [START/STOP] button.

*Note: Whenever the Arranger is not playing, the left half of the keyboard is reassigned to the Chord and Bass parts. That allows you to play your own chord backing and bass notes. You could use this for transitions, etc. See "Chord Tone Setting" on page 45 for how to assign a Tone to those parts.*

## Using Style disks (User Styles)

The KR-11 comes with a Style Disk that contains additional Music Styles and 16 Acoustic styles. These Styles must be loaded into the KR-11's internal memory and will be erased when you switch off your instrument. *Note: See "Internal Music Styles & Disk Styles" at the end of this manual for a list of the Music Styles on the supplied Style disk.*

*Note: Loading Music Styles from disk means that the Style in the KR-11's User Style memory will be erased. Always save your own Styles to disk before loading another one. See "Saving User Styles" on page 39.*

### 1. Insert the Style Disk into the disk drive.

### 2. Press the [DISK/USER] button.

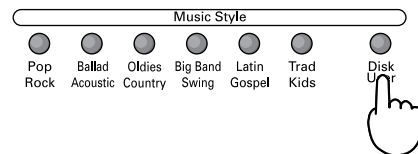

A list of the Styles on disk will be displayed.

### 3. Use the buttons next to the display to select the Style you want to load.

The name of the selected Style will be highlighted.

The indicator of the [DISK/USER] button remains lit to signal that the KR-11 now contains a User Style. To select it, press [DISK/USER].

*Note: When you switch off your KR-11, the Style you loaded from disk is erased. You will have to load it again next time you wish to use it.*

*Note: If you insert the Style disk into the drive before switching on the KR-11, it will automatically load the "Easy Listen" Style.*

*Note: Unlike internal Music Styles, Styles loaded from disk contain no default Upper Tone setting.*

## 7.3 Starting and Stopping Styles

### Starting a Music Style

You may remember that by pressing One Touch Program [ARRANGER] you also select a number of settings, one of which is called Sync Start. Let's look at that function first.

#### Starting automatically (Sync Start)

##### ■ Starting with a musical introduction

You can start Style playback in much the same way as a band or orchestra – with a nice introduction (called *Intro*). The length of the introduction depends on the Style you selected. Some Intros are two measures long, others eight, and so on.

1. Press the [SYNC] button.

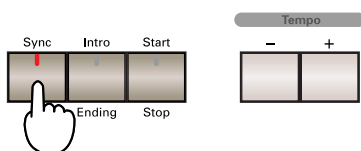

The [SYNC] button's indicator will light, and the TEMPO and [INTRO/ENDING] indicators will begin flashing.

Now all you have to do is to play a note or a chord in the chord recognition area (either the left half of the keyboard, or anywhere in Piano Style Arranger mode) to start the Arranger.

2. Play a note or chord in the chord recognition area. The Arranger now plays the Intro pattern. The INTRO/ENDING indicator will light, and go off at the end of the Intro.

To cancel Sync Start, just press the [SYNC] button once more.

##### ■ Shorter/simpler Intro

- Press the [SYNC] button (indicator lights).
- Press the Fill In [TO ORIGINAL] button (indicator flashes).
- Play in the chord recognition area of the keyboard. Style playback will begin with a short Intro.

##### ■ Starting without an Intro

1. Press the [SYNC] button.

The [SYNC] button's indicator will light, and the TEMPO and [INTRO/ENDING] indicators will begin flashing.

2. Press the flashing [INTRO/ENDING] button (indicator goes off).

3. Play a note or chord in the chord recognition area.

### Starting manually

If you prefer to be in complete control of the Arranger and therefore do not want it to start as soon as you play one or several notes, there are two options.

##### ■ Starting with an Intro

1. If necessary, press the [SYNC] button to switch off the Sync Start function.

Remember that you can now play your own chords and bass notes using the Chord and Bass parts that are automatically assigned to the Lower section of the keyboard.

2. Press the [INTRO/ENDING] button to start Style playback with the corresponding Intro.

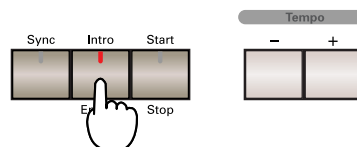

During the Intro, the [INTRO/ENDING] button's indicator will be lit. When the Intro is over, the indicator will go off.

##### ■ Starting without an Intro

1. If necessary, press the [SYNC] button to switch off the Sync Start function.

2. Press the [START/STOP] button. The Style will begin playing.

### Stopping a Music Style

There are two ways to stop Style playback:

#### Stopping a Style with an Ending

An Ending is usually referred to as a *Coda*. This is a musical way of ending a song, some of the most impressive examples can be found in classical music. But also in pop music, a song usually doesn't just stop. If that is what you are after, here is what to do:

Press the [INTRO/ENDING] button while the Music Style is running.

During the ending, the [INTRO/ENDING] button's indicator will be lit. When the Ending is over, the indicator will go off.

Again, the length of the Ending depends on the Music Style you select.

#### ■ If you want to shorten/simplify the Ending:

- Press the Fill In [TO ORIGINAL] button (indicator starts flashing).
- While the [TO ORIGINAL] button's indicator is flashing, press the [START/STOP] button.

#### Stopping a Music Style immediately

Press the [START/STOP] button.

### Alternatives for starting and ending Music Style playback

Using a PAD button or a footswitch, you can fade in (whereby the volume gradually increases) to the start of a Style, or fade out (whereby the volume gradually decreases) to the end of a Style. Please refer to “Performance Pad buttons: additional or frequently used functions” on page 46 and “Pedal functions” on page 47.

## 7.4 Style tempo

Every Style also contains a preset tempo value. If you think the Style is too slow or too fast, here is how to change it:

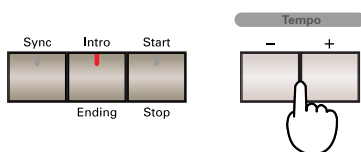

Press TEMPO [+] to increase the tempo and TEMPO [-] to decrease it.

The tempo value appears in the upper left part of the display. Additionally, you can confirm the tempo and time signature by looking at the TEMPO indicators.

## 7.5 Accompaniment and melody volume balance

### Global balance

You can adjust the balance of volume of the accompaniment (Music Style) and the Upper Tone you use to play the melody.

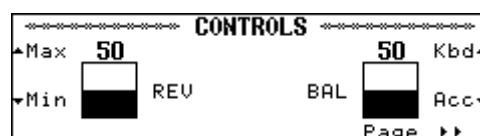

Press [UTILITY] and use the <▲> and <▼> to the right of the display to adjust the volume balance.

### Adjusting the volume of each part — Part Volume

The BAL function adjusts the balance of the overall accompaniment volume and that of the melody (Upper). With the Part Volume buttons, you can adjust the volume of individual parts, or prevent a part from even sounding.

There are two Part Volume buttons: [ACCOMP] and [KEYBOARD]. Press [ACCOMP] if you want to change the volume of an accompaniment part, and the [KEYBOARD] button to adjust the volume of a part that can be assigned to the keyboard.

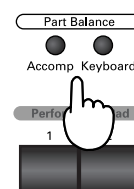

### Volume of the Rhythm, Bass, Accomp, and Chord/Bass Tones

These Tones are assigned or related to the Arranger (the automatic accompaniment).

1. Press the Part Volume [ACCOMP] button.

For each part, a bar graph and numerical value are displayed on screen. The correspondence between the parts and what is shown on the screen is as follows:

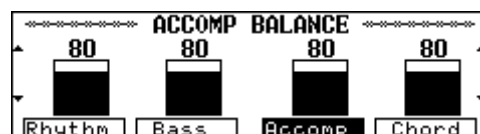

<Rhythm>— Drums

<Bass>— Accompaniment Bass and Bass Tones

<Accomp>— Accompaniment parts (1~3)

<Chord>— Chord Tone (see “Chord Tone Setting” on page 45 for details about the Chord and Bass Tones).

2. Select the part whose volume you wish to adjust using the buttons below the display.
3. Adjust its volume with the <▲> and <▼> buttons. Press the <▲> button to increase the volume, and the <▼> button to decrease it.

### Volume of the Drums, SFX, Lower, Upper, or Layer Tone

These are the parts you can play yourself, which is why you need to press the other Part Volume button.

1. Press the Part Volume [KEYBOARD] button.

For each part, a bar graph and numerical value are displayed on the screen.

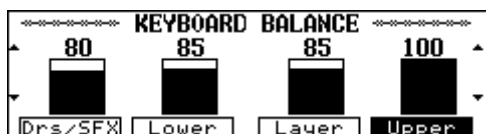

The correspondence between the parts and what is shown on the screen is as follows:

- <Drs/SFX>— Drums and SFX (sound effects)
- <Lower>— Lower
- <Layer>— Layer
- <Upper>— Upper

2. Use the buttons below the display to select the part whose volume you wish to adjust.
3. Use the <▲> and <▼> buttons to adjust the volume.

## 7.6 Switching Style arrangements (divisions)

For each Style, you can select the particulars of the orchestration (arrangement) and accompaniment pattern type. You can do this before starting a Style, or during playback of the Style.

*Note: There are other Arranger functions you can use by assigning them to a PAD button. See "Performance Pad buttons: additional or frequently used functions" on page 46.*

### Basic/Advanced: Level

At power on, the "Advanced" level is selected.

**Advanced**— more complex arrangement with more accompanying instruments.

**Basic**— simple arrangement with fewer accompanying instruments.

Here is how to select the desired level:

Press <Advnc◀Basic> or <Advnc▶Basic> on the Basic screen.

The correspondence between the levels and what is shown on the display is as follows:

<Advnc◀Basic>	Appears when Basic Arrangement is selected. Press <Advnc◀Basic> to switch to the Advanced level.
<Advnc▶Basic>	Appears when Advanced Arrangement is selected. Press <Advnc▶Basic> to switch to Basic level.



### Original/Variation: Accompaniment pattern

There are two kinds of accompaniment patterns: Original and Variation. The accompaniment pattern type is set to "Original" when power to the instrument is turned on. See "What is an Arranger?" for details.

Press <To Variation> or <To Original> on the Basic screen.

## Fill-Ins (transitions between Original and Variation)

To Original and To Variation are two fills (or transitions) you can use at the end of a musical phrase (verse, chorus, bridge). The two buttons do two things at a time:

	In Original mode	In Variation mode
To Original 	Plays the Original Fill.	Plays the Original Fill and selects the Original pattern.
To Variation 	Plays the Variation Fill and selects the Variation pattern.	Plays the Variation Fill.

Press these buttons now. Start with [TO VARIATION], next press [TO ORIGINAL].

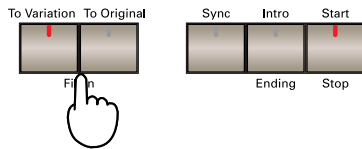

Think of a Fill as the moment in a song when the drummer is allowed to play a roll and the bassist and keyboard players vary their accompaniment by adding a few notes here and there.

Fill-Ins last one bar, but you can produce shorter fills by proceeding as follows: press [TO VARIATION] or [TO ORIGINAL] on the first through the penultimate beat of a bar (i.e. the 1st, 2nd or 3rd beat of a 4/4 bar, or the 1st or 2nd beat of a 3/4 bar) to start the fill right away. It will then last until the end of the current bar. If you press the [TO VARIATION] or [TO ORIGINAL] button on the last beat of the current bar, the fill will start on the following downbeat and last an entire bar.

*Note: Every time you stop a Music Style in One Touch Program ARRANGER mode, the KR-11 will select the Original pattern again.*

## 7.7 Easy fingering – Chord Intelligence

As stated before, the Arranger relies on the chords you play for choosing the key of the accompaniment. Playing chords isn't always easy, especially when you need to concentrate on your melody. That is why the KR-11 features a function called Chord Intelligence.

It is intelligent in that it allows you to play major chords by pressing just one key (the root note), while minor chords can be played with two keys, and complex chords with only three keys. Unlike other brands, Roland uses a musical system for simplifying chord fingering, so that once you understand the "intelligent" versions, you will have little trouble supplying the "missing" notes and playing full chords.

*Note: Chord Intelligence is normally set to "On," but you can turn it off. See "Auto: changing the Arranger defaults" on page 44.*

Here is how to play chords in Chord Intelligent and normal (without Chord Intelligence) modes. All examples are based on a "C" chord. For other chords, either count the distance of the indicated keys from the root note, or refer to "Chord Intelligence" at the end of this manual.

### Major chords:

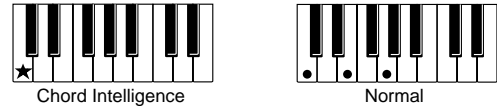

### Minor chords (m):

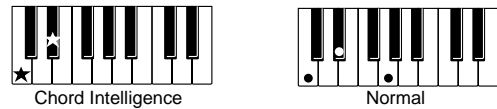

### Seventh chords (7):

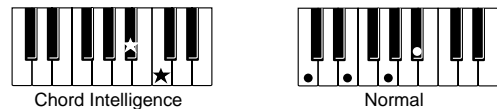

### Major Seventh chords (M7):

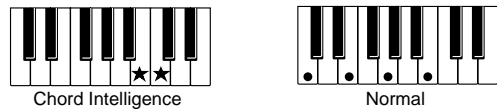

### Minor seventh chords (m7):

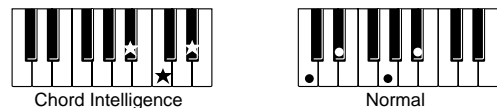

### Diminished (dim) chords:

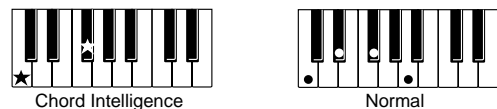

### Minor Major Seventh (mM7):

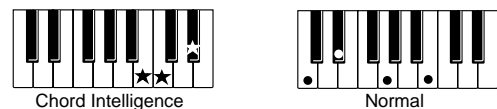

*Note: Even in Chord Intelligence mode, you can play chords the usual way. Sometimes, however, you may get a result that doesn't quite live up to your expectations. Furthermore, the name of the chord that appears on the display may not be the one you thought you were playing.*

## 7.8 Melody Intelligence

The Arranger of your KR-11 not only plays chords but also a counter-melody based on the chords you play in the chord recognition area. This counter-melody will be added to the Upper part.

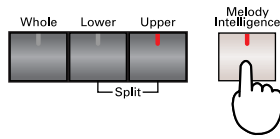

1. Press the [MELODY INTELLIGENCE] button to switch Melody Intelligence on (indicator lights) and off.

When you press the button and the indicator lights, harmony voices will be added to your melody. A screen like the one shown below will be displayed.

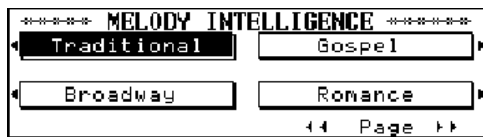

2. Use the buttons next to the display to select a Melody Intelligence type.

There are five pages you can select with <◀◀PAGE> and <PAGE▶▶>. Select the type you need for the song you want to play:

Duet	Broadway
Organ	Gospel
Combo	Romance
Strings	Latin
Choir	Country Guitar
Block	Country Ballad
BigBand	Waltz Organ
Country	Octave Type 1
Traditional	Octave Type 2

After several seconds, the previous screen will return to the display.

*Note: When "Full Auto" or "Tempo Lock" has been selected (see "Auto: changing the Arranger defaults"), the type of Melody Intelligence that is set may vary according to the Style.*

*Note: Please note that not all harmony voices will be played at all times, which is usually due to the fact that you are playing extremely high or low notes.*

# 8. Recording and Playback

## 8.1 Recording

### Normal recording

The KR-11 also features a “Composer” that functions like a digital tape recorder. You can record your own songs, as well as play songs using commercially available music data. Please be aware that the Composer records instructions (called *MIDI messages*) rather than sounds. That explains why you cannot record your singing.

You can store one song at a time. During recording, the data is automatically separated and recorded onto five separate tracks.

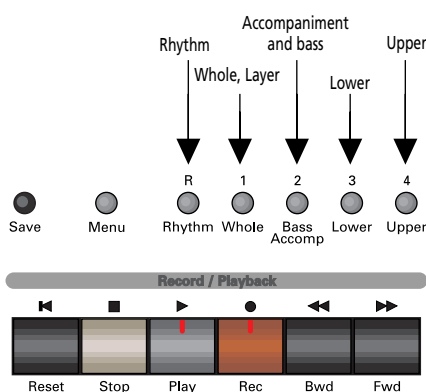

### What is a track?

On devices like tape recorders, sounds that are played back through the left and right speakers are recorded onto separate places on tape. These places are called “tracks”. As you see, your KR-11 provides five tracks in Normal mode, i.e. five places where MIDI messages can be recorded. The advantage of working with tracks is that you can re-record or change (edit) just one part while listening to the other tracks.

### Let's record something

#### 1. Press the [REC] button.

The Composer goes into standby mode. The [REC] indicator lights up, while the [PLAY] indicator flashes.

The tracks onto which the performance is recorded are selected automatically, and the track button's indicator will flash.

In Whole Keyboard mode, you can record onto any track except the Rhythm track. In that case, the track whose button is pressed last will be the recording track.

*Note: If a disk has been inserted into the disk drive, or after playing back a song on disk, you need to press the [SONG] button to bring up the Song Select screen. Select <U: User Song> and press the [REC] button.*

#### 2. Begin recording.

- When you are ready to record the melody of a song with Arranger backup, start Style playback (see “Starting a Music Style”), and recording begins.
- To record a piano or organ piece without accompaniment, press the [PLAY] button.

*Note: Remember that you can use the Rhythm section when playing a piano or organ piece. If that is what you want to do, see the preceding bullet.*

Two measures of count-in will sound, after which recording will begin. The [PLAY] indicator now lights.

#### 3. When the song is finished, press the [STOP] or [RESET] button.

The indicator for the track on which the performance was recorded will light.

*Note: Recording will also stop if you stop the Style (see above) by pressing either the [INTRO/ENDING] or the [START/STOP] button.*

*Note: It is also possible to keep the Composer from deactivating the Record Standby mode whenever you stop recording. See “Recording Mode” on page 36.*

*Note: If the internal memory of your KR-11 already contains a song, you will be unable to select songs from a disk. If that is what you want to do, first save your song to another disk (see page 34), then erase the song in the KR-11's internal memory (see “Erasing the Composer song” on page 33). Alternatively, press <OK> in response to the message “User Song will be erased. Are you sure?”*

*Note: Remember that there is only one DSP effect. That is why it is impossible to use different DSP types for different tracks.*

### Cautions

If, after recording, the power is turned off, the recorded performance will be erased. If you want to save performances you've recorded, please refer to “Saving a song to disk”.



## Recording Minus-One performances

Minus-One refers to a technique whereby a Standard MIDI File is used as backup, while you can mute the part you wish to play (usually the melody). Thanks to Minus-One, you can mute any part of a Standard MIDI File and play (and record) it yourself. If you just want to have fun with a Standard MIDI File without recording your performance, see “Track Mute: Muting specific tracks” on page 33.

1. Insert a music data disk into the disk drive.

2. Press the [SONG] button.

The Song Select screen will be displayed.

3. Select a song with the soft buttons surrounding the display. If necessary, use <◀◀PAGE> and <PAGE▶▶> to jump to another Song Select page.

4. Press the [REC] button (indicator lights).

Now select the track you wish to record your part to.

5. See below for the button to press.

As you know, the available parts are closely linked to the Keyboard modes. That is why you need to perform several actions to ensure that the right sound will be used for recording.

[Whole]— Press One Touch Program [PIANO].

[Lower], [Upper]— Press the [LOWER] button and select the Split mode.

[Rhythm]— Press the [Drums/SFX] button and select <Drum Set> or <SFX>.

*Note: You cannot record onto the [BASS/ACCOMP] track.*

*Note: If you select a part other than the ones shown above, nothing will be recorded on the corresponding track. Please be aware that Minus-One recording will erase all data on the selected track.*

6. Press the button of the track you want to record to (indicator flashes).

7. Press the [PLAY] button.

Two measures of count-in will sound, after which recording will begin.

8. Press the [STOP] or [RESET] button to stop recording.

The indicator of the track button you pressed now lights up to signal that the track contains data.

*Note: See also “Saving a song to disk” on page 34. Be aware, however, that due to copyright protection of the Standard MIDI File you used, it may not be possible to save a Minus-One song to disk.*

*Note: If you record in Whole mode, the Tone of the Lower and Upper parts you are playing may change. That is because a Standard MIDI File also contains so-called program change messages that tell your KR-11 which Tones to use.*

## Correcting minor mistakes

Let us now look at the advantages of working with tracks. If you don't like a particular line (the melody, say), you can correct it without re-recording the entire song. Here's how:

1. Press the [REC] button (indicator lights).

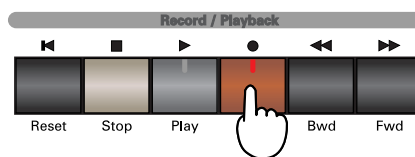

2. Press the button of the track you want to fix.

The track button's indicator and the [PLAY] indicator will flash.

3. Press the [PLAY] button.

Two measures of count-in will sound, after which recording will begin.

4. Play the correct (or desired) version of the part.

5. Press the [STOP] or [RESET] button when you're done.

### Notes about correcting mistakes

- If the re-recorded bit is shorter than the original track, all notes that lie beyond the point where you stopped recording will remain. To erase the entire track, see “Erase: removing data from a track or song” on page 40 and go back to step (1).
- There is no need to start at the beginning of the song. Use the [BWD] and [FWD] buttons to call up the measure where you want to start recording, and press the [REC] button. Press the [PLAY] button, and recording will begin after two measures of count-in.
- It is also possible to *add* (overdub) additional notes to a track without erasing what you have previously recorded. See “Recording Mode” on page 36 for details.



## 8.2 Playing back a Composer song

1. Press the [RESET] button to “rewind” to the beginning of the song.

By pressing [RESET], you will actually jump back to the first measure of the song, which is similar to using the SKIP function of a CD player.

2. Press the [PLAY] button.

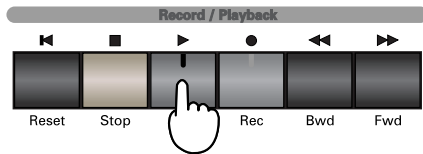

The recorded performance will begin to play. If there is a particular passage you want to listen to, select its measure by pressing [FWD] and then press [PLAY]. Likewise, you could rewind to a previous measure by pressing [BWD] and start playback.

3. Playback stops automatically when the song is finished.

To stop while the performance is running, press the [STOP] or the [RESET] button.

### Starting with a metronome count-in

By pressing the [PLAY] button while holding down the [STOP] button, you can have the song play back after two metronome count-in measures.

## 8.3 Track Mute: Muting specific tracks

It is also possible to temporarily switch off (mute) certain tracks. You can take advantage of this function when adding intricate (usually syncopated) parts to a complex accompaniment. Muting all distracting parts helps you concentrate on the task at hand.

You can also use the Track Mute function to switch off the part of a pre-recorded song you yourself would like to play (usually the melody). Playing to a Standard MIDI File or Composer song backing is called “Minus-One Play.” You can also record your Minus-One performance. Please refer to “Recording Minus-One performances” on page 32.

Press the button of the track you wish to mute (indicator goes off).

The track in question will no longer be played back. You can mute several tracks, if you like.

Press the track button once more to switch the track(s) on again.

## 8.4 Playing back songs without tempo changes

Some songs on music data disks contain tempo changes. When you use these kinds of songs for Minus-One play or recording, you may find it difficult to follow the tempo changes. Here is how to ignore these tempo changes.

While holding down the Composer [STOP] button, press either the Tempo [+] or [-] button.

The tempo value will be highlighted on the display.

*Note: If at this point you play back another song, or carry out the above step once again, the Composer will revert to the normal tempo and play back the song with tempo changes.*

## 8.5 Erasing the Composer song

Here is how to erase an entire song in the KR-11’s internal memory. Before doing so, you should save songs you wish to keep to disk (see below).

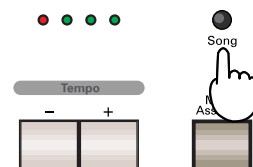

1. Press the [SONG] button.

A message will be displayed, asking you to confirm whether you want to erase the song if you have not yet saved the song to disk.

2. If you want to erase the data, press <OK>.

To cancel the operation without erasing the song, press <Cancel>.

After the song has been erased, the Song Select screen will be displayed.

3. Press <U: User Song> at the upper left of the display.

## 8.6 Saving a song to disk

The song in the Composer's memory is erased when the power is turned off. If you don't want to lose it, use the method described below.

The number of songs that can be saved onto a disk depends on the amount of performance data they contain, but the maximum number of songs you can save is 99.

*Note: New disks or disks which have been used on other equipment cannot be used just as they are. Please refer to "Formatting disks" on page 36.*

**1. Insert the disk you want to save your song to into the disk drive. Make sure the write protect tab is set to "Write".**

You can save onto the following disks:

- New disks formatted on the KR-11.
- Disks already containing KR-11, KR-3, KR-177, KR-777, KR-75, E-300, or E-500 songs.

**2. Press the Composer [SAVE] button.**

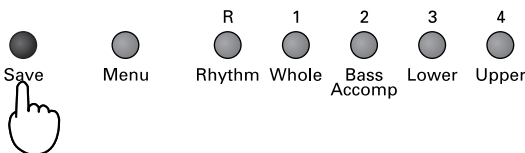

The display now jumps to the Song Save screen.

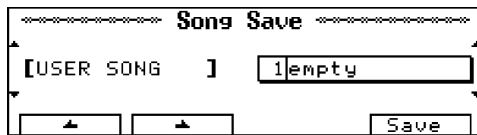

**3. Use the <▲> and <▼> buttons to the right of the display to select a song number.**

You can choose any number between "1" and "99".

Note, however, that selecting a song number that already contains data means that the song in question will be overwritten by the new song.

**4. Enter a name for your song with <◀> and <▶> below the display, and <▲> and <▼> to the left of the screen.**

The characters you can use to do this are listed below:

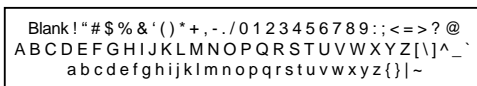

**5. Press <Save>.**

Press [EXIT] instead if you do not want to save the song after all.

# 9. Composer Menu

### Functions of the Composer Menu

**1. Press the Composer [MENU] button.**

The display now jumps to the Composer Menu.

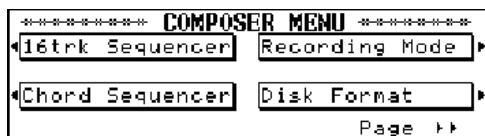

Choose one of the seven functions "on the menu".

**2. Use the buttons next to the display to select the function.**

The Composer Menu has two pages. Use the <◀◀PAGE> and <PAGE▶▶> buttons to bring up the other page.

To leave the menu, press the [EXIT] button. The display then returns to the previous screen.

### 9.1 16-track Sequencer

This sequencer allows you to record up to 16 different parts onto separate tracks using different Tones. You can take advantage of the sequencer to record your own songs with original arrangements.

*Note: See "Link to 16TRK Sequencer" on page 51 for a parameter you may want to set first.*

**1. On the Composer Menu, press <16trk Sequencer>.**

The display now jumps to a 16-Track Sequencer screen that looks similar to the following.

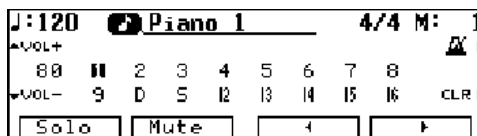

The [WHOLE] button also lights up to signal that the KR-11 will now function in Whole mode. The 16-track Sequencer uses only one Tone for each track, so you cannot record in Split or Layer modes.

**2. Use <◀> and <▶> to the lower right of the display to select the track you wish to record.**

The currently selected track appears in reverse video on the display.

*Note: Drum or SFX parts can only be recorded on the “D” or “S” tracks.*

**3. Get ready to play.**

Choose the Tone and make the necessary settings for the performance.

*Note: You can only assign Drum Sets to the “D” track, while the “S” track only triggers sound effects.*

Use <VOL+> and <VOL-> to the left of the display to set the volume level of each track.

*Note: To record the volume settings, press the [RESET] button while holding the [REC] button.*

**4. Press the [REC] button and then the [PLAY] button.**

Two bars are counted down, and after that recording starts.

**5. Press the [STOP] button to stop recording.**

A “□” appears next to the track that was recorded.

**6. Repeat steps 2, 3, 4, and 5 to record other parts.**

You can delete the data of a selected track by pressing <CLR>.

If you want to start recording halfway into the song, use the Composer [FWD] and [BWD] buttons to move to the desired measure.

**Muting or playing selected tracks**

<Mute>	Choosing a track and pressing <Mute> switches off playback of that track. A dotted “□” appears next to the muted track. Each press of <Mute> toggles between Mute on and off.
<Solo>	Choose a track and press <Solo> if you want to listen to a track without hearing the others. Each press of <Solo> toggles between Solo on and off.

*Note: There is only one DSP effect, so that you can only use one DSP Type for all 16 tracks. Use a DSP Type that can either be used for several tracks or restrict the use of the DSP effect to only one track.*

**Tracks vs. MIDI channels**

The relationship between tracks and MIDI channels is as follows:

Track	1	2	3	4	5	6	7	8	9	D	S	12	13	14	15	16
MIDI channel	1	2	3	4	5	6	7	8	9	10	11	12	13	14	15	16

*Note: When using 16-track Sequencer, the Composer’s five Track buttons do not function.*

*Note: Set the beat of the metronome before recording with the 16-track Sequencer. The Composer will use the metronome settings (time signature and tempo) in effect at the time you start recording the first track.*

## 9.2 Chord Sequencer

The Chord Sequencer allows you to “pre-program” the chord progression and Style divisions to be used by the Arranger. Doing so will allow you to concentrate on the melody because the Chord Sequencer will take care of feeding the Arranger with the correct chord information and selecting the desired Style division.

**1. Press <Chord Sequencer> on the Composer Menu page.**

A Chord Sequencer screen like the one below appears on the display.

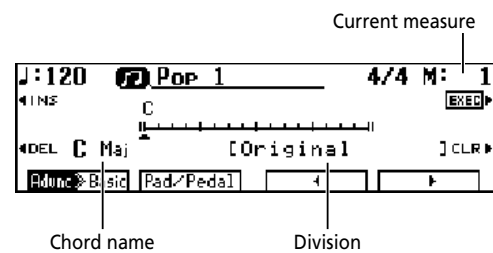

(For more information on divisions, see “Muting parts of a division” on page 38.)

**2. Use the MUSIC STYLE buttons to choose a Style group.**

After several seconds, the display returns to the Chord Sequencer screen.

**3. Use <INS> to insert the desired number of blank measures for the song you wish to input.**

**4. Use the <◀> and <▶> at the bottom right of the display or the [BWD] and [FWD] buttons to move the cursor (▲) to the position where the chord and division are to be input.**

**5. To enter a chord, play it in the lower half of the keyboard.**

The chord display serves as a guide for entering chords. If you have doubts about the correct way of playing a given chord, just look at what the display says.

**■ Here are the other things you can program:**

- Entering an **Intro** or **Ending**: press the [INTRO/ENDING] button.
- Changing the **Style Level**: press <Advnc▶Basic> (or <Advnc◀Basic>).
- Entering a **Fill-In**: press the desired Fill In button. (By assigning other functions to the PAD buttons or the left pedal, you can also use functions such as “Break.”)

You can also insert and delete measures by pressing <INS>, <DEL>, and <CLR> next to the display.

<INS>— Inserts a single blank measure at the position of the cursor.

<DEL>— Deletes a single measure after the position of the cursor, and shifts all subsequent bars to the left.

<CLR>— Deletes the information (chords and divisions) at the position of the cursor.

*Note: Activate the Leading Bass function if you wish to play complex chords, such as “Fm/C”. See “Performance Pad buttons: additional or frequently used functions” on page 46.*

**6. Press the Composer [PLAY] button to check your Chord Sequence.**

The accompaniment you've created is played, starting from the position of the cursor.

Press the Composer [STOP] button to stop playback.

**7. When you've finished inputting the accompaniment, press <EXEC> at the right-hand side of the display.**

After several seconds, the display returns to the Composer Menu screen.

**8. Press the Composer [PLAY] button.**

The accompaniment you've created is played, so try playing the melody along with the accompaniment as backup.

*Note: Once <EXEC> has been pressed, what you've input cannot be corrected. Always check whether everything has been entered correctly before you press <EXEC>.*

*Note: An Intro can only be input at the start of a song. Entering an Intro causes the number of measures corresponding to the Intro's length to be inserted automatically.*

### 9.3 Recording Mode

You can select the recording method and the way that recording stops.

**1. On the Composer Menu, press <Recording Mode>.**  
A screen like the one below appears on the display.

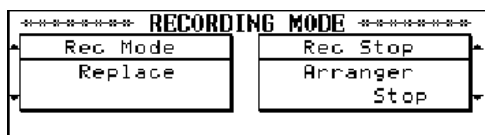

**2. Use the buttons on the left side of the display to select the recording method (Rec Mode), and the buttons on the right side of the display to select how recording ends (Rec Stop).**

**Recording method (Rec Mode)**

**Replace**— This is the usual recording mode. When recording to a track that already contains data, you overwrite the previous version up to the point where you stop recording. (This is also the case when you start recording without playing anything: the Composer will then record the equivalent number of rests.)

**Mix**— Allows you to add new notes to an existing recording without overwriting the previous version. This mode is ideal for programming the drums

because it allows you to start with the bass drum and snare drum and add the HiHat and cymbals the second time around.

*Note: If you choose Mix to add notes to a melodic part, be sure to switch on the Link function (see page 51). Otherwise, the track may suddenly use a different Tone.*

**Punch In/Out**— This mode allows you to use a footswitch (or a PAD button) to start and stop recording while listening to your song. Select this mode to correct minor mistakes. Press the pedal (or PAD button) again to cancel recording and returns to the playback state.

Punch-in recording can only be performed when “Punch In/Out” has been set as the footswitch (or the PAD button) function. To perform recording, be sure to set the pedal function before you start. See “Pedal functions” on page 47 and “Performance Pad buttons: additional or frequently used functions” on page 46.

*Note: Punch-in recording erases the previously recorded performance (same as Replace mode).*

**Stopping a recording (Rec Stop)**

**Arranger Stop**— Recording ends as soon as you stop the Arranger.

**Composer Stop**— Pressing the Composer [STOP] button ends recording. In this case, you can stop the Arranger and go on recording until you press the [STOP] button.

### 9.4 Formatting disks

In order to use new disks or disks which have been used on other equipment, it will be necessary to “format” such disks.

*Note: When a disk is formatted, all the data stored on it is completely erased. As a rule, you should always check the contents of a used disk (either on the KR-11 or on a PC) before formatting it.*

**1. Set the Write Protect tab on the disk to the “Write” position and insert the disk into the disk drive.**

**2. Press <Disk Format> on the Composer Menu screen.**

A screen like the one shown below will be displayed.



**3. If you really want to format the disk, press <OK>.**

When the formatting operation begins, a countdown will begin on the screen.

To cancel the operation, press <Cancel> shown on the screen, or the [EXIT] button.

*Note: Never remove a disk that is being formatted. Doing so may damage both the disk and the floppy drive.*

## 9.5 Style Composer

The KR-11 has a function called “Style Composer” that lets you compile new Music Styles from existing Style parts. You can take the bass part from the “Slow Waltz 1” Style, add the drums of the “Waltz” Style and use the melodic accompaniment from the “Vienna Waltz” Style. Music Styles you create with the Style Composer (or the Style Converter, see “Style Converter” on page 38) are called “User Styles”.

Every Music Style of the KR-11 is made up of five parts that are assigned to Arranger tracks (see below).

*Note: The User Style is deleted when the power is turned off. Do not forget to save it to disk (see “Saving User Styles” on page 39).*

### 1. On the Composer Menu screen, press <Style Composer>.

The rhythm part of the currently selected Music Style is played back, and a screen like the one below appears on the display.

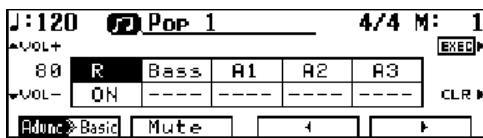

The part names are displayed at the center of the screen. The part that appears in reverse video is currently selected.

The Track buttons correspond to the parts as follows.

Arranger track	Display	Track button
Rhythm	R	[Rhythm]
Bass	Bass	[Bass/Accomp]
Accompaniment 1	A1	[Lower]
Accompaniment 2	A2	[Upper]
Accompaniment 3	A3	[Whole]

The tempo of a “composed” Style is determined by the tempo of the “R” track. You can change it, however, with the TEMPO [+]/[-] buttons.

*Note: You cannot use Arranger parts of a User Style because the KR-11 has only one User Style memory – the one you are copying Style parts to.*

### 2. Use the MUSIC STYLE buttons and the buttons next to the display to select the Style that contains the desired rhythm part.

Every time you select another Music Style, the rhythm that is played back changes. After several seconds, the display returns to the Style Composer screen.

### 3. After choosing the rhythm, use <◀> and <▶> at the lower right of the display to select another part. You can also choose a Part by pressing the Track buttons (see above). The selected part will be played along with the “R” and any other part you have already copied.

### 4. Repeat steps 2 and 3 to make the settings for the remaining parts.

You can use <VOL+> and <VOL-> to the left of the display to set the volume level for each track.

### 5. Press the <EXEC> button or the Composer [REC] button to confirm your settings.

The User Style is temporarily saved in the memory assigned to the [DISK/USER] button (indicator lights) and can be selected by pressing this button (see also “Using Style disks (User Styles)” on page 25).

You can also use the Composer [REC] button to end your programming session. To stop the operation, press the [Exit] button.

*Note: Press <Advnc▶Basic> (or <Advnc◀Basic>) at the lower left of the display to change the Style Level.*

*Note: Please note that Rhythm parts can only be assigned to “R”, while bass parts can only be assigned to “Bass”. The “A” parts, on the other hand can be freely assigned to memories A1~A3.*

As stated earlier, not all Music Styles use all available Arranger tracks (R, Bass, and A1~A3). If a given track is empty, select another one. Likewise, you don’t have to copy Style parts to all available Arranger tracks.

## Editing your User Style

See the chart (left) for the relationships between Track buttons and Arranger parts.

### 1. On the Composer Menu screen, press <Style Composer>.

The User Style is played back and the indicators of all Arranger tracks that contain data light.

### 2. Use <◀> and <▶> at the bottom of the display to select the part on screen that you wish to change. You can also select it by pressing the corresponding Track button (indicator must light).

Every time the Style is changed, the parts that are played back change.

### 3. Use the MUSIC STYLE buttons and the buttons next to the display to select the desired Style.

Every time the Style is changed, the parts that are played back change.

### 4. Use <◀> and <▶> at the bottom of the display to select another part.

### 5. If necessary, repeat steps 2, 3, and 4 until you’re happy with your User Style.

Press the <CLR> button to temporarily mute the selected Arranger part.

### 6. Press the <EXEC> button or the Composer [REC] button to confirm your settings.

### Muting parts of a division

See “What is an Arranger?” on page 24 for more information about Divisions. Here is a brief summary of the available divisions: Intro, Original, Variation, Fill In To Variation/To Original, Ending.

The KR-11 allows you to silence (mute) selected parts of a Style division.

You could, for example, mute the Accompaniment 1 part of a Variation pattern. Here's how:

**1. On the Composer Menu screen, press <Style Composer>.**

The User Style is played back and the Track buttons of all active Arranger tracks light up.

**2. Press the Fill In [TO VARIATION] button.**

Some divisions are not played back continuously (Intro, Ending or Fill-in), so carry out the next step while the Arranger plays it back.

**3. Use <◀> and <▶> at the bottom of the display to choose “A1”, then press <Mute>.**

(You can also select another part and then press <Mute>.)

Accompaniment 1 is muted, and the Track [UPPER] indicator goes out. To switch the A1 part back on again, press <Mute> once more.

Another way of muting an Arranger part is to hold down Composer [FWD] button and press the Track button assigned to the part you wish to mute. In this case, each press of the Track button toggles between playback (indicator lights) and muting (indicator off) of the Part.

**4. Press the <EXEC> button or the Composer [REC] button to confirm your settings.**

## 9.6 Style Converter

You can also program User Styles by using short phrases of a song recorded with the 16-track Sequencer (see page 34).

**1. Use the 16-track Sequencer to record a performance of “Major”, “Minor”, or “Seventh” types.**

Because only certain tracks can be converted to Style data, you should record the performance on the following tracks.

Track	Arranger Part
2	Bass
7	Accomp1
8	Accomp2
9	Accomp3
D	Rhythm

If you want to create a “professional” Style, don't forget to program the Intro, Fill-ins, and Ending as you record.

*Note: You want to brush up your song data before converting them into a User Style. See “Song Edit” below for details.*

**2. On the Composer Menu screen, press <Style Converter>.**

A screen like the one below appears on the display.

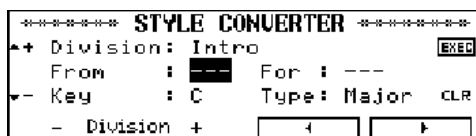

**3. For each division, select the bars to be used, the key, the chord type, and other settings.**

Use <◀> and <▶> at the bottom of the display to select the items to be set, and use the buttons on the left to change the settings.

Press <CLR> to disable a setting.

Division:	Accompaniment pattern.
From:	Starting measure of the excerpt.
For:	Number of bars from the starting measure.
Key:	Key of the excerpt.
Chord:	Chord type of the excerpt (select Major, Minor, or Seventh.)

**4. Press the Composer [PLAY] button to listen to the isolated passage.**

**5. After you've checked all the divisions that you want to make settings for, press <EXEC>.**

The Style is saved to the [DISK/USER] button.

*Note: For information on divisions, see page 24.*

*Note: Only certain tracks can be handled as Style data. If the performance has been recorded with the Composer, or if the song data is not on the specified tracks, use Track Exchange on the Edit screen to change the tracks. See page 41.*

*Note: If either “Fill to Variation” or “Fill to Original” has been chosen for “Division”, only one measure can be cut.*

*Note: Preset selections are used for divisions that are not selected.*

*Note: Be careful to remove all data types except the following from your song before converting it to a User Style: Performance information from the keyboard (notes and pedal information), Reverb Depth, Chorus Depth.*

*Note: Once <EXEC> has been pressed, the previous settings cannot be recovered.*

## 9.7 Saving User Styles

You can save User Styles onto floppy disks. You can call up Styles that have been saved to disk in the same way you do with Style disks.

1. Insert a formatted disk into the disk drive.
2. Press the [DISK/USER] button.

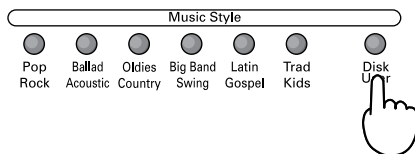

The Song Select Screen will be displayed.

3. Press <Save>.
4. Select a number with the <▲> and <▼> buttons to the left of the screen.

You can choose any number between “1” and “99”. Do note, however, that selecting a User Style number that already contains data means that the Style in question will be overwritten by your new User Style.

5. Enter a name for the User Style with <◀> and <▶> below the display and the <▲> and <▼> buttons to the left of the screen.

Please refer to page 34 for the list of the available characters.

6. Press <Save>.

*Note: If you want to cancel the operation, press the [EXIT] button.*

## 9.8 Song Edit

The KR-11 has eight functions that you can use to edit the songs you have recorded.

*Note: After carrying out one of the following functions, it may be impossible to restore the previous settings. Also, songs recorded with Arranger backup may sometimes yield surprising results. We recommend that you save your song to disk before editing it.*

### Steps for editing

1. On the Composer Menu screen, press <Song Edit>. An Edit Menu screen like the one below appears on the display.

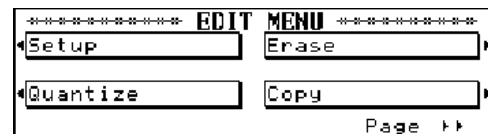

2. Use the buttons next to the display to choose the editing function.

The Edit screen has two pages. Use <◀◀PAGE> and <PAGE▶▶> to bring up the other page.

1. Changing the Tempo and Volume of a song – Setup.
2. Aligning imperfect Notes – Quantize
3. Erasing notes or tracks – Erase
4. Duplicating phrases – Copy
5. Deleting measures – Delete
6. Inserting blank measures – Insert
7. Changing the key – Transpose
8. Swapping and copying tracks – Track Exchange/ Track Copy

*Note: To cancel an operation, press the [EXIT] button.*

You can also edit a song on a floppy disk: Insert the disk in the disk drive and play back the performance one time. Then edit it.

### Setup: tempo and volume

Changes in tempo and volume that are made with the TEMPO and Part Volume buttons are only temporary. If you like your new settings better than the original ones, here is how to correct your song:

Before selecting the Song Edit screen, set the tempo by pressing the TEMPO buttons, and set the volume of the tracks you want to change on the 16-track Sequencer screen.

1. Press <Setup> on the Edit screen.

A screen like the one shown below will appear.

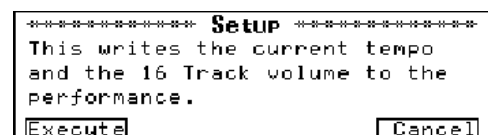

**2. Press <Execute>.**

The new tempo and volume values are stored.

*Note: You can also change the setting by holding down [REC] and pressing the [RESET] button.*

**Quantize: timing corrections**

Quantize is a function that corrects minor timing problems. It shifts notes whose timing are not exactly on the beat to the nearest beat.

Be careful, though, because the timing of the quantized notes may be mathematically correct, while the result may not be what you expected. Always select a resolution value that is fine enough to accept all note values you play. If the shortest notes of your accompaniment are 1/16th note triplets, set the Resolution value to 1/16t.

**1. Press <Quantize>.**

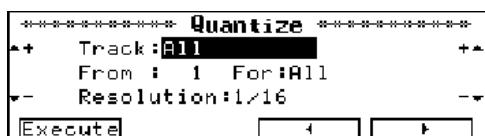

**2. Use <◀> and <▶> below the display to select a parameter, and set the value with <+> and <->.**

**Track**— Track number (you can also select “All” tracks)

**From**— The starting measure

**For** — The number of bars from the starting measure (you can also select “All” measures).

**Resolution**— Note value to be used for correcting the timing. (Select the length of the shortest note of the data to be quantized.)

**3. Press the <EXEC> button to confirm your settings and edit the data.**

**Erase: removing data from a track or song**

Erase is a function that erases a portion of the selected song, without removing the measures themselves. That will leave you with the equivalent number of blank measures. You could then record new data in those measures using the Punch In/Out recording method (see page 36).

*Note: The notes you erase cannot be restored.*

**1. Press <Erase>.**

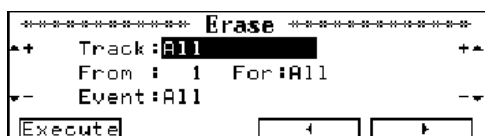

**2. Use <◀> and <▶> below the display to select a parameter, and set the value with <+> and <->.**

“Track”, “From”, “For”: see step (2) under “Quantize: timing corrections”.

*Event* refers to the types of data that will be erased:

- *All*: all data
- *Note*: the notes you played on the keyboard.
- *Except Note*: all data except the notes (e.g. footswitch, Pitch Bend, and Modulation data).
- *Tempo*: all tempo settings (changes) except the preset tempo. “Tempo” erases all tempo data, regardless of the Track numbers that have been selected.

**3. Press the <EXEC> button to confirm your settings and edit the data.**

**Copy(ing) measures**

This copies a portion of a track to another bar of the same track. Use this function if you’d rather not play the chorus or verse of a song more than once.

*Note: All data present at the copy destination is overwritten by what is copied.*

**1. Press <Copy>.**

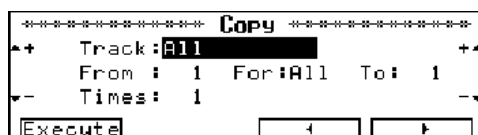

**2. Use <◀> and <▶> below the display to select a parameter, and set the value with <+> and <->.**

“Track”, “From”, “For”: see step (2) under “Quantize: timing corrections”.

**To** — The copy destination measure (“End” refers to the end of the song).

**Times**— The number of times the selected measures are to be copied.

**3. Press the <EXEC> button to confirm your settings and edit the data.**

**Delete: removing measures**

Though similar to *Erase*, the Delete function also removes the selected measures. You cannot select the data type to be deleted because Delete removes everything.

Delete means “remove all measures within the specified range” (for example bars 1 and 2 of a track, so that bar 3 becomes bar 1).

*Note: Once a measure has been deleted, it cannot be restored.*

**1. Press <Delete>.**

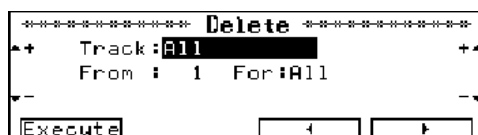

**2. Use <◀> and <▶> below the display to select a parameter, and set the value with <+> and <->.**

“Track”, “From”, “For”: see step (2) under “Quantize: timing corrections”.



3. Press the <EXEC> button to confirm your settings and edit the data.

### Insert: adding blank measures

Insert allows you to make a track longer by adding rests at the specified position. This will make room for new data and shift data that lie behind the From position further to the right. New data can be added using the Punch In/Out method (see page 36) or by copying excerpts.

*Note: The Insert function does not provide a To pointer. Instead, you have to specify the length of the insert using the For value. “For 2” thus means “insert 2 bars”.*

1. Press <Insert>.

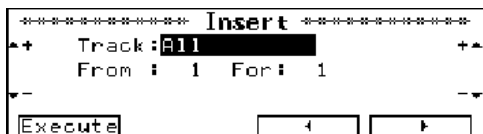

2. Use <◀> and <▶> below the display to select a parameter, and set the value with <+> and <->. “Track”, “From”: see step (2) under “Quantize: correcting the timing”.

**For**— The number of bars to insert.

3. Press the <EXEC> button to confirm your settings and edit the data.

### Transpose: changing the key

Transpose allows you to change the key of what has already been recorded. It can be invaluable for tricky phrases that you want to play only once.

1. Press <Transpose>.

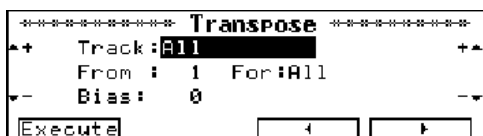

2. Use <◀> and <▶> below the display to select a parameter, and set the value with <+> and <->. “Track”, “From”, “For”: see step (2) under “Quantize: timing corrections”.

**Bias**— Amount of transposition. A value within the range of -24~+24 semitones (-2~+2 octaves) can be specified.

3. Press the <EXEC> button to confirm your settings and edit the data.

### Track Exchange/Track Copy: swapping and copying tracks

Here, you can choose to exchange the data from one track with that of another, or to copy data from one track to another (so that they both play the same from start to finish).

1. Press <Trk Exchng/Copy>.



2. Use <◀> and <▶> below the display to select a parameter, and set the value with <+> and <->.

**Mode**— *Track Exchange*: Swaps tracks

*Track Copy*: Copies a track

3. Press the <EXEC> button to confirm your settings and edit the data.

*Note: When copying a track, data existing at the copy destination is overwritten by what is copied.*

# 10. Function Menu

The Basic, Piano, and Organ screens provide access to several convenient functions you can take advantage of to optimize your KR-11's response.

## Operating procedure for the Function Menu

1. Press <Func...>.

The Function menu will appear on the screen.

2. Select a function with the buttons below the display.

3. Set the function with the buttons to the side of the display.

Simultaneously press <▲> and <▼> to revert to the default setting. The display automatically returns to the previous page after several seconds of inaction. If you can't wait to do something else, press the [EXIT] button.

If you want to cancel the operation, press the [EXIT] button before changing the settings.

## 10.1 Piano screen functions

### Metronome volume and beat

1. Press <Metronome>.

"Volume" (1~10) and "Beat" will be displayed.

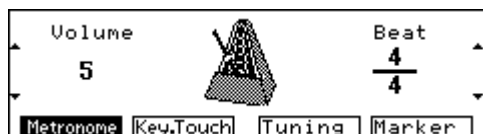

2. Adjust the volume and beat (time signature) with the buttons next to the display.

*Note: The volume is set to "5" when the power is turned on.*

The available Beat settings are: 0/4, 2/4, 3/4~7/4, 3/8, 6/8, 9/8, 12/8. The metronome always uses the time signature of the last Music Style you selected, so that you can set the Beat by selecting a Style with the appropriate time signature.

*Note: You cannot change the Beat in the Arranger mode or when you are using the Composer function.*

### Key Touch (velocity sensitivity)

You can adjust the way in which the KR-11 translates the velocity data.

1. Press <Key Touch>.

The touch level will appear in the right half of the screen. Refer to this scale when making settings as you play on the keyboard.

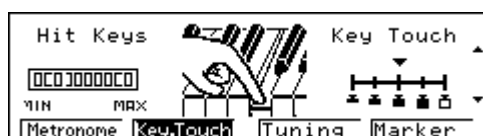

The velocity of the last note you played is displayed on the left-hand side of the screen. You can refer to this when setting the touch as you play the keyboard.

2. Move the arrow (▼) with the buttons to the right of the screen.

Each time you move the arrow, the touch level changes. The velocity sensitivity and the arrow correspond in the following way:

Super Light	Playing fortissimo doesn't require much strength.
Light	Little strength is required to play fortissimo.
Medium (Center)	Normal setting. Velocity sensitivity closest to that of an acoustic piano.
Heavy	Select this setting for maximum expressiveness: even small variations of the force with which you strike a key produce audible changes. The trade-off is that you have to strike the keys forcefully to achieve the maximum volume.
Fixed	This setting means that all notes are sounded with the same volume and timbre.

*Note: You can also change the velocity sensitivity using the Utility Menu (see page 48).*

### Tuning

You can select the tuning of the keyboard.

1. Press <Tuning>.

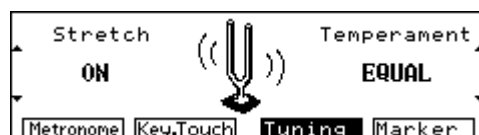

#### ■ Stretch Tuning

"Stretch Tuning" is a method of tuning unique to pianos. Compared with equal tuning, low notes are tuned slightly lower, while high notes are tuned slightly higher. At power on, this parameter is set to On.

2. Set the Stretch Tuning ON/OFF with the buttons to the left of the display.

**ON**— Like an acoustic piano, the low range is a little flat, and the upper range a little sharp.

**OFF**— The tuning of all notes has not been adjusted.

#### ■ Temperament

"Temperament" refers to alternative ways of tuning an instrument. Some of the options provided here allow you to play Baroque and Classical pieces with the tuning of those periods.

3. Set the tuning method with the buttons to the right of the display.

You can choose from the following seven types of tuning.

**EQUAL**— The most common kind of tuning today. In this tuning, an octave is divided into twelve equal steps.

**PYTHAGOREAN**— Uses the Pythagorean scale. The fourth and fifth intervals are kept from becoming ambiguous in this tuning.

**JUST (MAJOR)**— In this tuning, the third and fifth intervals are kept from becoming too ambiguous. Choose this setting for pieces in a major key.

**JUST (MINOR)**— With this tuning you can achieve the same effect as for Just Major, this time for pieces in a minor key.

**MEAN TONE**— A partial compromise of the Just (Major) tuning, to make transposition possible.

**WERCKMEISTER**— A combination of Mean Tone and Pythagorean tunings.

**KIRNBERGER**— An improvement of the Mean Tone and Just (Major) tunings, it is a tuning which allows greater freedom of transposition.

When performing with these alternative tunings, you need to specify the fundamental tone (the root for a major key, the sixth for minor) to match the key of the song you are performing.

When you are accompanying another instrument, please tune to the fundamental tones of that instrument.

#### 4. Set the Key note by pressing the key while holding down <Tuning>.

You need to do this for all temperaments except Equal.  
*Note: The temperament you select here applies to all KR-11 parts (the keyboard parts, the Arranger parts, and the Composer tracks/parts).*

### Marker function: repeatedly playing back the same section

The KR-11 also provides a Marker and loop function for you to practice difficult solos or to repeat a given song part.

Markers are placed at the beginning of measures.

#### 1. Press <Marker>.

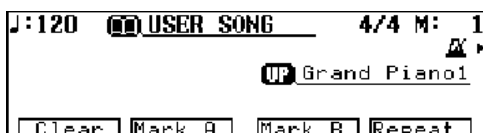

You can place markers at two locations in a song. When you put a marker in a song, playback will start from the beginning of the measure where the A marker is put.

By way of example, let's place a Marker at the beginning of measure 5.

#### 2. Go to the target measure by pressing the [FWD] and [BWD] buttons.

The measure number appears in the upper right of the screen. Select measure 5.

#### 3. Press <Mark A>.

<Mark A> changes to "A:5."

#### 4. Press the [PLAY] button.

Playback of the performance will begin at the beginning of measure 5.

#### 5. Press <A:5>.

The KR-11 will return to the beginning of the fifth measure, and begin playing back again.

You can press the <Mark A> button before, during, or after playback.

The KR-11 memorizes the next downbeat. In other words, if you press <Mark A> on the fourth beat of measure 4, for example, the beginning of measure 5 will be marked. A more precise approach would be to stop playback, fast forward or rewind to the desired measure and then press <Mark A>.

### ■ Repeated playback (Repeat)

Example: Repeating playback of measures 5- 8

#### 6. See steps (2) and (3) above.

#### 7. Go to the measure where you want the loop to end by pressing the [FWD] and [BWD] buttons.

The measure number appears in the upper right of the screen. Select measure 9.

#### 8. Press <Mark B>.

Here is what you have just programmed:

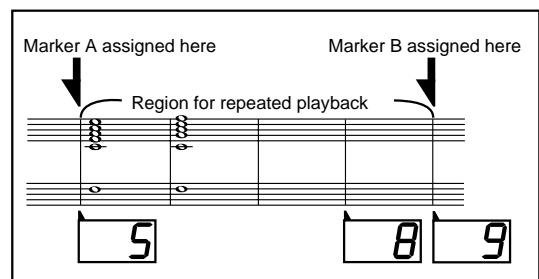

#### 9. Press <Repeat>.

The song will return to measure five, where Mark A is located.

#### 10. Press the [PLAY] button.

Measures 5~8 will play back repeatedly.

*Note: If you forgot to program <Mark B>, the song will repeat between <Mark A> and the end of the song.*

*Note: Likewise, if a song only has a <Mark B>, pressing <Repeat> will start a loop between the beginning of the song and <Mark B>.*

### ■ Erasing Marks

Hold down <Clear> and press either <A: (the measure number)> or <B: (the measure number)> to erase a marker.

## 10.2 Organ screen functions

For information on using markers, see above.

### Using the Arranger

By pressing the [START/STOP] or [INTRO/ENDING] button, you can start playback of the drum pattern of the selected Music or User Style. The Organ screen does, however, provide an Arranger function that allows you to use entire Music Styles (with bass and accompaniment lines). The split point can be set anywhere between the B1 and the B6.

1. Press <Arranger>.



2. Using the button to the side of the display, you can turn the Arranger function on and off.

At power on, this function will be set to Off.

### Lower Tone on/off and split point

You can switch the Lower Tone on and off and set the split point anywhere between the B1 and the B6.

1. Press <Split>.

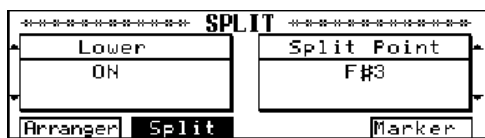

#### ■ Turning the Lower Tone on and off

Use the buttons to the left of the display to switch the Lower Tone on or off.

#### ■ Changing the Split point

Use the buttons to the right of the display to select the Split point.

Each time you press the button, the Split point will shift one key.

*Note: You can also set the split point by pressing the key where you want the keyboard to be split while holding down <Split>.*

## 10.3 Basic screen functions

*Note: See above for how to set the split point.*

*Note: See page 43 for information on using markers.*

### Auto: changing the Arranger defaults

Selecting a Music Style means that the KR-11 automatically loads its preset tempo, selects an Upper Tone that matches the mood of the Styles, and activates the Chord Intelligence function. Here is how to keep the KR-11 from loading some or all of these settings:

1. Press <Auto>.



2. Select what you are going to change with the buttons to the left of the display.

#### ■ One Touch Prg

**Full Aut**— By selecting a Music Style, you also recall its preset tempo, a suitable Upper Tone and a few other settings (see “Settings” on page 24).

**Tone Lock**— The KR-11 no longer selects an Upper Tone when you choose another Music Style.

**Tempo Lock**— The KR-11 no longer sets the preset tempo of the selected Music Style.

**Tone, Tempo Lock**— Selecting another Music Style no longer loads the preset tempo and Upper Tone.

**OFF**— In this mode, the KR-11 loads none of the settings related to the Music Style you select (see “Settings” on page 24).

*Note: Full Auto is switched on by default.*

#### ■ Chord Intelligence ON/OFF

3. Switch the Chord Intelligence function on/off with the buttons to the right of the display.

Chord Intelligence is set to be switched on by default. For more detailed information about Chord Intelligence, please refer to “Easy fingering – Chord Intelligence” on page 29.

### Chord Tone Setting

After stopping Style playback (or before starting the Arranger), you can play chords with your left hand that will sound the way you play them (without the automatic accompaniment). The Tone being used for sounding the chords is appropriately called “Chord Tone.” Along with the Chord Tone, the KR-11 will also play a bass note with (you guessed it!) the “Bass Tone”.

Ordinarily these Tones are preset, but they can be changed through the following procedure.

1. Press <Chord>.

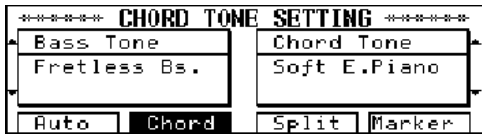

2. Select the Bass Tone using the buttons to the left of the display, and the Chord Tone with the buttons to the right of the display.

If you don't want the Bass Tone or Chord Tone to sound, select “OFF.”

*Note: Some Tones allow you to sustain the notes you play until you play other notes (Hold function), thus freeing up your left hand for other tasks between the changes.*

*Note: When the power is turned on, <Chord Tone> is set to “Soft E.Piano” and <Bass Tone> is set to “Fretless Bs”.*

*Note: See also “Volume of the Rhythm, Bass, Accomp, and Chord/Bass Tones” on page 27.*

## 11. Music Assistant, Pad buttons, pedals

### 11.1 Music Assistant: registering panel settings

The KR-11 is equipped with 32 Music Assistant memories that allow you to store almost all settings (or registrations) you make on the front panel. So far, we have only discussed the easy part of changing the preset settings. Later on, you will discover that you can also carry out a lot of in-depth programming. Those settings can also be saved to a Music Assistant memory.

1. Make the settings that you want to register.
2. Press the [Music Assistant] button.

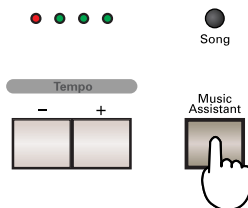

The display responds with:



3. While holding down <Write>, use the buttons to the side of the display to choose a memory number. After a few seconds, the display returns to the previous page.

*Note: You cannot store settings to the <Manual> memory.*

*Note: The KR-11 comes with a number of Music Assistant settings you can use as starting points for your own settings. Feel free to overwrite them when you run out of internal Music Assistant memories. Otherwise save your own settings to disk.*

*Note: You can also name your settings (see below).*

#### Loading a Music Assistant memory

1. Press the [Music Assistant] button  
The Music Assistant screen (see above) is displayed.
2. Use the buttons to the side of the display to select a Music Assistant memory.

*Note: Choosing <Manual> changes the panel settings to the ones in effect before the settings were recalled.*

*Note: You can also decide when the settings relating to the Arranger are loaded. See “Music Assistant Arranger Update” on page 51.*

#### Naming (or renaming) a Music Assistant memory

Here is how to name or rename a Music Assistant memory:

1. On the Music Assistant screen, hold down the [Music Assistant] button and select a memory.

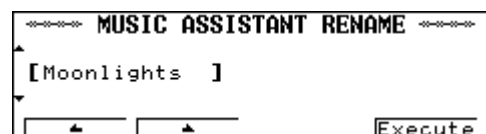

2. Use <◀> and <▶> below the display and <▲> and <▼> to the left of the display to enter the name. See page 34 for a list of available characters.

3. Press <Execute>.

### Saving Music Assistant settings to disk

You can store up to 32 Music Assistant settings, including Manual settings, on the KR-11. These 32 settings make up one set, and up to 99 sets can be saved on a disk.

Music Assistant settings can only be saved on a disk that has been formatted by the KR-11. If you're using a new disk, first format it (see page 36), then carry out the following steps.

1. Set the Write Protect tab on the disk to the "Write" position and insert the disk into the disk drive.
2. Press the [Music Assistant] button. The Music Assistant screen is displayed.
3. Press <Disk...>.

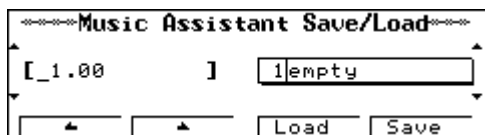

4. Use <▲> and <▼> to the right of the display to select a number.

You can choose any number between "1" and "99". Note that selecting a number that already contains data means that the set in question (i.e. 32 Music Assistant settings) will be overwritten by your new set.

5. Use <◀> and <▶> below the display and <▲> and <▼> to the left of the display to enter a name. See page 34 for a list of available characters.

6. Press <Save> at the bottom right of the display. *Note: To cancel without saving the Set, press the [EXIT] button.*

### Loading a Music Assistant set from disk

1. Insert the floppy disk that contains the desired Music Assistant file into the disk drive.
2. Press the [Music Assistant] button. The Music Assistant screen is displayed.
3. Press <Disk...>.
4. Use <▲> and <▼> to the right of the display to choose the set.
5. Press <Load> at the bottom right of the display. *Note: Please bear in mind that loading a set means that all 32 internal Music Assistant memories will be overwritten. You may want to save them to disk first (see above). Note: To stop the operation, press the [EXIT] button.*

## 11.2 Performance Pad buttons: additional or frequently used functions

You can assign a wide variety of performance-related functions to the two Performance Pad buttons on the panel. After a function has been assigned, it can be called up by pressing the corresponding Pad button.

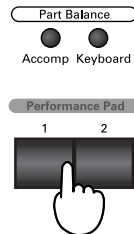

1. On the Basic screen, press <Pad/Pedal>.

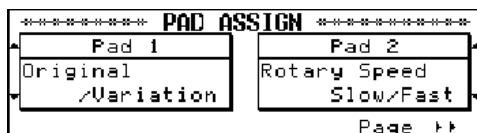

2. Use <▲> and <▼> next to the display to assign a function to "Pad 1" and "Pad 2".

Press [EXIT] if you've changed your mind about assigning one of the following functions to a Performance Pad button.

Here are the functions you can assign to the Performance Pad buttons:

**Leading Bass**— This switches the Leading Bass function on or off. During normal Style Play, the root of the chord played is used as the bass note, but when the Leading Bass function is used, the lowest note of the chord actually played is used as the bass note. This means that the bass note changes when an inverted chord is used.

*Note: If you assign this function to a footswitch, the Leading Bass function is "On" whenever the footswitch is depressed.*

**Break**— Break is a great function for Rock'n'Roll songs and ballads. Use it to halt the Arrangement either for the remainder of the current bar or for an entire bar (when pressed on the last beat of a bar). Usually, the melody or solo continues during such a silent (tacet) bar. This feature allows you to achieve the breaks in "Great Balls Of Fire", for example.

**Fill In To Variation.**— This has the same function as the [TO VARIATION] button.

**Fill In To Original.**— This has the same effect as the [TO ORIGINAL] button.

**Fill In**— This inserts a Fill-in, but the accompaniment pattern afterward does not change.

**Original/Variation**— This changes to Original or Variation without inserting a Fill-in.

**Basic/Advanced**— This has the same effect as pressing <Advnc◀Basic> or <Advnc▶Basic>.

**Simple Intro/Ending**— This function allows you to select the simple version of an Intro or Ending at the press of a button.

**Melody Intelligence**— This has the same effect as the [MELODY INTELLIGENCE] button.

**Arranger Intro/Ending**— This has the same effect as the [INTRO/ENDING] button.

**Arranger Start/Stop**— This has the same effect as the [START/STOP] button.

**Fade In/Out**— This function allows you to fade in (the volume gradually increases) when the Arranger is started, or to fade out (whereby the volume gradually decreases) at the end of your song.

**Chorus ON/OFF**— This switches the Chorus effect for the Whole or Upper Tones on or off.

**Rotary Speed Fast/Slow**— This changes the speed of the Rotary effect.

**DSP ON/OFF**— This switches the DSP effect on or off.

**Glide**— When the button assigned to this function is pressed, the pitch drops momentarily, then gradually rises to its original level. This is effective when used to play an instrument like the Hawaiian guitar.

**Composer Play/Stop**— This has the same effect as the Composer [PLAY] and [STOP] buttons.

**Metronome ON/OFF**— This switches the metronome on or off.

**Punch In/Out**— When you select this function, you can activate and deactivate the recording process during playback. See page 36 for details.

## 11.3 Pedal functions

You can also assign other functions to left pedal (Soft).

1. On the Basic screen, press <Pad/Pdl>.
2. Press <Page>.
3. Use <▲> and <▼> to the side of the display to select the functions of the SOFT footswitch.

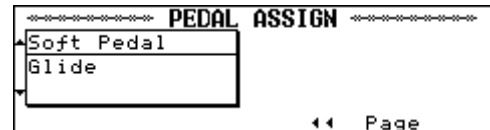

In addition to the following functions, all functions listed under “Pad buttons: additional or frequently used functions” can be assigned to either footswitch.

**Soft for Upper**— The footswitch acts as Soft pedal (affecting the Upper Part or the Whole Part).

**Sostenuto for Upper**— The pedal acts as Sostenuto pedal (affecting the Upper Part or the Whole Part).

**Damper for Lower**— The footswitch acts as separate Damper pedal for the Lower part.

**Bend Up**— Select this function if you want to use the left pedal to shift the pitch of the notes you are playing upward. The interval (range) can be set using the Pitch Bend Range parameter (see page 49). To shift a “C” to the “G” note above the C, set Pitch Bend Range to “7” and select “Bend Up”. “Bend Up” is probably what you will use most of the time.

**Bend Down**— Select this function if you want to use the left pedal to shift the pitch of the notes you are playing downward. The interval (range) can be set using the Pitch Bend Range parameter. To shift a “C” to the “G” note below the C, set Pitch Bend Range to “5” and select “Bend Down”.

After a few seconds, the display returns to the previous screen.

*Note: When you press the One Touch Program [PIANO] button, the pedals once again assume their normal functions (Soft and Sustain).*

# 12. Utility Menu

## 12.1 Operating procedure

1. Press the [UTILITY] button.

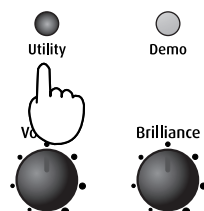

The Utility Menu screen appears. You can now select the function you wish to set.

2. Use <◀◀PAGE> and <PAGE▶▶> to jump to another Utility page.

The Utility Menu is made up of 14 pages.

3. Use the buttons to the side and below the display to make the settings for each of the functions.

To return to the settings in effect when the power was first turned on, simultaneously press <▲> and <▼>.

The display automatically returns to the original screen after a few seconds. You can also return to the original screen by pressing the [EXIT] button.

*Note: If you want to cancel the operation, press the [EXIT] button before changing any settings.*

## 12.2 Utility functions

### Master Tune

Master Tune allows you to tune your KR-11 to acoustic instruments that cannot be tuned. Like all electronic musical instruments, your KR-11 is set to A4=440Hz, which may be flat for certain acoustic instruments. Please note that the KR-11 will revert to A4=440Hz whenever you switch it on.

1. On the Utility Menu screen, press <◀◀PAGE> or <PAGE▶▶> to select the following display page:



2. Use the buttons to the left and right of the display to set the standard pitch (415.3~466.2Hz).

*Note: This setting affects all sounds, including songs played back from a disk.*

### Key Touch/Key Transpose

1. On the Utility Menu screen, press <◀◀PAGE> or <PAGE▶▶> to select the following display page.

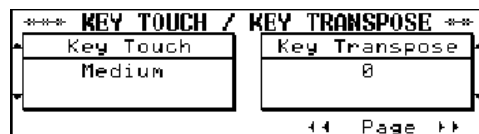

#### ■ Key Touch (velocity sensitivity)

Except for the fact that there are five options here, this function does the same as “Key Touch (velocity sensitivity)” on page 42.

2. Use the buttons on the left of the display to set the Key Touch.

For “Light”, “Medium”, and “Heavy”, see page 42.

**Super Light**— Playing fortissimo doesn’t require much strength.

**Fixed**— This setting means that all notes are sounded with the same volume and timbre.

#### ■ Transpose

If you are used to playing a song in a particular key, the Transpose function will allow you to keep playing in that key while sounding in another one. Doing so will allow you to accommodate the singer or musician you play with or to play to a Standard MIDI File backing that was recorded in a key other than the one you normally choose.

This function has the same effect as using the TRANSPOSE buttons, only here you see the value you set.

3. Use the buttons to the right of the display to select the amount of transposition.

Your setting (–12~0~12) appears on the display. The key changes in semitone steps.

**Example:** When you select “2”.

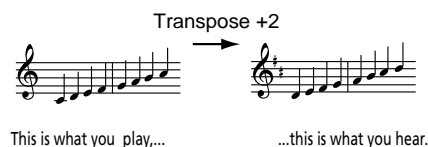

*Note: Key Transpose affects the entire keyboard and also the chords sent to the Arranger.*

*Note: You can also set the desired transposition interval with the TRANSPOSE [+ ] and [– ] buttons. Press these buttons simultaneously to return to normal pitch (no transposition).*



### Metronome Volume and Beat

1. On the Utility Menu screen, press <◀◀PAGE> or <PAGE▶▶> to select the following display page:

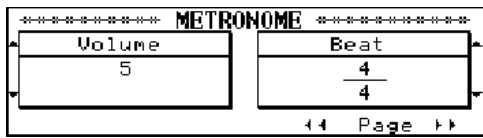

2. Use the buttons to the left and right of the display to set the desired values.

For Volume, a higher value produces a louder sound.

*Note: Whenever you press a MUSIC STYLE button, the Beat value (time signature) is automatically set to match the time signature of the Music Style.*

*Note: Beat cannot be changed during Style playback or when using the Composer.*

### Selecting a different Reverb and/or Chorus effect

As stated earlier, the KR-11 provides several types of Reverb and Chorus effects. Choose the one that matches the mood of the song you wish to play.

1. On the Utility Menu screen, press <◀◀PAGE> or <PAGE▶▶> to select the following display page:

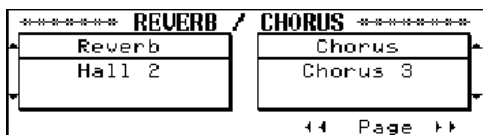

2. Use the buttons to the left of the display to choose the Reverb type, and the buttons to the right to choose the Chorus type.

#### ■ Reverb Types

**Room 1**— Reverberation of a conference room

**Room 2**— Reverberation of a small live-stage house

**Room 3**— Reverberation with a feeling of spaciousness

**Hall 1**— Reverberation of a large concert hall

**Hall 2**— Reverberation of a small concert hall

**Plate**— Bright, metallic reverberations

**Delay**— A sound that is repeated like an echo

**Panning Delay**— A delay sound that moves back and forth between the left and right speakers

#### ■ Chorus Types

**Chorus 1**— A light chorus with slow undulations

**Chorus 2**— A light chorus with rapid undulations

**Chorus 3**— A strong chorus with slow undulations

**Chorus 4**— A deep chorus with rapid undulations

**Feedback Cho.**— A soft sound with an effect like a flanger

**Flanger**— An effect that reminds you of a jet taking off and landing (ideal for guitar sounds).

**Short Delay**— A delay with a short delay time

**Short Dly (FB)**— A short delay with many repetitions

*Note: The type you select here is applied to all Tones (including the Arranger and the Composer).*

### Expansion Tone

See “Selecting Expansion Tones” on page 20.

### Lyric: switching off the display of lyrics

When using the KR-11 to play music data containing Lyrics, the lyrics are shown on the display. You can switch off this display of the lyrics.

1. On the Utility Menu screen, press <◀◀PAGE> or <PAGE▶▶> to select the following display page:



2. Use the buttons to the left and right of the display to select On or Off.

Now press any button on the front panel to hide the lyrics that are already being displayed. Press [PLAY] if you want a Karaoke performance.

### Pitch Bend Range

This sets the maximum amount of change (range) that controls how much the pitch changes when you press the Soft pedal. This only works when you assign the “Bend Up” or “Bend Down” function to the left pedal (see page 47).

1. On the Utility Menu screen, press <◀◀PAGE> or <PAGE▶▶> to select the following display page:

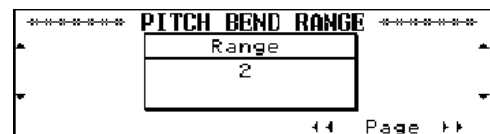

2. Use the buttons to the left and right of the display to set the value.

The value can be set to any number from 0 to 12 (in semitone steps, for a maximum of one octave).

**Program Change (and Bank Select)**

“Program changes” are MIDI messages that tell the receiving instrument to select another sound (or Tone) and also contain information about which Tone to select. There may be situations where you would like to double the Upper part melody with a sound of an external instrument that is not automatically selected.

Enter the Program Change function. It allows you to transmit sound select messages without choosing Tones on the KR-11 itself.

(\*) The term *sound select message* describes MIDI message clusters consisting of one or two bank select messages and a program change message.

1. On the Utility Menu screen, press <◀◀PAGE> or <PAGE▶▶> to select the following display page:



2. Use the <◀> and <▶> buttons at the lower left of the display to select the message type.
3. Use <▲> and <▼> to the left and right of the display to set the value.

Display	MIDI message	Value
CC 00	Bank Select MSB	0-127
CC 20	Bank Select LSB	0-127
PC	Program Change	1-128

Please note that each press of a <▲> or <▼> button will cause the KR-11 to transmit the value you set. Always set the numbers in the same order as they appear on the display: start with CC00, then set CC20, and finally set a PC value.

*Note: Most instruments do not understand CC20 messages, so feel free to skip that one.*

*Note: Sound select messages transmitted on the Program Change page are not executed by the KR-11.*

**MIDI: TX MIDI Ch./Local Control**

1. On the Utility Menu screen, press <◀◀PAGE> or <PAGE▶▶> to select the following display page:



**■ TX MIDI Channel**

TX MIDI Ch refers to the MIDI channel used for transmitting messages from the KR-11 to external instruments (TX is short for transmit). If the external instrument is set to receive on (RX) MIDI channel 3, select “3” here. Otherwise, the external instrument will neither play nor select sounds, etc.

2. Use the buttons to the left of the display to choose the MIDI transmit channel.

That channel number (1~16) appears on the display. *Note: MIDI messages sent from the external MIDI instrument to the KR-11 are received on all channels. However, all keyboard information (of the Upper, Layer, Lower, Chord, and Bass Tones) will be transmitted on one channel. Note: Composer and Music Style data are not transmitted.*

**■ Local Control**

Local Control is a switch between the keyboard of your KR-11 and its tone generator. This switch is usually set to On so that you hear the notes you play. When working with an external sequencer, you may have to select Off to avoid that every note is being sounded twice (once by yourself and again by the sequencer).

Local Control has no effect on what is being transmitted to the MIDI OUT connector.

After setting Local Control to Off, do not forget to set the sequencer’s Soft Thru parameter to On. That way, the messages can be transmitted from the sequencer’s MIDI OUT connector to the KR-11’s MIDI IN connector (use a MIDI cable to establish this connection).

3. Use the buttons on the right of the display to switch Local Control on or off.

### Music Assistant Arranger Update

You can also set when the Arranger's settings will change after you have selected another Music Assistant memory (see page 45).

1. On the Utility Menu screen, press <◀◀PAGE> or <PAGE▶▶> to select the following display page:



2. Use the buttons to the left and right of the display to select an option.

**Instant**— Arranger-related settings are called up as soon as the memory is selected.

**Delayed**— Arranger-related settings are only recalled if you hold down the soft button assigned to the desired Music Assistant memory.

*Note: All other programmable settings will be selected immediately.*

### Memory Backup

Some settings return to their initial values when the power is switched off. The Memory Backup function makes it possible to save such settings so that they don't revert to their initial values.

The following settings can be saved:

- Basic screen and Demo screen language
- Stretch Tuning, Temperament
- Octave Shift
- Types and depth of DSP effects for each Tone
- Chorus effect on/off status for each Tone

1. On the Utility Menu screen, press <◀◀PAGE> or <PAGE▶▶> to select the following display page:

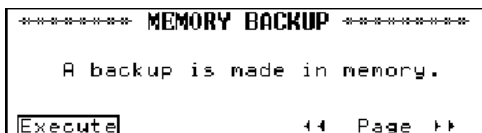

2. Press <Execute>.

3. Press <OK>.

*Note: To stop the operation, press <Cancel>.*

*Note: Do not turn the instrument off until the display shows "Backup complete".*

### Factory Preset (initialization)

This returns all settings stored in the KR-11 to their initial values when shipped from the factory.

*Note: The Music Assistant memories also return to their initial settings, so be sure to save them to disk first.*

1. On the Utility Menu screen, press <◀◀PAGE> or <PAGE▶▶> to select the following display page:

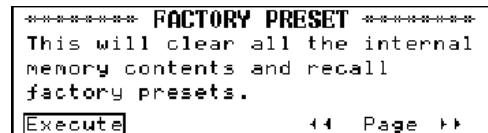

2. Press <Execute>.

3. Press <OK>.

All settings are returned to their initial values.

*Note: To cancel the operation without initializing the KR-11, press <Cancel>.*

*Note: Do not turn the instrument off until the display shows "Reset complete".*

### Link to 16TRK Sequencer

Link is a function you may need when working with the 16-track Sequencer. It allows you to establish a connection between the selected Composer track (in 16-track Sequencer mode) and the keyboard, so that the keyboard triggers the same Tone as the one assigned to the track.

Normally, such as when taking advantage of the Minus-One facility, it is wiser to set Link to Off. Doing so means that you can select whichever Tone you like for the part you play. If Link is set to On, the keyboard uses the Tone assigned to the track you select, thereby overruling your own selection.

1. On the Utility Menu screen, press <◀◀PAGE> or <PAGE▶▶> to select the following display page:

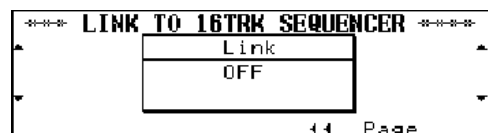

2. Use the buttons to the left and right of the display to switch Link on or off.

# 13. Connecting MIDI instruments

MIDI is a language that translates every action relating to music into binary digits that can be transferred via a MIDI cable. It is a universal standard, which means that musical data can be sent to and received by instruments of different types and manufacturers. MIDI allows you to connect your KR-11 to a computer or hardware sequencer.

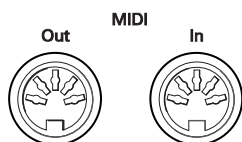

MIDI messages are transmitted and received using three connectors and special MIDI cables:

- MIDI IN: This connector receives messages from other MIDI devices.
- MIDI OUT: This connector transmits MIDI messages generated on your KR-11
- MIDI THRU: This connector “echoes back” all MIDI messages received via MIDI IN. The KR-11 does not provide a MIDI THRU connector.

Here is how to connect the KR-11 to an external sound module, sequencer, etc. When working with an external sequencer, be sure to establish both connections and to set Local Control (see page 50) to Off.

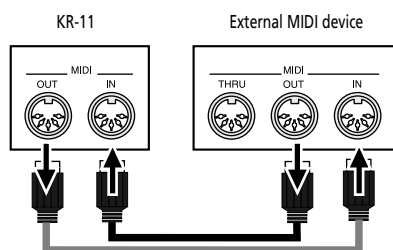

*Note: You don't always need two MIDI cables. Just look at the arrows in the above illustration for deciding which ports you need to connect the cables to.*

## ■ Caution

The KR-11 only transmits “realtime” MIDI data. Thus, only the notes you play on the keyboard as well as the Pitch Bend, Modulation, and pedal data are transmitted (but not the Arranger or Composer data). If you want to use the data of a Music Style (notes and sound select messages) on your computer, you can record them (see page 31), save them to disk, and then import them into your sequencer (software) as Standard MIDI File.

The KR-11 does not receive SysEx messages when the Composer is being used.

# 14. Appendix

## 14.1 DSP effects

1. Overdrive: Distorts the sound a little
2. Distortion: Distorts the sound a lot
3. Phaser: Gives a swelling sound
4. Enhancer: Makes the sound seem brighter and louder
5. Auto Wah: Changes the timbre in cycles
6. Compressor: Limits the dynamic range by reducing higher volumes
7. Gate Reverb: A reverb that ends abruptly
8. Rotary: Modulation effect of a rotating speaker
9. Hexa Chorus: Lends thickness and breadth to the sound
10. Tremolo Chorus: Thick tremolo effect
11. Stereo Chorus: A stereo chorus
12. Stereo Flanger: Adds metallic reverberations to the sound
13. Step Flanger: A flanger with stepwise changes in pitch
14. Stereo Delay: Adds a delay to the stereo sound
15. Modulation Delay: A delay that adds undulations to the delayed sound
16. Triple Tap Delay: A three-way delay
17. Quadruple Tap Delay: A four-way delay
18. 2-Voice Pitch Shifter: Adds two pitch-shifted notes to the original sound
19. Feedback Pitch Shifter: Adds a single pitch-shifted note the original sound
20. Overdrive → Chorus: Overdrive that is processed by a chorus
21. Overdrive → Flanger: Overdrive that is processed by a flanger
22. Overdrive → Delay: Overdrive that is processed by a delay
23. Distortion → Chorus: Distortion that is processed by a chorus
24. Distortion → Flanger: Distortion that is processed by a flanger
25. Distortion → Delay: Distortion that is processed by a delay
26. Enhancer → Chorus: Enhancer that is processed by a chorus
27. Enhancer → Flanger: Enhancer that is processed by flanger
28. Enhancer → Delay: Enhancer that is processed by a delay
29. Chorus → Delay: Chorus that is processed by a delay
30. Flanger → Delay: Flanger that is processed by a delay
31. Chorus → Flanger: Chorus that is processed by a flanger.
32. Sympathetic Resonance: A resonance effect that is produced every time you press the Damper pedal.

## 14.2 Specifications

### Keyboard

88 weighted keys

### Keyboard modes

Whole, Split, Layer, Split Arranger, Piano Style Arranger, Manual Drum/SFX

### Velocity sensitivity

Super Light, Light, Medium, Heavy, Fixed

### Maximum polyphony

64 voices

### Tones

6 Groups, 124 Variations  
(Tone Expansion Mode: 270 variations)

### Music Styles

Internal: 136 Styles, Disk: 81 Styles  
Expandable using (MSA) Music Style disks.

### Manual Drum/SFX Sets

Drum Set: 8/SFX Set: 1

### Programmable Music Styles

Yes

### Effects

Reverb (8 types), Chorus (8 types), DSP (32 types)

### Melody Intelligence

18 types

### Music Assistant

Internal: 32 memories, Disk: Max. 99 sets

### Composer

Tracks: 16 (Easy Mode: 5 tracks), Song: 1  
Note Storage: ±30,000 notes, Tempo: ♩ = 20~250  
Resolution: 120 ticks per quarter note  
Recording methods: Realtime, Step (in Chord Sequencer Mode)  
Playback: Standard MIDI File (Format 0/1), KR Songs  
Save: Standard MIDI File (Format 0)  
Edit: Setup, Copy, Quantize, Erase, Delete, Insert, Transpose,  
Track exchange, Track Copy

### Disk drive/data storage

3.5 inch micro floppy disk drive  
Disk Format: 720K bytes (2DD), 1.44M bytes (2HD)  
Songs: Max. 99  
Note Storage: ± 120,000 notes (2DD), ± 240,000 notes (2HD)

### Lyrics

Yes

### Languages

4 languages (English, German, French, Japanese)

### Display

AGD (Animated Graphic Display) 240 x 64 dots, graphic LCD, backlight

### Rated Output Power

40W x 2

### Power Supply

117/230/230VE/240VA, power cable (supplied)

### Speakers

Speakers 16 cm (x2), 5 cm (x2)

### Dimensions

Lid closed: 1,400 (W) x 940 (D) x 920 (H) mm  
Lid open: 1,587 (W) x 940 (D) x 920 (H) mm

### Options

MSA Music Style Disks, SMF Music Data  
Headphones (RH25/50)  
LVC-1 Lyrics to Video Converter

### Weight (including stand)

105kg

### Accessories

Owner's Manual, Music Style Disks (2), Demo Disk (1)  
Stand, AC power cable

*Note: In the interest of product improvement, the specifications and/or appearance of this instrument are subject to change without prior notice.*

# Tones, Drum Sets, Music Styles

## Normal Tones

### Piano

Grand Piano1 (Soft)  
Grand Piano2 (Bright)  
E.Piano 1  
Soft E.Piano  
Vibraphone  
E.Piano 2  
Honky-Tonk1  
MIDI Piano2  
Marimba  
60's E.Piano  
Steel Drums  
Hard E.Piano  
Upright Piano  
Rock Piano  
Honky-Tonk2  
MIDI Piano1  
Celesta  
Xylophone  
Glockenspiel  
Music Box  
Clav .  
Harpsichord 1  
Harpsichord 2  
Tubular-bell  
Santur  
Kalimba  
Balafon  
Vibra Bells

### Organ

Jazz Organ1  
Jazz Organ2  
Full Organ1  
Full Organ2  
Lower Organ1  
Lower Organ2  
Church Organ  
Organ Flute  
Theater Organ  
Trem. Flute  
Rock Organ 1  
Rock Organ 2  
Jazz Organ 3  
Jazz Organ 4  
Full Organ 3  
Full Organ 4  
Pop Organ  
VS Organ  
Accordion  
Harmonica

### Guitar/Bass

Nylon Guitar  
Gut Guitar  
Steel Guitar  
Jazz Guitar  
12-str Guitar  
Mandolin  
Hawaiian Guitar  
JC E. Guitar  
Acoustic Bs.  
Acoustic Bs. + Cymbal  
Fingered Bs.  
Picked Bs.  
Banjo  
Muted Guitar  
Overdrive Guitar  
Distortion Guitar  
Power Guitar  
Rock Rhythm  
Shamisen  
Koto  
Fretless Bs.  
Slap Bass 1  
Organ Bass  
Synth Bass 101

### Strings

Slow Strings  
Strings  
Violin  
Cello  
Harp  
Orchestra  
Syn Strings  
Warm Pad

### Sax/Brass

Blow Sax  
Soprano Sax  
Trumpet  
Trombone  
Alt Sax  
Clarinet  
Muted Trumpet  
Brass 1  
Oboe  
Flute  
French Horn  
Synth Brass 1  
Bassoon  
Blow Pipe  
French Horn Solo  
Synth Brass 2

### Voice

Choir  
Voice Oohs  
Pop Voice  
Syn Vox  
Fantasia  
Brightness  
Harpvox  
Orchestra Hit  
Pizzicato  
Poly Synth  
CC Solo  
Whistle  
Saw Wave  
Saw  
Doctor Solo  
Syn. Calliope  
Charang  
Bass & Lead  
Pan Flute  
Shakuhachi  
Square Wave  
Ocarina  
Metal Pad  
Sweep Pad  
Sound Track  
Atmosphere  
Crystal  
Sitar

## Internal Music Styles

### Pop/Rock

- 1 8B Pop2
- 2 Stevie
- 3 Sh Rock
- 4 Techno
- 5 16B Pop1
- 6 Dance
- 7 8B Pop3
- 8 8B Pop4
- 9 16B Pop4
- 10 Swingin
- 11 BluesBros
- 12 Blues
- 13 TR808 Ballad
- 14 '70s 8-Beat
- 15 16-Beat Pop1
- 16 16B Pop3
- 17 Swing Pop
- 18 16BeatPop
- 19 House
- 20 Rock1
- 21 Rock2
- 22 Rock3
- 23 Pop1

### Ballad/Acoustic

- 1 Ballad1
- 2 MediumBallad
- 3 G Bossa
- 4 P Ballad
- 5 Love Songs
- 6 PianoBallad
- 7 G Pop
- 8 P Jazz
- 9 12/8 Ballad
- 10 Ballad 1
- 11 P Night
- 12 G Slow
- 13 16BtBallad1
- 14 16BtBallad2
- 15 G FstPop
- 16 Classic 1
- 17 PianoBallad2
- 18 PianoBallad3
- 19 60's Ballad
- 20 Stride Piano
- 21 Piano Boogie
- 22 PianoBallad4

### Oldies/Country

- 1 50's
- 2 Slow Dance
- 3 Easy Country
- 4 New Country
- 5 50's Dance
- 6 Rock'n Time
- 7 Country Rock
- 8 C&W Ballad
- 9 Dreamin'
- 10 Early Rock
- 11 Cntry Ballad
- 12 Hoedown.
- 13 Rock'n'Night
- 14 Rock'n Roll2
- 15 Cntry Swing
- 16 TwoStep
- 17 Mersey Beat
- 18 Beach Sound
- 19 Bluegrass
- 20 Cntry Waltzl
- 21 Rock'n Cntry
- 22 Summer Days
- 23 Train Beat
- 24 Tejano
- 25 Twistin
- 26 Twist
- 27 Country Pick'n
- 28 Country
- 29 Sl Rock2

### Big Band/Swing

- 1 Jazz Z Band
- 2 SatrdayNight
- 3 Sw Combo
- 4 Small Combo
- 5 Big Serenade
- 6 BigBnd Bld 2
- 7 Organ Swing
- 8 FstSwing
- 9 Fast BigBand
- 10 BigBnd Swing
- 11 Sl Swing
- 12 Club Piano
- 13 Jazz Band
- 14 Big Band
- 15 Vocal Swing
- 16 Medium Swing
- 17 Boogie
- 18 Boogie Band
- 19 BigBand Pop
- 20 Slow Shuffle
- 21 Shuffle
- 22 BrtSwing

### Latin/Gospel

- 1 Smooth Bossa
- 2 Lets Salsa
- 3 Gospel Choir
- 4 Gospel
- 5 Sweet Rhumba
- 6 Jo Bossa
- 7 Chapel
- 8 PDoble
- 9 Bossa Nova 1
- 10 Cha Cha Cha
- 11 Dance Samba
- 12 Reggae
- 13 ArgenTango
- 14 TradMerengue
- 15 Brassy Mambo
- 16 Orch Beguine

### Trad./Kids

- 1 Foxing
- 2 Broadway
- 3 Kids1
- 4 Kids3
- 5 Hawaiian
- 6 Dixieland
- 7 Kids2
- 8 Kids 6/8
- 9 Foxtrot
- 10 Charleston
- 11 Kids Waltz
- 12 Kids 4/4
- 13 Euro Polka
- 14 Polka
- 15 Sl Waltz
- 16 SlJazz Waltz
- 17 March 6/8
- 18 March 4/4
- 19 Musette
- 20 Fast Waltz
- 21 Jazz Waltz
- 22 March 2/4
- 23 Last Dance
- 24 Slow Waltz 1

### Drum Sets

PC#	1	9	17	25	26
CC32	64	64	0	0	0
Type	STANDARD	ROOM	POWER	ELECTRONIC	TR-808
25	Bar Chime	-----			
26	Finger Snap	-----			
27	High Q				
28	Slap				
29	Scratch Push [EXC7]				
30	Scratch Pull [EXC7]				
31	Sticks				
32	Square Click				
33	Metronome Click				
34	Metronome Bell				
35	Std Kick 2	Std Kick 1	Kick 2	Kick 2	Kick 2
C2 36	Std Kick 1	Room Kick	MONDO Kick	Elec BD	808 Bass Drum 1
37	Side Stick				808 Rim Shot
38	Std Snr 1	Room Snr 1	Gated SD	Elec SD	808 Snare Drum
39	Hand Clap				
40	Std Snr 2	Std Snr 1	Snare 2	Gated SD	Snare 2
41	Low Tom 2	Room Low Tom 2		Elec Low Tom 2	808 Low Tom 2
42	Closed Hi-hat 1 [EXC1]		Closed Hi-hat 2 [EXC1]	Closed Hi-hat 2 [EXC1]	808 CHH [EXC1]
43	Low Tom 1	Room Low Tom 1		Elec Low Tom 1	808 Low Tom 1
44	Pedal Hi-hat 1 [EXC1]		Pedal Hi-hat 2 [EXC1]	Pedal Hi-hat 2 [EXC1]	808 CHH [EXC1]
45	Mid Tom 2	Room Mid Tom 2		Elec Mid Tom 2	808 Mid Tom 2
46	Open Hi-hat 1 [EXC1]		Open Hi-hat 2 [EXC1]	Open Hi-hat 2 [EXC1]	808 OHH [EXC1]
47	Mid Tom 1	Room Mid Tom 1	Room Mid Tom 1	Elec Mid Tom 1	808 Mid Tom 1
C3 48	High Tom 2	Room Hi Tom 2	Room Hi Tom 2	Elec Hi Tom 2	808 Hi Tom 2
49	Crash Cymbal1				808 Cymbal
50	High Tom 1	Room Hi Tom 1	Room Hi Tom 1	Elec Hi Tom 1	808 Hi Tom 1
51	Ride Cymbal 1				
52	Chinese Cymbal			Reverse Cymbal	
53	Ride Bell				
54	Tambourine				
55	Splash Cymbal				
56	Cowbell				808 Cowbell
57	Crash Cymbal 2				
58	Vibra-slap				
59	Ride Cymbal 2				
C4 60	High Bongo				
61	Low Bongo				
62	Mute High Conga				808 High Conga
63	Open High Conga				808 Mid Conga
64	Low Conga				808 Low Conga
65	High Timbale				
66	Low Timbale				
67	High Agogo				
68	Low Agogo				
69	Cabasa				
70	Maracas				808 Maracas
71	Short Hi Whistle [EXC2]				
C5 72	Long Low Whistle [EXC2]				
73	Short Guiro [EXC3]				
74	Long Guiro [EXC3]				
75	Claves				808 Claves
76	High Wood Block				
77	Low Wood Block				
78	Mute Cuica [EXC4]				
79	Open Cuica [EXC4]				
80	Mute Triangle [EXC5]				
81	Open Triangle [EXC5]				
82	Shaker				
83	Jingle Bell				
C6 84	Bell Tree				
85	Castanets				
86	Mute Surdo [EXC6]				
87	Open Surdo [EXC6]				
88	-----	-----	-----	-----	-----



PC#	26	41	49
CC32	64	64	0
Type	DANCE	BRUSH	ORCHESTRA
	25		
26			
28			
29			
31	Dance Snr 1		
32			
33			
34			
35	Std Kick 1	Kick 2	Concert BD 2
C2 36	808 Bass Drum 2	Kick 1	Concert BD 1
37	808 Rim Shot		
38	TR-909 Snr	Brush Tap	Concert SD
40	Dance Snr 2	Brush Slap	Castanets
41	808 Low Tom 2	Brush Swirl	Concert SD
42	808 CHH [EXC1]	Brush Low Tom 2	Timpani F
43	808 Low Tom 1	Closed Hi-hat 2 [EXC1]	Timpani F#
44	808 CHH [EXC1]	Brush Low Tom 1	Timpani G
45	808 Mid Tom 2	Pedal Hi-hat 2 [EXC1]	Timpani G#
46	808 OHH [EXC1]	Brush Mid Tom 2	Timpani A
47	808 Mid Tom 1	Open Hi-hat 2 [EXC1]	Timpani A#
		Brush Mid Tom 1	Timpani B
C3 48	808 Hi Tom 2	Brush Hi Tom 2	Timpani c
49	808 Cymbal		Timpani c#
50	808 Hi Tom 1	Brush Hi Tom 1	Timpani d
51			Timpani d#
52			Timpani e
53			Timpani f
54			
55	808 Cowbell		
56			
57			Concert Cymbal 2
58			
59			Concert Cymbal 1
C4 60			
61	808 High Conga		
62	808 Mid Conga		
63	808 Low Conga		
64			
65			
66			
67			
68			
69	808 Maracas		
70			
71			
C5 72			
73	808 Claves		
74			
75			
76			
77			
78			
79			
80			
81			
82			
83			
C6 84			
85			
86			
87			
88	-----	-----	Applause













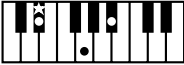









































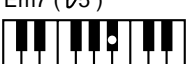









● SFX Set

PC#	57
CC32	0
Type	SFX
	39 High Q
40	Slap
41	Scratch Push [EXC7]
42	Scratch Pull [EXC7]
43	Sticks
44	Square Click
45	Metronome Click
46	Metronome Bell
47	Guitar sliding Finger
C3 48	Guitar cutting noise (down)
49	Guitar cutting noise (up)
50	String slap of double bass
51	Fl.Key Click
52	Laughing
53	Screaming
54	Punch
55	Heart Beat
56	Footsteps1
57	Footsteps2
58	Applause
59	Door Creaking
C4 60	Door
61	Scratch
62	Wind Chimes
63	Car-Engine
64	Car-Stop
65	Car-Pass
66	Car-Crash
67	Siren
68	Train
69	Jetplane
70	Helicopter
71	Starship
C5 72	Gun Shot
73	Machine Gun
74	Lasergun
75	Explosion
76	Dog
77	Horse-Gallop
78	Birds
79	Rain
80	Thunder
81	Wind
82	Seashore
83	Stream
C6 84	Bubble
85	Cat

PC# : Program Change Number  
 CC32 : Value of Control Change 32  
 \* Value of Control Change is set 0.

Blank : same percussion instruments  
 as the Standard Set  
 ----- : No sound  
 [EXC] : will not sound simultaneously  
 with other percussion instruments  
 of the same EXC number

## Chord Intelligence

C	C#	D	E $\flat$	E	F
					
CM7	C#M7	DM7	E $\flat$ M7	EM7	FM7
					
C7	C#7	D7	E $\flat$ 7	E7	F7
					
Cm	C#m	Dm	E $\flat$ m	Em	Fm
					
Cm7	C#m7	Dm7	E $\flat$ m7	Em7	Fm7
					
CmM7	C#mM7	DmM7	E $\flat$ mM7	EmM7	FmM7
					
Cdim	C#dim	Ddim	E $\flat$ dim	Edim	Fdim
					
Cm7 (b5)	C#m7 (b5)	Dm7 (b5)	E $\flat$ m7 (b5)	Em7 (b5)	Fm7 (b5)
					
Caug	C#aug	Daug	E $\flat$ aug	Eaug	Faug
					
Csus4	C#sus4	Dsus4	E $\flat$ sus4	Esus4	Fsus4
					
C7sus4	C#7sus4	D7sus4	E $\flat$ 7sus4	E7sus4	F7sus4
					

F#	G	A <sup>b</sup>	A	B <sup>b</sup>	B
F#M7	GM7	A <sup>b</sup> M7	AM7	B <sup>b</sup> M7	BM7
F#7	G7	A <sup>b</sup> 7	A7	B <sup>b</sup> 7	B7
F#m	Gm	A <sup>b</sup> m	Am	B <sup>b</sup> m	Bm
F#m7	Gm7	A <sup>b</sup> m7	Am7	B <sup>b</sup> m7	Bm7
F#mM7	GmM7	A <sup>b</sup> mM7	AmM7	B <sup>b</sup> mM7	BmM7
F#dim	Gdim	A <sup>b</sup> dim	Adim	B <sup>b</sup> dim	Bdim
F#m7 (b5)	Gm7 (b5)	A <sup>b</sup> m7 (b5)	Am7 (b5)	B <sup>b</sup> m7 (b5)	Bm7 (b5)
F#aug	Gaug	A <sup>b</sup> aug	Aaug	B <sup>b</sup> aug	Baug
F#sus4	Gsus4	A <sup>b</sup> sus4	Asus4	B <sup>b</sup> sus4	Bsus4
F#7sus4	G7sus4	A <sup>b</sup> 7sus4	A7sus4	B <sup>b</sup> 7sus4	B7sus4

### MIDI Implementation Chart

Function...	Transmitted	Recognized	Remarks	
Basic Channel : Default Changed	1 1 — 16	1 — 16 1 — 16		
Mode : Default Messages Altered	Mode 3 OMNI OFF, POLY *****	Mode 3 Mode 3, 4 (M = 1)	* 2	
Note Number : True Voice	0—127 *****	0 — 127 0 — 127		
Velocity : Note ON Note OFF	O X 8n v = 64	O X		
After Touch : Key's Ch's	X X	O O	* 1 * 1	
Pitch Bend	O	O	* 1	
Control Change	0, 32 O 1 X 5 X 6, 38 X 7 O 10 X 11 X 64 O 65 X 66 O 67 O 84 O 91 O 93 O 98, 99 X 100, 101 X	O O O O O O O O O O O O (Reverb) O (Chorus) O O	* 1 * 1 * 1 * 1 * 1 * 1 * 1 * 1 * 1 * 1 * 1 * 1 * 1 * 1 * 1 * 1	Bank Select Modulation Portamento time Data entry Volume Panpot Expression Hold 1 Portamento Sostenuto Soft Portamento control Effect 1 depth Effect 3 depth NRPN LSB, MSB RPN LSB, MSB
Prog Change : True #	0—127 *****	O 0 — 127	* 1 Program Number 1 — 128	
System Exclusive	O	O		
System Common : Song Pos : Song Sel : Tune	X X X	X X X		
System Real Time : Clock : Commands	X X	X X		
Aux Message : All Sounds OFF : Reset All Controllers : Local ON/OFF : All Notes OFF : Active Sensing : System Reset	X X X X O X	O (120, 126, 127) O O O (123 — 127) O X		
Notes	* 1 O X is selectable * 2 Recognize as M = 1 even if M ≠ 1			

Mode 1 : OMNI ON, POLY    Mode 2 : OMNI ON, MONO    O : Yes  
Mode 3 : OMNI OFF, POLY    Mode 4 : OMNI OFF, MONO    X : No

## Notes

**Notes**

## Distributors

### Information

When you need repair service, call your nearest Roland Service Center or authorized Roland distributor in your country as shown below.

#### AFRICA

##### EGYPT

**Al Fanny Trading Office**  
9, EBN Hagar A1 Askalany Street,  
ARD El Golf, Heliopolis,  
Cairo 11341, EGYPT  
TEL: 20-2-417-1828

##### REUNION

**Maison FO - YAM Marcel**  
25 Rue Jules Hermann,  
Chaudron - BP79 97 491  
Ste Clothilde Cedex,  
REUNION ISLAND  
TEL: (0262) 218-429

##### SOUTH AFRICA

**That Other Music Shop  
(PTY) Ltd.**  
11 Melle St., Braamfontein,  
Johannesburg, SOUTH AFRICA  
  
P.O.Box 32918, Braamfontein 2017  
Johannesburg, SOUTH AFRICA  
TEL: (011) 403 4105

**Paul Bothner (PTY) Ltd.**  
17 Werdmuller Centre,  
Main Road, Claremont 7708  
SOUTH AFRICA  
TEL: (08) 844-4068

P.O. BOX 23032, Claremont 7735,  
SOUTH AFRICA  
TEL: (021) 674 4030

#### ASIA

##### CHINA

**Beijing Xinghai Musical  
Instruments Co., Ltd.**  
6 Huangmichang Chao Yang  
District, Beijing, CHINA  
TEL: (010) 6774 7491

**Shanghai Xingtong Acoustics  
Equipment CO., Ltd.**  
5F, No.1500 Pingliang Road  
New East Club Plaza, Shanghai,  
CHINA  
TEL: (021) 5580-0800

##### HONG KONG

**Tom Lee Music Co., Ltd.  
Service Division**  
22-32 Pun Shan Street, Tsuen  
Wan, New Territories,  
HONG KONG  
TEL: 2415 0911

##### INDIA

**Rivera Digitec (India) Pvt. Ltd.**  
409, Nirman Kendra Mahalaxmi  
Flats Compound Off. Dr. Edwin  
Moses Road, Mumbai-400011,  
INDIA  
TEL: (022) 493 9051

##### INDONESIA

**PT Citra Inti Rama**  
Jl. Cideng Timur No. 15J-150  
Jakarta Pusat  
INDONESIA  
TEL: (021) 6324170

##### KOREA

**Cosmos Corporation**  
1461-9, Seocho-Dong,  
Seocho Ku, Seoul, KOREA  
TEL: (02) 3486-8855

##### MALAYSIA

**BENTLEY MUSIC SDN BHD**  
140 & 142, Jalan Bukit Bintang  
55100 Kuala Lumpur, MALAYSIA  
TEL: (03) 2144-3333

##### PHILIPPINES

**G.A. Yupangco & Co. Inc.**  
339 Gil J. Puyat Avenue  
Makati, Metro Manila 1200,  
PHILIPPINES  
TEL: (02) 899 9801

##### SINGAPORE

**Swee Lee Company**  
150 Sims Drive,  
SINGAPORE 387381  
TEL: 6846-3676

**CRISTOFORI MUSIC PTE  
LTD**  
Blk 3014, Bedok Industrial Park E,  
#02-2148, SINGAPORE 489980  
TEL: 6243-9555

##### TAIWAN

**ROLAND TAIWAN  
ENTERPRISE CO., LTD.**  
Room 5, 9fl. No. 112 Chung Shan  
N.Road Sec.2, Taipei, TAIWAN,  
R.O.C.  
TEL: (02) 2561 3339

##### THAILAND

**Theera Music Co., Ltd.**  
330 Verng NakornKasem, Soi 2,  
Bangkok 10100, THAILAND  
TEL: (02) 2248821

##### VIETNAM

**Saigon Music**  
138 Tran Quang Khai St.,  
District 1  
Ho Chi Minh City  
VIETNAM  
TEL: (08) 844-4068

#### AUSTRALIA/ NEW ZEALAND

##### AUSTRALIA

**Roland Corporation  
Australia Pty., Ltd.**  
38 Campbell Avenue  
Dee Why West, NSW 2099  
AUSTRALIA  
TEL: (02) 9982 8266

##### NEW ZEALAND

**Roland Corporation Ltd.**  
32 Shaddock Street, Mount Eden,  
Auckland, NEW ZEALAND  
TEL: (09) 3098 715

#### CENTRAL/LATIN AMERICA

##### ARGENTINA

**Instrumentos Musicales S.A.**  
Av. Santa Fe 2055  
(1123) Buenos Aires  
ARGENTINA  
TEL: (011) 4508-2700

##### BRAZIL

**Roland Brasil Ltda**  
Rua San Jose, 780 Sala B  
Parque Industrial San Jose  
Cofia - Sao Paulo - SP, BRAZIL  
TEL: (011) 4615 5666

##### COSTA RICA

**JUAN Bansbach  
Instrumentos Musicales**  
Ave.1, Calle 11, Apartado 10237,  
San Jose, COSTA RICA  
TEL: 258-0211

##### CHILE

**Comercial Fancy II S.A.**  
Rut.: 96.919.420-1  
Nataniel Cox #739, 4th Floor  
Santiago - Centro, CHILE  
TEL: (02) 688-9540

##### EL SALVADOR

**OMNI MUSIC**  
75 Avenida Norte y Final  
Alameda Juan Pablo II,  
Edificio No.4010 San Salvador,  
EL SALVADOR  
TEL: 262-0788

##### MEXICO

**Casa Veerkamp, s.a. de c.v.**  
Av. Toluca No. 323, Col. Olivar  
de los Padres 01780 Mexico D.F.  
MEXICO  
TEL: (55) 5668-6699

##### PANAMA

**SUPRO MUNDIAL, S.A.**  
Boulevard Andrews, Albrook,  
Panama City, REP. DE PANAMA  
TEL: 315-0101

##### PARAGUAY

**Distribuidora De  
Instrumentos Musicales**  
J.E. Olear y ESQ. Manduvira  
Asuncion PARAGUAY  
TEL: (021) 492-124

##### URUGUAY

**Todo Musica S.A.**  
Francisco Acuna de Figueroa 1771  
C.P.: 11.800  
Montevideo, URUGUAY  
TEL: (02) 924-2335

##### VENEZUELA

**Musiland Digital C.A.**  
Av. Francisco de Miranda,  
Centro Parque de Cristal, Nivel  
C2 Local 20 Caracas  
VENEZUELA  
TEL: (212) 285-8586

#### EUROPE

##### AUSTRIA

**Roland Austria GES.M.B.H.**  
Siemensstrasse 4, P.O. Box 74,  
A-6063 RUM, AUSTRIA  
TEL: (0512) 26 44 260

##### BELGIUM/HOLLAND/ LUXEMBOURG

**Roland Benelux N. V.**  
Houtstraat 3, B-2260, Oevel  
(Westerlo) BELGIUM  
TEL: (014) 575811

##### DENMARK

**Roland Scandinavia A/S**  
Nordhavnsvej 7, Postbox 880,  
DK-2100 Copenhagen  
DENMARK  
TEL: 3916 6200

##### FRANCE

**Roland France SA**  
4, Rue Paul Henri SPAAK,  
Parc de l'Esplanade, F77 462 St.  
Thibault, Lagny Cedex FRANCE  
TEL: 01 600 73 500

##### FINLAND

**Roland Scandinavia As,  
Filial Finland**  
Lautasaarentie 54 B  
Fin-00201 Helsinki, FINLAND  
TEL: (09) 68 24 020

##### GERMANY

**Roland Elektronische  
Musikinstrumente HmbH.**  
Oststrasse 96, 22844 Norderstedt,  
GERMANY  
TEL: (040) 52 60090

##### GREECE

**STOLLAS S.A.**  
Music Sound Light  
155, New National Road  
Patras 26442, GREECE  
TEL: (061) 043-5400

##### HUNGARY

**Roland East Europe Ltd.**  
Warehouse Area 'DEPO' Pf.83  
H-2046 Torokbalint, HUNGARY  
TEL: (23) 511011

##### IRELAND

**Roland Ireland**  
Audio House, Belmont Court,  
Donnybrook, Dublin 4,  
Republic of IRELAND  
TEL: (01) 2603501

##### ITALY

**Roland Italy S. p. A.**  
Viale delle Industrie 8,  
20020 Arese, Milano, ITALY  
TEL: (02) 937-78300

##### NORWAY

**Roland Scandinavia Avd.  
Kontor Norge**  
Lilleakerveien 2 Postboks 95  
Lilleaker N-0216 Oslo  
NORWAY  
TEL: 2273 0074

##### POLAND

**P. P. H. Brzostowicz**  
UL. Gibraltaraska 4,  
PL-03664 Warszawa POLAND  
TEL: (022) 679 44 19

##### PORTUGAL

**Tecnologias Musica e Audio,  
Roland Portugal, S.A.**  
Cais Das Pedras, 8/9-1 Dto  
4050-465 PORTO  
PORTUGAL  
TEL: (022) 608 00 60

##### ROMANIA

**FBS LINES**  
Piata Libertatii 1,  
RO-4200 Georghghi  
TEL: (095) 169-5043

##### RUSSIA

**MuTek**  
3-Bogatyrskaya Str. 1.k1  
107 564 Moscow, RUSSIA  
TEL: (095) 169 5043

##### SPAIN

**Roland Electronics  
de España, S. A.**  
Calle Bolivia 239, 08020  
Barcelona, SPAIN  
TEL: (93) 308 1000

##### SWEDEN

**Roland Scandinavia A/S  
SWEDISH SALES OFFICE**  
Danvik Center 28, 2 tr.  
S-131 30 Nacka SWEDEN  
TEL: (08) 702 00 20

##### SWITZERLAND

**Roland (Switzerland) AG  
Musitronic AG**  
Gerberstrasse 5, Postfach,  
CH-4410 Liestal, SWITZERLAND  
TEL: (061) 927-8383

##### UKRAINE

**TIC-TAC**  
Mira Str. 19/108  
P.O. Box 180  
295400 Munkachevo, UKRAINE  
TEL: (03131) 414-40

##### UNITED KINGDOM

**Roland (U.K.) Ltd.**  
Atlantic Close, Swansea  
Enterprise Park, SWANSEA  
SA7 9FJ,  
UNITED KINGDOM  
TEL: (01792) 700139

#### MIDDLE EAST

##### BAHRAIN

**Moon Stores**  
No.16, Bab Al Bahrain Avenue,  
P.O.Box 247, Manama 304,  
State of BAHRAIN  
TEL: 211 005

##### CYPRUS

**Radex Sound Equipment Ltd.**  
17, Diagorou Street, Nicosia,  
CYPRUS  
TEL: (02) 66-9426

##### IRAN

**MOCO, INC.**  
No.41 Nike St., Dr.Shariyati Ave.,  
Roberoye Cerah Mirdamad  
Tehran, IRAN  
TEL: (021) 285-4169

##### ISRAEL

**Halilit P. Greenspoon &  
Sons Ltd.**  
8 Retzif Ha'aliya Hashnaya St.  
Tel-Aviv-Yafo ISRAEL  
TEL: (03) 6823666

##### JORDAN

**AMMAN Trading Agency**  
245 Prince Mohammad St.,  
Amman 1118, JORDAN  
TEL: (06) 464-1200

##### KUWAIT

**Easa Husain Al-Yousifi**  
Abdullah Salem Street,  
Safat, KUWAIT  
TEL: 243-6399

##### LEBANON

**Chahine S.A.L.**  
Gerge Zeidan St., Chahine Bldg.,  
Achrafieh, P.O.Box: 16-5857  
Beirut, LEBANON  
TEL: (01) 20-1441

##### QATAR

**Al Emadi Co. (Badie Studio  
& Stores)**  
P.O. Box 62,  
Doha, QATAR  
TEL: 4423-554

##### SAUDI ARABIA

**aDawlah Universal  
Electronics APL**  
Corniche Road, Aldossary Bldg.,  
1st Floor, Alkhobar,  
SAUDI ARABIA  
  
P.O.Box 2154, Alkhobar 31952  
SAUDI ARABIA  
TEL: (03) 898 2081

##### SYRIA

**Technical Light & Sound  
Center**  
Khaled Ebn Al Walid St.  
Bldg. No. 47, P.O.BOX 13520,  
Damascus, SYRIA  
TEL: (011) 223-5384

##### TURKEY

**Barkat muzik aletleri ithalat  
ve ihracat Ltd Sti**  
Siraselvililer Caddesi Siraselvililer  
Pasaji No:74/20  
Taksim - Istanbul, TURKEY  
TEL: (0212) 2499324

##### U.A.E.

**Zak Electronics & Musical  
Instruments Co. L.L.C.**  
Zabeel Road, Al Sherooq Bldg.,  
No. 14, Grand Floor, Dubai, U.A.E.  
TEL: (04) 3360715

#### NORTH AMERICA

##### CANADA

**Roland Canada Music Ltd.  
(Head Office)**  
5480 Parkwood Way Richmond  
B. C., V6V 2M4 CANADA  
TEL: (604) 270 6626

**Roland Canada Music Ltd.  
(Toronto Office)**  
170 Admiral Boulevard  
Mississauga On L5T 2N6  
CANADA  
TEL: (905) 362 9707

##### U. S. A.

**Roland Corporation U.S.**  
5100 S. Eastern Avenue  
Los Angeles, CA 90040-2938,  
U. S. A.  
TEL: (323) 890 3700

As of October 16, 2002 (Roland)

---