

# Synth Plus 10

PROGRAMMABLE POLYPHONIC SYNTHESIZER HS-10

*Owner's Manual*

- The HS-10 is 49 key, 6 voice polyphonic, fully programmable synthesizer.
- The Liquid Crystal Display and the  $\alpha$  Dial serve to make the editing operation quicker and more accurate.
- The Tone Modify Function of the HS-10 allows you to edit the tone color easily to your taste.
- Provided with MIDI Connectors, the HS-10 can be set up with other MIDI devices.
- Dynamics or Aftertouch effect cannot be obtained by playing the HS-10, but using a foot control or relevant MIDI messages, those effects can be available.

Bescheinigung des Herstellers / Importeurs
Hiermit wird bescheinigt, daß der/die/das ROLAND POLYPHONIC SYNTHESIZER HS-10 <small>(Gerät, Typ, Bezeichnung)</small>
in Übereinstimmung mit den Bestimmungen der Amtsbl. Vfg 1046 / 1984 <small>(Anmeldeverordnung)</small>
funk-entstört ist. Der Deutschen Bundespost wurde das Inverkehrbringen dieses Gerätes angezeigt und die Berechtigung zur Überprüfung der Serie auf Einhaltung der Bestimmungen eingeräumt.
Roland Corporation Osaka / Japan <small>Name des Herstellers/Importeurs</small>

## CONTENTS

<b>1</b> PANEL DESCRIPTION .....	3	10. MIDI .....	31
<b>2</b> CONNECTION .....	5	a. Changing MIDI Function Data .....	32
<b>3</b> OPERATION .....	6	b. Writing MIDI Function Data .....	33
1. Power Up .....	6	c. $\alpha$ JUNO's Sound Range receivable and transmissible with MIDI .....	34
2. Tone Color Selection .....	7	d. Pedal Switch and Foot Control.....	34
3. Performance Control Functions .....	8	e. Program Change Messages .....	35
a. Pitch Bender/Modulation .....	8	11. Data Transfer .....	36
b. Portamento .....	8	a. Tape Interface .....	36
c. Octave Transpose .....	9	b. Data Transfer with MIDI .....	40
d. Chord Memory .....	9	<b>4</b> APPENDIX .....	42
e. Key Transpose .....	11	1. Parameter Table .....	42
f. Hold Pedal Jack .....	12	2. Error Message Table .....	45
g. Pedal Switch Jack .....	12	3. Memo .....	46
h. Foot Control Jack .....	12	<b>5</b> SPECIFICATIONS .....	47
4. Tone Modify .....	13		
5. Editing Performance Control Function .....	14		
a. How to edit the Performance Control Functions .....	14		
b. Writing the Performance Control Functions .....	16		
6. Edit .....	17		
7. Tone color parameters .....	18		
a. Synthesizer Structure .....	18		
b. Parameters .....	19		
8. Writing a Tone Color .....	29		
9. Naming the Tone Colors .....	30		

Please read the separate volume "MIDI", before reading this owner's manual.

Copyright © 1986 by ROLAND CORPORATION

All rights reserved. No part of this publication may be reproduced in any form without the written permission of ROLAND CORPORATION.

# 1 PANEL DESCRIPTION

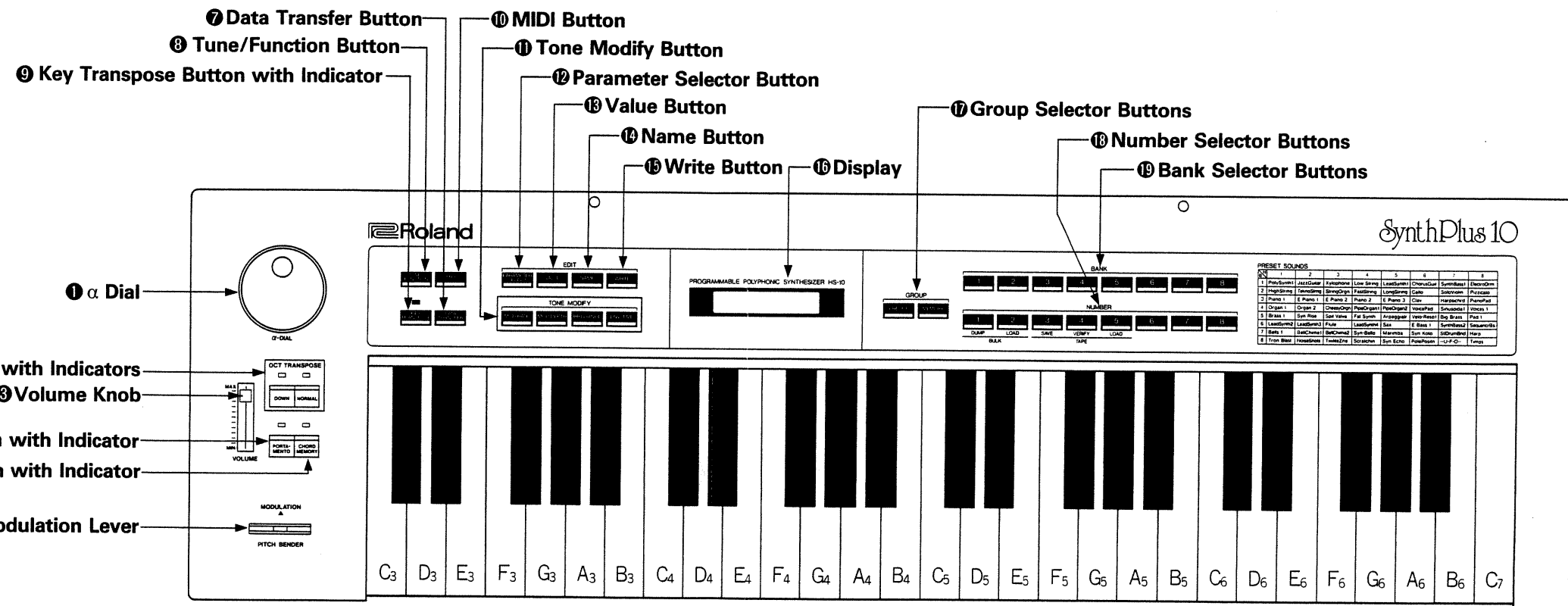
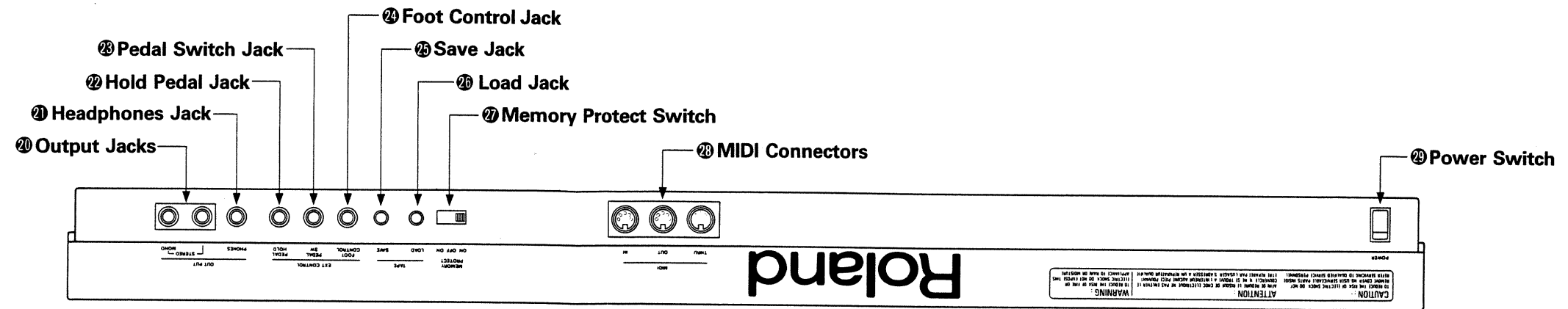

## IMPORTANT NOTES

### POWER

- The appropriate power supply for this unit is shown on its name plate. Please make sure that the line voltage in your country meets that.
- When setting up the HS-10 with an external amplifier, turn both of them off, plug the HS-10 in first, then the amplifier.
- This unit might not work properly when turned on immediately after turned off. If this happens, simply turn it off, and turn it on again after a few seconds.
- This unit might get hot while operating, but there is no need to worry about it.

### LOCATION

- Operating the HS-10 near a neon or fluorescent lamp may cause noise interference. If so, change the angle or position of the HS-10.
- Avoid using the HS-10 in excessive heat or humidity or where it may be affected by direct sunlight or dust.

### CLEANING

- Clean the unit with only soft cloth and mild detergent.
- Do not use solvents such as THINNER.

### OTHER NOTES

- The HS-10 is a 6 voice synthesizer, therefore if 6 keys are simultaneously pressed, no more key will sound.

- The HS-10's memory back-up system is fully supported by a battery. Normally, the battery replacement is required every five years, but the first replacement may be needed even before that depending how many months had passed before you bought it. Please ask for your local Roland dealer for replacement, when the Display responds with as shown below.

Check Battery!!



## 2 Connection

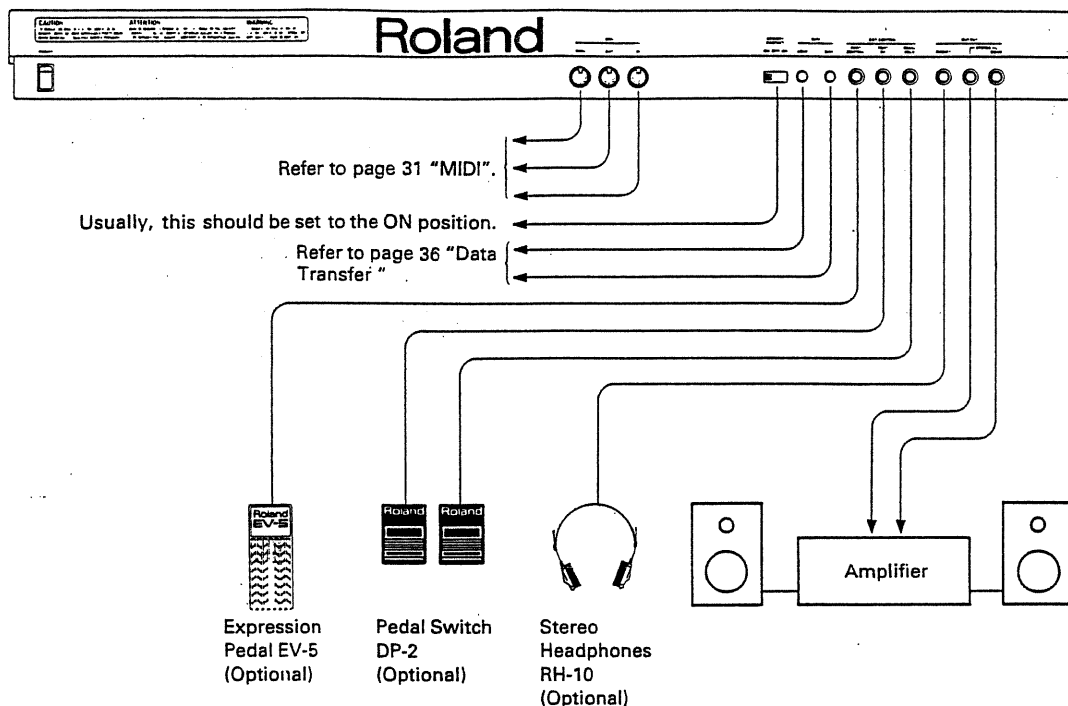

### Radio and television interference

**"Warning – This equipment has been verified to comply with the limits for a Class B computing device, pursuant to Subpart J, of Part 15, of FCC rules. Operation with non-certified or non-verified equipment is likely to result in interference to radio and TV reception."**

The equipment described in this manual generates and uses radio-frequency energy. If it is not installed and used properly, that is, in strict accordance with our instructions, it may cause interference with radio and television reception.

This equipment has been tested and found to comply with the limits for a Class B computing device in accordance with the specifications in Subpart J, of Part 15, of FCC Rules. These rules are designed to provide reasonable protection against such an interference in a residential installation.

However, there is no guarantee that the interference will not occur in a particular installation. If this equipment does cause interference to radio or television reception, which can be determined by turning the equipment on and off, the user is encouraged to try to correct the interference by the following measure:

- Disconnect other devices and their input/output cables one at a time. If the interference stops, it is caused by either the other device or its I/O cable.

These devices usually require Roland designated shielded I/O cables. For Roland devices, you can obtain the proper shielded cable from your dealer. For non Roland devices, contact the manufacturer or dealer for assistance.

If your equipment does cause interference to radio or television reception, you can try to correct the interference by using one or more of the following measures:

- Turn the TV or radio antenna until the interference stops.
- Move the equipment to one side or the other of the TV or radio.
- Move the equipment farther away from the TV or radio.
- Plug the equipment into an outlet that is on a different circuit than the TV or radio. (That is, make certain the equipment and the radio or television set are on circuits controlled by different circuit breakers or fuses.)
- Consider installing a rooftop television antenna with coaxial cable lead-in between the antenna and TV.

If necessary, you should consult your dealer or an experienced radio/television technician for additional suggestions. You may find helpful the following booklet prepared by the Federal Communications Commission:

"How to Identify and Resolve Radio-TV Interference Problems"

This booklet is available from the U.S. Government Printing Office, Washington, D.C., 20402, Stock No. 004-000-00345-4.

### 3 OPERATION

#### 1. Power Up

- ① Make sure that the Memory Protect Switch ⑦ on the rear panel is set to the ON position.
- ② Turn the Power Switch ⑨ on.

The Display Window ⑩ will respond with:

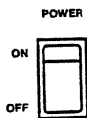
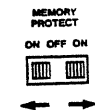

This is shown for a few seconds

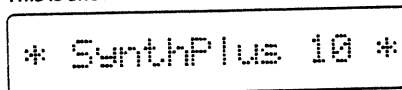

Then the Display changes

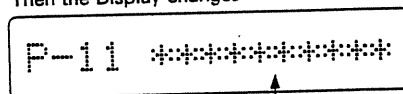

Tone Name

#### Music Rest

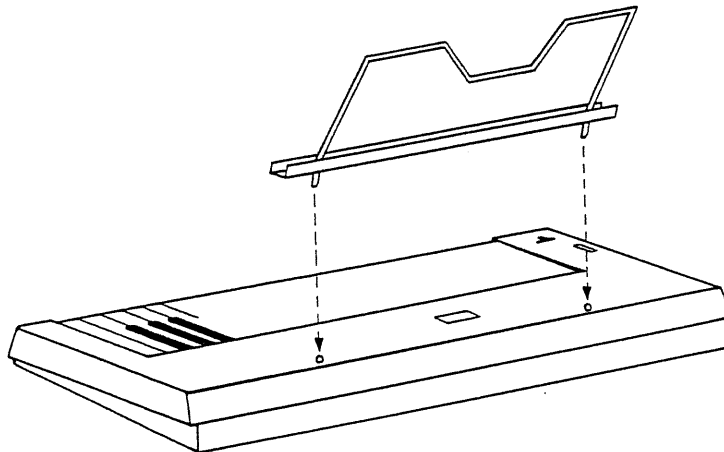

## 2. Tone Color Selection

Any of the 128 different tone colors can be called by using the Group Selector Button ⑦, Bank Selector Button ⑩ and the Number Selector Button ⑪.

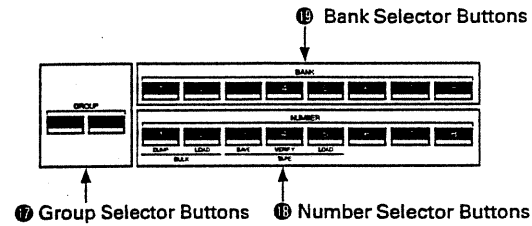

The Display ⑬ will show the tone color currently selected:

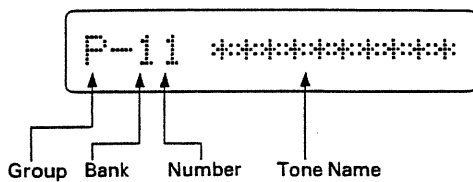

① By pressing either of the Group Selector Buttons ⑦, select Preset or Memory Group.

### P..... Preset Group

The tone colors in this group can be modified, but the modified patch cannot be written into memory.

### M..... Memory Group

The tone colors in this group can be modified and even rewritten.

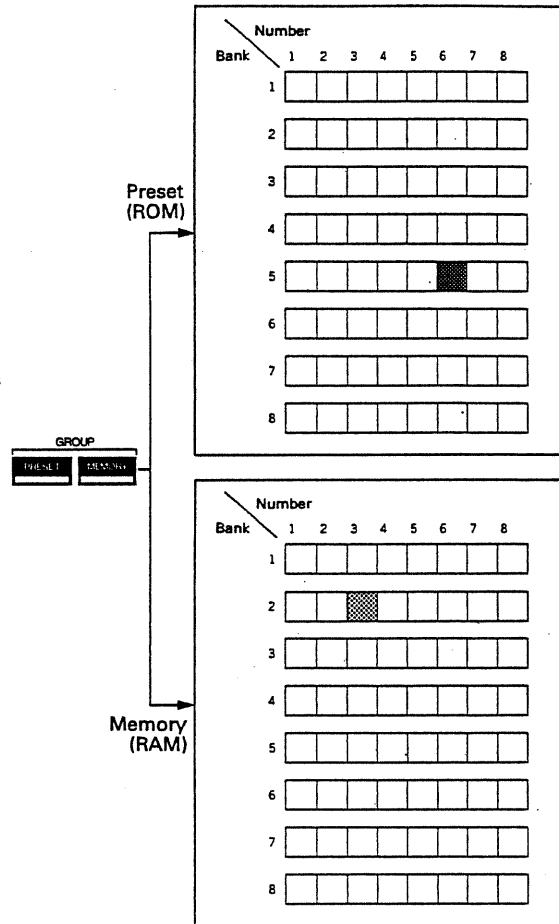

- ② Select the Bank (1 to 8) by pressing the relevant Bank Selector Button ⑩.
- ③ Select the Number (1 to 8) by pressing the relevant Number Selector Button ⑪.

Now, by using the Volume Knob ③, adjust the volume of the sound.

\* The above procedures ① to ③ can be done in any order you like.

### 3. Performance Control Functions

#### a. Pitch Bender/Modulation

By bending the Pitch Bender/Modulation Lever ④, guitar's bending like effect can be obtained. At its center position, this has no effect on the sound, while the left and right extremes of movement achieve the same amount of the pitch bend effect. Also, by pushing the same lever forward, vibrato effect is obtained.

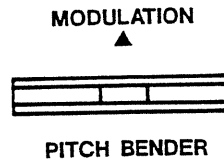

- \* The range of each tone color's Pitch Bender effect can be changed. If the tone color is in the Preset Group, see page 14 "Editing the Performance Control Functions", and if it is the one in the Memory Group, see page 17 "6. Edit".
- \* The depth of the Modulation can be changed as shown on page 14 "Editing the Performance Control Functions".

---

#### b. Portamento

Portamento effect is a slide from one pitch to another. This may be effectively used for the performance with the Chord Memory function.

##### <OPERATION>

To turn Portamento on:



Push the Portamento Button ④.

The indicator lights up.

To turn Portamento off:

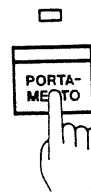

Push the Portamento Button ④ again.

The indicator goes out.

- \* The time needed for a sound to move from a pitch to another (Portamento time) can be changed as shown on page 14 "Editing the Performance Control Functions".



### c. Octave Transpose

The entire keyboard can be transposed one octave down.

<OPERATION>

To set Octave Down Transposition

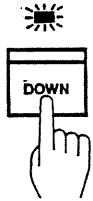

Push the Down Button of the Octave Transpose Buttons ②.

The indicator lights up.

To return to Normal

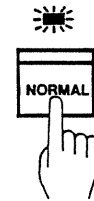

Push the Normal Button of the Octave Transpose Buttons ②.

The indicator lights up.

---

### d. Chord Memory

Chord data can be recorded and later played with one finger.

Example



Octave Transpose: Normal  
Key Transpose: 0



- When C<sub>4</sub> key is played, the actual chord you hear is exactly in the same pitch as the recorded one.

<OPERATION>

To set to the Chord Memory mode

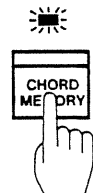

Push the Chord Memory Button ⑤.

The indicator lights up.

To return to the Normal mode

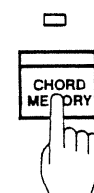

Push the Chord Memory Button ⑤ again.

The indicator goes out.

## ● How to record Chord Data used for Chord Memory Function

When a chord data is recorded into the HS-10 with the Memory Protect Switch set to the ON position, it is erased by power off. If you wish to retain the recorded chord data even after power off, you should record it with the Memory Protect Switch ⑦ set to the OFF position.

### <OPERATION>

- ① Set the Memory Protect Switch as shown below.

ON OFF ON



Memory Protect Switch ⑦: ON →  
Erased when the power is off.

ON OFF ON



Memory Protect Switch ⑦: OFF →  
Retained even after the power is off.

- ② Press the Write Button ⑬ while holding the Chord Memory Button ⑤ down.

The Display ⑩ will respond with:

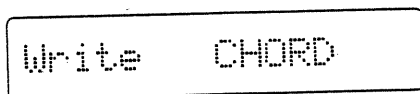

- ③ Play the chord you wish to record.

When all the keys are released, the chord data is recorded, and the Display ⑩ will respond with:

When the Memory Protect Switch is set to ON.

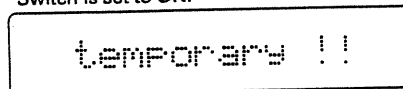

When the Memory Protect Switch is set to OFF.

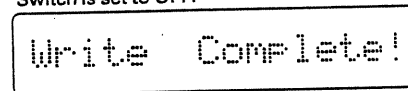

- ④ If necessary, return the Memory Protect Switch to the ON position.

\* While a chord data is being recorded, the Octave Transpose or Key Transpose function does not work, therefore, the middle C key always works as C4 key.

\* When the recorded chord is being played, the Octave Transpose and Key Transpose functions work. When Octave Transpose is normal and the Key Transpose is 0, playing the C4 key will faithfully recall the recorded chord.

\* By recording the C4 key, the HS-10 can be played as a monophonic keyboard.

\* If the keyboard is being played extremely fast or too many NOTE ON messages are continuously sent into the MIDI IN, the chords may not properly sound.

## e. Key Transpose

The keyboard can be transposed to any key you like within  $\pm$  an octave ( $-12$  to  $+12$  value). Therefore, you can play music in various keys without using different keys.

\* This Key Transpose operation cannot be done unless the Display **16** is showing a tone name and no key is played on the keyboard.

### How to Transpose

#### 1. Using the $\alpha$ Dial **1**

**1** Push the Key Transpose Button **9**.



The value ( **0** ) shown in the Display represents how many semi-tones (keys) are currently transposed.

Example ▼

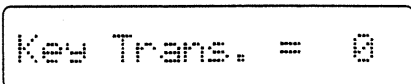

**2** While holding the Key Transpose Button **9** down, rotate the  $\alpha$  Dial to set the desired value. (Refer to the picture shown below.)

The Display **16** shows the corresponding value, and if it is other than 0, the indicator lights up.

#### 2. Using an appropriate key

**1** Push the Key Transpose Button **9**.



The value ( **0** ) shown in the Display represents how many semi-tones (keys) are currently transposed.

Example ▼

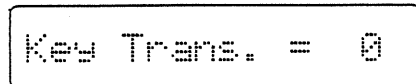

**2** While holding the key Transpose Button **9** down, push the key to which you wish to transpose.

The Display **16** shows the corresponding value, and if it is other than 0, the indicator lights up.

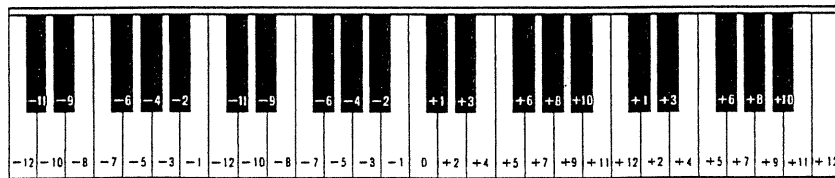

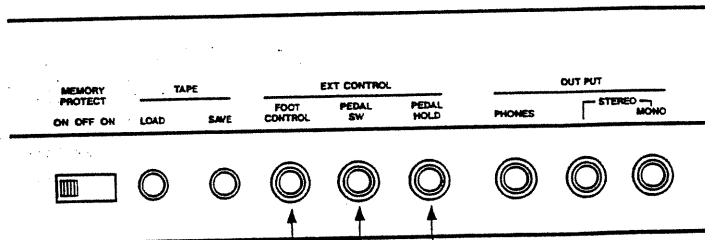

### f. Hold Pedal Jack

The HS-10 features the Hold effect that can retain the sound even after the key is released. Using the optional Pedal Switch DP-2, the Hold effect can be turned on or off.

### g. Pedal Switch Jack

Using the optional Pedal Switch DP-2, the function selected at "Editing Performance Control Functions" on page 14 can be controlled.

\* Program Shift function is set at the factory. Program Shift is the function of calling tone colors 1 to 8 sequentially.

When "M-13" is initially set, the Tone Number will change as shown below.

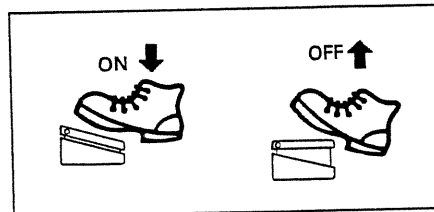
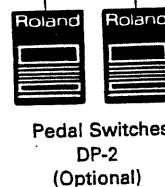
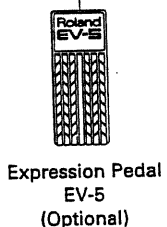
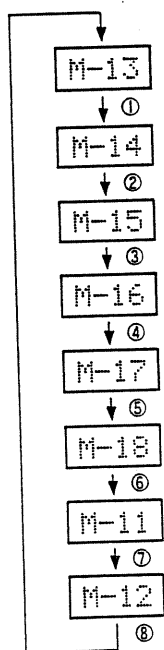

### h. Foot Control Jack

By using the optional Expression Pedal EV-5, the function selected at "Editing Performance Control Functions" on page 14 can be controlled.

## 4. Tone Modify

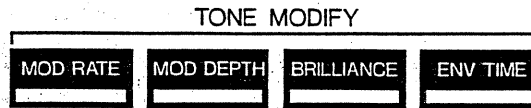

Several parameters of a tone color can be simultaneously changed with a simple operation. There are four modes for the Tone Modify.

Mode	Tone Modify Mode Button ①	Function
Modulation Rate		This mode changes the rate of the vibrato, growl or chorus effect.
Modulation Depth		This mode changes the depth of the vibrato or growl effect.
Brilliance		This mode changes the brilliance of the sound.
Envelope Time		This mode changes the time needed for a tone color to change from the moment the key is played.

### <OPERATION>

- ① Call the tone color you wish to edit.
- ② Select one of the four modes by pushing the corresponding Tone Modify Mode Button ①.

The Display will respond as shown right:

Modulation Rate ▼

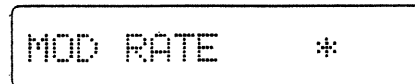

Modulation Depth ▼

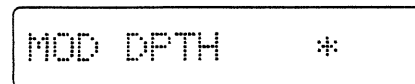

Brilliance ▼

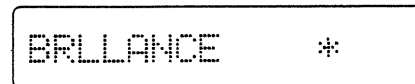

Envelope Time ▼

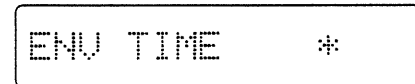

- ③ Using the  $\alpha$  Dial ①, modify the tone color to your taste.

Rotating the  $\alpha$  Dial will change the Display ② as shown below.

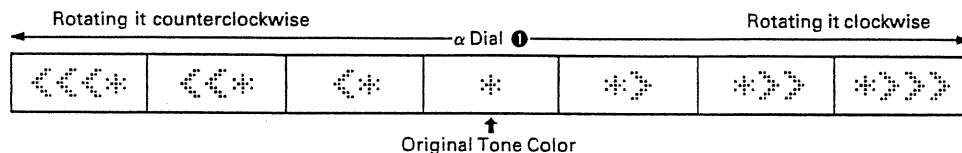

\* The edited tone color will be erased by selecting a different tone color. To retain the edited patch, take an appropriate writing procedure. (See page 29.)

\* This Tone Modify operation may have no effect on some tone colors. For instance, the tone color without vibrato or growl effect will not change at all even by changing the depth or rate of the Modulation effect.

## 5. Editing Performance Control Functions

Using the Tune/Function Button **ⓑ**, you can change the settings (data) of the Tuning and other functions for performance control. The changed data is erased when the unit is powered off. If you wish to retain the data even after powered off, take an appropriate writing operation.

Parameter
1. Tuning
2. Modulation Sensitivity
3. Portamento Time
4. Preset Tone Colors' DCO Bender Range
5. Foot Control
6. Pedal Switch

### a. How to edit the Performance Control Functions

<OPERATION>

- ① Press the Tune/Function Button **ⓑ** until the Display **ⓓ** shows the function you wish to edit.

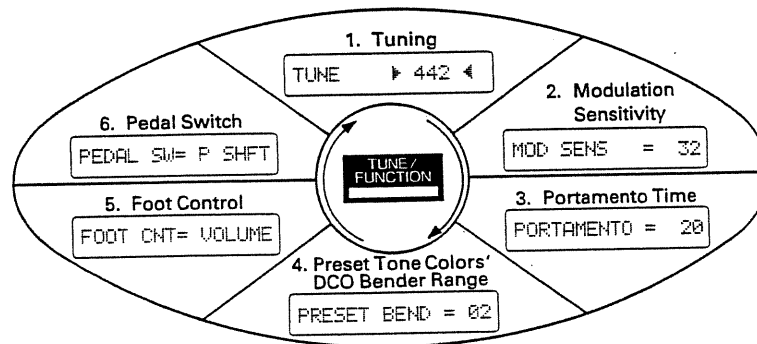

As shown in the picture, each time you push the Tune/Function Button **ⓑ**, the function shown in the Display changes.

- ② Using the  $\alpha$  Dial, change the value of the function to your taste.

## 1. Tuning

Example ▼

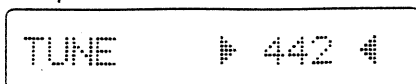

This function is used to tune with other instrument. The pitch of A4 key can be set to 430 to 454Hz.

The Display ⑩ shows the pitch currently set, and if "▶" mark is shown on the left of the Display, the actual pitch of the HS-10 is slightly lower than the set pitch shown in the Display. If "◀" mark is shown on the right side of the Display, the pitch is higher. When both "▶" and "◀" marks are shown at the both ends of the Display, tuning is done.

## 2. Modulation Sensitivity

Example ▼

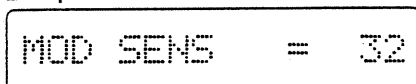

When the Pitch Bender/Modulation Lever ⑥ controls the Modulation effect, this function determines the depth of the Modulation effect from 0 to 127.

## 3. Portamento Time

Example ▼

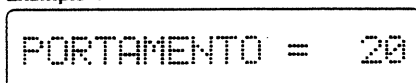

When the Portamento effect is on, this function sets the time needed for the slide of the pitch from one note to another.

\* At 0, no portamento effect is obtained, and 127 is the longest time.

## 4. Preset Tone Colors' DCO Pitch Bender Range

Example ▼

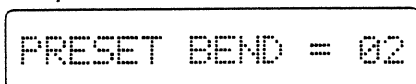

When the Pitch Bender/Modulation lever controls the Pitch Bender effect of the whole preset tone colors (P-11 to 88), this sets the depth of the effect from 0 to 12 (1 represents semi-tone).

## 5. Foot Control

Example ▼

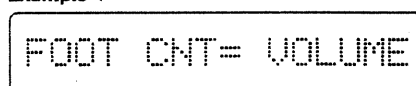

This function selects which of the Volume, Aftertouch or Dynamics function works by the foot control pedal connected to the Foot Control Jack ⑭.

	Display ⑩	Function
Volume	VOLUME	This controls the volume.
Aftertouch	AFTER	The setting of each Aftertouch Sensitivity (of DCO, VCF or VCA) determines the maximum effect of the Aftertouch.
Dynamics	DYNAMICS	When each ENV Mode (of DCO, VCF or VCA) is set to Dynamics, the volume pedal controls the dynamics effect.

\* The Dynamics effect is determined by the position of the pedal when the key is played. This means that the Dynamics effect is not affected by the pedal once the key is played.

## 6. Pedal Switch

Example ▼

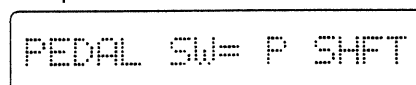

This function selects which of the Program Shift, Portamento, or Chord Memory function works by the pedal switch connected to the Pedal Switch Jack ⑮.

Mode	Display ⑩	Function
Program Shift	P SHFT	Pressing the pedal switch sequentially calls the tone colors 1 to 8. After 8, 1 will return.
Portamento	PORTA	This turns on or off the Portamento effect.
Chord Memory	CRD M	This turns on or off the Chord Memory effect.

\* When the Portamento or Chord Memory function is selected, the effect is on while the DP-2 is being depressed. If you wish to turn the effect on and off alternately by depressing the pedal, use the optional Foot Switch FS-1.

## b. Writing the Performance Control Functions

If you wish to retain the data of Tune/Function even after the HS-10 is switched off, you should write it in the back-up memory.

### <OPERATION>

- ① Set the Memory Protect Switch ⑦ to the OFF position.
- ② Push the Tune/Function Button ⑧.

- ③ While holding the Write Button ⑬ down, press the Tune/Function Button ⑧.

The Display ⑬ will respond with:

While holding the Write Button ⑬ down

Write TUNE/FUNC.



When the Tune/Function Button ⑧ is pushed.

Write Complete!

- ④ Return the Memory protect Switch ⑦ to the ON position.



## 6. Edit

Here, call each parameter of a tone color and change it. Regarding the details of the parameters, see page 18 "7. Tone Color Parameters".

<OPERATION>

- ① Call the tone color you wish to edit.
- ② Push the Parameter Selector Button ⑫.

The Display will respond with:

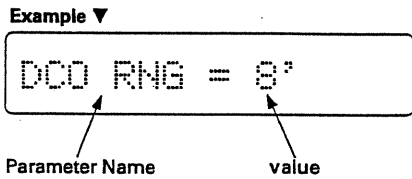

- ③ Using the  $\alpha$  Dial ①, call the parameter you wish to change.

- ④ Push the Value Button ⑬.

As shown in the picture, on the right of the Display ⑬, the current value and the prospective value are shown.

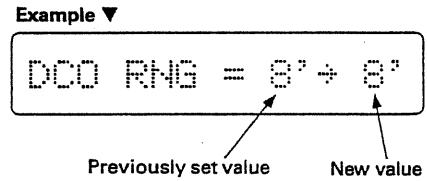

- ⑤ Using the  $\alpha$  Dial ①, change to the value you like.
- ⑥ Repeat the steps ② to ⑤ as many times as necessary.

## 7. Tone Color Parameters

A tone color consists of various parameters, therefore, to edit a tone color, change the values of those parameters.

### a. Synthesizer Structure

The HS-10's synthesizer section consists of several blocks as shown in the picture. Each block of the synthesizer section is controlled by relevant tone-color parameters.

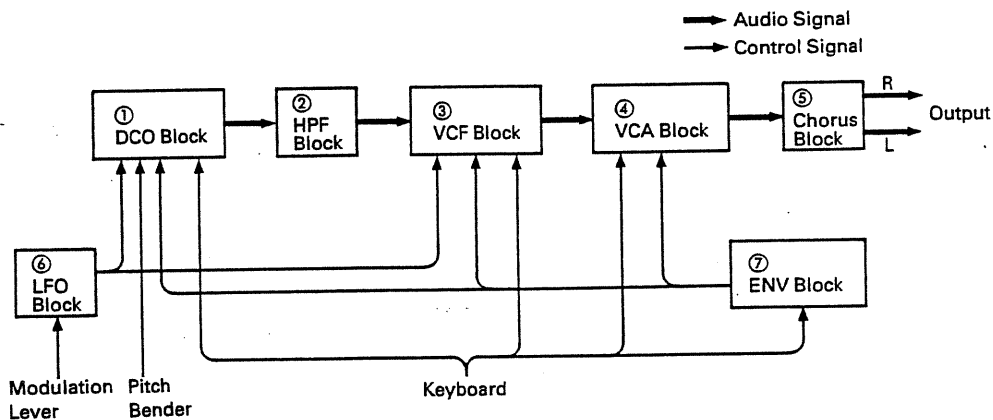

#### ① DCO (Digitally Controlled Oscillator)

DCO is the digitally controlled oscillator that controls the pitch and generates the waveforms that are the sound source of the synthesizer.

#### ② HPF (High Pass Filter)

The HPF (High-Pass Filter) is a filter that passes high frequency harmonics and cuts off the lower ones. This changes the waveform and controls the tone color.

#### ③ VCF (Voltage Controlled Filter)

Each VCF lets lower frequency harmonics of the input signal pass and cuts off the higher ones. In other words, it is a usual low pass filter. By controlling the cutoff point and resonance, the waveform changes, thereby the tone color alters.

#### ④ VCA (Voltage Controlled Amplifier)

After filtered in the VCF, the signal is fed to the VCA where the volume (amplitude) of the sound is controlled.

#### ⑤ CHORUS

#### ⑥ LFO (Low Frequency Oscillator)

This oscillator generates extremely low frequency, so produces a vibrato or growl effect by controlling the DCO or VCF.

#### ⑦ ENV (Envelope Generator)

This generates the control voltage (Envelope) which controls the DCO, VCF and VCA, therefore, alters the pitch, tone color and volume in each note.

## b. Parameters

### DCO (Digitally Controlled Oscillator)

#### □ DCO Range

##### Example ▼

DCO RNG = 8'

This is to change the pitch range of the DCO in exact one octave steps from 4' to 32' (4', 8', 16', 32'). 8' is standard.

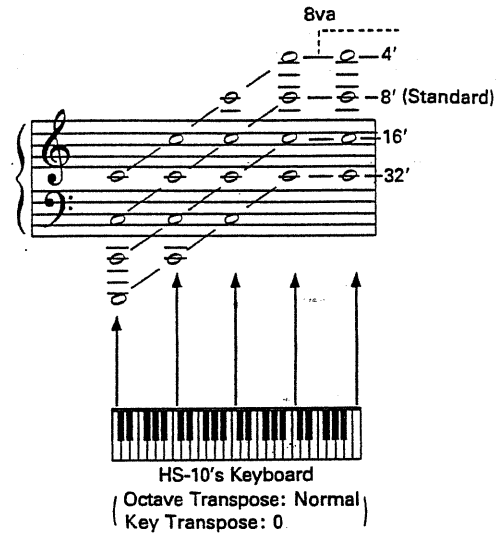

#### □ DCO LFO Depth

##### Example ▼

DCO LFO = 20

When the LFO is controlling the pitch of the DCO, this adjusts the depth of the vibrato effect in the range of 0 to 127.

#### □ DCO ENV Depth

##### Example ▼

DCO ENV = 60

When the ENV is controlling the pitch of the DCO, this parameter sets the depth of the modulation in the range of the 0 to 127.

#### □ DCO ENV Mode

##### Example ▼

DCO ENV =

This selects the polarity of the Envelope curve that controls the DCO. Usually may be used. In mode, ADSR pattern will be inverted.

Mode	Display	Function
Normal		ENV serves to increase the DCO's pitch.
Invert		ENV serves to decrease the DCO's pitch.
Normal with Dynamics		The ENV with Dynamics serves to increase the DCO's pitch.
Invert with Dynamics		The ENV with Dynamics serves to decrease the DCO's pitch.

DCO Aftertouch Sensitivity

Example ▼

DCO AFTR= 15

This parameter determines the depth of the vibrato effect when it is controlled by aftertouch. 0 to 15 are valid for this parameter.

DCO Bender Range

Example ▼

DCO BEND= 12

This sets the maximum effect of the Pitch Bender caused by moving the Pitch Bender/Modulation lever. 0 to 12 are valid for this parameter, and 1 is semi-tone, therefore, 12 is an octave.

DCO Pulse Waveform

Example ▼

PULSE = 01

Pulse wave is selected.

Display ⑩	Waveform	Spectrum
00	OFF	
01		
02		
03		See page 21 "DCO PW/PWM Depth"

\* The pulse width of 03 can be set at DCO PW/PWM Depth.

DCO Sawtooth Waveform

Example ▼

SAWTOOTH= 01

Sawtooth waveform is selected.

Display ⑩	Waveform	Spectrum
00	OFF	
01		
02		
03		See page 21 "DCO PW/PWM Depth"
04		
05		

\* The pulse width of 03 can be set at DCO PW/PWM Depth.

DCO Sub Oscillator Waveform

Example ▼

SUB = 00

This selects the waveform of the Sub Oscillator that generates the pitch 1 or 2 octaves lower than the pulse wave or sawtooth wave.

Display	Waveform	Pitch	Spectrum
00		1 oct. lower	
01		1 oct. lower	
02		1 oct. lower	
03		1 oct. lower	
04		2 oct. lower	
05		2 oct. lower	

DCO Sub Oscillator Level

Example ▼

SUB LEVEL= 03

This sets the volume of the Sub Oscillator from 0 to 3. At 0, there is no oscillation.

DCO Noise Level

Example ▼

NOIS LVL= 03

This sets the volume of the Noise which is often used for wind or surf. 0 to 3 are valid, and at 0, there is no Noise generated.

Noise



DCO PW/PWM Depth

Example ▼

PW / PWM= 80

This parameter works only on the Pulse Wave 03 and Sawtooth Wave 03. The pulse width of a wave can be determined by the value from 0 to 127.

PW/PWM Depth	PULSE 03		SAWTOOTH 03	
	Waveform	Spectrum	Waveform	Spectrum
00				
42				
64				
102				
127				

□ DCO PWM Rate

Example ▼

PWM RATE= 60

This parameter works only on the Pulse Wave 03 and Sawtooth Wave 03. The rate of the LFO modulation that changes the pulse width of the waveform can be set. 0 to 127 are the values valid for this parameter. At 0, however, the pulse width is not modulated by the LFO but set at the PW/PWM Depth. When this parameter is set to the value other than 0, the pulse width set with the DCO PW/PWM Depth is the widest pulse made by the LFO modulation.

**HPF (High Pass Filter)**

□ HPF Cutoff Frequency

Example ▼

HPF FREQ= 02

This parameter changes the cutoff point of the HPF.

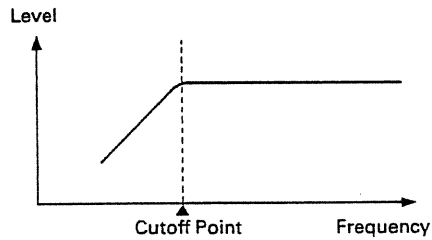

Display ①	Function	
00	The lower frequencies are emphasized, (This is useful for fat bass sound.)	
01	HPF is off.	
02	Cutoff point is set at lower frequency.	
03	Cutoff point is set at higher than 02. The produced sound is harder and thinner than that of 02.	

## VCF (Voltage Controlled Filter)

### □ VCF Cutoff Frequency

#### Example ▼

VCF FREQ= 80

This is for changing the cutoff point of the VCF. As you decrease the value, the cutoff frequency will come down, and the waveform gradually becomes approximation of a sine wave, then the sound will fade out. 0 to 127 are valid for this parameter.

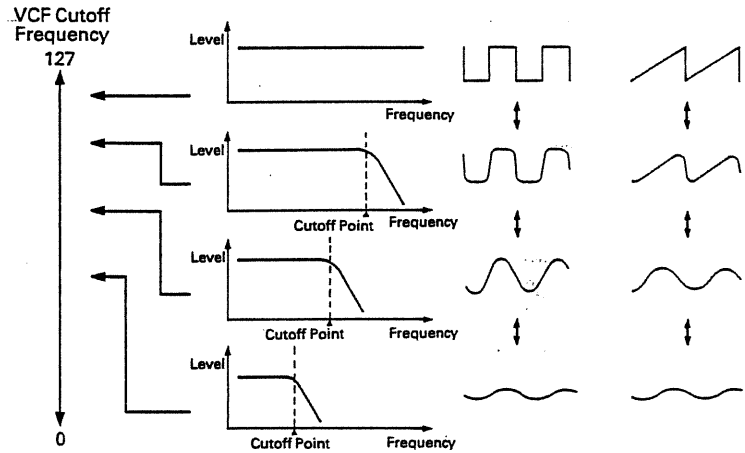

### □ VCF Resonance

#### Example ▼

VCF RESO= 20

This parameter emphasizes the cutoff point set at the VCF Cutoff Frequency. As you increase the value, the created sound will become more unusual, more electronic in nature. 0 to 127 are valid for this parameter.

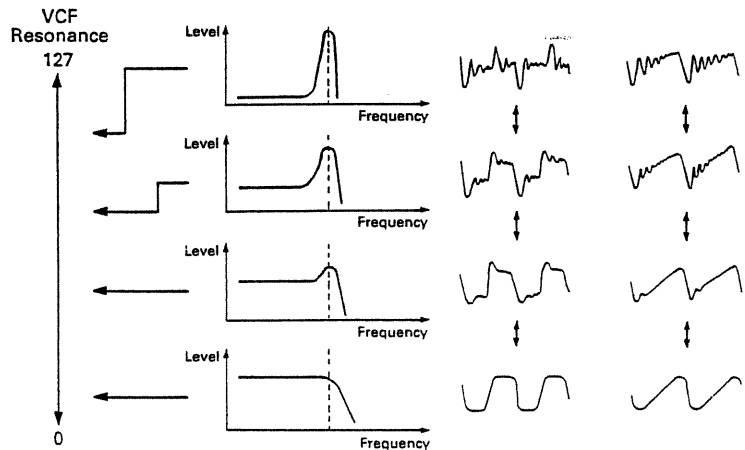

VCF ENV Depth

Example ▼

VCF ENV = 60

This parameter controls the cutoff point of the VCF in each note with the ENV curve set in the ENV section. As you increase the value, tone color within one note changes more drastically. 0 to 127 are valid for this parameter.

VCF ENV Mode

Example ▼

VCF ENV = ~

This is to select the polarity of the Envelope curve that controls the cutoff point of the VCF. Usually, "~" may be used, in "v" mode, ADSR pattern will be inverted.

Mode	Display	Function
Normal	~	ENV serves to increase the VCF's cutoff point.
Invert	∩	ENV serves to decrease the VCF's cutoff point.
Normal with Dynamics	D~	The ENV with Dynamics serves to increase the VCF's cutoff point.
Dynamics	d~	This mode is rather special; the ENV has nothing to do with the VCF's cutoff point and the Dynamics directly works to increase the VCF's cutoff point.

VCF LFO Depth

Example ▼

VCF LFO = 60

This parameter sets the depth of the LFO modulation that changes the cutoff point of the VCF (=growl effect). 0 to 127 are valid for this parameter.

VCF Keyboard Follower

Example ▼

VCF KYBD= 15

This parameter can shift the cutoff point depending on the key played (=pitch). 0 to 15 are valid, and decreasing the value will make the higher pitch softer.

VCF Aftertouch Sensitivity

Example ▼

VCF AFTR= 15

When the Aftertouch is controlling the cutoff frequency of the VCF, this parameter sets the sensitivity of the effect. 0 to 15 are valid for this parameter.



## VCA (Voltage Controlled Amplifier)

### □ VCA Level

Example ▼

VCA LEVL= 64

This is for changing the volume, and can be effectively used when writing a tone color. When the value is set too high, sound may be distorted.

### □ VCA ENV Mode

Example ▼

VCA ENV = 1~

This is to select whether to control the VCA by the signal from the ENV or by the Gate signal (Key On/Off signal).

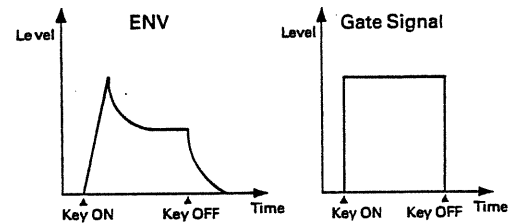

Mode	Display ⑩	Function
ENV	1~	ENV changes the volume.
Gate	GT	Gate signal changes the volume.
ENV with Dynamics	D1~	ENV with dynamics changes the volume.
Gate with Dynamics	DGT	Gate signal with dynamics changes the volume.

### □ VCA Aftertouch Sensitivity

Example ▼

VCA AFTR= 15

When the Aftertouch is controlling the volume, this parameter determines the sensitivity of the effect.  
0 to 15 are valid for this parameter.

## CHORUS

### Chorus On/Off

Example ▼

```
CHORUS = ON
```

This turns on or off the Chorus effect.

### Chorus Rate

Example ▼

```
CRS RATE= 70
```

This parameter determines the rate of the chorus effect from 0 to 127.

## LFO (Low Frequency Oscillator)

### LFO Rate

Example ▼

```
LFO RATE= 70
```

This parameter changes the rate of the LFO modulation.  
0 to 127 are valid for this parameter.

### LFO Delay Time

Example ▼

```
LFO DELY= 20
```

This parameter sets the time needed for the LFO modulation to work from the moment the key is played.  
0 to 127 are valid for this parameter.

## ENV (Envelope Generator)

<Fig. 1>

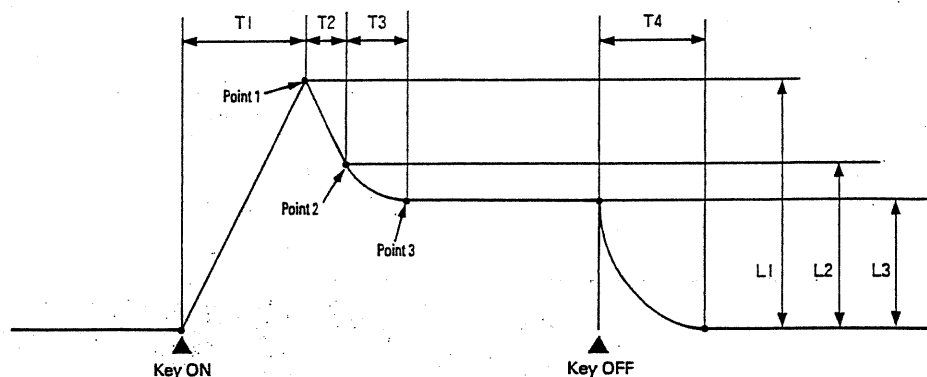

### ENV Time 1

Example ▼

ENV T1 = 00

This parameter can set the time needed for a note to reach the point 1 from the moment the key is played.

0 to 127 are valid for this parameter.

In Fig 1, the length of T1 represents it.

### ENV Level 1

Example ▼

ENV L1 = 127

This parameter sets the point 1's level. 0 to 127 are valid for this parameter.

In Fig 1, the height of L1 represents it.

### ENV Time 2

Example ▼

ENV T2 = 20

This parameter can set the time spent for a note to change from the point 1 to 2.

0 to 127 are valid for this parameter.

In Fig 1, the length of T2 represents it.

### ENV Level 2

Example ▼

ENV L2 = 80

This parameter sets the point 2's level. 0 to 127 are valid for this parameter.

In Fig 1, the height of L2 represents it.

### ENV Time 3

Example ▼

ENV T3 = 20

This parameter can set the time spent for a note to change from the point 2 to 3.

0 to 127 are valid for this parameter.

In Fig 1, the length of T3 represents it.

### ENV Level 3

Example ▼

ENV L3 = 60

This parameter sets the point 3's level. 0 to 127 are valid for this parameter.

In Fig 1, the height of L3 represents it.

### ENV Time 4

Example ▼

ENV T4 = 50

This parameter sets the time needed for a note to fall to 0 from the level 3 from the moment the key is released.

0 to 127 are valid for this parameter.

In Fig 1, the length of T4 represents it.

□ ENV Keyboard Follower

Example ▼

ENV KYBD= 15

The time required for the envelope to complete its curve can be changed depending on which key is pressed.

0 to 15 are valid for this parameter.

There is no change of the time at all when it is set to 0, but as the value is increased, envelope time becomes shorter with higher key pressed.

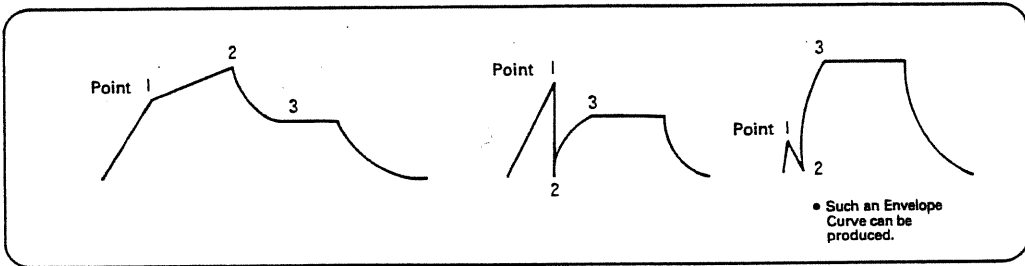
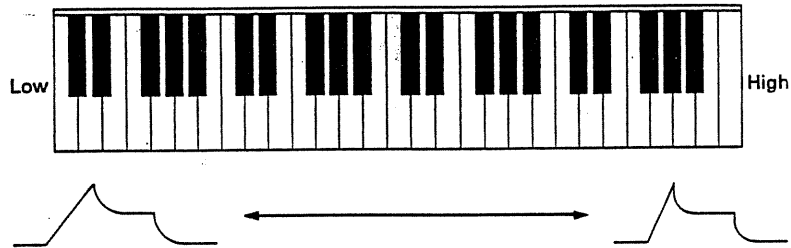

## 8. Writing a Tone Color

To retain the edited tone color data into the back-up memory, take the following writing operation.

### <OPERATION>

- ① Set the Memory Protect Switch to the OFF position.
- ② To select the tone number where the edited tone color is to be written, push the relevant Bank Selector Button **Ⓚ** and the Number Selector Button **Ⓝ** while holding the Write Button **Ⓦ** down.
- ③ Return the Memory Protect Switch to the ON position.

### Example ▼

Editing the Preset 11 and write it in the Memory 11

While holding the Write Button **Ⓦ** down.

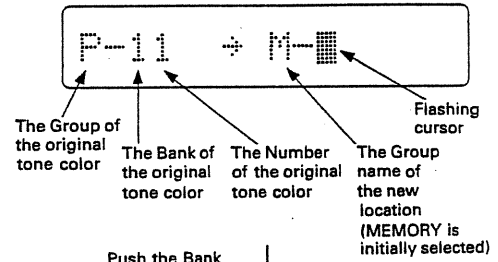

Push the Bank Selector Button **Ⓚ** ↓

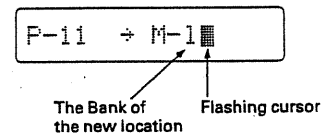

Push the Number Selector Button **Ⓝ** ↓

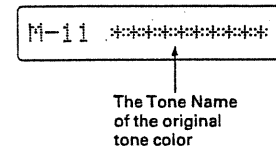

## 9. Naming the Tone Colors

You can write a name (within 10 letters) to each tone color, or rename it.

### <OPERATION>

- ① Call the tone color which you wish to rename.
- ② Push the Name Button ⑭.

The Display ⑫ will respond with:

#### Example ▼

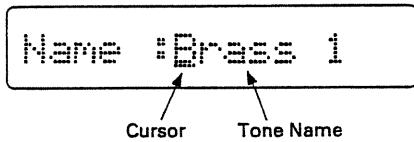

- ③ Push the Name Button ⑭ as many times until the cursor comes under the letter to be changed.

The cursor moves one letter rightward each time the Name Button is pressed. When the cursor reaches the right end, it goes back to the beginning.

- ④ Change the name by using the α-Dial ①.

The available letters for naming are as follows.

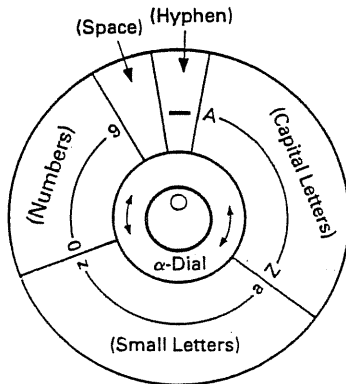

- ⑤ Repeat the steps ③ ④ as many times as necessary.

- ⑥ Set the Memory Protect Switch to the OFF position.

- ⑦ By pushing the appropriate Bank Selector Button ⑮ and the Number Selector Button ⑯, assign the same tone color you called in the step ①.

The Display ⑫ will change to:

#### Example ▼ Renaming M-11

While holding the Write Button ⑬ down

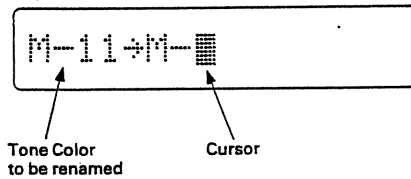

↓ Push the Bank Selector Button ⑮

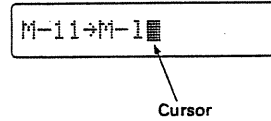

↓ Push the Number Selector Button ⑯

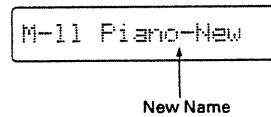

- ⑧ Return the Memory Protect Switch ⑰ to the ON position.

\* Taking the operation ⑦ will automatically write the tone color selected in the step ①. So if you do not change the tone color but only the tone name, assign the same tone color you called in the step ①.

## 10. MIDI

There are three MIDI Connectors ㉑ on the HS-10 as follows.

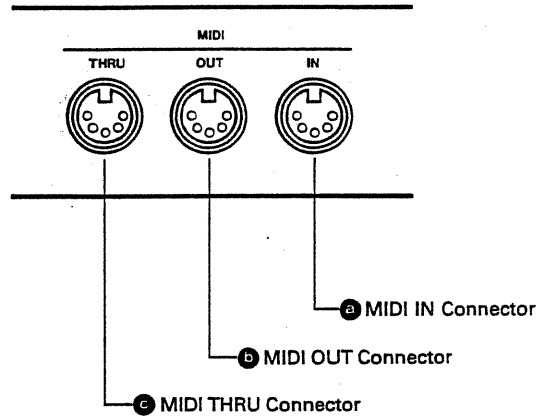

### ㉑ MIDI IN Connector

Use this connector for feeding signal from an external MIDI device to control the HS-10.

### ㉒ MIDI OUT Connector

Use this connector for sending signal from the HS-10 to control the external MIDI device.

\* The signal fed into the MIDI IN is not sent out through the MIDI OUT.

### ㉓ MIDI THRU Connector

The exact copy of the signal fed into the MIDI IN is sent out through this connector.

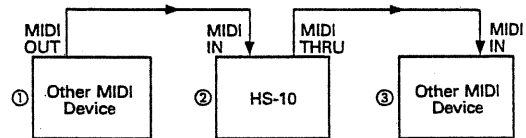

### NOTE

Please do not connect more than three MIDI devices through the MIDI THRU Connectors. Use the optional MIDI THRU Box MM-4.

## a. Changing MIDI Function Data

The setting of each MIDI function can be changed and written as follows.

MIDI Function	Factory Preset	Value Display	Description
1. MIDI Channel	1	1 ~ 16	This sets the channel on which the MIDI messages are communicated.
2. MIDI OMNI	OFF	ON/OFF	OMNI ON receives all messages regardless the channel setting.
3. MIDI Local Control	ON	ON/OFF	OFF separates the synthesizer section from the keyboard section in the HS-10.
4. MIDI Aftertouch	ON	ON/OFF	Aftertouch Message
5. MIDI Bender	ON	ON/OFF	Pitch Bender Message
6. MIDI Exclusive	OFF	ON/OFF	Exclusive Message
7. MIDI Hold	ON	ON/OFF	Hold Message
8. MIDI Modulation	ON	ON/OFF	Modulation Message
9. MIDI Program Change	ON	ON/OFF	Tone Color Selection Message
10. MIDI Volume	ON	ON/OFF	Volume Message
11. MIDI Portamento	ON	ON/OFF	Portamento Message

### <OPERATION>

- Push the MIDI Button **Ⓜ** as many times until the MIDI function you wish to change is shown in the Display **Ⓜ**.

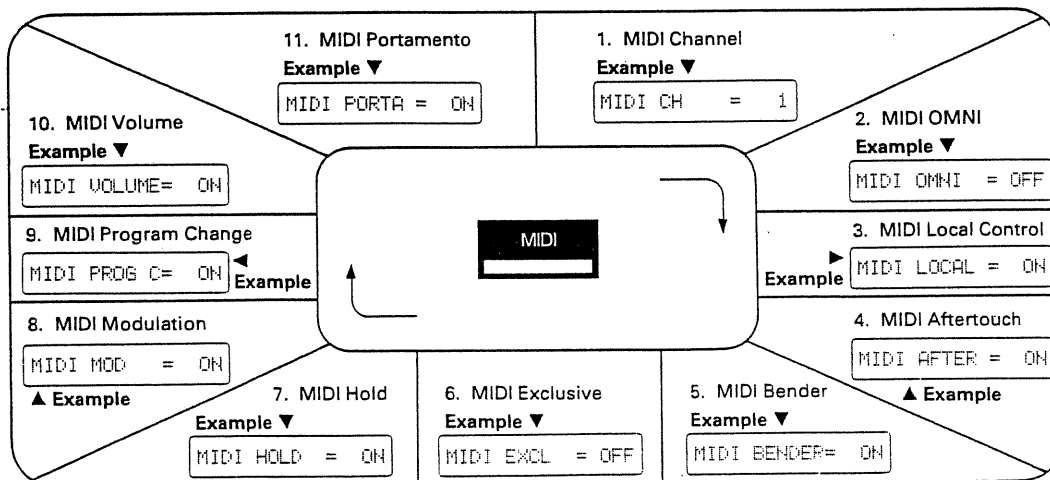

The MIDI parameter shown in the Display changes each time the MIDI Button is pushed.

- Using the  $\alpha$  Dial **Ⓜ**, change the MIDI function to what you like.



## b. Writing MIDI Function Data

By writing the data of the MIDI Function setting into the back-up memory, it can be retained even when the unit is turned off.

### <OPERATION>

- ① Set the Memory Protect Switch ⑦ to the OFF position.
- ② Push the MIDI Button ⑩.

- ③ While holding the Write Button ⑬ down, push the MIDI Button ⑩.

The Display will change to:

While holding the  
Write Button ⑬ down.

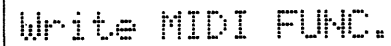

Write MIDI FUNC.



When the MIDI Button ⑩ is pushed.



Write Complete!

- ④ Return the Memory Protect Switch ⑦ to the ON position.

### c. HS-10's Sound Range receivable and transmissible with MIDI

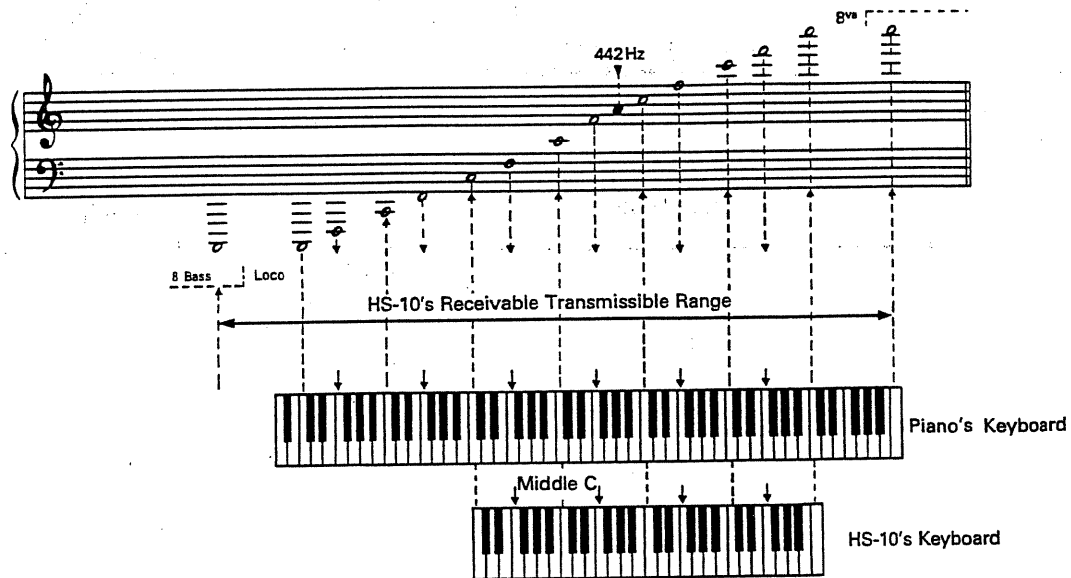

#### (1) Transmissible Sound Range

The HS-10 features the key Transpose (1 octave upper and lower), the Octave Transpose (1 octave lower) and the Chord Memory functions, therefore can transmit data from 3 octaves lower to 1 octave higher than the actual keyboard.

#### (2) Receivable Sound Range

The HS-10's receivable sound range with MIDI is 8 octaves as shown above. If the transmitted data exceeds this range, it will be automatically transposed up or down until it fits in the range. The Key Transpose and the Octave Transpose functions do not work on the data received at MIDI IN.

### d. Pedal Switch and Foot Control

Depending on the function currently in use, the MIDI messages sent by the pedal switch and foot control differ.

#### • Pedal Switch

Function	Messages transmitted with MIDI
Program Shift	*1 Program Change, *1 System Exclusive
Portamento	*1 Portamento
Chord Memory	No message

#### • Foot Control

Function	Messages transmitted with MIDI
Volume	Main Volume
Aftertouch	Foot Controller
Dynamics	Key Velocity

\*1 These messages are turned on or off with MIDI.

### e. Program Change Messages

The the colors of the HS-10 correspond to the Program Change numbers of the MIDI Format 1 to 128 as shown in the table below.

GROUP	NUMBER	1	2	3	4	5	6	7	8
	BANK								
MEMORY	1	1	2	3	4	5	6	7	8
	2	9	10	11	12	13	14	15	16
	3	17	18	19	20	21	22	23	24
	4	25	26	27	28	29	30	31	32
	5	33	34	35	36	37	38	39	40
	6	41	42	43	44	45	46	47	48
	7	49	50	51	52	53	54	55	56
	8	57	58	59	60	61	62	63	64
PRESET	1	65	66	67	68	69	70	71	72
	2	73	74	75	76	77	78	79	80
	3	81	82	83	84	85	86	87	88
	4	89	90	91	92	93	94	95	96
	5	97	98	99	100	101	102	103	104
	6	105	106	107	108	109	110	111	112
	7	113	114	115	116	117	118	119	120
	8	121	122	123	124	125	126	127	128

\* Number 0 to 127 are used as Program Change Messages in the actual MIDI Format.

\* When external MIDI devices such as keyboard recorders are connected to the HS-10, the HS-10 may not sound properly because of the MIDI loop junction.

In such a case, turn the MIDI Thru Switch on the keyboard recorder off or turn the MIDI Local message off.

#### Example

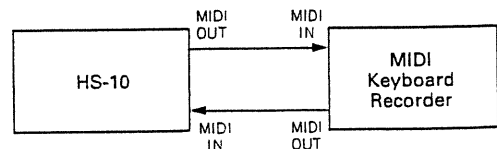

# 11. Data Transfer

The HS-10 features the tape interface function that can save the entire data in the Tone Memory (M-11 to 88) onto an ordinary tape recorder. Also it is possible to transfer the data into another HS-10.

Before taking any data transferring operation, be sure to turn the HS-10 to the Play mode, in other words, the Display **16** should be showing a tone name.

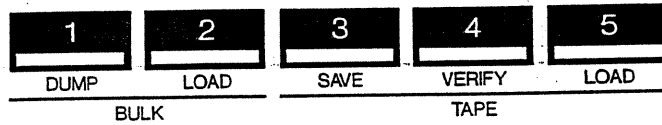

## a. Tape Interface

### CONNECTION

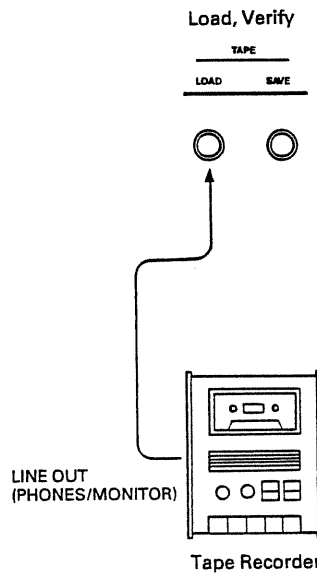
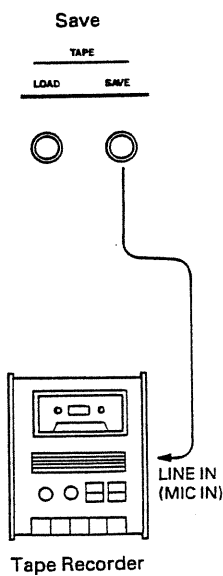

\* Some tape recorders do not allow proper operation when both Save and Load connections are made at the same time. In such a case, make only the relevant connection.

\* To cancel the saving, verifying or loading mode, simply push any of the Number Selector Buttons **1** to **5**.

\* It may be a good idea to take the verifying operation each time you have saved data on a tape.

## 1. Saving

### OPERATION

- ① Set the tape recorder to the recording mode, then start it.
- ② While holding the Data Transfer Button ⑦ down, push the Number Selector Button ③.

The Display ⑩ will react as shown below, and the saving starts.

While holding the Data Transfer Button ⑦ down.

Select Type.....



When the Number Selector Button ③ is pushed.

Save Tape...0

During saving, this changes like 0 → 1 → 2...

- ③ When the saving is completed, the Display ⑩ will change to:

Save ..END...

- ④ Stop the tape recorder.

## 2. Verifying

### <OPERATION>

- ① Rewind the tape up to the beginning of the saved data. And set the volume of the tape recorder to the medium.
- ② While holding the Data Transfer Button ⑦ down, push the Number Selector Button ④.

The Display will change to:

While holding the Data Transfer Button ⑦ down.

Select Type.....



When the Number Selector Button ④ is pushed.

Verify Tape...0

- ③ Set the tape recorder to the playing mode, then start it.

When the head of the data is found, the verifying starts.

Verify Tape...0

When the head of the data is found, 0 is shown, then it goes to 1 → 2 → 3...

- ④ The Display ⑩ will respond either with:

When the saving has been correctly done.

Verify ..END...

When the saving has been failed.

Verify ERR !

When error indication is shown, read "Notes on saving on a tape" on page 39, then carefully repeat the saving procedure.

- ⑤ Stop the tape recorder.

### 3. Loading

#### <OPERATION>

- ① Rewind the tape up to the beginning of the saved data. And adjust the volume of the tape recorder to the medium.
- ② Set the Memory Protect Switch ⑦ on the HS-10 to the OFF position.
- ③ While holding the Data Transfer Button ⑦ down, push the Number Selector Button ⑤.

The Display ⑩ will change to:

While holding the Data Transfer Button ⑦ down.

Select Type.....



When the Number Selector Button ⑤ is pushed.

Load Tape.....

- ④ Set the tape recorder to the playing mode, then start it.

When the head of the save data is found, the loading starts.

Load Tape...0

When the head of the data is found, 0 is shown, then goes to 1 → 2 → 3.... during loading.

- ⑤ The Display ⑩ will respond either with:

When the loading is correctly done.

Load ..END...

When the loading is failed.

Load ERR !

When error indication is shown, read "Notes on saving on a tape" on page 39, and carefully repeat the loading procedure.

- ⑥ Stop the tape recorder.
- ⑦ Return the Memory Protect Switch ⑦ to the ON position.

## ■ Notes on saving on a tape

When error indication is shown in the Display during verifying or loading operation, read the following notes then carefully repeat the saving or loading procedure.

### ▶ Tape rewinding

- \* Make sure that you have rewound the tape completely up to the beginning of the saved data.

### ▶ Playback Level of the Tape Recorder

- \* The appropriate playback level varies depending on the tape recorder. So change the level to find an appropriate level. Also, if your tape recorder features recording level control, try changing the recording level in saving.

- \* If the tape recorder features Tone control, adjust it, too.

### ▶ Connection

- \* Make sure that connections are made properly.
- \* If your tape recorder has two kinds of In/Out Jacks (i.e. MIC/LINE In, EAR/LINE Out, etc), try using different ones this time.
- \* Some tape recorders do not allow proper operation when both Save and Load connections are made at the same time. In such a case, make only the relevant connection.

### ▶ Where to start recording

- \* Please do not start recording from the very head of the tape, but after slightly winding it.

### ▶ Tape you use

- \* Use a new and high quality tape, if possible. An old tape is liable to have drop-out, therefore likely to cause error more often.
- \* Use a cassette tape shorter than C-60. The one longer than C-90 is too thin for proper operation.

### ▶ Tape Recorder

- \* Try using the same tape recorder in Saving and Loading, so that possibility of error will be reduced.
- \* Clean and demagnetize the head of the tape recorder.

### ★ If error is still indicated, use a different tape recorder

### \* Preservation of the data tape

Please do not keep the data recorded tape in extreme heat or humidity or near strongly magnetic units such as TV, speaker or amplifier.

### c. Data Transfer with MIDI

This function is available even when the MIDI Exclusive in the MIDI Functions is turned off.

#### CONNECTION

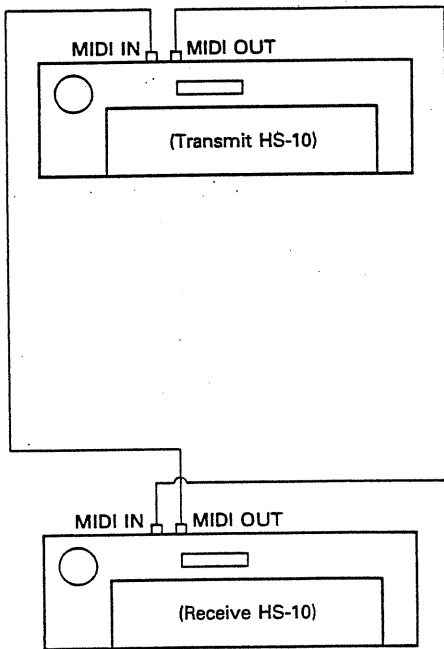

#### <OPERATION>

- ① Turn the Memory Protect Switch ⑦ on the receive HS-10 to the OFF position.
- ② On the receive HS-10, push the Number Selector Button ② (\*1 Bulk Load) while holding the Data Transfer Button ⑦ down.

The Display ⑩ will react as shown below, and the unit is ready to receive data.

While holding the Data Transfer Button ⑦ down.

Select Type.....



When the Number Selector Button ② is pushed.

Bulk Load MIDI..

- ③ On the transmit HS-10, push the Number Selector Button ① (\*2 Bulk Dump) while holding the Data Transfer Button ⑦ down.

The Display ⑩ will react as shown below, and the unit will begin to transmit data.

While holding the Data Transfer Button ⑦ down.

Select Type.....



When the Number Selector Button ① is pushed.

Bulk Dump MIDI..



- ④ When the data transfer is completed, the Displays ⑩ of the receive and transmit HS-10's will respond with:

Transmit HS-10

Bulk Dump ..END.

Receive HS-10

Bulk Load ..END.

When error indication is shown in the Display as below, check if the connections are made correctly and securely.

Receive HS-10

Bulk Load ERR !













- ⑤ Return the Memory Protect Switch ⑦ on the receive HS-10 to the ON position.

**\*1 Bulk Load means loading the entire data in the Memory group (=64 tone colors) from other HS-10 by means of MIDI Exclusive.**

**\*2 Bulk Dump means transferring the entire data in the Memory group (=64 tone colors) to other HS-10 by means of MIDI Exclusive.**

## 4 APPENDIX

### 1. Parameter Table

Parameter		Value	
Display ⑩		Display ⑩	
DCO RNG	DCO Range	32° ~ 4°	
DCO LFO	DCO LFO Depth	00 ~ 127	
DCO ENV	DCO ENV Depth	00 ~ 127	
DCO ENV	DCO ENV Mode	   	Normal Invert Normal with Dynamics Invert with Dynamics
DCO AFTR	DCO Aftertouch Sensitivity	00 ~ 15	
DCO BEND	DCO Bender Range	00 ~ 12	
PULSE	DCO Pulse Waveform	00 01 02 03	OFF   
SAWTOOTH	DCO Sawtooth Waveform	00 01 02 03 04 05	OFF     

Parameter		Value	
Display ⑩		Display ⑩	
SUB	DCO Sub Oscillator Waveform	00	
		01	
		02	
		03	
		04	
		05	
SUB LEVL	DCO Sub Oscillator Level	00 ~ 03	
NOIS LVL	DCO Noise Level	00 ~ 03	
PW/PWM	DCO PW/PWM Depth	00 ~ 127	
PWM RATE	DCO PWM Rate	00 ~ 127	
HPF FREQ	HPF Cutoff Frequency	00 ~ 03	
VCF FREQ	VCF Cutoff Frequency	00 ~ 127	
VCF RESO	VCF Resonance	00 ~ 127	
VCF ENV	VCF ENV Depth	00 ~ 127	
VCF ENV	VCF ENV Mode		Normal
			Invert
			Normal with Dynamics
			Dynamics
VCF LFO	VCF LFO Depth	00 ~ 127	
VCF KYBD	VCF Keyboard Follower	00 ~ 15	

Parameter		Value	
Display ⑩		Display ⑩	
UCF AFTR	Aftertouch Sensitivity	00 ~ 15	
VCA LEVL	VCA Level	00 ~ 127	
VCA ENV	VCA ENV Mode	↘ GT DT↘ DGT	ENV Gate ENV with Dynamics Gate with Dynamics
VCA AFTR	VCA Aftertouch Sensitivity	00 ~ 15	
CHORUS	Chorus	ON / OFF	
CRS RATE	Chorus Rate	00 ~ 127	
LFO RATE	LFO Rate	00 ~ 127	
LFO DELY	LFO Delay Time	00 ~ 127	
ENV T1	ENV Time 1	00 ~ 127	
ENV L1	ENV Level 1	00 ~ 127	
ENV T2	ENV Time 2	00 ~ 127	
ENV L2	ENV Level 2	00 ~ 127	
ENV T3	ENV Time 3	00 ~ 127	
ENV L3	ENV Level 3	00 ~ 127	
ENV T4	ENV Time 4	00 ~ 127	
ENV KYBD	ENV Keyboard Follower	00 ~ 15	

## 2. Error Message Table

Display ⑩	Description
Memory Protected	You have tried to write into the back-up memory when the Memory Protect Switch ⑦ set to the ON position.
Load ERR!	The tone color data has not been completely received from the tape.
Verify ERR!	The data saved on the tape is different from the one in the back-up memory.
Bulk Load ERR!	The bulk dump data has not been completely received.
Bulk DUMP ERR!	The bulk dump data has not been completely transferred.
Check Battery!!	The battery for back-up memory is flat. * When this indication is shown, the data in the back-up memory is lost. Consult with your local Roland dealer.

3. Memo

HS-10 TONE NAME

DATE: \_\_\_\_\_

TITLE: \_\_\_\_\_ PROGRAMMER: \_\_\_\_\_

Number Bank	1	2	3	4	5	6	7	8
1								
2								
3								
4								
5								
6								
7								
8								

## 5 SPECIFICATIONS

**HS-10 (SynthPlus 10): 6 voice polyphonic and programmable synthesizer**

**Keyboard** 49 keys, 4 octaves, C scale

**Memory Capacity** 64 RAM tone colors  
64 ROM tone colors

### Panel Switch Section

Group Selector Buttons  
Bank Selector Buttons (1 to 8)  
Number Selector Buttons (1 to 8)  
Tune/Function Button  
MIDI Button  
Key Transpose Button  
Data Transfer Button  
Parameter Selector Button  
Value Button  
Write Button  
Tone Modify Mode Buttons (Modulation Rate,  
Depth, Brilliance, Envelope Time)

### Control Section

$\alpha$  Dial  
Volume Knob  
Octave Transpose Buttons (Normal, Down)  
Portamento Button  
Chord Memory Button  
Pitch Bender/Modulation Lever

### Display Window

16 figures, LCD (with light)

### Indicators

Key Transpose Indicator  
Octave Transpose Indicators (Normal, Down)  
Portamento Indicator  
Chord Memory Indicator

### Rear Panel

Output Jacks (Mono, Stereo)  
Headphones Jack (8 to 150 $\Omega$  at Stereo)  
Hold Pedal Jack  
Pedal Switch Jack  
Foot Control Jack  
Save Jack  
Load Jack  
Memory Protect Switch  
MIDI Connectors (IN, OUT, THRU)  
Power Switch

**Dimensions** 802(W)  $\times$  240(D)  $\times$  79(H) mm  
31 $\frac{1}{2}$ "(W)  $\times$  9 $\frac{1}{2}$ "(D)  $\times$  3 $\frac{1}{8}$ "(H)

**Weight** 5.4kg/11 lb 14 oz

**Consumption** 12W

**Accessories** Music Rest  
Connection Cable LP-25 (X1)

### OPTIONS

Stereo Headphones RH-10  
Expression Pedal EV-5  
Pedal Switch DP-2, FS-1  
Stand KS-6  
Carrying Case AB-3  
MIDI/SYNC Cable MSC-07, 15, 25, 50, 100





6-voice polyphonic synthesizer

MODEL **HS-10** MIDI Implementation Chart

Date : Jan.27 1986  
Version : 1.1

Function.....		Transmitted	Recognized	Remarks
Basic Channel	Default	1 - 16	1 - 16	memorized
	Changed	1 - 16	1 - 16	
Mode	Default	Mode 3	Mode 1, 3	memorized
	Messages Altered	POLY; OMNI OFF *****	MONO, POLY, OMNI ON/OFF MONO(m ≠ 1) → Mode 1, 3	
Note Number	True voice	12 - 108	0 - 127	
		*****	12 - 108	
Velocity	Note ON	*	○ v = 1-127	
	Note OFF	× 9n v = 0	×	
After Touch	Key's	×	×	
	Ch's	×	*	
Pitch Bender		*	* 0 - 12 semi	9 bit resolution
Control Change	1	* Mod. lever	* Mod. depth	Modulation
	4	* Foot cont. in	* After touch	
	5	×	*	Portamento Time
	7	* Foot cont. in	** volume	
	64	* Pedal sw.	* Hold	Hold-1 Portamento Switch
	65	*	*	
Prog Change	True #	* 0-127	* 0 - 127	
		*****	0 - 127	
System Exclusive		*	*	
System Common	Song Pos	×	×	
	Song Sel	×	×	
	Tune	×	×	
System Real Time	Clock	×	×	
	Commands	×	×	
Aux Messages	Local ON/OFF	×	○	memorized
	All Notes OFF	○ (123)	○ (123 - 127)	
	Active Sense	×	○	
	Reset	×	×	
Notes		* Can be set to ○ or × manually, and memorized. The velocity value can be changed by FOOT CONTROL volume. ** Volume can adjust the volume of the sound within adjusted level by the panel volume knob.		

Mode 1 : OMNI ON, POLY

Mode 2 : OMNI ON, MONO

○ : Yes

Mode 3 : OMNI OFF, POLY

Mode 4 : OMNI OFF, MONO

× : No

# MODEL HS-10 MIDI Implementation

Date : Jan. 27 1986  
Version : 1.2

## 1. TRANSMITTED DATA

Status	Second	Third	Description	
1001 nnnn	0kkk kkkk	0vvv vvvv	Note ON kkkkkk = 12 - 108 vvvvvv = 16 - 127 (FOOT CONTROL ON) vvvvvv = 64 (FOOT CONTROL OFF)	#1
1001 nnnn	0kkk kkkk	0000 0000	Note OFF kkkkkk = 12 - 108	
1011 nnnn	0000 0001	0vvv vvvv	Modulation vvvvvv = 0 - 127	#2
1011 nnnn	0000 0100	0vvv vvvv	Foot type controller vvvvvv = 0 - 127	#1, #2
1011 nnnn	0000 0111	0vvv vvvv	Main volume vvvvvv = 0 - 127	#1
1011 nnnn	0100 0000	0111 1111	Hold ON	#2
1011 nnnn	0100 0000	0000 0000	Hold OFF	#2
1011 nnnn	0100 0001	0111 1111	Portamento ON	#2
1011 nnnn	0100 0001	0000 0000	Portamento OFF	#2
1100 nnnn	0ppp pppp		Program Change pppppp = 0 - 127	#2, #3
1110 nnnn	0bbb bbbb	0bbb bbbb	Pitch Bender Change	#2
1011 nnnn	0111 1011	0000 0000	ALL NOTES OFF	#4
1011 nnnn	0111 1100	0000 0000	OMNI OFF	#4
1011 nnnn	0111 1111	0000 0000	POLY ON	#4

### Notes :

#1 The data to be transmitted (0vvvvvv) in each FOOT CNT function is determined by the value of Foot Control volume as shown in the table below.

Transmitted data	FOOT CNT function
vvvvvv	DYNMCS AFTER VOLUME
9n kk vv (note on)	16 - 127 64 64
Bn O4 vv (foot type)	***** 0 - 127 *****
Bn O7 vv (main volume)	***** ***** 0 - 127

\*\*\*\*\* : not transmitted

While 'CHORD MEMORY' is on, modified notes with CHORD MEMORY are transmitted.

The value of the main volume message is controlled only by Foot Control In.

- #2 Transmitted if the corresponding function switch is ON. (The Foot Control corresponds to the AFTER switch in the MIDI function.)
- #3 0 - 63 : MEMORY GROUP  
64 - 127 : PRESET GROUP
- #4 When power up or MIDI channel number is set.

## 2. RECOGNIZED RECEIVE DATA

Status	Second	Third	Description	
1000 nnnn	0kkk kkkk	0vvv vvvv	Note OFF, velocity ignored	
1001 nnnn	0kkk kkkk	0000 0000	Note OFF kkkkkk = 0 - 127 (12 - 108)	#1
1001 nnnn	0kkk kkkk	0vvv vvvv	Note ON kkkkkk = 0 - 127 (12 - 108) vvvvvv = 1 - 127	#1
1011 nnnn	0000 0001	0vvv vvvv	Modulation vvvvvv = 0 - 127	#2
1011 nnnn	0000 0100	0vvv vvvv	Foot Control vvvvvv = 0 - 127	#3
1011 nnnn	0000 0101	0vvv vvvv	Portamento Time vvvvvv = 0 - 127	#2
1011 nnnn	0000 0111	0vvv vvvv	Main volume vvvvvv = 0 - 127	#2, #7
1011 nnnn	0100 0000	01xx xxxx	Hold ON	#2
1011 nnnn	0100 0000	00xx xxxx	Hold OFF	#2
1011 nnnn	0100 0001	01xx xxxx	Portamento ON	#2
1011 nnnn	0100 0001	00xx xxxx	Portamento OFF	#2
1100 nnnn	0ppp pppp		Program Change pppppp = 0 - 127	#2, #4
1101 nnnn	0vvv vvvv		Channel After Touch vvvvvv = 0 - 127	#2
1110 nnnn	0bbx xxxx	0bbb bbbb	Pitch Bender Change	#2
1011 nnnn	0111 1010	0000 0000	Local OFF	#5
1011 nnnn	0111 1010	0111 1111	Local ON	#5
1011 nnnn	0111 1011	0000 0000	ALL NOTES OFF	#6
1011 nnnn	0111 1100	0000 0000	OMNI OFF	#6
1011 nnnn	0111 1101	0000 0000	OMNI ON	#6
1011 nnnn	0111 1110	0000 0000	MONO ON	#6
1011 nnnn	0111 1111	0000 0000	POLY ON	#6
1111 1110			Active Sensing	

### Notes :

#1 Note numbers outside the range 12 - 108 are transposed to the nearest octave inside this range.

While 'CHORD MEMORY' is on, modified notes with CHORD MEMORY are sounded.

#2 Recognized if the corresponding MIDI function switch is ON.

#3 The Foot Control can be recognized specifically when AFTER is selected in the FOOT CNT function and AFTER in the MIDI function is on, and works just like the Channel After Touch.

#4 0 - 63 : MEMORY GROUP  
64 - 127 : PRESET GROUP

#5 Ignored during any key on.

#6 Mode Messages (123 - 127) are also recognized as ALL NOTES OFF.

Mode Messages are recognized as follows:

	POLY ON (127)	MONO ON (126)	MONO ON (126)
	mmmm = 1	mmmm = 1	mmmm < 1
OMNI OFF (124)	OMNI = OFF POLY	OMNI = OFF MONO **	OMNI = OFF POLY
OMNI ON (125)	OMNI = ON POLY	OMNI = ON MONO **	OMNI = ON POLY

\*\* 'CHORD MEMORY' on

#7 The volume of the sound can be controlled by main volume message within level which adjusted by the panel volume knob.

## 3. TRANSMITTED EXCLUSIVE MESSAGES

# Transmitted if EXCL in the MIDI function is on.

### 3.1 All Tone Parameters with Tone names ( APR )

When the Group, Bank or Number is changed.

Byte	Description
a 1111 0000	Exclusive status
b 0100 0001	Roland ID #
c 0011 0101	Operation code = APR (all parameters)
d 0000 nnnn	Unit # = MIDI basic channel, nnnn = 0 - 15 where nnnn + 1 = channel #
e 0010 0011	Format type (JU-1, JU-2)
f 0010 0000	Level # = 1
g 0000 0001	Group #
h 0vvv vvvv	Value ( 0 - 127 )
i 00tt tttt	In sequence (36 bytes total) Tone name ( 0 - 63 )
j 1111 0111	In sequence (10 bytes total) End of System Exclusive

### 3.2 Individual Tone Parameter ( IPR )

When the Parameters are changed.

Byte	Description
a 1111 0000	Exclusive status
b 0100 0001	Roland ID #
c 0011 0110	Operation code = IPR (individual parameter)
d 0000 nnnn	Unit # = MIDI basic channel, nnnn = 0 - 15 where nnnn + 1 = channel #
e 0010 0011	Format type (JU-1, JU-2)
f 0010 0000	Level # = 1
g 0000 0001	Group #
h 0ppp pppp	Parameter # ( 0 - 35, 48 )
i 0vvv vvvv	Value ( 0 - 127 )
j 1111 0111	h and i ( repetitively ) End of System Exclusive

4. RECOGNIZED EXCLUSIVE MESSAGES

\*Received if EXCL in the MIDI function is on.

4.1 All Tone Parameters without Tone names ( APR )

Byte	Description
a 1111 0000	Exclusive status
b 0100 0001	Roland ID #
c 0011 0101	Operation code = APR (all parameters)
d 0000 nnnn	Unit # = MIDI basic channel, nnnn = 0 - 15 where nnnn + 1 = channel #
e 0010 0011	Format type ( JU-1, JU-2 )
f 0010 0000	Level # = 1
g 0000 0001	Group #
h 0vvv vvvv	Value ( 0 - 127 )
i 1111 0111	In sequence (36 bytes total) End of System Exclusive

4.2 Bulk Dump ( BLD )

Bulk Dump has no relation with the EXCL in the MIDI function. When the 'DATA TRANSFER Button', 'WRITE Button' and 'BULK LOAD Button' are pressed.

Byte	Description
a 1111 0000	Exclusive status
b 0100 0001	Roland ID #
c 0011 0111	Operation code = BLD (bulk dump)
d 0000 nnnn	Unit # = MIDI basic channel, nnnn = 0 - 15 where nnnn + 1 = channel #
e 0010 0011	Format type ( JU-1, JU-2 )
f 0010 0000	Level # = 1
g 0000 0001	Group #
h 0000 0000	Extension of program #
i 00pp pppp	Program #
j 0000 tttt	Some sets of TONE data
k 1111 0111	End of System Exclusive

Notes :

The Program # is recognized as the first TONE number of the TONE data sets.  
32 bytes are recognized as a set of TONE data.  
TONE data is received in four-bit nibbles, right justified, least significant nibble received first.  
See 3.3 Bulk Dump, to understand the TONE data format.

4.3 Other Exclusive messages are described in section 3.

5. HANDSHAKING COMMUNICATION

5.1 Message type

5.1.1 Want to send a file (WSF)

Byte	Description
a 1111 0000	Exclusive status
b 0100 0001	Roland ID #
c 0100 0000	Operation code = WSF
d 0000 nnnn	Unit # = MIDI basic channel, nnnn = 0 - 15 where nnnn + 1 = channel #
e 0010 0011	Format type ( JU-1, JU-2 )
f 1111 0111	End of System Exclusive

5.1.2 Request a file (RQF)

Byte	Description
a 1111 0000	Exclusive status
b 0100 0001	Roland ID #
c 0100 0001	Operation code = RQF
d 0000 nnnn	Unit # = MIDI basic channel, nnnn = 0 - 15 where nnnn + 1 = channel #
e 0010 0011	Format type ( JU-1, JU-2 )
f 1111 0111	End of System Exclusive

5.1.3 Data (DAT)

Byte	Description
a 1111 0000	Exclusive status
b 0100 0001	Roland ID #
c 0100 0010	Operation code = DAT
d 0000 nnnn	Unit # = MIDI basic channel, nnnn = 0 - 15 where nnnn + 1 = channel #
e 0010 0011	Format type ( JU-1, JU-2 )
f 0000 tttt	4 sets of TONE data ( 256 bytes )
g 0sss ssss	Check sum
h 1111 0111	End of System Exclusive

Notes :

TONE data is sent in four-bit nibbles, right justified, least significant nibble sent first.  
See 3.3 Bulk Dump, to understand the TONE data format.  
Summed value of the all bytes in data and the check sum must be 0 (7bits).

5.1.4 Acknowledge (ACK)

Byte	Description
a 1111 0000	Exclusive status
b 0100 0001	Roland ID #
c 0100 0011	Operation code = ACK
d 0000 nnnn	Unit # = MIDI basic channel, nnnn = 0 - 15 where nnnn + 1 = channel #
e 0010 0011	Format type ( JU-1, JU-2 )
f 1111 0111	End of System Exclusive

5.1.5 End of file (EOF)

Byte	Description
a 1111 0000	Exclusive status
b 0100 0001	Roland ID #
c 0100 0101	Operation code = EOF
d 0000 nnnn	Unit # = MIDI basic channel, nnnn = 0 - 15 where nnnn + 1 = channel #
e 0010 0011	Format type ( JU-1, JU-2 )
f 1111 0111	End of System Exclusive

5.1.6 Communication error (ERR)

Byte	Description
a 1111 0000	Exclusive status
b 0100 0001	Roland ID #
c 0100 1110	Operation code = ERR
d 0000 nnnn	Unit # = MIDI basic channel, nnnn = 0 - 15 where nnnn + 1 = channel #
e 0010 0011	Format type ( JU-1, JU-2 )
f 1111 0111	End of System Exclusive

5.1.7 Rejection (RJC)

Byte	Description
a 1111 0000	Exclusive status
b 0100 0001	Roland ID #
c 0100 1111	Operation code = RJC
d 0000 nnnn	Unit # = MIDI basic channel, nnnn = 0 - 15 where nnnn + 1 = channel #
e 0010 0011	Format type ( JU-1, JU-2 )
f 1111 0111	End of System Exclusive

5.2 Sequence of communication

5.2.1 In the 'Dump' mode.

this unit	message	objective unit
-----	WSF ----->	
	<----- ACK or ( RQF )	
	DAT ----->	
	<----- ACK	
	:	
	:	
	DAT ----->	
	<----- ACK	
	EOF ----->	
	<----- ACK	

5.2.2 In the 'Load' mode.

this unit	message	objective unit
-----	RQF----->	
	( <----- WSF	
	ACK -----> )	
	<----- DAT	
	ACK ----->	
	:	
	:	
	<----- DAT	
	ACK ----->	
	<----- EOF	
	ACK ----->	

Notes :

- \* This unit sends RJC and the sequence is discontinued when it receives ERR or detects some error.
- \* This unit sends RJC when the sequence is discontinued manually.
- \* This unit stops the sequence if the unit receives RJC.

Notes :

Parameter #	Function	Value
0	DCO ENV MODE	0 = ENV normal 1 = ENV inverted 2 = ENV normal with dynamics 3 = ENV inverted with dynamics
1	VCF ENV MODE	0 = ENV normal 1 = ENV inverted 2 = ENV normal with dynamics 3 = dynamics
2	VCA ENV MODE	0 = ENV 1 = GATE 2 = ENV with dynamics 3 = GATE with dynamics
3	DCO WAVEFORM PULSE	0 - 3
4	DCO WAVEFORM SAWTOOTH	0 - 5
5	DCO WAVEFORM SUB	0 - 5
6	DCO RANGE	0 = 4' 1 = 8' 2 = 16' 3 = 32'
7	DCO SUB LEVEL	0 - 3
8	DCO NOISE LEVEL	0 - 3
9	HFP CUTOFF FREQ	0 - 3
10	CHORUS	0 = OFF 1 = ON
11	DCO LFO MOD DEPTH	0 - 127
12	DCO ENV MOD DEPTH	0 - 127
13	DCO AFTER DEPTH	0 - 127
14	DCO PW/PWM DEPTH	0 - 127
15	DCO PWM RATE	0 = PW manual 1 - 127 = PWM LFO RATE
16	VCF CUTOFF FREQ	0 - 127
17	VCF RESONANCE	0 - 127
18	VCF LFO MOD DEPTH	0 - 127
19	VCF ENV MOD DEPTH	0 - 127
20	VCF KEY FOLLOW	0 - 127
21	VCF AFTER DEPTH	0 - 127
22	VCA LEVEL	0 - 127
23	VCA AFTER DEPTH	0 - 127
24	LFO RATE	0 - 127
25	LFO DELAY TIME	0 - 127
26	ENV T1	0 - 127 (ATTACK TIME)
27	ENV L1	0 - 127 (ATTACK LEVEL)
28	ENV T2	0 - 127 (BREAK TIME)
29	ENV L2	0 - 127 (BREAK LEVEL)
30	ENV T3	0 - 127 (DECAY TIME)
31	ENV L3	0 - 127 (SUSTAIN LEVEL)
32	ENV T4	0 - 127 (RELEASE TIME)
33	ENV KEY FOLLOW	0 - 127
34	CHORUS RATE	0 - 127
35	BENDER RANGE	0 - 12
36	- 45	
	TONE NAME	0 - 63 (TONE NAME table)
		0=A 16=G 32=g 48=x 1=B 17=R 33=h 49=x 2=C 18=S 34=i 50=y 3=D 19=T 35=j 51=z 4=E 20=U 36=k 52=0 5=F 21=v 37=l 53=1 6=G 22=W 38=m 54=2 7=H 23=X 39=n 55=3 8=I 24=Y 40=o 56=4 9=J 25=Z 41=p 57=5 10=K 26=a 42=q 58=6 11=L 27=b 43=r 59=7 12=M 28=c 44=s 60=8 13=N 29=d 45=t 61=9 14=O 30=e 46=u 62=space 15=P 31=f 47=v 63=-
46,47	reserved	
48	TONE MODIFY (ignored if received)	0 = ENV TIME (increment) 1 = BRILLIANCE (increment) 2 = MOD DEPTH (increment) 3 = MOD RATE (increment) 16 = ENV TIME (decrement) 17 = BRILLIANCE (decrement) 18 = MOD DEPTH (decrement) 19 = MOD RATE (decrement)

3.3 Bulk Dump (BLD)

Bulk Dump has no relation with the EXCL in the MIDI function. When the 'DATA TRANSFER Button', 'WRITE Button' and 'BULK DUMP Button' are pressed.

Byte	Description
a 1111 0000	Exclusive status
b 0100 0001	Roland ID #
c 0011 0111	Operation code = BLD (bulk dump)
d 0000 nnnn	Unit # = MIDI basic channel, nnnn = 0 - 15 where nnnn + 1 = channel #
e 0010 0011	Format type (JU-1, JU-2)
f 0010 0000	Level # = 1
g 0000 0001	Group #
h 0000 0000	Extension of program #
i 00pp pppp	Program # (pppppp = n*4 : n = 0 - 15)
j 0000 tttt	4 sets of TONE data (256 bytes)
k 1111 0111	End of System Exclusive

Notes :

The Program # (i) represents the first TONE number of the TONE data sets (j). The 4 sets of TONE data are sequentially transmitted. TONE data is sent in four-bit nibbles, right justified, least significant nibble sent first. Each TONE data consists of 32 bytes. The Bulk Dump message repeats 16 times.

STONE data format

byte	msb	lab
0	DCO AFTER DEPTH	VCF KEY FOLLOW
1	VCF AFTER DEPTH	VCA AFTER DEPTH
2	ENV KEY FOLLOW	DCO BENDER RANGE
3	***	DCO LFO MOD DEPTH
4	b00	DCO ENV MOD DEPTH
5	b01	DCO PULSE PW/PWM DEPTH
6	b02	DCO PWM RATE
7	b03	VCF CUTOFF FREQ
8	b04	VCF RESONANCE
9	b05	VCF ENV MOD DEPTH
10	b06	VCF LFO MOD DEPTH
11	b07	VCA LEVEL
12	b08	LFO RATE
13	b09	LFO DELAY
14	b10	ENV T1
15	b11	ENV L1
16	b12	ENV T2
17	b13	ENV L2
18	b14	ENV T3
19	b15	ENV L3
20	b16	ENV T4
21	b17	*** TONE NAME - 1
22	b18	*** TONE NAME - 2
23	b19	*** TONE NAME - 3
24	b20	*** TONE NAME - 4
25	b21	*** TONE NAME - 5
26	b22	*** TONE NAME - 6
27	c 1	c 0 TONE NAME - 7
28	c 3	c 2 TONE NAME - 8
29	c 5	c 4 TONE NAME - 9
30	c 7	c 6 TONE NAME - 10
31		0 (dummy)

\*\*\* : 0, ignored if received

Switch bit

bit	Function	0 = OFF 1 = ON
b00	CHORUS	0 = OFF 1 = ON
b01 b02	DCO ENV MODE	ENV normal ENV inverted ENV normal with dynamics ENV inverted with dynamics
b03 b04	VCF ENV MODE	ENV normal ENV inverted ENV normal with dynamics dynamics
b05 b06	VCA ENV MODE	ENV GATE ENV with dynamics GATE with dynamics
b07 b08 b09	DCO WAVEFORM SUB	0 1 2 3 4 5
b10 b11 b12	DCO WAVEFORM SAWTOOTH	0 1 2 3 4 5
b13 b14	DCO WAVEFORM PULSE	0 1 2 3
b15 b16	HFP CUTOFF FREQ	0 1 2 3
b17 b18	DCO RANGE	4' 8' 16' 32'
b19 b20	DCO SUB LEVEL	0 1 2 3
b21 b22	DCO NOISE LEVEL	0 1 2 3
c7 c6 c5 c4 c3 c2 c1 c0	CHORUS RATE	0 v v v v v v v

vvvvvvv = 0 - 127



