



# Roland



ROLAND PIANO  
DIGITAL

HP 1700L/1700/900L/900

OWNER'S MANUAL

	<b>CAUTION</b> RISK OF ELECTRIC SHOCK DO NOT OPEN	
<b>ATTENTION</b> : RISQUE DE CHOC ELECTRIQUE NE PAS OUVRIR		
<p><b>CAUTION</b>: TO REDUCE THE RISK OF ELECTRIC SHOCK, DO NOT REMOVE COVER (OR BACK). NO USER-SERVICEABLE PARTS INSIDE. REFER SERVICING TO QUALIFIED SERVICE PERSONNEL.</p>		



The lightning flash with arrowhead symbol, within an equilateral triangle, is intended to alert the user to the presence of un-insulated "dangerous voltage" within the product's enclosure that may be of sufficient magnitude to constitute a risk of electric shock to persons.



The exclamation point within an equilateral triangle is intended to alert the user to the presence of important operating and maintenance (servicing) instructions in the literature accompanying the product.

INSTRUCTIONS PERTAINING TO A RISK OF FIRE, ELECTRIC SHOCK, OR INJURY TO PERSONS.

## IMPORTANT SAFETY INSTRUCTIONS

**WARNING** — When using electric products, basic precautions should always be followed, including the following:

1. Read all the instructions before using the product.
2. Do not use this product near water — for example, near a bathtub, washbowl, kitchen sink, in a wet basement, or near a swimming pool, or the like.
3. This product should be used only with a cart or stand that is recommended by the manufacturer.
4. This product, either alone or in combination with an amplifier and headphones or speakers, may be capable of producing sound levels that could cause permanent hearing loss. Do not operate for a long period of time at a high volume level or at a level that is uncomfortable. If you experience any hearing loss or ringing in the ears, you should consult an audiologist.
5. The product should be located so that its location or position does not interfere with its proper ventilation.
6. The product should be located away from heat sources such as radiators, heat registers, or other products that produce heat.
7. Avoid using the product where it may be affected by dust.
8. The product should be connected to a power supply only of the type described in the operating instructions or as marked on the product.
9. The power-supply cord of the product should be unplugged from the outlet when left unused for a long period of time.
10. Do not tread on the power-supply cord.
11. Do not pull the cord but hold the plug when unplugging.
12. When setting up with any other instruments, the procedure should be followed in accordance with instruction manual.
13. Care should be taken so that objects do not fall and liquids are not spilled into the enclosure through openings.
14. The product should be serviced by qualified service personnel when:
  - A. The power-supply cord or the plug has been damaged; or
  - B. Objects have fallen, or liquid has been spilled into the product; or
  - C. The product has been exposed to rain; or
  - D. The product does not appear to operate normally or exhibits a marked change in performance; or
  - E. The product has been dropped, or the enclosure damaged.
15. Do not attempt to service the product beyond that described in the user-maintenance instructions. All other servicing should be referred to qualified service personnel.

## SAVE THESE INSTRUCTIONS

**WARNING:** THIS APPARATUS MUST BE EARTHED

**IMPORTANT:** THE WIRES IN THIS MAINS LEAD ARE COLOURED IN ACCORDANCE WITH THE FOLLOWING CODE.  
GREEN-AND-YELLOW: EARTH, BLUE: NEUTRAL, BROWN: LIVE

As the colours of the wires in the mains lead of this apparatus may not correspond with the coloured markings identifying the terminals in your plug proceed as follows:

The wire which is coloured GREEN-AND-YELLOW must be connected to the terminal in the plug which is marked by the letter E or by the safety earth symbol  or coloured GREEN or GREEN-AND-YELLOW.

The wire which is coloured BLUE must be connected to the terminal which is marked with the letter N or coloured BLACK.

The wire which is coloured BROWN must be connected to the terminal which is marked with the letter L or coloured RED.

For the U.K.

The product which is equipped with a THREE WIRE GROUNDING TYPE AC PLUG must be grounded.

**Copyright © 1991 ROLAND CORPORATION**

All rights reserved. No part of this publication may be reproduced in any form without the written permission of ROLAND CORPORATION.

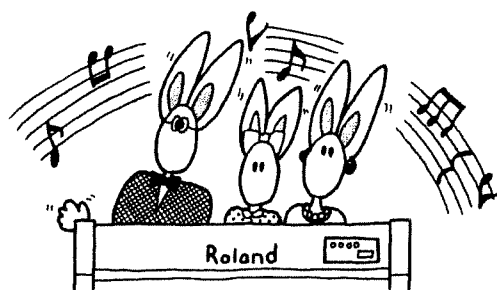

## INTRODUCTION

Thank you for purchasing the HP-1700L/1700/900L/900 Roland Digital Piano. As a further refinement of the SA sound technology found on previous Roland instruments, the HP-1700L/1700/900L/900 are based on an Advanced SA sound process which faithfully and realistically reproduces the deep lows and clear highs of a concert grand piano. The highly expressive keyboard gives you complete control over dynamics from *ppp* to *fff*. The HP-1700L/1700/900L/900 are economical and trouble-free digital instruments, built into a compact package that allows you to enjoy superb piano sound anywhere. In order to take full advantage of the wealth of features that have been made available, please take the time to read this manual in its entirety.

### Advanced SA sound process

Faithful reproduction of acoustic piano sounds is not an easy task, but Roland Digital Pianos reproduce the wide dynamic range, expressive nuances, and subtleties of hammer-strike and resonance of a concert grand piano with uncanny realism. The secret is "Advanced SA ( Structured Adaptive ) Synthesis". In SA synthesis – a Roland world's first –, the elements of a grand piano sound are extracted, analyzed, and re-synthesized to re-create the original sound. Advanced SA technology is a further refinement of this process, using Roland's proprietary digital signal processing and sound generation technology to achieve amazingly realistic and lifelike piano sounds.

## IMPORTANT NOTES

In addition to the items listed under Safety Precautions inside the cover, please read and observe the following points.

### [POWER SUPPLY]

- Before connecting this unit to other devices, turn off the power to all units to avoid malfunctions or damage to the speakers.
- Avoid using the same AC outlet as devices that generate noise (such as motors or variable lighting equipment) or devices that consume large amounts of power.

### [LOCATION]

- This unit may interfere with television and radio reception. Do not use this unit in the vicinity of such receivers.
- Do not expose this unit to temperature extremes (eg. direct sunlight in an enclosed vehicle can deform or discolor the unit) or install it near devices that radiate heat.

### [CARE]

- For everyday cleaning, wipe gently with a soft, dry cloth, or one that has been slightly dampened with water. To remove stubborn dirt, wipe with a mild neutral detergent. Afterwards, be sure to wipe with a soft, dry cloth.
- Never use solvents such as benzene, paint thinner, or alcohol, to avoid the risk of discoloration and/or deformation.

### [OTHER PRECAUTIONS]

- Protect this unit from strong impact.
- Do not allow foreign objects (paper clips or wires, etc.) or liquids (water, juice, alcohol, etc.) to enter this unit.
- Before using this unit in a foreign country, consult with qualified service personnel.
- After reading this manual, keep it in a safe place for future reference.



## FEATURES

- The quality finish brings out the natural grain of the wood. The HP-1700L and HP-900L feature a smooth-sliding keyboard cover.
- The compact design is especially convenient when it comes time to transport the instrument. Piano tuning is never required, meaning that the cost of upkeep is zero.
- Five high-quality sounds are built in, including a rich grand piano, a classic harpsichord, a vibraphone that is perfect for jazz, and an electric piano for pop or fusion.
- The Rotary Oil Damped mechanism provides quick and sensitive response to repeated notes, and comes extremely close to duplicating the feel of a concert grand piano.
- Playing strength allows complete control over tonal nuances for expressive performances. To match personal preferences, you can set the keyboard touch response to one of three settings: heavy/standard/light.
- The Sympathetic Resonance feature simulates the natural resonance that occurs between strings when the damper pedal of an acoustic piano is depressed.
- The stereo position of each note is located where it would naturally occur, with lower notes toward the left, and higher notes toward the right, simulating the natural sound field.
- Two stereo digital effect units are built in; chorus for enriching the sound, and reverb for adding the acoustic ambience of a concert hall.
- The Key Transpose function allows you to transpose the pitch to any interval; for example, letting you play that tricky D-flat piece using the fingering of the C major scale.
- The Recorder function lets you record and playback your performances just as easily as with a tape recorder.
- Line input jacks and MIDI connectors are provided, allowing you to connect other audio equipment or MIDI devices (such as ISM products). Since the sound source of the HP-1700L/1700/900L/900 is multi-timbral, you can even connect a sequencer to enjoy multi-timbral playback.

## ISM (Intelligent System of Music) [izm]



This is a series of Roland electronic musical instrument products (MT-200, PR-1 etc.: sold separately) designed to expand your system. These MIDI devices and ISM Music Data programs enhance the functionality of your Roland digital piano, providing even more creative musical possibilities. For details on ISM products, please refer to the page **P18**.

# PANEL DESCRIPTION

It will benefit you to learn the names and functions of the various parts.

## FRONT PANEL

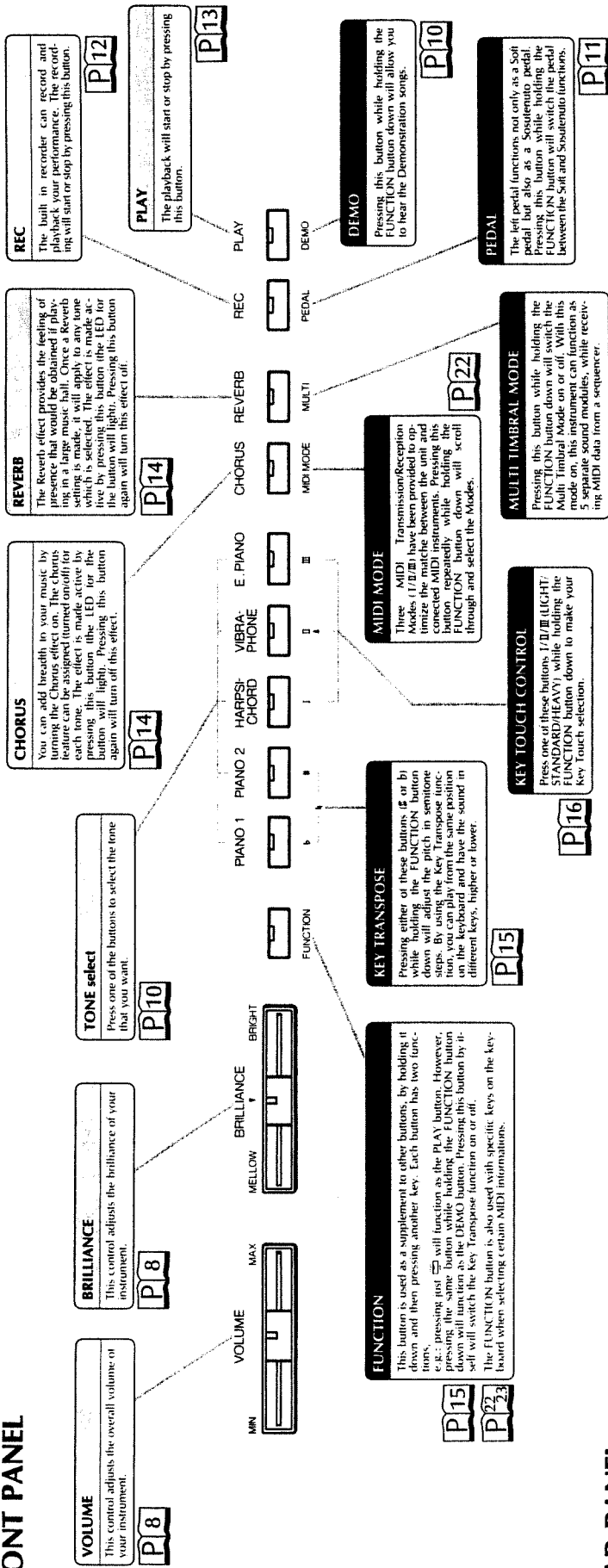

## REAR PANEL

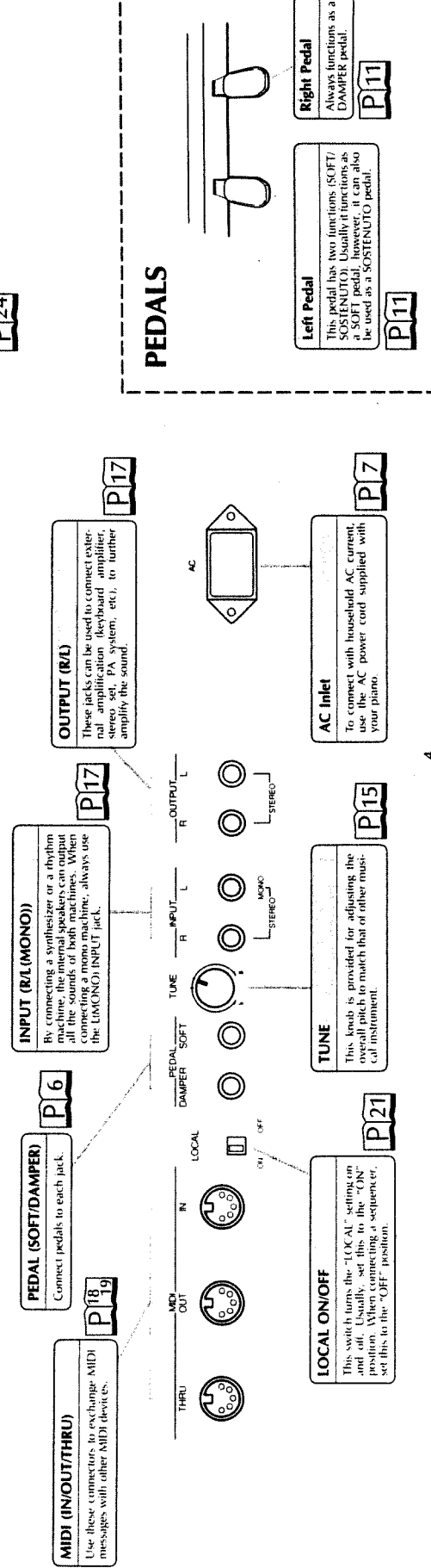





## TABLE OF CONTENTS

1	Setup	How to assemble the piano stand, Attaching the music stand, The lid (HP-1700L/900L), Moving the unit, Connect the power cable	6
2	Getting Started	Turn the power on, Adjust the volume, Adjust the brightness, Select a sound, Playback the Demo Song, Using the pedals	8
3	Using the Recorder Function	Record, Playback	12
4	Various features	Chorus, Reverb, Tuning, Key transpose, Keytouch control	14
5	Connections with audio devices	Listening to other sources through the internal speakers, Recording the piano sound on a cassette recorder, Playing at higher volume	17
6	Using MIDI	Connecting MIDI devices, MIDI Guide, Connecting a sequencer	18
7	Appendix	Troubleshooting, MIDI Implementation chart, Sound range diagram, Specifications	25
	Index	An index of terms is included at the end of the manual, allowing you to quickly find the explanation for any desired function.	29

### How to read this manual

This manual is intended especially for those who are using a digital piano for the first time. The result is a guide which provides step-by-step instructions. We recommend you read from the beginning (read the first chapter, then the second ...) while referring to the table of contents or Index when necessary. If you are already familiar with synthesizers or digital pianos, it may not be necessary for you to read this entire book. Read through the "Panel Description" once and then refer to specific pages in this manual if you need a more detailed explanation.

When you are using this piano by itself, you do not need to read chapters 5 and 6.

### Conventions used in this manual

Characters surrounded by  indicate panel buttons. For example, CHORUS indicates the CHORUS button.

# 1 Setup

## How to assemble the piano stand

### Check the parts

Ⓞ Before you begin assembly, check that you have all the parts.

- |   |                           |   |
|---|---------------------------|---|
| Ⓐ | Side board (left)         | 1 |
| Ⓑ | Side board (right)        | 1 |
| Ⓒ | Pedal board               | 1 |
| Ⓓ | Center board              | 1 |
| ① | Short screws (M4 x 27 mm) | 4 |
| ② | Long screws (M6 x 60 mm)  | 4 |
| ③ | Knob bolts                | 2 |
| ④ | Philips screwdriver       | 1 |

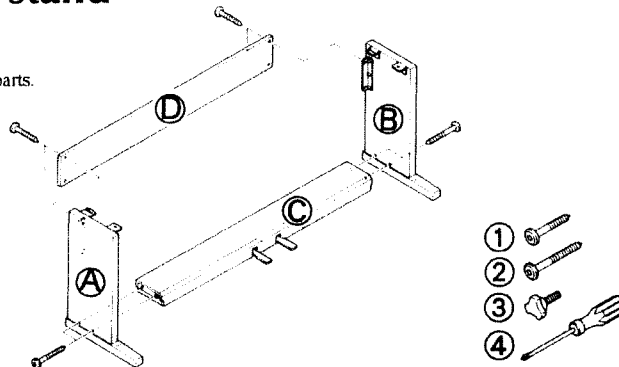

### Assembly procedure

**1 Attach the side boards (left and right) to the pedal board.**

☆ Extend the pedal cable out from the pedal board.  
 (Note) Be sure that the side boards are oriented correctly: the metal fittings are on the inside.

① Use the long screws (M6 x 60 mm) to fasten the side boards to the pedal board. (use two screws for each side.)

The metal fittings on the inside.

**2 Attach the center board.**

② Use the short screws (M4 x 27 mm) to attach the center board to the side boards. (use two screws for each side.)

**3 Attach the piano to the stand.**

(Note) When placing the piano on the stand, be careful not to pinch your fingers. (Avoid holding the ends of the piano.)

③ Align the screws (one on each side) located on the bottom of the piano with the slots in the metal fittings on the side boards. Slide the piano so the screws slide into the slots.

④ Lift up the piano and use the two connecting screws to fasten the piano to the stand. (One screw each side on the left and right.)

**4 Fasten the pedal cable with the cable clamps, and plug in the power cable and pedal cable.**

⑤ Fasten the pedal cable with the cable clamps (three locations) on the left side of the stand.

⑥ Insert the two plugs from the pedal cable into the jacks on the rear of the piano. (Insert the brown plug into the DAMPER jack (red). Insert the black plug into the SOFT jack (black).)

⑦ Connect the power cable into the AC inlet on the back panel of the piano. The power cable is included with the piano.

**5 Adjust the adjusting bolt**

☆ When you finish assembling the stand, rotate the adjusting bolt until it touches the floor.

(Note) If the piano is placed on carpeting, rotate the adjustment bolt little more.

(Note) When placing the piano in its location, be careful not to pinch the power cable underneath the piano.

⑧ Rotate the adjusting bolt until it touches the floor. (Rotate it to the right to touch the floor, and to the left to retract.)



## Attaching the music stand

The music stand is packed in the shipping carton.

- ① Hold the music stand horizontally and insert it to the holder.

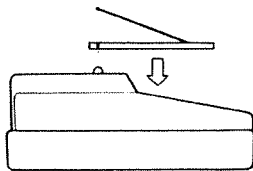

- ② Then raise the music stand.

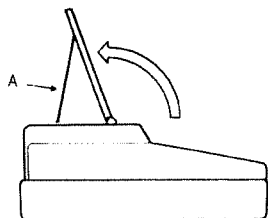

When wishing to swing the music stand to the rear, always hold it firmly on both sides, then move it gently.

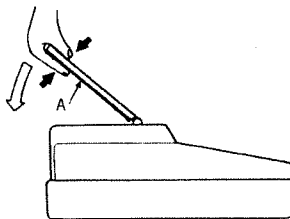

## The lid (HP-1700L/900L)

Open the lid as shown below.

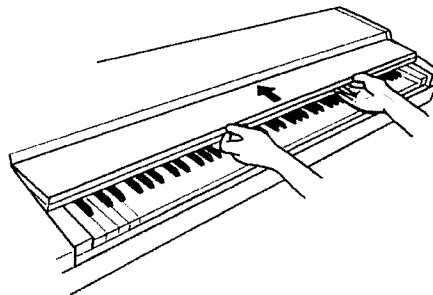

### Caution!!

Be careful not to get your fingers caught when closing the lid. To close the lid, slowly pull it completely forward, then lower it gently. Children may require help in opening and closing the lid.

## Moving the unit

To avoid accidents, always retract the adjusting bolt, close the lid, disassemble the music stand and unplug the power cord before moving the unit.

**Moving the unit should be done by two people. The unit (HP + Stand) is top-heavy, and should be handled carefully to avoid dropping it. Be careful not to drop or scratch any of the parts, or pinch your fingers.**

## Connect the power cable

- ① Check that the power switch (POWER) located on the left side of the piano is in the off position (not depressed).

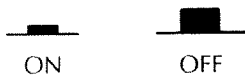

To turn the power on, press the switch. To turn the power off, press the switch again.

- ② Connect the included power cable to the AC inlet.

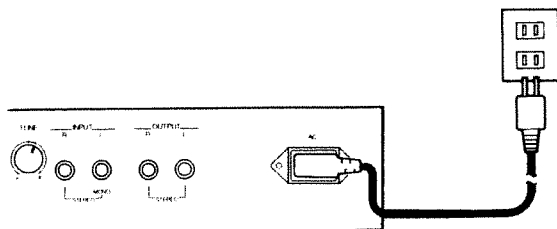

- 🎵 Use only the included power cable.
- 🎵 Be sure that the AC outlet provides the correct voltage for your unit.
- 🎵 If you will not be using the unit for an extended period of time, unplug the power cable from the AC outlet.

# 2 Getting Started

This section will explain basic operation. If you are using a digital piano for the first time, be sure to read this section first.

## Turn the power on

Press the **power switch (POWER)**.  
In a few seconds, the unit will be ready to produce sound.

 A muting circuit will operate for approximately 2 seconds after the power is turned on, so there will be no sound during this time.

Play the keyboard and you will hear the grand piano sound (PIANO1). Notice that your playing dynamics cause natural changes in timbre and volume.

## Adjust the volume

Use the **volume control (VOLUME)** to adjust the volume to a desired level. At "MAX" the volume will be at maximum, and at "MIN" the volume will be at minimum.

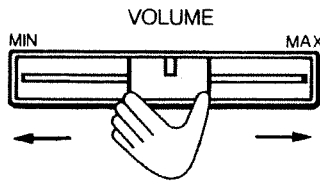

## Adjust the brightness

Use the **brilliance control (BRILLIANCE)** to adjust the desired tone quality. At "BRIGHT" the tone will be brighter, and at "MELLOW" the tone will be more mellow.

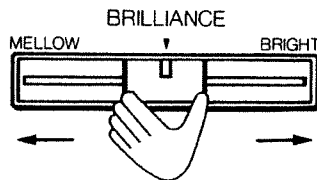

## Stereo panning

Listen carefully to the sound you play, and notice which direction it comes from. (To hear the effect most clearly, play a single note rather than a chord.) Notice that the sound of lower notes is heard more from the left side (see Fig. 1), and the sound of higher notes is heard more from the right side (see Fig. 2). This is because each note has been panned to the same stereo location (between the left and right speakers) as they would occur on an acoustic piano. This stereo panning effect adds to the realism of the soundfield.

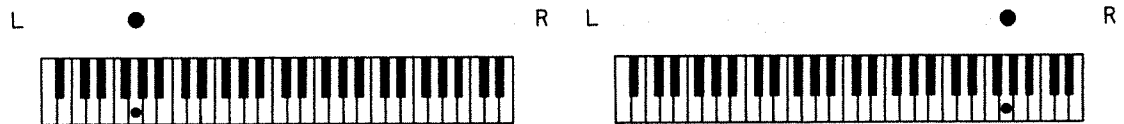
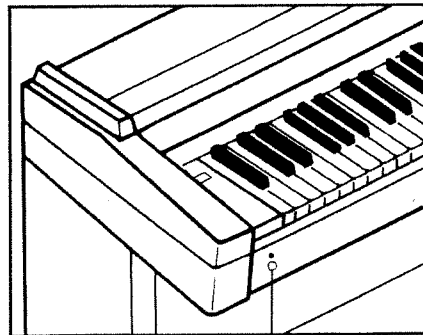

Fig. 1

Fig. 2

## Headphones

You can use stereo headphones to listen while you play. Insert the headphone plug into the headphone jack located on the left side of your instrument. This will turn off the built-in speakers, allowing you to practice privately.



The headphone volume is adjusted by the VOLUME control.

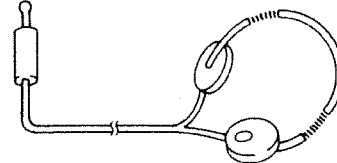

# Select a sound

Press a button to select one of the five instruments; Piano 1, Piano 2, Harpsichord, Vibraphone, or Electric Piano.



**When you select a sound**

If you select a new sound while a note is still depressed, the currently-sounding note will retain its sound, and the newly-selected sound will apply from the next note.

- Piano 1 (PIANO 1)**  
A rich-sounding, full concert grand piano.
- Piano 2 (PIANO 2)**  
A mellow-sounding, upright acoustic piano.
- Harpsichord (HARPSICHORD)**  
This delicate-sounding instrument is indispensable for Baroque music.
- Vibraphone (VIBRAPHONE)**  
A cool vibraphone sound.
- Electric piano (E.PIANO)**  
A Rhodes-type electric piano.

# Playback the Demo Song

Playing back the built-in Demo Song is a good way to hear the expressive possibilities of your new piano. You can playback the Demo Song whenever you like.



## To playback the Demo Song just once

**Title of the Song**

*“Variations”  
from Chopin’s Polonaise No.3  
«Militaire»*  
Music by F. Chopin  
Arranged by John Maul  
Copyright © 1990 by John Maul  
Piano 1 — Chopin’s Polonaise  
Harpsi. — Baroque arrangement  
E. Piano — Popular style arrangement  
Piano 2 & Vibes. — Ragtime arrangement

- ① While holding **FUNCTION**, press **DEMO** once.

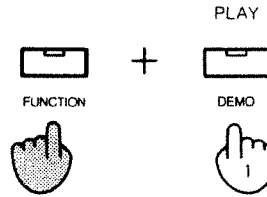

- ② The **DEMO** LED will light, and when you release **FUNCTION** the song will begin. When the song ends, the LED will go out automatically.

To stop playback, press either **PLAY** or **REC**.



## To playback the Demo Song continuously

- ① While holding **FUNCTION**, press **DEMO** twice.

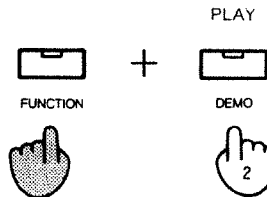

- ② The **DEMO** LED will light, and when you release **FUNCTION** the song will begin. During playback, the **PLAY** LED will blink.

The song will continue playing back until you press **PLAY** or **REC**.

**Biography of Demo Song's Arranger**

John Maul is a musician, composer and arranger having graduated from the Royal Academy of Music in London. John's work encompasses studio recordings and live performances, including work with top cabaret artists in the U.K. His writing credits include commercial music for radio and television, as well as scoring jazz and classical works. As a product specialist for Roland U.K., John's talents are well utilized in the preparation of support material for educational and instructional use.

## Using the pedals

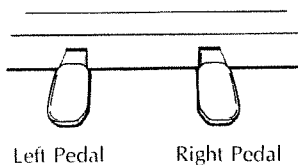

Two pedals are installed in the special stand; the **Damper pedal** on the right, and the **Soft pedal** on the left. The left pedal can also be used as a **Sostenuto pedal** (normally it functions as a Soft pedal). It is not possible for the left pedal to function simultaneously as both Soft and Sostenuto-pedals.

- **Damper pedal (right)**

Use this pedal to extend the decay of the notes. As long as you have the pedal depressed, notes will continue to decay gradually even after you release the keys. In addition, while this pedal is depressed, notes you play will cause other notes to resonate just as they would on an acoustic piano. This effect creates a richer and more natural sound (the **Sympathetic Resonance effect**).

 **The Sympathetic Resonance effect will only be heard when one of the piano sounds (PIANO 1/2) is selected. However, this effect may be unclear when the reverb is on.**

- **Soft pedal (left)**

When you press this pedal, the sound will become softer. Since pressing this pedal on a grand piano will make the keyboard slide a bit sideways, this pedal is sometimes known as the "Shift pedal".

 **Soft pedal effect will not apply to the harpsichord sound.**

- **Sostenuto pedal (left)**

Notes that were already pressed when you press this pedal will be sustained. Notes played after you press this pedal will not be affected.



### To use the left pedal as a Sostenuto pedal

① While holding **FUNCTION**, press **PEDAL**.

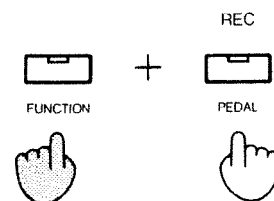

 **While you press **FUNCTION** the **PEDAL** LED will light, indicating that the pedal is functioning as the Sostenuto pedal.**

② Once again, while holding **FUNCTION**, press **PEDAL**. The LED will go out, and the pedal will function as the Soft pedal once again.

# 3 Using the Recorder Function

The built-in **recorder** function lets you record and playback a performance. During playback, you can play along if desired. This is convenient for playing duets by yourself, or for practicing. Unlike a tape recorder, the built-in recorder records not the actual sound, but rather the notes you play. It is therefore possible to select a different tone during playback of your recorded performance. To guard against accidents, the recorded notes will be stored for approximately 8 hours after the power is turned off.



Although the recorded notes will be stored for a time after the power is turned off, they will eventually disappear. If you wish to preserve your performance, you will need to connect an external sequencer and store your music on a sequencer disk. Using a sequencer will allow you to record pieces longer than would fit into the built-in recorder memory, and offers other advantages as well. For details refer to [P21](#).

## Record



### To record your own playing

- ① Press **REC** (the red LED will light).

REC



PEDAL



- ② Start playing (recording will begin when you start playing).



- ③ When you finish playing, press **REC** once again (the LED will go out).

REC



PEDAL



Program change messages and chorus, reverb on/off messages cannot be recorded in the recorder function.

 You can record up to approximately 2,000 notes. However, each press of a pedal will also be recorded, so the actual number of notes may be less.

☆ When you approach the recording limit...

REC



PEDAL

The **REC** LED will start blinking.

☆ If you continue recording...

The **REC** LED will blink faster.

☆ When no more recording is possible...

REC



PEDAL

The **REC** LED will go out, and recording will automatically stop.

 When you record again, the contents of the previous recording will be erased, and replaced by the new recording. It is not possible to recover a recording that has been erased.

## Playback



To playback your Music

① Press **PLAY**.

PLAY



DEMO



The LED will light, and playback will begin.

 If you select a new sound during play back, you can enjoy your recorded Music with different sounds.

② When your recorded Music ends, it will automatically stop and the LED will go out.

 To stop playback, press **PLAY**. When you press **PLAY** again, the song will playback from the beginning once again.

 To erase the recorded data, press **PLAY** and **REC** simultaneously.

# 4 Various Features

This section will explain more sophisticated features of the HP-1700L/1700/900L/900.

## Chorus

The Chorus effect adds depth and breath to the sound. You can set Chorus on or off independently for each sound.



### To add chorus to the sound

① Select the sound you intend to use.

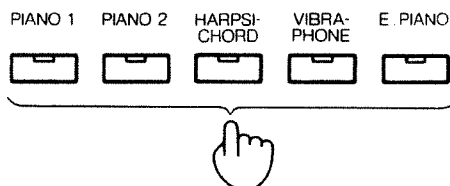

When shipped from the factory, chorus is turned on/off for each sound as follows. You are free to change these settings, but when the power is turned off, the factory settings will be restored.

Tone	Set up
Piano 1	off
Piano 2	off
Harpichord	off
Vibraphone	on
Electric piano	on

② Set the Chorus effect.

Each time you press **CHORUS**, the chorus effect will be turned on or off.

CHORUS



When the LED is lit, chorus is on,



## Reverb

Reverb is the abbreviation of "reverberation", and refers to the reflected sound that echoes back to us from the walls and ceiling of a concert hall. By turning reverb on, you can enjoy the same acoustic ambience of a spacious hall.



### To add reverb to the sound

Each time you press **REVERB**, reverb is turned on/off.

REVERB



When the LED is lit, reverb is on.



Reverb is turned on/off for all sounds. It is not possible to set reverb independently for each sound. Each time the power is turned on, reverb will be off.

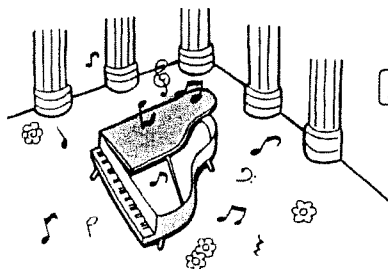



## Tuning

The tuning knob located on the rear panel allows you to tune the piano to other instruments. When the knob is in the center position, middle A will be 440 Hz. When the knob is at the “●” mark toward the “♯” side, A = 442 Hz. Tuning can be adjusted over a range of  $\pm 50$  cents.

 The tuning knob is set to the “●” position (A = 442Hz) by the manufacturer.

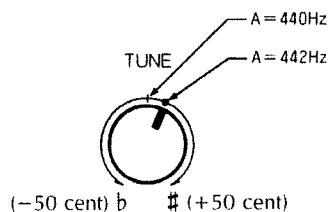

## Key transpose

The key transpose function lets you transpose the pitch without changing your keyboard fingering. This is especially convenient when you are accompanying a singer, etc.

For example if you have transposed down 5 semi-notes...

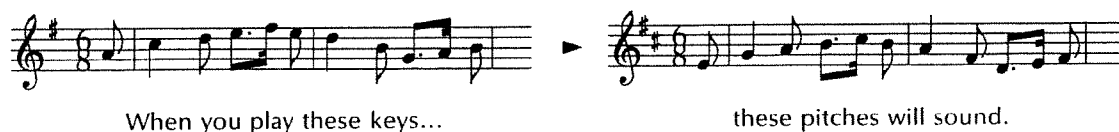



### To specify a key transposition

While holding **FUNCTION**, press either of **♯** or **♭** buttons.

Each time you press **♯** (**PIANO2**), the pitch will rise by one semi-tone (to a maximum of 5 semi-tones).

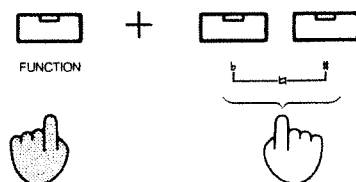
Each time you press **♭** (**PIANO1**), the pitch will become lower by one semi-tone (to a maximum of 6 semi-tones).



 By pressing both **♯** and **♭** simultaneously you can turn the transpose function off.

When you set a key transposition, the **FUNCTION** LED will light. If you press **FUNCTION** at this time, either the **♭** LED will light if the sound is lower than the key you press, or the **♯** LED will light if the sound is higher than the key you press. Press **FUNCTION** once again, and the LED will go out and the key transpose function will be turned off.

 Once you have made a key transpose setting, you can press **FUNCTION** to recall the previous setting. (The LED will light.) However, key transpose is always cancelled when you turn the power off.

## Keytouch control (adjusting the keyboard action)

You can select one of three keyboard actions to determine how sound is produced in response to your playing.

- I (Light): Since lighter than normal touch will produce fortissimo sounds, the keyboard will feel lighter. This lets children (whose fingers are not that strong) play with a consistent sound.
- II (Standard): This is the normal and most natural setting, and is closest to an acoustic piano.
- III (Heavy): Since only stronger than normal playing will produce fortissimo sounds, the keyboard will feel heavier. This will allow heavy-handed players a full range of expression.

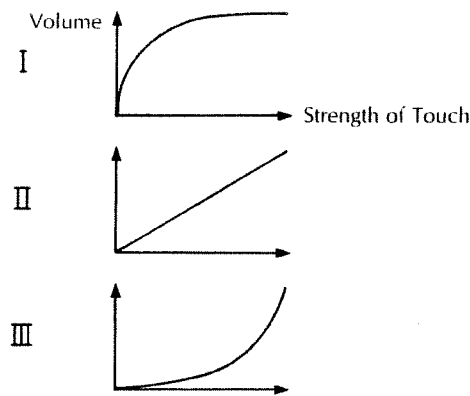

### To change the keytouch

- LIGHT: While holding **FUNCTION**, press **I**.
- STANDARD: While holding **FUNCTION**, press **II**.
- HEAVY: While holding **FUNCTION**, press **III**.

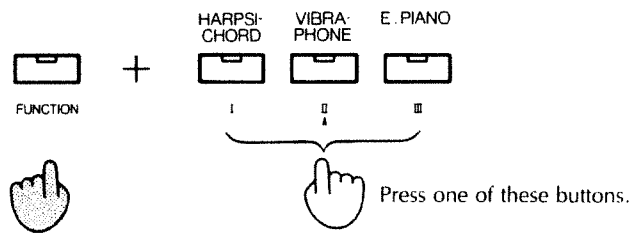

You can check your settings by pressing **FUNCTION**. While you hold the button, one of these LEDs will light to indicate the current setting.

 Each time the power is turned on, the keytouch will always be set to II (Standard).

# 5 Connecting with audio device

If you are using the HP-1700L/1700/900L/900 by itself, there is no need for you to read this section.

## Listening to other sources through the internal speakers

If you have another instrument that does not have its own speaker, you can listen to it through the HP-1700L/1700/900L/900's internal speakers.

You will need a connector cable (PJ-1M, etc.).

 If your instrument has a stereo output, you will need two cables.

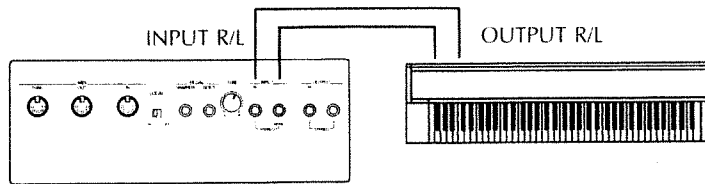

 Regulate the volume of the other instrument using its volume knob.

### PJ-1M

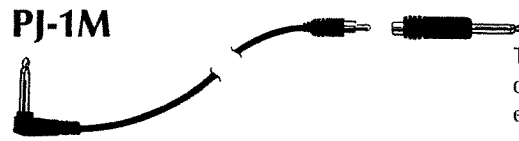



The PJ-1M (sold separately) consists of a standard cord with an adaptor plug for use with either RCA or 1/4" phone jacks.

## Recording the piano sound on a cassette tape recorder

If you have a cassette tape recorder that has LINE IN jacks, you can record the sound of the HP-1700L/1700/900L/900.

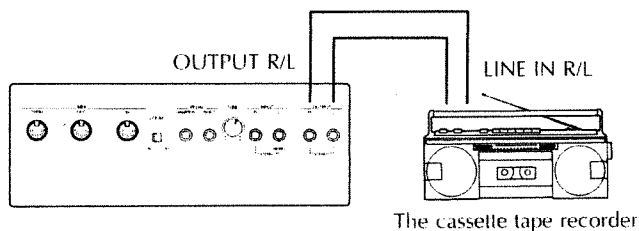
You will need a PJ-1M with the adaptor plug removed.



 If the cassette tape recorder has stereo input jacks, you will need two PJ-1M cables.

## Playing at higher volume

By connecting the HP-1700L/1700/900L/900 to a stereo or PA system, you can play at higher volumes.

You will need a PJ-1M with the adaptor plug removed.

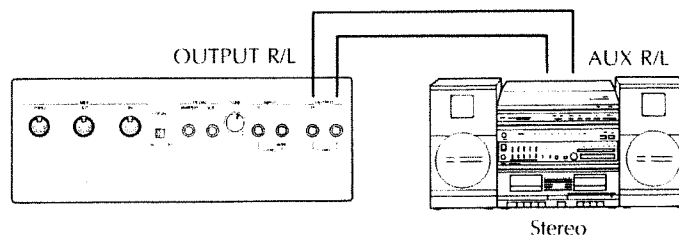

# 6 Using MIDI

## Connecting MIDI devices

“Roland Piano ISM” products (such as MT-200 and PR-1) and an “Intelligent Arranger” RA-90 allow you to expand your digital piano system for one-person sessions or ensembles, or even live performances with full orchestral accompaniment.

 If you will be connecting a PR-1 or an MT-200, first read the “MIDI Guide”. Then consult “MIDI Channel Settings” and “Program change” from the section “Connecting a sequencer” as you read this section.



### When a PR-1 is connected

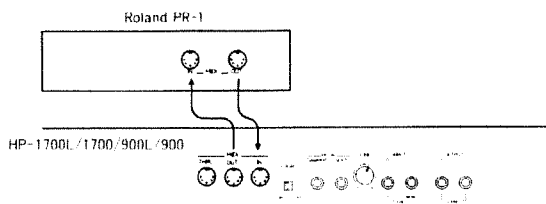

You can freely record and playback your performances. It's as easy as using a cassette tape recorder!



### When an MT-200 is connected

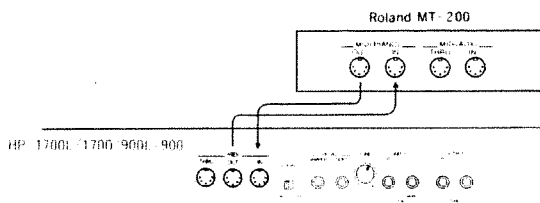

You can record multi-track songs, for composition or arranging, or simply for musically creative fun.

 By using the ISM Music Data (sold separately), you can play a piano part (even a piano concerto!) to the accompaniment of a full orchestra.

### ● When an RA-90 is connected

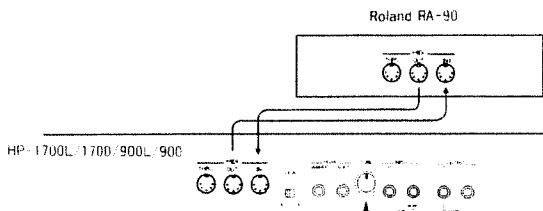

Your Roland Digital Piano will turn into an automatic accompaniment keyboard. Chords you play with the left hand will instantly be arranged into a beautiful orchestral accompaniment.

 By using Music Style Cards (TN-5C series, sold separately) you can enjoy even wider arrangement possibilities.

 When using your Roland Digital Piano together with an RA-90, set the tuning of the digital piano to A = 440 Hz (P15).

# MIDI Guide

## About MIDI

MIDI (pronounced "middy") stands for Musical Instrument Digital Interface. MIDI is a world-wide standard that allows musical instruments and computers to exchange musical data. Most electronic musical instruments sold today are MIDI compatible. MIDI-compatible devices have MIDI connectors which can be connected to each other using MIDI cables. MIDI does not transmit the sound of an instrument, but rather "messages" in digital form that tell the receiving instrument to "do something". These are known as "MIDI messages".

MIDI can be used to do a variety of things.

- Play the sounds of the HP-1700L/1700/900L/900 from other MIDI instruments.
- Play the HP-1700L/1700/900L/900 keyboard to make other MIDI instruments or **sound modules** (\*1) produce sound.
- Record your performance on the HP-1700L/1700/900L/900 into a **sequencer** (\*2), and then playback the recording to make the HP-1700L/1700/900L/900 produce sound.

(\*1) A sound module is a synthesizer or digital piano without a keyboard; i.e., a box containing only sound-producing circuitry. Sound modules produce sound in response to incoming MIDI messages. The Roland SC-33 is an example of a sound module.

(\*2) A sequencer is a device that records MIDI messages and plays them back to make MIDI instruments produce sound. Sequencers allow you to edit the recorded MIDI messages in many ways, and also let you control many MIDI instruments simultaneously to create a MIDI orchestra. The Roland PR-1 Player & Recorder and MC-50 Micro Composer are examples of sequencers. The MT-200 is a combination of a sound module and a sequencer.

## MIDI connectors

Look at the rear panel of your piano. The three MIDI connectors are used to connect the HP-1700L/1700/900L/900 to other MIDI equipment. Each connector has the following function:

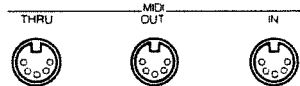

### MIDI IN

This connector is like an ear that listens to incoming messages (MIDI messages).

### MIDI OUT

This connector is like a mouth that sends messages (MIDI messages) to other devices.

### MIDI THRU

MIDI messages received at MIDI IN are re-transmitted by this connector. (This connector does not transmit messages that originate inside the unit itself.)

MIDI connectors accept a standard connector known as "5-pin DIN". You may occasionally see similar connectors on other devices, but be sure to use only cables that are intended especially for MIDI (MSC-15/25/50, sold separately).

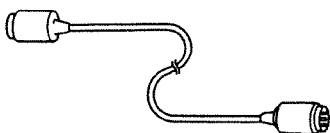

## MIDI connections

In this example we use a MIDI cable to connect two digital pianos, A and B.

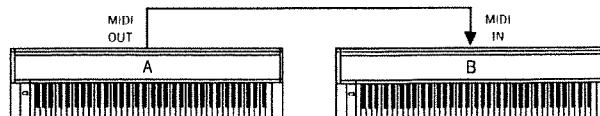

In this setup, playing the keyboard of A will cause the sound of B to be heard in unison with the sound of A. This is because when you play the note "C" on keyboard A, a message is sent from A to B saying "play the note C at such-and-such a loudness and hold the note until commanded to release it". (This is called a Note message.) B receives this message, and plays (and releases) the appropriate note with the appropriate loudness and timing.

## Master and slave

When MIDI devices are connected, the device that sends the message saying "do this" is called the "master" (the transmitter), and the device that responds to this message is called the "slave" (the receiver).

Since MIDI messages are always transmitted in one direction over a single cable, you will need to connect an additional MIDI cable from the output of B to the input of A if you want A and B to respond to each other.



## MIDI THRU connector

When transmitting the same MIDI messages to two or more slaves, use the MIDI THRU connectors.

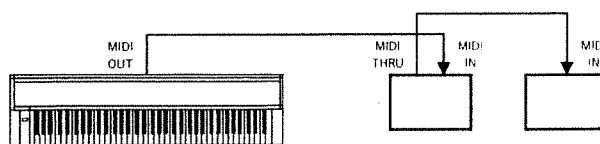

## MIDI channels

Simply connecting a MIDI cable is not always enough to establish communication. MIDI messages are transmitted on a "channel" (MIDI channel) of 1 - 16, and will be received only if the channels of the transmitter and receiver match.

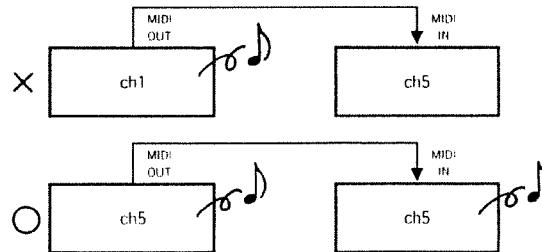

🎵 A single MIDI cable is able to carry messages of all 16 channels simultaneously.

## MIDI channels

MIDI channels are easy to understand if we use the analogy of television broadcasting. Many television programs are broadcast from many TV stations, and your TV antenna receives all of them. By setting your television to the channel you want to watch, you can watch only the desired program. The same idea applies to MIDI channels. The master device is somewhat like the broadcast station, and the slave device is like a television receiver. The MIDI messages carried by the MIDI cable are like the programs that are transmitted from the broadcast stations.

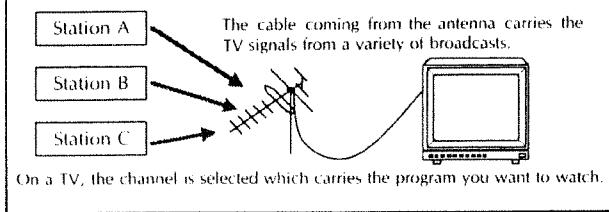

If two or more slave devices are connected, set the MIDI channel of each slave device to match the MIDI channel of the master device.

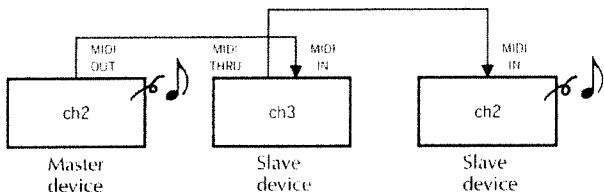

## Omni

As we mentioned earlier, it is generally necessary for the channel of the slave device to match the channel of the master device in order for MIDI messages to be received. However, there is one exception which you should know about; Omni on/off.

Omni on ..... MIDI messages of all channels will be received.  
 Omni off ..... only MIDI messages of the specified channel will be received.

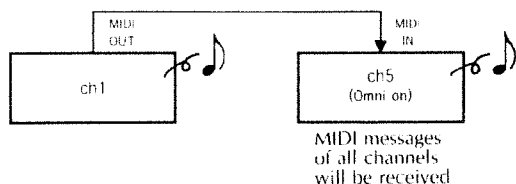

If you set the slave device to Omni on, it will receive MIDI messages regardless of the MIDI channel on which the master device transmits. However, when using a sequencer to create a MIDI ensemble, you must turn Omni off if you want each part to be played independently. Since most MIDI instruments are able to make effective use of MIDI channel, you will normally leave them set to Omni off.

## Program change messages

Program Change messages are MIDI messages that select different sounds. Actually, these messages tell the receiving device to "switch to sound number so-and-so"; not to "switch to a piano sound" (for example). The sounds of MIDI instruments are numbered from 1 to 128 (these are referred to as

program numbers), and when a program change message is received, the sound of the corresponding program number is selected. This means that even for the same program number, different instruments will produce different sounds. Make sure you know the correspondence between the program numbers and the sounds of the slave device before you transmit program change messages to it.

## Control change messages

These messages are used for greater musical expressiveness; for example by turning the chorus effect on/off or adjusting the volume. Control change messages can be divided into those that simply say "turn effect XYZ on/off", and those that say "set effect XYZ to a setting of ABC".

## MIDI messages used by the HP-1700L/1700/900L/900

The HP-1700L/1700/900L/900 uses the following MIDI messages. However, this will depend on how you set the "MIDI transmission/reception mode" [P22].

- Note messages..... are transmitted when you press a key; "play such a note at such a volume until such a time".
- Program Change messages..... "switch to sound number \*\*" is transmitted when you select sounds.
- Control Change messages.....
  - "activate the damper pedal effect" is transmitted when you press the damper pedal.
  - "activate the soft pedal effect" is transmitted when you press the soft pedal.
  - "activate the sostenuto pedal effect" is transmitted when you press the Sostenuto pedal.
  - "Turn the chorus effect on/off" is transmitted when you press [CHORUS] on/off.

🎵 When the above MIDI messages are received, the HP-1700L/1700/900L/900 will take the appropriate action by playing a note or controlling an effect. However, the MIDI messages actually used will depend on the "MIDI transmission/reception mode" [P22].

As a group, these messages are known as Channel messages, and are handled independently for each MIDI channel. In addition to these, MIDI includes messages that are handled for the entire system; system messages (for example, System Exclusive messages).

## System Exclusive messages

We mentioned earlier that MIDI is a world-wide standard, but exclusive messages are an exception to this. Exclusive messages are unique to each manufacturer. Unlike the general-purpose messages we have been describing, these messages are used to exchange information that is unique to specific manufacturers or devices.

The HP-1700L/1700/900L/900 can use the following exclusive message:  
 "Turn the reverb effect on/off" is transmitted when [REVERB] is turned on/off.  
 "Turn the Multi timbral mode on/off" is transmitted when holding [FUNCTION] and press [MULTI].

These messages allow increased musical expressiveness, but are not defined as one of the general-purpose controllers. This is why Roland uses exclusive message to cover this area. Of course, other types of instruments will not be able to understand or transmit these particular messages.

### MIDI Implementation chart

MIDI has made it possible for a wide variety of devices to exchange information, but it is not always true that all types of MIDI message can be exchanged between all types of device. For example, if you use a synthesizer as a master device to control a digital piano, the pitch bender (the lever or wheel that modifies the pitch) of the synthesizer will have no effect on the sound of the digital piano.

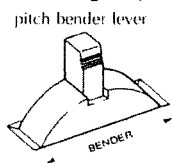

The important thing when using MIDI is that the slave device must be able to understand what the master is saying. In other words, the MIDI messages must be common to both master and slave.

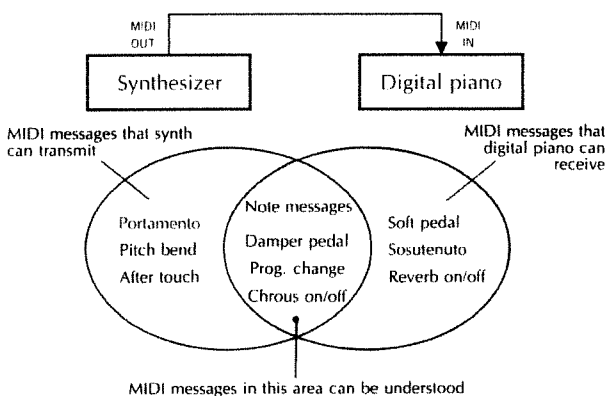

To help you quickly tell what types of MIDI message can be exchanged between master and slave, the operating manual of each MIDI device includes a "MIDI Implementation chart". By looking at this chart, you can quickly see what messages the device is able to transmit and receive. The left side of this chart lists the names of a variety of MIDI messages, and the Transmission and Reception columns use "O" and "X" marks to indicate whether or not each of these messages can be transmitted or received. This means that a certain type of MIDI message can be exchanged only if there is an "O" in both the Transmission column of the master and the Reception column of the slave. The MIDI implementation chart is always the same size and format, so you can fold the charts from two manuals together to see at a glance how the two devices can communicate.

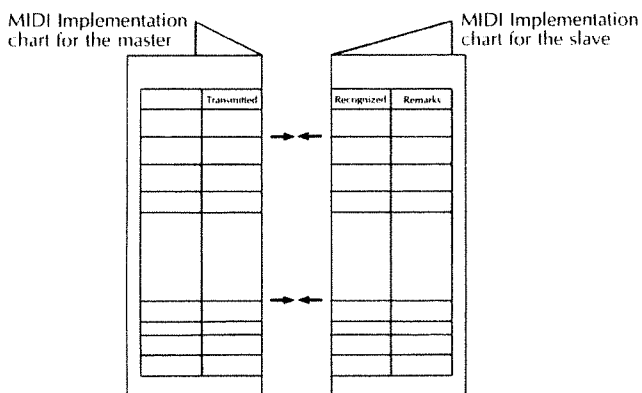

A MIDI Implementation chart is included at the end of this manual also. To avoid problems with MIDI, always compare Implementation charts before connecting this unit with other MIDI devices.

### Connecting a sequencer

If you are using a sequencer for the first time, please read the "MIDI Guide" on [P.19](#) before continuing with this section.

The following MIDI functions let you use the HP-1700L/1700/900L/900 together with a sequencer for even greater enjoyment.

- Local on/off function.
- MIDI channel settings.
- Program change.
- MIDI transmission/reception mode.
- Multi-timbral mode.

### Local on/off

When connecting a sequencer you will normally select Local Off. The Local on/off switch is located on the rear of the digital piano.

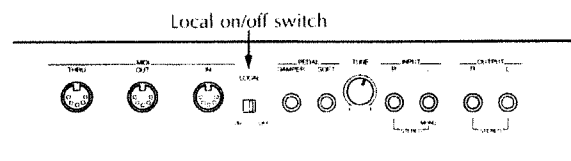

**If you are using a Roland Micro Composer MC-50, it will transmit a Local Off message, so there is no need to change this setting by yourself.**

If the digital piano is set to Local Off (when a MIDI cable is connected to the MIDI IN connector), the built-in keyboard will be disconnected from the built-in sound source, and playing the keyboard will not produce sound. However, the notes you play will trigger note message to be transmitted from the MIDI OUT connector.

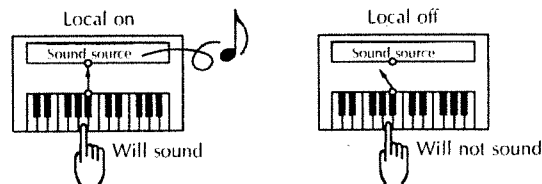

Most sequencers have a Soft Thru on/off setting. Normally this is turned on, so that musical messages received at MIDI IN are simultaneously re-transmitted from MIDI OUT. This means that while recording, you can play instruments that are connected to the MIDI OUT of the sequencer.

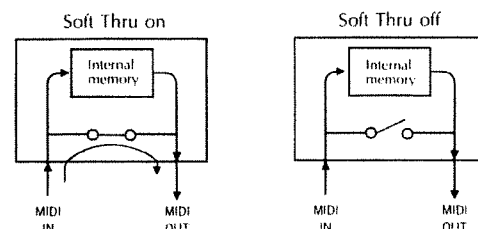

## Using MIDI

However, if the sequencer's Soft Thru function is turned on and you connect it to your digital piano set to Local On, the piano will sound in response to its own keyboard and also in response to the message re-transmitted through the sequencer. This may result in each note being played twice, or in some notes being skipped.

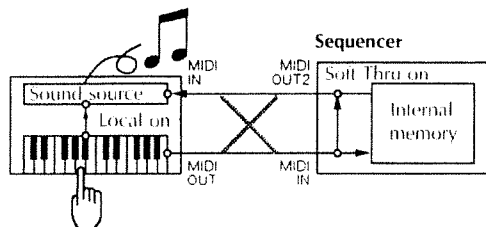

This is why you should set our sequencer to Soft Thru On, and your piano to Local Off. With these settings, there is only one route for note messages from the keyboard to reach the sound source. With this setting your music will be produced properly.

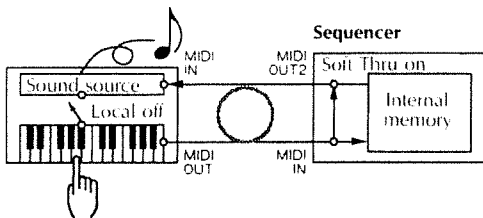

## MIDI channel settings

You can set the transmit channel and the receive channel independently.

**To set MIDI transmit and receive channels to the same setting**

- While holding **FUNCTION**, press the key corresponding to the desired MIDI channel.

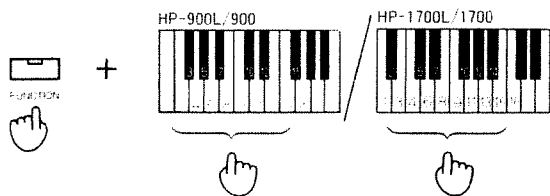

- If you hold **FUNCTION** and press the highest key, both the transmit channel and the receive channel will be set to channel 1 (receive channel: omni on).

It is also possible to set the MIDI transmit channel and receive channel to different settings.

**To set the MIDI transmit channel**

- While holding both **FUNCTION** and right pedal, press the key corresponding to the desired MIDI channel.

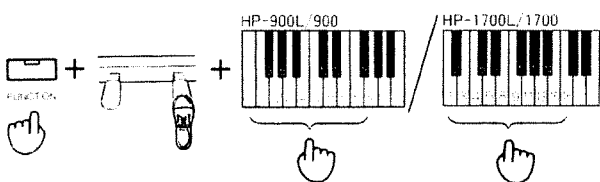

While continuing step 1, press the key corresponding to the desired MIDI channel.

**To set the MIDI receive channel**

When you set the receive channel, Omni will be turned off.

- While holding both **FUNCTION** and the left pedal, press the key corresponding to the desired MIDI channel.

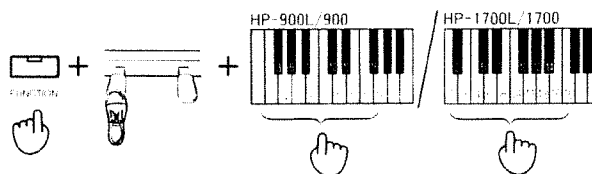

- If you hold **FUNCTION** and press the highest key, the receive channel will be set to channel 1. When the power is turned off, settings will automatically be restored to transmit channel 1 and receive channel 1 (Omni off).

## MIDI transmission/reception mode

There are three MIDI transmission/reception modes. Select the mode appropriate for your situation.

MIDI messages	Mode I		Mode II		Mode III	
	Tx.	Rx.	Tx.	Rx.	Tx.	Rx.
Note messages	○	○	○	○	○	○
Program Change messages	○	○	○	×	○*	○
Control Change messages	Volume	×	○	×	○	○
	Damper	○	○	○	○	○
	Sostenuto	○	○	○	○	○
	Soft	○	○	○	○	○
Exclusive messages	Chorus	×	×	×	○	○
	Reverb	×	×	×	×	○
	M.timbral	×	×	×	×	○

\*In Mode III, Program Change messages can be transmitted in one of two ways.

Normally Program Change messages will be transmitted only when you hold **FUNCTION** and press the corresponding keys. Moreover, Program Change messages can also be transmitted when you press one of the tone select buttons in Mode III.



**To select the mode**

- While holding **FUNCTION**, press **MIDI MODE**.

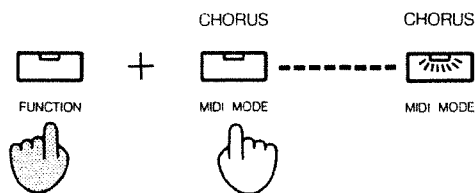

The **MIDI MODE** LED will blink, and mode II will be selected.

- While holding **FUNCTION**, press **MIDI MODE** again.

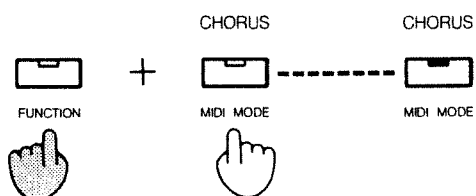

The **MIDI MODE** LED will light, and mode III will be selected.

- While holding **FUNCTION**, press **MIDI MODE** again.

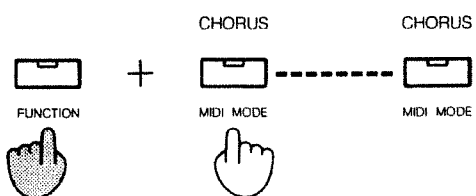

The **MIDI MODE** LED will go out, and mode I will be selected.

In this way, each time you press **MIDI MODE** while holding **FUNCTION**, you will cycle through modes I, II, and III.

- 🎵 Each time the power is turned on, mode I will be selected.

## Program changes

### <Program change transmission>

Specify a Program Change number (1~128) by selecting the Group (A/B), Bank (1~8), and Number (1~8). The selected Group/Bank/Number corresponds to the transmitted Program Change number as shown below.

Program Change Number Table

GROUP	NO. BANK	1	2	3	4	5	6	7	8
A	1	1	2	3	4	5	6	7	8
	2	9	10	11	12	13	14	15	16
	3	17	18	19	20	21	22	23	24
	4	25	26	27	28	29	30	31	32
	5	33	34	35	36	37	38	39	40
	6	41	42	43	44	45	46	47	48
	7	49	50	51	52	53	54	55	56
	8	57	58	59	60	61	62	63	64
B	1	65	66	67	68	69	70	71	72
	2	73	74	75	76	77	78	79	80
	3	81	82	83	84	85	86	87	88
	4	89	90	91	92	93	94	95	96
	5	97	98	99	100	101	102	103	104
	6	105	106	107	108	109	110	111	112
	7	113	114	115	116	117	118	119	120
	8	121	122	123	124	125	126	127	128

**To transmit a Program Change**

While holding **FUNCTION**, press the keys corresponding to the desired Group/Bank/Number.

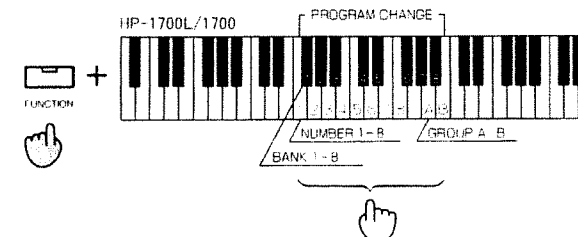
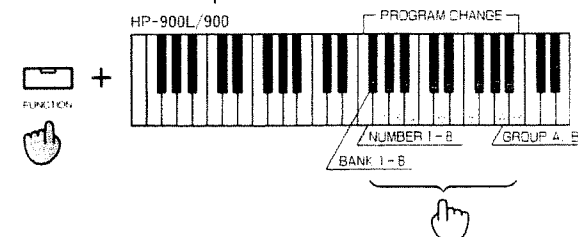

\* If **MIDI transmission/reception mode III** has been selected (P22), you can also simply press one of the sound select buttons to transmit the following Program Changes.

Sound select buttons	Transmitted program Change numbers
Piano 1	2
Piano 2	1
Harpsichord	4
Vibraphone	6
E.Piano	7

<Program change reception>

When a Program Change 1~8 is received, the corresponding sound will automatically be selected.

Program Change number	Tone
1	PIANO 2
2	PIANO 1
3	PIANO 1
4	HARPSICHORD
5	PIANO 1
6	VIBRAPHONE
7	E. PIANO
8	E. PIANO

🎵 Program Change numbers 9~128 will be ignored.

## Multi-timbral mode

Multi-timbral instruments are able to function as several independent slave instruments contained in a single unit. The HP-1700L/1700/900L/900 contains five instrumental sounds, but can normally play only one sound at a time. However, if the Multi-timbral mode is selected, you can use a different MIDI channel for each sound, and use an external sequencer etc. to play an ensemble of up to five sounds at once.

Multi-timbral mode off

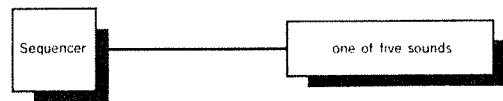

Multi-timbral mode on

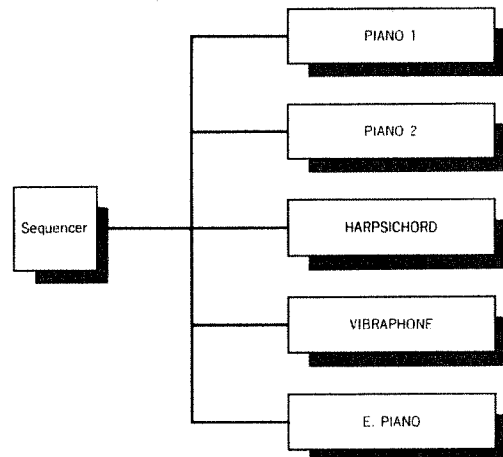

🎵 Each time the power is turned on, the Multi-timbral mode is turned off.

🎵 When the Multi-timbral mode is on, Omni will always be off, and up to 24 notes can be played simultaneously; the same number of notes as when the Multi-timbral mode is off.

To select the Multi-timbral mode

While holding **[FUNCTION]**, press **[MULTI]** to turn the Multi-timbral mode on/off. When the **[MULTI]** LED is lit, the instrument is in Multi-timbral mode.

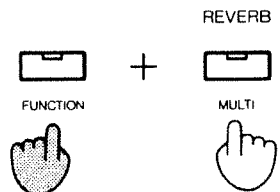

While holding **[FUNCTION]**, **[MULTI]** LED will light to indicate the Multi-timbral mode on.

default settings for each tone:

MIDI channel	Tone
1 ch	PIANO1
11ch	PIANO2
12ch	HARPSICHORD
13ch	VIBRAPHONE
14ch	E.PIANO

<Messages received in Multi-timbral mode>

Incoming MIDI messages on channels other than 1, 11, 12, 13, and 14 will be ignored.

- **Program change messages**  
Program Change messages will be received independently for channels 1, 11, 12, 13, and 14.
- **Pedal messages**  
The following Control Change messages will function independently for channels 1, 11, 12, 13, and 14.  
 Damper: control change number 64  
 Sostenuto: control change number 66  
 Soft: control change number 67
- **Chorus on/off**  
Chorus on/off messages (control change number 93) will function independently for each sound.
- **Reverb on/off**  
Reverb on/off (a Roland exclusive message) will apply to all sounds simultaneously.
- **Receive/transmit channel settings**  
In the Multi-timbral mode, the receive channels are permanently fixed at 1, 11, 12, 13, and 14, and cannot be changed. Nor it is possible to turn Omni On. Messages will be transmitted on the specified transmit channel, but if you set the transmit channel to one other than 1, 11, 12, 13, or 14, the internal sound source will not produce any sound.

# 7 Appendix

## Troubleshooting

Read this section if you have problems or questions when using your Roland Digital Piano by itself or with other MIDI equipment.

**Q**

**No sound.**

**A**

- Is the volume knob at "MIN"?
- Is a set of headphones connected?
- Is a MIDI cable connected to the MIDI IN connector while Local is turned Off?
- If MIDI equipment is connected, is the power turned off to these devices?
- In the Multi-timbral mode, is the transmit channel set to one other than 1, 11, 12, 13, or 14?

**Q**

**The damper effect (a long decay even after the key is released) applies to all sounds.**

**A**

Is the cable from the stand correctly connected to the piano? Refer to the assembly instructions on **[P.6]** and connect it properly.

**Q**

**The Soft effect does not function correctly when the left pedal is pressed.**

**A**

Is the function of the left pedal set to Sostenuuto? While holding **[FUNCTION]**, press **[PEDAL]** and return the pedal function to "Soft".

**Q**

**The notes sound at an incorrect pitch**

**A**

Did you set the Key Transpose function? (When you set Key Transpose, the **[FUNCTION]** LED will light.) Press **[FUNCTION]** to cancel the Key Transpose setting. (When you press the button the LED will go out.)

**Q**

**Data that was recorded in the recorder has been lost.**

**A**

- Recorded data will disappear approximately 8 hours after the power is turned off and cannot be recovered. If you wish to save your performance over a long period of time, use a sequencer (sold separately) and save your performance on a disk.
- Did you press **[PLAY]** and **[REC]** simultaneously?

**Q**

**The pitch of the digital piano does not match the pitch of ISM products.**

**A**

When shipped, the pitch of these products is set to A = 442 Hz. If you will be using your piano with these products, use the tuning knob located on the rear panel to set the tuning to A = 442 Hz.

**Q**

**Pressing of the panel buttons (chorus, tremolo, reverb, and the sound select buttons) are not recorded by the sequencer.**

**A**

Did you set the piano transmit/receive mode to mode 3? When the power is turned on, mode 1 is selected. To select mode 3, hold **[FUNCTION]** and press **[MIDI MODE]** repeatedly until the **[MIDI MODE]** LED lights.

## MIDI Implementation Chart

Function ...		Transmitted	Recognized	Remarks
Basic Channel	Default Changed	1 1 - 16	1 1 - 16	* 2
Mode	Default Messages Altered	Mode 3 OMNI OFF, POLY *****	Mode 3 ○ * 4	* 3
Note Number	True Voice	15-113 (22-108 : HP-900) *****	0 - 127 15 - 113	
Velocity	Note ON Note OFF	○ × 9n v = 0	○ ×	
After Touch	Key's Ch's	× ×	× ×	
Pitch Bender		×	×	
Control Change	7	×	○	Volume Hold - 1 Sostenuto Soft Chorus
	64	○	○	
	66	○	○	
	67	○	○	
	93	* 1	* 1	
	121	×	○	Reset all controllers
Prog Change	True #	* 1 (0 - 127) *****	* 1 (0 - 127) 0 - 7	
System Exclusive		○	○	
System Common	Song Pos Song Sel Tune	× × ×	× × ×	
System Real Time	Clock Commands	× ×	× ×	
Aux Message	Local ON/OFF All Notes OFF Active Sense Reset	× × ○ ×	○ ○ (123 - 127) ○ ×	
Notes		* 1 Able to chose between ○ and ×. * 2 Able to change indivisually transmit and receive channel. * 3 When power on, OMNI OFF and POLY are sent through the basic channel. * 4 Recognize as Mode 3 even if MONO (M = 1). Recognize as Mode 1 even if MONO (M ≠ 1).		

Mode 1 : OMNI ON, POLY  
Mode 3 : OMNI OFF, POLY

Mode 2 : OMNI ON, MONO  
Mode 4 : OMNI OFF, MONO

○ : Yes  
× : No

MIDI Implementation Chart

Function ...		Transmitted	Recognized	Remarks
Basic Channel	Default Changed	1 1 - 16 each	1 1, 11, 12, 13, 14	
Mode	Default Messages Altered	Mode 3 OMNI OFF, POLY *****	Mode 3 ×	* 2
Note Number	True Voice	15-113(22-108 : HP-900) *****	0 - 127 15 - 113	
Velocity	Note ON Note OFF	○ × 9n v = 0	○ ×	
After Touch	Key's Ch's	× ×	× ×	
Pitch Bender		×	×	
Control Change	7	×	○	Volume Hold - 1 Sostenuto Soft Chorus
	64	○	○	
66	○	○		
67	○	○		
93	* 1	* 1		
	121	×	○	Reset all controllers
Prog Change	True #	* 1 (0 - 127) *****	* 1 (0 - 127) 0 - 7	
System Exclusive		○	○	
System Common	Song Pos Song Sel Tune	× × ×	× × ×	
System Real Time	Clock Commands	× ×	× ×	
Aux Message	Local ON/OFF All Notes OFF Active Sense Reset	× × ○ ×	○ ○ (123 - 127) ○ ×	
Notes		* 1 Able to chose between ○ and ×. * 2 When power on, OMNI OFF and POLY are sent through the basic channel.		

Mode 1 : OMNI ON, POLY  
Mode 3 : OMNI OFF, POLY

Mode 2 : OMNI ON, MONO  
Mode 4 : OMNI OFF, MONO

○ : Yes  
× : No

# Sound range diagram

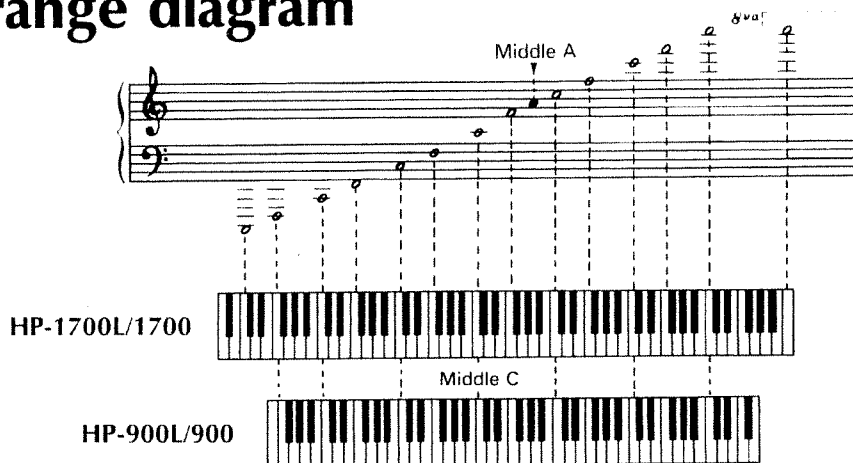

## Specifications

	HP-1700L/1700	HP-900L/900
Keyboard	88 keys	76 keys
Sound source	Advanced SA (Structured Adaptive) synthesis	
Maximum Polyphony	24 notes	
Preset Tones	PIANO1 PIANO2 HARPSICHORD VIBRAPHONE ELECTRIC PIANO	
Digital Effects	Chorus (on/off) Reverb (on/off): two effects	
Touch control	Light Standard Heavy: three levels	
Master tune	±50 cents	
Connectors	Output jacks (stereo) Input jacks (mono, stereo) Pedal jacks (damper, soft/sostenuto) Headphone jack MIDI connectors (IN, OUT, THRU)	
Pedal	Damper, Soft/Sostenuto	
Speakers	16 cm (6") × 2	
Output	20 W × 2	15 W × 2
Finish	Roland black oak	
Dimensions	HP-1700 (L) : 1,419(W)×456(D)×182(H)mm KS-1700 : 1,419(W)×456(D)×638(H)mm Overall : 1,419(W)×456(D)×810(H)mm	HP-900 (L) : 1,256(W)×456(D)×182(H)mm KS-900 : 1,256(W)×456(D)×638(H)mm Overall : 1,256(W)×456(D)×810(H)mm
Weight	HP-1700L : 42 kg KS-1700 : 13 kg Total : 55 kg	HP-1700 : 37.5 kg KS-1700 : 13 kg Total : 50.5 kg
Power consumption	55 W (117 V), 100 W (220/240 V)	
Accessories	Power cable Music Stand Owner's Manual	
Options	Piano stand (KS-1700)	Piano stand (KS-900)
	Audio cable (PJ-1M etc.) MIDI cable (MSC-15/25/50)	

\* In the interest of product development, specifications and appearance are subject to change without prior notice.

# Index

---

<b>A</b>	Adjusting bolt .....	6	<b>R</b>	Recorder function .....	12
	Advanced SA synthesis .....	1		Recording your performance .....	12
	Assembling the stand .....	6		Reverb .....	14
<b>B</b>	Brilliance .....	8	<b>S</b>	Sequencers .....	19, 21, 22
<b>C</b>	Channel messages .....	20		Slave .....	19
	Chorus .....	14		Soft pedal .....	11
	Control change messages .....	20		Soft thru on/off .....	21
<b>D</b>	Damper pedal .....	6, 11		Sostenuto pedal .....	11
	Demo song .....	10		Sound modules .....	19
<b>E</b>	Exclusive messages .....	20		Stereo panning .....	9
<b>H</b>	Headphone jack .....	9		System messages .....	20
<b>I</b>	ISM (Intelligent System of Music) .....	2, 18	<b>T</b>	Timing for selecting sounds .....	10
<b>K</b>	Keytouch control .....	16		Tuning .....	15
	Key transpose .....	15	<b>V</b>	Volume .....	8
<b>L</b>	Local on/off function .....	21, 22			
<b>M</b>	Master .....	19			
	MIDI .....	19			
	MIDI cables .....	19			
	MIDI channels .....	20, 22			
	MIDI implementation chart .....	21, 27, 28			
	MIDI IN connector .....	19			
	MIDI OUT connector .....	19			
	MIDI THRU connector .....	19			
	MIDI transmission/reception mode .....	22			
	Multi-timbral mode .....	24			
<b>N</b>	Note messages .....	19			
<b>O</b>	Omni .....	20			
<b>P</b>	Pitch bender .....	21			
	Power switch .....	7, 8			
	Program change messages .....	20, 23			
	Program change numbers .....	23			

## Information

When you need repair service, call your local Roland Service Station or the authorized Roland distributor in your country as shown below.

### U. S. A.

**Roland Corporation US**  
7200 Dominion Circle  
Los Angeles, CA. 90040  
3696, U. S. A.  
TEL: (213) 685-5141

### CANADA

**Roland Canada Music Ltd.**  
**(Head Office)**  
5480 Parkwood Way  
Richmond B. C. V6V 2M4  
CANADA  
TEL: (604) 270-6626

### Roland Canada Music Ltd.

**(Montreal Office)**  
9425 Transcanadienne  
Service Rd. N., St Laurent,  
Quebec H4S 1V3, CANADA  
TEL: (514) 335-2009

### Roland Canada Music Ltd.

**(Toronto Office)**  
346 Watline Avenue,  
Mississauga, Ontario L4Z  
1X2, CANADA  
TEL: (416) 890-6488

### AUSTRALIA

**Roland Corporation Australia Pty. Ltd.**  
38 Campbell Avenue  
Dee Why West, NSW 2099  
AUSTRALIA  
TEL: (02) 982-8266

### NEW ZEALAND

**Roland Corporation (NZ) Ltd.**  
97 Mt. Eden Road, Mt. Eden,  
Auckland 3, NEW ZEALAND  
TEL: (09) 3098-715

### UNITED KINGDOM

**Roland (U.K.) Ltd.**  
Rye Close Ancells Business  
Park Fleet, Hampshire GU1 3  
BUY, UNITED KINGDOM  
TEL: 0252-816181

### Roland (U.K.) Ltd., Swansea Office

Atlantic Close, Swansea  
Enterprise Park, Swansea,  
West Glamorgan SA79FL  
UNITED KINGDOM  
TEL: (0792) 700-139

### ITALY

**Roland Italy S. p. A.**  
Viale delle Industrie 8 20020  
ARESE MILANO ITALY  
TEL: 02-93581311

### SPAIN

**Roland Electronics de España, S. A.**  
Calle Bolivia 239 08020  
Barcelona, SPAIN  
TEL: 93-308-1000

### GERMANY

**Roland Elektronische Musikinstrumente Handelsgesellschaft mbH.**  
Oststrasse 96, 2000  
Norderstedt, GERMANY  
TEL: 040/52 60 090

### FRANCE

**Musikengro**  
102 Avenue Jean-Jaures  
69007 Lyon Cedex 07  
FRANCE  
TEL: (7) 858-54 60

### Musikengro (Paris Office)

Centre Region Parisienne 41  
rue Charles-Fourier, 94400  
Vitry SUR/SEINE FRANCE  
TEL: (1) 4680 86 62

### BELGIUM/HOLLAND/ LUXEMBOURG

**Roland Benelux N. V.**  
Houtstraat 1 B-2260 Oevel-  
Westerlo BELGIUM  
TEL: (0032) 14-575811

### DENMARK

**Roland Scandinavia A/S**  
Langebrogade 6 Box 1937  
DK-1023 Copenhagen K,  
DENMARK  
TEL: 31-95 31 11

### SWEDEN

**Roland Scandinavia A/S**  
Danvik Center 28 A, 2 tr.  
S-131 30 Nacka SWEDEN  
TEL: 08-702 00 20

### NORWAY

**Roland Scandinavia Avd.  
Kontor Norge**  
Lilleakerveien 2 Postboks 95  
Lilleaker N-0216 Oslo 2  
NORWAY  
TEL: 22-73 00 74

### FINLAND

**Fazer Musik Inc.**  
Länsituulentie POB 169,  
SF-02101 Espoo FINLAND  
TEL: 0-43 50 11

### SWITZERLAND

**Musitronic AG**  
Gerberstrasse 5, CH-4410  
Liestal, SWITZERLAND  
TEL: 061/921 16 15

### Roland CK (Switzerland) AG

P.O.Box Landstrasse 5  
CH-4452 Iltingen (BL)  
SWITZERLAND  
TEL: (61) 971 80 80  
Repair Service by Musitronic AG

### AUSTRIA

**E. Dematte & Co.**  
Neu-Rum Siemens-Strasse 4  
6021 Innsbruck P.O.Box 83  
AUSTRIA  
TEL: (0512) 26 44 260

### GREECE

**V. Dimitriadis & Co. Ltd.**  
20, Alexandras Avn., GR  
10682 Athens, GREECE  
TEL: 01-8232415

### PORTUGAL

**Casa Caius Instrumentos Musicais Lda.**  
Rua de Santa Catarina 131  
4000 Porto, PORTUGAL  
TEL: 02-38 44 56

### HUNGARY

**Intermusica Ltd.**  
Warehouse Area 'DEPO'  
Torokbalint, Budapest  
HUNGARY  
TEL: (1) 1868905

### ISRAEL

**D.J.A. International Ltd.**  
11 Bar Gviora St., Tel Aviv  
ISRAEL  
TEL: 972-3-528 3329

### CYPRUS

**Radex Sound Equipment Ltd.**  
17 Diagorou St., P.O.Box  
2046, Nicosia CYPRUS  
TEL: 45 3426, 466423

### U.A.E

**Zak Electronics & Musical Instruments Co.**  
P.O. Box 8050  
DUBAI, U.A.E  
TEL: 695774

### SAUDI ARABIA

**Omar Badoghaish Trading Corp.**  
P.O. Box 5980  
Jeddah, SAUDI ARABIA  
TEL: 966-02-6607038

### KUWAIT

**Easa Husain Al-Yousifi**  
P.O. Box 126 Safat 13002  
KUWAIT  
TEL: 965-5719499

### LEBANON

**A. Chahine & Fils**  
P.O. Box 16-5857  
Beirut, LEBANON  
TEL: 335799

### TURKEY

**Barkat Sanayi ve Ticaret**  
Siraselviler Cad. 86/6 Taksim  
Istanbul, TURKEY  
TEL: 149 93 24

### EGYPT

**Al Fanny Trading Office**  
9, Ebn Hagar Al Askalany  
Street, Ard El Golf,  
Heliopolis, Cairo, 11341  
EGYPT  
TEL: 2917803-665918

### QATAR

**Badie Studio & Stores**  
P.O.Box 62,  
DOHA Qatar  
TEL: 974 423554

### BAHRAIN

**Moon Stores**  
Bad Al Bahrain Road,  
P.O.Box 20077  
State of Bahrain  
TEL: (0973) 211 005

### BRAZIL

**Roland Brasil Ltda.**  
R. Alvarenga 591 CEP-05509  
Sao Paulo BRAZIL  
TEL: (011) 210-7266  
Repair Service for Roland and  
Rhodes products

### Oliver do Brasil S.A.

**Instrumentos Musicais**  
Rua Botuoca, 198/206  
CEP 05586-010 Vila Indiana  
Butanta Sao Paulo-SP BRAZIL  
TEL: (011) 814-1344  
Repair Service for BOSS products

### MEXICO

**Casa Veerkamp, s.a. de c.v.**  
Mesones No. 21 Col. Centro  
MEXICO D.F. 06080  
TEL: (5) 709-3716

### La Casa Wagner de

**Guadalajara s.a. de c.v.**  
Av. Corona No. 202 S.J.  
C.P.44100 Guadalajara,  
Jalisco MEXICO  
TEL: (36) 13-1414

### VENEZUELA

**Musicland Digital C.A.**  
Av. Francisco De Miranda,  
Centro Parque Cristal, Nivel  
C2 Local 20 Caracas  
VENEZUELA  
TEL: (2)2844497

### PANAMA

**Productos Superiores,  
S.A.**  
Apartado 655 - Panama 1  
REP. DE PANAMA  
TEL: 26-3322

### ARGENTINA

**Instrumentos Musicales S.A.**  
Florida 648  
(1005) Buenos Aires  
ARGENTINA  
TEL: (1)394-4029

### HONG KONG

**Tom Lee Music Co., Ltd.  
Service Division**  
22-32 Pun Shan Street, Tsuen  
Wan, New Territories,  
HONG KONG  
TEL: 415-0911

### KOREA

**Cosmos Corporation  
Service Station**  
261 2nd Floor Nak-Won  
Arcade Jong-Ro ku, Seoul,  
KOREA  
TEL: (02) 742 8844

### SINGAPORE

**Swee Lee Company**  
BLOCK 231,  
Bain Street #03-23  
Bras Basah Complex,  
Singapore 0718  
TEL: 3367886

### PHILIPPINES

**G.A. Yupangco & Co.  
Inc.**  
339 Gil J. Puyat Avenue  
Makati, Metro Manila 1200,  
PHILIPPINES  
TEL: 02 (817) 0013

### THAILAND

**Theera Music Co., Ltd.**  
330 Veng Nakorn Kasem,  
Soi 2, Bangkok 10100,  
THAILAND  
TEL: 2248821

### VIETNAM

**Saigon Music Distributor**  
383A Dien Bien Phu St.  
3rd. District  
Ho Chi Minh City, Vietnam  
TEL: 84-8-391395/332674

### MALAYSIA

**Syarikat Bentley**  
No.142, Jalan Bukit Bintang  
55100 Kuala Lumpur,  
MALAYSIA  
TEL: (03) 2443333

### INDONESIA

**PT Citrarama Belantika**  
Jl Alaydrus 84 B  
Jakarta 10130  
INDONESIA  
TEL: (021) 3802638,  
3802639

### TAIWAN

**Siruba Enterprise  
(Taiwan) Co., LTD.**  
Room. 5, 9th. No. 112 Chung  
Shan N.Road Sec.2 Taipei,  
TAIWAN, R.O.C.  
TEL: (02) 571-5860

### SOUTH AFRICA

**That Other Music Shop  
(PTY) Ltd.**  
11 Melle Street (Cnr Melle  
and Jula Street)  
Braamfontein 2001  
Republic of South Africa  
TEL: 27 11 403-4105

### Paul Bothner (PTY) Ltd.

17 Werdmuller Centre  
Claremont 7700  
Republic of South Africa  
TEL: 021-64-4030

As of Jun. 28. 1993



For Germany

### Bescheinigung des Herstellers / Importeurs

Hiermit wird bescheinigt, daß der/die/das  
ROLAND Digital Piano HP-1700L/1700/900L/900  
.....  
(Gerät, Typ Bezeichnung)

in Übereinstimmung mit den Bestimmungen der  
Amtsbl. Vfg 1046 / 1984  
.....  
(Amtsblattverfügung)

funk-entstört ist.  
Der Deutschen Bundespost wurde das Inverkehrbringen dieses Gerätes angezeigt und die Berechtigung zur Überprüfung der Serie auf Einhaltung der Bestimmungen eingeräumt.

.....  
Roland Corporation Osaka / Japan  
.....  
Name des Herstellers/Importeurs

For the USA

### FEDERAL COMMUNICATIONS COMMISSION RADIO FREQUENCY INTERFERENCE STATEMENT

This equipment has been tested and found to comply with the limits for a Class B digital device, pursuant to Part 15 of the FCC Rules. These limits are designed to provide reasonable protection against harmful interference in a residential installation. This equipment generates, uses, and can radiate radio frequency energy and, if not installed and used in accordance with the instructions, may cause harmful interference to radio communications. However, there is no guarantee that interference will not occur in a particular installation. If this equipment does cause harmful interference to radio or television reception, which can be determined by turning the equipment off and on, the user is encouraged to try to correct the interference by one or more of the following measures:

- Reorient or relocate the receiving antenna.
- Increase the separation between the equipment and receiver.
- Connect the equipment into an outlet on a circuit different from that to which the receiver is connected.
- Consult the dealer or an experienced radio/TV technician for help.

Unauthorized changes or modification to this system can void the users authority to operate this equipment.

For Canada

#### CLASS B

#### NOTICE

This digital apparatus does not exceed the Class B limits for radio noise emissions set out in the Radio Interference Regulations of the Canadian Department of Communications.

#### CLASSE B

#### AVIS

Cet appareil numérique ne dépasse pas les limites de la classe B au niveau des émissions de bruits radioélectriques fixés dans le Règlement des signaux parasites par le ministère canadien des Communications.

 Roland®

---

**10966**

UPC

10966



10966

 Roland