

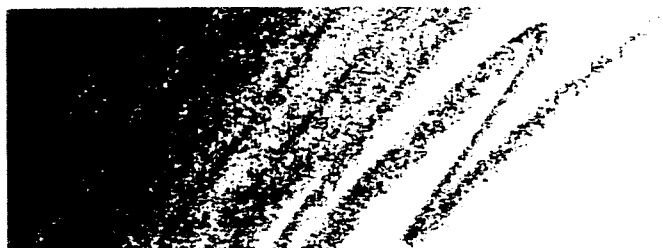

Roland



Roland Digital Piano HP 3700/2700

OWNER'S MANUAL

	CAUTION RISK OF ELECTRIC SHOCK DO NOT OPEN	
ATTENTION : RISQUE DE CHOC ELECTRIQUE NE PAS OUVRIR		
<p>CAUTION: TO REDUCE THE RISK OF ELECTRIC SHOCK, DO NOT REMOVE COVER (OR BACK). NO USER-SERVICEABLE PARTS INSIDE. REFER SERVICING TO QUALIFIED SERVICE PERSONNEL.</p>		



The lightning flash with arrowhead symbol, within an equilateral triangle, is intended to alert the user to the presence of un-insulated "dangerous voltage" within the product's enclosure that may be of sufficient magnitude to constitute a risk of electric shock to persons.



The exclamation point within an equilateral triangle is intended to alert the user to the presence of important operating and maintenance (servicing) instructions in the literature accompanying the product.

INSTRUCTIONS PERTAINING TO A RISK OF FIRE, ELECTRIC SHOCK, OR INJURY TO PERSONS.

IMPORTANT SAFETY INSTRUCTIONS

WARNING — When using electric products, basic precautions should always be followed, including the following:

1. Read all the instructions before using the product.
2. Do not use this product near water — for example, near a bathtub, washbowl, kitchen sink, in a wet basement, or near a swimming pool, or the like.
3. This product should be used only with a cart or stand that is recommended by the manufacturer.
4. This product, either alone or in combination with an amplifier and headphones or speakers, may be capable of producing sound levels that could cause permanent hearing loss. Do not operate for a long period of time at a high volume level or at a level that is uncomfortable. If you experience any hearing loss or ringing in the ears, you should consult an audiologist.
5. The product should be located so that its location or position does not interfere with its proper ventilation.
6. The product should be located away from heat sources such as radiators, heat registers, or other products that produce heat.
7. Avoid using the product where it may be effected by dust.
8. The product should be connected to a power supply only of the type described in the operating instructions or as marked on the product.
9. The power-supply cord of the product should be unplugged from the outlet when left unused for a long period of time.
10. Do not tread on the power-supply cord.
11. Do not pull the cord but hold the plug when unplugging.
12. When setting up with any other instruments, the procedure should be followed in accordance with instruction manual.
13. Care should be taken so that objects do not fall and liquids are not spilled into the enclosure through openings.
14. The product should be serviced by qualified service personnel when:
 - A. The power-supply cord or the plug has been damaged; or
 - B. Objects have fallen, or liquid has been spilled into the product; or
 - C. The product has been exposed to rain; or
 - D. The product does not appear to operate normally or exhibits a marked change in performance; or
 - E. The product has been dropped, or the enclosure damaged.
15. Do not attempt to service the product beyond that described in the user-maintenance instructions. All other servicing should be referred to qualified service personnel.

SAVE THESE INSTRUCTIONS

WARNING: THIS APPARATUS MUST BE EARTHED

For the U.K.

IMPORTANT: THE WIRES IN THIS MAINS LEAD ARE COLOURED IN ACCORDANCE WITH THE FOLLOWING CODE.
GREEN-AND-YELLOW: EARTH, BLUE: NEUTRAL, BROWN: LIVE

As the colours of the wires in the mains lead of this apparatus may not correspond with the coloured markings identifying the terminals in your plug proceed as follows:

The wire which is coloured GREEN-AND-YELLOW must be connected to the terminal in the plug which is marked by the letter E or by the safety earth symbol  or coloured GREEN or GREEN-AND-YELLOW.

The wire which is coloured BLUE must be connected to the terminal which is marked with the letter N or coloured BLACK.

The wire which is coloured BROWN must be connected to the terminal which is marked with the letter L or coloured RED.

The product which is equipped with a THREE WIRE GROUNDING TYPE AC PLUG must be grounded.

Copyright © 1990 by ROLAND CORPORATION

All rights reserved. No part of this publication may be reproduced in any form without the written permission of ROLAND CORPORATION.

Thank you, and congratulations on your choice of the Roland HP-3700/2700 Piano. The HP-3700/2700 is a digital piano which, thanks to its Advanced SA Process digital sound source, provides the utmost in quality and expressive capacity. In order to take full advantage of the wealth of features that have been made available, please take the time to read this manual in its entirety.

FEATURES

- **Six Different Sounds — Almost Any Style of Music Accommodated.** Page 6
The selection of 6 sounds include a luscious grand piano and classically refined harpsichord. There is also vibraphone, well-suited for jazz; and electric piano, indispensable for pops and fusion. Together, most every genre of music can be covered.
- **Newly Developed Damper Pedal Provides for Greater Expressivity.** Page 8
When the Damper pedal of an acoustic piano is depressed, strings adjacent to the notes played also resonate, creating much richer, expansive sonorities. Thanks to a realistic simulation of sympathetic resonance, the HP-3700/2700 piano can achieve this effect. Moreover, the pedal can be delicately controlled to produce a “half-pedalling” effect, giving you more control over the way notes linger on.
- **A Wealth of Effects** Page 7
Your new piano comes equipped with 3 types of internal digital effects. These include Chorus, which adds minute pulsations to the sound to give it more richness and breadth; Tremolo, which applies undulations to the sound; and Reverb, which allows you to play while enjoying the ambience of a concert hall.
- **A Dual Function Allows Two Voices to be Combined** Page 6
Any two of the six Voices provided can be combined and played together.
- **The Touch Can Be Changed To Suit Your Preference.** Page 11
Three levels (strong/average/weak) for the Touch are provided, so you can match the instrument with the playing strength that you normally use.
- **Comprehensive Tuning Functions**
With an electric piano, there is actually no need for tuning the piano at regular intervals, or after it has been moved. However, the HP-3700/2700, by providing a convenient range of tuning functions, allows you to easily change the way the instrument is tuned to satisfy whatever purpose you may have in mind.
 - **Master Tuning** Page 8
The overall pitch of the piano can be altered simply by turning this knob.
 - **Classical Tunings (Temperament)** Page 12
A selection of classical style tuning are provided. As a result you can, for example, greatly enhance the realism of a baroque interpretation.
 - **Stretch Tuning** Page 13
Stretch Tuning is a method of tuning specific to pianos, whereby the higher range notes are made higher and the lower notes are made lower. Several setting choices are provided.
- **MIDI Connectors Provide Further Applications** Page 14
The instrument also provides for use of MIDI, the interface standard designed to provide for the transfer of performance information among electronic musical instruments and computers.

A Word About the Advanced SA Process Sound Source

The sounds produced by this instrument are created using the “Advanced SA Process,” which represents a pooling of the best in the latest digital technology by Roland. The ASA process is first of all based on the SA process, which involves a series of efforts: first, an analysis of the properties of sound as generated by musical instruments, then an extraction, and finally a re-synthesis designed to facilitate the expressive needs of musicians. The result is a sound generation method which provides very finely textured and realistic sounds.

Table of Contents

How to assemble the KS-3700 Roland piano stand ...	2	2. Adjusting to Suit Your Preferences	10
How to assemble the KS-2700 Roland piano stand ...	4	Put the Template in Place	10
Attaching the Music Stand	5	Playing with the Key Transposed	10
Important notes	5	Changing the Weight of the Keyboard's Touch	11
1. Getting Started	6	Using the Pedals to Change Voices	11
Turning Power On	6	Playing Using Classical Tuning	12
Using Headphones	6	Setting the Tuning Curve (Stretch Tuning)	13
Adjusting the Volume	6	3. Using MIDI	14
Adjusting the Brilliance of the Sound	6	Connections Made With the MIDI Connectors	14
Selecting the Timbre	6	Put the Template in Place	15
Using the Chorus Effect to Add Breadth	7	Setting the MIDI Transmit/Receive Channels	15
Adding Tremolo to the Sound	7	Local On/Off	16
Applying Reverberation to the Sound	7	Omni On/Off	16
Listening to the Demonstration Songs	8	Selecting the Transmission/Reception Mode	17
How the Pedals Function	8	The Multi-Timbral Mode	18
Precision Adjustment of the Pitch		MIDI Implementation Chart	19
(Master Tuning)	9	Roland Exclusive Messages	20
Connecting External Devices	9	MIDI Implementation	21
Turning the Backup Mode On and Off	9	Specifications	29

How to assemble the KS-3700 Roland piano stand

- ◇ You will need a coin to tighten the screws.
- ◇ Assembly will be easier if done by two people.

<Check the parts>

◎ Before you begin assembly, check that you have all the parts.

- (A) Side board (left) 1
- (B) Side board (right) 1
- (C) Pedal board 1
- (D) Center board 1
- (E) Side covers 2
- (F) Rear board 1

- ① Short screws (M4 × 40 mm) ... 4
- ② Long screws (M6 × 60 mm) ... 8
- ③ Connecting screws 2
- ④ Philips screwdriver 1
- ⑤ Joint nuts 4

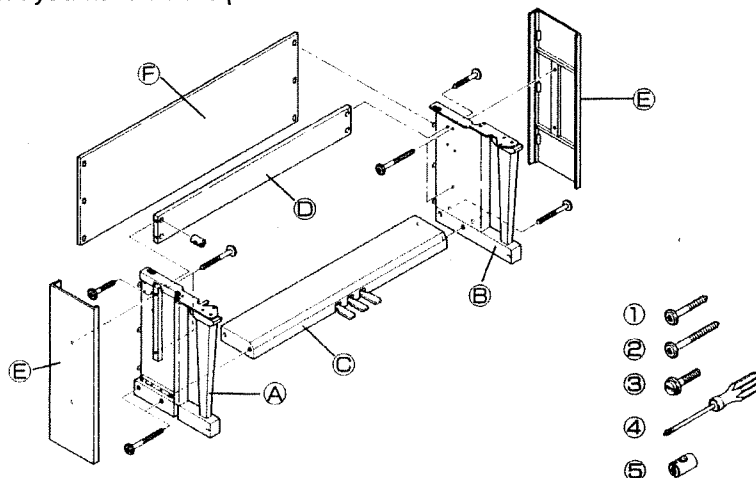

<Assembly procedure>

1 Attach the side boards (left and right) to the pedal board.

☆ Extend the pedal cable out from the pedal board.

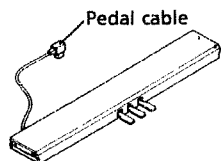

Note:
Note that the side boards have screws for attaching the rear board.

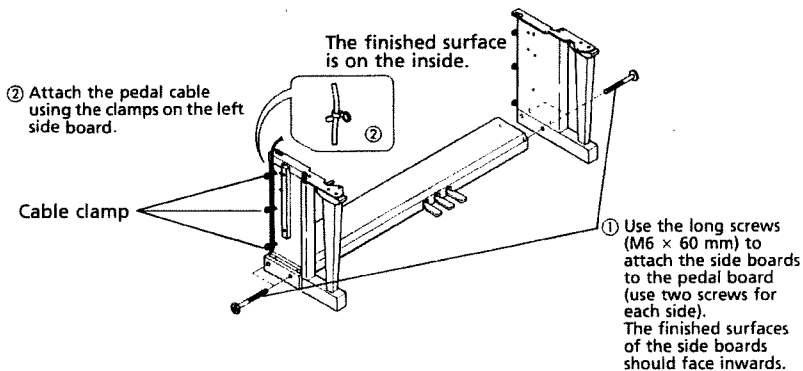

2 Attach the center board.

① Insert the four joint nuts into the center board with the long groove horizontal, making sure that the holes of the joint nuts are aligned with the holes of the center board. Insert a short screw before attaching the side boards to check that the holes of the joint nuts and the center board are positioned correctly.

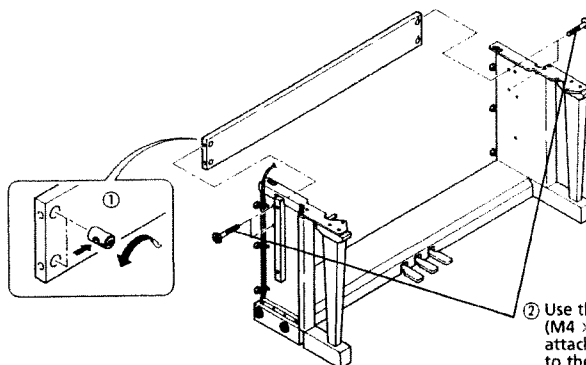

② Use the short screws (M4 × 30 mm) to attach the center board to the side boards (use two screws for each side).

3 Attach the piano to the stand.

Note:
When placing the piano on the stand, be careful not to pinch your fingers. (Avoid holding the ends of the piano.)

- ④ Plug the pedal cable into the bottom of the piano.
- ① Align the screws (one on each side) on the bottom of the piano with the slots in the metal fittings of the side boards, slide the piano towards the rear.

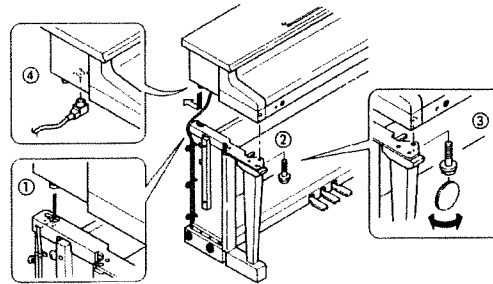

- ② Insert the two connecting screws (one on each side) through the holes in the metal fittings of the side boards into the screw holes on the bottom of the piano.
- ③ Use a coin to tighten the connecting screws, locking the piano to the stand.

4 Attach the rear board.

Note:
When attaching the rear board, be careful not to pinch the pedal cable.

Note:
The screw holes in the rear board are sunken on the outside to accommodate the screw head.

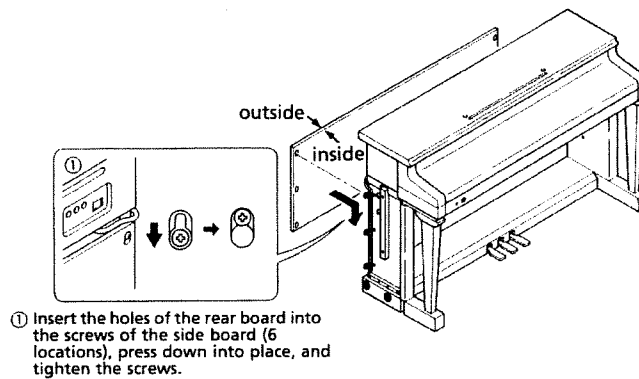
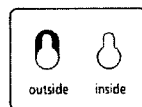

- ① Insert the holes of the rear board into the screws of the side board (6 locations), press down into place, and tighten the screws.

5 Attach the side covers.

Note:
Be sure that the side covers are oriented correctly. (The rims of the side covers are wider at the back.)

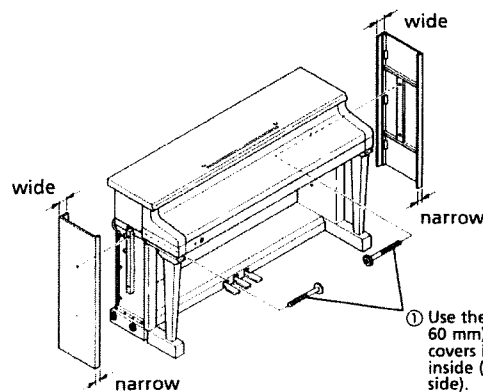

- ① Use the long screws (M6 x 60 mm) to fasten the side covers in place from the inside (two screws for each side).

6 Attach the AC cable and adjust the adjusting bolt.

☆ When you finish assembling the stand, attach the power cable (included with the piano), and rotate the adjusting bolt until it touches the floor.

Note:
If the piano is placed on carpeting, rotate the adjustment bolt a little more.

Note:
When placing the piano in its location, be sure not to pinch the AC cable underneath the piano.

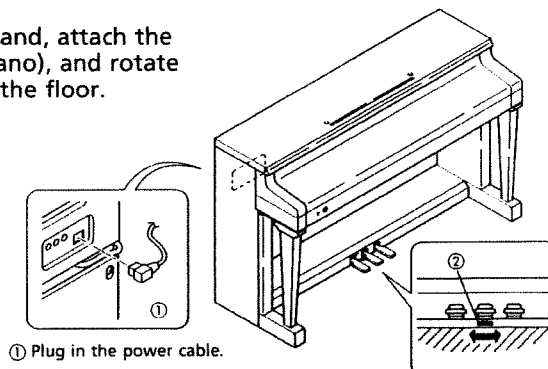

- ① Plug in the power cable.

- ② Rotate the adjusting bolt until it touches the floor. (Rotate it to the right to touch the floor, and to the left to retract.)

How to assemble the KS-2700 Roland piano stand Optional for the HP-2700

- ◇ You will need a coin to tighten the screws.
- ◇ Assembly will be easier if done by two people.

<Check the parts>

◎ Before you begin assembly, check that you have all the parts.

- (A) Side board (left) 1
- (B) Side board (right) 1
- (C) Pedal board 1
- (D) Center board 1

- ① Short screws (M4 × 30 mm) ... 4
- ② Long screws (M6 × 60 mm) ... 4
- ③ Connecting screws 2
- ④ Philips screwdriver 1

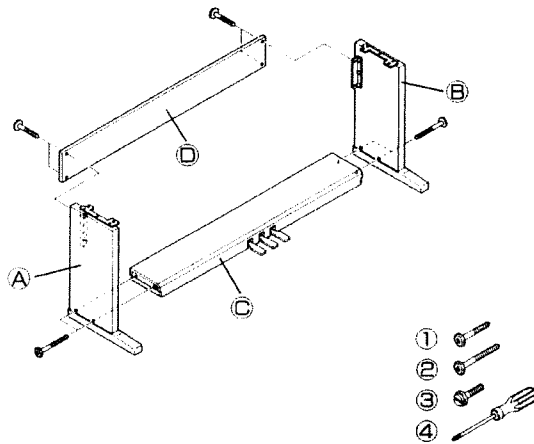

<Assembly procedure>

1 Attach the side boards to the pedal board.

☆ Extend the pedal cable out from the pedal board.

Note:

Be sure that the side boards are oriented correctly: the metal fittings are on the inside.

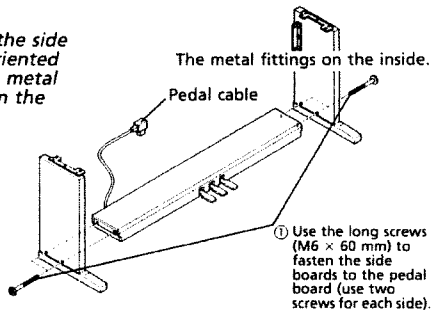

4 Fasten the pedal cable and plug in the power cable and pedal cable.

- ① Fasten the pedal cable using the cable clamps (three locations) on the left side of the stand.
- ② Plug the pedal cable into the bottom panel of the piano.
- ③ Plug the power cable into the back panel of the piano. The power cable is included with the piano.

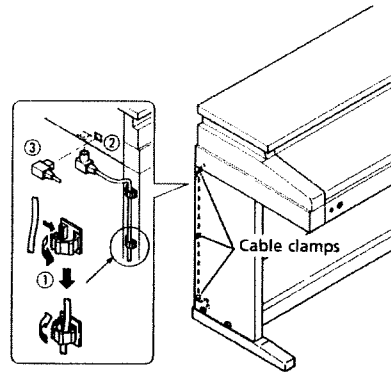

2 Attach the center board.

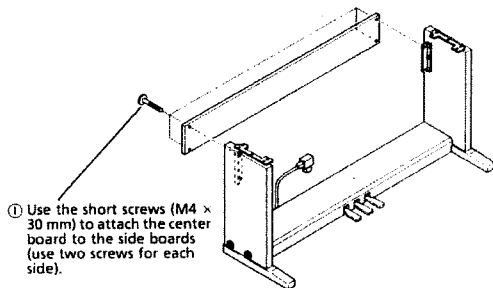

5 Adjust the adjusting bolt.

☆ When you finish assembling the stand, rotate the adjusting bolt until it touches the floor.

Note: If the piano is placed on carpeting, rotate the adjustment bolt little more.

Note: When placing the piano in its location, be careful not to pinch the power cable underneath the piano.

3 Attach the piano to the stand.

Note: When placing the piano on the stand, be careful not to pinch your fingers. (Avoid holding the ends of the piano.)

- ① Align the screws (one on each side) located on the bottom of the piano with the slots in the metal fittings on the side boards. Slide the piano so the screws slide into the slots.
- ② After securing the piano to the metal fittings of the side boards, insert the connecting screws into the bottom of the piano through the holes in metal fittings.
- ③ Use a coin to tighten the connecting screws, locking the piano to the stand.

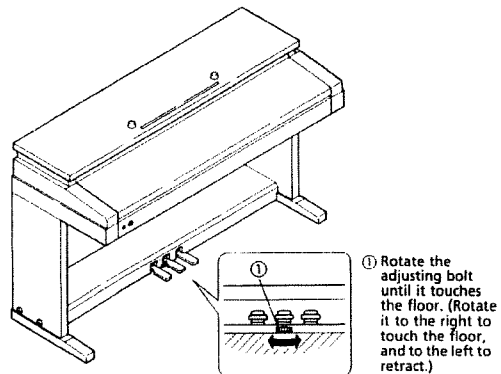

Attaching the Music Stand

Please attach the supplied Music Stand to KR-3700/2700

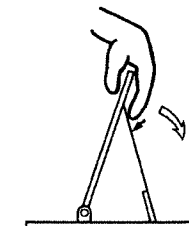
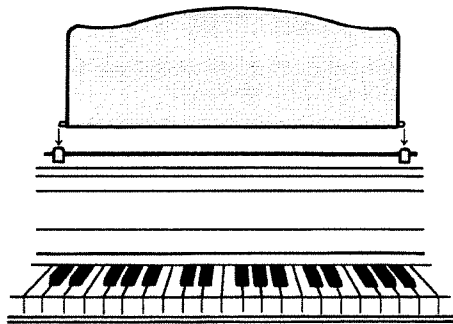

Fold the Music Stand

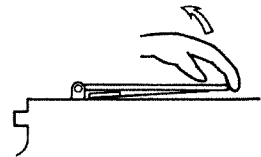

Raise the Music Stand

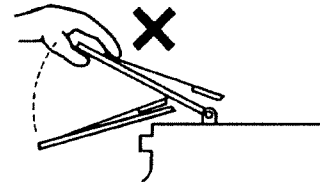

* Always make sure this Music Stand is removed whenever the instrument is moved or shipped.

* Be careful that you do not tilt the Music Stand towards you, as it may slip off of its stoppers.

Important notes

In addition to the items listed under Safety Precautions on the inside front cover, please read and adhere to the following:

[Power Supply]

- When making any connections with other devices, always turn off the power to all equipment first; this will help prevent damage or malfunction.
- Do not use this unit on the same power circuit with any device that will generate line noise, such as a motor or variable lighting system.

[Placement]

- Do not subject the unit to temperature extremes (eg. direct sunlight in an enclosed vehicle). Avoid using or storing the unit in dusty or humid areas or areas that are subject to high vibration levels.
- This unit may interfere with radio and television reception. Do not use this unit in the vicinity of such receivers.
- Do not expose this unit to temperature extremes (eg. direct sunlight in an enclosed vehicle can deform or discolor the unit) or install it near devices that radiate heat.

[Maintenance]

- For everyday cleaning wipe the unit with a soft, dry cloth (or one that has been slightly dampened with water). To remove stubborn dirt, use a mild neutral detergent. Afterwards, be sure to wipe the unit thoroughly with a soft, dry cloth.
- Never use benzene, thinners, alcohol or solvents of any kind, to avoid the risk of discoloration and/or deformation.

[Memory Backup]

- With the Backup Mode "On", the instrument retains the last settings that were made before power was turned off. If the Backup Mode is "Off", the default settings will be loaded the next time the unit is turned on, and all previous settings will be lost (Refer to page 9 for directions on how to turn on the Backup Mode.).
- This instrument is equipped with a backup-use battery which serves, when the Backup Mode is "on," in maintaining the contents of memory while power is turned off. This battery should, as a rule, be changed every 5 years. (The actual lifetime of the battery may vary depending on the conditions of use.) When it is time to replace the battery, check with your nearest Roland Service Station.

[Additional Precautions]

- Be careful not get your fingers caught when closing the lid. Special arrangements may need to be made for children. To close the lid, slowly pull it completely forward, then lower it gently.
- Never allow any foreign objects to enter the unit through any of its openings.
- Protect the unit from strong impact.
- Do not allow objects or liquids of any kind to penetrate the unit. In the event of such an occurrence, discontinue use immediately. Contact qualified service personnel as soon as possible.
- Before using the unit in a foreign country, consult with qualified service personnel.

1. Getting Started

Turning Power On

- 1 Insert the plug on the power cord into an outlet.

Rear Panel

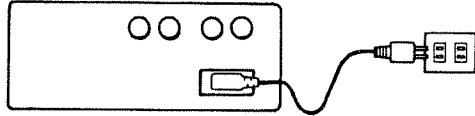

- 2 Turn the power switch on.
(Press the POWER button at the left side of the panel.)

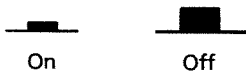

* This unit is equipped with a circuit protection device. A brief interval after power up is required before the unit will operate.

Using Headphones

To use headphones, insert the plug into the jack located at the left side of the instrument.

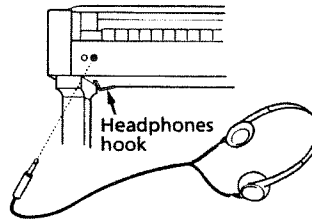

* HP-3700 owners can hang the headphones on the hook provided.



* The unit's speakers will no longer produce sound once you have headphones connected. This is convenient for playing the keyboard in circumstances where you do not want to disturb others, such as late at night.

* Use the VOLUME knob on the panel to adjust the volume if necessary.

Adjusting the Volume.

The VOLUME Slider

The further the slider is moved toward "MAX" the greater the volume becomes. Volume is lowered as the slider is moved toward "MIN."

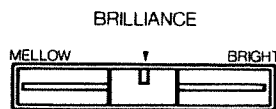
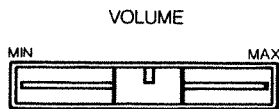

Adjusting the Brilliance of the Sound.

The BRILLIANCE Slider

The sound becomes brighter as the slider is moved to the right (toward BRIGHT). When moved to the left (toward MELLOW) the sound becomes more relaxed and mellow.

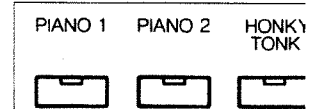
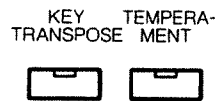

Selecting the Timbre

The Voice Buttons

Press one of the Voice buttons to select the sound that you want.

Timbre	
PIANO 1	A thick, rich concert grand piano sound.
PIANO 2	The timbre produced by a somewhat smaller grand piano.
HONKY TONK	The sound of a piano on the verge of going out of tune, and as such having a bright, pleasant familiarity.
HARPSICHORD	A distinctively sensitive and refined harpsichord sound, indispensable for baroque themes.
VIBRAPHONE	The sound of a large vibraphone.
E. PIANO (Electric Piano)	Provides the timbre of a luminous, transparent electric piano.

[About DUAL]

The DUAL function allows two different sounds to be combined and played simultaneously. You may wish to experiment with the creative possibilities afforded by the sound mixtures that can be obtained.



To mix sounds, simply press any two Voice buttons simultaneously (such as PIANO 1 and HARPSICHORD).

* Regarding the treatment of effects when the DUAL mode is being used: The settings for effects pertaining to the left one of the two Voices selected will be active.

Applying Reverberation to the Sound

The REVERB Button

Reverberation, creates a sense of spaciousness, and conveys the realistic presence an instrument would have in one of 3 different environments.

ROOM	Provides the ambience that would exist when playing in a room that is "live," that is, reverberates well.
STAGE	Provides the feeling of presence that would be obtained if playing on stage in a small hall.
HALL	Provides the reverberation of a concert hall.

The Reverb effect is made active by pressing one of the **REVERB** buttons (ROOM/STAGE/HALL). The indicator for the button will light.

To select the Depth of the reverberation, hold down one of the **REVERB** buttons while you use the **VALUE** buttons to choose from the 8 levels that are available.

- ▲ Deepens the Reverb effect. (Standard → level +3)
- ▼ Provides a more shallow Reverb effect. (Standard → level -4)

* To set Reverb at the standard Depth, simultaneously press both ▲ and ▼.

The Reverb effect is turned off by pressing one of the **REVERB** buttons again. Its indicator will go out.

* Once a Reverb setting is made, it will apply to any voice which is selected.

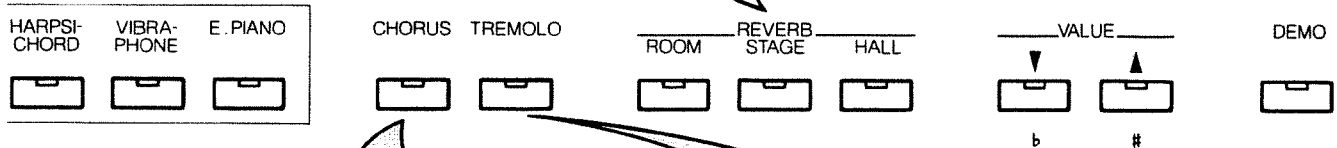
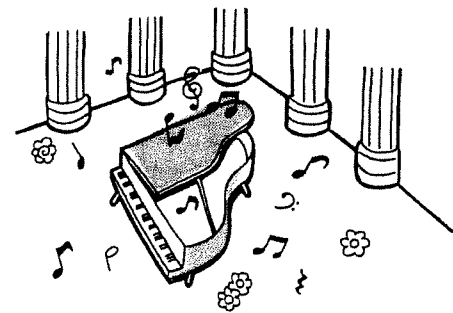

Using the Chorus Effect to Add Breadth

The CHORUS Button

The Chorus effect is made active by pressing the **CHORUS** button. The indicator for the button will light.

Further, if you press a **VALUE** button while the **CHORUS** button is held down, you can select the particular Depth for the Chorus effect that you wish, from among the 8 levels provided.

- ▲ Deepens the Chorus effect. (Standard → level +3)
- ▼ Provides a more shallow Chorus effect. (Standard → level -4)

* To set Chorus at the standard depth, simultaneously press both ▲ and ▼.

The Chorus effect is turned off by pressing the **CHORUS** button again. Its indicator will go out.

* Once a Chorus setting has been for a voice, it will only apply to that voice which has been selected.

Adding Tremolo to the Sound

The Tremolo Button

The Tremolo effect is produced by shifting the sound from left to right.

Press the **TREMOLO** button and its indicator will light.

Further, if you press the **VALUE** button while the **TREMOLO** button is held down, you can select the desired Speed for the Tremolo effect from among the 8 levels provided.

- ▲ Increases the speed of the Tremolo effect. (Standard → Level +3)
- ▼ Decreases the speed of the Tremolo effect. (Standard → Level -4)

* To set Tremolo at the standard rate, simultaneously press both ▲ and ▼.

The Tremolo effect is turned off by pressing the **TREMOLO** button again. Its indicator will go out.

* Once a Tremoro setting has been for a voice, it will only apply to that voice which has been selected.

Listening to the Demonstration Songs

The DEMO Button

If you press the **DEMO** button, its indicator will light, and the instrument is ready to begin playback of the demonstration songs. Then, all you need do is press any of the Voice buttons, and the song which applies to that button (see list) will begin playing.

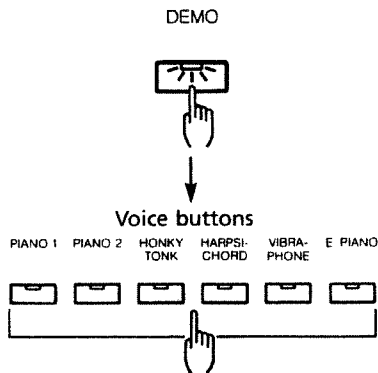

Voice buttons	Composer	Song Name
PIANO 1	Chopin	Etude in G-flat Major op.10-5 "Black keys"
PIANO 2	Chopin	Valse in D-flat Major op.64-1 "Petit Chien"
HONKY TONK	Beethoven	"Für Elise" Wo 0.59
HARPSICHORD	Debussy	Clair de Lune
VIBRAPHONE	Chopin	Nocturne in F-sharp Major op. 15-2
E. PIANO	Liszt	Liebesträume No. 3

When one song finishes, the next one will start playing automatically.

If you wish, you can also choose to have one song played repeatedly. The **VALUE** button is used to make this choice.

- ▲ The six songs are played in order, repeatedly.
- ▼ The same song is played repeatedly.

* If you press the button for another song during play of any particular song, the song that is playing will be terminated, and the unit will start playing the newly selected one.

To stop play of the demonstration songs, press the **DEMO** button once again. The instrument will return to the ordinary mode.

How the Pedals Function

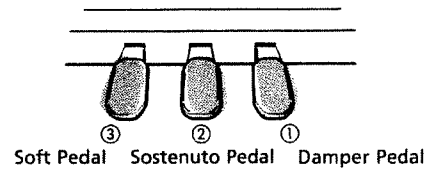

① Damper Pedal

When the Damper Pedal is depressed, notes that have been played will continue to sound even after your fingers have been removed from those keys. The amount of time over which the sound will linger can be sensitively controlled by varying the depth of the pedal.

② Sostenuto Pedal

This pedal is used to sustain only the sound of those keys that are pressed at the very moment it is depressed. It conveniently allows you to selectively choose specific notes that you wish to have linger on.

③ Soft Pedal

Used to apply softness to the notes played. If you have the Soft Pedal depressed while you play on the keys, you obtain a softer sound than you would using the same finger pressure without the pedal. The pedal's effect can be varied by small degrees by altering the depth of the pedal.

* Both the Sostenuto Pedal ② and Soft Pedal ③ can be changed and used to change voices. For details, refer to Page 11.

[About the Resonance Produced while the Damper Pedal is Depressed]

When the Damper Pedal is depressed, all strings on an acoustic piano are freed from the effect of the Damper. For this reason, not only will the notes that were played resonate for a longer time afterward, but such resonance is transmitted to other strings as well, causing them to resonate sympathetically. On the HP-3700/2700 such sympathetic resonance is faithfully simulated to create a richer, fuller sound.

[Half-Pedal Technique]

This instrument allows you to make use of "half-pedaling," an advanced technique employed by many skilled pianists. Half-pedaling involves using the Damper Pedal skillfully to gain precise, subtle control over the length of time that notes will resound.

Precision Adjustment of the Pitch (Master Tuning)

Using the Tuning knob located at the rear of the instrument, the pitch can be adjusted so it matches that of some other instrument.

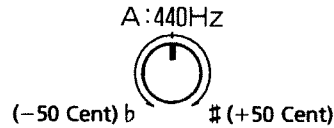

With the knob at its center position, the center A key on the keyboard will have a frequency of 440 Hz.

Connecting External Devices

- To connect other sound producing devices and have their sound output from this instrument's speakers:

Use audio cables to make connection between the output jacks on the device you wish to connect, such as a rhythm machine (CR-1000/TR-626) or external sound module (MT-100/RA-50), and the INPUT jacks on this instrument.

- When you wish to have this instrument's sound be played through other external speakers:

Using audio cable, make connections between the input jacks on the audio set, amplifier, or mixer, and the OUTPUT jacks on this instrument.

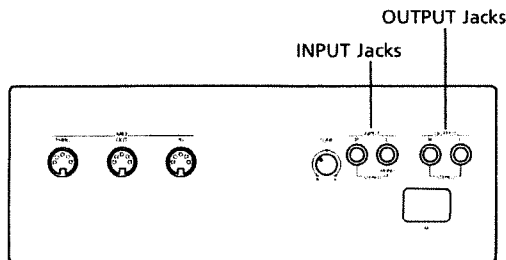

[Steps to Take to Make the Connections]

- ① Turn down the volume on both this instrument and the unit you intend to connect.
- ② Turn the power OFF on both this instrument and the unit you intend to connect.
- ③ Make the cable connections between this instrument and the unit you are connecting with it.
- ④ Turn the power ON on both this instrument and the unit you have connected.
- ⑤ Adjust the volume on both this instrument and the unit you have connected to an appropriate level.

* If you do not wish to have sound come from this instrument's speakers, use headphones.

Turning the Backup Mode On and Off

Once the Backup Mode is turned on, the status of everything set on the panel (excluding settings related to the Demo mode) is remembered. This way, the next time you turn power on the same settings profile will be in effect. You thus do not have to be troubled with making the settings you prefer each time power is turned on.

If the Backup Mode is set to "Off," the instrument will return to the factory default settings the next time power is turned on.

Procedure for Turning ON the Backup Mode

While holding down both the KEY TRANSPOSE and TEMPERAMENT buttons, turn the power ON.

Thereafter, the settings for all functions will be stored in memory, even while power is off.

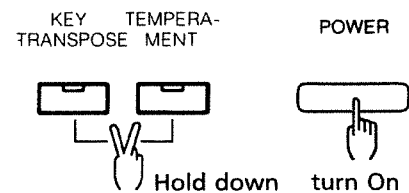

Procedure for Turning OFF the Backup Mode

While holding down both the ▲ and ▼ buttons for VALUE, turn the power ON. Each time power is turned on, all settings will be set at their factory defaults.

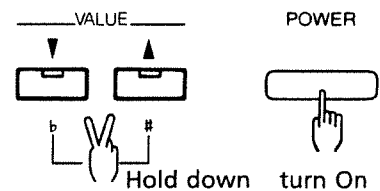

* This instrument is equipped with a backup-use battery which serves, when the Backup Mode is "on," in maintaining the contents of memory while power is turned off. This battery should, as a rule, be changed every 5 years. (The actual lifetime of the battery may vary depending on the conditions of use.) When it is time to replace the battery, check with your nearest Roland Service Station.

2. Adjusting to Suit Your Preferences

Put the Template in Place.

Your new instrument offers a wide range of functions which allow for creation of setups suited to particular playing habits, or musical tastes. In making use of these functions, you most likely will find it convenient to have the supplied template in place on the panel.

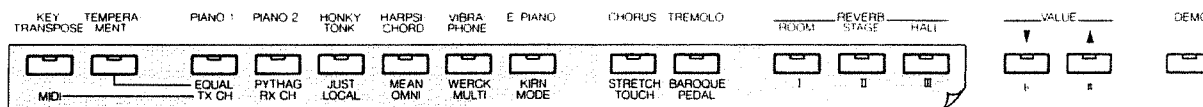

↑ Attach the template

* While you are pressing the KEY-TRANSDPOSE or TEMPERAMENT buttons, the instrument cannot be played.

Playing with the Key Transposed

KEY-TRANSDPOSE

If you wish, you can play the instrument with the key transposed, without needing to shift the position of keys played. This conveniently allows you to play in a key that matches a vocal accompaniment, or to change a song in a difficult key, having numerous sharps and flats, into a key that is easier to play.

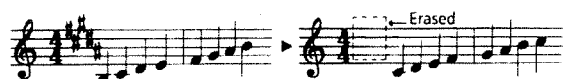

It seems difficult...

but it's really easy!



While holding down the **KEY-TRANSDPOSE** button, press either of the **VALUE** buttons ($\blacktriangle = \sharp$, $\blacktriangledown = \flat$) enough times to obtain the amount of transposition you wish.

- \sharp With each press, sound is raised by 1 semitone. (Max. of 5 semitones)
- \flat With each press, sound is lowered by 1 semitone. (Max. of 6 semitones)

KEY-TRANSDPOSE



Hold down

VALUE



and press

While the Key Transposition is in effect, the indicator on the **KEY-TRANSDPOSE** button will be lit.

The transposition is cancelled by once again pressing the **KEY-TRANSDPOSE** button (the indicator will go out.).

Once any setting has been made for a transposition, you thereafter only need press the **KEY-TRANSDPOSE** button to immediately obtain that setting again.

KEY-TRANSDPOSE



On

KEY-TRANSDPOSE



Off



ex.1

When you wish to play a song in the key of E major without using any black keys.

The following explains how the key can be transposed from E major to C major. Considering the note of Doh as the tonic for the C major key, you need to go up by four keys on the keyboard to reach the Me of E major. Therefore, press the \blacktriangle (\sharp) button 4 times.

\blacktriangle (\sharp) Button	Once	Twice	3 times	4 times
Pitch of the C key	C	C \sharp	D	D \sharp
Key	(C)	(D)	(E)	



ex.2

When you wish to play a song in the key of A major without using any black keys.

The following explains how the key is transposed from A major to C major. Considering the note of Doh as the tonic for the C major key, you need to go down by three keys on the keyboard to reach the Lah of A major. Therefore, press the \blacktriangledown (\flat) button 3 times.

\blacktriangledown (\flat) Button	Once	Twice	3 times
Pitch of the C key	C	B	B \flat
Key	(C)	(B)	(A)



ex.3

When you wish to play a song in the key of G minor without using any black keys.

The following explains how the key is transposed from G minor to A minor. Considering the note of Lah as the tonic for the key of A minor, you need to go down by two keys on the keyboard to reach the Soh of G minor. Therefore, press the \blacktriangledown (\flat) button twice.

\blacktriangledown (\flat) Button	Once	Twice
Pitch of the A key	A	A \flat
Key	(Am)	(Gm)

Changing the Weight of the Keyboard's Touch

This instrument provides you with 3 different choices for Touch. This setting determines how the strength the keys are played with, the volume, and the tone will relate to each other.

I	The keyboard will have a lighter feel to it, and fortissimo can be obtained with a touch that is weaker than normal. Convenient for those using lighter fingering than most people, or for young children.
II	An ordinary, natural touch.
III	At this setting, the keyboard will have a heavier feel, and quite a bit of force will be needed to obtain fortissimo. Useful for those who normally apply more pressure than others, or when wishing to strengthen the fingers.

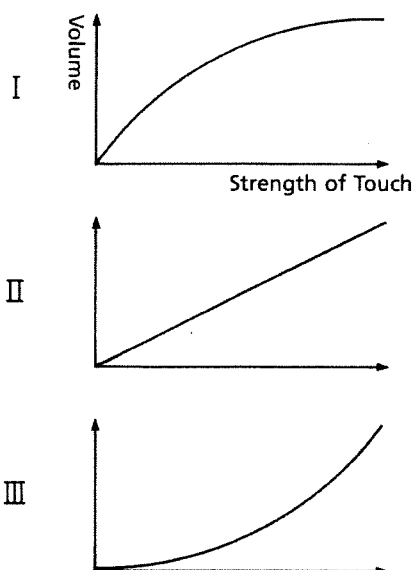

- Press the **KEY-TRANSCOPE** button. The indicator on the **CHORUS (TOUCH)** button will start blinking. One of the **REVERB (I/II/III)** buttons will also start blinking, indicating which Touch setting is currently in effect.
- With the **KEY-TRANSCOPE** button still pressed, select the new choice for the Touch by pressing one of the **REVERB (I/II/III)** buttons.

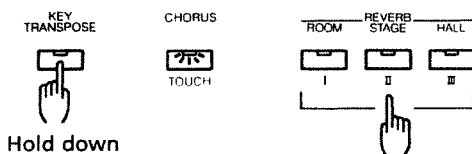

Using the Pedals to Change Voices

You can also use the Soft or Sostenuto pedals to change voices. This is convenient when you wish to keep both hands on the keys while changing to a different voice.

I	Reverts the unit to the standard mode of operation. (See page 8.)
II	Allows changing the voice using the Soft pedal (left pedal).
III	Allows changing the voice using the Sostenuto pedal (right pedal).



- While holding down the **KEY-TRANSCOPE** button, press the **TREMOLO (PEDAL)** button. The indicator on the **TREMOLO (PEDAL)** button will start blinking. One of the **REVERB (I/II/III)** buttons will also start blinking, indicating the function which is currently in effect.
- With the **KEY-TRANSCOPE** button still held down, make the selection by pressing one of the **REVERB (I/II/III)** buttons.

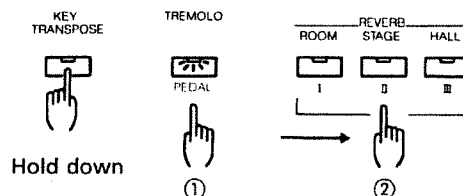

[Voice Changes Made With a Pedal]

The pedal switches between the currently selected voice and the previously selected voice.



If you have pressed PIANO 1, then have pressed VIBRAPHONE...

When the pedal is depressed, it will switch between the PIANO 1 and VIBRAPHONE sounds.



If you have pressed PIANO 1, then have simultaneously pressed both PIANO 2 and VIBRAPHONE...

When the pedal is depressed, it will switch you between the PIANO 1 sound, and PIANO 2 mixed with VIBRAPHONE sound.

Playing Using Classical Tuning

Your new piano allows you to play classical music, such as baroque, while tuned in a manner common to that age.

TEMPERAMENT refers to the method of tuning used. In modern times, most music is written with Equal Temperament in mind. During the course of the development of classical music, however, a number of other forms of tuning were also in common use. By playing while tuned in the manner which was correct for the period, you will be able to enjoy the sonorities that the chords in a particular piece were originally meant to have.

Button Used for Selection	Tuning Method
PIANO 1 (EQUAL)	EQUAL
PIANO 2 (PYTHAG)	PYTHAGOREAN
HONKY TONK (JUST)	JUST
HARPSICORD (MEAN)	MEAN TONE
VIBRAPHONE (WERCK)	WERCKMEISTER
E. PIANO (KIRN)	KIRNBERGER



- Press the **TEMPERAMENT** button. The indicator on the **TEMPERAMENT** button will light. One of the Voice buttons will start blinking. In this case, it represents the type of tuning that is active at that time.
- While continuing to hold down the **TEMPERAMENT** button, press the Voice button that corresponds to the temperament you wish to use. Once a setting for a temperament other than Equal has been made, the **TEMPERAMENT** button can thereafter be used to switch between Equal temperament and the other selected tuning.

Voice buttons

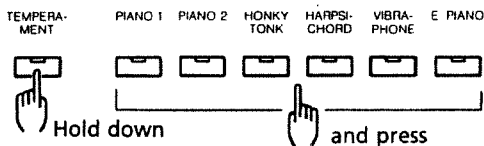

- Equal Temperament**
12-tone equal temperament. The temperament most commonly used today.
- Pythagorean Temperament**
Developed by the philosopher Pythagoras as a method of tuning which resolved the ambiguity of fourths and fifths. As a result melodies sound cleaner, but a certain amount of ambiguity is produced with triads.
- Just Temperament**
A method of tuning which resolved the ambiguity of fifths and thirds. Quite beautiful sonorities are produced with chords, but the scale is unbalanced and is thus not well-suited for melodies.

[Changing the Tonic]

● With the Major Scale

While holding down the **TEMPERAMENT** button, press the keynote for the key. (For C major, this is C.)



When wishing to play a piece in A major:
The keynote for A major is the note of A. So, while holding down the **TEMPERAMENT** button, press the A note.

● With the Minor Scale

While holding down the **TEMPERAMENT** button, press the note which is the keynote for a key that has an identical number of sharps and flats as the key in question.

However, when using Just temperament, the manner in which the setting is made differs, due to the need for differentiating between major and minor keys and sounding the principal triads in compliance with Just temperament.

While holding down the **TEMPERAMENT** button, press the keynote for the key, along with the key which is a minor third above.



When wishing to play a piece in the key of C minor (With temperaments other than Just)
The key which has an identical number of # and b as Cm is the E-flat major key. The keynote for the E-flat major key is Eb. So, while holding down the **TEMPERAMENT** button, press the Eb key.



When wishing to play a piece in the key of C minor (With Just temperament)
The keynote of Cm is C, and the key a minor third above is Eb. So, while holding down the **TEMPERAMENT** button, press the C and Eb keys.

- * Once a setting for the tonic has been made, it will not change even if you change temperaments.
- * When you have selected a temperament other than Equal and play in ensemble with other instruments, certain discrepancies in pitch may be noticed, depending on the key being used. In such cases, use the Tuning knob to adjust the pitch so it matches the tonic for the other instruments.

- Mean Tone Temperament**
A temperament which adds some compromises to Just temperament, and facilitates transposition.
- Werckmeister Temperament**
(The 3rd scale within the first group of scales)
Through combining the Mean Tone and Pythagorean temperaments, it allows for playing in any key.
- Kirnberger Temperament**
(The 3rd scale)
As a result of improvements made to the Mean Tone and Just temperaments, it is relatively tolerant towards transposition, and can be used to play in all keys.

Playing Using Classical Tuning

[Playing Using Baroque Pitch]

Currently, standard pitch is determined as being that where A = 440 Hz. However, in the Baroque period, it is believed that standard pitch was that where A = 415 Hz. Follow the procedure below in order to play using the standard pitch of the baroque period.



While holding down the **TEMPERAMENT** button, press the **TREMOLO (BAROQUE)** button.

If you press the **TREMOLO** button a second time while holding down the **TEMPERAMENT** button, its indicator will go out, and the pitch will be returned to normal.

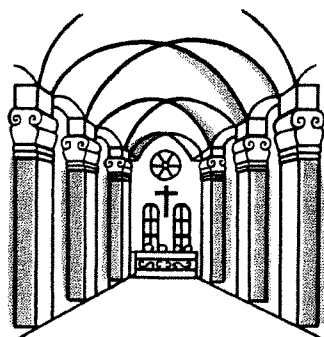
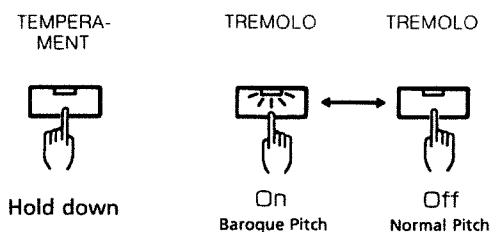

Setting the Tuning Curve
(Stretch Tuning)

Stretch Tuning refers to a method of tuning specific to pianos.

A piano is ordinarily tuned so that, in comparison with the pitches of equal temperament, the lower range notes are made lower and the higher notes are made higher.

The "Tuning Curve" represents the actual pitch changes produced by a particular tuning, when compared with the pitch changes of Equal temperament.

By changing the Tuning Curve, subtle changes in chord sonorities will be heard. You can choose whichever curve suits your purpose.

I	A natural tuning curve, with most wavering suppressed.
II	A tuning curve which tends to emphasize the lower notes. This acts in compensating for the fact that the lower notes are often perceived as being higher.
III	This tuning curve places emphasis on both lower and upper ranges.

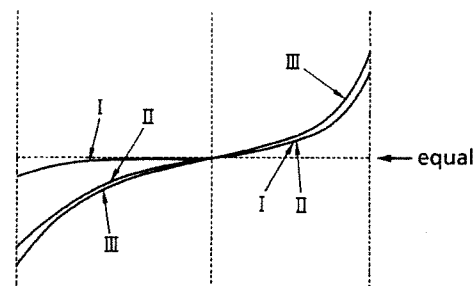

* Even when a temperament other than Equal is selected, the setting for the Tuning Curve that has been made will remain in effect.



① Press the **TEMPERAMENT** button. The indicator on the **CHORUS (STRETCH)** button will start blinking. The indicator on one of the **REVERB (I/II/III)** buttons will also be blinking. This indicates the Tuning Curve that is currently in effect.

② While holding down the **TEMPERAMENT** button, press the **REVERB (I/II/III)** button you need to make your selection.

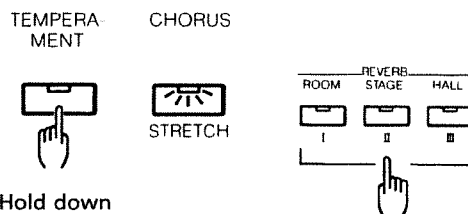

3. Using MIDI

About MIDI...

The MIDI (Musical Instrument Digital Interface) standard was formulated to provide for the transfer of performance information among electronic musical instruments and computers.

- Another MIDI keyboard or a sequencer can be used to play the sounds in the HP-3700/2700.
- The HP-3700/2700 can be played and used to trigger other instruments or sound modules equipped with MIDI.
- What you perform on the HP-3700/2700 can be recorded into a sequencer.

Connections Made With the MIDI Connectors

Three MIDI connectors are provided on the instrument's rear panel. (IN, OUT, and THRU)

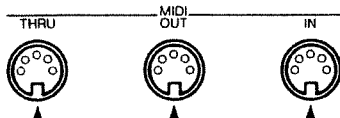

MIDI IN Connector

Here, MIDI data is received. When wishing to have the HP-3700/2700 played by a sequencer or other MIDI device, connect the cable so it runs from here to the MIDI OUT or MIDI THRU connector on the device being connected.

MIDI OUT Connector

MIDI data is sent out from this connector. When wishing to play the sounds of an external MIDI-equipped instrument or sound module, or record what you play into a sequencer, connect a cable between here and the MIDI IN connector on the device you are connecting.

MIDI THRU Connector

An exact copy of any MIDI signals arriving at this instrument's MIDI IN connector is sent out from this connector.

Connections between MIDI connectors should be made using MIDI cable as shown in the figure below (option: MSC-15/25/50).

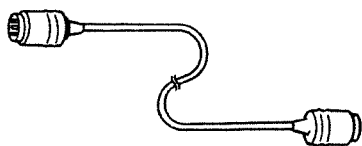

- Connecting a MIDI sound source (MT-32 etc...)

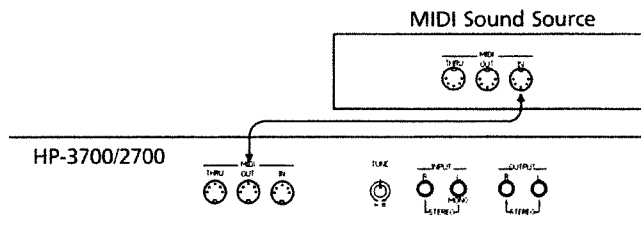

- Connecting an RA-50

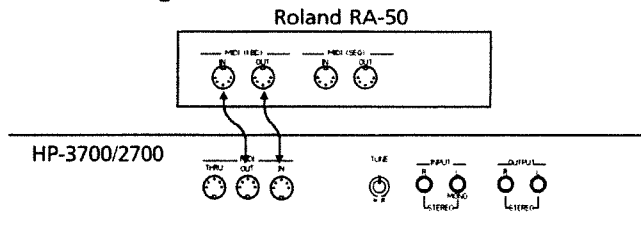

- Connecting an MT-100

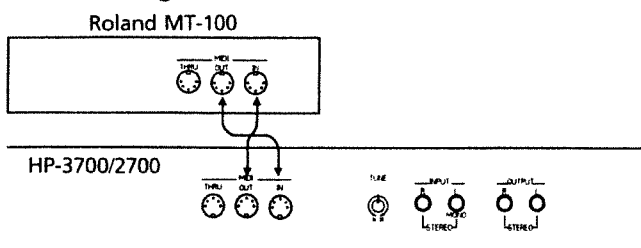

- Connecting a PR-100 and MIDI Sound Source

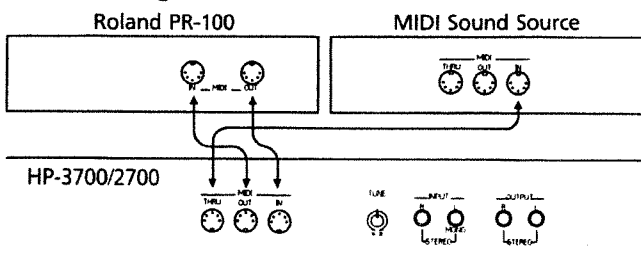

Put the Template in Place

Whenever you wish to make any settings for MIDI, it is helpful to have the supplied template in place on the panel.

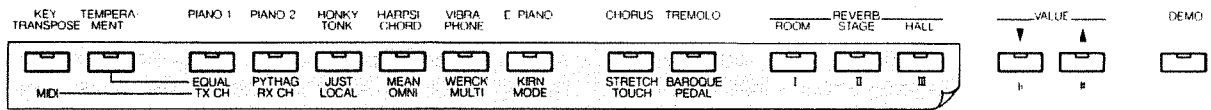

Attach the template

* While you are pressing the KEY-TRANSCOPE (MIDI) button, the instrument cannot be played.

Setting the MIDI Transmit/Receive Channels

MIDI allows you to play sounds on a remote unit, or change the sounds used (only if the channels used on the transmitter and receiver are matched.).

If the MIDI channels are not matched, no sound will be produced. Confirm that you have the channels set correctly.



To set the transmission and reception channels to the same channel:

- 1 Press the **KEY-TRANSCOPE** button and confirm that the indicators on the Piano 1 and Piano 2 buttons are both blinking. If only one of them is blinking, hold down the **KEY-TRANSCOPE** button while you press both buttons.
- 2 While holding down the **KEY-TRANSCOPE** (MIDI) button, press the key which corresponds to the desired MIDI channel. (See illustration below.)

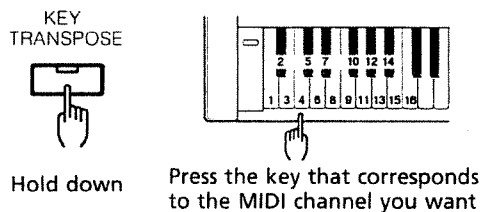

To set separate channels for the transmission and reception channels:

● Setting the Transmit Channel

- 1 While holding down the **KEY-TRANSCOPE** (MIDI) button, press the **PIANO 1** (TX CH) button.

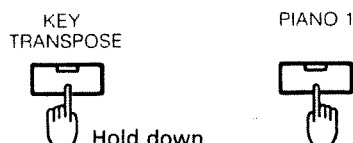

- 2 While still holding down the **KEY-TRANSCOPE** (MIDI) button, press the key which corresponds to the desired MIDI channel. (See illustration below.)

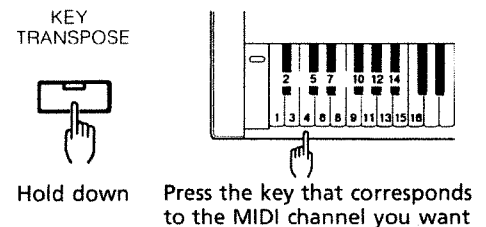

● Setting the Receive Channel

- 1 While holding down the **KEY-TRANSCOPE** (MIDI) button, press the **PIANO 2** (RX CH) button.



- 2 While still holding down the **KEY-TRANSCOPE** (MIDI) button, press the key which corresponds to the desired MIDI channel. (See illustration below.)

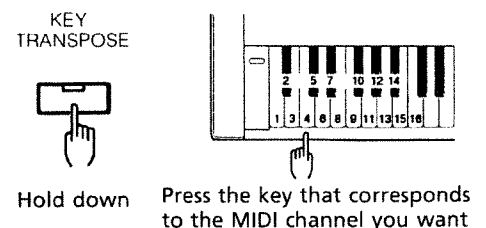

Local ON/OFF

The information below will be helpful when wishing to use the instrument in combination with a sequencer. (When one cable should run between the MIDI OUT on this instrument and the MIDI IN on the sequencer, and another should run between the sequencer's MIDI OUT and this unit's MIDI IN.)

When connections are made as illustrated below, the music you play can be recorded into a sequencer. Then, you can hear a reproduction of it when the sequencer is played back.

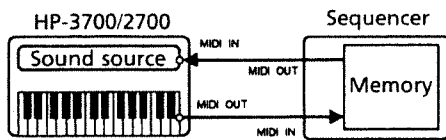

If "Soft Thru" on the sequencer is on at this time, the same notes will be produced twice. As a result, the sound may seem unnatural, and the maximum number of voices that can be produced simultaneously may be reduced.

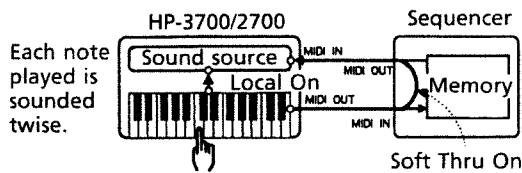

This is because the performance data generated by playing the keyboard reaches the internal sound source through two different routes, which are:

- ① The circuit connections within the HP-3700/2700.
- ② Soft Thru on the sequencer. (State whereby a copy of the performance data received at MIDI IN is sent out from MIDI OUT.)

In order to alleviate problems, the first route ① can be switched out of use. Doing this is referred to as setting the instrument to "Local Off." Conversely, the ordinary state, where the route in ① is left active, is known as "Local On."

Local On

This is the normal mode, in which the keyboard connected to its built-in sound source.

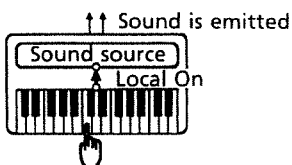

Local Off

In this mode, the keyboard will not be connected to its built-in sound source, and playing the keyboard will not produce sound.

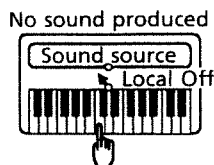

Omni On/Off

When set to "Omni On," the HP-3700/2700 will produce sound regardless of the channel that any performance data is received on. This is convenient for times such as when checking arrangements that require hearing the performance data on all channels at the same time.



While holding down the **KEY-TRANPOSE** (MIDI) button, press the **HARPSICHORD** (OMNI) button. This allows you to switch between Omni ON and OFF.

With the indicator blinking, it is ON, and when it is not lit, it is OFF.



* Settings for the transmission and reception channels are not affected by this setting.

The instrument can also be set to Omni ON by pressing the key at the farthest right (highest key) of the keyboard while holding down the **KEY-TRANPOSE** (MIDI) button. When set in this manner, the Transmit/Receive channel is automatically always set at channel 1.

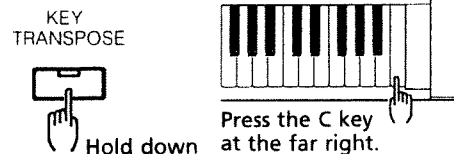

* Whenever a setting for the Receive channel is made, the unit returns to the Omni OFF mode.



While holding down the **KEY-TRANPOSE** (MIDI) button, press the **HONKY TONK** (LOCAL) button. This allows you to switch between Local ON and OFF.

With the indicator blinking, it is ON; and when it is not lit, it is OFF.

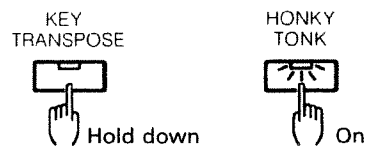

* If there is no MIDI cable connected to the piano's MIDI IN connector, the mode will automatically be at "Local On" regardless of what is indicated by the **HONKY TONK** (LOCAL) button.

Selecting the Transmission/Reception Mode

Three Transmission/Reception Modes have been provided to allow you to select the mode which best matches your needs.

* Note and Pedal messages can be received and transmitted regardless of the mode selected.

I	<p>Allows for transmission/reception of Program Change messages. (Data used to make changes in the Voice used.)</p> <p>Program Change messages can be transmitted by holding down the KEY-TRANSCOPE (MIDI) button and then pressing the relevant key. (See chart below.) Such messages are not sent out when simply changing the Voice using the panel.</p>
II	<p>Allows for transmission only of Program Change, Chorus, and Tremolo On/Off messages. Program Change messages can be transmitted by holding down the KEY-TRANSCOPE (MIDI) button and then pressing the relevant key. (See chart below.) They are not sent out when simply changing the Voice using the panel.</p> <p>When set to this mode, the Voice will not be changed even if Program Changes are received. It is thus convenient to use in combination with Omni On when wishing to have the instrument played using the Note messages on all channels.</p>
III	<p>Allows for transmission/reception of Chorus, Tremolo, Reverb On/Off, Volume, Brilliance, and Temperament messages.</p> <p>Program Change messages will be sent out when changing the Voice using the panel (See MIDI implementation.) At the same time, the Chorus and Tremolo On/Off messages for the Voice will be transmitted along with them.</p> <p>This mode is convenient to use when wishing to record a performance into a sequencer, or similar device.</p>

Chorus On/Off	Control No. 93
Tremolo On/Off	Control No. 92
Volume	Control No. 7
Reverb On/Off	Roland Exclusive Messages
Brilliance	Roland Exclusive Messages
Temperament	Roland Exclusive Messages



① While holding down the **KEY-TRANSCOPE (MIDI)** button, press the **E. PIANO (MODE)** button.

The indicator on the **E. PIANO (MODE)** button will start blinking.

The indicator on one of the **REVERB (I/II/III)** buttons will be blinking. This indicates the Mode that is currently in effect.

② While holding down the **KEY-TRANSCOPE (MIDI)** button, press the **REVERB (I/II/III)** button you need to make your selection.

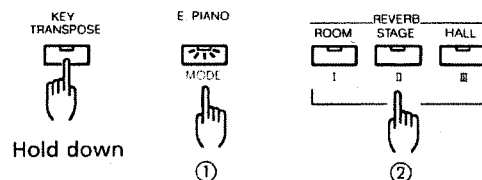

Transmitting Program Change messages (Mode I, II)

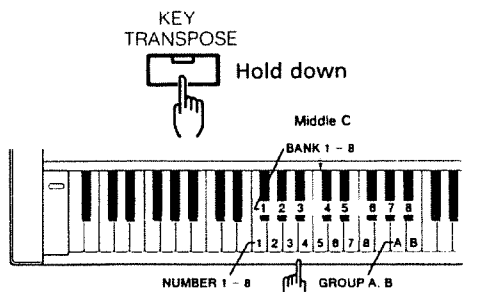

Press the keys that correspond to the program change number you want.

Group A

	Number							
Bank	1	2	3	4	5	6	7	8
1	1	2	3	4	5	6	7	8
2	9	10	11	12	13	14	15	16
3	17	18	19	20	21	22	23	24
4	25	26	27	28	29	30	31	32
5	33	34	35	36	37	38	39	40
6	41	42	43	44	45	46	47	48
7	49	50	51	52	53	54	55	56
8	57	58	59	60	61	62	63	64

Group B

	Number							
Bank	1	2	3	4	5	6	7	8
1	65	66	67	68	69	70	71	72
2	73	74	75	76	77	78	79	80
3	81	82	83	84	85	86	87	88
4	89	90	91	92	93	94	95	96
5	97	98	99	100	101	102	103	104
6	105	106	107	108	109	110	111	112
7	113	114	115	116	117	118	119	120
8	121	122	123	124	125	126	127	128

The Multi-Timbral Mode

This instrument also provides a Multi-Timbral mode which allows MIDI data that is received to be used to simultaneously play each of the 6 internal Voices. Employing the Multi-Timbral mode, you can create ensemble-like performances. For example, you could play the vibraphone while having performance data sent in from a sequencer used to provide piano accompaniment.

- **When the Multi-Timbral Mode is OFF**
Data arriving on the set Receive channel (see page 15) is received and used to play the currently selected Voice.
- **When the Multi-Timbral Mode is ON**
Of any MIDI data that arrives, that which arrives on channels 1, 11, 12, and 13 is received. Data on all other channels is ignored.
The Voice that is used to play the notes will be determined by the Program Change message that is received on the relevant channel. The correspondence between Program Change Numbers and the Voices switched to as a result of them is as shown at MIDI Implementation.



While holding down the **KEY-TRANPOSE** (MIDI) button, press the **VIBRAPHONE** (MULTI) button to make the setting for Multi-Timbral Mode. With the indicator blinking, it is ON, and when it is not lit, it is OFF.

KEY
TRANPOSE



Hold down

VIBRA-
PHONE



On

[How Various Types of Messages Function When in Multi-Timbral Mode on]

- **Pedal Messages**
The action of this instrument's pedals will effect only the notes actually played on the keyboard. Pedal messages received from an external MIDI device take effect only with respect to notes that play as a result of messages received from the external device.
* **Pedal Messages are:**

Damper:	Control Change Number 64
Sostenuto:	Control Change Number 66
Soft:	Control Change Number 67
 - **Concerning the Volume**
Volume messages (Control Number 7) control the volume, and function independently for each channel, 1, 11, 12, or 13. Such messages, however, have no effect on what is played on this instrument's keyboard. The actual volume obtained is determined by the value of the Volume message, and the position of the Volume slider on this instrument. When Volume messages at the maximum value are received, the volume produced will be in keeping with the position of the Volume slider.
 - **Chorus and Tremolo On/Off Messages**
Chorus and Tremolo On/Off messages function independently for each channel, 1, 11, 12, or 13.
 - **About Brilliance**
Brilliance messages (Roland Exclusive Messages) control the quality of the sound, and affect all Voices identically regardless of whether they are received on channels 1, 11, 12, or 13.
 - **Reverb On/Off Messages**
Reverb On/Off messages (Roland Exclusive Messages) affect all Voices identically regardless of whether they are received on channels 1, 11, 12 or 13.
- * When the Multi-Timbral Mode is "On," the unit will constantly be at "Omni OFF."

MIDI Implementation Chart

Function ...		Transmitted	Recognized	Remarks
Basic Channel	Default Changed	1 1 - 16 each	1 1 - 16 each	can be stored
Mode	Default Messages Altered	Mode 3 OMNI OFF,POLY *****	Mode 3 ○ MONO M<>→1,M=1→3	* 2
Note Number	True Voice	15 - 113 *****	0 - 127 15 - 113	
Velocity	Note ON Note OFF	○ × 9n v = 0	○ ×	
After Touch	Key's Ch's	× ×	× ×	
Pitch Bender		×	×	
Control Change	6,38	×	○	data entry volume hold - 1 sostenuto soft tremolo chorus
	7	×	○	
	64	○	○	
	66	○	○	
	67	○	○	
	92	* 1	* 1	
	93	* 1	* 1	
	100, 101	×	○	RPN LSB, MSB
	121	×	○	reset all controllers
Prog Change	True #	* 1 (0 - 127) *****	* 1 (0 - 127) 0 - 127	
System Exclusive		○	○	
System Common	Song Pos Song Sel Tune	× × ×	× × ×	
System Real Time	Clock Commands	× ×	× ×	
Aux Messages	Local ON/OFF All Notes OFF Active Sense Reset	× × ○ ×	○ ○ (123 - 127) ○ ×	
Notes		* 1 ○ or × is changed with MIDI function mode. * 2 When power on, OMNI OFF and POLY are sent through the basic channel.		

Mode 1 : OMNI ON, POLY
Mode 3 : OMNI OFF, POLY

Mode 2 : OMNI ON, MONO
Mode 4 : OMNI OFF, MONO

○ : Yes
× : No

Roland Exclusive Messages

1 Data Format for Exclusive Messages

Roland's MIDI implementation uses the following data format for all exclusive messages (type IV):

Byte	Description
F0H	Exclusive status
41H	Manufacturer ID (Roland)
DEV	Device ID
MDL	Model ID
CMD	Command ID
[BODY]	Main data
F7H	End of exclusive

MIDI status : F0H, F7H

An exclusive message must be flanked by a pair of status codes, starting with a Manufacturer-ID immediately after F0H (MIDI version 1.0).

Manufacturer-ID : 41H

The Manufacturer-ID identifies the manufacturer of a MIDI instrument that triggers an exclusive message. Value 41H represents Roland's Manufacturer-ID.

Device-ID : DEV

The Device-ID contains a unique value that identifies the individual device in the multiple implementation of MIDI instruments. It is usually set to 00H - 0FH, a value smaller by one than that of a basic channel, but value 00H - 1FH may be used for a device with multiple basic channels.

Model-ID : MDL

The Model-ID contains a value that uniquely identifies one model from another. Different models, however, may share an identical Model-ID if they handle similar data.

The Model-ID format may contain 00H in one or more places to provide an extended data field. The following are examples of valid Model-IDs, each representing a unique model:

01H
02H
03H
00H, 01H
00H, 02H
00H, 00H, 01H

Command-ID : CMD

The Command-ID indicates the function of an exclusive message. The Command-ID format may contain 00H in one or more places to provide an extended data field. The following are examples of valid Command-IDs, each representing a unique function:

01H
02H
03H
00H, 01H
00H, 02H
00H, 00H, 01H

Main data : BODY

This field contains a message to be exchanged across an interface. The exact data size and contents will vary with the Model-ID and Command-ID.

2 Address-mapped Data Transfer

Address mapping is a technique for transferring messages conforming to the data format given in Section 1. It assigns a series of memory-resident records-waveform and tone data, switch status, and parameters, for example to specific locations in a machine-dependent address space, thereby allowing access to data residing at the address a message specifies.

Address-mapped data transfer is therefore independent of models and data categories. This technique allows use of two different transfer procedures: one-way transfer and handshake transfer.

One-way transfer procedure (See Section 3 for details.)

This procedure is suited for the transfer of a small amount of data. It sends out an exclusive message completely independent of a receiving device status.

Connection Diagram

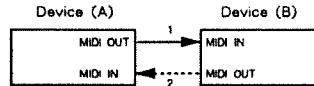

Connection at point 2 is essential for "Request data" procedures. (See Section 3.)

Handshake-transfer procedure (See Section 4 for details.)

This procedure initiates a predetermined transfer sequence (handshaking) across the interface before data transfer takes place. Handshaking ensures that reliability and transfer speed are high enough to handle a large amount of data.

Connection Diagram

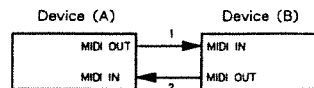

Connection at points 1 and 2 is essential.

Notes on the above two procedures

- * There are separate Command-IDs for different transfer procedures.
- * Devices A and B cannot exchange data unless they use the same transfer procedure, share identical Device-ID and Model ID, and are ready for communication.

3 One-way Transfer Procedure

This procedure sends out data all the way until it stops and is used when the messages are so short that answerbacks need not be checked. For long messages, however, the receiving device must acquire each message in time with the transfer sequence, which inserts intervals of at least 20 milliseconds in between.

Types of Messages

Message	Command ID
Request data 1	RQ1 (11H)
Data set 1	DT1 (12H)

Request data #1 : RQ1 (11H)

This message is sent out when there is a need to acquire data from a device at the other end of the interface. It contains data for the address and size that specify designation and length, respectively, of data required.

On receiving an RQ1 message, the remote device checks its memory for the data address and size that satisfy the request.

If it finds them and is ready for communication, the device will transmit a "Data set 1 (DT1)" message, which contains the requested data. Otherwise, the device will send out nothing.

Byte	Description
F0H	Exclusive status
41H	Manufacturer ID (Roland)
DEV	Device ID
MDL	Model ID
11H	Command ID
aaH	Address MSB
⋮	⋮
	LSB
ssH	Size MSB
⋮	⋮
	LSB
sum	Check sum
F7H	End of exclusive

- * The size of the requested data does not indicate the number of bytes that will make up a DT1 message, but represents the address fields where the requested data resides.
- * Some models are subject to limitations in data format used for a single transaction. Requested data, for example, may have a limit in length or must be divided into predetermined address fields before it is exchanged across the interface.
- * The same number of bytes comprises address and size data, which, however, vary with the Model-ID.
- * The error checking process uses a checksum that provides a bit pattern where the least significant 7 bits are zero when values for an address, size, and that checksum are summed.

Data set 1 : DT1 (12H)

This message corresponds to the actual data transfer process. Because every byte in the data is assigned a unique address, a DT1 message can convey the starting address of one or more data as well as a series of data formatted in an address-dependent order.

The MIDI standards inhibit non-real time messages from interrupting an exclusive one. This fact is inconvenient for the devices that support a "soft-through" mechanism. To maintain compatibility with such devices, Roland has limited the DT1 to 256 bytes so that an excessively long message is sent out in separate segments.

Byte	Description
F0H	Exclusive
41H	Manufacturer ID (Roland)
DEV	Device ID
MDL	Model ID
12H	Command ID
aaH	Address MSB
⋮	⋮
ddH	Data
⋮	⋮
sum	Check sum
F7H	End of exclusive

- * A DT1 message is capable of providing only the valid data among those specified by an RQ1 message.
- * Some models are subject to limitations in data format used for a single transaction. Requested data, for example, may have a limit in length or must be divided into predetermined address fields before it is exchanged across the interface.
- * The number of bytes comprising address data varies from one Model-ID to another.
- * The error checking process uses a checksum that provides a bit pattern where the least significant 7 bits are zero when values for an address, size, and that checksum are summed.

Example of Message Transactions

- Device A sending data to Device B

Transfer of a DT1 message is all that takes place.

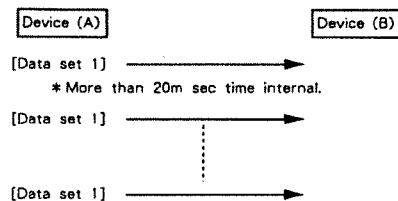

- Device B requesting data from Device A

Device B sends an RQ1 message to Device A. Checking the message, Device A sends a DT1 message back to Device B.

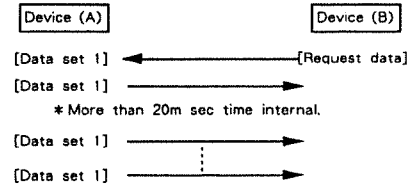

4. Handshake Transfer Procedure

Handshaking is an interactive process where two devices exchange error checking signals before a message transaction takes place, thereby increasing data reliability. Unlike one-way transfer that inserts a pause between message transactions, handshake transfer allows much speedier transactions because data transfer starts once the receiving device returns a ready signal.

When it comes to handling large amounts of data-sampler waveforms and synthesizer tones over the entire range, for example-across a MIDI interface, handshaking transfer is more efficient than one-way transfer.

Types of Messages

Message	Command ID
Want to send data	WSD (40H)
Request data	RQD (41H)
Data set	DAT (42H)
Acknowledge	ACK (43H)
End of data	EOD (45H)
Communication error	ERR (4EH)
Rejection	RJC (4FH)

Want to send data : WSD (40H)

This message is sent out when data must be sent to a device at the other end of the interface. It contains data for the address and size that specify designation and length, respectively, of the data to be sent.

On receiving a WSD message, the remote device checks its memory for the specified data address and size which will satisfy the request. If it finds them and is ready for communication, the device will return an "Acknowledge (ACK)" message.

Byte	Description
F0H	Exclusive status
41H	Manufacturer ID (Roland)
DEV	Device ID
MDL	Model ID
40H	Command ID
aaH	Address MSB
⋮	⋮
ssH	Size MSB
⋮	⋮
sum	Check sum
F7H	End of exclusive

Otherwise, it will return a "Rejection (RJC)" message.

- * The size of the data to be sent does not indicate the number of bytes that make up a "Data set (DAT)" message, but represents the address fields where the data should reside.
- * Some models are subject to limitations in data format used for a single transaction. Requested data, for example, may have a limit in length or must be divided into predetermined address fields before it is exchanged across the interface.
- * The same number of bytes comprises address and size data, which, however, vary with the Model-ID.
- * The error checking process uses a checksum that provides a bit pattern where the least significant 7 bits are zero when values for an address, size, and that checksum are summed.

Roland Exclusive Messages

Request data : RQD (41H)

This message is sent out when there is a need to acquire data from a device at the other end of the interface. It contains data for the address and size that specify designation and length, respectively, of data required.

On receiving an RQD message, the remote device checks its memory for the data address and size which satisfy the request.

If it finds them and is ready for communication, the device will transmit a "Data set (DAT)" message, which contains the requested data. Otherwise, it will return a "Rejection (RJC)" message.

Byte	Description
F0H	Exclusive status
41H	Manufacturer ID (Roland)
DEV	Device ID
MDL	Model ID
41H	Command ID
aaH	Address MSB
⋮	⋮
	LSB
ssH	Size MSB
⋮	⋮
	LSB
sum	Check sum
F7H	End of exclusive

- * The size of the requested data does not indicate the number of bytes that make up a "Data set (DAT)" message, but represents the address fields where the requested data resides.
- * Some models are subject to limitations in data format used for a single transaction. Requested data, for example, may have a limit in length or must be divided into predetermined address fields before it is exchanged across the interface.
- * The same number of bytes comprises address and size data, which, however, vary with the Model-ID.
- * The error checking process uses a checksum that provides a bit pattern where the least significant 7 bits are zero when values for an address, size, and that checksum are summed.

Data set : DAT (42H)

This message corresponds to the actual data transfer process. Because every byte in the data is assigned a unique address, the message can convey the starting address of one or more data as well as a series of data formatted in an address-dependent order.

Although the MIDI standards inhibit non-real time messages from interrupting an exclusive one, some devices support a "soft-through" mechanism for such interrupts. To maintain compatibility with such devices, Roland has limited the DAT to 256 bytes so that an excessively long message is sent out in separate segments.

Byte	Description
F0H	Exclusive status
41H	Manufacturer ID (Roland)
DEV	Device ID
MDL	Model ID
42H	Command ID
aaH	Address MSB
⋮	⋮
	LSB
ddH	Data
⋮	⋮
sum	Check sum
F7H	End of exclusive

- * A DAT message is capable of providing only the valid data among those specified by an RQD or WSD message.
- * Some models are subject to limitations in data format used for a single transaction. Requested data, for example, may have a limit in length or must be divided into predetermined address fields before it is exchanged across the interface.
- * The number of bytes comprising address data varies from one model ID to another.
- * The error checking process uses a checksum that provides a bit pattern where the least significant 7 bits are zero when values for an address, size, and that checksum are summed.

Acknowledge : ACK (43H)

This message is sent out when no error was detected on reception of a WSD, DAT, "End of data (EOD)", or some other message and a requested setup or action is complete. Unless it receives an ACK message, the device at the other end will not proceed to the next operation.

Byte	Description
F0H	Exclusive status
41H	Manufacturer ID (Roland)
DEV	Device ID
MDL	Model ID
43H	Command ID
F7H	End of exclusive

End of data : EOD (45H)

This message is sent out to inform a remote device of the end of a message. Communication, however, will not come to an end unless the remote device returns an ACK message even though an EOD message was transmitted.

Byte	Description
F0H	Exclusive status
41H	Manufacturer ID (Roland)
DEV	Device ID
MDL	Model ID
45H	Command ID
F7H	End of exclusive

Communications error : ERR (4EH)

This message warns the remote device of a communications fault encountered during message transmission due, for example, to a checksum error. An ERR message may be replaced with a "Rejection (RJC)" one, which terminates the current message transaction in midstream.

When it receives an ERR message, the sending device may either attempt to send out the last message a second time or terminate communication by sending out an RJC message.

Byte	Description
F0H	Exclusive status
41H	Manufacturer ID (Roland)
DEV	Device ID
MDL	Model ID
4EH	Command ID
F7H	End of exclusive

Rejection : RJC (4FH)

This message is sent out when there is a need to terminate communication by overriding the current message. An RJC message will be triggered when:

- a WSD or RQD message has specified an illegal data address or size.
- the device is not ready for communication.
- an illegal number of addresses or data has been detected.
- data transfer has been terminated by an operator.
- a communications error has occurred.

An ERR message may be sent out by a device on either side of the interface. Communication must be terminated immediately when either side triggers an ERR message.

Byte	Description
F0H	Exclusive status
41H	Manufacturer ID (Roland)
DEV	Device ID
MDL	Model ID
4FH	Command ID
F7H	End of exclusive

Example of Message Transactions

● Data transfer from device (A) to device (B).

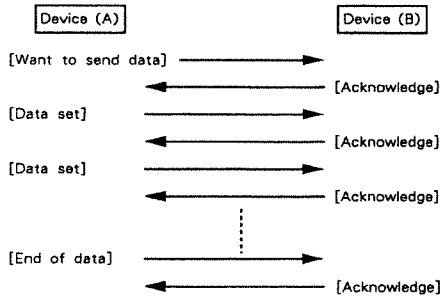

● Device (A) requests and receives data from device (B).

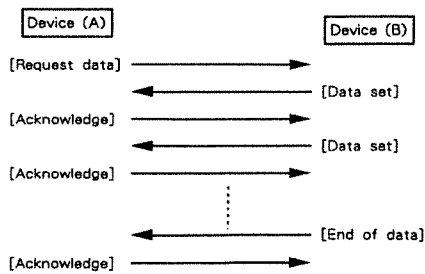

● Error occurs while device (A) is receiving data from device (B).

1) Data transfer from device (A) to device (B).

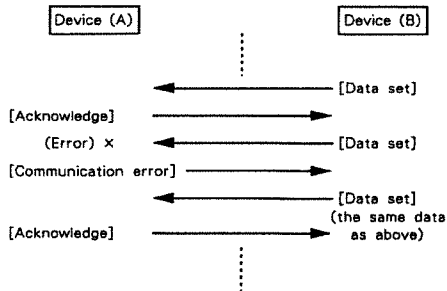

2) Device (B) rejects the data re-transmitted, and quits data transfer.

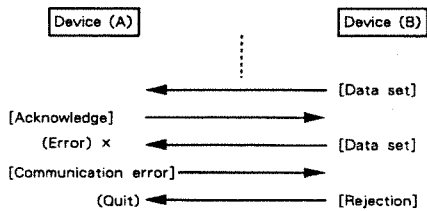

3) Device (A) immediately quits data transfer.

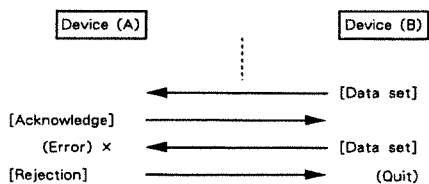

1. RECOGNIZED RECEIVE DATA

■ Channel voice message

● Note Off

Status Second Third

8nH kkH vvH
9nH kkH 00H

n = MIDI channel number : 0H - FH (0 - 15) 0 = ch.1 15 = ch.16
kk = note number : 00H - 7FH (0 - 127)
vv = velocity : 00H - 7FH (0 - 127)

* Velocity is ignored.

● Note On

Status Second Third

9nH kkH vvH

n = MIDI channel number : 0H - FH (0 - 15) 0 = ch.1 15 = ch.16
kk = note number : 00H - 7FH (0 - 127)
vv = velocity : 01H - 7FH (1 - 127)

Note numbers outside the range of 15-113 are transposed to the nearest octave within this range.
Transpose function does not affect the recognized note numbers.

● Control Change

○ Volume

Status Second Third

BnH 07H vvH

n = MIDI channel number : 0H - FH (0 - 15) 0 = ch.1 15 = ch.16
vv = volume : 00H - 7FH (0 - 127)

* Received volume messages affect received note event levels (Rx ch/Part), and cannot affect internal keyboard notes.
* MIDI volume control is relative to master volume slider.

○ Data Entry

Status Second Third

BnH 06H aaH
BnH 26H bbH

n = MIDI channel number : 0H - FH (0 - 15) 0 = ch.1 15 = ch.16
aabb = value defined by RPN parameter.

○ Hold-1

Status Second Third

BnH 40H vvH

n = MIDI channel number : 0H - FH (0 - 15) 0 = ch.1 15 = ch.16
vv = control value : 00H - 7FH (0 - 127)

* hold-1 (damper) is not a switch (ON/OFF) but a continuously variable controller.

○ Sostenuto

Status Second Third

BnH 42H vvH

n = MIDI channel number : 0H - FH (0 - 15) 0 = ch.1 15 = ch.16
vv = control value : 00H - 7FH (0 - 127) 0-63 = OFF 64-127 = ON

* sostenuto is an ON/OFF switch.

○ Soft

Status Second Third

BnH 43H vvH

n = MIDI channel number : 0H - FH (0 - 15) 0 = ch.1 15 = ch.16
vv = control value : 00H - 7FH (0 - 127)

* Soft is not a switch (ON/OFF) but a continuously variable controller.

○ Tremolo

Status Second Third

BnH 5CH vvH

n = MIDI channel number : 0H - FH (0 - 15) 0 = ch.1 15 = ch.16
vv = control value : 00H - 7FH (0 - 127) 0-63 = OFF 64-127 = ON

* tremolo settings via MIDI are treated as temporary messages. They are not stored in a patch setting or stored in back-up memory.

* tremolo is ignored when MIDI function II is selected.

○ Chorus

Status Second Third

BnH 5DH vvH

n = MIDI channel number : 0H - FH (0 - 15) 0 = ch.1 15 = ch.16
vv = control value : 00H - 7FH (0 - 127) 0-63 = OFF 64-127 = ON

* chorus settings via MIDI are treated as a temporary messages. They are not stored in a patch setting or stored in back-up memory.

* chorus is ignored when MIDI function II is selected.

○ RPN LSB

Status Second Third

BnH 64H 11H

n = MIDI channel number : 0H - FH (0 - 15) 0 = ch.1 15 = ch.16
11 = lower byte of the parameter number controlled with RPN.

* RPN LSB is recognized when MIDI functions set to Rx.RPN = ON.

○ RPN MSB

Status Second Third

BnH 65H mmH

n = MIDI channel number : 0H - FH (0 - 15) 0 = ch.1 15 = ch.16
mm = upper byte of the parameter number controlled with RPN.

* RPN MSB is recognized when MIDI functions set to Rx.RPN = ON.

** RPN (Registered Parameter Number) **

Using MIDI RPN, parameter can be changed with Control change messages. RPN MSB and LSB specify the parameter to be controlled, while Data Entry shows the parameter value.

HP-2700 and HP-3700 recognize only Fine Tune (RPN#1).

RPN	data entry	comments
MSB LSB	MSB LSB	
00H 01H	aaH bbH	fine tune
	aabb = -4096	+4096
	(-50 cent	+50 cent)

program number tone

8 PIANO 1
 9 PIANO 1 + PIANO 2
 10 PIANO 1 + HONKY TONK
 11 PIANO 1 + HARPSICHORD
 12 PIANO 1 + HARPSICHORD
 13 PIANO 1 + VIBRAPHONE
 14 PIANO 1 + E. PIANO
 15 PIANO 1 + E. PIANO

 16 PIANO 1 + PIANO 2
 17 PIANO 2
 18 PIANO 2 + HONKY TONK
 19 PIANO 2 + HARPSICHORD
 20 PIANO 2 + HARPSICHORD
 21 PIANO 2 + VIBRAPHONE
 22 PIANO 2 + E. PIANO
 23 PIANO 2 + E. PIANO

 24 PIANO 1 + HONKY TONK
 25 PIANO 2 + HONKY TONK
 26 HONKY TONK
 27 HONKY TONK + HARPSICHORD
 28 HONKY TONK + HARPSICHORD
 29 HONKY TONK + VIBRAPHONE
 30 HONKY TONK + E. PIANO
 31 HONKY TONK + E. PIANO

 32 PIANO 1 + HARPSICHORD
 33 PIANO 2 + HARPSICHORD
 34 HONKY TONK + HARPSICHORD
 35 HARPSICHORD
 36 HARPSICHORD
 37 HARPSICHORD + VIBRAPHONE
 38 HARPSICHORD + E. PIANO
 39 HARPSICHORD + E. PIANO

 40 PIANO 1 + VIBRAPHONE
 41 PIANO 2 + VIBRAPHONE
 42 HONKY TONK + VIBRAPHONE
 43 HARPSICHORD + VIBRAPHONE
 44 VIBRAPHONE + HARPSICHORD
 45 VIBRAPHONE
 46 VIBRAPHONE + E. PIANO
 47 VIBRAPHONE + E. PIANO

 48 PIANO 1 + E. PIANO
 49 PIANO 2 + E. PIANO
 50 HONKY TONK + E. PIANO
 51 HARPSICHORD + E. PIANO
 52 HARPSICHORD + E. PIANO
 53 VIBRAPHONE + E. PIANO
 54 E. PIANO
 55 E. PIANO

* Program change is ignored when MIDI function 11 is selected.

■ Channel Mode Message

● **Reset All Controllers**

Status Second Third
 BnH 79H 00H

n = MIDI channel number : 0H - FH (0 - 15) 0 = ch. 1 15 = ch. 16

* When this message is received, values of the controllers listed below are changed.

<u>controller</u>	<u>value</u>
volume	127 (maximum)
hold 1	0 (OFF)
sostenuto	0 (OFF)
soft	0 (OFF)

● **Local Control**

Status Second Third
 BnH 7AH vvH

n = MIDI channel number : 0H - FH (0 - 15) 0 = ch. 1 15 = ch. 16
 vv = value : 00H, 7FH (0, 127) 0 = OFF 127 = ON

● **All Note OFF**

Status Second Third
 BnH 7BH 00H

n = MIDI channel number : 0H - FH (0 - 15) 0 = ch. 1 15 = ch. 16

* When All Notes Off is received, all the On-Notes of the appropriate channel will be OFF.

● **OMNI OFF**

Status Second Third
 BnH 7CH 00H

n = MIDI channel number : 0H - FH (0 - 15) 0 = ch. 1 15 = ch. 16

* When OMNI OFF is received, all the On-Notes of the appropriate channel will be OFF.

● **OMNI ON**

Status Second Third
 BnH 7DH 00H

n = MIDI channel number : 0H - FH (0 - 15) 0 = ch. 1 15 = ch. 16

* When OMNI ON is received, all the On-Notes of the appropriate channel will be OFF.

● **MONO**

Status Second Third
 BnH 7EH null

n = MIDI channel number : 0H - FH (0 - 15) 0 = ch. 1 15 = ch. 16

mm : 0H - 10H

* When MONO is received, all the On-Notes of the appropriate channel will be OFF.

● **POLY**

Status Second Third
 BnH 7FH 00H

n = MIDI channel number : 0H - FH (0 - 15) 0 = ch. 1 15 = ch. 16

* When POLY is received, all the On-Notes of the appropriate channel will be OFF.

Mode Message Table

	POLY ON	MONO ON	MONO ON
	mm = 1	mm < 1	

OMNI OFF	OMNI = OFF	OMNI = OFF	OMNI = ON
	POLY	POLY	POLY

OMNI ON	OMNI = ON	OMNI = ON	OMNI = ON
	POLY	POLY	POLY

■ SYSTEM REAL TIME MESSAGE

● **Active Sensing**

Status
 FEH

* Upon receiving this message, time intervals between messages are measured. If no data is received within 300 milli seconds, all the MIDI On-Notes will be turned off, and all controllers will be reset. The system then returns to normal.

■ System Exclusive Message

Status data byte
 F0H 11H, ddH,, eeH
 F7H

F0H : system exclusive
 11 = ID number : 41H (65)
 dd,, ee = data : 00H-7FH (0-127)
 F7H : EOX (End of Exclusive/System common)

The following messages can be sent with exclusive messages.

brilliance
 reverb mode select (ROOM, STAGE, HALL ON/OFF)
 temperament select
 multi timbre ON /OFF
 chorus depth
 tremolo rate
 reverb intensity

Refer to "Roland Exclusive Message" and section 5.

2. TRANSMITTED DATA

■ Channel Voice Message

● Note Off

Status Second Third
 9nH kkH 00H

n = MIDI channel number : 0H - FH (0 - 15) 0 = ch.1 15 = ch.16
 kk = note number : 0FH - 7FH (15 - 113)

● Note On

Status Second Third
 9nH kkH vvH

n = MIDI channel number : 0H - FH (0 - 15) 0 = ch.1 15 = ch.16
 kk = note number : 0FH - 7FH (15 - 113)
 vv = velocity : 01H - 7FH (1 - 127)

* Note number's range can be changed with Key Transpose: up a maximum of 5, or down a maximum of 6 semitones. The table below shows the degrees of transposition.

transpose	transmitted note number
-6	15-102
-5	16-103
-4	17-104
-3	18-105
-2	19-106
-1	20-107
0	21-108
+1	22-109
+2	23-110
+3	24-111
+4	25-112
+5	26-113

● Control Change

○ Hold-1

Status Second Third
 BnH 40H vvH

n = MIDI channel number : 0H - FH (0 - 15) 0 = ch.1 15 = ch.16
 vv = control value : 00H - 7FH (0 - 127)

* Continuous value is transmitted.

○ Sostenuto

Status Second Third
 BnH 42H vvH

n = MIDI channel number : 0H - FH (0 - 15) 0 = ch.1 15 = ch.16
 vv = control value : 00H, 7FH (0, 127) 0 = OFF 127 = ON

○ Soft

Status Second Third
 BnH 43H vvH

n = MIDI channel number : 0H - FH (0 - 15) 0 = ch.1 15 = ch.16
 vv = control value : 00H - 7FH (0 - 127)

* Continuous value is transmitted.

○ Tremolo

Status Second Third
 BnH 5CH vvH

n = MIDI channel number : 0H - FH (0 - 15) 0 = ch.1 15 = ch.16
 vv = control value : 00H, 7FH (0, 127) 0 = OFF 127 = ON

* Transmitted when MIDI function III is selected.

○ Chorus

Status Second Third
 BnH 5DH vvH

n = MIDI channel number : 0H - FH (0 - 15) 0 = ch.1 15 = ch.16
 vv = control value : 00H, 7FH (0, 127) 0 = OFF 127 = ON

* Transmitted when MIDI function III is selected.

● Program Change

Status Second
 CnH ppH

n = MIDI channel number : 0H - FH (0 - 15) 0 = ch.1 15 = ch.16
 pp = program number : 00H - 7FH (0 - 127)

* When the key related to PROGRAM CHANGE (GROUP A-B, BANK 1-8, NUMBER 1-8) is pressed while the MIDI switch button is held down, a Program Change message will be transmitted.

KEY	GROUP, BANK, NUMBER
A 3	GROUP A
B 3	GROUP B
F# 2	BANK 1
G# 2	BANK 2
A# 2	BANK 3
C# 3	BANK 4
D# 3	BANK 5
F# 3	BANK 6
G# 3	BANK 7
A# 3	BANK 8
F 2	NUMBER 1
G 2	NUMBER 2
A 2	NUMBER 3
B 2	NUMBER 4
C 3	NUMBER 5
D 3	NUMBER 6
E 3	NUMBER 7
F 3	NUMBER 8

The following table shows GROUP, BANK and NUMBER values related to key position which is set while the TRANSPOSE/MIDI switch is held down.

GROUP A	NUMBER	1	2	3	4	5	6	7	8
	BANK	1	1	1	1	1	1	1	1
1	0	1	2	3	4	5	6	7	
2	8	9	10	11	12	13	14	15	
3	16	17	18	19	20	21	22	23	
4	24	25	26	27	28	29	30	31	
5	32	33	34	35	36	37	38	39	
6	40	41	42	43	44	45	46	47	
7	48	49	50	51	52	53	54	55	
8	56	57	58	59	60	61	62	63	
GROUP B	NUMBER	1	2	3	4	5	6	7	8
	BANK	1	1	1	1	1	1	1	1
1	64	65	66	67	68	69	70	71	
2	72	73	74	75	76	77	78	79	
3	80	81	82	83	84	85	86	87	
4	88	89	90	91	92	93	94	95	
5	96	97	98	99	100	101	102	103	
6	104	105	106	107	108	109	110	111	
7	112	113	114	115	116	117	118	119	
8	120	121	122	123	124	125	126	127	

When this piano is set to MIDI function III, pressing a TONE button will select a tone as usual.

At this time, the Program Change message assigned to that button is sent.

tone select button program change number

PIANO 1 0
 PIANO 2 1
 HONKY TONK 2
 HARPSICHORD 3
 VIBRAPHONE 5
 E. PIANO 6

PIANO 1 + PIANO 2 16
 PIANO 1 + HONKY TONK 24
 PIANO 1 + HARPSICHORD 32
 PIANO 1 + VIBRAPHONE 40
 PIANO 1 + E. PIANO 48

PIANO 2 + HONKY TONK 25
 PIANO 2 + HARPSICHORD 33
 PIANO 2 + VIBRAPHONE 41
 PIANO 2 + E. PIANO 49

HONKY TONK + HARPSICHORD 34
 HONKY TONK + VIBRAPHONE 42
 HONKY TONK + E. PIANO 50

HARPSICHORD + VIBRAPHONE 43
 HARPSICHORD + E. PIANO 51

VIBRAPHONE + E. PIANO 53

■ Channel Mode Message

● OMNI OFF

Status Second Third
 BnH 7CH 00H

n = MIDI channel number : 0H - FH (0 - 15) 0 = ch.1 15 = ch.16

* When power is turned on, OMNI OFF and POLY ON are sent through the Basic Channel.

● POLY

Status Second Third
 BnH 7FH 00H

n = MIDI channel number : 0H - FH (0 - 15) 0 = ch.1 15 = ch.16

* When power is turned on, OMNI OFF and POLY ON are sent through the Basic Channel.

■ System Real-Time Message

● Active Sensing

Status
 FEH

This message is sent within a 300 milli_second interval.

■ System Exclusive Message

Status data_byte
 F0H 11H, ddH, eeH
 F7H

F0H : system exclusive
 11 = ID number : 41H (65)
 dd,, ee = data : 00H-7FH (0-127)
 F7H : EOX (End of Exclusive/System common)

The following message can be sent:

Brilliance
 Reverb Mode Select (ROOM, STAGE, HALL ON/OFF)
 Temperament Select

Refer to "Roland Exclusive Message" and section 5.

3. BASIC CHANNEL SETTING

When the keyboard is played while TRANSPOSE/MIDI switch is held down, both transmit (Tx) and receive (Rx) channels are changed. Also, the transmit and receive mode is set to OMNI OFF, POLY ON (MODE 3). If the Tx switch (PIANO 1 button) is pressed while the TRANSPOSE/MIDI switch is held down, only the transmit channel is changed. If the Rx switch (PIANO 2 button) is pressed while the TRANSPOSE/MIDI switch is held down, only the receive channel is changed.

Pressing the highest key (C8) on the keyboard while holding TRANSPOSE/MIDI switch sets the Basic Channels (both transmit and receive) to 1, OMNI ON and POLY ON (MODE 1).

If the OMNI switch (HARPSICHORD button) is pressed while the TRANSPOSE/MIDI switch is held down, MODE is set to OMNI ON and POLY ON (MODE 1). At this time, Basic Channels are not changed.

key	basic channel (Tx or Rx)	OMNI
Power-on	1	OFF
A 1	1	OFF
A# 1	2	OFF
B 1	3	OFF
C 2	4	OFF
C# 2	5	OFF
D 2	6	OFF
D# 2	7	OFF
E 2	8	OFF
F 2	9	OFF
F# 2	10	OFF
G 2	11	OFF
G# 2	12	OFF
A 2	13	OFF
A# 2	14	OFF
B 2	15	OFF
C 3	16	OFF
C 8	1	ON

4. MULTI TIMBRE MODE

Pressing the MULTI switch (VIBRAPHONE button) while the TRANSPOSE/MIDI switch is held down (or while receiving exclusive messages (Multi Timbre ON)) switches the HP -2700/3700 to the Multi Timbre Mode.

■ Channel and Part

In the Multi Timbre Mode, the piano has 4 parts: each channel is 1,11,12 and 13. These channel numbers are fixed. Each part channel can receive program changes individually.

Transmitting message is sent through the current basic channel (Tx channel). If the basic channel is not set to 1,11,12 nor 13, any keyboard note is sent through MIDI, but the note is not heard.

■ Note Event

Transmitting note event is sent through the current basic channel (Tx channel). Receiving note event through channel 1,11,12 or 13 is recognized. Other channel messages are ignored.

■ Control Change

● Damper, Sostenuto and Soft

Damper, Sostenuto and Soft messages are sent through the basic channel (Tx channel). Receiving pedal messages through channel 1,11,12 or 13 affect each channel individually. These message can affect only MIDI notes.

● Volume

Volume cannot be transmitted.

Received volume messages through channel 1,11,12 or 13 affects each channel individually. These message can affect only MIDI notes. Volume control is relative to master volume slider.

● Brilliance

Transmitted brilliance messages are sent through the current basic channel. Received brilliance messages through channel 1,11,12 or 13 affect all the part notes and keyboard notes. The last control message the from panel brilliance slider or the last MIDI message has priority.

● Tremolo and Chorus

Tremolo and Chorus messages are sent through the basic channel (Tx channel). Received tremolo or chorus messages through channel 1, 11, 12 or 13 affect all the part of notes and keyboard play notes. The last control message from panel switches, or the last MIDI messages, has priority.

● Reverb

Transmitted reverb messages are sent through the current basic channel. Received reverb messages through channel 1, 11, 12 or 13 affect all the part of notes and keyboard play notes. The last control message from panel switches, or the last MIDI messages, has priority.

■ Program Change

Program Change messages are sent through the current basic channel (Tx channel). Received program change messages through channel 1, 11, 12 or 13 affect each part individually.

■ Mode Message

In the Multi Timbre mode, mode messages cannot be recognized. Always set to OMNI OFF, POLY ON. All Notes Off messages are not recognized.

5. EXCLUSIVE COMMUNICATIONS

HP-2700/3700 can transmit or receive its patch parameters with exclusive messages. Model ID of HP-2700/3700 exclusive message is 1AH, and device ID is defined by MIDI UNIT NUMBER. UNIT NUMBER is always the same as the current basic channel.

■ One Way Communication

● data set 1 DT1 (12H)

byte	comments
F0H	exclusive Status
41H	maker ID (Roland)
Dev	device ID (Dev = UNIT#-1)
1AH	model ID (HP-2700/3700)
12H	command ID (DT1)
aaH	address MSB
ccH	address LSB
ddH	data
:	:
eeH	data
sum	check sum
F7H	EOX (end of exclusive)

6. Parameter Address Map (Model ID = 1AH)

Parameter Address is divided into 2 bytes. Each byte is 7 bits.

address	MSB	LSB
binary	0aaa aaaa	0bbb bbbb
7bit hexa-decimal	AA	BB

■ Parameter base address

Start	address	Description
00 00	0aaa aaaa	Multi Timbre Mode #1
		0 : OFF, 01H - 7FH : ON
00 01	0aaa aaaa	Reverb Mode Select #2
		00H : OFF
		01H - (15H) - 2AH : Room
		2BH - (40H) - 55H : Stage
		56H - (6BH) - 7FH : Hall
00 05	0111 kkkk	Temperament Select #3
		ttt (0H - 6H), kkkk (0H - BH)
01 00	0aaa aaaa	Brilliance #4
		(00H - 7FH)
01 01	0aaa aaaa	Chorus depth #5
		(00H - 7FH)

01 02	0aaa aaaa	Tremolo rate #5
		(00H - 7FH)
01 03	0aaa aaaa	Reverb intensity #5
		(00H - 7FH)
01 04	0000 00aa	Stretch Tune #6
		(00H - 03H)
01 04	0000 000a	Baroque Tune #6
		(00H - 01H)

Notes:

*1 multi timbre mode

Multi Timbre settings via MIDI are treated as temporary messages, and are not stored in back-up memory.

*2 Reverb Mode Select

Pressing the MODE switch (E.PIANO) while the MIDI switch is held down selects MIDI function mode III. In this mode, the following exclusive messages are sent when one of the REVERB switches is pressed.

00H : REVERB OFF
 15H : ROOM ON
 40H : STAGE ON
 5BH : HALL ON

*3 Temperament Select

Pressing one of the tone selector switches while the TEMPERAMENT switch is held down selects Temperament Change. Playing the keyboard while the TEMPERAMENT switch is held down changes the key signature of the selected temperament.

111 0H - 6H : temperament select
 kkkk 0H - BH : key signature

Temperament Change values are assigned as follows:

When EQUAL temperament tuning is selected, the key signature change is ignored.

	IC#ID	ID#E	IF	IF#G	IG#A	IA#B
EQUAL	00	01	02	03	04	05
JUST (major)	10	11	12	13	14	15
JUST (minor)	20	21	22	23	24	25
MEAN TONE	30	31	32	33	34	35
WERCKMEISTER	40	41	42	43	44	45
KIRNBERGER	50	51	52	53	54	55
PYTHAGOREAN	60	61	62	63	64	65

(numbers are hexa decimal)

* Temperament settings via MIDI are treated as temporary messages, and are not stored in back-up memory.

*4 Brilliance

Brilliance affects all voices, all channel MIDI notes as well as all keyboard notes. The last MIDI or panel slider message has priority.

*5 Chorus Depth, Tremolo Rate, Reverb Intensity

Received control values are quantized in 8 degrees (0 - 7). Lower 4 bits are ignored.

*6 Stretch Tuning

Stretch tuning settings via MIDI are treated as temporary messages, and are not stored in back-up memory.

*7 Baroque Tuning

Baroque tuning settings via MIDI are treated as temporary messages, and are not stored in back-up memory.

Specifications

	HP-2700	HP-3700
Keyboard	88 keys	88 keys
Sound source	Advanced SA Process digital sound source	Advanced SA Process digital sound source
Voices	32 Voice Maximum	32 Voice Maximum
Preset Voices	Piano 1, Piano 2, Honky Tonk, Harpsichord, Vibraphone, Electric Piano	Piano 1, Piano 2, Honky Tonk, Harpsichord, Vibraphone, Electric Piano
Effects	Chorus (ON/OFF, Depth) Tremolo (ON/OFF, Tremolo Rate) Reverb (Room/Stage/Hall, ON/OFF, Intensity)	Chorus (ON/OFF, Depth) Tremolo (ON/OFF, Tremolo Rate) Reverb (Room/Stage/Hall, ON/OFF, Intensity)
Temperament	Equal, Pythagorean, Just (major or minor), Mean tone, Werckmeister, Kirnberger	Equal, Pythagorean, Just (major or minor), Mean tone, Werckmeister, Kirnberger
Touch Control	Light, Medium, Heavy	Light, Medium, Heavy
Stretched Tune	Normal, Middle, Wide	Normal, Middle, Wide
Master tuning	±50 cent	±50 cent
Connectors	Output Sockets (Stereo) Input Sockets (Mono, Stereo) Pedal Socket (8 pin DIN connector) MIDI IN Socket MIDI OUT Socket MIDI THRU Socket	Output Sockets (Stereo) Input Sockets (Mono, Stereo) Pedal Socket (8 pin DIN connector) MIDI IN Socket MIDI OUT Socket MIDI THRU Socket
Pedals	Damper, Soft, Sostenuto	Damper, Soft, Sostenuto
Switch	Power Switch	Power Switch
Speakers	16cm × 2	20cm × 2, 5cm × 4
Finish	Roland Black Oak	Roland Traditional Walnut
Dimensions W×D×H	HP-2700: 1422 × 499.5 × 204 mm (56" × 19 ¹¹ / ₁₆ " × 8 ¹ / ₁₆ " KS-2700: 1428 × 455 × 640 mm (56 ¹ / ₄ " × 17 ¹⁵ / ₁₆ " × 25 ³ / ₁₆ " TOTAL: 1428 × 499.5 × 834 mm (56 ¹ / ₄ " × 19 ¹¹ / ₁₆ " × 32 ¹³ / ₁₆ "	HP-3700: 1441 × 554 × 241 mm (56 ³ / ₄ " × 21 ¹³ / ₁₆ " × 9 ¹ / ₂ " KS-3700: 1435 × 503 × 837 mm (56 ¹ / ₂ " × 19 ¹³ / ₁₆ " × 32 ¹⁵ / ₁₆ " TOTAL: 1441 × 554 × 859 mm (56 ³ / ₄ " × 21 ¹³ / ₁₆ " × 33 ¹³ / ₁₆ "
Weight	HP-2700: 49 Kg 108 lb. 0 oz. KS-2700: 15 Kg 33 lb. 1 oz. TOTAL: 64 Kg 141 lb. 1 oz.	HP-3700: 59 Kg 130 lb. 1 oz. KS-3700: 23.5 Kg 51 lb. 13 oz. TOTAL: 82.5 Kg 181 lb. 14 oz.
Power	55 W (100V) 80 W (117V) 145 W (220/240V)	70 W (100V) 105 W (117V) 210 W (220/240V)
Output	20W × 2	30W × 2
Accessories	Power Cord Music Stand Owner's Manual Template	Power Cord Music Stand Owner's Manual Template
Options	Piano Stand (KS-2700)	Piano Stand (KS-3700)

* Specifications and appearance are subject to change without notice.

Information

●When you need repair service, call your local Roland Service Station or the authorized Roland distributor in your country as shown below.

U. S. A.

Roland Corp US
7200 Dominion Circle
Los Angeles, CA. 90040 - 3647
U. S. A.
☎ (213)685 - 5141

CANADA

Roland Canada Music Ltd.
(Head Office)
13880 Mayfield Place
Richmond B. C., V6V 2E4
CANADA
☎ (604)270 - 6626

Roland Canada Music Ltd.
9425 Transcanadienne Service Rd. N.,
St Laurent, Quebec H4S 1V3
CANADA
☎ (514)335 - 2009

Roland Canada Music Ltd.
346 Watline Avenue,
Mississauga, Ontario L4Z 1X2
CANADA
☎ (416)890 - 6488

AUSTRALIA

Roland Corporation
(Australia) Pty. Ltd.
(Head Office)
38 Campbell Avenue
Dee Why West. NSW 2099
AUSTRALIA
☎ (02)982 - 8266

Roland Corporation
(Australia) Pty. Ltd.
(Melbourne Office)
50 Garden Street
South Yarra, Victoria 3141
AUSTRALIA
☎ (03)241 - 1254

NEW ZEALAND

Roland Corporation (NZ) Ltd.
97 Mt. Eden Road, Mt. Eden,
Auckland 3
NEW ZEALAND
☎ (09)398 - 715

UNITED KINGDOM

Roland(UK)Ltd.
Amalgamated Drive
West Cross Centre, Brentford,
Middlesex TW8 9EZ,
UNITED KINGDOM
☎ (01)568 - 4578

WEST GERMANY

Roland Elektronische
Musikinstrumente
Handelsgesellschaft mbH.
Oststrasse 96,
2000 Norderstedt
WEST GERMANY
☎ 040/52 60 09 25

BELGIUM/HOLLAND/ LUXEMBOURG

Roland Benelux N. V.
Houtstraat 1
B - 2431 Oevel - Westerlo
BELGIUM
☎ 014 - 58 45 35

DENMARK

Roland Scandinavia A/S
Langebrogade 6
Box 1937
DK - 1023 Copenhagen K.
DENMARK
☎ 31 - 95 31 11

SWEDEN

Roland Scandinavia A/S
DanvikCenter 28 A, 2 tr.
S - 131 30 Nacka,
SWEDEN
☎ 08 - 702 00 20

NORWAY

Roland Scandinavia
Avd. Norge
Lilleakerveien 2
Postboks 95 Lilleaker
N - 0216 Oslo 2
NORWAY
☎ 02 - 73 00 74

FINLAND

Fazer Musik Inc.
Länsituulentie
POB 169
SF - 02101 Espoo
FINLAND
☎ 0 - 43 50 11

ITALY

Roland Italy S. P. A.
Viale delle Industrie 8
20020 ARESE MILANO
ITALY
☎ 02 - 93581311

SPAIN

Roland Electronics de España S. A.
Bolivia 239
08020 Barcelona
SPAIN
☎ 93 - 308 - 1000

SWITZERLAND

Musitronic AG
Gerberstrasse 5, CH - 4410
Liestal
SWITZERLAND
☎ 061/921 16 15

Roland CK (Switzerland) AG
Hauptstrasse 21
CH - 4456 Tenniken
SWITZERLAND
☎ 061/98 60 55
Repair Service by Musitronic AG

FRANCE

Musikengro
102, Avenue Jean - Jaures
69007 Lyon Cedex 07
FRANCE
☎ (7)858 - 54 60

Musikengro
(Paris Office)
Centre Region Parisienne
41 rue Charles - Fourier,
94400 Vitry s/Seine
FRANCE
☎ (1)4680 86 62

AUSTRIA

E. Dematte & Co.
Neu - Rum Siemens - Strasse 4
A - 6021 Innsbruck Box 591
AUSTRIA
☎ 43(05222)63 451

GREECE

A. Andreadis/V. Dimitriadis & Co. Ltd.
2 Fidiou Str., GR 106 78
Athens
GREECE
☎ 3620130

PORTUGAL

Casa Caius Instrumentos Musicais Lda.
Rua de Santa Catarina 131
Porto
PORTUGAL
☎ 02 - 38 44 56

HUNGARY

Intermusica Ltd.
Warehouse Area 'DEPO'
Budapest. P.O. Box 3,
2045 Torokbalint
Budapest
HUNGARY
☎ 1868905

Apparatus containing Lithium batteries

ADVARSEL!

Lithiumbatteri. Eksplosionsfare.
Udskiftning må kun foretages af en sagkyndig,
og som beskrevet i servicemanual.

VARNING!

Lithiumbatteri. Explosionsrisk.
Får endast bytas av behörig servicetekniker.
Se instruktioner i servicemanualen.

ADVARSEL!

Lithiumbatteri. Fare for eksplosion.
Må bare skiftes av kvalifisert tekniker som
beskrevet i servicemanualen.

VAROITUS!

Lithiumparisto. Räjähdyksvaara.
Pariston saa vaihtaa ainoastaan
alan ammottimies.

Bescheinigung des Herstellers/Importeurs

Hiermit wird bescheinigt, daß der/die/das

ROLAND Digital Piano HP-3700/2700

(Gerät. Typ. Bezeichnung)

in Übereinstimmung mit den Bestimmungen der

Amtsbl. Vfg 1046/1984

(Amtsblattverfügung)

funk-entstört ist.

Der Deutschen Bundespost wurde das Inverkehrbringen dieses Gerätes angezeigt und die Berechtigung zur Überprüfung der Serie auf Einhaltung der Bestimmungen eingeräumt.

Roland Corporation Osaka/Japan

Name des Herstellers/Importeurs

RADIO AND TELEVISION INTERFERENCE

WARNING — This equipment has been verified to comply with the limits for a Class B computing device, pursuant to Subpart J, of Part 15, of FCC rules. Operation with non-certified or non-verified equipment is likely to result in interference to radio and TV reception.

The equipment described in this manual generates and uses radio frequency energy. If it is not installed and used properly, that is, in strict accordance with our instructions, it may cause interference with radio and television reception. This equipment has been tested and found to comply with the limits for a Class B computing device in accordance with the specifications in Subpart J, of Part 15, of FCC Rules. These rules are designed to provide reasonable protection against such a interference in a residential installation. However, there is no guarantee that the interference will not occur in a particular installation. If this equipment does cause interference to radio or television reception, which can be determined by turning the equipment on and off, the user is encouraged to try to correct the interference by the following measure:

- Disconnect other devices and their input/output cables one at a time. If the interference stops, it is caused by either the other device or its I/O cable. These devices usually require Roland designated shielded I/O cables. For Roland devices, you can obtain the proper shielded cable from your dealer. For non Roland devices, contact the manufacturer or dealer for assistance.

If your equipment does cause interference to radio or television reception, you can try to correct the interference by using one or more of the following measures.

- Turn the TV or radio antenna until the interference stops.
- Move the equipment to one side or the other of the TV or radio.
- Move the equipment farther away from the TV or radio.
- Plug the equipment into an outlet that is on a different circuit than the TV or radio. (That is, make certain the equipment and the radio or television set are on circuits controlled by different circuit breakers or fuses.)
- Consider installing a rooftop television antenna with coaxial cable lead-in between the antenna and TV. If necessary, you should consult your dealer or an experienced radio/television technician for additional suggestions. You may find helpful the following booklet prepared by the Federal Communications Commission: "How to Identify and Resolve Radio — TV Interference Problems"

This booklet is available from the U.S. Government Printing Office, Washington, D.C., 20402, Stock No. 004-000-00345-4.

CLASS B

NOTICE

This digital apparatus does not exceed the Class B limits for radio noise emissions set out in the Radio Interference Regulations of the Canadian Department of Communications.

CLASSE B

AVIS

Cet appareil numérique ne dépasse pas les limites de la classe B au niveau des émissions de bruits radioélectriques fixés dans le Règlement des signaux parasites par le ministère canadien des Communications.

 Roland®

11039

UPC 11039



10981

 Roland