

Roland

Digital Piano

HP 1500

OWNER'S MANUAL

Thank you, and congratulations on your choice of the Roland HP-1500 Digital Piano. Thanks to its use of Advanced SA Process digital sound sources, the HP-1500 faithfully recreates the powerful lows and sparkling highs of a concert grand piano. Moreover, it comes equipped with a keyboard that is a delight to play — one which responds to every playing dynamic. And because the instrument's sound sources are digital, the piano will never need tuning to retain its sound quality. For these and many other reasons, you will now be able to enjoy everything you would expect from a traditional piano — all within a user-friendly, compact package that more readily fits into a modern lifestyle. In order to take full advantage of the HP-1500's numerous features, and to enjoy years of trouble-free service, please take the time to read through this manual.

Features

- Six Different Sounds <Page 4>
The selection of sounds, beginning with a luxurious grand piano, allows you to play music in virtually any style.
- A Dual Function <Page 4>
Any two Voices can be combined (layered) and played together.
- Digital Effects <Page 5>
Your new piano comes equipped with two digital effects: Chorus and Reverb.
- A "Recorder" <Page 6>
An easy-to-operate Recorder allows you to record and play back the music you create.
- A Key Touch Function <Page 8>
Three 'Touch' levels are available, allowing the player to adjust the keyboard feel to suit personal preferences.
- A Damper Pedal <Page 7>
When the Damper pedal is depressed, the HP-1500 provides a realistic simulation of "sympathetic resonance." This effect occurs when strings (on an acoustic piano) adjacent to the notes played also resonate, creating much richer, expansive sonorities.
- Tuning Functions
Even though there is no need to tune an electric piano at regular intervals, or after it has been moved, the instrument allows for the creative use of alternate tunings.
 - Master Tuning <Page 4>
The overall pitch of the piano can be changed to match the pitch of other musical instruments.
- MIDI Capability <from Page 8>
The instrument also provides for use of MIDI, the interface standard designed to provide for the transfer of performance information among electronic musical instruments and computers.

About the Advanced SA Sound Sources

The sounds produced by this instrument are created using the "Advanced SA Process," which represents a pooling of the best leading-edge digital technology by Roland. The ASA process, developed as a natural extension of the original SA process, involved a series of efforts: first, an analysis of the essential properties of sound as generated by musical instruments, then an extraction, and finally a re-synthesis designed to facilitate the expressive needs of musicians. The result is a sound generation method which provides very finely textured and realistic sounds.

Copyright © 1992 by Roland Corporation

All rights reserved. No part of this publication may be reproduced in any form without the written permission of Roland Corporation.

Assembling the KS-1500 Stand for the HP-1500

Two people are needed to carry out the assembly. Never attempt it alone.

* To move the main unit, be sure to keep it level while you lift it straight up. Be very careful, so as to avoid getting fingers pinched, or toes hurt by accidentally dropping the unit.

Check the parts

Before you begin assembly, check that you have all the parts.

- Ⓐ Side board (left).....1
- Ⓑ Side board (right).....1
- Ⓒ Pedal board.....1
- Ⓓ Center board.....1
- ① Long screws (M6 x 60 mm).....4
- ② Short screws (M4 x 27 mm).....4
- ③ Knob bolts.....2
- ④ Plus screwdriver.....1
- ⑤ Cable clamps.....2

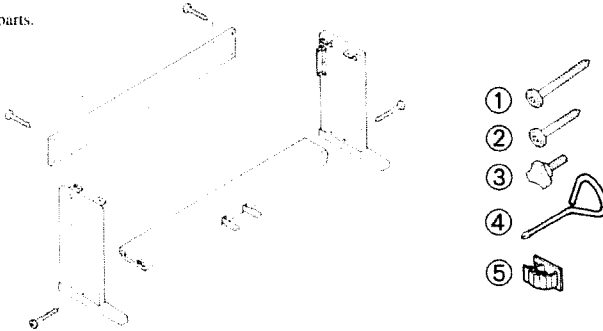

Assembly procedure

1 Attach the side boards (left and right) to the pedal board.

☆ Extend the pedal cable out from the pedal board.
(Note) Be sure that the side boards are oriented correctly: the metal fittings are on the inside.

The metal fittings on the inside.

Pedal cable

① Use the long screws (M6 x 60 mm) to fasten the side boards to the pedal board. (use two screws for each side.)

2 Attach the center board.

② Use the short screws (M4 x 27 mm) to attach the center board to the side boards. (use two screws for each side.)

3 Attach the piano to the stand.

(Note) When placing the piano on the stand, be careful not to pinch your fingers. (Avoid holding the ends of the piano.)

③ Align the screws (one on each side) located on the bottom of the piano with the slots in the metal fittings on the side boards. Slide the piano so the screws slide into the slots.

④ Lift up the piano and use the two knob bolts to fasten the piano to the stand. (One screw each side on the left and right.)

4 Fasten the pedal cable with the cable clamps, and plug in the power cable and pedal cable.

⑤ Affix the cable clamps on the back left side of the stand. Fasten the pedal cable with the cable clamps.

⑥ Insert the pedal cable into the pedal jack on the back panel of the piano.

⑦ Connect the power cable into the AC inlet on the back panel of the piano. The power cable is included with the piano.

Cable clamps

5 Adjust the adjusting bolt

☆ When you finish assembling the stand, rotate the adjusting bolt until it touches the floor.

(Note) If the piano is placed on carpeting, rotate the adjustment bolt little more.

(Note) When placing the piano in its location, be careful not to pinch the power cable underneath the piano.

⑧ Rotate the adjusting bolt until it touches the floor.

Setting Up the Music Rest

1. Move the Music Stand into the upright position.

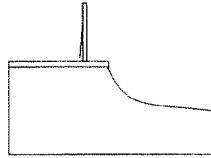

2. Move the legs at right and left (A) out into the proper position.

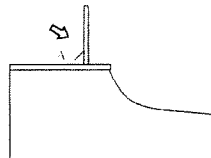

3. Lean the stand backward slightly until it is positioned firmly in place against the instrument.

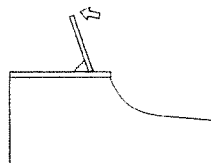

- * To fold down the Music Stand, first move (A) back into their original positions, then lower the stand. Be careful not to get your fingers caught.

Contents

Features	1
Assembling the KS-1500 Stand for the HP-1500 ...	2
Setting Up the Music Rest	3
Important Notes	3
Panel Description	4
Front Panel	4
Rear Panel	4
Turning the Power On	5
Using Headphones	5
Listening to the Demonstration Songs	6
Try Recording What You Play	6
Playing with the Key Transposed	7
Playing a piece in some other key with the fingering of C	7
Pedal Functions	7
Using the Left Pedal as a Sostenuto Pedal	7
Changing the Depth of the Chorus Effect	8
Applying Reverb to the Sound	8
Key Touch Function	8
For Those Who Wish To Use MIDI	8
About MIDI	8
Setting the MIDI Transmit/Receive Channels ...	9
Omni On/Off	9
Local On/Off	9
The Multi-Timbral Mode	10
Selecting the Transmission/Reception Mode ...	10
Transmission/Reception of Program Change Messages	11
Troubleshooting	12
Specifications	12
MIDI Implementation Chart	13

Important Notes

In addition to the items listed under Safety Precautions on page 16, please read and adhere to the following:

Power Supply

- When making any connections with other devices, always turn off the power to all equipment first; this will help prevent damage or malfunction.
- Do not use this unit on the same power circuit with any device that will generate line noise, such as a motor or variable lighting system.

Placement

- Do not subject the unit to temperature extremes (eg. direct sunlight in an enclosed vehicle). Avoid using or storing the unit in dusty or humid areas or areas that are subject to high vibration levels.
- This unit may interfere with radio and television reception. Do not use this unit in the vicinity of such receivers.
- Make sure you always have the instrument placed so it is level and sure to remain stable. Otherwise, if played while tilted, you risk causing damage to the keyboard as a result of the unnatural degree of force that might be applied to certain parts of it.

Maintenance

- For everyday cleaning wipe the unit with a soft, dry cloth (or one that has been slightly dampened with water). To remove stubborn dirt, use a mild neutral detergent. Afterwards, be sure to wipe the unit thoroughly with a soft, dry cloth.
- Never use benzene, thinners, alcohol or solvents of any kind, to avoid the risk of discoloration and/or deformation.

Additional Precautions

- Protect the unit from strong impact.
- Do not allow objects or liquids of any kind to penetrate the unit. In the event of such an occurrence, discontinue use immediately. Contact qualified service personnel as soon as possible.

Panel Description

Front Panel

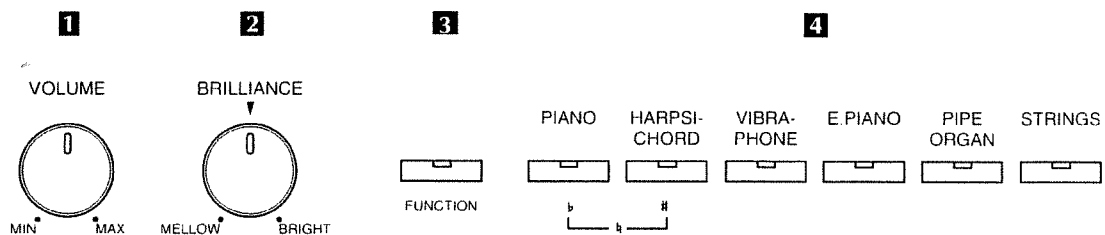

1 VOLUME Knob

At "MAX" the volume will be greatest.

2 BRILLIANCE Knob

The sound becomes brighter as the knob is turned toward BRIGHT.

3 FUNCTION Button

The FUNCTION button, when used in combination with other buttons, is used to perform the following procedures:

- Playing the demo songs (p. 6)
- Transposing to other keys (p. 7)
- Assigning pedal functions (p. 7)
- Setting the MIDI Transmit/Receive Channels (p. 9)
- Setting Omni ON or OFF (p. 9)
- Setting Local ON or OFF (p. 9)
- Setting the Multi-Timbral mode (p. 10)
- Setting the MIDI mode (p. 10)
- Transmission/Reception of Program Change Messages (p. 11)

4 Voice Buttons

Use these buttons to select the sound you want.

PIANO	A rich concert grand piano sound.
HARPSICHORD	A distinctively sensitive and refined harpsichord sound.
VIBRA-PHONE	The sound of a large vibraphone.
E. PIANO	Provides the timbre of a luminous, transparent electric piano.
PIPE ORGAN	A Cathedral pipe organ
STRINGS	The sound of a delightful string ensemble.

Press any two Voice buttons simultaneously to have those two sounds combined and played together. (This is known as the DUAL function.)

* The Chorus setting that will apply to the sounds in a layered pair will be the setting made for the Voice button on the left.

Rear Panel

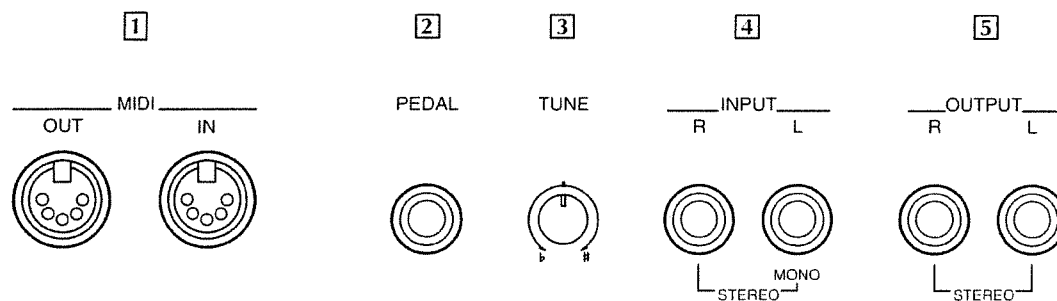

1 MIDI Connectors

Accept the MIDI cables used to connect external electronic instruments.

2 PEDAL Jack

This is where you'll connect the supplied pedals.

3 TUNE Knob

Allows the overall pitch to be adjusted. With the knob at its center position, the center A key (*la*) on the keyboard will have a frequency of 440 Hz.

Move the knob in the direction of "#" to raise the pitch, and toward "b" to lower it. By rotating the knob to either extreme, you obtain a change of 50 cents (1/2 semitone).

4 INPUT Jacks

Accept input of audio signals from some other unit (CD player, cassette deck etc.) that you wish to hear through the HP-1500's speakers.

5 OUTPUT Jacks

Provide output of sound produced by the HP-1500.

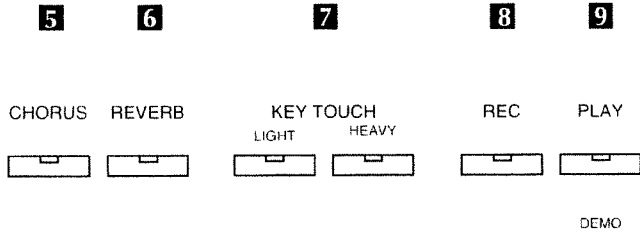

5 CHORUS Button

Press the CHORUS button (its indicator will light) to add minute pulsations to the sounds you play, and make them seem fatter and more expansive. You can select from six Chorus Depth levels. (p. 8)

* Chorus On/Off setting can be set individually for each Voice.
Hold down a Voice button while you press the CHORUS button to store the setting (ON /OFF) along with that Voice.

6 REVERB Button

Press the REVERB button (its indicator will light) to add reverberation (spacious ambience) to the sound. You can select from six Reverb Depth levels. (p. 8)

* Reverb On/Off cannot be set individually for each Voice.

7 KEY TOUCH Button

Allows you to adjust the keyboard's sensitivity. (p. 8)

8 REC Button

Allows you to record your performances. (p. 6)

9 PLAY Button

Pressed to play back what you have recorded. (p. 6)

Turning the Power On

1. Insert the plug on the power cord into an outlet.

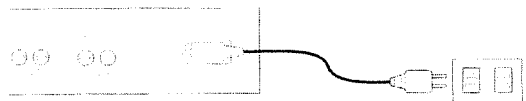

2. Press the POWER button on the left side of the panel. (Press the button again to turn it OFF.)

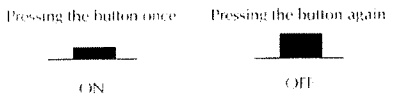

* A muting feature comes into effect for a brief interval (about 2 seconds) after power up. During this interval, nothing will be heard if you play the keyboard.

* Be sure to use only the power cord supplied with this unit.

* Whenever you do not intend to use the piano for an extended period of time, disconnect the power cord from the outlet.

Using Headphones

To use headphones, insert the plug into the jack located on the left side of the instrument.

* The piano's speakers will no longer produce sound once you have headphones connected. This is convenient for private practice or late-night playing.

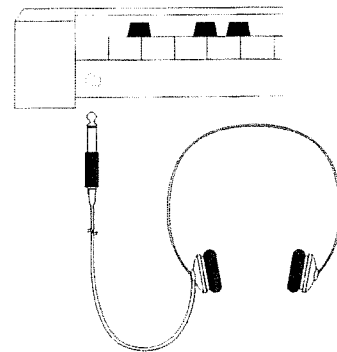

* The VOLUME knob on the instrument can be used to adjust the volume as necessary.

* We recommend the use of stereo headphones.

Listening to the Demonstration Songs

The HP-1500 contains three demonstration songs in memory which highlight the instrument's capability. To hear them, follow the steps below.

1. While holding down the FUNCTION button, press PLAY button (both buttons will start to flash) and in a few seconds the Demo songs will start to play.

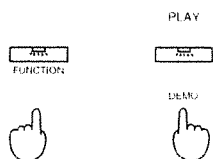

2. When one song finishes, the next one will start playing automatically.

If you wish to listen to only one song, press PLAY button while holding the FUNCTION button. Then within 2-3 seconds, press one of the PIANO, HARPSICHORD and VIBRAPHONE buttons. PIANO gives you the first song, HARPSICHORD the second one and VIBRAPHONE the third one. (The button indicator will be flashing for the song currently playing.)

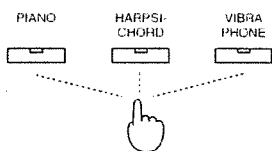

3. To stop playback of one song and have the another play, simply press the another Voice button (where the indicator is not flashing).

To stop playback of the demonstration songs (and return to the standard mode), press the FUNCTION or PLAY button.

Voice Buttons	Composer	Song Title
PIANO	Chopin	from Valse No.6 " Petit chien" op.64-1
HARPSICHORD	Chopin	from Nocturne No.1 op.9-1
VIBRAPHONE	J.S.Bach	from Cantata BWV. 147 arranged by Naoki Nisi

Profile of the demo song arranger

Naoki Nishi

Born in 1958 in Hiroshima.

Began working professionally at the age of 21. Has so far released 8 albums on which he is featured. He has also taken part in numerous other albums. His broad range of activities have included appearances at a number of jazz festivals in Japan and other parts of the world. In addition to his duties as an instructor at the Tokyo Conservatoire Shoubi, he has provided his services as a demonstrator for Roland since 1990. He is considered to be one of Japan's finest jazz pianist.

Try Recording What You Play

How to Create Recordings

Use whatever Voice you like to play whatever song you wish to record. When completed, you will be able to listen to the results, and check how well you played the song.

1. Select the Voice you wish to use for the recording, then make any other selections you wish, such as for Chorus and Reverb. When ready, press the REC button (its indicator will light). This means that the instrument is in stand-by, waiting for recording to begin.



2. Start playing. (Recording will start the moment the first note is played.)
3. When finished, press the REC button again to stop recording. The indicator should go out.



* During recording, you can change to any other Voice you wish to use.

* When the unit starts running low on memory space, the indicator on the REC button will start flashing. If you continue recording, the REC indicator will begin flashing faster.

Once you reach the stage where the unit cannot record any more, the indicator on the REC button will go out, and recording stops automatically.

* Once you begin a new recording, all of the performance data previously recorded will be erased. Once erased, performance data cannot be recovered.

Now try listening to what you just recorded

Press the PLAY button (its indicator will light).



The unit stops automatically after the song has played through. The indicator will then go out. (Press the PLAY button to stop playback at any point.)

* The performance data that you record will disappear about 8 hours after power has been turned off. If you need a more permanent form of storage for your songs, you will need to connect an external sequencer (p. 8) and record onto that unit.

* To manually erase all recorded performance data, simultaneously press the REC and PLAY buttons.

Playing with the Key Transposed

If you wish, you can play the instrument with the key 'transposed.' This conveniently allows you to play in a key that matches a vocal accompaniment, without changing your fingering on the keyboard. Transposition is also useful when you are going to play a piece in a key other than C, and wish to play it as if it were in the key of C. This makes it is easier to play.

While holding down the FUNCTION button, press either PIANO (♭) or HARPSICHORD (#) enough times to obtain the amount of transposition you wish.

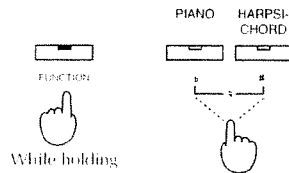

- # With each press, the sound is raised by 1 semitone. (Max. of 5 semitones.)
- ♭ With each press, the sound is lowered by 1 semitone. (Max. of 6 semitones.)

Playing a piece in some other key with the fingering of C

You need to specify which note you wish to sound when the C key (*do* in the key of C) is pressed. Hold down the FUNCTION button while you press the keynote for the key you wish to transpose to (using the C-B keys in the upper-most octave of the keyboard). For example, to play an E major piece in the key of C major, you would hold down the FUNCTION button while you press E (*mî*).

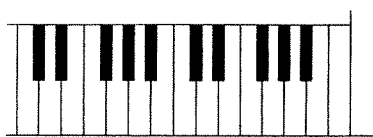

Press the keynote of the key to which you wish to transpose

- * To return to the key of C, press PIANO (♭) and HARPSICHORD (#) simultaneously while holding down the FUNCTION button. Or, you can hold down the FUNCTION button while you press C in the upper-most octave of the keyboard.
- * The indicator on the FUNCTION button will remain lit while transposition is in effect.
- * To cancel transposition, press the FUNCTION button again, and confirm that its indicator has gone out.

* Once you have set the transposition, all you need to do to obtain the same transposition the next time is to press the FUNCTION button.

* If you have used the Key Transpose feature to raise the pitch (by 1 to 5 semitones), the keyboard's 5 highest keys (at the far right) will sound one octave lower than normal when playing organ or string sounds.

Pedal Functions

The specialized stand comes equipped with 2 pedals. The right one is the Damper pedal, and the left one acts as the Soft pedal. (The left pedal can also be switched to become a Sostenuto pedal.)

Right (Damper Pedal)

While the Damper Pedal is depressed, notes that have been played will continue to sound even after your fingers have been removed from those keys.

Left (Soft Pedal)

When depressed, you obtain a softer sound.

(Sostenuto Pedal)

This pedal is used to sustain only the sound of those keys that are pressed at the very moment the pedal is depressed. Notes played afterwards are not effected.

Using the Left Pedal as a Sostenuto Pedal

If you wish to use the left pedal as a Sostenuto pedal, hold down the FUNCTION button while you depress the right pedal.

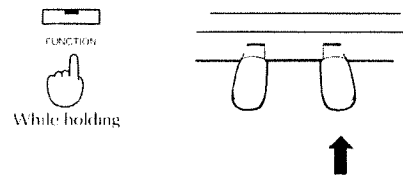

- * To have the pedal serve as the Soft pedal again, hold down the FUNCTION button while you depress the left pedal.
- * The Soft pedal and Sostenuto pedal functions cannot be obtained at the same time.
- * Whenever power is turned on, the instrument is set to provide the Soft pedal function.

Changing the Depth of the Chorus Effect

You can select from 6 different Chorus levels.

1. Hold down the CHORUS button for a few seconds until you have confirmed that its indicator has started to flash.
2. With the CHORUS button still depressed, press the appropriate Voice button to select the desired depth setting.

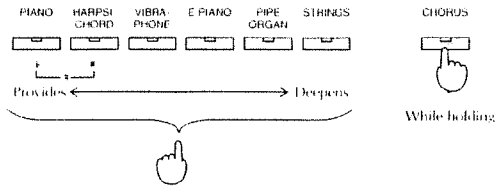

Applying Reverb to the Sound

You can select from 6 different Reverb levels.

1. Hold down the REVERB button for a few seconds and its indicator will start to flash.
2. With the REVERB button still depressed, press the appropriate Voice button to select the desired depth setting.

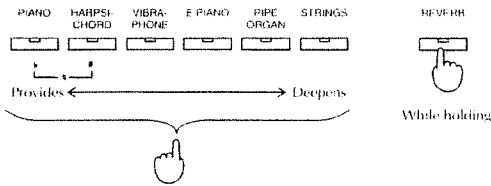

Key Touch Function

This instrument allows you to select one of three touch settings. These settings determine how the keyboard will respond to certain playing dynamics. Choose the setting which is most comfortable.

Medium

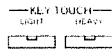

This is the standard setting. The response provided by this setting is generally perceived as being the most natural.

Light

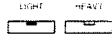

With this setting, the keys will seem lighter to the touch, and fortissimo levels can be achieved with much less effort.

Heavy

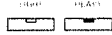

With this setting, the keys will seem heavier to the touch, and you will need to apply even more force than normal to obtain fortissimo levels.

* When powered up, the instrument will be at the default setting (Medium).

For Those Who Wish To Use MIDI

Those satisfied with playing the piano by itself need not read the following.

About MIDI...

The MIDI (Musical Instrument Digital Interface) standard was created to provide for the exchange of performance information among electronic musical instruments and computers.

The MIDI Connectors

Take a look at the rear panel of your piano. You should be able to quickly find the two MIDI sockets. These connectors enable the piano to 'converse' with other MIDI-equipped units. The two connectors function as follows:

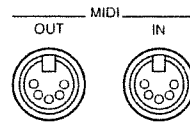

- MIDI IN Connector

This connector is where messages from other MIDI-equipped units are received, and can be likened to the "ears" which listen to what the other instrument has to convey.

- MIDI OUT Connector

From this connector, messages are sent out to other MIDI-equipped units. It can be likened to the "mouth" in the ongoing dialogue between the units.

In order to enable communication between two devices, you need to run a cable, such as shown at right, between their respective MIDI connectors.



Connecting a recorder or sequencer such as the PR-1 or MT-200

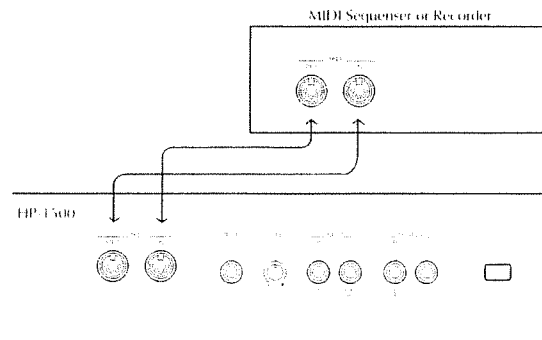

Setting the MIDI Transmit/Receive Channels

MIDI provides for the use of 16 channels, numbered 1—16. When the channel used by the transmitting unit matches that of a remote receiving unit, you can play sounds contained in the remote unit, or change the sounds it uses.

Hold down the FUNCTION button while you press the VIBRAPHONE button to set the MIDI Transmit/Receive Channel.

1. While the VIBRAPHONE button's indicator is dark, the transmission and reception channels will be set to the same channel. The Transmit channel alone can be set while the VIBRAPHONE button's indicator is blinking; whereas the Receive channel alone can be set while the VIBRAPHONE button's indicator is lit.

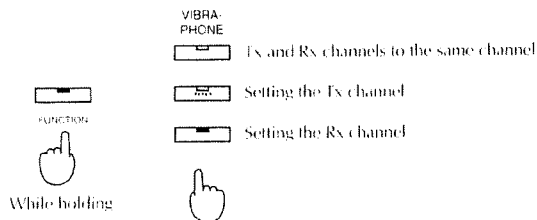

2. With the FUNCTION button still depressed, press the key which corresponds to the desired MIDI channel. (See illustration below.)

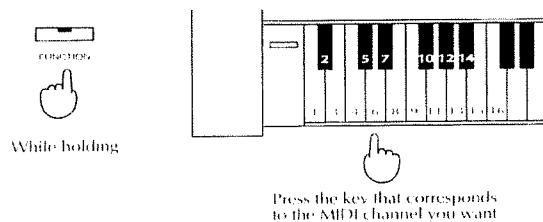

Omni On/Off

When set to "Omni ON," the HP-1500 will produce sound no matter which channel any performance data is received on. This is convenient for hearing the performance data on all channels at the same time.

To set the unit to Omni ON, hold down the FUNCTION button and press the key at the right end of the keyboard (the highest key). At the same time, both the transmission and reception channels are automatically set to channel 1.

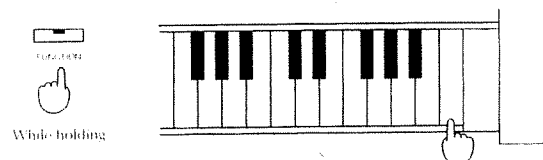

- * Thereafter, the unit will be placed back into the Omni OFF mode when a specific setting for the Receive channel is made.

Local On/Off

If you intend to record into a sequencer, set it so its "Soft Thru" function is ON. At the same time, set the piano's Local setting to OFF:

1. Press FUNCTION (the STRINGS button indicator should be dark). (When this indicator is dark, it means that the unit is set to Local ON.)

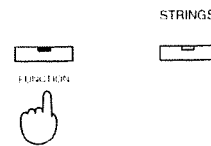

2. With the FUNCTION button still depressed, press the STRINGS button, and confirm that its indicator has lit. (When this indicator is lit, the unit is set to Local OFF.)

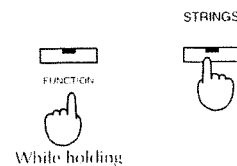

- * If the HP-1500 is set to "Local ON" while connected to a sequencer set with its "Soft Thru" function "ON," the same notes will be produced twice. This is because the locally produced keyboard notes first sound internally, and then are sounded a second time when the note messages (after having been sent out the HP-1500's MIDI OUT, and been routed through the sequencer) have arrived back again at the HP-1500's MIDI IN. The resulting sound might seem quite unnatural.

- * Some sequencers, such as the MT-200, automatically send out a "Local Off" message at power up. There are also sequencers (such as the PR-1) which are ordinarily used while set to Soft Thru Off, so the instrument being used can be left set at Local On.

- * This piano will always be set at "Local ON" whenever its power is turned on.

- * Whenever there are no cables connected to this instrument's MIDI connectors, it will always be at "Local ON."

The Multi-Timbral Mode

When the Multi-Timbral mode is ON, MIDI data arriving on several channels can be received. This allows you to simultaneously play several of the piano's internal sounds.

- When the Multi-Timbral Mode is OFF
Data that arrives on the specified Receive channel (see page 9) is received and used to play the currently selected Voice.
- When the Multi-Timbral Mode is ON
Of any MIDI data that arrives, that which arrives on channels 1, 11, 12, 13, 14 and 15 is received. Data on all other channels is ignored.
The Voice that is used to play the notes will be determined by the Program Change message that is received on the relevant channel. The correspondence between Program Change Numbers and Voices is shown on page 11.

While holding down the FUNCTION button, press the PIPEORGAN button to turn the Multi-Timbral Mode ON or OFF.

With the indicator lit, it is ON.

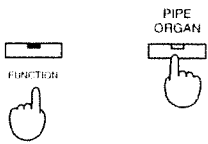

How Various Types of Messages Function While the Multi-Timbral Mode is ON

- **Pedal Messages**
Damper, sostenuto and soft pedal messages function independently for any of these channels: 1, 11, 12, 13, 14 or 15.
 - **Volume Messages**
Volume messages control the volume, and function independently for any of these channels: 1, 11, 12, 13, 14 or 15. Such messages, however, have no effect on what is played on this instrument's keyboard.
The actual volume obtained is determined by both the value of the Volume message, and the position of the Volume knob on this instrument. When a Volume message calls for the maximum value, the actual volume produced will directly reflect the position of the Volume knob.
 - **Chorus On/Off Messages**
Chorus On/Off messages affect independently for each channel 1, 11, 12, 13, 14 or 15.
 - **Reverb On/Off Messages**
Reverb On/Off messages affect all Voices equally, regardless of whether they are received on channel 1, 11, 12, 13, 14 or 15.
- * When the Multi-Timbral Mode is "On," the unit will always be at "Omni OFF."

Selecting the Transmission/Reception Mode

Three Transmission/Reception Modes have been provided to allow you to select the mode which best matches your needs.

- * **Note and Pedal messages are received/transmitted in every mode.**

Hold down the FUNCTION button while you press the E.PIANO button to set the Transmit/Receive mode. When the E.PIANO button's indicator is dark, you are in Mode 1. When the E.PIANO button's indicator is blinking, you are in Mode 2. When the E.PIANO button's indicator is lit, you are in Mode 3.

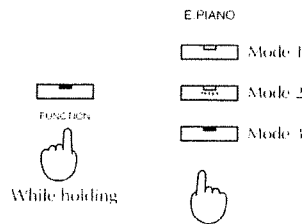

- * **When power is turned on, the unit will always be at the Mode 1 setting.**

Mode		I	II	III
MIDI Messages		TX	RX	TX RX
Note Messages		Yes	Yes	Yes Yes Yes
Program Change Messages		Yes	Yes	Yes No Yes*
Control Change Messages				
Volume	(7)	No	Yes	No Yes No Yes
Damper	(64)	Yes	Yes	Yes Yes Yes
Sostenuto	(66)	Yes	Yes	Yes Yes Yes
Soft	(67)	Yes	Yes	Yes Yes Yes
Chorus On/Off	(93)	No	No	No No Yes Yes
Reverb On/Off	(91)	No	No	No No Yes Yes
Master Tune	(32)	No	No	No No Yes Yes
Roland System Exclusive Messages				
Multi-Timbral Mode		No	Yes	No Yes Yes Yes
Chorus Depth		No	Yes	No Yes Yes Yes
Reverb Depth		No	Yes	No Yes Yes Yes
Brilliance		No	Yes	No Yes Yes Yes

- * **In Mode 3, the appropriate Program Change message will be transmitted whenever you press a Voice button. (See the following page.)**

Transmission/Reception of Program Change Messages

Transmitting

While holding down the FUNCTION button, press the keys corresponding to the Group, Bank, and Number which make up the Program Change message you wish to transmit.

While holding

Press the key that corresponds to the program change number you want

	Number							
	1	2	3	4	5	6	7	8
1	1	2	3	4	5	6	7	8
2	9	10	11	12	13	14	15	16
3	17	18	19	20	21	22	23	24
4	25	26	27	28	29	30	31	32
5	33	34	35	36	37	38	39	40
6	41	42	43	44	45	46	47	48
7	49	50	51	52	53	54	55	56
8	57	58	59	60	61	62	63	64

	Number							
	1	2	3	4	5	6	7	8
1	65	66	67	68	69	70	71	72
2	73	74	75	76	77	78	79	80
3	81	82	83	84	85	86	87	88
4	89	90	91	92	93	94	95	96
5	97	98	99	100	101	102	103	104
6	105	106	107	108	109	110	111	112
7	113	114	115	116	117	118	119	120
8	121	122	123	124	125	126	127	128

* In the Mode 3 Transmission/Reception mode, the appropriate Program Change message will be transmitted whenever you press a Voice button.

1 PIANO	13 PIANO + VIBRAPHONE	32 HARPSICHORD + STRINGS
3 HARPSICHORD	14 PIANO + E.PIANO	46 VIBRAPHONE + E.PIANO
5 VIBRAPHONE	15 PIANO + PIPEORGAN	47 VIBRAPHONE + PIPEORGAN
6 E.PIANO	16 PIANO + STRINGS	48 VIBRAPHONE + STRINGS
7 PIPEORGAN	29 HARPSICHORD + VIBRAPHONE	55 E.PIANO + PIPEORGAN
8 STRINGS	30 HARPSICHORD + E.PIANO	56 E.PIANO + STRINGS
11 PIANO + HARPSICHORD	31 HARPSICHORD + PIPEORGAN	64 PIPEORGAN + STRINGS

Receiving

When a Program Change message is received, a change is made to the correspondingly numbered Voice, as shown below.

1 PIANO	13 PIANO + VIBRAPHONE	32 HARPSICHORD + STRINGS
3 HARPSICHORD	14 PIANO + E.PIANO	46 VIBRAPHONE + E.PIANO
5 VIBRAPHONE	15 PIANO + PIPEORGAN	47 VIBRAPHONE + PIPEORGAN
6 E.PIANO	16 PIANO + STRINGS	48 VIBRAPHONE + STRINGS
7 PIPEORGAN	29 HARPSICHORD + VIBRAPHONE	55 E.PIANO + PIPEORGAN
8 STRINGS	30 HARPSICHORD + E.PIANO	56 E.PIANO + STRINGS
11 PIANO + HARPSICHORD	31 HARPSICHORD + PIPEORGAN	64 PIPEORGAN + STRINGS

* Program Changes except those mentioned above will be ignored.

Troubleshooting

Whenever you suspect that the instrument is not performing as it should, please consult the following information.

Q. No sound heard from speakers.

- A.**
- Have you checked to make sure you don't have the volume set at "MIN"?
 - Do you possibly have headphones connected?
 - If using other connected MIDI devices, have you made sure the power is ON for all such devices?
 - If in the Multi-Timbral mode, do you have the Transmit channel set to something other than 1, 11, 12, 13, 14, or 15 ?

Q. The damper effect is constantly applied to notes played (they continue sounding longer than normal). Or, the damper effect cannot be obtained at all.

- A.** Have you checked to make sure the cable from the stand is connected properly to the piano?
Refer to "Assembling the KS-1500 Stand for the HP-1500," page 2.

Q. Notes played on the keyboard are too high (or low) in pitch.

- A.**
- Have you checked to make sure that key transposition is not in effect? (If Key Transpose has been set, the indicator on the FUNCTION button will be lit.)
To exit the transposed state, press the FUNCTION button. (Its indicator should be out.)
 - Do you have the Master Tuning set appropriately?

Q. Data that was in the recorder has disappeared.

- A.**
- The performance data that you record into the recorder will be erased approx. 8 hours after power is turned off. Regrettably, there is no way to restore such data once it has been erased. If you need a more permanent form of storage for your songs, you will need to use a sequencer (eg., Roland MC-50mkII or MT-200) and store songs on floppy disks.
 - Have you possibly pressed the PLAY and REC buttons at the same time?

Q. The pitch differs from what it should be with "ISM" related products, or another manufacturer's sound generating unit.

- A.** Check to make sure that the Tuning knob on the rear of the unit hasn't been inadvertently moved.
Adjust the tuning knob until the piano's pitch matches that of the external units you are using.

Q. Operations you perform using the panel buttons (Chorus/Reverb/Voice selections) cannot be stored into a sequencer.

- A.** Have you made sure you have the Transmission/Reception Mode set to Mode 3? Note that each time power is turned on, the unit will by default be in Mode 1. In order to record operations you perform using the panel buttons, the piano must be set to Mode 3.

Specifications HP-1500

Keyboard	88 keys (weighted counter-lever action)	Speakers	16 cm X 2
Sound Source	Advanced SA Process	Output	15 W X 2
Voices	Piano	Finish	Roland Black Walnut
	Harpsichord	Power Consumption	50 W (120V), 40 W (230, 240V)
	Vibraphone	Dimensions :Piano	1419 (W) X 456 (D) X 182 (H) mm 55-7/8" (W) X 18" (D) X 7-3/16" (H)
	Electric Piano	:Stand	1419 (W) X 456 (D) X 638 (H) mm 55-7/8" (W) X 18" (W) X 25-1/8" (H)
	Pipe Organ	:Total	1419 (W) X 456 (D) X 810 (H) mm 55-7/8" (W) X 18" (D) X 31-15/16" (H)
	Strings	Weight	:Piano 33.7Kg 74lbs. 5oz.
Effects	Chorus (6 levels)	:Stand	12.3Kg 27lbs. 2oz.
	Reverb (6 levels)	:Total	46.0Kg 101lbs. 7oz.
Touch Control	Light	Supplied Accessories	Owner's Manual, Power Cable
	Medium	Options	Keyboard Stand (KS-1500)
	Heavy		
Controls	Volume, Brilliance, Master Tune, Key Transpose		
Connectors	Output Jacks (Stereo) Input Jacks (Stereo/Mono) Pedal Jacks MIDI IN Connector MIDI OUT Connector Headphones Jack		
Pedals	Damper, Soft / Sostenuto		

*** In the interest of product improvement, the specifications of this unit are subject to change without prior notice.**

MIDI Implementation Chart

Function***		Transmitted	Recognized	Remarks
Basic Channel	Default Changed	1 1-16	1 1-16. *4 (1,11,12,13,14,15)	
Mode	Default Messages Altered	Mode 3 OMNI OFF. POLY :#####	Mode 3 o. *4 (x) 15-113	*2
Note Number	True Voice	:#####	0-127 15-113	
Velocity	Note ON Note OFF	o o 8n v=1-127	o o	
After Touch	Key's Ch's	x x	x x	
Pitch Bend		x	x	
Control Change	6, 38	o	o	Data entry
	7	x	o	Volume
	64	o	o	Hold 1
	66	o	o	Sostenuto
	67	o	o	Soft
	91	*1	*1	Reverb
	93	*1	*1	Chorus
	100, 101	o	o	RPN LSB. MSB
	121	x	o	Reset all controllers
Prog Change	True #	*1 (0-127) :#####	*1 (0-127) 0...63	
System Exclusive		o	o	
System Common	Song Pos Song Sel True	x x x	x x x	
System Real Time	Clock Commands	x x	x x	
AUX Messages	Local ON/OFF All Notes OFF Active Sense Reset	x x o x	o o (123-127) o x	
Notes		*1 Able to choose between o and x. *2 When power on OMNI OFF and POLY are sent through the basic channel. *3 Recognized as Mode 3 even if MONO (M=1). Recognized as Mode 1 even if MONO (M≠1). *4 When the Multi-Timbral Mode is ON.		

Mode 1 : OMNI ON, POLY
Mode 3 : OMNI OFF, POLY

Mode 2 : OMNI ON, MONO
Mode 4 : OMNI OFF, MONO

o : Yes
x : No

Information

When you need repair service, call your local Roland Service Station or the authorized Roland distributor in your country as shown below.

U. S. A.

Roland Corporation US
7200 Dominion Circle
Los Angeles, CA.
90040-3647, U. S. A.
☎ (213)685 - 5141

CANADA

Roland Canada Music Ltd.
(Head Office)
5480 Parkwood
Richmond B. C., V6V 2M4
CANADA
☎ (604)270 - 6626

Roland Canada Music Ltd.
9425 Transcanadienne
Service Rd. N., St Laurent,
Quebec H4S 1V3,
CANADA
☎ (514)335 - 2009

Roland Canada Music Ltd.
346 Watline Avenue,
Mississauga, Ontario L4Z
1X2, CANADA
☎ (416)890 - 6488

AUSTRALIA

Roland Corporation
(Australia) Pty. Ltd.
(Head Office)
38 Campbell Avenue
Dee Why West, NSW 2099
AUSTRALIA
☎ (02)982 - 8266

Roland Corporation
(Australia) Pty. Ltd.
(Melbourne Office)
50 Garden Street
South Yarra, Victoria 3141
AUSTRALIA
☎ (03)241 - 1254

UNITED KINGDOM

Roland(U.K.) Ltd.
Rye Close
Ancells Business Park
Fleet, Hampshire GU13
8UY, UNITED KINGDOM
☎ 0252 - 816181

Roland(U.K.) Ltd.,
Swansea Office
Atlantic Close, Swansea
Enterprise Park, Swansea,
West Glamorgan SA79FJ,
UNITED KINGDOM
☎ (0792)700 - 139

ITALY

Roland Italy S. p. A.
Viale delle Industrie 8
20020 ARESE MILANO
ITALY
☎ 02 - 93581311

SPAIN

Roland Electronics
de España, S. A.
Calle Bolivia 239
08020 Barcelona, SPAIN
☎ 93 - 308 - 1000

GERMANY

Roland Elektronische
Musikinstrumente
Handelsgesellschaft mbH.
Oststrasse 96, 2000
Norderstedt, GERMANY
☎ 040/52 60 090

FRANCE

Musikengro
102 Avenue Jean-Jaures
69007 Lyon Cedex 07
FRANCE
☎ (7)858 - 54 60

Musikengro (Paris Office)
Centre Region Parisienne
41 rue Charles-Fourier,
94400 Vitry s/Seine
FRANCE
☎ (1)4680 86 62

BELGIUM/ HOLLAND/ LUXEMBOURG

Roland Benelux N. V.
Houtstraat 1
B-2260 Oevel-Westerlo
BELGIUM
☎ (0032)14 - 575811

DENMARK

Roland Scandinavia A/S
Langebrogade 6
Box 1937
DK-1023 Copenhagen K.
DENMARK
☎ 31 - 95 31 11

SWEDEN

Roland Scandinavia A/S
DanvikCenter 28 A, 2 tr.
S-131 30 Nacka
SWEDEN
☎ 08 - 702 00 20

NORWAY

Roland Scandinavia
Avd. Norge
Lilleakerveien 2
Postboks 95 Lilleaker
N-0216 Oslo 2
NORWAY
☎ 02 - 73 00 74

FINLAND

Fazer Musik Inc.
Länsituulentie
POB 169
SF-02101 Espoo
FINLAND
☎ 0 - 43 50 11

NEW ZEALAND

Roland Corporation
(NZ) Ltd
97 Mt. Eden Road, Mt.
Eden, Auckland 3,
NEW ZEALAND
☎ (09)3098 - 715

SWITZERLAND

Musitronic AG
Gerberstrasse 5, CH-4410
Liestal, SWITZERLAND
☎ 061/921 16 15

Roland CK (Switzerland)
AG
Postfach/Hauptstrasse 21
CH-4456 Tenniken
SWITZERLAND
☎ 061/98 60 55
Repair Service by
Musitronic AG

AUSTRIA

E. Dematte & Co.
Neu-Rum Siemens-
Strasse 4
A-6021 Innsbruck Box 591
AUSTRIA
☎ (0512)63 451

GREECE

V. Dimitriadis & Co. Ltd.
2 Phidiou Str., GR 106 78
Athens, GREECE
☎ 1 - 3620130

PORTUGAL

Casa Caius Instrumentos
Musicais Lda.
Rua de Santa Catarina 131
Porto, PORTUGAL
☎ 02 - 38 44 56

HUNGARY

Intermusica Ltd.
Warehouse Area 'DEPO'
Torokbalint, Budapest
HUNGARY
☎ (1)1868905

ISRAEL

D.J.A. International Ltd.
25 Pinsker St., Tel Aviv
ISRAEL
☎ 972 - 3 - 5283015

CYPRUS

Radex Sound Equipment
Ltd.
17 Panteli Katelari Str.
P.O.Box 2046, Nicosia
CYPRUS
☎ 453426, 466423

TURKEY

Barkat Sanayi ve Ticaret
Siraselviler Cad. 86/6
Taksim Istanbul, TURKEY
☎ 149 93 24

EGYPT

Al Fanny Trading Office
9, Ebn Hagar Askalany
Street, Ard El Golf,
Heliopolis, Cairo, EGYPT
☎ 2917803 - 665918

BRAZIL

Roland Brasil Ltda.
R. Alvarenga 591
CEP-05509 Sao Paulo
BRAZIL
☎ (011)813 - 7967
Repair Service for Roland
and Rhodes products

Oliver do Brasil S.A.
Instrumentos Musicais
Av. Ceci, No.578 Centro
Empresarial Tambore
Barueri SP CEP 06400
BRAZIL
☎ (011)709 - 1267
Repair Service for BOSS
products

MEXICO

Case Veerkamp, s.a. de c.v.
Mesones No. 21
Col. Centro
C. P. 06080 Mexico, D.F.
MEXICO
☎ (5)709 - 3716

La Casa Wagner de
Guadalajara s.a. de c.v.
Av. Corona No. 202 S.J.
C.P.44100
Guadalajara, Jalisco
MEXICO
☎ (36)13 - 1414

ARGENTINA

Netto S.A.
Venezuela 1433
1095 Buenos Aires
ARGENTINA
☎ 37 - 1632

HONG KONG

Tom Lee Music Co., Ltd.
Service Division
22-32 Pun Shan Street,
Tsuen Wan, New
Territories, HONG KONG
☎ 415 - 0911

KOREA

Cosmos Corporation
Service Station
261 2nd Floor Nak-Won
arcade
Jong-Ro ku, Seoul, KOREA
☎ (02) 742 8844

SINGAPORE

Swee Lee Company
Bras Basah Complex
#03-23 Singapore 0178
SINGAPORE
☎ 3367886

THAILAND

Theera Music Co., Ltd
330 Vereng Nakorn Kasem,
Soi 2, Bangkok 10100,
THAILAND
☎ 2248821

MALAYSIA

Syarikat Bentley
No.142, Jalan Bukit
Bintang 55100 Kuala
Lumpur, MALAYSIA
☎ 2421288

INDONESIA

PT Galestra Inti
Kompleks Perkantoran
Duta Merlin Blok C/59
Jl. Gajah mada No 3-5
Jakarta 10130
INDONESIA
☎ (021) 354604, 354606

TAIWAN

Siruba Enterprise(Taiwan)
Co., LTD.
Room. 5, 9fl. No. 112
Chung Shan N Road Sec.2
Taipei, TAIWAN, R.O.C.
☎ (02)5364546

SOUTH AFRICA

That Other Music
Shop(PTY) LTD.
256 Bree Street,
Johannesburg 2001
Republic of South Africa
☎ 337 - 6573

Paul Bothner(PTY) LTD.
17 Werdmuller Centre
Claremont 7700
Republic of South Africa
☎ 021 - 64 - 4030

For Germany

Bescheinigung des Herstellers/Importeurs

Hiermit wird bescheinigt, daß der/die/das

Roland Digital Piano HP1500

(Gerät. Typ. Bezeichnung)

in Übereinstimmung mit den Bestimmungen der

Amtsbl. Vfg 1046/1984

(Amtsblattverfügung)

funk-entstört ist.

Der Deutschen Bundespost wurde das Inverkehrbringen dieses Gerätes angezeigt und die Berechtigung zur Überprüfung der Serie auf Einhaltung der Bestimmungen eingeräumt.

Roland Corporation Osaka/Japan

Name des Herstellers/Importeurs

For the USA

FEDERAL COMMUNICATIONS COMMISSION RADIO FREQUENCY INTERFERENCE STATEMENT

This equipment has been tested and found to comply with the limits for a Class B digital device, pursuant to Part 15 of the FCC Rules. These limits are designed to provide reasonable protection against harmful interference in a residential installation. This equipment generates, uses, and can radiate radio frequency energy and, if not installed and used in accordance with the instructions, may cause harmful interference to radio communications. However, there is no guarantee that interference will not occur in a particular installation. If this equipment does cause harmful interference to radio or television reception, which can be determined by turning the equipment off and on, the user is encouraged to try to correct the interference by one or more of the following measures:

- Reorient or relocate the receiving antenna.
- Increase the separation between the equipment and receiver.
- Connect the equipment into an outlet on a circuit different from that to which the receiver is connected.
- Consult the dealer or an experienced radio/TV technician for help.

Unauthorized changes or modification to this system can void the users authority to operate this equipment.

For Canada

CLASS B



NOTICE

This digital apparatus does not exceed the Class B limits for radio noise emissions set out in the Radio Interference Regulations of the Canadian Department of Communications.

CLASSE B

AVIS

Cet appareil numérique ne dépasse pas les limites de la classe B au niveau des émissions de bruits radioélectriques fixés dans le Règlement des signaux parasites par le ministère canadien des Communications.

	CAUTION RISK OF ELECTRIC SHOCK DO NOT OPEN	
ATTENTION RISQUE DE CHOC ELECTRIQUE NE PAS OUVRIR		
<p>CAUTION: TO REDUCE THE RISK OF ELECTRIC SHOCK, DO NOT REMOVE COVER (OR BACK). NO USER-SERVICEABLE PARTS INSIDE. REFER SERVICING TO QUALIFIED SERVICE PERSONNEL.</p>		



The lightning flash with arrowhead symbol within an equilateral triangle, is intended to alert the user to the presence of un-insulated "dangerous voltage" within the product's enclosure that may be of sufficient magnitude to constitute a risk of electric shock to persons.



The exclamation point within an equilateral triangle is intended to alert the user to the presence of important operating and maintenance (servicing) instructions in the literature accompanying the product.

INSTRUCTIONS PERTAINING TO A RISK OF FIRE, ELECTRIC SHOCK, OR INJURY TO PERSONS.

IMPORTANT SAFETY INSTRUCTIONS

WARNING — When using electric products, basic precautions should always be followed, including the following:

1. Read all the instructions before using the product.
2. Do not use this product near water — for example, near a bathtub, washbowl, kitchen sink, in a wet basement, or near a swimming pool, or the like.
3. This product should be used only with a cart or stand that is recommended by the manufacturer.
4. This product, either alone or in combination with an amplifier and headphones or speakers, may be capable of producing sound levels that could cause permanent hearing loss. Do not operate for a long period of time at a high volume level or at a level that is uncomfortable. If you experience any hearing loss or ringing in the ears, you should consult an audiologist.
5. The product should be located so that its location or position does not interfere with its proper ventilation.
6. The product should be located away from heat sources such as radiators, heat registers, or other products that produce heat.
7. Avoid using the product where it may be affected by dust.
8. The product should be connected to a power supply only of the type described in the operating instructions or as marked on the product.
9. The power-supply cord of the product should be unplugged from the outlet when left unused for a long period of time.
10. Do not tread on the power-supply cord.
11. Do not pull the cord but hold the plug when unplugging.
12. When setting up with any other instruments, the procedure should be followed in accordance with instruction manual.
13. Care should be taken so that objects do not fall and liquids are not spilled into the enclosure through openings.
14. The product should be serviced by qualified service personnel when:
 - A. The power-supply cord or the plug has been damaged; or
 - B. Objects have fallen, or liquid has been spilled into the product; or
 - C. The product has been exposed to rain; or
 - D. The product does not appear to operate normally or exhibits a marked change in performance; or
 - E. The product has been dropped, or the enclosure damaged.
15. Do not attempt to service the product beyond that described in the user-maintenance instructions. All other servicing should be referred to qualified service personnel.

For Canada

For Polarized Attachment Plug

CAUTION: TO PREVENT ELECTRIC SHOCK, MATCH WIDE BLADE OF PLUG TO WIDE SLOT, FULLY INSERT.

ATTENTION: POUR ÉVITER LES CHOCS ÉLECTRIQUES, INTRODUIRE LA LAME LA PLUS LARGE DE LA FICHE DANS LA BORNE CORRESPONDANTE DE LA PRISE ET POUSSER JUSQU' AU FOND.

For the U.K.

IMPORTANT: THE WIRES IN THIS MAINS LEAD ARE COLOURED IN ACCORDANCE WITH THE FOLLOWING CODE.

BLUE : NEUTRAL
BROWN : LIVE

As the colours of the wires in the mains lead of this apparatus may not correspond with the coloured markings identifying the terminals in your plug proceed as follows:

The wire which is coloured BLUE must be connected to the terminal which is marked with the letter N or coloured BLACK.

The wire which is coloured BROWN must be connected to the terminal which is marked with the letter L or coloured RED.

Roland®

26055607

UPC

26055607



10981

Roland®