

 **Roland**

**HP-147Re**



Roland Digital Piano



## Owner's Manual

|   |           |
|---|-----------|
| Important Safety Instructions.....                      | 2         |
| Important notes .....                                   | 5         |
| <b>Starting out .....</b>                               | <b>6</b>  |
| Main features .....                                     | 6         |
| Button descriptions .....                               | 6         |
| <b>Before you start playing .....</b>                   | <b>7</b>  |
| Connecting the power cord .....                         | 7         |
| Setting up the music stand.....                         | 7         |
| Opening and closing the lid.....                        | 7         |
| About the pedals .....                                  | 7         |
| About the Volume slider .....                           | 8         |
| Turning the power on and off .....                      | 8         |
| Connecting headphones.....                              | 8         |
| <b>Listening to the demo songs.....</b>                 | <b>9</b>  |
| Playing back and stopping the demo songs.....           | 9         |
| List of demo songs .....                                | 10        |
| <b>Playing the keyboard .....</b>                       | <b>11</b> |
| Using the Piano sound.....                              | 11        |
| Performing with various instrument sounds.....          | 11        |
| Layering two instrument sounds – Dual .....             | 12        |
| Adding reverberation to the sound — Reverb Effect ..... | 14        |
| Changing the keyboard's touch sensitivity .....         | 15        |
| <b>Convenient functions.....</b>                        | <b>16</b> |
| Playing in different keys —Key Transpose .....          | 16        |
| Changing the Volume balance in Dual mode .....          | 16        |
| Adjusting the reference pitch — Master Tuning .....     | 17        |
| <b>Connecting external devices.....</b>                 | <b>18</b> |
| Using MIDI.....   | 18        |
| Connecting audio equipment.....                         | 21        |
| <b>Appendices.....</b>                                  | <b>22</b> |
| Troubleshooting .....                                   | 22        |
| Functions assigned to the keyboard .....                | 22        |
| Specifications .....                                    | 23        |
| MIDI Implementation Chart.....                          | 24        |

Before using this unit, carefully read the sections entitled: "Important Safety Instructions" (p. 2), "Using The Unit Safely" (p. 3), and "Important notes" (p. 5). These sections provide important information concerning the proper operation of the unit. Additionally, in order to feel assured that you have gained a good grasp of every feature provided by your new unit, Owner's manual should be read in its entirety. The manual should be saved and kept on hand as a convenient reference.

|  |   |
|--|---|
| <br><b>CAUTION</b><br>RISK OF ELECTRIC SHOCK<br>DO NOT OPEN                                     |  |
| <b>ATTENTION</b> : RISQUE DE CHOC ELECTRIQUE NE PAS OUVRIR   |   |
| <b>CAUTION</b> : TO REDUCE THE RISK OF ELECTRIC SHOCK,<br>DO NOT REMOVE COVER (OR BACK).<br>NO USER-SERVICEABLE PARTS INSIDE.<br>REFER SERVICING TO QUALIFIED SERVICE PERSONNEL. |   |



The lightning flash with arrowhead symbol, within an equilateral triangle, is intended to alert the user to the presence of uninsulated "dangerous voltage" within the product's enclosure that may be of sufficient magnitude to constitute a risk of electric shock to persons.



The exclamation point within an equilateral triangle is intended to alert the user to the presence of important operating and maintenance (servicing) instructions in the literature accompanying the product.

**INSTRUCTIONS PERTAINING TO A RISK OF FIRE, ELECTRIC SHOCK, OR INJURY TO PERSONS.**

## IMPORTANT SAFETY INSTRUCTIONS SAVE THESE INSTRUCTIONS

**WARNING** - When using electric products, basic precautions should always be followed, including the following:

1. Read these instructions.
2. Keep these instructions.
3. Heed all warnings.
4. Follow all instructions.
5. Do not use this apparatus near water.
6. Clean only with a damp cloth.
7. Do not block any of the ventilation openings. Install in accordance with the manufacturers instructions.
8. Do not install near any heat sources such as radiators, heat registers, stoves, or other apparatus (including amplifiers) that produce heat.
9. Do not defeat the safety purpose of the polarized or grounding-type plug. A polarized plug has two blades with one wider than the other. A grounding type plug has two blades and a third grounding prong. The wide blade or the third prong are provided for your safety. When the provided plug does not fit into your outlet, consult an electrician for replacement of the obsolete outlet.
10. Protect the power cord from being walked on or pinched particularly at plugs, convenience receptacles, and the point where they exit from the apparatus.
11. Only use attachments/accessories specified by the manufacturer.
12. Never use with a cart, stand, tripod, bracket, or table except as specified by the manufacturer, or sold with the apparatus. When a cart is used, use caution when moving the cart/apparatus combination to avoid injury from tip-over.
13. Unplug this apparatus during lightning storms or when unused for long periods of time.
14. Refer all servicing to qualified service personnel. Servicing is required when the apparatus has been damaged in any way, such as power-supply cord or plug is damaged, liquid has been spilled or objects have fallen into the apparatus, the apparatus has been exposed to rain or moisture, does not operate normally, or has been dropped.



**For the U.K.**



**IMPORTANT: THE WIRES IN THIS MAINS LEAD ARE COLOURED IN ACCORDANCE WITH THE FOLLOWING CODE.**



BLUE: NEUTRAL  
BROWN: LIVE

As the colours of the wires in the mains lead of this apparatus may not correspond with the coloured markings identifying the terminals in your plug, proceed as follows:  
 The wire which is coloured BLUE must be connected to the terminal which is marked with the letter N or coloured BLACK.  
 The wire which is coloured BROWN must be connected to the terminal which is marked with the letter L or coloured RED.  
 Under no circumstances must either of the above wires be connected to the earth terminal of a three pin plug.







# USING THE UNIT SAFELY

## INSTRUCTIONS FOR THE PREVENTION OF FIRE, ELECTRIC SHOCK, OR INJURY TO PERSONS

About  **WARNING** and  **CAUTION** Notices









|  |  |
|--|--|
|  <b>WARNING</b> | Used for instructions intended to alert the user to the risk of death or severe injury should the unit be used improperly.   |
|  <b>CAUTION</b> | Used for instructions intended to alert the user to the risk of injury or material damage should the unit be used improperly.<br>* Material damage refers to damage or other adverse effects caused with respect to the home and all its furnishings, as well to domestic animals or pets. |

About the Symbols







|   |  |
|---|--|
|  | The  symbol alerts the user to important instructions or warnings. The specific meaning of the symbol is determined by the design contained within the triangle. In the case of the symbol at left, it is used for general cautions, warnings, or alerts to danger.         |
|  | The  symbol alerts the user to items that must never be carried out (are forbidden). The specific thing that must not be done is indicated by the design contained within the circle. In the case of the symbol at left, it means that the unit must never be disassembled. |
|  | The  symbol alerts the user to things that must be carried out. The specific thing that must be done is indicated by the design contained within the circle. In the case of the symbol at left, it means that the power-cord plug must be unplugged from the outlet.        |

### ALWAYS OBSERVE THE FOLLOWING

#### **WARNING**

- Before using this unit, make sure to read the instructions below, and the Owner's Manual. 
- Do not open or perform any internal modifications on the unit. 
- Do not attempt to repair the unit, or replace parts within it (except when this manual provides specific instructions directing you to do so). Refer all servicing to your retailer, the nearest Roland Service Center, or an authorized Roland distributor, as listed on the "Information" page. 
- Never use or store the unit in places that are:
  - Subject to temperature extremes (e.g., direct sunlight in an enclosed vehicle, near a heating duct, on top of heat-generating equipment); or are 
  - Damp (e.g., baths, washrooms, on wet floors); or are 
  - Humid; or are
  - Exposed to rain; or are
  - Dusty; or are
  - Subject to high levels of vibration.
- Make sure you always have the unit placed so it is level and sure to remain stable. Never place it on stands that could wobble, or on inclined surfaces. 
- The unit should be connected to a power supply only of the type described in the operating instructions, or as marked on the unit. 
- Do not excessively twist or bend the power cord, nor place heavy objects on it. Doing so can damage the cord, producing severed elements and short circuits. Damaged cords are fire and shock hazards! 

#### **WARNING**

- This unit, either alone or in combination with an amplifier and headphones or speakers, may be capable of producing sound levels that could cause permanent hearing loss. Do not operate for a long period of time at a high volume level, or at a level that is uncomfortable. If you experience any hearing loss or ringing in the ears, you should immediately stop using the unit, and consult an audiologist. 
- Do not allow any objects (e.g., flammable material, coins, pins); or liquids of any kind (water, soft drinks, etc.) to penetrate the unit.   

- In households with small children, an adult should provide supervision until the child is capable of following all the rules essential for the safe operation of the unit. 
- Protect the unit from strong impact. (Do not drop it!) 
- Do not force the unit's power-supply cord to share an outlet with an unreasonable number of other devices. Be especially careful when using extension cords—the total power used by all devices you have connected to the extension cord's outlet must never exceed the power rating (watts/amperes) for the extension cord. Excessive loads can cause the insulation on the cord to heat up and eventually melt through. 
- Before using the unit in a foreign country, consult with your retailer, the nearest Roland Service Center, or an authorized Roland distributor, as listed on the "Information" page. 

**CAUTION**

- The unit should be located so that its location or position does not interfere with its proper ventilation. 

---

- Always grasp only the plug on the power-supply cord when plugging into, or unplugging from, an outlet or this unit. 

---

- Try to prevent cords and cables from becoming entangled. Also, all cords and cables should be placed so they are out of the reach of children. 

---

- Never climb on top of, nor place heavy objects on the unit. 

---

- Never handle the power cord or its plugs with wet hands when plugging into, or unplugging from, an outlet or this unit. 

---

- If you need to move the instrument, take note of the precautions listed below. At least two persons are required to safely lift and move the unit. It should be handled carefully, all the while keeping it level. Make sure to have a firm grip, to protect yourself from injury and the instrument from damage. 
  - Check to make sure the knob bolts securing the unit to the stand have not become loose. Fasten them again securely whenever you notice any loosening.
  - Disconnect the power cord.
  - Disconnect all cords coming from external devices.
  - Raise the adjusters on the stand (p. 8).
  - Close the lid.
  - Remove the music stand.

---

- Before cleaning the unit, turn off the power and unplug the power cord from the outlet (p. 7). 

---

- Whenever you suspect the possibility of lightning in your area, pull the plug on the power cord out of the outlet. 

---

- Be careful when opening/closing the lid so you do not get your fingers pinched (p. 7). Adult supervision is recommended whenever small children use the unit. 

---

- Should you remove the screws fastening the stand, make sure to put them in a safe place out of children's reach, so there is no chance of them being swallowed accidentally. 

# Important notes

In addition to the items listed under "IMPORTANT SAFETY INSTRUCTIONS" and "USING THE UNIT SAFELY" on pages 2, 3 and 4, please read and observe the following:

## Power supply

- Do not use this unit on the same power circuit with any device that will generate line noise (such as an electric motor or variable lighting system).
- Before connecting this unit to other devices, turn off the power to all units. This will help prevent malfunctions and/or damage to speakers or other devices.

## Placement

- Using the unit near power amplifiers (or other equipment containing large power transformers) may induce hum. To alleviate the problem, change the orientation of this unit; or move it farther away from the source of interference.
- This device may interfere with radio and television reception. Do not use this device in the vicinity of such receivers.
- Do not expose the unit to direct sunlight, place it near devices that radiate heat, leave it inside an enclosed vehicle, or otherwise subject it to temperature extremes. Also, do not allow lighting devices that normally are used while their light source is very close to the unit (such as a piano light), or powerful spotlights to shine upon the same area of the unit for extended periods of time. Excessive heat can deform or discolor the unit.
- To avoid possible breakdown, do not use the unit in a wet area, such as an area exposed to rain or other moisture.
- Do not allow rubber, vinyl, or similar materials to remain on the piano for long periods of time. Such objects can discolor or otherwise harmfully affect the finish.
- Do not put anything that contains water (e.g., flower vases) on the piano. Also, avoid the use of insecticides, perfumes, alcohol, nail polish, spray cans, etc., near the unit. Swiftly wipe away any liquid that spills on the unit using a dry, soft cloth.
- Do not allow objects to remain on top of the keyboard. This can be the cause of malfunction, such as keys ceasing to produce sound.
- Do not paste stickers, decals, or the like to this instrument. Peeling such matter off the instrument may damage the exterior finish.

## Maintenance

- To clean the unit, use a dry, soft cloth; or one that is slightly dampened. Try to wipe the entire surface using an equal amount of strength, moving the cloth along with the grain of the wood. Rubbing too hard in the same area can damage the finish.
- Never use benzine, thinners, alcohol or solvents of any kind, to avoid the possibility of discoloration and/or deformation.

## Additional precautions

- Use a reasonable amount of care when using the unit's buttons, sliders, or other controls; and when using its jacks and connectors. Rough handling can lead to malfunctions.
- When connecting/disconnecting all cables, grasp the connector itself—never pull on the cable. This way you will avoid causing shorts, or damage to the cable's internal elements.
- A small amount of heat will radiate from the unit during normal operation.
- To avoid disturbing your neighbors, try to keep the unit's volume at reasonable levels. You may prefer to use headphones, so you do not need to be concerned about those around you (especially when it is late at night).
- When you need to transport the unit, pack it in shock-absorbent material. Transporting the unit without doing so can cause it to become scratched or damaged, and could lead to malfunction.
- Use a cable from Roland to make the connection. If using some other make of connection cable, please note the following precautions.
  - Some connection cables contain resistors. Do not use cables that incorporate resistors for connecting to this unit. The use of such cables can cause the sound level to be extremely low, or impossible to hear. For information on cable specifications, contact the manufacturer of the cable.

# Starting out

## Main features

---

### ■ Authentic piano performances

High-quality concert grand piano tones, combined with the Progressive Hammer Action keyboard, which provides more realistic piano touch, with a heavier feel in the low end and a lighter feel in the upper notes, let you enjoy truly authentic piano performances.

### ■ Five tones for use in a wide variety of musical genres

The HP 147Re features not only a piano tone, but also four other sounds that you can use in a variety of musical genres.

### ■ Includes high-quality Reverb

The HP 147Re's reverb function can add various types of reverberation (sound that is reflected off the walls of a room) to the instrument sounds.

### ■ Compact design needs little space

The HP 147Re provides authentic hammer action and high-quality tones, all in a compact body.

## Button descriptions

---

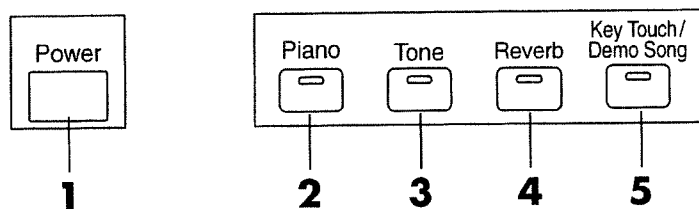

#### 1. [Power] switch

Turns the HP 147Re's power on and off (p. 8).

#### 2. [Piano] button

Press this button to select the HP 147Re's high-quality grand piano sound (p. 11).

#### 3. [Tone] button

Press this button to select one of the other sounds the HP 147Re contains (p. 11).

#### 4. [Reverb] button

Pressing this button adds reverberation to the sound (p. 14).

#### 5. [Key Touch/Demo Song] button

Hold this button while pressing a key (of the HP 147Re's keyboard) to start demo song playback, or to make various settings on the HP 147Re.



See "Functions assigned to the keyboard" (p. 22) for an overview of the keys you can use in combination with this button.



# Before you start playing

## Connecting the power cord

\* To prevent malfunction and/or damage to speakers or other devices, always turn down the volume, and turn off the power on all devices before making any connections.

1. Connect the supplied power cord to the AC Inlet socket on the rear panel of the unit.

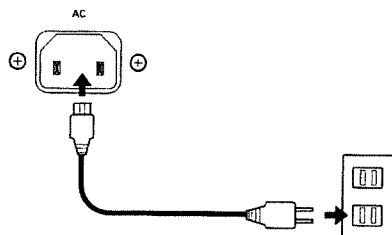

2. Plug the other end of the power cord into a wall outlet.

## Setting up the music stand

Set up the music stand as shown in the figures below.

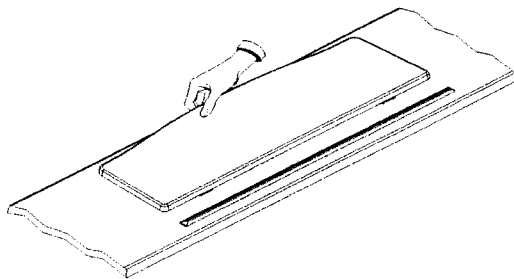

Fold the three supporting feet at the back of the stand and check whether the stand is held in place.

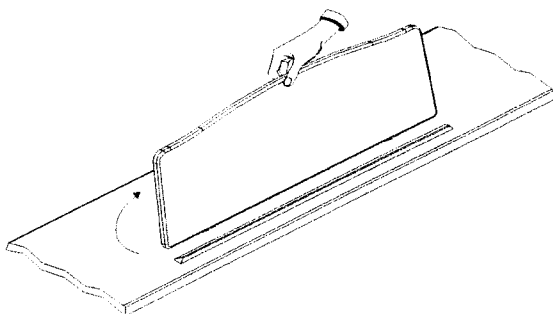

Before moving the HP 147Re, be sure to lower the music stand as a safety precaution.

## Opening and closing the lid

1. When opening the HP 147Re's lid, grasp it with both hands and gently lift it upwards, then slide it towards the back of the piano.
2. When closing the lid, slowly pull it forward, then gently lower it into place.

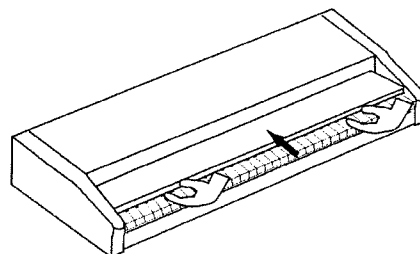

Do not insert your hands into the inside of the piano through the space between the lid and the keyboard.

- \* Make sure an adult is on hand to provide assistance when young children are playing the HP 147Re.
- \* For safety, transport the keyboard only with the lid in the closed position.

## About the pedals

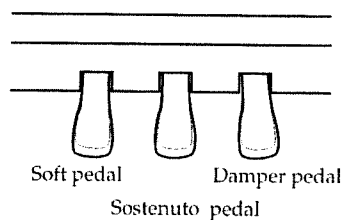

### Soft pedal

This pedal softens the sound. Playing with the soft pedal depressed produces a rounder and more subdued sound compared to what you hear when you play with the equivalent strength while not pressing the pedal.

### Sostenuto pedal

With the Sostenuto pedal, only the notes played at the moment the pedal is pressed are sustained.

### Damper pedal

Use this pedal when you want the sound to linger. While the damper pedal is depressed, the notes you played keep sounding for an extended period, even when you remove your fingers from the keys.

## About the adjuster

After you have moved this piano, or when you feel it is unstabled, lower the adjuster at the bottom of the pedal board as follows:

○ Lower the adjuster so that it is firmly in contact with the floor. If there is a gap between the adjuster and the floor, the unit may malfunction when the pedal is pressed. In particular when the instrument is placed on a carpeted floor, you must lower the adjuster so that it presses strongly against the floor.

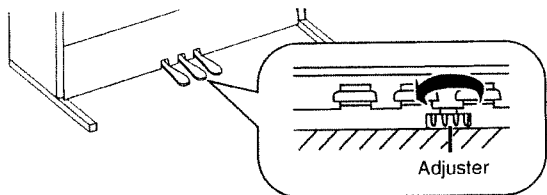

## About the Volume slider

The [Volume] slider adjusts the overall volume.

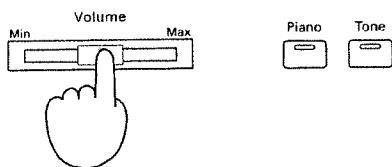

\* To protect your ears when using headphones for extended periods, take care not to listen at excessively high volume.

## Turning the power on and off

\* Once the connections have been completed, turn on power to your various devices in the order specified. By turning on devices in the wrong order, you risk causing malfunction and/or damage to speakers and other devices.

### ■ Turning on the power

Your HP 147Re is fitted with an amplifier and speakers so that you do not need additional devices.

1. Before switching the power on, set the [Volume] slider to the minimum position.
2. Press the [Power] switch.

Lower position

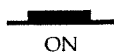

Several seconds after the power is turned on, you will hear the notes you play on the keyboard. Adjust the volume appropriately.

\* The HP 147Re is equipped with a protection circuit. A brief interval (a few seconds) after power up is required before the unit will operate normally.

### ■ Turning off the power

1. Before switching the power off, set the volume to the minimum position.

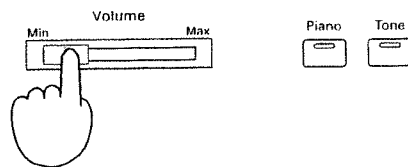

2. Press the [Power] switch.

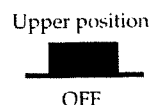

The power is turned off.

## Connecting headphones

The HP 147Re features two headphone jacks. This allows two people to listen through headphones simultaneously, making it very useful for lessons and when performing piano pieces for four hands. Additionally, this allows you to play without having to worry about bothering others around you, even at night.

1. Connect the headphones to either of the headphone jacks on the underside of the HP 147Re, on the left.

Sound will no longer be heard from the HP 147Re's speakers.

2. Adjust the headphones volume with the HP 147Re's [Volume] slider.

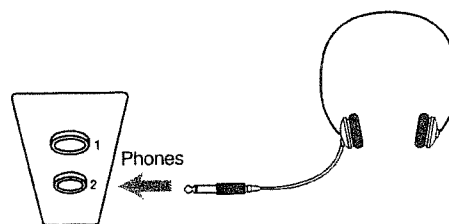

### ■ Precautions to take when using headphones

- \* To avoid damaging or severing the headphone cord, be sure to handle the headphones by holding the phones themselves, and grasping the plug and not the cord when pulling the headphone plug.
- \* Connecting the headphones when the volume of connected equipment is turned up may result in damage to the headphones. Connect the headphones only after turning the volume down completely.
- \* Listening at excessively high volume levels will not only damage the headphones, but may also cause hearing loss. Listen at appropriate levels.

# Listening to the demo songs

## Playing back and stopping the demo songs

### ■ Playing back the demo songs

While holding down the [Key Touch/Demo Song] button, press any of the keys within the “Demo Song” area.

There are four demo songs per key (for a total of 32). While holding down the [Key Touch/Demo Song] button, press a relevant key enough times to select the song you want to listen to. Pressing a key repeatedly will cycle you through the available options.

For example, to play back from song “1-3,” hold down the [Key Touch/Demo Song] button and press the E1 (the lowest “E”) key three times.

If you are already playing back song “1-1,” hold down the [Key Touch/Demo Song] button and press the E1 (the lowest “E”) key two times to play Song “1-3.”

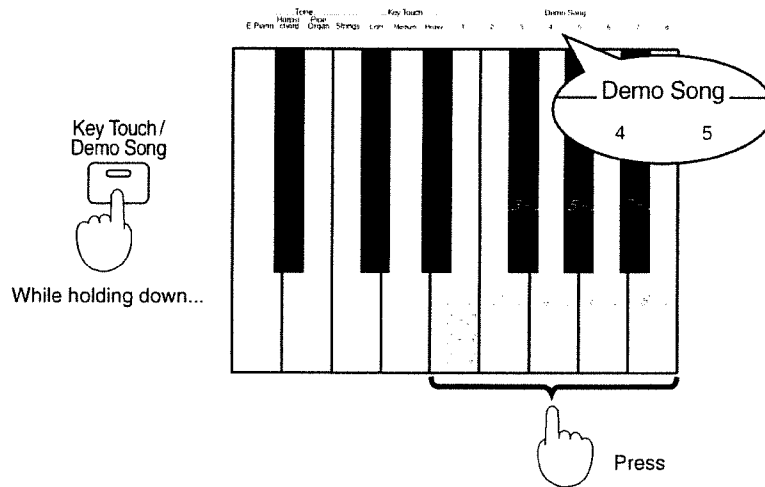

[Key Touch/Demo Song] indicator starts flashing and the song starts to play.

### ■ Stopping the demo songs

Press the [Key Touch/Demo Song] button again.

The indicator stops blinking and goes off, and playback of the Demo Song stops.

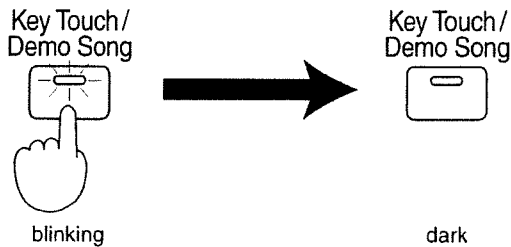

*When one song is finished, the next song automatically begins to play. Subsequent Demo Songs are automatically played one after another until you stop them playing.*

## ■ List of demo songs

| No. | Title  | Composer                    | Copyright                 |
|-----|--|-----------------------------|---------------------------|
| 1-1 | Intro  | J. Maul                     | © 1991, 1999 Roland UK    |
| 1-2 | Je Te Veux   | E. Satie                    | © 1997 Roland Corporation |
| 1-3 | Golliwog's Cakewalk  | C. Debussy                  | © 1996 Roland Corporation |
| 1-4 | "Fröhlicher Landmann" from "Album Für Die Jugend" Op. 68                   | R. Schumann                 | © 1996 Roland Corporation |
| 2-1 | Bagatelle "Für Elise" WoO. 59  | L. v. Beethoven             | © 1994 Roland Corporation |
| 2-2 | Arabesque No. 1 in E-Major   | C. Debussy                  | © 1994 Roland Corporation |
| 2-3 | Salut D'Amour Op. 12   | E. Elgar                    | © 1996 Roland Corporation |
| 2-4 | "Troika Drive: November" from "The Seasons," Op. 37                        | P. Tchaikovsky              | © 1996 Roland Corporation |
| 3-1 | A Maiden's Prayer  | T. Badarzewska              | © 1996 Roland Corporation |
| 3-2 | "Promenade" from "Tableaux d'une exposition"                               | M. Musorgsky                | © 1995 Roland Corporation |
| 3-3 | On Wings Of Song   | F. Mendelssohn              | © 1996 Roland Corporation |
| 3-4 | Moment musicaux No. 3, Op. 94-3  | F. Schubert                 | © 1994 Roland Corporation |
| 4-1 | No. 14 "La Styrienne" from "25 Easy Studies" Op. 100"                      | F. Burgmüller               | © 1992 Roland Corporation |
| 4-2 | Türkisch March (Piano Sonate No. 11 in A Major, 3rd Movement "Alla Turca") | W. A. Mozart                | © 1994 Roland Corporation |
| 4-3 | Rondo Brillante "Aufforderung Zum Tanz" in D-flat Major, Op. 65"           | C. M. v. Weber              | © 1994 Roland Corporation |
| 4-4 | "Frühlingslied" from "Lieder Ohne Worte Heft 5," Op. 62-6                  | F. Mendelssohn              | © 1996 Roland Corporation |
| 5-1 | Cantata BWV. 147 (Jazz Arranged)   | J. S. Bach /<br>Naoki Nishi | © 1993 Roland Corporation |
| 5-2 | Gymnopédie No. 1   | E. Satie                    | © 1997 Roland Corporation |
| 5-3 | Fantasia-Impromptu Op.66   | F. Chopin                   | © 1994 Roland Corporation |
| 5-4 | Etude No. 5 in G-flat Major "Black Keys," Op. 10-5                         | F. Chopin                   | © 1990 Roland Corporation |
| 6-1 | Etude No.3 in E Major "Chanson De L'Adieu," Op. 10-3                       | F. Chopin                   | © 1992 Roland Corporation |
| 6-2 | Mazurka No.5 in B-flat Major, Op. 7-1                                      | F. Chopin                   | © 1995 Roland Corporation |
| 6-3 | Valse No. 6 in D-flat Major, Op. 64-1 "Petit Chien"                        | F. Chopin                   | © 1990 Roland Corporation |
| 6-4 | Nocturne No. 2 in E-flat Major, Op. 9-2                                    | F. Chopin                   | © 1993 Roland Corporation |
| 7-1 | Fly Free   | J. Maul                     | © 1992 Roland Corporation |
| 7-2 | Piano Sonata No. 14 in C-sharp Minor, "Moonlight" 1st Movement             | L. v. Beethoven             | © 1998 Roland Corporation |
| 7-3 | "Berceuse" from "Dolly," Op. 56  | G. Fauré                    | © 1995 Roland Corporation |
| 7-4 | Slavonic Dance No. 10, Op. 72-2  | A. Dvořák                   | © 1998 Roland Corporation |
| 8-1 | Mood/Ending  | J. Maul                     | © 1991, 1999 Roland UK    |
| 8-2 | 3-Romances Sans Paroles No. 3, Op. 17                                      | G. Fauré                    | © 1996 Roland Corporation |
| 8-3 | "Clair de lune" from "Suite Bergamasque"                                   | C. Debussy                  | © 1990 Roland Corporation |
| 8-4 | "Träumerei" from "Scenes From Childhood" Op. 15                            | R. Schumann                 | © 1997 Roland Corporation |

\* All rights reserved. Unauthorized use of this material for purposes other than private, personal enjoyment is a violation of applicable laws.

\* No data for the music that is played will be output from MIDI OUT.

## Profiles of the composers

### John Maul

John Maul is a musician, composer and arranger having graduated from the Royal Academy of Music in London. John's work encompasses studio recordings and live performances including work with top UK jazz artists. His writing credits include commercial music for BBC radio and television, as well as scoring jazz and classical works.

Having been a product specialist for Roland U.K., John is now actively involved in music software composing/programming for both Roland Japan and various music publishers. Quite recently his "Musical Picture Book," a volume of original piano music encompassing all standards of musical ability, which included the piano and orchestral accompaniment data in SMF format, was published and printed.

### Naoki Nishi

Born in 1958 in Hiroshima, Japan. Began working professionally at the age of 21. Has so far released 9 albums on which he is featured. He has also taken part in numerous other albums. His broad range of activities have included appearances at a number of jazz festivals in Japan and other parts of the world. In addition to his duties as an instructor at the Tokyo Conservatoire Shoubi, he has provided his services as a demonstrator for Roland since 1990. He is considered to be one of Japan's finest jazz pianist.

# Playing the keyboard

## Using the Piano sound

The HP 147Re lets you enjoy performing with high-quality concert grand piano tone.

**When you press the [Piano] button, the button indicator lights.**

You can now play the piano tone.

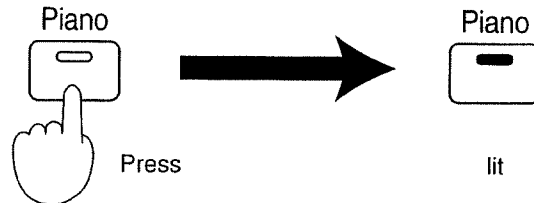

The HP 147Re selects this piano tone when the power is turned on.

## Performing with various instrument sounds

The HP 147Re also includes four other tones: E.Piano (Electric Piano), Harpsichord, Pipe Organ and Strings. You can assign any one of these four tones to the [Tone] button.

**Press the [Tone] Button**

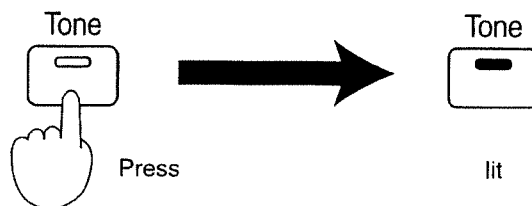

When the power is turned on, E.Piano (Electric Piano) is assigned to the [Tone] button, which allows you to alternate between the concert grand and electric piano sounds.

**When you press the [Tone] button, its indicator lights.**

The electric piano tone is produced when you play the keyboard.

### ■ Assigning another sound to the [Tone] button

Any of the four tones may be assigned to the [Tone] button. After assigning the desired sound to the [Tone] button, you can alternate between that sound and the concert grand piano sound by switching the [Tone] button on and off.

- 1. While holding down the [Tone] button, press the "Tone" key that is assigned to the desired tone.**

The [Tone] indicator blinks, indicating that your choice has been registered.

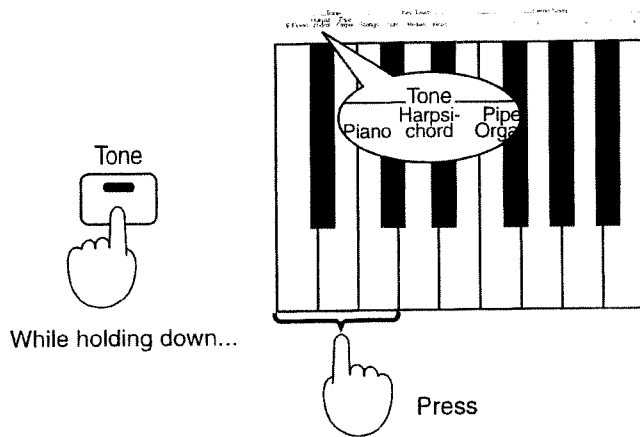

## 2. After releasing the button, play the keyboard.

The button indicator stops blinking and stays on, indicating that the tone selected in Step 1 has been assigned to the [Tone] button.



*When assigning tones to the [Tone] button, be sure to first select it (see step 1; indicator blinks) and then play a few notes on the keyboard (step 2, indicator lights). You can also register the tone by pressing the blinking [Tone] button instead of playing the keyboard. If you don't want to set the tone, then press the [Piano] button.*

# Layering two instrument sounds – Dual

Playing with two different tones on the keyboard simultaneously is called “Dual Play.”

## ■ Layering the Piano and Strings tones

### 1. First, assign the Strings tone to the [Tone] button.

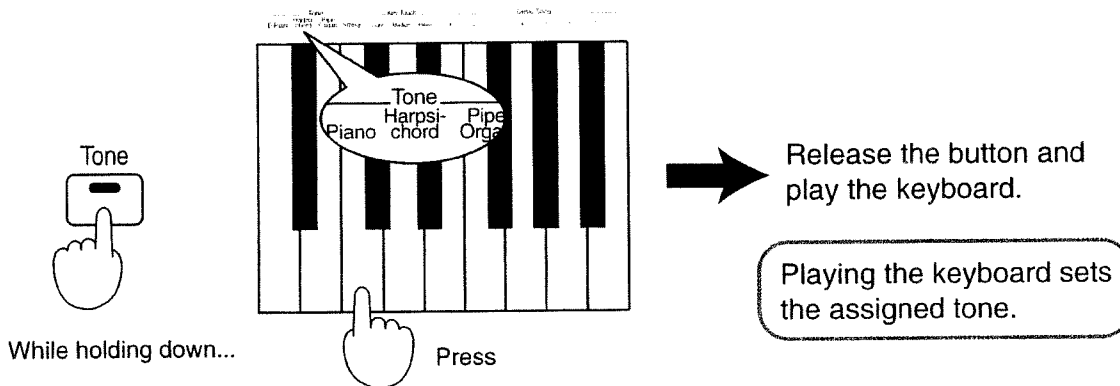

## 2. While holding down the [Piano] button, press the [Tone] button.

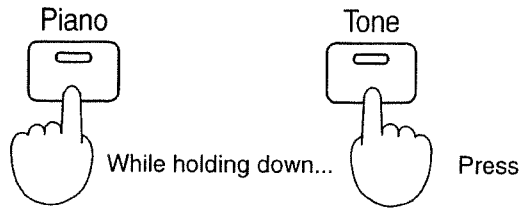

Both indicators of the [Piano] and [Tone] buttons light. When you play the keyboard, the Piano and Strings tones are layered and played simultaneously.

### ■ Reverting to a single instrument tone

Press either the [Piano] button or the [Tone] button.

Only the button indicator for the button that was pressed stays on, and only that instrument sound is produced.

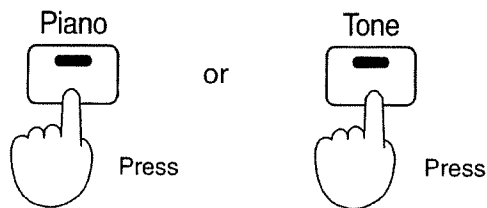

### Layering the Harpsichord and Strings Tones

The Layer (or Dual Play™) function is also available for two “non-piano tones” (i.e. the sounds available via the [Tones] button).

While holding down the [Tone] button, simultaneously press the keys assigned to the Harpsichord and Strings sounds.

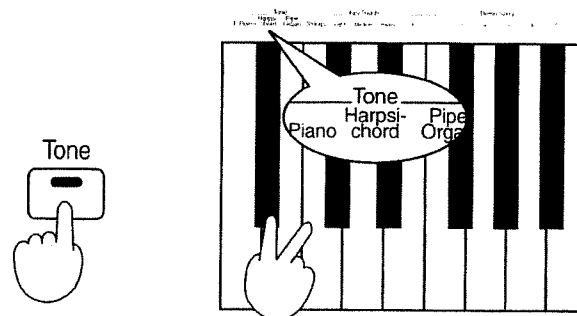

**NOTE** Though layering two non-piano sounds is no problem, it is not possible to alternate between these two tones and the piano sound by repeatedly pressing the [Tone] button. When [Tone] is pressed again, only the tone that was assigned to this button before you activated the layer is restored.

**MEMO** You can adjust the volume balance between the two selected tones in Dual Play. Please refer to “Changing the Volume balance in Dual Mode” (p. 16).

# Adding reverberation to the sound — Reverb Effect

---

The HP 147Re allows you to add reverberation to what you play on the keyboard. With the Reverb effect, you can create the impression that you are performing in a concert hall or similar space.

## 1. Press the [Reverb] button; the button indicator lights.

Reverberation is added to the sound.

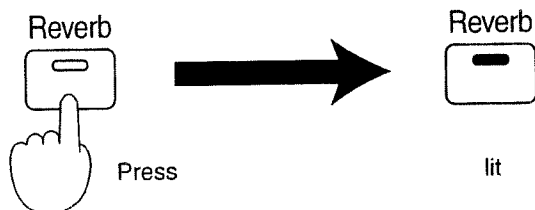

## 2. Press the [Reverb] button once more; the indicator goes off, and the Reverb effect is no longer audible.

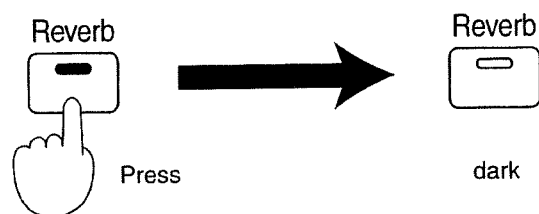

## ■ Changing the Reverb level

The HP 147Re features eight reverb levels, 1~8, allowing you to select the preferred reverb sound. The higher the reverb type number, the deeper the effect is.

The reverb is reset to "4" when the power is switched on.

To change the Reverb level, hold down the [Key Touch/Demo Song] button and press one of the keys C3~G3 (corresponding to Reverb levels 1~8).

### <Ex.> Selecting Reverb Type 6

While holding down the [Key Touch/Demo Song] button, press the F3 key (the fourth white key below Middle C).

Refer to "Functions assigned to the keyboard" (p. 22).

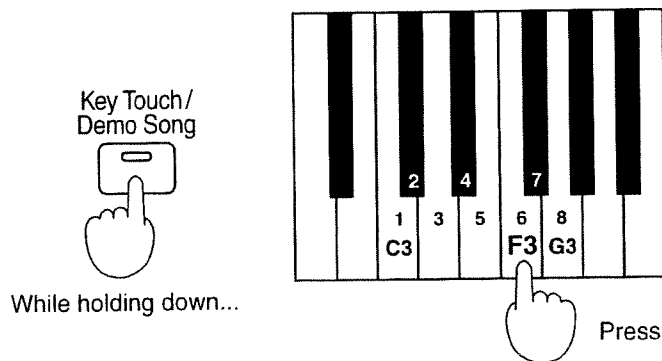



## Changing the keyboard's touch sensitivity

You can select from three touch sensitivity levels: Light, Medium, and Heavy. When the Keyboard is turned on, the response is set to "Medium."

**While holding down the [Key Touch/Demo Song] button, press the key indicating the preferred touch sensitivity.**

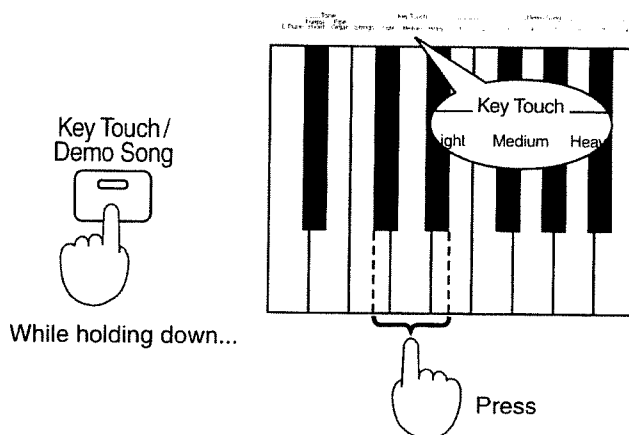

| Types         | Meaning  |
|---------------|--|
| <b>Medium</b> | Normal setting, providing the most natural touch, closest to that of an acoustic piano.  |
| <b>Heavy</b>  | With this setting, to play fortissimo the keys must be played much more strongly than normally, as if the keys had become heavier. Adds even more emotion when you play with lots of dynamics. This is useful for players who use a strong touch and for drill work. |
| <b>Light</b>  | With this setting, fortissimo can be produced using much less force than normal, thus making the keys seem lighter. This setting makes it easy to play, even for children.   |

# Convenient functions

## Playing in different keys — Key Transpose

You can play in a different key without pressing other keys. This function is called “Key Transpose.”

When you are accompanying a singer, you can use Key Transpose to match the vocal pitch of the singer, allowing you to transpose easily while using the same printed music (keyboard fingering).

Key transpositions remain in effect until the keyboard’s power is turned off.

\* The transposition setting is effective only on sounds performed on the HP 147Re’s keyboard. This setting is not effective on tones from external MIDI messages played on the HP 147Re.

### <Ex.> Using the C Major Keys to Play a Song in E Major

1. While holding down the [Key Touch/Demo Song] button, press the tonic (root) of the key to which you want to transpose.

Use the C2~B2 notes to select the tonic. Refer to “Functions assigned to the keyboard” (p. 22).

Here, press the E2 key.

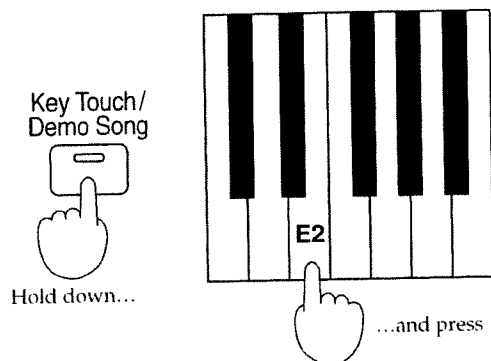

2. To return to the previous condition, hold down the [Key Touch/Demo Song] button while pressing the C2 key.

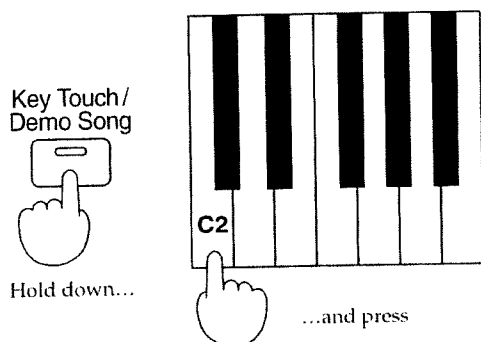

## Changing the Volume balance in Dual mode

You can change the volume balance between the two layered sounds after activating the Dual mode (p. 12).

When the Keyboard is turned on, the balance is set to “Standard.” This setting remains in effect until the power is turned off.

While holding down the [Key Touch/Demo Song] button, press the corresponding note (C7–E7).

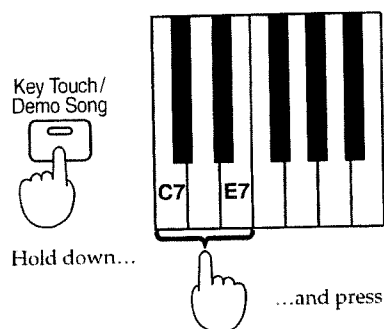

| Key | Description  |
|-----|--|
| C7  | One of the two layered tones sounds louder.                |
| C#7 | One of the two layered tones sounds somewhat louder.       |
| D7  | Standard   |
| D#7 | The other of the two layered tones sounds somewhat louder. |
| E7  | The other of the two layered tones sounds louder.          |

## Adjusting the reference pitch — Master Tuning

In situations such as when playing in ensemble with other instruments, you can adjust the HP 147Re's reference pitch to that of another instrument.

Middle A is generally used as the standard reference pitch for tuning instruments. When playing with other instruments, the ensemble will not sound good if the instruments are not in tune with each other. This tuning of all the instruments to a reference pitch is called "Master Tuning."

### MEMO

The reference pitch is reset to 440 Hz when the power is switched on, with 440 Hz played by Middle A (A4).

### ■ Lowering/ raising the Reference Pitch

Hold down the [Key Touch/Demo Song] button, and press the "C4" key to lower the reference pitch, or the "D4" key to raise it.

Refer to "Functions assigned to the keyboard" (p. 22).

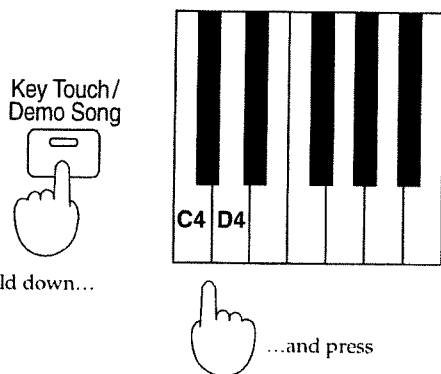

Hold down...

...and press

Each time you press the "C4" key, the pitch will fall by 0.1 Hz. If you continue holding the key, the pitch will continue falling.

Each time you press the "D4" key, the pitch will rise by 0.1 Hz. If you continue holding the key, the pitch will continue rising.

### ■ Setting the Reference Pitch to 440 Hz

While holding down the [Key Touch/Demo Song] button, press the "C#4" key on the keyboard.

Refer to "Functions assigned to the keyboard" (p. 22).

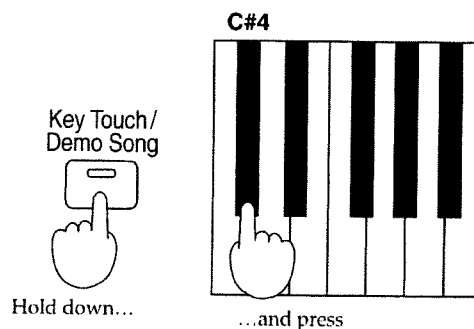

Hold down...

...and press

The reference pitch will be set to 440 Hz. This is the most commonly used setting. The A4 (Middle A) key will sound at 440 Hz.

### ■ Setting the Reference Pitch to 442 Hz

While holding down the [Key Touch/Demo Song] button, press the "D#4" key on the keyboard.

Refer to "Functions assigned to the keyboard" (p. 22).

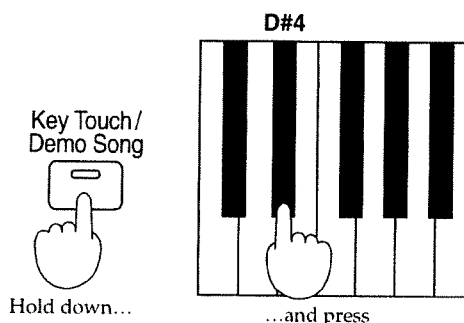

Hold down...

...and press

The standard pitch will be set to 442 Hz. This setting is often used for concert pianos. The A4 (Middle A) key will sound at 442 Hz.

# Connecting external devices

Please read this section if you are planning to use the HP 147Re's MIDI functions by connecting it to another MIDI device.

When connected to one of Roland's MT Series devices or a comparable instrument, the HP 147Re allows you to play the MT Series' sounds via its keyboard. But you can also use the MIDI functions for recording your music using an external sequencer.

## Using MIDI

### ■ About MIDI

MIDI, short for "Musical Instrument Digital Interface," was developed as a standard for the exchange of performance data between electronic instruments and computers.

The HP 147Re is equipped with MIDI connectors to allow such exchange of performance data with external equipment and devices. Connecting the piano to other devices with these jacks provides you with an even greater variety of ways to use your HP 147Re.

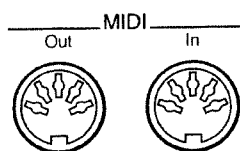

MIDI connectors on the rear panel

### MIDI Out Connector

Performance information, such as the notes you play on the keyboard or the pedals you press, is sent out from this socket to the MIDI connectors of external equipment.

### MIDI In Connector

MIDI messages sent from connected external equipment are received here. In response to such messages, the HP 147Re plays notes, selects other sounds, and/or performs other operations.

### ■ Sending and receiving Program Change messages

When you press the HP 147Re's [Piano] or [Tone] button to change tones, a Program Change Message with the corresponding number is sent via the MIDI Out connector. Furthermore, a Program Change Message received via the MIDI In connector causes the HP 147Re to select the tone or dual combination that corresponds to the incoming Program Number.

### Switching Tones with Program Change Messages

If you connect the HP 147Re's MIDI Out socket to the MIDI In socket of an external MIDI sequencer and then press the [Tone] button while you are recording with the external sequencer, a Program Change message for that tone is recorded by the sequencer. When you play back the sequence thus recorded (after connecting the sequencer's MIDI Out socket to the HP 147Re's MIDI In), the tone is changed in accordance with the Program Change messages recorded by the sequencer. This ensures that your songs are always played back with the correct sounds.

Program Change messages sent while the recording is in progress are also recorded, meaning you can also record songs that use several tones in sequence.

Program Numbers for of the HP 147Re's tones and dual combinations are shown below.

| Program Number | Tone                         |
|----------------|------------------------------|
| 1              | Piano                        |
| 4              | Harpsichord                  |
| 6              | Electric Piano               |
| 8              | Pipe Organ                   |
| 9              | Strings                      |
| 11             | Piano + Harpsichord          |
| 13             | Piano + Electric Piano       |
| 15             | Piano + Pipe Organ           |
| 16             | Piano + Strings              |
| 24             | Harpsichord + Electric Piano |
| 26             | Harpsichord + Pipe Organ     |
| 27             | Harpsichord + Strings        |
| 33             | Electric Piano + Pipe Organ  |
| 34             | Electric Piano + Strings     |
| 37             | Pipe Organ + Strings         |

\* Program numbers other than those listed above are ignored by the HP 147Re.

\* 11-37 apply to the Dual mode (p. 12).

## ■ Making connections

1. Turn off the HP 147Re.

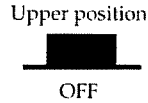

2. Connect the MIDI sockets on the external MIDI device and HP 147Re with MIDI cables.

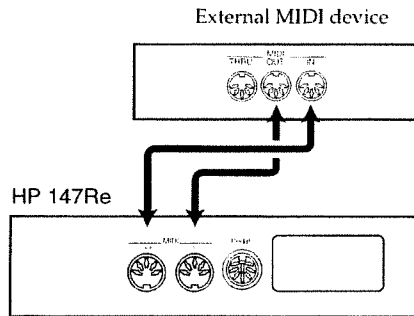

3. If necessary, set the MIDI channel, Local on/off, etc.

## ■ Setting the MIDI Channel

MIDI uses sixteen MIDI channels, numbered 1~16. Even after MIDI cables are connected, the connected devices must be set to use the same MIDI channels, otherwise no sound will be produced. When the HP 147Re is turned on, Channel "1" is selected.

**Hold down the [Key Touch/Demo Song] button, and press any key from C5~D#6.**

The keys C5~D#6 correspond to MIDI Channels 1~16. Refer to "Functions assigned to the keyboard" (p. 22).

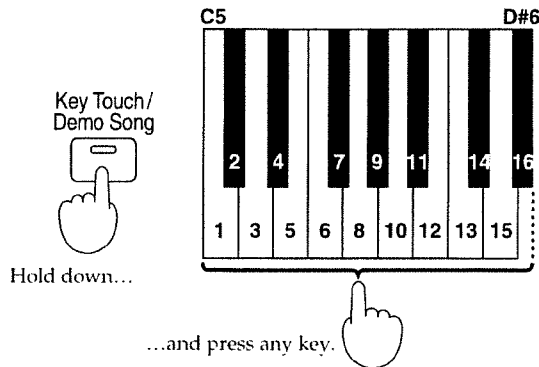

## <Ex.> Set the MIDI Channel to 10

Hold down the [Key Touch/Demo Song] button, while pressing the A5.

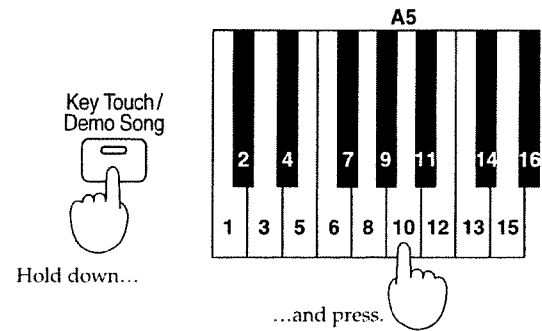

Here the HP 147Re's MIDI channel for sending/receiving is set to 10.

## ■ Local On/Off

With the HP 147Re connected to a MIDI sequencer, keyboard performances can be recorded to the sequencer; the sequencer can also be used to play back performances.

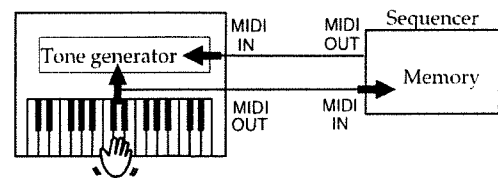

With the sequencer's "Thru" function on, the same notes may be sounded twice.

This is because the HP 147Re's performance data arrives at the sound generator via two different routes, (1) and (2). This can cause the sound to become strange, and also puts strain on the instrument's polyphonic capabilities. To prevent this from happening, route (1) must be broken, by means of what is called "Local Off."

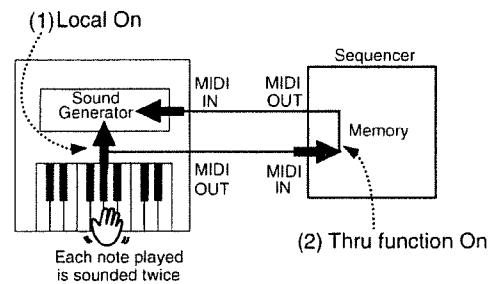

## Switching Local On/Off

1. Local On is set when the power is switched on.
2. While holding down the [Key Touch/Demo Song] button, press the second key from the far right (B7).

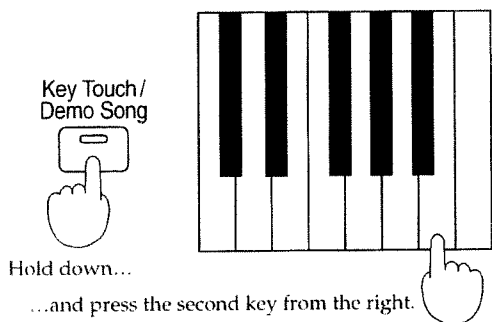

This sets Local Off.

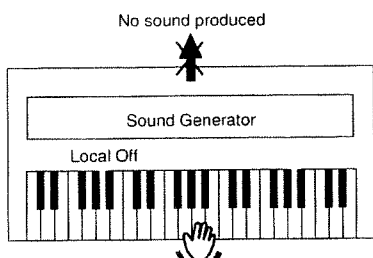

3. Once more, while holding down the [Key Touch/Demo Song] button, press the first key from the right (C8).

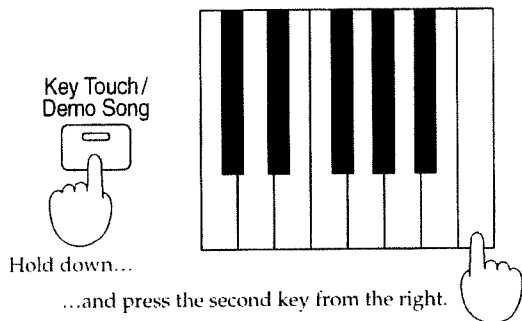

This sets Local On.

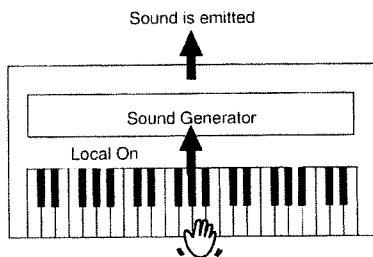

## ■ Omni on/off

When the Omni function is set to On, the HP 147Re responds to all MIDI messages, no matter which channel they arrive on.

When the Omni function is Off, the HP 147Re recognizes only the messages that arrive on the selected MIDI channel (see "Setting the MIDI Channel", p. 19).

## Switching Omni On/Off

1. Omni On is automatically set when the power is switched on.
2. Hold down the [Key Touch/Demo Song] button and press the A7 to turn the setting On, or the G7 to turn the setting Off.

Refer to "Functions assigned to the keyboard" (p. 22).

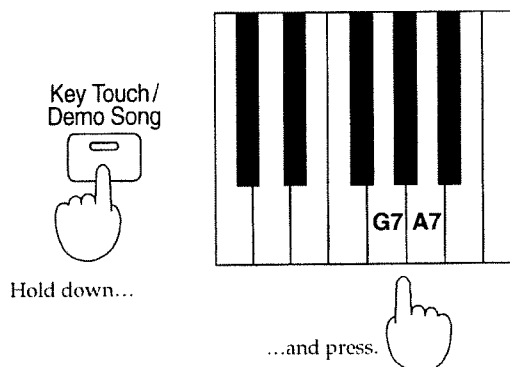

## Connecting audio equipment

When you connect the HP 147Re to audio equipment, you can amplify the HP 147Re's sounds via the speakers of your stereo, a PA, and the like, or record your performances on a tape recorder or other recording device.

### ■ Connectors

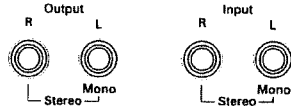

### Output jacks

You can connect audio equipment using audio cables (sold separately) and play the HP 147Re's sounds through the speakers on the connected equipment, or record your performances on a tape recorder or other recording device. If the input of the connected device is monaural, you must use the L/Mono jack.

### Input jacks

You can connect another sound source, such as audio equipment or an electronic instrument using audio cables (sold separately) and play the sounds of the connected device through the speakers on the HP 147Re. If the output of the connected device is monaural, connect it to the INPUT L/Mono jack.

### ■ Making the connections

- \* To prevent malfunction and/or damage to speakers or other devices, always turn down the volume, and turn off the power on all devices before making any connections.
- \* Always make sure to have the volume level turned down before switching on power. Even with the volume all the way down, you may still hear some sound when the power is switched on, but this is normal, and does not indicate a malfunction.

#### ○ Playing the HP 147Re's sounds through the speakers of external audio equipment, or recording your performances

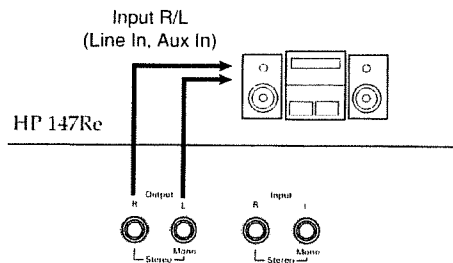

1. Turn the volume all the way down on the HP 147Re and on the device you're about to connect.

2. Turn off the power to the HP 147Re and other external equipment.
3. Use audio cables (sold separately) to make the connection.
4. Turn on the power of the HP 147Re.
5. Switch on the connected device.
6. Adjust the volume level on the HP 147Re and the connected device.

#### When recording HP 147Re performances on a recording device

7. Start recording with the connected device.
8. Play the keyboard.
9. When the performance ends, stop recording on the connected equipment.

#### ○ Connecting external signal sources/instruments to the HP 147Re

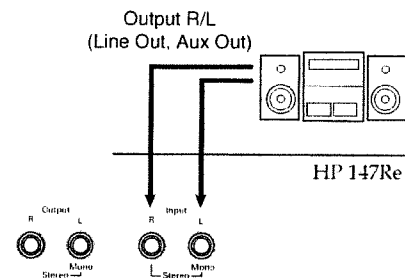

1. Turn the volume all the way down on the HP 147Re and on the device you're about to connect.
2. Turn off the power to the HP 147Re and other connected equipment.
3. Use audio cables (sold separately) to make the connection.
4. Turn on the power to the connected equipment.
5. Turn on the HP 147Re.
6. Adjust the volume level on the HP 147Re and the connected device.

#### ○ Turning the power off after use

After use, follow the steps below to switch off the power.

1. Turn the volume all the way down on the HP 147Re and on the connected device.
2. Turn off the power to the HP 147Re.
3. Turn off the connected equipment.

# Appendices

## Troubleshooting

If you encounter any problem with the HP 147Re, please read the section below before determining that it has malfunctioned.

### The piano cannot be switched on

- Is the power cord properly connected? (p. 7)

### No sound is produced

- Is the Volume knob set to the minimum position? (p. 8)
- Are headphones connected? (p. 8)  
When headphones are connected, the HP 147Re's speakers are switched off.
- Is Local On/Off set to "Off?" (p. 19)

### Two sounds are produced when the keyboard is played

- Have you selected Dual mode? (p. 12)

### The pitch of the notes sounds incorrect

- Is the Master Tuning setting correct? (p. 17)
- Is the Key Transpose setting correct? (p. 16)

### The pedals are not functioning, or function intermittently

- Are the pedals connected properly?  
Make sure the pedal cord is securely connected to the pedal jack on the back of the unit.

### ■ When using external sound devices No sound of external devices is produced

- Is the power to all equipment turned on?
- Is the volume of the external sound generator lowered?
- Are the MIDI connections between the HP 147Re and the external MIDI device correct? (p. 19)
- Is the MIDI channel setting correct? (p. 19)
- Is the Omni On/Off setting correct? (p. 20)

### ■ When using sequencers

#### The HP 147Re won't play

- Are the MIDI connections between the HP 147Re and the MIDI sequencer correct? (p. 19)
- Is the MIDI channel setting correct? (p. 19)
- Is the Omni On/Off setting correct? (p. 20)

#### Strange sounds (or two sounds) are produced when the HP 147Re is played

- With the sequencer's "Thru" function on, the same notes may be sounded twice. Set the HP 147Re to Local Off. (p. 19)

#### The volume level of the instrument connected to Input jack is too low.

- Could you be using a connection cable that contains a resistor?  
Use a connection cable that does not contain a resistor.

## Functions assigned to the keyboard

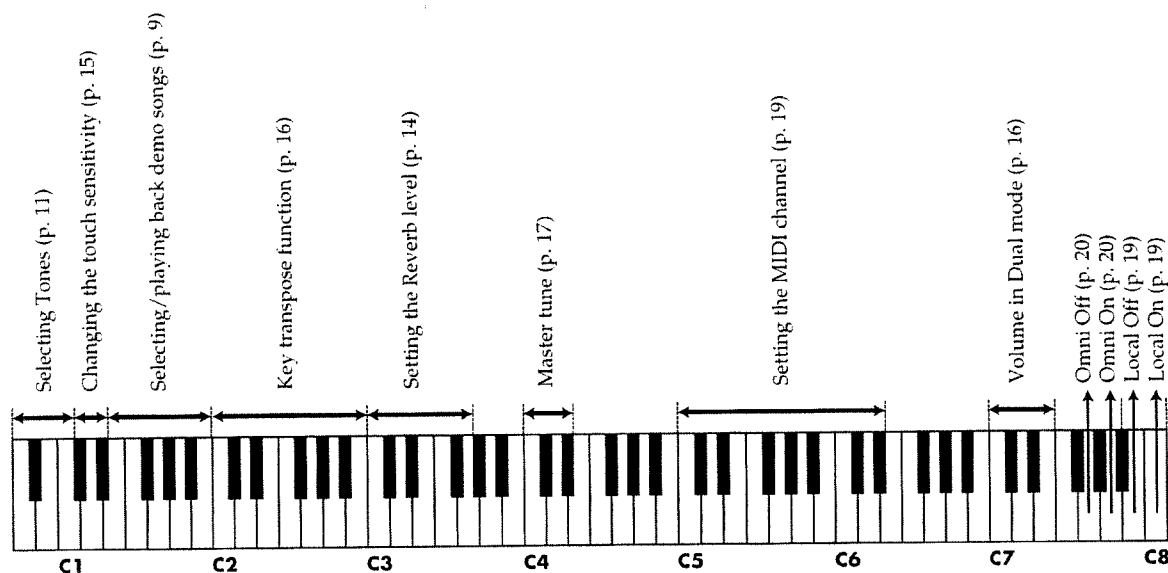



# Specifications

---

- **Keyboard**  
88 keys (Progressive hammer action mechanism)
- **Maximum Polyphony**  
64 voices
- **Tones**  
Piano, Electric Piano, Harpsichord, Pipe Organ, Strings
- **Effects**  
Reverb (8 levels)
- **Touch Control**  
Light, Medium or Heavy
- **Key Transposition**  
-6~+5 (semitone steps)
- **Master Tuning**  
415.3 Hz to 466.2 Hz (0.1 Hz steps)
- **Connectors**  
Output jacks (L/Mono, R)  
Input jacks (L/Mono, R)  
Headphones jack (stereo) x2  
MIDI connectors (In, Out)  
Pedal connector
- **Pedals**  
Damper, Sostenuto, Soft
- **Speakers**  
16cm x 2
- **Rated Power Output**  
20W x 2 RMS
- **Cabinet Finish**  
Simulated Rosewood
- **Power Supply**  
AC 117 V, AC 230 V, AC 240 V
- **Power Consumption**  
60W (117V), 45W (230/240V)
- **Dimensions (including the piano stand)**  
1,400 (W) x 477 (D) x 859 (H) mm
- **Weight (including the piano stand)**  
61,2kg
- **Accessories**  
Owner's Manual, power cord

\* In the interest of product improvement, the specifications and/or appearance of this unit are subject to change without prior notice.

## MIDI Implementation Chart

| Function...   | Transmitted                                  | Recognized  | Remarks   |
|---|--|---|---|
| Basic Channel<br>Default Changed  | 1<br>1—16                                    | 1<br>1—16   |   |
| Mode<br>Default Messages Altered  | Mode 1<br>x<br>*****                         | Mode 1<br>OMNI ON/OFF                               |   |
| Note Number :<br>True Voice   | 15—113<br>*****                              | 0—127<br>15—113                                     |   |
| Velocity<br>Note On<br>Note Off   | O<br>x 8n v = 64                             | O<br>x  |   |
| After Touch<br>Key's<br>Channel's   | x<br>x                                       | x<br>x  |   |
| Pitch Bend  | x  | x   |   |
| Control Change<br>6, 38<br>7<br>11<br>64<br>66<br>67<br>91<br>100, 101  | O<br>x<br>x<br>O<br>O<br>O<br>O<br>O         | O<br>O *1<br>O *1<br>O *1<br>O *1<br>O *1<br>O<br>O | Data entry<br>Volume<br>Expression<br>Hold 1<br>Sostenuto<br>Soft<br>Reverb<br>RPN LSB, MSB |
| Prog Change :<br>True Number  | O (0—36)<br>*****                            | O (0—127)<br>0—36                                   |   |
| System Exclusive  | O  | O   |   |
| System Common<br>: Song Position<br>: Song Select<br>: Tune Request   | x<br>x<br>x                                  | x<br>x<br>x   |   |
| System Real Time<br>: Clock<br>: Commands   | x<br>x                                       | x<br>x  |   |
| Aux Messages<br>: All Sound Off<br>: Reset All Controllers<br>: Local On/Off<br>: All Notes Off<br>: Active Sensing<br>: System Reset | x<br>x<br>x<br>x<br>O<br>x                   | x<br>O<br>O<br>O (123—127)<br>O<br>x                |   |
| Notes   | *1 These message can affect only MIDI notes. |   |   |

Mode 1 : OMNI ON, POLY  
Mode 3 : OMNI OFF, POLY

Mode 2 : OMNI ON, MONO  
Mode 4 : OMNI OFF, MONO

O : Yes  
X : No



**Roland®**

**K6018419**

UPC K6018419



10961

**Roland®**

602153434

HP 147 Re

RES 284-00

Printed in Italy by Alta Tecnografica S.r.l. - Grottole (AP)

00-12 - HP 147Re - O.M./E-D-F-It-SP-01