



GT-6

GUITAR EFFECTS PROCESSOR

Owner's Manual

Thank you, and congratulations on your choice of the BOSS GT-6 Guitar Effects Processor.

Before using this unit, carefully read the sections entitled:

- **USING THE UNIT SAFELY** (page 2–3)
- **IMPORTANT NOTES** (page 4)

These sections provide important information concerning the proper operation of the unit.

Additionally, in order to feel assured that you have gained a good grasp of every feature provided by your new unit, Owner's manual should be read in its entirety. The manual should be saved and kept on hand as a convenient reference.

■ Printing Conventions in This Manual

- Text or numerals enclosed in square brackets [] indicate buttons.

[WRITE] WRITE button

[UTILITY] UTILITY button

- Reference such as (p. **) indicate pages in this manual to which you can refer.

- * All product names mentioned in this document are trademarks or registered trademarks of their respective owners.



Copyright © 2001 BOSS CORPORATION

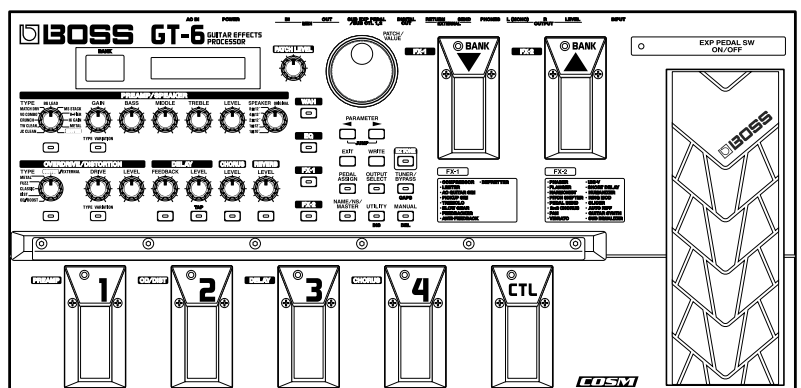

All rights reserved. No part of this publication may be reproduced in any form without the written permission of BOSS CORPORATION.









USING THE UNIT SAFELY

INSTRUCTIONS FOR THE PREVENTION OF FIRE, ELECTRIC SHOCK, OR INJURY TO PERSONS

About  WARNING and  CAUTION Notices

 WARNING	Used for instructions intended to alert the user to the risk of death or severe injury should the unit be used improperly.
 CAUTION	Used for instructions intended to alert the user to the risk of injury or material damage should the unit be used improperly. * Material damage refers to damage or other adverse effects caused with respect to the home and all its furnishings, as well to domestic animals or pets.

About the Symbols

	The  symbol alerts the user to important instructions or warnings. The specific meaning of the symbol is determined by the design contained within the triangle. In the case of the symbol at left, it is used for general cautions, warnings, or alerts to danger.
	The  symbol alerts the user to items that must never be carried out (are forbidden). The specific thing that must not be done is indicated by the design contained within the circle. In the case of the symbol at left, it means that the unit must never be disassembled.
	The  symbol alerts the user to things that must be carried out. The specific thing that must be done is indicated by the design contained within the circle. In the case of the symbol at left, it means that the power-cord plug must be unplugged from the outlet.



ALWAYS OBSERVE THE FOLLOWING

WARNING

- Before using this unit, make sure to read the instructions below, and the Owner's Manual. 



- Do not open (or modify in any way) the unit or its AC adaptor. 

- Do not attempt to repair the unit, or replace parts within it (except when this manual provides specific instructions directing you to do so). Refer all servicing to your retailer, the nearest Roland Service Center, or an authorized Roland distributor, as listed on the "Information" page. 

- Never use or store the unit in places that are:
 - Subject to temperature extremes (e.g., direct sunlight in an enclosed vehicle, near a heating duct, on top of heat-generating equipment); or are 
 - Damp (e.g., baths, washrooms, on wet floors); or are 
 - Humid; or are
 - Exposed to rain; or are
 - Dusty; or are
 - Subject to high levels of vibration.



- Make sure you always have the unit placed so it is level and sure to remain stable. Never place it on stands that could wobble, or on inclined surfaces. 

WARNING

- Be sure to use only the AC adaptor supplied with the unit. Also, make sure the line voltage at the installation matches the input voltage specified on the AC adaptor's body. Other AC adaptors may use a different polarity, or be designed for a different voltage, so their use could result in damage, malfunction, or electric shock. 

- Do not excessively twist or bend the power cord, nor place heavy objects on it. Doing so can damage the cord, producing severed elements and short circuits. Damaged cords are fire and shock hazards! 

- This unit, either alone or in combination with an amplifier and headphones or speakers, may be capable of producing sound levels that could cause permanent hearing loss. Do not operate for a long period of time at a high volume level, or at a level that is uncomfortable. If you experience any hearing loss or ringing in the ears, you should immediately stop using the unit, and consult an audiologist. 

- Do not allow any objects (e.g., flammable material, coins, pins); or liquids of any kind (water, soft drinks, etc.) to penetrate the unit. 

⚠ WARNING

- Immediately turn the power off, remove the AC adaptor from the outlet, and request servicing by your retailer, the nearest Roland Service Center, or an authorized Roland distributor, as listed on the “Information” page when:
 - The AC adaptor, the power-supply cord, or the plug has been damaged; or
 - Objects have fallen into, or liquid has been spilled onto the unit; or
 - The unit has been exposed to rain (or otherwise has become wet); or
 - The unit does not appear to operate normally or exhibits a marked change in performance.

- In households with small children, an adult should provide supervision until the child is capable of following all the rules essential for the safe operation of the unit.

- Protect the unit from strong impact. (Do not drop it!)

- Do not force the unit’s power-supply cord to share an outlet with an unreasonable number of other devices. Be especially careful when using extension cords—the total power used by all devices you have connected to the extension cord’s outlet must never exceed the power rating (watts/amperes) for the extension cord. Excessive loads can cause the insulation on the cord to heat up and eventually melt through.

- Before using the unit in a foreign country, consult with your retailer, the nearest Roland Service Center, or an authorized Roland distributor, as listed on the “Information” page.

⚠ CAUTION

- The unit and the AC adaptor should be located so their location or position does not interfere with their proper ventilation.

- Always grasp only the plug on the AC adaptor cord when plugging into, or unplugging from, an outlet or this unit.

- Whenever the unit is to remain unused for an extended period of time, disconnect the AC adaptor.

- Try to prevent cords and cables from becoming entangled. Also, all cords and cables should be placed so they are out of the reach of children.

- Never climb on top of, nor place heavy objects on the unit.

- Never handle the AC adaptor or its plugs with wet hands when plugging into, or unplugging from, an outlet or this unit.

- Before moving the unit, disconnect the AC adaptor and all cords coming from external devices.

- Before cleaning the unit, turn off the power and unplug the AC adaptor from the outlet (p. 12).

- Whenever you suspect the possibility of lightning in your area, disconnect the AC adaptor from the outlet.

IMPORTANT NOTES

In addition to the items listed under “USING THE UNIT SAFELY” on page 2–3, please read and observe the following:

Power Supply

- Do not use this unit on the same power circuit with any device that will generate line noise (such as an electric motor or variable lighting system).
- The AC adaptor will begin to generate heat after long hours of consecutive use. This is normal, and is not a cause for concern.
- Before connecting this unit to other devices, turn off the power to all units. This will help prevent malfunctions and/or damage to speakers or other devices.

Placement

- This device may interfere with radio and television reception. Do not use this device in the vicinity of such receivers.
- To avoid possible breakdown, do not use the unit in a wet area, such as an area exposed to rain or other moisture.

Maintenance

- For everyday cleaning wipe the unit with a soft, dry cloth or one that has been slightly dampened with water. To remove stubborn dirt, use a cloth impregnated with a mild, non-abrasive detergent. Afterwards, be sure to wipe the unit thoroughly with a soft, dry cloth.
- Never use benzine, thinners, alcohol or solvents of any kind, to avoid the possibility of discoloration and/or deformation.

Repairs and Data

- Please be aware that all data contained in the unit’s memory may be lost when the unit is sent for repairs. Important data should always be backed up in another MIDI device, or written down on paper (when possible). During repairs, due care is taken to avoid the loss of data. However, in certain cases (such as when circuitry related to memory itself is out of order), we regret that it may not be possible to restore the data, and Roland assumes no liability concerning such loss of data.

Memory Backup

- This unit contains a battery which powers the unit’s memory circuits while the main power is off. When this battery becomes weak, the message shown below will appear in the display. Once you see this message, have the battery replaced with a fresh one as soon as possible to avoid the loss of all data in memory. To have the battery replaced, consult with your retailer, the nearest Roland Service Center, or an authorized Roland distributor, as listed on the “Information” page.

Battery Low !

Additional Precautions

- Please be aware that the contents of memory can be irretrievably lost as a result of a malfunction, or the improper operation of the unit. To protect yourself against the risk of losing important data, we recommend that you periodically save a backup copy of important data you have stored in the unit’s memory in another MIDI device (e.g., a sequencer).
- Unfortunately, it may be impossible to restore the contents of data that was stored in another MIDI device (e.g., a sequencer) once it has been lost. Roland Corporation assumes no liability concerning such loss of data.
- Use a reasonable amount of care when using the unit’s buttons, sliders, or other controls; and when using its jacks and connectors. Rough handling can lead to malfunctions.
- Never strike or apply strong pressure to the display.
- When connecting / disconnecting all cables, grasp the connector itself—never pull on the cable. This way you will avoid causing shorts, or damage to the cable’s internal elements.
- To avoid disturbing your neighbors, try to keep the unit’s volume at reasonable levels. You may prefer to use headphones, so you do not need to be concerned about those around you (especially when it is late at night).
- When you need to transport the unit, package it in the box (including padding) that it came in, if possible. Otherwise, you will need to use equivalent packaging materials.
- Use only the specified expression pedal (EV-5, FV-300L; sold separately). By connecting any other expression pedals, you risk causing malfunction and/or damage to the unit.
- Use a cable from Roland to make the connection. If using some other make of connection cable, please note the following precautions.
 - Some connection cables contain resistors. Do not use cables that incorporate resistors for connecting to this unit. The use of such cables can cause the sound level to be extremely low, or impossible to hear. For information on cable specifications, contact the manufacturer of the cable.

Contents

USING THE UNIT SAFELY	2
IMPORTANT NOTES	4
Main Features	7
Names of Things and What They Do	8
Front Panel.....	8
Rear Panel.....	11
Chapter 1 Playing Sounds	12
Making the Connections.....	12
Turning on the Power.....	13
Adjusting the Output Level.....	13
Turning Off the Power.....	13
Making Settings for a Connected Device (Amp)	
(Output Select).....	14
What is a Patch?	15
How to Switch Patches (Patch Change)	15
Using the GT-6 to Select Patches.....	15
Switching Only the Number.....	15
Switching the Bank and Number.....	16
About the Display Indication	16
If the Patch Does Not Switch.....	16
Chapter 2	
Creating You Own Favorite Tones(Patches).....	17
Finding Tones Resembling	
Those You Have in Mind (EZ Tone).....	17
Adjusting the Tones with the Knobs	17
Adding Effects	18
Setting the Effect Tones (Quick Settings)	19
Making More Detail Settings	
with Individual Parameters	19
Using the Pedal Effects (Wah, Pedal Bend)	20
Wah.....	20
Pedal Bend.....	20
Naming Tones.....	21
Changing the Connection Order of Effects	
(Effect Chain)	21
Chapter 3	
Saving the Tones You Have Created	22
Write	22
Copying Patches	22
Exchanging Patches.....	23

Chapter 4 The Effects Explained	24
PREAMP/SPEAKER	
(Preamp/Speaker Simulator).....	24
OVERDRIVE/DISTORTION	27
DELAY.....	28
CHORUS.....	29
REVERB	29
WAH	30
WAH (Pedal Wah).....	30
AW (Auto Wah).....	31
FW (Fixed Wah).....	31
EQ (Equalizer).....	32
FX-1.....	32
CS (Compressor).....	33
LM (Limiter).....	33
AC (Acoustic Guitar Simulator).....	33
PIC (Pickup Simulator).....	33
TR (Tremolo).....	34
SG (Slow Gear).....	34
FB (Feedbacker).....	34
AFB (Anti-feedback).....	35
FRT (Defretter).....	35
FX-2.....	35
PH (Phaser).....	37
FL (Flanger).....	38
HR (Harmonist).....	38
PS (Pitch Shifter).....	39
PB (Pedal Bend).....	40
2CE (2x2 Chorus).....	40
PAN.....	40
VB (Vibrato).....	41
UV (Uni-V).....	41
SDD (short delay).....	41
HU (Humanizer).....	41
RM (Ring Modulator).....	42
SL (Slicer).....	42
AR (Auto Riff).....	42
SYN (Guitar Synth).....	43
SEQ (Sub Equalizer).....	45
NS (Noise Suppressor)	45
MASTER	46
FV (Foot Volume)	46

Chapter 5
Settings for Using the Expression and Control Pedals (Pedal Assign)..... 47

Settings for Using the Expression Pedal.....47
 Settings for Using the Expression Pedal Switch/CTL Pedal47
 Making Settings Instantly(Quick Setting)47
 Editing “Quick Settings”48
 Controlling Effects with the GT-6 Pedals, External Pedals, and External MIDI Devices.....49
 Controlling Wah and Pitch Bend with an External Expression Pedal52

Chapter 6
Using the Customize Function..... 53

Making “Custom” Preamp Settings53
 Making “Custom” Overdrive/Distortion Settings54
 Making “Custom” Pedal Wah Settings55

Chapter 7
Convenient Features of the GT-6 56

Quick Patch Volume Adjustment (PATCH LEVEL Knob)56
Turning the Effects On and Off with the Pedals (Manual Mode).....56
 Switching to Manual Mode.....56
 Selecting the Effect to Be Switched On and Off With the Pedals.....56
 Comparing Preamp Tones in Manual Mode.....57
Tuning the Guitar57
 Turning the Tuner/Bypass Function On57
 About the Display During Tuning.....57
 How to Tune.....58
 Changing the Tuner Settings58
 Switching Tuner/Bypass On and Off with the Number Pedals.....59
Adjusting the Overall Sound to Match the Usage Environment (Global)59
Using External Effect Processors.....60
Using the Digital Outs60
Checking the Effect Output Level with the Level Meter.....60

Chapter 8 Other Features 61

Adjusting the Display Contrast (LCD Contrast).....61
 Selecting the PATCH/VALUE Dial Function (Dial Function).....61
 Setting the Timing Used for Switching Patches (Patch Change Mode)61

Limiting the Banks That Can Be Switched (Bank Extent) 61
 Setting “Expression Pedal Hold” 62
 Setting the Knob Functions (Knob Mode) 62
 Setting the External Foot Switch Functions (SUB CTL 1, 2 Function)..... 63

Chapter 9 Using MIDI..... 64

What Can You Do with MIDI? 64
 Making the Settings for MIDI Functions..... 65
 Transmitting and Receiving MIDI Data..... 67
 Transmitting Data to an External MIDI Device (Bulk Dump) 67
 Receiving Data from an External MIDI Device (Bulk Load)..... 68
 Setting the Program Change Map..... 69
 Enabling/Disabling the Program Change Map Settings (MIDI Map Select) 69

Appendices..... 70

About MIDI..... 70
 How MIDI messages are transmitted and received 70
 Main types of MIDI message used by the GT-6..... 70
 About the MIDI implementation..... 71

Changing patches using bank select messages.....72
 Changing patch numbers on an external MIDI device from the GT-6..... 72
 Changing patch numbers on the GT-6 using the bank select messages sent from an external MIDI device 73

Factory Settings..... 74
 Restoring the Factory Settings (Factory Reset) 74

Troubleshooting..... 75
 Error Messages 76

MIDI Implementation Chart 77

Specifications..... 78

Index..... 80

Adjusting the Expression Pedal82

Main Features

Built-IN COSM Amp and COSM Overdrive/ Distortion for Maximum Distortion

The highly advanced combination of COSM amp with the COSM overdrive/distortion provides you with the most powerful distortion effects for your performances.

COSM Wah Included

This newly developed COSM wah, which features five different wah effects, including vintage wah, lets you perform with a wide variety of wah sounds.

Customize Function

Thanks to the GT-6's new Customize function, you can bring your own sensibilities into play and design totally new effects by tweaking the settings for the "Preamp," "Overdrive/Distortion," and "Wah" effects. The resulting creations can then be saved on the GT-6 as "Custom" settings.

EZ Tone

The GT-6 includes thirty major effect sounds used for creating new sounds. Now it's easy to select just the sounds you like.

Quick Settings

Each editing function contains preset recorded settings. Creating the effect sounds you want is simple—just select the preset settings for the function (effect) you are using.

Knob Controls for Intuitive Operation

The GT-6 is equipped with dedicated knob controls for the main internal effects. These allow you to make changes to the settings in real time as you play.

Professional Quality

The GT-6 comes with 37 different professional-quality effects, from studio reverb and delay, a newly developed defretter, uni-v, and more.

Expression Pedal/Expression Pedal Switch and Control Pedal

The unit features an expression pedal and control pedal that you can use for setting the functions in each patch. The functions that can be assigned to the expression pedal vary with each patch you select, allowing you to use it as a wah, volume, or other kind of pedal.

Furthermore, you can use the pedal as an "expression pedal switch" to control (turn on and off) the current effect by firmly pressing down at the front tip of the expression pedal.

Includes Digital Outs

The unit also includes digital out connectors (coaxial), convenient for digital recording.

COSM (Composite Object Sound Modeling)

Composite Object Sound Modeling (COSM) is Roland's innovative and powerful sound modeling technology. COSM analyzes the many factors that make up the original sound, such as the electrical and physical characteristics of the original, and then produces a digital model that can reproduce the same sound.

Names of Things and What They Do

Front Panel

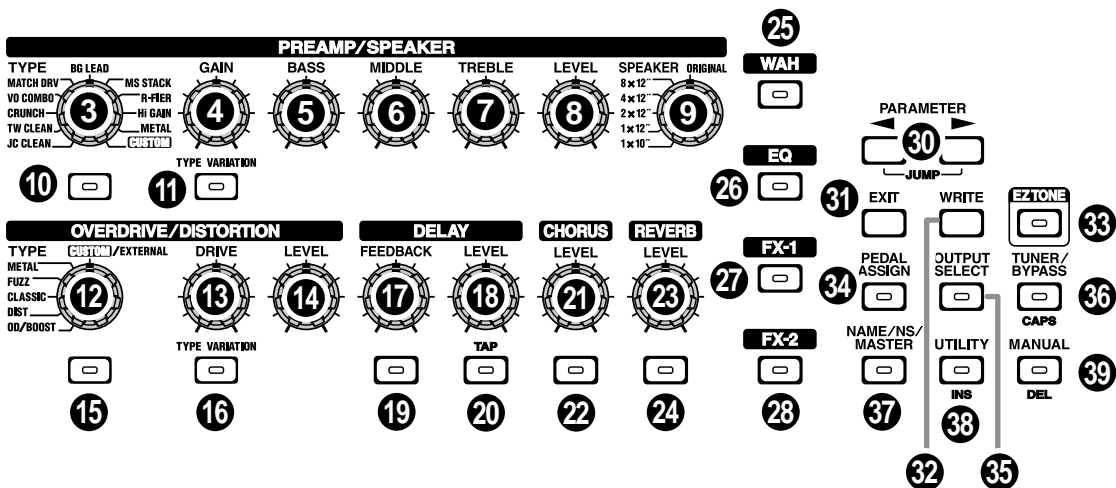
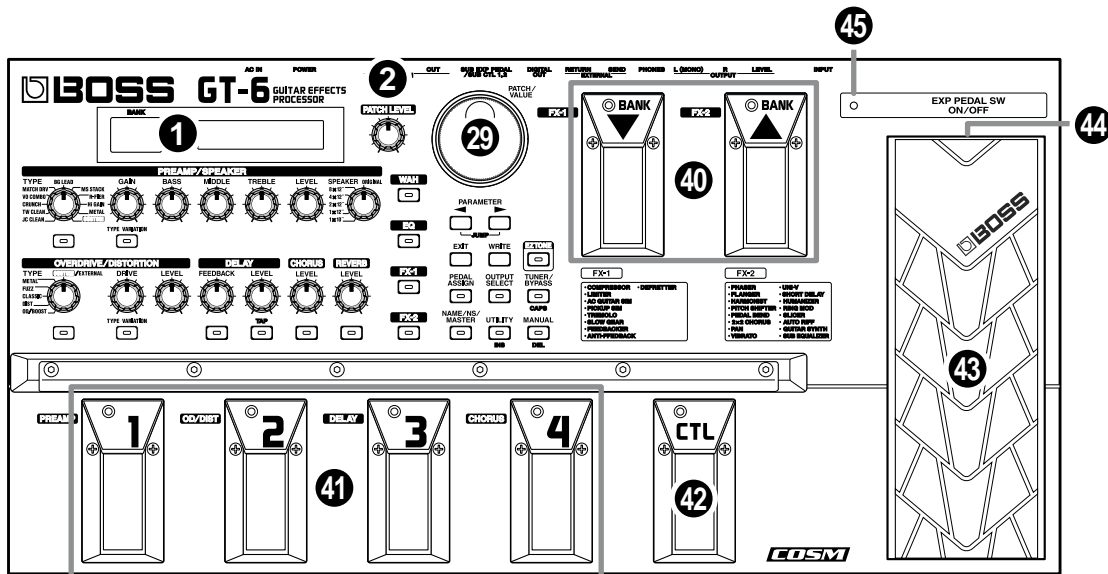

1 Display

A variety of information about the GT-6 appears here. The left display shows the bank number.

2 PATCH LEVEL Knob

Adjusts the volume level of the currently selected patch.

■ PREAMP/SPEAKER (p. 24) (PREAMP/SPEAKER SIMULATOR)

3 TYPE Knob

Selects the preamp type.

4 GAIN Knob

Adjusts the degree of preamp distortion.

5 BASS Knob

Adjusts the sound quality of the preamp's low-frequency range.

6 MIDDLE Knob

Adjusts the sound quality of the preamp's midrange.

7 TREBLE Knob

Adjusts the sound quality of the preamp's high-frequency range.

8 LEVEL Knob

Adjusts the preamp volume level.

9 SPEAKER Knob

Selects the speaker type.

10 PREAMP/SPEAKER ON/OFF Button

Press to change the setting.

11 TYPE VARIATION Button

Switches the type variation.

■ OVERDRIVE/DISTORTION (p. 27)

12 TYPE Knob

Selects the type of overdrive or distortion.

13 DRIVE Knob

Adjusts the degree of overdrive or distortion.

14 LEVEL Knob

Adjusts the overdrive/distortion volume level.

15 OVERDRIVE/DISTORTION ON/OFF Button

Press to change the settings.

16 TYPE VARIATION Button

Switches the type variation.

■ DELAY (p. 28)

17 FEEDBACK Knob

Adjusts the number of times the delay is repeated.

18 LEVEL Knob

Adjusts the volume level of the delay sound.

19 DELAY ON/OFF Button

Press to change the setting.

20 TAP Button

Use this when setting the delay time with the tap input.
(p. 28)

■ CHORUS (p. 29)

21 LEVEL Knob

Adjusts the volume level of the chorus sound.
The chorus sound increases as the knob is turned to the right (clockwise).

22 CHORUS ON/OFF Button

Press to change the setting.

■ REVERB (p. 29)

23 LEVEL Knob

Adjusts the volume level of the reverb sound.

24 REVERB ON/OFF Button

Press to change the setting.

■ WAH (p. 30)

25 WAH ON/OFF Button

Press to change the setting.

■ EQ (EQUALIZER) (p. 32)

26 EQ Button

Press when changing the settings.

■ FX-1 (p. 32)

27 FX-1 ON/OFF Button

Press to change the setting.

■ FX-2 (p. 35)

28 FX-2 ON/OFF Button

Press to change the setting.

Valid Settings:

29 PATCH/VALUE Dial

Use this when switching patches and changing the values of settings.

30 PARAMETER Buttons

Press to select parameters.

* *To jump to the main parameters, hold down one of these buttons while you press the other. With items for which there aren't that many parameters, the GT-6 jumps to the last (or initial) parameter.*

Names of Things and What They Do

31 EXIT Button

Use this to undo operations.

32 WRITE Button

Press to store settings.

33 EZ TONE Button

Used to search for tones.

34 PEDAL ASSIGN Button

Use this to make settings for the expression pedal and control pedal.

35 OUTPUT SELECT Button

Allows you to select an output appropriate for the connected device.

36 TUNER/BYPASS Button

Press to use the tuner and bypass functions.

37 NAME/NS/MASTER Button (p. 45, 46)

Use for naming patches (NAME), setting the noise suppressor (NS), and making the master settings (MASTER).

38 UTILITY Button

Use for making settings for the GT-6's overall operating environment.

39 MANUAL Button

Press to use the GT-6 in Manual mode.

40 BANK Pedals

These switch the bank number.

41 NUMBER Pedals

These switch the patch numbers.

42 CTL (CONTROL) Pedal

Any one of a number of different functions can be assigned to this pedal, then be controlled by it. For example, you could use it to switch the tuner on and off.

43 Expression Pedal

Controls volume, wah, and other parameters.



When you operate the expression pedal, please be careful not to get your fingers pinched between the movable part and the panel.

In households with small children, an adult should provide supervision until the child is capable of following all the rules essential for the safe operation of the unit.

44 EXP PEDAL SW (Expression Pedal Switch)

Firmly press down at the front of the pedal to switch the effect on and off.

45 EXP PEDAL SW ON/OFF Indicator (Expression Pedal Switch On/Off)

Lights when the effect being controlled with the Expression Pedal Switch is on, and goes out when the effect is turned off.

Rear Panel

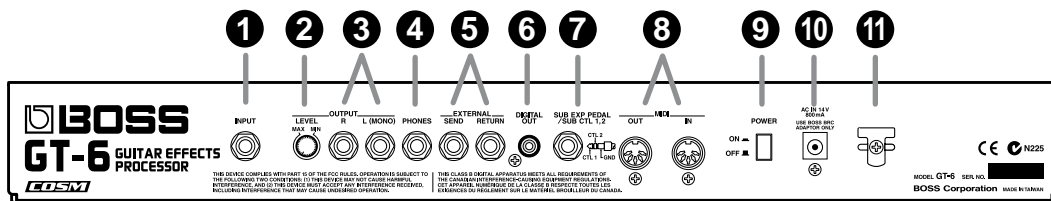

- 1 INPUT Jack**
The guitar is connected here.
- 2 OUTPUT LEVEL Knob**
Adjusts the volume level of the output from the output and headphone jacks.
- 3 OUTPUT R/L (MONO) Jacks**
Connect to your amp, mixer, or such device.
- 4 PHONES Jack**
Connect headphones here.
- 5 SEND/RETURN Jacks**
Connect these to external effects processors.
- 6 DIGITAL OUT Connector**
Outputs digital audio signals.
- 7 SUB EXP PEDAL/SUB CTL 1,2 Jack
(SUB EXP Pedal/SUB CONTROL Pedal)**
Connect an optional expression pedal (such as the EV-5) or foot switch (such as the FS-5U) here.
- 8 MIDI IN/OUT Connectors**
Connect an external MIDI device to these connectors to transmit and receive MIDI messages.
- 9 POWER Switch**
Turns the power on and off.
- 10 AC Adaptor Jack**
Connect the included AC adaptor (BRC series) here.
- 11 Cord Hook**
Hook the AC adaptor cord here to prevent the adaptor plug from being disconnected.

Chapter 1 Playing Sounds

Making the Connections

- * To prevent malfunction and/or damage to speakers or other devices, always turn down the volume, and turn off the power on all devices before making any connections.
- * Raise the amp volume only after turning on the power to all connected devices.
- * When outputting in mono, connect the cable to the OUTPUT L (MONO) jack.

Output Select (p. 14) :

JC-120, SMALL AMP, COMBO AMP, STACK AMP

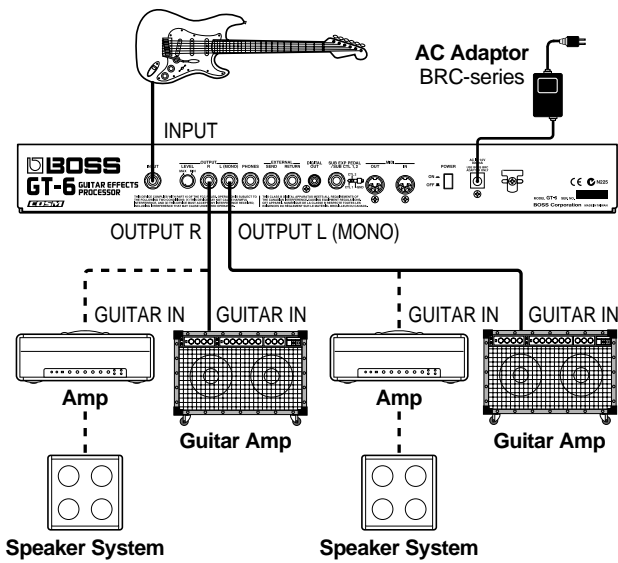

Output Select (p. 14) :

COMBO RETURN, STACK RETURN

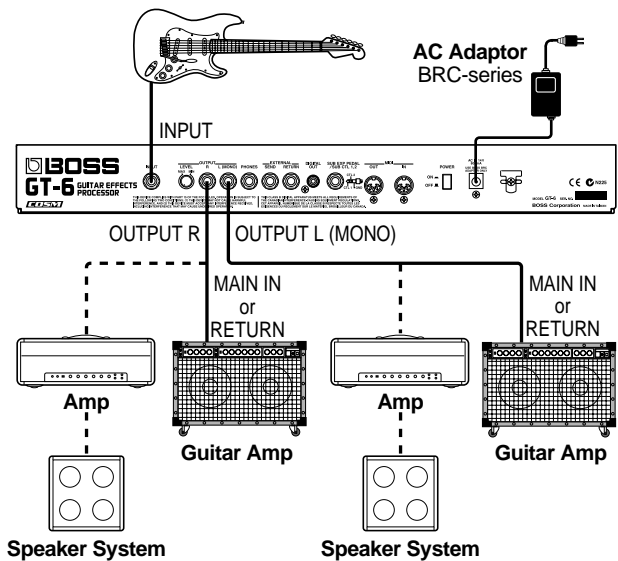

Output Select (p. 14): LINE/PHONES, LINE (PA)

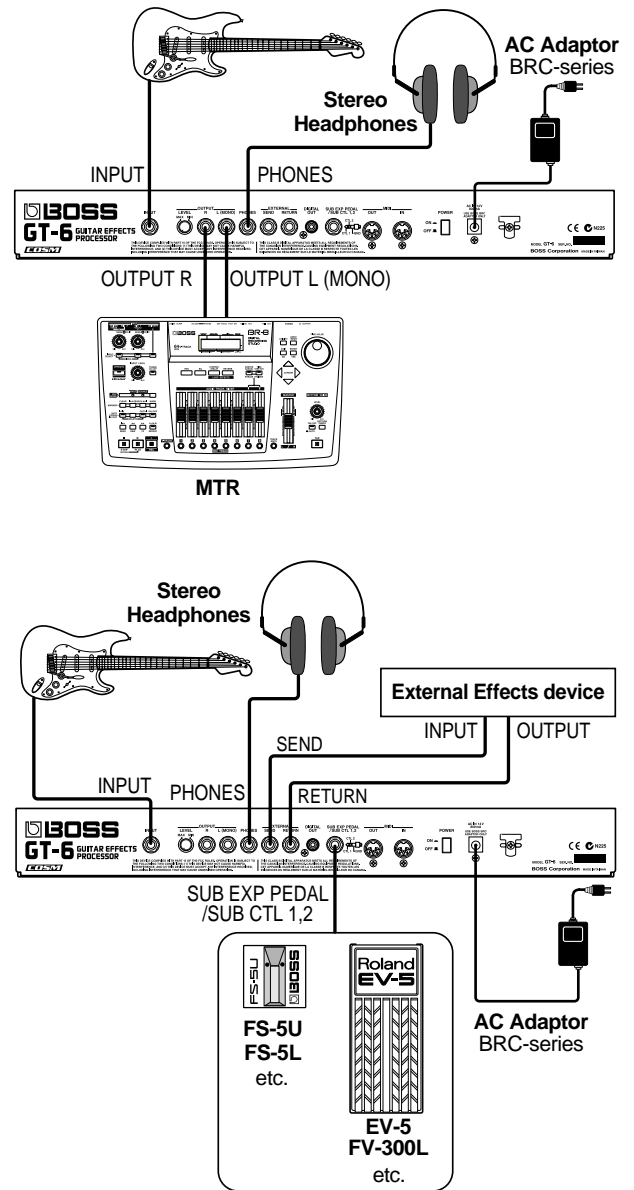

- * Use only the specified expression pedal (Roland EV-5 or Roland FV-300L and PCS-33; sold separately). By connecting any other expression pedals, you risk causing malfunction and/or damage to the unit.

- * To prevent the inadvertent disruption of power to your unit (should the plug be pulled out accidentally), and to avoid applying undue stress to the AC adaptor jack, anchor the power cord using the cord hook, as shown in the illustration.

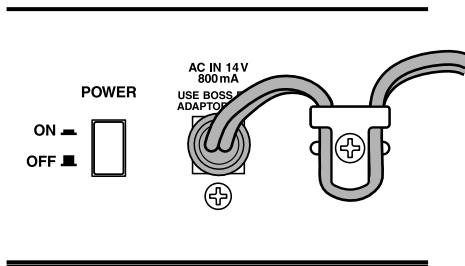

- * When using the unit with an expression pedal connected to the SUB EXP PEDAL/SUB CTL 1,2 jack, set Minimum Volume to the "MIN" position.
- * When using the unit with a foot switch (the optional FS-5U) connected to the SUB EXP PEDAL/SUB CTL 1,2 jack, set the polarity switch as shown below.

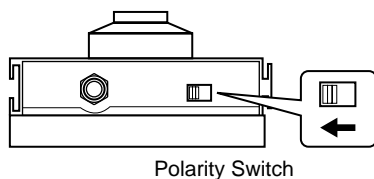

- * You can use the special (optional Roland) PCS-31 connector cord to connect two foot switches.

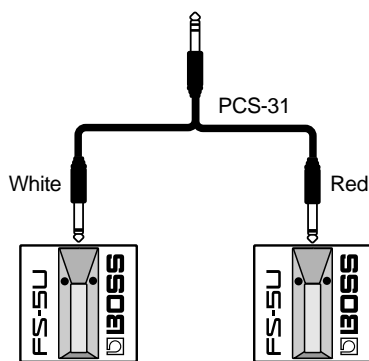

When using the unit with a foot switch (the optional FS-5U) connected to the SUB EXP PEDAL/SUB CTL 1,2 jack, make the settings given on p. 63.

Turning on the Power

Once the connections have been completed, turn on power to your various devices in the order specified. By turning on devices in the wrong order, you risk causing malfunction and/or damage to speakers and other devices.

1. **Before turning on the power, confirm the following.**
 - Are all external devices properly connected?
 - Is the volume on the GT-6, your amp, and all other connected devices turned down to the minimum level?
2. **Switch ON the POWER switch on the GT-6's rear panel.** The display changes, showing the following. A few seconds later, the unit enters the ordinary performance mode. The screen that appears at that point is called the "Play screen."



- * Upon power-up, the patch most recently selected when the power was last turned off is selected.
- * This unit is equipped with a protection circuit. A brief interval (a few seconds) after power up is required before the unit will operate normally.

3. Next, turn on the power to any external effects processors, then to the guitar amp (power amp).

Adjusting the Output Level

Adjust the GT-6's output level with the OUTPUT LEVEL knob on the rear panel.

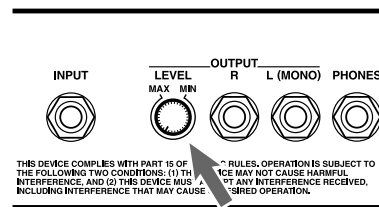

Turning Off the Power

1. **Before turning off the power, confirm the following.**
 - Is the volume on the GT-6, your amp, and all other connected devices turned down to the minimum level?
2. **Turn off the power to any external effects processors, then to the guitar amp (power amp) and other devices.**
3. **Turn the GT-6's power off.**

Making Settings for a Connected Device (Amp) (Output Select)

Select the type of device connected to the OUTPUT jack.

To derive the maximum performance from the GT-6, be sure to make the correct setting for OUTPUT SELECT, the one that's most suitable for your setup.

■ Procedure

1. Press [OUTPUT SELECT], causing the indicator to light.

The Output Select settings screen appears.



Output Select
COMBO AMP

2. Turn the PATCH/VALUE dial to select the type of device connected to the OUTPUT jack.

* When connecting to the input on a guitar amp, set the guitar amp's tone controls so BASS is at 0, MIDDLE (midrange) is at 10, and TREBLE is at 0. If the amp has switchable channels, select the normal (clean) channel.

JC-120:

Use this setting when connecting to Roland's JC-120 guitar amp.

SMALL AMP:

Use this setting when connecting to small guitar amp.

COMBO AMP:

Use this setting when connecting to the guitar input of a combo amp other than the JC-120 guitar amp (where the amp and speaker or speakers are combined in a single unit).

* Depending on your guitar amp, you may be able to obtain good results with the "JC-120" setting.

STACK AMP:

Use this setting when connecting to the guitar input of a stack-type guitar amp (where the amp and speaker or speakers are separated).

COMBO RETURN:

Use this setting when connecting to RETURN with a combo amp.

STACK RETURN:

Use this setting when connecting to RETURN with a stack amp.

LINE/PHONES:

Use this setting when using headphones or when connecting to a multi-track recorder for recording.

LINE (PA):

Use this setting when connecting to a mixer or other PA device.

Guitar Tuning

You can use the GT-6's built-in "tuner function" to tune your guitar.

For instructions on using this function, refer to "Tuning the Guitar" (p. 57).

What is a Patch?

The GT-6 can store 340 combinations (or “sets”) of effects and parameter settings. Each of these sets is called a “patch,” with patches organized by bank and number as shown below.

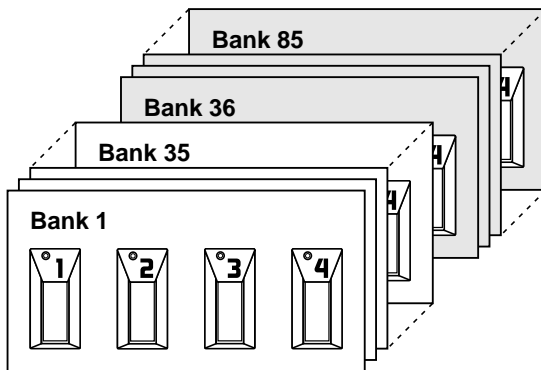

User Banks (1–35)

Newly created effects settings are saved in the User banks. Patches in these banks are called “User patches.”

* A “U” appears in the right display when a User patch is being used.

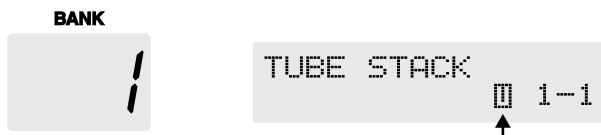

Preset Banks (36–85)

The Preset banks contain effect settings that really help bring out the special characteristics of the GT-6. The patches in these banks are called “Preset patches.” Although you cannot overwrite the Preset patches with your own settings, you can change (edit) a Preset patch’s settings, then save the result as a User patch.

* A “P” appears in the right display when a Preset patch is being used.



How to Switch Patches (Patch Change)

Using the GT-6 to Select Patches

Patches are switched by selecting a “bank” (1-85) and “number” (1-4).

The bank and number appear in the GT-6’s display as shown in the following figure.

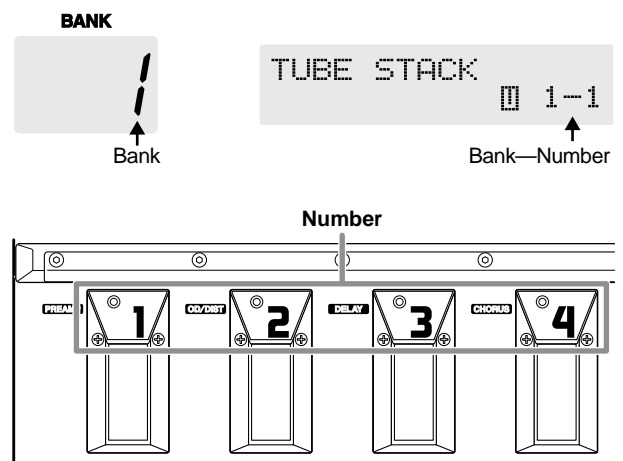

- * When selecting a patch, even if a new bank is selected, the patch is not switched until you also choose the number. If you want to be able to switch patches merely by selecting a different bank, carry out the Patch Change mode (p. 61) setting. You can also switch patches with the PATCH/VALUE dial.
- * Delay and reverb sounds are cut off when patches are switched.

Switching Only the Number

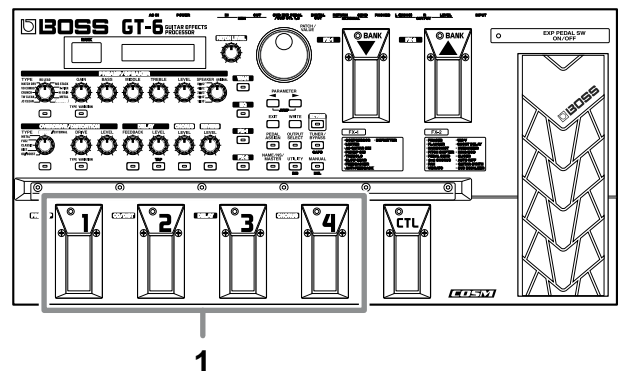

1. Select the number of the patch you want to switch to by pressing the corresponding number pedal. The indicator for the pressed number pedal lights up, and the GT-6 switches to that patch.

Switching the Bank and Number

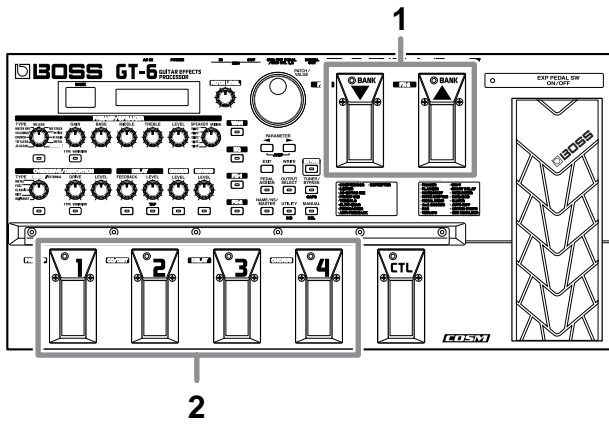

1. Press a BANK pedal.

The bank switches, then the indicator for the numbered pedal that was active before the BANK pedal was pressed starts flashing, indicating that the GT-6 is ready for specification of the patch number (at this stage, however, the patch is not switched yet).

2. Select the number of the patch you want to switch to by pressing the corresponding number pedal.

The indicator for the selected number pedal lights up, and the GT-6 switches to that patch.

About the Display Indication

The following information appears in the Play screen.

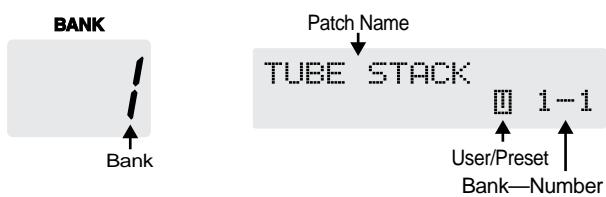

If the Patch Does Not Switch

On the GT-6, you cannot switch patches in any screen other than the Play screen. Press [EXIT] to return to the Play screen (p. 13).

Chapter 2 Creating Your Own Favorite Tones (Patches)

Finding Tones Resembling Those You Have in Mind (EZ Tone)

In addition to tones (patches) that you can actually use in performances, the GT-6 also features internal sample settings that are very useful when you want to create such tones on your own. This feature is called “EZ Tone.” Using the EZ Tone function lets you find tone settings similar to the ones you want to create.

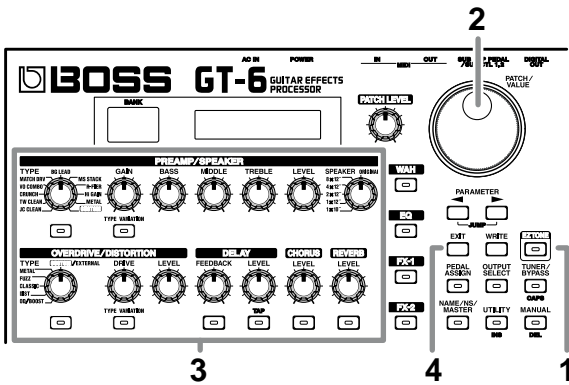

1. Press [EZ TONE].
2. Rotate the VALUE dial to select the settings resembling those for the tone you want.
3. Press the ON/OFF buttons to turn effects on and off; turn the knobs to adjust the tone.

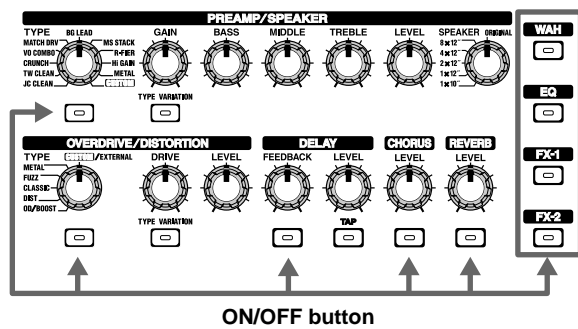

- * You can press [EZ TONE] again to compare the tone in use before entering EZ Tone mode with the present tone.
4. Press [EXIT] to return to the Play screen.
The tone switches to the tone selected in EZ Tone.
- * Pressing [EXIT] while the readout is flashing (when the tone prior to switching to EZ Tone mode is selected) returns you to the patch that was selected before going into EZ Tone mode.
 - * If you want to save a tone you've created, use the Write procedure (p. 22) to save it to a User patch.

Adjusting the Tones with the Knobs

The GT-6 panel features fifteen knob controls. These knobs let you make minor adjustments or changes to the selected patch's tone quickly and easily.

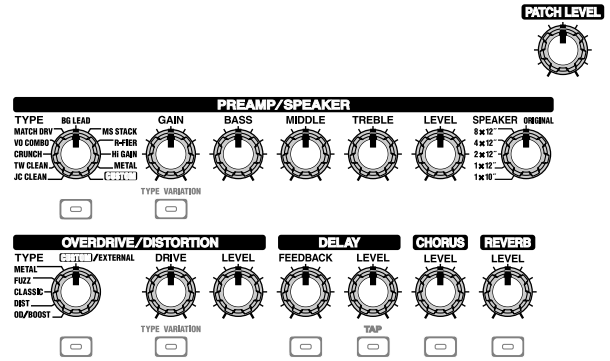

PREAMP TYPE:

Selects the preamp type.

- * After pressing [TYPE VARIATION], you can select variations by turning the knob to the type you want.

PREAMP GAIN:

Adjusts the degree of preamp distortion. The distortion gets stronger as the knob is turned to the right.

PREAMP BASS:

Adjusts the sound quality of the preamp's low-frequency range. The low frequencies are boosted as the knob is turned to the right.

PREAMP MIDDLE:

Adjusts the sound quality of the preamp's midrange. The midrange frequencies are boosted as the knob is turned to the right.

PREAMP TREBLE:

Adjusts the sound quality of the preamp's high-frequency range. The high frequencies are boosted as the knob is turned to the right.

PREAMP LEVEL:

Adjusts the preamp volume level. The volume increases as the knob is turned to the right.

SPEAKER:

Selects the speaker type. When ORIGINAL is selected, you can select the speakers that are best suited for the PREAMP TYPE settings.

OVERDRIVE/DISTORTION TYPE:

Selects the type of overdrive or distortion.

* After pressing [TYPE VARIATION], you can select variations by turning the knob to the type you want.

OVERDRIVE/DISTORTION DRIVE:

Adjusts the degree of overdrive or distortion. The distortion appears stronger as the knob is turned to the right.

OVERDRIVE/DISTORTION LEVEL:

Adjusts the overdrive/distortion volume level. The volume increases as the knob is turned to the right.

DELAY FEEDBACK:

Adjusts the number of times the delay is repeated. The number of repeats increases as the knob is turned to the right.

DELAY LEVEL:

Adjusts the volume level of the delay sound. The delay sound increases as the knob is turned to the right.

CHORUS LEVEL:

Adjusts the volume level of the chorus sound. The chorus sound increases as the knob is turned to the right.

REVERB LEVEL:

Adjusts the volume level of the reverb sound. The reverb sound increases as the knob is turned to the right.

PATCH LEVEL:

Adjusts the overall volume level. The volume increases as the knob is turned to the right.

When you want to save a tone created with EZ Tone, or changed with the knob controls, use the Write procedure (p. 22) to save the tone to a User patch.

Adding Effects

The GT-6's internal effects are switched on and off with button controls. The indicator for an effect's ON/OFF button lights up when the effect is enabled.

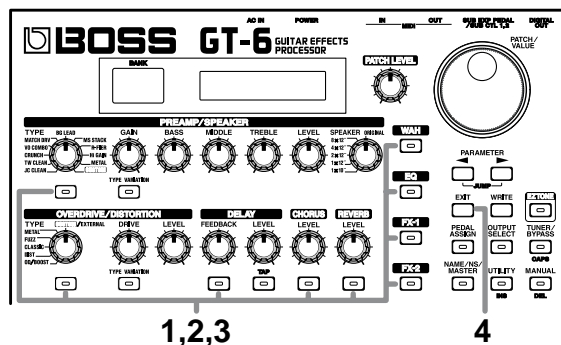

1. Press the ON/OFF button for the effect you want to be able to switch on and off.

The settings for the selected effect appear in the display.

```

Ovrdrive/Dst  On
Type          Turbo OD
    
```

2. Press the ON/OFF button again to switch the effect on or off.
 - * The effect name flashes in the display when that effect is disabled.
 - * When FX-1, FX-2, or WAH is selected in Step 1, the effect set with the FX Select parameter ("Making More Detail Settings with Individual Parameters," see p. 19) is switched on and off.
3. To select another effect to be switched on and off, repeat Steps 1 and 2.
4. Press [EXIT] to return to the Play screen.
 - * If you want to save a tone with the settings you've made, use the Write procedure (p.22) to save the tone to a User patch.

Setting the Effect Tones (Quick Settings)

Each effect includes prepared sample settings called “Quick Settings.” You can easily create new effect sounds just by selecting and combining these Quick Settings.

1. Press the on/off button for the effect with the settings you want to change.

The parameters for the selected effect appear in the display.

* During editing, the most recently edited parameter appears.

2. Press PARAMETER [◀] [▶] to select the Quick Settings parameter.



3. Rotate the VALUE dial to select the effect setting you want.

* “P00: User” indicates that the effect indicated in the upper row of the display is set to be saved to the currently selected patch, or that the settings are currently being modified.

* When FX-1, FX-2, or WAH has been selected in Step 1, the settings for the effect selected by means of the FX Select parameter (refer to the following item) are switched.

Making More Detail Settings with Individual Parameters

Each effect comprises several different kinds of parameters. You can more precisely create the sounds you want by editing each of these parameters individually.

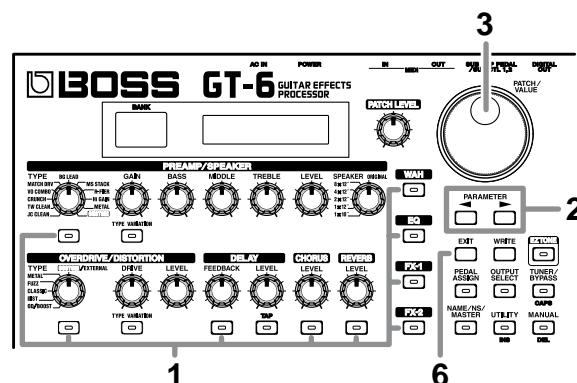

1. Press the on/off button for the effect with the settings you want to change.

The parameters for the selected effect appear in the display.

2. Press PARAMETER [◀] [▶] to select the parameter whose settings are to be changed.

When more than one parameter is shown in the display, press PARAMETER [◀] [▶] to move the cursor to the parameter to be set.

MEMO

You can jump to the core parameters by pressing PARAMETER [◀] (or [▶]) while holding down PARAMETER [▶] (or [◀]). With items for which there aren't that many parameters, the GT-6 jumps to the last (or first) parameter.

3. Rotate the VALUE dial to change the value of a setting.
4. Repeat Steps 2 and 3 for any other parameter settings you want to change.
5. If you further want to change parameter settings in any other effects, repeat Steps 1 through 4.
6. Press [EXIT] to return to the Play screen.

* If you want to save a tone with the settings you've made, use the Write procedure (p. 22) to save the tone to a User patch.

Using the Pedal Effects (Wah, Pedal Bend)

You can use the GT-6's expression pedal to obtain wah and pedal bend (pedal-controlled pitch bend) effects.

Wah

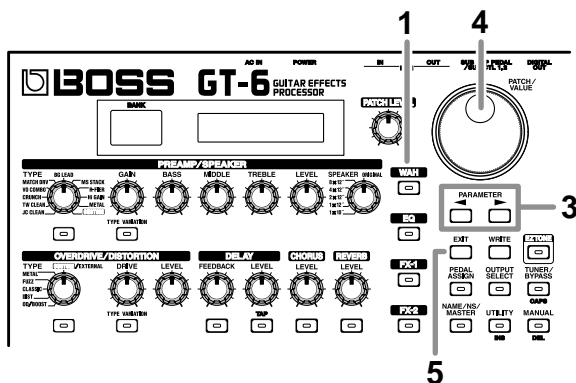

1. Press [WAH].
2. Turn on the wah effect (“Adding Effects”; p. 18).
 - * This step is not required if the effect is already on.
3. Press PARAMETER [◀] [▶] to select the FX Select parameter.
4. Rotate the VALUE dial to change the value (setting) to “WAH.”

You can now get a pitch wah effect by moving the expression pedal.

* By assigning the WAH ON/OFF function to the expression pedal switch, you can switch the wah effect on and off by firmly pressing down on the pedal's toe.

5. Press [EXIT] to return to the Play screen.
 - * If you want to save a tone with the settings you've made, use the Write procedure (p. 22) to save the tone to a User patch.

Pedal Bend

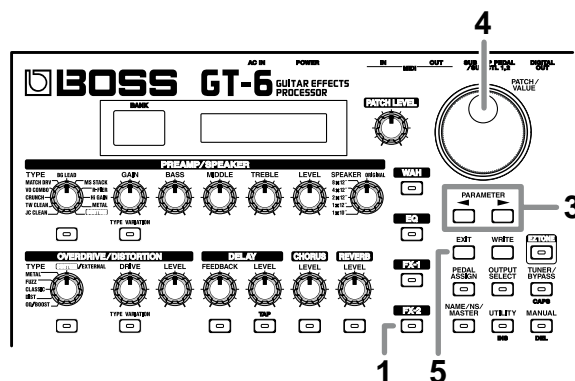

1. Press [FX-2].
2. Turn on the FX-2 effect (“Adding Effects”; p. 18).
 - * This step is not required if the effect is already on.
3. Press PARAMETER [◀] [▶] to select the FX Select parameter.
4. Rotate the VALUE dial to change the value (setting) to “PB.”

You can now get a pitch bend effect by moving the expression pedal.

* By assigning the PB ON/OFF function to the expression pedal switch, you can switch the Pedal Bend effect on and off by firmly pressing down on the pedal's toe.

Naming Tones

Each patch can be given a name (Patch Name) consisting of up to sixteen characters. You'll probably want to take advantage of this feature by assigning names that suggest the sound you'll obtain, or the song in which it'll be used.

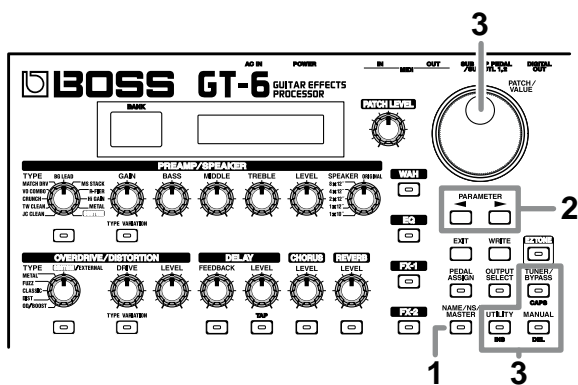

1. Press [NAME/NS/MASTER] so that the Name edit screen appears in the display.

* With each press of [NAME/NS/MASTER], you move to the next item that can be set, in this order:
 NAME → NOISE SUPPRESSOR → MASTER →
 FOOT VOLUME → EFFECT CHAIN.

2. Press PARAMETER [◀] [▶] to move the cursor to the text area you want to edit.
3. Rotate the VALUE dial to change the characters.

* You can use the following functions when changing text characters.

- CAPS:** Switches the character at the cursor position between upper and lower case.
- INS:** Inserts a blank space at the cursor position.
- DEL:** Deletes the character at the cursor position and shifts the characters following it to the left.

4. If you want to edit names further, repeat Steps 2 and 3.
5. If you want to save the sequence you've set up, use the Write procedure (p. 22) to save it to a User patch.
 Press [EXIT] to return to the Play screen.

Changing the Connection Order of Effects (Effect Chain)

Here's how you can change the order in which the effects are connected.

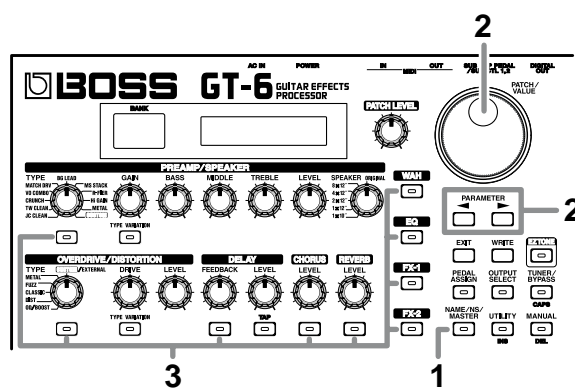

1. Press [NAME/NS/MASTER] until "Effect Chain" appears in the display.

* With each press of [NAME/NS/MASTER], you move to the next item that can be set, in this order:
 NAME → NOISE SUPPRESSOR → MASTER →
 FOOT VOLUME → EFFECT CHAIN.

- * Effects are shown in lowercase letters when turned off.
2. Use the VALUE dial or PARAMETER [◀] [▶] to move the cursor to the point where you want to have an effect inserted.
 3. Press the ON/OFF button for the effect you want to insert.
 The selected effect is inserted at the cursor position.
 * Use [PEDAL ASSIGN] to assign Foot Volume.
 4. If you want to change the sequence further, repeat Steps 2 and 3.
 5. If you want to save the sequence you've set up, use the Write procedure (p. 22) to save it to a User patch.
 Press [EXIT] to return to the Play screen.



Effects can be switched on and off even while making the settings for the connection order. With effects appearing to the left and right of the cursor, the ON/OFF button corresponding to the effect can be pressed to turn them on/off.

Chapter 3 Saving the Tones You Have Created

Write

When you want to save a tone created with EZ Tone, or a tone to which changes have been made, use the **Write** procedure to save the tone to a User patch.

- * If the power is turned off, or if the tone is switched (Patch Change; p. 15) before you've carried out the Write procedure, the newly created tone will be discarded.

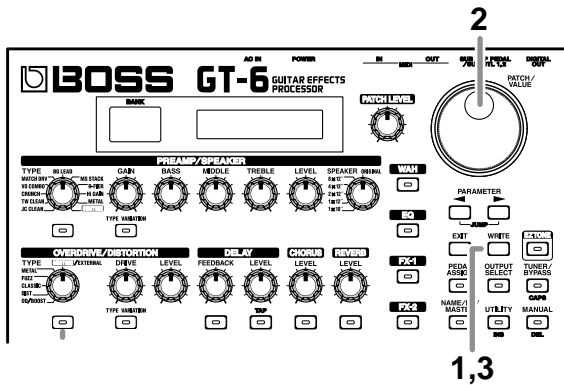

1. Press [WRITE].

The content of the display changes, and the GT-6 is ready for the save-destination User patch to be specified.

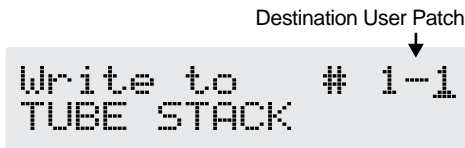

2. Rotate the VALUE dial to select the save-destination User patch.

- * This step is unnecessary if the current User patch is acceptable.
- * To cancel the Write procedure, press [EXIT]. The Play screen returns to the display.
- * You can also use the procedure described in "How to Switch Patches" (p. 15) to select the save destination.

3. Press [WRITE].

The GT-6 switches to the write-destination patch, and you're returned to the Play screen.

- * The sound of the patch previously stored at the write destination will be lost once the write is executed.

Copying Patches

You can copy a Preset or User patch to another User patch.

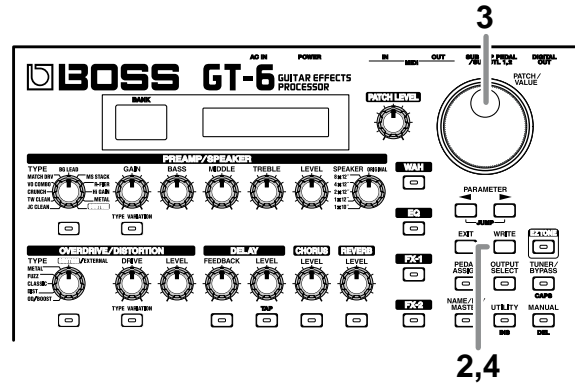

1. Select the copy-source patch (refer to "How to Switch Patches"; p. 15).
2. Press [WRITE].

The content of the display changes, and the GT-6 is ready for the copy-destination User patch to be specified.



3. Rotate the VALUE dial to select the copy-destination User patch.

- * To cancel the copy, press [EXIT]. The Play screen returns to the display.
- * You can also use the procedure described in "How to Switch Patches" (p. 15) to select the copy destination.

4. Press [WRITE].

The GT-6 switches to the copy-destination patch, and you're returned to the Play screen.

- * The sound of the patch previously stored at the copy destination will be lost once the copy is executed.

Exchanging Patches

On the GT-6, you can “swap” or exchange the positions of two User patches. The following explains how this is done.

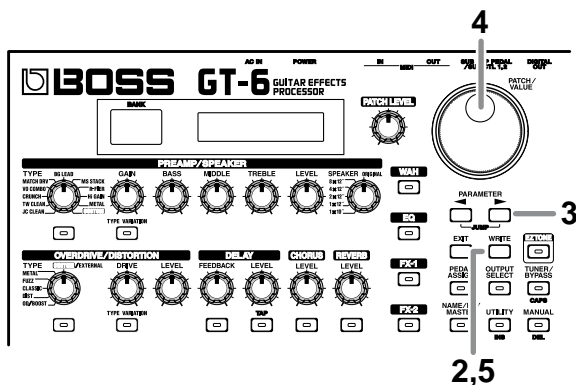

1. Select the exchange source patch (refer to “How to Switch Patches”; p. 15).

2. Press [WRITE].

3. Press PARAMETER [▶].

The content of the display changes, and the GT-6 is ready for the exchange destination User patch to be specified.



4. Rotate the VALUE dial to select the exchange destination User patch.

* To cancel the exchange, press [EXIT]. The Play screen returns to the display.

* You can also use the procedure described in “How to Switch Patches” (p. 15) to select the exchange destination.

5. Press [WRITE].

The patch stored in the exchange source memory location and the patch stored in the exchange destination memory location are exchanged, and you’re returned to the Play screen.

Chapter 4 The Effects Explained

In this chapter you will find detailed descriptions for each of the GT-6's onboard effects, and the parameters used to control them.

MEMO

The sound being input to each effect is called the “**direct sound**,” and the sound modified by the effect is called the “**effect sound**.”

The trademarks listed in this document are trademarks of their respective owners, which are separate companies from BOSS. Those companies are not affiliated with BOSS and have not licensed or authorized BOSS's GT-6. Their marks are used solely to identify the equipment whose sound is simulated by BOSS's GT-6.

PREAMP/SPEAKER (Preamp/Speaker Simulator)

COSM technology plays an indispensable role in simulating the distinguishing characteristics of various guitar amps in the “Preamp” section, and is also used to simulate various speaker sizes and cabinet constructions in the “Speaker Simulator.”

Parameter	Value
On/Off	Off, On
Type	refer to p. 25
Gain	0–100
Bass	0–100
Middle	0–100
Treble	0–100
Presence	0–100 (0– -100)
Level	0–100
Bright	Off, On
Gain SW	Low, Middle, High
Speaker SW	Off, On
Speaker Type	1x10”, 1x12”, 2x12”, 4x12”, 8x12”, ORIGINAL
Mic Setting (*)	Center, 1 cm–10 cm
Mic Level (*)	0–100
Direct Level (*)	0–100

(*) Displayed when OUTPUT SELECT is set to “LINE/PHONES” or “LINE (PA).”

TYPE

This sets the type of the guitar preamp.

	[TYPE VARIATION]		
	Extinguished	Illuminated: red	Illuminated: green
JC CLEAN	JC-120	Jazz Combo	Full Range
	This is the sound of the Roland JC-120.	This is a sound suited to jazz.	This is a sound with flat response.
TW CLEAN	Clean TWIN	Pro Crunch	Tweed
	This models a Fender Twin Reverb.	This models a Fender Pro Reverb.	This models a Fender Bassman 4 x 10" Combo.
CRUNCH	Crunch	Blues	Stack Crunch
	This is a crunch sound that can produce natural distortion.	This is a sound suited to blues.	This is a crunch sound with high gain.
VO COMBO	VO Drive	VO Lead	VO Clean
	This models the drive sound of a VOX AC-30TB.	This models the lead sound of the VOX AC-30TB.	This models the clean sound of a VOX AC-30TB.
MATCH DRV	MATCH Drive	MATCH Lead	Fat MATCH
	This models the sound input to left input on a Matchless D/C-30.	This models the sound input to right input on a Matchless D/C-30.	This models the sound of a MATCHLESS with a modified high gain.
BG LEAD	BG Lead	BG Drive	BG Rhythm
	This models the lead sound of the MESA/Boogie combo amp.	This models a MESA/Boogie with TREBLE SHIFT SW on.	This models the rhythm channel of a MESA/Boogie.
MS STACK	MS1959(I)	MS1959(I+II)	MS HiGain
	This models the sound input to Input I on a Marshall 1959.	This models the sound of a Marshall 1959 with Inputs I and II connected in parallel.	This models the sound of a Marshall with a modified midrange boost.
R-FIER	R-Fier Red	R-FierOrang	R-FierVint
	This models the lead channel of a MESA/Boogie Dual Rectifier.	This models the rhythm channel of a MESA/Boogie Dual Rectifier.	This models a MESA/Boogie Rectifier with VINTAGE SW on.
Hi GAIN	SLDN	Drive Stack	Lead Stack
	This models a Soldano SLO-100.	This is a drive sound with high gain.	This is a lead sound with high gain.
METAL	5150 Drive	Metal Stack	Metal Lead
	This models the lead channel of a Peavey EVH 5150.	This is a drive sound suited to metal.	This is a lead sound suited to metal.
CUSTOM	Custom1	Custom2	Custom3
	Custom amp 1	Custom amp 2	Custom amp 3

When CUSTOM is selected for TYPE

You can set the following parameters when TYPE is set to CUSTOM.



Making "Custom" Preamp Settings (p. 53)

Parameter	Value
Custom Type (1–3)	JC Clean, TW Clean, Crunch, VO Lead, BG Lead, MS1959 Stk, MODERN Stk
Custom Bottom (1–3)	-50→+50
Custom Edge (1–3)	-50→+50
Custom Bass Freq (1–3)	-50→+50
Custom Treble Freq (1–3)	-50→+50
Custom Preamp Low (1–3)	-50→+50
Custom Preamp High (1–3)	-50→+50
Custom SpeakerLow (1–3)	-50→+50
Custom SpeakerHigh (1–3)	-50→+50

Gain

Adjusts the distortion of the amp.

Bass

Adjusts the tone for the low frequency range.

Middle

Adjusts the tone for the middle frequency range.

Treble

Adjusts the tone for the high frequency range.

Presence

Adjusts the tone for the ultra high frequency range.

- * *If you have selected “MATCH DRY” or “VO COMBO” as the type, raising presence will cut the high range (the value will change from 0 to -100).*

Level

Adjusts the volume of the entire preamp.

- * *Be careful not to raise the Level setting too high.*

Bright

Turns the bright setting on/off.

Off:

Bright is not used.

On:

Bright is switched on to create a lighter and crisper tone.

- * *Depending on the “Type” setting, this may not be displayed.*

Gain SW (Gain Switch)

Provides for selection from three levels of distortion: Low, Middle, and High. Distortion will successively increase for settings of “Low,” “Middle” and “High.”

- * *The sound of each Type is created on the basis that the Gain is set to “Middle.” So, normally set it to “Middle.”*

Speaker SW

Turns the speaker simulator setting on/off.

SPEAKER TYPE

1x10”:

This is a compact open-back speaker cabinet with one 10-inch speaker.

1x12”:

This is a compact open-back speaker cabinet with one 12-inch speaker.

2x12”:

This is a general open-back speaker cabinet with two 12-inch speakers.

4x12”:

This is an optimal speaker cabinet for a large enclosed amp with four 12-inch speakers.

8x12”:

This is a double stack of two cabinets, each with four 12-inch speakers.

ORIGINAL:

This is the built-in speaker of the amp you selected with “Type.”

Mic Setting

This simulates the microphone position. “Center” simulates the condition that the microphone is set in the middle of the speaker cone. “1–10 cm” means that the microphone is moved away from the center of the speaker cone.

Mic Level

Adjusts the volume of the microphone.

Direct Level

Adjusts the volume of the direct sound.

- * *If you’ve chosen “Full Range” for Type, use with Mic Level = 100 and Direct Level = 0.*

OVERDRIVE/DISTORTION

This effect distorts the sound to create long sustain. It provides 15 types of distortion, two different custom settings, and an external overdrive/distortion that allows you to connect and use an external effect device.

Parameter	Value
On/Off	Off, On
Type	see below
Drive	0–100
Bass	-50+50
Treble	-50+50
Level	0–100

On/Off (effect on/off)

Turns the overdrive/distortion effect on/off.

Type

Selects the type of distortion.

	[TYPE VARIATION]		
	Extinguished	Illuminated: red	Illuminated: green
OD/BOOST	Blues OD	Turbo OD	Booster
	This is a crunch sound of the BOSS BD-2.	This is the high-gain overdrive sound of the BOSS OD-2.	This is a newly developed booster that works very well with COSM amps.
DIST	Distortion	American DS	GUV DS
	This gives a basic, traditional distortion sound.	This models a Proco RAT.	This models a Marshall GUV' NOR.
CLASSIC	OD-1	T-Scream	DST+
	This is the sound of the BOSS OD-1.	This models a Ibanez TS-808.	This models a MXR DISTORTION+.
FUZZ	'60s FUZZ	Oct FUZZ	MUFF FUZZ
	This models a FUZZFACE.	This models a ACETONE FUZZ.	This models a Electro-Harmonix Big Muff π
METAL	Metal Zone	R-MAN	Heavy Metal
	This is the sound of the BOSS MT-2.	This models a ROCKMAN.	This creates a heavier distortion sound.
CUSTOM	Custom1	Custom2	External
	Custom type 1	Custom type 2	Select this when using an external effects processor connected to the EXTERNAL jack.

When CUSTOM is selected for TYPE

You can set the following parameters when TYPE is set to CUSTOM.



Making "Custom" Overdrive/Distortion Settings (p. 54)

Parameter	Value
Custom Type (1–3)	OD-1, OD-2, CRUNCH, DS-1, DS-2, METAL-1, METAL-2, FUZZ
Custom Bottom (1–3)	-50+50
Custom Top (1–3)	-50+50
Custom Low (1–3)	-50+50
Custom High (1–3)	-50+50

Drive

Adjusts the depth of distortion.

Bass

Adjusts the tone for the low frequency range.

Treble

Adjusts the tone for the high frequency range.

Level

Adjusts the volume.

DELAY

This effect adds delayed sound to the direct sound, giving more body to the sound or creating special effects.

Parameter	Value
On/Off	Off, On
Type	Single, Tap
Delay Time	0 ms–1800 ms, BPM ♪ –BPM ♪
Delay Time (Fine)	0 msec–20 msec
Tap Time	0 %–100 % (Type=Pan)
Feedback	0–100
High Cut Filter	700 Hz–11.0 kHz, Flat
Effect Level	0–120

On/Off

Turns the delay effect on/off.

Type

This selects how to output the delay sound.

Single:

By adjusting the delay time and feedback, you can obtain a normal delay effect.

Tap:

This delay is specifically for stereo output. This allows you to obtain the tap delay effect that divides the delay time, then deliver them to L and R channels.

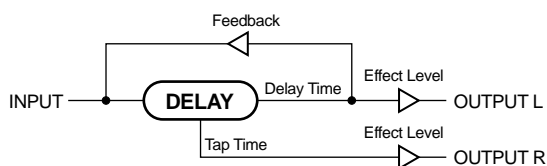

Delay Time

This determines the delay time.

- * When set to BPM, the value of each parameter will be set according to the value of the Master BPM (p. 46) specified for each patch. This makes it easier to achieve effect sound settings that match the tempo of the song (synchronizing the time to twice or four times the time length of the BPM when the set time is increased).

When setting to the BPM, pressing PARAMETER [▶] to display the Master BPM settings screen.

Delay Time Fine

Make fine adjustments to the delay time.

Tap Time

Adjusts the delay time of the right channel delay. This setting adjusts the right channel delay time relative to the left channel delay time (considered as 100 %).

Feedback

“Feedback” is returning a delay signal to the input. This parameter determines the amount of feedback. A higher value will increase the number of the delay repeats.

High Cut Filter

The high cut filter cuts the frequency contents that are higher than the set frequency. This parameter adjusts the frequency where the high cut filter starts working. When it is set to “Flat,” the high cut filter does not work at all.

Effect Level

This adjusts the volume of the delay sound.



After [TAP] is pressed several times, the interval between presses of the button is then used as the delay time setting.

You can change the Master BPM by setting the delay time to the BPM and pressing [TAP] several times.

CHORUS

In this effect, a slightly detuned sound is added to the original sound to add depth and breadth.

Parameter	Value
On/Off	Off, On
Mode	Mono, Stereo
Rate	0–100, BPM \circ –BPM ♪
Depth	0–100
Pre Delay	0.0 msec–40.0 msec
High Cut Filter	700 Hz–11.0 kHz, Flat
Effect Level	0–100

On/Off (effect on/off)

Turns the chorus effect on/off.

Mode

Selection for the chorus mode.

Mono:

This chorus effect outputs the same sound from both L and R.

Stereo:

This is a stereo chorus effect that adds different chorus sounds to L and R.

Rate

Adjusts the rate of the chorus effect.

* *When set to BPM, the value of each parameter will be set according to the value of the Master BPM (p. 46) specified for each patch. This makes it easier to achieve effect sound settings that match the tempo of the song (synchronizing the cycle to one-half or one-fourth of the BPM when the set cycle rate is increased). When setting to the BPM, pressing PARAMETER [▶] to display the Master BPM settings screen.*

Depth

Adjusts the depth of the chorus effect. To use it for doubling, set the value to “0.”

Pre Delay

Adjusts the time needed for the effect sound to be output after the direct sound has been output. By setting a longer pre delay time, you can obtain an effect that sounds like more than one sound is being played at the same time (doubling effect).

High Cut Filter

The low cut filter cuts the frequencies below the specified frequency. This setting adjusts the frequency at which the low cut filter will begin to take effect. When “Flat” is selected, the low cut filter will have no effect.

Effect Level

Adjusts the volume of the effect sound.

REVERB

This effect adds reverberation to the sound.

Parameter	Value
On/Off	Off, On
Type	Room 1, Room 2, Hall 1, Hall 2, Plate
Reverb Time	0.1 sec–10.0 sec
Pre Delay	0 msec–100 msec
Low Cut Filter	55.0 Hz–800 Hz
High Cut Filter	700 Hz–11.0 kHz, Flat
Density	0–10
Effect Level	0–100

On/Off (effect on/off)

Turns the reverb effect on/off.

Type

This selects the reverb type. various different simulations of space are offered.

Room 1:

Simulates the reverberation in a small room. Provides the bright reverberation of a live room.

Room 2:

Simulates the reverberation in a small room. Provides warm reverberations.

Hall 1:

Simulates the reverberation in a concert hall. Provides clear and spacious reverberations.

Hall 2:

Simulates the reverberation in a concert hall. Provides warm reverberations.

Plate:

Simulates plate reverberation (a reverb unit that uses the vibration of a metallic plate). Provides a metallic sound with a distinct upper range.

Reverb Time

Adjusts the length (time) of reverberation.

Pre Delay

Adjusts the time until the reverb sound appears.

Low Cut Filter

The low cut filter cuts the frequencies below the specified frequency. This setting adjusts the frequency at which the low cut filter will begin to take effect.

High Cut Filter

The high cut filter cuts the frequencies above the specified frequency. This setting adjusts the frequency at which the high cut filter will begin to take effect. When “Flat” is selected, the high cut filter will have no effect.

Density

This adjusts the density of the reverb sound.

Effect Level

Adjusts the volume of the reverb sound.

WAH

The wah effect creates a unique tone by changing the frequency response characteristics of a filter.

“Pedal wah” lets you use an Expression pedal or the like to obtain real-time control of the wah effect.

“Auto wah” creates an automatic wah by cyclically changing the filter, or by changing the filter in response to the volume of the input.

“Fixed Wah” provides the effect obtained when a filter-type effect is used with the wah pedal stopped at a given angle.

* When using an external expression pedal as a wah pedal, select Fixed Wah (FW).

Parameter	Value
On/Off	Off, On
FX Select	WAH, AW, FW

● WAH; Pedal Wah

Type	CRY WAH, VO WAH, Fat WAH, Light WAH, 7String WAH, Custom1, Custom2, Custom3
PdI Position	0–100
Level	0–100

● AW; Auto Wah

Mode	LPF, BPF
Polarity	Down, Up
Sensitivity	0–100
Frequency	0–100
Peak	0–100
Rate	0–100, BPM ◁ –BPM ♪
Depth	0–100
Level	0–100

● FW; Fixed Wah

Type	CRY WAH, VO WAH, Fat WAH, Light WAH, 7String WAH, Custom1, Custom2, Custom3
PdI Position	0–100
Level	0–100

On/Off (effect on/off)

Turns the pedal wah/auto wah/fixed wah effect on/off.

FX Select (effect select)

Selects either pedal wah “WAH,” auto wah “AW,” or fixed wah “FW”.

WAH:

The effect will function as a pedal wah.

AW:

The effect will function as an auto wah.

FW:

The effect will function as a fixed wah.

■ WAH (Pedal Wah)

The effect of the wah pedal can be obtained by operating the Expression pedal.

The GT-6’s expression pedal automatically switches to the wah pedal function when WAH is selected.

Type

This selects the wah type.

CRY WAH:

This models the sound of the CRY BABY wah pedal popular in the ‘70s.

VO WAH:

This models the sound of the VOX V846.

Fat WAH:

This a wah sound featuring a bold tone.

Light WAH:

This wah has a refined sound with no unusual characteristics.

7String WAH:

Wah featuring a broader range of variations for the seven-string guitar.

Custom1–3:

Wah created by editing the custom parameters.

When Type Is Set to Custom1–3

You can select the following parameters when TYPE is set to Custom1–3.



Making “Custom” Pedal Wah Settings (p. 55)

Parameter	value
Custom Type (1–3)	CRY WAH, VO WAH, Fat WAH, Light WAH, 7String WAH
Custom Q (1–3)	-50+50
Custom Range Low (1–3)	-50+50
Custom Range High (1–3)	-50+50
Custom Presence (1–3)	-50+50

PdI Position (pedal position)

This adjusts the position of the wah pedal.

Level

Adjusts the volume.

■ AW (Auto Wah)

Mode

Selection for the wah mode.

LPF (low pass filter):

This creates a wah effect over a wide frequency range.

BPF (band pass filter):

This creates a wah effect in a narrow frequency range.

Polarity

Selection for the direction in which the filter will change in response to the input.

Up:

The frequency of the filter will rise.

Down:

The frequency of the filter will fall.

Sens (sensitivity)

This adjusts the sensitivity at which the filter will change in the direction determined by the polarity setting. Higher values will result in a stronger response. With a setting of “0,” the strength of picking will have no effect.

Frequency

This adjusts the center frequency of the Wah effect.

Peak

Adjusts the way in which the wah effect applies to the area around the center frequency. Lower values will produce a wah effect over a wide area around the center frequency. Higher values will produce a wah effect in a narrow area around the center frequency.

* With a value of “50” a standard wah sound will be produced.

Rate

Adjusts the frequency of the auto wah.

* When set to BPM, the value of each parameter will be set according to the value of the Master BPM (p. 46) specified for each patch. This makes it easier to achieve effect sound settings that match the tempo of the song (synchronizing the cycle to one-half or one-fourth of the BPM when the set cycle rate is increased).

When setting to the BPM, pressing PARAMETER [►] to display the Master BPM settings screen.

Depth

Adjusts the depth of the auto wah effect.

Level

Adjusts the volume.

■ FW (Fixed Wah)

Provides the effect obtained when a filter-type effect is used with the wah pedal stopped at a given position.

Type

This selects the wah type.

For more on the effect of each type, refer to “Pedal Wah.”

PdI Position (pedal position)

This adjusts the position of the wah pedal.

* If this parameter is assigned to an external expression pedal, operating the pedal then provides the same effect as the pedal wah effect.

Level

Adjusts the volume.

EQ (Equalizer)

Adjusts the tone. Parametric control is provided for the high-mid range and low-mid range.

Parameter	Value
On/Off	Off, On
Low EQ	-20 dB→+20 dB
Low-Middle Frequency	100 Hz–10.0 kHz
Low-Middle Q	0.5–16
Low-Middle EQ	-20 dB→+20 dB
High-Middle Frequency	100 Hz–10.0 kHz
High-Middle Q	0.5–16
High-Middle EQ	-20 dB→+20 dB
High EQ	-20 dB→+20 dB
Level	-20 dB→+20 dB

On/Off (effect on/off)

Switches the equalizer effect on/off.

Low EQ (low equalizer)

Adjusts the low frequency range tone.

Low-Middle Frequency

Specify the center of the frequency range that will be adjusted by the “Low-Middle EQ.”

Low-Middle Q

Adjusts the width of the area affected by the EQ centered at the “Low-Middle Frequency.” Higher values will narrow the area.

Low-Middle EQ (low-middle equalizer)

Adjusts the low-middle frequency range tone.

High-Middle Frequency

Specify the center of the frequency range that will be adjusted by the “High-Middle EQ.”

High-Middle Q (high-middle Q)

Adjusts the width of the area affected by the EQ centered at the “High-Middle Frequency.” Higher values will narrow the area.

High-Middle EQ (high-middle equalizer)

Adjusts the high-middle frequency range tone.

High EQ (high equalizer)

Adjusts the high frequency range tone.

Level

Adjusts the volume after the equalizer.

FX-1

With FX-1, you can select the effect to be used from the following.

- COMPRESSOR
- LIMITER
- AC GUITAR SIM (acoustic guitar simulator)
- PICKUP SIM (pickup simulator)
- TREMOLO
- SLOW GEAR
- FEEDBACKER
- ANTI-FEEDBACK
- DEFRETTER

Parameter	Value
On/Off	Off, On
FX Select	CS, LM, AC, PIC, TR, SG, FB, AFB, FRT
● CS; Compressor	
Sustain	0–100
Attack	0–100
Tone	-50→+50
Level	0–100
● LM; Limiter	
Threshold	0–100
Release	0–100
Tone	-50→+50
Level	0–100
● AC; Acoustic Guitar Simulator	
Top	0–100
Body	0–100
Level	0–100
● PIC; Pickup Simulator	
Type	'S'to'H', 'H'to'S', 'H'to'HF'
Tone	-50→+50
Level	0–100
● TR; Tremolo	
Wave Shape	0–100
Rate	0–100, BPM ♪ -BPM ♪
Depth	0–100
● SG; Slow Gear	
Sensitivity	0–100
Rise Time	0–100

● FB; Feedbacker

Mode	OSC, Natural	
Rise Time	0–100	Mode= OSC
Rise Time (▲)	0–100	Mode= OSC
F.B.Level	0–100	
F.B.Level (▲)	0–100	Mode= OSC
Vibrato Rate	0–100, BPM	♩ –BPM ♪ Mode= OSC
Vibrato Depth	0–100	Mode= OSC

● AFB; Anti Feedback

Freq1	0–100
Depth1	0–100
Freq2	0–100
Depth2	0–100
Freq3	0–100
Depth3	0–100

● FRT; Defretter

Tone	-50+50
Sens	0–100
Attack	0–100
Depth	0–100
Resonance	0–100
Effect Level	0–100
Direct Level	0–100

On/Off (effect on/off)

Switches the FX-1 effect on/off.

FX Select (effect select)

This selects the effect to be used.

■ CS (Compressor)

The compressor is an effect that attenuates loud input levels and boosts soft input levels, thus evening out the volume to create sustain without distortion.

Sustain

Adjusts the range (time) over which low-level signals are boosted. Larger values will result in longer sustain.

Attack

Adjusts the strength of the picking attack. Larger values will result in a sharper attack, creating a more clearly defined sound.

Tone

Adjusts the tone.

Level

Adjusts the volume.

■ LM (Limiter)

The limiter attenuates loud input levels to prevent distortion.

Threshold

Adjust this as appropriate for the input signal from your guitar. When the input signal level exceeds this threshold level, limiting will be applied.

Release

This adjusts the time from when the signal level drops below the threshold until when limiting is removed.

Tone

Adjusts the tone.

Level

Adjusts the volume.

■ AC (Acoustic Guitar Simulator)

This simulates the sound of an acoustic guitar. It allows you to use an electric guitar to produce sounds similar to those of an acoustic guitar.

Top

This adjusts the interference to the strings made by the top plate. That is, it adjusts the attack sense or harmonic contents.

Body

This adjusts the resonance of the sound caused by the body. That is, it adjusts the softness and fatness of the sound which is the typical characteristics of acoustic guitars.

Level

This adjusts the volume of the acoustic guitar simulator.

■ PIC (Pickup Simulator)

This produces the sound of different types of pickup. You can produce thick humbucking-style sounds even with a single-coil guitar.

Type

Select the pickup type.

'S' to 'H' (Single to Hum):

This converts the sound of a single coil pickup to the sound of a humbucking pickup.

'H' to 'S' (Hum to Single):

This converts the sound of a humbucking pickup to the sound of a single coil pickup.

'H' to 'HF' (Hum to Half-tone):

This converts the sound of a humbucking pickup to the half-tone sound of a single-coil pickup.

Tone

Adjusts the tone.

Level

Adjusts the volume.

■ TR (Tremolo)

Tremolo is an effect that creates a cyclic change in volume.

Wave Shape

This adjusts changes in volume level.

Rate

Adjusts the frequency (speed) of the change.

- * When set to BPM, the value of each parameter will be set according to the value of the Master BPM (p. 46) specified for each patch. This makes it easier to achieve effect sound settings that match the tempo of the song (synchronizing the cycle to one-half or one-fourth of the BPM when the set cycle rate is increased).

When setting to the BPM, pressing PARAMETER [▶] to display the Master BPM settings screen.

Depth

Adjusts the depth of the effect.

■ SG (Slow Gear)

This produces a volume-swell effect ("violin-like" sound).

Sensitivity

This adjusts the sensitivity of the slow gear. When it is set to a lower value, the effect of the slow gear can be obtained only with a stronger picking, while no effect is obtained with a weaker picking. When the value is set higher, the effect is obtained even with a weak picking.

Rise Time

This adjusts the time needed for the volume to reach its maximum from the moment you begin picking.

■ FB (Feedbacker)

This allows you to use feedback playing techniques.

Mode

Select either oscillator "OSC" or natural "Natural."

OSC (oscillator):

An artificial feedback sound will be created internally.

When set to "OSC," play the guitar accurately using single notes, then turn the effect on. The feedback effect will be turned off by setting the effect to off. To turn on or off the effect, use the CTL pedal. Set the pedal so that the effect is on only while the pedal is depressed. Set it with the CTL pedal's setting.

- * For a detailed explanation, see "Chapter 5 Settings for Using the Expression and Control Pedals" (p. 47).
- * Note that the notes you want to apply feedback to must be played singly and cleanly. Then, when the note is sounding stably, turn on the effect.

Natural:

Analyzes the pitch of the guitar sound being input, and then creates a feedback sound based on that.

Rise Time

This determines the time needed for the volume of the feedback sound to reach its maximum from the moment the effect is turned on.

Rise Time (▲)

This determines the time needed for the volume of the one octave higher feedback sound to reach its maximum from the moment the effect is turned on.

F.B.Level (feedback level)

Adjusts the volume of the feedback sound.

F.B.Level (▲) (feedback level)

This adjusts the volume of the one octave higher feedback sound.

Vibrato Rate

This adjusts the rate of the vibrato when the feedbacker is on.

- * When set to BPM, the value of each parameter will be set according to the value of the Master BPM (p. 46) specified for each patch. This makes it easier to achieve effect sound settings that match the tempo of the song (synchronizing the cycle to one-half or one-fourth of the BPM when the set cycle rate is increased).
- When setting to the BPM, pressing PARAMETER [▶] to display the Master BPM settings screen.

Vibrato Depth

This adjusts the depth of the vibrato when the feedbacker is on.

■ AFB (Anti-feedback)

This prevents the acoustic feedback that can be produced by the body resonances of a guitar.

Freq1-3 (frequency 1-3)

Set the fixed frequency point at which feedback will be cancelled.

You can set up to three cancellation points.

Depth1-3

Adjusts the degree of the anti-feedback at each of the three cancellation points.

■ FRT (Defretter)

This simulates a fretless guitar.

Tone

Adjusts the amount of blurring between the notes.

Sens (sensitivity)

This controls the input sensitivity of the defretter.

Attack

Adjusts the attack of the picking sound.

Depth

This controls the rate of the harmonics.

Resonance

Adds a characteristically resonant quality to the sound

Effect Level

Adjust the volume of the defretter sound.

Direct Level

Adjust the volume of the direct sound.

FX-2

With FX-2, you can select the effect to be used from the following.

- PHASER
- FLANGER
- HARMONIST
- PITCH SHIFTER
- PEDAL BEND
- 2x2 CHORUS
- PAN
- VIBRATO
- UNI-V
- SHORT DELAY
- HUMANIZER
- RING MOD (ring modulator)
- SLICER
- AUTO RIFF
- GUITAR SYNTH
- SUB EQUALIZER

Parameter	Value
On/Off	Off, On
FX Select	PH, FL, HR, PS, PB, 2CE, PAN, VB, UV, SDD, HU, RM, SL, AR, SYN, SEQ
● PH; Phaser	
Type	4stage, 8stage, 12stage, Bi-Phase
Rate	0-100, BPM ◦ -BPM ♪
Depth	0-100
Manual	0-100
Resonance	0-100
Step	Off, On
Step Rate	0-100, BPM ◦ -BPM ♪ Step= On
Effect Level	0-100
Direct Level	0-100
● FL; Flanger	
Rate	0-100, BPM ◦ -BPM ♪
Depth	0-100
Manual	0-100
Resonance	0-100
Separation	0-100
Effect Level	0-100
Direct Level	0-100

Chapter 4 The Effects Explained

● HR; Harmonist

Voice	1-Voice, 2-Mono, 2-Stereo
Harmony	-2oct→+2oct, Scale 1–Scale29
Pre Delay	0 ms–300 ms, BPM ♪ –BPM ♪
Feedback	0–100
Level	0–100
Key	C(Am)–B(G#m)
Direct Level	0–100

(User Scale)

User	1–29
DIR	C–B
EFF	C–B (±2 octave)

● PS; Pitch Shifter

Voice	1-Voice, 2-Mono, 2-Stereo
Mode	Fast, Medium, Slow, Mono
Pitch	-24 →+24
Fine	-50→+50
Pre Delay	0 ms–300 ms, BPM ♪ –BPM ♪
Feedback	0–100
Level	0–100
Direct Level	0–100

● PB; Pedal Bend

Pitch Min	-24→+24
Pitch Max	-24→+24
PdI Position	0–100
Effect Level	0–100
Direct Level	0–100

● 2CE; 2x2 Chorus

Xover f	100 Hz–4.00 kHz
Low Rate	0–100, BPM ♪ –BPM ♪
Low Depth	0–100
Low Pre Delay	0.0 msec–40.0 msec
Low Level	0–100
High Rate	0–100, BPM ♪ –BPM ♪
High Depth	0–100
High Pre Delay	0.0 msec–40.0 msec
High Level	0–100

● PAN; Pan

Wave Shape	0–100
Rate	0–100, BPM ♪ –BPM ♪
Depth	0–100

● VB; Vibrato

Rate	0–100, BPM ♪ –BPM ♪
Depth	0–100
Trigger	Off, On
Rise Time	0–100

● UV; Uni-V

Rate	0–100, BPM ♪ –BPM ♪
Depth	0–100
Level	0–100

● SDD; Short Delay

Delay Time	0 ms–400 ms, BPM ♪ –BPM ♪
Feedback	0–100
Effect Level	0–120

● HU; Humanizer

Mode	Picking, Auto, Random
Vowel1	a, e, i, o, u Mode= Picking, Auto
Vowel2	a, e, i, o, u Mode= Picking, Auto
Sensitivity	0–100 Mode= Picking
Rate	0–100, BPM ♪ –BPM ♪
Depth	0–100
Manual	0–100 Mode= Auto
Level	0–100

● RM; Ring Modulator

Mode	Normal, Intelligent
Frequency	0–100
Effect Level	0–100
Direct Level	0–100

● SL; Slicer

Pattern	P1–P20
Rate	0–100, BPM ♪ –BPM ♪
Triggr Sens	0–100

● AR; Auto Riff

Phrase	Preset1–Preset30, User1–User10
Loop	Off, On
Tempo	0–100, BPM ♪ –BPM ♪
Sens	0–100
Key	C(Am)–B(G#m) Phrase = Preset
Attack	0–100
Hold	Off, On
Effect Level	0–100
Direct Level	0–100

(Auto Riff Phrase)

User	1–10
IN	C–B
Step	1–16
Out	C–B (±2 octave), -, end

● SYN; Guitar Synth

Sensitivity	0–100	
Wave	Square, Saw, Brass, Bow	
Chromatic	Off, On	Wave= Square, Saw
Octave Shift	0, -1, -2	Wave= Square, Saw
PWM Rate	0–100	Wave= Square
PWM Depth	0–100	Wave= Square
Cutoff Frequency	0–100	
Resonance	0–100	
Filter Sensitivity	0–100	
Filter Decay	0–100	
Filter Depth	-100 –100	
Attack	Decay, 0–100	
Release	0–100	
Velocity	0–100	
Hold	Off, On	Wave= Square, Saw
Synth Level	0–100	
Direct Level	0–100	

● SEQ; Sub Equalizer

Low EQ	-20 dB→20 dB
Low-Middle Frequency	100 Hz–10.0 kHz
Low-Middle Q	0.5–16
Low-Middle EQ	-20 dB→20 dB
High-Middle Frequency	100 Hz–10.0 kHz
High-Middle Q	0.5–16
High-Middle EQ	-20 dB→20 dB
High EQ	-20 dB→20 dB
Level	-20 dB→20 dB

On/Off (effect on/off)

Switches the FX-2 effect on/off.

FX Select (effect select)

This selects the effect to be used.

■ PH (Phaser)

By adding varied-phase portions to the direct sound, the phaser effect gives a whooshing, swirling character to the sound.

Type

Selects the number of stages that the phaser effect will use.

4Stage:

This is a four-phase effect. A light phaser effect is obtained.

8Stage:

This is an eight-phase effect. It is a popular phaser effect.

12Stage:

This is a twelve-phase effect. A deep phase effect is obtained.

Bi-Phase:

This is the phaser with two phase shift circuits connected in series.

Rate

This sets the rate of the phaser effect.

- * When set to BPM, the value of each parameter will be set according to the value of the Master BPM (p. 46) specified for each patch. This makes it easier to achieve effect sound settings that match the tempo of the song (synchronizing the cycle to one-half or one-fourth of the BPM when the set cycle rate is increased).

When setting to the BPM, pressing PARAMETER [►] to display the Master BPM settings screen.

Depth

Determines the depth of the phaser effect.

Manual

Adjusts the center frequency of the phaser effect.

Resonance

Determines the amount of resonance (feedback). Increasing the value will emphasize the effect, creating a more unusual sound.

Step

This sets on/off of the step function. When the step function is turned on, the change of a sound will be in steps.

Step Rate

This sets the cycle of the steps that changes the rate and depth. When it is set to a higher value, the change will be finer.

- * When set to BPM, the value of each parameter will be set according to the value of the Master BPM (p. 46) specified for each patch. This makes it easier to achieve effect sound settings that match the tempo of the song (synchronizing the cycle to one-half or one-fourth of the BPM when the set cycle rate is increased).

When setting to the BPM, pressing PARAMETER [►] to display the Master BPM settings screen.

Effect Level

This adjusts the volume of the phaser.

Direct Level

This adjusts the volume of the direct sound.

■ FL (Flanger)

The flanging effect gives a twisting, jet-airplane-like character to the sound.

Rate

This sets the rate of the flanging effect.

- * *When set to BPM, the value of each parameter will be set according to the value of the Master BPM (p. 46) specified for each patch. This makes it easier to achieve effect sound settings that match the tempo of the song (synchronizing the cycle to one-half or one-fourth of the BPM when the set cycle rate is increased). When setting to the BPM, pressing PARAMETER [▶] to display the Master BPM settings screen.*

Depth

Determines the depth of the flanging effect.

Manual

Adjusts the center frequency at which to apply the effect.

Resonance

Determines the amount of resonance (feedback). Increasing the value will emphasize the effect, creating a more unusual sound.

Separation

Adjusts the diffusion. The diffusion increases as the value increases.

Effect Level

This adjusts the volume of the flanger.

Direct Level

This adjusts the volume of the direct sound.

■ HR (Harmonist)

“Harmonist” is the amount of shifting is adjusted according to an analysis of the guitar input, allowing you to create harmonics based on diatonic scales.

- * *Because of the need to analyze the pitch, chords (two or more sounds played simultaneously) cannot be played.*

Voice

This selects the number of voices for the pitch shift sound (harmony).

1-Voice:

One-voice pitch-shifted sound output in monaural.

2-Mono:

Two-voice pitch-shifted sound (HR1, HR2) output in monaural.

2-Stereo:

Two-voice pitch-shifted sound (HR1, HR2) output through left and right channels.

Harmony

This determines the pitch of the sound added to the input sound, when you are making a harmony. It allows you to set it by up to 2 octaves higher or lower than the input sound. When the scale is set to “Scale 1–Scale29,” this parameter sets the user scale number to be used.

PreDly (pre delay)

Adjusts the time from when the direct sound is heard until the harmonist sounds are heard. Normally you can leave this set at “0ms.”

- * *When set to BPM, the value of each parameter will be set according to the value of the Master BPM (p. 46) specified for each patch. This makes it easier to achieve effect sound settings that match the tempo of the song (synchronizing the time to twice or four times the time length of the BPM when the set time is increased).*
When setting to the BPM, pressing PARAMETER [▶] to display the Master BPM settings screen.

Feedback

This adjusts the feedback amount of the harmonist sound.

Level

This adjusts the volume of the harmonist sound.

Key

Specify the key of the song you are playing. By specifying the key, you can create harmonies that fit the key of the song. The key setting corresponds to the key of the song (#, b) as follows.

Major	C	F	B ^b	E ^b	A ^b	D ^b	G ^b
--------------	---	---	----------------	----------------	----------------	----------------	----------------

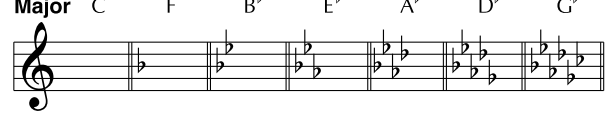

Minor	Am	Dm	Gm	Cm	Fm	B ^b m	E ^b m
--------------	----	----	----	----	----	------------------	------------------

Major	G	D	A	E	B	F [#]
--------------	---	---	---	---	---	----------------

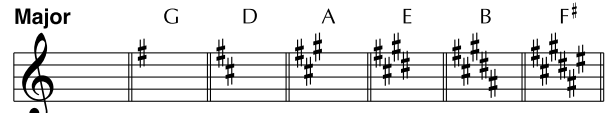

Minor	Em	Bm	F [#] m	C [#] m	G [#] m	D [#] m
--------------	----	----	------------------	------------------	------------------	------------------

Direct Level

This adjusts the volume of the direct sound.

Creating Harmonist Scales (User Scale)

When “Harmony” is set to any value from -2oct to +2oct, and the harmony does not sound the way you intend, use a “User scale.”

You can set any of 29 different “User scales.”

1. Press [FX-2], then press PARAMETER [◀] [▶] so that “FX Select” is displayed.
2. Rotate the PATCH/VALUE dial to select “HR.”
3. Press PARAMETER [◀] [▶] to select “HR1 Harm” (or “HR2 Harm”), then rotate the PATCH/VALUE dial to select a setting from “Scale 1–29.”
4. Press PARAMETER [▶] a number of times so that the User scale settings screen is displayed.

```
Key=C  DIR EFF
User1: C  -C ♯
```

5. Press PARAMETER [◀] [▶] to move the cursor, then rotate the PATCH/VALUE dial to set the User scale.

User:

You can change the number of the user scale.

DIR (direct):

Sets the note name of the input sound. You can also play individual notes on the guitar and let the GT-6 judge the note name.

EFF (effect):

Sets the note name of the output sound.

The triangle next to the note name indicates the octave.

One downward-pointing triangle indicates a note one octave below the note displayed; two triangles indicates a two-octave drop.

One upward-pointing triangle indicates a note one octave above the note displayed; two triangles indicates a two-octave rise.

■ PS (Pitch Shifter)

This effect changes the pitch of the original sound (up or down) within a range of two octaves.

Voice

This selects the number of voices for the pitch shift sound.

1-Voice:

One-voice pitch-shifted sound output in monaural.

2-Mono:

Two-voice pitch-shifted sound (PS1, PS2) output in monaural.

2-Stereo:

Two-voice pitch-shifted sound (PS1, PS2) output through left and right channels.

Mode

Selection for the pitch shifter mode.

Fast, Medium, Slow:

A chord can be input with a normal pitch shifter. The response is slower in the order of Fast, Medium and Slow, but the modulation is lessened in the same order.

Mono:

This mode is for the input of individual notes.

Select this setting when you want to obtain a pedal bend effect using an external expression pedal.

Pitch

Adjusts the amount of pitch shift (the amount of pitch change) in semitone steps.

Fine

Make fine adjustments to the pitch shift.

- * *The amount of the change in the Fine “100” is equivalent to that of the Pitch “1.”*

PreDly (pre delay)

Adjusts the time from when the direct sound is heard until the pitch shifted sounds are heard. Normally you can leave this set at “0ms.”

- * *When set to BPM, the value of each parameter will be set according to the value of the Master BPM (p. 46) specified for each patch. This makes it easier to achieve effect sound settings that match the tempo of the song (synchronizing the time to twice or four times the time length of the BPM when the set time is increased).*

When setting to the BPM, pressing PARAMETER [▶] to display the Master BPM settings screen.

Feedback

This adjusts the feedback amount of the pitch shift sound.

Level

This adjusts the volume of the pitch shift sound.

Direct Level

This adjusts the volume of the direct sound.

■ PB (Pedal Bend)

This lets you use the pedal to get a pitch bend effect. The The GT-6's expression pedal automatically switches to the pedal bend function when PB is selected.

Pitch Min

This sets the pitch at the point where the expression pedal is fully lifted.

Pitch Max

This sets the pitch at the point where the expression pedal is all the way down.

Pdl Position (pedal position)

This adjusts the position of the pedal bend.

Effect Level

This adjusts the volume of the pitch bend sound.

Direct Level

This adjusts the volume of the direct sound.

■ 2CE (2x2 Chorus)

Two separate stereo chorus units are used for the low-frequency and high-frequency ranges in order to create a more natural chorus sound.

Xover f (crossover frequency)

This parameter sets the frequency at which the frequency components of the direct sound are divided into bass and treble bands.

Low Rate

Adjust the speed of the chorus effect for the low frequency range.

- * *When set to BPM, the value of each parameter will be set according to the value of the Master BPM (p.46) specified for each patch. This makes it easier to achieve effect sound settings that match the tempo of the song (synchronizing the cycle to one-half or one-fourth of the BPM when the set cycle rate is increased). When setting to the BPM, pressing PARAMETER [▶] to display the Master BPM settings screen.*

Low Depth

Adjust the depth of the chorus effect for the low frequency range. If you wish to use this as a doubling effect, use a setting of "0."

Low Pre Delay

Adjust the time from when the low frequency range direct sound is output until the effect sound is output. Extending the pre-delay will produce the sensation of multiple sounds (doubling effect).

Low Level

Adjust the volume of the low frequency range.

High Rate

Adjust the speed of the chorus effect for the high frequency range.

- * *When set to BPM, the value of each parameter will be set according to the value of the Master BPM (p. 46) specified for each patch. This makes it easier to achieve effect sound settings that match the tempo of the song (synchronizing the cycle to one-half or one-fourth of the BPM when the set cycle rate is increased).*

When setting to the BPM, pressing PARAMETER [▶] to display the Master BPM settings screen.

High Depth

Adjust the depth of the chorus effect for the high frequency range. If you wish to use this as a doubling effect, use a setting of "0."

High Pre Delay

Adjust the time from when the high frequency range direct sound is output until the effect sound is output. Extending the pre-delay will produce the sensation of multiple sounds (doubling effect).

High Level

Adjust the volume of the high frequency range.

■ PAN

With the volume level of the left and right sides alternately changing, when playing sound in stereo, you can get an effect that makes the guitar sound appear to fly back and forth between the speakers.

Wave Shape

This adjusts changes in volume level.

Rate

Adjusts the frequency (speed) of the change.

- * *When set to BPM, the value of each parameter will be set according to the value of the Master BPM (p. 46) specified for each patch. This makes it easier to achieve effect sound settings that match the tempo of the song (synchronizing the cycle to one-half or one-fourth of the BPM when the set cycle rate is increased).*

When setting to the BPM, pressing PARAMETER [▶] to display the Master BPM settings screen.

Depth

Adjusts the depth of the effect.

■ VB (Vibrato)

This effect creates vibrato by slightly modulating the pitch.

Rate

This adjusts the rate of the vibrato.

- * When set to BPM, the value of each parameter will be set according to the value of the Master BPM (p. 46) specified for each patch. This makes it easier to achieve effect sound settings that match the tempo of the song (synchronizing the cycle to one-half or one-fourth of the BPM when the set cycle rate is increased).

When setting to the BPM, pressing PARAMETER [▶] to display the Master BPM settings screen.

Depth

This adjusts the depth of the vibrato.

Trigger

This selects on/off of the vibrato with the footswitch.

- * This effect assumes that the trigger will be turned on with a footswitch for attaining the vibrato effect.

Rise Time

This sets the time passing from the moment the trigger is turned on until the set vibrato is obtained.

■ UV (Uni-V)

Although this resembles a phaser effect, it also provides a unique undulation that you can't get with a regular phaser.

Rate

Adjusts the rate of the Uni-V effect.

- * When set to BPM, the value of each parameter will be set according to the value of the Master BPM (p. 46) specified for each patch. This makes it easier to achieve effect sound settings that match the tempo of the song (synchronizing the cycle to one-half or one-fourth of the BPM when the set cycle rate is increased).

When setting to the BPM, pressing PARAMETER [▶] to display the Master BPM settings screen.

Depth

Adjusts the depth of the Uni-V effect.

Level

Adjusts the volume.

■ SDD (short delay)

This is the delay with the maximum delay time of 400 ms. This effect is efficient for making the sound fatter.

Delay Time

Adjusts the delay time.

- * When set to BPM, the value of each parameter will be set according to the value of the Master BPM (p. 46) specified for each patch. This makes it easier to achieve effect sound settings that match the tempo of the song (synchronizing the time to twice or four times the time length of the BPM when the set time is increased).

When setting to the BPM, pressing PARAMETER [▶] to display the Master BPM settings screen.

Feedback

Feedback refers to returning the delayed signal back into the input of the delay. This parameter adjusts the volume that is returned to the input. Higher settings will result in more delay repeats.

Effect Level

Adjusts the volume of delay sound.

■ HU (Humanizer)

This can create vowel sounds of the human beings using the guitar sound.

Mode

This sets the mode that switches the vowels.

Picking:

It changes from vowel 1 to vowel 2 along with the picking. The time spent for the change is adjusted with the rate.

Auto:

By adjusting the rate and depth, two vowels (Vowel 1 and Vowel 2) can be switched.

Random:

Five vowels (a, e, i, o, u) are called out at random by adjusting the rate and depth.

Vowel 1

This selects the first vowel.

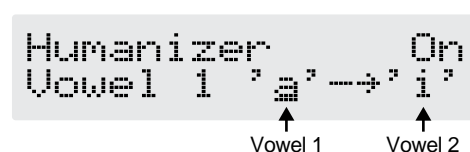

Vowel 2

This selects the second vowel.

Sensitivity

This adjusts the sensitivity of the humanizer. When it is set to a lower value, no effect of the humanizer is obtained with weaker picking, while stronger picking produces the effect. When it is set to a higher value, the effect of the humanizer can be obtained whether the picking is weak or strong.

Rate

This adjusts the cycle for changing the two vowels.

* *When set to BPM, the value of each parameter will be set according to the value of the Master BPM (p. 46) specified for each patch. This makes it easier to achieve effect sound settings that match the tempo of the song (synchronizing the cycle to one-half or one-fourth of the BPM when the set cycle rate is increased).*

When setting to the BPM, pressing PARAMETER [►] to display the Master BPM settings screen.

Depth

This adjusts the depth of the effect.

Manual

This determines the point where the two vowels are switched. When it is set to "50," vowel 1 and vowel 2 are switched in the same length of time. When it is set to lower than "50," the time for vowel 1 is shorter. When it is set to higher than "50," the time for vowel 1 is longer.

Level

This sets the volume of the humanizer.

■ RM (Ring Modulator)

This effect creates vibrato by slightly modulating the pitch.

Mode

This selects the mode for the ring modulator.

Normal:

This is a normal ring modulator.

Intelligent:

By ring-modulating the input signal, a bell like sound is created. The intelligent ring modulator changes the oscillation frequency according to the pitch of the input sound and therefore produces a sound with the sense of pitch, which is quite different from "Normal." This effect does not give a satisfactory result if the pitch of the guitar sound is not correctly detected. So, you must use a single note.

Frequency

This adjusts the frequency of the internal oscillator.

Effect Level

This adjusts the volume of the effect sound.

Direct Level

This adjusts the volume of the direct sound.

■ SL (Slicer)

This consecutively interrupts the sound to create the impression that a rhythm backing phrase is being played.

Pattern

Select the slice pattern that will be used to cut the sound.

Rate

Adjust the rate at which the sound will be cut.

* *When set to BPM, the value of each parameter will be set according to the value of the Master BPM (p. 46) specified for each patch. This makes it easier to achieve effect sound settings that match the tempo of the song (synchronizing the cycle to one-half or one-fourth of the BPM when the set cycle rate is increased).*

When setting to the BPM, pressing PARAMETER [►] to display the Master BPM settings screen.

Trigger Sens

Adjust the sensitivity of triggering. With low settings of this parameter, softly picked notes will not retrigger the phrase (i.e., the phrase will continue playing), but strongly picked notes will retrigger the phrase so that it will playback from the beginning. With high settings of this parameter, the phrase will be retriggered even by softly picked notes.

■ AR (Auto Riff)

This allows you to automatically produce a phrase simply by picking a single note. This can be used to easily play extremely rapid phrases.

* *Running the following operations while Auto Riff is playing may result in disturbances in the sound.*

- Using anti-feedback
- Reception of large amounts of MIDI data

Phrase

Select the phrase.

User-programmed phrases are used when User 1-10 is selected.

Loop

If “Loop” is turned “On,” the phrase will be played back continuously.

Tempo

Adjust the speed of the phrase.

- * When set to BPM, the value of each parameter will be set according to the value of the Master BPM (p. 46) specified for each patch. This makes it easier to achieve effect sound settings that match the tempo of the song (synchronizing the tempo to one-half or one-fourth of the BPM when the set tempo is increased).

When setting to the BPM, pressing PARAMETER [▶] to display the Master BPM settings screen.

Sens (sensitivity)

Adjust the sensitivity of triggering. With low settings of this parameter, softly picked notes will not retrigger the phrase (i.e., the phrase will continue playing), but strongly picked notes will retrigger the phrase so that it will playback from the beginning. With high settings of this parameter, the phrase will be retriggered even by softly picked notes. If this parameter is set to a value of “100,” retriggering will not occur.

Key

Select the key of the song that you wish to play.

Attack

Adjust the strength of the attack. By adding an attack to each note of the phrase you can produce a sensation as though the notes were being picked.

Hold

If you turn hold “On” after you pick a note, the effect sound will continue even after there is no input signal.

Effect Level

Adjust the volume of the effect sound.

Direct Level

Adjust the volume of the direct sound.

Creating Original Phrases (User Phrase)

In addition to the 30 different prepared phrases, you can also create up to ten of your own original phrases (User phrases).

1. Press [FX-2], then press PARAMETER [◀] [▶] so that “FX Select” is displayed.
2. Rotate the PATCH/VALUE dial to select “AR.”
3. Press [FX-2] a number of times to select “Phrase,” then rotate the PATCH/VALUE dial to select “User 1–10.”

4. Press PARAMETER [▶] a number of times until you have the User Phrase settings screen displayed.



```

User:1 STEP OUT
IN:C      1     C
  
```

5. Press PARAMETER [◀] [▶] to move the cursor, then rotate the PATCH/VALUE dial to set the User phrase.

User:

specify the user phrase number.

IN:

Sets the note name of the input sound. You can also play individual notes on the guitar and let the GT-6 judge the note name.

STEP:

You can also play on the guitar and put the step forward.

OUT:

Specify the note name of the output sound.

■ SYN (Guitar Synth)

This detects the pitch of an electric guitar and outputs a synthesizer sound.

MEMO

When you use a guitar synthesizer, observe the following points.

- * It does not work properly when a chord is played. Be sure to mute all the other strings and play in a single note.
- * When you are to play the next string while a certain sound is still playing, perfectly mute the previous sound then play the next one with a clear attack.
- * If the unit cannot detect the attack, it may not sound correctly.

Sensitivity

This adjusts the input sensitivity. The response of the internal sound source is better with a higher sensitivity value, but the malfunctions will be increased on the other hand. So, try to set it as high as possible without causing malfunction.

Wave

This selects a wave type that is the source of the guitar synthesizer.

Square (□□□):

The unit detects the pitch and attack information from the input guitar sound, then send the square waveform from the internal sound source.

Saw ():

The unit detects the pitch and attack information from the input guitar sound, then send the saw waveform from the internal sound source.

Brass:

The unit directly processes the input guitar sound and creates a guitar synthesizer sound. It gives a quick sound rise and send the sound with a sharp edge.

Bow:

The unit directly processes the input guitar sound and creates a guitar synthesizer sound. It outputs a soft sound without attack.

Chromatic

This switches on or off the chromatic function. When it is on, the pitch change of the synthesizer sound is in semitone steps. This does not respond to pitch changes less than a semitone, such as what might be obtained with bending or vibrato. Thus, this is effectively used for realistically playing musical instruments whose pitch will change in steps greater than a semitone, such as a keyboard.

- * Use this parameter when “Square” or “Saw” is selected for wave.

Octave Shift

This allows you to shift the pitch of the internal sound module in an octave step from the guitar sound.

- * This parameter should be set when “Square” or “Saw” is selected for the wave.

PWM Rate (pulse wise modulation rate)

This gives breadth or fatness to the sound by applying modulation to the waveform (only to Square) in the internal sound module. A higher value will quicken the rate of the modulation.

- * This parameter should be set only when “Square” is selected for the wave.

PWM Depth (pulse wise modulation depth)

This adjusts the depth of the PWM. When it is set to “0,” no PWM effect is obtained.

- * This parameter should be set only when “Square” is selected for the wave.

Cutoff Freq (cutoff frequency)

This adjusts the frequency where the harmonics contents of the sound is cut off.

Resonance

This adjusts how much of the harmonics contents around the cutoff frequency should be emphasized.

Filter Sensitivity

This adjusts the sensitivity of the filter. When it is set to a lower value, the filter is affected only with a stronger picking. When it is set higher, the filter changes even with a weaker picking. When it is set to “0,” the depth of the filter will be the same no matter how the picking strength may be.

Filter Decay

This sets the time needed until the filter change will be stable.

Filter Depth

This adjusts the depth of the filter. When the value is higher, the filter will change more drastically. The polarity of the filter will be opposite with “+” and “-.”

Attack

This adjusts the time needed for a synthesizer sound to reach its maximum. When it is set to a lower value, the sound will rise quickly. When it is set higher, the sound will rise slowly. When it is set to “Decay,” the sound will rise quickly and turn to a Release status regardless of the input of the guitar sound.

- * When “Brass” or “Bow” is selected for the wave, the attack time will not be quicker from a certain level even if the attack is set to “Decay” or “0.”

Release

This determines the time needed for the synthesizer sound to reach zero from the moment the input of the guitar sound is completed.

- * When “Brass” or “Bow” is selected for the wave, the guitar signal itself is processed. That is, the synthesizer sound will go down when the guitar signal goes down no matter how long the release may be set.

Velocity

This adjusts the amount of the volume change of the synthesizer sound. When it is set to high, the volume change will be greater depending on the picking strength. When it is set to “0,” no volume change is caused even by changing the picking manner.

Hold

The hold function can sustain the output of the synthesizer sound. If you turn on the hold while a synthesizer sound is being output, the synthesizer sound will be held until you turn it off.

You can control the on/off of the hold using the footswitch. Normally, select “Hold Off.”

- * This parameter is used when “Square” or “Saw” is selected for the wave.

Synth Level

This determines the volume of the synthesizer sound.

Direct Level

This determines the volume of the direct sound.

■ SEQ (Sub Equalizer)

This adjusts the tone as a sub equalizer. A parametric type is adopted for the high-middle and low-middle range.

Low EQ (low equalizer)

Adjusts the low frequency range tone.

Low-Middle Frequency

Specify the center of the frequency range that will be adjusted by the “Low-Middle Q.”

Low-Middle Q

Adjusts the width of the area affected by the EQ centered at the “Low-Middle Frequency.” Higher values will narrow the area.

Low-Middle EQ (low-middle equalizer)

Adjusts the “Low-Middle Frequency” range tone.

High-Middle Frequency

Specify the center of the frequency range that will be adjusted by the “High-Middle EQ.”

High-Middle Q

Adjusts the width of the area affected by the EQ centered at the “High-Middle Frequency.” Higher values will narrow the area.

High-Middle EQ (High-middle equalizer)

Adjusts the “High-Middle Frequency” range tone.

High EQ (high equalizer)

Adjusts the high frequency range tone.

Level

Adjusts the volume after the equalizer.

NS (Noise Suppressor)

This effect reduces the noise and hum picked up by guitar pickups. Since it suppresses the noise in synchronization with the envelope of the guitar sound (the way in which the guitar sound decays over time), it has very little effect on the guitar sound, and does not harm the natural character of the sound.

- * *Please connect the noise suppressor prior to the reverb type effect. This setup will prevent unnatural break of the reverb type effect.*

Parameter	Value
On/Off	Off, On
Threshold	0–100
Release	0–100

On/Off (effect on/off)

Turns the noise suppressor effect on/off.

This parameter can be set with the PATCH/VALUE dial.

- * *Even if [NAME/NS/MASTER] is pressed, you cannot switch the noise suppressor on and off.*

Threshold

Adjust this parameter as appropriate for the volume of the noise. If the noise level is high, a higher setting is appropriate. If the noise level is low, a lower setting is appropriate. Adjust this value until the decay of the guitar sound is as natural as possible.

- * *High settings for the threshold parameter may result in there being no sound when you play with your guitar volume turned down.*

Release

Adjusts the time from when the noise suppressor begins to function until the noise level reaches “0.”

MASTER

Parameter	Value
Patch Level	0–200
Master BPM	40–250

Patch Level

This adjusts the output volume of the GT-6.

Master BPM

Adjust the BPM value for each patch.

- * *BPM (beats per minute) indicates the number of quarter note beats that occur each minute.*
- * *When you have an external MIDI device connected, the Master BPM synchronizes to the external MIDI device's tempo, making it impossible to set the Master BPM. To enable setting of the Master BPM, set "MIDI Sync Clock" (p. 65) to Internal.*

Control with the Master BPM

To input the Master BPM with the CTL pedal, set "Pedal Assign" as follows.

Quick Setting (p. 47)

CTL PEDAL: P09= BPM (TAP)

Manual Settings (p. 49)

CTL PEDAL: On

CTL PEDAL Target: Master BPM (Tap)

CTL PEDAL Target Min: Off

CTL PEDAL Target Max: On

CTL PEDAL Source Mode: Normal

FV (Foot Volume)

This is a volume control effect.

Usually, this is controlled to the expression pedal.

Parameter	Value
Level	0–100

Level

This adjusts the volume.

Chapter 5 Settings for Using the Expression and Control Pedals (Pedal Assign)

This chapter describes how to make the settings that allow you to control effects with the expression pedal and control (CTL) pedal.

Settings for Using the Expression Pedal

Normally, “FV” (Foot Volume) is assigned to the expression pedal, allowing you to use the pedal as a “volume pedal” for controlling the volume level.

Setting the Range of the Volume Change

You can set the minimum and maximum values determining the range over which the volume level changes when you move the expression pedal.

1. Press [PEDAL ASSIGN]
2. Press PARAMETER [◀] [▶] to display the following screen.
(Setting the minimum value)

```
EXP PEDAL      On
Foot Vol Min   0
```

(Setting the maximum value)

```
EXP PEDAL      On
Foot Vol Max  100
```

3. Rotate the PATCH/VALUE dial to set the value.
Valid Settings: 0–100
4. To save the settings, perform the Write procedure (p. 22).
Press [EXIT] to return to the Play screen.

MEMO

When “WAH” (Pedal Wah; p. 30), or FX-2 “PB” (Pedal Bend; p. 40) is on, the expression pedal automatically functions as a “pedal wah” or “pedal bend.”

* When Pedal Wah and Pedal Bend are off, the expression pedal automatically functions as a “volume pedal.”

If You Don't Want to Use the Expression Pedal as a “Volume Pedal”

Use the procedure below to turn the expression pedal off.

1. Press [PEDAL ASSIGN].
2. Press PARAMETER [◀] [▶] a number of times, until you have one of the following screens displayed.

```
EXP PEDAL      On
Foot Vol Min   0
```

```
EXP PEDAL      On
Foot Vol Max  100
```

3. Press [PEDAL ASSIGN] to set it to “Off.”
4. To save the settings, perform the Write procedure (p. 22).
Press [EXIT] to return to the Play screen.

Settings for Using the Expression Pedal Switch/CTL Pedal

Making Settings Instantly (Quick Setting)

Quick Setting is a function that lets you set the most appropriate values for effect parameters instantly just by selecting the preset “pedal settings.” This greatly reduces the hassle of selecting and setting parameters one by one.

Pedal Settings for the Expression Pedal Switch

Select the parameter to be controlled when you press down on the toe of the expression pedal.

- P01: WAH
- P02: FX-2
- P03: OD/DS
- P04: DELAY
- P05: CHORUS
- P06: EQ
- P07: FX-1
- P08: LEVEL INC
- P09: TUNER
- P10: MANUAL

Pedal Settings for the CTL Pedal

- P01: OD/DS
- P02: DELAY
- P03: CHORUS
- P04: EQ
- P05: FX-1
- P06: FX-2
- P07: WAH
- P08: TUNER
- P09: BPM (TAP)
- P10: MANUAL

1. Press [PEDAL ASSIGN].
2. Press PARAMETER [◀] [▶] to display the following screens.
(Expression pedal switch)

```
EXP SW      On
P01: WAH
```

(CTL pedal)

```
CTL PEDAL  On
P01: OD/DS
```

HINT

You can rapidly switch to the two screens above by holding down [▶] (or [◀]) and pressing [◀] (or [▶]).

3. Rotate the PATCH/VALUE dial to select the pedal setting.
* If not using the expression pedal or CTL pedal, select "Off."
4. Repeat Steps 2 and 3 as needed.
5. To save the settings, use the Write procedure (p. 22).
Press [EXIT] to return to the Play screen.

Editing "Quick Settings"

Whenever necessary, you can edit parameter values set in the Quick Settings.

1. Press [PEDAL ASSIGN].
2. Press PARAMETER [◀] [▶] to display the following screen.

```
Expression Pedal Switch  EXP SW      Target
Target                   wah: On/Off
```

```
Expression Pedal Switch  EXP SW      Target
Target value range: Min  Min:         Off
```

```
Expression Pedal Switch  EXP SW      Target
Target value range: Max  Max:         Off
```

```
Expression Pedal Switch  EXP SW      Source
Source Mode              Mode:       Toggle
```

```
CTL Pedal                CTL PEDAL  Target
Target                   DD : On/Off
```

```
CTL Pedal                CTL PEDAL  Target
Target value range: Min  Min:         Off
```

```
CTL Pedal                CTL PEDAL  Target
Target value range: Max  Max:         Off
```

```
CTL Pedal                CTL PEDAL  Source
Source Mode              Mode:       Toggle
```

3. Rotate the PATCH/VALUE dial to change the setting's value.
4. Repeat Steps 2 and 3 as needed.
5. To save the settings, use the Write procedure (p. 22).
Press [EXIT] to return to the Play screen.

Target

The parameter to be controlled.

Target Variation Range

This sets the range within which the parameter being controlled will change.

The range between the minimum value (Min) and the maximum value (Max) is changed.

Source Mode

This selects the function of the foot switch (p. 51)

Controlling Effects with the GT-6 Pedals, External Pedals, and External MIDI Devices

Make these settings when controlling effects with the GT-6's expression pedal or CTL pedal, or with pedals or external MIDI devices connected to the GT-6.

You can make up to eight separate settings per patch (using Assign numbers 1–8) determining what parameters are controlled by which controllers.

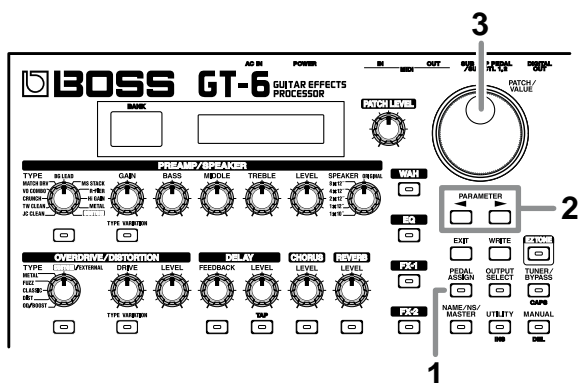

1. Press [PEDAL ASSIGN].
2. Press PARAMETER [◀] [▶] to display the following screen.

Assign On/Off	ASSIGN 1	On
Quick Setting	P01: PATCH	LEVEL
Target	ASSIGN 1	Target
	MST: Patch	Level
Target value range: Min	ASSIGN 1	Target
	Min:	0
Target value range: Max	ASSIGN 1	Target
	Max:	200
Source	ASSIGN 1	Source
	EXP	PEDAL
Source Mode	ASSIGN 1	Source
	Mode:	Normal
Action Range Low	ASSIGN 1	Source
	Act. Range	Lo: 0
Action Range High	ASSIGN 1	Source
	Act. Range	Hi: 127

3. Rotate the VALUE dial to change the setting's value.
4. Repeat Steps 2 and 3 as needed until the settings are completed.
5. To save the settings, use the Write procedure (p. 22). Press [EXIT] to return to the Play screen.

Assign ON/OFF

```
ASSIGN 1      On
P01: PATCH LEVEL
```

This selects the eight Assign ON/OFF settings (ASSIGN 1–8). Only set the assigns you will be using to “On.”

* Be sure to set any Assign settings not being used to “Off.”

Making Settings Instantly (Quick Setting)

Using Quick Setting lets you quickly finish making the settings to the parameters described below, without having to set them all individually.

As you rotate the PATCH/VALUE dial in the Assign ON/OFF screen to select the prepared pedal settings, the most appropriate values for the parameters are selected instantly.

- P01: PATCH LEVEL
- P02: PREAMP GAIN
- P03: OD/DS DRIVE
- P04: DELAY LEVEL
- P05: CHORUS LEVEL
- P06: REVERB LEVEL
- P07: MASTER BPM
- P08: SUB EXP FV
- P09: SUB EXP FW
- P10: SUB EXP PS

Target

```

ASSIGN 1 Target
FU :Level
    
```

This sets the parameter to be affected. The parameters that you can select as the target are shown below.

- Patch Level
- Patch Level Inc/Dec (how the level changes)
- Effect On/Off for each effect
- Effect parameters
- Master BPM (Tap input)
- Manual On/Off
- Tuner/Bypass On/Off
- Delay time (Tap input)
- MIDI Start/Stop
- MMC Start/Stop

* Although you can set this so that the same target is controlled by more than one controller, in such cases, make sure not to have different sources changing the parameter at the same time. Changing the parameter simultaneously using different sources may result in noise being generated.

* The receiving device's Sync Clock Mode must be set to "Remote" when MIDI Start/Stop is selected as the target.

Target Range

```

ASSIGN 1 Target
Min: 0
    
```

The value of the parameter selected as the target changes within the range defined by "Min" and "Max," as set on the GT-6.

When using a control pedal, foot switch, or other controller that acts as an on/off switch, "Min" is selected with Off (CLOSED), and "Max" is selected with On (OPEN).

When using an expression pedal or other controller that generates a consecutive change in the value, the value of the setting changes accordingly, within the range set by the minimum and maximum values.

Also, when the target is of an on/off type, the median value of the received data is used as the dividing line in determining whether to switch it on or off.

When using the foot switch:

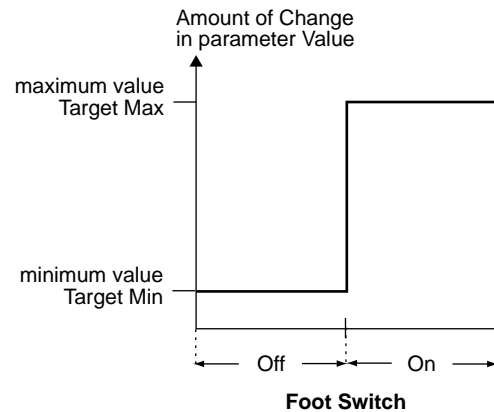

When using the expression pedal:

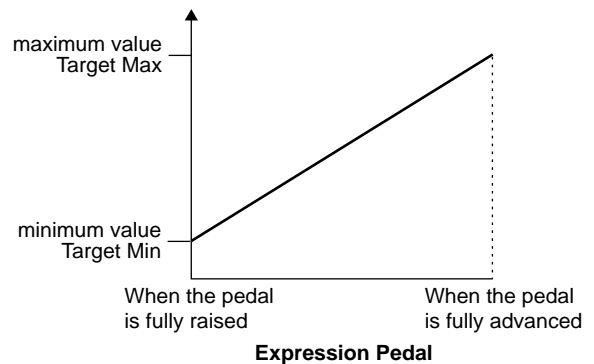

When controlling the On/Off target with the expression pedal:

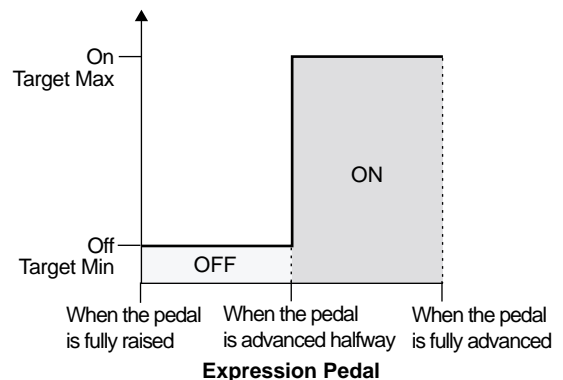

- * The range that can be selected changes according to the target setting.
- * When the "minimum" is set to a higher value than the "maximum," the change in the parameter is reversed.
- * The values of settings can change if the target is changed after the "minimum" and "maximum" settings have been made. If you've changed the target, be sure to recheck the "minimum" and "maximum" settings.

Source

```
ASSIGN 1 Source
EXP PADAL
```

This sets the controller (source) that affects the target parameter.

Controllers that can be selected as the source are shown below.

- GT-6 expression pedal
- GT-6 CTL pedal
- GT-6 expression pedal switch
- (this switch is activated when you press down on the toe of the pedal)
- External pedal connected to the SUB EXP PEDAL/SUB CTL 1, 2 jack (expression pedal or foot switch)
- Control Change messages from an external MIDI device (1–31, 64–95)

* *The CTL pedal indicator lights according to the settings made with the CTL pedal.*

Source Mode

```
ASSIGN 1 Source
Mode: Normal
```

This determines the manner in which the setting is to be changed when a momentary-type foot switch (such as the optional FS-5U) is used.

* *The GT-6's control pedal is a momentary-type pedal. Switch the settings as needed to accommodate your setup.*

Normal

The normal state is Off (minimum value), with the switch On (maximum value) only while the foot switch is depressed.

Toggle

The setting is toggled On (maximum value) or Off (minimum value) with each press of the foot switch.

* *Set this to "Normal" when a latch-type foot switch (such as the optional FS-5U) is connected, or when selecting something other than a foot switch as the controller.*

Differences Between Momentary-Type and Latch-Type Switches

When switching effects on and off with a foot switch

It does not matter whether a momentary-type or latch-type switch is used.

When using a momentary-type switch, set to "Toggle."

When using a latch-type switch, set it to "Normal."

When the effect is applied more, or is on only while the foot switch is being pressed

When using a momentary-type switch, set it to "Normal."

This allows you to change how the effect is applied as you press, or release from the foot switch.

Latch-type switches cannot function in this manner.

Active Range

```
ASSIGN 1 Source
Act. Range Lo: 0
```

```
ASSIGN 1 Source
Act. Range Hi: 127
```

This sets the operational range within which the value of the setting changes when an expression pedal or other controller that changes the value consecutively is used as the source. If the controller is moved outside the operational range, the value does not change, it stops at “minimum” or “maximum.”

(Example)

With Act. Range Lo: 40, Act. Range Hi: 80

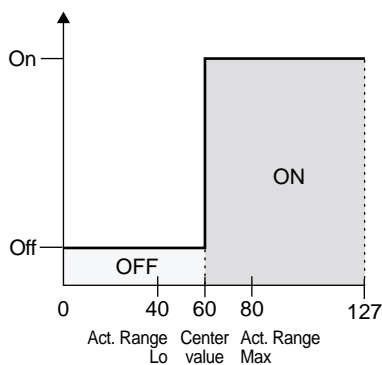
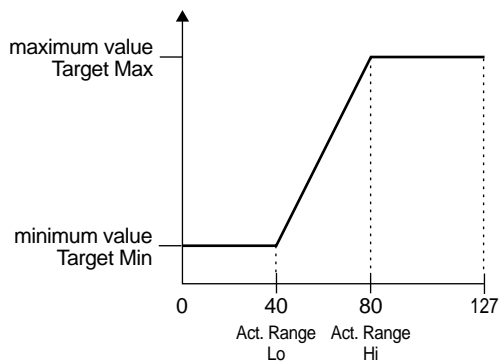

* When using a foot switch or other on/off switching controller as the source, leave these at “Lo: 0” and “Hi: 127.” With certain settings, the value may not change.

Controlling Wah and Pitch Bend with an External Expression Pedal

Make the following settings to control wah and pitch bend with an expression pedal connected to the SUB EXP PEDAL/ SUB CTL 1,2 jack.

* Set SYS: Sub CTL1 Func (p. 63) to “Assignable.”

1. Press [PEDAL ASSIGN].
2. Press PARAMETER [◀] [▶] to select from ASSIGN 1 through 8.
 - * If the indication in the upper part of the display is flashing, press [PEDAL ASSIGN] so it stops flashing, and is displayed normally.
3. Rotate the PATCH/VALUE dial to select the following settings:

Foot Volume:

P08: SUB EXP FV

Wah:

P09: SUB EXP FW

Pedal Bend:

P10: SUB EXP PS

```
ASSIGN 1 On
P08: SUB EXP FV
```

```
ASSIGN 1 On
P08: SUB EXP FW
```

```
ASSIGN 1 On
P08: SUB EXP PS
```

4. If Wah or Pitch Bend has been selected in Step 3, carry out the following.

For Wah:

Press [WAH]; “On” appears in the display.

Next, press PARAMETER [◀] [▶] to display “FX Select,” then select “FW” with the PATCH/VALUE dial.

For Pitch Bend:

Press [FX-2]; “On” appears in the display.

Next, press PARAMETER [◀] [▶] to display “FX Select,” then select “PS” with the PATCH/VALUE dial.

Chapter 6 Using the Customize Function

With the GT-6's Customize function, you can rely on your own sensibilities and create a totally new effect by tweaking the settings for the "Preamp/Speaker Simulator," "Overdrive/Distortion," and "Pedal Wah." The result can then be saved on the GT-6 as "Custom" settings.

You can also use these custom settings in other patches.

The trademarks listed in this document are trademarks of their respective owners, which are separate companies from BOSS. Those companies are not affiliated with BOSS and have not licensed or authorized BOSS's GT-6. Their marks are used solely to identify the equipment whose sound is simulated by BOSS's GT-6.

Making "Custom" Preamp Settings

You can make three different sets of settings, Custom1, Custom2, and Custom3.

* *The sound of any patch that uses Custom 1, 2, or 3 will be altered if the custom settings are edited.*

1. Turn the **PREAMP/SPEAKER TYPE** knob to "CUSTOM."
2. Press **PREAMP/SPEAKER [TYPE VARIATION]** to call up "Custom1," "Custom2," or "Custom3."

```
Preamp/SP      On
Type           Custom1
```

3. Press **[PREAMP/SPEAKER]**.
The PREAMP/SPEAKER edit screen appears.
4. Press **PARAMETER [◀] [▶]** to show the custom parameters.

```
Custom  EDIT CUSTOM 1
Type    Type      JC Clean

Custom  EDIT CUSTOM 1
Bottom  Bottom     0

Custom  EDIT CUSTOM 1
Edge    Edge      0

Custom  EDIT CUSTOM 1
Bass Frequency  Bass Freq  0

Custom  EDIT CUSTOM 1
Treble Frequency Treble Freq 0

Custom  EDIT CUSTOM 1
Preamp Low  Preamp Low 0
```

```
Custom  EDIT CUSTOM 1
Preamp High  Preamp High  0

Custom  EDIT CUSTOM 1
Speaker Low  Speaker Low  0

Custom  EDIT CUSTOM 1
Speaker High  Speaker High  0
```

5. Rotate the **PATCH/VALUE** dial to change the setting's value.
6. Repeat Steps 4 and 5 as needed.
7. Press **[EXIT]** to return to the Play screen.

Type

Selects the basic type of preamp.

JC Clean:

This is the sound of the Roland JC-120.

TW Clean:

This models a Fender Twin Reverb.

Crunch:

This is a crunch sound that can produce natural distortion.

VO Lead:

This models the drive sound of a VOX AC-30TB.

BG Lead:

This models the lead sound of the MESA/Boogie combo amp.

MS1959 Stk:

This models the sound input to Input I on a Marshall 1959.

MODERN Stk:

This models the rhythm channel of a MESA/Boogie Dual Rectifier.

Bottom -50--+50

Adjusts the amount of distortion in the low frequencies.

Edge -50--+50

Adjusts the amount of distortion in the high frequencies.

Bass Freq (Bass Frequencies) -50--+50

Adjusts the frequencies affected by the BASS knob.

Treble Freq (Treble Frequencies) -50--+50

Adjusts the frequencies affected by the TREBLE knob.

Preamp Low -50--+50

Adjusts the preamp section's low-frequency tone.

PreampHigh -50--+50

Adjusts the preamp section's high-frequency tone.

SpeakerLow -50--+50

Adjusts the speaker section's low-frequency tone.

SpeakerHigh -50--+50

Adjusts the speaker section's high-frequency tone.

Making "Custom" Overdrive/ Distortion Settings

Here you can make two different sets of settings, Custom 1 and Custom 2.

* Any patch tone using Custom 1 or 2 will be altered if the custom settings are edited.

1. Turn the OVERDRIVE/DISTORTION TYPE knob to "CUSTOM/EXTERNAL."
2. Press OVERDRIVE/DISTORTION [TYPE VARIATION] to call up "Custom1" or "Custom2."

```

Ovrdrive/Dst On
Type          Custom1
  
```

3. Press [OVERDRIVE/DISTORTION].
The OVERDRIVE/DISTORTION edit screen appears.
4. Press PARAMETER [◀] [▶] to show the custom parameters.

```

Custom  EDIT CUSTOM 1
Type    Type          OD-1

Custom  EDIT CUSTOM 1
Bottom Bottom          0

Custom  EDIT CUSTOM 1
Top     Top            0

Custom  EDIT CUSTOM 1
Low     Low            0

Custom  EDIT CUSTOM 1
High    High           0
  
```

5. Rotate the PATCH/VALUE dial to change the setting's value.
6. Repeat Steps 4 and 5 as needed.
7. Press [EXIT] to return to the Play screen.

Type

Selects the basic speaker type.

OD-1:

This is the sound of the BOSS OD-1.

OD-2:

This is the sound of the BOSS OD-2.

CRUNCH:

This is a crunch sound of the BOSS BD-2.

DS-1:

This gives a basic, traditional distortion sound.

DS-2:

This creates a heavier distortion sound.

METAL1:

This is the sound of the BOSS MT-2.

METAL2:

This gives a heavy metal sound.

FUZZ:

This models a FUZZFACE.

Bottom -50--+50

Adjusts the amount of distortion in the low frequencies.

Top -50--+50

Adjusts the amount of distortion in the high frequencies.

Low -50--+50

Adjusts low-frequency tone.

High -50--+50

Adjusts the high-frequency tone.

Making “Custom” Pedal Wah Settings

You can make three different sets of settings, Custom 1, Custom 2, and Custom 3.

* Any patch tone using Custom 1, 2, or 3 will be altered if the custom settings are edited.

1. Press [WAH].
The WAH edit screen appears.
2. Press PARAMETER [◀] [▶] to select “FX Select,” then rotate the PATCH/VALUE dial to select “WAH” or “FW.”
3. Press PARAMETER [◀] [▶] until “Type” appears in the display.
4. Rotate the PATCH/VALUE dial to select from “Custom1-3.”

```
Pedal Wah      On
Type           Custom1
```

5. Press PARAMETER [◀] [▶] to show the custom parameters.

```
Custom EDIT CUSTOM 1
Type   Type       CRY WAH

Custom EDIT CUSTOM 1
Q      Q           0

Custom EDIT CUSTOM 1
Range Low Range Low  0

Custom EDIT CUSTOM 1
Range High Range High 0

Custom EDIT CUSTOM 1
Presence  Presence  0
```

6. Rotate the PATCH/VALUE dial to change the setting's value.
7. Repeat Steps 3 through 5 as needed.
8. Press [EXIT] to return to the Play screen.

Type

Selects the basic type of wah.

CRY WAH:

This models the sound of the CRY BABY wah pedal popular in the '70s.

VO WAH:

This models the sound of the VOX V846.

Fat WAH:

This a wah sound featuring a bold tone.

Light WAH:

This wah has a refined sound with no unusual characteristics.

7String WAH:

Wah featuring a broader range of variations for the seven-string guitar.

Q -50+50

Adjusts the amount of characteristic effect applied to the wah tone.

Range Low -50+50

Selects the tone produced when the pedal is released.

Range High -50+50

Selects the tone produced when the pedal is stepped on.

Presence -50+50

Adjusts the tonal quality of the wah effect.

Chapter 7 Convenient Features of the GT-6

Quick Patch Volume Adjustment (PATCH LEVEL Knob)

For quick and easy adjustment of the current patch's volume, use the PATCH LEVEL knob.

You can turn the PATCH LEVEL knob to control the patch level of the currently selected patch.

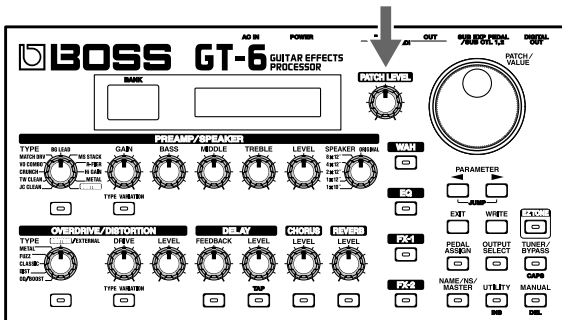

* The patch level that's been arrived at using the PATCH LEVEL knob is saved when the Write procedure (p. 22) is carried out.

Turning the Effects On and Off with the Pedals (Manual Mode)

The GT-6 features a Manual mode, in which the pedals are used for switching specified effects on and off.

In Manual mode, you can switch effects on and off without changing the patch number.

Switching to Manual Mode

The GT-6 switches Manual mode on or off each time [MANUAL] is pressed.

When Manual mode is on, the following appears in the display.



Selecting the Effect to Be Switched On and Off With the Pedals

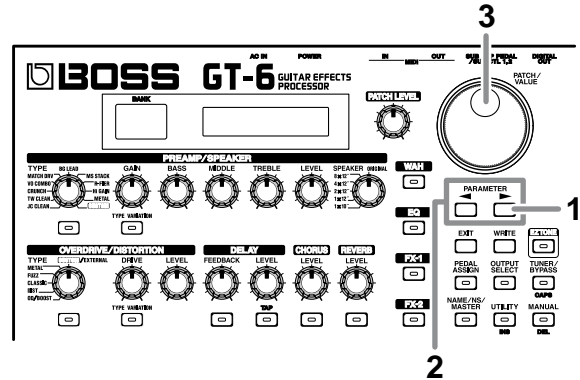

1. When Manual mode is on, press PARAMETER [▶] to display the following screen.



2. Press PARAMETER [◀] [▶] to move the cursor to the number for the pedal whose settings you want to change.
3. Rotate the VALUE dial to select the effect to be assigned to the pedal.
4. Repeat Steps 2 and 3 to select the effects assigned to each pedal.

Comparing Preamp Tones in Manual Mode

You can use the “Amp Switch Mode” setting to compare preamp tones before and after they are edited.

Press the pedal to which the preamp is assigned, switching it on to get to the preamp tone set in the patch, and switching it off to hear the preamp tone as it is with the current knob settings.

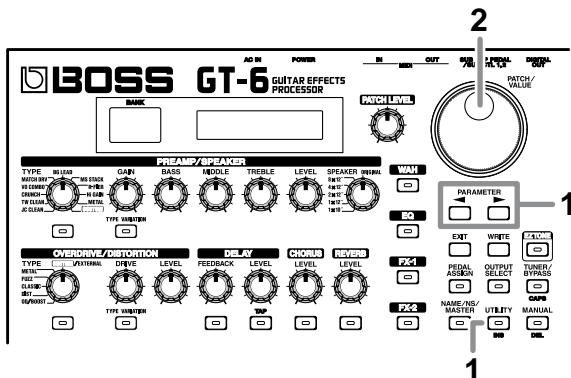

1. Press [UTILITY], then press PARAMETER [◀] [▶] to call up “Amp Switch.”

```
SYS: Amp Switch
      Amp On/Off
```

2. Rotate the VALUE dial to set Amp Switch Mode.

Amp On/Off:

Switches the preamp on and off.

Toggle to Knobs:

When the indicator for the pedal to which the preamp is assigned remains lit, the tone uses the settings in effect prior to switching to Manual mode; when the indicator flashes, the tone settings conform to the current knob positions.

* This has no effect when the preamp is set to OFF.

3. Press [EXIT] to return to the Play screen.

Tuning the Guitar

When the Tuner/Bypass is turned on, sounds input to the GT-6 are output directly as is (bypassed), and the tuner is activated.

Under these conditions you can then tune your guitar.

Turning the Tuner/Bypass Function On

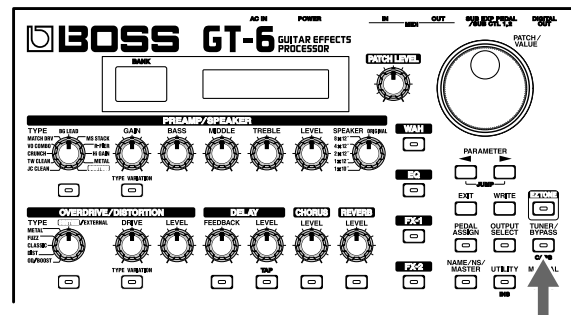

Each time [TUNER/BYPASS] is pressed, the Tuner/Bypass is switched on or off.

The [TUNER/BYPASS] button's indicator lights when the function is on.

About the Display During Tuning

With the GT-6's internal tuner, the note name is indicated in the upper row of the display and the Tuning Guide is shown in the lower row, indicating the difference between the input sound and the sound in the display.

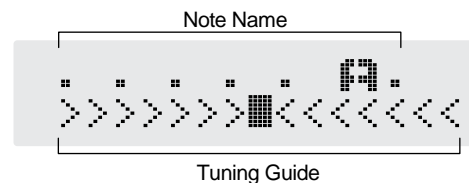

When the difference from the correct pitch falls within 50 cents, the Tuning Guide then indicates the size of that difference. As you watch the Tuning Guide, tune the guitar so that the “■” appears in the center.

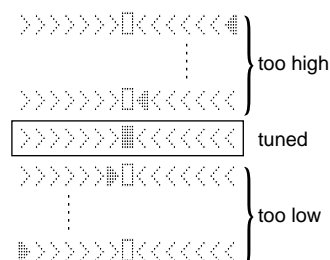

How to Tune

1. Play a single open note on the string being tuned.
The name of the note closest to the pitch of the string that was played appears in the display.
* Only play a single note on the one string being tuned.
2. Tune the string until the string name appears in the display.

	7th	6th	5th	4th	3rd	2nd	1st
Regular	B	E	A	D	G	B	E
1/2 Step Down	A#	D#	G#	C#	F#	A#	D#
1 Step Down	A	D	G	C	F	A	D

3. As you watch the Tuning Guide, adjust the guitar's tuning until "■" appears in the center.
4. Repeat Steps 1-3 until all of the strings are tuned.
* When tuning guitars equipped with a tremolo bar, when one string is tuned, the others may end up being out of tune. In this case, tune to the pitch indicated by the initial note name, then tune the other strings again, repeatedly fine-tuning each string.

Changing the Tuner Settings

You can change the following tuner-related settings.

Standard Pitch (435-445 Hz)

TUNER Pitch
A = 440Hz

The frequency of A4 (the middle A on a piano keyboard) played by an instrument (such as a piano) that provides the pitch to which the other instruments refer in tuning before a performance begins is called the standard pitch. You can set the standard pitch on the GT-6 from 435 to 445 Hz.

* This is set to 440 Hz when shipped from the factory.

Volume Settings with Tuner/Bypass (Mute, Bypass)

TUNER Out.
Bypass

This selects the output while Tuner/Bypass is on.

Mute:

Sounds are muted, and no sound is output.

Bypass:

Sounds input to the GT-6 bypass the processing and are output directly as is.

- * This is set to "Bypass" when shipped from the factory.
- * When this is set to "Bypass," and Tuner/Bypass is set to ON, you can adjust the volume of the direct sound by operating the expression pedal.

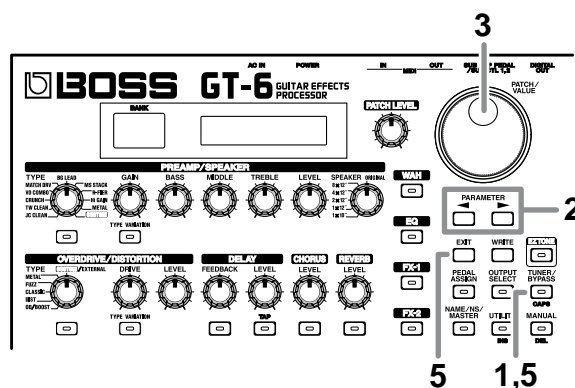

1. Press [TUNER/BYPASS]; the indicator lights up.
2. Press PARAMETER [◀] [▶] until you have either "TUNER Pitch" or "TUNER Out" displayed.
3. Rotate the VALUE dial to change the settings.
4. Repeat Steps 2 and 3 to change each parameter's settings.
5. Press [TUNER/BYPASS] or [EXIT] to return to the Play screen.

Switching Tuner/Bypass On and Off with the Number Pedals

If you wish, the GT-6 can also be set so the number pedals can be used to switch Tuner/Bypass on and off.

1. Press [UTILITY], then press PARAMETER [◀] [▶] so that “SYS: Pdl Tuner SW” is displayed.

```
SYS:Pdl Tuner SW
Off
```

2. Rotate the PATCH/VALUE dial to turn the switch on.
3. Press [EXIT] to return to the Play screen.
Tuner/Bypass is switched on when you press the pedal with the same number as the currently selected patch number. Press the pedal once more to turn it off.



Switching Tuner/Bypass On and Off with the CTL Pedal

With the Pedal Assign settings (p. 47), using Quick Settings to set the pedal setting P08= TUNER allows you to switch Tuner/Bypass on and off with the CTL pedal.

Switching Tuner/Bypass On and Off by Lifting Up on the Expression Pedal

When the expression pedal is functioning as a Foot Volume control, set one of the ASSIGN 1–8 Pedal Assign settings (p. 49) to one of the following settings.

Target: TUNER On/Off

Target Min: On

Target Max: Off

Source: EXP PEDAL

Mode: Normal

Act. Range Lo: 0

Act. Range Hi: 1–127

With this setting, you can switch on Tuner/Bypass by drawing back the expression pedal.

Adjusting the Overall Sound to Match the Usage Environment (Global)

The GT-6 includes a feature that allows you to change all of the pitch settings temporarily. This is called the “Global function.”

With the Global function, you can temporarily change your settings to match those of your equipment and the operating environment, while leaving the settings in the patches untouched.

1. Press [UTILITY], then press PARAMETER [◀] [▶] to display the following screen.

Global Low Equalizer	GLOBAL:Low EQ	0dB
Global High Equalizer	GLOBAL:High EQ	0dB
Global Noise Suppressor Threshold	GLOBAL:NS Threshold	0dB
Global Reverb Level	GLOBAL:Reverb Level	100%

2. Rotate the PATCH/VALUE dial to change the setting's value.
3. Repeat Steps 1 and 2 as needed.
4. Press [EXIT] to return to the Play screen.

Low EQ (Low Equalizer) -20 dB--+20 dB

Adjusts the tone in the low frequencies.

- * This adjusts the tone regardless of the equalizer on/off settings of individual patches.

High EQ (High Equalizer) -20 dB--+20 dB

Adjusts the tone in the high frequencies.

- * This adjusts the tone regardless of the individual patch equalizer on/off settings.

NS Threshold (Noise Suppressor Threshold) -20 dB--+20 dB

Adjusts the noise suppressor threshold level settings for each patch in a range from -20 dB to +20 dB.

This adjustment is an effective way to get equivalent output with each of your guitars when you are connecting more than one guitar.

- * Set to “0 dB” when using this in individual patch settings.
- * This has no effect on patches in which the noise suppressor is turned off.

Reverb Level 0%–200%

Adjusts the reverb level settings for each patch in a range from 0% to 200%.

Adjusting the reverb level is an effective way to match the reverberation of the performance venue.

- * Set to “100%” when using this in individual patch settings.
- * This has no effect on patches in which reverb is turned off.

Using External Effect Processors

You can use external effect processors connected to the EXTERNAL jack on the rear panel in place of the GT-6’s overdrive and distortion.

In order to use external effect processors, the OVERDRIVE/DISTORTION TYPE must be set to “External.”

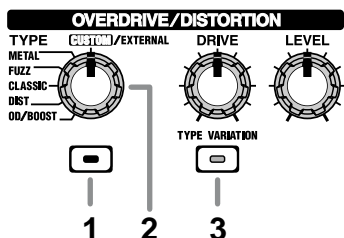

1. Press [OVERDRIVE/DISTORTION]; the indicator lights up.
2. Turn the OVERDRIVE/DISTORTION TYPE knob to CUSTOM/EXTERNAL.
3. Press OVERDRIVE/DISTORTION [TYPE VARIATION] a number of times until the indicator lights green and “External” is displayed.

Ovrdrive/Dst On
External

4. Press [EXIT] to return to the Play screen.
 - You can adjust the level of the signal sent to the external effect processor (the send level) with the OVERDRIVE/DISTORTION DRIVE knob.
 - You can adjust the level of the signal sent back from the external effect processor (the return level) with the OVERDRIVE/DISTORTION LEVEL knob.

Using the Digital Outs

Digital signals are output from the DIGITAL OUT connector on the rear panel. You can connect this directly to the digital in connector of a digital recorder or other device and record with no degradation in sound quality.

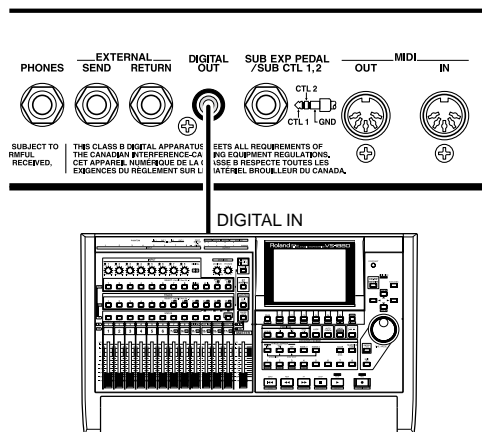

Checking the Effect Output Level with the Level Meter

You can meter the output level of each effect. This is handy for checking the effects’ output levels.

1. Press [UTILITY] a number of times until “METER” is displayed.
 - * You can also select this by pressing [UTILITY], and then pressing PARAMETER [◀] [▶].

METER: Input

2. Rotate the PATCH/VALUE dial to select the effect whose level you want to check.
 - * Only effects that are turned on can be selected.
 - * You can check the level of signals being input to the INPUT jack by selecting “Input.” Selecting “Output” allows you to check the level of signals output from the GT-6.
 - * You may not be able to achieve the effects you envision if your output levels are set too high. Adjust the output level of each of your effects to the optimum value while checking the meter and making sure the needle doesn’t swing too far to the right.
3. Press [EXIT] to return to the Play screen.

Chapter 8 Other Features

Adjusting the Display Contrast (LCD Contrast)

Depending on where the GT-6 is placed, the display (on the right) may become difficult to read. If this occurs, adjust the display contrast.

1. Press [UTILITY] a number of times until “LCD Contrast” is displayed.

* You can also select this by pressing [UTILITY], and then pressing PARAMETER [◀] [▶].

```
SYS:LCD Contrast
16
```

2. Rotate the PATCH/VALUE dial to adjust the contrast.
Valid Settings: 1–16
3. Press [EXIT] to return to the Play screen.

Selecting the PATCH/VALUE Dial Function (Dial Function)

This setting determines whether or not rotating the PATCH/VALUE dial switches the patches.

1. Press [UTILITY], then press PARAMETER [◀] [▶] so that “Dial Func” is displayed.

```
SYS:Dial Func
PATCH No.& VALUE
```

2. Rotate the PATCH/VALUE dial to select the PATCH/VALUE dial function.

PATCH No.& VALUE:

The dial is used both for switching patches and changing the value of settings. In addition to switching patches with the pedals, you can also switch them by rotating the PATCH/VALUE dial.

VALUE Only:

The dial is used only for changing the values of settings.

3. Press [EXIT] to return to the Play screen.

Setting the Timing Used for Switching Patches (Patch Change Mode)

This sets the timing with which the GT-6 switches to the next patch when switching patches with the pedals.

1. Press [UTILITY], then press PARAMETER [◀] [▶] so that “Patch Change” is displayed.

```
SYS:Patch Change
Wait for a NUM.
```

2. Rotate the PATCH/VALUE dial to set the timing for switching patches.

Immediate:

The patch switches the instant a BANK pedal or any of the number pedals is pressed.

Wait for a NUM. :

Although the indication in the display is updated to reflect the change in the bank when a BANK pedal is pressed, the patch doesn't get changed at that point. The actual change to the newly selected patch takes place only after a number pedal has been pressed, and a complete bank and number combination has thus been entered.

3. Press [EXIT] to return to the Play screen.

Limiting the Banks That Can Be Switched (Bank Extent)

By setting an upper limit to the banks, thus limiting the range of banks that can be switched, you can set the GT-6 so that only the patches you need can be selected.

1. Press [UTILITY], then press PARAMETER [◀] [▶] so that “Bank Extent” is displayed.

```
SYS:Bank Extent
85
```

2. Rotate the PATCH/VALUE dial to set the upper limit for the banks.
Valid Settings: 1–85

3. Press [EXIT] to return to the Play screen.

Setting “Expression Pedal Hold”

This setting determines whether or not the Pedal Assign’s (p. 47) operational status is carried over to the next patch when patches are switched.

* *Expression Pedal Hold does not function if the Assign Source mode is set to Toggle (whereby the value is toggled between Min and Max each time the pedal is pressed).*

1. Press [UTILITY], then press PARAMETER [◀] [▶] so that “EXP Pdl Hold” is displayed.

```
SYS:EXP Pdl Hold
                On
```

2. Rotate the PATCH/VALUE dial to set Expression Pedal Hold.

On: The Pedal Assign status is carried over.

(Example)

If a patch is switched while the volume is being controlled with the expression pedal, the volume of the subsequent patch will take on the value determined by the current pedal position (angle).

If the patch switched to has the expression pedal controlling the wah effect, then the volume assumes the value set in the patch, and the patch’s wah effect is given the value derived from the current pedal position (angle).

Off: The Pedal Assign status is not carried over.

(Example)

If a patch is switched while the volume is being controlled with an expression pedal, the volume of the subsequent patch is set to the value set in that patch.

If the expression pedal is operated, and that information is transmitted to the GT-6, the volume will change in accord with the pedal’s movement.

3. Press [EXIT] to return to the Play screen.

Setting the Knob Functions (Knob Mode)

This sets the way the values of settings are changed when the control knobs are turned.

1. Press [UTILITY], then press PARAMETER [◀] [▶] so that “Knob Mode” is displayed.

```
SYS:Knob Mode
                Immediate
```

2. Rotate the PATCH/VALUE dial to set the Knob mode.

Immediate:

Turning the knobs immediately changes the values.

Current Setting:

Values begin to change only once the knob position reaches the values set in the patch.

3. Press [EXIT] to return to the Play screen.

Setting the External Foot Switch Functions (SUB CTL 1, 2 Function)

This sets the foot switch functions for “Sub Control 1” and “Sub Control 2” when you have an external foot switch connected to the rear panel’s SUB EXP PEDAL/SUB CTL1,2 jack.

- * When connecting two foot switches using the special optional Roland PCS-31 connector cord, the foot switch connected with the white-banded plug functions according to the Sub Control 1 settings, and the foot switch connected with the red-banded plug functions according to the Sub Control 2 settings.
- * When you have only one foot switch connected, the Sub Control 1 settings are used.

1. Press [UTILITY], then press PARAMETER [◀] [▶] so that “SubCTL 1 Func” or “SubCTL 2 Func” is displayed.

```
SYS: SubCTL1 Func
    Assignable
```

```
SYS: SubCTL2 Func
    Assignable
```

2. Rotate the PATCH/VALUE dial to set the Knob mode.

Assignable:

The controller set in each patch’s Pedal Assign is used.

MANUAL On/Off:

The foot switch is used as a manual On/Off switch.

Use a momentary-type foot switch (such as the optional FS-5U).

TUNER On/Off:

The foot switch is used as a tuner On/Off switch.

Use a momentary-type foot switch (such as the optional FS-5U).

MIDI Start/Stop:

The foot switch is used for starting and stopping a connected MIDI device (for example a sequencer).

MMC Play/Stop:

The foot switch is used for controlling Play and Stop for the connected MIDI device (such as a hard disk recorder).

3. Press [EXIT] to return to the Play screen.

Chapter 9 Using MIDI

What Can You Do with MIDI?

You can perform the following operations using MIDI with the GT-6.

- * *The use of MIDI requires that the MIDI channels of the connected devices match. If the MIDI channel settings are not correct, the GT-6 will be unable to exchange data with other MIDI devices.*

Operating From the GT-6

Outputting Program Change Messages

When a patch is selected on the GT-6, a Program Change message corresponding to the patch number is transmitted simultaneously. The external MIDI device then switches its settings according to the Program Change message it receives.

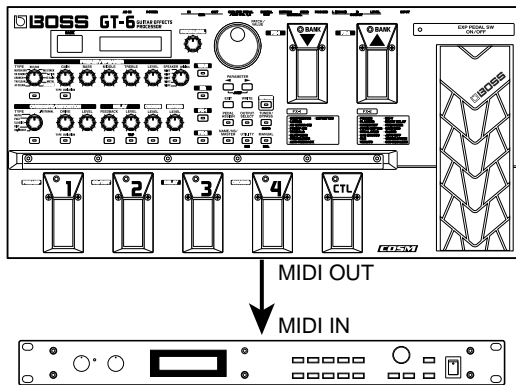

Outputting Control Change Messages

Data describing the actions of the CTL pedal, expression pedal, expression pedal switch, and external devices connected to the SUB EXP PEDAL/SUB CTL 1,2 jack are output as Control Change messages. Such messages can be used to (among other things) manipulate the parameters of an external MIDI device.

Transmitting Data

You can use Exclusive messages to transmit the settings for effect sounds and other content stored in the GT-6 to other MIDI devices. For example, you can provide another GT-6 with the same settings, and save effect sound settings to a sequencer or other device.

Remotely Controlling the GT-6 Using an External MIDI Device

Switching Patch Numbers

When the GT-6 receive Program Change messages from the external MIDI device, its patches are simultaneously switched.

MEMO

You can set up the correspondence between MIDI Program Change messages and the GT-6's patches using the Program Change Map (p. 69). You may need to work on these correspondences when you want to line up some effects in combination with other MIDI devices.

The connections shown in the figure below are for a sequencer automatically performing the backing as a guitar is being played. The patches are switched automatically when the program numbers corresponding to the patches are input along with the performance data at the points where you have determined the GT-6 patches are to be switched.

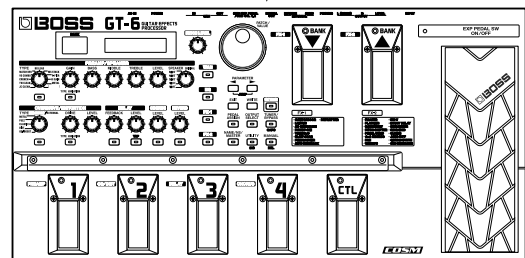
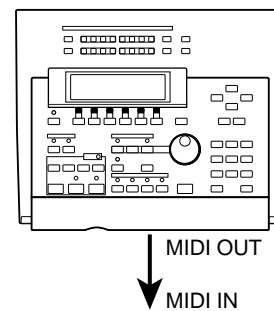

Receiving Control Change Messages

MEMO

You can control specified parameters during a performance by having the GT-6 receive Control Change messages. Parameters to be controlled are set with Pedal Assign (p.47).

Receiving Data

The GT-6 can receive data transmitted from another GT-6, as well as data that's been stored on a sequencer.

Making the Settings for MIDI Functions

Here is a description of the GT-6's MIDI functions. Set them as needed, depending on the intended use.

1. Press [UTILITY] a number of times until the following screen appears.

```
MIDI:RX Channel
Channel = 1
```

2. Press PARAMETER [◀] [▶] so that the parameter that you want to set appears in the display.
3. Rotate the PATCH/VALUE dial to change the setting's value.
4. Repeat Steps 2 and 3 as needed.
5. Press [EXIT] to return to the Play screen.

MIDI RX Channel (MIDI Receive Channel) 1-16

```
MIDI:RX Channel
Channel = 1
```

This sets the MIDI channel used for receiving MIDI messages.

* This is set to "1" when shipped from the factory.

MIDI Omni Mode Omni Off, Omni On

```
MIDI:Omni Mode
Omni On
```

When set to "Omni On," messages are received on all channels, regardless of the MIDI channel settings.

* Even when Omni Mode is set to ON, the only Exclusive messages received are for Device ID data set with "Device ID."

* This is set to "Omni On" when shipped from the factory.

MIDI TX Channel (MIDI Transmit Channel) 1-16, Rx

```
MIDI:TX Channel
Channel = Rx
```

This sets the MIDI Transmit channel used for transmitting MIDI messages. When set to "Rx," this MIDI channel is same as the MIDI Receive channel.

* This is set to "Rx" when shipped from the factory.

MIDI Device ID 1-32

```
MIDI:Device ID
ID = 1
```

This sets the Device ID used for transmitting and receiving Exclusive messages.

* This is set to "1" when shipped from the factory.

MIDI Sync Clock Auto, Internal

```
MIDI:Sync Clock
Auto
```

You can synchronize the performance of a sequencer or other external MIDI device.

Auto: When the MIDI Clock of the external MIDI device is not being received, the performance is synchronized to the tempo set in MASTER BPM; when the external MIDI device's MIDI Clock is being received, the performance is synchronized to that.

Internal: The performance is synchronized to the tempo set in MASTER BPM.

* This is set to "Auto" when shipped from the factory.

* When you have an external MIDI device connected, the Master BPM is then synchronized to the external MIDI device's tempo, thus disabling the Master BPM setting. To enable setting of the Master BPM, set to "Internal."

* When synchronizing performances to the MIDI Clock signal from an external MIDI device, timing problems in the performance may occur due to errors in the MIDI Clock.

MIDI PC OUT (MIDI Program Change Out) Off, On

```
MIDI:PC OUT
On
```

This setting determines whether or not Program Change messages are output when patches are switched on the GT-6.

Off: Program Change messages are not output, even when patches are switched.

On: Program Change messages are simultaneously output when patches are switched.

* On the GT-6, Bank Select messages are output simultaneously with Program Change messages. For more details, refer to "Changing patches using bank select messages" (p. 72).

MIDI EXP OUT (MIDI Expression Pedal Out)

Off, 1-31, 33-95

```
MIDI:EXP OUT
CC# 7
```

This sets the controller number when expression pedal operation data is output as Control Change messages. When set to "Off," Control Change messages are not output.

MIDI EXP SW OUT (MIDI Expression Pedal Switch Out)

Off, 1-31, 33-95

```
MIDI:EXP SW OUT
CC#81
```

This sets the controller number when expression pedal switch operation data is output as Control Change messages. When set to "Off," Control Change messages are not output.

MIDI CTL OUT (MIDI Control Pedal Out)

Off, 1-31, 33-95

```
MIDI:CTL OUT
CC#80
```

This sets the controller number when CTL pedal operation data is output as Control Change messages. When set to "Off," Control Change messages are not output.

MIDI SUB CTL 1 OUT (MIDI Sub Control 1 Out)

Off, 1-31, 33-95

```
MIDI:SubCTL1 OUT
Off
```

This sets the controller number when operation data from the external pedal connected to the SUB CTL 1 jack is output as Control Change messages. When set to "Off," Control Change messages are not output.

MIDI SUB CTL 2 OUT (MIDI Sub Control 1 Out)

Off, 1-31, 33-95

```
MIDI:SubCTL2 OUT
Off
```

This sets the controller number when operation data from the external pedal connected to the SUB CTL 2 jack is output as Control Change messages. When set to "Off," Control Change messages are not output.

Transmitting and Receiving MIDI Data

On the GT-6, you can use Exclusive messages to provide another GT-6 with identical settings, and save effect settings on a sequencer or other device.

Transmitting data this way is called “Bulk Dump,” while receiving such data is referred to as “Bulk Load.”

Transmitting Data to an External MIDI Device (Bulk Dump)

The following types of data can be transmitted. You can transmit data by specifying the range from the start to the end of transmission.

Displayed	Data Transmitted
System	Utility Parameters, Harmonist scales, Auto Riff phrases, and Preamp, Overdrive/Distortion, and Wah Custom Edit parameter settings
#1-1- #35-4	Settings for Patch Number 1-1 through 35-4
Temp	Settings for the patch the is currently called up

Making the Connections

When Saving to a MIDI Sequencer

Connect as shown in the figure below, and put the sequencer in the state where it is ready to receive Exclusive messages.

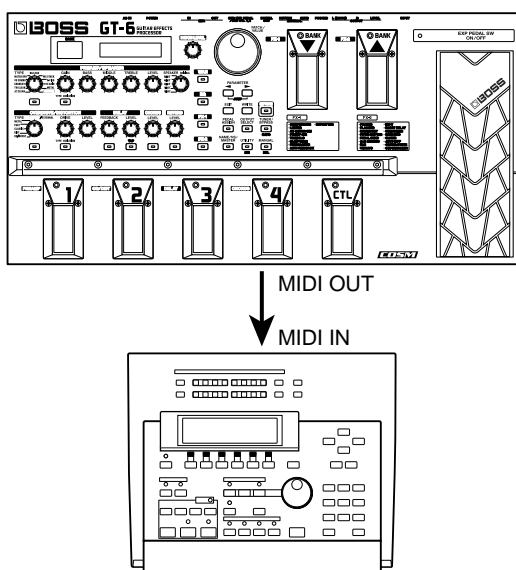

* For instructions on operating the sequencer, refer to the owner's manual for the sequencer you are using.

When Transmitting Data to Another GT-6

Connect as shown in the figure below, and match the Device ID for the transmitting and receiving devices.

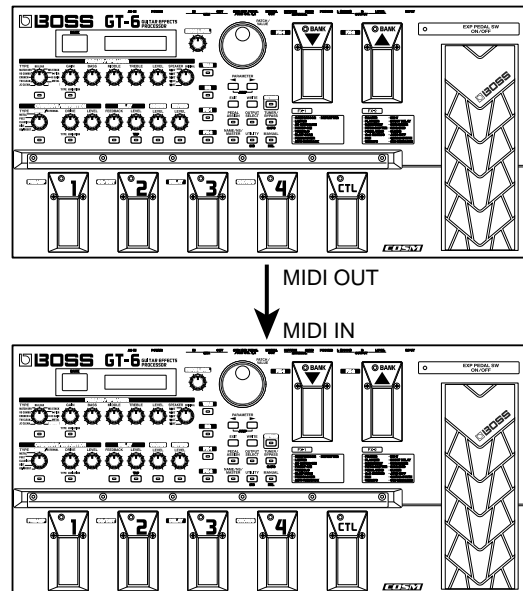

Transmitting

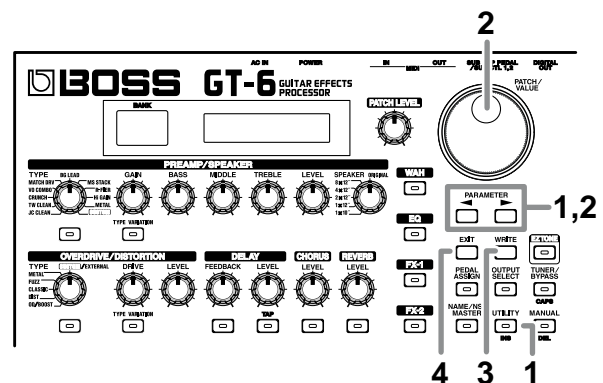

1. Press [UTILITY], then press PARAMETER [◀] [▶] so that “Bulk Dump” is displayed.

MIDI: Bulk Dump
System Temp

2. Press PARAMETER [◀] [▶] to move the cursor, and rotate the PATCH/VALUE dial to select the start and end of the data to be transmitted.
3. When the data to be sent has been determined, press [WRITE].

The data is transmitted.

MIDI: Bulk Dump
Data Dumping...

When the transmission is completed, the screen prior to transmission returns to the display.

4. Press [EXIT] to return to the Play screen.

Receiving Data from an External MIDI Device (Bulk Load)

Making the Connections

When Receiving Data Saved on a MIDI Sequencer

Connect as shown below. Set the GT-6's Device ID to the same number that was used when the data was transmitted to the MIDI sequencer.

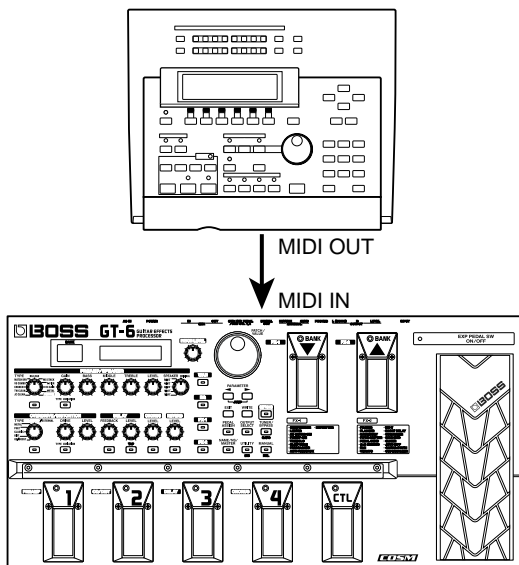

* For instructions on operating the sequencer, refer to the owner's manual for the sequencer you are using.

Receiving

1. Press [UTILITY], then press PARAMETER [◀] [▶] so that "Bulk Load" is displayed.

MIDI: Bulk Load
Waiting...

2. Transmit the data from the external MIDI device.
The following appears in the display when the GT-6 receives the data.

MIDI: Bulk Load
Receiving...

The following appears in the display when the GT-6 finishes receiving the data.

MIDI: Bulk Load
Idling...

At this stage, even more data can be received.

3. Press [EXIT] to quit Bulk Load.

After you press [EXIT], "Checking..." appears in the display, indicating that the GT-6 is checking the received data. When the check is completed, the Play screen returns to the display.

Setting the Program Change Map

When switching patches using Program Change messages transmitted by an external MIDI device, you can freely set the correspondence between Program Change messages received by the GT-6 and the patches to be switched to in the “Program Change Map.”

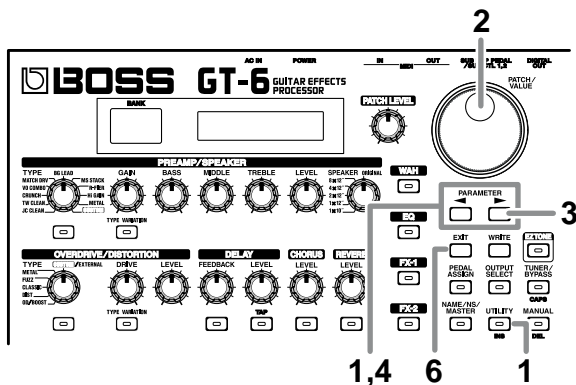

1. Press [UTILITY], then press PARAMETER [◀] [▶] so that “MIDI Map Select” is displayed.

MIDI:Map Select
Fix

2. Rotate the PATCH/VALUE dial to select “Prog.”
 - * You cannot set the Program Change Map when “Fix” is selected (it is not displayed).
 - * See below for more on “MIDI Map Select.”
3. Press PARAMETER [▶] until “MIDI Program Map” appears in the display.

MIDI:Program Map
B#0 PC# 1→ 1-1

↑ Bank Select Number ↑ Program Number ↑ Patch Number

4. Press PARAMETER [◀] [▶] to move the cursor, and rotate the PATCH/VALUE dial to set the received Program number and the corresponding patch number.
 - * Use this same procedure to select Bank Select Numbers.
 - * When using only Program Change messages to make program changes, without using Bank Select messages, set the Program number (1–128) when the Bank Select number is “0.”

5. Repeat Step 4 as needed, setting patch numbers to their corresponding Program numbers, until the Program Change Map is completed.
6. Press [EXIT] to return to the Play screen.

Enabling/Disabling the Program Change Map Settings (MIDI Map Select)

This setting determines whether patches are switched according to the Program Change Map settings, or to the default settings.

1. Press [UTILITY], then press PARAMETER [◀] [▶] so that “MIDI Map Select” is displayed.

MIDI:Map Select
Fix

2. Rotate the PATCH/VALUE dial to select “Fix” or “Prog.”

Fix:

Switches to the patches according to the default settings.

For more on the default settings, refer to “Changing patches using bank select messages” (p. 72).

Prog:

Switches to the patches according to the Program Change Map.

3. Press [EXIT] to return to the Play screen.

Appendices

About MIDI

MIDI is an acronym for Musical Instrument Digital Interface, and is a world-wide standard for allowing electronic musical equipment to communicate by transmitting messages such as performance information and sound selections. Any MIDI equipped device is able to transmit applicable types of data to another MIDI equipped device, even if the two devices are different models or were made by different manufacturers.

In MIDI, performance information such as playing a key or pressing a pedal are transmitted as MIDI Messages.

How MIDI messages are transmitted and received

First, we will explain briefly how MIDI messages are transmitted and received.

MIDI connectors

The following types of connector are used to convey MIDI messages. MIDI cables are connected to these connectors as needed.

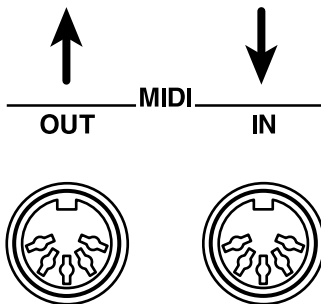

MIDI IN: This connector receives messages from another MIDI device.

MIDI OUT: This connector transmits messages from this device.

MIDI THRU: This connector re-transmits the messages that were received at MIDI IN.

* *The GT-6 features both "MIDI IN" and "MIDI OUT" connectors.*

MIDI channels

MIDI is able to independently control more than one MIDI device over a single MIDI cable. This is possible because of the concept of MIDI channels.

The idea of MIDI channels is somewhat similar to the idea of television channels. By changing channels on a television set, you can view a variety of programs. This is because the information of a particular channel is received when the channels of the transmitter and receiver match.

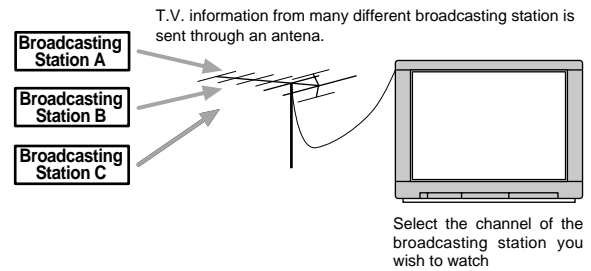

MIDI has sixteen channels 1 – 16, and MIDI messages will be received by the instrument (the receiving device) whose channel matches the channel of the transmitter.

* *If **omni mode** is on, data of all MIDI channels will be received regardless of the MIDI channel setting. If you do not need to control a specific MIDI channel, you may set **Omni On**.*

Main types of MIDI message used by the GT-6

MIDI includes many types of MIDI messages that can convey a variety of information. MIDI messages can be broadly divided into two types; messages that are handled separately by MIDI channel (channel messages), and messages that are handled without reference to a MIDI channel (system messages).

Channel messages

These messages are used to convey performance information. Normally these messages perform most of the control. The way in which a receiving device will react to each type of MIDI message will be determined by the settings of the receiving device.

Program change messages

These messages are generally used to select sounds, and include a program change number from 1 to 128 which specifies the desired sound. The GT-3 also allows you to select any of the 340 different patch numbers in conjunction with bank select messages; a type of control change message.

Control change messages

These messages are used to enhance the expressiveness of a performance. Each message includes a controller number, and the settings of the receiving device will determine what aspect of the sound will be affected by control change messages of a given controller number.

The specified parameters can be controlled with the GT-6.

System messages

System messages include exclusive messages, messages used for synchronization, and messages used to keep a MIDI system running correctly.

Exclusive messages

Exclusive messages handle information related to a unit's own unique sounds, or other device-specific information.

Generally, such messages can only be exchanged between devices of the same model by the same manufacturer.

Exclusive messages can be employed to save the settings for effects programs into a sequencer, or for transferring such data to another GT-6.

The two instruments must be set to the same device ID numbers when exchanging SysEx messages.

About the MIDI implementation

MIDI allows a variety of messages to be exchanged between instruments, but it is not necessarily the case that all types of message can be exchanged between any two MIDI devices. Two devices can communicate only if they both use the types of messages that they have in common.

Thus, every owner's manual for a MIDI device includes a "MIDI Implementation Chart." This chart shows the types of message that the device is able to transmit and receive. By comparing the MIDI implementation charts of two devices, you can tell at a glance which messages they will be able to exchange. Since the charts are always of a uniform size, you can simply place the two charts side by side.

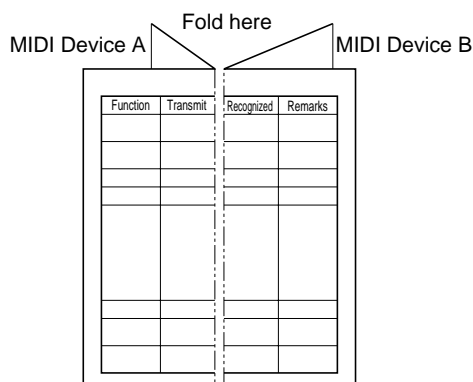

A separate publication titled "MIDI Implementation" is also available. It provides complete details concerning the way MIDI has been implemented on this unit. If you should require this publication (such as when you intend to carry out byte-level programming), please contact the nearest Roland Service Center or authorized Roland distributor.

Changing patches using bank select messages

A bank select message consists of a set of two control change messages, the controllers numbered 0 and 32. Normally, you select a sound by using the bank select message followed by a program change message. On the GT-6, these messages are used for changing patch numbers.

Changing patch numbers on an external MIDI device from the GT-6

When a patch is selected on the GT-6, the bank select and program change messages sent from the GT-6 correspond with each other as shown below.

Bank	Number				Bank	Number				Bank	Number			
	1	2	3	4		1	2	3	4		1	2	3	4
1	0,0,1	0,0,2	0,0,3	0,0,4	31	1,0,21	1,0,22	1,0,23	1,0,24	61	2,0,41	2,0,42	2,0,43	2,0,44
2	0,0,5	0,0,6	0,0,7	0,0,8	32	1,0,25	1,0,26	1,0,27	1,0,28	62	2,0,45	2,0,46	2,0,47	2,0,48
3	0,0,9	0,0,10	0,0,11	0,0,12	33	1,0,29	1,0,30	1,0,31	1,0,32	63	2,0,49	2,0,50	2,0,51	2,0,52
4	0,0,13	0,0,14	0,0,15	0,0,16	34	1,0,33	1,0,34	1,0,35	1,0,36	64	2,0,53	2,0,54	2,0,55	2,0,56
5	0,0,17	0,0,18	0,0,19	0,0,20	35	1,0,37	1,0,38	1,0,39	1,0,40	65	2,0,57	2,0,58	2,0,59	2,0,60
6	0,0,21	0,0,22	0,0,23	0,0,24	36	1,0,41	1,0,42	1,0,43	1,0,44	66	2,0,61	2,0,62	2,0,63	2,0,64
7	0,0,25	0,0,26	0,0,27	0,0,28	37	1,0,45	1,0,46	1,0,47	1,0,48	67	2,0,65	2,0,66	2,0,67	2,0,68
8	0,0,29	0,0,30	0,0,31	0,0,32	38	1,0,49	1,0,50	1,0,51	1,0,52	68	2,0,69	2,0,70	2,0,71	2,0,72
9	0,0,33	0,0,34	0,0,35	0,0,36	39	1,0,53	1,0,54	1,0,55	1,0,56	69	2,0,73	2,0,74	2,0,75	2,0,76
10	0,0,37	0,0,38	0,0,39	0,0,40	40	1,0,57	1,0,58	1,0,59	1,0,60	70	2,0,77	2,0,78	2,0,79	2,0,80
11	0,0,41	0,0,42	0,0,43	0,0,44	41	1,0,61	1,0,62	1,0,63	1,0,64	71	2,0,81	2,0,82	2,0,83	2,0,84
12	0,0,45	0,0,46	0,0,47	0,0,48	42	1,0,65	1,0,66	1,0,67	1,0,68	72	2,0,85	2,0,86	2,0,87	2,0,88
13	0,0,49	0,0,50	0,0,51	0,0,52	43	1,0,69	1,0,70	1,0,71	1,0,72	73	2,0,89	2,0,90	2,0,91	2,0,92
14	0,0,53	0,0,54	0,0,55	0,0,56	44	1,0,73	1,0,74	1,0,75	1,0,76	74	2,0,93	2,0,94	2,0,95	2,0,96
15	0,0,57	0,0,58	0,0,59	0,0,60	45	1,0,77	1,0,78	1,0,79	1,0,80	75	2,0,97	2,0,98	2,0,99	2,0,100
16	0,0,61	0,0,62	0,0,63	0,0,64	46	1,0,81	1,0,82	1,0,83	1,0,84	76	3,0,1	3,0,2	3,0,3	3,0,4
17	0,0,65	0,0,66	0,0,67	0,0,68	47	1,0,85	1,0,86	1,0,87	1,0,88	77	3,0,5	3,0,6	3,0,7	3,0,8
18	0,0,69	0,0,70	0,0,71	0,0,72	48	1,0,89	1,0,90	1,0,91	1,0,92	78	3,0,9	3,0,10	3,0,11	3,0,12
19	0,0,73	0,0,74	0,0,75	0,0,76	49	1,0,93	1,0,94	1,0,95	1,0,96	79	3,0,13	3,0,14	3,0,15	3,0,16
20	0,0,77	0,0,78	0,0,79	0,0,80	50	1,0,97	1,0,98	1,0,99	1,0,100	80	3,0,17	3,0,18	3,0,19	3,0,20
21	0,0,81	0,0,82	0,0,83	0,0,84	51	2,0,1	2,0,2	2,0,3	2,0,4	81	3,0,21	3,0,22	3,0,23	3,0,24
22	0,0,85	0,0,86	0,0,87	0,0,88	52	2,0,5	2,0,6	2,0,7	2,0,8	82	3,0,25	3,0,26	3,0,27	3,0,28
23	0,0,89	0,0,90	0,0,91	0,0,92	53	2,0,9	2,0,10	2,0,11	2,0,12	83	3,0,29	3,0,30	3,0,31	3,0,32
24	0,0,93	0,0,94	0,0,95	0,0,96	54	2,0,13	2,0,14	2,0,15	2,0,16	84	3,0,33	3,0,34	3,0,35	3,0,36
25	0,0,97	0,0,98	0,0,99	0,0,100	55	2,0,17	2,0,18	2,0,19	2,0,20	85	3,0,37	3,0,38	3,0,39	3,0,40
26	1,0,1	1,0,2	1,0,3	1,0,4	56	2,0,21	2,0,22	2,0,23	2,0,24					
27	1,0,5	1,0,6	1,0,7	1,0,8	57	2,0,25	2,0,26	2,0,27	2,0,28					
28	1,0,9	1,0,10	1,0,11	1,0,12	58	2,0,29	2,0,30	2,0,31	2,0,32					
29	1,0,13	1,0,14	1,0,15	1,0,16	59	2,0,33	2,0,34	2,0,35	2,0,36					
30	1,0,17	1,0,18	1,0,19	1,0,20	60	2,0,37	2,0,38	2,0,39	2,0,40					

Bank Select MSB ————┐
 Bank Select LSB ————┘
 Program Number ————┐
 └──────────────────┘

* If you wish to know whether the receiving device can recognize bank select messages or not, refer to the description for control changes in the MIDI implementation chart provided in the owner's manual of the receiving device.

* If the receiving device does not recognize bank select messages, it will ignore the bank select messages and recognize only the program change messages.

Changing patch numbers on the GT-6 using the bank select messages sent from an external MIDI device

To change patch numbers on the GT-6 using bank select messages sent from an external MIDI device, check how the external bank select and program change messages correspond with the patch numbers on the GT-6.

PC#	Bank Select				PC#	Bank Select				PC#	Bank Select			
	0	1	2	3		0	1	2	3		0	1	2	3
1	1-1	26-1	51-1	76-1	36	9-4	34-4	59-4	84-4	71	18-3	43-3	68-3	:
2	1-2	26-2	51-2	76-2	37	10-1	35-1	60-1	85-1	72	18-4	43-4	68-4	:
3	1-3	26-3	51-3	76-3	38	10-2	35-2	60-2	85-2	73	19-1	44-1	69-1	:
4	1-4	26-4	51-4	76-4	39	10-3	35-3	60-3	85-3	74	19-2	44-2	69-2	:
5	2-1	27-1	52-1	77-1	40	10-4	35-4	60-4	85-4	75	19-3	44-3	69-3	:
6	2-2	27-2	52-2	77-2	41	11-1	36-1	61-1	:	76	19-4	44-4	69-4	:
7	2-3	27-3	52-3	77-3	42	11-2	36-2	61-2	:	77	20-1	45-1	70-1	:
8	2-4	27-4	52-4	77-4	43	11-3	36-3	61-3	:	78	20-2	45-2	70-2	:
9	3-1	28-1	53-1	78-1	44	11-4	36-4	61-4	:	79	20-3	45-3	70-3	:
10	3-2	28-2	53-2	78-2	45	12-1	37-1	62-1	:	80	20-4	45-4	70-4	:
11	3-3	28-3	53-3	78-3	46	12-2	37-2	62-2	:	81	21-1	46-1	71-1	:
12	3-4	28-4	53-4	78-4	47	12-3	37-3	62-3	:	82	21-2	46-2	71-2	:
13	4-1	29-1	54-1	79-1	48	12-4	37-4	62-4	:	83	21-3	46-3	71-3	:
14	4-2	29-2	54-2	79-2	49	13-1	38-1	63-1	:	84	21-4	46-4	71-4	:
15	4-3	29-3	54-3	79-3	50	13-2	38-2	63-2	:	85	21-1	47-1	72-1	:
16	4-4	29-4	54-4	79-4	51	13-3	38-3	63-3	:	86	22-2	47-2	72-2	:
17	5-1	30-1	55-1	80-1	52	13-4	38-4	63-4	:	87	22-3	47-3	72-3	:
18	5-2	30-2	55-2	80-2	53	14-1	39-1	64-1	:	88	22-4	47-4	72-4	:
19	5-3	30-3	55-3	80-3	54	14-2	39-2	64-2	:	89	23-1	48-1	73-1	:
20	5-4	30-4	55-4	80-4	55	14-3	39-3	64-3	:	90	23-2	48-2	73-2	:
21	6-1	31-1	56-1	81-1	56	14-4	39-4	64-4	:	91	23-3	48-3	73-3	:
22	6-2	31-2	56-2	81-2	57	15-1	40-1	65-1	:	92	23-4	48-4	73-4	:
23	6-3	31-3	56-3	81-3	58	15-2	40-2	65-2	:	93	24-1	49-1	74-1	:
24	6-4	31-4	56-4	81-4	59	15-3	40-3	65-3	:	94	24-2	49-2	74-2	:
25	7-1	32-1	57-1	82-1	60	15-4	40-4	65-4	:	95	24-3	49-3	74-3	:
26	7-2	32-2	57-2	82-2	61	16-1	41-1	66-1	:	96	24-4	49-4	74-4	:
27	7-3	32-3	57-3	82-3	62	16-2	41-2	66-2	:	97	25-1	50-1	75-1	:
28	7-4	32-4	57-4	82-4	63	16-3	41-3	66-3	:	98	25-2	50-2	75-2	:
29	8-1	33-1	58-1	83-1	64	16-4	41-4	66-4	:	99	25-3	50-3	75-3	:
30	8-2	33-2	58-2	83-2	65	17-1	42-1	67-1	:	100	25-4	50-4	75-4	:
31	8-3	33-3	58-3	83-3	66	17-2	42-2	67-2	:	:	:	:	:	:
32	8-4	33-4	58-4	83-4	67	17-3	42-3	67-3	:	:	:	:	:	:
33	9-1	34-1	59-1	84-1	68	17-4	42-4	67-4	:	:	:	:	:	:
34	9-2	34-2	59-2	84-2	69	18-1	43-1	68-1	:	:	:	:	:	:
35	9-3	34-3	59-3	84-3	70	18-2	43-2	68-2	:	128	25-4	50-4	75-4	85-4

PC# : Program Number

Factory Settings

Tuner

TUNER Pitch: A= 440 Hz
TUNER Out: Bypass

Output Select

Output Select: COMBO AMP

Global

Low EQ: 0dB
High EQ: 0dB
NS Threshold: 0dB
Reverb Level: 100%

System

LCD Contrast: 16
BANK Extent: 85
Patch Change Mode: Wait for a Num.
Assign Hold: On
Dial Function: PATCH No.& VALUE
Knob Mode: Immediate
Pedal Tuner SW: Off
Amp Switch Mode: Amp On/Off
Sub CTL1 Func: Assignable
Sub CTL2 Func: Assignable

MIDI

MIDI RX Channel: 1
MIDI Omni Mode: Omni On
MIDI TX Channel: Rx
MIDI Device ID: 1
MIDI Sync Clock: Auto
MIDI PC OUT: On
MIDI EXP OUT: 7
MIDI EXP SW OUT: 81
MIDI CTL OUT: 80
MIDI Sub CTL1OUT: Off
MIDI Sub CTL2OUT: Off
MIDI Map Select: Fix

Manual

1: PRE (PRE/SP SIM)
2: OD (OD/DS)
3: DD (DELAY)
4: CE (CHORUS)
▲: FX-1
▼: FX-2

Restoring the Factory Settings (Factory Reset)

Restoring the GT-6 to the settings made at the factory is referred to as "Factory Reset."

Not only can you return all of the settings to the values in effect when the GT-6 was shipped from the factory, you can also specify the range of settings to be reset.

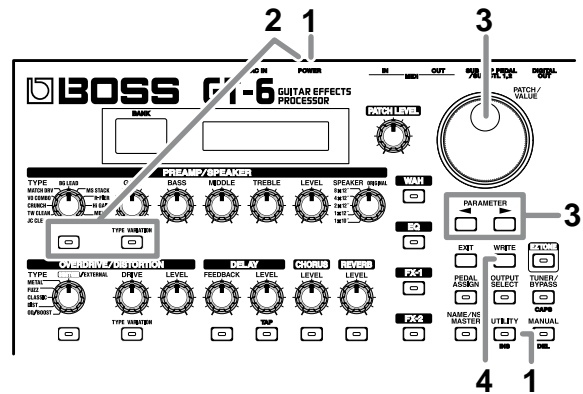

1. Turn off the power.
2. While holding down PREAMP/SPEAKER On/Off button and [TYPE VARIATION], turn on the power. The Factory Reset range setting screen appears in the display.

```
Factory Reset
System #35-4
```

The range of data you wish to factory reset.

* To cancel Factory Reset, press [EXIT].

3. Press PARAMETER [◀] [▶] to move the cursor, and rotate the PATCH/VALUE dial to specify the range of settings you want to restore to factory settings.

System:

System parameters, Harmonist scales, Auto Riff phrases, and Preamp, Overdrive/Distortion, and Wah Custom Edit parameter settings

#1-1-#35-4:

Settings for Patch Number 1-1 through 35-4

4. If you want to proceed with the factory reset, press [ENTER].

The specified range of data will be returned, and return to the Play screen.

Troubleshooting

If there is no sound or other operational problems occur, first check through the following solutions. If this does not resolve the problem, then contact your dealer or a nearby Roland service station.

No sound / volume too low

- Are the connection cables broken?
→ Try using a different set of connection cables.
- Is the GT-6 correctly connected to the other devices?
→ Check connections with the other devices (p. 12).
- Is the connected amp/mixer turned off, or the volume lowered?
→ Check the settings of your amp/mixer system.
- Is the OUTPUT LEVEL knob lowered?
→ Adjust the OUTPUT LEVEL knob to an appropriate position (p. 13).
- Is Tuner/Bypass set to On?
→ When the volume is set to “Mute” in the Tuner/Bypass mode, even the direct sound will not be output by setting the Tuner/Bypass to “On” (p. 58).
- Is each effect set correctly?
→ Use the “Meter function” (p. 60) to check the output level of each effect. If there is an effect for which the meter does not move, check the settings for that effect (p. 24).
- Is “FV: Level” or “MST: Patch Level” specified as a pedal assign Target?
→ Move the controller to which it is assigned.
- Is the power to the external device connected to the SEND/RETURN jack off, or is the volume of the device turned down?
→ Check the settings for the connected device.

The volume level of the instrument connected to INPUT and RETURN are too low

- Could you be using a connection cable that contains a resistor?
→ Use a connection cable that does not contain a resistor.

Patch does not change

- Is something other than the Play screen shown in the display?
→ On the GT-6, patches can be selected only when the Play screen is displayed. Press [EXIT] to return to the Play screen (p. 13).

Parameters specified with control assign can't be controlled

- Could the effect be switched off?
→ To control a parameter using the expression pedal or CTL pedal, make sure the effect that contains the parameter you intend to control is switched on.
- Is something other than “Assignable” selected for the SUB CTL 1,2 function setting?
→ When operating a foot switch connected to the SUB EXP/SUB CTL 1, 2 jack, set the SUB CTL 1, 2 function (p. 63) to “Assignable.”
- Do the MIDI channel settings of both devices match?
→ Make sure that the MIDI channels of both devices match (p. 65).
- Do the controller number settings of both devices match?
→ Make sure that the controller number of both devices match (p. 66).

MIDI messages are not transmitted/received

- Are the MIDI cables broken?
→ Try another set of MIDI cables.
- Is the GT-6 correctly connected to the other MIDI device?
→ Check connections with the other MIDI device.
- Do the MIDI channel settings of both devices match?
→ Make sure that the MIDI channels of both devices match (p. 65).
- When you send messages from the GT-6, make sure the GT-6 is set to the settings appropriate for sending data.
→ Check the on/off status (p. 66) for transmission of program change messages and the settings for the controller numbers to be transmitted (p. 66) .

Error Messages

If you attempt an incorrect operation or if an operation could not be executed, the display will indicate an error message. Refer to this list and take the appropriate action.

Battery Low !

- The memory backup battery inside the GT-6 has run down. (This message will appear when the power is turned on.)
- Replace the battery as soon as possible. For battery replacement, please contact a nearby Roland service center or your dealer.

MIDI Off Line !

- There is a problem with the MIDI cable connection.
- Check to make sure the cable has not been pulled out or is not shorted.

VALUE Locked !

- You've attempted to switch patches by rotating the PATCH/VALUE dial, but the Dial function (p. 61) is set to "VALUE Only."
- If you want to be able to switch patches using the PATCH/VALUE dial, set the Dial function to "PATCH No.& VALUE."

MIDI Buffer Full

- More MIDI messages were received in a short time than could be processed correctly.

MIDI Implementation Chart

Function...		Transmitted	Recognized	Remarks
Basic Channel	Default Changed	1—16 1—16	1—16 1—16	Memorized
Mode	Default Messages Altered	X X *****	OMNI ON/OFF X X	Memorized
Note Number :	True Voice	X *****	X *****	
Velocity	Note ON Note OFF	X X	X X	
After Touch	Key's Ch's	X X	X X	
Pitch Bend		X	X	
Control Change	0, 32	O (0—3)	O * 1	Bank Select
	1—31	O	O * 2	
	33—63	O	X	
	64—95	O	O * 2	
Prog Change	: True #	O 0—127	O 0—127	Program Number 1—128
System Exclusive		O	O	
System Common	: Song Pos : Song Sel : Tune	X X X	X X X	
System Real Time	: Clock : Command	X O	O X	
Aux Message	: All sound off : Local ON/OFF : All Notes OFF : Active Sense : Reset	X X X X X	X X X O X	
Notes	<p>* 1 MSB data of a value of 04H or higher, and the LSB are ignored. * 2 Recognizes messages designated for use for realtime control over parameters. A separate publication titled MIDI Implementation is also available. It provides complete details concerning the way MIDI has been implemented on this unit. If you should require this publication (such as when you intend to carry out byte-level programming), please contact the nearest Roland Service Center or authorized Roland distributor.</p>			

Mode 1 : OMNI ON, POLY
 Mode 3 : OMNI OFF, POLY

Mode 2 : OMNI ON, MONO
 Mode 4 : OMNI OFF, MONO

O : Yes
 X : No

Specifications

GT-6: Guitar Effects Processor

AD Conversion

24 bit + AF method

DA Conversion

24 bit

Sampling Frequency

44.1 kHz

Program Memories

340: 140 (User) + 200 (Preset)

Nominal Input Level

INPUT: -10 dBu

RETURN: -10 dBu

Input Impedance

INPUT: 1 M Ω

RETURN: 220 k Ω

Nominal Output Level

OUTPUT: 0 dBu

SEND: -10 dBu

Output Impedance

OUTPUT: 2 k Ω

SEND: 2 k Ω

Digital Output

EIAJ CP1201, S/P DIF

Dynamic Range

100 dB or greater (IHF-A)

Controls

< Front Panel >

(PREAMP/SPEAKER)

TYPE knob

GAIN knob

BASS knob

MIDDLE knob

TREBLE knob

LEVEL knob

SPEAKER knob

On/Off button

TYPE VARIATION button

(OVERDRIVE/DISTORTION)

TYPE knob

DRIVE knob

LEVEL knob

On/Off button

TYPE VARIATION button

(DELAY)

FEEDBACK knob

LEVEL knob

On/Off button

TAP button

(CHORUS)

LEVEL knob

On/Off button

(REVERB)

LEVEL knob

On/Off button

(WAH)

On/Off button

(EQ)

On/Off button

(FX-1)

On/Off button

(FX-2)

On/Off button

(MASTER)

PATCH LEVEL knob

PARAMETER buttons L/R
 EXIT button
 WRITE button
 EZ TONE button
 PEDAL ASSIGN button
 OUTPUT SELECT button
 TUNER/BYPASS button
 NAME/NS/MASTER button
 UTILITY button
 MANUAL button
 Number pedals 1-4
 BANK pedals (Up/Down)
 CTL pedal
 Expression pedal
 Expression pedal switch
 PATCH/VALUE dial

< **Rear Panel** >

OUTPUT LEVEL knob
 POWER switch

Display

16 characters, 2 lines (backlit LCD)
 2 characters, 7 segment LED

Connectors

INPUT jack
 OUTPUT jacks L (MONO)/R
 PHONES jack
 SEND jack
 RETURN jack
 DIGITAL OUT connector (coaxial)
 SUB EXP PEDAL/SUB CTL PEDAL 1,2 jack
 MIDI connectors IN/OUT
 AC Adaptor jack

Power Supply

AC 14 V; Supply AC adaptor (BOSS BRC series)

Current Draw

800 mA

Dimensions

515 (W) x 261 (D) x 75 (H) mm
 20-5/16 (W) x 10-5/16 (D) x 3 (H) inches

Weight

4.7 kg/10 lbs 6 oz (excluding AC Adaptor)

Accessories

AC Adaptor (BRC series)
 Owner's Manual
 Read this first (leaflet)
 Patch List
 Roland Service (information sheet)

Options

Foot Switch: FS-5U, FS-5L
 Expression Pedal: EV-5 (Roland), FV-300L + PCS-33 (Roland)
 Foot Switch Cable: PCS-31 (Roland)
 (1/4 inches Phone Plug (stereo) - 1/4 inches Phone Plug (mono) x 2)

* $0 \text{ dBu} = 0.775 \text{ Vrms}$



In the interest of product improvement, the specifications and/or appearance of this unit are subject to change without prior notice.

AF Method (Adaptive Focus method)

This is a proprietary method from Roland that vastly improves the signal-to-noise (S/N) ratio of the A/D and D/A converters.

Index

A

AC Adaptor	11
Active Range	52
Assign	49

B

BANK	10
Bank	15
Bank Extent	61
Bank Select Message	72
BASS	8
BPM	46
Bulk Dump	67
Bulk Load	67–68

C

Channel Message	70
CHORUS	9, 29
Control Change Message	70
Copy	22
Cord Hook	11, 13
COSM	7
CTL	10
CTL Pedal	47
Custom	53–55
Customize function	53

D

DELAY	9, 28
Dial Function	61
DIGITAL OUT	11, 60
Direct Sound	24
Display	8, 16
DRIVE	9

E

Effect Chain	21
Effect Sound	24
EQ	9, 32
Exchange	23
Exclusive Message	71
EXIT	10
EXP PEDAL SW	10
EXP PEDAL SW ON/OFF	10
Expression Pedal	10, 13, 47
Expression Pedal Hold	62
Expression Pedal Switch	47
External Effect Processor	60
EZ TONE	10, 17

F

Factory Reset	74
FEEDBACK	9
Foot Switch	13
Foot Volume	46
FV	46
FX-1	9, 32
FX-2	9, 35

G

GAIN	8
Global	59

I

INPUT	11
-------------	----

K

Knob Mode	62
-----------------	----

L

Latch-Type	51
LCD Contrast	61
LEVEL	9
Level Meter	60

M

MANUAL	10
Manual Mode	56
MASTER	46
Master BPM	46
MIDDLE	9
MIDI Channel	70
MIDI Connector	70
MIDI Implementation	71, 77
MIDI Implementation Chart	77
MIDI IN	11
MIDI Map Select	69
MIDI OUT	11
Momentary-Type	51

N

NAME/NS/MASTER	10
NS	45
NUMBER	10
Number	15

O

OUTPUT	11–12, 14
OUTPUT LEVEL	11, 13

OUTPUT SELECT	10	TUNER/BYPASS	10
Output Select	12, 14	Tuner/Bypass Function	57
OVERDRIVE/DISTORTION	9, 27, 54	Tuning	57
P		Tuning Guide	57
PARAMETER	9	TYPE	8-9
Patch	15	TYPE VARIATION	9, 17-18
Patch Change	15	U	
Patch Change Mode	61	User Bank	15
PATCH LEVEL	8, 56	User Patch	15
Patch Name	21	User Phrase	43
PATCH/VALUE	9	User Scale	39
PEDAL ASSIGN	10	UTILITY	10
Pedal Assign	47	W	
Pedal Bend	20	WAH	9, 30
Pedal Effects	20	Wah	20
Pedal Wah	55	WRITE	10
PHONES	11	Write	22
Play Screen	13, 16		
Polarity Switch	13		
POWER	11		
Preamp	53		
PREAMP/SPEAKER	8-9, 24		
Preset Bank	15		
Preset Patch	15		
Program Change Map	69		
Program Change Message	70		
Q			
Quick Setting	19		
R			
RETURN	11		
REVERB	9, 29		
S			
SEND	11		
Source	51		
Source Mode	51		
SPEAKER	9		
Standard Pitch	58		
SUB CTL 1, 2 Function	63		
SUB EXP PEDAL/SUB CTL 1,2	11		
System Message	71		
T			
TAP	9, 28		
Target Range	50		
TREBLE	9		

Adjusting the Expression Pedal

Although the GT-6's expression pedal has been set for optimum operation at the factory, extended use and the operating environment can result in the pedal going out of adjustment.

If you encounter problems such as being unable to fully cut off the sound with the volume pedal, you can use the following procedure to readjust the pedal.

1. Hold down [PEDAL ASSIGN] while you switch on the power.

The following messages alternate in the display.

```
EXP CALIBRATION  
Set Pedal to MIN
```



```
EXP CALIBRATION  
Press [WRITE]
```

2. With the pedal completely released, press [WRITE].

The message "--- OK! ---" appears, and then the following messages alternate in the display.

```
EXP CALIBRATION  
Set Pedal to MAX
```



```
EXP CALIBRATION  
Press [WRITE]
```

* If you press [WRITE] when the pedal is not completely released, or when the pedal position (angle) is not correct, the message "--- Area Over! ---" appears in the display, and you are prevented from proceeding to the next step. If this occurs, readjust the pedal position.

3. With the pedal fully depressed, press [WRITE].

"--- OK! ---" appears, followed by "press [EXIT]."

* If you press [WRITE] when the pedal is not fully depressed, or when the pedal position (angle) is not correct, the message "--- Area Over! ---" appears in the display, and you are prevented from proceeding to the next step. If this occurs, readjust the pedal position.

4. Press [EXIT].

After the message "Checking data please wait..." has been displayed, you'll be returned to the Play screen.

For the U.K.

IMPORTANT: THE WIRES IN THIS MAINS LEAD ARE COLOURED IN ACCORDANCE WITH THE FOLLOWING CODE.

BLUE: NEUTRAL
BROWN: LIVE

As the colours of the wires in the mains lead of this apparatus may not correspond with the coloured markings identifying the terminals in your plug, proceed as follows:

The wire which is coloured BLUE must be connected to the terminal which is marked with the letter N or coloured BLACK.
The wire which is coloured BROWN must be connected to the terminal which is marked with the letter L or coloured RED.
Under no circumstances must either of the above wires be connected to the earth terminal of a three pin plug.

For EU Countries

Apparatus containing Lithium batteries

ADVARSEL!

Lithiumbatteri - Eksplosionsfare ved fejlagtig håndtering.
Udskiftning må kun ske med batteri af samme fabrikat og type.
Levér det brugte batteri tilbage til leverandøren.

ADVARSEL

Eksplosjonsfare ved feilaktig skifte av batteri.
Benytt samme batteritype eller en tilsvarende type anbefalt av apparatfabrikanten.
Brukte batterier kasseres i henhold til fabrikantens instruksjoner.

CAUTION

Danger of explosion if battery is incorrectly replaced.
Replace only with the same or equivalent type recommended by the manufacturer.
Discard used batteries according to the manufacturer's instructions.

VARNING

Explosionsfara vid felaktigt batteribyte.
Använd samma batterityp eller en ekvivalent typ som rekommenderas av apparattillverkaren.
Kassera använt batteri enligt fabrikantens instruktion.

VAROITUS

Paristo voi räjähtää, jos se on virheellisesti asennettu.
Vaihda paristo ainoastaan laitevalmistajan suosittelemaan tyyppiin. Hävitä käytetty paristo valmistajan ohjeiden mukaisesti.

For EU Countries



This product complies with the requirements of European Directive 89/336/EEC.

For the USA

FEDERAL COMMUNICATIONS COMMISSION RADIO FREQUENCY INTERFERENCE STATEMENT

This equipment has been tested and found to comply with the limits for a Class B digital device, pursuant to Part 15 of the FCC Rules. These limits are designed to provide reasonable protection against harmful interference in a residential installation. This equipment generates, uses, and can radiate radio frequency energy and, if not installed and used in accordance with the instructions, may cause harmful interference to radio communications. However, there is no guarantee that interference will not occur in a particular installation. If this equipment does cause harmful interference to radio or television reception, which can be determined by turning the equipment off and on, the user is encouraged to try to correct the interference by one or more of the following measures:

- Reorient or relocate the receiving antenna.
- Increase the separation between the equipment and receiver.
- Connect the equipment into an outlet on a circuit different from that to which the receiver is connected.
- Consult the dealer or an experienced radio/TV technician for help.

This device complies with Part 15 of the FCC Rules. Operation is subject to the following two conditions:

- (1) This device may not cause harmful interference, and
- (2) This device must accept any interference received, including interference that may cause undesired operation.

Unauthorized changes or modification to this system can void the users authority to operate this equipment.
This equipment requires shielded interface cables in order to meet FCC class B Limit.

For Canada

NOTICE

This Class B digital apparatus meets all requirements of the Canadian Interference-Causing Equipment Regulations.

AVIS

Cet appareil numérique de la classe B respecte toutes les exigences du Règlement sur le matériel brouilleur du Canada.

