

Roland®

FR-3 **FR-3_b**
FR-3_s **FR-3_{sb}**



Owner's Manual

WARNING – To reduce the risk of fire or electric shock, do not expose this device to rain or moisture.



For EU Countries

This product complies with the requirements of European Directive EMC 89/336/EEC.
Dieses Produkt entspricht der europäischen Richtlinie EMC 89/336/EEC.
Ce produit est conforme aux exigences de la directive européenne EMC 89/336/EEC.
Questo prodotto è conforme alle esigenze della direttiva europea EMC 89/336/EEC.
Este producto cumple con la directrice EMC 89/336/EEC de la CE.
Dit product beantwoordt aan de richtlijn EMC 89/336/EEC van de Europese Unie.

For the USA

FEDERAL COMMUNICATIONS COMMISSION RADIO FREQUENCY INTERFERENCE STATEMENT

This equipment has been tested and found to comply with the limits for a Class B digital device, pursuant to Part 15 of the FCC Rules. These limits are designed to provide reasonable protection against harmful interference in a residential installation. This equipment generates, uses, and can radiate radio frequency energy and, if not installed and used in accordance with the instructions, may cause harmful interference to radio communications. However, there is no guarantee that interference will not occur in a particular installation. If this equipment does cause harmful interference to radio or television reception, which can be determined by turning the equipment off and on, the user is encouraged to try to correct the interference by one or more of the following measures:

- Reorient or relocate the receiving antenna.
- Increase the separation between the equipment and receiver.
- Connect the equipment into an outlet on a circuit different from that to which the receiver is connected.
- Consult the dealer or an experienced radio/TV technician for help.

This device complies with Part 15 of the FCC Rules. Operation is subject to the following two conditions:

- (1) This device may not cause harmful interference, and
- (2) This device must accept any interference received, including interference that may cause undesired operation.

Unauthorized changes or modification to this system can void the users authority to operate this equipment.
This equipment requires shielded interface cables in order to meet FCC class B Limit.

For Canada

NOTICE

This Class B digital apparatus meets all requirements of the Canadian Interference-Causing Equipment Regulations.

AVIS

Cet appareil numérique de la classe B respecte toutes les exigences du Règlement sur le matériel brouilleur du Canada.

For the U.K.

IMPORTANT: THE WIRES IN THIS MAINS LEAD ARE COLOURED IN ACCORDANCE WITH THE FOLLOWING CODE.

BLUE: NEUTRAL
BROWN: LIVE

As the colours of the wires in the mains lead of this apparatus may not correspond with the coloured markings identifying the terminals in your plug, proceed as follows:

The wire which is coloured BLUE must be connected to the terminal which is marked with the letter N or coloured BLACK.
The wire which is coloured BROWN must be connected to the terminal which is marked with the letter L or coloured RED.
Under no circumstances must either of the above wires be connected to the earth terminal of a three pin plug.



This product must be disposed of separately at your local waste recycling centre.
Do not dispose of in household waste bin.

The technology used in the FR-3s, FR-3sb, FR-3 and FR-3b is covered by U.S. Patent No. 6.946.594.

Roland

FR-3 **FR-3^b**
FR-3_s **FR-3_{sb}**



Owner's Manual

Thank you for purchasing the Roland FR-3 V-Accordion. The FR-3 is an amazingly versatile electronic instrument that can emulate the sounds of a vast array of accordions. You may know that the term "accordion" refers to a portable musical instrument of the free reed family, that its sound is controlled by air flow from the bellows, and that there are almost as many types as there are countries. The accordion family indeed includes instruments called "Aeloine", "Aerophone", "Bayan", "Buzika", "Concertina", "Drängkammorgel", "Fisarmonica", "Hanuri", "Melodeon", "Pedalowka", "Schwyzerorgeli", "Squeeze Box", "Sun Fin Chin", and many others.

The major advantage of the FR-3 is that it allows you to change sounds without changing instruments. Apart from the financial benefit (the FR-3 costs far less than what you have to pay for the emulated originals), this also means that you can use your familiar playing style and techniques while covering a host of different musical genres.

To get the most out of the FR-3 and to ensure many years of trouble-free service, we urge you to read through this Owner's Manual thoroughly.

Before using this instrument, carefully read the "Important notes" (p. 9). They provide information concerning the proper operation of the FR-3. Be sure to keep this manual in a safe place for future reference.

This manual applies to four instruments:

FR-3s & FR-3 (the keyboard versions) FR-3sb & FR-3b (the button versions)

For reasons of space, we will use the term "FR-3" to refer to all four of them, and only use "FR-3s" and "FR-3sb" functions that are only available on the versions with speakers.

Contents

1. Features	6
2. Important notes	9
3. Panel descriptions	11
Treble control panel	11
Bass control panel	12
Connection panel	13
4. Setting up	14
Connections	14
Securing the adapter and/or MIDI cable	14
Attaching the straps	15
Switching the power on and off	16
Listening to the demo songs	18
First steps	19
Touring the FR-3's sections	21
Using the orchestral sounds	25
5. Other practical functions	31
Switching off sections you don't need	31
Using the metronome	31
Pitch-related functions	34
6. Editing settings	36
Selecting the desired function	37
PARAM LIST parameters	37
MIDI parameters	45
7. Restoring the factory defaults	53
8. Using optional batteries	54
What can you do with batteries?	54
Installing and removing batteries	54
9. Troubleshooting	56
10. Specifications	57
11. Appendix	58
Factory Sets	58
Demo Songs	58
MIDI implementation	59
MIDI Implementation Chart	61
12. Information	62
13. Index	63

1. Features

Stand-alone electronic instrument

Though the FR-3 is a fully electronic instrument, you do not need to connect the FR-3s/FR-3sb to an amplifier in order to produce sounds. Its onboard amplification system is powerful enough for small venues, restaurants, etc. (The FR-3/FR-3b has no internal amplification.)

Sophisticated MIDI control

The FR-3 is the most versatile and "musical" MIDI controller to date, going far beyond the control possibilities of a MIDI keyboard with optional performance functions or of MIDIified wind instruments.

PBM (Physical Behavior Modeling)

The FR-3 V-Accordion is based on Roland's sound generation technology called "PBM" (Physical Behavior Modeling) whose sonic result is very close to the sound of traditional accordions.

Super realistic accordion simulations

The FR-3 provides 10 memories called "Sets", with 10 treble registers, 7 bass & chord registers, and 7 Free Bass registers. All sounds it produces were obtained by sampling popular traditional acoustic accordions. Different tuning systems are also available.

This V-Accordion allows you to switch from an Italian jazz accordion to German folk, French musette or a historic bandoneon sound – without changing your technique.

Orchestral sounds

10 orchestral sounds can be used in combination with traditional accordion sounds – complete with full bellows articulation (something like breath control for accordions, but much more refined) and unique keyboard modes (Solo, Dual, High and Low).

Orchestral bass and chord sounds

The FR-3 also provides 7 orchestral bass and chord sounds for the Bass and Chord sections as well as the Free Bass section.

The digital advantage

The V-Accordion includes all functions and sounds of a traditional accordion, thus conveying a truly natural feel and sound. Yet it also provides the advantages only an electronic musical instrument can give you:

- reduced overall weight;
- possibility to choose among a wide variety of sounds;
- tuning stability over time and wear resistance of all mechanical parts;
- you can sound in a different key than the one you are playing in (transpose function);
- you can play with headphones, i.e. without disturbing your neighbors or family.

Superb performance flexibility

The V-Accordion allows you to control external MIDI-compatible instruments. The Treble keyboard and chord/bass buttons are velocity-sensitive, while the bellows controller provides more articulation possibilities than any other MIDI keyboard, MIDI wind instrument, etc., you may know.

In High or Low mode (see p. 25), you can control up to 4 parts simultaneously (two sounds in the right hand/ two sounds in the left).

Useful accessory

The FR-3 has a compartment for optional AA-type batteries. Consider purchasing such batteries (you will need 10) when performing on stage, or to use the FR-3s/FR-3sb as a stand-alone instrument (taking advantage of its internal speakers).

-
- All product names mentioned in this document are trademarks or registered trademarks of their respective owners.

USING THE UNIT SAFELY

INSTRUCTIONS FOR THE PREVENTION OF FIRE, ELECTRIC SHOCK, OR INJURY TO PERSONS

About ⚠ WARNING and ⚠ CAUTION Notices

⚠ WARNING	Used for instructions intended to alert the user to the risk of death or severe injury should the unit be used improperly.
⚠ CAUTION	Used for instructions intended to alert the user to the risk of injury or material damage should the unit be used improperly. * Material damage refers to damage or other adverse effects caused with respect to the home and all its furnishings, as well to domestic animals or pets.

About the Symbols

	The ⚠ symbol alerts the user to important instructions or warnings. The specific meaning of the symbol is determined by the design contained within the triangle. In the case of the symbol at left, it is used for general cautions, warnings, or alerts to danger.
	The ⚡ symbol alerts the user to items that must never be carried out (are forbidden). The specific thing that must not be done is indicated by the design contained within the circle. In the case of the symbol at left, it means that the unit must never be disassembled.
	The ● symbol alerts the user to things that must be carried out. The specific thing that must be done is indicated by the design contained within the circle. In the case of the symbol at left, it means that the power-cord plug must be unplugged from the outlet.

ALWAYS OBSERVE THE FOLLOWING

⚠ WARNING

- Before using this instrument, read the instructions below and the Owner's Manual.
- Do not open (or modify in any way) the unit or its AC adapter.
- Do not attempt to repair the FR-3 or replace parts within it (except when this manual provides specific instructions directing you to do so). Refer all servicing to your retailer, the nearest Roland Service Center or an authorized Roland distributor, as listed on the "Information" page.
- Never use or store the FR-3 in places that are:
 - Subject to temperature extremes (e.g., direct sunlight in an enclosed vehicle, near a heating duct, on top of heat-generating equipment); or are
 - Damp (e.g., baths, washrooms, on wet floors); or are
 - Humid; or are
 - Exposed to rain; or are
 - Dusty; or are
 - Subject to high levels of vibration.
- When not in use, do not place the FR-3/FR-3b or FR-3s/FR-3sb vertically due to instability. If placed in the vertical position on the floor/stage, ensure that it leans against a stable vertical surface e.g. a wall or a heavy musical instrument.
- The FR-3's adapter should only be connected to a power supply of the type described in the operating instructions or as marked on the adapter's label.
- Be sure to use only the AC adaptor supplied with the unit. Also, make sure the line voltage at the installation matches the input voltage specified on the AC adaptor's body. Other AC adaptors may use a different polarity, or be designed for a different voltage, so their use could result in damage, malfunction, or electric shock.

⚠ WARNING

- Do not excessively twist or bend the adapter cord, nor place heavy objects on it. Doing so can damage the cord, producing severed elements and short circuits. Damaged cords are fire and shock hazards!
- Use only the attached power-supply cord. Also, the supplied power cord must not be used with any other device.
- This instrument, either alone or in combination with an amplifier and headphones or speakers, may be capable of producing sound levels that could cause permanent hearing loss. Do not operate for a long period of time at a high volume level or at a level that is uncomfortable. If you experience any hearing loss or ringing in the ears, you should immediately stop using the FR-3 and consult an audiologist.
- Do not allow any objects (e.g., flammable material, coins, pins); or liquids of any kind (water, soft drinks, etc.) to penetrate the FR-3.
- Batteries must never be recharged, heated, taken apart, or thrown into fire or water.
- In households with small children, an adult should provide supervision until the child is capable of following all rules essential for the safe operation of the FR-3.
- Protect the FR-3 from strong impact. (Do not drop it!)

- Immediately turn the power off, remove the adapter from the outlet and request servicing by your retailer, the nearest Roland Service Center or an authorized Roland distributor, as listed on the "Information" page when:
 - The adapter's cord or the plug has been damaged; or
 - Objects have fallen into or liquid has been spilled onto the FR-3; or
 - The unit has been exposed to rain (or otherwise has become wet); or
 - The unit does not appear to operate normally or exhibits a marked change in performance.
- Do not force the adapter to share an outlet with an unreasonable number of other devices. Be especially careful when using extension cords—the total power used by all devices you have connected to the extension cord's outlet must never exceed the power rating (watts/ amperes) for the extension cord. Excessive loads can cause the insulation on the cord to heat up and eventually melt through.



WARNING

- Before using the FR-3 in a foreign country, consult with your retailer, the nearest Roland Service Center or an authorized Roland distributor, as listed on the "Information" page.



CAUTION

- The FR-3 should be located so that its location or position does not interfere with its proper ventilation.
- Always grasp only the plug on the power-supply cord when plugging into or unplugging from, an outlet or this unit.
- At regular intervals, you should unplug the AC adaptor and clean it by using a dry cloth to wipe all dust and other accumulations away from its prongs. Also, disconnect the power plug from the power outlet whenever the FR-3 is to remain unused for an extended period of time. Any accumulation of dust between the power plug and the power outlet can result in poor insulation and lead to fire.
- If used improperly, batteries may explode or leak and cause damage or injury. In the interest of safety, please read and observe the following precautions.
 - Carefully follow the installation instructions for batteries, and make sure you observe the correct polarity.
 - Avoid using new batteries together with used ones. In addition, avoid mixing different types of batteries.
 - Remove the batteries whenever the unit is to remain unused for an extended period of time.
- Used batteries must be disposed of in compliance with whatever regulations for their safe disposal that may be observed in the region in which you live.
- Try to prevent cords and cables from becoming entangled. Also, all cords and cables should be placed out of the reach of children.
- Never climb on top of, nor place heavy objects on the FR-3.



- Never handle the adapter or its plugs with wet hands when plugging into or unplugging from, an outlet or this unit.
- If you need to move the FR-3, take note of the precautions listed below. Make sure to have a firm grip, to protect yourself from injury and the instrument from damage.
 - Disconnect the adapter.
 - Disconnect all cords coming from external devices.
- Before cleaning the FR-3, turn off the power and unplug the power cord from the outlet.
- Whenever you suspect the possibility of lightning in your area, disconnect the adapter from the outlet.
- Should you remove screws, make sure to put them in a safe place out of children's reach, so there is no chance of them being swallowed accidentally.



2. Important notes

In addition to the items listed under "Using the unit safely" on p. 7, please read and observe the following:

Power supply

- Do not connect the FR-3 to same electrical outlet that is being used by an electrical appliance that is controlled by an inverter (such as a refrigerator, washing machine, microwave oven, or air conditioner), or that contains a motor. Depending on the way in which the electrical appliance is used, power supply noise may cause this unit to malfunction or may produce audible noise. If it is not practical to use a separate electrical outlet, connect a power supply noise filter between this unit and the electrical outlet.
- Do not use this instrument on the same power circuit with any device that will generate line noise (such as an electric motor or variable lighting system).
- Before connecting the FR-3 to other devices, turn off the power to all units. This will help prevent malfunctions and/or damage to speakers or other devices.
- The AC adaptor will begin to generate heat after long hours of consecutive use. This is normal, and is not a cause for concern.
- Although the display and LEDs are dark when the POWER switch is off, this does not mean that the unit has been completely disconnected from the power source. To turn off the power completely, first turn off the POWER switch, then unplug the power cord from the wall outlet. For this reason, the outlet to which you connect the power cord's plug should be one that is within easy reach.

Placement

- Using the FR-3 near power amplifiers (or other equipment containing large power transformers) may induce hum. To alleviate the problem, change the orientation of this unit; or move it farther away from the source of interference.
- This device may interfere with radio and television reception. Do not use this device in the vicinity of such receivers.
- Do not place the FR-3 near devices that produce a strong magnetic field (e.g., loudspeakers).
- Install the FR-3 on a solid, level surface.
- Noise may be produced if wireless communications devices, such as cell phones, are operated in the vicinity of this unit. Such noise could occur when receiving or initiating a call or while conversing. Should you experience such problems, relocate such wireless devices so they are at a greater distance from this unit or switch them off.
- Do not expose the unit to direct sunlight, place it near devices that radiate heat, leave it inside an enclosed vehicle or otherwise subject it to temperature extremes. Also, do not allow lighting devices that normally are used while their light source is very close to the unit (such as a piano light) or powerful spotlights to shine upon the same area of the unit for extended periods of time. Excessive heat can deform or discolor the unit.
- To avoid possible breakdown, do not use the unit in a wet area, such as an area exposed to rain or other moisture.
- Do not allow rubber, vinyl or similar materials to remain on the instrument for long periods of time. Such objects can discolor or otherwise harmfully affect the finish.
- Do not put anything that contains water (e.g., flower vases) on the instrument. Also, avoid the use of insecticides, perfumes, alcohol, nail polish, spray cans, etc., near the unit. Swiftly wipe away any liquid that spills on the unit using a dry, soft cloth.
- Do not allow objects to remain on top of the keyboard or buttons. This can be the cause of malfunction, such as keys or buttons ceasing to produce sound.

- Do not paste stickers, decals or the like on this instrument. Peeling these off, particularly when strong adhesives have been used, can damage the instrument's exterior finish (the stickers provided with this instrument feature a weak adhesive).

Maintenance

- For everyday cleaning wipe the FR-3 with a soft, dry cloth or one that has been slightly dampened with water. To remove stubborn dirt, use a mild, non-abrasive detergent. Afterwards, be sure to wipe the instrument thoroughly with a soft, dry cloth.
- Never use benzene, thinner, alcohol or solvents of any kind, to avoid the possibility of discoloration and/or deformation.

Repairs and data

- Please be aware that all data contained in the instrument's memory may be lost when it is sent for repairs. In certain cases (such as when circuitry related to memory itself is out of order), we regret that it may not be possible to restore the data. Roland assumes no liability concerning such loss of data.

Additional precautions

- When moved from one location to another where the temperature and/or humidity is very different, water droplets (condensation) may form inside the FR-3. Damage or malfunction may result if you attempt to use the FR-3 in this condition. Therefore, before using the FR-3, you must allow it to stand for several hours, until the condensation has completely evaporated.
- Please be aware that the memory contents can be irretrievably lost as a result of a malfunction or the improper operation of the instrument. Therefore, be sure to archive important settings using the FR-3's Bulk Dump function (see p. 52).
- Use a reasonable amount of care when using the instrument's buttons, other controls and jacks/connectors. Rough handling can lead to malfunctions.
- Never strike or apply strong pressure to the display.
- When connecting/disconnecting cables, grasp the connector itself—never pull on the cable. This way you will avoid causing shorts or damage to the cable's internal elements.
- A small amount of heat will radiate from the instrument during normal operation. This is perfectly normal.
- To avoid disturbing your neighbors, try to keep the instrument's volume at reasonable levels. You may prefer to use headphones, so you do not need to be concerned about those around you (especially late at night).
- When you need to transport the instrument, package it in the box (including padding) that it came in. Otherwise, you will need to use equivalent packaging materials or a flightcase.
- Use Roland cables to make audio connections. If using some other make of connection cable, please note the following precautions. Some connection cables contain resistors. Do not use cables that incorporate resistors for connecting to this unit. The use of such cables can cause the sound level to be extremely low or impossible to hear. For information on cable specifications, contact the manufacturer of the cable.

Precautions for optional batteries

- The temperature range for use of the batteries depends on the battery type being used. Please see the documentation that came with the batteries.
- Do not use or store batteries at high temperature, such as in strong direct sunlight, in cars during hot weather or directly in front of heaters. This may cause battery fluid leakage, impaired performance and shorten the batteries' service life.
- Do not splash fresh or saltwater on a battery or allow the terminals to become damp. This may cause heat generation and formation of rust on the battery and its terminals.
- If newly purchased batteries exhibit rust, generate heat or seem abnormal in any other way, do not use them. Take them back to your dealer.
- Keep the batteries out of reach of babies or small children.
- Be sure to carefully instruct any person on the proper way of handling a battery.
- Never dispose of the battery in a fire. Never heat it. Doing so may melt the insulation, damage the gas release vents or protective devices, cause combustion through chemical reaction with generated hydrogen, ejection of battery fluid, bursting or fire.
- Do not use batteries with the positive (+) and negative (-) terminals reversed, as this may drain the batteries or cause abnormal chemical reactions.
- Do not strike or drop the batteries. Strong impact can cause leakage of battery fluid, heat generation, bursting or fire.
- Never try to connect several batteries in parallel as this may cause leakage of battery fluid, heat generation, bursting or fire.
- Do not alter or remove protective mechanisms or other parts. Never disassemble the batteries.
- If any fluid from a battery comes in contact with the eyes, flush the eyes immediately, washing them thoroughly with clean water from a tap or other source and consult a doctor. Strong alkaline fluid can damage the eyes and lead to permanent loss of eyesight.
- If skin or clothing comes in contact with any fluid from the battery, wash the area immediately with clean water from a tap. Battery fluid can cause skin damage.
- When a battery is no longer usable, dispose of it in accordance with all applicable local laws and regulations.
- If a battery leaks fluid, changes color or shape or changes in any other way, do not use it, otherwise it may cause heat generation, bursting or fire.

Strap holder precaution

- Never unscrew the strap holder rings to avoid damaging the FR-3's plastic housing, which eventually compromises overall stability and safety.

3. Panel descriptions

Treble control panel

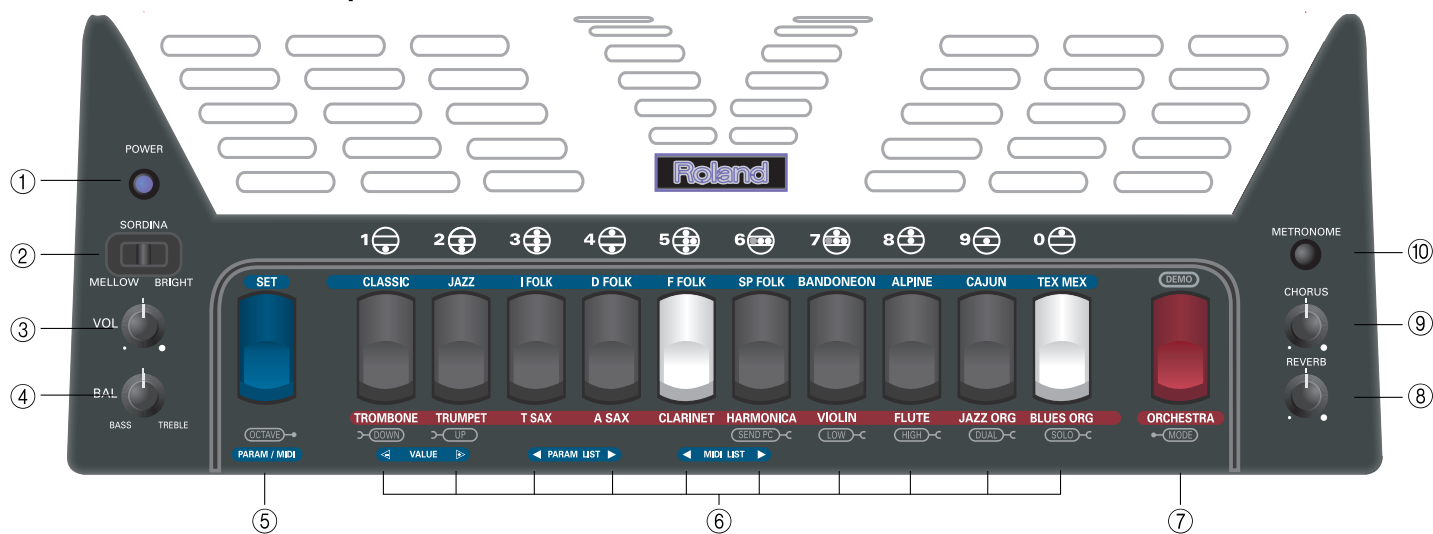

- ① **POWER button**
Press this button to switch the V-Accordion on (the button lights) and off (button dark).
- ② **SORDINA switch**
This MELLOW/BRIGHT switch allows you to switch the simulation of the wooden resonance chamber on ("BRIGHT") and off ("MELLOW").
- ③ **VOL knob**
This knob allows you to set the V-Accordion's overall volume.
- ④ **BAL knob**
This knob allows you to set the balance between the Bass and the Treble sections. Turn it towards "BASS" to decrease the Treble section's volume. Turn it towards "TREBLE" to decrease the Bass section's volume.
- ⑤ **SET register**
This register has three functions: if you press and then release it, you can select the desired Set (from among 10 available Sets).

After pressing [SET], you can use the Treble registers to select one of the following Sets:

1	CLASSIC	6	SP FOLK
2	JAZZ	7	BANDONEON
3	I FOLK	8	ALPINE
4	D FOLK	9	CAJUN
5	F FOLK	0	TEX MEX

By pressing and holding it, you gain access to the parameter and MIDI functions printed below the remaining registers that allow you to change several settings.

Press it together with register [1/-] or [2/+] to change octaves.

- ⑥ **Treble registers**
The Treble section provides the following 10 switches ("registers") that allow you to select various footages (see p. 21).

Treble registers					
1		Bassoon	6		Musette
2		Bandon	7		Violin
3		Harmon	8		Oboe
4		Organ	9		Clarinet
5		Master	0		Piccolo

If you hold down [SET] or [ORCHESTRA], the Treble registers can also be used to select and/or set various parameters.

Note: The Treble register assignments change when you select Set 5 "F FOLK". See page 22 for details.

- ⑦ **ORCHESTRA register**
The [ORCHESTRA] register serves three purposes: after pressing it, you can use the Treble registers to select one of the 10 on-board orchestral sounds for the Treble section. Activate it, then press one of the registers 1~0 to select the desired sound ("TROMBONE", "TRUMPET", "T SAX", "A SAX"). See the red legends below the registers. Press it again to assign registers 1~0 to the Treble section.

Press and hold this register to activate the demo song function (see p. 18) and select a demo song using registers [1/-] (previous) or [2/+] (next).





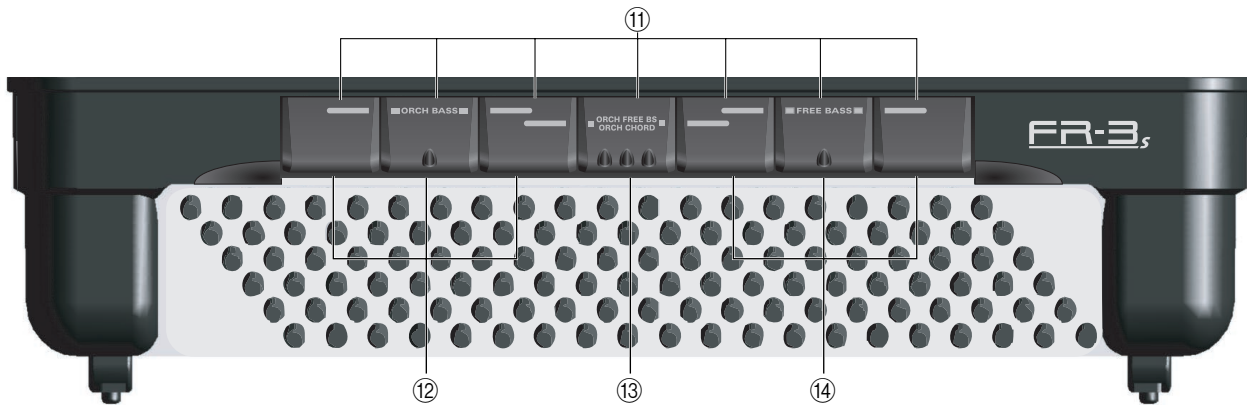

Press and hold it while pressing register [7], [8], [9] or [0] to select an Orchestra mode (see p. 25).

- ⑧ **METRONOME button**
Press this button to switch the metronome on and off (see p. 31). It can also be used to transmit Start/Stop messages to external MIDI devices.
- ⑨ **CHORUS knob**
Use this knob to set the level of the chorus effect (see p. 22).
- ⑩ **REVERB knob**
Use this knob to set the level of the reverb effect (see p. 22).







Bass control panel



- ⑪ **Bass registers**
These switches allow you to select the desired bass mix. They include the following footages:
- ⑬ **ORCH FREE BS/ORCH CHORD registers**
By pressing these three registers, you activate (or switch off) one of two Orchestra sections: ORCH CHORD (if the Free Bass section is off) or ORCH FREE BS (if the Free Bass section is on). "ORCH CHORD" allows you to assign an orchestral sound to the chord buttons. "ORCH FREE BS" can be used to select an orchestral bass sound for the Free Bass section. See p. 28 for details.

Bass registers	
1  2'	5  8'/4'/2'
2  4'	6  16'/8'/8-4'
3  8-4'	7  16'/2'
4  16'/8'/8-4'/4'/2'	

- ⑭ **FREE BASS registers**
Press the first three ("FREE BASS") registers (viewed from the top) simultaneously to enter Free Bass mode. Press the first three registers again to return to normal bass mode.

Free Bass registers	
1  Low	5  Low Low + High
2  High	6  High Low + High
3  Low + High	7  Low High
4  Low + High Low	

- ⑮ **Display**
The display keeps you informed about the FR-3's status and helps you locate the functions you may wish to set.



Connection panel

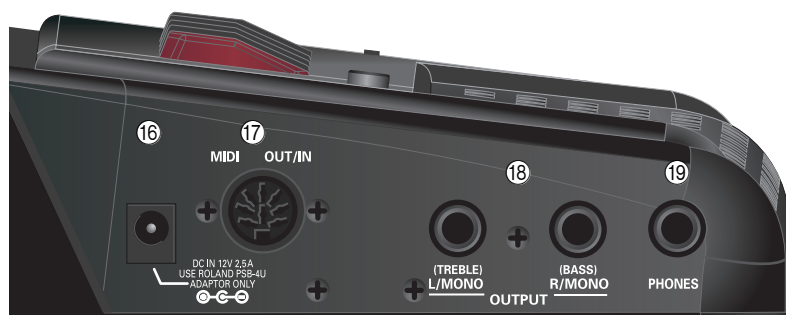

⑩ DC IN socket

This is where you need to connect the supplied power adapter (PSB-4U). Note that you can also purchase 10 optional batteries and use the FR-3 without the adapter.

⑪ MIDI OUT/IN socket

This socket can be used to receive or transmit MIDI data. Its function depends on the setting of the "MIDI" parameter (see p. 48).

⑫ OUTPUT L/MONO (TREBLE) & R/MONO (BASS) sockets

These sockets can be connected to an amplifier, a mixing console or a wireless system. If you use both connectors, the FR-3's output is stereo. In that case the signals of the Treble section is transmitted to the L/MONO socket, while the R/MONO socket transmits the bass (and chord) signal. If you only use one jack (connected to the "L" or "R" socket), the FR-3's output is mono.

Note: On the FR-3s/FR-3sb, connecting jacks to these sockets does not mute the internal speakers.

⑬ PHONES socket

This is where you can connect stereo headphones (Roland RH-25, RH-50 or RH-200). On the FR-3s/FR-3sb, connecting a pair of headphones mutes the internal speakers.

Important remark

After connecting any cable to the FR-3, be sure to never place it on the side when not using it.

- Always stand the V-Accordion on its rubber feet (and in the corresponding direction) to avoid damaging the plugs.
- Always handle and move the FR-3 with care and pay special attention to the cable slack to avoid damaging or bending the cables.
- If you place the FR-3 on your lap, ensure that the audio and adapter cables run between your legs (not sideways) to avoid damaging or bending the cables.

4. Setting up

Connections

The FR-3 has a compartment for 10 optional AA-type batteries. Consider purchasing such batteries when performing on stage, or to use the FR-3s/FR-3sb as a stand-alone instrument (taking advantage of its internal speakers). An FR-3/FR-3b with optional batteries still needs to be connected to an amplifier.

Using the OUTPUT sockets

If you are using optional batteries and need to connect the FR-3 to a PA system or mixer, we recommend using a wireless system to avoid having to use excessively long signal cables.

The FR-3s/FR-3sb is equipped with an internal speaker system and thus does not need to be connected to an amplifier at all. The FR-3/FR-3b, on the other hand, does require an audio connection.

You can also use a pair of headphones (Roland RH-25, RH-50, RH-200 or RH-300). In the case of the FR-3s/FR-3sb, connecting headphones switches off the internal speakers.

Note: To prevent malfunction and/or damage to speakers or other devices, always turn down the volume, and turn off the power on all devices before making any connections.

The FR-3's sounds have been arranged in such a way as to provide a **natural stereo image**. If you connect the V-Accordion to a mixing console, set the PAN parameter of the input to which the OUTPUT L socket (Treble section) is connected to "3 o'clock" and the PAN control of the channel to which the OUTPUT R socket (Bass section) is connected to "11 o'clock" to preserve this balance. Something like this: . This setting can be changed, however (see "Stereo Width" on p. 41).

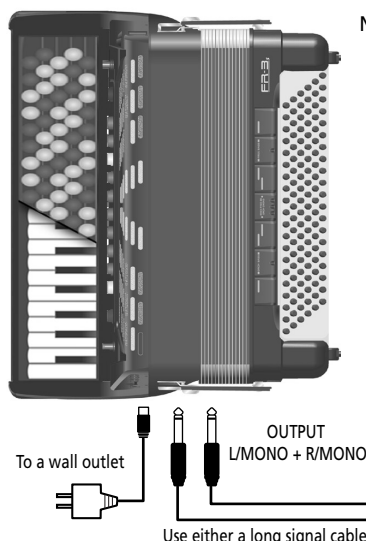

Note: The same connections apply to the FR-3sb and FR-3b.

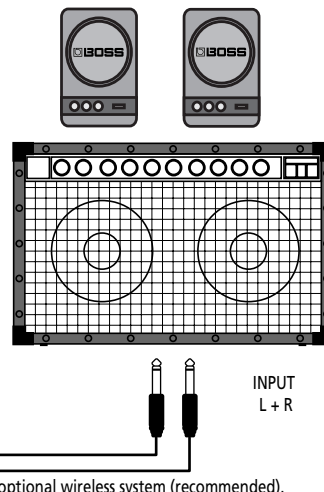

Use either a long signal cable (10m or more) or an optional wireless system (recommended).

Securing the adapter and/or MIDI cable

Proceed as follows to ensure that the adapter cable – or a MIDI cable – doesn't come loose while you are playing.

- (1) Remove the padding at the back of the FR-3. The padding is attached with several clips and can be removed simply by unclipping it.



Note the guide next to the right clip closest to the connection panel.



- (2) Connect the small plug of the adapter cable to the DC IN socket and wind the cable around the guide:



You can also connect the MIDI cable to the MIDI OUT/IN socket and wind it around the guide like the adapter cable.

- (3) Reinstall the padding, taking care to secure the adapter cable and/or MIDI cable you have just installed.



When finished, the FR-3 should look as follows:



- (4) Reverse these steps to remove and disconnect the adapter when you want to stop playing.

Attaching the straps

Proceed as follows to attach the straps to your FR-3:

- (1) Unpack the straps.
- (2) Put the FR-3 on a stable surface. The connection panel must face down.
- (3) Slide the upper end of one strap through the holder ring (see the illustration). The upper end is the part with the velcro portions and the clip.



- (4) Fasten the strap's upper part to the velcro layer below it.

- (5) Close the security clip to ensure that the strap cannot come loose.



- (6) Repeat steps (3)~(5) for the other strap. The upper strap ends should look as follows:



- (7) Turn the FR-3 around (with the connection panel on the left side, see below).

- (8) Slide the lower end of one strap through the holder ring as shown.



- (9) Slide the strap end through the upper eyelet of its plastic buckle (see the illustration).



- (10) Turn the strap end around and insert it into the lower eyelet, then pull it tight.

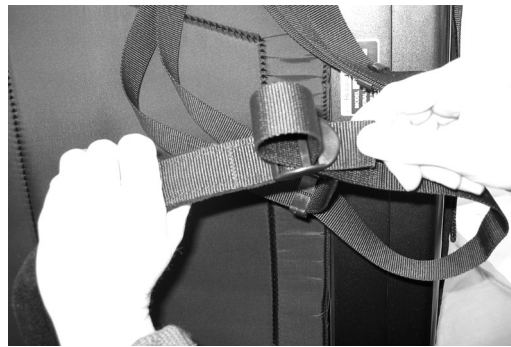

- (11) Slide the plastic clip over the loose and long lower strap ends to secure the strap.



Note: You may want to adjust the length first to suit your preference.

- (12) Repeat steps (8)~(11) for the other lower strap end.

Switching the power on and off

The power-on procedure depends on whether or not you are using optional batteries.

Note: If you decide to use rechargeable AA batteries, be aware that they cannot be recharged simply by leaving them in the FR-3's compartment and connecting the adapter. You will need an external charging unit.

Note: Once the connections have been completed, turn on power to your various devices in the order specified. By turning on devices in the wrong order, you risk causing malfunction and/or damage to speakers and other devices.

If you are using the supplied adapter

If the FR-3 is powered by the supplied adapter, proceed as follows:

- (1) Connect the supplied adapter to the FR-3's DC IN socket.

- (2) Connect the FR-3's DC INLET socket to a wall outlet that meets the specifications (see p. 57).



To a wall outlet



The adapter should only be connected to a power source of the type marked on its label. For details on the power consumption, please refer to page 57.

- (3) Turn down the output volume of the receiving audio device.
You can also simply switch it off.
- (4) Connect the FR-3's OUTPUT sockets to the external audio device (amplifier, mixing console, etc.).

- (5) Press the FR-3's **POWER** button to switch it on.
- (6) Switch on the receiving audio device.
- (7) Start playing (see "First steps" on page 19).
Note: This unit is equipped with a protection circuit. A brief interval (a few seconds) after power up is required before the unit will operate normally.

—To switch off you system—

- (8) Turn down the output volume of the receiving audio device or switch it off.
- (9) Press the FR-3's **POWER** button again so that its indicator goes dark.

Using batteries and no external amplification (FR-3s/FR-3sb only)

Note: See page 54 for how to work with batteries.

- (1) Press the FR-3s/FR-3sb's **POWER** button (it lights) to switch it on.

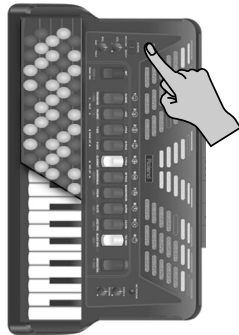

Note: You can also connect headphones.

- (2) Start playing (see "First steps" on page 19).
- (3) Press the **POWER** button again so that it goes dark when you are finished.

If you are using batteries and an audio connection to an external device

The FR-3/FR-3b needs to be connected to an amplification system of some sort (unless you want to use headphones).

Note: You can also purchase a wireless transmitter from third-party suppliers and connect it to the FR-3's OUTPUT sockets.

- (1) Turn down the output volume of the receiving audio device.
You can also simply switch it off.
- (2) Connect the FR-3's OUTPUT sockets to the external audio device using two 1/4" guitar cables.
Note: You can also connect headphones to the PHONES socket, in which case you do not need to establish an audio connection.
- (3) Press the FR-3's **POWER** button (it lights) to switch it on.
- (4) Switch on the receiving audio device.
- (5) Start playing (see "First steps" on page 19).

—To switch off your system—

- (6) Turn down the output volume of the receiving audio device, or switch it off.
- (7) Press the FR-3's **POWER** button again so that it goes dark.

Listening to the demo songs

One of the most striking aspects of your V-Accordion may be that it can play all by itself! It contains a series of demo songs that illustrate its wide variety of sounds and applications. Here is how to listen to the demo songs:

- (1) Switch on the FR-3.
See "Switching the power on and off" on p. 16.
- (2) Press and hold the **ORCHESTRA** register until the display looks as follows:



Playback starts automatically with the first demo song (there are 25 demo songs in all). At the end of the first song, the FR-3 starts playing songs "2", "3" etc. You can also directly jump to the song you're interested in:

- (3) Use registers **1** and **2** ("VALUE -/+") to select the demo song you want to listen to.

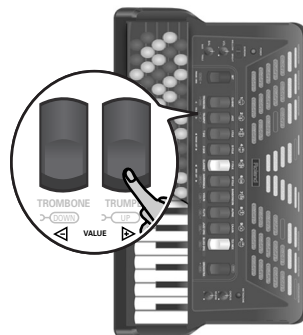

- (4) Use the **VOL** knob to change the volume if it is too loud or too soft.
Note: All demo songs are copyright ©2006 by Roland Europe. Public performance or recording of these songs is prohibited.
- (5) Press **ORCHESTRA** again to leave the demo song mode.

First steps

The sections of your FR-3

Before showing you how to use the FR-3, let's briefly look at the various "sections" of your instrument, as that will help you understand how your V-Accordion works.

The FR-3 is a "virtual" accordion. That term was borrowed from synthesizers that recreate the sounds of other synthesizers using a different technology (hence the term "virtual analog synthesizer", for example).

The FR-3 recreates the sounds of various accordion instruments (the "virtual" part) and can even generate orchestral sounds, like trumpet, flute, etc. (the **synthesizer** part).

The sections outlined in the illustration to the right contain several functions you can set. Let us agree to call those functions "parameters".

The parameters allow you to change certain aspects of the FR-3's sound: you can set the Musette detuning system, the levels of various sections, add digital effects, and more. Your settings can be saved. There is thus no need to set the parameters time and again. Note, however, that they always apply to all Sets.

The accordion sections are combined into "Sets".

Those Sets have been programmed at the factory and cannot be changed. The FR-3's internal structure looks as follows:

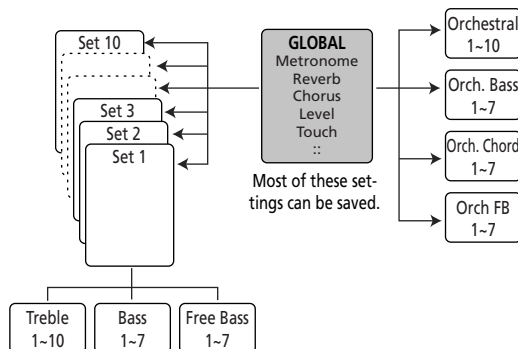

There are 10 Set memories that contain useful settings right out of the box. You cannot replace them with your own settings. They are influenced, however, by certain GLOBAL settings. The GLOBAL parameters apply to all Sets and all sections.

Sets are like the trunk of a car that contains several instruments (bandoneon, musette, etc.). The instruments themselves can be recalled via the registers.

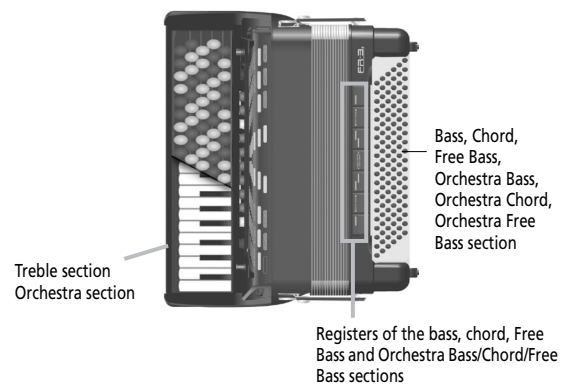

There are 10 Treble registers, 7 Bass, and 7 Free Bass registers. In addition, each section can play an orchestral sound (piano, guitar, etc.): Orchestra (10 sounds), Orchestra Bass (7), Orchestra Chord (7), and Orchestra Free Bass.

The (accordion) registers behave like on an acoustic accordion, i.e. they allow you to change the footage combinations. Those registers also double as sound selection buttons when one of the sections (Treble, Bass, Chord or Free Bass) plays an orchestral sound.

Oh, and... the Sets can be selected by pressing the **SET** register and a numbered register (**1**~**0**).

As stated above, the Sets have been programmed at the factory and cannot be changed.

How to read the display

With the exception of the display and the additional buttons and knobs, the FR-3 looks like a conventional accordion. The display contains important clues about the settings that are currently in effect.

What's shown in the display depends on how you are using your FR-3 and what you are doing.

■ Sets

After pressing the [SET] register, the display looks more or less as follows:



"St" flashes to signal that you need to press a register ([1]~[0]) to select a Set memory. "0" (TEX MEX), by the way, refers to Set number "10".

Each Set represents one accordion type whose sound can be modified by switching the desired registers on and off. This is identical to the behavior of an acoustic accordion. Unlike an acoustic accordion, however, your FR-3 can simulate different instrument types.

Note: If you don't select a Set, the "St" message stops flashing. If you then press a Treble register, only the sound of the right hand (Treble) changes.

■ Accordion sections

Once you have selected a Set, the display indication changes to something like this (after a few seconds):

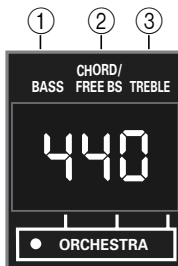

Carefully look at what is printed above the display:

BASS (1) The digit in this column refers to the Bass register you selected last. (It is also displayed in Free Bass mode to remind you of the Bass register you will return to when you leave Free Bass mode.)

CHORD (2) The digit in this column refers to:
 • The selected chord register (when Free Bass mode is off) -OR-
 • The selected Free Bass register (the middle digit **flashes** to signal that you are in Free Bass mode)

The chord register is always identical to the bass register. The first two digits are therefore usually the same. When Free Bass mode is active, however, the digit in the middle may differ from the left one (and it flashes).

TREBLE (3) The digit in this column refers to the selected Treble register.

The above applies to situations where **no orchestral sound** is used.

■ Orchestral sections

If you do select an orchestral sound, the display looks as follows:



A dot (see "2.") means that the section in question plays an orchestral sound.

As printed below the display (4), a **dot** to the right of a figure means that the section in question (BASS in the example above) does not play an accordion but an orchestral sound.

Our example therefore means:

- You have assigned orchestral sound "2" ("Bowed") to the Bass section.
- The chord buttons are assigned to accordion register "4".
- The Treble section plays register "10" (which is called "0").

Both the chord buttons and the Treble keyboard play accordion sounds, while the 2 bass rows of the button keyboard play an orchestral sound.

If the middle digit **flashes** and is followed by a **dot**, the bass buttons play an orchestral sound that is assigned to the Free Bass section.



The middle digit flashes when the ORCH FREE BS section is active.

See also "Using two different orchestral sounds for the Bass button keyboard" on p. 29 for details about the left and middle dots.

Touring the FR-3's sections

It's time we put the FR-3 through its paces, because that's what you purchased it for. We'll work section by section.

Bellows resistance regulator

Your FR-3 is equipped with a bellows resistance regulator knob that allows you to specify the bellows' inertia (the force needed to push and pull it).

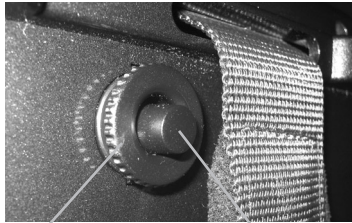

Bellows resistance regulator. Turn to select the bellows' resistance.

Air button. Press to purge remaining air after playing.

Located next to one of the bellows clips and mounted onto the air button (which allows you to release remaining air from the bellows without producing sound), it can be set to one of four positions, each one corresponding to a lighter or stronger inertia. Choose the setting that feels most comfortable for you.

Bass strap

The FR-3's bass strap (used to move the bellows in and out) is made of fabric and fitted with a velcro strip that allows you to adjust its slack:



Treble section

The Treble section can be played using the 37-key "piano" keyboard (FR-3s and FR-3) or the 92 treble buttons (FR-3sb and FR-3b).

The sound it produces is determined by the register (1~0) you pressed last. This section can be used as "accordion", to play an orchestral sound or both.

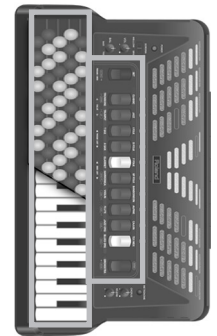

- (1) Connect the FR-3 (if necessary) and switch it on.
See pages 14 and 16.

- (2) Grab the FR-3, press a Treble register and start playing on the keyboard.

Though the FR-3 is an electronic musical instrument, it only produces sound when you move the bellows. As long as you don't move the bellows, you hear nothing at all (like on an acoustic accordion).

Note: If you want to play the FR-3 without moving the bellows, you need to set the "bLC" parameter (see p. 41) to "2" (you can also select "1" or "3").

Note: When the FR-3 is controlled via MIDI, there is no need to move the bellows.

- (3) Press the **[SET]** register.

The "St" message starts flashing to signal that you need to press a register.

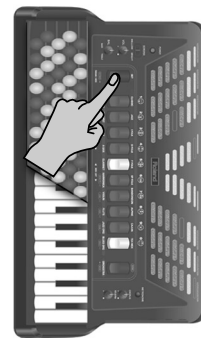

The "Roland" logo now flashes in blue.

- (4) Press one of the registers **[1]~[0]** to select a Set memory.

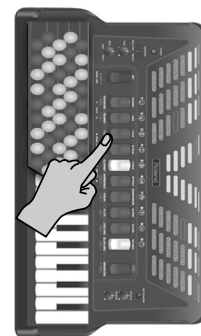



The "Roland" logo changes color and stops flashing.

- (5) Play a few notes to audition the sound.

- (6) Press one of the registers [1]~[0] to select another footage.







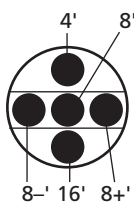



The display now shows the number of the newly selected Treble register:



The indications printed on the front panel refer to the octaves (vertical direction, ) and the number of slightly detuned reeds that are used (horizontal direction, ). The detuned reeds are only available for the central register (8').















Here is what the footages correspond to:

Treble registers (Sets 1~4, 6~0)					
1		Bassoon	6		Musette
2		Bandon	7		Violin
3		Harmon	8		Oboe
4		Organ	9		Clarinet
5		Master	0		Piccolo

The gray dots of registers [6] and [7] mean that you can add a second detuned reed (8'-) for a fuller sound. To do so, press the corresponding register again.

When you select **Set 5 "F FOLK"**, the footages change as follows. This is not printed on the front panel, so please refer to the table below:

Treble registers (Set 5)					
1		Bassoon	6a		Av Musette
2		Jazzy	6b		Sos Musette
3		Arnold	7a		Sw Valse
4		Beguine	7b		Mr Gus
5		4 Voix	8		Oboe
			9		Clarinet
			0		Piccolo

Note: For Set [5] (and only for that Set), registers [6] and [7] provide access to two sounds (a/b). To select a "b" sound, press the corresponding register twice.

- (7) If you think the sound is too loud or too soft, you can change the setting of the [VOL] knob.

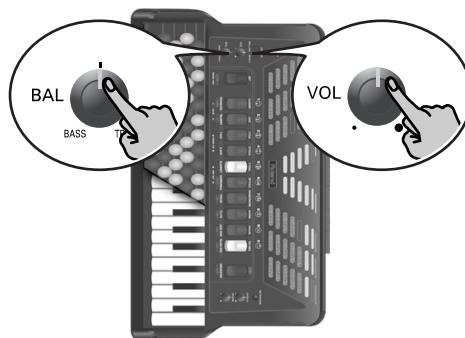

- (8) If you still can't hear the Treble notes, set the [BAL] knob to the center position.

This knob is used to set the balance between the Treble and Bass registers. When it is turned all the way to "BASS", the Treble section is inaudible. When you change the Balance setting, the display briefly confirms your setting ("t1"~"t63", "0" or "b1"~"b63").

- (9) Press [SET] and one of the registers [1]~[0] to select another Set and again play a few notes.

■ Using the Sordina

The [SORDINA] switch allows you to attenuate the sound (make it softer, select "MELLOW"). On an acoustic accordion, this closes the wooden resonance chamber inside the instrument.

The FR-3 simulates this effect electronically (it contains not a single reed!).

Note: The Sordina only applies to the Treble section.

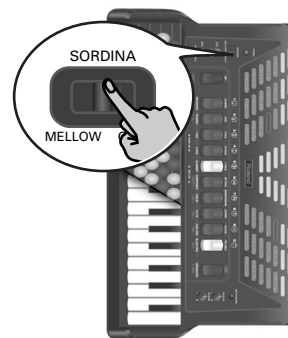

■ Using the FR-3's digital effects

While playing on the Treble keyboard, you may have noticed that the accordion sounds are enhanced by effects (probably reverb).

The FR-3 contains 2 digital effects:

Reverb: This effect creates the impression that you are playing in a concert hall, a church or a room. It adds "depth" to the sound.

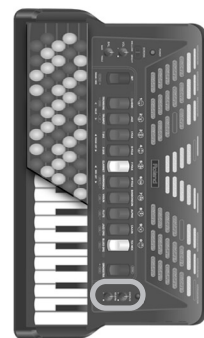

Chorus: This effect creates the impression that several instruments of the same type are playing at the same time (it is similar to detuning several reeds of a register).

The **[CHORUS]** and **[REVERB]** knobs allow you to set the volume of these effects. Turn them all the way towards the left (the small dot) if you don't need the effect in question. The selected value (0~127) is briefly shown in the display.

Turn them towards the right (the big dot) to increase the effect volume.

Note: The settings of these knobs apply to all sections and all Sets.

Bass section

The Bass section can be played via the "Stradella" buttons.

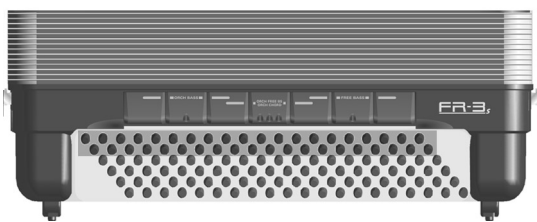

The buttons in this section allow you to play *both* bass notes *and* chords. The chords use the (sound) register selected for the Bass section – hence the name of this section. The "real" bass notes are assigned to the two highlighted rows. The remaining buttons are used to play chords.

The FR-3 is supplied with *several reference caps* (concave and with lines) to help you locate the bass and chord buttons without looking at them. At the factory, three caps are installed on the black buttons in the following illustration. Feel free to remove them and to slide them over other buttons if that feels more comfortable.

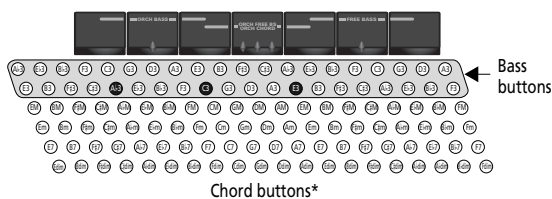

(*) This can be changed to 3 bass and 3 chord rows. See "Bass & Chord Mode" on p. 42.

Here is what the caps look like:

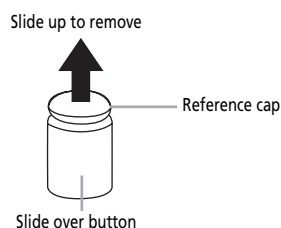

The overall sound the Bass section produces is determined by the register you pressed last. This section can be used as "accordion", to play orchestral sounds, or both.

- (1) Connect the FR-3 (if necessary) and switch it on. See pages 14 and 16.
- (2) Grab the FR-3, press a register and start playing on the Bass (button) keyboard. Though the FR-3 is an electronic musical instrument, it only produces sound if you move the bellows.
- (3) Press another register to change the sound.



Bass registers	
1	2'
2	4'
3	8-4'
4	16'/8'/8-4'/4'/2'
5	8'/4'/2'
6	16'/8'/8-4'
7	16'/2'

Note: The numbers shown in the illustration above do not appear on the registers themselves. They have been added for your reference.

The display briefly confirms your setting and indicates which footage you selected:



When you use only the accordion sounds, the left (Bass) and middle (Chord) digits are the same, because the bass and chord buttons use the same register (they belong to the same accordion section).

- (4) If you think the sound is too loud or too soft, you can change the setting of the **[VOL]** knob.

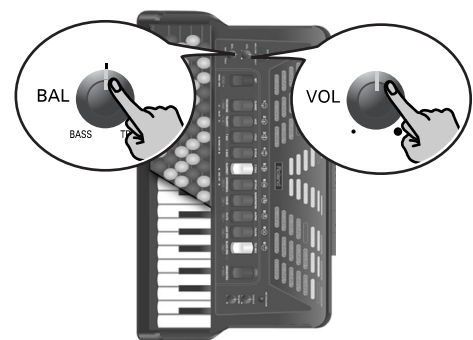

- (5) If you still don't hear the bass and chord notes you are playing, change the **[BAL]** knob's setting. This knob is used to set the balance between the Treble and Bass registers. When it is turned all the way to "TREBLE", you won't be able to hear the Bass section.
- (6) Press the **[SET]** register.

The "St" message starts flashing to signal that you need to press a register.



The "Roland" logo now flashes in blue.

- (7) Press one of the registers [1]~[0] to select a Set memory.

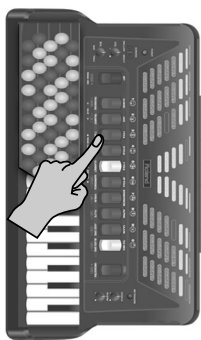

The "Roland" logo changes color and stops flashing.

Playing in Free Bass mode

The FR-3 also provides a Free Bass mode, which is chiefly used by musicians who prefer to play the left-hand notes (Bass section) differently. You may never need it, but if you wish to experiment with it...

Note: See page 42 for how to select the note system for Free Bass mode. That setting is shared by all Sets.

- (1) Simultaneously press the three registers labeled "FREE BASS".



Note: The numbers shown in the illustration above do not appear on the registers themselves. They have been added for your reference.

The digit in the middle starts flashing to indicate that Free Bass mode has been activated:

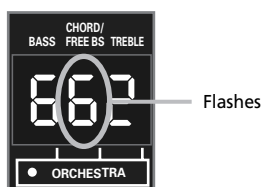

Again, the left and flashing middle digits are the same. This time, however, they refer to the currently selected Free Bass register.

Note: See page 43 for the assignment of the bass buttons to the available Free Bass notes.

- (2) Use the Bass registers to select another registration (if necessary).

Free Bass registers			
1	Low	5	Low Low + High
2	High	6	High Low + High
3	Low + High	7	Low High
4	Low + High Low		

- (3) Press the three FREE BASS registers again to return to the normal Bass mode.

Using the FR-3's digital effects

While playing on the Bass keyboard, you may have noticed that the accordion sounds were enhanced by effects (probably reverb). It may also have struck you that the effects change whenever you select a different Set.

The FR-3 contains 2 digital effects that apply to all sections. See page 22 for details and how to use them.

Using the orchestral sounds

Your FR-3 contains PCM sounds (samples) of various instruments that are not related to accordion sounds. Those sounds allow you to expand your musical endeavours without using external MIDI devices. Of course, you are free to add external MIDI tone generators to your setup and to control them from your FR-3. See page 47 for details. Let us first look at how to use the on-board orchestral sounds, however.

The FR-3's Orchestra functionality actually comprises four sections: one for the Treble keyboard (called "Orchestra"), another for the Bass buttons (first two rows, called "ORCH BASS"), a third for the chord buttons (remaining rows, called "ORCH CHORD"), and one for Free Bass mode ("ORCH FREE BS").

You can specify for each section whether the orchestral sounds should be used instead of the accordion sounds. Only the Treble keyboard can play both an accordion and an orchestral sound (so that each note you play results in a combination of accordion + instrument sound).

Orchestral sounds for the Treble section

Note: Only one orchestral sound can be selected at any one time.

- (1) Press the **ORCHESTRA** register.

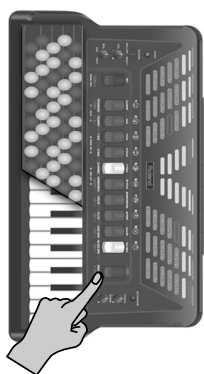

The "Roland" logo now lights in red. The display shows the number of the last Orchestra sound you selected. That number (the right-most digit) is followed by a dot:

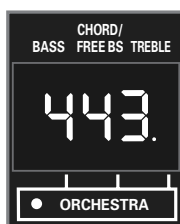

- (2) Press one of the registers to select the desired orchestral sound (see the names below the Treble registers).

The 10 available Orchestra sounds and associated registers are:

ORCHESTRA sounds			
1	Trombone	6	Harmonica
2	Trumpet	7	Violin
3	T Sax	8	Flute
4	A Sax	9	Jazz Org
5	Clarinet	0	Blues Org

- (3) Play a few notes on the Treble keyboard.

Note: By pressing register **9** or **0** again after selecting the associated organ sound, you switch on the Rotary effect available for that sound.

■ Selecting the Orchestra mode

Depending on the ORCHESTRA MODE setting, the Orchestra part may sound together with the Treble accordion section. That's because there are four ways in which the Orchestra section can be combined with the Treble accordion section.

Orchestra mode (which only applies to the Treble section) can be set as follows:

- (1) While holding down the **ORCHESTRA** register, press **7**, **8**, **9** or **0** to select the desired mode.

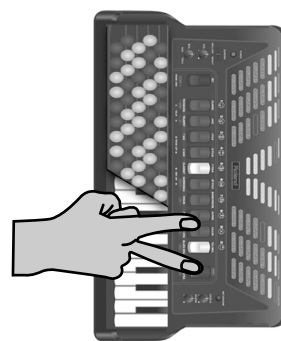

SOLO 0: When you switch on the Orchestra section (see step (2) above), you only hear the Orchestra instrument sound. Press **ORCHESTRA** to return to the Treble accordion sound.

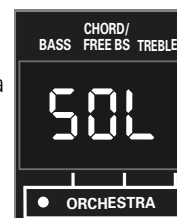

DUAL 9: The Orchestra sound is added to the Treble accordion, so that each note you play sounds like an accordion, with the selected instrument playing in unison.

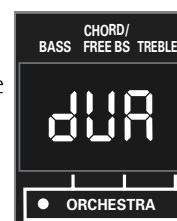

HIGH [12]: Now it becomes a little more complicated – but very interesting indeed. If you select this mode and play just one note, you will hear the orchestral sound. If you keep holding that key/button while pressing another (lower) key/button to its left, the upper note is played by the Orchestra sound. Lower notes, however, are played by the Treble accordion sound. This is perfect for situations where you need to play chords and a solo line using different sounds. Something like this:

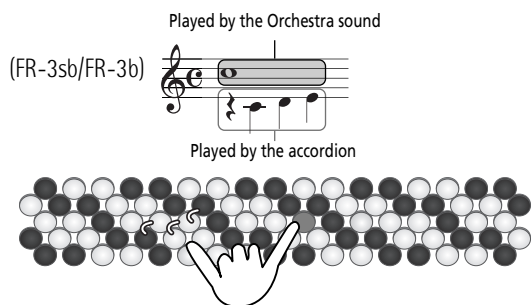
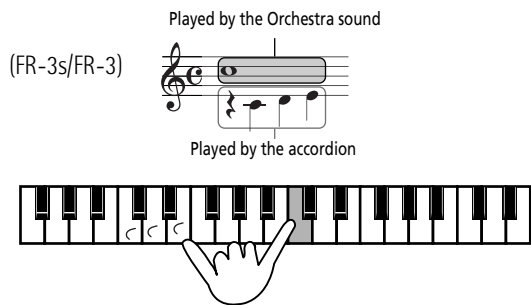
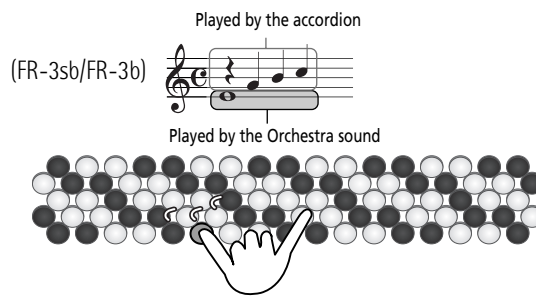

LOW [11]: This is the opposite of HIGH and can be used in situations where the melody (or counter-melody) lies above the notes you wish to hold.

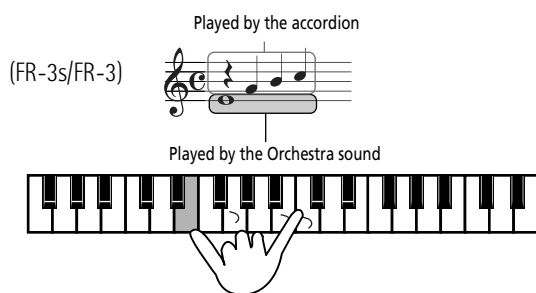
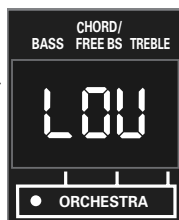

(2) Again play a few notes and listen to the result.

■ **Setting the volume of the (Treble) Orchestra sound**

There may be times (in DUAL, HIGH or LOW mode) when the ORCHESTRA sound is too loud or too soft with respect to the Treble accordion sound. In that case, you can change its volume:

- (1) Press and hold the **[SET]** register until the display shows a parameter name, then release it.
- (2) Use register **[3/◀]** or **[4/▶]** to select the following parameter:



By doing so, you enter a mode called "PARAM LIST" where you can set the available parameters (see also p. 37). "O L" is short for "Orchestra Level", i.e. the volume setting of the Orchestra section.

- (3) Use register **[1/−]** or **[2/+]** to set the desired value.



This is actually a balance parameter with a setting range of −40~"Std"~+40. "Std" means that the Orchestra part uses its "normal" volume. Negative values (−) make the Orchestra part softer, while positive values (+) make it louder.

Note: Press registers **[1]** and **[2]** simultaneously to return to the factory setting of the currently selected parameter.

You can now decide whether or not to save your settings:

Saving your changes

- (4) Press and hold the **[SET]** register until the display looks as follows:



- (5) Press register **[2/+]** to save the settings.
The display now looks as follows:



If you don't want to save your changes, press **[1/-]**. In that case the display briefly shows the "No" message. If don't save, your changes remain in effect until you switch off the FR-3. (If the FR-3 is powered off automatically, see page 42, your changes are lost as well.)

- (6) Press **[SET]** again to confirm your intention (save or ignore).
The display now looks as follows and then once again displays the numbers of the registers currently in effect:



■ Switching off the Orchestra part

To return to a state where only the Treble accordion section sounds:

- (7) Press the **[ORCHESTRA]** register. Now, the FR-3 is a normal accordion again.
To activate the Orchestra part again, perform steps (1) and (2) on page 25.

Orchestral sounds for the Bass section

The orchestral bass part can be used instead of the Bass section (thus replacing the accordion sound assigned to the bass rows). There are no clever modes (DUAL, SOLO, etc.) here.

Furthermore, the ORCH BASS part does what its name implies: it **only applies to the bass rows** (the ones closest to the bellows) and has no effect on the chord buttons.

- (1) Simultaneously press the three registers labeled "ORCH BASS".



The display shows the number of the last orchestral bass sound you selected. That number (the leftmost digit) is followed by a dot:



(See "Using two different orchestral sounds for the Bass button keyboard" on p. 29 for details about the dot.) Note that in this situation, the leftmost digit differs from the one in the middle. The leftmost digit refers to an orchestral sound, while the middle one represents the accordion register, which is still used by the chord rows of the button keyboard.

Note: The numbers shown in the illustration above do not appear on the registers themselves. They have been added for your reference.

- (2) Use the Bass registers to select the desired sound.

ORCH BASS sounds			
1	Acoustic	5	Picked
2*	Bowed*	6*	Tuba*
3	Fingered	7	Tuba Mix
4	Fretless		

Note: While ORCH BASS mode is active, you cannot assign a different accordion register to the chord rows. You need to leave ORCH BASS mode, select the desired accordion register, then return to ORCH BASS mode.

Note: The dynamics of sounds marked with an asterisk (*) can only be controlled by bellows movements. Those sounds are not velocity sensitive. For the other sounds, see also "Orch. Bass/Free Bass/Chord Touch" on p. 41.

■ Setting the volume of the ORCH BASS sound

There may be times when the orchestral bass sound is too loud or too soft with respect to the other available sections. In that case, you can change its volume:

- (1) Press and hold the **[SET]** register until the display shows a parameter name, then release it.
- (2) Use register **[3/◀]** or **[4/▶]** to select the following parameter:



By doing so, you enter a mode called "PARAM LIST" where you can set the available parameters (see also p. 37). "ObL" is short for "Orchestra Bass Level", i.e. the volume setting of the orchestral bass section.

- (3) Use register **[1/-]** or **[2/+]** to set the desired value.

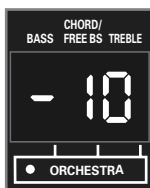

This is actually a balance parameter with a setting range of -40~"Std"~+40. "Std" means that the ORCH BASS part uses its "normal" volume. Negative values (-) make the ORCH BASS part softer, while positive values (+) make it louder.

Note: Press registers **[1]** and **[2]** simultaneously to return to the factory setting of the currently selected parameter.

- (4) See "Saving your changes" on p. 26 if you want to keep your changes.
To use them only temporarily, press the **[SET]** register to leave "PARAM LIST" mode.

■ Switching off the Orchestra Bass part

- (5) Press the three ORCH BASS registers again to return to normal Bass mode.

Orchestral sounds for the Chord section

The orchestral chord part can replace the accordion sound played by the chord rows of the button keyboard. There are no clever modes (DUAL, SOLO, etc.) here.

The ORCH CHORD part does what its name implies: it **only applies to the chord rows** and has no effect on the bass buttons.

- (1) If the digit in the middle of the display ("CHORD/FREE BS") is flashing, select the FR-3's Bass mode by pressing the three FREE BASS registers. The ORCH CHORD part is not available in Free Bass mode (because there are no chord buttons in that mode).
- (2) Simultaneously press the three registers labeled "ORCH CHORD".



The display shows the number of the last orchestral chord sound you selected. That number (the digit in the middle) is followed by a fixed dot:



Note that in this situation, the middle digit differs from the one to its left. The leftmost digit refers to an accordion register, while the middle one represents the orchestral chord sound used by the chord rows of the button keyboard.

Note: The numbers shown in the illustration above do not appear on the registers themselves. They have been added for your reference.

- (3) Use the Bass registers to select the desired sound.

ORCH CHORD sounds			
1*	St. Strings*	5*	Choir*
2*	Chorus Organ*	6*	Harps + Strings*
3	Steel Guitar	7*	Guitar + Organ*
4*	Stereo Orch Brass*		

Note: While ORCH CHORD mode is active, you cannot assign a different accordion register to the bass rows. You need to leave ORCH CHORD mode, select the desired accordion register, then return to ORCH CHORD mode.

Note: The dynamics of sounds marked with an asterisk (*) can only be controlled by bellows movements. Those sounds are not velocity sensitive. For the other sounds, see also "Orch. Bass/Free Bass/Chord Touch" on p. 41.

■ Setting the volume of the ORCH CHORD sound

There may be times when the orchestral chord sound is too loud or too soft with respect to the other available sections. In that case, you can change its volume:

- (1) Press and hold the **[SET]** register until the display shows a parameter name, then release it.
- (2) Use register **[3/◀]** or **[4/▶]** to select the following parameter:



By doing so, you enter a mode called "PARAM LIST" where you can set the available parameters (see also p. 37). "OCL" is short for "Orchestra Chord Level", i.e. the volume setting of the orchestral chord section.

- (3) Use register **[1/-]** or **[2/+]** to set the desired value.

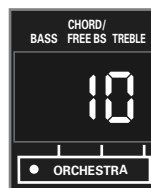

This is actually a balance parameter with a setting range of -40~"Std"~+40. "Std" means that the orchestral chord section uses its "normal" volume. Negative values (-) make the ORCH CHORD section softer, while positive values (+) make it louder.

Note: Press registers **[1]** and **[2]** simultaneously to return to the factory setting of the currently selected parameter.

- (4) See "Saving your changes" on p. 26 if you want to keep your changes.
To use them only temporarily, press the **[SET]** register to leave "PARAM LIST" mode.

■ Switching off the ORCH CHORD part

- (5) Press the three ORCH CHORD registers again to return to the normal Chord mode.

■ Using two different orchestral sounds for the Bass button keyboard

The FR-3 also allows you to use assign one orchestral sound to the bass rows of the button keyboard, and another to the chord rows. In that case, the display looks as follows (notice the two dots):

One of the two dots flashes.



The flashing dot refers to the orchestral section you can assign another sound to.

→ The following only applies while you are *not* in Free Bass mode, i.e. while the *digit* (not the dot) in the middle *does not flash*.

When both the ORCH BASS and the ORCH CHORD sections are active, one of the two dots flashes to indicate that the Bass registers allow you to assign a different sound to that orchestral section: "ORCH BASS" if the left dot is flashing, "ORCH CHORD" if the dot in the middle is flashing.

- (1) Simultaneously press the three registers labeled "ORCH BASS".

This activates the Orchestra Bass section (a dot appears next to the leftmost digit).

- (2) Simultaneously press the three registers labeled "ORCH CHORD".

This activates the Orchestra Chord section (another dot appears next to the middle digit).

To assign a different orchestral sound to the section whose dot is not flashing...

- (1) Simultaneously press its three registers (ORCH BASS or ORCH CHORD).

This does not change the status of the section in question (the corresponding ORCH section is not switched off).

The dot that has been flashing up to now lights steadily, while the "other" dot starts flashing.

- (2) Use the 7 Bass registers to select a different orchestral sound for the ORCH BASS or ORCH CHORD section.

Note: To leave either ORCH BASS or ORCH CHORD mode in this state, you need to press the associated 3 registers twice.

Orchestral sounds for the Free Bass section

The orchestral Free Bass part can replace the accordion sound played by the button keyboard while Free Bass mode is active. In that case, all bass buttons play bass notes – no chords. There are no clever modes (DUAL, SOLO, etc.) here.

- (1) Simultaneously press the three registers labeled "FREE BASS".

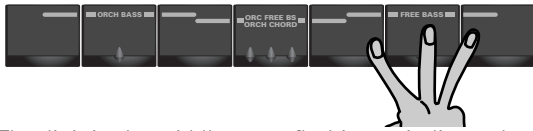

The digit in the middle starts flashing to indicate that Free Bass mode has been activated:

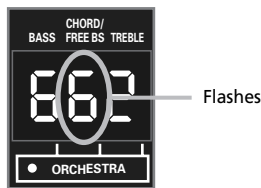

- (2) Simultaneously press the three registers labeled "ORCH FREE BS".



The display shows the number of the last orchestral Free Bass sound you selected. That number (the flashing digit in the middle) is followed by a dot:

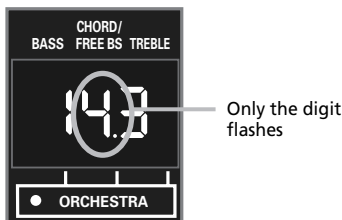

In this situation, the leftmost digit often differs from the one in the middle. The leftmost digit refers to an accordion sound (which is currently unavailable), while the middle one (which flashes) represents the orchestral sound assigned to the button keyboard. As the button keyboard is in Free Bass mode, the middle digit flashes.

- (3) Use the Bass registers to select the desired sound.

ORCH FREE BS sounds			
1*	Trombone*	5*	Perc Organ*
2*	Clarinet*	6	Ac Guitar
3*	Oboe*	7	Ac Piano
4*	Flute*		

Note: The dynamics of sounds marked with an asterisk (*) can only be controlled by bellows movements. Those sounds are not velocity sensitive. For the other sounds, see also "Orch. Bass/Free Bass/Chord Touch" on p. 41.

Note: The numbers shown in the illustration above do not appear on the registers themselves. They have been added for your reference.

Setting the volume of the ORCH FREE BS sound

There may be times when the orchestral Free Bass sound is too loud or too soft with respect to the Treble accordion and/or orchestral sound. In that case, you can change its volume:

- (1) Press and hold the **[SET]** register until the display shows a parameter name, then release it.
- (2) Use register **[3/◀]** or **[4/▶]** to select the following parameter:



"OFL" is short for "Orchestra Free Bass Level", i.e. the volume setting of the orchestral Free Bass section.

- (3) Use register **[1/-]** or **[2/+]** to set the desired value.



This is actually a balance parameter with a setting range of -40~"Std"~+40. "Std" means that the orchestral Free Bass part uses its "normal" volume. Negative values (-) make the ORCH FREE BS part softer, while positive values (+) make it louder.

Note: Press registers **[1]** and **[2]** simultaneously to return to the factory setting of the currently selected parameter.

- (4) See "Saving your changes" on p. 26 if you want to keep your changes.
To use them only temporarily, press the **[SET]** register to leave "PARAM LIST" mode.

Switching off the ORCH FREE BS part

- (5) Press the three ORCH FREE BS registers again to return to normal Free Bass mode.
(Press them yet again to leave Free Bass mode and return to Bass mode.)

Note: To leave either FREE BASS or ORCH FREE BS mode in this state, you need to press the associated 3 registers twice.

5. Other practical functions

After looking at the accordion and Orchestra functions, let's have a look at the "purely electronic" functions of your FR-3. Your FR-3 is what we call a virtual instrument. Though its physical appearance is similar to that of its acoustic ancestor, it is based on an altogether different concept (technology) – and it can do a lot more. In this section, we will look at functions that may be new to you but may come in handy once you know what they do and how they work.

Switching off sections you don't need

If, for some reason, you do not want one of the currently active parts to respond to your playing, you can switch it off:

This may apply to any of the following combinations and mute the corresponding keys or buttons (where applicable):

Treble and/or Orchestra	+ Bass + Chord
Treble and/or Orchestra	+ ORCH BASS + Chord
Treble and/or Orchestra	+ ORCH BASS + ORCH CHORD
Treble and/or Orchestra	+ Bass + ORCH CHORD
Treble and/or Orchestra	+ Free Bass
Treble and/or Orchestra	+ ORCH FREE BS
Treble and/or Orchestra	+ ORCH BASS + ORCH FREE BS
Treble and/or Orchestra	+ ORCH BASS + Free Bass

- To switch off a section you do not want to hear, press and hold any single register for a while. Use a register in the Treble section to mute the Treble or Orchestra part; use a Bass register to mute the bass, chord, Free Bass, or any of the associated orchestral parts. The section in question must be assigned to the associated registers. See the previous pages for how to decide which section can be muted.
- To switch a muted section back on, briefly press any of the associated registers.

Using the metronome

Your FR-3 contains a metronome that may come in handy when you are practising new pieces, or during your accordion classes. You can set the time signature, the tempo and the level.

Note: The following only works if "MFN" (see p. 42) is set to "1".

Setting up the metronome

Before using the metronome, you probably need to set it to the desired tempo. The FR-3 allows you to save these settings, so that you can use them again next time you switch it on.

Setting the time signature

To set the time signature, proceed as follows:

- Press and hold the **[SET]** register until the display shows a parameter name, then release it.
- Use register **[3/◀]** or **[4/▶]** to select the following parameter:



"MtS" is short for "Metronome TS", i.e. the metronome's time signature.

- Use register **[1/-]** or **[2/+]** to set the desired value.



Here's what the displayed values correspond to:

1	1/4	5	5/4
2	2/4	6	6/4
3	3/4	7	6/8
4	4/4	8	9/8

If you don't need to change any other metronome parameter, press the **[SET]** register to leave "PARAM LIST" mode. Otherwise, proceed.

■ Setting the tempo

We'll assume that you are still in "PARAM LIST" mode (and so didn't press **[SET]** to leave it). To set this parameter at a later stage, repeat steps (1) and (2) above.

- (4) Press register **[3/◀]** (or **[4/▶]**) to return to the name indication of the last parameter you selected:



- (5) Press register **[3/◀]** once to select the following parameter:



(As you see, there is no need to leave "PARAM LIST" mode if you want to set several parameters.)

"MtP" is short for "Metronome Tempo", i.e. the metronome's speed.

- (6) Before changing this value, it might be a good idea to switch the metronome on by pressing the **[METRONOME]** button.

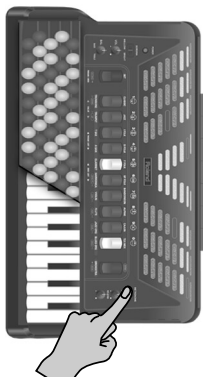

The "Str" message briefly appears and the metronome starts counting.

- (7) Use register **[1/-]** or **[2/+]** to set the desired value.

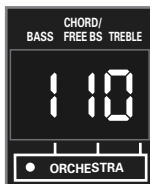

The setting range is ♩ = 20~250.

If you don't need to change any other metronome parameter, press the **[SET]** register to leave "PARAM LIST" mode. Otherwise, proceed.

■ Setting the metronome level

Here's how to set the desired metronome level to ensure that it is neither too loud, nor too soft. We'll assume that you are still in "PARAM LIST" mode (and so didn't press **[SET]** to leave it). To set this parameter at a later stage, repeat steps (1) and (2) above, then proceed.

- (8) Press register **[3/◀]** (or **[4/▶]**) to return to the name indication of the last parameter you selected:



- (9) Press register **[4/▶]** twice to select the following parameter:

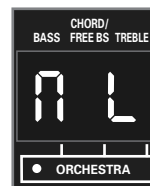

"M L" is short for "Metronome Level", i.e. the metronome's volume.

- (10) Use register **[1/-]** or **[2/+]** to set the desired value.

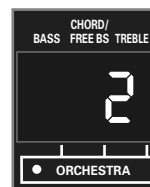

You can select "Off", "1" (low volume), "2" (medium volume), or "3" (high volume).

- (11) Press the **[SET]** register to leave "PARAM LIST" mode.

Note: Press registers **[1]** and **[2]** simultaneously to return to the factory setting of the currently selected parameter.

- (12) See "Saving your changes" on p. 26 if you want to keep your changes.

To use them only temporarily, press the **[SET]** register to leave "PARAM LIST" mode.

Using the metronome

After setting the metronome's parameters to your liking (or if you don't need to change them), you can start using the metronome:

- (13) Press the **METRONOME** button to start the metronome ("Str").

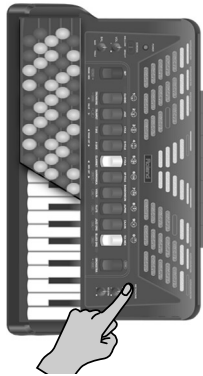

- (14) Press it again to switch the metronome back off (the display briefly shows "StP").

Pitch-related functions

Transpose function

The FR-3 contains a Transpose function that allows you to change the key of the music you are playing. The advantage of this system is that you can play a song in E major (for example), while using the fingering of the C major scale (for example). This may come in handy when you are used to playing a given song in one key and suddenly need to play it in a different key.

Let's look at an example:

(FR-3s/FR-3)

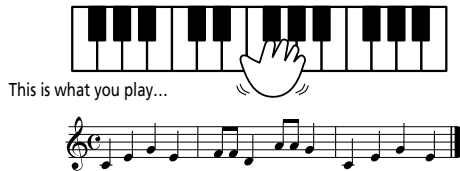

(FR-3s/FR-3)

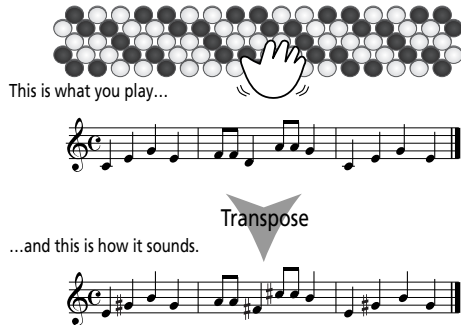

- (1) Press and hold the **SET** register until the display shows a parameter name, then release it.
- (2) Use register **3/◀** or **4/▶** to select the following parameter:



- (3) Use register **1/-** or **2/+** to set the desired value.

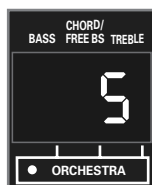

The setting range is -6~0~5 (where "0" means that no transposition is used). The value ("3" in the example above) refers to the interval. This can be calculated as follows:

- In what key do you want to play? (This is your "0" value.)
Example → C major
 - What key does the song use?
Example → E major
 - How many semitones do you need to "shift" the notes?
Example → [C#, D, Eb, E] = 4 up, so "4".
- (4) Press the **SET** register to leave "PARAM LIST" mode.
- Note:** This parameter is reset when you switch off the FR-3.

Transposing the Treble section in octave steps

The parameter discussed here allows you to transpose the Treble (accordion) section one octave up ("UP") or down ("dn"). This can be used for two purposes: to quickly correct the pitch that results from the active reeds, or to avoid overlaps of the selected register when using a Treble Orchestra sound.

Here is how to transpose the Treble section (i.e. the accordion notes) one octave up or down.

- (1) Leave "PARAM LIST" or "MIDI LIST" mode (if you haven't yet done so) by pressing **SET** once.
- (2) Hold down **SET** while using register **1/-** or **2/+** to select the desired setting:



- dn** Transposes the Treble section one octave down.
- No transposition of the Treble section.
- UP** Transposes the Treble section one octave up.

Note: If the display now shows another message, briefly press **SET** again, then repeat this step.

- (3) Release the **SET** register and start playing.

Transposing the Orchestra section in octave steps

You can also transpose the Orchestra section (i.e. the currently selected orchestral sound) up or down. This can be interesting when you are using the Orchestra part in Dual mode (page 25) and want it to sound above or below the selected Treble accordion register. Here is how to transpose the Orchestra section (i.e. the selected PCM sound).

- (1) Switch on the Orchestra section.
 See "Orchestral sounds for the Treble section" on p. 25 and following for details. Registers [1]~[0] are now assigned to the 10 available orchestral sounds.
- (2) Hold down [SET] while using register [1/-] or [2/+] to select the desired setting:



dn Transposes the Orchestra section one octave down.

--- No transposition of the Orchestra section.

UP Transposes the Orchestra section one octave up.

Note: If the display now shows another message, briefly press [SET] again, then repeat this step.

- (3) Release the [SET] register and start playing.

Musette Detune

You probably know that an accordion's 8' Treble register may consist of 2 or even 3 reeds that are usually tuned apart to provide a richer sound (accordionists call it the "musette effect"). One reed is tuned slightly above, the other slightly below the correct pitch (and the third, if available, is tuned "properly").

Tuning those reeds is a specialist job and usually not performed by accordion players themselves.

On the FR-3, however, "tuning" the "reeds" (that do not really exist) is a matter of pressing a few buttons.

- (1) Press and hold the [SET] register until the display shows a parameter name, then release it.
- (2) Use register [3/◀] or [4/▶] to select the following parameter:



- (3) Use register [1/-] or [2/+] to set the desired value.

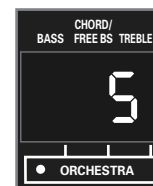

The possibilities are: "Off" (no detune), "1" (Dry), "2" (Classic), "3" (F-Folk), "4" (American L), "5" (American_H), "6" (North Eur), "7" (German L), "8" (D-Folk L), "9" (Italian L), "10" (German H), "11" (Alpine), "12" (Italian H), "13" (D-Folk H), "14" (French), "15" (Scottish).

They refer to commonly used detune settings.

- (4) Press the [SET] register to leave "PARAM LIST" mode.

Note: This parameter is reset when you select a different Set.

6. Editing settings

The FR-3 provides a whole series of specialized parameters you probably don't need every day. They may come in handy, however, when you need to fine-tune the FR-3's response to your playing style. This chapter discusses all parameters that are not related to MIDI. See p. 47 for the MIDI parameters. The parameters are:

Memorized	Display indication	Full name	Setting range	Default	See page
SET X	dEt	Musette Detune	Off, 1~15	Off	35
OK	tUn	Master Tune	15.3~40.0~66.2 (Hz)	40.0	37
POWER	tP	Transpose	-6~0~5	0	34
OK	tR	Treble Mode	1~6	1	37*
OK	OL	Orchestra Level	-40~Std~40	Std	26
OK	ObL	Orchestra Bass Level	-40~Std~40	Std	28
OK	OCL	Orchestra Chord Level	-40~Std~40	Std	29
OK	OFL	Orchestra Free Bass Level	-40~Std~40	Std	26
OK	tVn	Treble Valve Noise	Off, -40~Std~40	Std	40
OK	bBn	Bass Button Noise	Off, -40~Std~40	Std	40
OK	bRG	Bass Reed Growl	Off, -40~Std~40	Std	40
OK	FbN	Free Bass Button Noise	Off, -40~Std~40	Std	40
OK	FbRG	Free Bass Reed Growl	Off, -40~Std~40	Std	40
OK	tP	Metronome Tempo	20~250	120	32
OK	tS	Metronome Time Sign	1~8	4	31
OK	L	Metronome Level	Off, 1~3	2	32
OK	rEv	Reverb Type	1~8	6	40
OK	Ch	Chorus Type	1~8	7	40
OK	t	Orchestra Touch	1~10	6	41
OK	Obt	Orch. Bass/Free Bass/Chord Touch	1~10	8	41
OK	bLC	Bellows Curve	1~8	6	41
OK	StE	Stereo Width	-63~-1, FUL	FUL	41
OK	FbM	Free Bass Mode	1~6	1	42
OK	bCM	Bass & Chord Mode	1, 2	1	42
OK	tFn	Metronome Function	1, 2	1	42
OK	APo	Auto Power Off	Off, 1~3	1	42
OK	COL	Roland Logo Color	Off, 1~26	2	44

"SET X": This setting changes when you select another Set.
"OK": Can be saved in the Global area (common to all Sets).

"POWER": Reset when you switch off the FR-3.
(* Only on the FR-3sb and FR-3b)

Selecting the desired function

- (1) Press and hold the **[SET]** register until the display shows a parameter name, then release it.
- (2) Use register **[3/◀]** or **[4/▶]** to select the desired parameter.

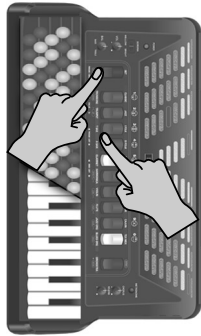

- (3) Use register **[1/−]** or **[2/+]** to set the desired value.

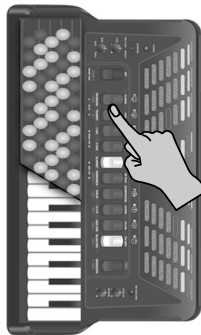

Press registers **[1]** and **[2]** simultaneously to return to the factory setting of the currently selected parameter.

- (4) If you don't need to change any other PARAM LIST parameter, press the **[SET]** register to leave this mode. Otherwise, proceed:
- (5) Use register **[3/◀]** or **[4/▶]** to select another parameter, and continue with steps (3)~(4).
- (6) See "Saving your changes" on p. 26 if you want to keep your changes.
To use them only temporarily, press the **[SET]** register to leave "PARAM LIST" mode.

PARAM LIST parameters

Musette Detune

This parameter allows you to choose the system used for detuning the 8' reeds of registers **[5]** MASTER, **[6]** MUSETTE and **[7]** VIOLIN. It only applies to the Treble section. See page 35 for details. Also remember that registers **[6]** and **[7]** allow you to add a third 8' reed by pressing that register twice in succession.



The possibilities are: "Off" (no detune), "1" (Dry), "2" (Classic), "3" (F-Folk), "4" (American L), "5" (American_H), "6" (North Eur), "7" (German L), "8" (D-Folk L), "9" (Italian L), "10" (German H), "11" (Alpine), "12" (Italian H), "13" (D-Folk H), "14" (French), "15" (Scottish).

Master Tune

(15.3~66.2, Default setting: 40.0) This parameter allows you to change the FR-3's overall tuning, which may be necessary when you play with acoustic instruments that cannot be tuned easily, or if you use a CD or cassette tape as accompaniment. The factory default, "40.0", represents the reference pitch used by all electronic musical instruments. Note that for space reasons the first digit of the frequency value (a "4") is not shown.



Transpose

(−6~0~5, Default setting: Std) This parameter allows you to transpose all sections of the FR-3. See page 34 for details.



Treble Mode (only on the FR-3sb and FR-3b)

([1] C-Griff Europe, [2] C-Griff 2, [3] B-Griff Bajan, [4] B-Griff Fin, [5] D-Griff 1, [6] D Griff 2, Default setting: 1) Like for the accordion instrument itself, there are different varieties of chromatic instruments, with different Treble button layouts.



Since your FR-3sb or FR-3b is an electronic musical instrument, changing the note assignments to the buttons is a matter of selecting the preset that best suits your playing style. You'll probably only change this setting once. But it's nice to know that it exists in case you let a fellow accordion player from another country play your FR-3sb/b.

Please look at the illustrations on page 37 to identify the setting you need. Pay attention to the note names (all Cs appear on a grey background) and look at how they are arranged, then make your selection. The numbers next to the letters refer to the octave. The numbers below the note names represent the corresponding MIDI note numbers.

You may have noticed that the Treble buttons are colored white (for notes without alteration) and black (notes with alteration, i.e. #/b). This coloring doesn't change when you select another system.

(You can, however, unscrew the buttons and install the in the right places so as to make the white and black buttons correspond to the notes being played.)

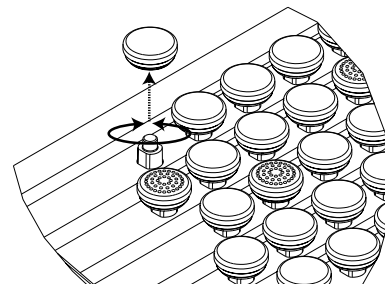

The FR-3sb/b is supplied with additional white and black buttons that may come in handy. The white buttons come in two varieties: normal buttons and knurled buttons. The latter are usually used to indicate the "C" notes.

Treble Mode (1/2)

C-Griff Europe

Eb3 51	C#3 49	D3 50	C3 48	C#3 49
F#3 54	E3 52	F3 53	Eb3 51	E3 52
A3 57	G3 55	G#3 56	F#3 54	G3 55
C4 60	Bb3 58	B3 59	A3 57	Bb3 58
Eb4 63	C#4 61	D4 62	C4 60	C#4 61
F#4 66	E4 64	F4 65	Eb4 63	E4 64
A4 69	G4 67	G#4 68	F#4 66	G4 67
C5 72	Bb4 70	B4 71	A4 69	Bb4 70
Eb5 75	C#5 73	D5 74	C5 72	C#5 73
F#5 78	E5 76	F5 77	Eb5 75	E5 76
A5 81	G5 79	G#5 80	F#5 78	G5 79
C6 84	Bb5 82	B5 83	A5 81	Bb5 82
Eb6 87	C#6 85	D6 86	C6 84	C#6 85
F#6 90	E6 88	F6 89	Eb6 87	E6 88
A6 93	G6 91	G#6 92	F#6 90	G6 91
C7 96	Bb6 94	B6 95	A6 93	Bb6 94
Eb7 99	C#7 97	D7 98	C7 96	C#7 97
F#7 102	E7 100	F7 101	Eb7 99	E7 100
G7 103	F7 101	F#7 102	F7 101	E7 100

C-Griff 2

Eb3 51	D3 50	E3 52	Eb3 51	F3 53
F#3 54	F3 53	G3 55	F#3 54	G#3 56
A3 57	G#3 56	Bb3 58	A3 57	B3 59
C4 60	B3 59	C#4 61	C4 60	D4 62
Eb4 63	D4 62	E4 64	Eb4 63	F4 65
F#4 66	F4 65	G4 67	F#4 66	G#4 68
A4 69	G#4 68	Bb4 70	A4 69	B4 71
C5 72	B4 71	C#5 73	C5 72	D5 74
Eb5 75	D5 74	E5 76	Eb5 75	F5 77
F#5 78	F5 77	G5 79	F#5 78	G#5 80
A5 81	G#5 80	Bb5 82	A5 81	B5 83
C6 84	B5 83	C#6 85	C6 84	D6 86
Eb6 87	D6 86	E6 88	Eb6 87	F6 89
F#6 90	F6 89	G6 91	F#6 90	G#6 92
A6 93	G#6 92	Bb6 94	A6 93	B6 95
C7 96	Bb6 94	C#7 97	C7 96	D7 98
Eb7 99	D7 98	E7 100	Eb7 99	F7 101
F#7 102	F7 101	G7 103	F#7 99	G#7 104
G#7 104	G7 103	A7 105	G#7 104	

B-Griff Bajon

D3 50	C#3 49	Eb3 51	D3 50	E3 52
F3 53	E3 52	F#3 54	F3 53	G3 55
G#3 56	G3 55	A3 57	G#3 56	Bb3 58
B3 59	Bb3 58	C4 60	B3 59	C#4 61
D4 62	C#4 61	Eb4 63	D4 62	E4 64
F4 65	E4 64	F#4 66	F4 65	G4 67
G#4 68	G4 67	A4 69	G#4 68	Bb4 70
B4 71	Bb4 70	C5 72	B4 71	C#5 73
D5 74	C#5 73	Eb5 75	D5 74	E5 76
F5 77	E5 76	F#5 78	F5 77	G5 79
G#5 80	F#5 78	A5 81	G#5 80	Bb5 82
B5 83	G#5 80	B5 83	B5 83	C#6 85
D6 86	B5 83	C#6 85	D6 86	E6 88
F6 89	D6 86	Eb6 87	F6 89	G6 91
G#6 92	F6 89	F#6 90	G#6 92	Bb6 94
B6 95	G#6 92	A6 93	B6 95	C#7 97
D7 98	Bb6 94	C#7 97	D7 98	E7 100
F7 101	D7 98	Eb7 99	F7 101	G7 103
G7 103	F7 101	F#7 102	G7 103	

Treble Mode (2/2)

B-Griff Fin	D-Griff 1	D-Griff 2
D3 50	C3 48	C3 48
E3 52	D3 50	C#3 49
F3 53	E3 52	D3 50
G3 55	F3 53	E3 52
Bb3 58	G3 55	F3 53
C#4 61	A3 57	G3 55
D4 62	B3 59	A3 57
E4 64	C4 60	Bb3 58
F4 65	D4 62	B3 59
G4 67	E4 64	C#4 61
Bb4 70	F4 65	D4 62
C#5 73	G4 67	E4 64
D5 74	A4 69	F4 65
E5 76	Bb4 70	G4 67
F5 77	C5 72	A4 69
G5 79	D5 74	B4 71
Bb5 82	E5 76	C#5 73
C#6 85	F5 77	D5 74
D6 86	G5 79	E5 76
E6 88	A5 81	F5 77
F6 89	Bb5 82	G5 79
G6 91	C6 84	A5 81
Bb6 94	D6 86	Bb5 82
C#7 97	E6 88	B5 83
D7 98	F6 89	C6 84
E7 100	G6 91	D6 86
F7 101	Bb6 94	E6 88
G7 103	C#7 97	F6 89
	D7 98	G6 91
	E7 100	A6 93
	F7 101	Bb6 94
	G7 103	B6 95
		C#7 97
		D7 98
		E7 100
		F7 101
		G7 103

Orchestra Level

(-40~"Std"~40, Default setting: Std) This parameter allows you to create the desired "mix" (volume balance) between the Treble accordion and the Orchestra section.



This is a relative parameter, which means that its value is added to or subtracted from the standard value ("Std").

Orchestra Bass Level, Orchestra Chord Level, Orchestra Free Bass Level

(-40~"Std"~40, Default setting: Std)

These parameters allow you to create the desired "mix" (volume balance) between the orchestral section in question and the Treble accordion/Orchestra section.



You can't use both the accordion sound of the Bass, Chord or Free Bass section and the associated orchestral section.

This is a relative parameter, which means that its value is added to or subtracted from the standard value ("Std").

Treble Valve Noise

(Off, -40~"Std"~40, Default setting: Std)

You will probably agree that electronic sounds must not only reproduce the basic timbre of an existing sound, but also the original instrument's behavior and typical "noises" in order to be perceived as authentic. In the case of a guitar that would be the sliding noise of the fingers. An accordion, on the other hand, produces mechanical valve noises that cannot be suppressed on an acoustic instrument. Use this parameter to specify how prominent the noise produced by the simulated Treble valves should be.



Bass Button Noise

(Off, -40~"Std"~40, Default setting: Std)

The bass section of almost all accordion instruments can be played via buttons. Such buttons produce a typical noise when pressed. Use this parameter to specify how prominent that button noise should be.



Bass Reed Growl

(Off, -40~"Std"~40, Default setting: Std)

This parameter allows you to simulate the typical noise a bass reed makes just before it stops vibrating altogether (a kind of "musical flatulence" if you will). Each instrument of the accordion family produces its own typical growl.

Use this parameter to specify how prominent that growl should be.



Free Bass Button Noise

(Off, -40~"Std"~40, Default setting: Std)

The bass section of almost all accordion instruments can be played via buttons. Such buttons produce a typical noise when pressed. Use this parameter to specify how prominent that button noise should be in Free Bass mode.



Free Bass Reed Growl

(Off, -40~"Std"~40, Default setting: Std)

This parameter allows you to simulate the typical noise a bass reed makes just before it stops vibrating altogether (a kind of "musical flatulence" if you will). Each instrument of the accordion family produces its own typical growl.

Use this parameter to specify how prominent that growl should be in Free Bass mode.



Metronome Tempo

(20~250, Default setting: 120) This parameter allows you to set the metronome tempo. See page 32 for details.



Metronome Time Sign

(1~8, Default setting: 1) This parameter allows you to set the metronome's time signature. See page 31 for details.



Metronome Level

(Off, 1~3, Default setting: 2) This parameter allows you to change the metronome's level when it is too loud or too soft. See page 32 for details.



Reverb Type

This effect creates the impression that you are playing in a concert hall, a church or a room. It adds "depth" to the sound. This is where you can specify what kind of effect the Reverb processor should generate.



This parameter is a "Macro" function that recalls suitable preset values for all reverb parameters (which have been preset at the factory). The available options are:

[1] Room1	These reverbs simulate the reverberation of a room. They provide a well-defined spacious reverberation.
[2] Room2	
[3] Room3	
[4] Hall1	These reverbs simulate the reverberation of a concert hall with a deeper reverberation than the Room Reverbs.
[5] Hall2	
[6] Plate*	This effect type simulates a plate reverb (a studio device using a metal plate to simulate natural Reverb).
[7] Delay	This is a conventional delay that produces echo effects.
[8] PanningDly	This is a special delay in which the delayed sounds move left and right. It is effective when you are listening in stereo.

The overall reverb level can be set with the **[REVERB]** knob on the front panel.

Chorus Type

Chorus broadens the spatial image of the sound, adding richness. You can choose from 8 types of chorus.

This parameter is a "Macro" function that recalls suitable preset values for all Chorus parameters (which have been preset at the factory).



The available options are:

[1] Chorus 1	These are conventional Chorus effects that add spaciousness and depth to the sound.
[2] Chorus 2	
[3] Chorus 3	
[4] Chorus 4	
[5] FBack Chr	This is a Chorus with a Flanger-like effect and a soft sound.
[6] Flanger	This is an effect that sounds somewhat like a jet airplane taking off or landing.
[7] Short Delay*	This is a delay with a short Delay time.
[8] ShortDly FB	This is a short delay with many repeats.

The overall chorus level can be set with the **[CHORUS]** knob on the front panel.

Orchestra Touch

(1~10, Default setting: 6) This parameter allows you to specify the velocity sensitivity of the Treble keys/buttons when they are used to play an external MIDI tone generator via the Orchestra section (on the Orchestra section's MIDI channel). The FR-3's Treble Orchestra sounds are **not** velocity sensitive.



The available options are:

1	Fixed Low	6*	High
2	Fixed Med	7	Fixed L + Bellows
3	Fixed High	8	Fixed M + Bellows
4	Low	9	Fixed H + Bellows
5	Medium	10	Bellows

There are three "**Fixed**" curves that always use the same value, no matter how hard or lightly you press the keys. "Low" means that a low value is used, "Med" represents a medium value and "High" a high value.

"Low" means that even relatively light presses already allow you to play loud notes. "High" represents the most responsive velocity curve that requires a considerable amount of strength for fortissimo notes, but it also provides more expressive options.

"Fixed L+Bellows" and "Fixed H+Bellows" mean that the Orchestra section transmits fixed velocity values but can also be controlled by the bellows movements.

"Bellows" means that the Orchestra section's expression is controlled by the bellows movements – not the velocity values generated by the buttons.

Remember, however, that all these options only apply to MIDI messages the Orchestra section transmits to an external device.

Orch. Bass/Free Bass/Chord Touch

(1~10, Default setting: 8) This parameter allows you to specify the velocity sensitivity of the bass buttons, which are used to play bass notes and chords (in Bass mode), or bass notes (in Free Bass mode). Again, your selection only applies to the MIDI messages transmitted by the currently active ORCH section(s).



There are two exceptions, however: the "Ac. Guitar" and "Ac. Piano" sounds of the ORCH FREE BS section **are** velocity sensitive and therefore respond to your striking force and/or bellows movements (depending on the option you select).

See "Orchestra Touch" above for a discussion of the available options.

Bellows Curve

([1] Fixed Low, [2] Fixed Med, [3] Fixed High, [4] X-Light, [5] Light, [6] Standard, [7] Heavy, [8] X-Heavy, Default setting: 6) This parameter allows you to specify how the FR-3 should respond to the bellows' movements. Use it to adapt the FR-3's expressive potential to your playing style.



If you think the sounds don't respond the way you would like them to, try another curve that better "translates" your movements.

There are three "**Fixed**" curves that always use the same value, no matter how hard or lightly you push/pull the bellows (no dynamic control). "Low" means that a low value is used, "Med" represents a medium value and "High" a high value.

The remaining settings do depend on the strength with which you push/pull the bellows, but in different ways: "**Light**" means that you do not need to push/pull hard to achieve a meaningful effect. "**X-Light**" requires even less strength (the "X" stands for "extra"). "**Standard**" refers to a normal response (or so we believe). "**Heavy**" provides a greater variety of nuances and "**X-Heavy**" is even more detailed. It would be a good idea to select each curve without the "Fixed" addition, play a few notes, select the next curve, etc. until you find the response that feels just right.

Stereo Width

(-63~-1, Full, Default setting: FUL) As stated on p. 14, much care has been taken to provide a natural stereo image for the accordion sounds. If you think the stereo image is too wide for comfort (or if you prefer to set the Pan controls on your mixing console differently), you can use this parameter to reduce the stereo image.



"Full" means that the original stereo image is used, while "-63" corresponds to an extremely narrow stereo image. All other values represent slight (or increasingly drastic) reductions of the stereo width.

Free Bass Mode

([1] Minor 3rd, [2] Bajan, [3] Fifth, [4] N. Europe, [5] Finnish, Default setting: 1) This parameter allows you to choose the note system used in Free Bass mode. We already mentioned that there are a vast number of accordion varieties. The same is true of Free Bass systems.



Your FR-3 contains the most popular ones. Be aware that the system you select here is only used when you activate the FR-3's Free Bass mode. It is of no consequence for the "regular" Bass mode. See the illustration on page 43 for the note assignments.

Note: The FR-3 is supplied with several reference caps designed to help you locate the bass buttons without looking at them. See also page 23.

Bass & Chord Mode

(1~6, Default setting: 1) This parameter allows you to specify the number of button rows for playing bass notes. The default is "1" (2 bass rows and 4 chord rows). By selecting "3 Bs Rows", you thus gain 20 bass buttons (an entire row) and lose the "dim" chord buttons – but that may just be more convenient for you. See also the illustration on page 44.



There are four "3 Bs Rows" options: "[2] **A-7th**" and "[4] **B-7th**" mean that the 6th chord row plays seventh chords ("7") that don't contain the fifth. In the case of a C7 chord, you therefore hear C-E-B \flat (but not the G). "A-7th" and "B-7th" differ in the arrangement of the bass notes (see the illustration on page 44).

The "[3] **A-5dim**" and "[5] **B-5dim**" options mean that those seventh chords don't contain the root note. A C7 chord is then sounded with the notes E-G-B \flat (but not the C). "A-5dim" and "B-5dim" differ in the arrangement of the bass notes (see the illustration on page 44).

The "[6] **Bx-7th**" option reverses the "B-7th" settings (from right to left), so that the C3 note shifts from 9th to 12th position.

Note: The FR-3 is supplied with several reference caps designed to help you locate the bass and chord buttons without looking at them. See also page 23.

Metronome Function

([1] Metronome, [2] MIDI Start/Stop, Default setting: 1) This parameter allows you to specify how you want to use the **METRONOME** button. In most cases, you will probably use "1" to take advantage of the internal metronome. You can, however, also define it as a MIDI remote control in order to start and stop playback of an external sequencer or arranger module. In that case, select "2". The metronome function is then no longer available. See page 47 for details about the MIDI functions.



Note: The remote control function only works when you set the FR-3's "Mid" parameter to "OUT".

Auto Power Off

(Off, 1~3, Default setting: 1) This parameter allows you to specify how long the FR-3 should wait before deciding that you won't be using it for a while. If you have ever worked with a computer, you may remember that a similar function is called "sleep", "energy saver", or the like.



Obviously, this is meant to preserve battery power, and so this function only applies when the FR-3 is used without the supplied adapter. To "wake" the FR-3 after it has fallen asleep, press its **POWER** button. Select "Off" to switch this function off. "1" corresponds to 10 minutes, "2" to 15 minutes, and "3" to 20 minutes.

Free Bass Mode

Minor 3rd

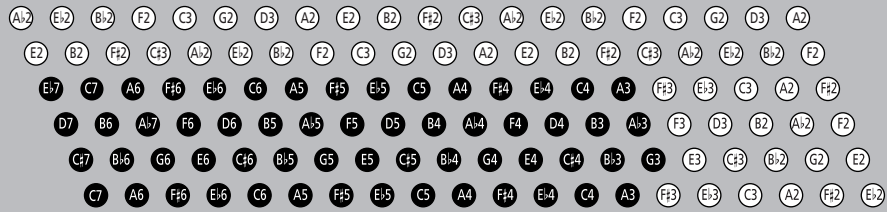

Bajan

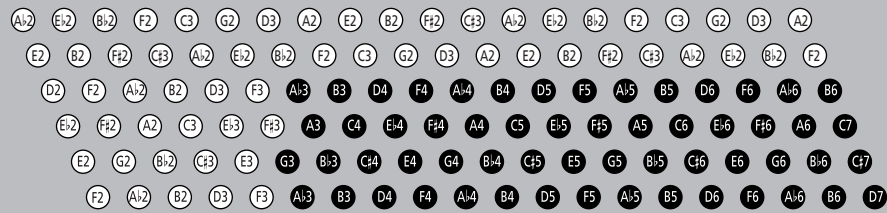

5th

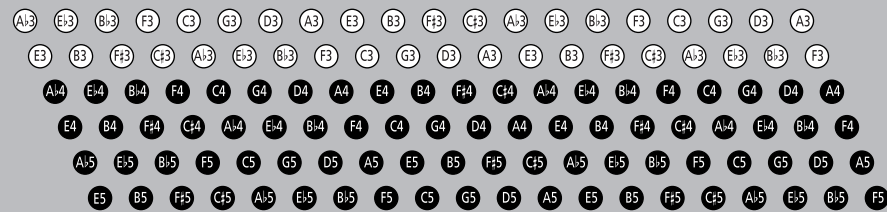

N. Europe

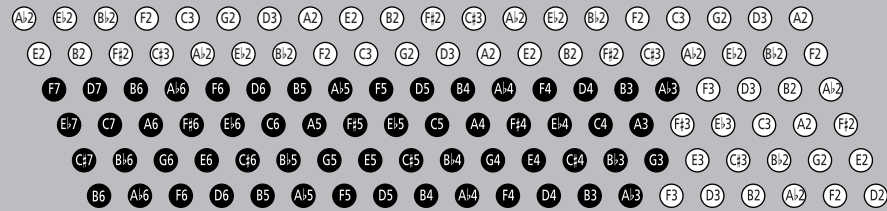

Finnish

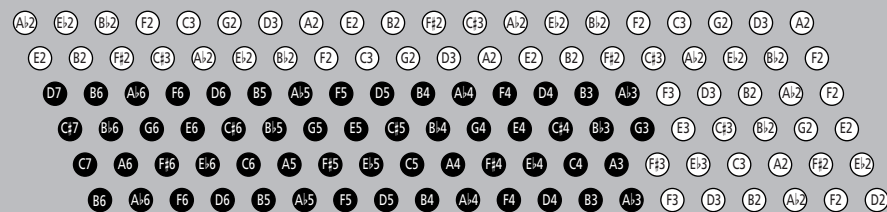

(C3= note number 48)

Note: The note names on the bass buttons correspond to the MIDI note numbers. The note range of the Bass part is 1 octave.
Note: The actual sound range depends on the type of reed and footage.

Bass & Chord Mode

[1] 2 Bass Rows

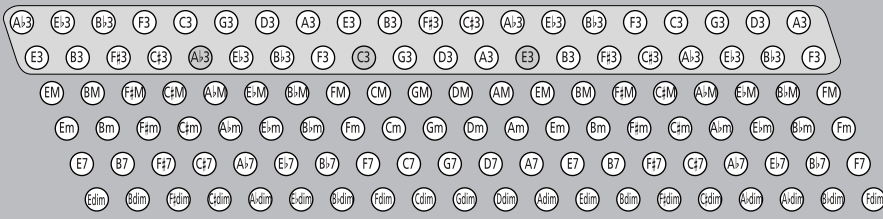

[2] & [3] 3 Bass Rows A

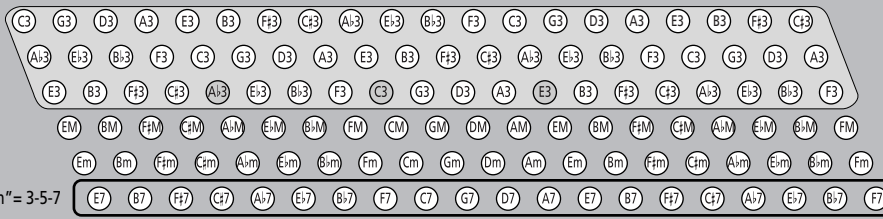

"7th" = 1-3-7; "5dim" = 3-5-7

[4] & [5] 3 Bass Rows B

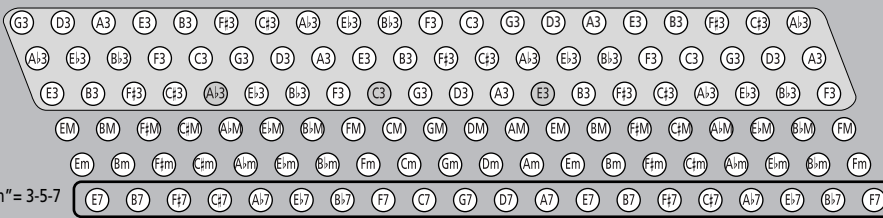

"7th" = 1-3-7; "5dim" = 3-5-7

[6] 3 Bass Rows Bx

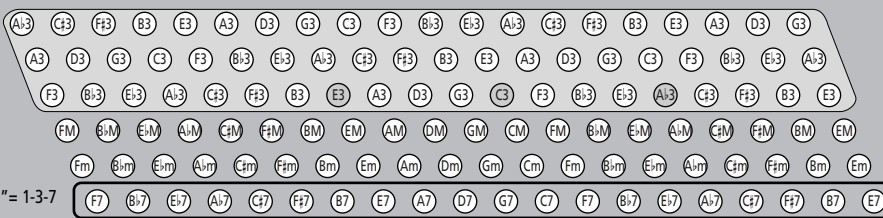

"7th" = 1-3-7

Roland Logo Color

(Off, 1~26, Default setting: 2) You may have noticed that the Roland logo above the Treble control panel lights when you switch on the FR-3. If you haven't changed this setting yet, the color of that logo changes each time you switch on the FR-3. With this parameter, you can change that behavior.



Select "Off" if you don't want the logo to light. Select "1" to use the logo as an indication of the Set you are currently using. With every Set you select, the logo's color changes (the color assignments have been set at the factory and cannot be changed).

"2" means that the color changes ad random at fixed intervals. The remaining options (3~26) represent the available colors. Selecting such an option means that the logo always lights in that color. We are not going to

describe the colors here – just try out various settings and pick the one you like best. The range goes from pastel to solid/dark colors.

If you select "1", the color assignments of the Sets are used (each Set has its own color).

MIDI parameters

Your FR-3 can also transmit or receive MIDI data. In this section, we'll look at what MIDI is and does and which MIDI functions are available on the FR-3.

IMPORTANT REMARK: The FR-3 only has one MIDI socket that can be used to either send ("OUT") or receive ("IN") MIDI data.

Connect the FR-3 as follows to **transmit** MIDI data to an external device:

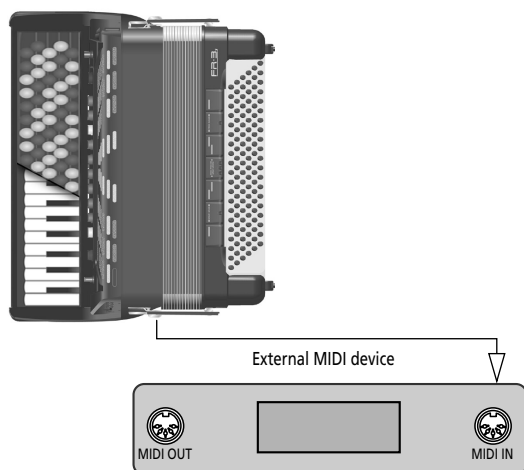

Then, set the "MId" parameter (see p. 48) to "Out".

Connect the FR-3 as follows to **receive** MIDI data from an external device:

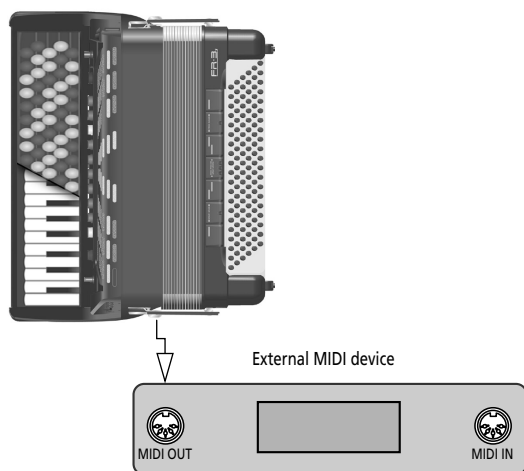

Then, set the "MId" parameter (page 48) to "In".

About MIDI

Even though your FR-3 is already a remarkably flexible instrument (quite unlike any other accordion available today), you may also want to use it with other MIDI-compatible instruments, sequencers and computers to record your performances in the same way as keyboard players, drummers, guitarists, etc., have been doing for a while.

Another important application for the FR-3's MIDI functions is controlling an arranger module that supplies the accompaniment. "Arranger modules" use short accompaniment patterns that can be selected in real-time and whose key depends on the note information they receive.

All MIDI-compatible sound sources allow you to use the FR-3's Treble and Bass keyboards for playing sounds the FR-3 does not provide.

This is possible thanks to a common language for musical applications, which is called "**Musical Instrument Digital Interface**", or "**MIDI**" for short. MIDI has a lot in common with the internet: you can link one or several instruments to one another via a cable (but you don't need a telephone line).

You can also use the FR-3 as "master keyboard", i.e. an instrument that transmits MIDI messages to a device (or software program) that can record MIDI messages. Such a device or program is called a "sequencer".

To take advantage of the FR-3's MIDI functions, you must connect it as shown above.

MIDI can simultaneously transmit and receive messages on 16 channels, so that up to 16 instruments (or parts of a module or synthesizer) can be controlled. Nowadays, most instruments –like your FR-3– are multitimbral, which means that they can play several musical parts with different sounds. This requires the use of several MIDI channels. The FR-3, for instance, has several accordion and orchestral sections that can be played simultaneously. They can transmit and receive on different channels.

The FR-3's sections use the following MIDI channels:

Part	Channel
Treble	1
Bass/Free Bass	2
Chord	3
Orchestra (Treble)	4
Orchestra Bass	5
Orchestra Chord	6
Orchestra Free Bass	7
Basic channel (for selecting Sets)	13
Control channel (for the "SPC" function)	13

As you see, there are separate channels for the chord and bass buttons, even though they both belong to the Bass section. That separation may look distracting at first, but it actually makes sense. It allows you to use the bass buttons for controlling an external bass sound, while the chord buttons could control a piano sound, for example. If they used the same MIDI channel, the bass line would have to be played by a piano, or the chords would be played by a bass sound (unless you own a MIDI instrument that allows you to program note ranges for incoming MIDI messages).

Working with a sequencer and other tone generators

The FR-3 can be used as "input device" for recording your music. In the case of a keyboard instrument, such a device is usually called a "master keyboard". For other kinds of MIDI input sources, the term "controller" is

used. There are actually two kinds of master keyboards: those that only transmit MIDI data and contain no tone generator, and those that can also be used for playing back music (synthesizers, digital pianos, organs, etc.).

Sequencers do not record the audio of the notes you play. They only register "events" whose position and distance specify when the notes are to be played. The sequencer as such usually cannot sound what you record – you need an instrument with a tone generator for that. A sequencer must therefore be connected to an electronic sound source, like your FR-3, for example. The FR-3 can be used for two things: to "input" new parts (i.e. MIDI events) and to play them back.

When you play on the FR-3's keyboards, it sends MIDI data to the MIDI OUT/IN socket (if the "Mid" parameter is set to "Out"). That socket must be connected to the sequencer's MIDI IN port. MIDI data always go from OUT to IN:

(FR-3s/FR-3)

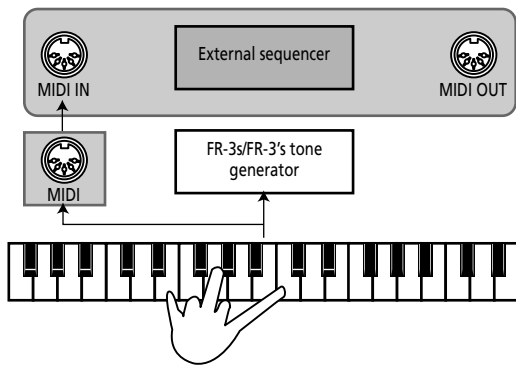

(FR-3sb/FR-3b)

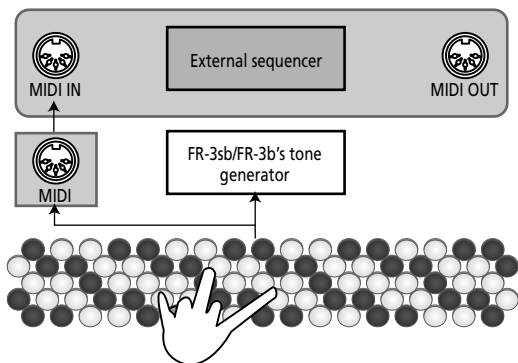

If the FR-3 is used as tone generator for an external sequencer, you must connect the sequencer's MIDI OUT socket to the FR-3's MIDI OUT/IN port and set the "Mid" parameter to "In" (because MIDI data always go from OUT to IN).

Though you can also play the FR-3 from another MIDI instrument, we do not really recommend doing so, because your V-Accordion has far more versatile performance functions than any other MIDI controller available today: the FR-3 translates all known accordion techniques and physical effects into MIDI messages to precisely reproduce the natural behavior of an acoustic accordion. Conversely, it might be interesting to try out the FR-3 with a Roland Fantom-XR module,

because the FR-3's countless expressive "gizmos" are bound to further enhance the stunning realism of the module's sounds.

If you use the FR-3 as a MIDI controller while recording a sequence, all actions you perform on the FR-3 (including the bellows pressure strength) are included in the recorded part. They can therefore be sent back to the FR-3 (by the sequencer) – and then, all expression details are preserved. Be aware, however, that you also need a versatile sound source (like the FR-3's) to use the recorded MIDI events to their full potential.

A "sequencer" can also be a software program running on a computer. Most computers do not have MIDI sockets to which you can connect the FR-3's MIDI socket. You therefore also need one of the following:

- A sound card with a joystick port to which you can connect MIDI cables;
- A card called a "MIDI interface" that is installed in your computer;
- An external device to which you connect the MIDI cable coming from the FR-3 at one end and whose other end is connected to the computer's USB port (companies like Edirol, www.edirol.com, offer several models with a varying number of inputs and outputs).

You also need a software program that allows you to record and play back your music. Such programs are available from companies like Cakewalk. Please ask your Roland dealer for details. And finally, you may need to install applications called "drivers" on your computer to ensure that it can talk and listen to the MIDI interface.

MIDI parameter list

Memorized	Display indication	Full name	Setting range	Default	See page
POWER	01d	MIDI Out/In	Out, In	Out	48
OK	trb	Treble TX/RX channel	Off, 1~16	1	48
OK	trO	Treble Octave Tx	-3~0~3	0	49
OK	bFr	Bass/Free Bass TX/RX Channel	Off, 1~16	2	49
OK	bFO	Bass/Free Bass Octave TX	-3~0~3	0	49
OK	CHd	Chord TX/RX Channel	Off, 1~16	3	49
OK	CHO	Chord Octave TX	-3~0~3	0	49
OK	OrC	Orchestra TX/RX Channel	Off, 1~16	4	49
OK	OrO	Orchestra Octave TX	-3~0~3	0	49
OK	ObS	Orchestra Bass TX/RX Channel	Off, 1~16	5	49
OK	ObO	Orchestra Bass Octave TX	-3~0~3	0	49
OK	OCd	Orchestra Chord TX/RX Channel	Off, 1~16	6	49
OK	OCO	Orchestra Chord Octave TX	-3~0~3	0	49
OK	OFb	Orchestra Free Bass TX/RX Channel	Off, 1~16	7	49
OK	OFO	Orchestra Free Bass Octave TX	-3~0~3	0	50
OK	bCH	Basic Channel TX/RX	Off, 1~16	13	50
OK	cCH	Control Channel TX	Off, 1~16	13	50
OK	PCH	Program Change TX	Off, On	On	50
OK	bES	Bellows Expression TX	Off, On	On	50
OK	VEL	Velocity TX	On, 1~127	On	50
OK	brE	Bellows TX Resolution	1~3	2	50
OK	bPC	Send Bank PC TX	1~4	1	51
OK	CC0	Send CC00 TX	0~127	0	51
OK	CC32	Send CC32 TX	0~127	0	51
OK	dNP	Dump TX	Register [1] or [2] to transmit		52

"OK": Can be saved in the Global area (common to all Sets).

"POWER": Reset when you switch off the FR-3.

Selecting the desired MIDI LIST function

- (1) Press and hold the **[SET]** register until the display shows a parameter name, then release it.
- (2) Use register **[5/◀]** or **[6/▶]** to select the desired MIDI LIST parameter.

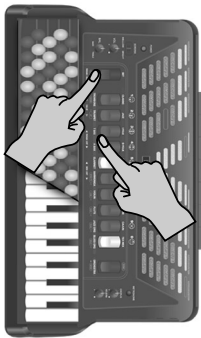

- (3) Use register **[1/-]** or **[2/+]** to set the desired value.

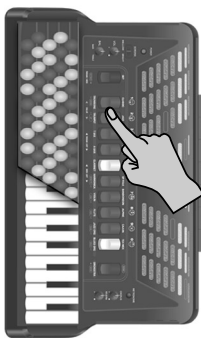

Press registers **[1]** and **[2]** simultaneously to return to the factory setting of the currently selected parameter.

- (4) If you don't need to change any other MIDI LIST parameter, press the **[SET]** register to leave this mode. Otherwise, proceed.
- (5) Use register **[5/◀]** or **[6/▶]** to select another parameter.
- (6) Use register **[1/-]** or **[2/+]** to set the desired value. Press registers **[1]** and **[2]** simultaneously to return to the factory setting of the currently selected parameter.
- (7) Press and hold the **[SET]** register until the display looks as follows:



(This means "Write".)

- (8) Press register **[2/+]** to save the settings. The display now looks as follows:



If you don't want to save your changes, press **[1/-]**. In that case the display briefly shows the "No" message, and then return to the indication of the currently selected registers.

If you decide not to save, your changes remain in effect until you switch off the FR-3. (If the FR-3 is powered off automatically, see page 42, your changes are lost as well.)

- (9) Press **[SET]** again to confirm your intention. The display now looks as follows and then once again displays the numbers of the registers currently in effect:



MIDI Out/In

(Out, In, Default setting: Out) This parameter allows you to define the function of the FR-3's MIDI socket.



Select "Out" if you want to play on the FR-3's keyboards and transmit the MIDI data generated by your playing to an external device. You also need to select this setting for the "Send PC" function (page 51).

Be aware that MIDI parameters labeled "TX" (without "RX") are not available if you set this parameter to "In". Conversely, the FR-3 doesn't receive MIDI data when this parameter is set to "Out".

If you select "In" here, the FR-3's sound source can no longer be played via its keyboards. The display therefore shows "---" instead of a set number or register numbers.

Treble TX/RX channel

(Off, 1~16, Default setting: 1) The table on page 45 specifies the default MIDI channel assignments the FR-3 uses.



Those choices are based on how most accordion players prefer (or are allowed) to use their instrument. You can, however, change the MIDI channel assignments. An obvious candidate for such a change would be the Treble section if you want it to conform to a generally accepted (i.e. standardized) usage, whereby the melody part transmits on MIDI channel 4.

There is indeed a format called "General MIDI" that requires you to use MIDI channel 4 for the melody. General MIDI-compatible musical instruments use that channel for the most important part of a song, so it may be a good idea to assign it to the Treble section.

This parameter allows you to define the MIDI channel for the Treble (accordion) section. The assignment set here applies both to the transmission ("TX") and reception ("RX") of MIDI data. Obviously, "TX" is only used when "MId" (see above) is set to "Out", while the "RX" part is only used when "MId" is set to "In".

The options are: "Off" and 1~16. Select "Off" if the Treble section should neither receive nor transmit MIDI data.

Note: Though it is perfectly possible to assign the same MIDI channel to several sections, the result is usually disappointing and may lead to a lot of confusion.

Treble Octave Tx

(-3~0~3, Default setting: 0) This parameter allows you to transpose the Note-on messages transmitted by the Treble section up to three octaves up or down.



This can be used for songs where an accordion register of the Treble section (for example) should be doubled by a piccolo flute played by an external module whose notes would be far too low if they were used as is. As stated above, each MIDI note has a unique number. This parameter allows you to add (or subtract) 12 ("1" octave), 24 ("2" octaves) or 36 ("3" octaves) to (from) the note numbers generated by your playing.

Note: "TX" means that this parameter only applies to the note messages transmitted to external devices. Messages the FR-3 receives from another device are not affected by it.

Bass/Free Bass TX/RX Channel

(Off, 1~16, Default setting: 2) This parameter allows you to define the MIDI channel for the bass buttons or Free



Bass (accordion) section, depending on which mode is currently active. The assignment set here applies both to the transmission ("TX") and reception ("RX") of MIDI data. Obviously, "TX" is only used when "MId" (see above) is set to "Out", while the "RX" part is only used when "MId" is set to "In". Select "Off" if the Bass or Free Bass section should neither receive nor transmit MIDI data.

Note: Though it is perfectly possible to assign the same MIDI channel to several sections, the result is usually disappointing and may lead to a lot of confusion.

Bass/Free Bass Octave TX

(-3~0~3, Default setting: 0) This parameter allows you to transpose the Note-on messages transmitted by the bass buttons or Free Bass section up to three octaves up or down.

**Chord TX/RX Channel**

(Off, 1~16, Default setting: 3) This parameter allows you to define the MIDI channel for the chord buttons when they are used to play the selected accordion register. The assignment set here applies both to the transmission ("TX") and reception ("RX") of MIDI data. Obviously, "TX" is only used when "MId" (see above) is set to "Out", while the "RX" part is only used when "MId" is set to "In".



Note: Though it is perfectly possible to assign the same MIDI channel to several sections, the result is usually disappointing and may lead to a lot of confusion.

Chord Octave TX

(-3~0~3, Default setting: 0) This parameter allows you to transpose the Note-on messages transmitted by the chord buttons up to three octaves up or down.

**Orchestra TX/RX Channel**

(Off, 1~16, Default setting: 3) This parameter allows you to define the MIDI channel for the Treble Orchestra part.



The assignment set here applies both to the transmission ("TX") and reception ("RX") of MIDI data. Obviously, "TX" is only used when "MId" (see above) is set to "Out", while the "RX" part is only used when "MId" is set to "In".

Orchestra Octave TX

(-3~0~3, Default setting: 0) This parameter allows you to transpose the Note-on messages transmitted by the Orchestra section.



Note: "TX" means that this parameter only applies to the note messages transmitted to external devices. Messages the FR-3 receives from another device are not affected by it.

Orchestra Bass TX/RX Channel

(Off, 1~16, Default setting: 5) This parameter allows you to define the MIDI channel for the ORCH BASS part. The



assignment set here applies both to the transmission ("TX") and reception ("RX") of MIDI data. Obviously, "TX" is only used when "MId" (see above) is set to "Out", while the "RX" part is only used when "MId" is set to "In".

Orchestra Bass Octave TX

(-3~0~3, Default setting: 0) This parameter allows you to transpose the Note-on messages transmitted by the ORCH BASS part.

**Orchestra Chord TX/RX Channel**

(Off, 1~16, Default setting: 6) This parameter allows you to define the MIDI channel for the ORCH CHORD part. The



assignment set here applies both to the transmission ("TX") and reception ("RX") of MIDI data. Obviously, "TX" is only used when "MId" (see above) is set to "Out", while the "RX" part is only used when "MId" is set to "In".

Orchestra Chord Octave TX

(-3~0~3, Default setting: 0) This parameter allows you to transpose the Note-on messages transmitted by the ORCH CHORD part.

**Orchestra Free Bass TX/RX Channel**

(Off, 1~16, Default setting: 7) This parameter allows you to define the MIDI channel for the ORCH FREE BS part. The



assignment set here applies both to the transmission ("TX") and reception ("RX") of MIDI data. Obviously, "TX" is only used when "MId" (see above) is set to "Out", while the "RX" part is only used when "MId" is set to "In".

Orchestra Free Bass Octave TX

(-3~0~3, Default setting: 0) This parameter allows you to transpose the Note-on messages transmitted by the ORCH FREE BS part.



Basic Channel TX/RX

(Off, 1~16, Default setting: 13) This parameter allows you to set the basic MIDI channel number. The "Basic Channel" can be used for selecting Sets from an external MIDI device (using program change numbers 1~10). If your external source sends Bank Select messages along with the program change number, CC00 and CC32 must both be set to "0". The assignment set here applies both to the transmission ("TX") and reception ("RX") of MIDI data. Obviously, "TX" is only used when "MId" (see above) is set to "Out", while the "RX" part is only used when "MId" is set to "In".



Control Channel TX

(Off, 1~16, Default setting: 13) The "Control Ch" can only be used for sending program change messages (see p. 51). This parameter allows you to set the control MIDI channel number.



Program Change TX

(Off, On, Default setting: On) This is the first of a series of MIDI filters, i.e. parameters that allow you to specify whether or not the given MIDI type should be transmitted. "TX", as you know, is short for "transmission". This means two things: (1) the filter only applies to program changes sent by the FR-3, and (2) it is only meaningful when the "MId" parameter (see p. 48) is set to "Out".



Program change messages are used to select sounds or memories on the receiving instrument simply by recalling another sound (or memory) on the transmitting instrument. The FR-3 transmits program changes when you select Sets (on the Basic Channel) and registers (on the MIDI channel assigned to the section for which you are selecting a different register). Select "Off" if you don't need that.

Note: This filter has no effect on the "Send PC" function (see p. 51).

Bellows Expression TX

(Off, On, Default setting: On) You probably noticed that the strength/speed with which the bellows is pressed or pulled influences the sound – which corresponds to an acoustic accordion's response. This effect can be translated into a MIDI message most external instruments understand. The MIDI standard provides a message ("control change") for remotely controlling the volume of an external instrument: CC11. It is chiefly used for expression purposes (similar to the way in which a guitarist or organ player uses a volume pedal).



If you want to use the bellows for expressive purposes, set this parameter to "On". If you don't (because the external instrument is too sensitive and therefore changes its volume too often), select "Off". Note that there is a second parameter (see below) that allows you to specify the bellows' resolution.

Velocity TX

(On, 1~127, Default setting: On) Your FR-3 is velocity sensitive. That is a very learned term for the fact that the volume and brightness of the notes you play on the Treble or Bass keyboard depend on how hard (or fast) you press the buttons. The accordion sounds do not respond to these playing dynamics, but the Orchestra (Treble, Bass, Chord, Free Bass) sounds do, and so do most MIDI-compatible sound modules.



This parameter allows you to specify whether the velocity values corresponding to the strength with which you press a key/button should be transmitted ("On") or whether your playing dynamics should not be translated as such.

In the latter case, you need to select a value (1~127) that will be applied to all notes that are transmitted via MIDI. "64" is still relatively soft. Even lower values are probably not what you want in most cases. Fixed velocity values can be useful for playing organ sounds on an external module.

Bellows TX Resolution

(1~3, Default setting: 2) This parameter allows you to specify how many data the FR-3's bellows may transmit for expression purposes. As long as the external sequencer you work with does not display a "MIDI buffer overflow" message, you can leave its setting at "2". If, however, the bellows' data amount is too much for the receiving sequencer (because such data are transmitted on several channels simultaneously), select "1". In that case, the amount of data will be reduced. This leads to a coarser resolution, and maybe even audible steps, but at least, your sequencer will be able to record the data. If your sequencer accepts "3", use that setting, because it will lead to even more nuances being captured.



"TX" means that this parameter only applies to data sent by the FR-3. Its own MIDI buffer is big enough to receive high-resolution data ("3").

Sending program change messages when necessary (bPC, C00, C32)

Though each register or Set can transmit a program change/bank select cluster when pressed (see "Program Change TX" on p. 50), you can also transmit sound select messages on the fly – without changing registers on the FR-3. These are MIDI messages that cause an external instrument or device to select a different memory (i.e. another sound or effect).

This functionality is mainly intended for selecting setting groups of various sounds on external instruments. Such setting groups may be called "Performances" or "Multis", which you may want to select while playing, because using those multitimbral memories has the advantage that all sound addresses and MIDI channels are configured "automatically" simply by sending the correct "PC" address from the FR-3.

As the first half of the name ("Send PC") suggests, this function only *transmits* messages to an external device whose MIDI IN port is connected to the FR-3's MIDI socket.

Here is how to take advantage of that function:

- (1) Connect the FR-3's MIDI socket to the MIDI IN port of the module, synthesizer, etc., you wish to control.
- (2) Set the "MId" parameter (page 48) to "Out".
- (3) Set the module's MIDI receive channel (often called "RX") to "13".
See its manual for details. If you are unable to change the receiver's MIDI channel, set the FR-3's "Control Ch" to match the external instrument's "RX" channel. See "Control Channel TX" on p. 50.
- (4) Hold down the **ORCHESTRA/MODE** register while pressing register **6** (SEND PC).



- (5) Use Treble registers **1**~**0** to enter the **sound number**.

You may have to look in the owner's manual of the module or synthesizer you are controlling to find out which number you need to transmit for the sound (or memory) you want to select. You can enter any number from "1" to "512".

The **0** register acts as "0" here. To enter "502", for example, press registers **5**, **0**, and **2**.

- (6) If necessary, press the **SET** register to erase the last entry you made.

If you entered "55", for example, while the second figure should have been a "2", press **SET** once (so that the display indicates "--5" again), then press register **2** ("-52").

Note: The FR-3 uses a smart entry system: after entering "52" (or "53", "54", "55",... "59"), you can't add a third figure, because the highest number supported by the SEND PC function is "512".

Note: The **SET** button has two functions here: when pressed lightly, it deletes the last entry you made ("backspace"). By holding it for ±1 second, you delete all figures and start again.

- (7) Press the **ORCHESTRA** register to transmit the number you entered.

Bear in mind that despite the function's name ("Send PC"), the value you enter here is *not* really a program change number, but rather the memory number used by the receiving device.

"502" therefore refers to Performance number 502 of the receiver, but that number cannot be conveyed as such via MIDI.

The MIDI standard provides only 128 program change numbers (for selecting memories) and two messages called "Bank Select" that allow you to select 128 banks each. Two bank addresses ("MSB" and "LSB") with 128 possibilities each, plus 128 Program Change numbers provide 128 x 128 x 128 values= 2,097,152 possible memories.

The numbers you enter on the page shown above should therefore be taken to mean "memory XX of the receiving device". But how does the FR-3 then convert it to a MIDI address that conforms to the CC00/CC32/PC format (each of which supports a maximum of 128 possibilities)? Enter the following parameters:

Defining the 'PC' format

- (1) Press and hold the **SET** register until the display shows a parameter name, then release it.
- (2) Use register **5/4** or **6/7** to select the following parameter.

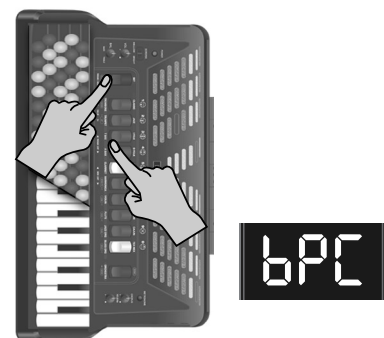

"bPC" is short for "Send Bank PC TX".

- (3) Use register **1/-** or **2/+** to select the memory group whose "real" MIDI address you want to define.

The possibilities are: "1" (1~128), "2" (129~256), "3" (257~384), "4" 385~512.

You probably noticed that each entry represents a group of 128 possibilities. By selecting an entry, you tell the FR-3: "Whenever I select a memory number between 257 and 384 on the 'SPC' page, please convert that to a program change number 1~128, and add the two CC values I'm about to specify."

Note: This function can also be used to select the Patches on an SRX-series expansion board which you installed in a G-70, for example.

- (4) Press the register to select "C00" and use or to select a value (0~127).

"0" corresponds to the first bank (called the "Capital bank" on GM2/GS-compatible instruments).

Be sure to select this number based on the information given in the owner's manual of the instrument you wish to control. Be sure to also specify the correct CC32 number.

- (5) Press the register to select "C32" and use or to select a value (0~127).

Again, the value to enter here depends on the information you find in the manual of the instrument you want to control. Some manufacturers don't use CC32 messages for sound selection, others use them to define modes, and still others rely on them as complementary bank information.

- (6) Press register to select "bPC" again, then use register or to select the next memory group, and repeat steps (4) and (5).
- (7) See "Saving your changes" on p. 26 if you want to keep your changes.
To use them only temporarily, press the register to leave "MIDI LIST" mode.
- (8) Now use the "SPC" page to test your assignments. See step (1) and following on p. 51.

Archiving your settings via MIDI (Bulk Dump)

MIDI can also be used for transmitting parameter settings from the FR-3 to an external MIDI device and back.

■ Archiving your settings with a sequencer

The parameter allows you to transmit the contents of the global area (that contains the PARAM LIST and MIDI LIST settings) to a second FR-3s/FR-3sb or FR-3/FR-3b, an external sequencer, computer or data filer. Sending these data to other instruments (a digital piano, synthesizer, etc.) does nothing at all. That's because the setting data are special MIDI messages only one model (or model family) understands. They are called "system exclusive messages" – or "SysEx" for short. By transmitting them to a second FR-3, however, you can "copy" the settings of your V-Accordion to that of a friend, colleague or student.

A sequencer or data filer does not know what the messages mean and so does not use them in any way. It merely records them. Afterwards, you only need to start playback on your sequencer or data filer to transmit the settings back to the FR-3.

- Connect the FR-3's MIDI OUT/IN socket to the sequencer's/computer's MIDI IN socket.
See page 45 for a connection diagram.
Note: Your computer needs to be equipped with (or connected to) an appropriate MIDI interface.
- Set the "Mid" parameter (page 48) to "Out".
- If you are working with a computer, launch the sequencer program.
- Create or select an empty song.
- Create (or select) an empty track.
The track's MIDI channel is of no importance here. You need to ensure, however, that the sequencer/program accepts SysEx data. If necessary, switch off the MIDI filter in question (see the manual of your sequencer or software).
- Activate the record-ready mode of the track you selected/created.
Note: It would be wise not to change the tempo on your sequencer/in the software. By default, most sequencers/programs use the tempo value ♩ = 120. Leave it that way (or else do whatever is necessary to ensure that the new tempo value is stored along with the data).
- Press and hold the register until the display shows a parameter name, then release it.
- Use register or to select the following parameter.

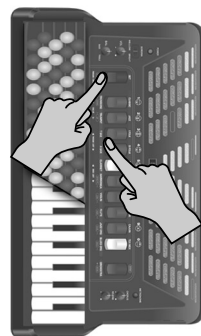

"dMP" is short for "Dump TX".

- (9) Start recording on your sequencer/computer.
Wait until the count-in (one or two measures) is finished, then...
- (10) Press register **[1/-]** or **[2/+]** on the FR-3 to start the transmission of the bulk data.
(Press the **[SET]** register if you do not want to transmit your settings after all.)
- (11) Wait until the following message appears, then stop recording on your sequencer.



This message appears after a while.

- (12) Name the "song" (it may only contain data so far) and save it to hard or floppy disk.
See below for how to transmit the settings back to the FR-3 at a later stage.

■ Sending Bulk data (back) to the FR-3

The FR-3 not only sends SysEx data to external devices (see above), it also receives them.

- (1) Connect the FR-3's MIDI socket to the sequencer's/ computer's MIDI OUT socket.
See page 45 for a connection diagram.

Note: Your computer needs to be equipped with (or connected to) an appropriate MIDI interface.

- (2) Set the "MId" parameter (page 48) to "In".
- (3) If you are working with a computer, launch the sequencer program.
- (4) Load the song that contains the data you want to transmit.
- (5) On your sequencer, perform all necessary actions to ensure that it transmits SysEx data.
See its manual for details.
Note: Be aware that by proceeding, you replace all internal settings.
- (6) Start playback of the data file or song on your sequencer, etc.
Note: Wait until the "don" message appears before stopping playback on your sequencer. Failure to do so will render your FR-3 inoperable. If that happens, you need to initialize it (see "Restoring the factory defaults" on p. 53).
- (7) Stop playback of your sequencer.

7. Restoring the factory defaults

You can reset the FR-3 to its factory settings, which means that your own Global settings are replaced by the settings the FR-3 contained when you first got it. You may wish to archive your settings before initializing the FR-3 (see p. 52).

- (1) Switch on the FR-3 while holding down the **[SET]** and **[ORCHESTRA]** registers.

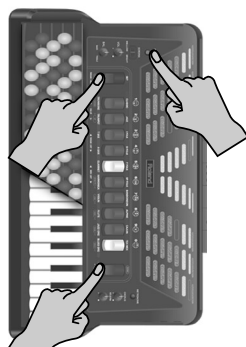

The display changes to:



When all settings have been initialized, the display briefly shows the following message:



The FR-3 now again sounds and behaves like when you first bought it.

8. Using optional batteries

Your FR-3 has a compartment that contains a special holder unit into which you can install 10 optional AA-type batteries. You can therefore play your instrument without connecting the supplied adapter.

What can you do with batteries?

- After installing optional batteries, the FR-3s/FR-3sb (where the "s" stands for "speakers") can be used like an acoustic accordion – without any connection whatsoever.
- FR-3s/FR-3sb and FR-3/FR-3b: If you use an optional wireless system, you don't need audio cables that run from the FR-3 to your amplifier or mixing console.
- FR-3s/FR-3sb and FR-3/FR-3b: If you use headphones, you can play just about anywhere.

Note: Though it is perfectly possible to use rechargeable batteries, be aware that they cannot be recharged simply by leaving them in the FR-3's compartment and connecting the adapter. You will need an external charging unit.

Installing and removing batteries

The FR-3 provides a battery compartment with a special holder unit into which 10 AA-type (R6) batteries can be installed.

General remarks about batteries

- Be sure to dispose of used batteries in accordance with local regulations.
- First, read the precautions on page 10 and following.
- New (or fully recharged) batteries should last about 2.5 hours (FR-3s/FR-3sb) or ± 5 hours (FR-3/FR-3b) under continuous use.
- Slightly before the batteries are fully exhausted, the following message appears.



Note: The FR-3 contains an energy saving function that switches off the instrument when it is left unattended for more than 10 minutes. You may therefore have to switch it on again from time to time.

- (1) Switch off the FR-3.
- (2) Remove the cushion located between the Treble keyboard and the bellows.

(FR-3s/FR-3)

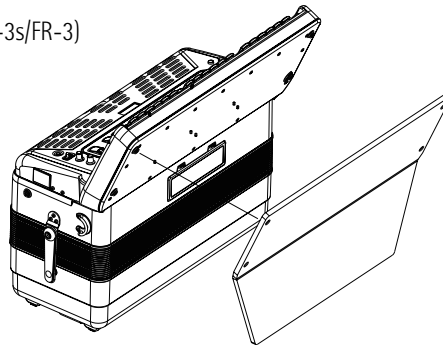

(FR-3sb/FR-3b)

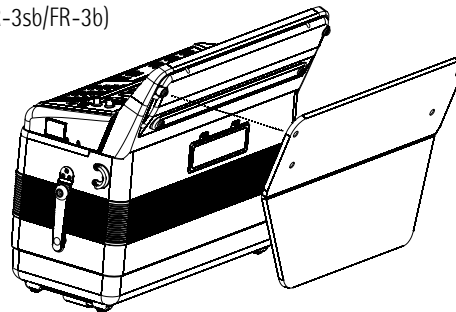

- (3) Remove the cover from the FR-3's battery compartment by pressing the two tabs and lifting the cover.

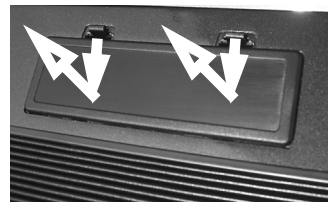

You should now see a tab that allows you to remove the battery case:



- (4) Use the tab to pull the battery case out of the compartment and turn the case around.

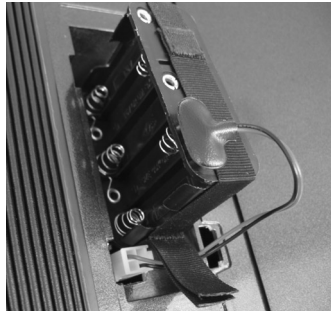

The battery case is connected to the FR-3 by means of a cable with a padded connector strip. You can disconnect the cable from the battery case by pulling off the padded connector strip.

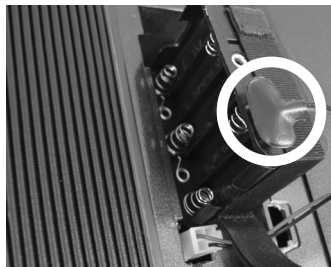

Note that this is unnecessary if you manage to install (or remove) the batteries without disconnecting the strip

- (5) Insert 10 AA-type (R6) batteries into the compartment (5 on either side), taking care to orient them in accordance with the "+" and "-" indications.

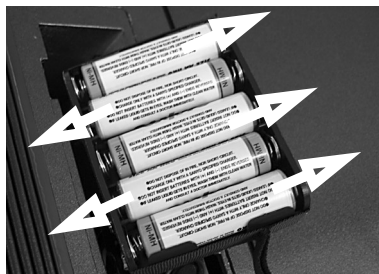

- (6) Insert the case with the 10 batteries into the compartment.
- (7) Close the FR-3's battery compartment and re-install the cushion.

Note about rechargeable batteries

Certain batteries can be recharged several times before they need to be replaced with a new ones. Note that it is normal for the battery to last increasingly shorter as time goes by. At the end of its life cycle, it may only last one hour, for example. But that is a gradual process.

9. Troubleshooting

This section provides an overview of points to check and actions to take when the FR-3 does not function as you expect. Feel free to contact your Roland dealer if your issue remains unsolved after reading through this section.

No sound

- **Did you turn the [VOL] knob all the way to the small dot?**

Set it to a higher value.

- **Did you turn the [BAL] knob all the way to one side?**

Change its setting and try again.

- **Are you moving the bellows while triggering accordion sounds?**

The Treble and Bass/Free Bass sections only produce sound if you move the bellows while playing notes (like on an acoustic accordion).

- **Did you connect the FR-3/FR-3b to an external amplifier?**

The FR-3/FR-3b doesn't contain internal speakers and therefore needs to be connected to an external amplification system. Alternatively, you can use a pair of headphones.

- **Did you connect the audio cables to the correct sockets?**

If so, check whether the external amplifier, mixing console, etc., is switched on. Also check the cables for possible damage.

No sound and the display shows "---"

- **Did you set the "MId" parameter to "In"?**

In that case, the FR-3 only responds to MIDI messages. Set the parameter to "Out" (page 48).

No power

- **Did you disconnect the adapter?**

Connect the supplied adapter, or install optional batteries.

- **Did you remove the battery cover?**

For your safety, the power is automatically switched off within a few seconds after the battery cover is removed.

- **Did the FR-3 go off after several seconds?**

You probably did not install the battery cover all the way, which is why the power was automatically switched off.

The FR-3 does not respond to your playing

- **Did you set the "MId" parameter to "In"?**

In that case, the FR-3 only responds to MIDI messages. Set the parameter to "Out" (page 48).

- **Are you moving the bellows while triggering accordion sounds?**

The Treble and Bass/Free Bass sections only produce sound if you move the bellows while playing notes (like on an acoustic accordion).

Issues related to the bass buttons

- **Why do the bass buttons only provide three chord rows?**

Because you set the "Bass & Chord Mode" parameter to "2", "3", "4" or "5" (page 42). Set it to "1".

- **Why can't I play diminished chords using the bass buttons?**

Because you set the "Bass & Chord Mode" parameter to "2", "3", "4" or "5" (page 42). Set it to "1".

- **In Free Bass mode, the bass buttons play the wrong notes.**

You may have changed the "Free Bass Mode" setting. Be sure to select the system that best suits your playing style (page 42).

MIDI-related issues

- **What MIDI channels does the FR-3 use by default?**

See the table on page 45.

- **The FR-3 does not change sounds when my sequencer transmits program change numbers.**

The program change number probably outside the range of the FR-3's registers (1~10 for Treble, 1~7 for Bass/Free Bass/Orch. Bass/Orch Chord/Orch Free Bass, 1~10 for Orchestra). Such "excess" program numbers are ignored by the FR-3.

- **The FR-3 does not receive the MIDI messages I recorded for it.**

That's because the "MId" parameter is currently set to "Out". Set it to "In" (page 48).

- **All of the FR-3's settings have changed.**

You probably transmitted a "Bulk" file. The settings of that file have replaced your own settings. We regret that your settings cannot be restored. Be sure to archive the internal settings before transmitting bulk data to the FR-3 (page 52).

- **The external sequencer keeps displaying a "MIDI Buffer Overflow" message**

The bellows sends too many data at once (its data are transmitted on five channels simultaneously). Select a different setting ("2" or "1"). This leads to a coarser resolution, and maybe to audible steps, but at least, your sequencer will be able to record the data. See "Bellows TX Resolution" on p. 50.

10. Specifications

■ Keyboards

Right hand:	FR-3s/FR-3	37 piano-type keys, velocity sensitive (starting at a G key)
	FR-3sb/FR-3b	92 buttons, with velocity
Left hand:	(All models)	120 velocity-sensitive bass buttons,
Modes:	Standard, Free Bass, Orch. Bass, Orch. Chord, Orch. Free Bass	

■ Bellows

Real pneumatic detection of bellows pressure (high-resolution pressure sensor)
Bellows resistance regulator: 4 positions

■ Sound source

Max polyphony: 64 voices
Wave ROM: 32MB of waveforms
Tones: 10 accordion Sets, each including:
12 Treble registers, 7 Bass registers, 7 Free Bass registers, 7 Orchestra Bass registers, 7 Orchestra Chord registers, 7 Orchestra Free Bass registers, 10 Orchestra sounds
Treble reed footages: 4
Bass reed footages: 5
Chord reed footages: 3
Free Bass footages: 2

■ PBM (Physical Behavior Modeling)

Noises: stopping-reed growl, closing valve noise, left button noise
Individual reed simulation: hysteresis threshold, Expression curve, pressure-variant filter, pressure-variant pitch deviation
Reed sound wave switching: by bellows acceleration, by note repetition speed

■ Musette tuning

Micro tuning presets: 16 (Off, Dry, Classic, F-Folk, American L/H, North Europe, German L/H, D-Folk L/H, Alpine, Italian L/H, French, Scottish)

■ Effects

Reverb: 8 types, Chorus: 8 types,
"Cassotto" and "Sordina" simulation

■ Panel controls

Knobs: VOL, Treble/Bass BAL, Reverb, Chorus
Panel Switches: 10 Treble registers + Orchestra + Set, 7 Bass registers, METRONOME button, SORDINA switch, POWER switch

■ Operation modes

ORCHESTRA modes: Solo, Dual, High, Low
Free Bass modes: Minor 3rd, Bajan, Fifth, N. Europe, Finnish
Treble modes (FR-3sb/FR-3b): C-Griff Europe, C-Griff 2, B-Griff Bajan, B-Griff Fin, D-Griff 1, D-Griff 2
Octave: Down, 0, Up (for Treble and Orchestra)

■ Display

LED, 3 x 7 segments, 3 dots

■ Rated power output (FR-3s/FR-3sb)

2 x 11W RMS

■ Speakers (FR-3s/FR-3sb)

2 x 10cm speakers (neodymium transducer magnets)

■ Power consumption (FR-3s/FR-3sb)

1000mA (FR-3s/FR-3sb)
450mA (FR-3/FR-3b)

■ Expected battery life under continuous use:

Ni-MH (2500mAh): . . . 2.5 hours (FR-3s/FR-3sb)
Ni-MH (2500mAh): . . . ±5 hours (FR-3/FR-3b)

These figures vary depending on the actual conditions of use. Roland recommends the use of Ni-MH batteries (2500mAh or more)

Note: Carbon and alkaline batteries should not be used.

■ Others

Connectors: HEADPHONE socket (stereo), OUTPUT sockets (stereo), MIDI socket (Out/In function adjustable via MIDI parameter)

Power supply: external AC adapter (100~240V, universal)

Dimensions (mm):

FR-3s/FR-3: 425 (H) x 481 (W) x 270 (D) mm

FR-3sb/FR-3b: 387 (H) x 472 (W) x 240 (D) mm

Weight: FR-3s: 8.3kg, FR-3sb: 8.25, FR-3: 7.5kg,
FR-3b: 7.5kg (without straps or optional batteries)

■ Supplied accessories

External AC adapter
Owner's Manual
Reference caps for the bass buttons
Reference caps for the treble buttons (FR-3sb/FR-3b)
Accordion cloth
Straps
Battery holder (pre-installed in compartment)

■ Options

Accordion soft bag
AA-type batteries (10) from third-party suppliers

Note: In the interest of product improvement, the specifications and/or appearance of this unit are subject to change without prior notice.

11. Appendix

Factory Sets

01 CLASSIC	04 D FOLK (German Folk)	07 BANDONEON	00 TEX MEX
02 JAZZ	05 F FOLK (French Folk)*	08 ALPINE	
03 I FOLK (Italian Folk)	06 SP FOLK (Spanish Folk)	09 CAJUN	

(*) Changes the assignments of the Treble registers. See page 22.

Demo Songs

#	SONG TITLE*	PERFORMED BY
01	Walking in old Paris by S. Scappini	Sergio Scappini
02	Carnival in Venice - Traditional	Sergio Scappini
03	Passionate Red Rose by S. Scappini	Sergio Scappini
04	Bezaubernder Sinaklia by S. Scappini	Sergio Scappini
05	O Sole Mio - Traditional	Sergio Scappini
06	Sonata in C Maj by D. Scarlatti	Sergio Scappini
07	Edelweiss by S. Scappini	Sergio Scappini
08	Mexican Hat Dance - Traditional	Luigi Bruti
09	Smells from Toccata by J. S. Bach	Sergio Scappini
10	Capriccio 13 by N. Paganini	Sergio Scappini
11	Salvador by L. Bruti	Luigi Bruti
12	Scattered Jazz by S. Scappini	Sergio Scappini
13	Figaro by G. Rossini	Sergio Scappini
14	Rêve d'amour by L. Bruti	Luigi Bruti
15	Sugar cane by L. Bruti	Luigi Bruti
16	To my beloved teacher by S. Scappini	Sergio Scappini
17	Dancing in the courtyard by L. Beier	Ludovic Beier
18	Sotto I ponti della Senna	Ludovic Beier
19	Sunny grasslands by L. Beier	Ludovic Beier
20	Hanging around by L. Beier	Ludovic Beier
21	Lights and Shadows of the Moon by L. Beier	Ludovic Beier
22	Acrobat by L. Beier	Ludovic Beier
23	Islands by L. Beier	Ludovic Beier
24	Fence Jumper by L. Beier	Ludovic Beier
25	Passion in the Atmosphere by L. Beier	Ludovic Beier

[*] Copyright ©2006 Roland Europe Spa. All rights reserved. All rights reserved.
Unauthorized use of the demo songs for purposes other than private enjoyment is a violation of applicable laws.

Note: The performance data of the demo songs are not transmitted to the MIDI socket.

MIDI implementation

1. Received data

■ Channel Voice Messages

● Note off

Status	2nd byte	3rd byte
8nH	kkH	vvH
n = MIDI channel number:	0H~FH (Ch.1~16)	
kk = note number:	00H~7FH (0~127)	
vv = note off velocity:	00H~7FH (0~127)	

● Note on

Status	2nd byte	3rd byte
9nH	kkH	vvH
n = MIDI channel number:	0H~FH (Ch.1~16)	
kk = note number:	00H~7FH (0~127)	
vv = note on velocity:	01H~7FH (1~127)	

● Control Change

- The value specified by a Control Change message is not reset by a Program Change, etc.

○ Bank Select (Controller number 0, 32)

Status	2nd byte	3rd byte
BnH	00H	mmH
BnH	20H	llH
n = MIDI channel number:	0H~FH (Ch.1~16)	
mm = Bank number MSB:	00H~7FH	
ll = Bank number LSB:	00H~7FH	

- Only for Free Bass.

○ Expression (Controller number 11)

Status	2nd byte	3rd byte
BnH	0BH	vvH
n = MIDI channel number:	0H~FH (Ch.1~16)	
vv = Expression:	00H~7FH (0~127)	

- This adjusts the volume of a Part. It can be used independently from Volume (CC07) messages. Expression messages are used for musical expression within a performance, e.g., expression pedal movements, crescendo and decrescendo.

○ Program Change

Status	2nd byte
CnH	ppH
n = MIDI channel number:	0H~FH (Ch.1~16)
pp = Program number:	00H~0BH: Treble Register 1~12 00H~0AH: Orchestra Register 1~10 00H~06H: Bass/FreeBass/Orch.Bass/ Orch.Chord/Orch. FreeBs Register 1~7 00H~0AH: Set 1~10

■ System Realtime Messages

○ Active Sensing

Status
FEH
When Active Sensing is received, the FR-3 starts monitoring the intervals of all further messages. While monitoring, if the interval between messages exceeds 420 ms, the same processing will be carried out as when All Sounds Off, All Notes Off and Reset All Controllers are received, and message interval monitoring will be halted.

○ Start

Status
FAH
When an FA message is received from an external MIDI device such as sequencer, the FR-3 sends all necessary MIDI information for a song header setup: Treble, Orchestra, Bass/Free, Orchestra Bass, sound setup.

■ System Exclusive Messages

Status	Data byte	Status
F0H	iiH, ddH,, eeH	F7H
F0H:	System Exclusive Message status	
ii = ID number:	An ID number (manufacturer ID) to indicate the manufacturer whose Exclusive message this is. Roland's manufacturer ID is 41H.	
dd, ..., ee = data:	00H~7FH (0~127)	
F7H:	EOX (End Of Exclusive)	

The System Exclusive Messages received by the FR-3 are messages related to Data Set (DT).

● Data Set 1 DT1 (12H)

Status	Data byte	Status
F0H	41H, dev, 42H, 12H, aaH, bbH, ccH, ddH, ... eeH, ffH, sum	F7H
Byte	Explanation	
F0H	Exclusive status	
41H	ID number (Roland)	
10H	Device ID	
00H	Model ID #1 (FR-3 V-Accordion)	

Status	Data byte	Status
7CH	Model ID #2 (FR-3 V-Accordion)	
12H	Command ID (DT1)	
aaH	Address MSB: upper byte of the starting address of the data to be sent	
bbH	Address: upper middle byte of the starting address of the data to be sent	
ccH	Address: lower middle byte of the starting address of the data to be sent	
ddH	Address LSB: lower byte of the starting address of the data to be sent	
eeH	Data: the actual data to be sent. Multiple bytes of data are transmitted in order starting from the address.	
::	::	
ffH	Data	
sum	Checksum	
F7H	EOX (End of Exclusive)	

- The amount of data that can be received at one time depends on the type of data, and data will be transmitted from the specified starting address and size.
- Data larger than 256 bytes must be divided into packets of 256 bytes or less, and each packet must be sent at an interval of about 20ms.

2. Transmitted data

■ Channel Voice Messages

● Note off

Status	2nd byte	3rd byte
8nH	kkH	vvH
n = MIDI channel number:	0H~FH (Ch.1~16)	
kk = note number:	00H~7FH (0~127)	
vv = note off velocity:	00H~7FH (0~127)	

● Note on

Status	2nd byte	3rd byte
9nH	kkH	vvH
n = MIDI channel number:	0H~FH (Ch.1~16)	
kk = note number:	00H~7FH (0~127)	
vv = note on velocity:	01H~7FH (1~127)	

● Control Change

○ Bank Select (Controller number 0, 32)

Status	2nd byte	3rd byte
BnH	00H	mmH
BnH	20H	llH
n = MIDI channel number:	0H~FH (Ch.1~16)	
mm = Bank number MSB:	00H~7FH	
ll = Bank number LSB:	00H~7FH	

○ Expression (Controller number 11)

Status	2nd byte	3rd byte
BnH	0BH	vvH
n = MIDI channel number:	0H~FH (Ch.1~16)	
vv = Expression:	00H~7FH (0~127)	

- This adjusts the volume of a Part. Expression messages are used for musical expression within a performance, e.g., expression pedal movements, crescendo and decrescendo.

○ Program Change

Status	2nd byte
CnH	ppH
n = MIDI channel number:	0H~FH (Ch.1~16)
pp = Program number:	00H~7FH: program no. 1~128

■ System Realtime Messages

○ Active Sensing

Status
FEH
Transmitted about every 250ms.

○ Start

Status
FAH
This message is transmitted when the METRONOME switch is pressed after assigning the "2" option to the "MFn" parameter.

○ Stop

Status
FCH
This message is transmitted when the METRONOME switch is pressed after assigning the "2" option to the "MFn" parameter.

System Exclusive Messages

Status	Data byte	Status
F0H	iiH, ddH,eeH	F7H
F0H:	System Exclusive Message status	
ii = ID number:	An ID number (manufacturer ID) to indicate the manufacturer whose Exclusive message this is. Roland's manufacturer ID is 41H.	
dd,.....ee= data:	00H-7FH (0-127)	
F7H:	EOX (End Of Exclusive)	

The System Exclusive Messages transmitted by the FR-3 are messages related to Data Set (DT).

Data Set 1 DT1 (12H)





Status	Data byte	Status
F0H	41H, dev, 42H, 12H, aaH, bbH, ccH, ddH, ... eeH, ffH, sum	F7H
Byte	Explanation	
F0H	Exclusive status	
41H	ID number (Roland)	
10H	Device ID	
00H	Model ID #1 (FR-3 V-Accordion)	
7CH	Model ID #2 (FR-3 V-Accordion)	
12H	Command ID (DT1)	
aaH	Address MSB: upper byte of the starting address of the data to be sent	
bbH	Address: upper middle byte of the starting address of the data to be sent	
ccH	Address: lower middle byte of the starting address of the data to be sent	
ddH	Address LSB: lower byte of the starting address of the data to be sent	
eeH	Data: the actual data to be sent. Multiple bytes of data are transmitted in order starting from the address.	
::	::	
ffH	Data	
sum	Checksum	
F7H	EOX (End of Exclusive)	

- The amount of data that can be transmitted at one time depends on the type of data, and data will be transmitted from the specified starting address and size.
- Data larger than 256 bytes will be divided into packets of 256 bytes or less, and each packet will be sent at an interval of about 20ms.

3. Bulk Dump

Bulk Dump allows you to transmit a large amount of data at once, and is convenient for storing settings for the entire unit on a computer or sequencer. The FR-3 is able to transmit and receive a SET.

4. Program change messages

BANK SELECT		PROGRAM CHANGE	SECTION
MSB CC00	LSB CC 32		
BANK SELECT AND PROGRAM CHANGE TX			
0	0	1-10	Treble Register
0	0	1~7	Bass Register
0	1	1~7	Free Bass Register
0	0	1~7	Orch Bass Register
0	0	1~7	Orch Chord Register
0	0	1~7	Orch FreeBs Register
0	0	1-10	Orchestra Register
0	0	1-10	Set
TREBLE REGISTER RX			
—	—	1	Bassoon
—	—	2	Bandon
—	—	3	Harmon
—	—	4	Organ
—	—	5	Master
—	—	6	Musette 
—	—	11	Musette 
—	—	7	Violin 
—	—	12	Violin 
—	—	8	Oboe
—	—	9	Clarinet
—	—	10	Piccolo
ORCHESTRA REGISTER RX			
—	—	1	Trombone
—	—	2	Trumpet
—	—	3	T Sax
—	—	4	A Sax
—	—	5	Clarinet
—	—	6	Harmonica
—	—	7	Violin
—	—	8	Flute
—	—	9	Jazz Org
—	—	10	Blues Org

BASS REGISTER RX			
—	—	1	2'
—	—	2	4'
—	—	3	8-4'
—	—	4	16'/8/8-4'/4'/2'
—	—	5	8'/4'/2'
—	—	6	16'/8/8-4'
—	—	7	16'/2'
FREE BASS REGISTER RX			
0	1	1	Low
0	1	2	High
0	1	3	Low+High
0	1	4	Low+High Low
0	1	5	Low Low+High
0	1	6	High Low+High
0	1	7	Low High
ORCH BASS REGISTER RX			
—	—	1	Acoustic
—	—	2	Bowed
—	—	3	Fingered
—	—	4	Fretless
—	—	5	Picked
—	—	6	Tuba
—	—	7	Tuba Mix
ORCH CHORD REGISTER RX			
—	—	1	St. Strings
—	—	2	Chorus Organ
—	—	3	Steel Guitar
—	—	4	St. Orch Brass
—	—	5	Choir
—	—	6	Harps+Strings
—	—	7	Guitar+Organ
ORCH FREE BASS REGISTER RX			
—	—	1	Trombone
—	—	2	Clarinet
—	—	3	Oboe
—	—	4	Flute
—	—	5	Perc Organ
—	—	6	Ac Guitar
—	—	7	Ac Piano
SET RX			
—	—	1	CLASSIC
—	—	2	JAZZ
—	—	3	I FOLK
—	—	4	D FOLK
—	—	5	F FOLK
—	—	6	SP FOLK
—	—	7	BANDONEON
—	—	8	ALPINE
—	—	9	CAJUN
—	—	10	TEX MEX

MIDI Implementation Chart

[V-Accordion]

Model: FR-3s/FR-3sb/FR-3/FR-3b

Date: April 2006

Version: 1.00

Function...		Transmitted	Recognized	Remarks
Basic Channel	Default Changed	1~16 1~16, Off	1~16 1~16, Off	7 Parts: 1= Treble, 2= Bass/Free Bass, 3= Chord, 4= Orchestra, 5= Orchestra Bass, 6= Orchestra Chord, 7= Orchestra Free Bass, 2 Logical parts: 13= Basic MIDI Channel for SET change, 13= Control MIDI Channel only TX
Mode	Default Message Altered	Mode 3 ***** *****	Mode 3 *****	
Note Number	True Voice	0~127 *****	*1 0~127 0~127	
Velocity	Note ON Note OFF	O O	*1 O O	
After Touch	Key's Ch's	X X	X X	
Pitch Bend		X	X	
Control Change	0,32	O	*1 O	Bank Select Volume Panpot Expression Hold 1 Reverb Send Chorus Send
	7	X	X	
	10	X	X	
	11	O	O	
	64	X	X	
	91	X	X	
Program Change	93	X	X	Program Number 1~128 transmitted Recognized: 1~12: 1~12: Treble Registers 1~7 Bass 1~7 Free Bass 1~7 Orchestra Bass 1~7 Orchestra Chord 1~7 Orchestra Free Bass 1~10 Orchestra 1~10 Sets
		O	*1 O	
		0~127	0~11	
System Exclusive		O	O	*3
System Common	Song Position Pointer	X	X	
	Song Sel	X	X	
	Tune	X	X	
System Real Time	Clock	X	X	
	Commands	O	*4 X	
Aux Messages	All Sounds Off	X	X	
	Reset All Controllers	X	X	
	Local On/Off	X	X	
	All Notes Off	X	X	
	Active Sense	O	O	
	Reset	X	X	
Notes	*1 O X is selectable *2 Recognized as M=1 even if M≠1 *3 SysEx used for Bulk Dump only *4 Transmit Start (FA) and Stop (FC)			

Mode 1: OMNI ON, POLY
Mode 3: OMNI OFF, POLY

Mode 2: OMNI ON, MONO
Mode 4: OMNI OFF, MONO

O: Yes
X: No

13. Index

A		Convert PC	51	L	
Adapter	14	Curve	41	Logo color	44
Alpine	35	D		Low	26
American	35	D Griff	37	M	
RPO	42	DC IN	13	MP	32
Auto Power Off	42	Delay	40	Master Tune	37
B		Demo songs	18	Memorize	26
B Griff	37	dEt	35	Metronome	31, 40
BAL	22, 23	Detune	35, 37	Function	42
Balance	22, 23	D-Folk	35	MPn	42
Basic Channel	50	Diplay	29	Mid	48
Bass		Display	20	MIDI	
& Chord Mode	42	dnp	52	Channels	45, 48
Button Noise	40	Dots	29	Filters	50
Orchestra	27	Dry	35	Implementation	59
Panel functions	12	Dual	25	List	48
Reed Growl	40	Dynamics	41	Out/In	48
Touch	41	E		Program change	51
Using	23	Editing	36	Socket function	48
Batteries	10, 54	Effect	40	Mode	25, 42
Install	54	Chorus	23	Module	45
bbn	40	Level	22	MP	32
bCH	50	Reverb	22	MS	31, 40
bcn	42	F		Multi	51
Bellows		Factory Setup	53	Musette Detune	35, 37
Curve	41	Fbn	42	N	
Expression TX	50	Fbn	40	North Eur.	35
Resistance regulator	21	F-Folk	35	O	
TX Resolution	50	Fin	37	OL	26, 30
bES	50	Flanger	40	Et	41
bFO	49	Free Bass	24	ObL	28
bFr	49	Button Noise	40	ObL	39
bLC	41	Mode	42	ObO	49
bPC	51	Orchestra	30	ObS	49
brE	50	Panel functions	12	Obt	41
brG	40	Reed Growl	40	OCn	49
Bulk		French	35	OCCL	29
Dump	52	FrG	40	OCO	49
Reception	53	FtY	53	Octave	34, 35
Button layout	37	G		Bass/Free Bass	49
Button Noise	40	German	35	Chord	49
C		Growl	40	Orchestra	49
C Griff	37	H		Orchestra Bass	49
COO	52	Hall	40	Orchestra Chord	49
COZ	52	Headphones	13, 14	Orchestra Free Bass	50
cCH	50	High	26	Treble	49
CHd	49	I		OFb	49
CHO	49	Initialize	53	OFFL	30
Chord	23, 45	Italian	35	OFFO	50
Orchestra	28	K		OrC	49
TX/RX Channel	49	Key (of your music)	34	ORCH BASS	27
Chorus	23, 40			Volume	28
CHr	40			ORCH CHORD	28
Classic	35			Volume	29
COL	44			ORCH FREE BS	
Color	44			Volume	30
Connections	14				
Control Channel	50				

Orchestra	25	Touch	41
Bass Level	28	Transpose	34, 37
Bass TX/RX Channel	49	ErB	48
Chord	28	Treble	11
Chord Level	29	Mode	37
Chord TX/RX Channel	49	Octave	34
Free Bass	30	Orchestra	25
Free Bass TX/RX Channel	49	Panel functions	11
Level	26, 30	Using	21
Mode	25	Valve Noise	40
Octave	35	ErF	37
Touch	41	ErG	40
TX/RX Channel	49	ErO	49
Velocity	41	ErP	34, 37
Volume	26, 39	Tuning	37
ErQ	49		
Output	14	U	
		UrE	26
P			
Pan	14, 41	V	
Delay	40	Valve	40
Panel functions	11	VEL	50
PC	51	Velocity	41
PCH	50	TX	50
Performance	51	VOL	22, 23
PHONES	13	Volume	22, 23
Pitch	34	Effects	22
Plate	40	Orchestra	26, 39
Program Change TX	50	Orchestra Bass	28
		Orchestra Chord	29
R		Orchestra Free Bass	30
Reed Growl	40		
Register		W	
Bass	12	Write	26
Treble	11	UrE	26
Resetting	53		
rEu	40		
Reverb	22, 40		
Roland (logo)	44		
Room	40		
S			
Save	26		
Scottish	35		
Send PC	51		
Sequencer	45		
Set			
Description	19		
Program change	50		
Solo	25		
Sordina	22		
SPE	51		
Specifications	57		
Std	26		
StE	41		
Stereo			
Position	14		
Width	41		
Straps	15		
Switching on/off	16		
SysEx	52		
T			
Tempo	32		
Time Signature	40		
Tone Generator	45		

