

FDR-1

Deluxe Reverb

Owner's Manual

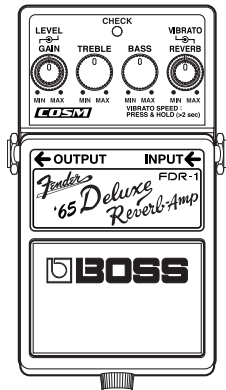

—Legend Series—

BOSS

Thank you, and congratulations on your choice of the BOSS FDR-1 Deluxe Reverb. Before using this unit, carefully read the sections entitled: “USING THE UNIT SAFELY” and “IMPORTANT NOTES” (supplied on a separate sheet). These sections provide important information concerning the proper operation of the unit. Additionally, in order to feel assured that you have gained a good understanding of every feature provided by your new unit, this manual should be read in its entirety. The manual should be saved and kept on hand as a convenient reference.

About COSM (Composite Object Sound Modeling)

Composite Object Sound Modeling—or “COSM” for short—is Roland’s innovative and powerful technology that’s used to digitally recreate the sound of classic musical instruments and effects. COSM analyzes the many factors that make up the original sound—including its electrical and physical characteristics—and creates a digital model that accurately reproduces the original.

A battery is supplied with the unit. The life of this battery may be limited, however, since its primary purpose is to enable testing.

Copyright © 2007 BOSS CORPORATION

All rights reserved. No part of this publication may be reproduced in any form without the written permission of BOSS CORPORATION.

Main Features

- Uses COSM technology to model the amp sound of a Fender® DELUXE REVERB®.
- Makes it easy for you to enjoy that vintage Fender® amp sound simply by connecting the FDR-1 to your usual guitar amp.
- Features reverb and vibrato effects like those on an actual DELUXE REVERB® amp.
 - * *Reverb: An effect that adds reverberations to sound.*
 - * *Vibrato: An effect that changes the volume level in a cyclical way.*

About the Fender® DELUXE REVERB®



The DELUXE REVERB® amp was announced in 1963. It's medium wattage and pure tone made it a top choice throughout the '60s, '70s and '80s, for use in recording sessions and live performances in a full range of genres, from surf music, blues, and country to jazz, soul, and even hard rock.

In addition to its characteristic clean and crisp tones, at high volume levels the amp delivers a lustrous overdrive sound that could only come from the DELUXE REVERB®.

Among the several members of the series, the 1965 model is especially acclaimed and has captured the hearts of many guitarists. Reissued in 1994, the DELUXE REVERB® is truly one of Fender's finest amps and a perennial best-seller to this day.

Panel Descriptions

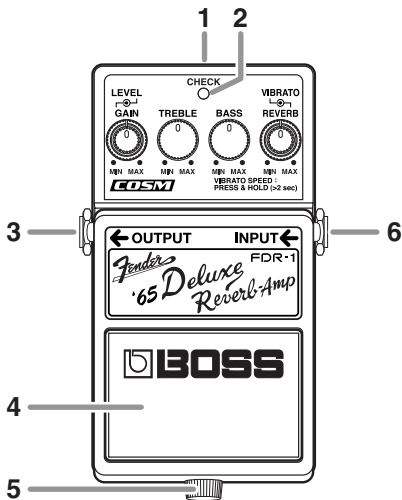

1. AC Adaptor Jack

This jack accepts the connection of an AC adaptor (optionally available BOSS PSA-series). By using an AC adaptor, you can play without being concerned about how much battery power you have left.

- * Use only the specified AC adaptor (PSA-series), and make sure the line voltage at the installation matches the input voltage specified on the AC adaptor's body. Other AC adaptors may use a different polarity, or be designed for a different voltage, so their use could result in damage, malfunction, or electric shock.
- * If the AC adaptor is connected while power is on, the power supply is drawn from the AC adaptor.
- * If there is a battery in the unit while an AC adaptor is being used, the FDR-1 will switch over to battery-powered operation should the line voltage be interrupted due to a power blackout or power cord disconnection.

2. CHECK Indicator

This indicator shows whether the effect is on or off, and also doubles as the battery check indicator. The indicator lights when the effect is on.

- * *If you're powering the unit with a battery and the CHECK indicator goes dim—or doesn't light at all—when you try to turn the effect on, the battery is near depletion and should be replaced. For instructions on changing the battery, refer to “Changing the Battery” (p. 14).*
- * *The CHECK indicator shows whether the effect is being applied or not. It does not indicate whether the power to the device is on or not.*

3. OUTPUT Jack

This output jack is used for connecting to guitar amps and other effects processors.

4. Pedal Switch

This switch turns the effect on/off.

5. Thumbscrew

When this screw is loosened, the pedal will open, allowing you to change the battery. For instructions on changing the battery, refer to “Changing the Battery” (p. 14).

6. INPUT Jack

These jacks are for connecting the output from an electric guitar or other instrument or effects device.

- * *These jacks double as power switch. Power to the FDR-1 is turned on when you plug into the INPUT jack; the power is turned off when the cable is unplugged. When not using the FDR-1, be sure to disconnect the plug from the INPUT jack.*

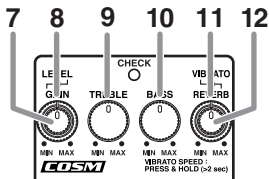

7. GAIN Knob

This adjusts the amount of distortion and the volume level. Turning it clockwise makes distortion stronger and increases the volume level.

8. LEVEL Knob

This adjusts the volume of the effect sound.

** No sound is output when this knob is turned completely counterclockwise.*

9. TREBLE Knob

This knob controls the tone of the effect at higher frequencies.

10. BASS Knob

This knob controls the tone of the effect at lower frequencies.

11. REVERB Knob

This adjusts the amount of reverb effect that is applied.

12. VIBRATO Knob

This adjusts the amount of vibrato effect (cyclical fluctuations in volume) that is applied. Turning it clockwise makes the effect more intense.

Turning the VIBRATO knob while depressing the pedal switch changes the vibrato rate (RATE setting mode).

Turning it clockwise increases the rate.

Connections

- * *Inserting a connecting plug into the INPUT jack turns on the power to the unit.*
- * *Raise the amp volume only after turning on the power to all connected devices.*
- * *The use of an AC adaptor is recommended as the unit's power consumption is relatively high. Should you prefer to use a battery, please use the alkaline type.*
- * *To prevent malfunction and/or damage to speakers or other devices, always turn down the volume, and turn off the power on all devices before making any connections.*
- * *If there is a battery in the unit while an AC adaptor is being used, normal operation will continue should the line voltage be interrupted due to power blackout or power cord disconnection.*
- * *Some connection cables contain resistors. When connection cables with resistors are used, the sound level may be extremely low, or impossible to hear. For information on cable specifications, contact the manufacturer of the cable.*
- * *Once the connections have been completed, turn on power to your various devices in the order specified. By turning on devices in the wrong order, you risk*

causing malfunction and/or damage to speakers and other devices.

When powering up:

Turn on the power to your guitar amp last.

When powering down:

Turn off the power to your guitar amp first.

- * *Always make sure to have the volume level turned down before switching on power. Even with the volume all the way down, you may still hear some sound when the power is switched on, but this is normal, and does not indicate a malfunction.*
- * *When operating on battery power only, the CHECK indicator will become dim when battery power gets too low. Replace the battery as soon as possible.*

Recommended Settings

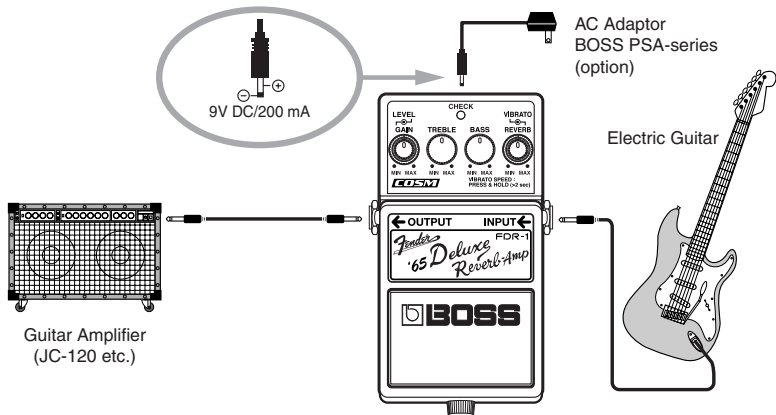

* This unit is equipped with a protection circuit. A brief interval (a few seconds) after power-up is required before the unit will operate normally.

Recommended Settings for a Roland JC-120

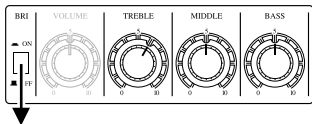

Set to OFF

Recommended Settings for a Fender® Combo Amp

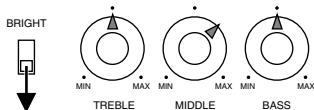

Set to OFF

Recommended Settings for a Stack Amp

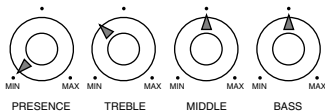

TIP

We recommend using a clean setting (no distortion) on the connected amp.

Operating the Unit

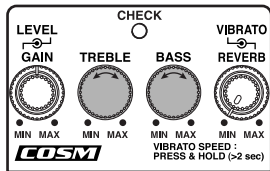
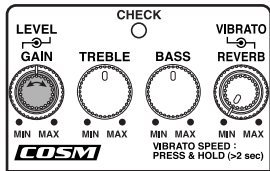
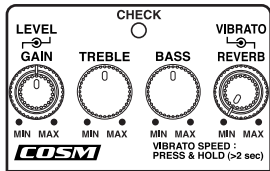

1. After you have made the necessary connections (p. 7, p. 8), set the panel knobs as shown in the illustration.
2. Depress the pedal switch to turn the effect on. (The CHECK indicator lights when the effect is on.)
3. Adjust the gain (the amount of distortion) with the GAIN knob.
** Setting both knobs at extremely high levels may also result in increased noise.*
4. Adjust the tone with the BASS knob and TREBLE knob.

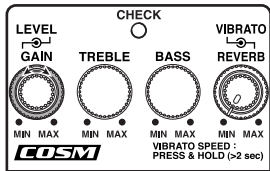

- 5.** Adjust the output volume with the LEVEL knob.

TIP

Normally, you should adjust the LEVEL knob so there's no difference in the volume when switching the effect on and off.

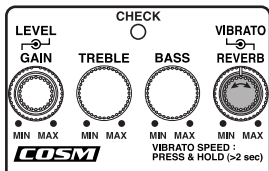

- 6.** Adjusts the amount of vibrato effect (cyclical fluctuations in volume) with the VIBRATO knob.

MEMO

You can change the vibrato rate by turning the VIBRATO knob while depressing the pedal switch (RATE setting mode). When you've finished setting the rate, release the pedal switch, then depress it again, holding it down for two or more seconds. The rate will be stored in FDR-1.

MEMO



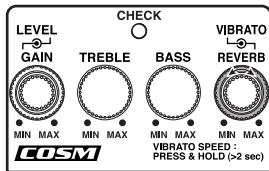





When the vibrato rate is changed, the actual vibrato effect and the indicated scale of VIBRATO knob might be different.



- 7.** Adjusts the amount of reverb effect with the REVERB knob.









Setting the Vibrato Rate Using the Pedal Switch (RATE Setting Mode)

When Setting the Vibrato by Inputting the Tempo with the Effect On (CHECK indicator: Red)

CHECK Indicator	Red 	Off 	Red/Green Blinking 	Red 
Effect	On	Off	On	On
Pedal Switch		 1 Press and hold the FDR-1's pedal switch for at least two seconds.	 2 Tap the FDR-1's pedal switch in timing with the tempo.	 3 Press and hold the FDR-1's pedal switch for at least two seconds. The rate is stored.
Rate Setting	Off	Off	On	Off→Rate confirmed

- * Vibrato rate for use with the tempo settings can be made in the range of 0.3–3.0 seconds.
- * If you carry out Step 3 immediately after Step 2, Step 3 may inadvertently be interpreted as tempo input, thus changing the RATE setting. Allow a brief interval to pass before progressing from Step 2 to Step 3.
- * You can also set the rate by turning the VIBRATO knob while depressing the pedal switch (p. 11). When you've finished setting the rate, release the pedal switch, then depress it again, holding it down for two or more seconds.

When Setting the Vibrato by Inputting the Tempo with the Effect Off (CHECK indicator: Off)

CHECK Indicator	Off 	Red 	Red/Green Blinking 	Red 
Effect	Off	On	On	On
Pedal Switch		 1 Press and hold the FDR-1's pedal switch for at least two seconds.	 2 Tap the FDR-1's pedal switch in timing with the tempo.	 3 Press and hold the FDR-1's pedal switch for at least two seconds. The rate is stored.
Rate Setting	Off	On	On	Off→Rate confirmed

- * Vibrato rate for use with the tempo settings can be made in the range of 0.3–3.0 seconds.
- * If you carry out Step 3 immediately after Step 2, Step 3 may inadvertently be interpreted as tempo input, thus changing the RATE setting. Allow a brief interval to pass before progressing from Step 2 to Step 3.
- * You can also set the rate by turning the VIBRATO knob while depressing the pedal switch (p. 11). When you've finished setting the rate, release the pedal switch, then depress it again, holding it down for two or more seconds.

Changing the Battery

When the indicator goes dim or no longer lights while the effect is on, it means that the battery must be replaced. Replace the battery following the steps below.

* *The use of an AC adaptor is recommended as the unit's power consumption is relatively high. Should you prefer to use a battery, please use the alkaline type.*

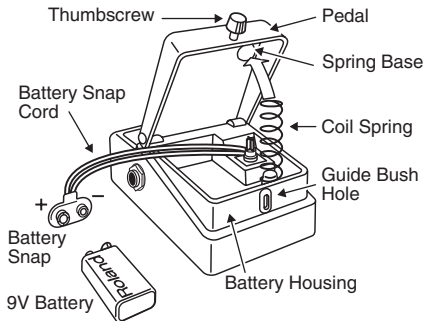

1. Hold down the pedal and loosen the thumbscrew, then open the pedal upward.
 - * *The pedal can be opened without detaching the thumbscrew completely.*
2. Remove the old battery from the battery housing, and remove the snap cord connected to it.
3. Connect the snap cord to the new battery, and place the battery inside the battery housing.
 - * *Be sure to carefully observe the battery's polarity (+ versus -).*
4. Slip the coil spring onto the spring base on the back of the pedal, and then close the pedal.
 - * *Carefully avoid getting the snap cord caught in the pedal, coil spring, and battery housing.*
5. Finally, insert the thumbscrew into the guide bush hole and fasten it securely.

Troubleshooting

The power won't come on/ the CHECK indicator doesn't light

- **Is the specified adaptor (PSA-series, sold separately) properly connected?**

Check the AC adaptor connection (p. 7, p. 8).

* *Never use any AC adapter other than one specified for use with the FDR-1.*

- **Is the battery low or dead?**

Replace it with a new battery (p. 14).

* *The battery that is supplied with the unit is for temporary use, intended primarily for testing the pedal's operation.*

* *The use of an AC adaptor is recommended as the unit's power consumption is relatively high. Should you prefer to use a battery, please use the alkaline type.*

* *To prevent unnecessary battery consumption, be sure to disconnect the plug from the INPUT jack when not using the effects unit (p. 5).*

- **Is your guitar properly connected to the INPUT jack?**

Check the connection once more (p. 7, p. 8).

* *The power is switched on only when a cable is*

plugged in to the INPUT jack.

* *The CHECK indicator shows whether the effect is being applied or not. It does not indicate whether the power to the device is on or not.*

No sound / low volume

- **Is your instrument properly connected to the FDR-1?**

Check the connection once more (p. 7, p. 8).

- **Is the LEVEL knob set too low?**

The further counterclockwise you turn the LEVEL knob, the more the volume is reduced when the effect is on. Turn the LEVEL knob clockwise to increase the volume.

- **Is the volume turned down on any guitar amp or effects device you have connected?**

Check the settings of the connected device.

- **Is the battery low or dead?**

Replace it with a new battery (p. 14).

Effect won't turn off

- **Could you be in the vibrato rate setting mode (p. 12, p. 13)?**

Setting Samples

Standard Crunch Sound

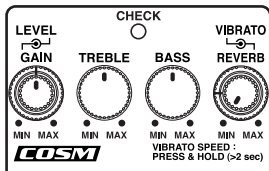

Surf Rock Sound

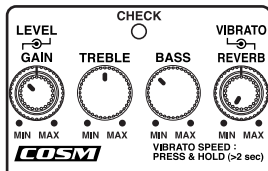

Hard Overdrive Sound

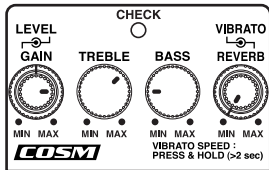

Vibrato Sound

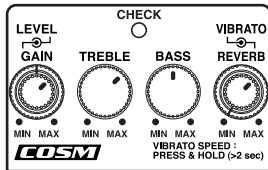

TIP

For details about the vibrato rate, please refer to p. 12, p. 13.

Setting Memo

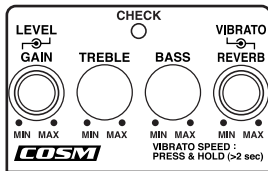
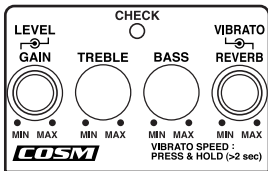
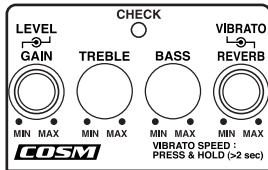
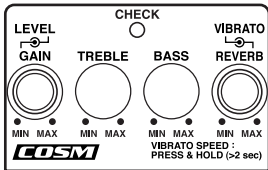

Setting Memo

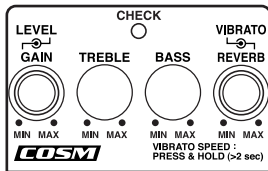
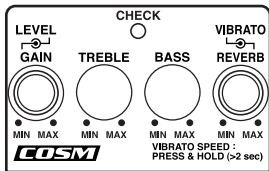
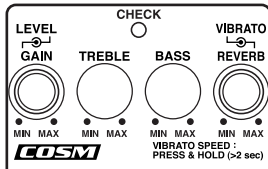
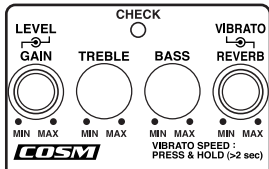

Specifications

FDR-1: Deluxe Reverb

Nominal Input Level:..... -20 dBu

Input Impedance:..... 1 M Ω

Nominal Output Level:..... -20 dBu

Output Impedance: 2.2 k Ω

Recommended Load Impedance:... 10 k Ω or greater

Controls:..... Pedal switch, GAIN knob, LEVEL knob, TREBLE knob,
BASS knob, REVERB knob, VIBRATO knob

Indicators:.....CHECK indicator (for effect on/off status and battery check)

Connectors:..... INPUT jack, OUTPUT jack, AC adaptor jack (DC 9 V)

Power Supply:..... DC 9 V: Dry battery 6F22 (9 V) type (carbon)/
Dry battery 6LR61 (9 V) type (alkaline)
AC Adaptor (PSA-series: optional)

Current Draw: 40 mA (DC 9 V)

** Expected battery life under continuous use:*

Carbon: 2.7 hours, Alkaline: 9 hours

These figures will vary depending on the actual conditions of use.

Dimensions: 73 (W) x 129 (D) x 59 (H) mm /
2-7/8 (W) x 5-1/8 (D) x 2-3/8 (H) inches

Specifications

Weight:	440 g /1 lb (including battery)
Accessories.....	Owner's manual, leaflet ("USING THE UNIT SAFELY," "IMPORTANT NOTES," and "Information"), dry battery /9 V type (6LR61) <i>* The battery that is supplied with the unit is for temporary use, intended primarily for testing the unit's operation. We suggest replacing this with an alkaline dry cell.</i>
Option	AC adaptor (PSA-series)

* $0 \text{ dBu} = 0.775 \text{ Vrms}$

* *In the interest of product improvement, the specifications and/or appearance of this unit are subject to change without prior notice.*

* *Fender® and DELUXE REVERB® are the trademarks of FMIC. All rights reserved.*

* *All product names mentioned in this document are trademarks or registered trademarks of their respective owners. In this document, their names are used solely to identify the equipment whose sound is simulated by COSM.*





This product complies with the requirements of European Directive 89/336/EEC.

For EU Countries

For the USA

FEDERAL COMMUNICATIONS COMMISSION RADIO FREQUENCY INTERFERENCE STATEMENT

This equipment has been tested and found to comply with the limits for a Class B digital device, pursuant to Part 15 of the FCC Rules. These limits are designed to provide reasonable protection against harmful interference in a residential installation. This equipment generates, uses, and can radiate radio frequency energy and, if not installed and used in accordance with the instructions, may cause harmful interference to radio communications. However, there is no guarantee that interference will not occur in a particular installation. If this equipment does cause harmful interference to radio or television reception, which can be determined by turning the equipment off and on, the user is encouraged to try to correct the interference by one or more of the following measures:

- Reorient or relocate the receiving antenna.
- Increase the separation between the equipment and receiver.
- Connect the equipment into an outlet on a circuit different from that to which the receiver is connected.
- Consult the dealer or an experienced radio/TV technician for help.

This device complies with Part 15 of the FCC Rules. Operation is subject to the following two conditions:

- (1) This device may not cause harmful interference, and
- (2) This device must accept any interference received, including interference that may cause undesired operation.

Unauthorized changes or modification to this system can void the users authority to operate this equipment.
This equipment requires shielded interface cables in order to meet FCC class B Limit.

For Canada

NOTICE

This Class B digital apparatus meets all requirements of the Canadian Interference-Causing Equipment Regulations.

AVIS

Cet appareil numérique de la classe B respecte toutes les exigences du Règlement sur le matériel brouilleur du Canada.

 **BOSS**[®]
BOSS Corporation



This product must be disposed of separately
at your local waste recycling centre.
Do not dispose of in household waste bin.

G6027116R0