

# Fantom-S Fantom-S88

## QUICK START

Thank you, and congratulations on your choice of the Roland *Fantom-S / Fantom-S88* .

Before using this unit, carefully read the sections entitled: "IMPORTANT SAFETY INSTRUCTIONS" (Owner's Manual p. 2), "USING THE UNIT SAFELY" (Owner's Manual p. 3), and "IMPORTANT NOTES" (Owner's Manual p. 4). These sections provide important information concerning the proper operation of the unit. Additionally, in order to feel assured that you have gained a good grasp of every feature provided by your new unit, Quick Start, Owner's Manual, and Sound/Parameter List should be read in their entirety. These manuals should be saved and kept on hand as a convenient reference.

### How to Read This Manual

The Fantom-S comes with four manuals: Quick Start, Owner's Manual, Parameter List. The manual you're reading now, Quick Start, offers a basic introduction to the Fantom-S, and provides simple, easy-to-understand explanations, allowing the beginner to quickly experience many of the Fantom-S's exciting features. As you read the Quick Start, we recommend actually performing the described operations on your Fantom-S. For feature details, and for explanations of advanced uses, read the separate Owner's Manual. Sound/Parameter List contains sound lists and parameter and information on the Fantom-S's MIDI implementation. This Owner's Manual applies to both the Fantom-S and the Fantom-S88. The manual uses the term "Fantom-S" to indicate both models. If you have the Fantom-S88, please read "Fantom-S" as "Fantom-S88."

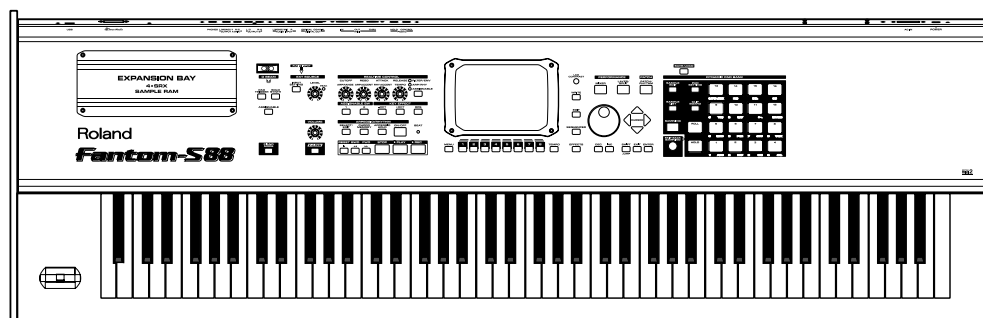
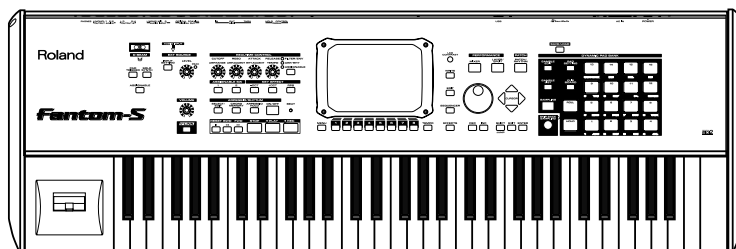

Copyright © 2003 ROLAND CORPORATION

All rights reserved. No part of this publication may be reproduced in any form without the written permission of ROLAND CORPORATION.

# Contents

<b>Getting Ready</b> .....	<b>3</b>
Connecting an Amp and Speaker System .....	3
Placing the Fantom-S88 on a Stand (For Fantom-S88 user) .....	4
Turning On the Power .....	4
Adjusting the Display Contrast (LCD Contrast).....	5
Turning Off the Power.....	5
<b>Listen to the Demo Song</b> .....	<b>6</b>
<b>Try Out the Sounds</b> .....	<b>7</b>
Playing the Sounds .....	7
Selecting Patches by Category .....	8
Selecting Patches by Group.....	9
Auditioning Patches with Phrases (Phrase Preview).....	10
Changing the Patch Settings .....	10
Playing Percussion Sounds with the Pad (Rhythm Set).....	11
Changing the Rhythm Set Settings .....	12
Layering Two or More Patches (Layer) .....	12
Changing the Performance Settings.....	13
Splitting the Keyboard to Play an Ensemble (Split).....	13
Changing the Performance Settings.....	14
<b>Try Out the Various Performance Features</b> .....	<b>15</b>
Moving Your Hand Above the D Beam Controller to Apply Effects (D Beam Controller).....	15
Changing D Beam Controller Settings .....	16
Using Knobs and Buttons to Modify the Sound in Realtime (Realtime Controller) .....	17
Changing Realtime Controller Settings.....	19
Playing Arpeggios(Arpeggio/Rhythm function).....	20
Changing Arpeggio Settings.....	21
Performing Rhythms while a Rhythm Pattern Plays.....	22
Changing Rhythm Group Settings.....	23
Other Performance Features.....	25
Velocity/Aftertouch.....	25
Pitch Bend/Modulation Lever .....	25
Octave Shift (Oct).....	25
Hold Pedal.....	25
Control Pedal.....	26
Transpose (Trans) .....	26
Using the RPS Function.....	27
<b>Using Skip Back Sampling to Sample a Favorite Phrase (Skip Back Sampling)</b> .....	<b>29</b>
Assigning a Sample to a Pad (Assign to Pad).....	30
<b>Creating a Song</b> .....	<b>31</b>
Erasing a Song From Internal Memory (Song Clear).....	32
Selecting a Performance .....	33
Selecting a Part.....	34
Assigning a Vocal Phrase to a Part as a Patch .....	35
Assigning the Selected Sample to a Part as a Patch (Assign to Keyboard).....	36
Recording the Rhythm Part .....	38
Selecting the Part to Record .....	38
Selecting the Recording Method .....	38
Playing and Recording Rhythm Part.....	39
Recording the Bass Part.....	42
Recording the Piano Part .....	43
Recording the Vocal Part.....	44
Mixing in the MIXER Screen .....	45
Loop the Song .....	45
Making Fine Adjustments in the MIXER Screen .....	46
Using Effects .....	48
Switching the Effects On/Off .....	48
Editing the Effect Settings .....	49
Saving the Song You Recorded .....	50

# Getting Ready

## Connecting an Amp and Speaker System

Since the Fantom-S contains no amplifier or speakers, you'll need to connect it to audio equipment such as a keyboard amplifier, monitor speaker system or home stereo, or use headphones to hear its sound.

1. Before hooking anything up, make sure that the power on all of your gear is turned OFF.
2. Connect one end of the supplied power cable to the Fantom-S, and the other end to a power outlet.
3. Connect the Fantom-S to your amp/speaker system as shown in the diagram.

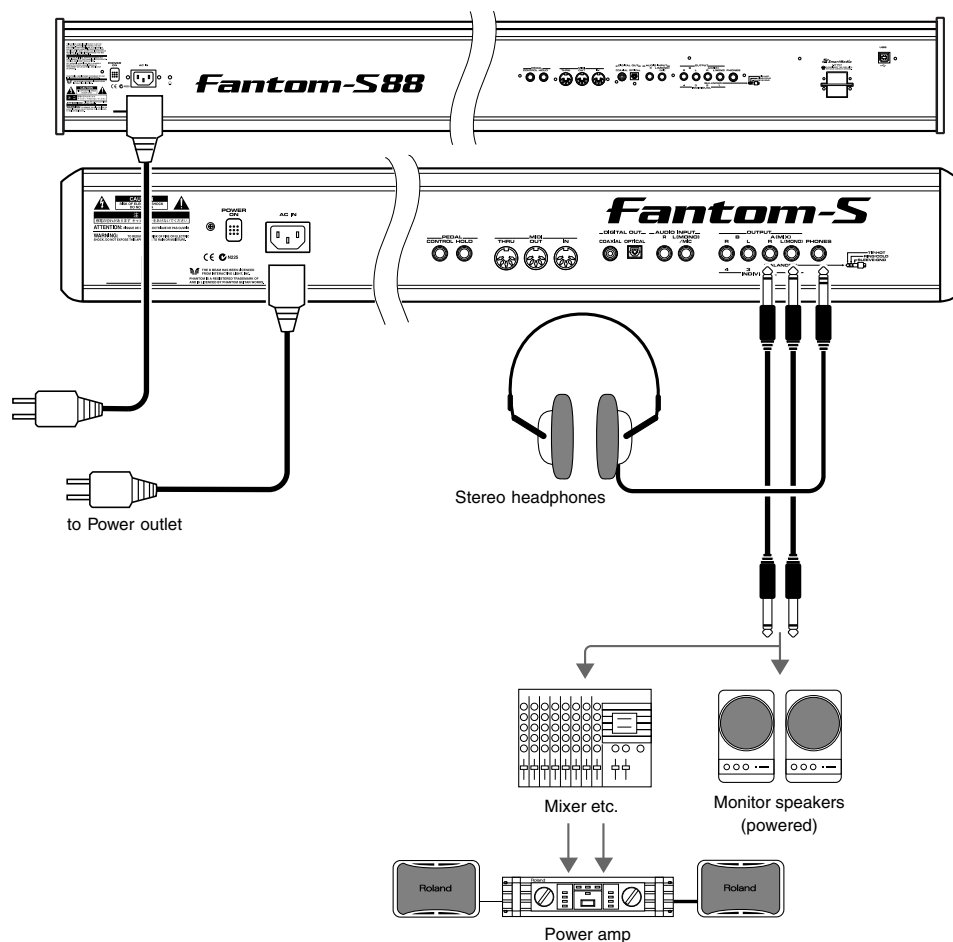

Use audio cables to connect audio equipment such as an amp or speakers. If you're using headphones, plug them into the PHONES jack.

### NOTE

To prevent malfunction and/or damage to speakers or other devices, always turn down the volume, and turn off the power on all devices before making any connections.

### HINT

In order to fully experience the Fantom-S's sound, we recommend using a stereo amp/speaker system. If you're using a mono system, however, make your connections to the Fantom-S's OUTPUT A (MIX) jack L (MONO).

### NOTE

Audio cables are not included with the Fantom-S. You'll need to provide them.



For details on how to install a Wave Expansion Board (sold separately), refer to "Installing the Wave Expansion Board" (Owner's Manual; p. 203).

## Getting Ready

### Placing the Fantom-S88 on a Stand (For Fantom-S88 user)

If you want to place the Fantom-S88 on a stand, we recommend that you use the Roland KS-17.  
Place the instrument on the stand as follows.

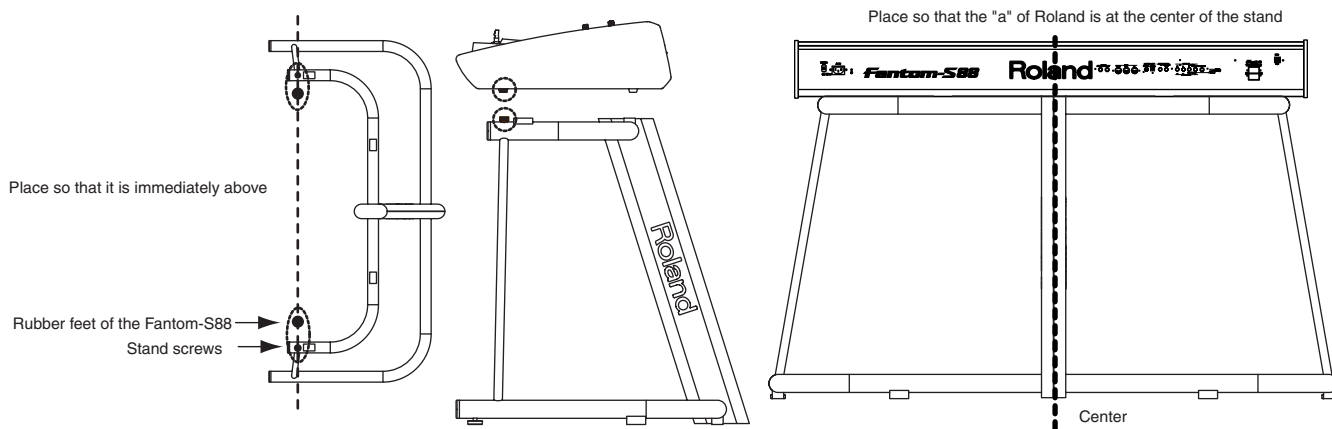

### Turning On the Power

\* Once the connections have been completed (previous page), turn on power to your various devices in the order specified. By turning on devices in the wrong order, you risk causing malfunction and/or damage to speakers and other devices.

- 1. Before turning on the Fantom's power, consider these two questions:**
  - Are all peripheral devices connected correctly?
  - Have the volume controls of the Fantom-S and all connected audio devices been turned to their lowest settings?
- 2. Turn on the POWER ON switch located on the rear panel of the Fantom-S.**

#### NOTE

To ensure proper operation of the pitch bend lever, make sure not to touch the lever when turning the Fantom-S's power on.



Do not touch!

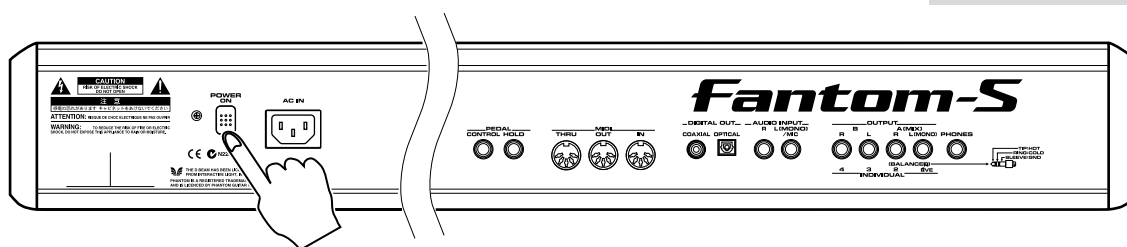

\* This unit is equipped with a protection circuit. A brief interval (a few seconds) after power up is required before the unit will operate normally.

3. Turn on the power for any connected amplifiers or speakers.
4. Play the Fantom-S's keyboard, gradually increasing the setting of its volume control, and then carefully raise the volume of your connected amplifiers or speakers to the desired listening level.

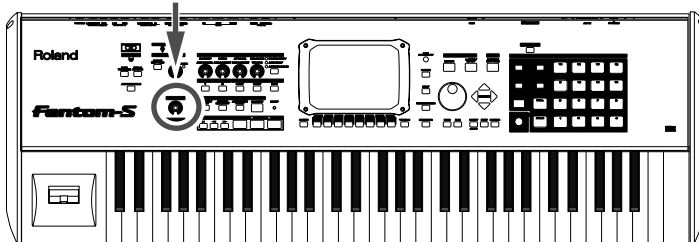
**NOTE**

Be careful not to set your listening volume too high to avoid damage to your amp/speaker system or your hearing.

## Adjusting the Display Contrast (LCD Contrast)

The characters in the display may be difficult to view immediately after turning on the Fantom-S's power or after extended use. Your viewing angle or the current lighting conditions can also affect the appearance of the display. In such situations, you can turn the CONTRAST knob (located on the rear panel) to adjust the contrast of the display.

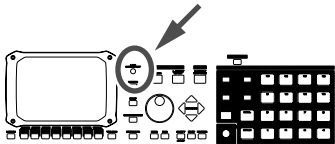

## Turning Off the Power

1. Before you turn off the power, consider these two questions:
  - Have the volume controls for the Fantom-S and all connected audio devices been turned to their lowest settings?
  - Have you saved your Fantom-S sounds or other data you've created?
2. Turn off the power for all connected audio devices.
3. Turn off the POWER ON switch of the Fantom-S.

# Listen to the Demo Song

The Fantom-S contains a demonstration (“demo”) song that you can listen to using the Fantom-S’s Demo Play feature. The demo will introduce you to the Fantom-S’s exceptional sounds and effects.

**1. Press [MENU].**

The pull-down menu appears.

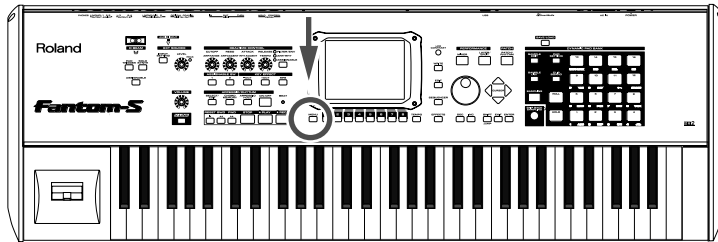
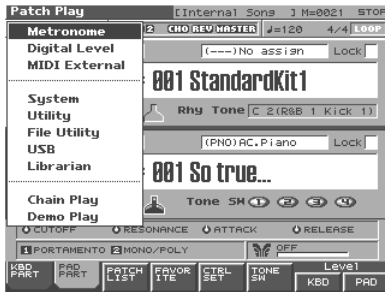

**2. Press ▼ to select a “Demo Play,” and then press [ENTER].**

There are four demo songs.

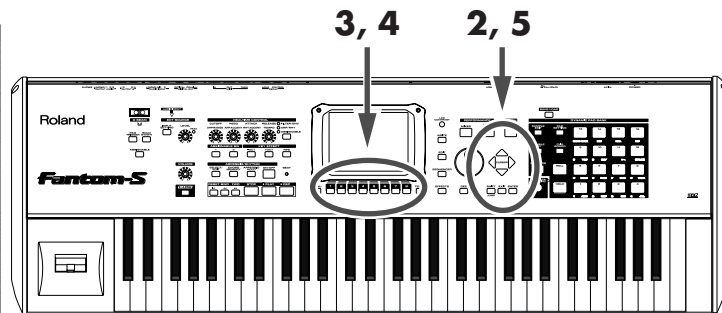

**3. Press [1 (SONG1)]–[5 (SONG5)] to start demo song playback.**

Otherwise, playback will stop automatically when the song ends.

If you press [7 (All Songs)], the songs will playback successively, beginning from the first.

	Demo Song Title	Composer	Copyright
1	Something About Your Soul	Shinichiro Murayama, Scott Tibbs	©Roland Corporation
2	Dregs	Roland	©Roland Corporation
3	Boxing Clever	MJ Cole	©BMG Music Publishing
4	Kappa	Roland	©Roland Corporation
5	Isn't That Grand?	Scott Wilkie	©2003 Scott Wilkie Media (ASCAP)

**4. Press [8 (Exit)] to return to the Demo Menu screen.**

**5. Press [EXIT] to return to the previous screen.**

**NOTE**

When you perform demo playback, any patch or performance you may have been editing will be lost.

**NOTE**

All rights reserved. Unauthorized use of this material for purposes other than private, personal enjoyment is a violation of applicable laws.

**NOTE**

No data for the music that is played will be output from MIDI OUT.

# Try Out the Sounds

## Playing the Sounds

The Fantom-S comes with a wide range of onboard sounds, including single tones called **patches**. Let's select a few patches to get an idea of the variety of sounds available with the Fantom-S.

### 1. Press [PATCH/RHYTHM].

The Patch Play screen appears.

On the Fantom-S you can play patches and rhythm sets from both the keyboard and the pads. Play the keyboard and pads to hear the sound.

On the Fantom-S, a "part" is something to which you assign a patch or rhythm set. Patch mode has two parts, the **Keyboard part** and the **Pad part**, and you can assign a patch or rhythm set to each of these parts.

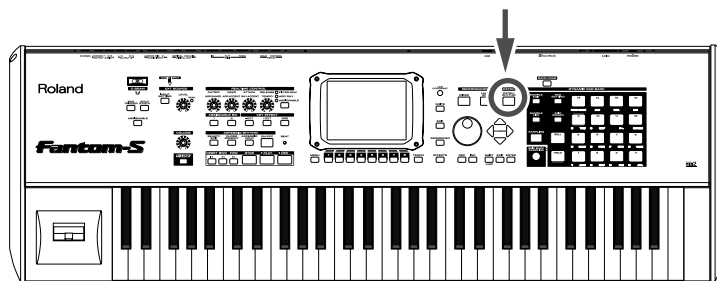
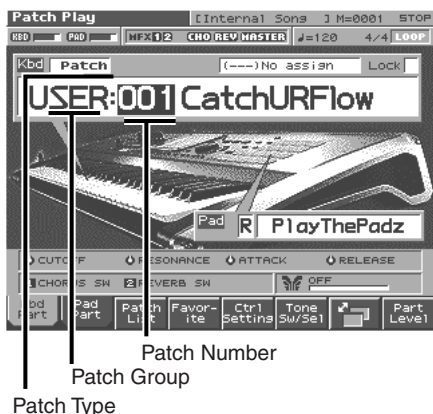

### 2. To select the Keyboard part, press [1 (Kbd Part)].

### 3. To select the Pad part, press [2 (Pad Part)].



### 4. If you want to switch the patch of the Keyboard part to another patch, press [1 (Kbd Part)] to move the cursor to the patch number, and then turn the VALUE dial or use [INC] [DEC].

When the patch number is highlighted, you can select a patch. When the patch group is highlighted, you can select a group. On the Fantom-S, the patches are organized into five groups; user, preset, GM, card, and expansion board. Use ◀ ▶ to move the highlighted cursor.

### 5. If you want to switch the patch of the Pad part to another patch, press [2 (Pad Part)] to move the cursor to the patch number, and then turn the VALUE dial or use [INC] [DEC].

### 6. To switch between playing a patch or a rhythm set, use [CURSOR] to move the cursor to the patch type, and then use [INC] [DEC] to select either patch (Patch) or rhythm set (Rhythm).

#### HINT

**What is a Patch?** Patches are the basic sound configurations that you play during a performance. Each patch can be configured by combining up to four tones.

#### HINT

**What is a Tone?** On the Fantom-S, the tones are the smallest unit of sound. However, it is not possible to play a tone by itself. The patch is the unit of sound which can be played, and the tones are the basic building blocks which make up the patch.



For more information about factory patches and rhythm sets, refer to "Patch List," "Rhythm Set List".

#### NOTE

Patches and Rhythm sets XP-A-D can be selected only if a Wave Expansion Board (sold separately) has been installed in the corresponding slot.

## Try Out the Sounds

### 7. Press [7] to switch the Patch Play screen.

This screen simultaneously displays the settings of the Keyboard part and the Pad part.

You can use [CURSOR] to move the cursor to a parameter, and turn the VALUE dial or use [INC] [DEC] to select the patch type, patch group, or patch number from this screen as well.

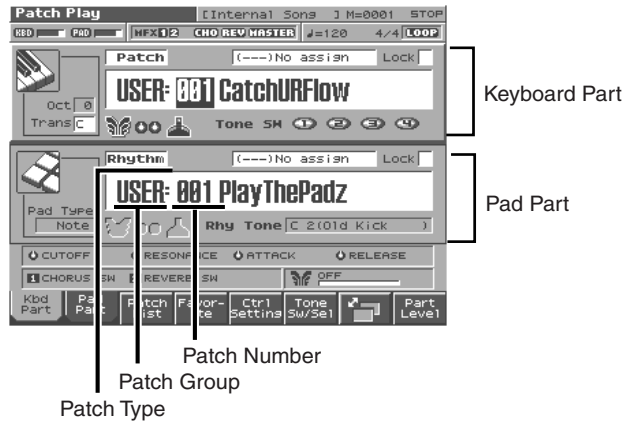

## Selecting Patches by Category

You can quickly find any patch by first choosing the type of patch you're looking for.

1. Press [PATCH/RHYTHM] to access the Patch Play screen.
2. Press [1 (Kbd Part)] to select the keyboard part.
3. Press [3 (Patch List)].  
The Patch List window appears.
4. Make sure that [6 (Categ)] has a check mark (✓).  
The display shows a list of patches organized by category.



### NOTE

The display screens printed in this owner's manual are based on the factory settings. However, please be aware that in some cases they may differ from the actual factory settings.



For details on the categories you can select, refer to the Owner's Manual (p. 30).



**5. Press [1 (↑)] or [2 (↓)] to select the categories.**

The Patch List window shows a list of patches in the categories.



**6. Press ▲ or ▼ to select a patch.**

Play the patch to hear how it sounds.

**7. When you press [8 (Select)] the Patch List screen will close automatically.**

## Selecting Patches by Group

You can view a group of patches and select a patch from this group.

**1. Press [PATCH/RHYTHM] to access the Patch Play screen.**

**2. Press [1 (Kbd Part)] to select the keyboard part.**

**3. Press [3 (Patch List)].**

The Patch List window appears.

**4. Press [6 (Categ)] to remove the check mark (✓).**

The list will show the patch groups.



**5. To select a different patch group, press [1 (↑)] or [2 (↓)].**

**6. Use ▲ or ▼ to select a patch.**

When you have made your selection, play the keyboard to hear the patch.

**7. When you press [8 (Select)] the Patch List screen will close automatically.**

**HINT**

By pressing [7 (Preview)] you can audition the sound of the patch being played by a preset phrase suitable for each type of patch (Phrase Preview function) (p. 10).

**HINT**

By pressing [7 (Preview)] you can audition the sound of the patch being played by a preset phrase suitable for each type of patch (Phrase Preview function) (p. 10).

### Auditioning Patches with Phrases (Phrase Preview)

The Fantom-S allows you to preview a patch by listening to a short musical phrase appropriate to the patch.

#### 1. Access the Patch List window (p. 8)



#### 2. Press and hold [7 (Preview)].

The currently selected patch plays a short preview phrase.

#### 3. Release your finger from [7 (Preview)] to stop playback of the preview phrase.

#### 4. To select a different patch, Press ▲ or ▼ .

#### 5. Press [EXIT] to close the Patch List window.

### Changing the Patch Settings

For details on the most important settings of a patch, refer to the following pages of the Owner's Manual.

- Changing how a patch tone is sounded → (Owner's Manual; p. 46)
- Adjusting the pitch of a patch tone → (Owner's Manual; p. 49)
- Using the filter to change the brightness of the patch tone sound → (Owner's Manual; p. 50)
- Setting the volume of a patch → (Owner's Manual; p. 53)
- Applying modulation to the sound → (Owner's Manual; p. 56)
- Applying effects to a patch → (Owner's Manual; p. 175)
- Saving a patch you've modified → (Owner's Manual; p. 42)

#### HINT

**What is a Tone?** On the Fantom-S, the tones are the smallest unit of sound. However, it is not possible to play a tone by itself. The patch is the unit of sound which can be played, and the tones are the basic building blocks which make up the patch.

## Playing Percussion Sounds with the Pad (Rhythm Set)

The Fantom-S has rhythm sets that contain a variety of percussion instruments and special-effects sounds. In the same way as for patches, a rhythm set can be played from either the keyboard or the pads. Here's how to play the sounds in a rhythm set.

**1. Press [PATCH/RHYTHM] to access the Patch Play screen.**

**2. Press [2 (Pad Part)] to select a Pad part.**

Make sure that a rhythm set is assigned to a pad part.

If a rhythm set is not assigned, use [CURSOR] to move the cursor to the patch type, and press [DEC] to set "Patch" to "Rhythm."

Use [CURSOR] to move the cursor to the rhythm set group or rhythm set number, and turn the VALUE dial or use [INC] [DEC] to make your selection.

### HINT

If you press [7], you can switch the Patch Play screen.

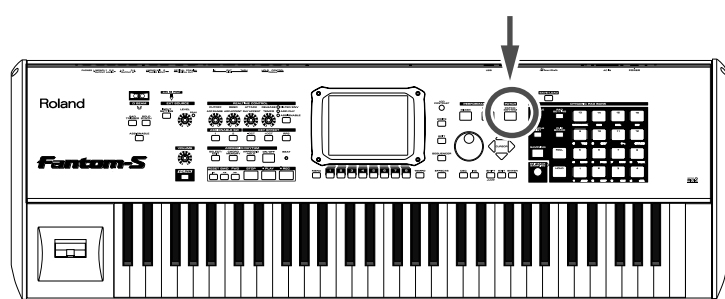

**3. Play the pads to hear the percussion instrument sounds.**

**4. Press different pads to play the percussion instruments in the rhythm set.**

**5. To select another rhythm set, turn the VALUE dial or press [INC]/[DEC].**

When the rhythm set group is highlighted, you can select a new rhythm set group. Press ◀ to move the highlight cursor, turn the VALUE dial or press [INC]/[DEC]

When the rhythm set number is highlighted, you can select a rhythm set. When the rhythm set group is highlighted, you can select a group. The rhythm sets of the Fantom-S are organized into five groups: User, Preset, GM, Card, and Expansion Board. Use ◀ ▶ to move the highlight cursor.

\* You can also assign a rhythm set to the Pad part. To switch between playing a patch or a rhythm set, use [CURSOR] to move the cursor to the patch type, and turn the VALUE dial, or use [INC] [DEC] to select either patch (Patch) or rhythm set (Rhythm).



For more information about factory rhythm sets, please refer to "Rhythm Set List" (Parameter List).

### NOTE

Rhythm sets XP-A-D can be selected only if a Wave Expansion Board (sold separately) is installed in the corresponding slot (Owner's Manual; p. 203).

### Playing Percussion Instruments From the Keyboard

**1. From the Patch Play screen, press [1 (Kbd Part)] to select the keyboard part.**

**2. Use [CURSOR] to move the cursor to "Patch."**

**3. Turn the VALUE dial or press [INC] to select "Rhythm."**

Play the keyboard. Different percussion instruments will sound depending on the note you play.

## Changing the Rhythm Set Settings

For details on how to adjust the most important settings for a rhythm set, refer to the following pages of the owner's manual.

- Changing how a rhythm tone is sounded → (Owner's Manual; p. 70)
- Adjusting the pitch of a rhythm tone → (Owner's Manual; p. 71)
- Using the filter to modify the brightness of the rhythm tone sound → (Owner's Manual; p. 72)
- Setting the volume of a rhythm set → (Owner's Manual; p. 73)
- Applying effects to a rhythm set → (Owner's Manual; p. 184)
- Saving a rhythm set whose settings you've modified → (Owner's Manual; p. 66)

## Layering Two or More Patches (Layer)

When you wish to play multiple patches or rhythm sets at the same time, use a **performance**. In Performance mode, you can play up to 16 different patches or rhythm sets simultaneously. A performance in which two or more patches are played together is referred to as a **layer**. Let's select Performance "PRST: 61 Piano&Str," which layers two patches.

### 1. Press [LAYER/SPLIT].

The Performance Layer screen will appear.

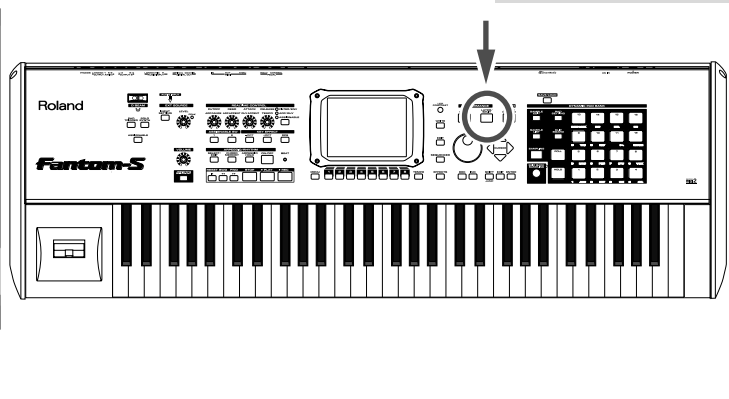
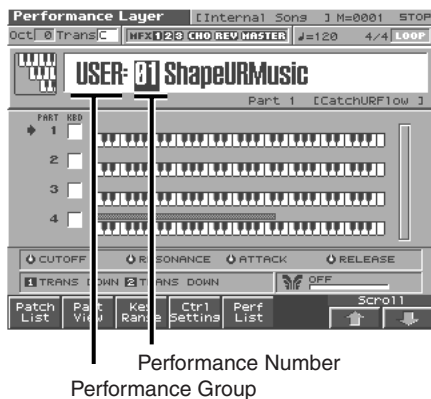

### HINT

**What is a Rhythm Tone?** On the Fantom-S, the rhythm tones are the smallest unit of sound. However, it is not possible to play a tone by itself. The rhythm set is the unit of sound which can be played, and the tones are the basic building blocks which make up the rhythm set.

### 2. Press [CURSOR] to move the cursor to the performance group.

### 3. Turn the VALUE dial or use [DEC]/[INC] to select "PRST."

### 4. Press **▶** to move the cursor to the performance number.

### 5. Turn the VALUE dial or use [DEC]/[INC] to choose "61."

Performance "PRST: 61 Piano&Str" is now selected.

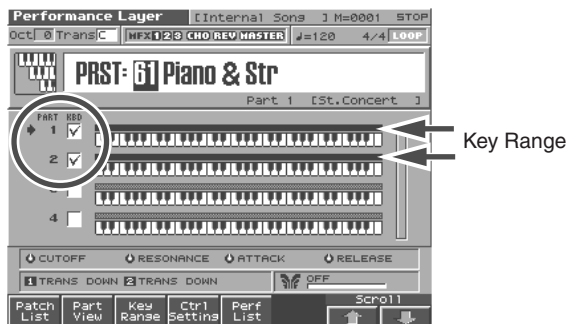

### HINT

**What is a Performance?** A performance has a patch or rhythm set assigned to each of the 16 parts, and can simultaneously handle 16 sounds. The Fantom-S's performance has two screens; a Layer screen (press [LAYER/SPLIT]) and a Mixer screen (press [MIXER]). Use the Layer screen if you want to play two or more patches together (Layer) or play different patches in separate areas of the keyboard (Split). Use the Mixer screen if you want to "mix" by individually adjusting the pan and level settings for each of the sixteen parts.

### MEMO

Similarly to patches and rhythm sets, performances are also organized into groups. There are three performance groups: User, Preset, and Memory Card.

**6. Play the keyboard.**

The two patches assigned to Parts 1 and 2 sound together. If you uncheck “KBD,” that part will no longer sound.

Use [CURSOR] to move the cursor to “KBD,” press [DEC] to remove the check mark from “KBD,” and move the cursor away from that part; you will no longer hear the sound of that part.

Use [CURSOR] to move the  to part 1 or part 2 and play just one of the parts to hear which sounds are being layered.

## Changing the Performance Settings

For details about how you can adjust the most important settings for a performance, refer to the following pages of the owner’s manual.

- Selecting the parts that’ll sound → (Owner’s Manual; p. 79)
- Switching the patch assigned to a part → (Owner’s Manual; p. 79)
- Adjusting volume/pan/pitch → (Owner’s Manual; p. 85)
- Applying effects to the performance → (Owner’s Manual; p. 178)
- Saving a performance whose settings you’ve modified → (Owner’s Manual; p. 96)

## Splitting the Keyboard to Play an Ensemble (Split)

Performances in which different patches play in different parts of the keyboard are called **split**. A split performance is actually a type of layer in which each sound is assigned to a specified keyboard part.

Here we will explain how to select the “PRST: 62 Ensemble Pfm” performance, which contains settings for a divided keyboard range, and use the arpeggiator and rhythm patterns to produce a guitar and drum ensemble.

**MEMO**

In Performance mode, the arpeggiator can be applied to one part. To select the part to which the arpeggiator will apply, press ARPEGGIO/RHYTHM [SELECT/EDIT]/[3 (Arp)] to display the Arpeggiator screen, and check the “Arp Part” setting. Press [EXIT] to return to the previous screen.

**1. Press [LAYER/SPLIT] to select the performance “PRST: 62 Ensemble Pfm.” (p. 12)**

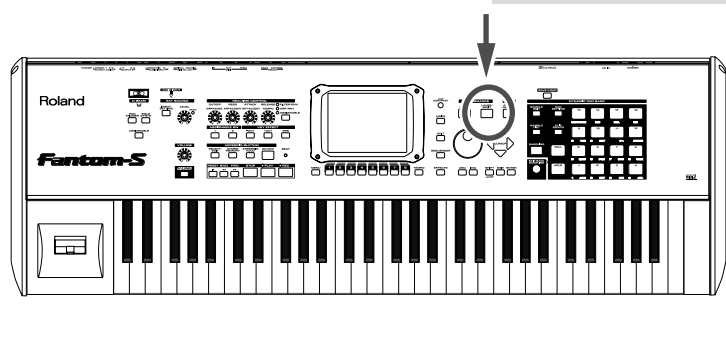
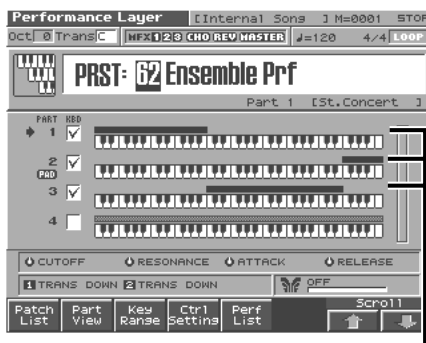

Key range for part

In this performance, the key range settings are shown below.

- Part1: C2–B3 (backing part)
- Part2: F6–C7 (rhythm part)
- Part3: C4–E6 (solo part)

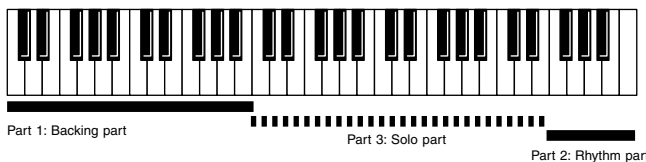

The arpeggiator is assigned to part 1, and the rhythm patterns are assigned to part 2.

You may notice that “PAD” is shown below the part number; this means that part 2 is the part that will sound when you play the pads.

## Try Out the Sounds

2. First, we will use rhythm patterns to play the drum part. Press **ARPEGGIO/RHYTHM [ON/OFF]** located at the left of the display so the button's indicator is lit.

Rhythm tones are assigned to pads 1–8, and rhythm pattern numbers are assigned to pads 9–16.

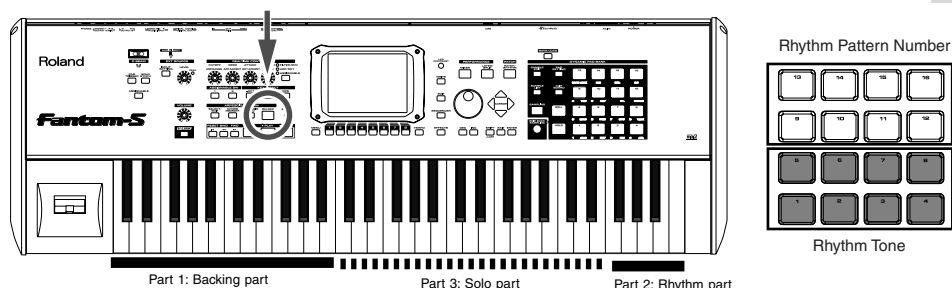

3. Press a pad 9–16 to which a rhythm pattern number is assigned.  
The force with which you strike the pads will vary the dynamics (velocity) of the sound.  
The rhythm pattern assigned to the pad you pressed will sound.
4. Next, use the arpeggiator to play the backing part. Verify that the **ARPEGGIO/RHYTHM [ON/OFF]** indicator is blinking, and press a note in the key range of part 1 (C3–B3).

The bar displayed above the keyboard for part 1 is the range of notes that will sound. Hold down a chord in the appropriate area. According to the keys you press, an arpeggiated guitar backing will begin playing.

5. Finally, let's play a guitar solo along with the drum part and backing part that are currently sounding.

The guitar solo part has the key range of part 3 (C4–E6). The location of the bar in the screen indicates the range in which you should play.

6. To stop the rhythm pattern and arpeggiator, press **[ON/OFF]** to make the respective indicator go dark.

How did it go? Most likely, you now see how easy it is to play ensembles like this on your own—by specifying the keyboard range for each part (as in the performance you selected here), and using rhythm patterns and the arpeggiator.

### MEMO

On the Fantom-S, a set of rhythm pattern numbers or percussion instrument sounds assigned to the sixteen pads is stored as a **Rhythm Group** (p. 22).

### HINT

If you press **ARPEGGIO/RHYTHM [HOLD]** to make the button light, the rhythm pattern or arpeggiator will continue playing even after you take your hand off the keys (the Hold function).

### HINT

You can also stop playback by pressing the blinking pad.

## Changing the Performance Settings

For details about how you can adjust the most important settings for a split performance, refer to the following pages of the owner's manual.

- Changing arpeggiator settings → (Owner's Manual; p. 105)
- Changing rhythm pattern settings → (Owner's Manual; p. 113)
- Changing the key range → (Owner's Manual; p. 80)
- Selecting the parts that will sound → (Owner's Manual; p. 79)
- Switching the patch assigned to a part → (Owner's Manual; p. 79)
- Adjusting volume/pan/pitch → (Owner's Manual; p. 85)
- Applying effects to the performance → (Owner's Manual; p. 178)
- Saving a performance whose settings you've modified → (Owner's Manual; p. 96)

# Try Out the Various Performance Features

The Fantom-S is equipped with a variety of powerful performance features that can raise your musical expressiveness to new levels. These include the D Beam controller and the Arpeggio function. Take a moment to try out some of the Fantom-S's performance features.

## Moving Your Hand Above the D Beam Controller to Apply Effects (D Beam Controller)

You can apply various effects to the currently selected patch by simply moving your hand over the D Beam controller on the Fantom-S's panel.

Let's select a patch that makes use of the D Beam controller, and try it out.

1. Press [PATCH/RHYTHM] to access the Patch Play screen.
2. Press [1 (Kbd Part)] to select a patch "PR-E: 032 SynthForce." (p. 7)
3. Press [7] to switch the Patch Play screen.



D Beam controller is turned ON for the Keyboard part

D Beam controller is turned OFF for the Pad part

With the factory settings, "Breath" is assigned to the D Beam controller.

4. When the D BEAM [ASSIGNABLE] indicator is dark, press [ASSIGNABLE], so that its indicator lights.

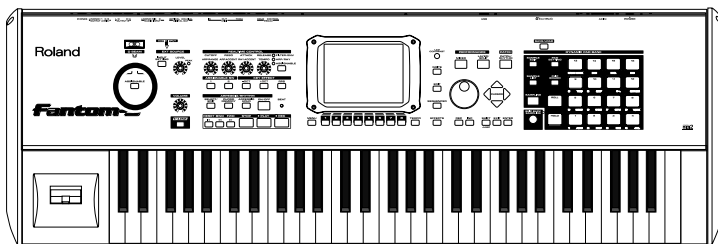

The D Beam controller is now active.

5. Move your hand up and down slowly over the D Beam controller as you play the keyboard.

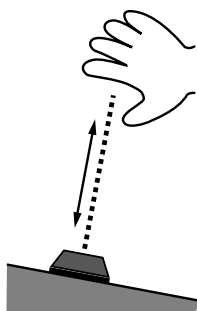

6. To turn off the D Beam controller, press [ASSIGNABLE] once again so that its indicator light goes out.

### NOTE

When the D Beam controller is responding, the [ASSIGNABLE] button will blink. Once you leave the usable range of the D Beam controller, the [ASSIGNABLE] button stops blinking, and lights solidly instead.

### Changing D Beam Controller Settings

1. Hold down [SHIFT] and press D BEAM [ASSIGNABLE].

The D Beam Assignable screen appears.

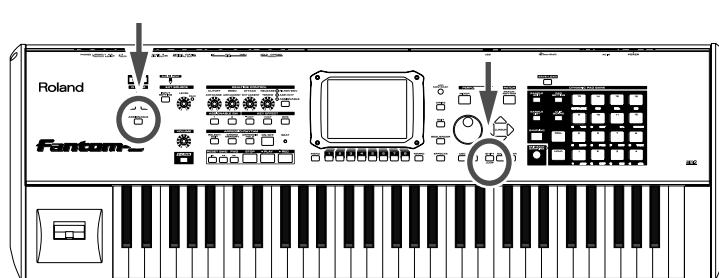
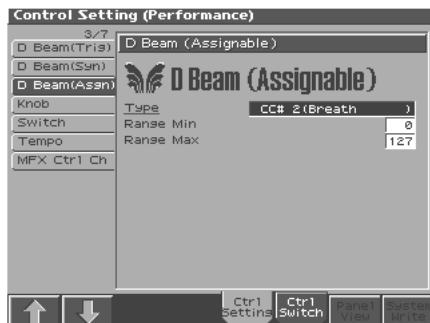

In this window you can modify the settings for the D Beam controller. Let's change what the D Beam controls.

2. Press [CURSOR] to move the cursor to "Type," and then turn the VALUE dial.

For example, if you specify "Bend Up," press [ASSIGNABLE], and the pitch will rise if you move your hand near the D Beam controller while playing the keyboard to produce sound.

3. When you have made setting, press [EXIT].



For details on using the D Beam controller, refer to "Modifying the Sound in Real Time" (Owner's Manual; p. 34, P. 98).



## Using Knobs and Buttons to Modify the Sound in Realtime (Realtime Controller)

By using the REALTIME CONTROL knobs and ASSIGNABLE switches while you play, you can control the various functions that've been assigned to them.

Let's select Patch "PR-E: 031 ShapeURMusic" and try out the realtime controllers.

1. Press [PATCH/RHYTHM] to access the Patch Play screen.
2. Press [1 (Kbd Part)] to select Patch "PR-E: 031 ShapeURMusic" (p. 11).
3. Press [7] to switch the Patch Play screen.

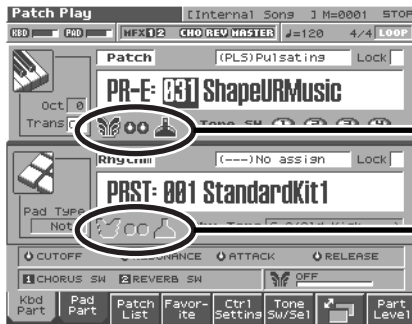

State of the controller settings  
The controller applies to the part whose display is visible

4. The parameter that will change when you operate the realtime controller is displayed at the bottom of the screen.



REALTIME CONTROL knob

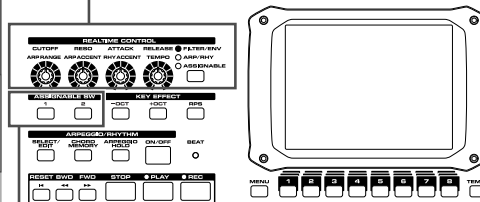

ASSIGNABLE switch

Parameters that will change when you turn a realtime controller knob

Parameters that will change when you press an assignable switch

## Try Out the Various Performance Features

5. You can select the function of the knobs by pressing the button located at the right of the realtime control knobs. The parameter display at the bottom of the screen will also change. In this example, get the **FILTER/RHY** indicator to light.

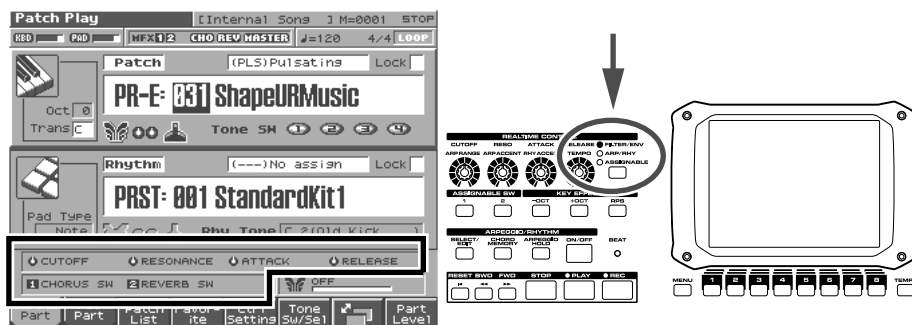

- If the **FILTER/ENV** indicator is lit  
Turning the knobs will control Cutoff, Resonance, Attack, and Release.
  - If the **ARP/RHY** indicator is lit  
Turning the knobs will control the arpeggio parameters Range and Accent, and the rhythm parameters Accent Rate and Tempo.
  - If the **ASSIGNABLE** indicator is lit  
Turning the knobs will control the assigned parameters. You can freely assign parameters.
- \* If the indicators are unlit, turning the knobs will not control any parameters.

6. While playing the keyboard, play with the **REALTIME CONTROL** knobs and **ASSIGNABLE** switches. For example, try turning the knob.

Turning the knob at the far left clockwise will open the filter, brightening the sound.

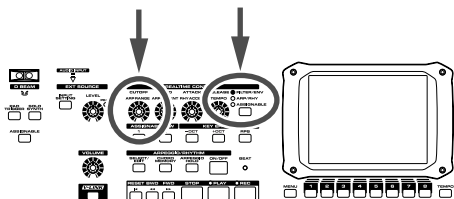

7. Try playing with the other knobs and buttons to hear what they do.

## Changing Realtime Controller Settings

1. Hold down [SHIFT] and press the ASSIGNABLE switch or the button located at the right of the REALTIME CONTROL knobs.

The Assignable Knob window or Assignable Switch window will appear.

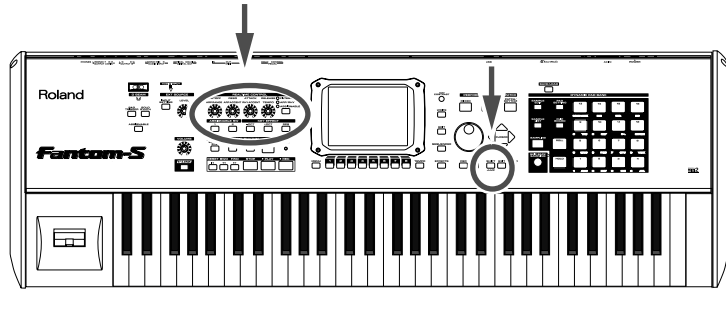
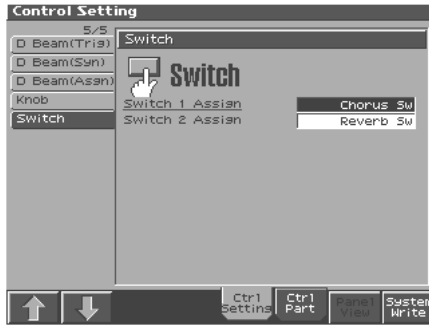

In these windows you can change the parameters controlled by the REALTIME CONTROL knobs or ASSIGNABLE switches.

2. Turn the VALUE dial to assign various functions.

As you select each parameter, play the keyboard and turn or press the corresponding realtime controller and assignable switches. Listen to the changes the controller makes to the sound of the patch.

3. Press [EXIT] to return to the previous screen.

### NOTE

For details on using the realtime controllers, refer to "Modifying the Sound in Real Time" (Owner's Manual; p. 33, P. 98).

# Playing Arpeggios (Arpeggio/Rhythm function)

You can create a broken chord (arpeggio) automatically by simply playing the chord.

For example, if you press the keys of a C major chord, the Fantom-S arpeggiates the chord as C → E → G → C → E → G → C...

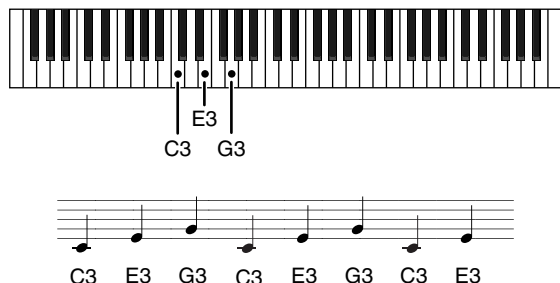

1. Press [PATCH/RHYTHM] to access the Patch Play screen, and then press [1 (Kbd Part)] to select Patch “PR-A: 001 So true...” (p. 7).



2. Press ARPEGGIO/RHYTHM [ON/OFF] so its indicator lights.

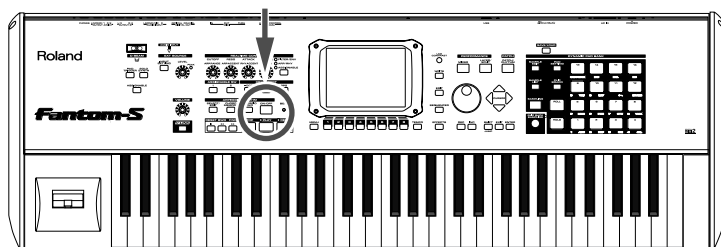

The Arpeggio function is turned on.

3. Play a chord on the keyboard.

The Fantom-S plays the notes of the chord as an arpeggio.

If you hold down ARPEGGIO/RHYTHM [ARPEGGIO HOLD] so the button lights, the arpeggio will continue playing even after you take your finger off the keyboard.

4. To finish listening to the arpeggio, press ARPEGGIO/RHYTHM [ON/OFF] again so its indicator turns off.

### MEMO

For a list of arpeggio styles, refer to “Arpeggio styles” in the parameter list.

## Changing Arpeggio Settings

1. Press **ARPEGGIO/RHYTHM** [SELECT/EDIT], and then press **[3 (Arp)]**.

The Arpeggiator screen appears.

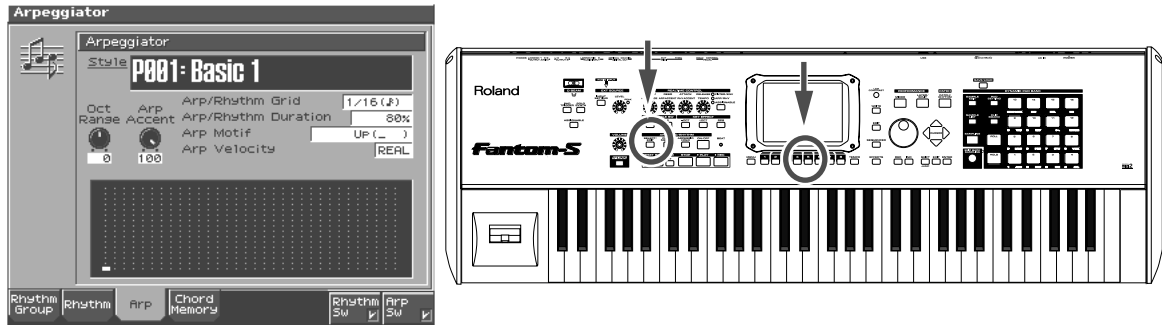

In this window you can adjust various arpeggio-related settings.

2. Press **▲** or **▼** to select a parameter, and then turn the **VALUE** dial to change the settings for the various parameters.

These settings determine how the arpeggiator plays its notes.

## Switching to Another Arpeggio Style

You can switch to another arpeggio style by moving the cursor to "Style" and turning the VALUE dial to change the number.

3. Press **[EXIT]** to close the Arpeggio window.

### Using the Chord Memory Function with the Arpeggio

Chord Memory is a function that sounds a specified chord form when you press a single key. For example you can register the chord form "C," "E," and "G" so that the chord "C-E-G" will sound when you press the C key.

When the arpeggiator is on, you can recall a chord form to easily create complex arpeggio sounds.

Press **ARPEGGIO/RHYTHM** [CHORD MEMORY] to make the button light, and the Chord Memory function will be turned on.

### HINT

In arpeggio settings, Style (Arpeggio Style) is particularly important. The arpeggio's playback pattern is determined primarily by the value selected for this parameter. For details, refer to "Arpeggio Settings (Arpeggio)" (Owner's Manual; p. 107).

### MEMO

If you want to make more detailed settings, press [EDIT]. For details, refer to p. 105 in the Owner's Manual.

### HINT

In Performance mode, Arpeggio/Rhythm function settings can be saved as performance settings for each individual performance. This allows you to create a performance that contains the desired arpeggiator settings. In addition, when you use the Fantom-S's sequencer to create a song, the Fantom-S offers you the convenience of using the Arpeggio function to perform bass and other parts during recording (p. 42).

# Performing Rhythms while a Rhythm Pattern Plays

The Fantom-S contains various Rhythm patterns. Simply by pressing a single key or pad, you can play the Rhythm patterns. The Fantom-S contains various rhythm patterns. You can play these rhythm patterns simply by pressing a single key or pad. You can also use a **rhythm group**, in which rhythm patterns, percussion instruments from the rhythm set, and fill-ins are assigned to the pads. Here's how to use a rhythm group to play additional rhythm sounds and fills while a rhythm pattern plays back.

### 1. Make sure that a rhythm set is assigned to a pad part (p. 11).

If a rhythm set is not assigned, use [CURSOR] to move the cursor to the patch type, and press [DEC] to set "Patch" to "Rhythm."

Use [CURSOR] to move the cursor to the rhythm set group or rhythm set number, and turn the VALUE dial or use [INC] [DEC] to make your selection.

### 2. Press ARPEGGIO/RHYTHM [ON/OFF].

Pads 9–16 will go out, and you will be able to play rhythms.

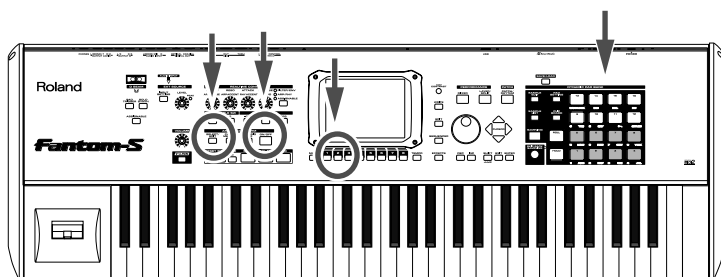

Rhythm groups have rhythm pattern numbers and percussion instruments (rhythm tones) assigned to the pads as follows.

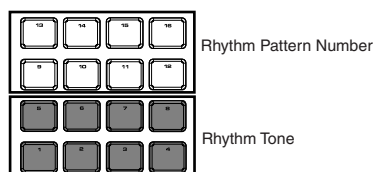

### 3. Press a pad (9–16) to which a rhythm pattern number is assigned.

The force with which you strike the pads will vary the dynamics (velocity) of the sound. According to the pad you pressed, the assigned rhythm pattern will play.

### 4. In time with the pattern that is playing, try adding your own rhythm performance.

Pads 1–8 will play percussion sounds.

### 5. To finish listening to the rhythm, press ARPEGGIO/RHYTHM [ON/OFF] again so its indicator turns off.



You can also stop playback by pressing the blinking pad.



For details on using the Arpeggio, refer to "Playing Rhythms (Arpeggio/Rhythm Function)" (Owner's Manual; p. 104), "Playing Rhythm" (Owner's Manual; p.112)

## Switching to Another Rhythm Group

1. Press ARPEGGIO/RHYTHM [SETUP/EDIT] and then press [1 (Rhythm Group)].  
The Rhythm Group window appears.



2. Use ▲ ▼ to select “Rhythm Group,” then turn the VALUE dial to change the value.
3. Verify that the ARPEGGIO/RHYTHM [ON/OFF] indicator is lit, and strike the pads to play rhythms.

## Changing Rhythm Group Settings

1. Press ARPEGGIO/RHYTHM [SELECT/EDIT].
2. Press [1 (Rhythm Group)], and then press [EDIT].  
The Rhythm Group Edit window appears.

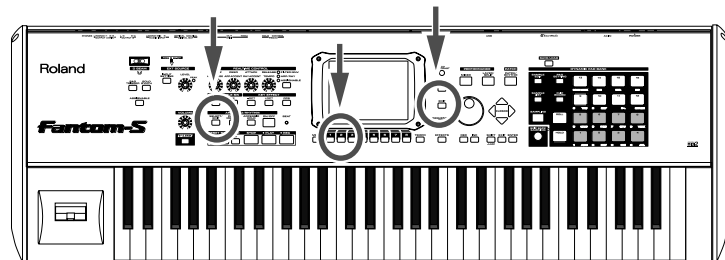
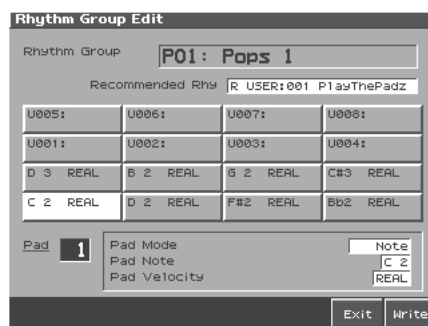

In this window you can make various settings for a rhythm group, such as assigning a rhythm pattern number or percussion instrument to each pad.

3. Use [CURSOR] and the VALUE dial to edit the parameters.

In this window you can adjust various settings for rhythm groups.

- **Pad**  
Select the pad 1–16 for which you will make settings. You can also select a pad by pressing it directly.
- **Pad Mode**  
Specifies whether a rhythm tone (Note) or a rhythm pattern (Pattern) number will be assigned to the pad.
- **Pad Note**  
If Pad Mode is set to Note, specifies the note number (C-1–G9) that will sound when you press the pad.
- **Pad Velocity**  
Specifies the strength of the sound (REAL, 1–127) heard when you strike the pad. If this is set to REAL, you can add dynamics by varying the strength of your strike.

## Try Out the Various Performance Features

- **Rhythm Pattern Number**

If Pad Mode is set to Pattern, specifies the pattern number that will sound when you press the pad.

- **Rhythm Pattern Velocity**

If Pad Mode is set to Pattern, specifies the strength of the rhythm pattern (REAL, 1–127) heard when you strike the pad. If this is set to REAL, you can add dynamics by varying the strength of your strike.

**4. Press [7 (Exit)] to close the Rhythm Group Edit window.**

**5. Press [EXIT] to close the Rhythm Group window.**



For details on using rhythm groups, refer to “Playing Rhythms” (Owner’s Manual; p. 112).



You can also edit the settings of the rhythm pattern. For details, refer to “Rhythm Pattern Settings” (Owner’s Manual; p. 113).



Rhythm Group settings can be saved independently with each performance. This allows you to create a performance that uses rhythm group settings of your choice. When you use the sequencer to create a song, you can use rhythm group to perform your drum part.



## Other Performance Features

### Velocity/Aftertouch

The force with which you play the keyboard, or the “velocity” with which you play, can affect the volume or timbre of a sound. Aftertouch—downward pressure you apply to a key after playing a note—can also affect the sound.



### Pitch Bend/Modulation Lever

While playing the keyboard, move the lever to the left to lower the pitch of the currently selected patch, or to the right to raise its pitch. This is known as **pitch bend**. You can also apply vibrato by gently pushing the lever away from you. This is known as **modulation**.

If you push the lever away from you and at the same time move it to the right or left, you can apply both effects at once.

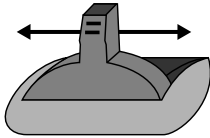

Pitch Bend

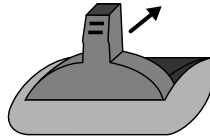

Modulation

### Octave Shift (Oct)

On the Patch Play, Performance Layer and Performance Mixer screen, you can shift the pitch of the keyboard in one-octave units over a range of +/-3 octaves by adjusting the value of the Octave Shift parameter.

Use KEY EFFECT [-OCT] or [+OCT] at the left of the screen to make the desired setting.

To return to the original setting, press both buttons simultaneously.

### Hold Pedal

If an optional pedal switch (DP series) is connected to the rear panel PEDAL HOLD jack, you can press the pedal switch to cause notes to sustain or “hold” even after their keys have been released.

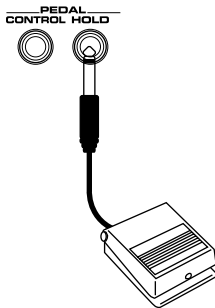

## Try Out the Various Performance Features

### Control Pedal

If an optional expression pedal (EV-5, etc.) is connected to the rear panel PEDAL CONTROL jack, you can use the pedal to control the volume or timbre of sounds you play.

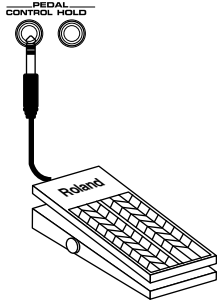

The way in which the sound changes will depend on the settings. For details on settings for parameters controlled by the pedal, refer to “Making Control Pedal Settings” (Owner’s Manual; p. 102).



Use only the specified expression pedal (EV-5; sold separately). By connecting any other expression pedals, you risk causing malfunction and/or damage to the unit.



For details, refer to “Transposing the Keyboard in Octave Units (Octave Shift)” (Owner’s Manual; p. 32).

### Transpose (Trans)

On the Patch Play, Performance Layer and Performance Mixer screen, you can transpose the pitch of the keyboard in semitone steps, over a range of G–F# (-5– +6 semitones) by adjusting the Transpose parameter’s value.

Press [CURSOR] to move the cursor to “Trans” in the upper part of the screen, and turn the VALUE dial or press [INC] or [DEC] to change its setting.

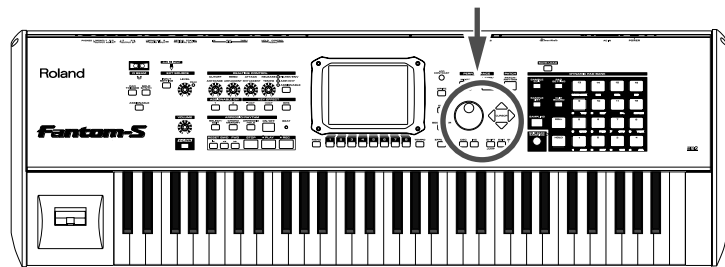
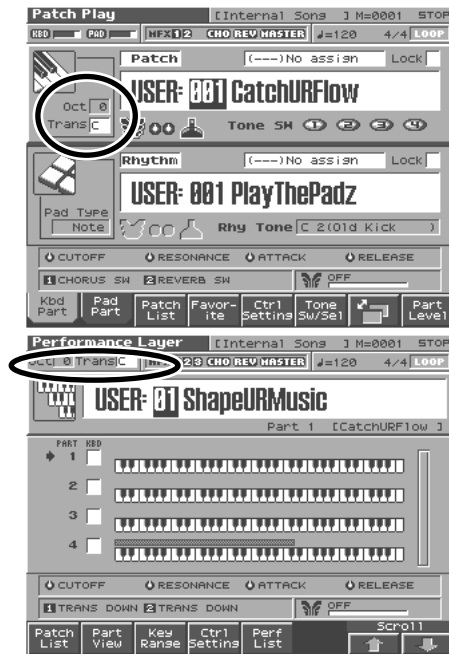

## Using the RPS Function

**RPS (Realtime Phrase Sequence)** is a function that lets you freely assign single-part patterns to the keyboard and play them back them by pressing a single key or pad. Since different phrases can be played back by pressing different keys or pads, this feature can be especially useful in live performance.

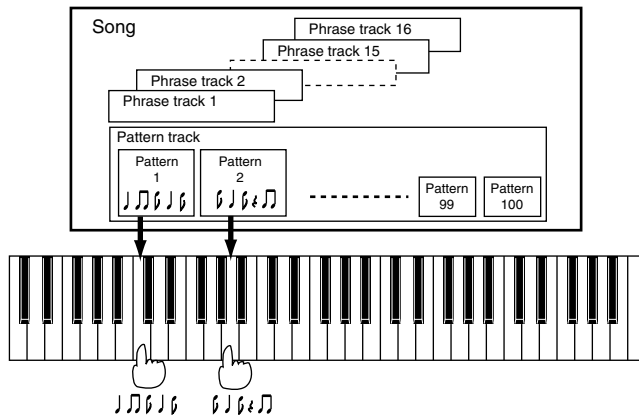

Using RPS is a three-step procedure.

1. Create a pattern (i.e., record into a pattern).
2. Assign the pattern to a note of the keyboard or to a pad.
3. Turn on the RPS button, and press the key or pad to which you assigned the pattern.

As an example, here's how a phrase recorded in pattern 1 can be played from a pad or key.

### Create the Pattern

1. Press [PATCH/RHYTHM] to access the Patch Play screen.
2. Press [1 (Kbd Part)] to select the keyboard part.
3. Press [SEQUENCER] to access the Song Play screen, and then press [2 (Ptn)] to add a check mark (✓). The screen switches to the Pattern Play screen.
4. Press [REC].

The Realtime Rec Standby window appears.

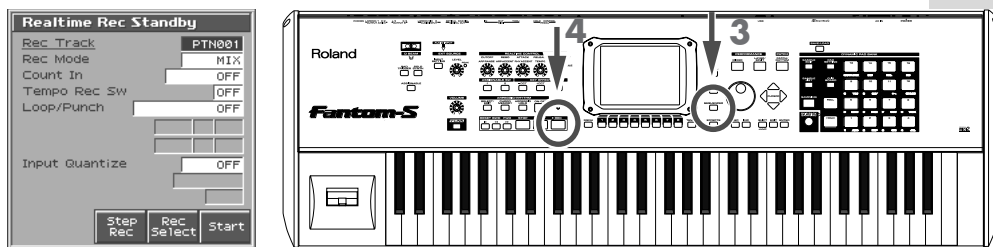

5. Make sure that the cursor is located at "Rec Track," and turn the VALUE dial to select "PTN001."

This lets us record a phrase on pattern 1.

6. Press [8 (Start)].  
Recording will begin after a one-measure count. Play a phrase on the keyboard.
7. Press [STOP] to stop recording.

A phrase has now been recorded in pattern 1. Press [RESET] to return to the beginning, and press [PLAY] to hear the pattern.

8. Press [SEQUENCER], and in the Pattern Play screen that appears, press [2 (Ptn)] to remove the check mark.

#### NOTE

In this example, you played the phrase manually and recorded it in real time. For more about recording methods, refer to "Recording Songs" (p. 141) in the Owner's Manual.

## Try Out the Various Performance Features

### Assign the Pattern to a Key or Pad

1. Hold down [SHIFT] and press [RPS].  
The RPS Setup screen appears.

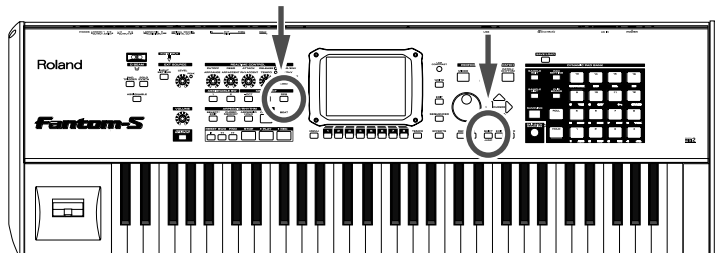
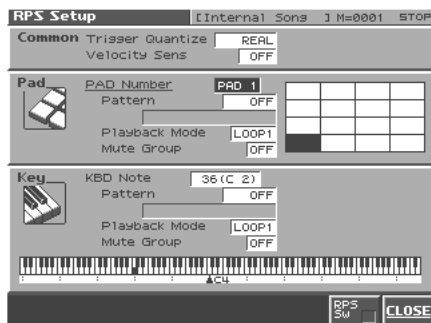

2. If you want to play the pattern from a pad, press the pad to which the pattern is to be assigned. If you want to play the pattern from a key, press the key to which the pattern is to be assigned.  
The cursor will move to "Pattern."
3. Turn the VALUE dial to select "PTN001."  
With these settings, pressing the pad or key you selected in step 2 will play pattern 1, which you recorded earlier.
4. Press [7 (RPS Sw)] to turn on the RPS function.  
The RPS button at the left of the screen will also light.

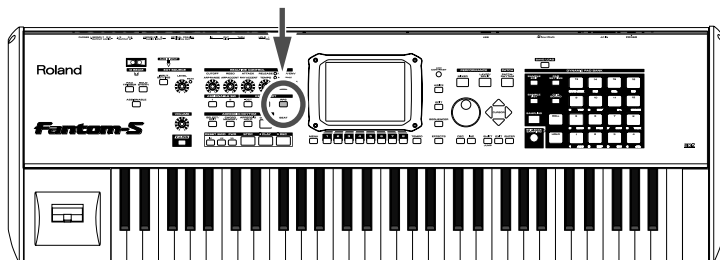

5. Press [8 (Exit)] to return to the previous screen.  
This completes the preparations.

### Use the RPS Function

1. Keep pressing the key or pad that you selected in step 2 of "Assign the pattern to a key or pad."  
While you are pressing the key or pad, the pattern will play once.  
For example, a complex phrase that would be difficult to play manually could be assigned to a key or pad, and played with one finger during a live performance.
2. Press the RPS button to turn off the RPS function.

# Using Skip Back Sampling to Sample a Favorite Phrase (Skip Back Sampling)

Sometimes you may want to preserve a nice phrase that you happened to play a bit earlier. In such cases, you can use the **Skip Back Sampling** function to sample sounds that were played earlier in time.

When you execute **Skip Back Sampling**, the phrase you played previously will be captured as a sample. You can assign this sample to a pad and play it from the pad.

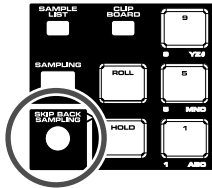

- Button lit:** Skip Back Sampling is possible.
- Button unlit:** Skip Back Sampling is not possible.
- Button blinking:** After sampling, the sample is being edited by adjusting the loop point, etc.

1. Press **[PATCH/RHYTHM]** to access the patch play screen.
2. Perform by playing phrases on the keyboard or striking the pads.
3. Press **[SKIP BACK SAMPLING]** located at the left of the pads.

The following screen will appear, and Skip Back sampling will be executed. Sampling will stop automatically, and the Sample Edit screen will appear.

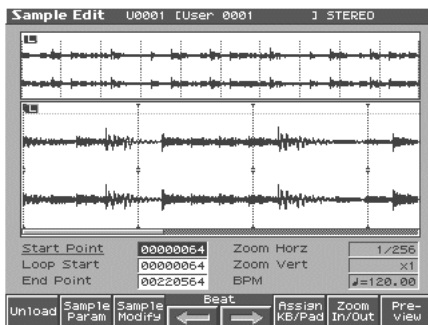

4. Press **[8 (Preview)]** to listen to the sample.
 

It will continue playing while you hold down the button. The sampled phrase will be added as a sample to the sample list in a dedicated storage location called "sample memory."
5. Press **[SAMPLE LIST]** to display the Sample List screen.



The highlighted sample is the sample that was captured by Skip Back Sampling.

## HINT

**What is a sample?** A sample contains the waveform data sampled by the Fantom-S. In addition to the actual waveform data itself, a sample also contains parameters such as start point, loop start, and loop end.

## MEMO

With the factory settings, Skip Back Sampling will capture the previous ten seconds of your performance. You can change the setting so that Skip Back Sampling will capture as much as the previous forty seconds of your performance.

## Assigning a Sample to a Pad (Assign to Pad)

Here's how you can assign a sample as a rhythm tone to a pad. This operation is called **Assign To Pad**.

Before you begin this procedure, make sure that a rhythm set is assigned to the Pad part (p. 11).

- 1. In the Sample List screen, make sure that the sample you recorded is highlighted, and then press [7 (Load Util)].**

The Load Utility Menu window appears.

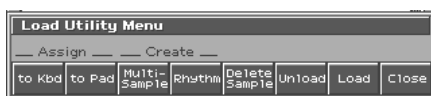

- 2. Press [2 (Assign to Pad)].**

The Assign to Pad screen appears.



- 3. Press the pad that you want to assign.**  
The pad shown in the screen will be highlighted.
- 4. Press [8 (Exec)].**  
A message will ask you confirmation.
- 5. Press [8 (Exec)] to assign the sample to the pad.**  
To cancel, press [7 (Cancel)].  
Strike the pad to hear the sample you assigned.

# Creating a Song

To create a song, you will use the Fantom-S's Performance mode to create a set of sounds for your song, and then record the song data into the sequencer.

## What is a Performance?

A performance is a set patches and/or rhythm sets assigned to each of the sixteen parts, allowing you to use sixteen sounds simultaneously.

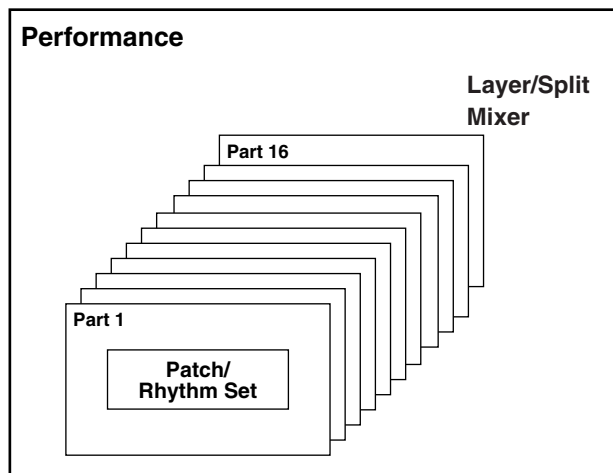

The Fantom-S has a Layer screen (press [LAYER/SPLIT]) and a Mixer screen (press [MIXER]). Use the Layer screen when you want to make settings for playing multiple patches together (layered) or separately in different regions of the keyboard (split). Use the Mixer screen when you want to make mixing settings such as adjusting the level and pan for each of the sixteen parts.

Here's how you can easily create a song by using rhythm patterns or the sampling function to record into the sequencer.

This chapter explains how to create a song like the following.

fig.score1

The musical score consists of four staves. The top staff is labeled 'Vocal part' and contains the lyrics 'There's something about you, baby' in a text box. The second staff is 'Piano part' in treble clef, showing a sequence of chords with a 'Sw.' (swell) marking. The third staff is 'Bass part' in bass clef, showing a rhythmic arpeggiated pattern with a 'Sw.' marking. The fourth staff is 'Rhythm part' in bass clef, showing a complex rhythmic pattern with 'x' marks above the notes, likely representing a drum or percussion part.

1. Play the rhythm part on the pads, and mix-record it while looping
2. Recording the bass part as arpeggios
3. Realtime-record the piano part
4. Record the vocal part

## HINT

**What is a Part?** A part is a location or "slot" to which you can assign a patch or rhythm set. In Performance mode, each performance has 16 parts, and you can assign a patch or rhythm set to each part.

## HINT

**Mix recording** A method of recording in which you can listen to the previously-recorded sounds while you continue recording additional material.

## HINT

**Realtime recording** A method of recording in which your keyboard or pad playing and controller operations are recorded exactly as you perform them.

# Erasing a Song From Internal Memory (Song Clear)

When you record a song, the performance data is temporarily held in internal memory. If you want to record a new song, you must first erase all of the recorded performance data from internal memory.

### HINT

The area in which patch and performance settings are kept is called **memory**.

### NOTE

If internal memory contains a song that you want to keep, you must first save that song to disk (p. 50).

1. Press [SEQUENCER] to access the Song Play screen.

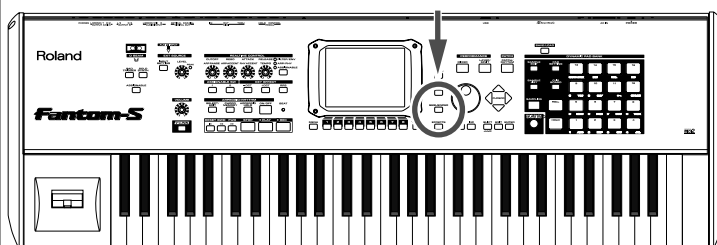

2. Press [3 (Song Clear)].

A message will ask for confirmation.

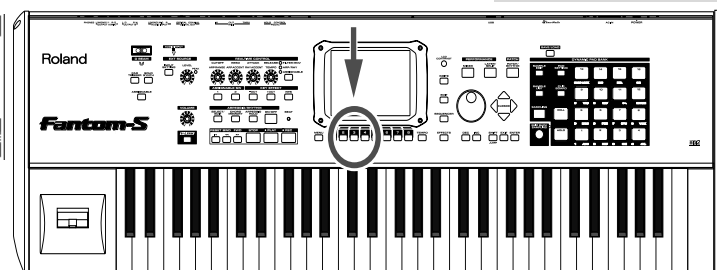
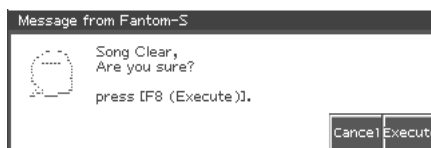

3. Press [8 (Exec)] to execute.

When the operation has been completed, the display will briefly indicate "Song Clear Completed!"

\* If you decide to cancel, press [7 (Cancel)].



## Selecting a Performance

Now we will begin creating our song, but we must first select a performance. In this example, we will use the performance “PRST: 63 SongMake Tmp” to create our song, so select “PRST: 63 SongMake Tmp”.

**1. Press [LAYER/SPLIT].**

The performance Layer screen will appear.

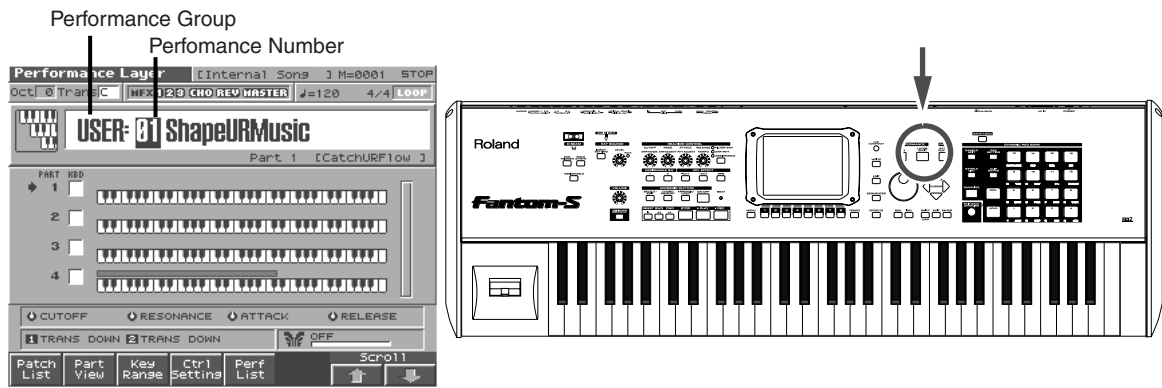

**2. Use [CURSOR] to move the cursor to the performance group.**

**3. Either turn the VALUE dial or use [INC] [DEC] to select “PRST.”**

**4. Press  to move the cursor to the performance number.**

**5. Either turn the VALUE dial or use [INC] [DEC] to select “63”.**

Performance “PRST: 63 SongMake Tmp” will be selected.



## Selecting a Part

### Selecting a Part from the Layer screen

1. When you press ▲ or ▼ in the Layer screen, which appears when you press [LAYER/SPLIT],  appears at the left side of "PART." This is the currently selected part.

Below the performance name, the screen shows the patch name of the selected part.



#### MEMO

The currently selected part is called the **current part**.

### Selecting a Part from the Mixer screen

1. In the Mixer screen, which appears when you press [MIXER], use [CURSOR] to move the cursor to the part number.

It displays the part numbers and the name of the patch assigned to each part.

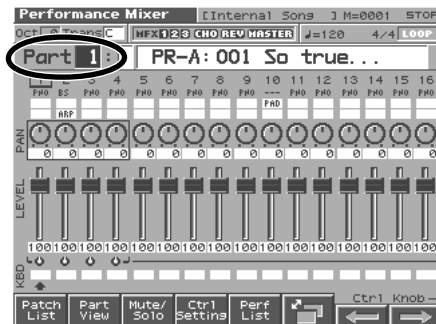

#### MEMO

The Mixer screen is ideal when you want to mix or make settings for the sixteen parts.

2. Turn the VALUE dial or use [INC] [DEC] to select a part.

Now we will be recording the parts in the order of the rhythm part → bass part → piano part → vocal part. At each step, we will select the part as described here for the Layer screen.

### About the Keyboard Switch

The "KBD" indication in the screen is the Keyboard Switch. As the result of turning this switch on (by assigning a check mark (✓) in the Layer screen, or by getting "KBD" to be displayed in the Mixer screen), you will hear all parts for which it has been turned on. The currently selected part will always sound, regardless of the keyboard switch. In other words, you will hear the currently selected part and the parts for which the keyboard switch is on.

3. In this recording, we will hear the sound of each individual part as we record it. If the keyboard switch is on, use the VALUE dial or press [DEC] to switch it off for all parts.

The parts in this performance have been assigned patches and a rhythm set that are suitable for recording, but if you want to select different patches or rhythm sets you can press [1 (Patch List)] and make your choice.

## Assigning a Vocal Phrase to a Part as a Patch

To part 1 we will assign a vocal phrase as a patch. We will use sample data that the Fantom-S already contains.

### HINT

**What is a sample?** This term indicates waveform data sampled by the Fantom-S. A sample consists of the actual waveform data together with sample parameters such as loop start and loop end points.

### 1. Press [SAMPLE LIST].

The Sample List screen will appear.

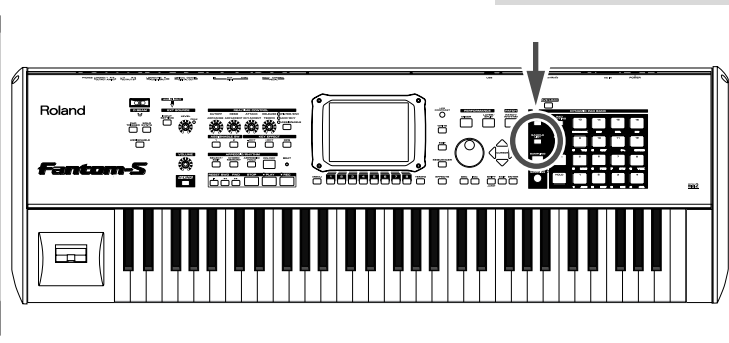
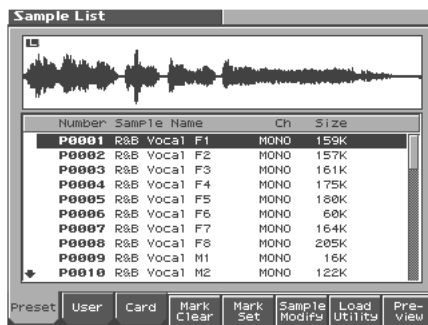

### 2. Press [1 (Preset)].

“Preset” shows the preset samples. In this example we will use “P0001 R&B Vocal F1.”

### 3. Press ▲ or ▼ to select “P0001 R&B Vocal F1.”

You can audition the sample by pressing [8 (Preview)].

Next we will create a patch from this sample, and assign it to a part.



### Assigning the Selected Sample to a Part as a Patch (Assign to Keyboard)

The selected sample can be assigned to a part as a patch.

We will use the Assign to Keyboard function to create a patch from the selected sample.

4. Press [7 (Load Utility)] to access the Load Utility window, and then press [1 (Assign to Kbd)].

The Assign to Keyboard window will appear. Here you can specify the part to which the newly created patch will be assigned. In this example we will assign the patch to part 1.

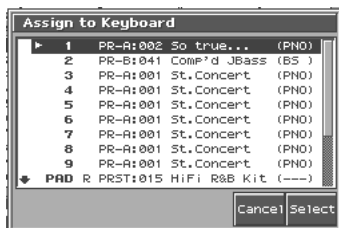

5. Either turn the VALUE dial or use [INC] [DEC] to set the setting to "1".
6. Press [8 (Select)], and a message will ask you for confirmation.
7. Press [8 (Exec)].  
A message will ask you for confirmation.
8. Press [8 (Exec)] once again.  
The vocal phrase has now been assigned to part 1.
9. Play the C4 key of the keyboard.  
The vocal phrase will sound.

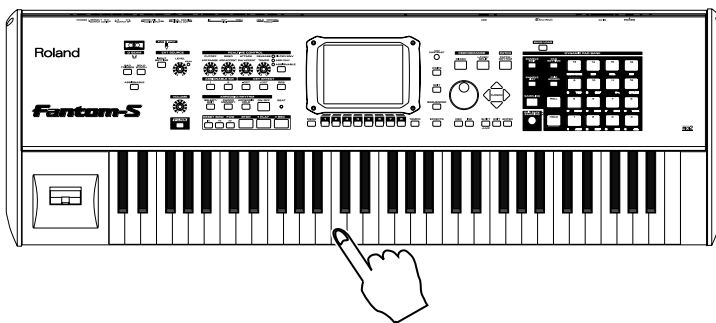

10. Press [EXIT] to return to the previous screen.

#### MEMO

In the Load Utility window you can execute various operations on a sample.

#### MEMO

If you decide to cancel, press [7 (Cancel)].

### Sample Key and Original BPM

If you play the patch created by Assign To Keyboard from a note other than C4 of the keyboard, it will sound differently. This is because the "Original Key" parameter of this sample has been set to "C4". The original key is the note number (a number assigned to each key) that will play the sample at the pitch at which it was sampled. To view this setting, use the following steps.

1. Press [SAMPLE LIST], and then press [1 (Preset)].
2. Press ▲ or ▼ to select "P0001 R&B Vocal F1."
3. Press [SAMPLE EDIT], and then press [2 (Sample Param)].

The Sample Parameter screen will appear.

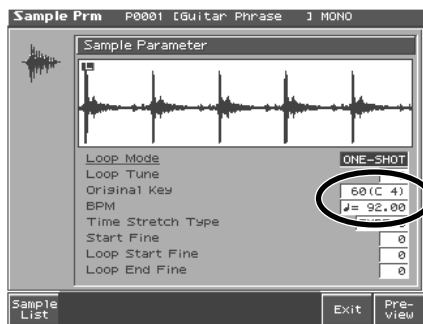

"Original Key" is set to "60 (C4)".

Also notice that "BPM" is set to "92". This is the original tempo of the sample. You should set the tempo of the song we will be recording to "92" so that it will match the tempo of this phrase.

4. Press [7 (Exit)].
5. Press [EXIT] to return to the previous screen.

## Recording the Rhythm Part

We will begin by recording the rhythm part as a rhythmic guide.  
First we will record the bass drum and snare drum, and then add the hi-hat.

### Selecting the Part to Record

\* Press [LAYER/SPLIT] to access the Performance Layer screen, and verify that the performance "PRST: 63 SongMake Tmp" is selected.

1. Press ▼ to move ➡ to "PART10."

An indication of "PAD" will appear below the part number. This indicates that "part 10" is specified for playing from the pads.



### Selecting the Recording Method

1. Press [TEMPO] to set the tempo for recording. Turn the VALUE dial to specify "92."

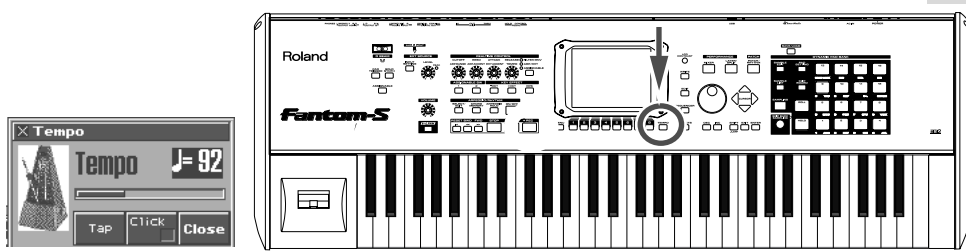

Press [8 (Close)] to close the window.

2. When you have finished setting, press [8 (Close)].
3. Press [REC].

The [REC] indicator will blink, and the Realtime Rec Standby window will appear.

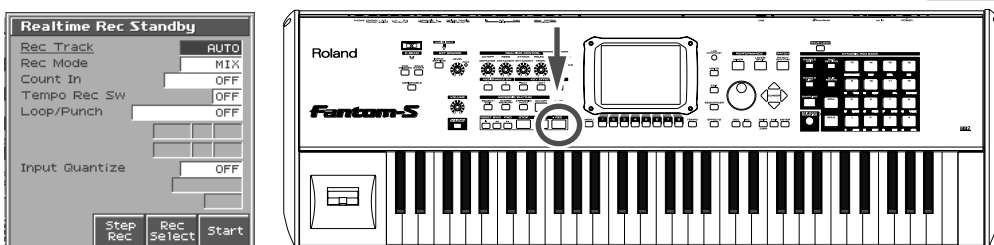

In this window you can edit various settings related to realtime recording.

**4. Set the parameters of the Realtime Rec Standby window as shown below. Press ▲ or ▼ to move the cursor to each parameter, and turn the VALUE dial or use [INC] [DEC] to set the value.**

- **Rec Track: AUTO**

A location where recording occurs is called a “track.” Specify the recording-destination phrase track. If you select “Auto,” a location where recording occurs is called a “track.” This setting specifies the recording-destination phrase track. If this is set to “Auto,” the phrase track of the same number as the part currently selected for the keyboard will be chosen automatically.

- **Rec Mode (recording mode): MIX**

Selects how recording will occur. If you specify “MIX,” the newly-recorded material will be added to any performance that is already recorded on the recording-destination track without erasing it.

- **Count In: WAITE NOTE**

Selects how recording will begin. If you select “WAITE NOTE,” recording will begin when you play the keyboard or press the Hold pedal.

- **Loop/Punch: LOOP (2 MEAS)**

When repeatedly recording over a specified region, this specifies the length of that region. If you specify “2 MEAS,” you will be able to repeatedly record over a two-measure region without stopping.

- **Input Quantize: GRID**

This function automatically corrects the timing at which you play keys or pads, so that they will be aligned to precise intervals of time. You can quantize while recording. If you set this to “GRID,” the notes will be recorded at precise timing intervals.

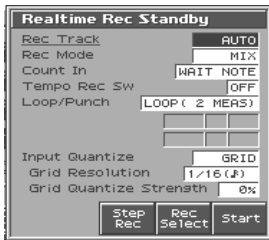

- **Grid Resolution: 1/16 ( ♩ )**

This setting is used by grid quantization. Set this to the shortest of the note values that you will be inputting.

*\* Parameters other than the above will not be used in this example, so you do not need to set them.*

## Playing and Recording Rhythm Part

*\* Make sure that the parameters of the Realtime Rec Standby window are set correctly.*

**1. In the Realtime Rec Standby window, press [8 (Start)], and then press [7 (Rehearsal)].**

In the Realtime Recording window, a check mark (✓) will be applied to [7 (Rehearsal)], indicating that the Rehearsal function is on. The **Rehearsal function** temporarily disables recording during realtime recording. This is convenient when you want to check the sound that you will record next during loop recording, or when you want to practice the phrase that you will record next.

**When the Rehearsal function is on, the [REC] indicator will blink.**



## Creating a Song

- 2. In time with the metronome, practice playing the rhythm part on the pads. First practice the bass drum and snare drum.**

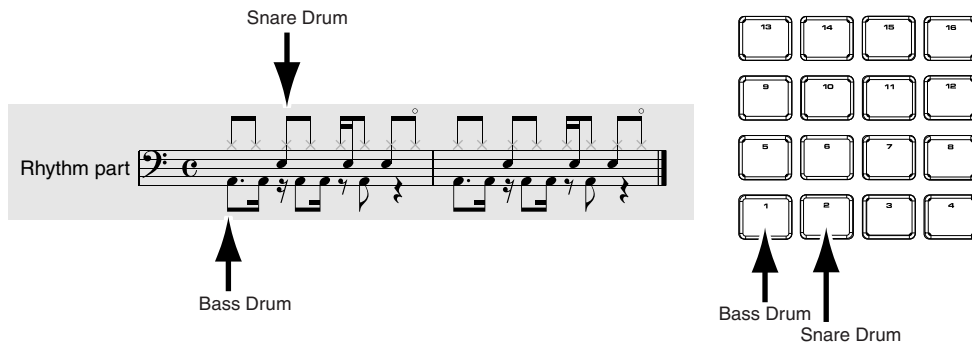

- 3. When you have finished practicing, press [REC] to begin recording.**

The [REC] indicator will change from blinking to lit, and recording will begin. The measure is shown in the Realtime Recording window. Since we are using Mix recording, it is not necessary for you to record the full two measures completely. Even if you record one measure at a time, each recording pass will be added to the previously recorded material.

- 4. When you have finished recording, press [7 (Rehearsal)].**

The [REC] indicator will change from lit to blinking, and the Rehearsal function will be turned back on, temporarily disabling recording.

### If You Make a Mistake (Realtime Erase)

Realtime Erase is a function that erases unwanted data while you are still recording. This function is convenient during Loop recording since you can erase data without halting recording.

- 1. In the Realtime Recording window, press [6 (Erase)].**

If this window is not displayed, press [PLAY] during recording to access it. Each time you press [PLAY], the Realtime Recording window will alternately be hidden or displayed.



- 2. If you press [7 (Erase All)], all data will be erased. To erase notes of a specific pad, press that pad. Data will be erased while you continue pressing that pad.**



- 5.** Next practice the open hi-hat and closed hi-hat. Since you are in Rehearsal mode, practice the hi-hat while you listen to the previously-recorded bass drum and snare drum.

The diagram illustrates the hi-hat practice setup. On the left, a musical staff labeled 'Rhythm part' shows a bass line with hi-hat symbols: 'x' for closed hi-hat and 'o' for open hi-hat. Arrows point from the labels 'Closed Hi-Hat' and 'Open Hi-Hat' to these symbols. On the right, a 4x4 grid of 16 numbered pads is shown. Arrows point from the labels 'Closed Hi-Hat' and 'Open Hi-Hat' to pads 3 and 4 in the bottom row, respectively.

- 6.** When you are able to play the hi-hat correctly, press [7 (Rehearsal)] (Rehearsal mode is defeated), and use the pads to record the hi-hat. The measure is shown in the Realtime Recording window for your reference.
- 7.** When you have recorded the hi-hat, press [STOP]. This completes the rhythm part.
- 8.** Press [RESET] to return to the beginning of the measures, and press [PLAY] to hear the playback. Press [RESET] to return to the beginning of the measures.

## Recording the Bass Part

When you have successfully recorded the drum track, let's proceed to recording the bass part. We will explain how to record the bass using the arpeggiator function.

- 1. Make sure that the Performance Layer screen is displayed, and that performance "PRST: 63 SongMake Tmp" is selected.**
- 2. Press ▲ to move ▣ to "PART2."**  
This selects the bass part. Play the keyboard and verify that you hear the bass sound.
- 3. Press ARPEGGIO/RHYTHM [ON/OFF] so its indicator is lit.**  
In this performance, the arpeggiator is set to operate on part 2.
- 4. Press [REC], and then press [8 (Start)] to begin recording.**

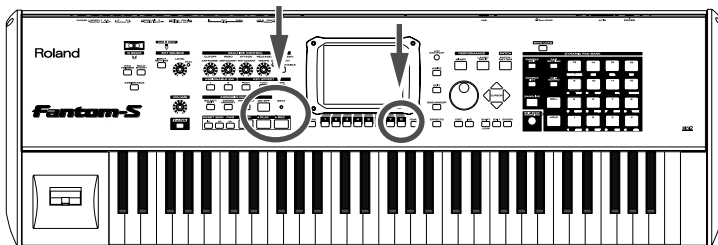

- 5. Press [7 (Rehearsal)].**  
The Rehearsal function is on.

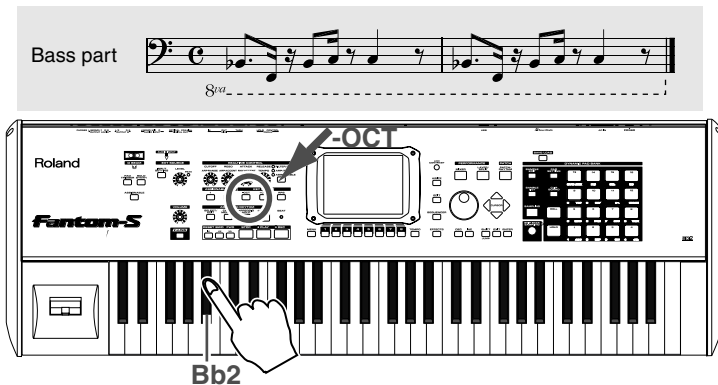

- 6. Press the Bb1 key of the keyboard (on the Fantom-S, the Bb2 key).**  
If you are using the Fantom-S, the keyboard does not have a Bb1 key, so press [-OCT] once. Now, when you press the Bb2 key the Bb1 note will sound (Octave Shift). Arpeggios will begin playing according to the keys you press.
- 7. Press [7 (Rehearsal)] once again (this defeats Rehearsal mode), and record for two measures.**  
The measure is shown in the Realtime Recording window for your reference.
- 8. When you have finished recording, press [STOP].**  
Press [RESET] to return to the beginning of the measures, and press [PLAY] to hear the playback.
- 9. Once again press ARPEGGIO/RHYTHM [ON/OFF] so its indicator goes out, and the Arpeggio/Rhythm function is turned off.**  
If you are using the Fantom-S, press [+OCT] once to return the Octave Shift setting to normal.

### MEMO

If you want to select a different sound, press [1 (Patch List)].

### NOTE

If you also hear the sound of other parts, make sure that "KBD" does not have a check mark (✓).

### MEMO

In Performance mode, the arpeggiator can be applied to one part. To see the part to which the arpeggiator is applied, press ARPEGGIO/RHYTHM [SELECT/EDIT]→[3 (Arp)] to access the Arpeggio screen and check the "Arp Part" setting.

### MEMO

The "8va" indication in the score means that you are to play one octave lower than written.

### MEMO

If you are using the Fantom-S88, pressing the Bb1 key will sound the pitch as written.

## Recording the Piano Part

Next we will record the piano part. Use the keyboard to record the piano part in realtime.

1. **From the Performance Layer screen, press ▼ to move [ ] to “PART3.”**  
Play the keyboard, and verify that you hear the piano sound.
2. **Press [REC] to access the Realtime Rec Standby window.**
3. **In the Realtime Rec Standby window, press [8 (Start)] and then press [7 (Rehearsal)] to make the indicator blink.**

You will hear the rhythm part and bass part. Since the rehearsal function is on, nothing will be recorded when you play the keyboard. Play the keyboard to practice the piano part. The “8va” indication in the score indicates that you are to play one octave lower than written.

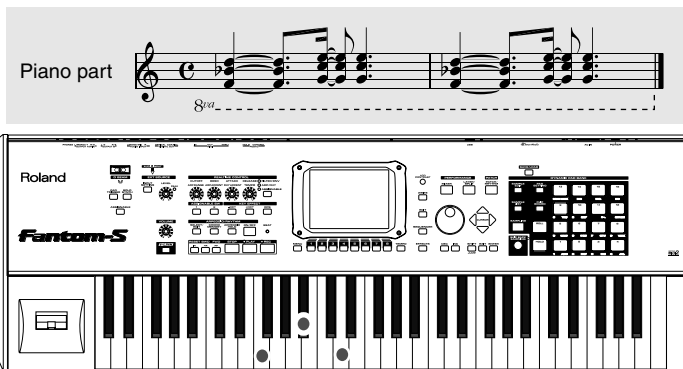

4. **When you have finished practicing, press [7 (Rehearsal)] to start recording (this defeats Rehearsal mode).**

The [REC] indicator will change from blinking to lit, and recording will begin. The measure is shown in the Realtime Recording window. Since you are using Mix recording, it is not necessary for you to input both measures completely. Even if you record one measure at a time, your recording will be added to the previously-recorded material.

### If You Make a Mistake (Realtime Erase)

Realtime Erase is a function that erases unwanted data while you are still recording. This function is convenient during Loop recording since you can erase data without halting recording.

1. **In the Realtime Recording window, press [6 (Erase)].**

If this window is not displayed, press [PLAY] during recording to access it. Each time you press [PLAY], the Realtime Recording window will alternately be hidden or displayed.



2. **If you press [7 (Erase All)], all data will be erased. To erase notes of a specific pad, press that pad. Data will be erased while you continue pressing that pad.**

3. **When you have finished recording, press [STOP].**

This completes recording of the piano part.

Press [RESET] to return to the beginning of the measures, and press [PLAY] to hear the playback.

#### HINT

**Realtime recording** This is a method in which your performance on the keyboard or pads and your controller operations are recorded exactly as you play them.

#### NOTE

If you also hear the sound of other parts, make sure that “KBD” does not have a check mark (✓).

#### MEMO

If you want to choose a different sound, press [1 (Patch List)].

### Recording the Vocal Part

Last we will record the vocal part. We will record the vocal part in the same way as the piano part.

- 1. From the Performance Layer screen, press ▲ to move [PART1.]**  
Play the C4 key and verify that you hear the vocal phrase.
- 2. Press [REC] to access the Realtime Rec Standby window.**
- 3. In the Realtime Rec Standby window, press [8 (Start)] and then press [7 (Rehearsal)].**

You will hear the rhythm part, bass part, and piano part. Since the rehearsal function is on, nothing will be recorded when you play the keyboard. Practice the part. Hold down the C4 key until you no longer hear the vocal phrase (approximately one measure).

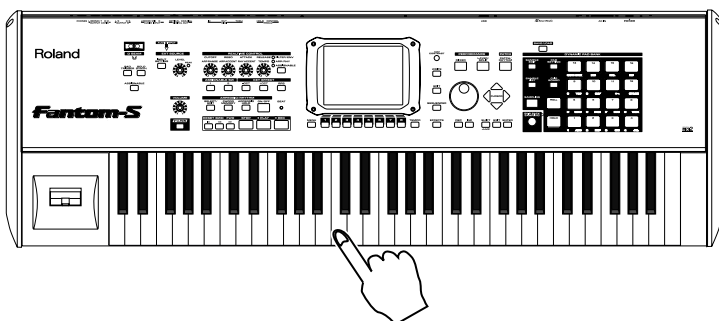

- 4. When you have finished practicing, press [7 (Rehearsal)] to begin recording (this defeats Rehearsal mode).**

The [REC] indicator will change from blinking to lit, and recording will begin. The measure is shown in the Realtime Recording window.

- 5. When you have finished recording, press [STOP] to stop recording.**

You have now finished recording the song. Press [RESET] to return to the beginning of the measures, and press [PLAY] to listen to the playback. When the playback ends, press [RESET] to return to the beginning of the measures.

#### NOTE

If you also hear the sound of other parts, make sure that "KBD" does not have a check mark (✓).

## Mixing in the MIXER Screen

The Fantom-S's performance mode has a Layer screen (press [LAYER/SPLIT]) and a Mixer screen (press [MIXER]).

The Layer screen is convenient when you want to make settings for playing multiple patches together (layered) or separately in different regions of the keyboard (split). In contrast, the Mixer screen lets you make mixing settings such as adjusting the level and pan for each of the sixteen parts. In this example we will use the MIXER screen to make fine adjustments to the song that you just recorded.

## Loop the Song

Since the song you recorded is just two measures long, let's loop the song so that it will play back repeatedly.

### 1. Press [SEQUENCER].

The Song Play screen will appear.

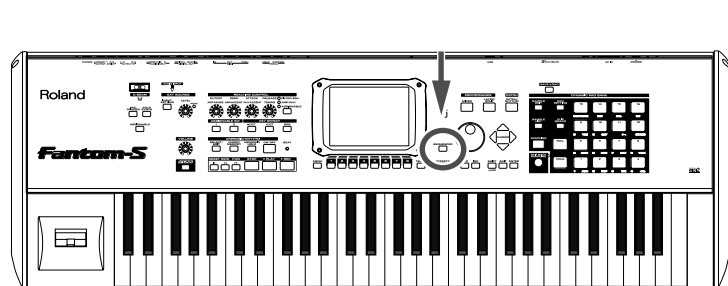
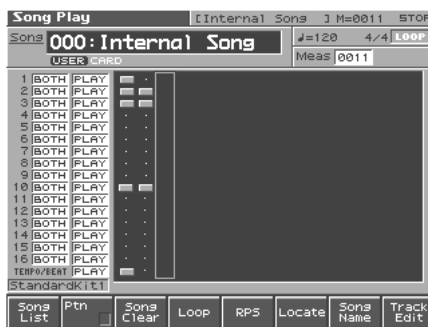

### 2. Press [4 (Loop)].

The Loop window will appear.

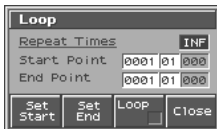

### 3. Press ▲ to move the cursor to “Repeat Times,” and either turn the VALUE dial or use [INC] [DEC] to set this to “INF.”

“Repeat Times” specifies the number of times that the song will repeat. With the “INF (INFINITE)” setting, playback will repeat until you press [STOP].

### 4. Press ▼ to move the cursor “End Point,” and turn the VALUE dial or use [INC] [DEC] to set the end point of the song.

In this example the song is two measures long, so set this to “003-01-000”.

### 5. Press [7 (Loop)] to assign a check mark (✓).

Make sure that “LOOP” is displayed in the upper right of the screen to indicate that the loop setting is turned on.



### 6. Press [8 (Close)] to close the window, and then press [EXIT].

## Making Fine Adjustments in the MIXER Screen

### 1. Press [MIXER].

The Performance Mixer screen will appear.

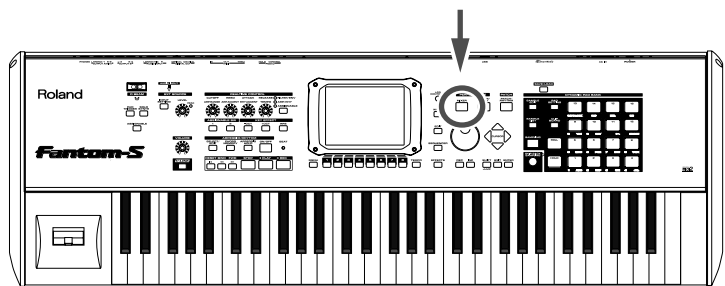

### 2. Press [PLAY] to play back the song.

The song will play repeatedly.

### 3. Press the button located at the right of the realtime control knobs to go dark the indicator.

### 4. Use [7 (←)] [8 (→)] and press ▲ or ▼ to move the frame in the screen to the "LEVEL" of parts 1 through 4.

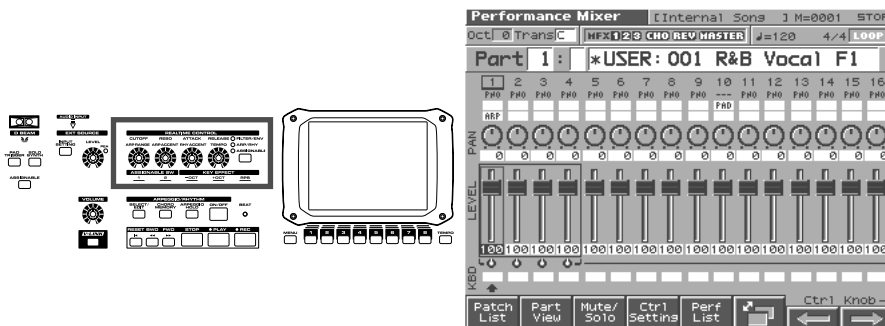

The levels of the four enclosed parts correspond to the four knobs at the left of the display. Turning the far left knob will adjust the volume of the vocal part. In this way, adjust the volume balance of the four parts 1, 2, 3, and 10.

### NOTE

You can set the value either by turning the VALUE dial or by using [INC] [DEC].

- Use [7 (←)] [8 (→)] and press ▲ or ▼ to move the frame in the screen, and set the panning (PAN: stereo location of the sound) in the same way.



- By pressing [6] to switch screens, you can also adjust the reverb send level and chorus send level.



- When you have finished making settings, press [STOP] to stop playback.

## Using Effects

The Fantom-S provides the following four types of effects. Each of these effects can be set independently.

- **Multi effect**  
This multi-effect unit provides 78 types (77 types on the Fantom-S) of effects such as distortion and rotary.
- **Chorus**  
This is an effect that adds depth and spaciousness to the sound.
- **Reverb**  
This effect adds the reverberation that is characteristic of a performance heard in acoustical spaces such as a hall.
- **Mastering effect**  
This is a stereo compressor (limiter) that can be applied to the final output.

### NOTE

Effect on/off settings are common to the entire Fantom-S. These settings are not for individual patches or performances.

## Switching the Effects On/Off

### 1. Press [EFFECTS].

The Effects Routing screen will appear.

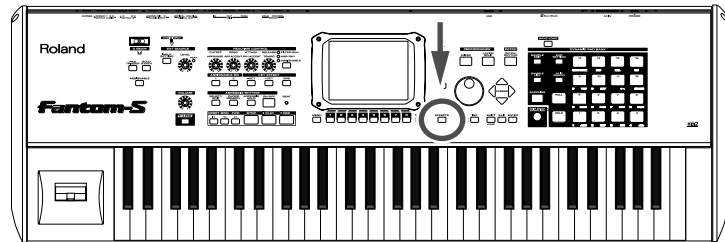
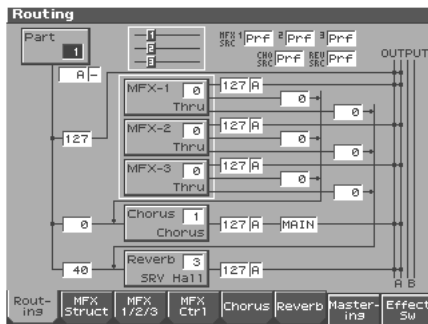

### 2. Press [8 (Effect Sw)].

The Effects Sw window will appear.



### 3. Press [1 (MFX1)]–[6 (Master)] to turn each effect switch on/off. Each time you press a button the setting will alternate between on and off.

### 4. When you have finished making settings, press [8 (Close)].

### 5. Press [EXIT] to return to the previous screen.

When you return to the Performance screen, the effect on/off settings will be displayed in the following area.

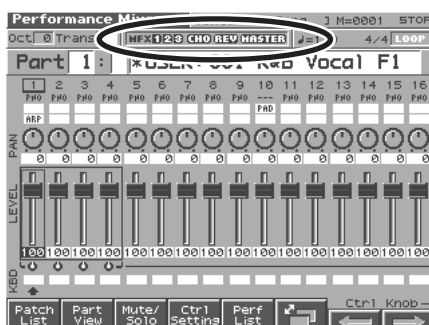



## Editing the Effect Settings

1. Press [EFFECTS] to access the Effects screen.

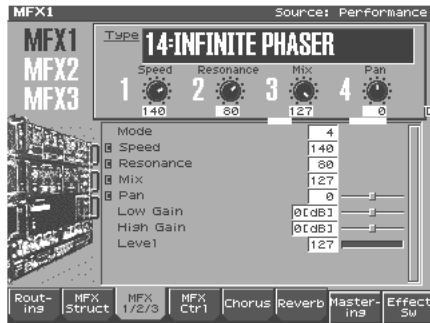

2. Press the [1 (Routing)]–[7 (Mastering)] to select the effect that you want to edit.

[3 (MFX1/2/3)] will alternate between 1, 2, and 3 each time you press the button.

- Specify how effects are connected and applied → [1 (Routing)]
- Edit the multi-effect settings → [3 (MFX1/2/3)]
- Edit the chorus settings → [5 (Chorus)]
- Edit the reverb settings → [6 (Reverb)]

3. Press [CURSOR] to select a parameter.

4. Turn the VALUE dial or press [INC]/[DEC] to specify the value.

When you have finished editing, press [EXIT] to return to the previous screen.



For details on effect settings, refer to “Adding Effects” (p.175) in the Owner’s Manual.

# Saving the Song You Recorded

The song you created is temporarily held in a location called “internal memory,” but all data in internal memory is lost when you turn off the power. If you want to keep your song, you must save it in the Fantom-S’s user memory.

### 1. Press [SAVE/LOAD].

The Save/Load Menu screen will appear.

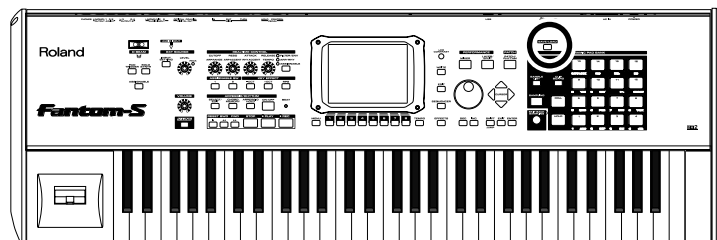

### 2. Press [2 (Save Song)].

The Song File Name screen will appear.



Samples you record will be held in sample memory, but the data in sample memory will be lost when you turn off the power. If you want to save the samples as well, choose [1 (S+S)].

### 3. Assigning a file name (up to 8 characters). Turn the VALUE dial or press [INC]/[DEC] to select the character that you want to input.

To change the type of character, press [1 (Change Type)]. The type will alternate each time you press this.

To insert a space at the cursor location, press [3 (Insert)].

To delete the character at the cursor location, press [2 (Delete)].

Press ◀ or ▶ to move the cursor (the location at which to enter / edit a character).

**4. Press [8 (Write)] to finalize the file name.**

The Song Save screen will appear.

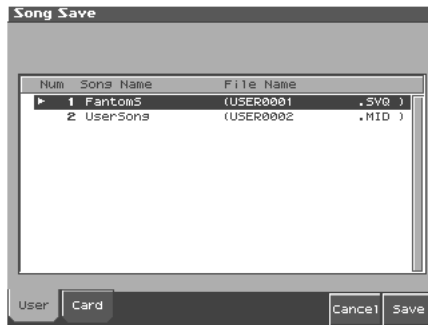

**5. Press [1 (User)] (user memory) to select the destination of the save.**

**6. Press [8 (Save)].**

A message will ask you confirmation.

**7. Press [8 (Exec)] to save the file.**

When the file has been saved, the display will indicate "Completed !"



For details on saving, refer to "Saving / Loading a Song" (p.168) in the Owner's Manual.

*\* The display screens printed in this owner's manual are based on the factory settings. However, please be aware that in some cases they may differ from the actual factory settings.*

