

Roland ep·5 DIGITAL PIANO

OWNER'S MANUAL



Thank you, and congratulations on your choice of the Roland ep-5.

The ep-5 Digital Piano, designed to make it easier for more people to have fun with music, has firm roots in the same leading-edge technology and manufacturing know-how that has made Roland a leader in electronic musical instrument development.

The ep-5 provides a selection of 5 realistic sounds (including piano) and offers a keyboard that is a pleasure to play.

What's more, the instrument provides a complete range of features, including a convenient recording function.

To make sure you are comfortable in using all the features the ep-5 offers, and to ensure satisfaction for years to come, please read this Owner's Manual in its entirety before starting out.

© 1990 ROLAND CORP.

Unauthorized copy or transfer of this document by any means, whether in whole or in part, is strictly prohibited.

Important Notes

[Power Supply]

- Be sure to use only the AC adaptor supplied with the unit. Use of any other power adaptor could result in damage, malfunction, or electric shock.
- When making any connections with other devices, always turn off the power to all equipment first; this will help prevent damage or malfunction.
- Do not use this unit on the same power circuit with any device that will generate line noise, such as a motor or variable lighting system.
- The power supply required for this unit is shown on its nameplate. Ensure that the line voltage of your installation meets this requirement.
- Avoid damaging the power cord; do not step on it, place heavy objects on it etc.
- When disconnecting the AC adaptor from the outlet, grasp the plug itself; never pull on the cord.
- If the unit is to remain unused for a long period of time, unplug the power cord.

[Placement]

- Do not subject the unit to temperature extremes (eg. direct sunlight in an enclosed vehicle). Avoid using or storing the unit in dusty or humid areas or areas that are subject to high levels of vibration.
- Using the unit near power amplifiers (or other equipment containing large transformers) may induce hum.
- This unit may interfere with radio and television reception. Do not use this unit in the vicinity of such receivers.
- Do not expose this unit to temperature extremes (eg. direct sunlight in an enclosed vehicle can deform or discolor the unit) or install it near devices that radiate heat.

[Maintenance]

- For everyday cleaning wipe the unit with a soft, dry cloth (or one that has been slightly dampened with water). To remove stubborn dirt, use a mild neutral detergent. Afterwards, be sure to wipe the unit thoroughly with a soft, dry cloth.
- Never use benzene, thinners, alcohol or solvents of any kind to avoid the risk of discoloration and/or deformation.

[Memory Backup]

- The unit contains a battery which maintains the contents of memory while the main power is off. The expected life of this battery is 5 years or more. However, to avoid the unexpected loss of memory data, it is strongly recommended that you change the battery every 5 years. Please be aware that the actual life of the battery will depend on the physical environment (especially temperature) in which the unit is used. When it is time to change the battery, consult with qualified service personnel.
- Please be aware that the contents of memory may at times be lost: when the unit is sent for repairs or when by some chance a malfunction has occurred.

[Additional Precautions]

- Protect the unit from strong impact.
- Do not allow objects or liquids of any kind to penetrate the unit. In the event of such an occurrence, discontinue use immediately. Contact qualified service personnel as soon as possible.
- Before using the unit in a foreign country, consult with qualified service personnel.
- Should a malfunction occur (or if you suspect there is a problem) discontinue use immediately. Contact qualified service personnel as soon as possible.

Specifications

KEYBOARD	61 key with touch-sensitivity.		MIDI OUT Connector: 1
MAX. POLYPHONY	24 notes		Damper Pedal Jack (DAMPER): 1
VOICES	Five (Piano, Electric Piano, Vibraphone, Organ, Strings)		Output Jacks (OUTPUT L(MONO)/R)
RECORDER	Provides for recording and playback. (Can record a maximum of approximately 1,600 notes.)	SPEAKERS	Headphone Jacks (PHONES): 2
MASTER TUNING	Range: approx. +/- 50 cents	OUTPUT	3.8 W: 2
BUTTONS	Power Switch (POWER): 1 Recording Button (REC): 1 Playback Button (PLAY): 1 Voice Buttons (PIANO, E. PIANO, VIBRA-PHONE, ORGAN, STRINGS)	DIMENSIONS	929(W) × 338(D) × 100(H) mm 3' 0-37/64"(W) × 1' 1-5/16"(D) × 3-15/16"(H)
KNOBS/SLIDERS	Tuning Knob (TUNE):1 Volume Control Slider (VOLUME):1	WEIGHT	7.5 kg 16.5 lbs
CONNECTORS/JACKS	AC Adaptor Jack (DC IN): 1 MIDI IN Connector: 1	POWER CONSUMPTION	1000 mA (DC 9 V)
		SUPPLIED ACCESSORIES	Damper Pedal, AC Adaptor, Music Stand, Owner's Manual, MIDI Guidebook.
		OPTIONS	Keyboard Stand KS-8 Headphones RH-12/100

* Specifications and/or external appearance of this product are subject to change without notice.

Making the Connections/Powering up

Before making any connections, make sure you have the power on your instrument turned off.

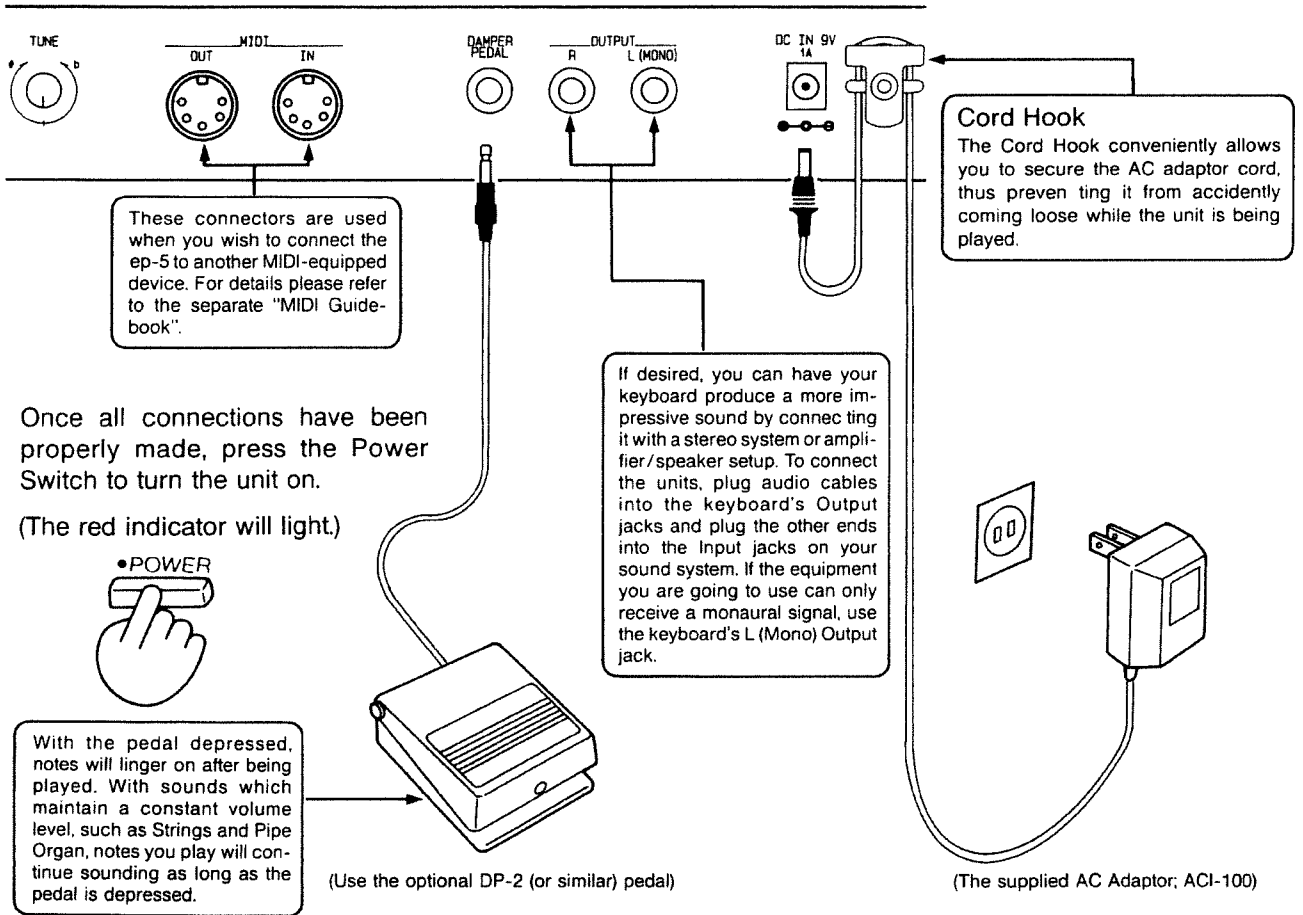

Listening to the Demo

① Press PIANO, VIBRAPHONE and STRINGS simultaneously.

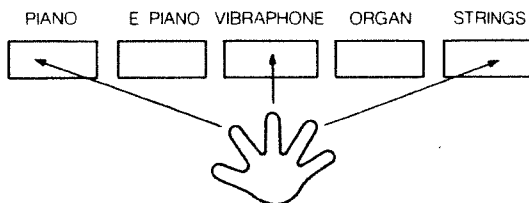

The demonstration song will start playing.

③ To stop playback of the demo, press any Voice button.

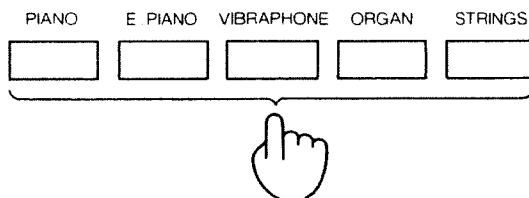

② Adjust the volume.

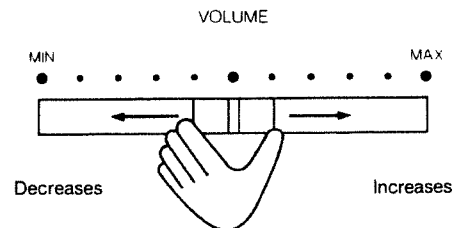

Volume Slider

Adjusts the volume obtained through the speakers or headphones. The further it is moved to the right, the greater the volume level becomes.

Power Switch

Turns power on and off. When the power is on, the indicator will be lit.

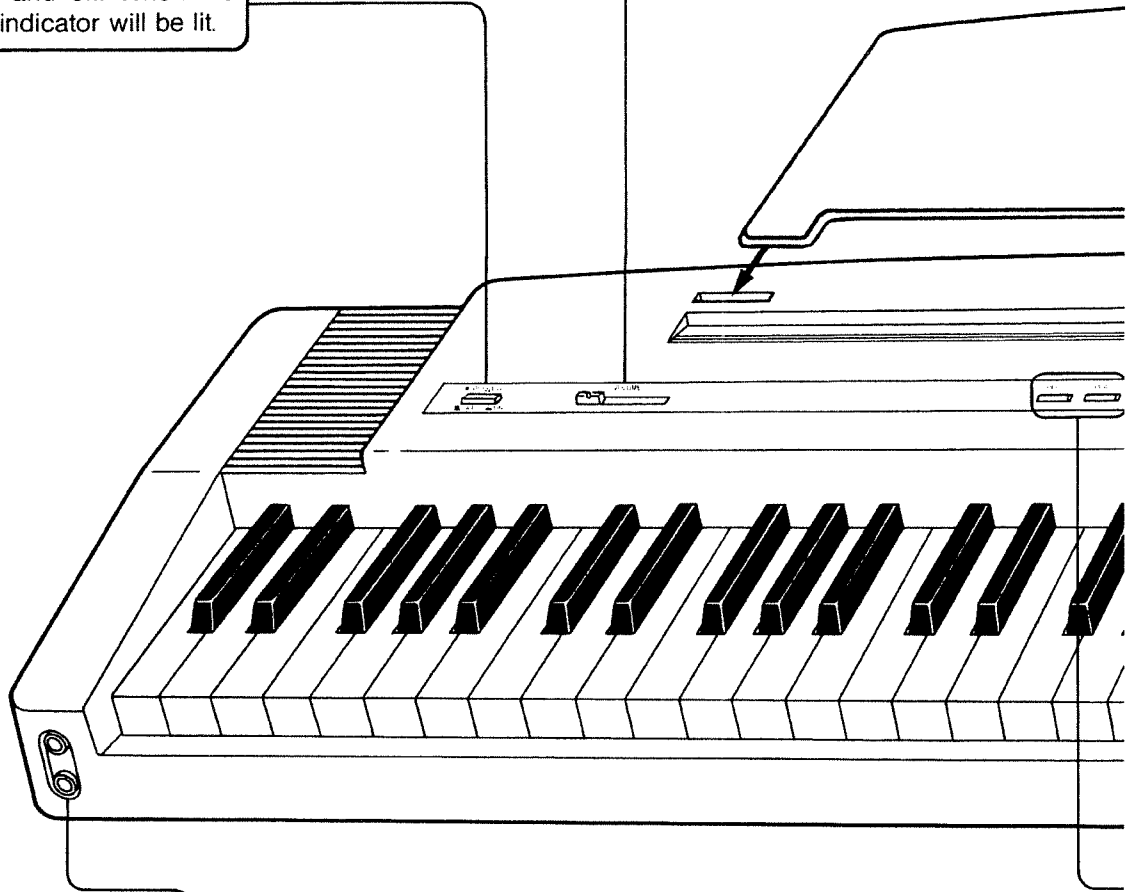

Headphone Jacks

The ep-5 can accommodate two sets of headphones at the same time. Once headphones are connected to either (or both) of these jacks, sound is no longer output from the speakers. This makes it ideal for times when you wish to play without disturbing those around you (late at night, for example).

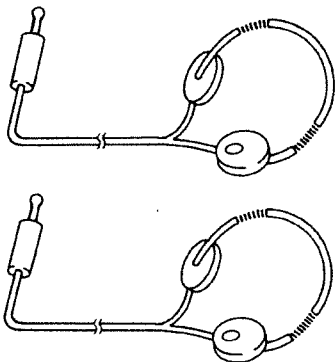

(RH-12/100, etc.; sold separately)

Voice Buttons

Provides selection of the sound you desire.

BUTTON	VOICE DESCRIPTION
PIANO	A realistic grand piano sound.
E. PIANO	The dazzling sound of an electric piano.
VIBRAPHONE	A refreshing vibraphone sound.
ORGAN	The sublime, impressive sound of a pipe organ
STRINGS	The sound of a string ensemble.

* If you wish, you can press two buttons at the same time — you can then play with the two voices layered together.

Music Stand

A music stand is included in the packing carton. Attach it to the instrument as shown in the illustration to the left.

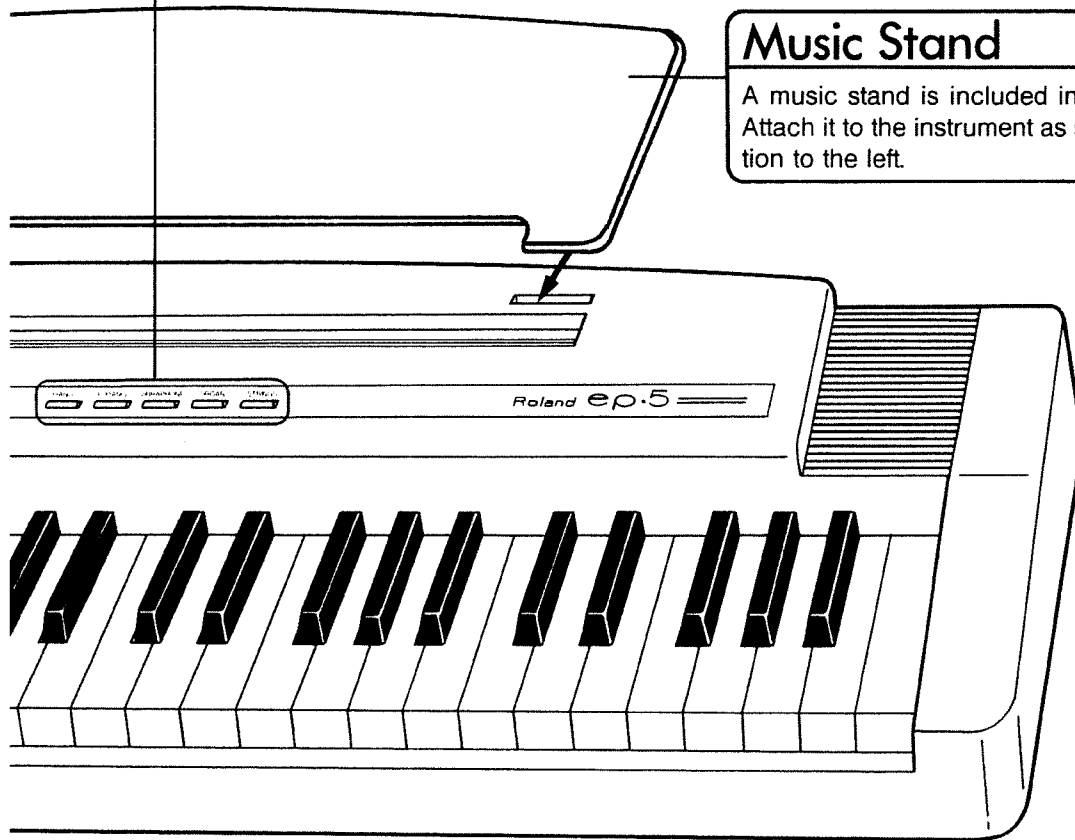

➔ See next page.

Tune Knob

This knob allows you to precisely adjust the pitch of the ep-5 so it matches that of some other instrument; useful when playing in an ensemble. When the knob is rotated clockwise, the pitch rises; when rotated counter-clockwise, it is lowered.

- * With the knob at the center position, the frequency of the A key in the middle of the keyboard will be 440.0 Hz.
- * By rotating the knob completely in either direction, you obtain a pitch change of about 50 cents (1/2 of a half-step).

<Rear Panel>

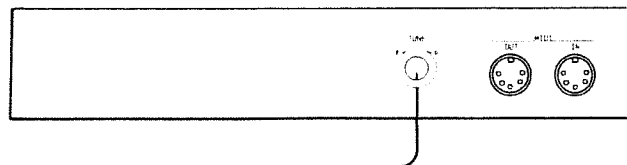

The Recorder

The Recorder allows you to capture what you play, and then listen to the playback whenever you like.

Recording

① Select the voice you intend to use.

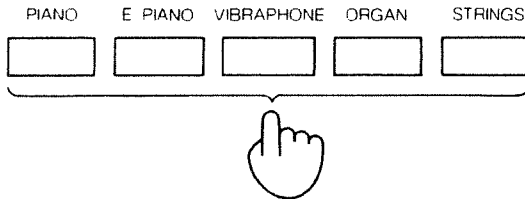

② Press the REC button.
(The red indicator will light.)

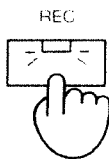

③ Start playing.



(The moment you begin playing, the recording will also start.)

④ When you are finished playing, press the REC button again. (The indicator will go out.)

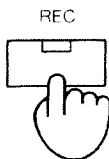

- **Everything you do while recording is in progress, including making changes in the voice, will be faithfully recorded.**

- **The recording feature allows you to record a total of approximately 1,600 notes.**

☆ **When you are running out of space for additional notes...**

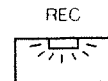

the red indicator on the REC button will start blinking.

☆ **And if you continue to record...**

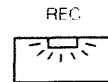

the REC button indicator will blink more rapidly.

☆ **When you reach the point where no more notes can be recorded...**

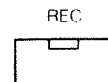

the indicator on the REC button goes out, and the recording stops automatically.

Playback

Press the PLAY button.
Playback will begin.
(The green indicator will light.)

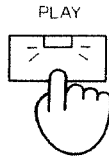

When the end of the piece is reached, the playback mode stops automatically. (The indicator goes out.)

Should you want to stop playback at any time, press the PLAY button.

- If you desire, you can play an accompaniment part (using any voice) while a recorded piece is being played back. This conveniently allows you to create an ensemble effect, even though you are playing by yourself. For example, you could play a melody using STRINGS to accompany a recorded piano piece.

* Voices used in a recorded performance cannot be changed afterward.

SAVE THESE INSTRUCTIONS

For the U.K.

IMPORTANT: THE WIRES IN THIS MAINS LEAD ARE COLOURED IN ACCORDANCE WITH THE FOLLOWING CODE.

BLUE : NEUTRAL
BROWN : LIVE

As the colours of the wires in the mains lead of this apparatus may not correspond with the coloured markings identifying the terminals in your plug proceed as follows:

The wire which is coloured BLUE must be connected to the terminal which is marked with the letter N or coloured BLACK.

The wire which is coloured BROWN must be connected to the terminal which is marked with the letter L or coloured RED.

The product which is equipped with a THREE WIRE GROUNDING TYPE AC PLUG must be grounded.

For Nordic Countries

Apparatus containing Lithium batteries

ADVARSEL!

Lithiumbatteri. Eksplosionsfare.
Udskiftning må kun foretages af en sagkyndig,
og som beskrevet i servicemanual.

VARNING!

Lithiumbatteri. Explosionsrisk.
Får endast bytas av behörig servicetekniker.
Se instruktioner i servicemanualen.

ADVARSEL!

Lithiumbatteri. Fare for eksplosion.
Må bare skiftes af kvalificeret tekniker som
beskrevet i servicemanualen.

VAROITUS!

Lithiumparisto. Räjähdyksvaara.
Pariston saa vaihtaa ainoastaan
alan ammottimies.

For West Germany

Bescheinigung des Herstellers/Importeurs

Hiermit wird bescheinigt, daß der/die/das

Roland ep.5

(Gerät. Typ. Bezeichnung)

in Übereinstimmung mit den Bestimmungen der

Amtsbl. Vfg 1046/1984

(Amtsblattverfügung)

funk-entstört ist.

Der Deutschen Bundespost wurde das Inverkehrbringen dieses Gerätes angezeigt und die Berechtigung zur Überprüfung der Serie auf Einhaltung der Bestimmungen eingeräumt.

Roland Corporation Osaka/Japan

Name des Herstellers/Importeurs

For the USA

RADIO AND TELEVISION INTERFERENCE

WARNING — This equipment has been verified to comply with the limits for a Class B computing device, pursuant to Subpart J, of Part 15, of FCC rules. Operation with non-certified or non-verified equipment is likely to result in interference to radio and TV reception.

The equipment described in this manual generates and uses radio frequency energy. If it is not installed and used properly, that is, in strict accordance with our instructions, it may cause interference with radio and television reception. This equipment has been tested and found to comply with the limits for a Class B computing device in accordance with the specifications in Subpart J, of Part 15, of FCC Rules. These rules are designed to provide reasonable protection against such a interference in a residential installation. However, there is no guarantee that the interference will not occur in a particular installation. If this equipment does cause interference to radio or television reception, which can be determined by turning the equipment on and off, the user is encouraged to try to correct the interference by the following measure:

- Disconnect other devices and their input/output cables one at a time. If the interference stops, it is caused by either the other device or its I/O cable. These devices usually require Roland designated shielded I/O cables. For Roland devices, you can obtain the proper shielded cable from your dealer. For non Roland devices, contact the manufacturer or dealer for assistance.
- If your equipment does cause interference to radio or television reception, you can try to correct the interference by using one or more of the following measures.
 - Turn the TV or radio antenna until the interference stops.
 - Move the equipment to one side or the other of the TV or radio.
 - Move the equipment farther away from the TV or radio.
 - Plug the equipment into an outlet that is on a different circuit than the TV or radio. (That is, make certain the equipment and the radio or television set are on circuits controlled by different circuit breakers or fuses.)
 - Consider installing a rooftop television antenna with coaxial cable lead-in between the antenna and TV. If necessary, you should consult your dealer or an experienced radio/television technician for additional suggestions. You may find helpful the following booklet prepared by the Federal Communications Commission: "How to Identify and Resolve Radio — TV Interference Problems"

This booklet is available from the U.S. Government Printing Office, Washington, D.C., 20402, Stock No. 004-000-00345-4.

For Canada

CLASS B

NOTICE

This digital apparatus does not exceed the Class B limits for radio noise emissions set out in the Radio Interference Regulations of the Canadian Department of Communications.

CLASSE B

AVIS

Cet appareil numérique ne dépasse pas les limites de la classe B au niveau des émissions de bruits radioélectriques fixés dans le Règlement des signaux parasites par le ministère canadien des Communications.

Information

● When you need repair service, call your local Roland Service Station or the authorized Roland distributor in your country as shown below.

U. S. A.

Roland Corp US
7200 Dominion Circle
Los Angeles, CA. 90040 - 3647
U. S. A.
☎ (213)685 - 5141

CANADA

Roland Canada Music Ltd.
(Head Office)
13880 Mayfield Place
Richmond B. C., V6V 2E4
CANADA
☎ (604)270 - 6626

Roland Canada Music Ltd.
9425 Transcanadienne
Service Rd. N.,
St Laurent, Quebec H4S 1V3
CANADA
☎ (514)335 - 2009

Roland Canada Music Ltd.
346 Watline Avenue,
Mississauga, Ontario L4Z 1X2
CANADA
☎ (416)890 - 6488

AUSTRALIA

Roland Corporation
(Australia) Pty. Ltd.
(Head Office)
38 Campbell Avenue
Dee Why West. NSW 2099
AUSTRALIA
☎ (02)982 - 8266

Roland Corporation
(Australia) Pty. Ltd.
(Melbourne Office)
50 Garden Street
South Yarra, Victoria 3141
AUSTRALIA
☎ (03)241 - 1254

NEW ZEALAND

Roland Corporation (NZ) Ltd.
97 Mt. Eden Road, Mt. Eden,
Auckland 3
NEW ZEALAND
☎ (09)398 - 715

UNITED KINGDOM

Roland(UK)Ltd.
Amalgamated Drive
West Cross Centre, Brentford,
Middlesex TW8 9EZ,
UNITED KINGDOM
☎ (81)568 - 4578

WEST GERMANY

Roland Elektronische
Musikinstrumente
Handelsgesellschaft mbH.
Oststrasse 96,
2000 Norderstedt
WEST GERMANY
☎ 040/52 60 09 25

BELGIUM/HOLLAND/ LUXEMBOURG

Roland Benelux N. V.
Houtstraat 1
B - 2431 Oevel - Westerlo
BELGIUM
☎ 014 - 58 45 35

DENMARK

Roland Scandinavia A/S
Langebrogade 6
Box 1937
DK - 1023 Copenhagen K.
DENMARK
☎ 31 - 95 31 11

SWEDEN

Roland Scandinavia A/S
DanvikCenter 28 A, 2 tr.
S - 131 30 Nacka,
SWEDEN
☎ 08 - 702 00 20

NORWAY

Roland Scandinavia
Avd. Norge
Lilleakerveien 2
Postboks 95 Lilleaker
N - 0216 Oslo 2
NORWAY
☎ 02 - 73 00 74

FINLAND

Fazer Musik Inc.
Länsituulentie
POB 169
SF - 02101 Espoo
FINLAND
☎ 0 - 43 50 11

ITALY

Roland Italy S. P. A.
Viale delle Industrie 8
20020 ARESE MILANO
ITALY
☎ 02 - 93581311

SPAIN

Roland Electronics
de España S. A.
Bolivia 239
08020 Barcelona
SPAIN
☎ 93 - 308 - 1000

SWITZERLAND

Musitronic AG
Gerberstrasse 5, CH - 4410
Liestal
SWITZERLAND
☎ 061/921 16 15

Roland CK (Switzerland) AG
Hauptstrasse 21
CH - 4456 Tenniken
SWITZERLAND
☎ 061/98 60 55
Repair Service by Musitronic AG

FRANCE

Musikengro
102, Avenue Jean - Jaures
69007 Lyon Cedex 07
FRANCE
☎ (7)858 - 54 60

Musikengro
(Paris Office)
Centre Region Parisienne
41 rue Charles - Fourier,
94400 Vitry s/Seine
FRANCE
☎ (1)4680 86 62

AUSTRIA

E. Dematte & Co.
Neu - Rum Siemens - Strasse 4
A - 6021 Innsbruck Box 591
AUSTRIA
☎ 43(05222)63 451

GREECE

V. Dimitriadis & Co. Ltd.
2 Fidiou Str., GR 106 78
Athens
GREECE
☎ 3620130

PORTUGAL

Casa Caius Instrumentos
Musicais Lda.
Rua de Santa Catarina 131
Porto
PORTUGAL
☎ 02 - 38 44 56

HUNGARY

Intermusica Ltd.
Warehouse Area 'DEPO'
Budapest. P.O. Box 3,
2045 Torokbalint
Budapest
HUNGARY
☎ 1868905

BRAZIL

Oliver do Brazil S.A.
Instrumentos Musicais
Rua Ludovico Ariostos, 55
Butanta Cep. 05542,
Sao Paulo - SP
BRAZIL
☎ 5511 869 2561



Roland ep·5 DIGITAL PIANO

MIDI GUIDEBOOK

Read This If You Intend To Use MIDI To Join Your Keyboard With Other Electronic Instruments or Computers

The term MIDI is an acronym for the "Musical Instrument Digital Interface." MIDI is a standard that was created to allow electronic musical instruments, computers and other devices to communicate with each other. The great majority of contemporary electronic instruments provide MIDI compatibility.

A device equipped with MIDI is easily identified by the fact that it has one or more MIDI Connectors. In order to share performance information with other units, cables need to be connected using these connectors.

The ep-5 has a MIDI IN connector, used to receive MIDI messages; and a MIDI OUT connector, from which it sends messages.

The MIDI feature makes possible applications such as below:

- **The notes you play on the ep-5 can be relayed and sounded simultaneously on other MIDI-equipped instruments or sound module (*1).**
- **The ep-5 can be sounded under the control of another MIDI-equipped keyboard, or a sequencer (*2).**
- **Everything you play on the ep-5 can be recorded into a sequencer (*2).**

(*1) A sound module is a device which generates sound as a result of whatever information it receives at its MIDI IN connector. In appearance it is often box-like. Among Roland products the MT-32 is probably the most well known.

(*2) A sequencer is a device which is capable of recording and playing back MIDI messages. The PR-100 Recorder is a representative example of a Roland sequencer. There is also the MT-100, which combines a sequencer and sound module in the same unit.

MIDI Connections

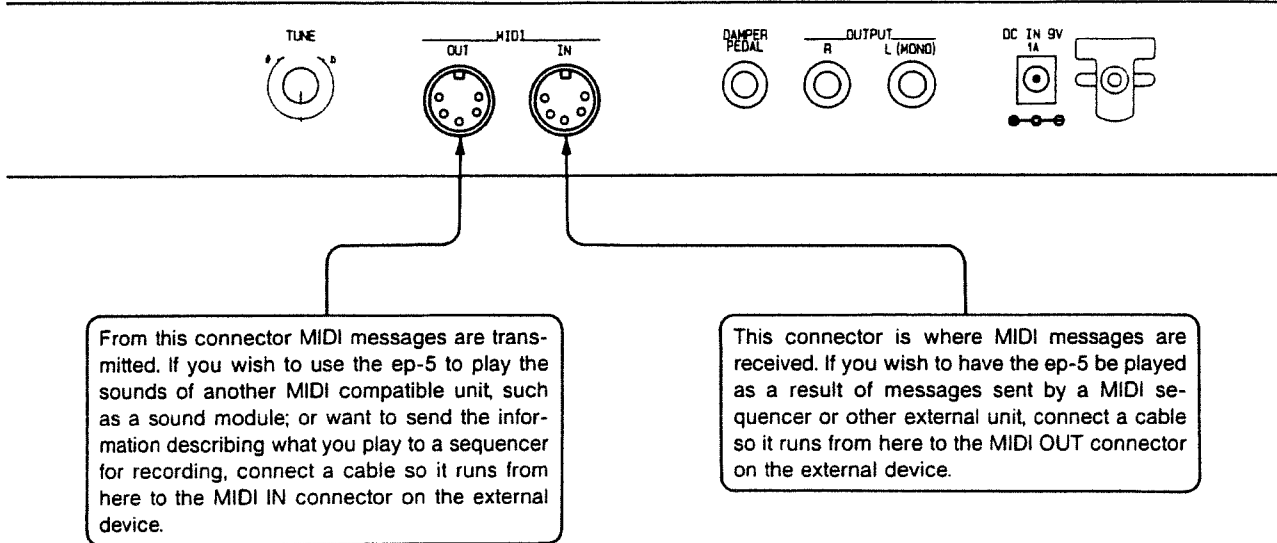

In order to make the connections between the connectors on two units, you will need to have at least one MIDI Cable. (MSC-15/25/50, sold separately.)

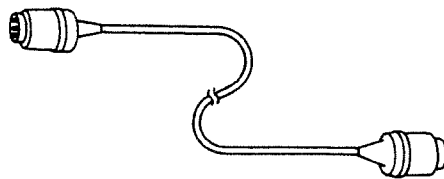

Example Setups

- Connecting a sound module, such as the MT-32

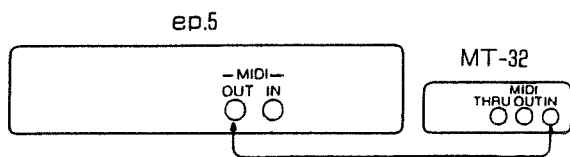

- Connecting a sequencer

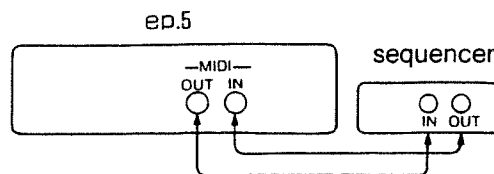

- Connecting the MT-100

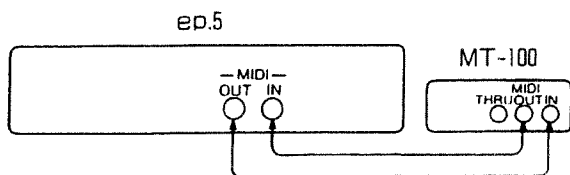

Local On/Off

In a setup where the ep-5 is combined with a sequencer, the sequencer would usually be set at "Soft Thru ON." In this case, as explained below, the ep-5 should be set at "Local OFF."

With the cable connections between the ep-5 and the sequencer made as illustrated below, what you play can be recorded into the sequencer; and the sequencer can be played back to hear a reproduction of of what you played.

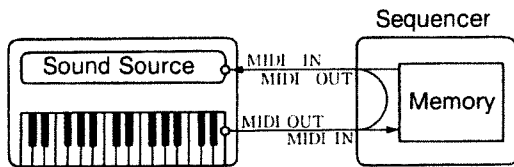

Take for example that "Soft Thru" on the sequencer is "ON", and Local is left at "ON" on the ep-5 — each note played will then sound twice. This may cause the music to sound somewhat strange, and can result in some notes being omitted.

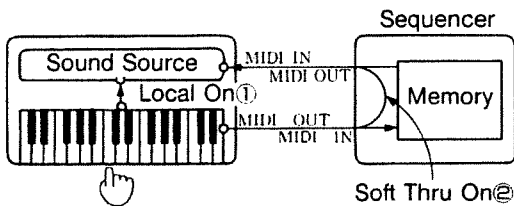

Key pressed once, yet note sounds twice.

The reason the above occurs is because the keyboard's performance information reaches the sound source by means of two paths:

- ① The ep-5's internal circuitry.
- ② The "Soft Thru" feature on the sequencer, which when ON, sends from MIDI OUT a copy of everything received.

Since this situation is undesirable, path ① can be disabled. To do this the unit is set to "Local OFF".

The ordinary condition — where path ① remains operative — is referred to as "Local ON".

LOCAL ON

Ordinary condition — the keyboard and the internal sound module are connected.

Sound is produced

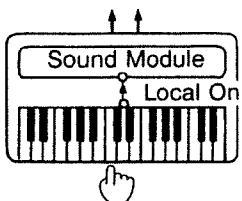

LOCAL OFF

Since there is no longer a connection between the keyboard and the internal sound module, when the keyboard is played no sound is produced.

No sound is produced

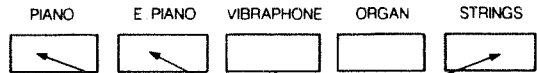
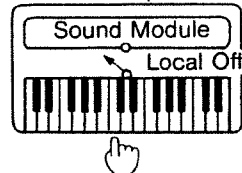

While holding these down, press the key for either "On" or "Off."

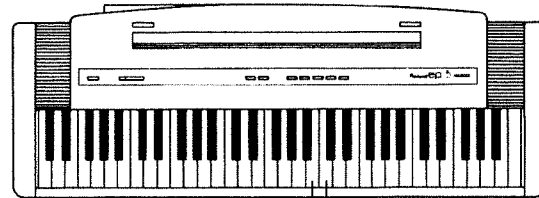

ON: Local On
OFF: Local Off

*Each time power is turned on this setting will always be at "ON."

Omni On/Off

When set to "Omni On", MIDI messages received on any of the channels will result in sound being produced.

With the ep-5 set to Omni On, when data is received from a sequencer or other device you will be able to hear all the performance data for all the channels played at the same time. This makes it convenient for times when you wish to check how a complete arrangement sounds.

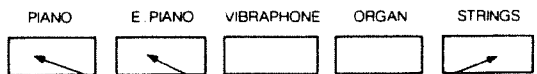

While holding these down, press the key for either "On" or "Off."

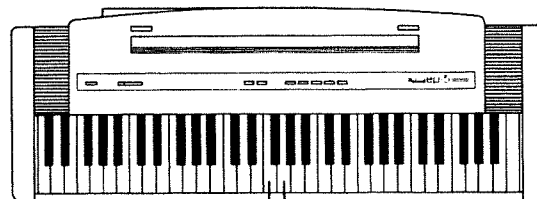

ON: Omni On
OFF: Omni Off

* Each time power is turned on, the instrument will be at "Off."
* This setting switches to Omni Off whenever selection of a particular Receive channel is made.

Setting the MIDI Channel

MIDI communication takes place on separate channels (MIDI Channels), numbered from 1 through 16. The channel used by the transmitting unit must be matched with that used by the receiving unit. Only then will sound be produced as expected.

- In a setup where you wish to play the ep-5 and also have another MIDI-equipped instrument or sound module play the same notes, you first should set the channel used for reception on your external device to the same channel that you have the ep-5 set to use for transmission.
- If using another MIDI keyboard as a master instrument, and you wish to have the ep-5 played by it, you would need to set the channel used for reception on the ep-5 to the same channel that the master keyboard will be transmitting on.
- When wishing to have a sequencer play the ep-5, you need to set the channel used for reception on the ep-5 to the same channel that the recorded MIDI data is set to use.

Setting the Channel Used for Transmission

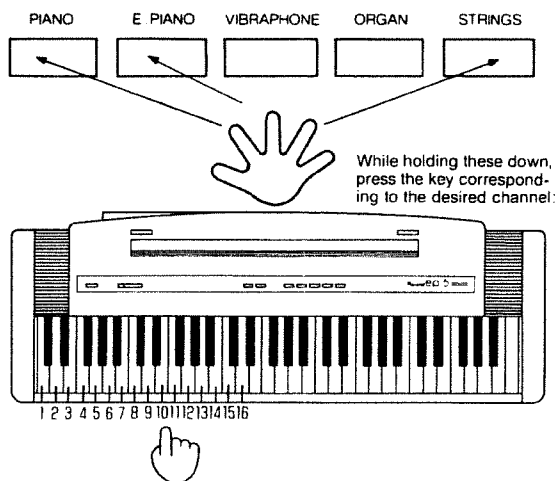

Setting the Channel Used for Reception

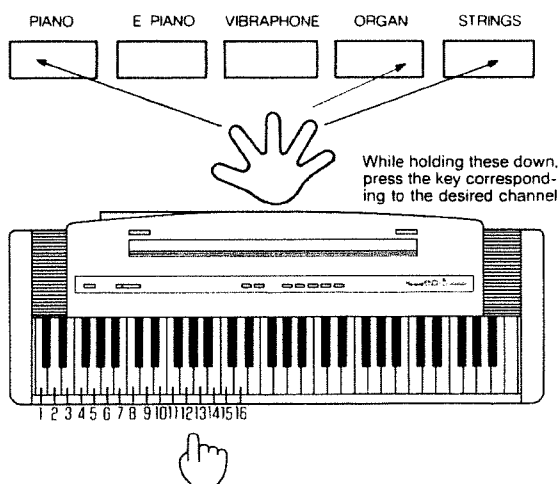

- * Each time power is turned on, the unit defaults to "1" as the channel used for both transmission and reception.

Turning Transmission/ Reception of Program Changes On and Off

Program Change messages basically state something to this effect: "A change has been made to the number such-and-such voice." They do not convey any further specifics about the voice, such as "The voice to which a change has been made is named Piano."

An instrument sends out a Program Change whenever a change in the voice being used is made. The Program Change is sent as a number which has been assigned to a certain voice. Such numbers and what they mean in terms of specific voices can vary from instrument to instrument. When another device receives a Program Change message, it will respond based on the number and what it means on that instrument — it changes to the voice that it uses for that particular number.

For this reason, it is entirely possible that on the master keyboard you could change to "Piano" and yet another instrument would begin sounding using "Vibraphone."

Correspondence charts can be referred to beforehand to avoid such surprises.

The setting shown here allows you to turn off Program Change communication. When off, the ep-5 no longer will transmit Program Change messages when its Voices are changed. Also, if the ep-5 should receive Program Changes sent from another unit, no change is made in its voices.

It should be so to "Off" if, for example, you want a connected unit to always use a particular voice while you play using a variety of voices on the ep-5.

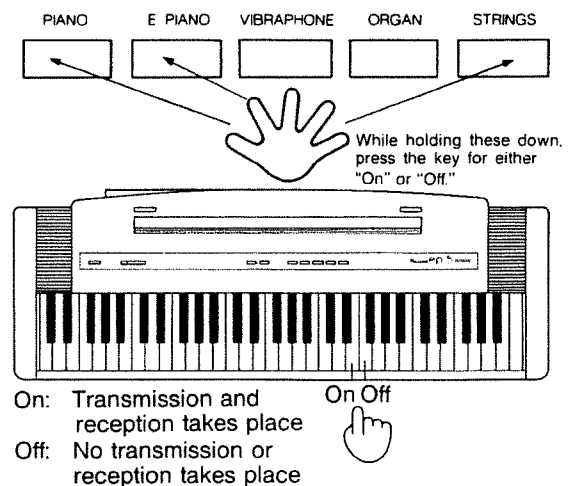

- * Each time power is turned on the instrument will always be at "On."

- * The ep-5 considers a combination of two Voices selected together as a separate Voice with a unique Program Change number. Moreover, it assigns individual numbers to every possible combination of a Voice plus Chorus, Reverb or both. (Please see the "Program Change Number Chart.")

Program Change Number Chart

VOICE	Program Change Number	
	Transmitted	Recognized
Piano	1	1 ~ 4
E. Piano	5	5 ~ 8
Vibraphone	9	9 ~ 12
Organ	13	13 ~ 16
Strings	17	17 ~ 20
Piano+E. Piano	21	21 ~ 24
Piano+Vibraphone	25	25 ~ 28
Piano+Organ	29	29 ~ 32
Piano+Strings	33	33 ~ 36
E. Piano+Vibraphone	37	37 ~ 40
E. Piano+Organ	41	41 ~ 44
E. Piano+Strings	45	45 ~ 48
Vibraphone+Organ	49	49 ~ 52
Vibraphone+Strings	53	53 ~ 56
Organ+Strings	57	57 ~ 60

Turning On/Off Transmission of MIDI During Recorder Playback

When the setting shown below is turned "On," you get the performance information for your recordings to be transmitted from MIDI OUT while playback takes place. This conveniently allows you to have any connected sound generating units also play a piece you have recorded.

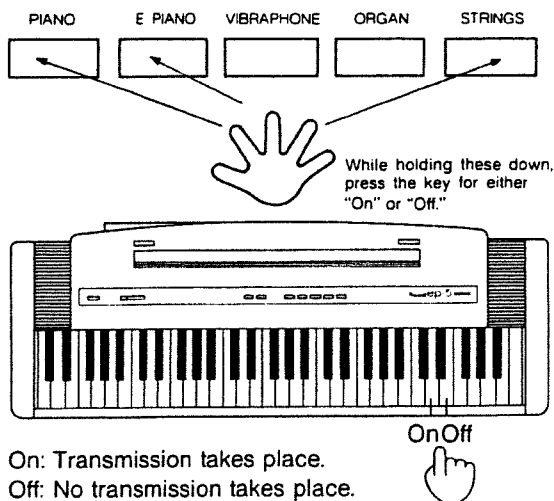

* Each time power is turned on this setting will always be at "Off."

Turning Transmission/Reception of Damper Messages On and Off

When the setting shown below is switched to "Off," Damper messages (Hold 1: Control Change No. 64) will no longer be transmitted when a pedal connected to the ep-5 is depressed. Also, should any external device send Damper messages, they will have no effect: sounds playing on the ep-5 will not be sustained.

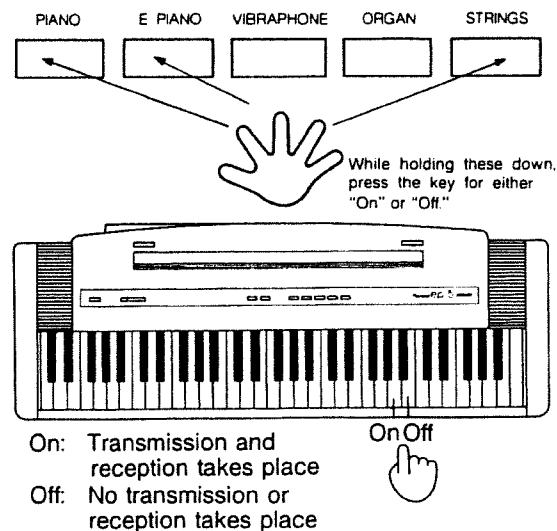

* Each time power is turned on this setting will always be at "On."

MIDI Implementation Chart

Function ...		Transmitted	Recognized	Remarks
Basic Channel	Default Changed	1 1 - 16	1 1 - 16	
Mode	Default Messages Altered	Mode 3 × *****	Mode 3 Omni Off, Poly	
Note Number	True Voice	36 - 96 *****	21 - 108 * 3 21 - 108 * 3	
Velocity	Note ON Note OFF	○ v = 1 - 127 ○ v = 1 - 127	○ v = 1 - 127 ×	
After Touch	Key's Ch's	× ×	× ×	
Pitch Bender		×	×	
Control Change		64 * 1	* 1	Hold 1
		121 ×	○	Reset All Controllers
Prog Change	True #	* 1 (* 2) *****	* 1 (0 - 59) * 2	
System Exclusive		×	×	
System Common	Song Pos Song Sel Tune	× × ×	× × ×	
System Real Time	Clock Commands	× ×	× ×	
Aux Messages	Local ON/OFF All Notes OFF Active Sense Reset	× × ○ ×	○ ○ ○ ×	
Notes		* 1 Can be set to ○ or × manually. * 2 0, 4, 8, 12, 16, 20, 24...56. * 3 21 - 107 (Strings is selected).		

Mode 1 : OMNI ON, POLY
 Mode 3 : OMNI OFF, POLY

Mode 2 : OMNI ON, MONO
 Mode 4 : OMNI OFF, MONO

○ : Yes
 × : No

Roland®

10517

UPC

10517



10501

Roland