

# DD-5 Digital Delay

## Owner's Manual

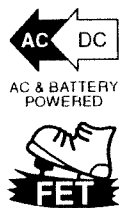

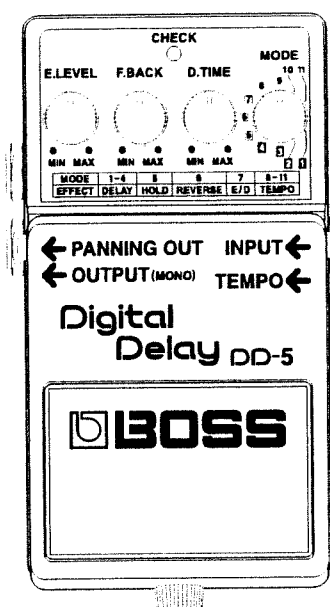

For EU Countries

This product complies with the requirements of European Directive 89/336/EEC.

For the USA

### FEDERAL COMMUNICATIONS COMMISSION RADIO FREQUENCY INTERFERENCE STATEMENT

This equipment has been tested and found to comply with the limits for a Class B digital device, pursuant to Part 15 of the FCC Rules. These limits are designed to provide reasonable protection against harmful interference in a residential installation. This equipment generates, uses, and can radiate radio frequency energy and, if not installed and used in accordance with the instructions, may cause harmful interference to radio communications. However, there is no guarantee that interference will not occur in a particular installation. If this equipment does cause harmful interference to radio or television reception, which can be determined by turning the equipment off and on, the user is encouraged to try to correct the interference by one or more of the following measures:

- Reorient or relocate the receiving antenna.
- Increase the separation between the equipment and receiver.
- Connect the equipment into an outlet on a circuit different from that to which the receiver is connected.
- Consult the dealer or an experienced radio/TV technician for help.

This device complies with Part 15 of the FCC Rules. Operation is subject to the following two conditions:

- (1) This device may not cause harmful interference, and
- (2) This device must accept any interference received, including interference that may cause undesired operation.

Unauthorized changes or modification to this system can void the users authority to operate this equipment. This equipment requires shielded interface cables in order to meet FCC class B Limit.

For Canada

#### NOTICE

This Class B digital apparatus meets all requirements of the Canadian Interference-Causing Equipment Regulations.

#### AVIS

Cet appareil numérique de la classe B respecte toutes les exigences du Règlement sur le matériel brouilleur du Canada.

2

Thank you, and congratulations on your choice of BOSS DD-5 Digital Delay.

Before using this unit, carefully read the sections entitled: "USING THE UNIT SAFELY" and "IMPORTANT NOTES" (separate sheet). These sections provide important information concerning the proper operation of the unit. Additionally, in order to feel assured that you have gained a good grasp of every feature provided by your new unit, this manual should be read in its entirety. The manual should be saved and kept on hand as a convenient reference.

© 1995 BOSS Corporation

All right reserved. No part of this publication may be reproduced in any form without the written permission of BOSS Corporation.

3

## FEATURES

The DD-5 is a compact Digital Delay unit containing a totally new DSP (digital signal processing) chip of superior quality. It offers a wealth of features in addition to high quality sound.

The DD-5 can create wide varieties of delay sounds from an extremely short delay (1 ms) to a long delay (2000 ms).

Set Delay Times to match the Tempo by depressing a special foot switch (optional) in time with the music, you can set delay times that match the tempo.

It features the Reverse Mode that creates a special effect that reminds you of reverse playback.

When the effects are turned off, there will not be any unnatural, abrupt elimination of the delay sounds.

When used in stereo output, the DD-5 can output the delay sound through the Panning Out Jack and Output Jack in sequence (Panning Delay Effect) or output the direct and delay sound separately.

4

## IMPORTANT NOTES

When using an AC adaptor, use only the specified device (PSA Series). Use of any other AC adaptor could result in damage, malfunction or electric shock.

### POWER SUPPLY

The power requirement for this unit is indicated on its nameplate (rear panel). Ensure that the voltage in your installation meets this requirement.

If the unit is to remain unused for an extended period of time, unplug the power cord.

The use of an AC adaptor is recommended as the unit's power consumption is relatively high. However, when using batteries, please use the alkaline type.

### PLACEMENT

Do not subject the unit to temperature extremes (eg., direct sunlight in an enclosed vehicle). Avoid using or storing the unit in dusty or humid areas, or areas that are subject to high levels of vibration.

### ADDITIONAL PRECAUTIONS

Protect the unit from strong impact.

Should a malfunction occur, or if you suspect there is a problem, discontinue use immediately. Contact qualified service personnel as soon as possible.

To avoid the risk of electric shock, do not open the unit.

### CHANGING BATTERY

Remove the battery whenever the unit is to remain unused for an extended period of time.

### POWER ON

This unit is equipped with a protection circuit. A brief interval (a few seconds) after power up is required before the unit will operate normally.

## PANEL DESCRIPTIONS

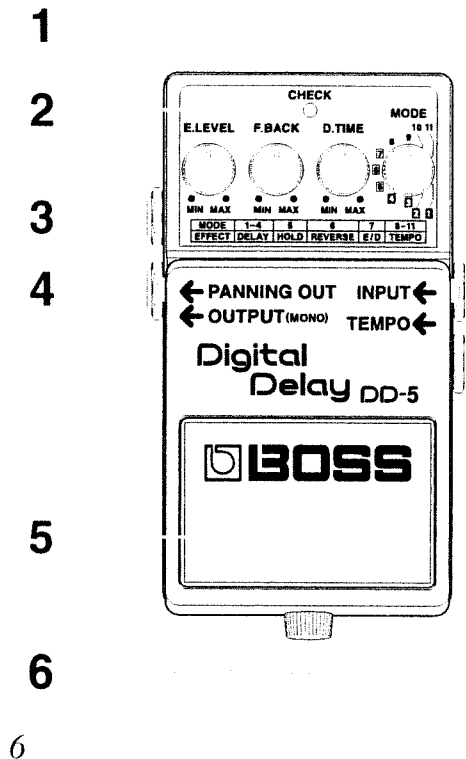

### 1. AC Adaptor Jack

Accepts connection of an AC Adaptor (optionally available BOSS PSA-Series). By using an AC Adaptor, you can play without being concerned about how much battery power you have left.

*\* As soon as you connect the AC adapter, the unit is turned ON.*

*\* You may find that it is a good idea to keep a battery installed in the unit even while using an adaptor. That way your playing won't be disrupted even if the adaptor is accidentally disconnected.*

*\* If you are going to use an AC adaptor, be sure to use the specified unit (BOSS PSA-Series). Use of any other adaptor may result in damage, malfunction or electric shock. Also, if you are not going to be using it for an extended period of time, disconnect the AC adaptor from the AC outlet.*

### 2. CHECK Indicator

This indicator shows whether an effect is ON/OFF, and also doubles as the Battery Check indicator. The indicator lights when an effect is ON. If this indicator goes dim or no longer lights while an effect is ON, the battery is near exhaustion and should be replaced immediately.

### 3. PANNING OUT Jack

This is an output jack used for stereo output. What is output through this jack differs depending on how the Mode Switch is set.

**Mode 1 to 6, 8 to 11 :**

Delay sound is output through the Panning Out and Output Jacks in sequence, and therefore the Panning Delay effect is created.

*\* When the Panning Out Jack is used, the interval of the delay sounds will be half of the delay time.*

**Mode 7 :**

Only the direct sound is output through the Panning Out Jack. Only effect sound is output through the Output Jack (MONO).

### 4. OUTPUT Jack (MONO)

The output jacks are used to connect the unit to amplifiers or other devices. When you are using a mono output, connect the cord to the OUTPUT jack (MONO).

### 5. Pedal Switch

This switch turns the effects ON/OFF.

### 6. Thumbscrew

This thumbscrew is loosened to open the pedal, allowing battery replacement. For instructions on how to replace the battery, please refer to "CHANGING THE BATTERY" (page 19).

### 7. INPUT Jack

This jack accepts input signals (coming from a guitar, some other musical instrument, or another effects unit).

*\* The INPUT jack also serves as the power switch while using the unit on battery power. Power is turned on whenever a plug is inserted into the INPUT jack, and is turned off when the plug is disconnected. When not using the unit, you should disconnect any cord connected to the INPUT jack.*

### 8. TEMPO Jack

Connect the Footswitch (FS-5U : optional) used for the Tempo Delay (Mode 8 to 11) to this jack.

*\* For a detailed explanation about how to use the Tempo Delay, see "USING THE TEMPO DELAY" (page 15).*

### EFFECT LEVEL Knob

### FEEDBACK Knob

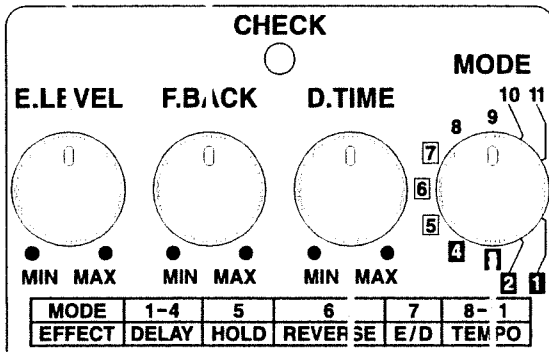

### DELAY TIME Knob

### MODE Switch

### EFFECT LEVEL Knob

This adjusts the output level of the effect sound.  
 \* Rotating this knob fully counterclockwise will mute the effect sound.

### FEEDBACK Knob

Adjusts the amount of feedback. When you alter the feedback amount, the number of repetitions of the delay sound will change.

\* This knob is not used in Mode 5 (Hold Mode).

### DELAY TIME Knob

Used to carry out precision adjustment of the delay time. The delay time will change within the selected range.

\* This knob is not used in Mode 5 (Hold Mode) or Mode 8 to 11 (Tempo Mode).

### MODE Switch

This switch is used to selected one of the DD-5's 11 modes. For information on each mode, please refer to "MODE CHART" (page 12) .

8

## MAKING THE CONNECTIONS

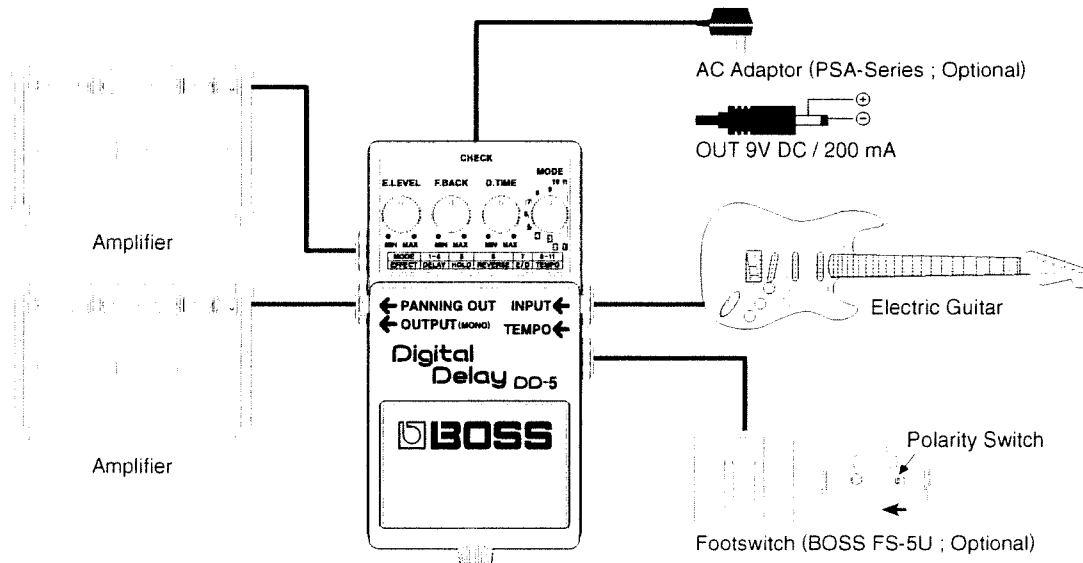

- \* While using the unit on battery power, power is turned on when a plug is inserted into the INPUT jack.
- \* The unit's output is muted for approximately 4 seconds after the power is turned on; no sound will be heard during this interval.
- \* Before connecting or disconnecting any patch cords, be sure all the volume controls in your system are set to minimum. This will help prevent any damage to system components.

9

## OPERATING THE UNIT

- Once the connections have been completed, set the panel's knobs as shown in the illustration.
- Step on the pedal switch to turn the effect ON. (The CHECK indicator lights up.)
- Select a mode using the MODE Switch.
  - \* When you have selected the Mode 5 (Hold Mode) or 8 to 11 (Tempo Mode), you need to take different procedures. Refer to the relevant explanation about the necessary operation.*
- Make fine adjustment of the delay time using the Delay Time Knob.

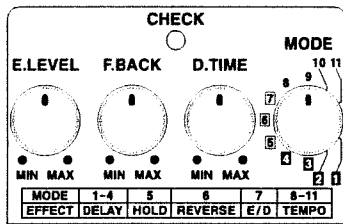

10

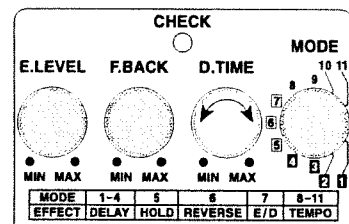
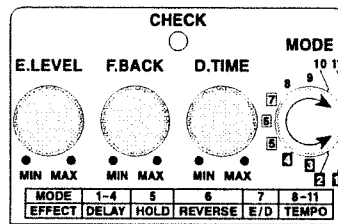

- Adjust the amount of feedback using the Feedback Knob.
- Adjust the output level of the effect sound using the Effect Level Knob.

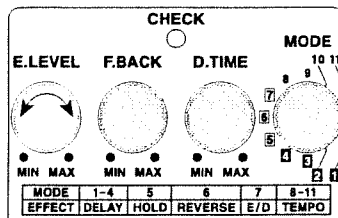
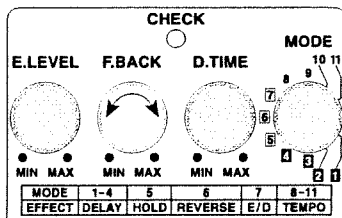

## MODE CHART

- Mode **1** DELAY : 1 to 50 ms  
Delay sound of 1 to 50 ms delay time.
- Mode **2** DELAY : 50 to 200 ms  
Delay sound of 50 to 200 ms delay time.
- Mode **3** DELAY : 200 to 800 ms  
Delay sound of 200 to 800 ms delay time.
- Mode **4** DELAY : 800 to 2000 ms  
Delay sound of 800 to 2000 ms delay time.
- Mode **5** HOLD  
This mode allows you to record performance data of up to 2 seconds and play it back repeatedly.  
*\* For a detailed explanation about operation of the Hold Mode, see "USING THE HOLD FUNCTION" (page 14).*

12

- Mode **6** REVERSE  
This mode creates a special effect that reminds you of reverse playback.
- Mode **7** E / D: 1 to 400 ms  
This mode allows you to output the effect sound and the direct sound separately. The effect sound is output through "OUTPUT (MONO)" and the direct sound is output through "PANNING OUT".  
*\* Only the effect sound is output in monaural output through "OUTPUT (MONO)".*
- Mode 8 TEMPO ♪
- Mode 9 TEMPO ♪
- Mode 10 TEMPO ♪
- Mode 11 TEMPO ♪<sub>3</sub>  
The delay time can be set with the Tempo and Mode by pressing the Footswitch (optional) along with the tempo of the song. For a detailed explanation, see "USING THE TEMPO DELAY" (page 15).

13

## USING THE HOLD FUNCTION

Using the Hold function, you can record up to 2 seconds performance data and play it back repeatedly. This, therefore, can create a special effect such as you play the musical instrument with the recorded data being played back.

**\* The recorded data will be erased when you change the positions of the Mode Switch or switch off the unit.**

### (PROCEDURE)

1. Set the Mode Switch to "5".  
The Check Indicator will go out.
2. Press the Pedal Switch to the performance you wish to record.  
The Check Indicator will flash and the performance will be recorded.
3. Release your foot from the Pedal Switch when the performance to be recorded is completed.  
The Check Indicator will be lit constantly and the recorded performance data will be played back repeatedly.
4. Adjust the output level for playback with the Effect Level Knob.
5. To stop playback, press the Pedal Switch. The Check Indicator will go out and returns to the status of Step 1.  
**\* If you stop playing, the recorded data will be erased and therefore cannot be played back again.**

**\* The maximum time for recording is 2 seconds. Even if you keep pressing the pedal for more than 2 seconds, the DD-5 will automatically stop recording then start playing the recorded data.**

14

## USING THE TEMPO DELAY

By pressing the Footswitch (FS-5U : optional, connected to the Tempo Jack) to the tempo of the song currently being played, you can set an appropriate delay time for the tempo or change the delay time during playing.

### <Connecting the Footswitch>

Connect the Footswitch to the Tempo Jack. Set the Polarity Switch on the connected Footswitch as shown below.

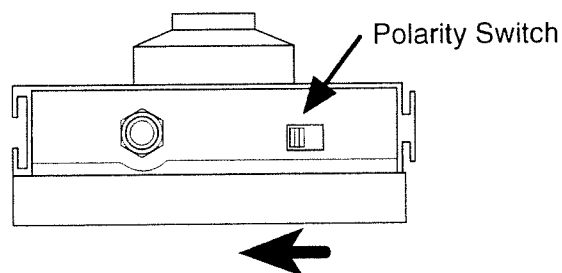

15



**(PROCEDURE)**

1. Select the Mode you like.  
Set the Mode depending on the interval of the delay sound.  
The delay time will be set as shown in the following page depending on the timing (calculated as the basic tempo : a quarter note) you press the Footswitch and the Mode setting.
2. Press the Footswitch to the tempo of the song being played.  
Pressing the Footswitch more than four times will automatically set the basic tempo according to the timing you press the pedal. When the basic tempo is set, the delay time will be determined depending on the basic tempo and the Mode selection.

*\* If the interval of pressing the Footswitch is longer than 2 seconds, the basic tempo will remain until it is pressed again more than four times.*

3. Adjust the Feedback Knob and Effect Level Knob.

*\* Changing the Modes will not affect the basic tempo.*

*\* Even if you select a Mode 8 to 11 (Tempo Mode), the delay time will be as follows when the basic tempo is not determined yet.*

- Mode 8 ♩ : 300 ms
- Mode 9 ♩ : 225 ms
- Mode 10 ♩ : 150 ms
- Mode 11 ♩<sub>3</sub> : 200 ms

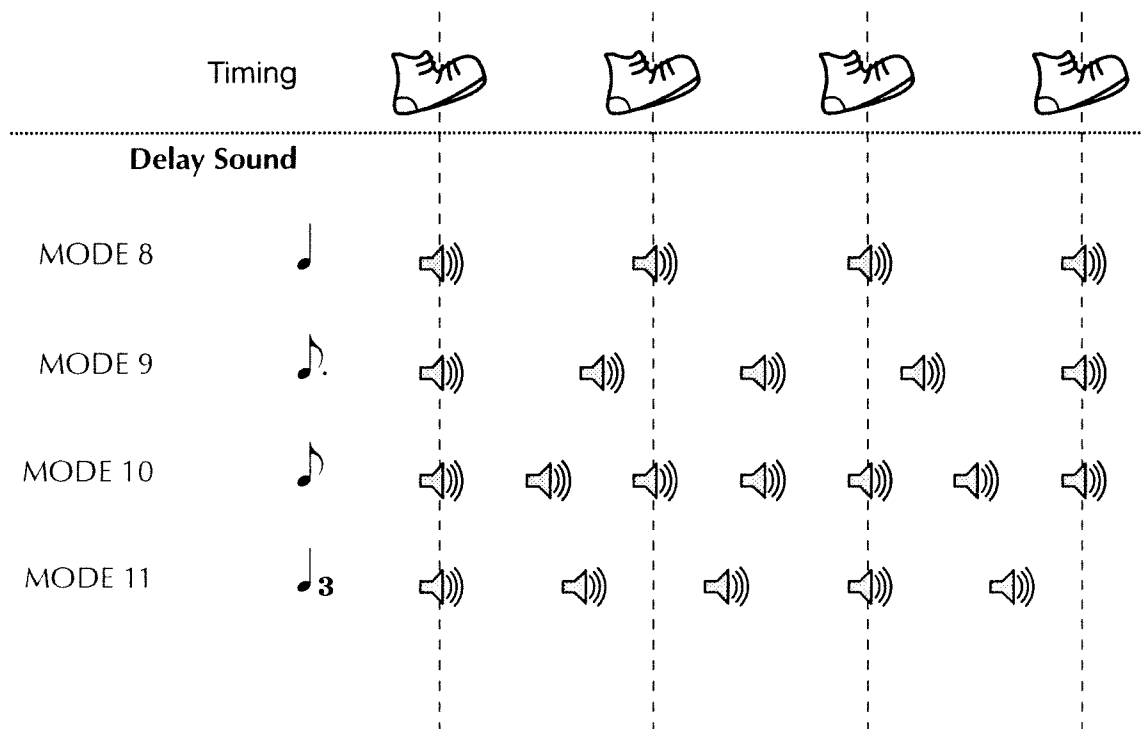

## USING THE MODE LABEL

The DD-5 is supplied with a mode Label which shows the effect obtained with each of the modes. The Label (which serves as a quick reference) can be attached as shown in the illustration.

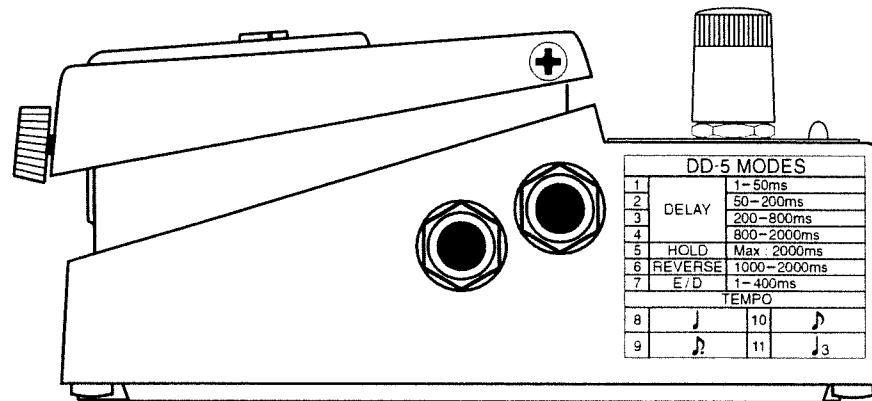

18

## CHANGING THE BATTERY

When the indicator goes dim or no longer lights while an effect is on, it means that the battery is nearly dead and must be replaced. Replace the battery following the steps below.

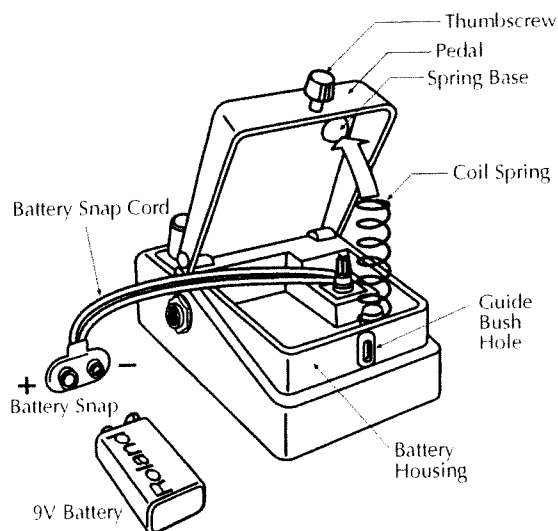

1. Loosen the thumbscrew at the front of the pedal, then lift the pedal upwards to open the unit.

*\* The thumbscrew can be left in the pedal while changing the battery.*

2. Remove the old battery from the battery housing, and remove the snap cord connected to it.

3. Connect the snap cord to the new battery, and place the battery inside the battery housing.

*\* Be sure to carefully observe the battery's polarity (+ versus -).*

4. Slip the coil spring onto the spring base on the back of the pedal, then close the pedal.

*\* Carefully avoid getting the snap cord caught in the coil spring.*

5. Finally, insert the thumbscrew into the guide bush hole and fasten it securely.

19

## SAMPLE SETTING

### Slow Ballad Solo

It is ideal for slow ballad solo.

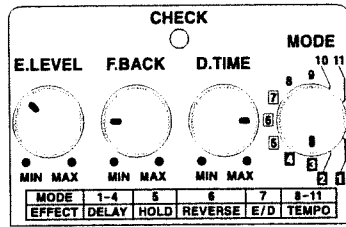

### Solo Play

It is ideal for playing a guitar solo.

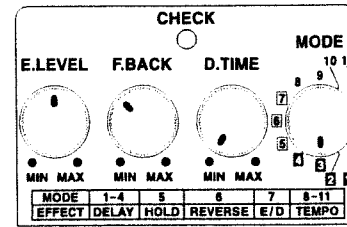

### Reverse Playback Delay

It is the delay that sounds like reverse playback. It may be unique delay sound.

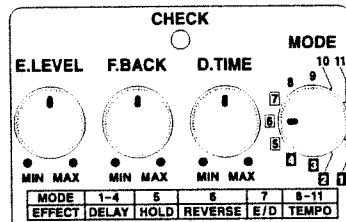

### Hard Refrain Sound

It is ideal for playing the refrain of hard distortion sound.

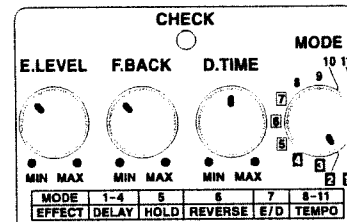

20

### Arpeggio

It is ideal for guitar sound played in arpeggio manner.

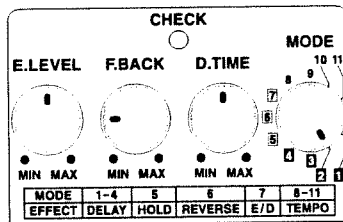

### Stereo Sound

If you output sounds in stereo using both the Panning Out and Output Jacks, it will sound as if it is panned to the right and left.

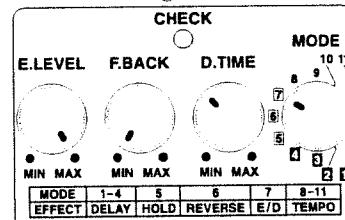

### Room Ambience Like Sound

It is the delay sound that sounds as if it was picked with an ambience microphone standing in a room.

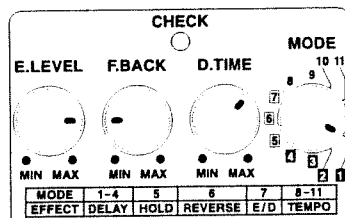

### Muting Arpeggio

If you play arpeggio by muting while pressing the FS-5U (connected to the TEMPO jack) four times, a normal arpeggio will turn to a spacious sound.

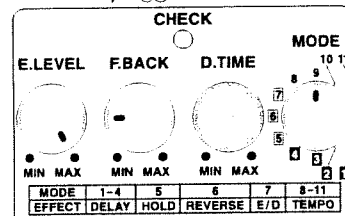

21

# SPECIFICATIONS

## DD-5 : Digital Delay

A/D Conversion .....	16 bit linear, 64 times oversampling, using quad : $\Delta\Sigma$ modulation, AF method
D/A Conversion .....	16 bit linear
Sampling Frequency .....	32 kHz
Nominal Input Level .....	-20 dBu
Input Impedance .....	1 M $\Omega$
Nominal Output Level .....	-20 dBu
Output Impedance .....	1 k $\Omega$
Dynamic Range .....	110 dB or greater (Direct) 100 dB or greater (Effect)

\* 0 dBu = 0.775 V rms

### About the AF Method (Adaptive Focus Method)

This new method dramatically reduces quantization noise by carrying out the digitization (A/D) in a manner that is optimum for the input signal.

22

Controls .....	Pedal Switch, EFFECT LEVEL Knob, FEEDBACK Knob, DELAY TIME Knob, MODE Switch
Indicator .....	CHECK Indicator (serves also as battery check indicator)
Connectors .....	INPUT Jack, OUTPUT Jack (MONO), PANNING OUT Jack, TEMPO Jack, AC Adaptor Jack (9 V DC)
Power Supply .....	9 V DC: Dry Battery (6AM6/9 V), AC Adaptor (PSA-Series: Optional)
Current Draw .....	65 mA (DC 9V) <b>* Expected battery life under continuous use:</b> Alkaline: 5 hours
Dimensions .....	These figures will vary depending on the actual conditions of use. 73 (W) x 129 (D) x 59 (H) mm 2-7/8 (W) x 5-1/8 (D) x 2-3/8 (H) inches
Weight .....	420 g / 15 oz (including battery)
Accessories .....	Owner's Manual, MODE Label, Dry Battery; 6AM6/9 V (alkaline), Leaflet ("USING THE UNIT SAFELY," "IMPORTANT NOTES," and "Information")
Options .....	AC Adaptor PSA-Series, Footswitch FS-5U

**\* In the interest of product development, the specifications and/or appearance of this unit are subject to change without prior notice.**

23



 Roland®

**2601720802**

UPC

2601720802



10981

 **BOSS**

2601720802