

BOSS

DC-3 Digital Dimension

INSTRUCTIONS

Please read the instructions carefully.

- The BOSS DC-3 is a completely digital dimension unit that allows extremely spacious and realistic chorus effect.
- The BOSS DC-3 is a completely digital dimension unit allows extremely spacious and realistic chorus effect.
- Owing to the high-quality digital delay line and the BOSS special digital modulation, the DC-3 can produce perfect modulation and synchronization of two phases.
- As well as the conventional preset system, the DC-3 features four manual control knobs which allows more variable and accurate sound creation.

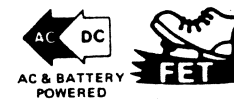
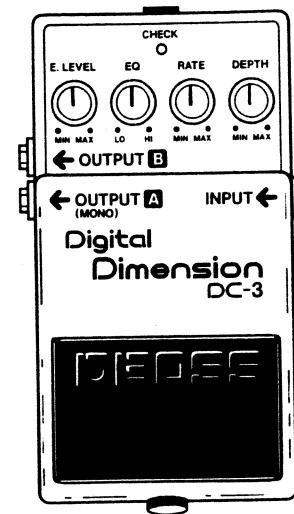

PANEL DESCRIPTION

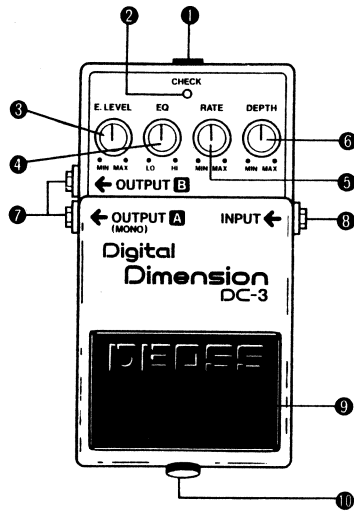

1 AC Adaptor

Connect an AC adaptor (BOSS PSA-120, 220 or 240) to this jack for long and secure operation from the mains. (Life of the BOSS alkaline battery is approximately 5 hours when it is continuously used.)

2 Check Indicator

This lights up when the effect is turned on, and therefore can be used as an effect on/off indicator.

* This indicator also serves as battery check. When it becomes dimmer or does not light at all, battery replacement is required.

3 Effect Level Knob

This adjusts the volume of the effect sound. Clockwise rotation raises the volume and counterclockwise rotation lowers it.

4 Equalizer Knob

This adjusts the tone of the effect sound. As you rotate the knob clockwise, higher frequencies are emphasized, and counterclockwise cuts them.

5 Modulation Rate Knob

This adjusts the speed of the modulation. Rotating the knob clockwise quickens the speed.

6 Modulation Depth Knob

This adjusts the depth of the modulation. Rotating the knob clockwise deepens the effect.

7 Output A/B Jacks

Connect an amplifier to these jacks. For monaural output, connect to the Output A Jack.

8 Input Jack

Connect an electronic musical instrument such as a guitar to this jack.

* Plugging in this jack will automatically switch the unit on. Be sure to disconnect the cord from this jack when the unit is not to be used.

9 Pedal Switch

Effect can be turned on or off by pressing the pedal.

10 Thumb Screw

Loosen the screw to open the cover for battery replacement.

* Do not remove the screw from the cover, or you may lose it.

CONNECTIONS

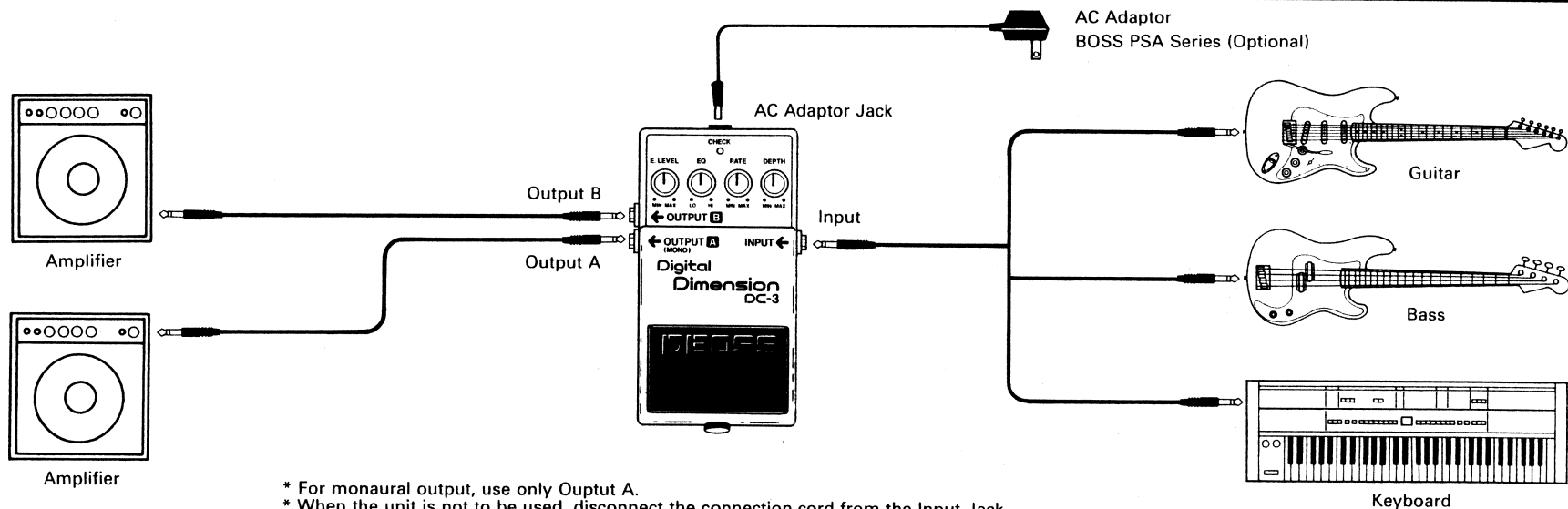

* For monaural output, use only Output A.

* When the unit is not to be used, disconnect the connection cord from the Input Jack.

OPERATION

- ① Set the controls on the panel as shown below.

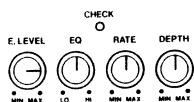

- ② Press the Pedal Switch to turn the effect on. (Make sure that the Check Indicator lights up.)

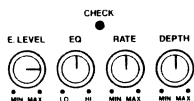

- ③ Adjust the speed of modulation using the Modulation Rate Knob.

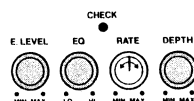

- ④ Adjust the depth of modulation using the Modulation Depth Knob.

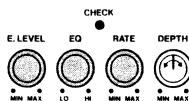

- * Moving the Rate or Depth Knob may stop either of two modulations, but this will become normal within five seconds.

- ⑤ Adjust the tone of effect sound using the Equalizer Knob.

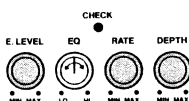

- ⑦ Adjust the volume of the effect sound using the Effect Level Knob.

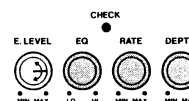

SETTING SAMPLES

Heavy dimension effect

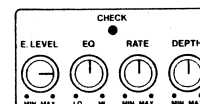

Warm dimension effect

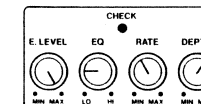

Bright dimension effect

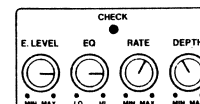

Tremolo/chorus effect

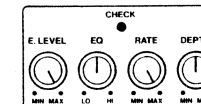

BATTERY REPLACEMENT

- ① Loosen the Screw of Pedal to open it.
- ② Take out the battery from the Battery Housing and disconnect the Battery Snap.
- ③ Replace with a new battery and connect the Battery Snap.
 - * Be sure that the polarity (+/-) of the battery is correct
- ④ Put the Coil Spring to the Spring Base and close the Pedal.
 - * Make sure that the Battery Snap is not caught in the Pedal or Coil Spring.
- ⑤ Insert the screw into the Guide Bush Hole and firmly tighten the screw.

Use one 9-volt battery

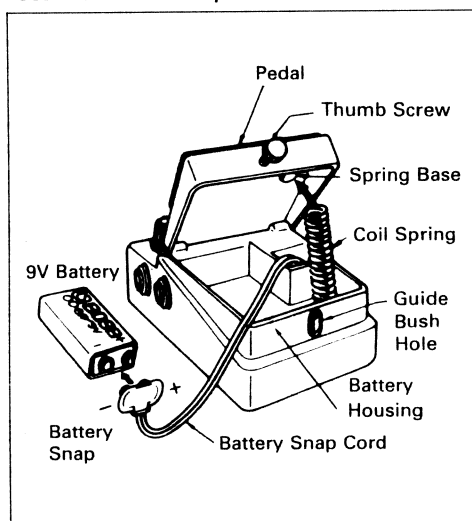

IMPORTANT NOTES

- If the battery voltage drops (=the Check Indicator lights dimmer), various troubles occur, such as the effect becomes weak, no sound is produced, etc. To prevent that, replace the battery immediately.
- Use the BOSS alkaline battery if possible.
- When replacing the battery, be sure that polarity is correct.
- When the unit is not to be used for a long period of time, remove the battery to prevent problems caused by battery leakage.
- Be sure to use the BOSS AC adaptor, PSA-120, 220 or 240 depending on the line voltage system in your country.
- Be sure to keep battery securely connected even while using the AC adaptor, then the unit will continue to operate even if the AC adaptor cord comes out during performance.
- Plugging in the Input Jack automatically turns the unit on, so disconnect the cord from the Input Jack when the unit is not in use.
- By the muting circuit system, no effect sound is heard for about 5 seconds after the unit is turned on.
- Do not let any solid or liquid substance into the unit.
- If the unit does not function properly, immediately turn it off, and call authorized Roland dealer in your country.

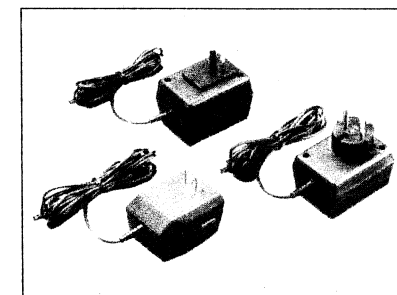

BOSS PSA-120/220/240 (Optional)

Roland®

2603068200

UPC 2603068200



18981

■ SPECIFICATIONS

Power: 9VDC 006P × 1, AC Adaptor: PSA series (optional)
Current Draw: 65mA
Controls: Effect Level, Equalizer, Rate and Depth.
Switches: Effect ON/OFF
Indicator: Effect ON/OFF (=Battery check)
Jacks: Input, Outputs A and B, AC Adaptor
Sampling Rate: 50kHz
Frequency Characteristic: 20Hz to 20kHz (± 3 dB)
Residual Noise: Less than -100dBm (IHF-A)
Input Impedance: 1M Ω
Output Load Impedance: More than 20k Ω
Dimensions: 70(W) × 55(H) × 125(D)mm / 2-3/4" × 2-3/16" × 4-15/16"
Weight: 450g / 1lb

*Specifications are subject to change without notice.

Products of Roland

Printed in Japan Feb. '88 E-3

Bescheinigung des Herstellers/Importeurs

Hiermit wird bescheinigt, daß der/die/das

BOSS DIGITAL DIMENSION DC-3

(Gerät, Typ. Bezeichnung)

in Übereinstimmung mit den Bestimmungen der

Amtsbl. Vfg 1046 / 1984

(Amtsblattverfügung)

funk-erstört ist.

Der Deutschen Bundespost wurde das Inverkehrbringen dieses Gerätes angezeigt und die Berechtigung zur Überprüfung der Serie auf Einhaltung der Bestimmungen eingeräumt.

Roland Corporation Osaka/Japan

Name des Herstellers/Importeurs

RADIO AND TELEVISION INTERFERENCE

Warning – This equipment has been verified to comply with the limits for a Class B computing device, pursuant to Subpart J, of Part 15, of FCC rules. Operation with non-certified or non-verified equipment is likely to result in interference to radio and TV reception.

The equipment described in this manual generates and uses radio-frequency energy. If it is not installed and used properly, that is, in strict accordance with our instructions, it may cause interference with radio and television reception.

This equipment has been tested and found to comply with the limits for a Class B computing device in accordance with the specifications in Subpart J, of Part 15, of FCC Rules. These rules are designed to provide reasonable protection against such a interference in a residential installation. However, there is no guarantee that the interference will not occur in a particular installation. If this equipment does cause interference to radio or television reception, which can be determined by turning the equipment on and off, the user is encouraged to try to correct the interference by the following measure:

- Disconnect other devices and their input/output cables one at a time. If the interference stops, it is caused by either the other device or its I/O cable.
- These devices usually require Roland designated shielded I/O cables. For Roland devices, you can obtain the proper shielded cable from your dealer. For non Roland devices, contact the manufacturer or dealer for assistance.
- If your equipment does cause interference to radio or television reception, you can try to correct the interference by using one or more of the following measures:
 - Turn the TV or radio antenna until the interferences stops.
 - Move the equipment to one side or the other of the TV or radio.
 - Plug the equipment farther away from the TV or radio.
 - Plug the equipment into an outlet that is on a different circuit than the TV or radio. (That is, make certain the equipment and the radio or television set are on circuits controlled by different circuit breakers or fuses.)
 - Consider installing a rooftop television antenna with coaxial cable lead-in between the antenna and TV.

If necessary, you should consult your dealer or an experienced radio/television technician for additional suggestions. You may find helpful the following booklet prepared by the Federal Communications Commission:

"How to Identify and Resolve Radio-TV Interference Problems"
This booklet is available from the U.S. Government Printing Office, Washington, D.C., 20402, Stock No. 004-000-00345-4.