

# DB-700 D-BASS AMPLIFIER



## OWNER'S MANUAL

Thank you, and congratulations on your choice of the Roland DB-700 bass amplifier.

Before using this unit, carefully read the sections entitled: "IMPORTANT SAFETY INSTRUCTIONS" (page 2), "USING THE UNIT SAFELY" (page 3), and "IMPORTANT NOTES" (page 5). These sections provide important information concerning the proper operation of the unit. Additionally, in order to feel assured that you have gained a good grasp of every feature provided by your new unit, OWNER'S MANUAL should be read in its entirety. The manual should be saved and kept on hand as a convenient reference.

### Contents

<b>IMPORTANT SAFETY INSTRUCTIONS</b> .....	<b>2</b>
<b>USING THE UNIT SAFELY</b> .....	<b>3</b>
<b>IMPORTANT NOTES</b> .....	<b>5</b>
<b>Introduction</b> .....	<b>6</b>
Main Features.....	6
Before You Use the DB-700 .....	6
<b>Button Names and Functions</b> .....	<b>7</b>
Front panel.....	7
Rear panel.....	8
<b>Connect your DB-700</b> .....	<b>10</b>
Turn the power on and off .....	10
<b>The Memory Function</b> .....	<b>11</b>
Calling Up Memory .....	11
Changing the Settings for Memory A and Memory B (Edit).....	11
Storing the Panel Settings in Memory A and Memory B (Write).....	11
<b>How to handle the Casters</b> .....	<b>12</b>
<b>Appendixes</b> .....	<b>13</b>
Block diagram .....	13
Factory-default Settings.....	13
Returning to the Factory-default Settings.....	13
Sample Settings.....	14
Specifications.....	16

 <b>ATTENTION</b>	<b>CAUTION</b> RISK OF ELECTRIC SHOCK DO NOT OPEN	 <b>ATTENTION</b>
RISK OF ELECTRIC SHOCK DO NOT OPEN		
<b>CAUTION:</b> TO REDUCE THE RISK OF ELECTRIC SHOCK, DO NOT REMOVE COVER (OR BACK). NO USER-SERVICEABLE PARTS INSIDE. REFER SERVICING TO QUALIFIED SERVICE PERSONNEL.		



The lightning flash with arrowhead symbol, within an equilateral triangle, is intended to alert the user to the presence of uninsulated "dangerous voltage" within the product's enclosure that may be of sufficient magnitude to constitute a risk of electric shock to persons.



The exclamation point within an equilateral triangle is intended to alert the user to the presence of important operating and maintenance (servicing) instructions in the literature accompanying the product.

INSTRUCTIONS PERTAINING TO A RISK OF FIRE, ELECTRIC SHOCK, OR INJURY TO PERSONS.

## IMPORTANT SAFETY INSTRUCTIONS SAVE THESE INSTRUCTIONS

**WARNING** - When using electric products, basic precautions should always be followed, including the following:

1. Read all the instructions before using the product.
2. Do not use this product near water — for example, near a bathtub, washbowl, kitchen sink, in a wet basement, or near a swimming pool, or the like.
3. This product should be used only with a cart or stand that is recommended by the manufacturer.
4. This product, either alone or in combination with an amplifier and headphones or speakers, may be capable of producing sound levels that could cause permanent hearing loss. Do not operate for a long period of time at a high volume level or at a level that is uncomfortable. If you experience any hearing loss or ringing in the ears, you should consult an audiologist.
5. The product should be located so that its location or position does not interfere with its proper ventilation.
6. The product should be located away from heat sources such as radiators, heat registers, or other products that produce heat.
7. The product should be connected to a power supply only of the type described in the operating instructions or as marked
8. The power-supply cord of the product should be unplugged from the outlet when left unused for a long period of time.
9. Care should be taken so that objects do not fall and liquids are not spilled into the enclosure through openings.
10. The product should be serviced by qualified service personnel when:
  - A. The power-supply cord or the plug has been damaged; or
  - B. Objects have fallen, or liquid has been spilled into the product; or
  - C. The product has been exposed to rain; or
  - D. The product does not appear to operate normally or exhibits a marked change in performance; or
  - E. The product has been dropped, or the enclosure damaged.
11. Do not attempt to service the product beyond that described in the user-maintenance instructions. All other servicing should be referred to qualified service personnel.

For the USA

### GROUNDING INSTRUCTIONS

This product must be grounded. If it should malfunction or breakdown, grounding provides a path of least resistance for electric current to reduce the risk of electric shock.

This product is equipped with a cord having an equipment-grounding conductor and a grounding plug. The plug must be plugged into an appropriate outlet that is properly installed and grounded in accordance with all local codes and ordinances.

**DANGER:** Improper connection of the equipment-grounding conductor can result in a risk of electric shock. Check with a qualified electrician or serviceman if you are in doubt as to whether the product is properly grounded. Do not modify the plug provided with the product — if it will not fit the outlet, have a proper outlet installed by a qualified electrician.

For the U.K.

**WARNING:** THIS APPARATUS MUST BE EARTHED  
**IMPORTANT:** THE WIRES IN THIS MAINS LEAD ARE COLOURED IN ACCORDANCE WITH THE FOLLOWING CODE.  
 GREEN-AND-YELLOW: EARTH, BLUE: NEUTRAL, BROWN: LIVE

As the colours of the wires in the mains lead of this apparatus may not correspond with the coloured markings identifying the terminals in your plug, proceed as follows:

The wire which is coloured GREEN-AND-YELLOW must be connected to the terminal in the plug which is marked by the letter E or by the safety earth symbol (⊕) or coloured GREEN or GREEN-AND-YELLOW.

The wire which is coloured BLUE must be connected to the terminal which is marked with the letter N or coloured BLACK.



The wire which is coloured BROWN must be connected to the terminal which is marked with the letter L or coloured RED.

The product which is equipped with a THREE WIRE GROUNDING TYPE LINE PLUG must be grounded.



# USING THE UNIT SAFELY

## INSTRUCTIONS FOR THE PREVENTION OF FIRE, ELECTRIC SHOCK, OR INJURY TO PERSONS

### About ⚠ WARNING and ⚠ CAUTION Notices







 <b>WARNING</b>	Used for instructions intended to alert the user to the risk of death or severe injury should the unit be used improperly.
 <b>CAUTION</b>	Used for instructions intended to alert the user to the risk of injury or material damage should the unit be used improperly. * Material damage refers to damage or other adverse effects caused with respect to the home and all its furnishings, as well to domestic animals or pets.

### About the Symbols







	The ⚠ symbol alerts the user to important instructions or warnings. The specific meaning of the symbol is determined by the design contained within the triangle. In the case of the symbol at left, it is used for general cautions, warnings, or alerts to danger.
	The ⊘ symbol alerts the user to items that must never be carried out (are forbidden). The specific thing that must not be done is indicated by the design contained within the circle. In the case of the symbol at left, it means that the unit must never be disassembled.
	The ● symbol alerts the user to things that must be carried out. The specific thing that must be done is indicated by the design contained within the circle. In the case of the symbol at left, it means that the power-cord plug must be unplugged from the outlet.

### ALWAYS OBSERVE THE FOLLOWING

#### **WARNING**

- Before using this unit, make sure to read the instructions below, and the Owner's Manual. 
- Do not open or perform any internal modifications on the unit. 
- Do not attempt to repair the unit, or replace parts within it (except when this manual provides specific instructions directing you to do so). Refer all servicing to your retailer, the nearest Roland Service Center, or an authorized Roland distributor, as listed on the "Information" page. 
- Never use or store the unit in places that are:
  - Subject to temperature extremes (e.g., direct sunlight in an enclosed vehicle, near a heating duct, on top of heat-generating equipment); or are 
  - Damp (e.g., baths, washrooms, on wet floors); or are 
  - Humid; or are
  - Exposed to rain; or are
  - Dusty; or are
  - Subject to high levels of vibration.
- Make sure you always have the unit placed so it is level and sure to remain stable. Never place it on stands that could wobble, or on inclined surfaces. 

#### **WARNING**

- The unit should be connected to a power supply only of the type described in the operating instructions, or as marked on the unit. 
- Do not excessively twist or bend the power cord, nor place heavy objects on it. Doing so can damage the cord, producing severed elements and short circuits. Damaged cords are fire and shock hazards! 
- This unit, either alone or in combination with an amplifier and headphones or speakers, may be capable of producing sound levels that could cause permanent hearing loss. Do not operate for a long period of time at a high volume level, or at a level that is uncomfortable. If you experience any hearing loss or ringing in the ears, you should immediately stop using the unit, and consult an audiologist. 
- Do not allow any objects (e.g., flammable material, coins, pins); or liquids of any kind (water, soft drinks, etc.) to penetrate the unit.   

- In households with small children, an adult should provide supervision until the child is capable of following all the rules essential for the safe operation of the unit. 

**⚠ WARNING**

- Protect the unit from strong impact. (Do not drop it!) 

---

- Do not force the unit's power-supply cord to share an outlet with an unreasonable number of other devices. Be especially careful when using extension cords—the total power used by all devices you have connected to the extension cord's outlet must never exceed the power rating (watts/amperes) for the extension cord. Excessive loads can cause the insulation on the cord to heat up and eventually melt through. 

---

- Before using the unit in a foreign country, consult with your retailer, the nearest Roland Service Center, or an authorized Roland distributor, as listed on the "Information" page. 

**⚠ CAUTION**

- The unit should be located so that its location or position does not interfere with its proper ventilation. 

---

- Always grasp only the plug on the power-supply cord when plugging into, or unplugging from an outlet. 

---

- Try to prevent cords and cables from becoming entangled. Also, all cords and cables should be placed so they are out of the reach of children. 

---

- If the unit could become a hazard if it moves, all caster wheels should be removed once the unit has been placed at the place of installation, or has been loaded onto a vehicle. 

---

- Never climb on top of, nor place heavy objects on the unit. 

---

- Never handle the power cord or its plug with wet hands when plugging into, or unplugging from, an outlet. 

---

- Before moving the unit, disconnect the power plug from the outlet, and pull out all cords from external devices. 

---

- Before cleaning the unit, turn off the power and unplug the power cord from the outlet. 

---

- Whenever you suspect the possibility of lightning in your area, pull the plug on the power cord out of the outlet. 

# IMPORTANT NOTES

In addition to the items listed under “IMPORTANT SAFETY INSTRUCTIONS” and “USING THE UNIT SAFELY” on pages 2–4, please read and observe the following:

## Power Supply

- Do not use this unit on the same power circuit with any device that will generate line noise (such as an electric motor or variable lighting system).
- Before connecting this unit to other devices, turn off the power to all units. This will help prevent malfunctions and/or damage to speakers or other devices.

## Placement

- Using the unit near power amplifiers (or other equipment containing large power transformers) may induce hum. To alleviate the problem, change the orientation of this unit; or move it farther away from the source of interference.
- This device may interfere with radio and television reception. Do not use this device in the vicinity of such receivers.
- Do not expose the unit to direct sunlight, place it near devices that radiate heat, leave it inside an enclosed vehicle, or otherwise subject it to temperature extremes. Excessive heat can deform or discolor the unit.
- To avoid possible breakdown, do not use the unit in a wet area, such as an area exposed to rain or other moisture.
- Do not allow rubber, vinyl, or similar materials to remain on the unit for long periods of time. Such objects can discolor or otherwise harmfully affect the finish.
- Do not put anything that contains water (e.g., flower vases) on the unit. Also, avoid the use of insecticides, perfumes, alcohol, nail polish, spray cans, etc., near the unit. Swiftly wipe away any liquid that spills on the unit using a dry, soft cloth.
- During operation, this device must be placed at a distance of no less than 50 cm from any walls.
- Do not allow objects to remain on top of the unit.

## Maintenance

- For everyday cleaning wipe the unit with a soft, dry cloth or one that has been slightly dampened with water. To remove stubborn dirt, use a cloth impregnated with a mild, non-abrasive detergent. Afterwards, be sure to wipe the unit thoroughly with a soft, dry cloth.
- Never use benzine, thinners, alcohol or solvents of any kind, to avoid the possibility of discoloration and/or deformation.
- For routine care of the carpeted area, use a brush with stiff bristles.

## Additional Precautions

- Use a reasonable amount of care when using the unit’s buttons, sliders, or other controls; and when using its jacks and connectors. Rough handling can lead to malfunctions.
- When connecting / disconnecting all cables, grasp the connector itself—never pull on the cable. This way you will avoid causing shorts, or damage to the cable’s internal elements.
- A small amount of heat will radiate from the unit during normal operation.
- To avoid disturbing your neighbors, try to keep the unit’s volume at reasonable levels. You may prefer to use headphones, so you do not need to be concerned about those around you (especially when it is late at night).
- When you need to transport the unit, package it in the box (including padding) that it came in, if possible. Otherwise, you will need to use equivalent packaging materials.
- At least two persons are required in order to safely lift the unit when it is to be moved.

# Introduction

## Main Features

---

- Thanks to FFP technology, this DSP (Digital Signal Processing) bass amplifier offers superior performance regardless of its compact and lightweight body.
- Benefits of FFP Technology
  - 1) FFP technology makes it possible to achieve dynamic, high-powered sound that surpasses the output spec. The Power Injection indicator allows you to monitor the effect.
  - 2) Although the cabinet is compact, the unit is able to deliver a truly powerful low end, far out of proportion to its size.
  - 3) You can obtain clear sound with excellent response.
- You can store the settings for controls in memory A or memory B (Memory feature). It's also possible to call up the contents of memory with a foot switch. This means you can also change amp settings quickly during live performances.
- The amplifier section employs COSM technology, which uses modeling to re-create sound characteristics originating in differences in amplification systems and circuit design. This makes it possible for you to obtain everything from high-response, wide-ranging sounds to overdriven sounds. The Compression feature even replicates the unique compression characteristics of amps through modeling.
- The amp is equipped with a three-band equalizer offering easy operability. Because the midrange-band frequencies can be changed, you can create a wide range of sounds. You can also use it in combination with the Shape switch to obtain a rich variety of sounds.
- This amp features a newly developed D-chorus that has been specially tuned for bass. Dynamic band-division processing is performed as appropriate for the input signal, to produce a great chorus effect that does not impair the low-frequency response even when you use "slap" playing techniques or when you play harmonics.
- The input and output connectors include a headphones jack with optimized tonal correction, a high-performance XLR-type DI connector, two types of Line Out jacks (an XLR type and a balanced phone jack), and convenient Insert jacks for connecting external effects units or other equipment, thus providing support for a wide variety of applications.



What's FFP (Feed Forward Processing) Technology?

FFP is innovative technology from Roland that predicts how to obtain optimal operation for the amplifier, cabinet, speaker, and respective input signals that make up the bass amp system. By performing signal processing based on these predictions, it obtains maximum performance from each of these components.



What's COSM (Composite Object Sound Modeling) Technology?

Technology that uses different means to create a virtual reconstruction of physical structures, materials, and so on that actually exist is called modeling technology. COSM is proprietary technology from Roland that combines several kinds of sound-modeling technology to create even newer sounds.

## Before You Use the DB-700

---

When you want to use the amplifier like a conventional analog amp or want to play sounds using the present control settings, such as when you've adjusted the controls to new settings, press the **MANUAL button** to make the indicator light up.

The factory-default control settings are stored in memory A and memory B (p. 13). When you switch on the power for the first time after purchase, the sounds play according to the settings in memory A, regardless of the present control settings.



*After that, starting with the next time you turn on the power, sounds are played with the settings in effect when the power was last switched off. For instance, if you turn off the power while the settings in memory A are in effect, sounds are played using the settings in memory A the next time you turn on the power.*

# Button Names and Functions

## Front panel

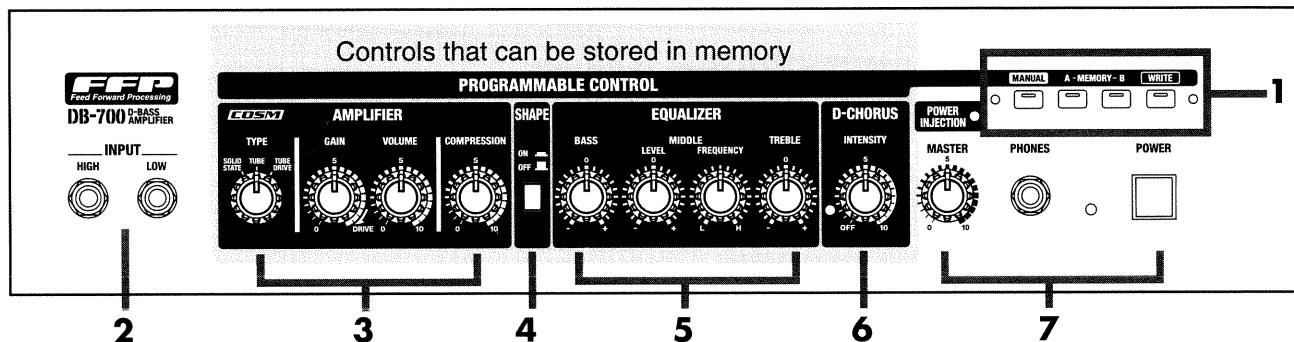

### 1. Control Buttons

You can store the settings of the controls in memory A or memory B. For more information, take a look at “The Memory Function” (p. 11).

#### MANUAL Button

To play sounds in a way that faithfully reflects the control settings, press this button to make the indicator light up (the Manual function).



You can use a foot switch to switch the Manual function on and off.

#### MEMORY A and MEMORY B Buttons

These buttons are used to call up control settings from memory A or memory B, and to store such control settings in memory A or memory B. To call up control settings, press the corresponding button to make the indicator light up.



You can use a foot switch to switch between memory A and memory B.

#### WRITE Button

Press this to store the control settings in memory.

### 2. Input Jacks

#### HIGH Jack

#### LOW Jack

Connect the bass guitar to the corresponding jack according to the bass guitar’s output level.

### 3. Amplifier

Thanks to the modeling function using COSM technology, you can make the settings for a variety of amp sounds.

#### TYPE Switch

This selects three amp types: solid state, tube, and tube drive.

#### GAIN Knob

This adjusts the input gain. You can make the settings for a wide range of sounds, from clean to overdrive.

#### VOLUME Knob

These adjust the volume level. When toggling between memory A and memory B as you use the amp, the **VOLUME knob** is handy for adjusting the volume level between the two.

#### COMPRESSION Knob

This adjusts the compression effect.

### 4. Shape

#### SHAPE Switch

Turning this switch on allows you to add the particular sound characteristics to each type of amp selectable with COSM amp modeling.

### 5. Equalizer

The DB-700 comes with a three-band equalizer. You can change midrange frequencies, so it’s possible to create a wide variety of sounds.

#### BASS Knob

This adjusts the tone of the bass range.

#### MIDDLE LEVEL Knob

This adjusts the tone of the middle range.

#### MIDDLE FREQUENCY Knob

This adjusts the frequency of the middle range.

#### TREBLE Knob

This adjusts the tone of the treble range.

## 6. D-Chorus

Thanks to dynamic band-splitting processing according to input signals, you can perform with a chorus effect with no loss in bass-range response.

### INTENSITY Knob

This adjusts the amount of chorus that's applied. When you don't want to use a chorus effect, set this to "Off" (the indicator goes dark). If you want to obtain a longer pre-delay effect, set this to a value of 7 or more.



You can use a foot switch to toggle the chorus effect on and off. Note that this is not possible when the **INTENSITY knob** is off.

## 7. Master

### Power Injection Indicator (Only when using speaker)

This indicator shows the power-boosting effect of DSP. The color of the indicator changes from green to orange according to the effect.

### MASTER Knob

This adjusts the volume level of the unit's speaker or the headphones.



The setting of the **MASTER knob** is not stored in memory A or memory B.

### PHONES Jack

This is for connecting headphones. Tonal correction is performed in order to produce the optimal headphones sound.



When headphones are connected, no sound is output to the unit's speaker.



Output to the headphones is monaural.



Before plugging in or unplugging headphones, be sure to adjust the **MASTER knob** to 0.

### POWER Switch

This switches the power on and off. The pilot light illuminates when the power is on.



Before turning the power on or off, be sure to put the **MASTER knob** at 0.

## Rear panel

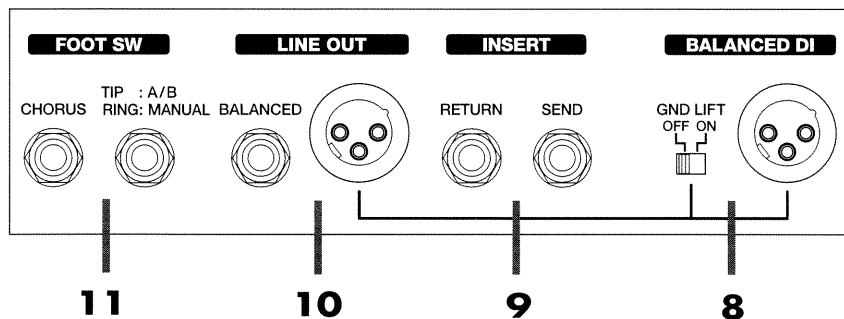

## 8. Balanced DI

### Balanced DI Connector

This is an XLR-type, superior sound quality, balanced DI connector for output of the direct sound of the bass guitar.

### GND LIFT Switch

This selects whether the balanced DI connector and the XLR-type Line Out jack are grounded or not. If hum occurs, try changing a switch position

## 9. Insert

These jacks are for connecting external effecters and the like.

### SEND Jack

This is the output jack that connects to the input on the external effects unit.

### RETURN Jack

This jack is for input of the returned sound from the external effects unit.

## 10. Line Out

These output preamp sound with D-chorus. There are two types of connectors: an XLR type and a balanced TRS 1/4" phone jack. Use the appropriate one for the equipment you're connecting.



## 11. Foot Switch

By connecting a foot switch such as the FS-5L (sold separately), you can control a variety of such as with your feet.

### TIP:A/B and RING:MANUAL Jack

You can use a foot switch to switch between memory A and memory B or switch the Manual function on and off.

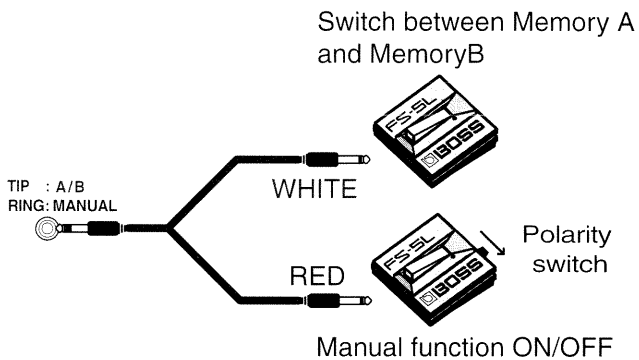

TIP: Switches between memory A and memory B.

RING: This switches the Manual function on and off. When switched off, the settings of the memory just selected are used.



(When using the FS-5L)

When using the FS-5L to switch the Manual function on and off, set the polarity switch as shown in the diagram above. With this setting, the indicator of the FS-5L will light when the Manual function is on.



When using a stereo connection cord, be sure to use two foot switches. Use with one plug empty may result in unstable operation.



When a foot switch is connected to this jack, the **MANUAL, MEMORY A**, and **MEMORY B buttons** do not function.



When using the amp with a single foot switch, use a monaural cord to connect the foot switch. In this case, this switches between memory A and memory B. Also **MANUAL button** does not function.

## CHORUS jack

This lets you switch the chorus effect on and off.



(When using the FS-5L)

Set the polarity switch as shown in the diagram below. With this setting, the indicator of the FS-5L will light when the Chorus effect is on.



When the D-chorus **INTENSITY knob** setting is made or stored while at "OFF," the foot switch cannot be used to switch chorus on or off.



If the D-chorus **INTENSITY knob** has been used to turn on the Chorus effect, using the foot switch to turn off the Chorus effect will cause the D-CHORUS indicator to blink.

# Connect your DB-700

Refer to the following diagram and connect the DB-700 to the external equipment you are using.

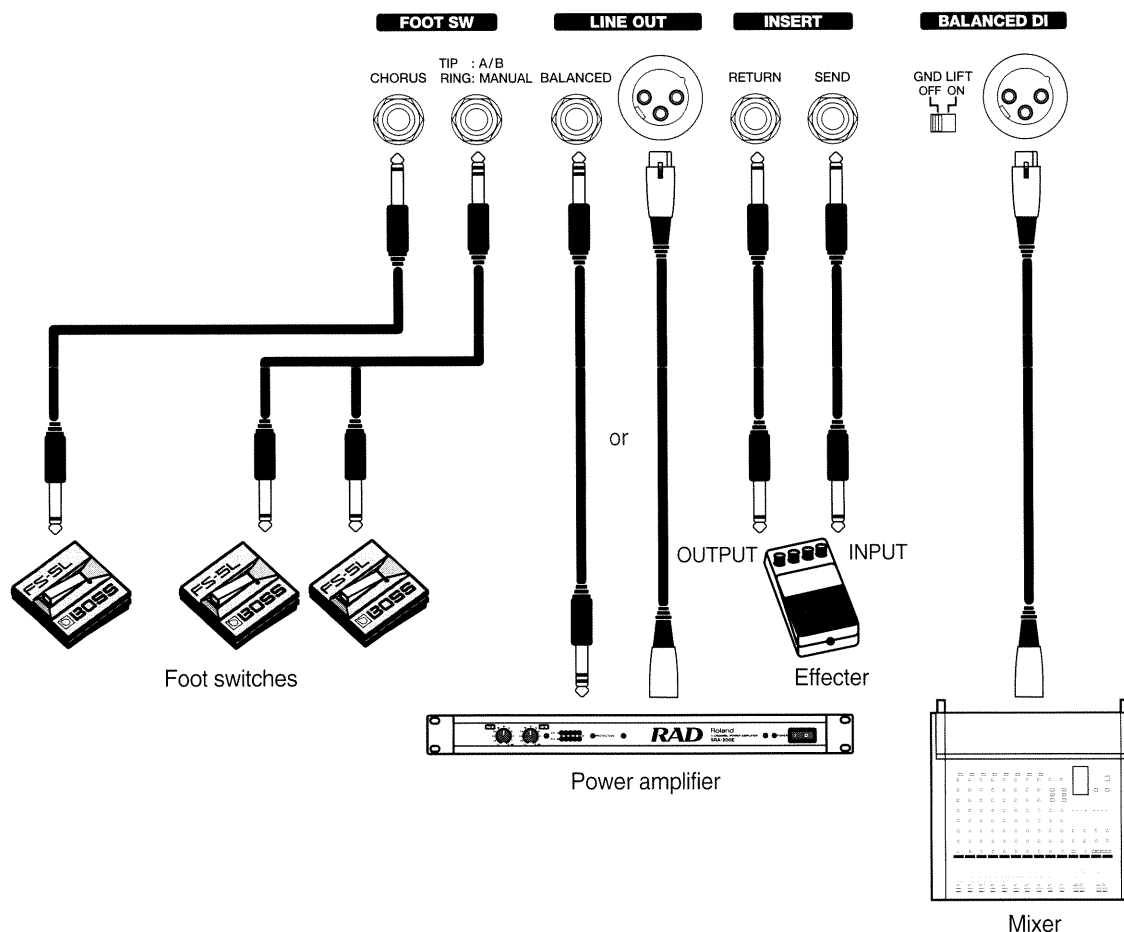

- \* To prevent malfunction and/or damage to speakers or other devices, always turn down the volume, and turn off the power on all devices before making any connections.
- \* The pin assignment for the XLR type connectors is as shown below. Before making any connections, make sure that this pin assignment is compatible with that of all your other devices.

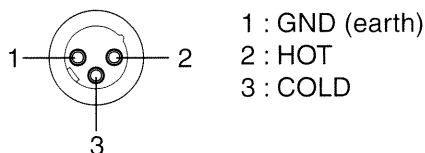

## Turn the power on and off

Once the connections have been completed, turn on power to your various devices in the order specified. By turning on devices in the wrong order, you risk causing malfunction and/or damage to speakers and other devices.

- Effector -> DB-700 -> others output equipment
- \* The heat-dissipation fins on the back of the unit become hot while the equipment is in operation. Do not touch them!
- \* This unit is equipped with a protection circuit. A brief interval (a few seconds) after power up is required before the unit will operate normally.
- \* Always make sure to have the volume level turned down before switching on/off power. Even with the volume all the way down, you may still hear some sound when the power is switched on/off, but this is normal, and does not indicate a malfunction.
- \* Although activation of the heat-protection circuitry, which occurs when the amp is used in overly hot weather or other such conditions, may result in interruptions of the sound, this does not indicate a malfunction.

# The Memory Function

## Calling Up Memory

1. Press the **MEMORY A** or **MEMORY B** button to choose the memory you want.



For more on the factory-default settings for memory A and memory B, see “Factory-default Settings” (p. 13).



You can also choose a memory using the foot switch. When doing so, however, be aware that the **MEMORY A** and **MEMORY B** buttons do not function.

## Changing the Settings for Memory A and Memory B (Edit)

1. Press the **MEMORY A** or **MEMORY B** button to choose the memory whose settings you want to change.



You can also choose a memory using the foot switch. When doing so, however, be aware that the **MEMORY A** and **MEMORY B** buttons do not function.

2. Operate the controls.

When you change the control settings, the indicator for the **MEMORY A** or **MEMORY B** button flashes.



When operating the controls, note that editing mode is actually entered after you’ve hit the same setting as the one in memory. This means it’s a good idea to give the control knob a big turn through all the possible settings, then bring it back to the setting you want.



If you switch off the power, or press the **MANUAL**, **MEMORY A**, or **MEMORY B** buttons before you’ve saved the settings using the Write procedure, all settings changes will be lost. Be sure to carry out a Write operation for any important settings you don’t want to lose.

## Storing the Panel Settings in Memory A and Memory B (Write)

You can store the settings for all controls except the **MASTER knob** in memory A or memory B.

1. When you’re done making the settings with the controls, press the **WRITE** button.
2. Press the **MEMORY A** or **MEMORY B** button to choose memory A or memory B.



You can also choose a memory using the foot switch.



To cancel the Write operation at this time, press the **MANUAL** button, so that return Manual settings.

3. Press the **WRITE** button to write (store) the settings to memory. The indicator flashes while writing is in progress, and remains steadily lit when it ends.



If it is necessary to adjust the volume-level balance between memory A and memory B, adjust the **VOLUME knob** on the amplifier, and then store the settings.

# How to handle the Casters

## Attaching and Removing the Casters

You can attach or remove casters as shown in the following figure.

- ! Be sure to remove all casters when accidental movement may be dangerous such as when setting up the DB-700 on stage or when transporting it in a vehicle.
- ! If casters have been attached to the amp, make sure it is used only on a stable, level surface.
- Attaching all of the casters can make it easier to move the amplifier.

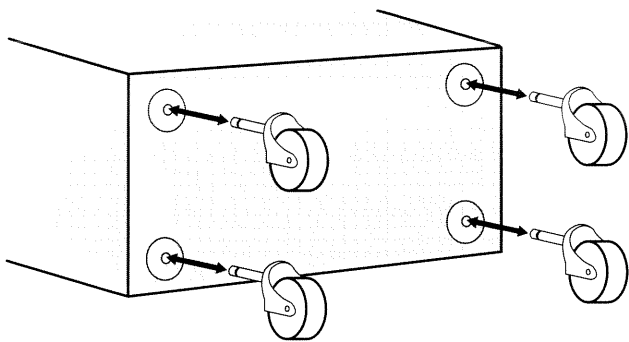

### (Usage Examples)

- You can use the DB-700 as a floor monitor by removing the two wheels on the rear-panel side and setting the amplifier at an angle. (Be sure it remains stable when you do so.)

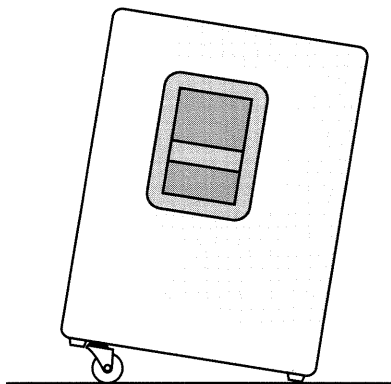

# Appendixes

## Block diagram

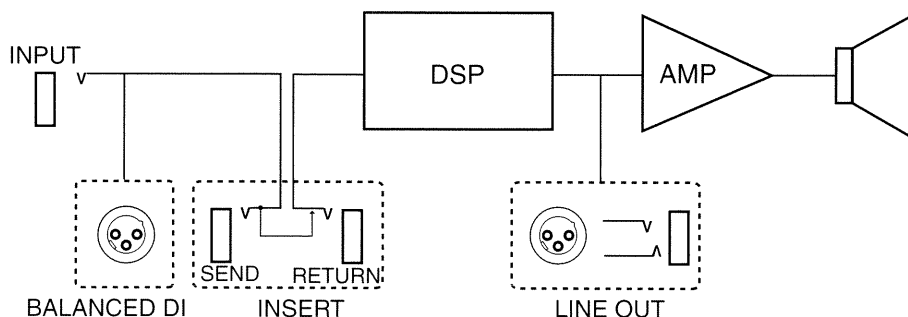

## Factory-default Settings

### Memory A: Slap Bass

Typical slap sound used in studios. Adjust the **COMPRESSION knob** to your taste.

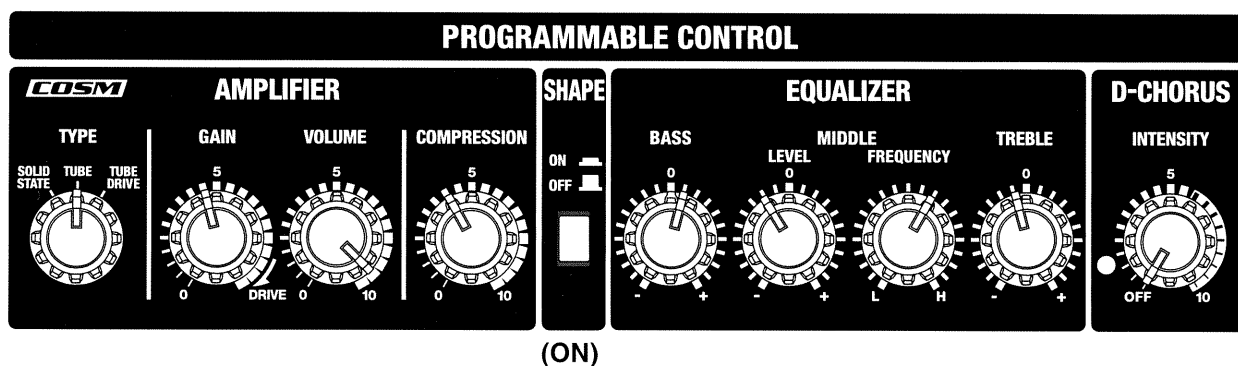

### Memory B: Rock Drive

Heavy rock sound. The amount of distortion can be adjusted with the **GAIN knob**.

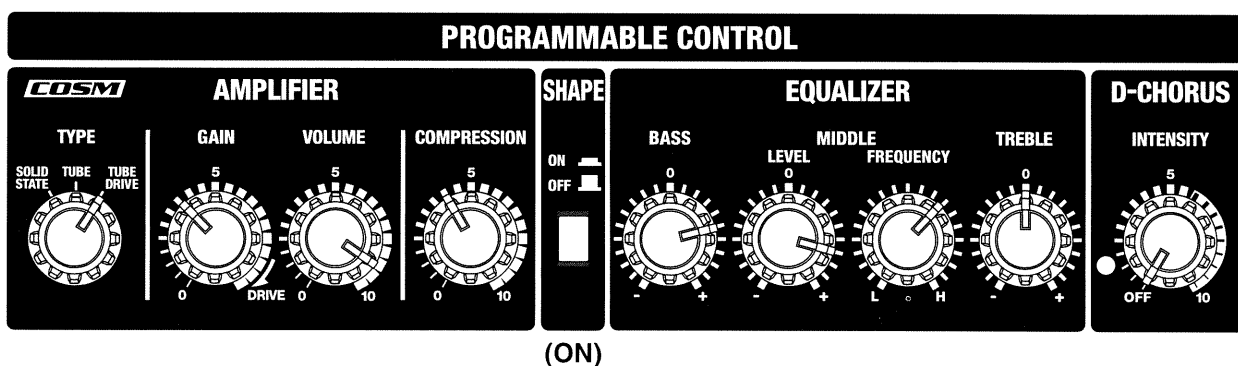

## Returning to the Factory-default Settings

To return the settings in memory A and B to their factory defaults, while holding down the **MANUAL button**, turn on the **POWER switch**.

## Sample Settings

In addition to the default settings, the following sample settings (which are geared toward specific styles of playing) are also provided.

**NOTE** Once you call up the following sample settings, any settings you've stored at Memory A and B will be lost.

### Sample 1

Hold down the **MEMORY A button** while you switch on the power. Then, select either the **MEMORY A button** or the **MEMORY B button**.

#### MEMORY A: Rock Bass

Standard rock sound. The amount of tube-compression can be adjusted with the **GAIN knob**.

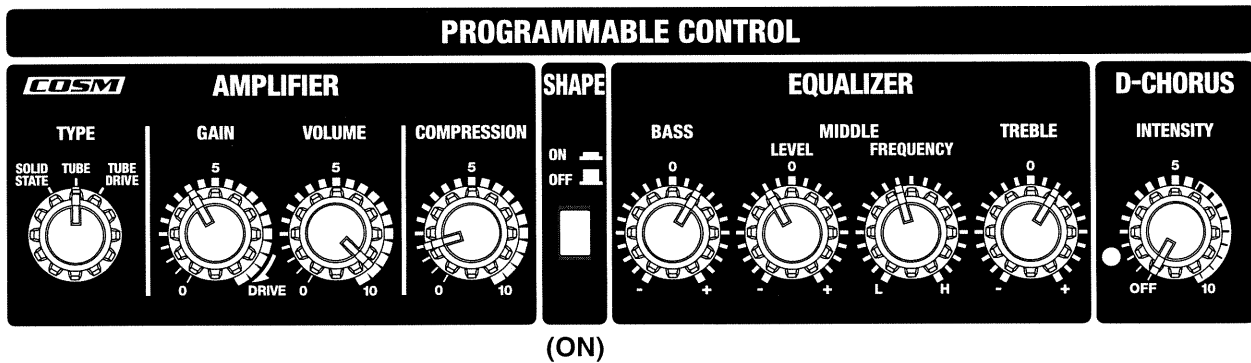

#### MEMORY B: Solo Fretless

Warm sound suited for fretless bass. Adjust the **D-CHORUS INTENSITY knob** to enhance the harmonics.

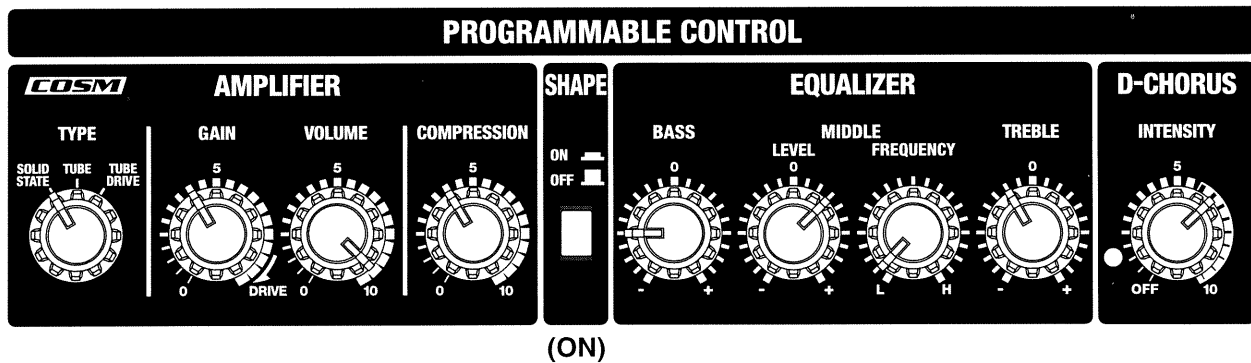

## Sample 2

Hold down the **MEMORY B button** while you switch on the power. Then, select either the **MEMORY A button** or the **MEMORY B button**.

### MEMORY A: Chorus Bass

Transparent chorus sound suited for slapping or flat-picking. The modulation amount can be controlled with the **D-CHORUS INTENSITY knob**.

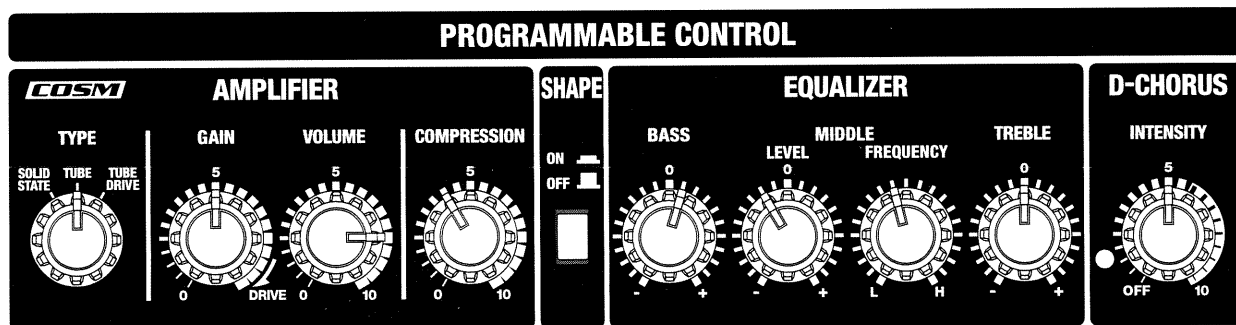

(ON)

### MEMORY B: Overdrive Bass

Wildly over-driven sound of the seventies. Great for flat-picking. The edge of the picking can be adjusted with the **TREBLE knob**.

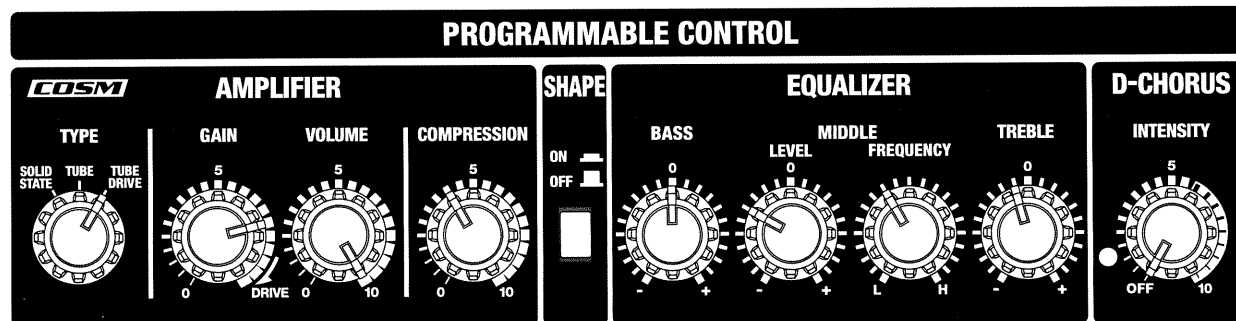

(OFF)

## Specifications

### Rated Power Output

250 W / 8 ohms

### Nominal Input Level (@1KHz)

INPUT HIGH	-30 dBm/1 M ohms
INPUT LOW	-20 dBm/300 k ohms
	(AMP TYPE: SOLID STATE)
INSERT RETURN	+4 dBm

### Nominal Output Level

BALANCED DI	+4 dBm
INSERT SEND	+4 dBm
LINE OUT (XLR type)	+4 dBm
LINE OUT (PHONE type)	+4 dBm

\* 0 dBm=0.775 Vrms

### Speakers

38 cm (15 inches) X 1

Horn Tweeter X 1

### Memory

A, B (2 memories)

### Controls

AMPLIFIER

- TYPE Switch (3 types)
- GAIN Knob
- VOLUME Knob
- COMPRESSION Knob

SHAPE Switch

EQUALIZER

- BASS Knob
- MIDDLE LEVEL Knob
- MIDDLE FREQUENCY Knob
- TREBLE Knob

D-CHORUS

- INTENSITY Knob (with switch)

MASTER Knob

PROGRAM

- MANUAL Button
- A Button
- B Button
- WRITE Button

POWER Switch

GND LIFT Switch

### Indicators

POWER INJECTION (2 colors)

D-CHORUS

POWER

### Connectors

INPUT Jacks (HIGH, LOW)

HEADPHONE Jack

BALANCED DI Connector

INSERT Jacks (SEND, RETURN)

LINE OUT Jacks (XLR type balanced, 1/4" TRS Phone type balanced)

FOOT SWITCH Jacks (TIP: A/B RING: MANUAL, CHORUS)

### Power Supply

AC 117 V, 230 V or 240 V

### Power Consumption

290 W (117 V, 230 V, 240 V)

### Dimensions

578(W) x 407 (D) x 598 (H) mm

22 - 13/16 (W) x 16 - 1/16 (D) x 23 - 9/16 (H) inches

(Include casters)

### Weights

34.0 kg / 75 lbs

### Accessories

Owner's Manual

Casters (x4)

### Options

Foot Switch FS-5L (BOSS)

\* In the interest of product improvement, the specifications and/or appearance of this unit are subject to change without prior notice.









This product complies with the requirements of European Directives EMC 89/336/EEC and LVD 73/23/EEC.

For EU Countries

## FEDERAL COMMUNICATIONS COMMISSION RADIO FREQUENCY INTERFERENCE STATEMENT

This equipment has been tested and found to comply with the limits for a Class B digital device, pursuant to Part 15 of the FCC Rules. These limits are designed to provide reasonable protection against harmful interference in a residential installation. This equipment generates, uses, and can radiate radio frequency energy and, if not installed and used in accordance with the instructions, may cause harmful interference to radio communications. However, there is no guarantee that interference will not occur in a particular installation. If this equipment does cause harmful interference to radio or television reception, which can be determined by turning the equipment off and on, the user is encouraged to try to correct the interference by one or more of the following measures:

- Reorient or relocate the receiving antenna.
- Increase the separation between the equipment and receiver.
- Connect the equipment into an outlet on a circuit different from that to which the receiver is connected.
- Consult the dealer or an experienced radio/TV technician for help.

Unauthorized changes or modification to this system can void the users authority to operate this equipment.  
This equipment requires shielded interface cables in order to meet FCC class B Limit.

For the USA

## NOTICE

This Class B digital apparatus meets all requirements of the Canadian Interference-Causing Equipment Regulations.

## AVIS

Cet appareil numérique de la classe B respecte toutes les exigences du Règlement sur le matériel brouilleur du Canada.

For Canada





 Roland®

---

**02235123**

UPC

02235123



10981

**Roland**