

# CUBE-20X

## Owner's Manual

Thank you, and congratulations on your choice of the Roland CUBE-20X Guitar Amplifier.

### Before using this unit, carefully read the sections entitled



- **IMPORTANT SAFETY INSTRUCTIONS** (page 2)
- **USING THE UNIT SAFELY** (page 3–5)
- **IMPORTANT NOTES** (page 5)

Additionally, in order to feel assured that you have gained a good grasp of every feature provided by your new unit, Owner's manual should be read in its entirety. The manual should be saved and kept on hand as a convenient reference.

### Main Features

- 20-watt output, high-performance, DSP guitar amp with built-in 20 cm (8-inch) speaker.
- The "LEAD" offers six different COSM pedal effects: ACOUSTIC, OVERDRIVE, DISTORTION, METAL, METAL STACK, and TUBE DRIVE.  
Composite Object Sound Modeling (**COSM**) is Roland's innovative and powerful sound modeling technology. COSM analyzes the many factors that make up the original sound, such as the electrical and physical characteristics of the original, and then produces a digital model that can reproduce the same sound.
- Channels can be switched between CLEAN and LEAD. Channel switching can be done via optional footswitch.
- The CUBE-20X includes Roland's Power Squeezer function. This feature enables you to reduce the maximum output from 20 watts to 2 watts at the press of a single button. When switched on, Power Squeezer reproduces the distortion of a fully-cranked power amp along with a great sound, regardless of the volume level, but with a 2-watt output that is easy to handle in the home.
- A tuner function is also included. This feature allows you to tune your guitar while the instrument is connected to the CUBE-20X.
- Includes easy-to-use, three-band equalizer (Bass/Middle/Treble).
- Onboard EFX section includes 4 types of digital effect, chorus, flanger, phaser and tremolo; footswitch (optional) can be used to switch EFX on and off.
- Separate "Delay" and "Reverb" effects provided in addition to the EFX.
- Equipped with "RECORDING OUT jack" convenient for use in recording and for use as headphone out.
- The unit is equipped with an external input jack, which is convenient for your practice sessions. Use this to play along with sounds from CD players and MP3 players.

**WARNING:** To reduce the risk of fire or electric shock, do not expose this apparatus to rain or moisture.

	<b>CAUTION</b> RISK OF ELECTRIC SHOCK DO NOT OPEN	
<b>ATTENTION:</b> RISQUE DE CHOC ELECTRIQUE NE PAS OUVRIR		
<b>CAUTION:</b> TO REDUCE THE RISK OF ELECTRIC SHOCK, DO NOT REMOVE COVER (OR BACK). NO USER-SERVICEABLE PARTS INSIDE. REFER SERVICING TO QUALIFIED SERVICE PERSONNEL.		



The lightning flash with arrowhead symbol, within an equilateral triangle, is intended to alert the user to the presence of uninsulated "dangerous voltage" within the product's enclosure that may be of sufficient magnitude to constitute a risk of electric shock to persons.



The exclamation point within an equilateral triangle is intended to alert the user to the presence of important operating and maintenance (servicing) instructions in the literature accompanying the product.

INSTRUCTIONS PERTAINING TO A RISK OF FIRE, ELECTRIC SHOCK, OR INJURY TO PERSONS.

## IMPORTANT SAFETY INSTRUCTIONS SAVE THESE INSTRUCTIONS

**WARNING** - When using electric products, basic precautions should always be followed, including the following:

1. Read these instructions.
2. Keep these instructions.
3. Heed all warnings.
4. Follow all instructions.
5. Do not use this apparatus near water.
6. Clean only with a dry cloth.
7. Do not block any of the ventilation openings. Install in accordance with the manufacturers instructions.
8. Do not install near any heat sources such as radiators, heat registers, stoves, or other apparatus (including amplifiers) that produce heat.
9. Do not defeat the safety purpose of the polarized or grounding-type plug. A polarized plug has two blades with one wider than the other. A grounding type plug has two blades and a third grounding prong. The wide blade or the third prong are provided for your safety. If the provided plug does not fit into your outlet, consult an electrician for replacement of the obsolete outlet.
10. Protect the power cord from being walked on or pinched particularly at plugs, convenience receptacles, and the point where they exit from the apparatus.
11. Only use attachments/accessories specified by the manufacturer.
12. Unplug this apparatus during lightning storms or when unused for long periods of time.
13. Refer all servicing to qualified service personnel. Servicing is required when the apparatus has been damaged in any way, such as power-supply cord or plug is damaged, liquid has been spilled or objects have fallen into the apparatus, the apparatus has been exposed to rain or moisture, does not operate normally, or has been dropped.

**For the U.K.**

**IMPORTANT:** THE WIRES IN THIS MAINS LEAD ARE COLOURED IN ACCORDANCE WITH THE FOLLOWING CODE.

BLUE: NEUTRAL  
BROWN: LIVE

As the colours of the wires in the mains lead of this apparatus may not correspond with the coloured markings identifying the terminals in your plug, proceed as follows:

The wire which is coloured BLUE must be connected to the terminal which is marked with the letter N or coloured BLACK.  
The wire which is coloured BROWN must be connected to the terminal which is marked with the letter L or coloured RED.  
Under no circumstances must either of the above wires be connected to the earth terminal of a three pin plug.

# USING THE UNIT SAFELY

## INSTRUCTIONS FOR THE PREVENTION OF FIRE, ELECTRIC SHOCK, OR INJURY TO PERSONS

### About ⚠ WARNING and ⚠ CAUTION Notices

<b>⚠ WARNING</b>	Used for instructions intended to alert the user to the risk of death or severe injury should the unit be used improperly.
<b>⚠ CAUTION</b>	Used for instructions intended to alert the user to the risk of injury or material damage should the unit be used improperly. * Material damage refers to damage or other adverse effects caused with respect to the home and all its furnishings, as well to domestic animals or pets.

### About the Symbols

	The ⚠ symbol alerts the user to important instructions or warnings. The specific meaning of the symbol is determined by the design contained within the triangle. In the case of the symbol at left, it is used for general cautions, warnings, or alerts to danger.
	The ⚡ symbol alerts the user to items that must never be carried out (are forbidden). The specific thing that must not be done is indicated by the design contained within the circle. In the case of the symbol at left, it means that the unit must never be disassembled.
	The ⚡ symbol alerts the user to things that must be carried out. The specific thing that must be done is indicated by the design contained within the circle. In the case of the symbol at left, it means that the power-cord plug must be unplugged from the outlet.

## ALWAYS OBSERVE THE FOLLOWING

### ⚠ WARNING

- Before using this unit, make sure to read the instructions below, and the Owner's Manual.
- Do not open or perform any internal modifications on the unit.
- Do not attempt to repair the unit, or replace parts within it (except when this manual provides specific instructions directing you to do so). Refer all servicing to your retailer, the nearest Roland Service Center, or an authorized Roland distributor, as listed on the "Information" page.
- Never use or store the unit in places that are:
  - Subject to temperature extremes (e.g., direct sunlight in an enclosed vehicle, near a heating duct, on top of heat-generating equipment); or are
  - Damp (e.g., baths, washrooms, on wet floors); or are
  - Humid; or are
  - Exposed to rain; or are
  - Dusty; or are
  - Subject to high levels of vibration.
- Make sure you always have the unit placed so it is level and sure to remain stable. Never place it on stands that could wobble, or on inclined surfaces.
- The unit should be connected to a power supply only of the type described in the operating instructions, or as marked on the unit.

### ⚠ WARNING

- Do not excessively twist or bend the power cord, nor place heavy objects on it. Doing so can damage the cord, producing severed elements and short circuits. Damaged cords are fire and shock hazards!
- This unit, either alone or in combination with an amplifier and headphones or speakers, may be capable of producing sound levels that could cause permanent hearing loss. Do not operate for a long period of time at a high volume level, or at a level that is uncomfortable. If you experience any hearing loss or ringing in the ears, you should immediately stop using the unit, and consult an audiologist.
- Do not allow any objects (e.g., flammable material, coins, pins); or liquids of any kind (water, soft drinks, etc.) to penetrate the unit.
- Immediately turn the power off, remove the power cord from the outlet, and request servicing by your retailer, the nearest Roland Service Center, or an authorized Roland distributor, as listed on the "Information" page when:
  - The power-supply cord, or the plug has been damaged; or
  - If smoke or unusual odor occurs
  - Objects have fallen into, or liquid has been spilled onto the unit; or
  - The unit has been exposed to rain (or otherwise has become wet); or
  - The unit does not appear to operate normally or exhibits a marked change in performance.

**⚠ WARNING**

- In households with small children, an adult should provide supervision until the child is capable of following all the rules essential for the safe operation of the unit. 

- Protect the unit from strong impact. (Do not drop it!) 

- Do not force the unit's power-supply cord to share an outlet with an unreasonable number of other devices. Be especially careful when using extension cords—the total power used by all devices you have connected to the extension cord's outlet must never exceed the power rating (watts/amperes) for the extension cord. Excessive loads can cause the insulation on the cord to heat up and eventually melt through. 

- Before using the unit in a foreign country, consult with your retailer, the nearest Roland Service Center, or an authorized Roland distributor, as listed on the "Information" page. 



- Do not put anything that contains water (e.g., flower vases) on this unit. Also, avoid the use of insecticides, perfumes, alcohol, nail polish, spray cans, etc., near the unit. Swiftly wipe away any liquid that spills on the unit using a dry, soft cloth. 

**⚠ WARNING**





## Placement

- Using the unit near power amplifiers (or other equipment containing large power transformers) may induce hum. To alleviate the problem, change the orientation of this unit; or move it farther away from the source of interference.
- This device may interfere with radio and television reception. Do not use this device in the vicinity of such receivers.
- Noise may be produced if wireless communications devices, such as cell phones, are operated in the vicinity of this unit. Such noise could occur when receiving or initiating a call, or while conversing. Should you experience such problems, you should relocate such wireless devices so they are at a greater distance from this unit, or switch them off.
- Do not expose the unit to direct sunlight, place it near devices that radiate heat, leave it inside an enclosed vehicle, or otherwise subject it to temperature extremes. Also, do not allow lighting devices that normally are used while their light source is very close to the unit (such as a piano light), or powerful spotlights to shine upon the same area of the unit for extended periods of time. Excessive heat can deform or discolor the unit.
- When moved from one location to another where the temperature and/or humidity is very different, water droplets (condensation) may form inside the unit. Damage or malfunction may result if you attempt to use the unit in this condition. Therefore, before using the unit, you must allow it to stand for several hours, until the condensation has completely evaporated.
- Do not allow rubber, vinyl, or similar materials to remain on the unit for long periods of time. Such objects can discolor or otherwise harmfully affect the finish.
- Do not paste stickers, decals, or the like to this instrument. Peeling such matter off the instrument may damage the exterior finish.
- Depending on the material and temperature of the surface on which you place the unit, its rubber feet may discolor or mar the surface.  
You can place a piece of felt or cloth under the rubber feet to prevent this from happening. If you do so, please make sure that the unit will not slip or move accidentally.





**⚠ CAUTION**

- The unit should be located so that its location or position does not interfere with its proper ventilation. 
- Always grasp only the plug on the power-supply cord when plugging into, or unplugging from an outlet. 
- At regular intervals, you should unplug the power plug and clean it by using a dry cloth to wipe all dust and other accumulations away from its prongs. Also, disconnect the power plug from the power outlet whenever the unit is to remain unused for an extended period of time. Any accumulation of dust between the power plug and the power outlet can result in poor insulation and lead to fire. 

**⚠ CAUTION**

- Try to prevent cords and cables from becoming entangled. Also, all cords and cables should be placed so they are out of the reach of children. 
- Never climb on top of, nor place heavy objects on the unit. 
- Never handle the power cord or its plug with wet hands when plugging into, or unplugging from, an outlet. 
- Before moving the unit, disconnect the power plug from the outlet, and pull out all cords from external devices. 

**⚠ CAUTION**

- Before cleaning the unit, turn off the power and unplug the power cord from the outlet. 
- Whenever you suspect the possibility of lightning in your area, pull the plug on the power cord out of the outlet. 
- The cooling vents on either side of the unit may become hot, so take care to avoid burns. 
- Do not remove the speaker grille and speaker by any means. Speaker not user replaceable. Shock hazardous voltages and currents are present inside the enclosure. 

## IMPORTANT NOTES

In addition to the items listed under “IMPORTANT SAFETY INSTRUCTIONS” and “USING THE UNIT SAFELY” on pages 2, 3, 4 and 5, please read and observe the following:

### Power Supply

- Do not connect this unit to same electrical outlet that is being used by an electrical appliance that is controlled by an inverter (such as a refrigerator, washing machine, microwave oven, or air conditioner), or that contains a motor. Depending on the way in which the electrical appliance is used, power supply noise may cause this unit to malfunction or may produce audible noise. If it is not practical to use a separate electrical outlet, connect a power supply noise filter between this unit and the electrical outlet.
- Before connecting this unit to other devices, turn off the power to all units. This will help prevent malfunctions and/or damage to speakers or other devices.
- Although the LEDs are switched off when the POWER switch is switched off, this does not mean that the unit has been completely disconnected from the source of power. If you need to turn off the power completely, first turn off the POWER switch, then unplug the power cord from the power outlet. For this reason, the outlet into which you choose to connect the power cord’s plug should be one that is within easy reach and readily accessible.

### Maintenance

- For everyday cleaning wipe the unit with a soft, dry cloth or one that has been slightly dampened with water. To remove stubborn dirt, use a cloth impregnated with a mild, non-abrasive detergent. Afterwards, be sure to wipe the unit thoroughly with a soft, dry cloth.
- Never use benzine, thinners, alcohol or solvents of any kind, to avoid the possibility of discoloration and/or deformation.

### Additional Precautions

- Use a reasonable amount of care when using the unit’s buttons, sliders, or other controls; and when using its jacks and connectors. Rough handling can lead to malfunctions.
- When connecting / disconnecting all cables, grasp the connector itself—never pull on the cable. This way you will avoid causing shorts, or damage to the cable’s internal elements.
- A small amount of heat will radiate from the unit during normal operation.
- To avoid disturbing your neighbors, try to keep the unit’s volume at reasonable levels. You may prefer to use headphones, so you do not need to be concerned about those around you (especially when it is late at night).
- When you need to transport the unit, package it in the box (including padding) that it came in, if possible. Otherwise, you will need to use equivalent packaging materials.
- Use a cable from Roland to make the connection. If using some other make of connection cable, please note the following precautions.
  - Some connection cables contain resistors. Do not use cables that incorporate resistors for connecting to this unit. The use of such cables can cause the sound level to be extremely low, or impossible to hear. For information on cable specifications, contact the manufacturer of the cable.
- Wrap the power cord around the cord hook when transporting or storing the unit.

# Panel descriptions

## Control Panel

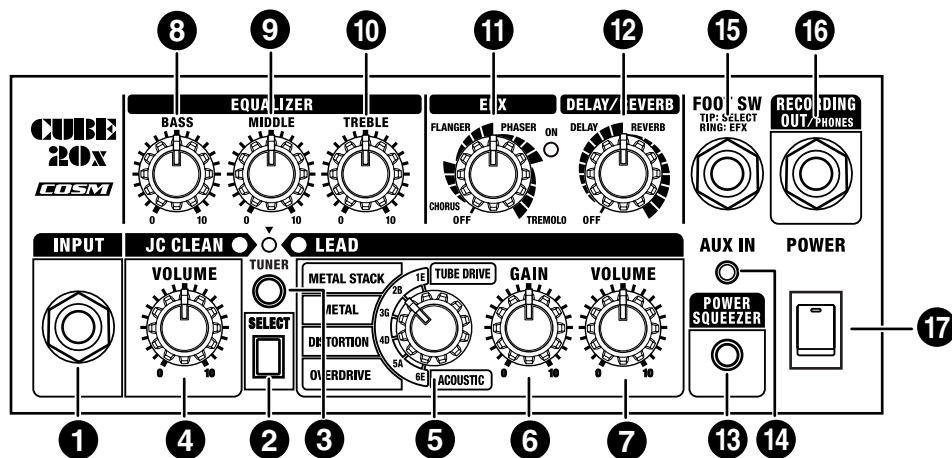

### 1. INPUT Jack

Connect your guitar here.

### 2. SELECT Switch

Switches between the CLEAN and LEAD channels.

You can confirm which channel is selected by checking the indicator's color (JC CLEAN: left; LEAD: right).

Channels can be switched using optional BOSS FS-5U or FS-6 footswitches.

### 3. TUNER Switch

The switch lights in red when the tuner function is on; the switch is unlit when the tuner is off.

For more detailed information, refer to p. 8.

## JC CLEAN Channel

This is a model of Roland's famous JC-120 Jazz Chorus guitar amplifier. The ultra-clean, ultra-flat sound offers a smooth feel.

### 4. VOLUME Knob

Adjusts the JC CLEAN channel volume.

## LEAD Channel

### 5. Type Switch

You can select from the following six types.

When the tuner function is on, you can use this to select the name of the string to be tuned (p. 8).

#### ACOUSTIC

By combining acoustic guitar simulation with COSM amplifier modeling technology, this original amplifier model gives you a dynamic acoustic guitar sound using a standard electric guitar.

#### OVERDRIVE

Natural distortion sound similar to that obtained by turning an amp's volume up completely.

#### DISTORTION

Harder distortion than OVERDRIVE.

#### METAL

Even harder and heavier than DISTORTION, which can get long sustained notes.

#### METAL STACK

Very fat sound of a Heavy Metal full amp stack.

#### TUBE DRIVE

This creates long-lasting distortion like that you get with a tube amp but with greatly enhanced dynamic range.

### 6. GAIN Knob

Adjusts the LEAD channel's distortion level.

### 7. VOLUME Knob

Adjusts the LEAD channel volume.

## EQUALIZER

### 8. BASS Knob

Adjusts the tone quality of the lower range.

### 9. MIDDLE Knob

Adjusts the tone quality of the midrange.

### 10. TREBLE Knob

Adjusts the tone quality of the upper range.

## EFX (Effects)

### 11. EFX (Effects) Knob

Turn this knob to chorus, flanger, phaser, or tremolo to select the corresponding effect. Turn the knob to adjust the amount of effect applied.

The ON indicator lights up when EFX is turned on, and goes out when EFX is turned off. You can also turn EFX on and off using optional footswitches (BOSS FS-5U or FS-6).

- \* Graduations for CHORUS, FLANGER, PHASER, TREMOLO on a panel are for reference. Be sure to check the sound as you adjust the effects.

#### CHORUS

In this effect, a slightly detuned sound is added to the original sound, giving the sound greater breadth and fullness.

#### FLANGER

This creates a flanging effect that creates a sort of spinning sensation with the sound.

#### PHASER

This effect adds a variable phaseshifted signal to the direct sound, giving the sound a swirling character.

#### TREMOLO

Tremolo is an effect that creates a cyclic change in volume.

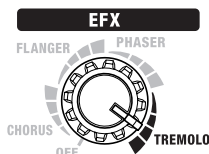
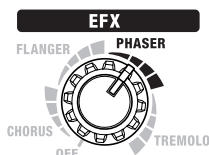
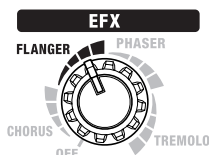
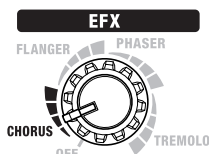

## DELAY/REVERB

### 12. DELAY/REVERB Knob

Turn this knob to DELAY or REVERB to switch to that effect. Turn the knob to adjust the amount of effect applied.

- \* Graduations for DELAY, REVERB on a panel are for reference. Be sure to check the sound as you adjust the effects.

#### DELAY

Turn the knob to change the time and amount of delay effects.



### REVERB

Turn the knob to adjust the reverb level.

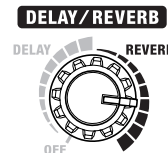

### 13. POWER SQUEEZER Switch

The switch lights in red when the power squeezer function is on; the switch is unlit when the power squeezer is off.

Switching on the Power Squeezer function allows you to reduce the amp's output to 2 watts.

Switching this on allows you to produce a sound that preserves the same tone and balance as when the amp is played at maximum volume, but at an output of 2 watts, for volume levels that are more suitable for the average home.

- \* The Power Squeezer function affects only sounds input through the INPUT jack. It has no effect on sounds input via the AUX IN jack.

### 14. AUX IN Jack

You can connect a CD player, MP3 player or other kind of device and have it play along with your guitar.

This accepts a stereo miniature phone plug. However, the speaker and RECORDING OUT/PHONES output is monaural.

- \* Determine the volume level by adjusting the volume control of the connected device.

### 15. FOOT SW (Footswitch) Jack

You can use footswitches (optional BOSS FS-5U or FS-6) connected using a connection cable (optional Roland PCS-31) to switch channels (JC CLEAN/LEAD), and to turn EFX on and off.

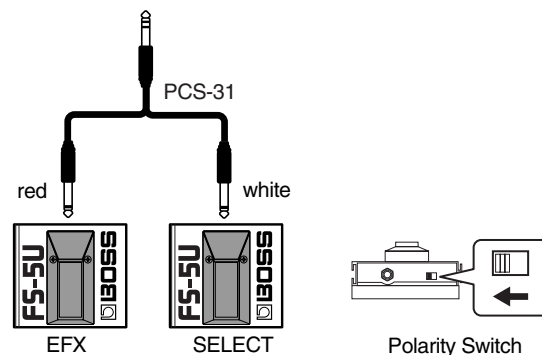
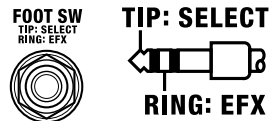

- \* When you connect only one footswitch by mono cable, you can only use it to switch channels (JC CLEAN/LEAD).

## 16. RECORDING OUT/PHONES Jack

### When Using RECORDING OUT

Use mono 1/4" phone plugs when connecting to this jack.

Volume level of RECORDING OUT can be easily adjusted if you set the CLEAN or LEAD channel VOLUME as shown in the diagram on the right.



### When Using Headphones

Connect headphones to this jack.

- \* No sound is played through the unit's speaker while the RECORDING OUT/PHONES jack is in use.

## 17. POWER Switch

This switches the power on and off.

- \* This unit is equipped with a protection circuit. A brief interval (a few seconds) after power up is required before the unit will operate normally.
- \* If you need to turn off the power completely, first turn off the POWER switch, then unplug the power cord from the power outlet. Refer to "Power Supply" (p. 5).

## TUNING

You can use "manual tuning," whereby you switch to each individual string to tune it separately, and "chromatic tuning," which automatically determines the closest pitch to that played by the string.

### Tuning in "Manual Mode"

1. Press the TUNER switch.
2. Use the Type switch to select the name of the string you want to tune, then play a single note on the open string.
  - \* No sound is played through the unit's speaker while the tuner function is in use.

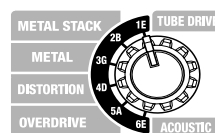

Type Switch Position	String Name
6E	Open sixth string
5A	Open fifth string
4D	Open fourth string
3G	Open third string
2B	Open second string
1E	Open first string

- \* Reference Pitch: A4=440 Hz

3. Tune the string until the green indicator lights.

<The Pitch is flat>

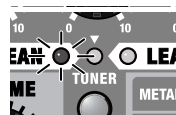

<The Pitch is flat, but almost in tune>



- \* When the pitch is even lower, the indicator flashes.

<The Pitch is correct>



<The Pitch is sharp, but almost in tune>



<The Pitch is sharp>



- \* When the pitch is even higher, the indicator flashes.

### Tuning in "Chromatic Mode"

1. Hold down the TUNER switch for at least one second so that the red indicator flashes.
2. Play a single note on the open string you want to tune.
3. Tune the string until the green indicator lights.



# Connections

Refer to the figure shown below to connect the CUBE-20X to other equipment.

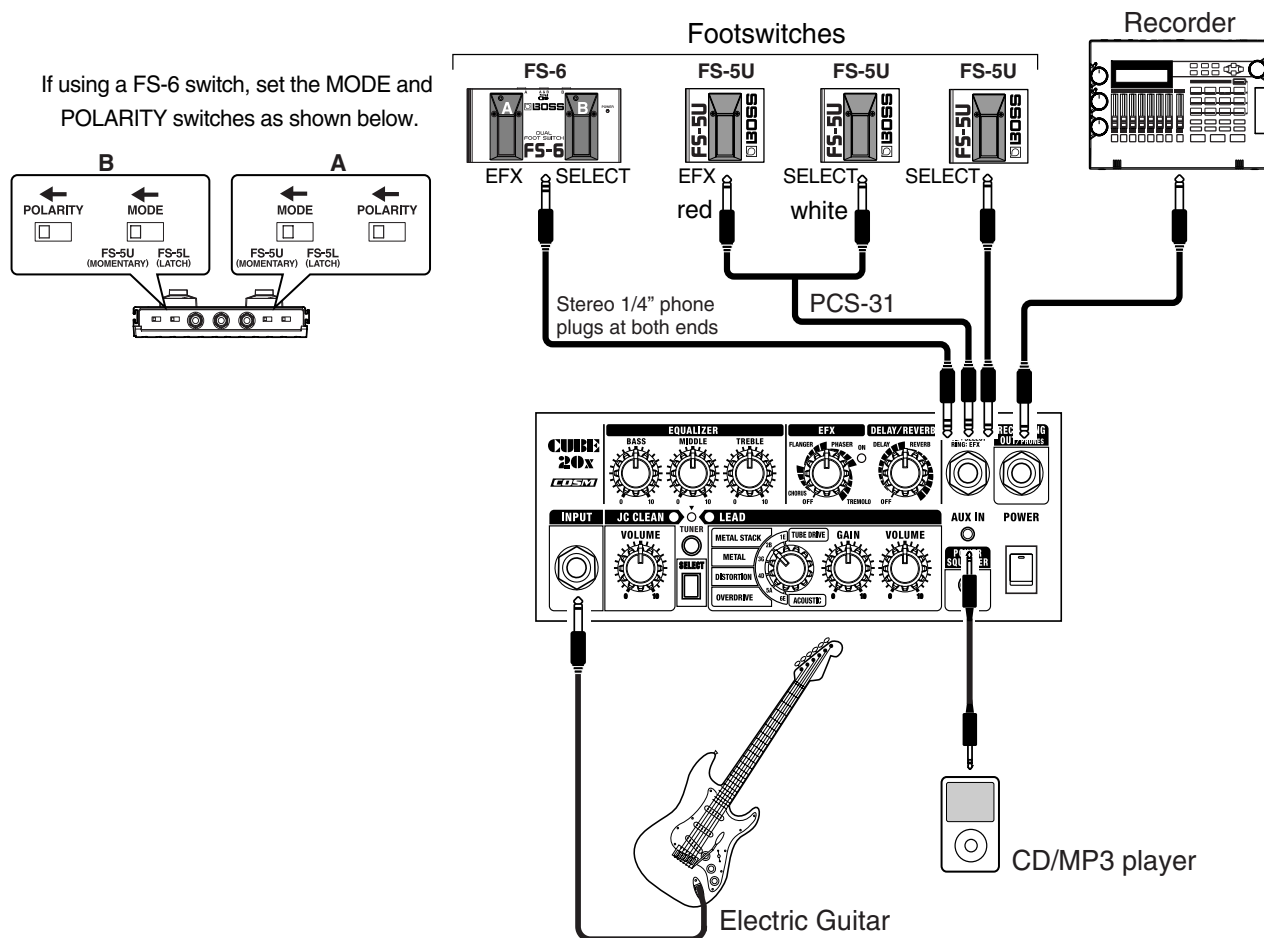

## Switching the Power On and Off

Once the connections have been completed, turn on power to your various devices in the order specified. By turning on devices in the wrong order, you risk causing malfunction and/or damage to speakers and other devices.

1. Make sure that all volume controls on the CUBE-20X and connected devices are set to 0.
2. Turn on all the devices connected to the CUBE-20X 's input jacks (INPUT jack and AUX IN jack).
3. Turn on the CUBE-20X.
4. Switch on any equipment connected to the CUBE-20X's RECORDING OUT/PHONES jack.
5. Adjust the volume levels for the devices.
6. Before switching off the power, lower the volume on each of the devices in your system and then TURN OFF the devices in the reverse order to which they were switched on.

\* This unit is equipped with a protection circuit. A brief interval (a few seconds) after power up is required before the unit will operate normally. For protection from sudden big sound, always make sure to have the volume level turned down before switching on power. Even with the volume all the way down, you may still hear some sound when the power is switched on and off, but this is normal, and does not indicate a malfunction.

- \* If you need to turn off the power completely, first turn off the POWER switch, then unplug the power cord from the power outlet. Refer to "Power Supply" (p. 5).
- \* To prevent malfunction and/or damage to speakers or other devices, always turn down the volume, and turn off the power on all devices before making any connections.
- \* Before making the connections, be sure that the volume setting of the VOLUME knob for both amplifiers is set to "0."
- \* When connection cables with resistors are used, the volume level of equipment connected to the inputs may be low. If this happens, use connection cables that do not contain resistors, such as those from the Roland PCS series.

# Sample Settings

## Alternative Metal

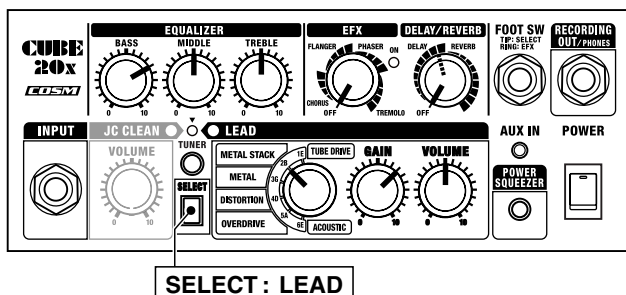

The perfect sound for heavy, sharp riffs.

Select the high-gain METAL STACK, then use the equalizer to boost the low end even more.

Used with a humbucking pickup in the rear position, it results in an extreme distortion effect.

Plus, you can add a long delay to use this as a lead sound with great sustain.

Adding a short delay produces a doubling sound like that from two performers playing the same phrases simultaneously.

## Space Clean

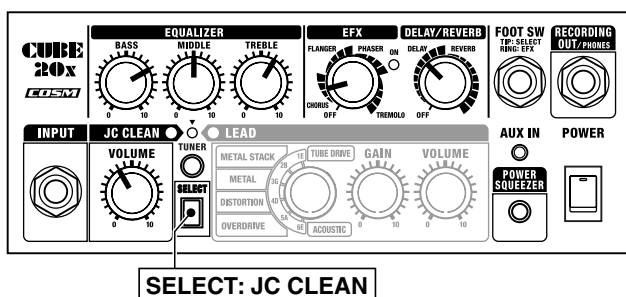

This is a transparent sound using spacial effects.

Select the JC CLEAN amp, modeled on the Roland JC-120, then add chorus and long delay.

Using this setting with a guitar equipped with single coil pickups makes great sounding arpeggios and chord strumming.

Depending on the phrase being played, it can be effective to set the delay sound's delay time slightly slower than the phrase's tempo.

## Power Grunge

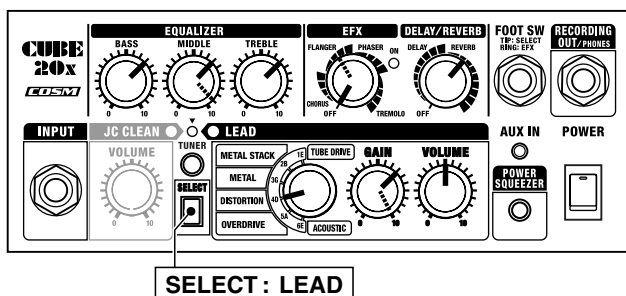

This produces a raging distortion sound that is very trebly and roughly textured.

Setting the GAIN knob to prevent excessive distortion of the guitar sound results in a straight guitar sound with brilliant harmonics and powerful chord sounds.

You can also add the FLANGER to produce a sound with a powerful swirling effect, much like the sound from a jet.

Additionally, using the guitar's front pickup and raising the GAIN and MIDDLE knobs results in a fat lead sound with long sustain.

## Vintage Crunch

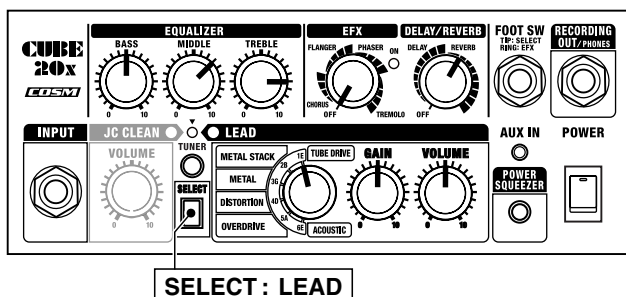

This sound enables you to achieve precision and subtlety in performance expression based on the relative force of your picking, allowing you to use the guitar controls to fully express all the nuance of your sound.

Strong picking results in a textured sound with tube-like compression.

Setting the GAIN knob to the optimal position gives you a guitar sound with great dynamics, more gentle picking delivers a clean sound, and the stronger picking also produces deep distortion.

# Main Specifications

## CUBE-20X

### ● Rated Power Output

20 W

### ● Nominal Input Level

INPUT (JC CLEAN channel): -10 dBu/1 M $\Omega$

AUX IN: -10 dBu

### ● Speakers

20 cm (8 inch)

### ● Controls

POWER Switch

SELECT Switch

TUNER Switch

POWER SQUEEZER Switch

#### <JC CLEAN Channel>

VOLUME Knob

#### <LEAD Channel>

TYPE Switch (ACOUSTIC, OVERDRIVE,  
DISTORTION, METAL, METAL STACK, TUBE DRIVE)

GAIN Knob

VOLUME Knob

#### <EQUALIZER>

BASS Knob

MIDDLE Knob

TREBLE Knob

#### <EFX>

EFX Knob (CHORUS, FLANGER, PHASER, TREMOLO)

#### <DELAY/REVERB>

DELAY/REVERB Knob

### ● Indicators

JC CLEAN Channel

LEAD Channel

EFX

TUNER

POWER SQUEEZER

### ● Connectors

INPUT Jack

AUX IN Jack

FOOT SW Jack (SELECT, EFX)

RECORDING OUT/PHONES Jack

### ● Power Supply

AC 117 V, AC 230 V or AC 240 V

### ● Power Consumption

24 W

### ● Dimensions

335 (W) x 240 (D) x 335 (H) mm

13-3/16 (W) x 9-1/2 (D) x 13-3/16 (H) inches

### ● Weight

7.2 kg / 15 lbs 14 oz

### ● Accessories

Owner's Manual

### ● Options

Footswitch: FS-5L (BOSS)

FS-6 (BOSS)

Connection Cable: PCS-31

\* 0 dBu = 0.775 Vrms

### NOTE

In the interest of product improvement, the specifications and/or appearance of this unit are subject to change without prior notice.

For EU Countries



This product complies with the requirements of European Directives EMC 89/336/EEC and LVD 73/23/EEC.

For the USA

## FEDERAL COMMUNICATIONS COMMISSION RADIO FREQUENCY INTERFERENCE STATEMENT

This equipment has been tested and found to comply with the limits for a Class B digital device, pursuant to Part 15 of the FCC Rules. These limits are designed to provide reasonable protection against harmful interference in a residential installation. This equipment generates, uses, and can radiate radio frequency energy and, if not installed and used in accordance with the instructions, may cause harmful interference to radio communications. However, there is no guarantee that interference will not occur in a particular installation. If this equipment does cause harmful interference to radio or television reception, which can be determined by turning the equipment off and on, the user is encouraged to try to correct the interference by one or more of the following measures:

- Reorient or relocate the receiving antenna.
- Increase the separation between the equipment and receiver.
- Connect the equipment into an outlet on a circuit different from that to which the receiver is connected.
- Consult the dealer or an experienced radio/TV technician for help.

This device complies with Part 15 of the FCC Rules. Operation is subject to the following two conditions:

- (1) This device may not cause harmful interference, and
- (2) This device must accept any interference received, including interference that may cause undesired operation.

Unauthorized changes or modification to this system can void the users authority to operate this equipment.  
This equipment requires shielded interface cables in order to meet FCC class B Limit.

For Canada

### NOTICE

This Class B digital apparatus meets all requirements of the Canadian Interference-Causing Equipment Regulations.

### AVIS

Cet appareil numérique de la classe B respecte toutes les exigences du Règlement sur le matériel brouilleur du Canada.



This product must be disposed of separately at your local waste recycling centre.  
Do not dispose of in household waste bin.