

# CUBE

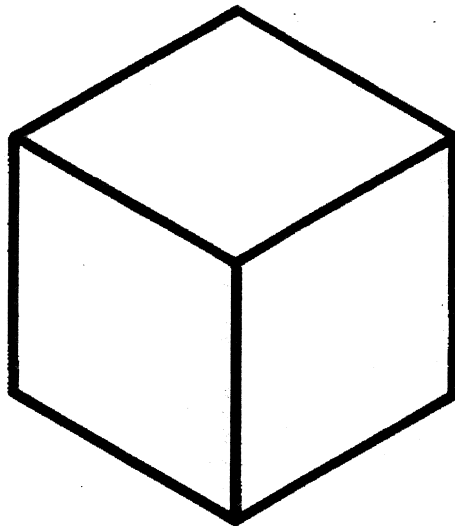

## CUBE-Chorus CH-60,40

★This operation manual covers the instructions of both the CUBE CH-60 and CH-40. (The front panel shown here is the CH-60's.)  
The controls marked with \* are not provided in the CH-40.

---

### ● Features

- These compact CUBE CH-60/40 include newly developed high quality speakers of 30 cm (\*)/25 cm and the amplifiers of 60\*/40W (RMS).
- Includes the Chorus and Reverb.
- Using an external amplifier will expand the Chorus and Reverb effects even more.
- Two-channel input system (Over Drive /Normal) allows you to choose either of them depending on the output power of the guitar you use.
- Various useful jacks are provided such as CHORUS/REVERB FOOT SWITCH, CHORUS/REVERB OUT; PRE OUT, MAIN IN, EXT. SPEAKER, OVER DRIVE FOOT SWITCH (\*) and HEADPHONES.
- Wide variety of Overdrive sounds are available by controlling the OVER DRIVE volume (\*), MASTER volume and VOLUME knobs.

---

### ● Cautions

- Locating the amplifier or the musical instrument near a neon or fluorescent lamp may cause noise interference. In such a case, move them out of the interference range.
- Be sure to set the volume of the CUBE to "zero" before pulling out the cord to protect the speaker from excessive strain.
- When connecting the musical instrument to the amplifier, be sure to connect the cord to the musical instrument first, then to the amplifier. When disconnecting, unplug the cord from the amplifier first, then from the instrument.
- Avoid giving a strong shock to the amplifier or moving it while it is operating.
- Do not use the amplifier in excessive heat or humidity or where it may be affected by direct sunlight or dust.
- Use a neutral detergent to clean the amplifier. Do not use solvent such as paint thinner.
- Use the specific fuse when replacement is required.

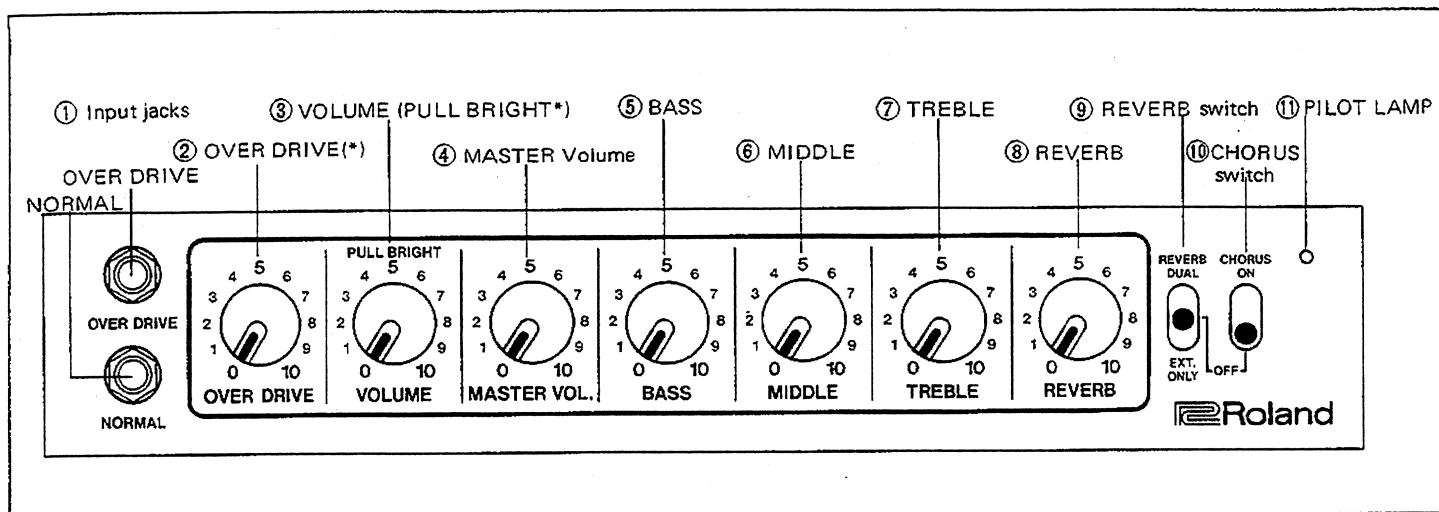

### ① Input jacks

You can use either of these jacks depending on the output power of your guitar.

#### ● OVER DRIVE

Connect your guitar to this jack if you wish to obtain the Overdrive effect.

#### ● NORMAL

Connect the high output to this jack. Also, use this jack to prevent the sound from distortion.

### ② OVER DRIVE (\*)

This knob controls the Overdrive sound. Turning it clockwise (↻) will increase the Overdrive effect.

\* This knob works just when the OVER DRIVE jack is plugged in.

### ③ VOLUME (PULL-BRIGHT (\*\*))

This knob is to adjust the input level. Turning this clockwise (↻) increases the volume level.

### ④ MASTER Volume

This knob adjusts the output level. Turning this clockwise (↻) increases the volume level. When this knob is turned fully counterclockwise (↶, set to zero), there will be no sound heard.

### ⑤ BASS

### ⑥ MIDDLE

### ⑦ TREBLE

#### Tone Controls

Turning them to clockwise (↻) will emphasize the sound ranges as follows.

- BASS Low sound range
- MIDDLE Medium sound range
- TREBLE High sound range

### ⑧ REVERB knob

This knob is to control the Reverb effect. Turning this clockwise (↻) will increase the intensity of the effect.

\* This knob does not function when the REVERB switch ⑨ is turned off.

### ⑨ REVERB switch

This turns the Reverb effect on or off. If an external amplifier is connected to the CUBE, this switch selects the output mode (DUAL or EXT. ONLY). When an external amplifier is connected, direct sounds will be sent from the built-in amplifier and Chorus sounds will be sent from the external amplifier. The direct sound is controlled with the MASTER Volume ④ and the Chorus sound is controlled with the Volume knob of the external amplifier.

#### ● DUAL

If an external amplifier is connected, both the external and built-in amplifiers will output the Reverb and direct sounds. The volume level of the direct sound is adjusted with the MASTER Volume ④ and the Reverb sound with the REVERB knob ⑧.

#### ● EXT: ONLY

If an external amplifier is connect, the built-in amplifier sends the direct sounds and the external amplifier sends Acoustic Reverb sounds. The direct sound is controlled with the MASTER Volume ④ and the Acoustic Reverb sounds with the REVERB knob ⑧.

\* If not using any external amplifier, you can obtain the Reverb effect in either DUAL or EXT. ONLY mode.

### ⑩ CHORUS switch

This turns the Chorus effect on or off. If an external amplifier is connected to the CUBE, the built-in amplifier sends the direct sounds and the external amplifier sends the Chorus sounds. The direct sound is controlled with the MASTER Volume ④, and the Chorus sound is controlled with external amplifier.

### ⑪ PILOT LAMP

This lights up when the CUBE is turned on.

## ● Connection

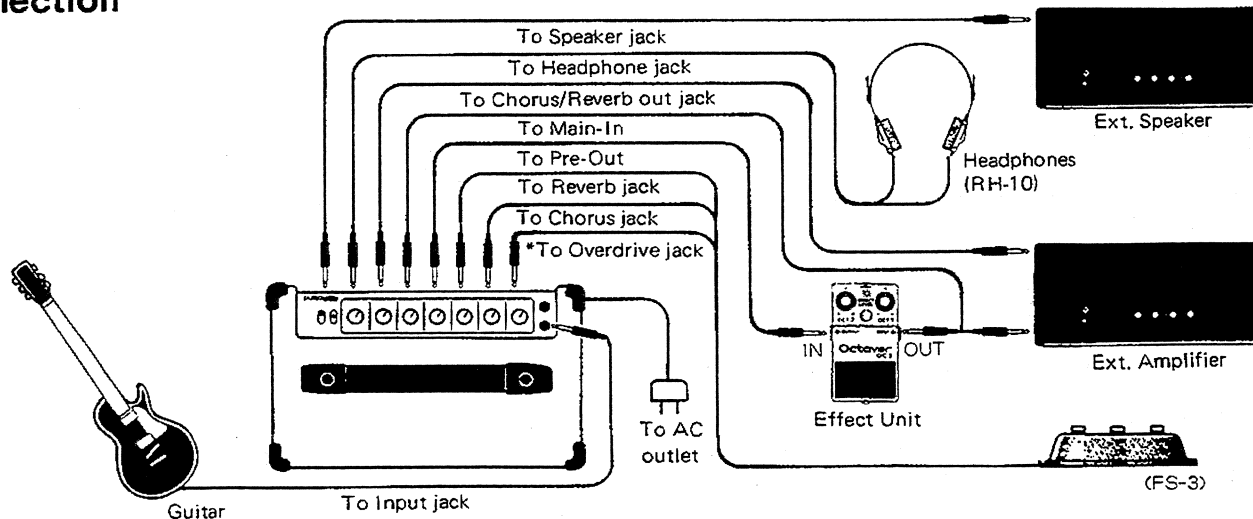

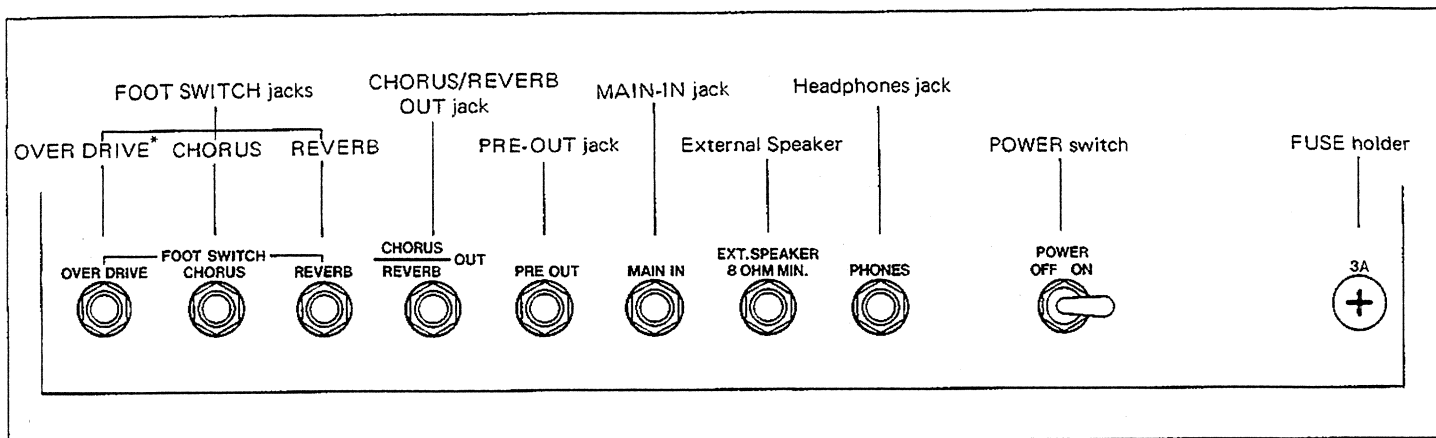

**Rear Panel**

● **OVER DRIVE FOOT SWITCH jack (\*)**  
This jack is used to turn the Overdrive effect on or off during live performance.

**<NOTE>**

If the OVER DRIVE knob ② is set to zero, there will be little effect even if the FOOT SWITCH is turned on.

● **CHORUS FOOT SWITCH jack**  
By using this jack, you can turn the Chorus effect on or off during live performance. Make sure that the CHORUS switch ⑩ is turned on.

● **REVERB FOOT SWITCH jack**  
By using this jack, you can turn the Reverb effect on or off during live performance. Make sure that the REVERB switch ⑨ is set to either DUAL or EXT. ONLY.

● **CHORUS/REVERB OUTPUT jack**  
Connect this jack to Main-In or Low Input of the external amplifier. Using an external amplifier expands the Chorus and Reverb effects even more.

\* How to set up the external amplifier is shown on the next page.

● **PRE-OUT jack**  
To this jack, you can connect the tape recorder, PA mixer or the Main-In or Line-In of the other guitar amplifier. The output level should be adjusted with the VOLUME ③ and MASTER Volume ④.

● **MAIN-IN jack**  
An effect unit can be set up between the PRE-OUT jack and this MAIN-IN jack.

● **EXT. SPEAKER jack**  
By connecting the external speaker of more than 8Ω to this jack, you can obtain richer and more expanded sounds. (No sound is heard from the built-in speaker of the CH-40.)

● **PHONES jack**  
An ordinary stereo headphones may be plugged into this jack for private listening at night time or sound check during live performance. The speaker does not work while this jack is used.

● **POWER switch**  
If you hear a noise or hum, disconnect the plug from the wall outlet, turn it upside down, and plug it in again.

**● Operation**

**1 Normal Sound**

Set the controls and switches as shown below. Then adjust the VOLUME and TONE CONTROLS (BASS/MIDDLE/TREBLE), while playing the guitar.

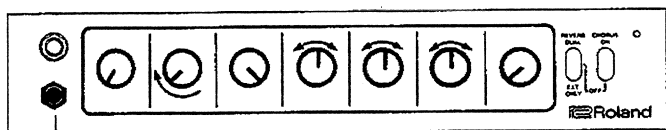

Normal

**2 Hard/\*Soft Overdrive sound**

Soft or hard overdrive sound can be obtained by adjusting the MASTER Volume and OVER DRIVE control.

Overdrive

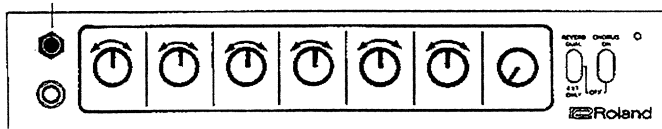

**3 Reverb Control**

Set the REVERB switch to DUAL or EXT. ONLY and adjust the Reverb effect with REVERB knob.

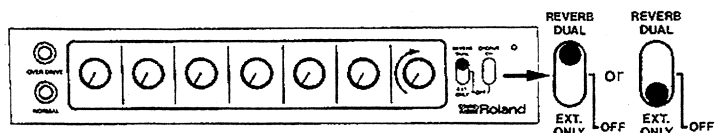

**4 Reverb effect in DUAL mode**

Connect the CHORUS/REVERB OUTPUT jack to the Main-In or Low Input jack of the external amplifier. The Reverb effect can be obtained from both the built-in and the external amplifiers by setting the REVERB switch to DUAL and turning the REVERB knob clockwise (↻).

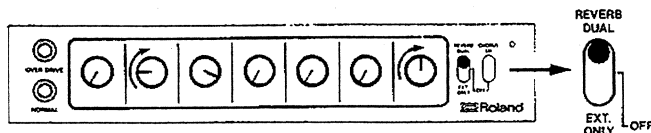

**5 Reverb effect in EXT ONLY mode**

Connect the CHORUS/REVERB OUTPUT jack to the Main-IN or Low Input jack of the external amplifier. Set the REVERB switch to EXT. ONLY. Then control the direct sound sent from the built-in amplifier with the MASTER Volume, and the acoustic Reverb sound from the external amplifier with the REVERB knob.

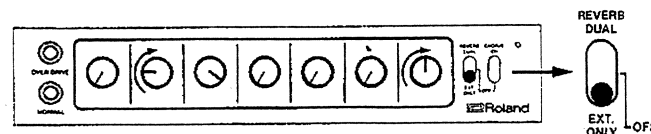

\* If you use any of Roland CUBE series as an external amplifier, more realistic effect is obtained.

- Connection for Stereo effect and variations of the effect sounds

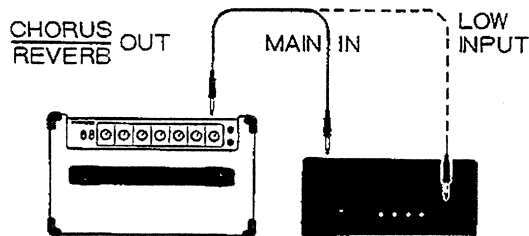

		CUBE	External Amplifier
Reverb	EXT. ONLY	Direct sound	Acoustic Reverb sound
	DUAL	Direct + Reverb sounds	Direct + Reverb sound
	OFF	Direct sound	Direct sound
Chorus	ON	Direct sound	Acoustic Chorus sound
	OFF	Direct sound	Direct sound

- When an External Amplifier is used

External Amplifier Input	External Amplifier		Operation on the Built-in Amplifier
	Operation	Result	
MAIN IN	Set the MASTER Volume to maximum.	The VOLUME, Tone Controls, REVERB do not function.	<ul style="list-style-type: none"> <li>• Control the Volume level with the Volume knob.</li> <li>• Control the tone color with the Tone Controls and REVERB, etc.</li> </ul>
LOW INPUT	Adjust the volume depending on the tone color of the built-in amplifier.	All the Controls function.	<ul style="list-style-type: none"> <li>• Adjust the volume level with the Volume knob.</li> <li>• Adjust the tone color with the Tone Controls and REVERB, etc.</li> </ul>

If the REVERB/CHORUS OUTPUT jack is plugged in, Chorus sounds are not heard from the built-in amplifier. Therefore, if you wish the Chorus sounds from the built-in amplifier, unplug from this jack.

Symptom	Possible Cause	Action to be taken
The Pilot lamp does not light up and no sound is heard even if the power switch is turned on.	The power cable is not firmly inserted.	Firmly insert the power cable.
The Pilot lamp lights up, but no sound is heard.	The VOLUME or MASTER Volume is set to low.	Turn up the volume.
The Overdrive effect is not obtained. (CH-60)	The Foot switch is turned off.	Press the Foot switch to turn it on.
	The OVERDRIVE knob is set too low.	Turn up the level.
The Reverb effect is not obtained.	The Foot switch is turned off.	Press the Foot switch to turn it on.
	The REVERB knob is set too low.	Turn up the level.
The Chorus effect is not obtained	The CHORUS switch is set to OFF. The FOOT switch is turned off. The REVERB, or CHORUS OUT is plugged in.	Set the CHORUS switch to ON. Turn the FOOT switch on. Disconnect the plug.
The Overdrive effect is obtained, but too weak.	Insufficient input.	Turn up the Guitar volume.
Noise or hum is heard.	There is something wrong with connection cord.	Replace the cord with a proper one.
	Improper connections.	Securely plug in the cords.

## Specifications

- Output 60W (CH-60), 40W (CH-40)
- Speaker 30 cm x 1, Imp. 8Ω (CH-60)  
25 cm x 1, Imp. 8Ω (CH-40)
- Input Jacks
  - OVER DRIVE -53 dBm/200kΩ or more (CH-60)  
-50 dBm/200kΩ or more (CH-40)
  - NORMAL -24.5 dBm/100kΩ or more (CH-60)  
-23.5 dBm/100kΩ or more (CH-40)
- Controls VOLUME, MASTER Volume, BASS, MIDDLE, TREBLE, REVERB, OVERDRIVE Volume (\*).
- Switches REVERB (DUAL/OFF/EXT. ONLY), CHORUS (ON/OFF).
- FOOT SWITCH Jacks CHORUS, REVERB, OVERDRIVE (\*).
- CHORUS/REVERB OUT Jack 0 dBm/10kΩ or less
- PRE-OUT Jack 0 dBm/10kΩ or less
- MAIN-IN Jack 0 dBm/100kΩ
- PHONES Jack Load Impedance 8 Ω or more
- EXT. SPEAKER Jack Load Impedance 8 Ω or more
- Power Consumption 160VA (CH-60), 98VA (CH-40)
- Dimensions 375(W) x 435(H) x 238(D) mm  
14-3/4 x 17-1/8 x 9-3/8 in. (CH-60)  
319(W) x 376(H) x 208(D) mm  
12-5/8 x 14-4/4 x 8-1/4 in. (CH-40)
- Weight 12.5 kg/27 lb. 9 oz. (CH-60)  
10.5 kg/23 lb. 2 oz. (CH-40)

Roland®

11279

UPC 11279



1898